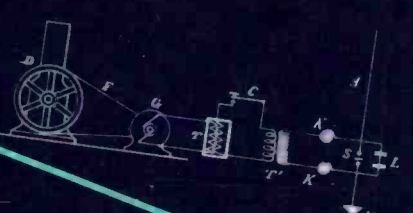


# RCA Engineer

Vol. 30 No. 4 July/Aug 1985

UNITED STATES PATENT OFFICE.  
L. DE FOREST, OF NEW YORK, N. Y.  
WIRELESS TELEGRAPHY.  
Patented January 19, 1904.

No. 746,435  
L. DE FOREST.  
GENERATING SET FOR WIRELESS TELEGRAPHY.  
Patented JAN. 12, 1904.  
APPLICATION FILED JUNE 19, 1902.

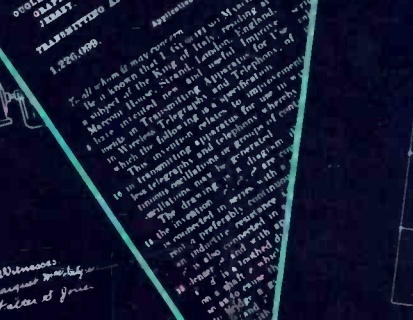


UNITED STATES PATENT OFFICE.  
E. R. JOHNSON, OF PHILADELPHIA, PENNSYLVANIA, ASSIGNOR TO THE WESTINGHOUSE TELEGRAPH COMPANY OF AMERICA, A CORPORATION OF NEW JERSEY.  
MEANS FOR RECEIVING ELECTRICAL OSCILLATIONS.  
Patented July 17, 1904.

L. I. BUTCHER.  
MEANS FOR RECEIVING ELECTRICAL OSCILLATIONS.  
Patented July 17, 1904.

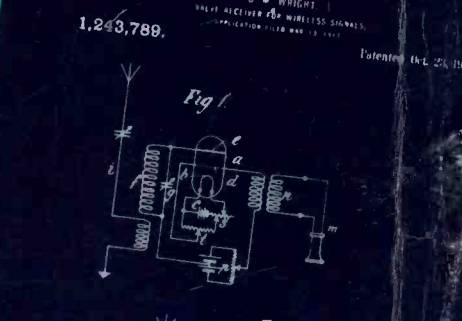


UNITED STATES PATENT OFFICE.  
CLIFFORD D. BARCOCK, OF NEW YORK, N. Y., ASSIGNOR TO THE WESTINGHOUSE TELEGRAPH COMPANY OF AMERICA, A CORPORATION OF NEW YORK, N. Y.  
TRANSMITTING APPARATUS FOR USE IN WIRELESS TELEGRAPHY.  
Patented Dec. 21, 1904.

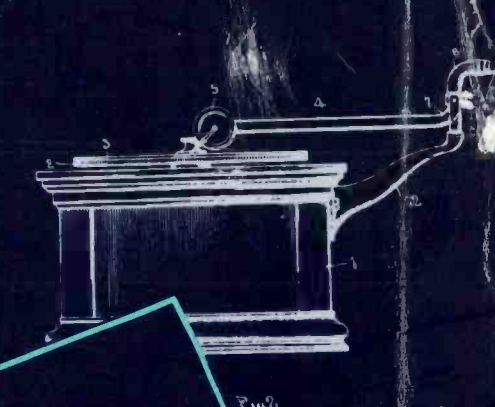


It is known that in the use of wireless telegraphy, the signals transmitted are subject to variations and distortions, and it is desirable to provide means for receiving such signals in a clear and undistorted form. In my various patents, I have described means for receiving such signals, and in this patent, I describe a further improvement in such means.

## 30th Anniversary Issue



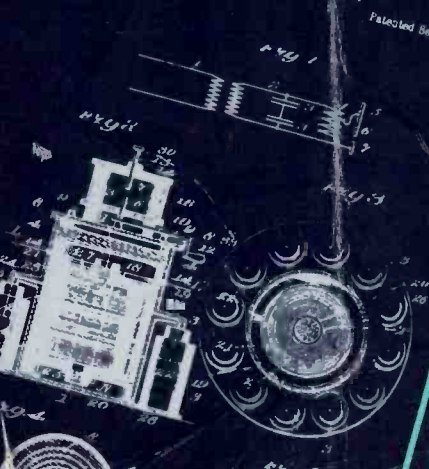
E. R. JOHNSON.  
SOUND CONVERTING TUBE FOR TALKING MACHINES.  
Patented Aug. 26, 1903.



UNITED STATES PATENT OFFICE.  
CLIFFORD D. BARCOCK, OF NEW YORK, N. Y., ASSIGNOR TO THE WESTINGHOUSE TELEGRAPH COMPANY OF AMERICA, A CORPORATION OF NEW YORK, N. Y.  
WIRELESS TELEGRAPHY.  
Patented Dec. 21, 1904.



C. D. BARCOCK.  
WIRELESS TELEGRAPHS TRANSMITTERS.  
Patented Sept. 21, 1904.



# RCA Engineer

A technical journal published by the  
RCA Technical Excellence Center □ 13 Roszel Road □ P. O. Box 432 □ Princeton, NJ 08540-0432 □ Tacnet: 226-3090

## RCA Engineer Staff

**Tom King** Editor

**Mike Lynch** Associate Editor

**Louise Carr** Art Editor

**Maria Pragliola** Secretary

## Editorial Advisory Board

**Tony Bianculli** Manager, Engineering Information, Technical Excellence Center □ **Jay Brandinger** Staff Vice-President, Systems Engineering, RCA Laboratories □ **Jim Carnes** Division Vice-President, Engineering, Consumer Electronics Division □ **John Christopher** Vice-President, Technical Operations, RCA Americom □ **Jim Feller** Division Vice-President, Engineering,

Government Systems Division □ **Mahlon Fisher** Division Vice-President, Engineering, Video Component & Display Division □ **Larry Gallace** Division Vice-President, Product Assurance and Environmental Engineering, Solid State Division □ **Arch Luther** Senior Staff Scientist, RCA Laboratories □ **Howie Rosenthal** Staff Vice-President, Engineering □ **Bill Underwood** Director, Technical Excellence Center □ **Bill Webster** Vice-President, RCA Laboratories

## Consulting Editors

**Ed Burke** Administrator, Marketing Information and Communications, Government Systems Division □ **Walt Dennen** Manager, Naval Systems Department Communications and Information, Missile and Surface Radar □ **John Phillips** Director, Business Development, RCA Service Company



As our cover shows, this issue marks the 30th anniversary of the *RCA Engineer*. Thirty years of documenting, and contributing to, RCA history. However, as a corporation RCA has a much longer history. The Radio Corporation of America was formed on October 17, 1919, but its origins go back even further. Patents of the late 19th and early 20th centuries provided the basis for the new corporation's first products. Look closely at the montage of patent documents on the cover. All of them predate RCA, and some of them bear the names of famous people.

Like the cover, the inside of this issue is also a montage. We honor the 1985 winners of the David Sarnoff Award for Outstanding Technical Achievement, and we provide a listing of all winners since 1958. We urge you to look over these past citations.

There is a special pull-out reprint of *RCA—A historical perspective, Part 7—The years 1977-1984*. And there are articles by authors representing six different business units on subjects as diverse as weather satellites and the Dimensia system.

## Cover design by RCA Engineer Staff

The patent documents on the cover, and some very helpful historical information, are courtesy of **George Haas**, Patent Operations, DSRC, Princeton, N.J.

□ To disseminate to RCA engineers technical information of professional value □ To publish in an appropriate manner important technical developments at RCA, and the role of the engineer □ To serve as a medium of interchange of technical information among various groups at RCA □ To create a community of engineering interest within the company by stressing the interrelated nature of all contributions □ To help publicize engineering achievements in a manner that will promote the interests and reputation of RCA in the engineering field □ To provide a convenient means by which the RCA engineer may review professional work before associates and engineering management □ To announce outstanding and unusual achievements of RCA engineers in a manner most likely to enhance their prestige and professional status.

---

## A sense of who we are

Over the past 30 years, the *RCA Engineer* has established a clear path for the exchange of technical ideas among the diverse groups of the corporation. Within its charter, the magazine disseminates information of professional value, reports important technical developments, and seeks to create a community of engineering interests within RCA.

Perhaps just as important as these functions, the *RCA Engineer* introduces you to people with specific skills. Remember these people for future reference. Better yet, call or visit them if you have an interest in

their fields (the amount of knowledge written is only a small part of that to be gained).

Many of RCA's products during the last half of the decade will depend on a cross-fertilization of disciplines, requiring the collaboration and cooperation of engineers in several of our businesses. I am confident that the *RCA Engineer* will continue to keep us aware of the many resources upon which we may draw.

*Howard Rosenthal*



*Howard Rosenthal*  
Staff Vice President  
Engineering  
RCA Laboratories



**in this issue . . .**  
**the David Sarnoff Awards**

■ **RCA's highest honor for outstanding technical achievement, the David Sarnoff Awards, were first announced at a dinner at the Waldorf-Astoria, New York, on September 30, 1956.**

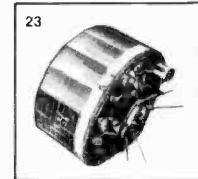


■ **Manna:** "TIROS has steadily progressed through four generations of design, with each generation of satellites having more capabilities than its predecessors."

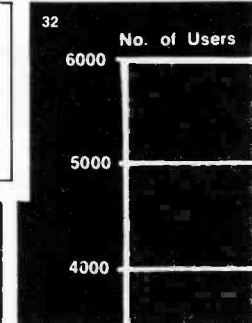
■ **Handman:** "The EC<sup>3</sup> has been able to simultaneously support a wide mix of job sizes with effective turnaround."

■ **Dreher:** "The number of computer information centers has grown dramatically in the last four years; approximately 80 percent of the Fortune 500 companies now have at least one."

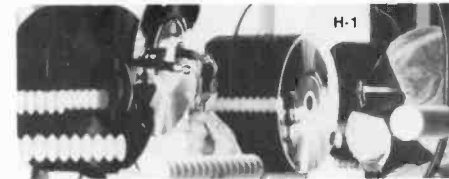
■ **Bauer/Bronecke/Kolc/Schelhorn:** "Surface mounting technology is permitting reductions in circuit module size, weight, and cost by improving packaging density."



29 IBM 3083J  
 PROCESSOR  
 16MB  
 16 CHANNELS 3MBps  
 8-13 MIPS



■ **Webster:** "Of the many events that involved RCA in the challenging years 1977-1984, the most crucial was the watershed decision made in 1981 by top management to focus on those business areas offering the greatest potential for growth—electronics, communications, and entertainment."



■ **Gurley:** "While no practical television system can simultaneously provide both effects optimally, a CCD camera equipped with a fast shutter does provide sharp images in slow motion and unequalled stop-action clarity."



■ **Hemschoot/Weir:** "The Trident Integrated Radio Room (IRR), designed and manufactured by RCA, introduced communications automation into the US fleet."



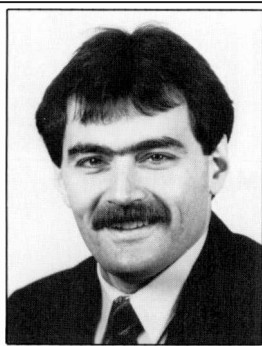
■ **Pitsch:** "Uniform formats were established for command control and status reporting to allow maximum utility with future Dimensia components."



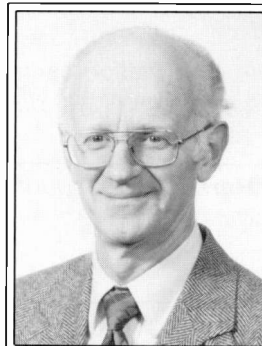
**in future issues . . .**  
 computer graphics  
 mechanical engineering

# The 1985 David Sarnoff Awards for Outstanding Technical Achievement

**CITATION:** For the design, development and space qualification of the first commercial cooled low-noise microwave amplifier.



**George R. Busacca**  
Member, Technical Staff  
RCA Astro-Electronics



**Robert E. Askew**  
Member, Technical Staff  
RCA Laboratories

## ACHIEVEMENT

The individuals cited for the award conceived and implemented the design of a thermoelectrically-cooled low-noise amplifier (CLNA). The concept of thermoelectrically cooling a low-noise amplifier to achieve greatly improved low-noise performance was developed and implemented in a demonstration unit. The device was brought to commercial reality on a crash program to replace a parametric amplifier design that was not meeting performance specification requirements. This effort resulted in a space-qualified amplifier, currently being manufactured at Astro-Electronics, that provides 2-dB noise figure at 14 GHz and will be flown in the RCA Satcom K communication satellite. The CLNA represents a major engineering advancement in the achievement of a low-noise figure that was previously only obtainable from a parametric amplifier. The CLNA, due to the simplicity of its design, offers low noise performance with improved reliability and operational stability. Cost of the CLNA is one-tenth that of a parametric amplifier. Four CLNAs are used aboard each satellite, hence the economy of design and manufacture results in considerable overall cost savings and reduces RCA's dependence on external sources.

The CLNA design effort includes a series of technical achievements:

1. Characterization of microwave FET transistors for optimum low-noise performance at 14 to 14.5 GHz. The design of the FET amplifiers was computer-aided to achieve the low-

est noise figure and flat frequency response across the 14- to 14.5-GHZ communication band. This amplifier (not cooled) was also incorporated into the G-STAR series of satellites performing, within a 1/2-dB noise figure of a parametric amplifier, with far greater reliability and lower cost.

2. Innovative techniques for development of a plastic waveguide that thermally isolates the cooled amplifier from the input and output environment at a temperature 80 degrees warmer than the amplifier. This special waveguide has a thin silver coating to provide low-loss operation at microwave frequencies, and yet is thin enough to prevent thermal conduction of heat into the amplifier from the mating spacecraft waveguides.
3. Characterization of cooling requirements and specification of the thermoelectric Peltier Junction device to cool the amplifier. A special flexible strap made of multilayer silver foil was designed to connect the amplifier to the cooler, thus minimizing mechanical stresses on the cooler.
4. Coordination of the various design activities to produce a manufacturable product that is now being assembled and tested for RCA Satcom K spacecraft. The CLNA was designed for operation in a space environment with little or no past experience to draw upon, and achieved a producible design on schedule.

## BUSINESS IMPLICATIONS

The investment in the development of the CLNA has permitted RCA to be the first commercial communication satellite manufacturer to offer a space-qualified CLNA on its transponders. The use of the CLNA provides improved transponder G/T performance, which permits the use of smaller antennas on the

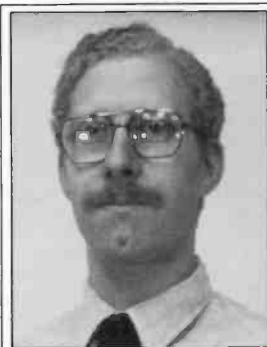
ground to transmit to the satellite. The more reliable CLNA provides the same low-noise performance as a parametric amplifier at a much lower cost and with greatly enhanced reliability, thus making RCA more cost-competitive in the manufacture of communications satellites.

## INDIVIDUAL CONTRIBUTIONS

**George R. Busacca** was project engineer, and was responsible for the electrical design and the coordination of the mechanical and thermal designs of the CLNA.

**Robert E. Askew** was responsible for the initial design concept, early developmental models, and transfers of the thermoelectrically-cooled design from RCA Laboratories to RCA Astro-Electronics.

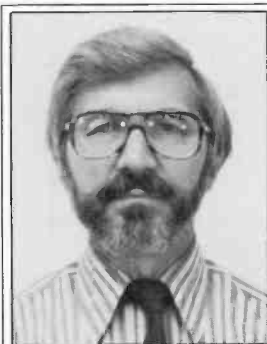
**CITATION: For an automatic purity and convergence alignment system for color television receivers.**



**Martin J. Herskowitz,**  
Member, Engineering Staff  
Consumer Electronics  
Division



**David P. McCorkle**  
Manager, Advanced  
Electronic Systems  
Consumer Electronics  
Division



**George J. Moore**  
Member, Engineering Staff  
Consumer Electronics  
Division

## ACHIEVEMENT

This team award is based on successful development and implementation of the Convergence and Purity Adjustment System (CAPAS) for color television yokes and kinescope alignment. This accomplishment ranks as an achievement in television manufacture because of its technical merit and its significant cost savings.

The convergence and purity adjustments are the "cornerstone" of television instrument setup. They are the most precise and difficult adjustments, requiring very accurate mechanical and electrical systems. The television manufacturing industry has attempted to automate this function prior to CAPAS, but without notable success. Previous attempts have included

expensive sensor cameras and digital conversion systems, but the noisy instrument assembly environment made considerable bandwidth filtering necessary, and the resulting performance was too slow to support line running rates. The feedback systems also lacked the sophistication required to make the total approach feasible.

CAPAS solved all these problems. It is fast, accurate, and has a very cost-effective measurement system. The speed exceeds that of a manual operator and competing systems, yet it has achieved an accuracy improvement of 3 to 1. A differential diode measurement system is the heart of the equipment and allows it to be very cost effective. It replaces the TV camera and digital scan converter required in some other systems.

CAPAS is the fundamental tool required to automate TV instrument alignment. All other adjustments and/or functions are a straightforward application of engineering principles. The system will pave the way for the evolution of a technology that

is expected to lead to the entire automation of instrument test and alignment.

The computer control of the CAPAS system is complex and sophisticated. The feedback is accomplished through the computer, which controls stepping motors and beam magnetizers. The computer measures convergence and purity from pattern recognition on the face of the kinescope. The position of the signal source relative to kinescope edge is also under computer control.

At the end of 1983, there were several systems installed in Bloomington and Prescott. The systems have operated beyond expectation and have withstood the "test" of being in a manufacturing environment with highly variable yoke-tube combinations. These systems are the sole method used for center purity and convergence on the color TV assembly lines. Additional systems have been constructed and implemented.

## BUSINESS IMPLICATIONS

The CAPAS development is a basic building block to television instrument automation. It also provides increased setup accuracy and significant cost reductions over previous methods. The television product is more uniform and should provide for greater customer satisfaction.

Monitor products are now a fast growing segment of the color TV business. These new products feature higher resolution and make manual yoke adjustment economically undesirable. Other new products that require CAPAS include the new 110-degree kinescope-and-yoke combinations scheduled to become a larger portion of color production. CAPAS speed and accuracy are absolutely required.

Today, the ColorTrak 2000 product line is set up using

CAPAS equipment. This product contains a 110-degree yoke/tube combination and features the highest picture quality. The accuracy and uniformity of the CAPAS setup is required, and the program would be jeopardized without it.

The capital investment analysis for these systems shows a two-year payback. There is the potential for additional direct labor savings when the CAPAS engagement equipment is installed.

The previous manual system used for purity and convergence setup required operator judgment. This permitted a variation to exist, and occasional operator errors allowed misaligned product to "escape." The TV instrument as measured at final inspection is more uniform since using CAPAS.

## INDIVIDUAL CONTRIBUTIONS

**Martin J. Herskowitz** was instrumental in the development of the computer hardware and software. Neither of these were straightforward tasks, and particularly not the software development. Very detailed code was required to achieve desired control of a complex system. The feedback paths were closed through the computer, and alignment time was of the utmost importance. Computer overhead was minimized. His creativity led to the successful completion of the computer portion of this project.

**David P. McCorkle** contributed uniquely to this project through his expert development of analog circuits. This included interface and amplification of sensor diodes; a digitally-controlled cross-hatch generator; and a programmable high-current pulse generator for beam bender magnetization. He is

also noted for his understanding of color TV adjustment and his skillful coordination of a project involving electrical, mechanical, and software engineering. His responsibilities also included system design, documentation, and field training on system use.

**George J. Moore** is recognized for his design of the mechanical systems. Specifically, this was an intricate mechanical manipulator using a stepping motor that adjusts a yoke on the neck of the kinescope with high accuracy and virtually no backlash or drift. He also designed the clamshell that houses the magnetizing coils used to magnetize the tape beam bender. A rugged and easy-to-operate mechanism was required and developed. He demonstrated creativity in his designs and is noted for his ability to deliver a mechanical system with a minimum of development cycles.



**CITATION: For the conception, design, and implementation of Narrowband Speech Terminals.**



*Left to right: Gordon, Barger, Meeker, Richards, Ozga, Nelson, Moyer.*

**Jerry R. Richards**

Manager, Microelectronics Laboratories  
Advanced Technology Laboratories  
Aerospace and Defense

**Stanley E. Ozga**

Manager, Signal Processor  
and Computer Systems Section  
Missile and Surface Radar Division  
Aerospace and Defense

**Willard F. Meeker**

Principal Member, Technical Staff (Retired)  
Advanced Technology Laboratories  
Aerospace and Defense

**Robert B. Gordon**

Unit Manager, Engineering Staff  
Design Engineering  
Government Communications Systems Division  
Aerospace and Defense

**Richard H. Moyer**

Senior Member, Engineering Staff  
Microelectronics Laboratories  
Advanced Technology Laboratories  
Aerospace and Defense

**James R. Barger**

Senior Member, Engineering Staff  
Microelectronics Laboratories  
Advanced Technology Laboratories  
Aerospace and Defense

**Allan L. Nelson**

Senior Member, Engineering Staff  
Microelectronics Laboratories  
Advanced Technology Laboratories  
Aerospace and Defense

## ACHIEVEMENT

Over the past few years many people have contributed to the success of the narrowband voice terminal development project. The effort identified in this nomination is focused on the early hardware, software, and LSI developments that led to the opportunity for the Government Communications Systems Division to design and build the secure mobile units. The project began with a study in 1975 to develop an approach to fabricate a low-power, small-size voice terminal that would allow secure voice communication over a standard telephone network. The effort ended in 1983 with the successful demonstration of the hardware and software that verified the concepts developed in the earlier study.

At the present time a program is in place to transfer the technology from ATL to the COMSEC group in GCS. The development of the CMOS/SOS technology and the availability of the tools to develop LSI chips were significant factors in the success of the program. The achievements in the early phases of the effort have led to the award of more than \$20 million sole-source for the final development and fabrication of the secure mobile unit. Furthermore, the early efforts led to the opportunity for RCA to participate in the Future Secure Voice System (FSVS), a program that is expected to grow to more than \$100 million during the next 3 to 5 years and will include the manufacture of at least 25,000 secure terminals.

The objective of the narrowband terminal development was to demonstrate the feasibility of developing a low-power (20-watt), small-size (300-cu. in.) terminal capable of transmitting speech at 2,400 bits per second over standard telephone lines. ATL bid against several large companies for the development of the terminal. ATL's approach was to build a special-purpose, low-power, high-speed microprocessor as the heart of the system to implement all of the required software. The government chose not to fund the proposal, believing it to be too aggressive, and government representatives were skeptical that a microprocessor could be developed with the speed and power to meet the application requirements. ATL, however, was convinced that with the CMOS/SOS technology such a processor could and should be built, not only to capture future terminal business, but to demonstrate the capability of the technology. Paul Wright, who was director of ATL at the time, approved the development of the microprocessor and the hardware to demonstrate portions of a narrowband terminal.

A linear predictive coding (LPC) algorithm was developed to digitize speech to 2,400 bits/second. The algorithm was completely implemented on the four-chip Advanced Technology Microelectronic Array Computer (ATMAC). A portion of the effort to build the hardware was funded by DARPA through Ft. Monmouth. The government, after seeing the dem-

onstration of the hardware, placed ATL under contract to start the development of a low-power, portable, narrowband terminal. The government's ongoing developments were going to produce terminals that were projected to be more than 1,000 cubic inches in size and would consume between 150 and 200 watts of power, and RCA had committed to 300 cubic inches and 20 watts. The technology clearly provided the means to achieve the goals.

The performance of the ATMAC microprocessor was such that it could perform both the speech processing algorithm and a 2,400 bit/second modem algorithm, eliminating the need for a second processor in the system. The software development for the speech processor, modem, and scrambler required that a demonstration model be developed for debugging and demonstrating the real-time signal processing software. The demonstration model also provided a test bed for the additional large-scale integration (LSI) that had to be built for the system. This LSI consisted of a 16×16 multiplier (four chips) and a 32-bit accumulator (two chips).

This hardware was used to demonstrate that the LSI chips were fully functional and that all the speech, modem, and scrambler software could be implemented in real time on the 10-chip processor assembly. The successful demonstration of the hardware and software led to a subsequent contract for an advanced development model of the narrowband terminal.

For this equipment the ten LSI chips were packaged in leadless carriers and mounted on a ceramic circuit board in order to reduce the space and meet the goal of packaging the unit within 300 cubic inches. This approach was chosen because the Moorestown hybrid shop was just starting the development of ceramic circuit boards and the processor assembly was the largest and the first double-sided assembly built. The remaining circuitry on the first board is the RAM and ROM for the processor assembly. The second of the three boards contained the remainder of the digital logic for the unit, and the third board contained the required analog circuitry. A total of ten units were built and tested over a variety of phone connections and found to operate successfully over even the poorest quality phone lines. The units were then tested with Motorola radios in a mobile network, and again all tests were highly successful. The units demonstrated for the first time the feasibility of producing a terminal small enough for application in a portable or mobile environment.

## INDIVIDUAL CONTRIBUTIONS

**Jerry R. Richards**, Program Manager for the Narrowband Speech Terminal Development Project, has had management responsibility for all of the IR&D and contracts leading to the delivery of the advanced development models. Throughout his career, first at Philco and then at RCA, he has been associated with pattern recognition and signal processing as applied to

image and speech processing applications. Since joining RCA in 1971, Mr. Richards has led ATL in the areas of speech recognition, speaker identification, and speech bandwidth compression developments.

This experience provided the background for expanding the speech bandwidth compression work into linear predictive

coding and modem processing. His insights into the technology made it possible to address the government's requirements with early accomplishments in algorithm developments and system simulation and evaluation. As Program Manager he was a key technical contributor from concept studies through to the completion of the advanced development models.

Mr. Richards has provided overall management for the narrowband terminal development and the subsequent technology development contracts within the Microelectronics Laboratory. He brought to the project an understanding of the government's requirements and the technical issues, as well as the management skills to build and lead a team to successful terminal development.

**Stanley E. Ozga** was the principal computer architect, detail designer, and project engineer of the ATMAC microprocessor, the heart of the narrowband speech processing terminal. He conceived the microprocessor architecture, developed the instruction set, performed the digital logic design and simulation, and directed the layouts of the CMOS/SOS VLSI arrays in the ATMAC microprocessor. The novel computer architecture features of the ATMAC coupled with its CMOS/SOS VLSI implementation provided RCA with a highly competitive approach for the low-power, narrowband speech terminal business area.

Mr. Ozga analyzed the processing requirements of the linear predictive coding (LPC-10) algorithm and the main processing function in the narrowband speech terminals, and evolved the ATMAC microprocessor. Numerous program mable parallel computing structures and a modular design provided a practical VLSI implementation that proved to be optimal for this class of application. Also, he was a key contributor in the development of the hardware architecture that is the basis for the narrowband speech terminals being produced by RCA today.

Mr. Ozga's efforts in the ATMAC microprocessor development were the basis for two issued patents.

**Willard F. Meeker** was responsible for the speech processing software for all equipment. Prior to the development of the narrowband equipment, he programmed simulations of linear predictive coding (LPC) speech systems on the Lockheed MAC16 laboratory computer. He wrote diagnostic and test programs for the first breadboard speech processor that used the first samples of the ATMAC processor, and he assisted in debugging the hardware for that system.

He collaborated in the system design of the demonstration equipment and programmed the entire LPC-10 speech processing algorithm for the ATMAC processor, meeting stringent run-time requirements. He collaborated in writing software for the high-frequency modem and incorporated a compact version of a Fast Fourier Transform for improved accuracy and execution time.

**Robert B. Gordon** was responsible for the complete mechanical design of the demonstration model, advanced development

model, and the associated equipment. This work encompassed conceiving the packaging approach, working interactively with the electrical hardware design engineers to define the system partitioning, generating detail drawings for chassis and custom component circuit board fabrication, and ordering parts used in the assemblies. It also included conceiving the thick film circuit approach and configuration used to mount and interconnect the ten LSI devices in the ATMAC microprocessor, multiplier, and accumulator assembly. Mr. Gordon further provided direction during the assembly, wiring, and testing phases of the program.

**Richard H. Moyer** was responsible for the development of the modem and terminal signaling functions of the narrowband speech equipment demonstration models. He implemented the 2400-bit/second wireline modem algorithm in real time on the ATMAC microprocessor embedded in the demonstration models. He coded the Doppler frequency offset correction algorithm for real-time operation of a high-frequency modem. He also developed and implemented a Doppler frequency offset tracking algorithm and the algorithms to maintain synchronization on fading signals in the mobile environment for both the wireline and high-frequency modem. Mr. Moyer also developed many software tools required for use in the ATMAC software development systems.

**James R. Barger** made significant contributions to the design and development of the hardware associated with the narrowband speech terminal development. In the early phases of the project he developed the analog and digital logic that operated in conjunction with the ATMAC microprocessor. For the demonstration and advanced development models he had the major responsibility for the design fabrication, testing, and demonstration of all equipment associated with the project.

**Allan L. Nelson** was a member of the team that initiated ATL's work in LPC and software modems. He contributed to the development of LPC and modem software for the MAC-16 minicomputer. He also designed and developed the real-time speech and modem I/O facilities for the minicomputer, and he designed the system software that was used with the LPC and modem programs.

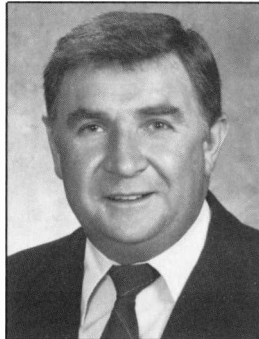
After the ATMAC microprocessor became available, Mr. Nelson participated in the development of the ATMAC breadboard system that was designed for LPC and modem development. He was in charge of system integration and contributed to the development of ATMAC software for LPC. He developed a 16-tone, high-frequency modem and diagnostic software, and contributed to the design and development of an interface to a minicomputer that was used in the debugging of the breadboard system. Mr. Nelson participated in the integration of the speech and modem system on the narrowband equipment, and he supervised the development of the ATMAC/multiplier hybrid that was used in these units.



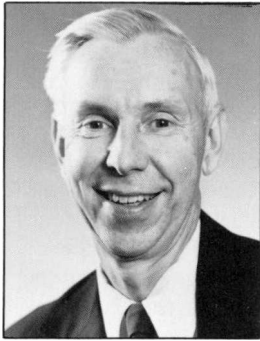
**CITATION: For the development of the CMOS product line, a new family of high-speed CMOS logic circuits.**



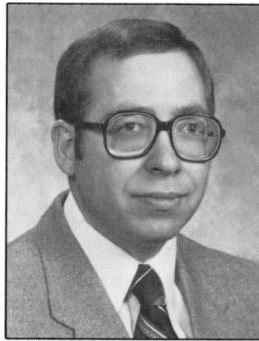
**Kenneth W. Brizel**  
 Manager,  
 Logic Engineering  
 RCA Solid State Division



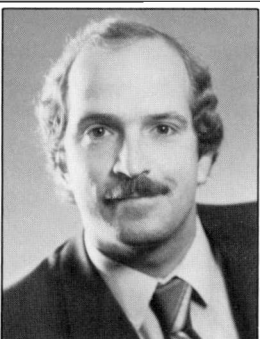
**Frank Dezura**  
 Section Manager,  
 Manufacturing Engineering  
 RCA Solid State Division



**Richard E. Funk**  
 Manager, Applications,  
 Standard IC Products  
 RCA Solid State Division



**Barry A. Goldsmith**  
 Section Manager,  
 Process Development  
 RCA Solid State Division



**Brian J. Petryna**  
 Section Manager,  
 Logic Design  
 RCA Solid State Division

**ACHIEVEMENT**

This award is for the successful development of a family of high-speed logic CMOS integrated circuits. A team effort consisting of Design, Engineering, Product Engineering, Applications Engineering, Process Development Engineering, and Manufacturing Engineering was responsible for this development, which resulted in a product line superior to the low-power Schottky TTL lines offered by other companies.

CMOS integrated circuits, which were pioneered by RCA, have always been known for their low power consumption,

and hence have been designed into equipment where power savings are important. Their relatively slow speed compared to LSTTL circuits, however, has precluded their use in computers and other high-speed applications. With the development of the oxide-isolated, 3-micron, self-aligned silicon gate technology the design and fabrication of devices compatible with LSTTL speeds and with the low power consumption of CMOS became feasible.

After a period of market research, a full line of logic devi-

ces was defined. Two versions of each device were to be marketed, one a pin-for-pin direct parametric replacement for existing LSTTL parts and one compatible with the logic levels of CMOS, both to run at LSTTL speeds. In order to achieve this end, a proprietary circuit was developed that allows both versions to be made with only a change at the metal definition photolithographic process, thus minimizing design and mask fabrication effort. A patent was issued covering RCA in proprietary low-power QMOS HCT input design.

The development of the high-speed CMOS (QMOS) product line required significant contribution in several areas:

- The design of space-effective devices and circuits to maximize device performance with minimum silicon die size.
- The accurate characterization of devices to provide a basis for data sheets and redesign to resolve specific issues.

## BUSINESS IMPLICATIONS

In April 1983, RCA introduced the QMOS Product Family. Jointly developed with Philips/Signetics, QMOS represents an evolutionary step beyond RCA's "4000" CMOS logic line in both performance and reliability.

QMOS is divided into two families, HCT and HC, based on the long levels of devices with which it interfaces. HCT is targeted at current low-power Schottky (LSTTL) applications valued at approximately \$1.3 billion per year, while HC is focused on high-speed CMOS applications estimated at nearly \$3 billion per year.

Starting with 23 types at introduction in 1983, the QMOS product line had grown to 181 types by January 1985. The QMOS family will include 274 device types by late 1985. QMOS revenues for 1984 were \$11 million. The Strategic Plan estimates that revenues will exceed \$200 million annually by 1990.

The business implications of the development of QMOS directly affect RCA's revenue potential, but equally important, they affect the future position of RCA in CMOS logic. The cur-

- The establishment of a state-of-the-art manufacturing process in the Findlay, Ohio facility.
- Bringing the manufacturing wafer process to full production in minimum time while maintaining control of yields and cycle time.
- Introduction of the QMOS product line to customers through seminars, data sheets, application notes, and leadership in the establishment of an industry JEDEC standard to facilitate customer designs and LSTTL replacements.

The outcome of this work was a major new product line for RCA incorporating state-of-the-art manufacturing processes, and having switching speeds comparable to LSTTL parts while maintaining the low power consumption characteristics of CMOS integrated circuits.

rent CD4000 series is a mature product line and its use in high-growth end markets such as telecommunications and computers is limited. QMOS allows RCA to address new and larger markets that were previously open to LSTTL because of its speed. Without QMOS, RCA would have been excluded from participation in designs of current and future systems requiring high speed, low power, and high reliability.

The same Solid State Division team that developed QMOS is now developing the AQMOS product line, which is competitive at FAST/AS logic speeds, and which will keep RCA in the forefront of CMOS logic technology. Six to ten AQMOS types are expected by late 1985.

The breadth and performance of the QMOS family place the RCA Solid State Division in a leadership position among the industry's largest competitors: Texas Instruments, National Semiconductor, Motorola, and Hitachi. This leadership position was made possible through the dedication and commitment of the implementation-team members.

## INDIVIDUAL CONTRIBUTIONS

**Kenneth W. Brizel** was responsible for the device and circuit designs, layouts, and prototype evaluation of the QMOS integrated circuits. Specific technical contributions included the introduction of sophisticated computer-aided design tools and development of space saving transistor structures and circuits. He was also responsible for the design and implementation of the wafer acceptance test key that provides basic device and process information for process control and the generation of simulation parameters for future designs.

**Frank Dezura** was responsible for bringing the QMOS wafer process into full production in the Findlay, Ohio factory. This was accomplished in less than half the planned startup time while maintaining full control of the wafer process, wafer yields, and production cycle time. Specific contributions included staffing and training a three-shift technical team to provide 24-hour manufacturing capability, providing effective

interface with equipment representatives to maximize equipment performance and uptime, and implementing process improvements and controls that resulted in achieving planned yields three months ahead of schedule.

**Richard E. Funk** was responsible for specifying the device characteristics to assure competitiveness with LSTTL circuits. He was also instrumental in introducing the product line to RCA customers through seminars and the writing of Application Notes. He is chairman of the JEDEC Committee that was responsible for the standardization of QMOS specifications.

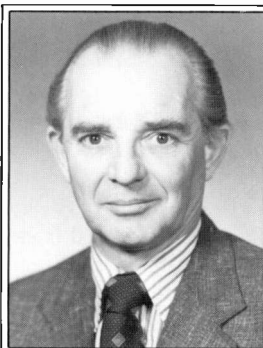
**Barry A. Goldsmith** was responsible for establishing a state-of-the-art silicon gate process in the Findlay facility for the manufacture of QMOS integrated circuits. By interfacing with other RCA facilities he defined a process that incorporated all of the

latest processing techniques. By performing as Technology Coordinator he molded these techniques into a high-yield state-of-the-art process. During production startup he supported manufacturing in establishing process limits, debugging equipment, yield analysis, and the training of sustaining engineering personnel.

**Brian J. Petryna** was responsible for the characterization of all the high-speed CMOS devices. He provided the Design Group

with the feedback necessary for design changes to improve latch-up susceptibility, voltage spiking, and other electrical characteristics. He was also responsible for establishing a coherent set of manufacturing electrical specifications that guaranteed published data for all QMOS types.

**CITATION: For numerous contributions to consumer electronics and broadcast systems including the definition of a standard for multichannel sound for television.**



**James J. Gibson**  
Fellow, Technical staff  
RCA Laboratories

## ACHIEVEMENT

The following achievement, although very significant, is just one of many contributions that James J. Gibson has made in the areas of consumer electronics systems and broadcast systems during his career at RCA Laboratories. This award is in recognition of all those contributions.

In June 1984 the FCC passed a ruling that allowed broadcast of multichannel television sound. Although the ruling does allow multiple standards, it protects the signal standard selected and recommended by the Electronic Industries Association Broadcast Television Systems Committee. This event allowed manufacturers and broadcasters to concentrate on a single standard for Multichannel TV Sound (MTS), and a new service was started.

Broadcasters and manufacturers recognized very early that a single standard was required to make the MTS service successful. Many proposals were put forward, and an industry wide committee was formed to select a single standard. This committee, the Electronic Industries Association Broadcast Television Systems Committee, had to select the single standard on technical grounds that were above reproach. The key person on this task was James J. Gibson.

Dr. Gibson was the main contributor and the leader of the technical team that studied the theory of operation and performed tests on the various proposed systems. In the course of this work, he studied the theoretical quality of the system, analyzed sources of interference, including intermodulation among the new and existing carriers, pickup from the receiver horizontal sweep and its harmonics, and various nonlinearities in the implementation of practical receiver circuits. He also analyzed

compression-expansion systems for noise reduction and created a package of computer programs that calculates gain/phase relationships for single and multitone signals, determines stereo separation, and evaluates the effects of errors in the system transfer function.

When it became clear that specific technical measurements were needed for the various proposed systems, Dr. Gibson played a key role in setting up the official test center and supervising the tests.

The results of the task force were published as "Multichannel Television Sound—The Basis for Selection of a Single Standard," which now serves as the industry reference on MTS. Dr. Gibson contributed to all parts of this document and was responsible for the entire contents of several key sections.

During the time of the committee voting, Dr. Gibson was very instrumental in giving information to the various voting entities. In the end, the system most favored by RCA was selected as the industry choice.

A wisely chosen multichannel TV sound system is essential to both Consumer Electronics Division and NBC. The chosen system is one that can be added to a home TV receiver at modest cost, and the cost in the broadcasting station is affordable. With the new capability in place, new services can be added with anticipated increase in viewers and in the purchase of new TV receivers. Due to the intimate knowledge of the standards committee work, Consumer Electronics Division was able to do the required ground work early, and TV models with MTS were introduced in 1984. NBC broadcast a limited number of stereo programs in 1984, and in 1985 the MTS cap-

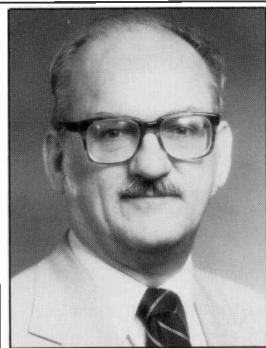
ability will be spread throughout the network.

Dr. Gibson has continued working on MTS. He has made improvements in the standards through his committee work

and in the circuits in RCA receivers. He also contributed to the design of transmission equipment, since none was commercially available; some of his designs are in use by NBC.



## CITATION: For establishing new dimensions in radar antenna technology.



**Willard T. Patton**  
Manager, Antenna,  
Microwave and Transmitter  
Systems  
Missile and Surface Radar  
Division  
Aerospace and Defense

## ACHIEVEMENT

RCA is widely acknowledged as a world leader in military microwave/antenna technology. This well-deserved position, in large part, is directly attributable to the innovative concepts and practical implementations of one man—**Willard T. Patton**. Dr. Patton's preeminence in the field of phased array technology has been recognized for more than 20 years; in 1979 his peers honored his accomplishments in the field by electing him to the grade of Fellow of the IEEE "for contributions to the development of phased-array technology."

Although all the contributions leading to his election as a Fellow were noteworthy, clearly the crowning achievement was his conceptual and developmental work on the U.S. Navy's AN/SPY-1 radar antenna. This phased-array sensor has literally set new standards in all areas of performance for multifunction tactical radars. Dr. Patton's contributions were spelled out in a 1975 David Sarnoff Team Award for Outstanding Technical Achievement in which he was cited for his initial conception of the AN/SPY-1 antenna "virtually in its final form," and for his direction of the engineering team that developed it.

The extraordinary success of the AN/SPY-1 radar in the *USS Norton Sound* led to production of the AN/SPY-1A as the heart of the AEGIS Weapon System being produced for the first 12 *Ticonderoga*-class guided-missile cruisers. The performance of the radar, in many parameters, is paced by the performance of the antenna. In every phase of operation the AN/SPY-1A has set performance records that were unimagined in the early 1970s.

This record of accomplishment makes Dr. Patton's more recent contributions even more extraordinary—designing a new phased-array antenna with an order of magnitude improvement in performance over the AN/SPY-1A. This new design, designated AN/SPY-1B, provides the unprecedented low sidelobe levels required for full performance in a high clutter/counter-

measures environment. Designed and tested as an engineering development model(EDM-4), the AN/SPY-1B was released for production late in 1984. His contributions to and leadership of this development are the basis for this award.

This effort began with his direction of a major portion of a joint Navy/RCA study, undertaken in the mid-1970s to determine approaches to a phased-array antenna with ultra-low sidelobes and to establish realistic goals for the design of such a radar (to be designated AN/SPY-1B). He guided many of the tradeoff studies and analyses leading to the identification of errors in such a system and their categorization into those that are controllable in alignment/adjustment and those that must be addressed through precision fabrication.

One of the study results was the recognition that a key to the alignment process is measurement resolution. Precise phase and amplitude measurements for each radiating element are essential inputs to the correction data used to set each of the 4350 individual phase shifters such that phase errors are eliminated. In practice this process applies the most modern computer technology to correct these errors. Correction data is stored in ROM (containing a total of 160 bits for each element) within the array electronics and is used to correct each beam steering command.

Although the need for this high level of resolution in the antenna alignment process was apparent, the approach for attaining such resolution was not. Dr. Patton's theoretical understanding of the problem, combined with his working knowledge of near-field technology, led him to a solution that was so radical it raised serious doubts. The antenna working group assembled by the Navy to assist and advise on the program consists of the Western World's most acknowledged experts in near-field technology. A number of them were uncertain that Dr. Patton's novel "spectrum merging" process would work or

provide the needed resolution. His persistence in explaining the complex technique and in demonstrating its operation ultimately resulted in their acceptance of the concept as a viable approach to the problem.

The technique (for which a U.S. patent has been issued in his name) involves a method for obtaining a total array factor, which is a more complete radiation pattern than can be obtained from a single beam position. In practice the technique uses four steered beams to accumulate a total pattern, one quadrant at a time, scanning the array so that the array factor shifts and brings into visible space those portions that are otherwise unmeasurable. Although conceptually abstruse, this technique proved to be the key that made it possible to extend near-field techniques to the resolution required for alignment of individual elements.

Implementation of these alignment techniques is accomplished in a new, second-generation near-field test and alignment facility employing a 12-degree-of-freedom laser measurement system to provide the unprecedented level of measurement accuracy required for the individual element alignment process. Two dedicated Perkin-Elmer Series 32 computers control the measuring system and process data on the measurements. Dr. Patton supervised the instrumentation and software development required to automate the several million measurements required for each antenna.

The result of all this effort is the basis for RCA's world leadership in this field—a phased-array antenna that defines the state of the art, in practical terms, for years to come. Unquestionably, the principal architect of this truly extraordinary achievement is Dr. Willard T. Patton.

## BUSINESS IMPLICATIONS

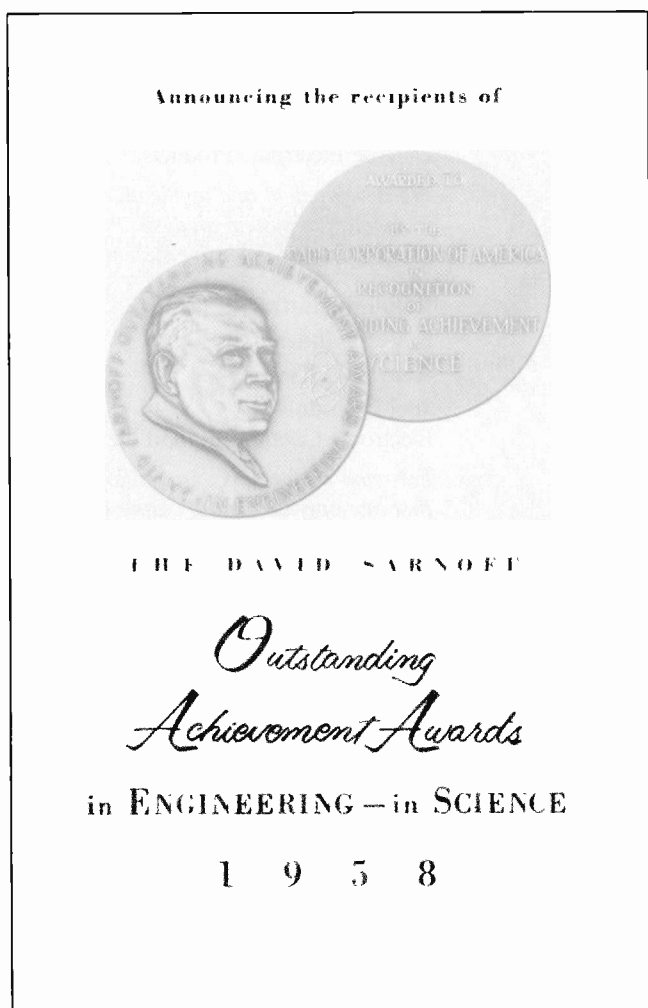
RCA's position as a leading developer of phased-array radar systems is solidly established as a result of the performance record of the AN/SPY-1A radar. The fundamental understanding and capabilities that have been gained by RCA in the recent development of the AN/SPY-1B radar have far-reaching potential.

The business implications of such a technology lead are

difficult to quantify in terms of a broad market for phased-array radars and advanced near-field test and alignment facilities. There can be no doubt, however, that the successful development of the AN/SPY-1B radar was a key element in the Navy's decision to build an additional 15 AEGIS cruisers and to pursue development of the DDG 51-class guided-missile destroyer. Construction of 29 of these warships is planned.



# The David Sarnoff Awards: A chronology



RCA's highest honor for outstanding technical achievement, the David Sarnoff Awards, were first announced at a dinner at the Waldorf-Astoria, New York, on September 30, 1956, commemorating General David Sarnoff's fifty years of service to radio, television, and electronics.

On this occasion, Dr. Elmer W. Engstrom, Senior Executive Vice President, said to General Sarnoff: "During the many years that it has been my privilege to serve RCA and work with you I have come to know and to understand the interest you take in men of science, the inspiration you give them, the encouragement you provide for their work, and the boundless faith that you have in the accomplishments of the men of science.

"Because of this your associates are establishing two awards as a tribute to you."

These original awards were called the David Sarnoff Outstanding Achievement Award in Science, and the David Sarnoff Outstanding Achievement Award in Engineering. The award in science was to be given annually to the RCA engineer who during the preceding year had accomplished what was deemed to be the outstanding research achievement in a field of interest to RCA. All members of the research staff of RCA Laboratories were eligible for this award.

The award in engineering was to be given annually to the RCA engineer who during the previous year had accomplished what was deemed to be the outstanding engineering achievement in a field of interest to RCA. All members of the engineering staffs of RCA divisions and subsidiary companies were eligible for this award.

The first awards were conferred in 1958, and RCA continued to confer two awards per year through 1960. In 1961 the Team Awards in Science and Engineering were initiated, and from then until 1973 four annual awards were conferred; one Individual Award each for Science and Engineering, and one Team Award each for Science and Engineering.

In 1973 the name of the award was changed, eliminating the distinction between science and engineering. Henceforth, the award would be called the David Sarnoff Award for Outstanding Technical Achievement, and the Selection Committee would no longer be limited to four awards per year.

The following is a complete list of David Sarnoff Award conferees, with citations, from 1958 through 1985. As you read through this list, you will be reminded of significant technical achievements made by RCA people over the years.

# David Sarnoff Awards for Outstanding Achievement in Engineering

**1958**

**David K. Barton**

Missile and Surface Radar Division

*For important contributions to precise tracking radars.*

**1959**

**Lorne D. Armstrong**

Semiconductor Division

*For his pioneering contributions to the development of semiconductor devices and for his engineering leadership in overcoming basic problems relating to their design and manufacture.*

**1960**

**Duane C. Brown**

RCA Service Company

*For his development of original and effective solutions to complex problems of missile and rocket trajectories at the Atlantic Missile Range.*

**1961**

**Wayne Porter**

Missile and Surface Radar Division

*For development and implementation of the means by which the Ballistic Early Warning System (BMEWS) discriminates between missiles and other space objects, thereby improving materially the defenses of this nation and the free world.*

**Joseph F. Cashen**

**Saul B. Dinman**

**Gardner C. Hendrie**

**Lawrie W. Honens**

**Grant D. Rummell**

Computer Systems

*For team performance in the application of advanced system concepts and practical engineering to the successful design of the RCA 110 industrial control computer.*

**1962**

**Robert Lieber**

Missile and Surface Radar Division

*For contributions to the field of high-precision space tracking and navigational systems.*

**Morris Berg**

**Fred G. Block**

**Fred W. Peterson**

**Merrald B. Shrader**

Electronic Components and Devices

*For team performance in conceiving and developing entirely new concepts in power-tube-construction which have resulted in compact, rugged, and more powerful ultra-high-frequency tubes.*

**1963**

**Morrel P. Bachynski**

RCA Limited

*For outstanding and widely recognized achievements in the fields of microwaves and plasma physics.*

**L.G. Caprarola**

**John J. Carrona**

**Norman S. Freedman**

**Lewis H. Gnau**

**Carel W. Horsting**

**Walter F. Lawrence, Jr.**

Electronic Components and Devices

*For team performance in developing practical structures and production methods for thermo-electric power generators.*

**1964**

**Jack Breckman**

Defense Electronics Products

*For far-reaching contributions to space technology by means of the Breckman Projection and the comprehensive simulation of the earth-space environment.*

**Phyllis B. Branis**

**Austin E. Hardy**

**A.M. Morrell**

**Theodore A. Saulnier**

**Terry M. Shrader**

**Morris R. Weingarten**

Electronic Components and Devices

*For team performance in making many important contributions to the development of the shadow-mask design and screen application of techniques which made possible the commercial success of the RCA color picture tube.*

**1965**

**Donald R. Carley**

Electronic Components and Devices

*For the extension of the frequency and*

*power of solid-state devices by the invention and development of the RCA Overlay Transistor.*

**A. Gravel**

**J.J. Hawley**

**R.F. Schmicker**

Astro-Electronics Division

*For the successful design and development of the television cameras, associated circuitry, and mechanical elements of a system for high-resolution photography of the lunar surface from an impacting vehicle.*

**1966**

**Spurgeon H. Buder**

Defense Electronic Products

*For development and application of novel techniques of system analysis and synthesis to advanced defensive systems.*

**Ralph S. Hartz**

**F. Peter Jones**

**Henry M. Kleinman**

**Joel Ollendorf**

Electronic Components and Devices

*For team performance in developing the first line-operated audio output transistor for the economical transistorization of home radio and television receivers.*

**1967**

**Martin R. Royce**

Electronic Components and Devices

*For the invention and development of a more efficient red-emitting phosphor for color picture tubes which results in superior brightness and provides essentially unity current ratios.*

**George J. Armbruster**

**Ulrich A. Frank**

**Hajime J. Kishi**

**Dale L. Kratzer**

**James L. Sullivan**

**Robert A. Van Olst**

**Clayton E. Yost**

Missile and Surface Radar Division

*For team performance for advances in all-solid-state lightwave tactical radar, including the first successful application of phase coded CW techniques.*

## 1968

### Otto H. Schade, Sr.

Electronic Components and Devices

*For the conception of electronic techniques to determine accurately the response of the total television system, including lenses and photographic films.*

### Nicholas M. Amdur

### Frank C. Hassett

### William B. Locke

### Angelo Muzi

### Herbert W. Silverman

### Earle D. Wyant

Automated Systems Division

*For design, development, and installation of a computer-controlled fully automatic production test system for the on-line electrical test of color kinescopes.*

## 1969

### E.J. Nossen

Defense Communications

*For outstanding individual contribution through the recognition of an unfilled need in the Apollo mission, and the invention of a novel ranging system to fulfill that need.*

### Henry Ball

Consumer Electronics Systems Division

### Charles D. Boltz, Jr.

Consumer Electronics Division

### Lewis A. Briel

Consumer Electronic Systems Division

### Frank B. Lang

Astro-Electronics Division

### R. Kennon Lockhart

Consumer Electronics Division

### Theodore M. Wagner

Consumer Electronics Systems Division

### J. Hugh Wharton

Consumer Electronics Division

*For excellence of team effort and inter-divisional cooperation leading to the rapid development of a low-cost, single-tube, color-television camera.*

## 1970

### J.L. Hathaway

NBC

*In recognition of his many outstanding technical innovations in the field of broadcasting.*

### A. Lichowsky

Defense Electronic Products

*For outstanding engineering leadership of the TIROS meteorological satellite team.*

### M. Burmeister

Automated Systems Division

### H.U. Burri

Automated Systems Division

### W.W. Carter

Missile and Surface Radar Division

### F.A. Hartshorne

Defense Communications Systems Division

### M.J. Kurina

Automated Systems Division

### R.J. Mason

Missile and Surface Radar Division

### R.A. Morley

Automated Systems Division

### J.J. Napoleon

Electronic Components and Devices

### H.L. Slade

Automated Systems Division

### M. Weiss

Missile and Surface Radar Division

### D.W. Wern

Defense Communications Systems Division

### L.B. Wooten

Automated Systems Division

*For design, development and construction of highly successful major electronic systems for the Lunar Module.*

### Abraham Schnapf

Astro-Electronics Division

*For outstanding engineering leadership of the TIROS meteorological satellite team.*

## 1971

### Jack Avins

Consumer Electronics Division

### B.V. Vonderschmitt

Solid State Division

*For excellence of team effort and leadership in the timely development of superior integrated circuits for use in television receivers.*

## 1972

### W.W. Weinstock

Missile and Surface Radar Division

*In recognition of his outstanding technical leadership in building RCA's pre-eminence in the field of radar and defense systems.*

### D.E. Burke

Solid State Division

### W.F. Dietz

Solid State Division

### G.L. Grundmann

Consumer Electronics Division

### E. Lemke

Consumer Electronics Division

### J.M. Neilson

Solid State Division

*For the highly successful development of the thyristor horizontal deflection system and required components for television receivers.*

## David Sarnoff Awards for Outstanding Achievement in Science

## 1958

### Albert Rose

*For basic contributions to the understanding and utilization of photoelectronic phenomena.*

## 1959

### Nils E. Lindenblad

*For the invention and pioneering development of many important electronic devices and for his research on thermoelectric cooling apparatus.*

## 1960

### Leon S. Nergaard

*For basic and practical contributions to the science of microwave electron tubes and thermionic cathodes.*

## 1961

### Dwight O. North

*For insight in interpreting the role of a theorist at the Laboratories and for resourcefulness in translating theory into practical results.*

### Harold B. Law

### Edward G. Ramberg

*For team performance in making basic and practical contributions to the science of electron optics.*

## 1962

### Ray D. Kell

*For many outstanding contributions which continue to lead to major innovations in the field of television.*

Gerald B. Herzog  
Bernard J. Lechner  
Morton H. Lewin  
Henry S. Müller  
James C. Miller  
Charles W. Mueller  
Herbert Nelson  
Henry S. Sommers, Jr.

*For team performance in conceiving and developing devices, circuits, and memories for kilomegacycle computers.*

### 1963

Paul K. Weimer

*For basic and practical contributions leading to the successful and widely diversified application of evaporated thin films.*

Benjamin Abeles  
George D. Cody  
John P. Dismukes  
Lincoln Ekstrom  
Fred D. Rosi

*For team performance in making outstanding advances in thermoelectric alloys for generating electric power.*

### 1964

Alfred H. Sommer

*For meritorious contributions in the field of electron-emission phenomena leading to new emitter materials for electron tubes.*

Joseph A. Briggs  
Frederic P. Heiman  
Steven R. Hofstein  
Thomas O. Stanley  
J. Torkel Wallmark

*For team performance in making outstanding contributions to silicon-based integrated electronics.*

### 1965

Harold G. Greig

*For original and significant contributions to the development of the Electrofax process of electro-photography.*

G.D. Cody  
G.W. Cullen  
J.J. Hanak

*For team performance in research leading to development of a novel technique for synthesizing super-conductive niobium*

*stannide for application in high-field superconducting magnets.*

### 1966

Charles W. Mueller

*For outstanding contributions to the technology of semiconductor devices and circuits.*

Simon Larach  
Ross E. Shrader  
S. Milton Thomsen  
P. Neil Yocom

*For team performance in making substantial advances in the science, art, and practical application of photoconductive materials.*

### 1967

Kern K.N. Chang

*For original contributions to the basic understanding of microwave phenomena and for the invention and development of superior microwave components.*

Martin S. Abrahams  
James A. Amick  
Ronald E. Enstrom  
David Richman  
James J. Tietjen

*For team performance in significantly advancing the synthesis and characterization of gallium arsenide, gallium phosphide, and their alloys.*

### 1968

Herbert Nelson

*For conception and application of the solution regrowth technique for making semiconducting devices.*

Leslie L. Burns  
John J. Carrona  
Robert A. Gange  
Eugene M. Nagle  
Andrew R. Sass  
Howard G. Scheible

*For team performance in conceiving cryoelectric memories and developing necessary theoretical understanding and technologies for their realization.*

### 1969

Zoltan J. Kiss

*For outstanding contributions to photochromic and laser materials.*

L.A. Barton  
J.A. Castellano  
J.E. Goldmacher  
G.H. Heilmeyer  
R. Williams  
L.A. Zanoni

*For basic studies of liquid crystals and imaginative application to practical displays.*

### 1970

P. Niel Yocom

*For outstanding research leading to superior inorganic compounds for luminescent and electro-optic applications.*

R.E. Simon  
A.H. Sommer  
J.J. Tietjen  
B.F. Williams

*For the conception and successful embodiment of new principles and materials technology in markedly superior photo-multiplier tubes.*

### 1971

David L. Greenaway

*For scientific exploration of holography and the conception and implementation of numerous applications.*

H.R. Beelitz  
A.G.F. Dingwall  
P.D. Gardner  
H.S. Müller

*For outstanding team research leading to the effective use and fabrication of large scale integrated arrays for logic and memory.*

### 1972

Edward G. Ramberg

*In honor of an entire career of uncommonly valuable theoretical and practical contributions in fields of importance to RCA.*

W.J. Hannan  
F.E. Flory  
D. Karlsons  
M.J. Lurie  
R.J. Ryan

*For outstanding technical leadership of a large team in the successful development of a holographic prerecorded video system.*

## David Sarnoff Awards for Outstanding Technical Achievement

1973

**H. Ray Warren**  
Consumer Electronics Division

*For outstanding achievement in the development of a highly innovative magnetic tape video player-recorder.*

**Robert L. Barbin**  
Electronic Components and Devices

**William H. Barkow**  
RCA Laboratories

**John Evans, Jr.**  
Electronic Components and Devices

**Josef Gross**  
RCA Laboratories

**Horst E. Haslau**  
Consumer Electronics Division

**Richard H. Hughes**  
Electronic Components and Devices

**W.D. Masterton**  
Electronic Components and Devices

**I.F. Thompson**  
Consumer Electronics Division

*For outstanding technical achievements in color picture tube systems.*

**Alfonse Acampora**  
Globcom

**Denis P. Dorsey**  
RCA Laboratories

**John T. Frankle**  
Globcom

**Samuel N. Friedman**  
Globcom

**William D. Houghton**  
RCA Laboratories

**Lewis B. Spann**  
Globcom

*For outstanding corporate team effort leading to an innovative video-by-telephone system.*

**Glen W. Cullen**  
RCA Laboratories

**Gerald B. Herzog**  
RCA Laboratories

**Charles W. Mueller**  
RCA Laboratories

**Joseph H. Scott, Jr.**  
RCA Laboratories

*For outstanding team research leading to a new class of integrated semiconductor arrays.*

1974

**Peter Foldes**  
RCA Limited

*For sustained outstanding achievement in antennas for satellite communications.*

**Karl G. Hernqvist**  
RCA Laboratories

*For innovative contributions to the development of gas lasers and for his ability to shorten the time cycle between research and commercial application.*

**Henry Kressel**  
RCA Laboratories

*For outstanding research and leadership in the development and advancement of semiconductor devices.*

**Wilfred P. Bennett**

**Eugene J. Chabak**

**Larry J. Gallace**

**Gilman A. Lang**

**Sandy J. Mattei**

**Ural Roundtree, Jr.**  
Solid State Division

*For major contributions and leadership in the development of high-voltage power transistors for automotive ignition and other applications.*

**John W. Barbour**  
Consumer Systems

**Douglas J. Frank**  
Consumer Systems

**Ralph J. Pschunder**  
Missile and Surface Radar Division

**Richard L. Rocamora**  
Consumer Systems

**Matti S. Siukola**  
Consumer Systems

**Henry H. Westcott**  
Consumer Systems

*For outstanding conception, design analysis, development and installation of an array of television and FM antennas on a single tower serving the San Francisco Bay area.*

1975

**Arch C. Luther**  
Broadcast Systems Division

*In recognition of his many outstanding technical contributions enhancing RCA's reputation as a leading supplier of television systems.*

**Steven A. Lipp**  
RCA Laboratories

**Theodore A. Saulnier, Jr.**  
Picture Tube Division

**Stephen S. Trond**  
Picture Tube Division

*For outstanding achievement in the development and practical implementation of a high-contrast phosphor television screen.*

**Richard A. Baugh**

**Thomas H. Mehling**

**Willard T. Patton**

**George H. Stevens**  
Missile and Surface Radar Division

*For outstanding contributions in the development of a multifunction tactical phased array radar system.*

**Bill Autry**

Commercial Communications Systems Division

**Lee F. Crowley**

Commercial Communications Systems Division

**Heshmat Khajezadeh**  
Solid State Division

**Andrew M. Missenda**  
Commercial Communications Systems Division

*For excellence in the design and development of a hand-held, two-way portable radio.*

1976

**Eugene O. Keizer**  
RCA Laboratories

*For his inventiveness, technical contributions, and leadership in video systems research.*

**Albert M. Morrell**  
Picture Tube Division

*For his continuing outstanding technical contributions to the design of color picture tubes.*

**Jack Avins**  
RCA Laboratories

**J. Peter Bingham**  
Consumer Electronics Division

**Walter G. Gibson**  
RCA Laboratories

**Marvin M. Norman**  
Consumer Electronics Division

**Chandrakant B. Patel**

RCA Laboratories

**Robert L. Shanley II**

Consumer Electronics Division

**Bernard Yorkanis**

Solid State Division

*For outstanding team cooperation in bringing certain revolutionary video concepts from research to commercial product in the ColorTrak system.*

**John E. Keigler**

Astro-Electronics Division

**Lorne Keyes**

RCA Limited

*For outstanding contributions to the development of a highly cost-effective communications satellite.*

**Joseph A. Weisbecker**

RCA Laboratories

**Robert O. Winder**

Solid State Division

*For excellence of team effort leading to the development and marketing of an advanced microprocessor.*

## 1977

**Leopold A. Harwood**

Consumer Electronics Division

*For the invention, development and application of chroma processing integrated circuits used in color television.*

**James L. Sullivan**

Missile and Surface Radar Division

*For conceptual contributions and technical leadership in the development and implementation of advanced signal processing systems.*

**Lucas J. Bazin**

**Sidney L. Bendell**

**John J. Clarke**

**Donald A. Herrmann**

**Cydney A. Johnson**

**Anthony H. Lind**

**Mark R. Nelson**

**Dennis M. Schneider**

**Alexis G. Shukalski**

**Harry G. Wright**

Broadcast Systems Division

*For team effort leading to the highly successful TK-76 electronic news gathering TV camera.*

**Bennie L. Borman**

Consumer Electronics Division

**Larry J. Byers**

Consumer Electronics Division

**Eduard Luedicke**

RCA Laboratories

**Larry A. Olson**

Consumer Electronics Division

**Larry M. Turpin**

Consumer Electronics Division

*For team effort in the design, construction and installation of automated test equipment used in the assembly of color TV chassis.*

## 1978

**Albert Feller**

Advanced Technology Laboratories

*For outstanding achievement in the use of computer-aided design techniques for large-scale integrated circuits.*

**Fernand F. Martin**

**Jason H. Woodward**

**Samuel Waldstein**

Automated Systems Division

*For excellence of team effort in the product development of a hand held laser range finder.*

**David W. Luz**

**James A. McDonald**

**John C. Peer**

Consumer Electronics Division

*For outstanding team achievement in the development of scan and power supply systems for color television.*

**Kenneth C. Adam**

**Ramon H. Aires**

**Charles A. Clark, Jr.**

**William J. Davis**

**John G. Gorski**

**Kazuo Katagi**

**Akira Sasaki**

Avionics Systems

*For outstanding technical achievement in the development of airborne color weather radar indicators.*

**Murray A. Polinsky**

**Otto H. Schade, Jr.**

Solid State Division

*For outstanding technical achievement in the development of high performance BiMOS integrated circuits.*

## 1979

**Ellwood P. McGrogan, Jr.**

Advanced Technology Laboratories

*For outstanding technical contribution and creativity in the fields of secure communications and switching systems.*

**Robert J. McIntyre**

**Paul P. Webb**

Solid State Division

*For outstanding team performance in the development of theory and fabrication techniques for superior silicon photodiodes.*

**Bertram L. Compton**

Government Communications Systems Division

**Stephen L. Corsover**

Government Communications Systems Division

**Lawrence W. Dobbins**

Government Communications Systems Division

**Donald G. Herzog**

Government Communications Systems Division

**Charles R. Horton**

Government Communications Systems Division

**Kenneth C. Hudson**

Advanced Technology Laboratories

**Paul B. Pierson**

Government Communications Systems Division

**Bohdan W. Siryj**

Advanced Technology Laboratories

*For research, development, and implementation of laser beam image recording systems.*

**William F. Allen, Jr.**

Solid State Division

**Myung S. Bae**

Solid State Technology Center

**Norman H. Ditrack**

Solid State Technology Center

**Saleem Y. Husni**

Solid State Division

**Peter P. Idel**

Solid State Division

**James D. Mazzy**

Solid State Division

**Fred J. Reiss**

Solid State Division

**Thomas J. Robe**

Solid State Division

**George L. Schnable**

RCA Laboratories

*For developing a unique family of radiation-tolerant, dielectrically-isolated integrated circuits.*

## 1980

**Richard Noto**  
Advanced Technology Laboratories

**Allan M. Smith**  
Advanced Technology Laboratories

*For the development and application of automated techniques for the design of integrated circuits.*

**Auguste H. Fortin, Jr.**

**Richard E. Hanson**

**Eldon M. Sutphin**  
Automated Systems Division

*For the development of unique and effective test equipment for internal combustion engines.*

**Robert A. Dischert**  
RCA Laboratories

**Robert E. Flory**  
RCA Laboratories

**Charles B. Oakley**  
RCA Laboratories

**Laurence J. Thorpe**  
Broadcast Systems Division

*For the conception, development, and design of a microprocessor-controlled automatic studio camera system.*

**Harold Blatter**  
Consumer Electronics Division

**J. Barrett George**  
Consumer Electronics Division

**Robert M. Rast**  
Consumer Electronics Division

**Charles M. Wine**  
RCA Laboratories

*For the conception, design, and implementation of the ChanneLock frequency synthesis tuning system.*

## 1981

**James E. Carnes**  
Consumer Electronics Division

**Jack S. Fuhrer**  
Consumer Electronics Division

**William A. Lagoni**  
Consumer Electronics Division

**Peter A. Levine**  
RCA Laboratories

**Walter F. Kosonocky**  
RCA Laboratories

**Dalton H. Pritchard**  
RCA Laboratories

**Donald J. Sauer**  
RCA Laboratories

*For the development and implementation of a CCD comb filter integrated circuit in color TV receivers.*

**Walter H. Braun**  
Americom

**Marvin R. Freeling**  
Americom

**Krishnamurthy Jonnalagadda**  
RCA Laboratories

**Leonard Schniff**  
RCA Laboratories

*For achieving dramatic increases in the capacity of the RCA domestic satellite system.*

**Todd J. Christopher**  
SelectaVision VideoDisc

**Jon K. Clemens**  
RCA Laboratories

**Pabitra Datta**  
RCA Laboratories

**Leonard P. Fox**  
RCA Laboratories

**Jerome B. Halter**  
SelectaVision VideoDisc

**Eugene O. Keizer**  
RCA Laboratories

**Marvin A. Leedom**  
RCA Laboratories

**Michael E. Miller**  
SelectaVision VideoDisc

**Frederick R. Stave**  
SelectaVision VideoDisc

*For key contributions to the development of the VideoDisc System.*

## 1982

**Karl G. Hernqvist**  
RCA Laboratories

*For understanding the cause and eliminating quality defects in color picture tubes.*

**Frank J. Reifler**  
Missile and Surface Radar Division

*For contributions to mid-course and terminal guidance technology.*

**Darrel Billings**  
Consumer Electronics

**Bennie L. Borman**  
Consumer Electronics

**Larry J. Byers**  
Consumer Electronics

**James M. Keeth**  
Consumer Electronics

**Gerald E. Theriault**  
RCA Laboratories

**Larry M. Turpin**  
Consumer Electronics

*For team accomplishment in the design, development, and implementation of automated alignment systems for consumer electronic instruments.*

**Martin L. Levene**  
Advanced Technology Laboratories

**Peter T. Patterson**  
Government Communications Systems Division

**Manuel A. Robbins**  
Government Communications Systems Division

**Gerald Spector**  
Government Communications Systems Division

**Dennis J. Woywood**  
Government Communications Systems Division

*For team performance in analysis of U. S. Postal Service operations, conceptualization, and implementation of an electronic mail service.*

## 1983

**George L. Schnable**  
RCA Laboratories

*For contributions to improvement in the reliability of solid state devices.*

**James R. Arvin**

**Robert E. Fein**

**Perry C. Olsen**

**Paul C. Wilmarth**  
Consumer Electronics Division

*For team achievement in the design and development of a highly manufacturable and reliable color television receiver.*

**Roger C. Alig**  
RCA Laboratories

**William H. Barkow**  
RCA Laboratories

**Dennis J. Bechis**  
RCA Laboratories

**Hsing-Yao Chen**  
Video Component and Display Division

**Richard H. Hugher**  
Video Component and Display Division

**Ira F. Thompson**  
Consumer Electronics Division

*For team effort in the development of the COTY family of picture tubes and yokes.*

**Everett Aaron Boyd**  
RCA Astro-Electronics

**Brian R. Dornan**  
RCA Laboratories

**Ho-Chung Huang**  
RCA Laboratories

**J. Nicholas LaPrade**  
RCA Astro-Electronics

**Robert M. Schuster**  
RCA Astro-Electronics

**Walter J. Slusark**  
RCA Laboratories

**Herbert J. Wolkstein**  
RCA Laboratories

*For team effort leading to the first commercial solid state microwave power amplifier in space.*

## 1984

**Michael Ettenberg**  
RCA Laboratories

*For leadership in the understanding, development and manufacture of solid state optoelectronic devices.*

**John R. Field**  
RCA Laboratories

**Thomas C. Lausan**  
Video Component and Display Division

**Ronald Sverdlove**  
RCA Laboratories

**Norman D. Winarsky**  
RCA Laboratories

*For development of the physical understanding and computer software for simulating electron trajectories in picture tubes.*

**Richard Denning**  
RCA Laboratories

**Larry J. Gallace**  
Solid State Division

**Leonard H. Gibbons**  
Solid State Division

**Lewis A. Jacobus**  
Solid State Division

**Maurice I. Rosenfield**  
Solid State Division

*For major reliability improvement in plastic encapsulated integrated circuits.*

**John F. Benford**

**James Hettiger**

**James J. Kopczynski**

**James A. Milnes**  
Consumer Electronics Division

*For development of compact television receivers and monitors.*

**Donald F. Battson**  
New Products Division

**Sidney L. Bendell**  
Broadcast Systems Division

**Gary W. Hughes**  
RCA Laboratories

**Walter F. Kosonocky**  
RCA Laboratories

**Peter A. Levine**  
RCA Laboratories

**Eugene D. Savoye**  
RCA Laboratories

**L. Franklin Wallace**  
New Products Division

*For developing high-performance CCD television cameras.*

## 1985

**James J. Gibson**  
RCA Laboratories

*For numerous contributions to consumer electronics and broadcast systems including the definition of a standard for multichannel sound for television.*

**George R. Busacca**  
RCA Astro-Electronics

**Robert E. Askew**  
RCA Laboratories

*For the design, development and space qualification of the first commercial cooled low-noise microwave amplifier.*

**Martin J. Herskowitz**

**David P. McCorkle**

**George J. Moore**  
Consumer Electronics Division

*For an automatic purity and convergence alignment system for color television receivers.*

**Jerry R. Richards**

Advanced Technology Laboratories

**Stanley E. Ozga**

Missile and Surface Radar Division

**Willard F. Meeker**

Advanced Technology Laboratories

**Robert B. Gordon**

Government Communications Systems Division

**Richard H. Moyer**

Advanced Technology Laboratories

**James R. Barger**

Advanced Technology Laboratories

**Allan L. Nelson**

Advanced Technology Laboratories

*For the conception, design, and implementation of Narrowband Speech Terminals.*

**Willard T. Patton**

Missile and Surface Radar Division

*For establishing new dimensions in radar antenna technology.*

**Kenneth W. Brizel**

**Frank Dezura**

**Richard E. Funk**

**Barry A. Goldsmith**

**Brian J. Petryna**

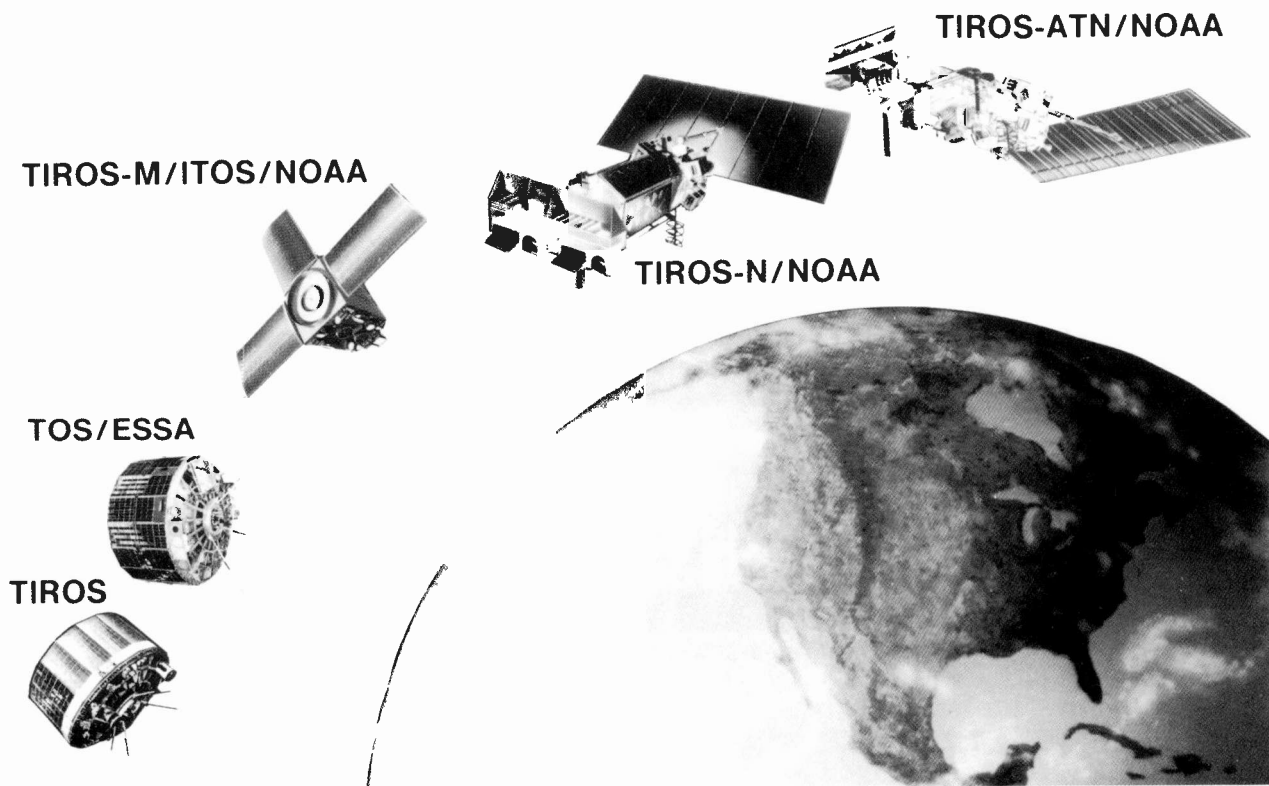
Solid State Division

*For the development of the QMOS product line, a new family of high-speed CMOS logic circuits.*



## 25 years of weather satellites

Since 1966, the entire earth has been photographed at least once a day by weather satellites.



**Abstract:** *The TIROS meteorological satellite system has been furnishing countries around the world with weather observations for the last 25 years. Supplying advanced warning of major storms and weather changes and yielding invaluable scientific data on solar disturbances, surface sea ice, and water temperatures, the TIROS system has helped save countless lives and millions of dollars in property damage around the globe.*

©1985 RCA Corporation.  
Final manuscript received May 22, 1985  
Reprint RE-30-4-3

The TIROS meteorological satellite system has been furnishing countries around the world with weather observations for the last 25 years. Supplying advanced warning of major storms and weather changes and yielding invaluable scientific data on solar disturbances, surface sea ice, and water temperatures, the TIROS system has helped save countless lives and millions of dollars in property damage around the globe.

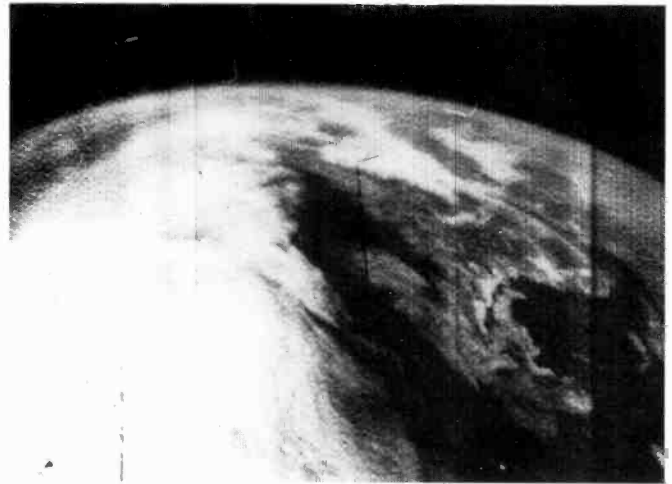
The first cloud pictures returned from TIROS-I in 1960 demonstrated the feasibility of using satellites for weather observations (see Fig. 1). TIROS has steadily progressed through four generations of design, with each generation of satellites having more

capabilities than its predecessors. With this progression, TIROS has provided significant improvements in 3- to 5-day weather forecasts.

TIROS forecasts are used by the agricultural, building, forestry, and water management industries, to name a few. Some of the benefits are illustrated in Fig. 2. Some estimates have been made in the US on the economic benefits derived from accurate 3-to 5-day forecasts. In agriculture, by knowing when to plant, when to irrigate, and when to harvest, annual savings of \$400 million have been realized. In the building industry, just by knowing when to schedule outdoor work, as well as knowing when to deliver perishable materials, savings are estimated at \$1 billion per year. Water management, which leads to flood control and efficient operation of electric plants, is estimated to provide savings of \$100 million per year. By controlled burning, the risk of forest fires is reduced. This is only possible through very accurate 3- to 5-day forecasts. Savings due to this are estimated to be \$10 million a year, based on the average cost of a single fire.

The TIROS family of polar-orbiting meteorological satellites is designed, built, and tested by RCA Astro-Electronics Division under the technical management of the National Aeronautics and Space Administration (NASA). The satellites are owned and operated by the National Oceanic and Atmospheric Administration (NOAA).

The satellites transmit meteorological information collected from areas all around the globe to the National Environmental Satellite Data and Information Service in Washington, D.C. The information is then transformed into a broad variety of data for worldwide distribution.



**Fig. 1.** One of the first cloud pictures returned by TIROS-I in 1960.

### Background

The first generation of weather satellites originated in 1958 when Astro was awarded the TIROS contract (Television Infrared Observation Satellite). TIROS-I returned useful cloud pictures that helped improve the accuracy of weather forecasts. For the first time, forecasters were able to monitor remote areas of the planet, including oceanic regions of the southern and northern hemispheres, deserts, and the polar regions.

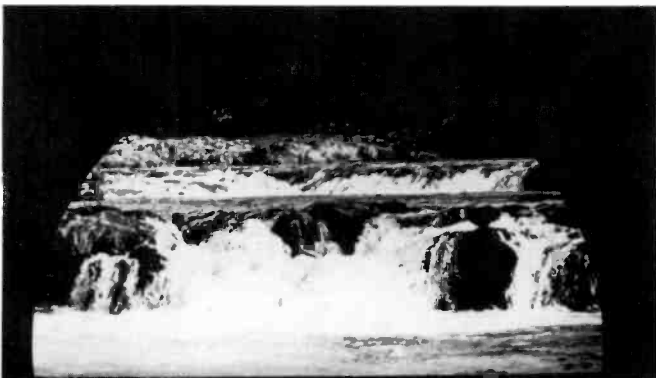
Initially, the TIROS satellites provided limited coverage of the



**Fig. 2(a).** The building industry—an estimated \$10 billion annual savings.



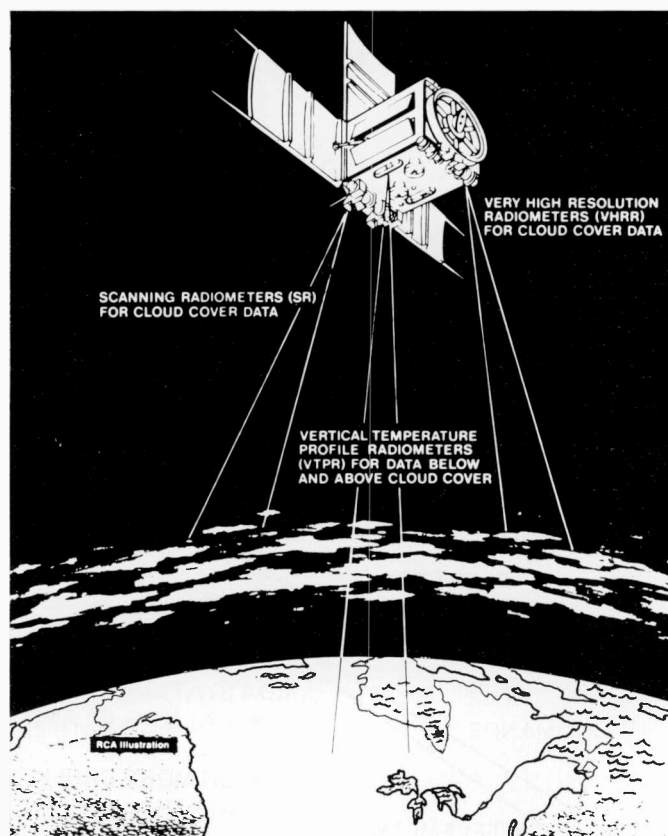
**Fig. 2(b).** Agriculture—\$400 million annual savings.



**Fig. 2(c).** Water management—an estimated annual savings of \$100 million.



**Fig. 2(d).** Forest fire prevention—an estimated annual savings of \$10 million, based on the cost of an average fire.



**Fig. 3.** *ITOS-I*, the first spacecraft equipped with an operational two-channel, medium resolution scanning radiometer for day and night radiometric data.

earth's surface. As the system evolved, global coverage was realized. The first operational system was the Environmental Satellite Service Administration (ESSA) system in 1966, followed by the ITOS (Improved TIROS Observation Satellite) system, which for the first time provided day and night observation with its scanning radiometers. TIROS-N, introduced into service in 1978, improved the quality and the quantity of data. Advanced TIROS-N (ATN) was introduced into service in 1983. Among the new instruments on board these satellites are a solar backscatter ultraviolet radiometer to map the earth's ozone layer, the ERBE (earth radiation budget experiment) to measure the earth's heat gains and losses, and a search and rescue system that helps locate downed aircraft and ships in distress.

Today, TIROS provides global coverage four times a day and is the only source of environmental data for 80 percent of the globe not covered by conventional means.

### Evolution of the TIROS satellite program

The TIROS satellite program evolved from a research and development project in 1958 into a semi-operational satellite system in which nine additional TIROS satellites were launched from 1960 to 1965. Each satellite carried a pair of miniature television cameras and, in approximately half of the missions, a scanning infrared radiometer and an earth radiation budget instrument.

The second-generation satellites, known as ESSA, provided the first routine daily worldwide observations without interruption in data acquisition. In February 1966, the TIROS Operational System (TOS) employed a pair of ESSA satellites, each configured

for a specific mission. Between 1966 and 1969, nine ESSA satellites were successfully launched. Through their onboard data storage systems, the odd-numbered satellites (ESSA 1,3,5,7,9), with redundant advanced vidicon camera systems (AVCS), provided global weather data to the National Environmental Satellite Service at Suitland, Maryland for processing and dissemination to forecasting centers around the world. The even-numbered satellites (ESSA 2,4,6,8) provided direct real-time readout of their automatic picture transmission (APT) television pictures to stations located around the world.

In the 1970s, the third generation of meteorological satellites, known as ITOS (Improved TIROS Operational System), was developed. The satellite system evolved from the proven technology of the TIROS and ESSA spacecraft, and dramatically surpassed the capabilities of the ESSA system.

These satellites evolved from spin-stabilized spacecraft to a three-axis-stabilized earth-oriented platform in which each of the three orthogonal axes were held to within one-half degree or better throughout the mission. This change improved performance, providing more accurate and more frequent acquisition of meteorological data and more timely dissemination of the processed data to the users. The new system was compatible with the global ground network of local receiving stations, as well as the two principal command and data acquisition sites. It also had the capacity for future growth.

ITOS-I combined the capabilities of two ESSA spacecraft, which included the direct readout APT system and the global stored images of the advanced vidicon camera system, in a single spacecraft. In addition, ITOS-I was the first spacecraft equipped with an operational two-channel scanning radiometer for day and night radiometric data (see Fig. 3), with both real-time data transmission and stored data for later playback to the earth station. A single ITOS spacecraft furnished global observation of the earth's cloud cover every 12 hours, as compared to every 24 hours with two ESSA satellites.

Further changes made to the ITOS system included a new sensor complement that provided day visual and night IR imaging by means of very-high-resolution radiometers (VHRR) and medium-resolution scanning radiometers. Vertical temperature profile radiometers made temperature soundings of the atmosphere, and a solar proton monitor measured the proton and electron flux. The ITOS system is shown in Fig. 4.

### The TIROS-N/NOAA series

RCA completed development of the first spacecraft of the next generation in the polar-orbiting environmental satellite system, designated TIROS-N/NOAA, in 1978. That spacecraft was followed by NOAA-6 in 1979, NOAA-7 in 1981, NOAA-8 in 1983, and NOAA-9 in 1984. The NOAA satellites collect meteorological data from several hundred platforms located on land, in the air, and at sea, including fixed and floating platforms, buoys, and balloons located throughout the world. Data are received, processed, and distributed by NOAA's central processing facility at Suitland, Md., via the command and data acquisition stations.

This series had a new complement of data-gathering instruments. The advanced very-high-resolution radiometer (AVHRR) increases the amount of radiometric information for more accurate sea-surface temperature mapping and identification of snow and sea ice, in addition to day-and-night imaging in the visible and infrared bands. The infrared sensors produce charts showing sea-surface temperature over a larger area with more frequency than is

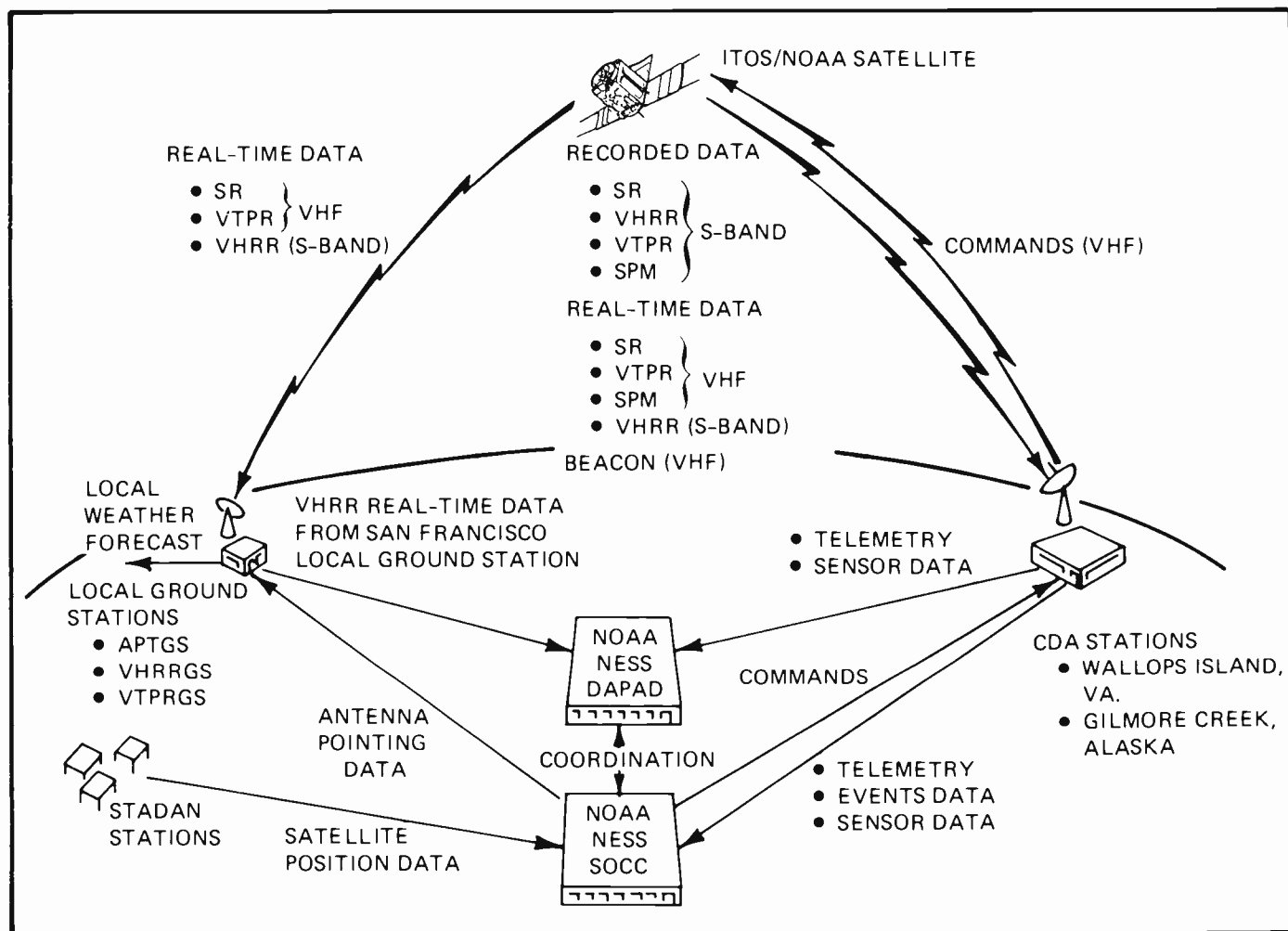


Fig. 4. The complete ITOS system.

possible from any other source. The AVHRR imaging system helps locate large-scale cloud formations and can identify storm systems, fronts, upper-level troughs and ridges, jet streams, fog, stratus, sea-ice conditions, snow cover, and to some extent upper-level wind direction and speed. Other instruments on board the spacecraft are the TIROS operational vertical sounder (TOVS), a three-instrument complement that provides vertical profile measurements of temperature and moisture distribution in the atmosphere. The solar environmental monitor measures solar electron and proton particles for solar research and radiation warning. These data are useful to the fishing and maritime industry, and are vital to meteorological forecasts.

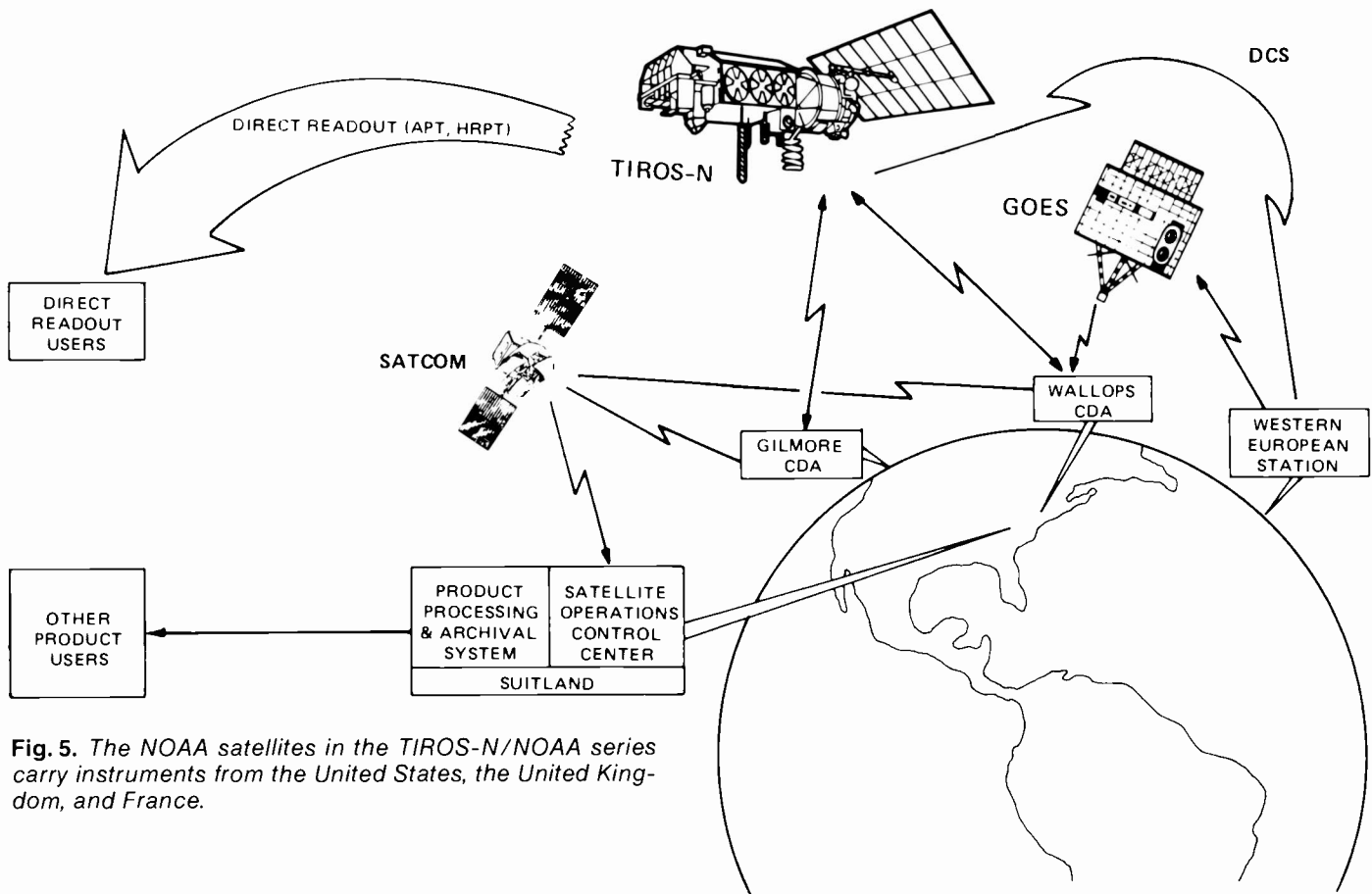
Worldwide temperature soundings provided by the TOVS instruments result in more complete and accurate analyses for use in weather forecasts. Soundings by satellite provide coverage over oceans and remote areas not covered by conventional sounding instruments. Satellite soundings aid in the interpretation of satellite picture data by providing correlations at specific geographical locations. The satellite soundings also enable the location of atmospheric gradients for use in studying atmospheric phenomena. The sounding data are important in the global atmospheric numerical modeling that is being developed to help provide more accurate long-range forecasts in middle and high latitudes.

The TIROS-N/NOAA satellites operate in a near-polar circular sun-synchronous orbit with a nominal altitude of 870 kilom-

eters (470 nautical miles) for the afternoon orbit and 833 kilometers (450 nautical miles) for the morning orbit. In the operational configuration, two satellites are positioned with a nominal orbit plane separation of 90 degrees. One satellite operates in an afternoon ascending orbit, crossing the equator at 1500 LST (Local Solar Time). The second satellite operates in a morning descending orbit, with an equator crossing of 0730 LST. The satellites take 101 and 102 minutes, respectively, to orbit the earth.

The integrated attitude control and propulsion subsystems within the spacecraft control the spacecraft's injection into orbit after separation from the Atlas-F launch vehicle and maintain proper spacecraft attitude in orbit. The thermal subsystem controls the temperature of the spacecraft subsystems and instruments, and the telemetry and data handling subsystem records and transmits the environmental data to ground stations. Many of the subsystems are controlled by two redundant onboard computers. The spacecraft design is modular in concept, permitting growth and modification.

NOAA satellites in the TIROS-N/NOAA series (see Fig. 5) include instruments from the United Kingdom and France. The United Kingdom, through its Ministry of Defense Meteorological Office, provides the stratospheric sounding unit, one of the three atmospheric sounding instruments on each satellite. The Centre National d'Etudes Spatiales of France supplies the data collection and location system (DCS) for the satellite and also the ground



**Fig. 5.** The NOAA satellites in the TIROS-N/NOAA series carry instruments from the United States, the United Kingdom, and France.

facilities that process the DCS data and make it available to users. The Centre National d'Etudes Spatiale, uses its ground facilities to receive atmospheric sounder data from the satellite during orbits in which the satellite does not come within contact range of the command and data acquisition stations of the U.S. The data are then relayed to the United States through the GOES-East satellites.

### Advanced TIROS-N

The last six spacecraft in the TIROS-N series (NOAA-E through J) have been designed for a larger payload complement to further enhance the TIROS operational system. In addition to the TIROS-N basic complement, a list of growth sensors anticipated for future requirements was used to develop the requirements for the spacecraft's support system. This resulted in a satellite design with inherent growth capabilities for continued orderly evolution. NOAA-E, the first in the ATN series, was equipped with a search and rescue system. A solar backscatter ultraviolet radiometer for ozone mapping and two earth radiation budget experiment instruments were added to NOAA-F (see Fig. 6). The search and rescue experiment enables detection and location of downed aircraft or marine vessels in distress. This technology breakthrough can pinpoint the emergency site within 13 miles. The search and rescue experiment is a joint U.S./Canada/France/USSR project.

While the basic instrument payload, with the exception of these new instruments, remains essentially the same, the spacecraft bus is of an elongated design, approximately 50 centimeters (20 inches) longer than TIROS-N. The launch weight of 1,712 kilo-

grams (3,775 pounds), including apogee motor, is a 270-kilogram increase over the TIROS-N spacecraft. The use of higher efficiency cells increased the solar array power output from 1,260 watts to 1,470 watts to accommodate the additional payload requirements.

Over the past 25 years, the U.S. National Operational Meteorological Satellite System has improved the quantity, quality, and reliability of satellite coverage. Since 1966, the entire earth has been photographed at least once a day on a continuous basis. The photographs are not only used for daily operations, but are also placed in archives from which they can be retrieved for use in research case studies. The data gathered are almost indispensable for analyses and short-range forecasts by meteorologists and environmental scientists.

### Where do we go from here?

Future meteorological satellites will undoubtedly be larger and carry more diverse instruments for a wider variety of missions. A major portion of the earth's weather-generating phenomena lie between 30 degrees north and 30 degrees south latitude. However, current atmospheric models based on temperature and pressure soundings are inadequate for this region. Active lidar wind measuring sensors will provide the data with which accurate numerical forecast models can be developed for this region. Current technology is headed toward the development of a satellite-borne differential absorption lidar (DIAL) capable of global measurements of moisture profiles, aerosol concentrations, local visibility, surface pressure, and concentrations of constituents such as ozone and carbon dioxide. Furthermore, the capability to establish links

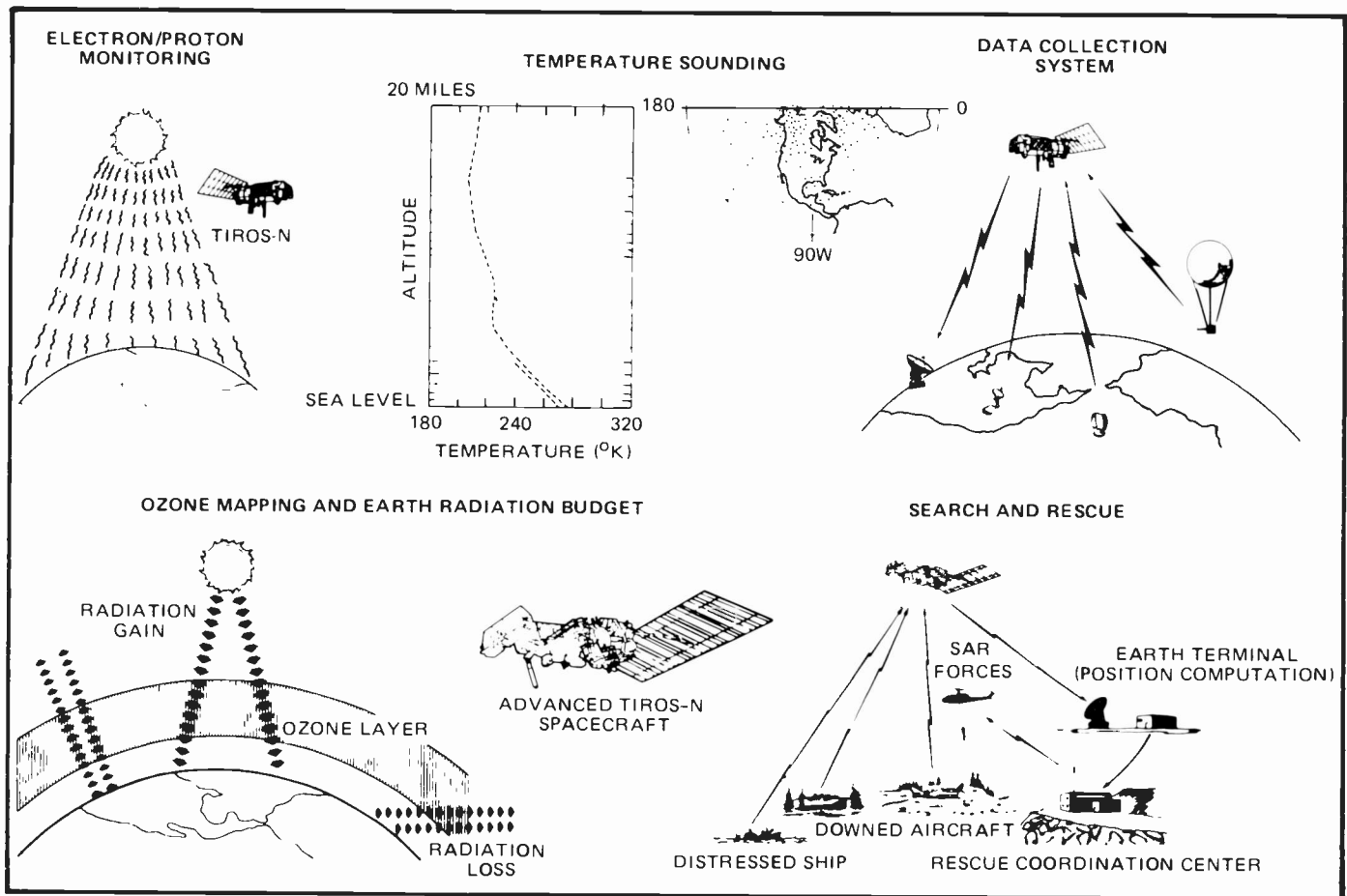


Fig. 6. The capabilities of the NOAA-E, the first satellite in the Advanced TIROS-N (ATN) series. The search and rescue experiment is a joint US/Canada/France/USSR project.

between low-orbiting and geostationary satellites will allow continuous real-time observation of major storm developments on a global basis.

There is a vast realm of possible applications for which low-or-

biting environmental satellites are suited. The potential of these satellites to enhance the public's well being and safety and increase the productivity of our major industries is limited only by our own imagination and innovative applications of today's technology.

**Anthony J. Manna** is the Division Vice-President, Marketing and Advanced Planning at RCA Astro-Electronics Division. He was promoted to this position in May 1985. In this capacity, he is responsible for all marketing and advanced planning functions at Astro including the planning of resources, developing strategies, customer contact plans and management plans, and securing new business. Prior to this he was Director, Marketing and Advanced Planning. He joined RCA in 1962. In 1982 he was the recipient of the RCA Government Systems Division Distinguished Marketing Performance Award.

Contact him at:  
**RCA Astro-Electronics Division**  
**Princeton, NJ**  
**Tacnet: 229-2711**



# The Engineering Corporate Computer Center

*EC<sup>3</sup>— The fast track for engineering computing.*

Because of the rapidly increasing complexity of chips, RCA engineers rely heavily on the computer to aid them in designing integrated circuits. By using computer tools, they are able to take the circuit design from conception to finished drawing and verify that the design will work within prescribed boundaries. There are computer tools that display the circuit, allow for changes, and give the designer the freedom to ask "what if" questions to determine the best solution.

## From mini to mainframe

RCA designers began to encounter bottleneck problems with their computer tools as designs grew in complexity. Simulations that once ran for an hour or two on a departmental VAX were taking 12, or even 20, hours. These long runs began to impair

---

**Abstract:** *When the users of various minicomputers needed faster turnaround for their work, they turned to management for a solution. As a result of the joint efforts of Corporate Information Systems and Services and the engineering community, the new Engineering Corporate Computing Center was conceived, designed, and built. The facility, housed in Moorestown, serves as a batch facility for computer-intensive engineering work. This article outlines the process that took place to create the center and get it running. To date, the Center has been well received by users. Design cycles have been shortened and productivity improved.*

---

RCA's capacity to deliver a timely, competitive product. The one-MIPS (millions of instructions per second) family of computers was no longer totally effective, and the need for higher mainframe speed became evident. The Engineering Corporate Computer Center (EC<sup>3</sup>) was conceived to address this growing problem.

The Aerospace and Defense engineering staff approached Corporate Information Systems and Services (CISS) with a proposal to participate in a task force responsible for selecting a computer that could, within a viable economic framework, supply faster cycles to RCA designers. The EC<sup>3</sup> was conceived as a joint venture among business units. It would process design work at least 10 times faster than the departmental computers being used. The facility would be operated by CISS, an organization that already had years of experience in the implementation and operation of large shared mainframe centers. The entire operation was conceptualized, readied, and functioning within 13 months.

## The committee

Contrary to the belief that committees rarely accomplish anything, the EC<sup>3</sup> Planning Committee, headed jointly by Dr. Ron Andrews of ATL and Paul Berger of CISS, completed the Request for Quotation (RFQ) and benchmark criteria for the mainframe within 10 weeks. Five mainframe vendors received the RFQ; four of them returned their bids and benchmarks within one business quarter. During this period, much information was gathered concerning software, MIPS, operating systems, and communications. By the time the request for capital was submitted, the committee had expanded to include specialists in many fields.

## Which mainframe?

Based on a combination of benchmark results and financial factors, an IBM 3083 computer was chosen to provide the cycles necessary to satisfy the processing needs of engineering design. Communications would be handled by a network of VAX machines connected to the IBM through an Interlink Model 3711. The operating system chosen was IBM's Virtual Machine (VM).

## Operating principles

The Planning Committee determined that the EC<sup>3</sup> would not be launched as a full-service support center in order to limit investment and support costs. Its charter was to supply background, batch-oriented computing to the participating units. This would be accomplished with the assistance of a limited CISS support staff and by using the engineering community to acquire and maintain the applications software.

A key concept was to take advantage of the widespread DEC knowledge base so that users would, to the maximum possible degree, view the EC<sup>3</sup> as another DECNET node. This technique took advantage of the user's experience and minimized the training and support requirements. EC<sup>3</sup> would additionally appear as an extension of the corporate Cherry Hill facility to service those users familiar with IBM.

The EC<sup>3</sup> facility is fully funded by its participants. It runs batch processing only—there are no interactive users. Disk storage is limited to 72 hours of inactivity, thereby putting the responsibility for maintenance of data and software on the users. EC<sup>3</sup> is governed by a management committee that is comprised of representatives of participating units and CISS management.

## System hardware

Figure 1 illustrates the hardware configuration of the EC<sup>3</sup>. The IBM 3083 Model-J processor is the heart of the arrangement. It has 16 megabytes of memory and performs 8 to 13 MIPS. In addition, there are tape and disk units, an NCR Comten communications processor, and a printer. The entire system is protected from electrical disturbances by a uninterruptible power supply (UPS). This ensures that a stable power source is supplied to the mainframe in case unforeseen electrical surges or interruptions in service are experienced.

## System software

EC<sup>3</sup> uses a host of computer systems software facilities for interaction with its users and batch job execution.

## VM

The EC<sup>3</sup> mainframe operates under the IBM Virtual Machine (VM) operating system. VM is designed so that multiple "guest" virtual machines can be executed on one mainframe with minimum overhead. The "guest" virtual machines can be other operating systems or special-purpose VM subsystems. The EC<sup>3</sup> VM system will host an MVS operating system virtual machine, VM's Remote Spooling Communications Subsystem (RSCS), and a number of VM BATCH virtual machines. Each of these are described in following sections.

VM was selected as the EC<sup>3</sup> operating system because it allows maximum cpu resources for the "guest" virtual machines. The "guest" virtual machines of particular concern are the VM BATCH machines that will execute cpu-intensive engineering applications.

## RSCS

The Remote Spooling Communications Subsystem (RSCS) is a software facility that allows VM to be networked to other IBM systems, whether they are "guests" under VM on the same mainframe or exist on separate mainframes. EC<sup>3</sup> uses RSCS to interact with both the MVS "guest" and the VM System at the Cherry Hill Corporate Computer Center.

## VM BATCH

VM BATCH is a VM software facility that allows the background execution of batch jobs. VM BATCH consists of a monitor or

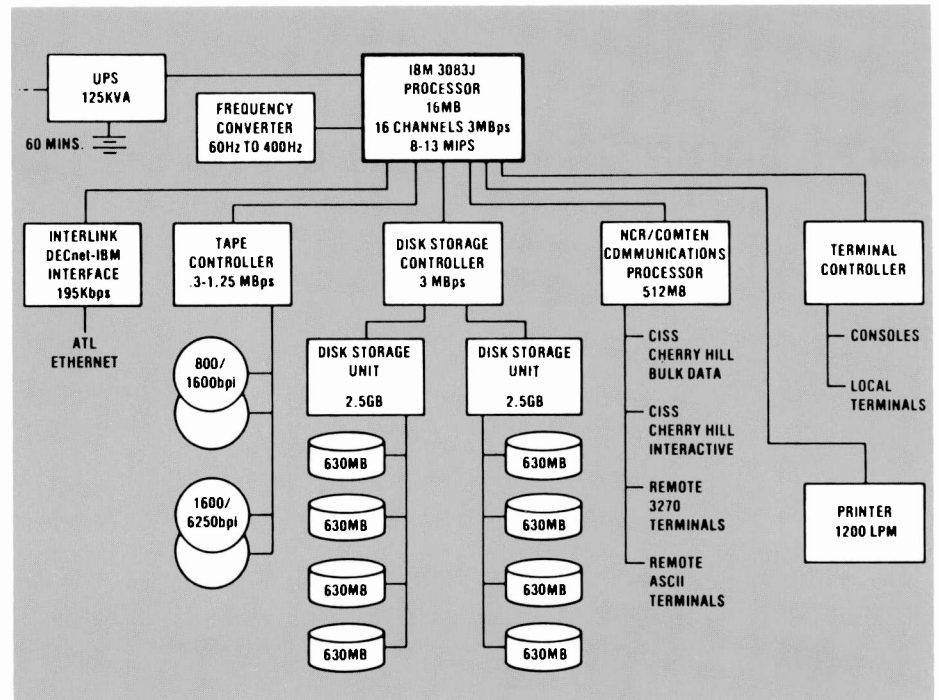


Fig. 1. EC<sup>3</sup> hardware configuration.

controller and a variable number of batch virtual machines. One batch job executes in one batch virtual machine. The monitor receives input jobs, places them in its job queue, and monitors batch machine status, i.e., available, busy, resource usage, etc. It also transfers jobs to available and "appropriate" batch machines to initiate execution. "Appropriate" is used here because batch machines can be defined with different characteristics, resource configurations, and maximums. The monitor then matches the requirements of a job with the appropriate batch machines. Batch machine job output is routed to the specified destination—either a different virtual machine or to RSCS for transfer to another IBM system.

Paramount to implementation was ease of use. It was decided that an engineer using a VAX device should not have to learn any new operating systems or complicated routines. An Interlink 3711 was acquired, and its DEC-to-IBM interface capabilities were tested. Interlinks provided both the hardware and software necessary to translate VAX submissions to the IBM computer and back to the VAX. It also provided record-level access to the data residing on the IBM disks. This implementation allowed DEC users to submit jobs through local DECNET nodes, over dedicated telecommunications lines, into the IBM operating system. When a job completes execution, upon user request, the Interlink transfers the data to the user's DEC machine.

The EC<sup>3</sup> participating units then ordered any ancillary equipment necessary to interface with the system. CISS assisted them by ordering the telecommunications lines.

Figure 2 shows the telecommunications network currently being used. The network allows the EC<sup>3</sup> to simultaneously look like a DECNET node to the VAX users and a VM RSCS node to the Cherry Hill Center VM user. Engineers can currently access the EC<sup>3</sup> facility from either their local VAX or through the data center in Cherry Hill.

## Standards

The next major task for the new EC<sup>3</sup> staff was to establish standards and documentation, and to communicate their new computer center's offerings to the engineers. A committee with representatives from all participating units was convened to review these standards and offer suggestions. A user guide was written that provides the information engineers need to use the EC<sup>3</sup> facilities. Additionally, a campaign designed to sign up prospective users and assign IDs was begun.

Included among the EC<sup>3</sup> standards was the definition of five job categories, or classes (see Fig. 3). When users submit jobs to the EC<sup>3</sup>, they specify the job classifications. By running only the small, medium, and large jobs during peak hours, the Center is able to process jobs with a minimum of system overhead and cpu contention, and a maximum of job throughput. During



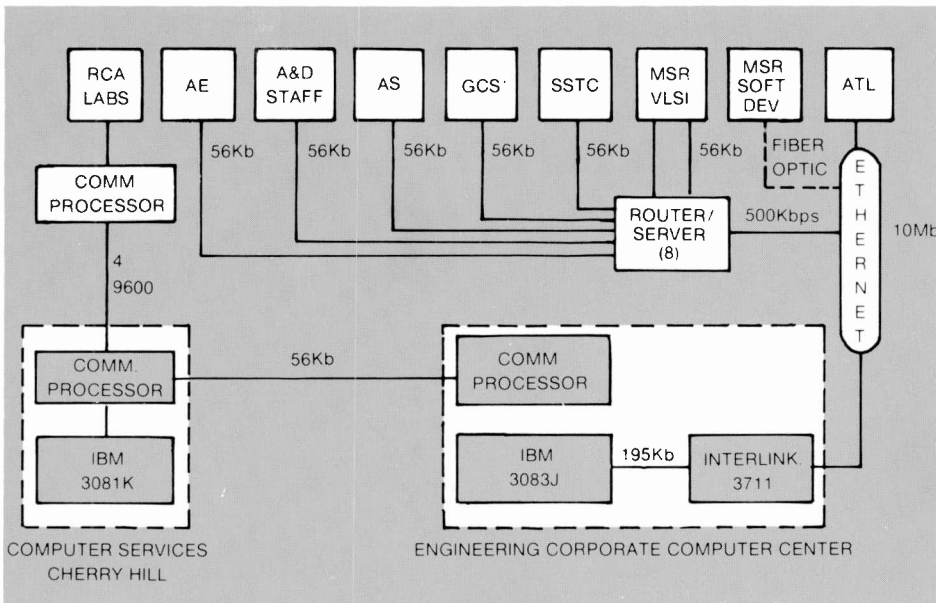


Fig. 2. EC<sup>3</sup> communications network configuration.

CLASS CODE	MAXIMUM CPU TIME
Small	15 Minutes
Medium	1 Hour
Large	6 Hours
Xtra Large	NO Limit
Tape	5 Minutes

Fig. 3. EC<sup>3</sup> job classifications.

off-peak hours any job requiring more than six hours of cpu time can be initiated to take advantage of the decreased workload. Normally, these extra-large jobs would require more than 600 hours to process data on a VAX system. Early performance data suggests this set of standards is sound. The EC<sup>3</sup> has been able to simultaneously support a wide mix of job sizes with effective turnaround.

### Application software

A host of engineering application software is available for execution at EC<sup>3</sup>. The software has either been developed or acquired by the participating EC<sup>3</sup> units. Generally, the applications are popular, cpu-intensive simulation programs, and software is maintained by "custodians" at the participating sites. Users having questions that pertain to software are directed to contact the appropriate software custodian.

Some of the software tools currently available at the EC<sup>3</sup> are:

#### Compilers

Fortran

PL/1

C Language

Assembler

#### Applications

MP2D

MIMIC

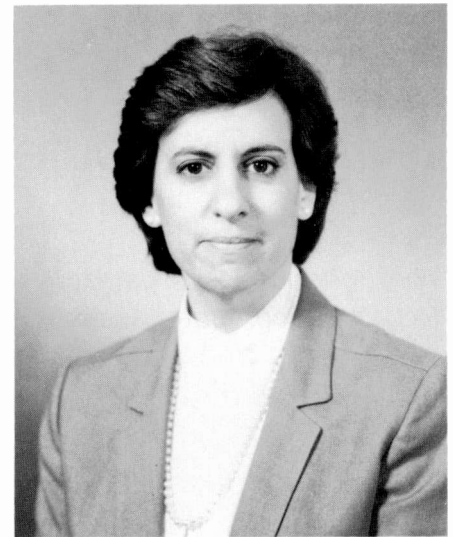
RCAP

MINIMOS

SPICE2G6

The EC<sup>3</sup> became operational on January 31, 1985. The participating business units are:

- Advanced Technology Laboratories—Moorestown, N.J.
- Astro-Electronics—Hightstown, N.J.
- Automated Systems Division—Burlington, Mass.
- Government Communications Systems—Camden, N.J.
- Missile and Surface Radar Division—Moorestown, N.J.
- Aerospace and Defense Staff—Cherry Hill, N.J.



Susan Handman is currently Managing Analyst, Technical Computing, at RCA Corporate Information Systems and Services. She is primarily responsible for investigation and implementation of various computing techniques and tools for use by the RCA engineering and scientific computer users. She received a BS in Mathematics from the University of Pittsburgh. After joining RCA in 1980, she provided technical support on math and statistical packages, and also worked as an engineering liaison for the shared corporate data center in Cherry Hill. Mrs. Handman is the RCA Engineer Editorial Representative for CISS.

Contact her at:  
**RCA CISS**  
**Cherry Hill, N.J.**  
**Tacnet: 222-6242**

- RCA Laboratories—Princeton, N.J.
- Solid State Technology Center—Somerville, N.J.

Engineers and scientists at these locations are now taking advantage of the speed of the IBM 3083-J processor to facilitate their heavily computer-dependent work. Already they are proclaiming the EC<sup>3</sup> a success.

### Acknowledgments

The author would like to express her appreciation for the editorial support and guidance provided by R.J. Carelli, Corporate Information Systems and Services. He spent a considerable amount of time reviewing all text matter to make it more readable.

## RCA's Computer information centers

*Throughout RCA, organizations are being formed to provide computer support to professionals.*



Illustration by Joe McGarrity

During the past four years, the term "information center" (IC) has become commonly used in the computer industry. The words bring malls, libraries, and state borders to mind because they are places where you can find information centers. The connotation of IC is a source you can go to for assistance or information. In the computer industry, it is a place or person you can go to for help with using a computer.

Information centers have become widespread because more and more people are using computers directly to perform their job. Within RCA the best estimated ratio of terminals or personal computers to "knowledge workers" is 10:1. By 1990, that proportion will approach 1:1. Although technological advances have made computers smaller, faster, less expensive, and much easier to program, considerable time and effort are still required to learn to make computers perform the functions we want

---

**Abstract:** *The term "information center" has been a buzzword in the computer industry for several years. RCA is implementing Information Centers in several of its operating units as the need grows to provide assistance to employees in their daily use of computers. This article explains what an Information Center is (as it relates to the computer industry) and details the growth of Information Centers at RCA.*

---

them to perform. Therefore, because of the increasing number of users and the difficulty sometimes involved in using a computer, there is a great need for effective support.

The number of computer information centers has grown dramatically in the last four years; approximately 80 percent of the Fortune 500 companies now have at least one. The reason for this dramatic increase has been the popularity of the personal computer, especially the IBM PC, because it "legitimized" the use of personal computers within business and industry.

### History of the computer information center

The conception of the information center is usually attributed to IBM of Toronto, Canada. In 1974, a group called the Information Center was formed to address four critical issues they felt were hindering productivity: (1) the poor service that the user community was receiving from the backlogged Data Processing (DP) department; (2) the increasing emphasis on maintenance of existing systems versus new development; (3) the "obstructive" image of DP to user requirements; and (4) the fact that four DP staff members were already spending the majority of their time supporting timesharing users.

The IBM Information Center was formed to formally offer support to IBM users who were already receiving some sort of support and to promote the use of timesharing tools. In addition, the IBM IC offered training, consultation, and technical support. The IC

group's goals were to increase the productivity of knowledge workers, enhance the image of the DP department, and reduce the backlog of programs waiting to be written by the DP department.

In 1976 and 1978, surveys were made to determine the benefits resulting from the formation of this group. The costs of the IC were easily determined, and user department heads estimated the benefits of headcount avoidance, recurring savings, and one-time savings. The analyses showed a 50-percent return on investment (ROI) in 1976 and a 100-percent ROI in 1978. The ROIs may be questioned, but the success of the IC cannot be. Statistics showing the reduction in application backlog traffic are not readily available; however, most people who have followed the growth of ICs now believe that the amount of known backlog has not been drastically reduced, if at all. I state "known" backlog here because there is an "unknown" backlog, i.e. those applications that a user would like to have but does not even request because of the size of the known backlog. This additional unknown backlog is estimated to be twice the size of the known backlog, according to a survey by the MIT Sloan School of Management. Moreover, it is this unknown backlog that the IC is interested in addressing.

The experiences of IBM Canada were formalized into a strategy that both IBM Canada and IBM United States began promoting. IBM saw it as a unique opportunity to solve their customers' problems while meeting corporate growth objectives. The strategy not only helped satisfy some

end-user needs but also encouraged IBM's clients to purchase IBM hardware and software.

IBM may have coined the term "information center" and helped ensure the success of IC strategy, but the idea has really existed for quite some time. In retrospect, information center growth has been very pronounced during the past few years. Although the concept, i.e., promotion and support of end-users who actually work with computers, continues unchanged, its implementation and scope have changed considerably. For years, universities have had "user services" departments (synonymous with ICs) to support students. Engineering organizations, which were using timesharing systems long before 1974, also have had informal support structures available to them. Such support arrangements usually consisted of individuals who were considered to be experts in the use of computing technology.

Information centers originally were developed to support mainframe or minicomputer timesharing users. The idea of having a formalized organization called an "information center" began growing steadily in U.S. commercial organizations in the late 1970s. The number and the emphasis of ICs changed between 1981 and 1983. Because personal computers have become so popular, a place where a computer novice can go to receive help with his or her new productivity tool is essential. Today, personal computers are relatively simple to use, but with a \$5,000 price tag, they can hardly be considered toys. Most information centers currently being formed are either a combination of timesharing and microcomputer support or simply microcomputer support. As software tools become easier to use, information center clients are no longer part-time programmers.

### Description of an information center

Changes in philosophy and technology have altered the roles of IC staff. The overall transition involves more than switching from the support of large-scale machines to providing support for personal computers. Booz, Allen, and Hamilton indicate that there has been a philosophical change from the "bigger is better" notion to "let's get more out of what we have," and from diversification and expansion to increasing the productivity of human resources. The information center functions as both a support organization and a control organization. As a support organi-

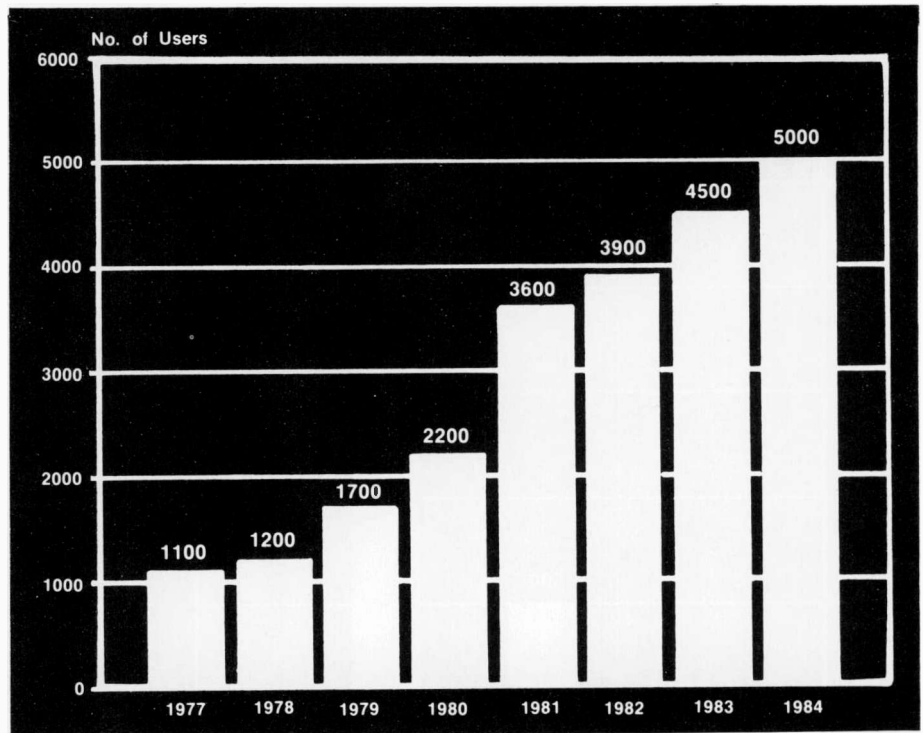


Fig. 1. The number of users accessing the timesharing services provided by Corporate Information Systems and Services has grown steadily over the past seven years.

zation, some of the roles performed by the IC are presented in the sidebar at the end of this article. As a control function, the IC may serve as the promoter of backup and disaster recovery programs, and as a filter for allowing access to corporate data. But not every IC performs all these functions. In fact, depending upon the availability of human resources and management objectives for establishing such a support arrangement, the IC may perform as few as one of these functions.

### The information center at RCA

Like most large corporations, RCA is very much aware that increasing the effectiveness of its workers is a key to its success. RCA has, through its operating units, implemented many versions of the information center concept. For several years now, RCA has been providing support for its knowledge workers who use computers, and no reference to an "information center" has ever been made. The main sources of end-user support have been the local (department or MOU) expert, the Management Information Systems (MIS) department, and, for Corporate Center use, Corporate Information Systems and Service (CISS). In most cases the local expert is an engineer or other professional who has acquired hands-on experience by try-

ing various tools on different computers. This role slowly developed into a part-time job and in some instances became recognized as an official responsibility. In the past, the local expert mostly supported individuals whose functions entailed heavy computer usage. Today, however, many people are using computers, and as a consequence the overall number of local experts has increased, and many have become specialized. For instance, you may ask one person for help with a FORTRAN program and another about using BASIC on a personal computer.

When software-related support is required, the MIS department has been the focal point for the business professional. The MIS organization's main responsibility has been to develop and maintain company-wide information systems. In the past, this support function had been a supplementary part of the MIS group's role; however, this is no longer the case.

CISS started as Information Services in 1975 and has been providing software support to RCA users as part of its timesharing service since 1978. An Education and Publications group was formed in 1977 to expand the support services offered by CISS. Services offered by the Product Support and Education and Publication groups include technical support for the access and use of software residing at the

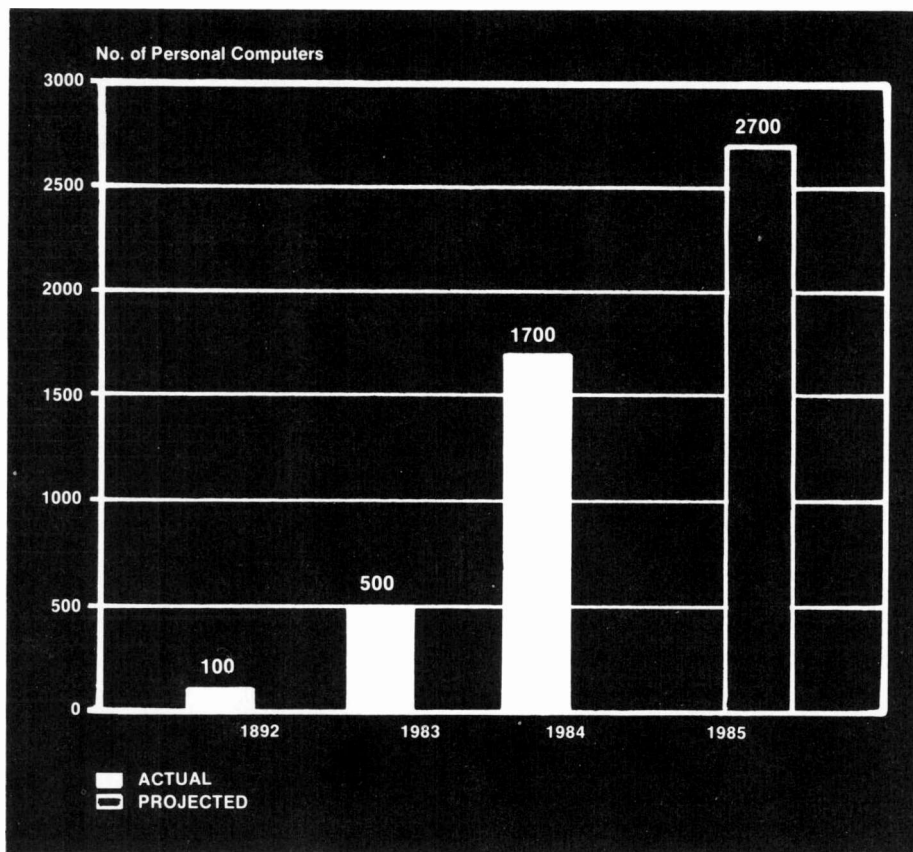


Fig. 2. Personal computers are now a way of life at RCA. Dramatic increases in the number of PCs have occurred since IBM introduced its PC in 1981.

Shared Corporate Centers, training for use of the timesharing system and other widely used products, and publications such as a monthly newsletter and user guide. The support offered by these groups has served the needs of RCA's knowledge workers quite well over the years.

Two charts show why changes regarding software support have occurred. These charts indicate how rapidly computer usage has grown over the past five years. Figure 1 represents the number of timesharing users actively using the Cherry Hill Corporate Center, and Fig. 2 represents the number of PC users. No numbers are currently available that indicate the actual number of timesharing users of RCA's many and diverse computer systems, and the number of personal computers depicted is only an estimate based on known sales by our major personal computer vendors. The projected 1985 purchase amount consists of a combination of Corporate Purchasing surveys and MOU MIS operating plans. The numbers of timesharing and PC users have both grown significantly, but the growth rate of PC usage has been far greater than that of mainframe usage.

During the past decade the needs of computer users, as well as their overall

software requirements, have changed. Current users are, in many cases, first-time or casual users of terminals and personal computers. As such, they require assistance in getting acquainted with the hardware. The requirements of these new computer users have prompted operating units, as well as CISS, to reevaluate the entire end-user support structure. The statement "let's get more out of what we have" is quite relevant throughout RCA today. Formal end-user support organizations have begun to appear in many RCA operating units. For many MOUs, computing is not something that must be introduced but, rather, something that has to be managed. By simply providing computers and software to RCA's knowledge workers, there is no guarantee that they will increase their work volume at a more rapid, less expensive rate. Assistance is required to ensure efficient, effective, and proper use of the available resources.

In 1983, CISS formed a group called Information Centers Support to promote and initiate ICs within the MOUs. In the latter part of 1983, CISS and Americom agreed to form an IC at Americom's Princeton, N.J. headquarters. As a result, this service facility became the first support

function within RCA to be called an "information center." Three other organizations followed the lead of Americom—Government Communications System in Camden, N.J., Video Component and Display Division in Lancaster, Pa., and Solid State Division in Somerville, N.J. With the exception of GCS, the organizations have named their support activities information centers. The functions performed by these groups are not identical; they are dependent on the user requirements of each operating unit. For example, at VCDD 60 IBM PCs had been distributed to engineering management and 80 more were on order when that IC was formed. At that time the main support function was for the installation and troubleshooting of PCs. Since then the situation has altered, and a more intensive effort is being made in the areas of training, hardware and software evaluation, and exchange of information. In fact, all VCDD PCs are linked on an Ungermann Bass local area network.

The underlying similarity found in all previously mentioned ICs is the concentration of effort in providing support for PC users. The Americom Information Center is a good case in point. This organization was formed to support end-users located at the Cherry Hill Corporate Center and the users of a local machine in Princeton. Support provided by the IC staff started out at about a 90-percent mainframe and 10-percent PC ratio. Within 13 months this rate has changed to approximately 60-percent PC and 40-percent mainframe.

Bill Washington, the MIS Manager for GCS, has stated that some of the benefits of starting an information center have been (1) the strategic handling of office automation/personal computers, (2) the improvement of the perception of MIS (MIS had been thought of as a bottleneck), (3) the ability to keep up to date with new technologies, and (4) the increase in productivity as a result of the efficient and effective use of computer tools.

#### Current and future status of end-user support at RCA

During the time that this article was written, nine MOUs either established or were in the process of establishing formal end-user support organizations. Two other MOUs have started learning centers—organizations designed to provide computer training for end-users (usually personal computers), and at least two more operating units have specific plans for starting

## Common information functions

- Technical support for the use of personal computer and mainframe products
- Training relative to using personal computers and mainframe packages
- Consultation on the development of end-user applications
- Focal point for access to company data
- Purchasing agent for PC hardware and software
- Personal computer installation and maintenance
- Publishing and distribution of the Information Center Newsletter
- Help desk for all computer-related problems, communications and product usage
- Development of prototype systems for end-users

information centers. Today, emphasis is being placed on the support and management of personal computer growth within each operating unit. Much effort is being concentrated in the area of training, both in specific tools and in more general computer literacy courses.

If end-user computing is to increase the productivity level of RCA's knowledge workers, the Corporation as a whole must effectively use available software tools and integrate all stand-alone equipment into one coherent unit. A term often heard these days is networking. End-users, who make the most use of software on their personal computers, often find that they need to obtain data that someone else has. As a result, PC networks, local area networks, and inter-MOU networks will

be key ingredients of end-user computing in the next three to five years. Information centers, in combination with MOU organizations, will take on more responsibility for providing users with the support required to obtain data. Moreover, ICs will provide the training and consultation necessary for using mainframe and microcomputer software. The link between mainframes and micros will become closer by next year.

## Information center support today

In 1985, CISS Information Center Support has assumed a role directed at personal computers. IC support provides assistance to the established information centers as well as to the personal computer coordinators located at various divisions. The goal of this support arrangement is to provide a focal point at which divisional support groups can interact. To facilitate the objective, quarterly user group meetings are held so that participating MOUs can exchange information about their involvement and experiences in end-user computing. A Personal Computing Issues group has been formed to meet, discuss, and prepare recommendations relative to where CISS should concentrate its efforts in the area of personal computers, and to prepare informative documents for IC use that discuss current issues in personal computing. A personal computer Bulletin Board System has been established in Cherry Hill so that anyone having a personal computer and communications capability can dial in and exchange public domain software. A Personal Computing Technology Fair is planned for 1986. It will have vendor exhibits as well as presentations made by CISS and various operating units about new technologies and what is being done by RCA in the world of end-user computing.

## Summary

The information center, defined as formal and announced support for all RCA employees who use a computer (large or



Roger Dreher is currently Manager, Customer Support for Corporate Information Systems and Services. His group provides a liaison between RCA's operating units and the corporate computer centers. They are also involved in helping operating units start information centers. Roger has an MS in Computer Science from the University of Rhode Island and an MBA from Monmouth College. He joined RCA Corporate Staff in 1978.

Contact him at:  
**RCA Corporate Staff**  
**Cherry Hill, N.J.**  
**Tacnet: 222-4264**

---

small), is a concept that has existed for some time. It has gained popularity in the last two years, and will remain a regular and important function in all RCA business units.

More information can be obtained about the CISS Bulletin Board System, the Personal Computing Technology Fair, and information centers in general by contacting Roger Dreher at Tacnet 222-4264 or via CISS's PROFS system, nicknamed RDREHER.

## Acknowledgments

The author would like to express his appreciation for the editorial support and guidance provided by R. J. Carelli, Corporate Information Systems and Services (CISS). He spent a considerable amount of time performing a comprehensive review of all text matter in an effort to enhance the overall quality of this article.

# Surface mounting technology:

## Promoting cost-effective production and enhancing package performance

*Smaller size, better performance, easier handling, and low-cost automated assembly of chip components provide new capabilities for military and commercial applications.*

In 1972, a new IC package, the leadless chip carrier, was introduced by American Lava. It held a packaging density advantage of nearly 5:1 over the popular dual-in-line package (DIP), provided a means for pre-testing and screening before attachment and interconnection onto the wiring board,

---

**Abstract:** *Surface mounting has become the prime technique for reducing integrated circuit board size by improving the packaging density. Originally developed for military applications with size and weight restrictions, this technology offers additional advantages of better performance, easier handling, and low-cost automated assembly of chip components that are now benefiting production processes in commercial industry.*

*The high density hybrid circuits based on ceramics and the lower density organic printed circuit board technologies now utilize surface mounted components and techniques. This paper presents a review of the developments leading to surface mounting technology and comparisons of the different interconnection/packaging (I/P) structures, including the associated design, manufacturing, and test technologies.*

---

and thereby increased overall interconnection/packaging (I/P) structure yield and reliability. Produced in leadless or leaded versions, this package engendered the development of surface mounted components.

Following JEDEC standardization of square chip carriers with connecting pads on 40-and 50-mil centers, a wide variety of high-density modules was designed and manufactured using surface-mounted chip carriers. In addition to its board size advantage over the DIP, the chip carrier provides improved electrical performance through shorter, more direct chip-to-package output. It is capable of handling all types of ICs, from small-scale to very-large-scale integrated circuits. Passive components in chip form are comparable in performance to their radial or axial counterparts.

Virtually any electronic circuit—digital, analog, or microwave—can be built with these surface-mounted devices (SMDs). A major benefit of SMD technology (in addition to reducing size and weight) is its potential for substantial reduction in unit production cost. Three manufacturing expense factors contribute to this savings:

1. The intrinsic cost of the materials is less: SMDs require one-fifth the board area, and therefore one-fifth the materials. Axial or radial lead passive components are more expensive because they use more material and require additional operations to attach the leads. Leadless

carriers have one-fifth the material, and require no glass-to-metal seals.

2. High-speed, microprocessor-controlled pick-and-place equipment can be used to attach the SMDs to boards. The cost of this equipment is only a fraction of the cost of DIP insertion equipment. And since SMDs can self-align during the solder reflow operation, reasonably accurate high-speed placement is sufficient to meet manufacturing requirements.
3. Because SMDs are very small, large quantities can be kept in various configurations—on tape, in cartridges, or in matrix holding fixtures. Automatic or semiautomatic high-speed loading is possible. In many cases, the high-speed pick-and-place equipment can be configured to handle parts as received from the part manufacturer without additional handling or component preparation. Reduced handling results in reduced costs.

### Basic substrate materials

High-density, surface-mounted boards are developed from a variety of circuit board materials. The most popular material is ceramic, which permits the board to match the temperature coefficient of expansion of ceramic chip carriers and, therefore, puts the least stress on the solder joint at the extreme temperatures encountered in military applications. Many materials, how-

ever, are used to produce boards. The six basic board types are the thick film multilayer board, the co-fired punched-dielectric multilayer ceramic board, the co-fired screened-dielectric multilayer ceramic board, the ceramic double-sided board, the organic mother board/ceramic baby board, and the organic printed wiring board.

The printed wiring board uses organic insulating material with copper conductors. A number of temperature stabilizing materials are being investigated to match the temperature coefficient of expansion to that of the ceramic chip carriers.

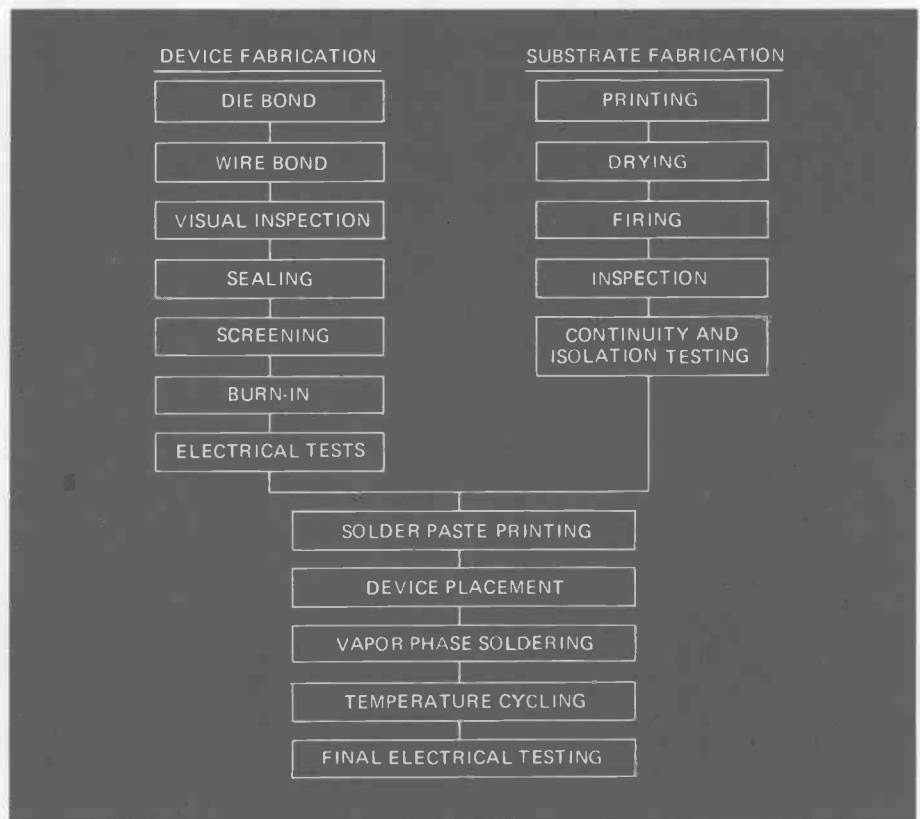
### SMD/substrate production

In many cases, SMDs are an alternative to conventional chip-and-wire hybrids. In other cases, SMDs are attached to organic boards and replace DIPs.

Fabrication of a conventional hybrid is a sequential operation—first the substrates, then the chips. The assembly process begins with die bonding and wire bonding, followed by attachment of the package to the substrate, and ends with the first electrical tests. Two basic problems arise. First, for complex chip-and-wire hybrids, it is virtually impossible to completely test the substrate by automatic equipment since adequate test-and-probe fixtures cannot be made to match the small bonding pad dimensions. Second, the first time the active devices and substrate are completely tested is in the assembled unit during the first electrical test. If either the substrate or any of the devices is defective, a large repair operation is necessary. In contrast, chip carrier fabrication is a parallel operation of chip assembly-and-test with substrate fabrication-and-test, as indicated in Fig. 1.

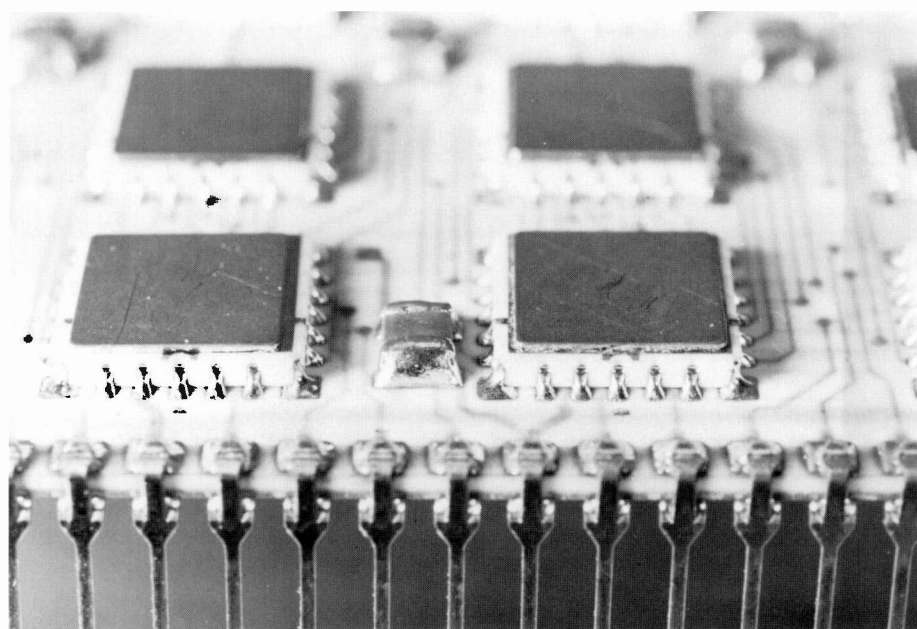
The hybrid manufacturer can buy or fabricate parts that have been statically and dynamically tested and burned in. Indeed, devices in chip carriers can be obtained to meet whatever quality level the user requires. Single devices in chip carriers are readily tested using the same testers and programs that presently exist on standard IC testers. Multiple chips in chip carriers are easily tested by a simple reprogramming of most standard IC testers. Burn-in sockets, cards, and frames are available for components in chip carriers (see Fig. 2).

The assembly procedures for attaching leadless chip carrier SMDs (LCCs) to the various board structures are basically the same. The individual assembly steps start with the probing of the board substrate and end with the assembled, electrically tested circuits.



**Table I. A comparison of LCC solder attachment techniques**

Technique	Convenient Atmosphere Control	Minimization of Time	Approximate Equipment Cost (\$K)	Process Control	Double Sided Assembly	Cleaning Ease	Volume Production Capability
Vapor Phase (Belt) see Fig.3.	Yes	Excellent	20-30	Excellent	Yes	Excellent	Excellent
Vapor Phase (Batch)	Yes	Good	10-16	Excellent	Yes	Excellent	Good
Belt Conduction	No	Good	5-10	Good	Difficult	Fair	Fair
Belt Infrared	Yes	Poor	2-10	Fair	Yes	Poor	Good
Belt Convection	Yes	Good	5-10	Fair	Yes	Fair	Good
Laser	Possible	Excellent	60-80	Good	Yes	Excellent	Very Poor
Hot Plate	No	Poor	0.1	Poor	Difficult	Fair	Poor



**Fig. 3. Solder joints of an HCC soldered in belt vapor phase solder system at a belt speed of 183 centimeters per minute (6 feet per minute).**

coating. Wheel and wave immersion coating add from 3 to 4 mils of solder height to the bottom of the LCC pad—STAT adds just 1 mil.

The optimum final height of the LCC above the substrate is of great significance in the thermal performance, environmental performance, and cleanability of the package. For maximum cleanability under the LCC, it is desirable to have a minimum clearance of 4 to 10 mils between LCC and board. The fatigue ("wearout") resistance of the LCC/substrate structure is also dependent on the solder height. The thermal dissipation of the LCC device can also be significantly affected by the spacing. Standoff spacers attached to the LCC pads may be used to control spacing to the desired specification.

### Automated assembly of circuit boards

To illustrate the key features and requirements of the automated assembly, we will discuss a representative system for the medium-and high-volume assembly of I/P structures. Two important requirements for this type of automated assembly are the standardization of the LCC and the design of a cartridge handling system for the LCC. The components are procured, pretested, and loaded in a cartridge format. Alternatively, individual, loose LCCs are cartridge-loaded, utilizing automated loading equipment. Discrete components are also cartridge-loaded.

The first phase of the automatic assembly involves translating a design input into

a circuit definition and a parts procurement list. The second phase involves pre-assembly and component preparation. At this phase, the solder is screened onto the substrate, the edge clips are cut and mechanically attached to the substrate, chip components and/or LCCs are cartridge-loaded, and the LCCs are solder-coated.

The third phase involves the assembly of the LCCs and components onto the substrate structure. This is accomplished by a high-speed, microprocessor-controlled, pick-and-place parts handling system. This system is based on self-teach programming of the controller. The cartridge-loaded LCCs and components are placed in the cartridge magazine, which is positioned by an x-positioning stepping motor to locate parts for a pick-up tray. The device is picked up and prealigned. Simultaneously with this operation, the y-motion substrate table positions the substrate at the required location for device placement. The device is then transferred from the prealignment station to the board. Components can be handled at a rate of up to 4,000 per hour with this equipment.

### Cleaning and coating processes

The cleaning process for the completed LCC/substrate structure must remove the contamination inherent in circuit board fabrication, which includes the residue from plating, solvents, soldering flux, and handling. The circuits will be degraded physically and electrically if ionic or polar residues are permitted to remain on the boards. This damage can be extended by the entrapment of non-polar organic material such as activated soldering flux. The result is degradation in the form of corrosion and the possible interference of electrical conduction between circuit paths.



A conformal coating to provide insulation and protection against contamination and degradation by moisture is essential in the manufacture of high-reliability military circuits. The conformal coating of the LCC/board configuration has to satisfy the additional requirement of adequately coating or bridging the space between the LCC and the board (4 to 10 mils, optimum).

The five major conformal coating material categories include acrylics, parylenes, epoxies, silicones, and polyurethanes.

### Board continuity and isolation testing

A necessary consideration in fabricating large, complex, multilayer substrates (with more than 500 interconnections and interconnecting 20 or more 45-pin chip carriers containing many LSI devices) is that all substrates must be tested for continuity and isolation of all networks. The greater the substrate complexity, the greater the need to perform electrical tests. This testing is very difficult and expensive to implement with conventional chip-and-wire substrates because the small pad spacing requires a complex custom probe setup. On the other hand, the pad spacing for mounting chip carriers allows fixturing in pogo-pin testers.

To accomplish accurate testing for any reasonable quantity and cost, a system is used that consists of a probe fixture and an automatic network analyzer. The probe fixtures used to test these types of boards are of two designs. The first consists of a replaceable probe head and substrate holder. The probe head is custom-fabricated for each circuit design. The pad locations are determined from the circuit artwork. The blank head is then drilled and a spring-loaded probe is fastened in place. This approach is ideally suited for testing circuits in medium and high quantity, and has the capability of handling a probe count of several thousand. Figure 4 shows two custom probe fixtures.

The second type is a universal probe system that incorporates individual reusable unit probe heads. The leads are fashioned to probe each group of pads for a particular circuit component, such as an LCC, chip capacitor, or edge clip. The probe locations are determined when the circuit is designed, and an inexpensive template is drilled with a hole configuration corresponding to each probe point. The individual blocks are then snapped into the template and a backplate is clamped on, completing the probe head.

This second probing technique is suited



**Fig. 4.** Custom probe fixtures are ideally suited for testing circuits in medium and high quantity, and can handle counts of several thousand probes.

for the 100-percent probing of a large variety of LCC-type boards with the same basic probe fixture, and affords a low tooling cost for each board type to be probed.

An automatic wiring analyzer is used to perform continuity and isolation testing of the structure. A programmable analyzer tests interconnect networks for opens and shorts at rates up to 2,800 tests per minute. Isolation test resistance limits can be programed for values from 1 megohm to 1,000 megohms; the tests are performed at voltages up to 1,500 vdc. Continuity test current limits are programmable from 10 milliamperes to 2.5 amperes; continuity test resistance limits from 1 ohm to 900,000 ohms can be programed. Continuity tests are performed at 28 vdc.

### Current and future developments

The rapid evolution of very-large-scale integration (VLSI) and the military emphasis on development of very-high-speed integrated circuits (VHSIC) are leading to the production of circuits that are again requiring excessive amounts of space when packaged in the standard 40- or 50-mil surface-mounted chip carriers. Components requiring 132 connections already exist. A new set of standards for 20- and 25-mil pad spacing have been selected that are compatible with the 40- and 50-mil standards. These are in the process of being standardized by JEDEC. Other surface mounted packages are being considered, including both smaller-spaced, peripheral-

pad packages and area grid arrays (see Figure 5).

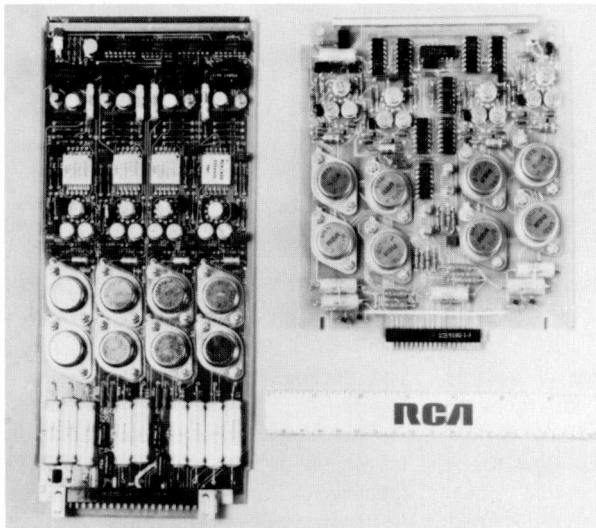
These advances in IC packaging technology, with high pin counts and close spacings, will continue to tax the design and test technologies of the future. In order to design and fabricate VLSI-based boards and systems in a practical manner, the design and test functions will have to be enhanced. With VLSI technology, today's system test problem is tomorrow's subassembly test problem. A subassembly circuit may contain up to 500, I/O connections and 10,000 networks; many of the latter are inaccessible because they are not brought out through the I/O connectors.

### Bare substrate testing

For bare substrate testing, the problems of large numbers of nodes and high circuit densities must be addressed. IC packages of the types described above produce substrate designs with circuit node densities of 200-250 points per square inch. For an 8-inch square substrate, this results in up to 16,000 points that will have to be probed. Using the present spring-loaded probe technique, a force of 1,000 pounds would be needed to mate the substrate to the probe fixture (if each probe requires 1 ounce of pressure for activation). Also, each probe must be individually wired into the tester; this presents a significant fixturing cost due to the quantity of wires, the number of connectors needed to interface the probe head with the tester, and the mechanical structure of the probe head itself.

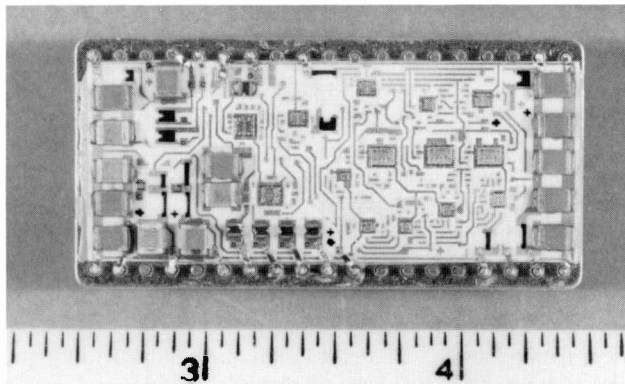
## The development of surface mounting technology

Surface mounting technology has grown rapidly in response to the demand for higher packaging density at a lower cost.



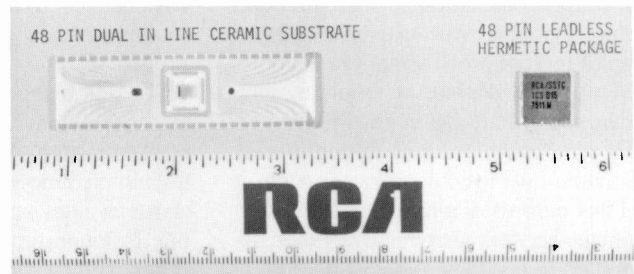
1953—Typical medium density printed wiring board modules with through-hole-mounted components.

**The 50s:** The multiple-layer printed circuit board with plated through-holes was invented in 1953. It was capable of supporting and interconnecting a modest packaging density with standardized DIP, flat-packaged, and axial components.



1965—Typical single cavity chip-and-wire thick film hybrid.

**The 60s:** Following the development of the IC with interconnected transistors in 1961, high-density packaging became feasible and popular with a surface mounting technique called chip-and-wire hybrids. In these hybrids, the IC chip was mounted directly on a ceramic substrate with multilayer interconnections that were screen-printed and fired. Resistors and capacitors also could be screened and fired. The chip was wire-bonded directly to the substrate, and the entire package was then coated or hermetically sealed. Packaging density improvements of about 10:1 were achieved with the chip-and-wire thick film hybrid over the DIP components. As the ICs became more complex, however, they also became more difficult to test at the chip level, and hybrid yield and reliability dropped to unacceptable levels.



1972—Leadless chip carrier.

**The 70s:** In 1972, American Lava introduced a new package, the leadless chip carrier, with a 5:1 density advantage over the DIP. This improvement provided a means for pretesting and screening prior to attachment and interconnection onto the PWB, thereby increasing overall yield and reliability. Produced in leadless and leaded versions, the chip carrier was the package that engendered the development of surface mounted components. In the mid 70s, Hughes Aircraft Corp., Texas Instruments and RCA, under government contract, generated outlines for JEDEC standardization of two families of square chip carriers with connecting pads on 40- and 50-mil centers. In 1976, RCA developed surface soldering production methods for manufacturing boards with chip carriers mounted on both sides; this brings the packaging density nearly equal to that achieved by the single-cavity sealed hybrid.

*This article continues on page 41 after the adjacent History section (which may be removed from the magazine).*





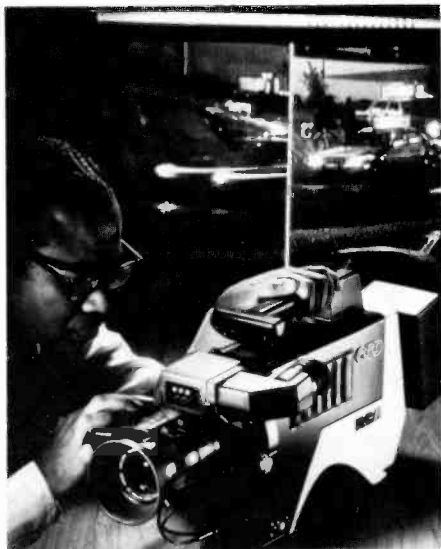
1  
2



# Part 7—The years 1977–1984

By William M. Webster

*RCA targets three major growth areas — electronics, communications, and entertainment — corresponding to its basic strengths and competencies.*



3

1. *The first AEGIS guided missile cruiser, Ticonderoga, during second sea trials demonstrated her capability to carry out her mission.*

2. *Zubin Mehta directed the New York Philharmonic as part of NBC's Live from Studio 8H series.*

3. *RCA's new solid-state CCD color TV camera eliminates many problems of tube cameras. The camera was used in 1984 at the World Series and at both Democratic and Republican Conventions.*

Of the many events that involved RCA in the challenging years 1977-1984, the most crucial was the watershed decision made in 1981 by top management to focus on those business areas offering the greatest potential for growth—electronics, communications, and entertainment. The decision was made after a long hard look at RCA's strengths, talents, and special abilities and at the industries in which RCA competes. This significant decision was welcomed because it recognized that RCA's greatest strength was, as stated by the Chairman and Chief Executive Officer Thornton F. Bradshaw, "our technological base of 6200 scientists and engineers." This group of highly talented technical people, augmented by equally talented marketing, production, and administrative personnel, is constantly meeting the challenge to bridge the frontiers of technology with the realities of the marketplace.

This seventh segment of RCA's history will focus largely on the accomplishments in these core areas. However, it will not overlook other areas of RCA business interests, including some that have been discontinued or sold, or the several very profitable ones that have remained an important part of the RCA family.

The most important management change was made in July, 1981, when Mr. Bradshaw became Chairman and Chief Executive Officer, succeeding Edgar H. Griffiths. In 1982, Mr. Bradshaw selected Robert R. Frederick as President and Chief Operating Officer.

First, let us review the highlights of RCA's electronics business during 1977-1984.

The company that introduced television to the world continued its leadership by introducing several significant innovations into RCA television receivers. One, in 1978,

was the ChannelLock color tuning system that electronically (rather than mechanically) locates and locks onto the selected TV channel, eliminating the need for a manual fine-tuning adjustment. The year 1978 also marked the introduction of charge-coupled delay-line integrated circuits that brought about a significant increase in picture sharpness and quality.

More recently, in 1984, this delay-line or "comb-filter" has been improved to extract 100% of the color information from the broadcast video signal. The increased color resolution has provided a demonstrable improvement for TV viewers.

Another source of major and continuing improvement in picture quality lies with the picture tube. First, the precision in-line matrix color picture tube, introduced in 1972, offered a more efficient energy-saving color TV system. Then, in 1982, another forward step was achieved with the COTY-29 color picture tube system. This system optimized the design of the tube, yoke, and the receiver to provide improved focus and generally superior performance and reliability with reduced system and operating costs.

RCA continued its leadership in CMOS integrated circuits by introducing a number of large-scale ICs having applications ranging from TV receivers to automotive fuel management systems. In 1981, sales of the RCA CMOS Microprocessor 1802 surpassed two million units, firmly establishing it as a leading low-cost CMOS microprocessor in the industry. By 1984 the annual RCA sales of CMOS devices, now 7% of the IC industry, passed \$200 million. RCA is well positioned in this fastest growing part of the IC business.

The VideoDisc System, introduced in 1981, was an outstanding technological achievement combining RCA's skills in

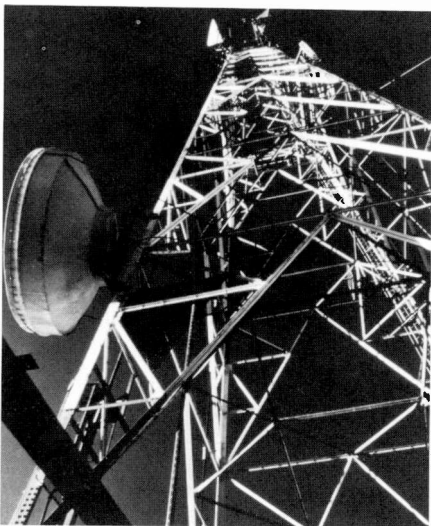
both electronics and entertainment but with a major emphasis on video signal processing. In 1984, sale of the VideoDisc player was discontinued. The sale of VideoDiscs is continuing, with more than 1200 titles available.

RCA's efforts in behalf of the country's military defense also featured outstanding achievements. One of the most important is the AEGIS weapons system, a significant advance in fleet defense. This first fully tested AEGIS system became operational in the Navy's new guided-missile cruisers, USS Ticonderoga (CG47) and USS Yorktown (CG48). To date, Congress has authorized construction of 16 CG47 class cruisers plus the lead ship in the Arleigh Burke class (DDG51) of guided-missile destroyers. The AEGIS system includes four fixed phased-array antennas mounted on four sides of the ship's superstructure, instead of conventional rotating radars. These radars can search and track in all directions simultaneously. The AEGIS weapons control system can simultaneously fire and direct more missiles at more targets with greater accuracy than any other system. The AEGIS weapon system represents the biggest defense program in RCA's history with a total dollar value since its inception in 1969 exceeding \$2.5 billion.

Another RCA innovation, the TK-47 broadcast color TV camera, was honored with an EMMY in 1981 by the National Academy of Television Arts and Sciences. With its microprocessor controls, the TK-47 automatically checks and aligns its circuitry in seconds, thereby eliminating the hour or more of manual adjustment required for conventional TV cameras.

Another EMMY winner was the circu-

4



larly polarized antenna that provides stronger signals for broadcasters in their areas of coverage.

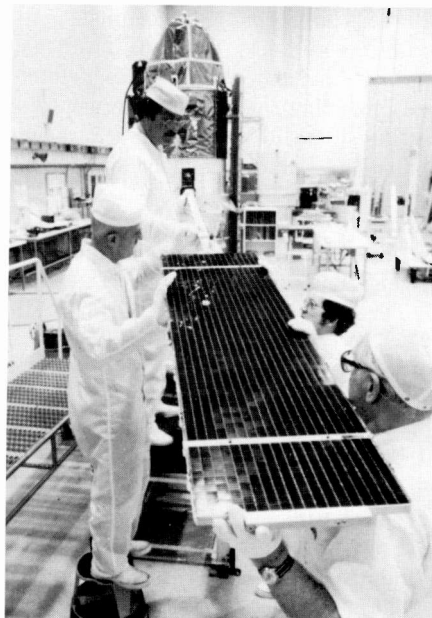
A crowning achievement in TV cameras came in 1984 with the introduction of the CCD (charge-coupled device) camera that takes pictures in very low light, has a very wide dynamic range, completely eliminates lag and fuzziness usually associated with moving objects, is very rugged, and has unique special-effects capabilities. The CCD image sensor technology employed in this camera is finding use not only in broadcast operations but in military, surveillance, and consumer applications.

It is worth mentioning at this point that RCA's traditional expertise in video signal processing has been the keystone of many of its electronics and communications activities and has helped gain and hold world leadership.

The line separating electronics and communications activities is not a sharply defined one from the technology standpoint. In fact, one could easily affirm that RCA's tremendous satellite activities are major achievements in both areas. In the 1977-1984 period, twenty five RCA-built satellites were launched, including five in 1981—making it the busiest RCA year in space since the company entered the field in 1958. These satellites have a wide range of applications including communications, weather information, search and rescue missions, navigation, and scientific studies. RCA also made major contributions to NASA's Space Shuttle program, particularly with camera equipment and radio systems.

Before we continue the highlights of

5



RCA's recent communications achievements, it is appropriate to recall that wireless communications was RCA's first business and that the RCA communications specialists today are maintaining a long-standing tradition of world leadership in international communications systems.

In the fall of 1975, RCA began to make cable television a household word by distributing Home Box Office programming to two earth stations, in Jackson, Mississippi and Fort Pierce, Florida. Four years later, there were over 5,000 earth stations in this service, and today RCA has two satellites dedicated to cable television that reach over 6,000 cable systems in the U.S.

In 1978 RCA introduced the first high-speed, high-quality facsimile service for international use in concert with Kokusai Denshin Denwa, a Japanese international telecommunications company. It now serves twenty-eight countries. Other communications services initiated during this period include telex access to and from computers, a full service electronic mail system (RCA Mail), domestic telex and leased-channel services, and a national paging service that is expanding towards a worldwide personal messaging service.

In the entertainment field, the third area of RCA's core businesses, RCA has continued its accomplishments in broadcasting, records and tapes, and has entered several new areas of home software distribution.

In the field of TV broadcasting, NBC has continued to be a leader in a dynamic, ever changing industry. Revenues, over the 1977-1984 period, have increased at an average annual rate of nearly 11 percent. Although profits declined between 1978 and 1981, they have risen since. In 1983 and 1984, NBC experienced the highest profits in its history. In the 1984 ratings, with quality programs, NBC-TV has advanced from third to second place in prime time. It has won a good share of Emmy Awards. One program alone, "Hill Street Blues," has won 25 during the 1981-1984 period. The new CCD camera, mentioned earlier, was introduced by NBC and used in the 1984 World Series to achieve some remarkable slow-motion

6



4. *Microwave relay antenna towers, used by RCA Network Services, transmit voice and data among RCA's major locations between New York City and Camden, N.J.*

5. *Technicians at RCA Astro-Electronics attach a solar array panel to the U.S. Navy's NOVA-1 navigation satellite. Nova satellites were launched in 1981 and 1984.*

6. *"Nipper" originally joined RCA with the acquisition of the Victor Talking Machine Co in 1929. The trademark was brought back into use in 1978 for consumer and commercial products.*

7. *The Control Center of RCA's Dimensia Audio/Video System communicates commands to audio and video components providing remote control. The user simply enters a command, and the microcomputers carry it out, allowing multiple functions to be operated simultaneously.*

8. *RCA offers a wide choice of color video cameras, including the incredibly light (only 35 ounces) "Small Wonder."*

9. *Computer controls the placement of circuit-board components for a color TV chassis at RCA Consumer Electronics' Bloomington, Ind., plant.*

action scenes that would not have been possible with a conventional tube-based broadcast camera.

RCA Records during the 1977-1984 period increased its share of the market both world-wide and in North America. In addition to records and cassettes, RCA began to market laser-based digital Compact Discs and became distributors throughout the United States and nine foreign countries of video cassettes for Columbia Pictures. It expanded its record clubs by launching a

Compact Disc club. In 1984 it began a year long celebration of Elvis Presley's fiftieth anniversary. To date, over one billion copies of Presley's recordings have been sold by RCA.

The subsequent text is a more detailed coverage of the historical highlights and accomplishments of RCA during the 1977-1984 period. The author owes considerable gratitude to the divisions and subsidiaries of the RCA Corporation for their help in the completion of this history.

## Electronics—RCA Enhances Its Heritage

### Consumer Electronics Division

In the years 1977 through 1984, RCA continued on a "fast track" in terms of technological developments and in rapid expansion of the video products market. The period properly can be characterized as one in which RCA continued at the forefront of the "video revolution" with significant advances in color television receivers, with entry into the marketing of video cassette recorders (VCRs) and the early assumption of a leadership position, and, near the end of the period, with the introduction of broadcast stereo and "Dimensia," a dramatic new concept in audio/video system control.

In early 1977, RCA announced the introduction of its XtendedLife television receiver chassis. Because the chassis requires reduced operating power, less than that used in a 100-watt electric light bulb, the

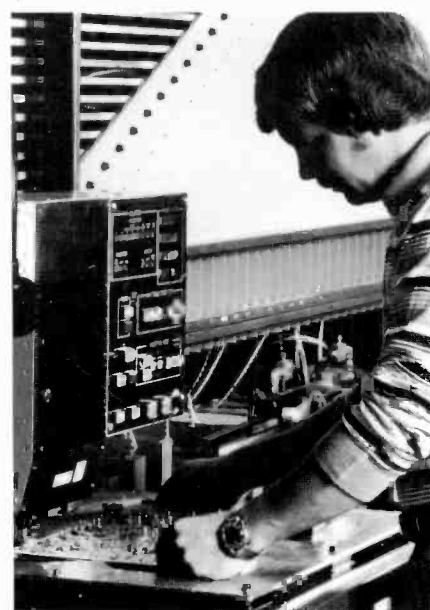
potential operating life of the receiver is extended. The XL chassis first was incorporated in XL-100 models and then just a few months later it was incorporated in ColorTrak models. By mid-1978 all RCA color receivers utilized this energy-saving chassis.

1978 also witnessed the use of large-scale integrated circuits (LSIs) in new RCA ColorTrak receivers to eliminate the need for fine tuning, a manual control that had

8



9



7



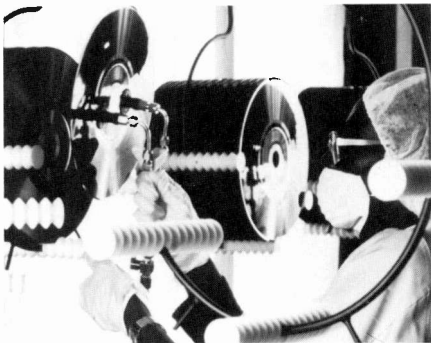
been part of television receivers since the introduction of color in 1954. Called ChannelLock, the tuning system is based on an RCA-developed frequency-synthesis system using a precision quartz crystal that automatically matches the exact station frequency and locks in, ending tuner drift that can distort colors in the picture.

The period 1977-1984 was also significant for RCA in terms of the VCR distribution business, which it entered near the end of 1977. The company aggressively pursued this new business opportunity with heavy investments in advertising and promotional programs. These programs together with careful choice of product specifications and capabilities led to RCA's becoming the recognized leader in VCR marketing. New products included programmable recorders, portable recorders (some with on-screen display graphics to facilitate remote programming), and the introduction of associated color cameras, like the 2.2-pound RCA "Small Wonder."

Other developments during the 1977-1984 period included:

- First, as an interim step, the addition of the capability of receiving mid-band cable television channels on some models of color receivers. This step initiated the development program for RCA's frequency-synthesis, multiband tuning system that by 1982 led to receivers having 127-channel tuning capability.
- Emphasis on the remote control feature for color receivers. Remote control receivers accounted for 35 percent of all RCA color television unit sales in 1981, a growth that is continuing.
- Entry into the promising projection television business in early 1981. These large-screen television receivers are a natural for the "videophile" and RCA has made significant advances in picture brightness and resolution.

10



□ The introduction, beginning 1980, of a line of high-technology color monitor receivers particularly suited for use with video cassette recorders, video games, and home computers. These monitors have been enthusiastically received by the American consumer.

□ In mid-1984 the introduction of color TV receivers having the built-in capability for receiving broadcast stereo transmissions. These receivers also include a "second audio program" channel offering the broadcaster a variety of options including the audio programming of a second language.

□ Near the end of 1984 the "marriage" of audio and video in a new audio/video system called "Dimensia." Using extensive computer technology, this product is the first consumer system to wholly integrate a variety of audio/video components into a full-function media center, providing simplified operation and full remote control of each component, independently or in concert, by means of a single remote device.

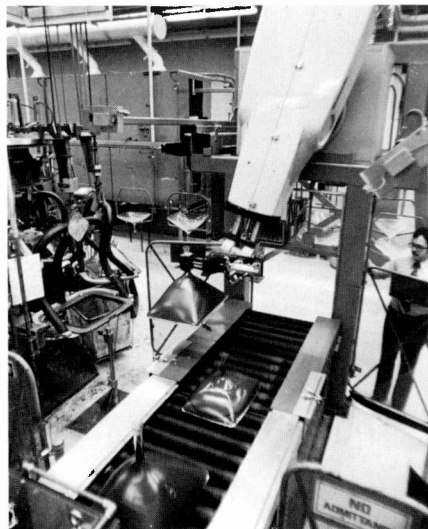
### Video Disc Venture

In March of 1981, RCA introduced its "SelectaVision" VideoDisc system to the general public, culminating more than 20 years of research and development. The 12-inch plastic discs, which resemble audio long-play records in appearance, contain up to one hour of prerecorded audio and color video information on each side. The video disc player can be attached to any television set for playback.

In developing the video disc system, RCA scientists had to advance the state-of-the-art in several technologies by developing:

- A method of recording a spiral groove over 7 miles long, having over 10 thousand turns per inch.

11



□ Optical, mechanical and electron beam techniques for recording signal elements as short as one millionth of a meter on the disc master.

□ Signal systems for providing processed TV pictures and audio signals, synchronized for either mechanical or electron-beam recording on a disc master.

□ Methods of making suitable metal stampers and plastic discs from the masters.

□ Technology in fabricating an unprecedented new stylus having a tip less than one tenth the size of those used for audio records.

□ Ultra-sensitive circuitry to detect capacitance variations between stylus and disc surface.

□ Players capable of tracking the finely pitched grooves and processing record information into electronic signals that provide full color pictures and stereo sound.

The "CED" (capacitance electronic disc) system is a widely acknowledged tribute to the skill and ingenuity of RCA scientists and engineers.

When the playback-only video disc system was introduced, RCA management recognized that it would be successful only as long as it could maintain a substantial price advantage over the video cassette recorders, which offered consumers the additional ability to record off-the-air or with a home TV camera. The combination of steep price cuts on VCRs and the availability of inexpensive cassette rentals, however, eroded the sales of video disc players and in 1984 forced RCA to halt player production. The company continues to manufacture video discs and there are more than 1,200 "CED" titles available to consumers.

12





10. Video discs are pressed and then sprayed with a special solution at the manufacturing facility in Indianapolis.

11. Giant mechanical arm used for transporting funnels for color TV tubes from a coating machine to a conveyor at the Scranton, Pa., plant.

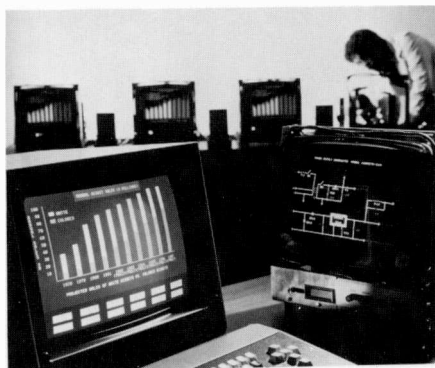
12. Interiors of color television picture-tube faceplates—already treated with a photosensitive phosphor solution—are exposed to ultraviolet light in a mechanized screen room.

13. High-resolution display tubes for computer-graphics applications being tested in 1981 at RCA's facility in Lancaster, Pa.

14. A designer is shown using a graphics terminal for computer-aided design and manufacture. More than 150 personal computers and graphic design terminals were introduced into the VCD Division as part of a multiyear program.

15. Computerized equipment is used to check performance of electron beams in color picture tubes. The large coils surrounding the tube are used during tests to provide control of ambient magnetic conditions.

13



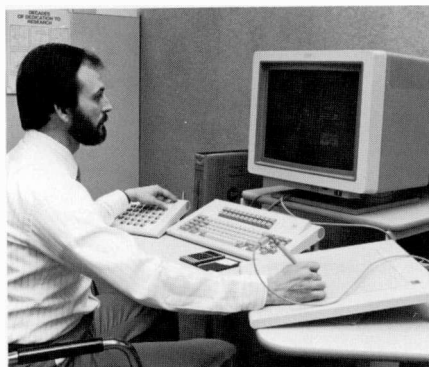
## RCA Video Component and Display Division

Throughout the history of commercial television and particularly since RCA scientists pioneered the shadow-mask color TV tube, RCA has held a leading role in the production and sales of picture tubes. RCA celebrated the 25th anniversary of the shadow-mask tube in 1979, and by 1984 RCA and its affiliates had produced over 130 million TV picture tubes. Of these, 90 million were color and 40 million were black-and-white picture tubes. RCA discontinued black-and-white production in 1977 to be better able to support the growing demand for color.

By 1978, RCA's line of precision in-line matrix color picture tubes, which supported the more efficient energy-saving color TV system, was well established not only in the U.S. market but also in Europe. In 1982 RCA reasserted its technical leadership with the commercial announcement of the COTY-29 program (Combined Optimum Tube and Yoke, having a neck diameter of only 29 millimeters). Its improved focus and miniaturized yoke resulted in savings in materials costs and a reduction in the deflection power required. This advance was followed in 1983 with the COTY-FS (Full Square) color picture tube featuring a rectangular screen, i.e., one having straight sides and square corners, and, consequently, a larger viewing area. The latest version (1984) COTY-SP (Square Planar) has a nearly planar screen edge, a much flatter faceplate, and a rectangular screen. These new tubes represent the first major change in industry screen size and format in 13 years.

The period 1977-1984 brought about some interesting developments in picture tube manufacture. In 1981, worldwide overcapacity for color picture tubes compounded the impact of the general economic situation and made it difficult to maintain ade-

14



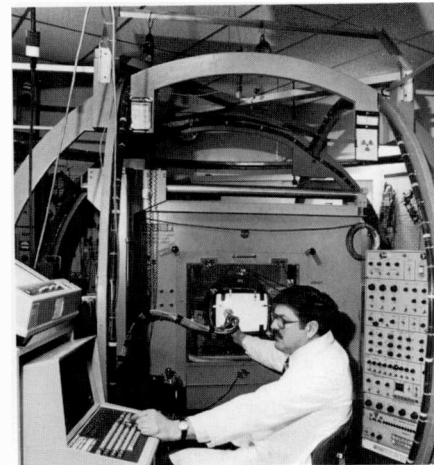
quate profits. Consequently, major steps were launched to improve operating efficiencies in all areas of the business. Among them were the decisions to end the partnership arrangement with VideoColor (France) and, in 1982, to close the Midland (Canada) plant.

The technology portion of the international business, however, was very active. From 1978-1983 RCA sold color picture tube manufacturing equipment to the U.S.S.R.; in 1982, a 7-year equipment and technology transfer contract with Poland was successfully completed; and in 1984, top-level discussions were held with the People's Republic of China with the goal of establishing a joint program. In addition to the profit opportunities, these efforts reinforced RCA's technical image and contributed to its domestic position of strength and leadership.

During this period, a number of production advances also were made. In 1978, three Unimate robots were installed in Scranton, marking the beginning of a focus on automation in the manufacturing plants. From this modest start, the effort grew over subsequent years to include highly automated screen rooms and computer-controlled or monitored equipment of all kinds. The rising cost of labor coupled with the rapid advances in computer technology has tipped the scale dramatically toward greater automation efforts.

The Picture Tube Division was renamed in 1983 as the "Video Component and Display Division," signifying a new charter to pursue OEM sales of video display products for computer and other major commercial and industrial applications, as well as to sustain its traditional role as a major supplier of color picture tubes to the TV industry. RCA entered the color data-display CRT

15



market in 1982 with a high-resolution tube having a 13-inch diagonal and 90-degree deflection angle.

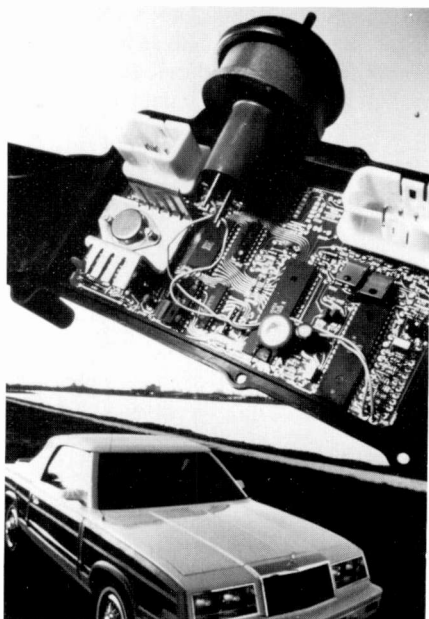
A line of monochrome and color monitors was introduced to the computer market in 1984. Monitor design efforts draw on the expanded engineering capabilities of the Consumer Electronics and New Products Divisions. Existing manufacturing facilities in these divisions are utilized to produce the display monitors. The RCA Laboratories provide the extensive research and development support required for future products.

**Solid State Division**

In 1977-1984 RCA continued to maintain leadership in CMOS integrated circuits through cooperative efforts by the engineering staffs of the RCA Solid State Division, the Solid State Technology Center, and the Laboratories. The RCA-invented CMOS technology, which made digital watches and hand-held calculators possible, has been at the forefront of RCA's solid state efforts. RCA is one of the few manufacturers to offer a total line of CMOS logic products. During this period, RCA introduced a very large number of new integrated circuits having applications ranging from television receivers to automotive fuel-management systems.

In 1977, RCA Solid State introduced a single-package IC for television receivers that replaced three ICs in use only a year earlier. The result was a simpler and more reliable chassis having an added feature,

16



automatic tint control. Other RCA IC designs for TV receivers are described in the Consumer Electronics section of this history. Throughout 1977-1984, RCA Solid State introduced a large number of linear and digital ICs designed for specific applications. In many cases, ICs were also designed and manufactured for specific customers throughout the electronics industry, including the military and aerospace, for whom high reliability has been a major requirement.

In 1981, the company produced new ICs for both the U.S. and European automotive markets. RCA introduced the first commercially available ignition control IC in 1981. In 1983, Chrysler chose RCA as the major supplier for the microprocessor for the spark-control computer system to be used in 1985 models.

Because the RCA-developed CMOS technology offers low power consumption, good reliability, and high speed, a number of new applications for large-scale integrated circuits (LSI) using the CMOS technology appeared late in the 1977-1984 period. These applications included automotive fuel management systems, pollution and timing controls, portable instrumentation and equipment, and implantable medical electronics. Also in 1981, the sale of the RCA CMOS 1802 microprocessor surpassed 2-million units, firmly establishing this device as a leading low-cost CMOS general microprocessor system in the industry.

The latter part of this period also saw a trend toward alternate-source agreements and joint ventures in the semiconductor industry. RCA was a participant in this trend. In 1981, RCA broadened its line of

17



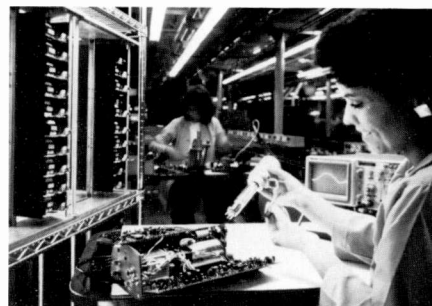
microprocessors by obtaining the right to produce and sell Motorola's 8-bit CMOS microprocessor design. In 1982, RCA signed an agreement with Philips of the Netherlands for a joint development of high-speed CMOS logic chips, known as QMOS. QMOS devices are important because they include high-speed CMOS replacements for LSTTL devices in existing designs and also low-power all-CMOS designs for new digital systems. In 1983, alternate-source agreements were completed with LSI Logic, Inc. for semicustom gate arrays. In 1984, RCA announced a joint venture with Sharp Corporation, a Japanese electronics company, to engage in the design, development and fabrication of CMOS VLSI integrated circuits in the United States.

During the later half of 1977-1984 period, the semiconductor industry was rapidly becoming aware that the CMOS technology, which RCA invented in 1962, was the technology of the future for large scale integrated circuits. RCA's experience and expertise in CMOS put the company in a firm position for rapid and healthy growth with this product in the years beyond 1984.

**New Products Division**

The New Products Division, headquartered in Lancaster, Pennsylvania, was created in late 1983 to implement RCA's strategy of increasing new-business development within the electronics area. The Division is organized to plan, develop, manufacture, and market new electronic products. It was formed with a base business of RCA's exist-

18



16. Many engine functions of Chrysler automobiles are monitored and controlled by an advanced electronic engine-control kit composed largely of integrated circuits produced at RCA Solid State Division.

17. A "carousel" of integrated circuit wafers is lowered into an ion implantation chamber at RCA Solid State, in Somerville, N.J.

18. An employee inserts a silicon-intensified target (SIT) tube into a surveillance-type TV camera at New Products Div., Lancaster, Pa.

19. Charged-coupled device used as image sensor in solid state color television cameras, such as the RCA CCD-1 broadcast camera.

20. The 320-lb. electronic vacuum-switch tube, manufactured in Lancaster, Pa., and delivered to Princeton University in 1978.

21. At D&SP's warehouse in Deptford, N.J., orders are processed and an inventory of thousands of items is maintained by computer.

19



ing closed-circuit video equipment, power tube and other electro-optics components activities.

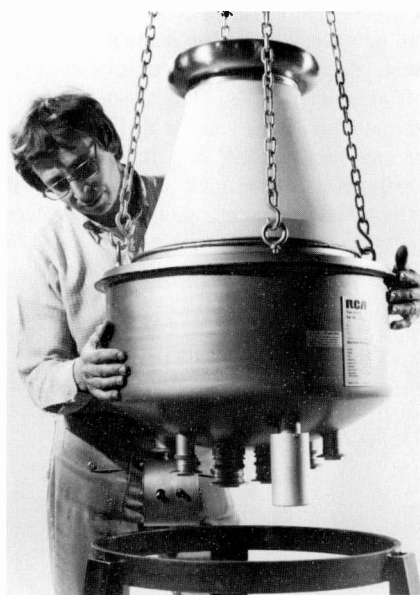
The division encompasses several different businesses participating in unrelated markets. The largest is the Closed Circuit Video Equipment (CCVE) line. A leader in its marketplace, this division manufactures closed-circuit television cameras and monitors. It also purchases and resells various accessory products such as tape recorders, time/date generators, motion detectors, and other installation accessories. RCA's CCVE products are sold to banks, supermarkets, shopping centers, department stores and the like, as well as to Government installations.

A product line for many years is NPD's Tube Operations. In the Tube Operations, RCA's power tubes have given the company a leading position in the VHF transmitter tube market and a solid position in specific military applications for radars, communications, and countermeasure systems. Power Tube Operations is also heavily involved in the government's Fusion Research Program for energy development.

NPD's Tube Operations is also the world's largest manufacturer of Silicon Target Vidicons (trademarked Ultricons), for low-light-level closed-circuit television.

Photomultipliers and high-resolution display tubes completed the Tube Operations' product line.

New Products Division is responsible for



the development and production of solid-state imagers, known as charge-coupled devices (CCDs). These devices are also mentioned in connection with the Broadcast Systems Division's new color TV camera.

NPD also operates a Solid State Emitters and Detectors product line, headquartered in Montreal, Canada. High-performance light-emitting diodes, solid state injection lasers, IR photodiodes, and avalanche photodetectors have given RCA a leadership position in many military and telecommunications applications.

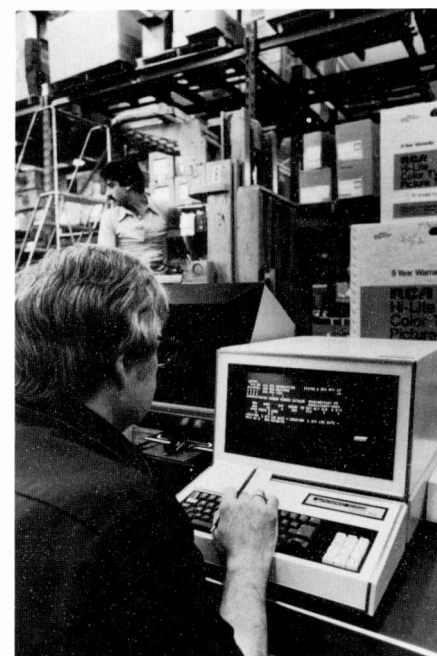
### Distributor and Special Products Division

During 1977-1984, the RCA Distributor and Special Products Division focused on its major role of marketing parts, components, and accessories through a network of more than 500 electronics distributors.

From a vast inventory of some 80,000 separate items, the Distributor and Special Products Division provides replacement parts and components to support RCA electronic equipment throughout the world. Many of the Division's products are also used in equipment of other manufacturers and are marketed for general industry use.

In order to capitalize on the tremendous growth in VCR instruments, the division entered the VCR accessories business in 1982. This new business activity was a natural outgrowth of the TV accessories business in which the division had been involved. In 1983, the division further broadened its base in VCR-related products by adding blank video tape. Both of these new busi-

21



nesses show exceptional promise for future growth.

Other products marketed by the division include RCA exact replacement parts, solid state devices, receiving tubes, picture tubes, and industrial tubes.

The Division's products are utilized in equipment ranging from TV sets and other consumer instruments to sophisticated manufacturing and broadcast systems. The items vary in size from microscopic solid state devices to huge transformers. The division's warehousing and shipping facilities cover more than 26 acres, equivalent to seven football fields.

**Broadcast Systems**

The 1977-84 period saw RCA Broadcast Systems record peak sales, growth and profits during the early years, followed by a sharp contraction of sales, with severe operating losses during 1982-84.

Camera design activity during this time was maintained at a high level. The innovative TK-76 portable camera, introduced in 1975, was an engineering and marketing success. In five years, more than 3,000 of these cameras were put in operation in 50 countries.

The TK-47 automatic color camera introduced in 1979 was a microprocessor-based design that permitted fast, automated setup and established new standards for camera performance, stability, and reliability. The automatic features

22



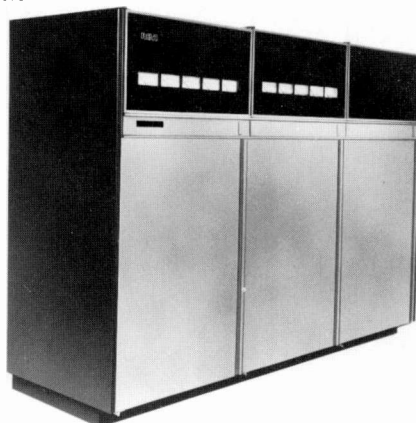
were adapted to telecine (film to video transfer) with the introduction of the TK-290 automatic telecine system. The TK-290 utilized the same set-up terminal as the TK-47, allowing operation as an integrated system with attendant economies. In 1984, RCA announced the TK-48 automatic color camera having added features and expanded software capability for enhanced performance.

Clearly, the technological achievement of the 1982-84 period was the development and introduction of the CCD-1 (charge-coupled device) camera. This solid-state camera represents a significant breakthrough because it eliminates problems associated with conventional tube-type cameras—tube replacement, lag, comet tailing, image burn-in. Used by NBC in 1984, delivery to others began in 1985.

A key new product, the TR-800 one-inch videotape recorder developed in the late 1970s, was expected to generate excellent sales as a replacement for aging quadruplex videotape machines. However, although the product design included many advanced features, it proved difficult to manufacture and required extensive field servicing. Consequently, the TR-800 was discontinued and inventory written down, contributing substantially to 1982-1984 operating losses.

For videotape, a new half-inch ChromaTrak recording technique was developed in 1983 utilizing VHS videocassettes, yet achieving video quality approaching that of the far more expensive one-inch VTRs. The new format was the basis for the one-piece recording camera, a unique concept introduced by RCA. The system was a technological achievement and RCA earned an engineering "EMMY" in 1983 for its development. The lack of standards in half-inch videotape recording, however,

23



hampered industry acceptance of the format, and the system has not achieved anticipated market penetration.

Among the bright spots throughout the period was the continued broadcaster preference for RCA television antenna and transmitter products. A new line of advanced solid-state VHF transmitters was introduced in 1979 and expanded to cover 26 models in power levels from 10 kW to 100 kW. More than 100 of these G-Series transmitters were delivered in the first two years. The transmitter line was extended in 1984 with the announcement of a solid-state 100-kW UHF transmitter, an advanced design system utilizing high-efficiency klystrons.

In 1979, RCA completed erection of the world's largest multiple TV antenna on top of the 110-story World Trade center in New York City. The 351.5-foot RCA antenna tower accommodates antennas for 10 TV stations and 15 FM radio stations.

Circular polarization of TV signals to improve reception and reduce ghosts and similar reflections became increasingly popular, and RCA was ready with a range of innovative antenna designs. In 1984, the division was awarded an engineering EMMY for its pioneering role in the development of circular polarization for broadcast television.

Broadcast Systems entered a "new beginning" in 1984 with the move from Camden to Gibbsboro, N.J. A new building with administrative, engineering, and production facilities was completed in the early fall and was fully operational by

24



22. The microprocessor controls of RCA's TK-47 color TV camera provide automatic set up and alignment—features which earned it an Emmy Award in 1981.

23. The G-line of VHF Transmitters developed by RCA now includes 26 models covering power levels from 10 kW to 100 kW.

24. RCA designed antenna atop the World Trade Center's north tower in New York City is "topped out," as signified by the American flag attached to last antenna section put in place.

25. Electronic Computer-Originated Mail (or E-COM) system for the U.S. Postal Service under test at RCA Government Communications Systems in Camden, N.J.

26. Extensive testing of the AEGIS system is carried out by resident Navy crew and RCA engineers under computer-simulated battle conditions at the Navy's Combat System Engineering Development site.

25



year end. This move consolidated all operations of Broadcast Systems with the already operational Antenna Systems unit in Gibbsboro.

### Government Systems Division Missile & Surface Radar

The RCA Government Systems Division (GSD) work on the Navy's AEGIS weapon system represents the biggest defense program in RCA's history. The total dollar value since the program's inception in 1969 exceeds \$2.5 billion. AEGIS can simultaneously and automatically detect, track, and engage multiple missile, aircraft, surface, and subsurface threats.

Built around a highly sophisticated radar system developed by RCA, the AEGIS system takes advantage of advanced electronics technology in radar, command and control data processing, and communications. The system uses novel designs and circuitry, including specialized integrated circuits.

The primary mission of AEGIS ships is to destroy hostile aircraft, missiles, submarines, and surface ships in order to prohibit their employment against U.S. forces. AEGIS ships are normally assigned to carrier battle groups or surface action groups. RCA's dual role in the AEGIS program is unique in the history of U.S. Navy Contracting. The Corporation is the first independent contractor to be selected to perform systems engineering for a total ship combat system. RCA is also the first to serve as prime contractor in the development, production,

integration, and testing of a complete weapon system for the Navy. In 1984, RCA Missile and Surface Radar received a contract for the design and development of the AEGIS Combat System that will be installed in the DDG51 class of guided-missile destroyers. The lead ship in the multiyear building program will be named *Arleigh Burke*, after the famous World War II destroyer commander and later Chief of Naval Operations. DDG51 is scheduled for commissioning in 1989.

### Government Communications Systems

During 1981, RCA Government Communications Systems, part of GSD, developed and installed for the U.S. Postal Service an electronic communications (E-COM) system that enables volume mailers to electronically send computer-originated statements and letters to 25 cities. The E-COM system was operated successfully from 1982 through 1984.

Among many communications programs, Government Communications Systems provides Integrated Radio Rooms for Trident ballistic missile submarines. Developed under a series of Navy contracts, the advanced system controls submarine communications from a single console. The system gives Trident commanders a wider range of communications capabilities than ever before. The Integrated Radio Room also has potential applications for other submarines.

Another computer-controlled communi-

26



cations system is being produced for the Navy's CG47 class cruisers. Designated the Integrated Voice Communications Systems (IVCS), it uses two computer-assisted switching centers to automate shipboard telephone communications traffic. The system can be expanded to handle 2,000 to 3,000 communication stations on large ships, such as aircraft carriers. The AEGIS IVCS is an advanced version of equipment developed by GCS for the Navy's LHA assault ships.

Government Communications Systems also developed a family of small super-high-frequency satellite communications terminals for the U.S. Army and U.S. Air Force. Transportable by trailer or light truck, they are designed to provide short- or long-range communications within 20 minutes after arrival at a chosen site.

**Government Volume Production**

A new separate business unit, RCA Government Volume Production, was established to handle production programs like that for the SHF satellite communications terminals. This business unit, which shares facilities with RCA Government Communications, handles major production contracts for U.S. government customers. One of its first programs is a contract to build 111 transportable ground stations and related equipment for the Air Force's satellite communications networks. This five-year production contract calls for delivery of four types of ground stations and 250 low-rate multiplexers. Initial production includes a large contract for secure-communi-

27



cations equipment that was an outgrowth of a research effort performed by RCA under government contract. Later, the production program was expanded several times. In late 1983, RCA was awarded a secure-communications production program based on an equipment design provided by the government. This program is being fulfilled by Government Volume Production.

**Automated Systems**

Automated Systems (AS), a business unit of GSD in New England, achieved a rapid annual growth rate through the years 1977-1984, mainly through its leadership in developing automatic test equipment (ATE) for electronic, communications, and automotive equipment. EQUATE, a third-generation tri-service ATE-system was selected as the U.S. Army standard for depot and intermediate-level maintenance. Systems are being delivered worldwide to support every major combat system and combat support system in Army inventories into the 21st century. Through the years to 1984, 145 EQUATE Systems were ordered and 114 delivered, with total contract values exceeding \$300 million.

AS's vehicle test system capabilities carried over to solve a more fundamental Army testing problem. Simplified Test Equipment (STE) was developed for soldiers to perform complex diagnostics on military vehicles in the field. In 1981, the David Sarnoff Award for Outstanding Technical Achievement was presented to the AS team for its work on STE, and over 7,000 test sets were delivered to support the M-1 Abrams main battle tank, the M1/M2 Bradley fighting vehicles, and all other Army combat and training vehicles.

Another David Sarnoff Award was granted



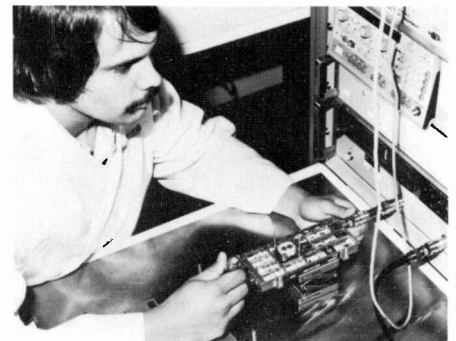
to AS for the development and production of the AN/GVS-5 hand-held laser range-finder. The AN/GVS-5 is part of AS's Command, Control, Communications and Intelligence business area, which developed TCAC (Technical Control Analysis Center), tactical and strategic terminals and REM-BASS (Remotely Monitored Battlefield Sensor System), among other products. These systems represented a wave of emerging technologies that are being applied to new military readiness requirements.

**Astro-Electronics**

The entire 1977-1984 period was a major one for the space endeavors of RCA Astro-Electronics. Twenty-five RCA-built satellites were launched into space since the company entered the field in 1958. Seven RCA Satcom domestic communications satellites were operating until RCA Satcom I was retired on June 4, 1984, after eight and a half years of service. RCA Satcom II continued in operation, along with the other satellites in the RCA network: III-R, launched in 1981; IV and V, launched in 1982, and I-R and II-R, launched in 1983. Satellites V, I-R, and II-R are Advanced RCA Satcoms equipped with highly reliable all-solid-state power amplifiers. Each spacecraft contains 28 C-band 8.5-watt amplifiers in a redundant configuration that allows 24 operating channels.

Astro Electronics entered a major expansion program and put into operation a worldwide launch control network for tracking, monitoring and control of communications satellites as they orbit the Earth prior to being placed into equatorial orbits.

29



27. Navy personnel work with an integrated radio room at RCA Government Communications Systems in Camden, N.J.

28. Mechanics use simplified test equipment built by RCA to test and diagnose problems in the U.S. Army's M1 Abrams Main Battle Tank.

29. Testing of one of the solid-state power amplifiers used in the communications satellites built by RCA Astro-Electronics.

30. Computer-aided design of solid-state circuits at the Advanced Technology Laboratories.

31. At the Solid State Technology Center, Somerville, N.J., automatic bonding of wires within an integrated circuit device known as a 64-lead flat pack.

32. RCA Service Company is known for its nationwide network of service centers providing prompt, reliable home service of RCA TV sets, and certain other appliances.

30



The network placed RCA in a leading position in commercial satellite control operations.

Also placed into operation by RCA was the nation's largest clean-pumped thermal vacuum chamber for testing satellites in a simulated space environment. The chamber can test half of a Space Shuttle payload, including 15-ton spacecraft measuring 35 feet by 15 feet.

Astro-Electronics started work on four RCA Satcom Ku-band satellites. (The first two satellites were scheduled for launch in 1985.)

Also received were the following contracts for communications satellite systems:

- Four dual-band "Spacenet" communications satellites for GTE Spacenet Corp. Spacenets 1 and 2 were successfully launched in May and November 1984. Spacenet 3 is scheduled for launch in 1985.

- Also for GTE, four Ku-band "GSTAR" communications satellites. GSTAR-1 is scheduled for launch in 1985.

- Three dual-band domestic communications satellites for American Satellite Co. First launch will be in the summer of 1985.

- A contract from NASA to design and build an Advanced Communications Technology Satellite (ACTS) and supporting ground stations.

- Direct Broadcast Satellites for Satellite Television Corp. and United States Satellite Broadcasting Co. Inc. These satellites will broadcast directly to homes by way of inexpensive, 24-inch diameter, dish-shaped rooftop antennas.

In addition, Astro-Electronics continued to build Advanced TIROS-N weather satellites for the National Oceanic and Atmospheric Administration (NOAA), as well as the U.S. Air Force's Block 5D defense meteorological satellites. More than 50 weather satellites have been launched

31



since 1960, when TIROS-1, the world's first weather satellite, was launched.

The NOAA-8 and -9 spacecraft were the first American satellites equipped to assist in search and rescue missions. The number of persons saved with the help of these spacecraft reached 400 by the end of 1984.

In other space developments, RCA-built NOVA navigation satellites were launched for the U.S. Navy in 1981 and 1984, and NASA dual-launched a pair of Dynamics Explorer scientific satellites in 1981 to study the interactive coupling between the Earth's magnetosphere, ionosphere, and plasmasphere.

The Corporation also played a major role in NASA's Space Shuttle program, with RCA equipment and services involved in each flight from liftoff to touchdown. Shuttle missions carry as many as eight television cameras that were designed and built by Astro-Electronics. The shuttle's UHF radio system was developed by RCA Government Communications Systems.

## RCA Service Company

During 1977-1984, the RCA Service Company set new sales records annually. By developing new advanced-technology businesses, expanding existing businesses, and cultivating new servicing opportunities, the Company has met the increasing needs of its consumer, commercial, telephone, data, and government markets.

Consumer Services, while building and maintaining a customer base of more than one million service contracts on RCA home entertainment products and Whirlpool appliances, expanded its service capabilities significantly in the past three years. In 1983, the Service Company assumed the

32



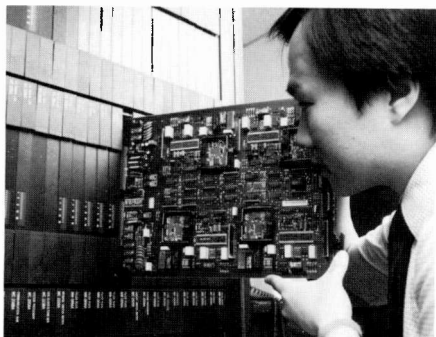
responsibility for the nationwide servicing of JCPenney home electronics products and microwave ovens, accounting for an additional 440,000 contracts in force. Also in 1983, Consumer Services helped launch the first direct broadcast satellite (DBS) home TV service, installing and maintaining small earth stations and peripheral equipment. In 1984, Consumer Services initiated a test of the microcomputer service market in the home and small business environments.

The Service Company's Commercial Products activity maintained its leading position in providing commercial television receivers and a wide range of communications and entertainment products to the lodging, healthcare, educational and industrial markets. In 1983, RCA began marketing a satellite TV receiving system and premium entertainment programming packages for hotels and motels. Also in 1983, RCA introduced two "dedicated" TV receivers to its product line — a 9-inch personal color TV for bedside use in the healthcare market and a 25-inch monitor/receiver having advanced design features for industrial and educational applications.

RCA Telephone Systems installed its one millionth line in 1983, despite the intense competition in the interconnect market. Throughout this period, the Service Company maintained its leadership position in the sale, installation, and servicing of the telephone interconnect systems. In 1984, RCA met the increasing complex high-traffic demands of its large business and hotel customers by adding advanced digital voice/data switching systems to its product line. RCA currently markets telecommunications and call-accounting systems manufactured by Mitel, Hitachi, TIE, and Summa Four.

Data Services sales and profits continued to rise during the eight-year period. Growth in this activity stems from the lease, installation, and service of teleprint-

33

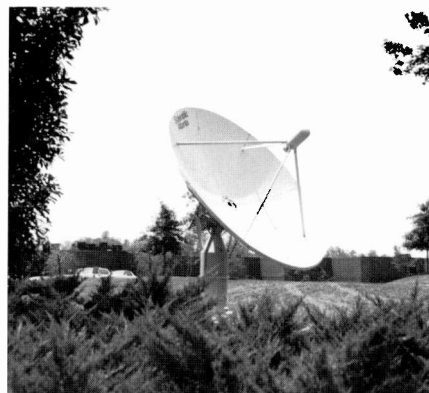


ers and peripheral equipment, as well as the third-party maintenance of news, transportation, and commodities services and microcomputers. Major third-party customers include American Airlines, for which RCA provides service on reservation, operation, and security terminals; the Reuters, UPI, and Commodity news services; and the Norland chain of restaurants and convenience stores. In 1982, Apple Computer selected RCA to be the exclusive third-party supplier of on-site maintenance of Apple's original equipment manufacturer (OEM) and national account customers. In 1983, contract service was initiated in IBM personal computers. In 1984, RCA introduced a multiuser, multitasking workstation, designed to communicate with other workstations, terminals, mainframes, and peripherals in the office environment.

### Communications — RCA Continues Its Leadership Traditions

RCA Communications, Inc. was established in 1981 to consolidate the Corporation's telecommunications businesses and to provide the overall strategic and financial planning support that enables RCA to compete in the rapidly changing telecommunications industry. The Communications group is made up of four operating companies. RCA American Communications (RCA Americom) provides domestic satellite services to the cable TV and broadcast industry, to business, and to government. RCA Global Communications (RCA Glob-

34



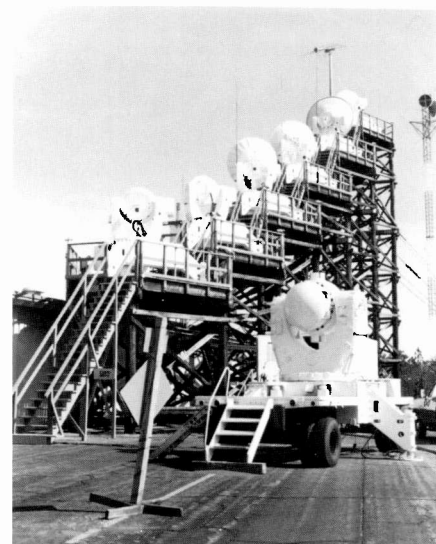
The Government Services activity experienced significant growth while furnishing technical, educational, and support service to government customers in the U.S. and abroad. Contributing to record sales and earnings were contracts awarded and renewed for the operation and maintenance of full-scale drone operations for the U.S. Air Force; range instrumentation and communication for the testing and tracking of missile and space operations for the Air Force; weapons testing at the Missile Test Project in Florida; remote Alaskan Air Command aircraft control and warning stations; flight simulation equipment for the Air Force and Navy; as well as the operation and support of several military bases, Job Corps Centers, and a variety of Defense, NASA, and other government programs and installations.

com) offers communications services to more than 240 countries as well as within the United States. RCA Cylix Communications Network (RCA Cylix) provides on-line data network services, and RCA Network Services primarily operates the Corporation's telecommunications network.

### RCA Americom

In 1973, using channels leased from a Canadian satellite, RCA became the first company in the United States to operate a domestic satellite-communications service. By 1977, RCA Americom had reached a leading position in supplying satellite communications services to the cable television industry. This leadership continues. In 1984, for example, the company distrib-

35





**33.** *RCA Service Company engineer conducts a post-installation check of the Mitel SX-2000 integrated communications system recently installed at RCA's Broadcast Systems Division, Gibbsthorpe, N.J.*

**34.** *RCA installs and maintains satellite receiving Earth Stations for hotels and other commercial properties for distribution of premium TV programming and teleconferencing capability.*

**35.** *RCA operates and maintains multiband radar for electronic countermeasures and pattern-measurements at Eglin Air Force Base.*

**36.** *Two of the four antennas at the Vernon Valley, New Jersey earth station of RCA Americom. Believed to be the largest such facility in the free world, this earth station handles voice, video, radio and data telecommunications into and out of the New York area, and via terrestrial extensions, from Boston to Washington.*

**37.** *RCA Americom's Communications Console in Vernon Valley, N.J. provides continuous monitoring of all communications equipment within the earth station and between the earth station and New York City.*

36



uted more than 30,000 hours per month of programming to an estimated 36 million homes served by some 6,000 CATV systems.

In 1979, RCA Americom sold RCA Alascom, its Alaskan service, to Pacific Power and Light, but continues to provide satellite control services for Alaska's telephone company, Alascom, Inc. These services comprise operation of Alascom's spacecraft, Aurora, which was launched by RCA Astro-Electronics in 1982 as Satcom V, RCA's first Advanced Satcom.

The company's commercial services have continued to expand over the years. In 1983, a long-term contract was signed with MCI Telecommunications Corp. under which RCA Americom would lease to the carrier long-distance intermachine trunks connecting the customer's switching centers. Similar agreements have been made with other alternative long-distance telephone companies as the nation's telecommunications industry proceeds through divestiture.

During the same time period, the number of private leased channels on the Satcom satellite system increased to 12,500, making RCA Americom far and away the nation's leading domestic satellite carrier for this service.

The NASA Shuttle video and data network operated by RCA Americom brought to the public live coverage of the historic first launch and landing of the Space Shuttle in 1981. The company continues to provide coverage of the Shuttle missions as part of its extensive government services network.

A new type of satellite communications service was announced in 1982 as the company applied to the FCC to construct and operate a series of spacecraft operating in the Ku-band of the radio-frequency spectrum. These satellites are scheduled for

37

launching starting in late 1985. This service is specially suitable for transmissions serving satellite master antenna and direct-to-home television services as well as for the development of direct-access private business networks for voice, data, and video communications. In 1984, the company applied to the FCC to increase the transponder power on its planned Ku-band satellites to 45 watts from 40. This increase will make these the most powerful satellites in such service.

RCA Americom's in-orbit satellite fleet had grown to seven in 1983. At year end, Satcom I and Satcom II were used as in-orbit spares. That year saw the inauguration of the company's digital audio transmission service, which has set the standard in superior quality distribution of stereo network radio programs. ABC, CBS, NBC, and RKO radio as well as Westwood One, a leading syndicator, now use this service to access an estimated 2,500 radio stations equipped with small receive-only antennas. The company also inaugurated its international video services in 1983. RCA Americom has since expanded the service offering it to and from 87 Atlantic Intelsat signatory countries via its international earth stations in Etam, West Virginia and Andover, Maine.

From an historical perspective, the most significant event for RCA Americom during 1984 was the retirement of Satcom I and Satcom II from the orbital arc. These two spacecraft, which together logged over one billion miles of travel, were largely responsible for the development of the nation's satellite communications industry.

By the end of 1984, the company's government services network had grown to 44 antennas at 37 locations. Its commercial services network was reaching 16 major



metropolitan areas ranging from Boston to Honolulu.

**RCA Globcom**

The 1977 to 1984 period was one of unprecedented expansion of services and facilities for RCA Globcom. Some of the major services introduced during this period included high-speed international facsimile, telex access from computers, RCA Mail (full-service electronic mail), and domestic telex and leased channel services.

In 1978 the company introduced the first high-quality, high-speed international facsimile service, called Q-Fax, in concert with Kokusai Denshin Denwa (KDD), the Japanese international telecommunications company. Subsequently, this service was expanded to serve 28 overseas locations. In 1980, RCA Globcom provided customers with the ability to send as telex messages ASCII messages at 110 and 300 bits per second (bps), such as from a personal computer.

Between 1977 and 1982, RCA Globcom expanded its domestic gateway cities for international service to more than 80 city areas, from 5 in 1976. In March of 1982, RCA Globcom began offering domestic as well as international telex service. During the same year, RCA Globcom introduced its computer-to-telex service. This service enabled customers to send and receive telex messages at 300 and 1200 bps with their personal computers. With access to RCA's network as close as the nearest phone, every area of the country could now use RCA Globcom telex service.

In 1983, a domestic leased-channel service, ExpressNet, was inaugurated. This service transmits data at speeds up to 1200 bps and is suitable for both data and telex applications. The company also began of-



fering DataLink service that enables overseas customers to use telex terminals to access databases in the U.S.

Also in 1983 with its DDD-50 service, RCA began offering common telephone line access from dedicated telex terminals. This service reduced the cost of direct connection to its telex service in anticipation of large increases in the rates for private leased channels expected in 1985. The company began offering an additional telex news and information service in 1983 called "Hotline" in the United States and marketed overseas as "FYI."

In 1984, Radio Page America was formed. This company, a joint venture between RCA Globcom and Page America Group, offers pocket radio message service and has been referred to as pocket telex. It is contemplated that this venture will expand towards a worldwide personal messaging service.

RCA Mail, a full-feature, sophisticated electronic mail system, made its debut in September of 1984. The same service was made available through RCA Network Services to units of RCA Corporation.

The period of 1977 to 1984 was also one in which operations were carefully analyzed, streamlined, and consolidated. The Lodi Communications Center and the Port Arthur Marine radio station were closed. Rocky Point, originally known as Radio Central when it was RCA Globcom's main international radio center in the days of Morse code, was also closed. The company's operating center in Piscataway, New Jersey, however, was expanded and by the end of 1984 handled virtually all of the

39



company's switched and leased services, including a much expanded AIRCON public shared-message switching system for larger customers who develop and operate their own international networks using leased channels.

**RCA Cylix Communications Network**

In 1982, RCA Communications acquired Cylix Communications Network, a value-added data communications company. RCA Cylix is a satellite-based network providing end-to-end services for a wide spectrum of industries and applications. Routing data by RCA Satcom satellites, the network can link any two or more locations in the United States and Canada. At the heart of the RCA Cylix network is the central switching site in Memphis, Tennessee. The specially constructed bunker is earthquake- and tornado-resistant, has back-up power supplies, and all network components are duplicated for reliability.

Since the conversion to a satellite network was completed in 1981, RCA Cylix has focused a large share of its resources on the reliability of the network's technology. At the same time, customer service has been viewed as an important aspect of the company's product offering. RCA Cylix intensified its commitment to providing reliable data communications in January, 1985, with the introduction of the Customer Resource Team (CRT), a personal approach to customer service. The CRT service concept integrates each of the company's major operations departments into regional teams of network specialists finely tuned to each customer's communications needs.

40



38. This photo shows telex message being sent via a public telephone from a hand-held computer. Two-way contact with virtually any telex or TWX machine can be made by phone from a home computer or word processor.

39. The first fully integrated electronic mail service for business firms, called RCA Mail, offered by RCA Globcom, is designed to operate with almost any type of computer terminal and can interface with telex.

40. An operations support director at RCA Cylis looks over network statistics in front of equipment that converts digital signals into radio-wave frequencies needed for satellite transmission.

41. The examination of a design developed through CAD-CAM technology at RCA Laboratories.

42. A recently installed high-energy particle accelerator at RCA Laboratories in Princeton, N.J. provides scientists with a new tool in materials research.

41



## RCA Network Services

With the formation of Network Services in 1981, came an extensive examination of all RCA's internal communications. The objective was to determine how Network Services could best provide existing and new telecommunications services to the corporation at cost as a service to the corporation. As a result of this examination, plans were made to improve TACNET, RCA's private long distance voice network (one of the largest in the United States) by replacing the six AT&T switches throughout the United States with RCA owned and operated switches. The substitution will begin in February of 1985 and be accompanied by the establishment of an RCA microwave link supporting the network between New York and Camden.

In June of 1984 Nippernet, RCA's private data network was established making possible communications among many data terminals and host computers throughout RCA, regardless of their interface compatibility. At approximately the same time, a new group called Communications Consulting Services was formed by RCA Network Services. This telecommunications consulting organization provides practical solutions to daily telecommunications problems and assists in long-range planning. It offers information, expertise, and analytical tools to its customers to help manage their changing communications needs. These customers include real estate developers, hospitals, hotels and motels, other businesses of all sizes, and government agencies. The group's services include facil-

ities analysis, network design, user operating support, and facilities management.

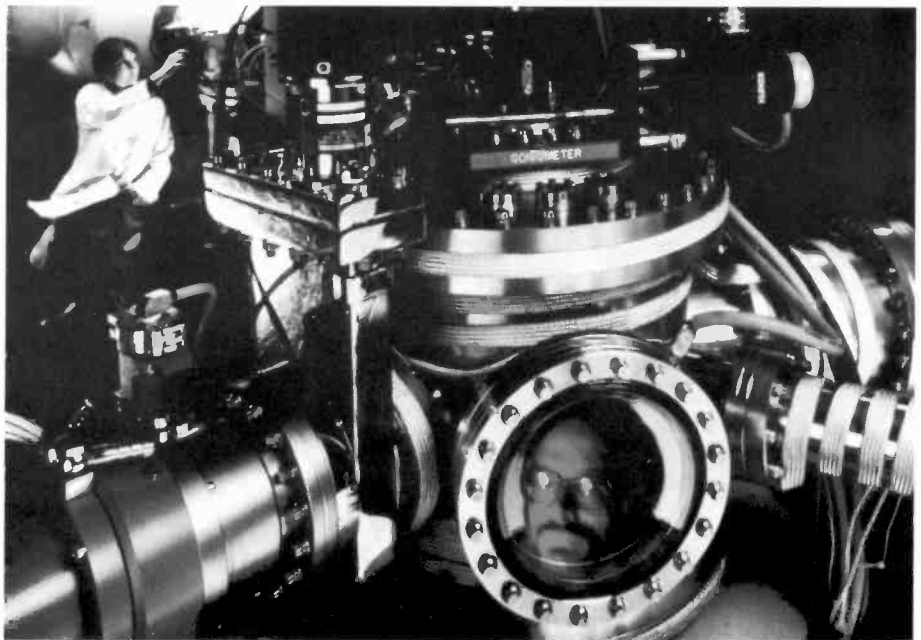
## RCA Laboratories

Throughout 1977-1984, RCA's central research organization, RCA Laboratories, continued its program started in the early 1970s of strengthening the working relationships between the research and development staffs of the product divisions and the Laboratories.

To speed innovation's development into product, satellite laboratories were established at product division headquarters. This arrangement began in the early 1970s when the Solid State Technology Center was set up at the Solid State Division's headquarters in Somerville, New Jersey. By the end of 1981 there were four other satellite laboratories: the New Products, the Manufacturing Technology, and the Advanced Yoke Development Laboratories, all at Consumers Electronics in Indianapolis, and the Technology Transfer Laboratory at the Video Component and Display Division headquarters in Lancaster, Pa. These groups provide a close coupling between the product divisions and the Laboratories, thereby fostering communication and effective engineering development.

The establishment of Manufacturing Systems and Technology Research Laboratories at RCA Laboratories in the mid-1970s—and their subsequent growth in size and status—is another factor in RCA's growing technological strength. RCA early recognized that, for a technical product to

42



be successfully produced and marketed, innovation and advanced technology in product design requires innovation and advanced technology in product manufacturing. This recognition has enabled RCA to compete successfully with the Japanese, for instance, in the production of the top-rate color television receivers. During this period RCA Laboratories spearheaded Computer-Aided Design and Computer-Aid Manufacturing (CAD/CAM) technology to make possible the creation of designs quickly and efficiently.

Because of the close relationship between RCA Laboratories and the product divisions, the Laboratories are involved in both long-range and short-range research and development operations. One ongoing program is the development of a higher-definition TV (HDTV) picture compatible with the present NTSC broadcast standards. RCA also continues research on technologies for a flat screen TV. In 1980 the Laboratories demonstrated a basic technical concept for a 50-inch (diagonal) color TV display only about 4 inches thick. While the concept remains viable, research efforts on flat panel TV have been redirected to better understand the high-resolution capabilities of other technologies.

Several excellent examples of research projects that demonstrate the close relationship of RCA Laboratories and the product divisions have been described previously. Among them are the COTY-29 color picture tube, the "SelectaVision" Video

43



Disc system, the TK47 microprocessor-controlled color TV camera, the use of charge-coupled-device (CCD) comb filters to improve substantially the horizontal resolution of the TV picture, and the highly advanced solid state portable TV camera using CCD chips.

In advanced television technology, RCA is developing digital television receivers. The processing of a television signal through digital techniques permits precision picture control and promotes the introduction of new features while reducing the number of electronic components. In High-Definition TV research, RCA Laboratories are constructing demonstration hardware to further evaluate the performance of future TV systems. A major objective of the effort is to preserve compatibility with the present NTSC system.

In 1984, as part of an interdivisional RCA effort, a new Information Systems Research laboratory was formed at RCA Laboratories to lay the groundwork for the development of a communications-oriented home information system. This laboratory is developing the hardware and software that the consumer would use.

In 1981, RCA Laboratories and RCA Automated Systems demonstrated an experimental infrared imager that by detecting temperature differences creates TV pictures in total darkness. The camera contains a high-performance solid-state imager, about the size of a dime, containing over 800 infrared-sensitive elements. The heat-sensing camera has potential applications in the field of medicine to locate tumors and blood clots, in industry as a detector

44



for heat-leaking areas, in environmental control as a pollution-measurement system, and in the military for tracking planes, tanks, and personnel.

During 1977-1984, RCA Laboratories and GSD's Advanced Technology Laboratories continued to improve an optical-disc mass-data-storage system, which features vast memory capacity and quick random access. A major advance was the development of a high-powered solid-state laser—replacing a much more bulky and unwieldy gas laser—for recording and retrieving data and pictures from optical discs up to 14 inches in diameter. The proposed storage system could contain the complete *Encyclopedia Britannica* (100 billion bits of information) on one disc. In 1984, the Laboratories announced its new multichannel optical recording system, by which three channels of information can be recorded simultaneously onto an optical disc using three semiconductor lasers on a single chip. It is a major step in the development of a compact system that can store and retrieve vast amounts of information at extremely high speeds.

Studies of direct broadcast satellite systems to provide television, audio, and other services to individual and community receiving stations were undertaken by the Laboratories and RCA Americom early in 1981. The results have provided valuable guidance to RCA, NBC, and customers.

The RCA Satcom V, launched in 1982, is the first commercial communications satellite to use GaAs FET microwave amplifiers. These amplifiers were developed in a combined program by RCA Laboratories,

Astro-Electronics, and RCA Americom. More reliable and durable than the tube units they replace, the solid-state amplifiers also increase the communications capacity of the satellite. The useful life of the RCA Satcom satellites, which is now about 7 years, is expected to increase to 10 years as a result of the amplifiers.

Also in microwave research, Laboratories scientists have been working with physicians at several medical centers on the use of microwave-induced heat for the treatment of external and some internal cancers. Results have been encouraging.

Another noteworthy RCA Laboratories accomplishment did not concern existing RCA products, but, rather, a possible future product. To investigate alternative sources

of energy, an Energy Resource Laboratory was established in 1977, the same year RCA received a basic patent on the use of amorphous silicon—a low-cost but relatively efficient material—in solar cells. Working constantly to improve the efficiency of amorphous silicon solar cells, RCA Laboratories researchers reached 6 percent in 1980 and 7 percent in 1981. They “broke the four-minute mile” in mid-1982 by reaching 10 percent conversion efficiency, a major step toward large-scale power production. Despite the successful research results, it was determined that further development of solar cell technology was not compatible with RCA’s long-range research goals and the technology was sold in its entirety to Solarex in 1983.

**43.** RCA Labs scientist aligns the optics of a laser used for multichannel high-speed data recording. The new recording technique is considered a major step in the development of a compact system that can store and retrieve vast amounts of information at extremely high speeds.

**44.** In 1982, engineers and scientists from RCA Automated Systems and RCA Labs, demonstrated the sensitivity of a heat-sensing image sensor. The inset at the lower right shows a photomicrograph of the 64 x 128 element infrared CCD image sensor.

**45.** Vision-assisted robot assembles parts at RCA robotics research laboratory.

**46.** Solid state power amplifier under test at RCA Laboratories.

**47.** In the Zurich Laboratories, a member of the engineering development group works on a systems design.

45



## Entertainment—RCA Emphasizes High Quality

### National Broadcasting Company (NBC)

The years 1977-1984 were a time of transition at NBC during which the company adapted to a changed broadcasting marketplace and emerged with new strength. Over the period, revenues doubled, rising at an average annual rate of nearly 11 percent. Profits declined between 1978 and 1981 due primarily to difficulties in the Television Network division—including a \$33.7 million net loss resulting from the forced cancellation of NBC coverage of the 1980 Moscow Olympics following the U.S. decision to boycott the Games. The slump ended in 1982, however, with a 32 percent rise in earnings, and NBC went on to experience the highest profits in its history the following year, a surge which continued through 1984.

The 1977-1984 period was marked by

46



gradual erosion in the combined audience share of the three commercial networks caused by the inroads of cable, pay-TV, VCR and other rival technologies, and more competition from independent television stations. When the programming efforts failed to stem a decline in NBC-TV’s competitive position, a new management team headed by Grant A. Tinker was named in June 1981. By the end of 1984, with such new hit series as “The Cosby Show” and “The A-Team,” NBC-TV had advanced from third to second place in the prime-time ratings and was leading in those audience groups most attractive to advertisers.

NBC remained “the quality network”

47



with award-winning programs such as "Holo-caust" (1978) and "Shogun" (1980). The most honored drama series in television history, "Hill Street Blues," amassed 25 Emmies during 1981-1984, a period in which NBC led the networks year after year in prime-time Emmies.

The NBC-Owned Television Stations Division sustained record profits throughout most of 1977-1984. The NBC Radio Division successfully adopted the "narrowcasting" approach of radio in the '80s, winning new specialized audiences through two additional networks, "The Source" and "Talknet."

Under a \$300 million 10-year agreement with Comsat General Corp., NBC in 1983 became the first network to adopt Ku-band satellite distribution, assuring superior transmission to affiliates. The system has been successfully operated since January 1985. In 1984, NBC-TV introduced the RCA CCD television camera, which takes pictures in very low light and has unique special-effects capabilities. On July 26, 1984, NBC aired the first network TV broadcast in stereo.

**RCA Records**

From 1977 to 1984, RCA Records improved its share of the market, both in North America and in major international markets, including Latin America and the Far East. In addition to albums and cassettes, RCA began marketing digital compact discs, the new state-of-the-art, laser-read format for recorded music.

Among the RCA artists who achieved prominence during this period are Dolly Parton, Kenny Rogers, Diana Ross, Ala-

bama, Rick Springfield, Daryl Hall & John Oates, Irish flutist James Galway, and the new British recording duo, Eurythmics. In 1984, RCA began a year-long celebration of Elvis Presley's fiftieth anniversary. Presley's recordings for RCA have sold in excess of one billion copies, worldwide.

During this period RCA added several record companies to its wide distribution network: Arista, in which RCA has an equity position, whose artists include Air Supply and Dionne Warwick; A&M, for which the Police and Supertramp record; and, outside of North America and Africa, Motown Records, home of such top-selling artists as Stevie Wonder and Lionel Richie.

At the heart of RCA's automated, com-

puterized U.S. manufacturing and distribution system are its Indianapolis pressing facilities and warehouses, which service the entire nation. RCA also added strategically located satellite "hits warehouses," to provide extremely fast service on a regional basis for fast-selling new recordings.

Also during the 1977-1984 period, RCA began distributing the videocassettes of Columbia Pictures Industries throughout the U.S. and in nine foreign countries. In the Direct Marketing division, RCA launched the Compact Disc Club, which offers laser-read digital audio discs from virtually every major record label. RCA's three record clubs now service the popular, classical, and Compact Disc markets.

**Other Businesses —  
RCA Streamlines and Strengthens Its Operations**

**The Hertz Corporation**

The period 1977-1984 was one in which Hertz pioneered new and improved policies and services for the rent-a-car industry. The most innovative new policy was the implementation of unlimited mileage rates on all rentals. This changed a 60-year-old industry policy of charging time and mileage on basic car rental rates. The new policy of a flat daily charge with no charge for mileage permits customers to know in advance the cost of their car rentals. The new policy was quickly adopted by others in the industry.

As car rental volume at airports continued to grow and car rental counters

became increasingly strained, Hertz in 1980 introduced Express Service to let frequent travelers who are members of #1 Club bypass the counters in the airport terminals and proceed directly to the ready-car area where they complete their arrangements for the pre-assigned cars.

To expedite car return as well as car check-out, Hertz in 1983 introduced Express Return at major airports. Available to #1 Club members who are charging their rentals on credit cards acceptable to Hertz, the computerized Express Return system provides customers with instant receipts for their car rental transactions.

49



Hertz currently operates in over 120 countries from more than 4,500 locations with a fleet of nearly 400,000 rental and lease vehicles.

#### Coronet Industries, Inc.

The years 1977-1979 were marked by record sales and earnings return on sales as Coronet capitalized on its new innovative multicolor dyeing technique. To expand its product/coloration innovation, Coronet undertook major capital additions at both its domestic and Canada operations for new multicolor dyeing equipment along with new state-of-the-art continuous heat-set equipment that improved carpet quality and performance as well as appearance.

During the last ten to fifteen years, yarn prices escalated rapidly in response to the shortage and subsequent price fixing of the petrochemical feedstocks used in the manufacture of carpet yarn fibers. The shortage was brought on by an embargo on oil shipments from the Mid-East countries and price fixing by the establishment of the OPEC Cartel. Coronet was able to recover most of these cost increases because of its style leadership. However, margins were depressed.

In mid-1979 in a move to broaden its product offering and to capitalize on the forecast rapid expansion of the commercial carpet market segment, Coronet acquired MarJon Carpet Mills, Inc. Prior to this acquisition Coronet's line was primarily residential carpeting. This acquisition gave

Coronet immediate access to floor covering users such as offices, hospitals, motels, and other public buildings.

In 1980 as inflation reached double digits and interest rates reached peaks in the low 20s, a recession hit the housing industry and carpet sales declined sharply.

The year 1981 was marked by the 25th anniversary of the founding of Coronet in the year 1956. A new high-speed energy-efficient Finishing Range was installed which gave the carpet pile a finely tailored look in addition to reducing the cost of the carpet. MarJon, the commercial carpet operation introduced a new line called "Gibraltar" to meet the needs of contract specifiers, interior decorators, and architects.

In 1982 the U. S. economy was hit by a major recession, accompanied by high inflation and high interest rates, which caused a depressed market. Coronet, however, launched a major transition of its manufacturing operations to eliminate obsolete facilities, reduce overhead costs, and install new high-speed state-of-the-art manufacturing technology. A major part of this transition was the shutdown and sale of its obsolete dyeing facilities and consolidation of the dyeing process into the existing finishing plant. Coronet Canada also eliminated obsolete facilities and installed new state-of-the-art equipment in 1982.

In 1983 Coronet continued its program of streamlining facilities and productivity improvements. In a major move to reduce overhead and provide more immediate access to the recently installed state-of-

48. "NBC Nightly News" is produced and directed from this control room in NBC's New York studios.

49. Hertz rents and leases a variety of equipment for construction and factory use.

50. Hertz's computerized reservation center in Oklahoma City features the latest in communications and data systems.

51. Coronet Industries lab technicians mix dye formulas for different shades of carpet colors.

50



51



the-art manufacturing equipment at its Dalton, Georgia facilities, the MarJon commercial carpet operations in Calhoun, Georgia were relocated and consolidated into the Dalton facilities. Additional warehouse space was constructed and additional foam dye equipment was installed.

In 1984 key technical personnel changes and additions were made to strengthen the overall organization. The latest of its newly acquired multicolor dye lines was started up, which gave Coronet needed capacity to support the sharp increase in sales in 1984 over 1983. Sales in 1984 reached an all time record high and kept Coronet as one of the top manufacturers in the industry.

### Divestments and Acquisitions

RCA Corporation's program of growth through diversification began with the acquisition of Random House in 1966 and ended in 1974 with the addition of two food distribution businesses England (Oriental Foods and Morris and David Jones) to the company's already substantial interest in the food industry in the U.S. Soon after, however, RCA began to sell off or discontinue selected portions of its businesses because they no longer fit or offered little prospect of future growth.

The first major divestment came in 1976, with the sale of Cushman & Wakefield to Rockefeller Center, Inc., and then RCA Alaska Communications, Inc., to Pacific Power & Light Company in 1979, each representing an area of business activity in which RCA had no continuing interest for further investment.

In 1980, RCA adopted a formal plan to divest certain of its operations that were seen as peripheral to those lines of business on which RCA intended to concentrate its future attention. In the period from 1980 through 1984, all of RCA's non-traditional businesses except Hertz, NACOLAH, and Coronet Industries were sold, including CIT Financial, which had been acquired in 1980 in an effort to stabilize RCA's historically cyclical earnings pattern. These divestments included several long-held technology-based businesses in which RCA decided not to continue.

Avionics Systems was sold in 1981 to Sperry Corporation when it became apparent that RCA's leadership position in certain product categories could be sustained only with major new investment to take advantage of important new tech-

nology developments. Mobile Communications was sold in 1981 and Cablevision Systems in 1983. In these activities, RCA's position had deteriorated unacceptably in highly competitive market environments.

In 1981, RCA announced that it would henceforth concentrate its resources on the interrelated core areas of communications, electronics and entertainment. Thus, as the divestment program continued, interest developed in acquisitions to expand the core businesses. The first was Cylix Communications Network, a value-added data communications business purchased in 1982. Early in January 1985, RCA purchased a minority interest in PageAmerica, Inc., a radio common carrier operator with whom RCA had been developing a nation-wide radio paging venture.

### Future Prospects

The history of RCA recounted above shows that the company in the main returned to its traditional and well established heritage in electronics, communications, and entertainment — its "roots". RCA has been and will continue to be the company that introduced and enhanced television, that brings you the nightly news, that transmits words and pictures to and from the far corners of this planet and beyond, that builds satellites and electronic defense systems. Its products range from the commonplace and the ubiquitous to the highly complex and the very special.

What are our expectations for the future? RCA expects that the television set will evolve and merge with the functions of the home computers and telephone systems to become the center of an entirely new concept in home entertainment and information. This evolved product will permit both broadcast reception and two-way communications with educational institutions,

banks, retail stores, and a variety of databases. It will also have "stand alone" capabilities for such functions as word processing and keeping accounts that will exceed those of today's personal computers and be far easier to use. Consumers will be able to retrieve information, make banking transactions, or shop from the home. A major step toward this goal has already been taken with the establishment of the Home Information Systems Division that will be responsible for developing consumer information services accessible through home computers.

RCA expects continued growth in its government systems business. In the development of the AEGIS defense system for the U.S. Navy, RCA has attained a leadership position at the highest technical level in information collection and interpretation. Our experience and our highly skilled scientists and engineers give us unusual strength for developing information systems for the future, both for government applications and for the private sector.

RCA's communications businesses will continue growth, paced in large measure by satellites. "End-to-end" services for businesses will be an increasingly important communications product.

NBC expects that the turn-around in ratings will gain momentum and that its programs will continue to receive both critical and popular acclaim.

RCA has many great expectations in many fields for its future, too many to be listed. By careful planning and astute action, however, we intend to transform these expectations into practical business successes. At the close of 1984, RCA is well positioned financially and in terms of momentum and required skills to make these expectations become reality.

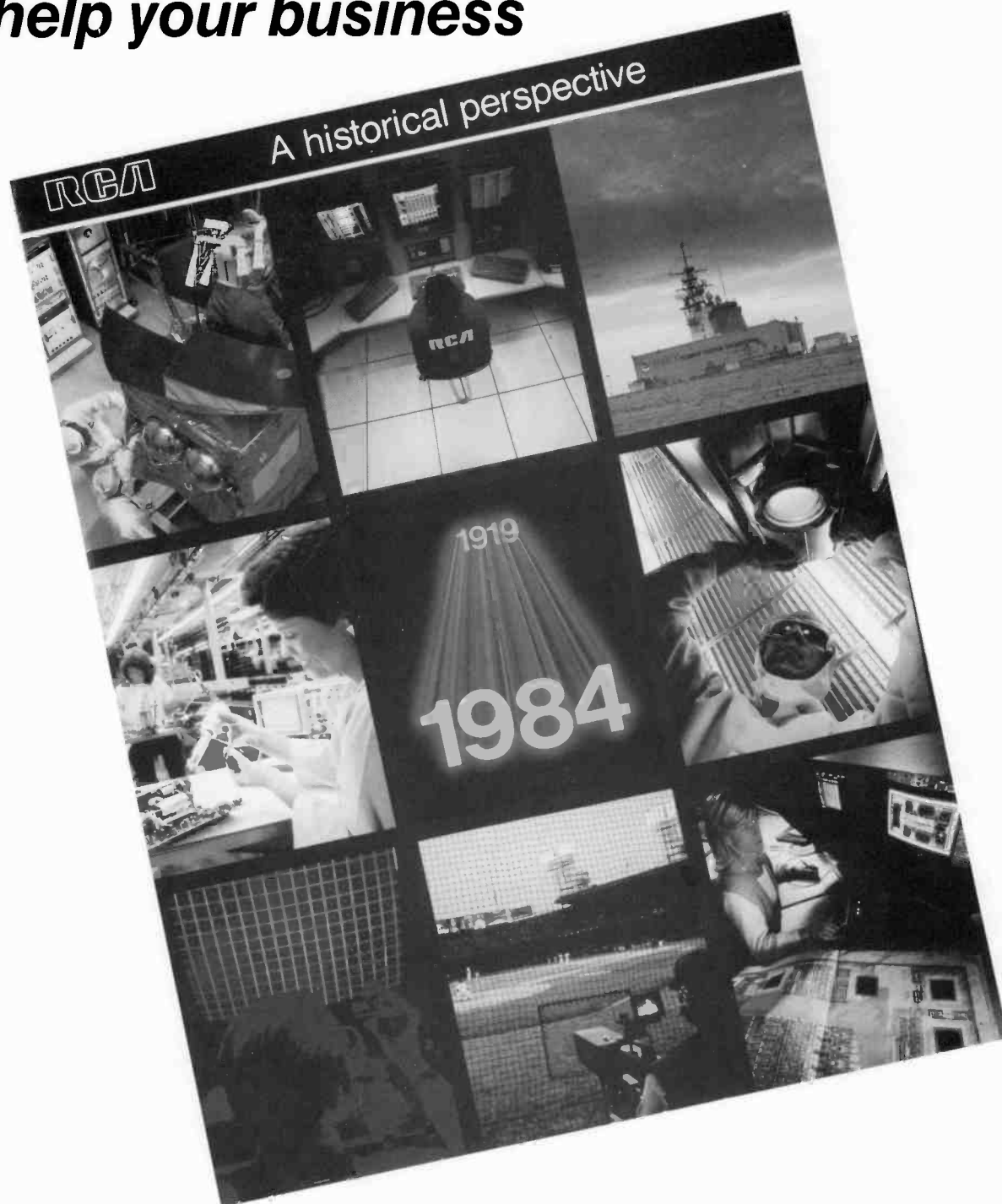
52



52. Work is underway at RCA Laboratories on future products and services of the Home Information Systems Division.



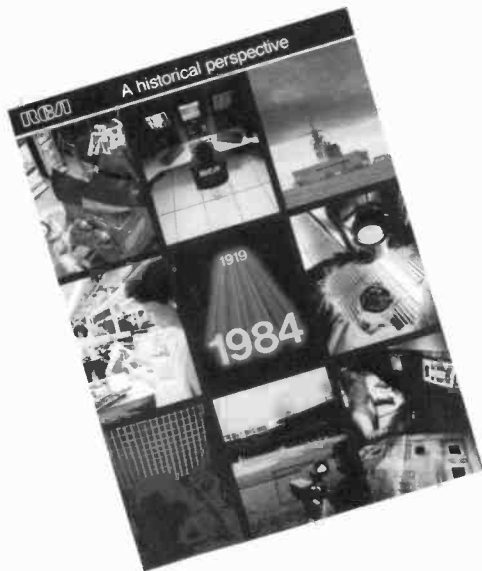
# Use RCA's History to help your business



What are the uses for this new edition of the RCA History at your location? Orientation of new people. Support for proposal documents. Handouts to visitors and candidates for employment. Gifts to regular customers. You can probably recall how the last edition, published in 1978, came in handy.

Distribution of the History from the Technical Excellence Center is limited to RCA Corporation. Single copies are free to RCA employees. Multiple copies are \$1.00 apiece, and the minimum order is \$10.00. To obtain your copies of the History, complete the order form on the next page — no telephone orders, please.

# To order your copies of RCA—A historical perspective . . .



Color cover  
88 pages

Single copies of the History are free.

Multiple copies are \$1.00 each,  
and the minimum order is \$10.00.

**Note:** Distribution from the  
Technical Excellence Center  
is limited to RCA Corporation.

### *For single copies:*

Simply fill in your name and address  
on the right and mail it in.

### *For multiple-copy orders:*

This order form must be accompanied  
by a purchase order or a check  
made out to RCA Corporation.  
All the requested information must be  
supplied for multiple-copy orders.

*Mail completed order forms to:*  
Engineering Publication  
RCA Technical Excellence Center  
Mail Stop RR13, Princeton Labs.  
Please do not telephone.

## Billing information

(Purchase orders or checks must accompany multiple-copy orders.)

Name: \_\_\_\_\_

RCA Business Unit: \_\_\_\_\_

Dept. Number: \_\_\_\_\_

Billing Address: \_\_\_\_\_

Charge Number: \_\_\_\_\_

Quantity ordered: \_\_\_\_\_

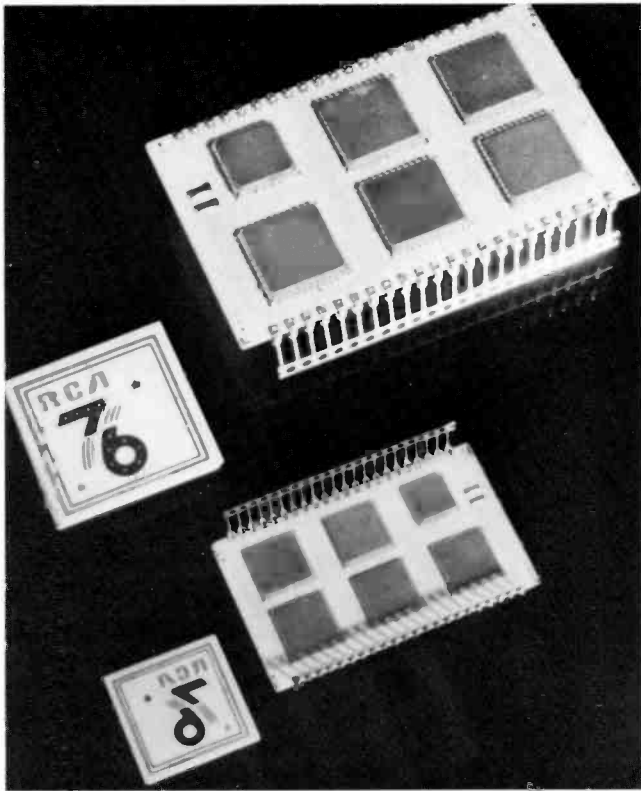
## Mailing information

(Use RCA internal mail for quantities up to 30 copies  
and your organization's Shipping Address for larger quantities.)

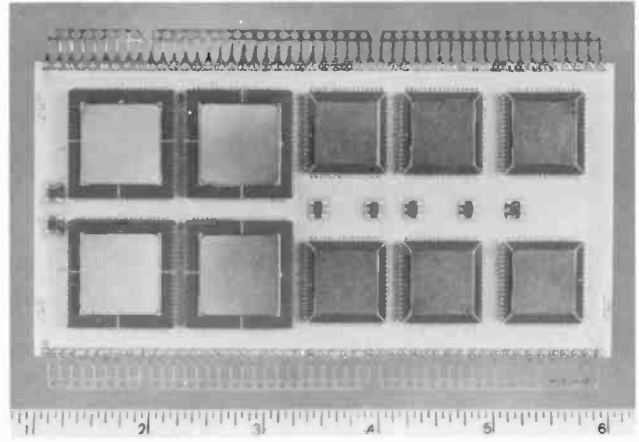
Name: \_\_\_\_\_

Mail Stop: \_\_\_\_\_

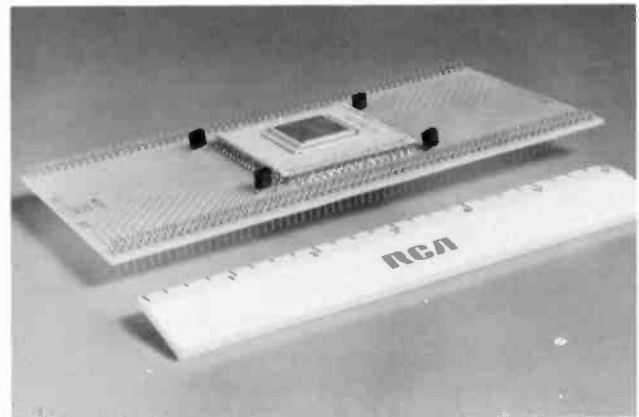
Address: \_\_\_\_\_



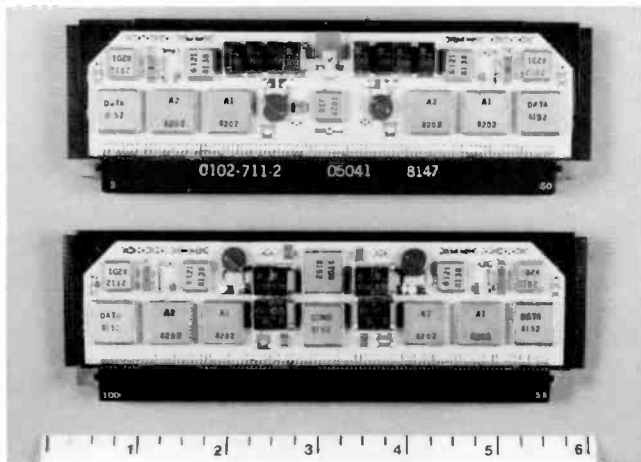
**1976**—Double-sided ceramic module, demonstrated in 1976 by RCA.



**1980s**—Microprocessor utilizing 84- and 64-pad surface mounting components.

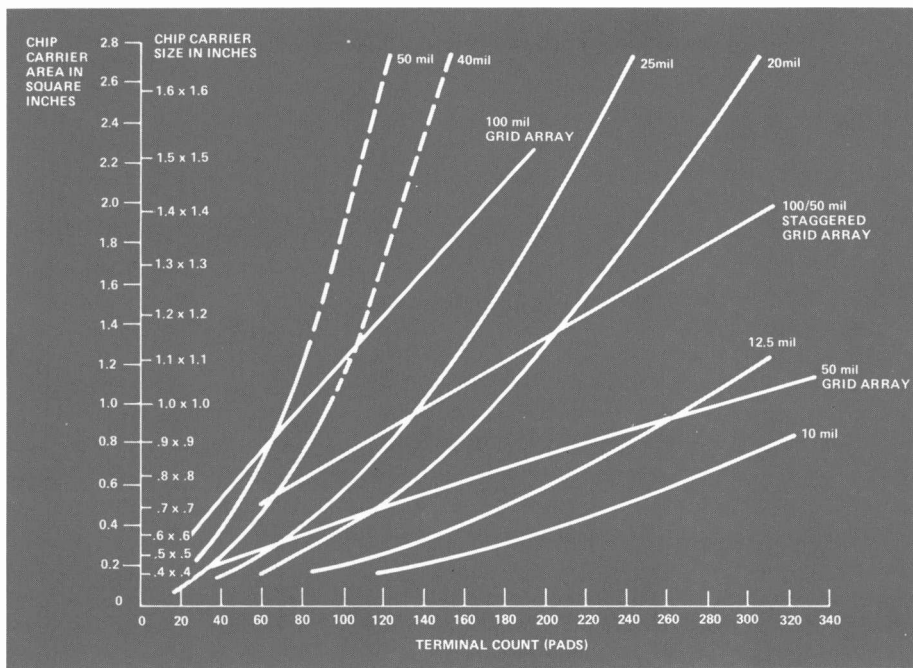


**1982**—132-pad, 25-mil chip carrier mounted on dual-in-line test board.



**1980s**—Navy ISEM module with a variety of surface-mounted components.

**The 80s:** A wide variety of high-density modules have recently been designed and manufactured with surface-mounted chip carriers. A 132-pad chip carrier with 25-mil pad spacing was developed in 1982.



**Fig. 5.** Surface-mounted chip carriers: terminal count versus carrier area for four standard and two proposed pad spacings (50, 40, 25, 20, 12.5, and 10 mils); for three types of grid arrays (100-mil, 50-mil, and 100/50-mil staggered grid).

Bare substrate testing will consequently need a test technique other than traditional "bed-of-nails" approaches. Optical techniques can possibly be used at this level, just as E-beam testing is being developed for integrated circuits. Such techniques reduce the mechanical fixturing costs with an investment in more sophisticated optical recognition and computational equipment.

#### Board testing

Basically, two strategies are in vogue today for board testing: card-edge testing and in-circuit testing. With card-edge testing, the board is interfaced to the tester only through its input/output connections. Internal nodes are not monitored. Since many test vectors have to be applied at the card edge before its response can be sensed, this complicates the test program development and fault isolation effort.

In-circuit testing gets around this problem by probing all internal nodes of the board. An in-circuit tester has the capability of sensing these nodes and forcing signals onto them by back-driving the ICs on the board. This approach tells the tester what is happening within the unit under test, shortens test times, and aids in fault isolation.

While board testers with the thousand-pin capability required for this type of test approach are now on the market, chip carrier assemblies may not be a practical

application because all the internal nodes have to be probed in a manner similar to that used for bare substrate probing. For a leadless chip carrier with 10-mil pad spacings, special test points are needed for the probes. This uses up real estate on the module, and the fixturing problems associated with bare substrate testing also remain. Given the cost of the tester and the cost of fixturing, the in-circuit testing approach appears to be an expensive method of board testing.

#### New testing strategies

Testing approaches have to become more practical in order to test assemblies of this complexity. Two approaches are now being developed. One approach, developed by IBM, is called Level Sensitive Scan Design (LSSD). It begins within the IC design itself. Blocks of logic are isolated with registers that can: (1) act as normal storage registers; (2) be accessed serially to read out their states; or (3) be loaded to force an internal state. At the subassembly level, these same registers are cascaded to provide the same accessibility into internal nodes as is available at the IC level. Fault isolation and test coverage are simplified with this view into the circuit.

The second approach under development is to design the circuit so that it tests itself. Such an approach must also originate

at the IC design level. With this built-in, self-test approach, each IC has its own test generator/sensor that can be interrogated and set up externally. Again, as in LSSD, this self-test can be expanded into the sub-assembly level of testing.

Both of these approaches eliminate the need for the complicated mechanical fixturing required to probe a high number of points on tight spacings. They also tie in with fault isolation, which is needed to repair any defective devices at the sub-assembly level.

For the future, the impact of high packaging density on design and testing will be driven by the large number of circuit nodes and interconnects—the test techniques of today will not be effective tomorrow. By designing a measure of testability and self-test as part of the circuit, the fixturing, test program development, and the test equipment can be simplified and made less costly.

#### Conclusion

Surface mounting technology is permitting reductions in circuit module size, weight, and cost by improving packaging density. The high-density hybrid based on ceramic substrates, as well as the lower-density circuit board technologies, are now employing surface-mounted components and techniques. As families of compatible, standardized 20- and 25-mil peripheral chip carriers become available for the rapidly developing VLSI and VHSIC applications, fine-line, fine-via interconnecting substrates and new testing strategies must be readied for efficient I/P structure production.

#### References

- Bauer, J.A., "The changing role of hybrids in modern electronics systems," *RCA Engineer*, Vol. 23, No. 2, p. 16 (Aug./Sept. 1977).
- Bauer, J.A., "Design considerations with leadless chip carriers," ISHM Surface Mounting Workshop, Dallas, Tex. (September 1984).
- Bauer, J.A., and Kolc, R.F., "Growth in application of chip carriers," *NEPCON '80 Proceedings*, (February 1980).
- Kolc, R.F., "Attachment of hermetic chip carriers to various substrate materials," First Annual International Electronics Packaging Conference, Cleveland, Ohio (November 1981).
- Schelhorn, R.L., "Thick film multilayer board for chip carrier circuits," *NEPCON West*, Anaheim, Ca. (February 1981).
- Schelhorn, R.L., "Universal probing technique for continuity and isolation testing of HCC circuits," *International Journal for Hybrid Microelectronics* (January 1981).

## Glossary

Most of the following definitions are from Jones, R. D., *Hybrid Circuit Design and Manufacture*, The International Society for Hybrid Microelectronics, New York: Marcel Dekker, Inc., 1982.

**Card edge testing**—An IC test where the state of the board is determined by what occurs through its I/O connections. Internal nodes are not monitored.

**Chip**—The uncased and normally leadless form of an electronic component part, either passive or active, discrete or integrated.

**Chip carrier**—A special type of enclosure or package used to house a semiconductor device or hybrid microcircuit, and which has metallized electrical terminations around its perimeter instead of an extended lead frame or plug-in pins.

**CMC**—Co-fired multilayer ceramic (punched or screened dielectric boards).

**DIP**—Dual-in-line package. An IC package having two rows of leads extending at right angles from the base and having standard spacings between leads and rows of leads.

**Double-sided board**—An assembly variation of the single-sided circuit that can be used with the PWB, TFM or CMC.

**HCC**—Hermetic chip carriers, hermetically sealed (gastight) to protect components in adverse environments. Applications in high-density, high-yield, and high reliability circuits for the military and for human implantation.

**Hybrid integrated circuit**—A microcircuit including thick-film or thin-film paths and circuit elements on a supporting substrate to which prepackaged or uncased devices are attached. It is usually enclosed in a suitable package (epoxy or hermetic).

**In-circuit testing**—A board tester that probes all internal nodes of the board, forcing signals onto the nodes by back-driving the ICs.

**I/P structure**—Interconnection/packaging. The combination of LCCs and components representing a finished module (product).

**JEDEC**—Joint Electronic Device Engineering Council. The professional society that standardized the 40- and 50-mil-center square chip carriers in the mid 1970s; currently standardizing compatible 20- and 25-mil pad spacing.

**LSSD**—Level-sensitive scan design. An IBM-developed, IC-incorporated test strategy that isolates blocks of logic with registers that can (1) act as normal storage, (2) be accessed serially for status readout, or (3) be loaded to force an internal state.

**Mother board/baby board**—An assembly combination of the PWB and (generally) either the CMC or TFM structure.

**Probe fixture**—Contains spring-loaded probes that make electrical contact with the circuit pads at each node location for testing complete isolation and continuity, and to take line resistance measurements.

**PWB**—Printed wiring board.

**Resist**—A protective coating that keeps another material from coating or attaching itself.

**SMD**—Surface mounted device. A permanent, protective structure that provides for mounting and electrical continuity in the application of a chip to a major substrate. Examples include chip-and-wire and chip carrier components.

**Subassembly/subsystem**—A smaller part of an electronic system that performs part of the system function but can be removed intact and tested separately.

**Substrate**—The supporting material upon which the elements of a hybrid microcircuit are deposited or attached, or within which the elements of an integrated circuit are fabricated. Commonly referred to as boards.

**TFM**—Thick film multilayer board.

**VHSIC**—Very-high-speed integrated circuits. Large-scale digital ICs with typical logic gate propagation delays of less than 1 nanosecond.

**VLSI**—Very-large-scale integration. A complete system function fabricated as a single microcircuit containing 1000 or more gates or circuitry of similar complexity.



Authors, left to right: Schelhorn, Kolc, Bauer, and Bronecke.

**John Bauer** is Manager, Design Automation, at the Missile and Surface Radar Division, Moorestown, N.J. During his 21 years at MSR, John established both the hybrid and design automation facilities. He initiated the use of the chip carrier for high reliability products at MSR in 1972, and has promoted the technology within industry and the military internationally. John was named "Electronic Packaging Engineer of the Year" by the International Electronics Packaging Society in 1983. He holds a BSEE degree from Virginia Polytechnic Institute and has 35 years of industrial experience with the Franklin Institute Research Laboratory, Bendix Corporation, and RCA.

Contact him at:  
**Missile and Surface Radar Division**  
**Moorestown, N.J.**  
**Tacnet: 224-2325**

**Pete Bronecke**, Unit Manager, Hybrid Test Development, Missile and Surface Radar Division, joined RCA in 1973. He has been involved in the development, design, and test of various thick film multilayer hybrids, including the generation of wiring rules for packaging LSI circuits on ceramic and printed wiring board structures. He is also developing automatic test methods for large hybrids on Datatron and Sentry Series LSI testers. Pete received the BSEE degree from Lehigh University in 1973, and has pursued graduate studies at the University of Pennsylvania.

Contact him at:  
**Missile and Surface Radar Division**  
**Moorestown, N.J.**  
**Tacnet: 224-2202**

**Ron Kolc** is Manager of the Missile and Surface Radar Division Engineering Equipment Design Section. Since joining RCA in 1970, he has been involved in the design, fabrication, and testing of hybrid circuits, and in the implementation of interactive computer graphic techniques for use in the development of complex thick film multilayer hybrids. Ron received the BSEE from Carnegie Institute of Technology in 1960, and the MSEE and MBA degrees from Drexel University in 1966 and 1973. Prior to joining RCA, he was employed by TeleDynamics as section head in charge of Telemetry Products and Hybrid Microcircuits.

Contact him at:  
**Missile and Surface Radar Division**  
**Moorestown, N.J.**  
**Tacnet: 224-3047**

**Bob Schelhorn** is Unit Manager, Processing Development and Module Assembly at Missile and Surface Radar Division. Before joining the Moorestown Hybrid Facility in 1970, Bob worked with integrated circuits and silicon chip technology for four years at RCA Solid State Division in Somerville, N.J. At Moorestown he has developed advanced processing and assembly equipment and procedures for fabrication of thick film hybrid, thin film microwave, and printed wiring circuits. He received a BS in Physics from Penn State University in 1961, and pursued graduate studies at Stevens Institute of Technology. He was employed by ITT prior to joining RCA.

Contact him at:  
**Missile and Surface Radar Division**  
**Moorestown, N.J.**  
**Tacnet: 224-3230**

T.M. Gurley

## Using CCD imagers in broadcast-quality cameras: A fresh look at television resolution

*CCD imagers make conventional thinking about television resolution as outdated as the pickup tubes they replace.*

This tutorial is based upon "Resolution Considerations in Using CCD Imagers in Broadcast-Quality Cameras," by Thomas M. Gurley and Carl J. Haslett, published in *Components of the Future*, Society of Motion Picture and Television Engineers (1985).

The evolution of a totally solid-state camera, with performance suitable for broadcast applications, has been underway for many years. RCA introduced the first all-transistor cameras some two decades ago.<sup>1</sup> We called this product line "The New Look." But the imaging device remained a pickup tube, with its inherent instability, fragility, and limited life.

Now, the charge-coupled-device (CCD) camera has arrived. RCA Broadcast Systems introduced the CCD-1 at the National Association of Broadcasters (NAB) Convention in April 1984, and began deliveries earlier this year.<sup>2</sup> Besides extending generic solid-state advantages to the total camera, the CCD is now bringing to television what has often been described as "the film look."

In those early days of transistorized equipment, many were intimidated by the new technology—it worked better, but it worked differently. A lot of old ideas had to give way to new thinking. CCD imagers work differently from pickup tubes, so

**Abstract:** *CCD imagers make possible substantial improvements in camera performance for a number of applications. But the opportunity to achieve "film look" video and to benefit from the many advantages of CCDs presents a new challenge to television engineers. Basic differences in operation between tubes and CCDs require new ways of looking at technical parameters such as resolution. This tutorial covers static, dynamic, and temporal resolution from a theoretical viewpoint and relates these concepts to the performance of RCA's new CCD-1 and CCD-1S cameras.*

©1985 RCA Corporation.  
Final manuscript received May 15, 1985  
Reprint RE-30-4-B



once again, television engineers face an exciting challenge. In this tutorial, we'll discuss some of the significant differences between tubes and CCDs that affect their performance in broadcast-quality cameras. We'll concentrate on the topics of static, dynamic, and temporal resolution, and offer some recommendations on new ways to think about them. Our treatment will consider only the RCA frame-transfer approach, since it has a number of advantages over other types of CCD in such areas as sensitivity, signal-to-noise ratio, highlight handling, and absence of lag. Developed jointly by RCA Laboratories, New Products Division, and Broadcast Systems Division, it is responsible for the superior performance of the CCD-1 camera.

### Tube vs. CCD operation

First, a brief review of some differences in tube and CCD operation may be helpful. As Fig. 1 depicts, tubes contain a photoconductive layer upon which the scene is imaged. Charge is developed and stored capacitively proportional to the illumination at each point. An electron beam converts this charge image into a signal current. Ideally, the beam is focused to a circular spot and deflected continuously over the image area in two interlaced fields of horizontal lines.

In the CCD, shown in Figs. 2 and 3, photoelectrons are integrated in the "A" register, upon which the scene is imaged.

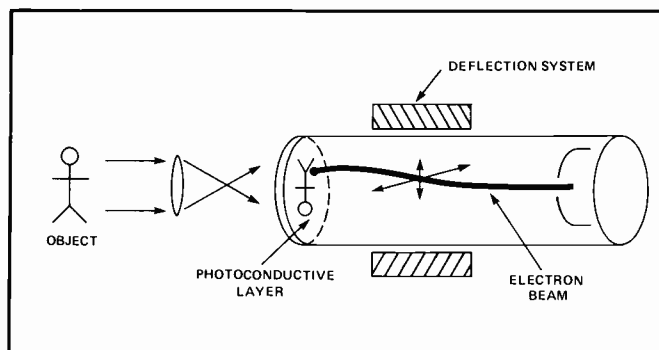


Fig. 1. Basic photoconductive tube operation.

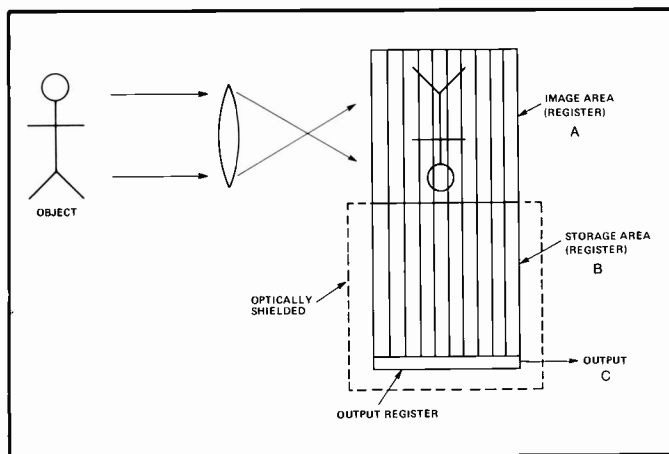


Fig. 2. Basic frame-transfer CCD operation.

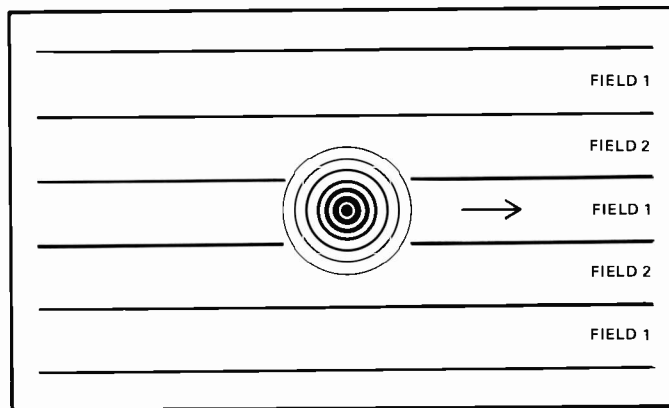


Fig. 4. Overlap into adjacent interlaced lines by the scanning spot in a pickup tube.

Channel stops divide the register horizontally into discrete elements. Blooming drains beneath the stops eliminate excess charges from highlights. The CCD is illuminated from the back side, so that all of the incident light is used and the picture elements are effectively contiguous.

Vertically, the centers of charge collection are shifted electrically on one field with respect to the other to achieve interlace. At each vertical interval, the entire charge image is transferred to an unilluminated "B" register. During the next field, this charge is clocked out line-by-line through the "C" register. The A-to-B transfer is rapid. But meanwhile, the "A" register is still integrating, so some vertical smearing can occur unless the CCD is shuttered during the transfer time.

These fundamental differences in operation result in differences in a number of parameters. We'll consider four: exposure time, lag, highlight handling, and sensitivity.

Exposure time is the interval during which charges integrate between successive readouts. Both fields integrate simultaneously in a tube. As a result of the interlacing technique used to read out the signal, a given point on the photoconductive surface is scanned once every 1/30 of a second. This fact alone would lead to a 1/30-second exposure time. However, as Fig. 4 suggests, the scanning spot does not have a sharp boundary. So, in reading out the lines of one field, it partially discharges the interlaced lines of the other field. Thus, the 1/30-second exposure for each field is effectively weighted toward the latter 1/60-second. In the CCD, only one field integrates at a time, so the device's expo-

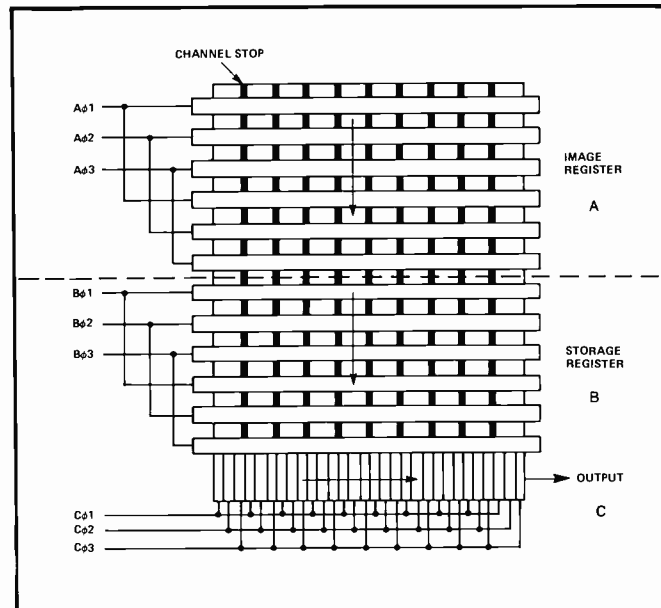


Fig. 3. Details of frame-transfer CCD operation.

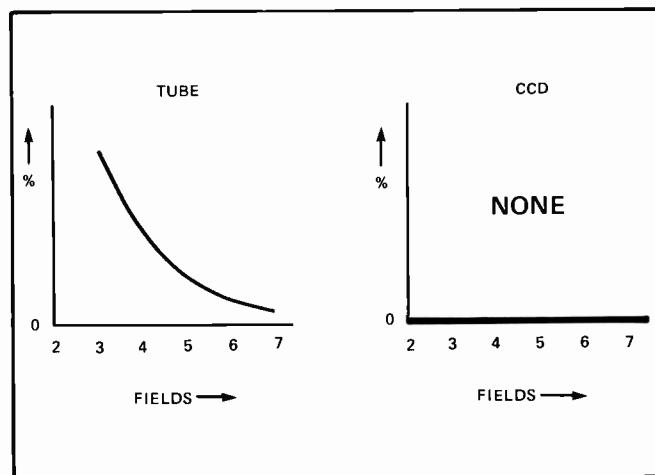


Fig. 5. Lag comparison of tube and CCD.

sure time is 1/60 of a second—the interval between successive A-to-B transfers. However, in a CCD camera, the required frame-transfer-smear shutter shortens the exposure time. The CCD-I's effective exposure time is about 1/100 of a second.

Lag is a delay in response of the video signal after a change in illumination. Figure 5 shows that a tube's response is exponential due to the beam resistance and the photoconductor capacitance. A CCD has no lag—the charge is all clocked out at once.

When a highlight hits a tube, excess charge is created, requiring many scans of the electron beam to neutralize it. The electrical image may persist for dozens of fields after the highlight has gone. A common effect is comet tails on moving lights. Another is blooming—from the attraction of the beam to the highly-charged area when it scans nearby. The CCD's blooming drains bleed any excess charge and give the CCD essentially unlimited highlight-handling capability.

A tube camera's signal-to-noise ratio, or SNR, is limited by the output capacitance of the tube and by the external preamplifier circuitry. The frame-transfer CCD has very low capacitance and an on-chip amplifier. External signal recovery circuitry can use



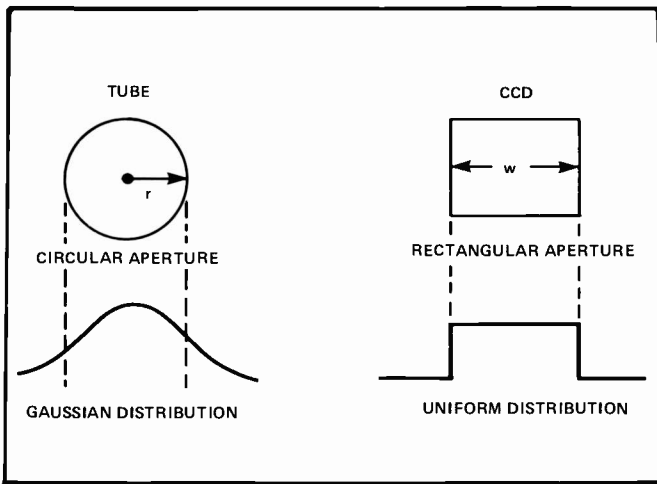


Fig. 6. Comparison of tube and CCD resolving apertures.

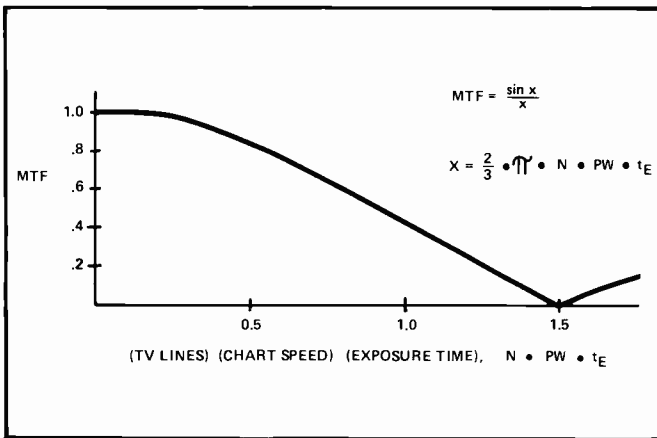


Fig. 8. Theoretical MTF curve for a CCD.

filtering and sample-and-hold techniques that take advantage of the signal's time-discrete nature to further reduce noise. Of course, in a camera design, the imager's higher SNR can be traded off to gain sensitivity. At the present time, CCD imagers have a threefold or better SNR/sensitivity advantage over pickup tubes.

### Static resolution

Resolution measurement is an attempt to quantify the ability of a pickup device to reproduce picture detail. In practice, it is often used to compare the performance of different cameras on the assumption that the measurement bears a direct relationship to the subjective picture quality. For tube cameras, there is a long record of experience in developing static resolution test charts that optimize this relationship—from the early “Indian head” to the familiar EIA and SMPTE charts and the more recent RCA P200 and P300.<sup>4,5</sup>

Historically, “resolution” was understood to denote “limiting resolution”—the point at which a pickup device has no response to fine detail. But limiting resolution is very difficult to measure. Moreover, greater limiting resolution does not always correspond to greater subjective sharpness of the picture.<sup>4,6</sup>

So today, resolution is normally expressed as the ratio of the response at a specified horizontal spatial frequency (typically, 400 TV lines per picture height) to the response at a low frequency (such as 50 lines). It is understood that these two points are located

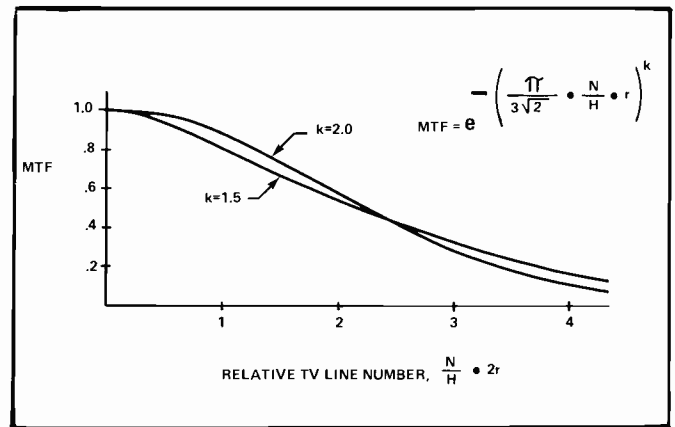


Fig. 7. Theoretical MTF curves for photoconductive tubes.

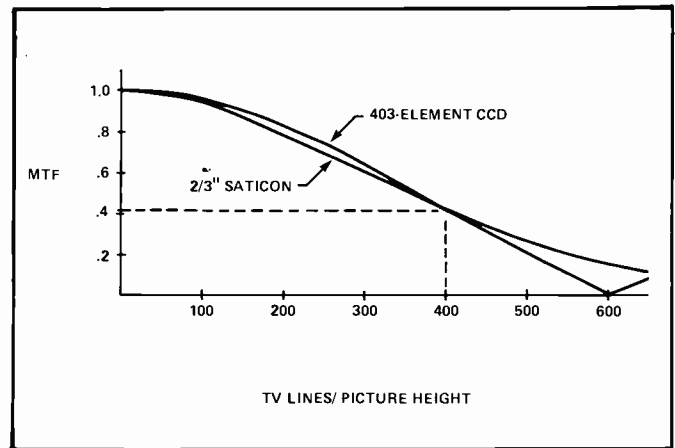


Fig. 9. Ideal MTF curves for 2/3-inch Saticon tube and 403-element CCD.

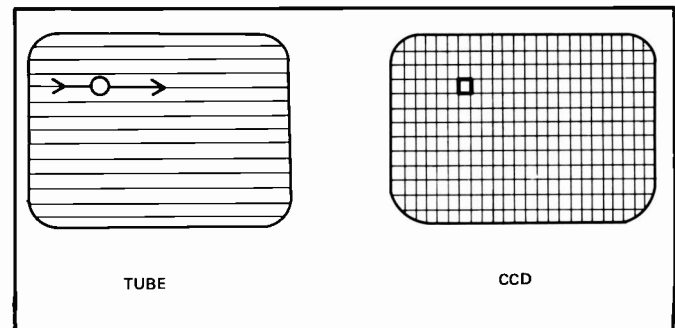


Fig. 10. Difference in aperture operation for tube and CCD.

on a curve of the modulation transfer function, or MTF, whose shape is generic to the particular type of pickup device. The curve is mainly determined by the size and shape of the resolving aperture, which is different for a CCD than for a tube, as shown in Fig. 6.

The resulting theoretical MTF curve for a tube (Fig. 7) is Gaussian-shaped and depends on the beam radius and a factor “k” related to the type of photoconductor.<sup>5</sup> The CCD has a (sin x)/x-shaped MTF curve (Fig. 8) whose null point depends on the aperture width.

The ideal MTFs for a 403-element CCD and a 2/3-inch Saticon tube are comparable, as Fig. 9 indicates. Both have 42-percent response at the conventional reference point of 400 TV

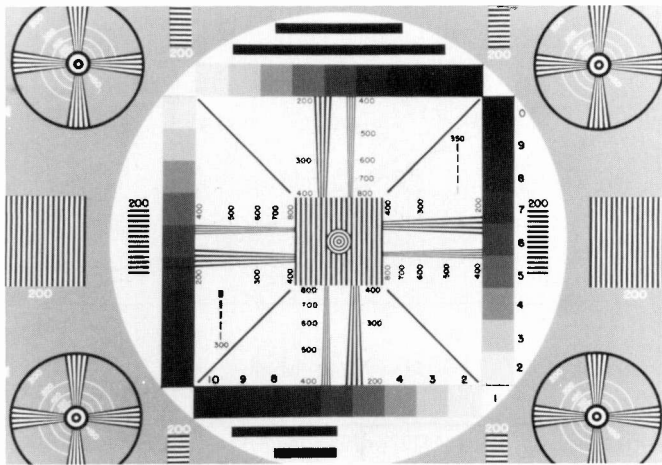


Fig. 11. Standard EIA Resolution Chart.

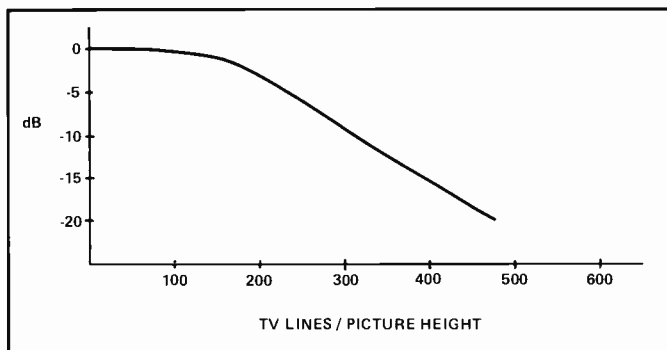


Fig. 13. Recommended anti-aliasing filter characteristic.

lines per picture height. So, what impairs the measurement and specification of CCD resolution using tube methods? Clearly, the aperture response is not a limiting factor. The answer lies in the fundamental difference in operation of the two devices, as portrayed in Fig. 10. In a tube, the resolving aperture is a single aperture that scans across the image continuously. In a CCD, the resolving aperture is actually an array of discrete apertures that are fixed in position relative to the image. Therefore, in the CCD, the line is represented by a finite number of samples—one from each aperture.

In any sampled system, "aliasing" occurs for signal frequencies that exceed half the sampling frequency. To avoid aliasing, there must be at least two samples per cycle or two samples within the transition time of an edge. Historically, television images have always been discrete vertically (composed of a finite number of lines). We are all familiar with the effects on lines and edges in the scene that are nearly horizontal. The CCD image is also discrete horizontally, so we can expect similar effects on lines and edges that are nearly vertical, even though a tube shows no such effects on them.

Conventionally, a tube's horizontal resolution is measured using wedges of nearly-vertical lines on a standard test chart, such as the EIA chart pictured in Fig. 11. A CCD can respond to the high spatial frequencies far down the same wedges, even though they may exceed the Nyquist frequency and excite aliasing. Because of this contamination, the determination of a number that accurately reflects the perceived response of the CCD is impossible. Let's calculate the point at which aliasing should begin to occur for a 403-element CCD:

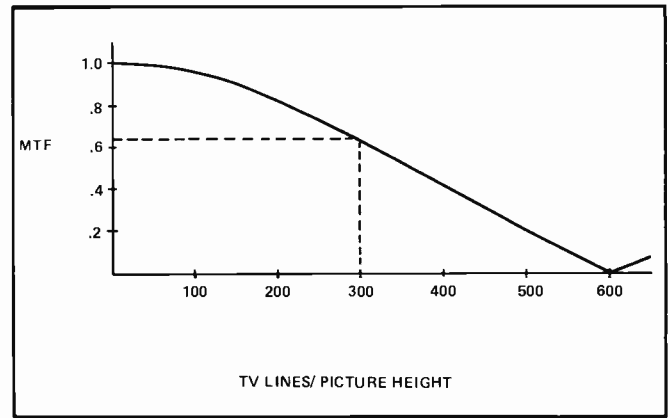


Fig. 12. Theoretical MTF curve for a 403-element CCD, showing response at the Nyquist frequency.

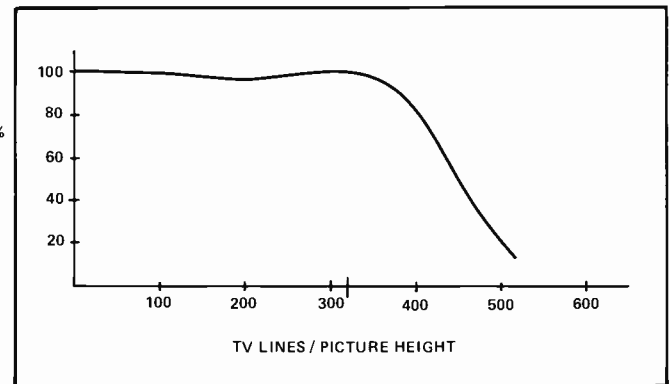


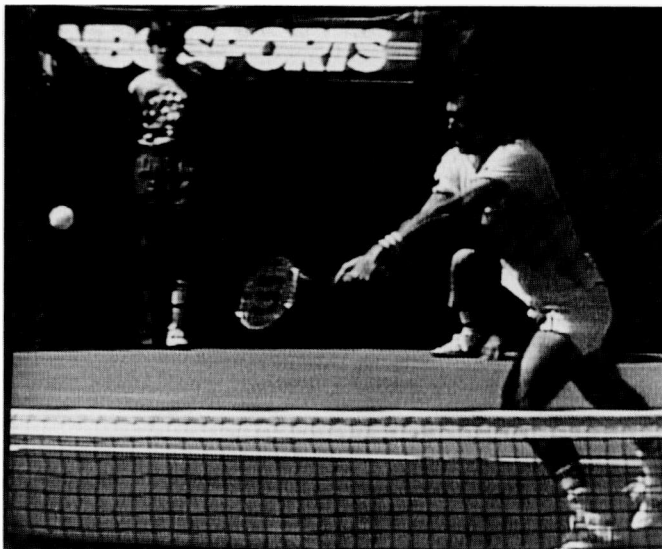
Fig. 14. Camera response after processing, showing full level at 320 lines.

$$\underbrace{\frac{403 \text{ SAMPLES}}{\text{PICTURE WIDTH}}}_{\text{CCD SIZE}} \times \underbrace{\frac{1 \text{ CYCLE}}{2 \text{ SAMPLES}}}_{\text{NYQUIST}} \times \underbrace{\frac{2 \text{ TV LINES}}{\text{CYCLE}}}_{\text{TV TERMINOLOGY}} \times \underbrace{\frac{3 \text{ PICTURE WIDTHS}}{4 \text{ PICTURE HEIGHTS}}}_{\text{ASPECT RATIO}} = 302 \text{ TV Lines / Picture Height}$$

In round numbers, and in resolution terminology familiar to television engineers, 300 TV lines per picture height is the Nyquist frequency for this device. At this point on the MTF curve of Fig. 12, the response is 64 percent. So it's far from being the point of limiting resolution. This, then, is the theoretical basis for the response that extends well beyond the aliasing point on the resolution test chart.

Of course, filtering can theoretically prevent aliasing. But previous RCA work in digital video has shown that more subjectively pleasing pictures result if frequencies somewhat above the Nyquist limit are allowed to alias.<sup>7</sup> Thus, the recommended filtering has a response such as that shown in Fig. 13—a compromise between in-band roll off that softens the picture, and sharp cut off that causes ringing on edges, which is more objectionable than aliasing.

Subsequent camera processing, including contouring, can provide full response at 320 lines, or 4 MHz, as plotted in Fig. 14. Since the introduction of the CCD-1, numerous industry experts have assessed pictures from this camera, whose design follows these recommendations. Their consensus is that the apparent picture sharpness equals or exceeds that of the best tube-type



**Fig. 15.** Off-monitor photograph of stop action, captured by NBC Sports during coverage of the 1985 Paine Webber Classic Tennis Tournament, with a CCD camera having a 1/500-second shutter. NBC has used this technique extensively since introducing it at the 1985 World Series.

cameras designed for electronic newsgathering (ENG) applications.

Even when higher-resolution devices become available to extend CCD imager applications beyond ENG into studio-quality cameras, designers are likely to exploit the subjective "snap" that aliasing contributes to typical pictures, rather than incorporate textbook frequency responses. What's more, we have a moving target provided by the emergence of even higher-definition systems.

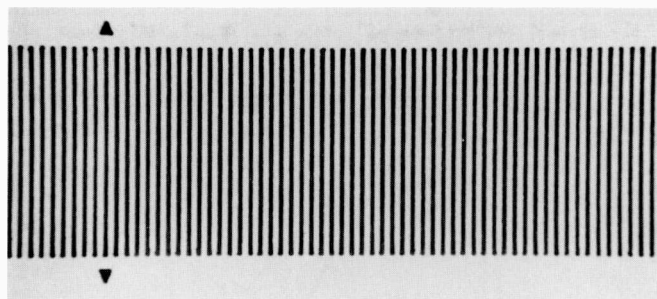
We conclude, then, that the effects of spatial sampling must not be ignored in our solid-state-imager future. Since conventional test methods—based on tube technology—cannot be used, the emphasis must be on subjective picture performance until we learn how to make correlated quantitative measurements.

### Dynamic resolution

Any assessment of overall picture performance must also consider that typical pictures move. So dynamic resolution—the ability to preserve image detail during movement—is at least as important as static resolution. Good dynamic resolution is important not only because it provides sharper real-time pictures but also because of the increasing use of non-real-time video for stop-action effects in television productions. Figure 15 is one example. In such applications, any blurring due to poor dynamic resolution would be quite noticeable.

Dynamic resolution may be affected by two factors. Primarily, any motion that occurs during the effective exposure time will be blurred. Secondly, if the pickup device exhibits image retention, then further blurring will occur on motion from one exposure time to the next.

For tube cameras, both factors must always be considered. In addition to short-term lag, long-term image retention (comet-tailing) occurs on moving highlights. But for CCD cameras, only the exposure time need be considered. This fact is one contributor to the so-called "film look," since the ability of film to resolve moving detail is purely a function of the amount of motion that occurred during the exposure time.



**Fig. 16.** Dynamic resolution test pattern.

### Measurement

Unlike static resolution, there is no conventional measurement technique for dynamic resolution. The poor dynamic performance of all photoconductive tubes traditionally has been accepted without the need to quantify it for comparison purposes. Lag is the only tube parameter, that affects dynamic resolution, for which a measurement convention is more or less established. But mere extrapolation of lag data fails to provide an accurate indication of dynamic resolution because it gives little weight to the primary contributing factor of exposure time.

We've devised a test pattern and measurement technique that allow us to compare the dynamic resolution of tubes and CCDs fairly, considering both exposure time and image retention. The loss in response to fine detail in motion may be thought of, and graphically represented as, the change in the static MTF curve when the spatial frequencies it is based on are moving with respect to the sensor. To generate data points for such a graphical representation, a pattern having a known frequency is moved past the sensor at a uniform and calibrated rate. The pattern is of relatively low frequency to avoid spatial sampling effects.

Figure 16 shows the test pattern of alternating black and white lines of constant pitch, calibrated in TV lines per picture height, that was printed on a paper belt. This belt was moved by a "teleprompter" mechanism whose speed was calibrated in picture widths per second for horizontal travel of the pattern across the picture. The CCD measurements used an experimental 403-element CCD camera with a shutter having a variable exposure time of from 1/110 to 1/1200 of a second. The depth of modulation of the green channel device was measured on a line-selecting television waveform monitor, a specialized oscilloscope. The same procedure was used for tube camera measurements on an RCA TK-86 camera equipped with 2/3-inch Saticons.

The results of these tube camera measurements are presented in Fig. 17. The same tests were performed on the CCD camera with a 1/110-second shutter speed.\* The results are shown in Fig. 18. The data at 50 TV lines per picture height are highlighted in both figures. The highlighted data points for the two cameras are directly compared in Fig. 19. This quantitative comparison of dynamic performance shows that the tube camera's response falls off substantially compared to that of the CCD camera.

We should note here that all of the measurements were taken with the cameras operating in their "0 db" gain mode, intended for

\* In this discussion the term "shutter speed" is used in the sense that is familiar to 35mm still photographers—it means "exposure time." A "faster" shutter speed corresponds to a shorter exposure time. The CCD camera shutter is a disk that rotates at 1800 rpm and has two equal openings, the size of which determine the exposure time.

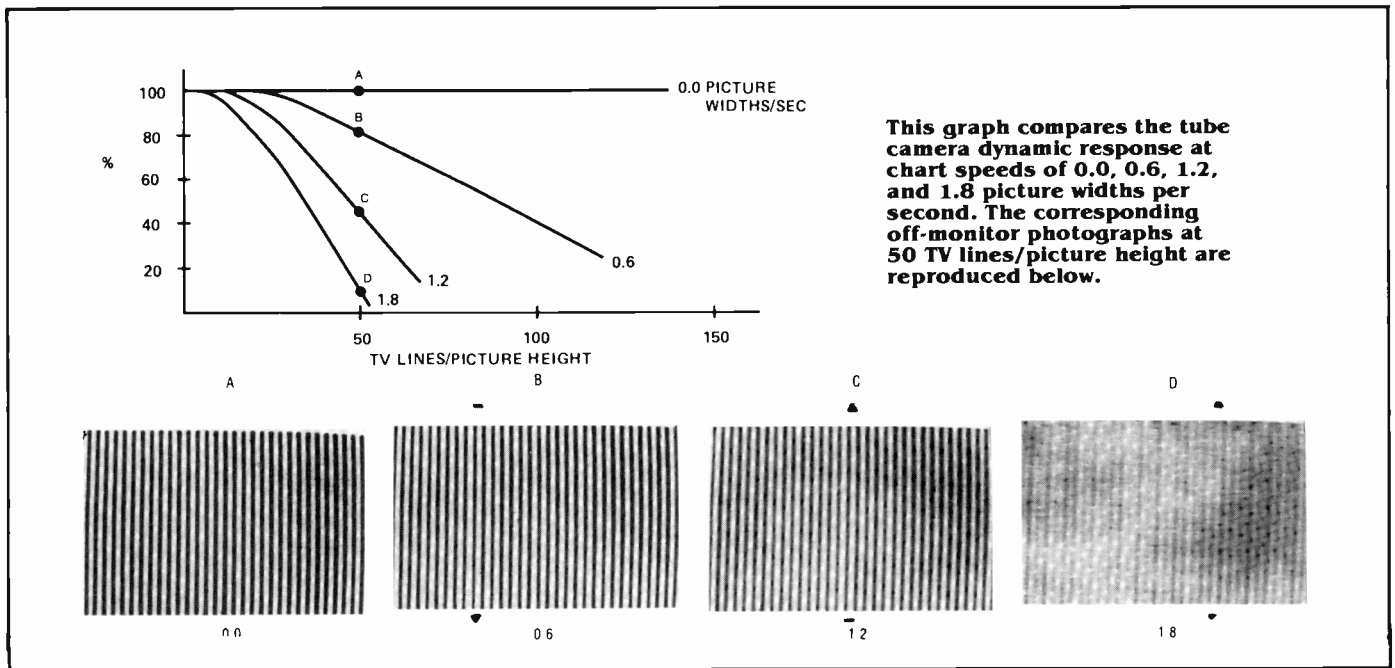


Fig. 17. Tube camera dynamic response.

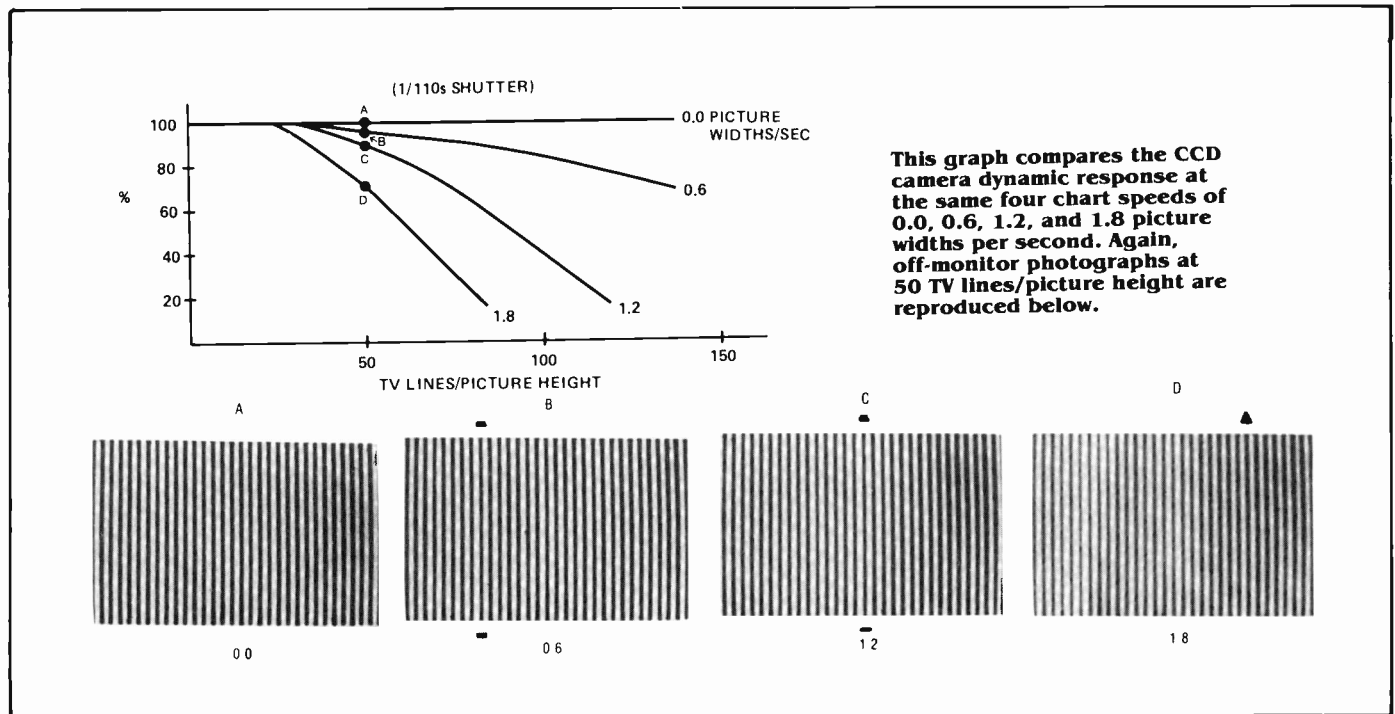


Fig. 18. CCD camera dynamic response.

normal lighting situations. "High-sensitivity" modes, providing up to 24 db of electrical gain in the case of the CCD-1, and up to 18 db of gain in a typical tube camera, may be used under low light conditions, with a commensurate decrease in SNR. Tube lag worsens by at least two or three times under such conditions, depending on how much beam reserve has been allowed for highlights. But the CCD has no lag under any lighting condition, so the dynamic resolution advantage of the CCD camera is even more dramatic when lighting is marginal and lag becomes a more significant contributing factor.

#### Subjective evaluation

We conducted an evaluation to compare subjectively the dynamic performances of a tube camera and a fast-shutter CCD camera. Sports action was recorded simultaneously from both using a split screen. Off-monitor photographs of a runner and a golf swing are shown in Fig. 20. Also shown are dynamic response curves for both cameras, measured using the moving chart method, for the speeds of action in the photographs. We can see that the quantitative measurements correlate well with the subjective clarity.

## Derivation of dynamic MTF

In general, when a signal's depth of modulation is measured, the difference between its maximum and minimum values is recorded. That difference is then compared to the maximum achievable difference to determine any loss in modulation. If these quantities can be expressed mathematically, a formula for the modulation transfer function can be developed.

To derive an MTF that accounts for motion during the exposure time, we must consider what physically occurs in the image plane of the sensing device. As a sinusoidal pattern moves past the sensor, a given point in the image plane will see a sinusoidal variation in the light being integrated, as shown in Fig. 33. The sensor output signal is given by the integral of the light flux,  $f$ , over the given time interval,  $t_E$ . Hence, the signal is maximum for interval A, centered at  $\pi/2$ , and minimum for interval B, centered at  $3\pi/2$ . Performing these integrations results in the following expressions:

$$\text{Signal Max} = A \frac{\omega t_E}{2} + A \sin \frac{\omega t_E}{2} \quad (1)$$

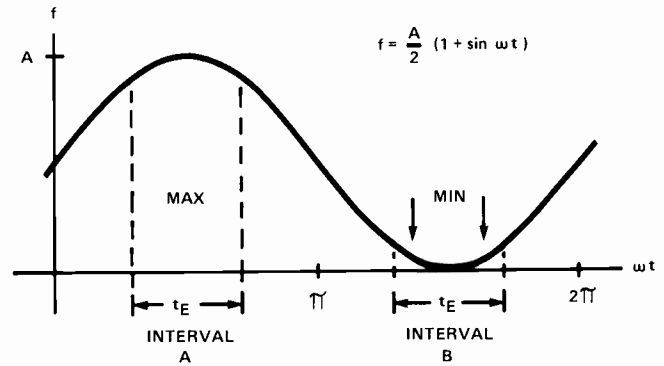
$$\text{Signal Min} = A \frac{\omega t_E}{2} - A \sin \frac{\omega t_E}{2} \quad (2)$$

The depth of modulation, Signal Max minus Signal Min, is then:

$$2A \sin \frac{\omega t_E}{2} \quad (3)$$

An expression for the maximum value of (3) is required to complete the MTF formula. To determine that expression, compare the areas under the curve for intervals A and B in Fig. 33. The maximum area difference occurs for infinitesimally small values of  $t_E$ . At such values of  $t_E$ , the  $\omega t_E/2$  argument in (3) is also infinitesimally small, allowing it to replace the sine function. Therefore, the expression for the maximum depth of modulation is:

$$2A \frac{\omega t_E}{2} \quad (4)$$



Plot of sinusoidally varying light flux used for derivation of dynamic MTF.

The dynamic MTF is then given by the ratio of (3) to (4):

$$\frac{2A \sin \frac{\omega t_E}{2}}{2A \frac{\omega t_E}{2}} \quad \text{or} \quad \frac{\sin \frac{\omega t_E}{2}}{\frac{\omega t_E}{2}} \quad (5)$$

where  $\omega$  is pattern repetitions per second and  $t_E$  is exposure time.

Expressing  $\omega$  in terms of TV lines and picture widths/second:

$$\omega = \frac{2\pi \text{ RADIANS}}{\text{CYCLE}} \cdot \frac{1 \text{ CYCLE}}{2 \text{ TV LINES}} \cdot \frac{N \text{ TV LINES}}{\text{PICTURE HEIGHT}} \cdot \frac{4 \text{ PICTURE HEIGHTS}}{3 \text{ PICTURE WIDTHS}} \cdot \frac{PW \text{ PICTURE WIDTHS}}{\text{SECOND}}$$

With this final substitution, expression (5) becomes:

$$\text{Dynamic MTF} = \frac{\sin \left( \frac{2}{3} \pi \cdot N \cdot PW \cdot t_E \right)}{\frac{2}{3} \pi \cdot N \cdot PW \cdot t_E}$$

where  $N$  is TV lines/picture height,  $PW$  is picture widths/second, and  $t_E$  is exposure time.

This analysis is similar to a method for deriving the MTF for a uniform flux aperture, shown in Fig. 8, that was suggested by Sidney L. Bendell, Retired, RCA Broadcast Systems. The major difference in the above derivation is that the aperture is in time instead of distance.

—C.J. Haslett

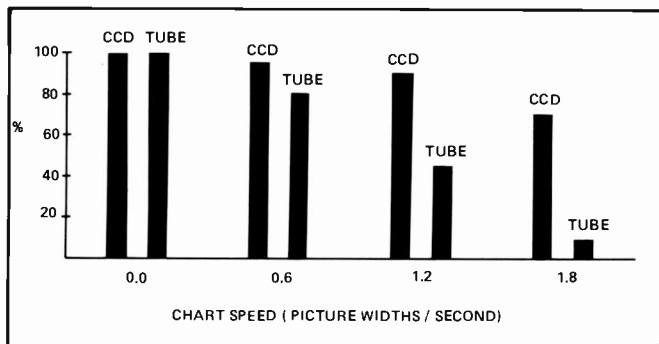
### Dynamic MTF theory

We've noted that any relative motion between subject and sensor during the exposure time blurs the recorded image. But it is important to point out that this resolution loss occurs as the scene is imaged, before the resolving aperture is applied. Therefore, it is independent of the aperture response of the sensing device and affects tubes, CCDs, and film in the same manner.

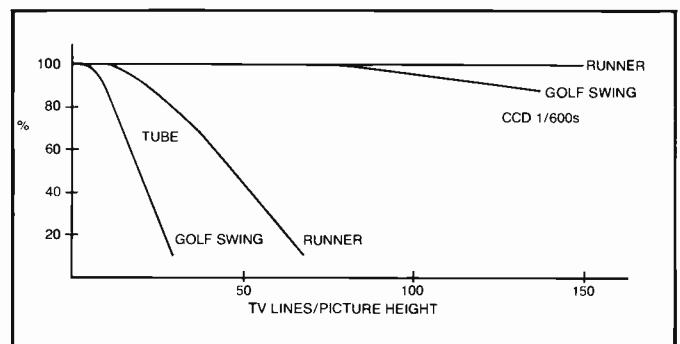
A mathematical expression for the dynamic modulation transfer function, which accounts for the effect of motion during the exposure time, is derived in the sidebar. Figure 21 is a plot of that equation. Note that this expression predicts nulls in the

dynamic response. These nulls occur when the input pattern moves through one or more complete cycles during the exposure time. For a given speed of motion, a shorter exposure time will shift the null points to higher TV line numbers, thereby increasing the dynamic resolution. It is well known that sine-wave responses follow the product rule; the response for a complete system is the product of the responses for each individual part.<sup>8</sup> Therefore, the product of this expression and the other MTFs of an imaging system provides for the specification of that system's dynamic resolution.

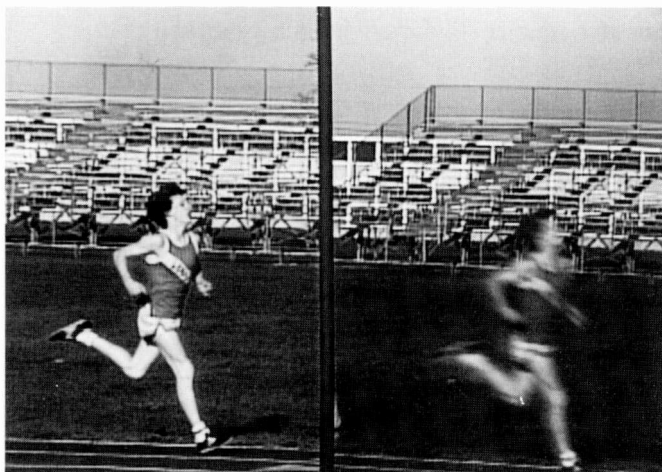
The effect of shortening the exposure time of a CCD camera is



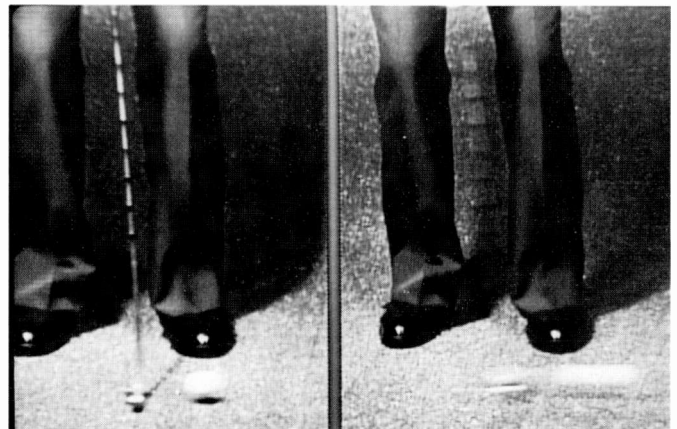
**Fig. 19.** Comparison of dynamic responses of tube and CCD cameras at 50 TV lines per picture height. The shutter speed of the CCD camera is 1/110 of a second.



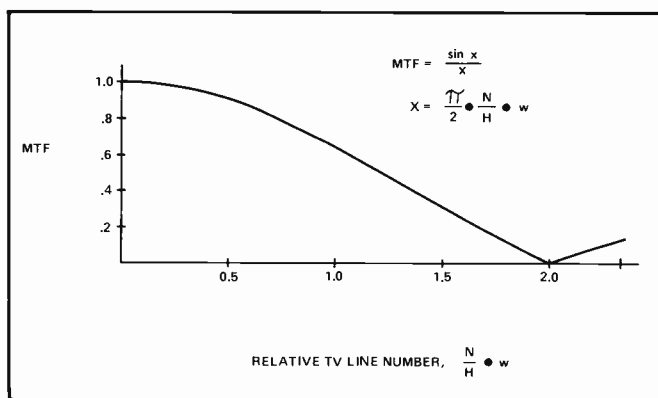
**Fig. 20a.** Comparison of dynamic responses of tube and fast-shutter CCD cameras for typical sports action.



**Fig. 20b.** Split-screen comparison on runner moving at 1.2 picture widths per second.



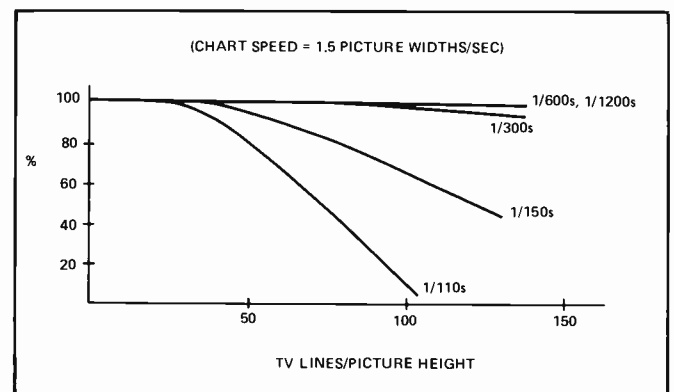
**Fig. 20c.** Split-screen comparison on golf swing. Head of putter is moving at 3 picture widths per second.



**Fig. 21.** Theoretical dynamic MTF curve.

shown in Fig. 22. Quantitative data measured at five different shutter speeds are presented. It is obvious that dynamic resolution increases with increasing shutter speed, but the amount of improvement from one shutter speed to the next diminishes. The data compare well with the values predicted by the dynamic MTF expression for the different exposure times.

Somewhat surprisingly, the measurements from tube cameras generally follow the curve for a 1/60-second exposure time. However, the data are consistently lower than the predicted values, with best correlation only near the null point. This result



**Fig. 22.** CCD camera dynamic response at five shutter speeds.

may be explained by recalling that although a tube's actual exposure time is 1/30 of a second, it is heavily weighted toward the latter 1/60 of a second. Therefore, the tube's theoretical dynamic MTF should consider this weighting. Curve B of Fig. 23 is a modified 1/60-second dynamic MTF curve obtained by summing 90 percent of the dynamic MTF evaluated at 1/60 of a second and 10 percent of the dynamic MTF evaluated at 1/30 of a second. Tube data measurements, highlighted in the figure, agree more closely with the shape of this modified curve than with the 1/60-second curve (curve A). The remaining disparity may be theorized to result from image retention from more

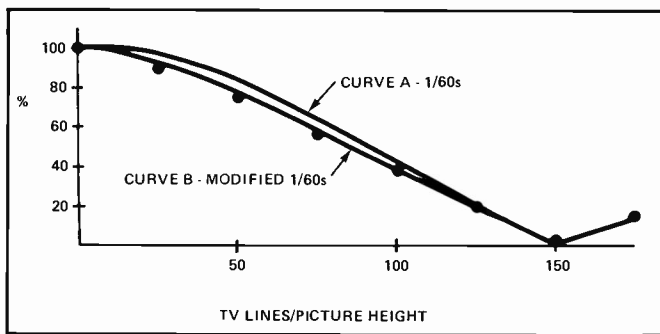


Fig. 23. Theoretical dynamic MTF curves at 0.6 picture widths/second, showing effect of weighted exposure time in a tube. Dots correspond to measured tube data.

CCD CAMERA SHUTTER SPEED	SHUTTERING TRADEOFF	REMAINING MARGIN TRADED OFF BETWEEN SENSITIVITY & SNR		DYNAMIC RESOLUTION IMPROVEMENT OVER TUBE
UNSHUTTERED	—	8dB	—	10%
1/100s	4dB	4dB	—	50%
1/100s	4dB	—	4dB	50%
1/150s	8dB	—	—	63%

Fig. 25. Possible camera design tradeoffs for CCD's 8-db sensitivity margin.

than one field ago, including the effect of lag as it is commonly measured. A more accurate model might result from extending the weighted exposure time concept to these earlier fields.

#### Shuttering tradeoff

Operating a shutter ahead of the imager to shorten the exposure time proportionately reduces the amount of light falling on the imager and the signal level it generates. The signal level may be restored by using additional video gain, at the expense of SNR. Or, the light level may be restored by using a wider lens aperture, at the expense of depth-of-field. Figure 24 shows the relationship between lens aperture and shutter speed for an arbitrary illumination level.

In a camera design, SNR and sensitivity may be traded off in the ratio of 6 db of SNR to 1 f-stop of sensitivity. With present technology, the frame-transfer CCD achieves at least an 8-db margin in sensitivity over state-of-the-art pickup tubes. Figure 25 tabulates some of the ways in which this margin may be traded off. The CCD's dynamic resolution advantage, considering only the effect depicted in Fig. 23, is approximately 10 percent, based on moving a pattern of 75 TV lines/picture height at a speed of 0.6 picture widths/second. The required frame-transfer-smear shutter cuts into the sensitivity margin, but it simultaneously provides a further dynamic resolution advantage. The CCD-1 has an exposure time of 1/100 of a second. This provides a 50-percent improvement in dynamic resolution over a state-of-the-art tube camera while preserving 4 dB of the device's sensitivity advantage. This is traded off to provide a 4-dB SNR margin for equivalent sensitivity or depth-of-field. It may be noted that, were the full SNR margin to be traded off, shut-

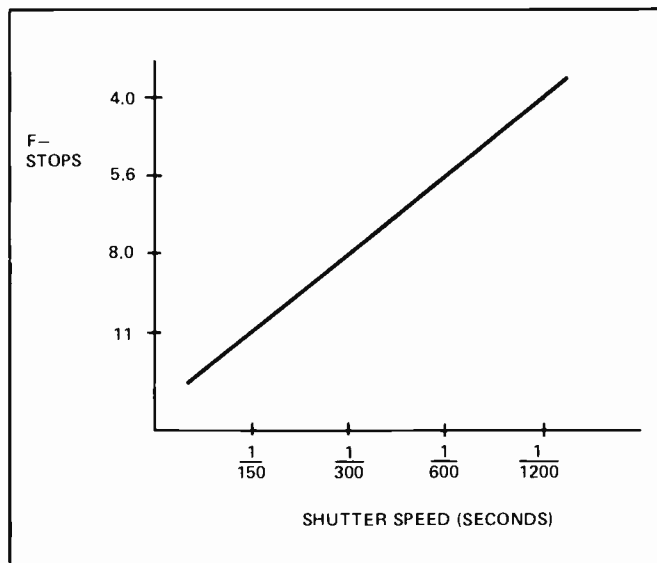


Fig. 24. Relationship of lens aperture to shutter speed for an arbitrary illumination level.



Fig. 26. Double exposure effect on a bouncing soccer ball, created by shuttering a tube camera and arising from the tube's weighted exposure time characteristic.

ter speed could be increased to 1/150 of a second without loss of depth-of-field. This would result in a dynamic resolution improvement over the tube camera of 63 percent.

#### Shuttering a tube camera

The concept of shuttering a television camera to improve its dynamic resolution is far from new. RCA made available a shuttered version of the TK-44 some fourteen years ago. Although the shutter did reduce blurring, acceptance of this camera was poor. Users learned that the improvement shuttering can make in the dynamic resolution of a tube camera is practically limited by the immediate loss in depth-of-field. Furthermore, the weighted exposure time characteristic of tubes affects the subjective clarity of stop action, as can be seen in Fig. 26.

To understand this effect, recall from our earlier discussion that the 1/30-second exposure time of a tube actually com-

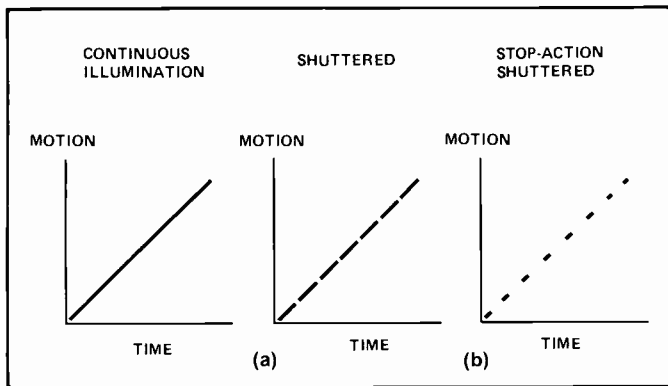


Fig. 27. Discontinuous motion, or "strobing," effect produced by shuttering a camera.

prises two 1/60-second parts, having relative weightings of about ten and ninety percent. Shuttering the tube truncates both parts of the exposure, creating two discrete images rather than one continuous blur. The subjective effect is that of double exposures, 1/60 of a second apart. The earlier image is about ten percent as bright as the latter one.

Recently, a company called Nisus Video has revived this concept commercially. Tube-type ENG cameras are modified by Nisus to incorporate a proprietary variable shutter. Although tube performance has improved since the early RCA experiments, the clarity achieved by this technique remains limited by tube technology.

### Strobing

The use of a shutter in a camera, and the resulting periodic illumination of the imager, can create a strobing effect on moving subjects in the scene. Since the imager does not view the subject all the time, portions of its movement are lost, and the effect is that of discontinuous motion. Figure 27a portrays this effect.

We explained earlier that a camera based on a frame-transfer CCD must employ a shutter to cover the A-to-B register vertical transfer and prevent smearing of the image. This is analogous to the shutter required in a motion picture camera to cover the film pull-down interval. For this degree of shuttering, strobing is barely perceptible. However, if exposure time is reduced further, to increase dynamic resolution and achieve greater stop-action clarity, then strobing may become more pronounced because more of the motion continuity is lost. This effect is represented in Fig. 27b.

### Shuttering recommendations

Ideally, a camera design should provide a variable exposure time to maximize artistic flexibility in terms of depth-of-field and stop-action clarity under a variety of lighting conditions. But, when the design is restricted to a fixed shutter speed, the sensitivity margin tradeoff should be optimized to satisfy the majority of anticipated applications. For ENG use, a 1/100-second shutter, as employed in the CCD-1 camera, is preferred. The tradeoff used in its design corresponds to the third line in the table of Fig. 25. For typical sports production, a shutter speed of 1/500 of a second should suffice. RCA has designed an optional 1/500-second shutter for the CCD-1 to serve this application. The option is designated CCD-1S. Its design trades off depth-of-field for greater dynamic resolution.

### Temporal resolution

As the dynamic resolution of a camera is increased, effects related to its temporal resolution become more apparent. Temporal resolution is the ability to distinguish events that are closely spaced in time. It is determined by the number of images recorded per second. Since the records constitute a sampling of the scene in the time domain, the imaging is time discrete. Thus, aliasing can occur when a temporal Nyquist rate, related to the system's imaging rate, is exceeded. For a moving repetitive pattern, this temporal aliasing appears as an incorrect velocity of the image. A well-known example of this effect is the apparently backward-turning wagon wheels seen in western movies.

One way of studying the effect is to use the moving test chart that was described previously for dynamic resolution measurements. In making such measurements, temporal aliasing effects can be observed as apparent stopping or reversal of direction of the moving pattern, depending on the line pitch and chart speed. It is important to note that this temporal aliasing does not interfere with the dynamic resolution measurement, as spatial aliasing was earlier shown to interfere with measurement of static resolution. There are two reasons. First, the temporal alias has no effect on video amplitude, the parameter being measured. Second, if a recording of the video is still-framed so that no temporal alias occurs, measurement produces the same results as under "live" conditions. In short, dynamic response is a real, electrically-measurable parameter; temporal aliasing is a psychophysical phenomenon.

To avoid temporal aliasing, the frequency of the pattern, its speed of movement, and the system imaging rate must be such that at least two images are taken per cycle of pattern movement. If the test chart is moved one half cycle of its pattern between images, then its apparent direction of movement will be ambiguous. This defines the Nyquist limit. Stated as a formula, it is:

$$\underbrace{\frac{\text{IMAGES}}{\text{SECOND}}}_{\text{SYSTEM IMAGING RATE}} = 2 \times \underbrace{\frac{\text{CYCLES}}{\text{PICTURE WIDTH}}}_{\text{PATTERN FREQUENCY IN DIRECTION OF MOVEMENT}} \times \underbrace{\frac{\text{PICTURE WIDTHS}}{\text{SECOND}}}_{\text{SPEED OF PATTERN MOVEMENT}}$$

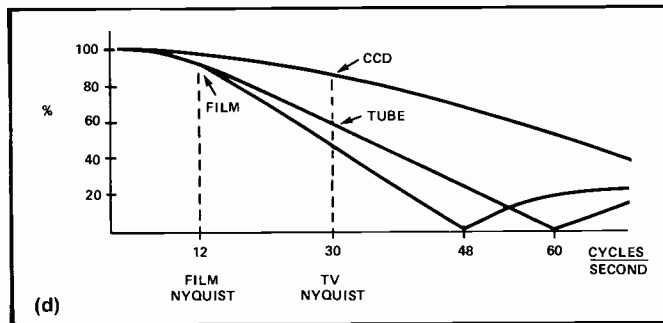
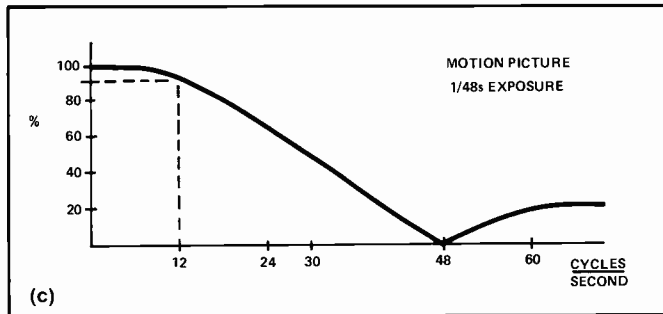
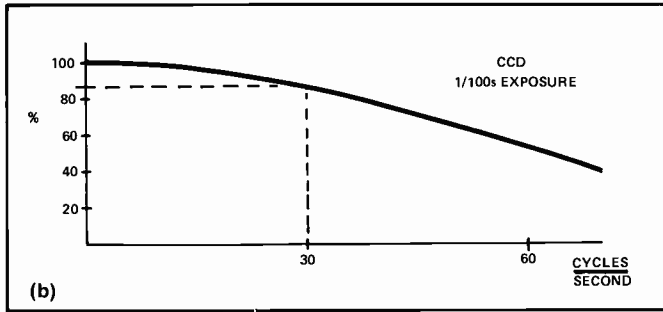
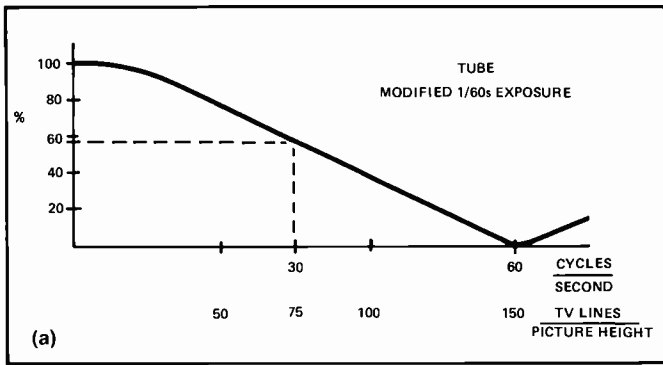
Note that the expression on the right side of the equation has the dimensions of cycles/second, meaning cycles of pattern movement per second. For the television rate used in this country, 60 images per second, the Nyquist limit is 30 cycles of pattern per second.

In order to relate this criterion to measurements using the dynamic resolution test chart, the pattern frequency, expressed in cycles/picture width, must be converted to the chart calibration in TV lines/picture height. The resulting formula is:

$$\frac{\text{IMAGES}}{\text{SECOND}} = \frac{4}{3} \times \frac{\text{TV LINES}}{\text{PICTURE HEIGHT}} \times \frac{\text{PICTURE WIDTHS}}{\text{SECOND}}$$

The horizontal axes of Fig. 28 show this relationship for a horizontal chart speed of 0.6 picture widths per second. At this speed, horizontal pattern frequencies above 75 TV lines per picture height will excite temporal aliasing in the television system. A tube camera's response at the Nyquist limit is 57 percent, as shown in Fig. 28a. A CCD camera's higher dynamic response increases the visibility of temporal aliasing. As Fig. 28b shows,

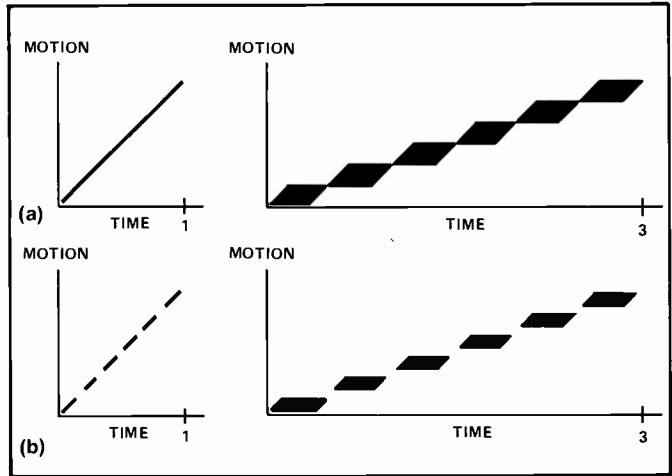




**Fig. 28.** Comparison of temporal resolution of tube, CCD, and motion picture cameras for movement at 0.6 picture widths per second. The response of each at its temporal Nyquist frequency is shown.

a 1/100-second shutter raises the response at the Nyquist limit to 86 percent. A motion picture camera operating at 24 frames per second with a typical 180-degree (1/48-second) shutter has slightly greater response (90 percent) at its 2.5-times lower Nyquist limit of 12 cycles of pattern per second, as plotted in Fig. 28c. These responses are overlaid in Fig. 28d. These theoretical considerations lead to the following conclusion:

*The higher dynamic response of the CCD camera—a major contributor to its praised “film look”—increases the visibility of*



**Fig. 29.** (a) Jerkiness of motion, or “judder,” produced by repetition of identical images. (b) Combined judder and strobing effects.

*any temporal aliasing over that of tube cameras. But it is less likely than film to exhibit this undesirable artifact because of the faster imaging rate—the higher Nyquist frequency—of the television system.*

This conclusion is borne out by subjective assessment, which is, after all, the best evaluation method for a psychophysical effect.

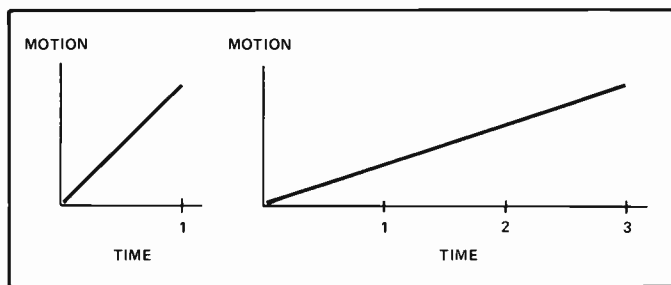
### Non-real-time video applications

Two non-real-time video applications, stop action and slow motion, have become increasingly popular since the advent of the Type C VTR, which makes them easy. This one-inch helical-scan format videotape recorder is now widely used in broadcasting operations. Such applications require consideration of the dynamic and temporal resolution characteristics of the imaging system.

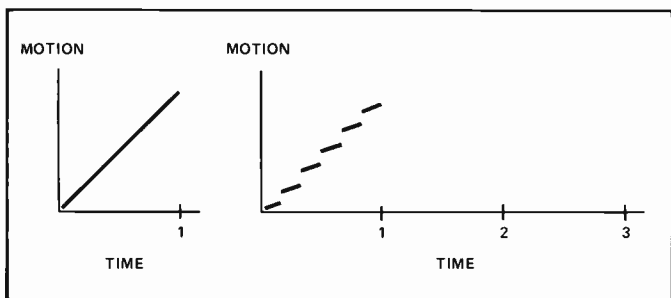
We’ve already discussed stop action. Since this effect converts real-time dynamic resolution to static resolution, the presence or absence of fine detail in moving subjects is much more noticeable. Sharp stills require high dynamic resolution. Generally, this implies use of a short exposure time in the camera. We’ve seen that shuttering a CCD camera is more practical and more effective in producing sharp stills than shuttering a tube camera. But we’ve noted that a short exposure time can cause an artifact—strobing—on motion. This effect is more noticeable in slow-motion playback than in real time. Each image is held longer, so it is easier to recognize that some of the motion has been missed.

One way of holding each image longer is to simply repeat it. This repetition can, by itself, create a motion artifact independent of whether strobing is simultaneously present. The effect is that of jerkiness of motion, as diagrammed in Fig. 29a, and it is commonly referred to as judder. If judder and strobing are both present, then the motion is not only jerky but also discontinuous, as represented in Fig. 29b.

The smoothest slow motion requires that the slow down be achieved without repetition of identical images, and that all of the motion be imaged. The first requirement may be met by increasing the imaging rate—the temporal resolution—of the camera and recording system. The second mandates that the dynamic resolution be limited by the temporal resolution, since the exposure time can be no shorter than the reciprocal of the imaging rate.



**Fig. 30.** Smooth 3-to-1 slow motion achieved by operating camera and recorder at 3 times the standard imaging rate.

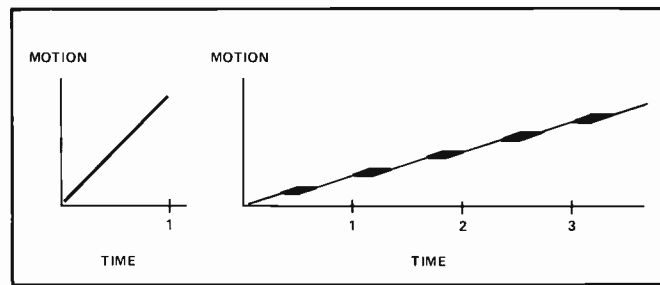


**Fig. 32.** Strobging produced when a 3x-rate video is converted to standard rate for viewing motion in real time. Only one of every three images recorded is actually viewed.

So the requirements on dynamic resolution for stop action and for slow motion are contradictory for practical imaging rates. Only by resorting to rates of perhaps 300 to 500 per second can a single system provide both blur-free stop action and smooth slow motion. A practical system must be optimized for one and trade off the other.

In this tutorial we've described a system optimized for stop action. Achieving a 1/500-second exposure time, for example, requires nothing more than a shutter change in an otherwise standard CCD camera. Stop-action and slow-motion effects are readily attained by recording the camera signal on a standard Type C VTR having variable playback speed capability. The tradeoff for the enhanced stop-action performance is the potential for strobing on motion. Slow motion has the appearance of a sequence of crisp still images, any of which may be used individually as "freeze frames."

A system more optimal for slow motion has been developed jointly by ABC Television and Sony Corporation. It was first used extensively during ABC's telecast of the 1984 Summer Olympics. This "Super Slo-Mo" system, as ABC called it, has often been compared and confused with the RCA shuttered-CCD system, which NBC Sports has dubbed "Super-Duper Slo-Mo." A few words to clarify the distinction between them are in order. The ABC/Sony slow-motion system utilizes a special high-frame-rate tube camera, a wideband transmission link, multiple fieldstores, and a special high-speed videotape recorder to achieve the required temporal resolution. For its complexity, it achieves the appearance of fluid slow motion for a unique slow-down rate. The camera and recorder operate at three times the standard imaging rate. So the smoothest slow motion occurs for a three-to-one slow down, as portrayed in Fig. 30. At some rates, judder can occur from image repetition. In particular, it occurs for greater than three-to-one slow down, such as the four-to-one depicted in Fig.



**Fig. 31.** Judder produced when a 3x rate recording is played back at 3/4 of standard speed to achieve 4-to-1 slow motion.

31. At other rates, including real-time, strobing can occur from omission of parts of the motion (see Fig. 32). The mandatory exposure time limitation results in blurring on freeze frames. In addition, the highlight-handling limitation of the tube technology is emphasized in both slow motion and still modes.

We believe that specific applications exist that mandate the use of one system or the other for the stop action or slow motion toward which it is optimized. The majority of non-real-time applications should be well served by the performance of either. The relative system complexity and adaptability for normal real-time applications must then be considered. The user should be fully aware of the tradeoffs involved.

## Conclusion

In this tutorial, we've examined some of the fundamental differences in tube and CCD operation. To summarize:

In the case of static resolution, the accepted quantitative evaluation technique for tubes has proven to be unusable for CCDs—subject to sampling effects—because of poor correlation with subjective picture quality. We've offered some food for thought as we continue to search for an effective means to measure this parameter. In the meantime, subjective assessments by industry experts have confirmed that the CCD-1 color camera, using three 403-element CCDs, has an apparent picture sharpness equal to or better than the best tube-type ENG cameras.

In the case of dynamic resolution, no quantitative test method has existed for tube cameras. We've suggested one that permits fair comparison of tube and CCD camera performance and whose results do correlate with those of subjective testing and theoretical analysis. The CCD camera has proven superior in this parameter.

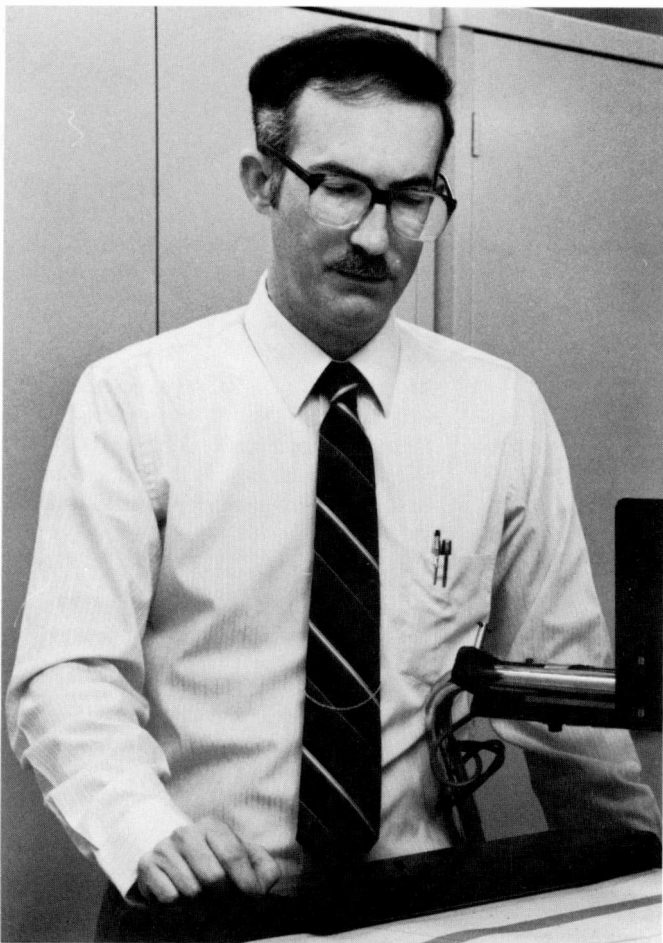
As the dynamic resolution of a camera is increased, psychophysical effects related to its temporal resolution become more apparent. Understanding both dynamic and temporal resolution is essential to the design of systems for stop-action and slow-motion effects. While no practical television system can simultaneously provide both effects optimally, a CCD camera equipped with a fast shutter does provide sharp images in slow motion and unequalled stop-action clarity.

## Acknowledgment

The author would like to express appreciation to Carl J. Haslett, coauthor of the original SMPTE-published paper and contributor of the dynamic MTF derivation. Thanks are also due Cydney A. Johnson and Gary R. Peterson, who performed the dynamic resolution measurements and provided other useful inputs.

## References

1. *RCA Broadcast News*, Vol. 120, April 1964.
2. Woywood D. J., "The RCA CCD-1 Broadcast Color Camera," 38th Annual NAB Broadcast Engineering Conference.
3. Hughes G. W., "Electronic imaging with CCDs," *RCA Engineer*, Vol. 29 No. 6, Nov./Dec. 1984.
4. Neuhauser R. G., "Measuring Camera Tube Resolution with RCA P200 Test Chart," *SMPTE J.*, Vol. 89, pp. 97-100, Feb. 1980.
5. Miller L. D., "A New Method of Specifying the Resolving Power of Television Camera Tubes Using the RCA P-300 Test Chart," *SMPTE J.*, Vol. 89, pp. 249-256, April 1980.
6. Schut T. G., "Resolution Measurements on Camera Tubes," *SMPTE J.*, Vol. 92, pp. 1287-1293, Dec. 1983.
7. Reitmeier G. A., "The Effects of Analog Filtering on the Picture Quality of Component Digital Television Systems," *SMPTE J.*, Vol. 90, pp. 949-955, Oct. 1981.
8. Coltman J. W., "The Specification of Imaging Properties by Response to a Sine Wave Input," *J. Optical Society of America*, Vol. 44, pp. 468-471, June 1954.



**Tom Gurley** is Unit Manager, Advanced Development Engineering, RCA Broadcast Systems Division. His professional experience in the broadcasting industry spans twenty years. With RCA since 1970, he has been involved in television systems engineering, studio automation, digital video product development, and video recording equipment development. His most recent work has centered on enhancing the resolution performance of CCD cameras. He has been active in industry standardization activities related to television studio facilities and to digital, component analog, and high-definition video. Recently he was appointed Chairman of the IEEE Subcommittee on Video Generation and Processing Measurement. A Duke University graduate, he earned an MSE in EE from the University of Pennsylvania. Tom is an author of three SMPTE-published papers, a previous *RCA Engineer* article, and he has been granted three patents. He holds memberships in SMPTE, Eta Kappa Nu, and Tau Beta Pi, and is a Senior Member of IEEE.

Contact him at:

**Broadcast Systems Division  
Gibbsboro, N.J.  
Tacnet: 266-3852**

## Room at the bottom: The Trident integrated radio room

*Undersea communications is not just a reality—  
it is a vital link in US strategic defense*

Trident-class submarines dwarf the Polaris and Poseidon, their predecessors. Side by side in dry dock, the Trident and Poseidon look like mother and daughter. Trident displaces 18,000 tons, is 559 feet long, and is as tall as a five-story building. Nonetheless, it is extremely agile under the sea, and is as difficult to locate as the proverbial needle in a haystack. This paper describes communications with deployed Trident submarines through the Integrated Radio Room, or the "room at the bottom."

**Abstract:** *The Trident is the largest, most sophisticated strategic submarine in the US Navy. Its mission is to act as a nuclear deterrent. A Trident on patrol is completely mobile and virtually undetectable. It carries a destructive force that is unparalleled on one platform. However, the Trident can never be a credible deterrent unless it can maintain a constant, reliable communications link with the US national shore-based command centers. The Integrated Radio Room (IRR) provides this vital link. It is a computerized, automated communications suite that covers the radio bands from ELF through UHF. This article describes how automation and integration have combined to produce a sophisticated communications system that has more capability and is controlled by fewer operators than ever before.*

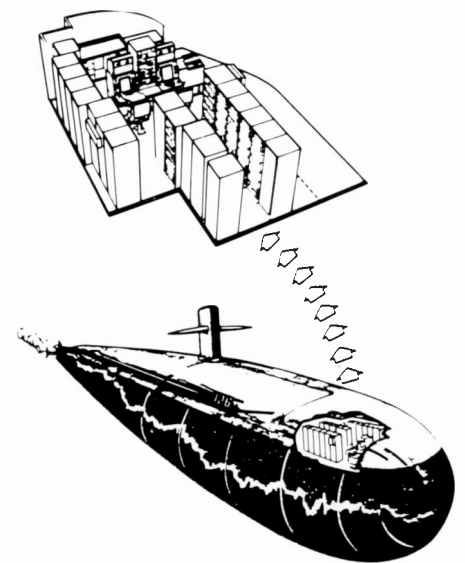
### Mission

The U.S. Navy has two types of submarines; attack submarines and strategic submarines. The Trident (SSBN 726 class) is a strategic submarine that represents one arm of the U.S. strategic defense triad—Minuteman and manned bombers are the other two arms. Trident submarines are extremely quiet, seldom transmit, and are virtually undetectable on patrol. A primary mission of a Trident while on patrol is to monitor radio frequencies for emergency action messages (EAM's). These messages contain the command and control information related to ballistic missile launch.

The Trident Integrated Radio Room (IRR), designed and manufactured by RCA, introduced communications automation into the US fleet. It is the first computer-controlled communications center on a submarine. Its function is to provide accurate and reliable exterior communications between the Trident-class submarine and satellites, aircraft, shore facilities, and other ships. Its official nomenclature is the AN/BSC-1 Communications Central. Figures 1 and 2, respectively, provide a simplified overview of Trident communications for surface operations while entering and leaving port, and for submerged operations while on patrol.

### Program status

IRR is a mature system in production, and is fully supported logistically. At least 20 submarines are planned, with the first 11 ship sets already delivered or under con-



struction. To date, RCA has delivered IRR equipment for the first seven ships. Four of these are operationally deployed out of the West Coast sub base in the Hood Canal at Bangor, Washington. Deployed submarines include:

- USS Ohio, SSBN 726
- USS Michigan, SSBN 727
- USS Florida, SSBN 728
- USS Georgia, SSBN 729

Submarines nine and above will operate out of the future East Coast Trident base at Kings Bay, Georgia.

### System description

Figure 3 is a simplified block diagram of the Trident Radio Room depicting the seven major subsystems that make up the IRR, as well as the future growth subsystem (EHF).

A "to scale" physical layout of the radio room is shown in Fig. 4. As can be seen, the IRR comprises 23 racks of electronic equipment and two dummy loads. These racks are partitioned into subsystems as follows:

- VLF/LF subsystem
- HF/UHF subsystem
- ELF subsystem
- Control, monitor and test subsystem
- Data switching subsystem
- Support subsystem
- Antenna interface subsystem

Radio signals to and from the Trident submarine are routed through one of seven

antenna suites; two multifunctioned masts, two periscope masts, a towed buoy antenna, a buoyant cable antenna, or an emergency whip antenna.

Radio room electronic equipment consists of Navy inventory equipment such as AN/UYK-20 standard Navy minicomputer and OJ-326(V) standard Navy display, off-the-shelf militarized equipment, and RCA-designed equipment. Within the radio room, there is a large degree of commonality and standardization. Equipment rack enclosures are a common design. The majority of the racks are water-cooled and contain one of three standard water to air heat exchangers or thermal control units. Each rack contains a power control unit, again of common design. The various subsystems throughout the radio room contain standard mechanical hardware and common printed circuit boards for power distribution, switching, and processor interfacing.

Applicable specifications with respect to EMI, EMC, TEMPEST, environmental conditions, airborne and structureborne noise, and reliability and maintainability have been met or exceeded.

### Communications capability

A broad overview of the radio room communications capability is shown in Table I. The primary communications, where the radio receivers and transmitters are physically located within the radio room, are described in the top half of the table. The bottom half of the table represents situations where the receivers are located externally to the radio room, and the radio room function is to provide an interface to an appropriate antenna.

The primary communications link to the submarine is via VLF secure data. UHF Satcom secure data and HF secure radioteletype are secondary or backup links. The submarine broadcast control authority assigns serial numbers to all messages for accountability. All strategic submarines are required to monitor the submarine broadcast and to maintain message accountability. Since VLF is the primary communications mode for transmitting to the submarine and is the normal way submarine broadcasts are received, many special features were designed into the VLF/LF subsystem.

VLF software calculates the transmission delay based on the latitude/longitude of both the transmitter and the ship, and adjusts the delay as the ship moves. Many of the VLF modes have quality indicators associated with received characters, such as

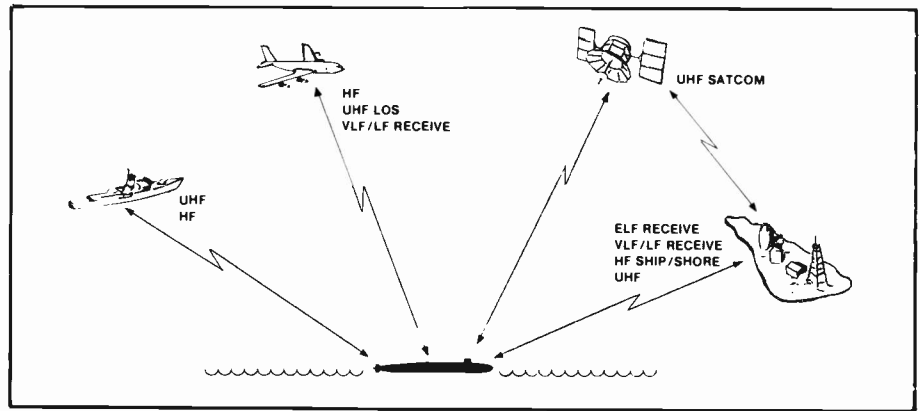


Fig. 1. For surface communications, Trident must have an antenna broaching the surface of the water to transmit. Trident is normally only surfaced for entrance to and egress from port. Transmission may be over a high-speed satellite data link, radio/teletype or voice communications.

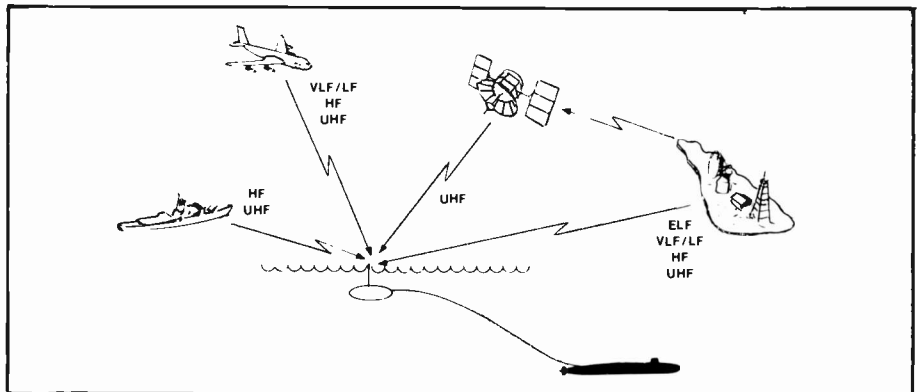


Fig. 2. On patrol, Trident is normally submerged, listening to submarine broadcasts that can be received under water. In this mode of operation, Trident is virtually undetectable.

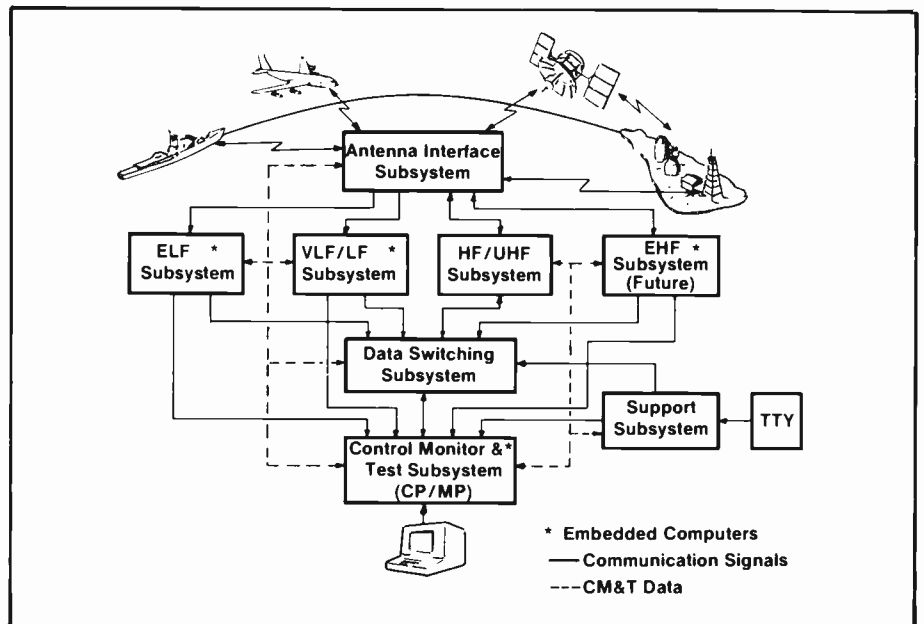


Fig. 3. Simplified block diagram of the IRR, showing the seven major subsystems: antenna interface subsystem, VLF/LF subsystem, HF/UHF Subsystem, ELF Subsystem, Data Switching Subsystem, control monitor and test subsystem, and support subsystem. All subsystems are under centralized computer control.

no errors detected, errors detected, errors detected and corrected.

### Automation

The Integrated Radio Room provides enhanced communications capability while reducing the number of personnel required via processor-assisted operation. Centralized control of the AN/BSC-1 is accomplished via the Operator's Console. Using an interactive display and keyboard, the following can be accomplished:

- System initialization
- Remote control of communications links (configuration control)
- Operational readiness testing, and communications plan maintenance
- Single-point message reception, message transmission, storage, and retrieval

- Remote system monitoring, fault detection, and isolation

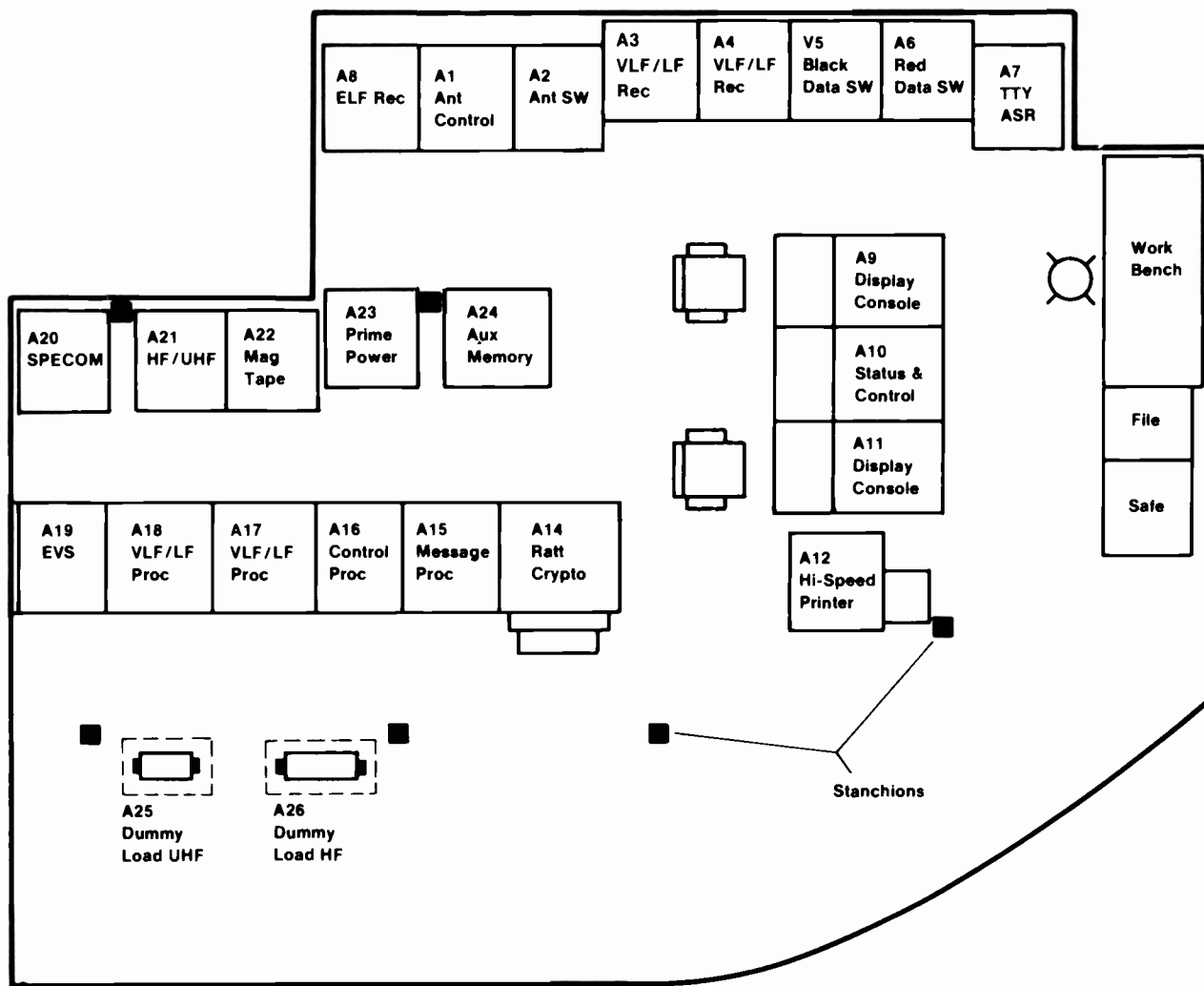
Supplementing these automated features, the AN/BSC-1 system provides both local and manual backup modes of operation for the vital communications links.

As with all other functions, configuration is accomplished by selecting items from a display menu. Menus are used because they are simple to program, easy to use, and they tell the operator all options at a glance. Once a circuit has been established from the configuration menu, the operator will select the option to perform an operational readiness test. Each portion of the circuit is individually tested. For a clear HF teletype circuit, four tests are run: a receiver self-test, a noise burst test, a teletype converter test, and an input buffer test. In the receiver self test, the internal receive

circuitry is checked using built-in test equipment. A noise generator is then triggered, and a rf noise burst is sent through the receiver switch and detected to check the rf receive path. In a data circuit, the teletype converter is looped back on itself to check the teletype receive path. Finally, the input message buffer is checked for received teletype traffic.

If any problems are observed in the new link, the operator can use another set of menus to select a piece of equipment for automatic fault isolation. The computers are programmed to run a full set of tests on the equipment selected by the operator and to isolate the fault to a replaceable set of modules. After the repair, the operator runs a retest to verify that the equipment is now operational.

After the circuits have been configured, the control processor will spend its time



**Fig. 4.** The Radio Room is located on the forward port side of ship on the top deck immediately in front of the sail area, which houses the antenna suites. Hull curvature is such that head room drops rapidly from approximately 8 feet behind the A14 thru A19 racks to 0 feet at the hull.

automatically scanning the radio room for failed equipment or switches out of position. If any are found, it will raise an alarm and command the wayward switch back to the correct setting. This "performance monitor" function is repeated every 30 seconds and will not only pick up failed equipment, but operator setup errors as well.

### Degraded mode system operation

In all complex electronic systems, failures are expected to occur at some point. The failure may involve a runaway computer, a failed radio, or an anomaly in the control circuits. It is important that the system not fail under these conditions, but that it should degrade to some lower but acceptable level of performance. Sustained performance is achieved through extensive use of redundant equipment for all critical operations.

In the case of a runaway computer, the operator can switch any affected equipment to local control and override the computer commands. After the faulty computer is stopped, the operator can load a backup program into the surviving computer. The backup program will maintain essential configuration control, performance monitoring, and message processing functions. Less important functions like fault isolation and message transmission will be dropped.

Failed radios and control circuits have redundant equipment to provide backup capability. When individual radios or control circuits fail, the submarine will not be able to monitor as many channels as before the failure, but essential communications will be maintained.

### Message handling

The primary function of the Trident radio room is to continuously monitor the shore station broadcasts for an Emergency Action Message (EAM). These Emergency Action Messages control the readiness status of the ballistic missile system of each Trident submarine. In the event of a nuclear conflict it is the EAM that transmits the Presidential directives to launch the missiles. Needless to say, the EAMs are a critical element in our nuclear deterrent system. For this reason, should it ever be necessary to send a real EAM, it would be broadcast over many separate shore stations simultaneously. To allow for more reliable monitoring of a greater number of stations, automated message handling was included as an integral part of the radio room.

**Table I.** Radio room communications capability

#### Primary—inside radio room

<i>Frequency</i>	<i>Range</i>	<i>Links</i>	<i>Traffic</i>
ELF	3-300Hz	1 Receive	Secure Data
VLF	14-60 KHz	6 Receive	Secure Data
LF/MF	60-160 KHz 500	2 Receive	Clear & Secure radio teletype clear voice international distress
HF	2-30 MHz	2 receive 1 transceive 1 transmit	clear & secure radio teletype clear & secure voice secure data CW
UHF	225-400 MHz	1 transceive	clear and secure voice satcom secure radio teletype satcom secure data satcom secure voice

#### Secondary—external connectivity

<i>Frequency</i>	<i>Connectivity</i>	<i>Function</i>
LF	external loran receiver	navigation signals
VHF	external receiver	navigation signals
UHF	external receiver	navigation signals
MF/HF	external broadcast receiver	entertainment
WWV AUDIO	to navigation center	time signals
TV	to TV receiver	entertainment

Messages sent to submarines at sea may be addressed to individual submarines, to groups of submarines, or to all submarines copying a particular broadcast. The choice of address form is dependent on the message content and the tactical situation.

All incoming messages are sorted into addressed, non-addressed, and garbled categories based on information in the message header. Each category is further sorted so that the highest-priority message will be acted on first. Addressed messages are always displayed, printed, and filed. Non-addressed and garbled messages are displayed to the operator and await disposition.

The last 160 messages to arrive are kept on disk in the message file. Using the Logical Retrieval function, the operator can search the file for groups of messages by originator, date/time of the message, or by time of receipt. An editing function is also provided in case a service message directs the operator to correct a message in the file.

### Maintenance

The following is a quick summary of the organizational, intermediate, and depot levels of maintenance on IRR.

### Organizational maintenance (O-level)

O-Level maintenance includes all categories of authorized maintenance performed on IRR equipment by the submarine crew. Primary reliance is placed on the use of computer software routines in the execution of performance monitoring and fault isolation functions, the results of which are displayed on the operator's console. Additionally, certain equipment is provided with built-in test equipment (BITE) to augment or substitute for automatic performance monitoring and fault isolation. A manual troubleshooting capability is also provided through on-board general and special-purpose electronic test equipment; however, reliance on manual troubleshooting has been minimized.

At sea, corrective maintenance is kept to a minimum by restricting it to modular replacement of printed circuit boards (PCBs), plug-in modules, and designated subassemblies and assemblies. Maintenance actions requiring more than four hours to complete have been relegated to Intermediate (I-Level) maintenance. Maintenance assistance modules (MAMs) and on-board repair parts (OBSPs) are provided on each submarine to support O-Level maintenance.

### **Intermediate level maintenance (I-level)**

I-Level maintenance is performed during a refit period by Trident Refit Facility (TRF) personnel on board the submarine or in the Refit Industrial Facility (RIF) at the sub base. To be an effective nuclear deterrent, a strategic submarine must be on patrol. Time spent in port is time during which the submarine is not accomplishing its mission. In order to minimize the time off patrol, strategic submarines have two complete crews that alternate patrols. This gives them the highest ratio of on-patrol to in-port time of any class of ships in the Navy. The normal operational cycle of the submarine is 95 days, consisting of 70 days at sea on patrol and 25 days off patrol. A continuous 18-day period between patrols is planned for refit and resupply functions. Due to the requirements for system-level checkout and grooming, all maintenance and refit must be performed during a 13-day period.

I-Level IRR maintenance at TRF is subject to the capabilities of available personnel, tools, time, and test equipment. I-level maintenance tasks that exceed these capabilities will be referred to the appropriate depot. Major Shore Spares (complete drawers or racks) are available within 48 hours for substitution in the event of catastrophic failure. System-level repair and replacement of components (and some calibration) will be performed on board the submarine during the 13-day maintenance period. Support and test equipment that is defective will be exchanged for operable equipment at TRF.

### **Depot level maintenance (D-level)**

D-level maintenance for IRR-unique equipment will be performed by RCA and other contractors assigned as designated overhaul points (DOPs). These DOPs are reflected in the current issue of the Master Repairable Items List. D-level maintenance includes all maintenance tasks authorized to be performed at specified facilities using the full range of capabilities, special features, and test equipment for maintenance that is outside the capabilities of O-and I-level maintenance personnel.

### **Support equipment**

In addition to the tactical hardware, RCA designed, fabricated, and delivered ancillary support equipment that facilitates both training and maintenance. This equipment includes:

**Trainer A**—A fully-operational IRR tacti-

cal system used solely for realistic hands-on training. An expansion of the physical radio room layout as is found in the submarine was provided at the trainer to enable better equipment access and more room for multiple students to participate in training exercises.

**Stimulation, monitor, and control equipment**—Provides rf stimulation to Trainer A as well as simulation of all of the IRR interfaces with other ship systems. One innovative aspect of this design features prerecorded, encrypted rf signals on a 16-track, 14-inch magnetic tape. These analog scenario tapes (with their associated magnetic tape reproducer) simulate message traffic for all operational modes. The tape output simulates transmitted signals and interfaces with IRR equipment at the antenna junction. Substitution of modules from a prefaulted module set permits maintenance training. Computer programs for a training processor allow computer-controlled fault simulation, simulation of ships navigation data inputs, and storage and retrieval of IRR configuration data. This equipment also includes antenna input simulation equipment that replicates antenna suite control and status interfaces. A teletype simulation rack is provided for interactive teletype circuit simulation.

**Trainer B**—A computer-controlled IRR simulator that provides operator training in system operations under normal and casualty modes of operation. It utilizes commercial equipment, and unlike the tactical equipment, provides for trainee feedback. The instructor has complete control over the learning experience, including selecting the subject matter, prescribing the format of the exercise, and tailoring the feedback mechanism to each training situation. Incorrect trainee actions result in visual and audible alarms. After an instructor-selected number of trainee errors, the system will prompt the trainee with an indication of the correct action. At the conclusion of an exercise or training scenario, performance evaluation software generates a report indicating how well the trainee performed.

**Trainer C**—A composite of three separate training devices that provide for IRR maintenance training. The first device is the Tactical Equipment Trainer that consists of four selected pieces of IRR tactical hardware. All are electromechanical devices used for hands-on preventive and correc-

tive maintenance. The second device is a Part Task Trainer that is designed to provide specialized training in cumbersome maintenance tasks on selected IRR equipment. With specialized simulation equipment the trainee can practice such tasks as removing/replacing an AN/UYK-20 memory, a disk memory pod, and a rotary switch in the antenna interface subsystem. The third device is the Signal Tracing Trainer, a computer-controlled training device that provides generic troubleshooting training. Accurate physical, mechanical, and electronic facsimiles of four selected pieces of IRR equipment (power control unit, AN/WRR-3 LF/MF receiver, R-1738 VLF receiver, and thermal control unit) are used for training. In a similar fashion to the B Trainer, student feedback and report cards are provided.

**TRIME (Trident intermediate level maintenance equipment)**—A combination of special maintenance test equipment, I-level technical manuals, and training videotapes. The majority of the special maintenance equipment is for on-board use dockside, and includes:

- An rf stimulation set
- A digital interface unit simulator
- An antenna control simulator
- An auxiliary diagnostic program loader
- Breakout boxes, special test cables, tool kits, and a drawer dolly

The remainder of the equipment is shop equipment and includes:

- A fan balancing set
- A NICAD battery maintenance set
- Shipping containers
- Alignment fixtures

**TESS (test, evaluation and stimulation subsystem) equipment**—Special test equipment that enables system acceptance testing in the factory.

### **Integration and testing**

As with any large computerized system, the hardware and software must be integrated at various stages to assure a fully tested system. However, before the integration, each part must be thoroughly tested. Prior to assembly, the drawer and rack wiring is checked using automatic continuity testers. The modules are tested using automatic test equipment before they are inserted into the drawer. Similarly, the drawers are tested before they are put into racks, and racks are



tested before they are delivered to the system integration area.

The most difficult problem in system integration is determining whether an observed malfunction is caused by hardware or software. Another possibility is a system design problem where the hardware and software were both built to specifications, but the specifications had a flaw in them. In order to minimize these problems, the system integration is performed by an engineering team well versed in both disciplines. This team is supported by the hardware and the software design groups.

The integration testing starts with a specific check of each change to the system since the last integration period. This is followed by a benchmark test that compares the present system performance against that of the last delivered version. Finally, a formal acceptance test is run before the radio room is shipped to the Navy's Land Based Evaluation Facility (LBEF) for another gamut of tests.

At the LBEF, the radio room goes on the air and joins the operational network. During this time, Navy testers and operational crew members dry-run a patrol scenario. Once the radio room has been proven "seaworthy," it is shipped to the shipyard for installation on the next Trident submarine.

### Conclusions/future radio rooms

Future integrated radio rooms or communications centers for submarines, surface ships, aircraft, and land based installations will evolve and contain even more levels of sophistication. The mission of surface combatant ships, for example, has changed radically over the last twenty years. The role the cruisers (CG) and destroyers (DDG) play in a battle group is multipurpose and dynamically changes from anti-air warfare (AAW) to surface warfare (ASUW) to subsurface warfare (ASW) as a function of the tactical threat. The multipurpose mission of these ships places highly sophisticated demands upon exterior communications suites, which are currently manually-operated to provide radio circuit re-configuration. The same can be said about other communications centers, and leads to the inevitable conclusion that more automation and centralization is required. The following presents a broad-brush picture of some of the things that will be included in future communications centers.

**Local area networks** (time division or frequency division multiplexed TDM/ FDM)



*Authors Hemschoot and Weir*

**James Hemschoot** is Manager, System Integration and Test in the Systems Activity at Camden. He currently manages three Integration groups. One group is responsible for system integration and test of the Ground Wave Emergency Network (GWEN) program. The other two groups perform system integration and test on the Integrated Radio Room (IRR) Production Systems and the IRR Software Maintenance Contracts. He joined RCA in 1972 as a design engineer on the Small Terminal satellite communications program. After three years, he moved to integration of the Control Terminal on Small Terminal. In 1976 he joined the IRR program, as a Hardware/Software Integration (HSI) engi-

neer. His group was responsible for the successful integration of 380,000 lines of code and 19 racks of equipment into the first Integrated Radio Room. Mr. Hemschoot received his BSEE degree from the University of Cincinnati, and his MSEE degree from Drexel University.

Contact him at:  
**Government Communications Systems  
Camden, N.J.  
Tacnet: 222-4965**

**Kendall Weir** is currently a Program Manager in the Integrated Communications System Business Area. He is responsible for all Trident Integrated Radio Room (IRR) Programs, including E-Contract IRR production for four ship sets, TRIME, IRR Trainers B and C, and IRR software maintenance, training, and field support contracts. Mr. Weir joined RCA in 1958, and has been in system assurance, systems engineering, and program management for 26 years. He has served as Manager in charge of an internal IR&D project, as a Unit Manager on the Trident IRR program, and was part of the initial systems engineering team that developed the system architecture and hardware configuration for the USPS electronic mail system. Mr. Weir holds a BSEE from Pennsylvania State University and an MSEE from the University of Pennsylvania.

Contact him at:  
**Government Communications Systems  
Camden, N.J.  
Tacnet: 222-3254**

will be used for control and signal distribution throughout the communications centers.

**Integration** of selected communications subsystems on platforms, and establishing communications links to provide effective management of a multi-platform communications system in a responsive manner will evolve. More specifically, interfaces between the interior communications systems (voice communications aboard a ship) and exterior communications systems (radio room) will expand, and because of commonality of both function and equipment, the ESM (electronic surveillance measures) system and the exterior communications system could merge in the future. Looking at the larger picture, communications links will be established between multiplatforms to enhance the battle group commander's ability to immediately view the status of all ships and manage the entire resources of the battle group.

The **man/machine interfaces** will change. Color graphic displays will be used to provide expanded status and decision making information. Operator input/output devices will change and include one or more of the following: light pens, touch screens, and voice synthesis and recognition. Prestored configurations will be used extensively. The increased display capability will be used for on-line training of crews when the activity in the communication center is low.

**Automation** will expand in the areas of link configuration, recovery, network management, quality monitoring, and trend analysis. Trends of equipment performance will be tracked and will indicate degrading equipment prior to actual failures. More decisions will be made by the computer, and additionally, more decision aid data will be presented to the operator.

**Test equipment** will be upgraded. Portable

and fixed communications test sets will be developed that provide a flexible, all-digital approach to realistic encrypted message simulations for the testing of military communications centers.

**Technology** advances will be seen, some of which are highlighted below:

- Solid state HF/UHF antenna switches
- (PIN diodes) replacing coaxial, rotary, or patch panel switching.
- Non-volatile EEPROMs (electrically erasable programmable read only memories). Program changes won't require card or component changes, and will be accomplished via down-line loading.
- Bubble memories
- Digital signal processing techniques
- Plasma displays
- Next-generation NAVY standard computers and minicomputers (AN/UYK-43 and AN/UYK-44)
- Standardization of software language ADA
- Fiber optic cabling
- Next-generation radio equipment

## Buzzards, eggs, and Diophenes

*Or . . . Put chicken wire over your coop and you won't have all that messy math. . . .*

In our May/June issue, Mike Keith posed some problems for readers in his article "Recreational mathematics." As promised, here are the answers.

**1.** From clue 1, one-and-a-third hens lay eggs at the rate of one per day. Therefore, one hen lays eggs at the rate of 3/4 eggs per day. Clue 2 yields 2/3 entries per day, and clue 3 yields 4/5 eggs eaten per entry. Multiplying these last two gives 8/15 eggs eaten per day by each buzzard. But  $6 \times (3/4) \times 10 = 45$  eggs laid in the 10 days, and only 13 are left. Therefore 32 were eaten, which means there were  $32 / [10(8/15)] = 6$  buzzards.

**2.** This problem can be analyzed by a parity argument. At the start of a game of checkers, White has parity and will win if the game ends by blockage. In the problem, however, a capture was made by each side. Such an exchange causes parity to switch. Therefore Black won the game.

**3.** By straightforward counting for the 400-year cycle of the Gregorian calendar, we find that the probability of Christmas falling on a Sunday is 58/400, while the probability of Halloween falling on a Friday is 57/400. Therefore the former is just a hair more likely.

**4.** It is easy to see from clue 1 that  $P$  is greater than 4. For each value of  $P$ , there are only a few possible values for  $Q, R, S, T$  that fit clues 1 and 2 and such that  $U$  is greater than  $V$  (required by clue 3). Trying each of these in turn, we find only one combination that yields distinct values for all eleven variables and such that clue 5 can be met. The answer is

$$P-Z = [10, 9, 1, 7, 3, 8, 4, 2, 6, 5, 11].$$

The Bible verse is Esther 8:9, which contains  $P^2 - P = 90$  words.

**5.** There are 32 possible combinations of yes and no answers that Dr. Diophenes might have received. For 31 of these combinations, there are either no solutions or more than one solution. Only the answers (No, Yes, Yes, Yes, Yes) lead to a unique solution. Since he was able to determine uniquely the mailbox number from the answers to the questions, these must have been the answers he received. The mailbox number is 11.

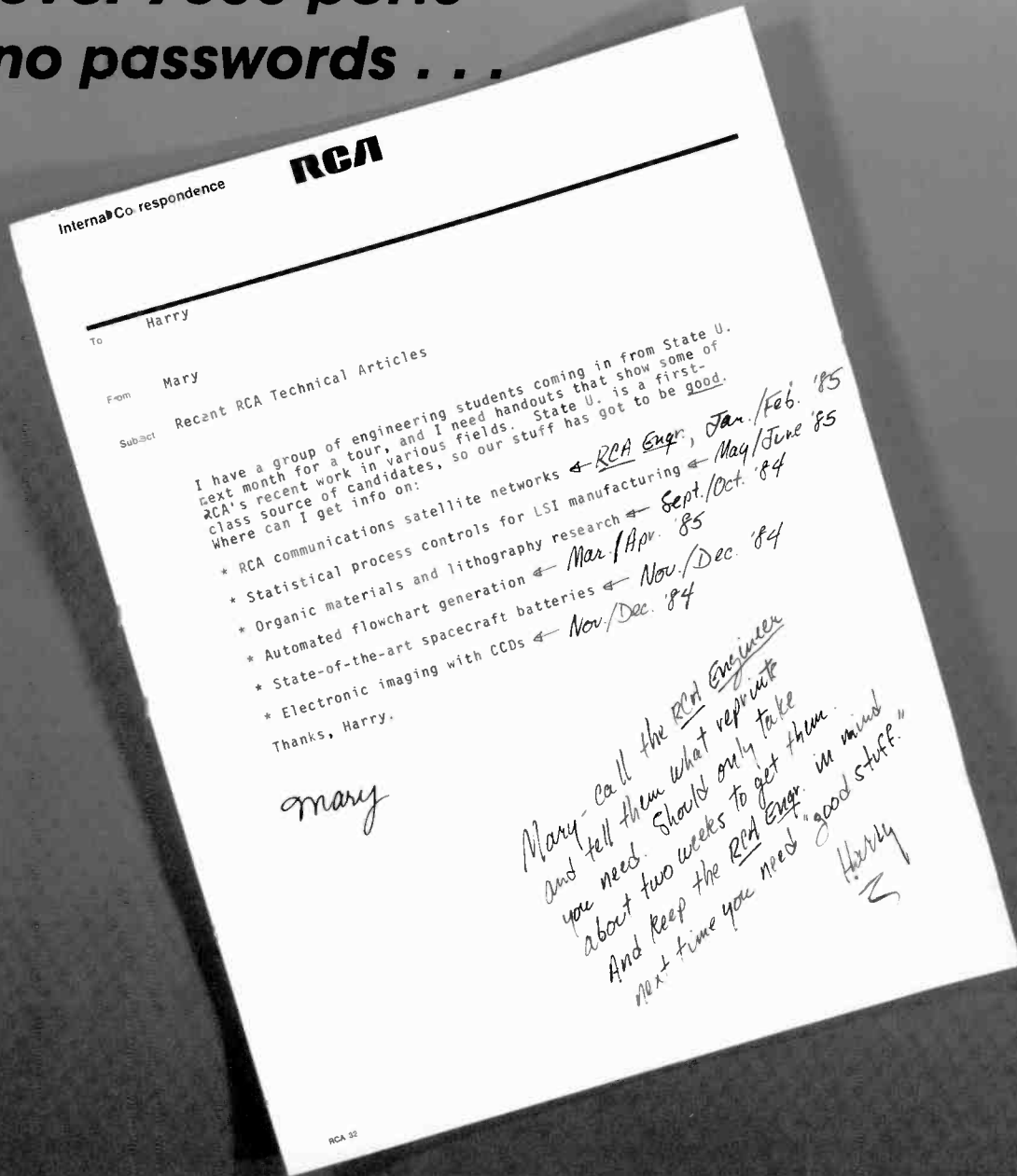
**6.** By the prime number theorem, the probability of an  $n$ -digit number being prime is approximately  $1/\ln(10^n)$ . The  $n$ th term of the sequence is an  $n$ -digit number, so the total number of expected primes in the sequence would be

$$\sum_{n=1}^{\infty} 1/\ln(10^n) = \sum_{n=1}^{\infty} 1/n \cdot \ln(10) = 1/\ln(10) \sum_{n=1}^{\infty} 1/n$$

But this last summation is the harmonic series, which diverges. So the expected number of primes is infinity! In fact, I tested the first 12 terms of the sequence and found three primes: -2, 271, and 2718281. This agrees quite well with the expected number for the first 12 terms.

**7.** The only other solution is 1666/6468. This can be discovered either by brute-force search of the several million 4-digit fractions (not too hard with a computer) or, more elegantly, by solving a Diophantine equation (a single equation in several variables with integer solutions).

# An information network with over 7500 ports and no passwords . . .



The *RCA Engineer* information network operates informally, but effectively. Memos, phone calls, and word-of-mouth are its protocols.

*RCA Engineer* articles are a reusable resource. Reprints are valuable tools for recruitment, marketing seminars, and meetings with colleagues.

Reprints of single articles take about two weeks. If you want to put together a booklet of reprints from several issues, it will

take from four to eight weeks. We can, in fact, give you pretty much what you want, and the prices are lower than the original cost of printing the articles.

For more information and a complete price schedule, call or write to:

**Louise Carr**  
*RCA Engineer*  
 M.S. RR 13  
 Princeton Labs  
 Tacnet: 226-3092

## Dimensia: The next dimension of sight and sound

*Dimensia, RCA's integration of microcomputer technology with advanced audio/video equipment, has created a product that gives the consumer visual feedback and simplified remote control.*

The Dimensia system was introduced in August 1984. The design goal was an easy-to-use component entertainment system. To achieve that, particular emphasis was placed on remote control, expandability, future compatibility, system interconnection, distribution of costs, and cost-effective use of microcomputer technology. Features previously available only with the video components (i.e. remote control and on-screen display) are shared by all the components in the Dimensia system.

---

**Abstract:** *This paper describes "Dimensia," a new system for the video/audio industry. The design goal of the Dimensia system was an easy-to-use component entertainment system. Particular emphasis was placed on remote control, expandability, future compatibility, system interconnection, distribution of costs, and cost-effective use of microcomputer technology. Features previously available only with the video components (i.e. remote control and on-screen display) are shared by all the components in the Dimensia system. Dimensia also sets standards in human interface. The combination of remote control and visual feedback gives the consumer increased flexibility in controlling the system devices.*

---

The design includes a complete set of audio and audio/video components connected by a single-wire control bus and daisy-chained signal buses. The system intelligence and infrared (IR) receiver are located in the TV monitor/receiver. Signal bus switching, local control for each Dimensia component, and bus communication are contained in each component. IR commands are received by the TV monitor/receiver and relayed to the appropriate Dimensia component. The resulting component status is returned to the TV and displayed on the screen. Uniform formats were established for command control and status reporting to allow maximum utility with future Dimensia components. Simultaneity is obtained by placement of series switches in the signal paths in the amplifier and TV. Non-system devices such as non-Dimensia VCRs, satellite receivers, AM/FM tuners, amplifiers, and tape decks can be added to supplement system devices. Non-system devices are accommodated by standard phono connections in the TV and audio amplifier.

### System configuration

The Dimensia system consists of seven different pieces of audio and audio/video equipment. The system interconnect is shown in Fig. 1. The audio-only devices are on one bus, and the audio/video devices are on a separate bus, both of which

are connected to the system controller (the TV monitor/receiver). The system components are:

- FKC2600/2601 monitor/receiver
- Two VKT700 video cassette recorders
- MSA100 stereo amplifier
- MAT110 AM/FM tuner
- Two MTR120 audio cassette recorders
- MTT130 phonograph
- MCD140 compact digital disc player

### System features

Any one of the Dimensia components can be directly addressed by simply pressing the appropriate device button on the remote hand unit (see Fig. 2). The device button selects the device to be operated, and any subsequent buttons pressed (except another device button) will refer to this selected device. The amplifier does not have a device button. The amplifier is used by all the system devices and is treated as a subset of the selected device.

The selection of external non-system devices can be done in several different ways. The monitor can accept up to four independent audio/video sources. These inputs can be accessed locally by the input select buttons on the TV, or remotely by selecting the respective input number (e.g. 91, 92). The tuner, tape, compact disc (CD), and phono remote control device buttons can be used to select those devices with the

Dimensia amplifier if a Dimensia device of the same type is not present. If the same Dimensia device is present then selection of the non-Dimensia device can be made locally at the amplifier. An external amplifier can be directly connected to the monitor volume-controlled outputs.

On-screen messages appear in response to a keypress on the remote hand unit or local keypress on the Dimensia device. The display will show the newly requested state of operation. Time set and character background can be programmed by the user at any time TV is selected by using the program key on the remote hand unit. The amplifier volume level indication allows the user visual feedback while setting the volume level. An error display is included for functions that cannot be performed. "DEVICE CANT" signifies that a requested operation, such as requests for the TV to rewind or to scan, cannot be performed.

The system allows the connection of up to 16 different system devices to the signal bus. This allows future expansion beyond currently available system components. The additional devices can be accessed by pressing remote device "AUX" button and a digit. The signal bus for audio and video is a "daisy chain" bus and features a simple, low-cost connection scheme. This interconnection scheme eliminates the "rat's nest" of wires used to connect conventional audio and video systems. The signal transfer characteristics rival the performance of conventional connection schemes.

The record protection software assists the user in preventing an accidental button press from changing a recording in progress. This system condition is entered whenever a recording is started. The software prevents the turning off of the source device or the recording device. It also inhibits a change in source selection when recording. Record protection can only be stopped by selecting the recording device and pressing the stop button.

Switching is done in three places in the system. The source of the signal may be switched on or off the signal bus by bus-switching in each component. Any one of the normal inputs or a bus input on the TV set may be switched to the CRT display and TV speakers or external amplifier. If there is a Dimensia audio amplifier present, one of its normal inputs or one of the two bus inputs may be switched to its speakers. Signal paths may be broken in the amplifier or TV to allow up to three independent operations. A video recording and separate audio recording can be going on while the user is watching his

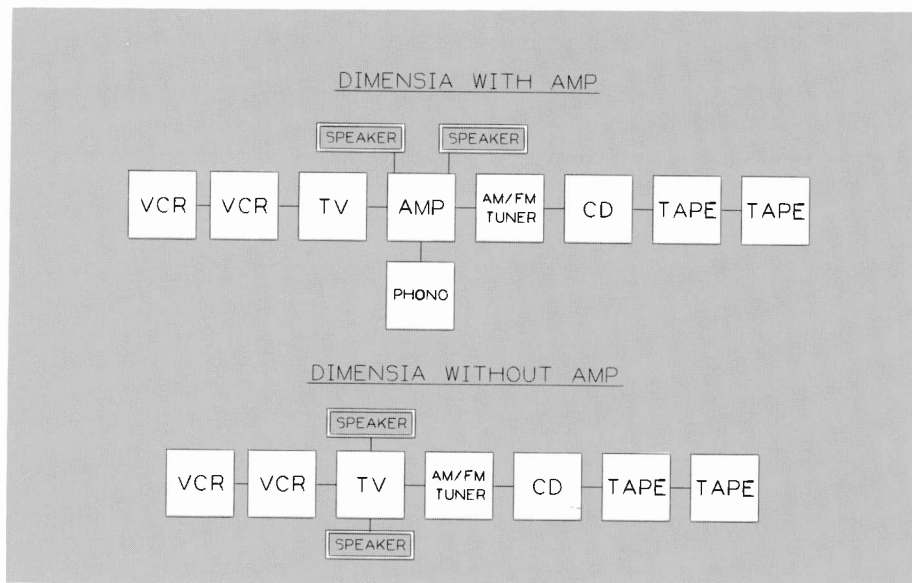


Fig. 1. Typical system interconnect.

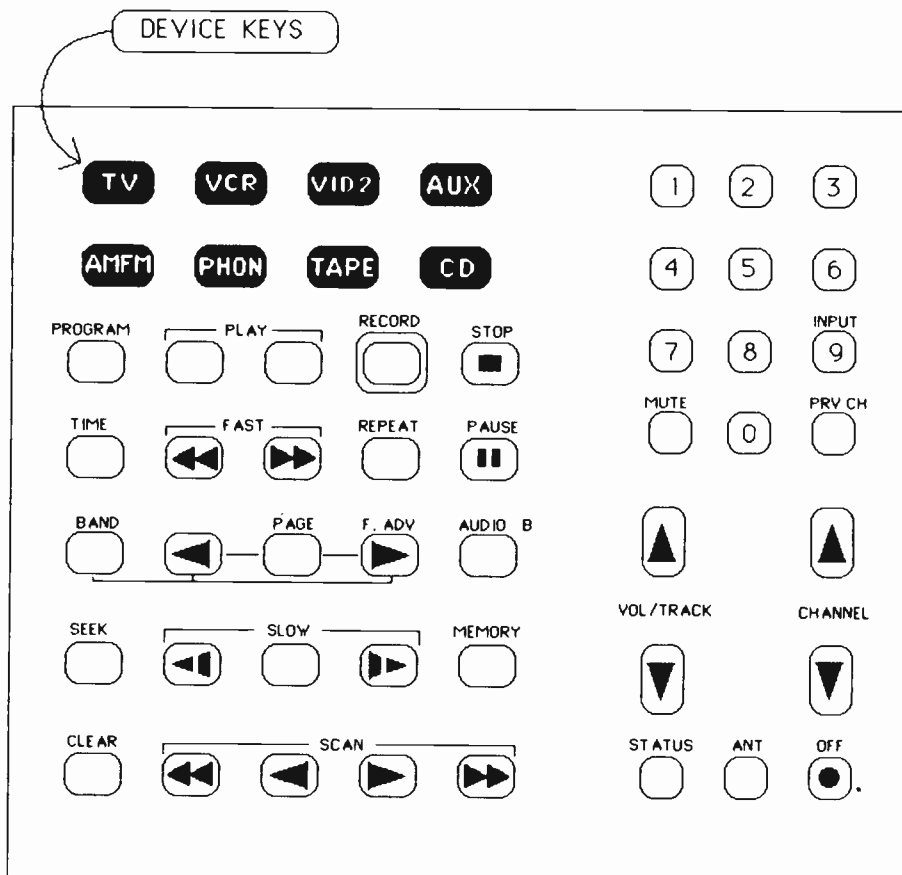
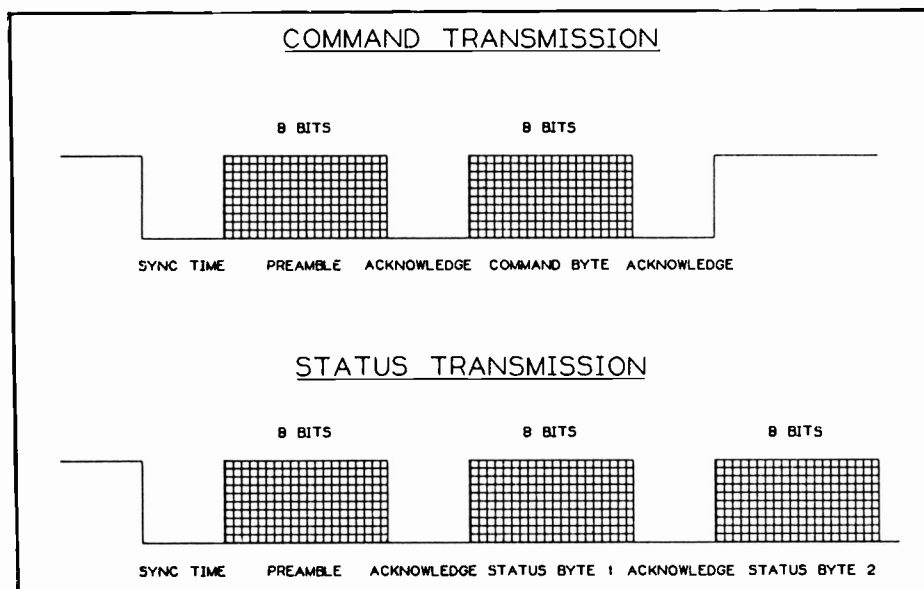


Fig. 2. Dimensia remote transmitter.

favorite program on TV. The switching also allows mixing of separate audio with a video signal. This mixing of signals is used in simulcast transmissions in cable TV systems. The picture is on a television channel and the stereo audio comes from the FM receiver.

Unified remote products are supported with rudimentary control performance. These devices are marketed by RCA and are used in conjunction with the CRK32 remote hand unit. They work together with a standard TV monitor/receiver to allow the user to exercise remote control



**Fig. 3.** Control bus communication. The status or command bytes relay device or controller information with 8 bits of data. Sync low times represent device identification. Acknowledge low times signal the message acceptance by the sync device.

over the components with one hand unit. The Dimensia system treats a unified remote product as a loosely coupled system component. The IR receiver contained in the unified remote product is used in controlling the product. The monitor is switched to the component when requested through device selection on the remote hand unit. The component functions are then controlled through the remote hand unit. On-screen messages showing the current remote button pressed are displayed on the monitor. The control bus is not connected to this remote product, so no status is returned to the system controller.

### Vendor interface

A vendor produces all the various audio and audio/video pieces except the monitor/receiver. Product and operational specifications were written for each device and supplied to the company. A working system emulator for each device was supplied to give an example of how the device should work individually and as part of a system. To confirm an operational system, a Dimensia control bus tester and system test software were also supplied. The control bus tester can be programmed to simulate a system controller and display all of the bus responses on a CRT screen. In that way, each device can be tested on an individual basis through the Dimensia control bus. The system test software exercises all the command sequences and states for a particular device without operator inter-

vention through the Dimensia control bus. Several weeks worth of testing can be performed on each device in a matter of hours. This testing is done by the vendor, and a double check is done at Indianapolis. Results can be returned to the vendor the next day for verification.

### Control bus and bus communication format

The control bus interconnection is the main communication link to all the system devices. It consists of a single-wire connection to the communication microprocessor in each component. The communication microprocessor uses one I/O pin to monitor the bus and an open-collector transistor to drive the bus. This type of connection to the bus places all the system devices in parallel. The pull-up resistor is contained in the system controller. The use of an open-collector transistor to access the bus allows the use of collision access multiplicity for arbitration. That is, each device has the ability to access the bus, but each device has a different level of access depending on its system priority. The device with the highest priority has immediate access, and the other devices wait their turn. The digital data transmitted in this link contains all the commands from the system master and the status reports from each system device.

The data on the bus is in a rise-time- and fall-time-controlled digital format, which reduces RFI emissions. The digital data can be broken down into two separate trans-

missions of information. One transmission is the command information and the other is the status information (see Fig. 3).

### Command transmissions

Command transmissions originate from the system master, and they can be broken down into three separate sections. The first section is the sync time. The control bus is pulled low by the controller for a specific amount of time. The length of time is longer than any other sync time in the system, thus signaling other system devices that the system master has the highest priority and a message is forthcoming.

After the sync time an 8-bit preamble/device address is transmitted. Each device in the system has its own preamble/device address. The destination device acknowledges the transmitted preamble by pulling the bus low for a predetermined length of time. The master then sends the next byte of information.

The last part of a command transmission is the command byte. This consists of 8-bit word or byte of information that conveys the requested function to the addressed device. An example of a command byte is EA (hexadecimal). This command byte tells the device to go into play mode. Some of the other command bytes are: stop, pause, repeat, scan+, and scan-. After the command byte is received by the selected device the device acknowledges the command. The device then executes the command.

### Status transmissions

Status transmissions originate in the system components, and can be broken down into three separate sections. The first section is the sync time. The controller has the longest sync time and has highest priority to use the control bus. If the device obtains the use of the control bus, then the second section of the status transmission is sent.

The second section is the preamble of the device sending the status transmission. The preamble is used for arbitration between devices. After the preamble is acknowledged by the controller the third section is sent.

The third section is the actual device status. This section can be as long as 16 bytes in length. The status describes the operation that is occurring in the slave device. The status information can include numbers such as counter values, current band numbers, time remaining, etc. The status is then displayed on the screen.

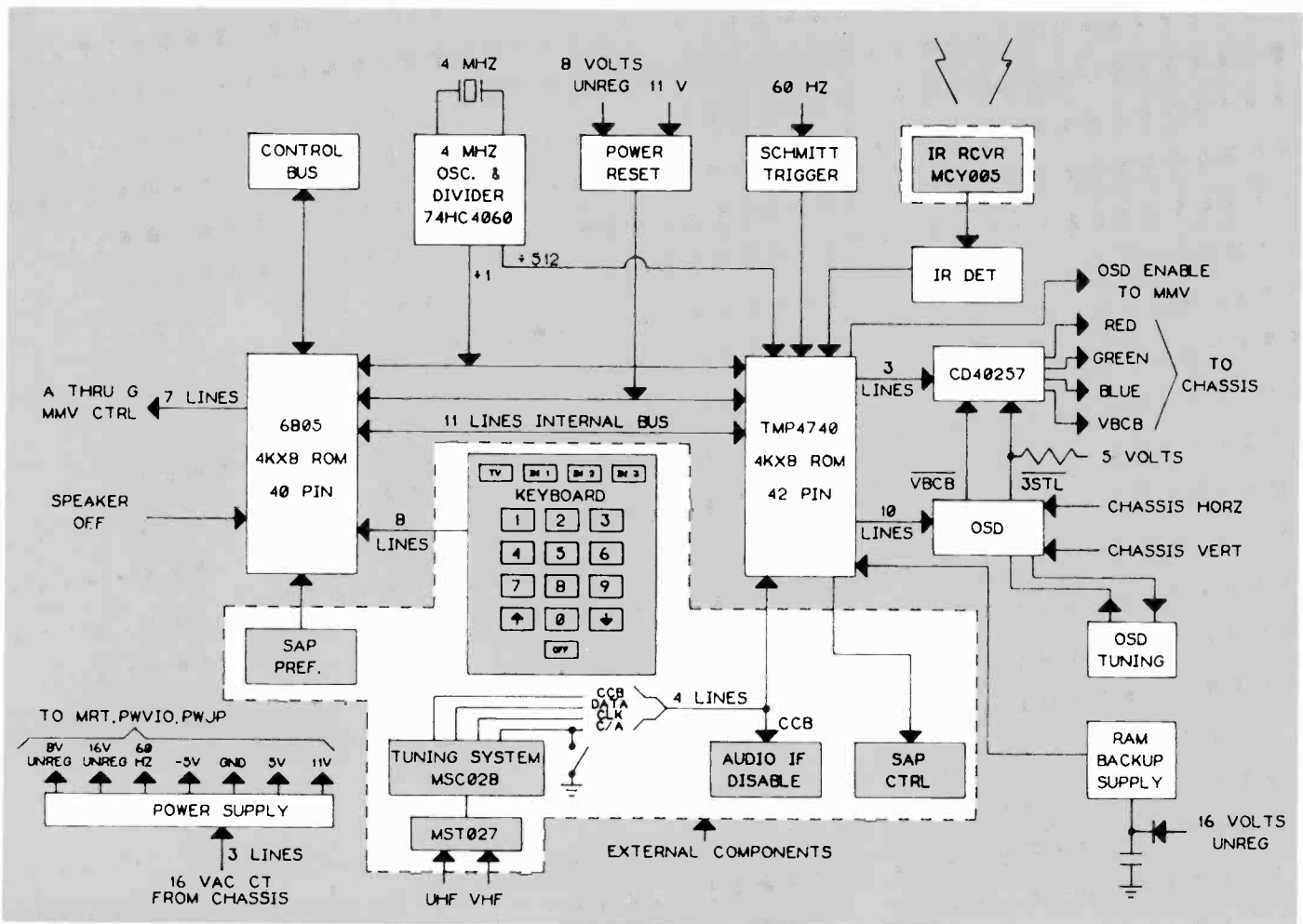


Fig. 4. Dimensia's intelligent controller.

### System device states

The amplifier can be in up to three separate states, depending on its hookup; independent operation, stand-alone audio equipment operation, and full system operation. The TV monitor/receiver and VCR can enter up to two separate states, depending on their hookups; independent operation and full system operation.

Independent operation is defined as operation of the particular device alone (not connected to any system component). Local control is retained by all the devices. Devices that can be controlled remotely, like the TV monitor, retain the same remote control functions. Devices that have their IR disabled in the Dimensia system, like the VCR, now can be controlled by their remote hand unit. The monitor bus input to the amplifier is treated as an AUX input. The input-3/bus input to the monitor is treated as a standard video/audio input.

The stand-alone audio equipment state is supported by the amplifier. This state occurs when system audio devices are connected to the amplifier without the connection of

the monitor/receiver. The amplifier becomes the audio system master and provides a limited control of the other pieces of audio equipment. The amplifier provides bus switching control for system devices, allowing the user to select devices without directly operating the amplifier. For example, if an on/off keypress occurs to turn on the AM/FM radio, the amplifier will also turn on and the appropriate bus switches will be closed. Sound will now come from the speakers. This eliminates turning on the amplifier and selecting the AM/FM input.

The system state occurs when system devices are connected to the monitor/receiver. The monitor/receiver controls the selection of bus switches and determines which devices are enabled to use the signal bus. Command information originates from the monitor and status information is returned to it from the system devices.

### System intelligence

The system intelligence is provided by a module (MRT003) in the TV receiver/

monitor. This module contains two microcomputers for system and monitor control. A block diagram of the main circuitry and hardware functions is shown in Fig. 4.

### System software

The software for the controller is divided into several modules, each performing a specific task. The tasks are further subdivided between the two microcomputers in the MRT003. The actual division of tasks is based on ROM and RAM usage, processor utilization, I/O pin count, and internal architecture of the processor. Some of the tasks are decoding pulse-width-modulated IR signals, controlling the frequency synthesis TV tuner, switching rf inputs to the VHF TV tuner, switching video and audio inputs on the back of the TV set, providing a real-time clock, and generating an alphanumeric on-screen display. Tasks related to system operation include sending and receiving messages over the control bus, converting status from system components to on-screen display messages, sending switch-

ing commands to components, and error checking for invalid user commands or commands that would violate record protection.

### Software development

Software development of this multiprocessor, multitasking system followed a product specification, software design, coding, and test cycle. The source-to-object code conversion and testing of the software was accomplished with Z80/CPM-based computers with CPM-compatible assemblers, emulators, and other interfaces.

### Status reporting

Status from the components is categorized to provide information to the system controller to determine whether signal switching is required or an OSD message is to be generated. The system controller also keeps an array in memory showing which components are attached to the system, what type of signals the components generate (audio, video, rf, or none), whether they can record, whether they are on or off, whether they are recording or not, which signal paths are being used in recording, and which component is the source. This information is used in the decision making process of what devices can access the signal bus and to what extent the signal bus is available to it.

### Software testing

The number of possible combinations of command inputs and status outputs in this system is extremely large. A reasonable solution to this problem was to use a combination of computerized (CPM-based) test equipment and manual testing. Remote inputs and expected status were tested via the bus interface with the computer. This allowed extensive, rapid, and complete software testing of the devices. Local and user interfaces were tested via structured test procedures and with the assistance of users unfamiliar with the equipment.

### Summary

The Dimensia system has set a path for RCA in the next audio/video revolution.



**Robert Pitsch** is a Member, Technical Staff, of the Digital Products Group at RCA Consumer Electronics Division in Indianapolis, Ind. In 1977 he restructured the corporate specifications for wire identification. In 1981 he was a recipient of a Technical Excellence team award for establishing chassis/ATE test correlations procedures. His current responsibilities

include project coordination for the MRT003 module and future Dimensia products. Mr. Pitsch has two patents pending on the Dimensia system.

Contact him at:  
**Indianapolis, Ind.**  
**Tacnet: 422-5826**

Human interface and performance were a prime design consideration, as were system flexibility and expandability. New products are currently being added to the system to expand its functionality. In short, RCA has integrated the best of the video/audio world into Dimensia.

### Acknowledgments

The author wishes to acknowledge the following groups and some of the people whose contributions assisted in the development of Dimensia and whose assistance transformed it from a concept into a manufacturable product.

### Digital Products Group

C. Brumbaugh, B. Beyers, R. Patterson, M. Deiss, J. Hailey, G. Vernon, L. Moore, and T. Heichelbech.

### Instrumentation Group

L. Babcock

### TV Design Group

C. Freedline and D. Griepentrog.

### RCA Purco Office, Tokyo, Japan

S. Kohari



# Patents

## Advanced Technology Laboratories

McCann, J.T. | Dobbins, L.W. | Reno, C.W.  
**High efficiency precision laser beam switch**—4507773

Michaelis, T.D.  
**Optical disc system having momentum compensation**—4516231

Reno, C.W.  
**Beam expansion and relay optics for laser diode array**—4520472

Tarzaiski, R.J.  
**Dynamic record level control for optical disc recorder**—4516235

## Astro Electronics

Phillips, K.J. | Tracy, T.G.  
**Control of nutation in a spacecraft**—4504032

## Automated Systems Division

Dion, D.F. | Cantella, M.J.  
**Compression of the dynamic range of video signals**—4516167

Sutphin, Jr., E.M.  
**Commutating filter passing only the fundamental frequency and odd harmonics thereof**—4518936

## Broadcast Systems Division

Bendell, S.L.  
**Color TV camera with four-port prism**—4507679

Easter, F.C. | Aires, R.H.  
**Switching DC-to-DC converters**—4504896

Gurley, T.M.  
**Worldwide compatible synchronizing signal for accurate time base correction in an analog component interface standard**—4516150

Hudson, K.C.  
**Automatically adjustable aperture stop for optical scanning system**—4516024

Olson, C.L. | Monahan, J.F.  
**Black level clamp for television signals**—4513321

Seer, Jr., H.G.  
**Synchronously detected DC | DC converter for regulated power supply**—4510564

## Consumer Electronics Division

Filliman, P.D.  
**Switching network with suppressed switching transients**—4513322

Griffis, P.D. | Rindal, A.E.  
**Frequency translation phase-locked loop for separate or intercarrier type television sound detection**—4511924

Harlan, W.E. | Marsh, Jr., J.C.  
**Television receiver with manual and selectively disabled automatic picture control**—4511921

Hicks, J.E.  
**Shutdown circuit for a switching regulator in a remote controlled television receiver**—4516168

Krull, D.K. | Naimpally, S.V.  
**Composite Video signal processing apparatus providing amplitude equalization**—4516153

Lagoni, W.A. | Harlan, W.E.  
**Video signal peaking system**—4509080

Murphy, 3rd, W.W. | Hettiger, J.  
**Dynamic noise filter for an audio signal in a television**—4517602

Rindal, A.E.  
**Sound signal and impulse noise detector for television receivers**—4514763

Schier, Jr., J.H. | Brooks, Jr., W.E.  
**Modified deflection yoke coils having shootback windings**—4511871

Vanbreenen, B.  
**Rear projection television screen incorporating a prism lens**—4512631

Verma, S.K. | Kim, G.A.  
**Silicon oxide lapping coatings**—4514192

Willis, D.H.  
**Video signal processor with automatic kinescope white balance and beam current limiter control systems**—4516152

Young, J.R. | Vanbreenen, B.  
**Projection television receiver with unitary optics frame**—4506295

## Government Communications Systems Division

Basile, P.C.  
**Transceiver having collision detection capability for contention-formatted FDM local area networks**—4519074

Crowley, A.T.  
**Frequency synthesizer using an arithmetic frequency synthesizer and plural phase locked loops**—4516084

Nossen, E.J.  
**Fast correlation system**—4510579

Starner, E.R.  
**Event selector for wide range probability of occurrence**—4516217

## Missile and Surface Radar Division

Bowman, D.F.  
**Selective waveguide mode converter**—4510469

Bowman, D.F.  
**Dipole radiating element**—4513292

Young, W.C.  
**Device for indicating the polar coordinate position of a given point anywhere within a circular area**—4513505

## SelectaVision

Brauer, E.A.  
**Stylus cartridge having stylus arm restraint**—4504941

Kelleher, K.C.  
**Linear pulse width to current converter for brushless DC motors**—4507591

Kirschner, T.F.  
**Disc record player having player control apparatus**—4516233

Prusak, J.J. | Lock, B.E. | Thorn, J.H.  
**Lubricant detector and measuring device**—4503806

Thorn, J.H. | Prusak, J.J.  
**Disc turnover device**—4512455

Weaver, C.A. | Stephens, J.W.  
**Apparatus and method for automatically**

controlling an extruder for thermoplastic material—4510104

Westerman, Jr., H.H. | Prusak, J.J.  
**Method and apparatus for removing flash from a molded recorded disc**—4516301

Westerman, Jr., H.H.  
**Transfer apparatus for a record molding press**—4519767

## RCA Laboratories

Bloom S.  
**Mesh lens focus mask for a cathode-ray tube**—4514658

Carlin, D.B.  
**Multi-channel recording | playback optics for laser diode arrays**—4520471

Datta, P.  
**Video disc molding composition**—4512916

Denhollander, W.  
**Horizontal deflection phasing arrangement**—4510527

Dimarco, L.A.  
**Solvent-cast capacitive high density information disc**—4515830

Dischert, R.A. | Libbey, R.L.  
**FM Video transmission system having coring and coring compensation for reducing effects of triangular noise**—4520396

Dischert, R.A. | Williams, Jr., J.J.  
**Digital matrixing system**—4507676

Fairbanks, D.W.  
**Pickup cartridge having stylus holder**—4513410

Glock, T.L. | Credelle, T.L.  
**Modulator structure and method for flat panel display devices**—4517489

Goodman, A.M.  
**Surface preparation for determining diffusion length by the surface photovoltage method**—4507334

Haferl, P.E.  
**Linearity corrected horizontal deflection circuit**—4516058

Harbeke, G. | Duffy, M.T.  
**Optical reflectance method for determining the surface roughness of materials in semiconductor processing**—4511800

Hernquist, K.G.  
**Method of electrically processing a CRT mount assembly to reduce arcing and afterglow**—4515569

Hinn, W. | Fecht, H.R.  
**Apparatus for accurate adjustment of kinescope black level bias**—4518986

Hsu, S.T.  
**Method of fabricating high speed CMOS devices**—4519126

Hsu, S.T.  
**Method of forming self-aligned contact openings**—4512073

Hurst, Jr., R.N.  
**Independent fleshtone contours**—4506293

Hurst, Jr., R.N.  
**Video apparatus with burst locked heterodyne chroma converter and residual time base error correction**—4520402

Ipri, A.C. | Stewart, R.G.  
**Electrically alterable, nonvolatile floating gate memory device**—4514497

Kane, J. | Murr, Jr., J.  
**CRT with internal neck coating of crystal-line tin oxide for suppressing arcing therein**—4518893

Knop, K.H.  
**Diffractive color separation filter**—4506949

Kohn, E.S.  
**Television receiver adaptable for des-crambler module**—4509210

Labib, M.E. | Wang, C.C.  
**Stabilizers for CED compositions**—4517117

Lewis, Jr., H.G.  
**Digital television system with truncation error correction**—4511922

Lewis, Jr., H.G.  
**Television receiver with digital signal processing having a digital-to-analog converter control capability**—4506291

Lewis, Jr., H.G.  
**Color television receiver with a digital processing system that develops digital driver signals for a picture tube**—4503454

Lewis, Jr., H.G.  
**CCD delay line system for translating an analog signal**—4506288

Lin, P.T.  
**Mechanical scribe for semiconductor devices**—4502225

Lin, P.T.  
**Method and apparatus for trimming and finishing the outer edge of a molded record**—4518551

Nowogrodzki, M. | Mawhinney, D.D.  
**Dual frequency heart rate monitor utilizing doppler radar**—4513748

Osaka, S. | Sagawa, M.  
**Venetian blind construction**—4503900

Patel, C.B.  
**Bus reduction for intercarrier type television sound detection**—4513323

Peters, K.D. | Anderson, C.H.  
**Modular guided beam flat display device**—31894

Pritchard, D.H. | Sauer, D.J.  
**CCD comb filter employing floating gate subtractor techniques**—4510522

Rao, S.T. | Hawrylo, F.Z.  
**Bonding pads for semiconductor devices**—4514265

Raychaudhuri, D.  
**Time division multiple access communication systems**—4504946

Reitmeier, G.A. | Aschwanden, F.  
**Digital phase comparator circuit producing sign and magnitude outputs**—4506175

Reitmeier, G.A.  
**Error concealment system using dropout severity information for selection of concealment method**—4517600

Reitmeier, G.A. | Thompson, C.R.  
**Synchronization system that uses all valid signals**—4518996

Robinson, J.W. | Kaganowicz, G.  
**Glow discharge apparatus for use in coating a disc-shaped substrate**—4512284

Rockett, Jr., L.R.  
**Pulse duration modulator using charge coupled devices**—4508975

Sauer, D.J.  
**CCD Charge subtraction arrangement**—4509181

Sauer, D.J.  
**Dynamic CCD input source pulse generating circuit**—4503550

Schnable, G.L. | Wu, C.P.  
**Method of forming semiconductor contacts by implanting ions of neutral species at the interfacial region**—4502206

Schnitzler, P.  
**Communication system compandor**—4518994

Tarng, M.L. | Romito, W.S.  
**Method for determining the integrity of passivant coverage over rectifying junctions in semiconductor devices**—4520312

Tower, J.R.

**Electro-optical CCD transversal filter with analog reference weights—4514821**

Truskalo, W.

**Synchronized switching regulator for a multiple scanning frequency video monitor—4516169**

Vanraalte, J.A. | Riddle, G.H.

**Video disc player with compensation for stylus holder mechanical resonance—4516232**

Vieland, L.J.

**Electron beam injection structure for flat panel display devices—4514663**

Warren, H.R.

**Color moviola for two-track VTR—4504869**

Wedam, W.F. | Babcock, W.E.

**Deflection circuit with linearity correction—4503367**

Whitley, G.J. | Rayl, M.

**Component lead processing device—4513493**

Widmer, A.E. | Fehlmann, R.

**LPCVD deposition of tantalum silicide—4504521**

Wine, C.M.

**Analog signal comparator using digital circuitry—4503465**

Woodward, O.M. | Greaves, Jr., M.P.

**Broadband loop antenna with low wind resistance—4510501**

Zelez, J.

**Diamond-like film and process for producing same—4504519**

## Solid State Division

Balaban, A.R. | Steckler, S.A.

**Digital television receiver with time-multiplexed analog-to-digital converter—4514760**

Balaban, A.R. | Steckler, S.A.

**Digital television receiver with analog-to-digital converter having time multiplexed gain—4517586**

Battson, D.F.

**Reducing grain in multi-phase-clocked CCD imagers—4507684**

Dingwall, A.G. | Zazzu, V.

**Flash A/D converter having reduced input loading—4507649**

Miller, R.D.

**Linear ramp voltage generator circuit—4516036**

## Video Component and Display Division

Berardi, R.L.

**Apparatus for accurately establishing the sealing length of CRT envelopes—4507873**

Bleacher, J.N. | Cushman, B.M.

**Method for ablating a coded marking into a glass workpiece and product thereof—4515867**

Chen, H.

**Color picture tube having reconvergence slots formed in a screen grid electrode of an inline electron gun—4513222**

Chen, H.

**Inline electron gun for high resolution color display tube—4514659**

Deal, S.B. | Cushman, B.M.

**Method of making a coded marking in a glass workpiece employing a trisilicate coating and product thereof—4514456**

Deyer, C.E.

**System for providing a multi-bit input to a computer controlled system—4513394**

Ditty, L.H.

**Method for removing a phosphor layer from a support surface—4517224**

Opresko, S.T.

**Cathode-ray tube having an electron gun assembly with a bimetal cathode eyelet structure—4514660**

Ragland, Jr., F.R.

**Method for screening line screen slit mask color picture tubes—4516841**

Stone, R.P.

**Arc-suppression means for an electron gun having a split electrode—4514661**

Vanhekken, F. | Chen, H.

**Cathode-ray tube having an asymmetric slot formed in a screen grid electrode of an inline electron gun—4520292**

Wardell, Jr., M.H.

**Method for casting a base directly on an electron tube—4504430**

---

# Pen and Podium

Recent RCA technical papers and presentations

---

To obtain copies of papers, check your library or contact the author or divisional Technical Publications Administrator (listed on back cover) for a reprint.

## Astro-Electronics

H. Curtis | P. Pierce | D. Chalmers | K. Johnson

**Power and Thermal Management of Free Flying Platforms for the Space Station—** Presented at the 22nd Space Congress, Cocoa Beach, Fla. (April 23-25, 1985)

J.J. Horan

**Radiometric Calibration of Spaceborne**

**Remote Sensors—** Presented at the NBS-1985 CORM Conference (May 29, 1985)

R. Miller

**Use of Computers in Space Engineering—** Presented at the University of Witwatersrand, Johannesburg, South Africa (May 6-28, 1985)

P.K. Oey | F.X. O'Connell | S. Teitelbaum  
**The SCP-STAR, A Low-Power Radiation**

**Hardened Spaceborne Computer—** Presented at NAECON '85 (May 20-24, 1985)

S.V. Parekh-AE | J. Richie | H. Kritisko  
**Beamforming for Direct Broadcast Satellite Array Antennas—** Presented at the IEEE Ben Franklin Symposium, Philadelphia, Pa. (May 4, 1985)

K. Praba | S.V. Parekh

**Beamforming Networks for Satellite**

**Applications**—Presented at the IEEE Benjamin Franklin Symposium, Philadelphia, Pa. (May 4, 1985)

F.C. Weaver

**DBS Satellite Technology**—Presented at Electro '85, New York, N.Y. (April 23-25, 1985)

## Automated Systems Division

R.E. Hartwell

**A role for artificial intelligence in ATE**—*RCA Engineer*, Vol. 31, No. 2 (March/April 1985)

A.T. Hospodor

**Computers: Hardware, Software, and Communications**—Presented at the Cornell Electrical Engineering Centennial, East Windsor, N.J. (April 1985)

D.A. Krieger

**AI Concepts Applied to ATE Software**—Presented at the 40th Mechanical Failures Prevention Group Symposium, Gaithersburg, Md. (April 1985)

A. Tabak | R. Watts

**Continuous Structure Fault Detection**—Presented at the IEEE Reliability Seminar, Framingham, Mass. (April 1985)

## Government Communications Systems Division

L.A. Mishrell

**Bite Frequency Test**—Presented at the Mini/Microcomputer Architecture Class, RCA, Moorestown, N.J. (April 19 and 26, 1985)

A.T. Rimback

**Camden RCA IBM PC User Group Forms**—*TREND* (March 1985)

A.P. Surany

**An Algorithm for Determining the Draw Start Point of a Hyperbola Given the System Direction of Draw and the Coordinates of the Video Window**—Presented at the NATO ASI Conference, Yorkshire, England (March 30 and April 12, 1985), and published in the *Proceedings*

A.P. Surany

**A simple Algorithm for Determining Whether a Point Resides Within an Arbitrarily Shaped Polygon**—Presented at the NATO ASI Conference, Yorkshire, England (March 30 and April 12, 1985), and published in the *Proceedings*

E. Tom | D.E. McGovern

**Intrusion Detection Using Ferroelectric Sensor Technology**—Presented at the

1985 Joint Government/Industry Symposium on Physical Security, Eglin AFB, Florida (April 9-11, 1985), and published in the *Proceedings*

## Missile and Surface Radar Division

F.J. Buckley

**Software Quality Assurance**—Presented at the IEEE Software Quality Assurance Seminar, Washington, D.C. (March 4, 1985) and San Francisco, Ca. (April 15, 1985)

R.J. Camlin

**In-Plant Photocomposition for the '80s**—Presented at the Electronic Publishing Symposium, Moorestown, N.J. (May 15, 1985), and published in the *Proceedings*

D.J. Dempsey

**The CROSSBOW-S Generic Radar**—Presented at the 1985 International Radar Conference, Arlington, Va. (May 8, 1985)

W.J. Graham

**A Super-Resolution Digital Beamforming Array Design**—Presented at the 1985 IEEE/AP/MTT-S Benjamin Franklin Symposium, Philadelphia, Pa. (May 4, 1985)

W.C. Grubb, Jr.

**Solid State Electronics for Non-Electrical Engineers**—Presented at George Washington University, Orlando, Fla. (March 27, 1985)

W.C. Grubb, Jr.

**Electro-Optics for Non-Electrical Engineers**—Presented at George Washington University, San Diego, Ca. (February 12, 1985)

W.C. Grubb, Jr.

**Minicomputers and Microcomputers for Non-Electrical Engineers**—Presented at George Washington University, Washington, D.C. (May 15, 1985)

D.J. Herman

**AEGIS Combat Training System**—Presented at ASNE, Port Hueneme, Ca. (May 30, 1985)

D.R. Higgs

**Corporate Electronic Publishing—An Introduction**—Presented at the Electronic Publishing Symposium, Moorestown, N.J. (May 15, 1985), and published in the *Proceedings*

R.E. Killion

**Establishing Screening Objectives and Measuring Their Achievement**—Presented at the IES 31st Annual Technical Meeting, Las Vegas, Nev. (May 2, 1985)

R.L. Lampe

**A Technique for Determining Cutoff Frequencies of a Stripline**—Presented at the 1985 IEEE/AP/MTT-S Benjamin Franklin Symposium, Philadelphia, Pa. (May 4, 1985)

R.M. O'Donnell

**Synopsis of 1980 International Radar Conference**—Presented at the 1985 International Radar Conference, Washington, D.C. (May 6, 1985)

P. Scher | H.F. Inacker

**Experiences Utilizing LCC Module Designs on a Military System**—Presented at the Electronics Components Conference, Washington, D.C. (May 20, 1985) and published in the *Proceedings*

F.I. Sheftman | D.F. Bowman

**A Novel Radiating Element and Element Lattice for a Wideband Limited-Scan Phased Array**—Presented at the Fourth Technical ELINT Observables Seminar, Ft. Meade, Md. (May 14, 1985)

M.D. Stein | R.W. Lampe

**Comparison of Two Approaches for Determining the Effective Dielectric Constant of a Coplanar Strip Transmission Line**—Presented at the 1985 IEEE/AP/MTT-S Benjamin Franklin Symposium, Philadelphia, Pa. (May 4, 1985)

D.N. Thomson

**Monopulse Design for Tactical Tracking Radar**—*Microwave Journal* (May 1985)

A.W. Wainwright, Jr.

**Second Party Software—One Year Later**—Presented at the Applicon User's Group 10th Annual Meeting, Phoenix, Ariz. (May 19, 1985)

W.W. Weinstock

**Special Purpose and General Purpose Programmable Signal Processors**—Presented at ASNE, Washington, D.C. (May 2-4, 1985) and published in the *Naval Engineers Journal*

## RCA Laboratories

E.H. Adelson | J.R. Bergen

**Spatiotemporal energy models for the perception of motion**—*J. Opt. Soc. Am. A*, Vol. 2, No. 2 (2/85)

R.E. Askew

**Limiting Amplifier for Instantaneous Frequency Measuring System**—*RCA Review*, Vol. 45, page 681 (12/84)

R.L. Camisa | G.C. Taylor | F.P. Cuomo | W.F. Reichert | R. Brown

**A GaAs Power FET Suitable for Monolithic Integration, with Laser-Processed**

**Gate and Drain Via Connections**—*RCA Review*, Vol. 45, page 606 (12/84)

B. Dornan | M. Cummings | F. McGinty  
**Advances in the Design of Solid-State Power Amplifiers for Satellite Communications**—*RCA Review*, Vol. 45, page 619 (12/84)

L.A. Goodman  
**Recent Advances in Discrete Power Transistors**—*Proceedings*, IEEE International Electron Devices Meeting (12/9/84)

J.M. Hammer  
**Closed Form Theory of Multicavity Reflectors and the Output Power of External Cavity Diode Lasers**—*IEEE Journal of Quantum Electronics*, Vol. QE-20, No. 11 (11/84)

J.G. Simmons | F.L. Hsueh | L. Faraone  
**Two-Carrier Conduction in MOS Tunnel Oxides II—Theory**—*Solid State Electronics*, Vol. 27, No. 12 (1984)

H. Kiess | R. Keller | G. Wieners  
**Photoconductivity in Trans (CH)<sub>3</sub>**—*Mol. Cryst. Liq. Cryst.*, Vol. 117 (1985)

V. Mangulis  
**Earth-Station Size vs. Error-Correction Coding in the Design of Ku-Band Satellite Communications Systems**—*International Journal of Satellite Communications*, Vol. 2 (1984)

W.H. Meyer | H. Kiess | B. Binggelli | E. Meier | G. Harbeke  
**Polypyrrole for Use in Information Storage**—*Synthetic Metals*, Vol. 10 (1985)

J.P. Russell | L.A. Goodman | A.M. Goodman | P.H. Robinson | J.M. Neilson  
**High-Power Conductivity-Modulated FETs (COMFETs) with a p-Type Channel**—*IEEE Electron Device Letters*, Vol. EDL-5, No. 11 (11/85)

K. Palit  
**Influence of an Electrically Conductive Filler on the Rheology and Processing of Polyvinyl Chloride Formulations for Molding Video Records**—*Proceedings*, 43rd Annual Technical Conference and Exhibition (1985)

D.H. Pritchard  
**US Color Television Fundamentals—A Review**—An invited presentation at the 1985 IEEE Region Five Conference, Lubbock, Tex. (March 13-15, 1985)

P.J. Stabile | A. Rosen  
**A Silicon Technology for Millimeter-Wave Monolithic Circuits**—*RCA Review*, Vol. 45, page 587 (12/84)

E.F. Steigmeier | H. Auderset  
**Structural Perfection Testing of Films and Wafers by Means of Optical Scanner**—*J. Electrochem. Soc.* (7/84)

E.F. Steigmeier | H. Auderset | M. Almeida  
**Raman Effect and Infrared Reflectivity in MNEB(TCNQ)<sub>2</sub> and TEA(TCNQ)<sub>2</sub>**—*Mol. Cryst. Liq. Cryst.*, Vol. 120 (1985)

C. Steinbruchel  
**A Simple Formula for Low-Energy Sputtering Yields**—*Appl. Phys. A*, Vol. 36 (1985)

C. Steinbruchel | H.W. Lehmann | K. Frick  
**Mechanism of Dry Etching of Silicon Dioxide**—*J. Electrochem. Soc.*, Vol. 132, No. 1 (1/85)

R.G. Stewart | A.C. Ipri | L. Faraone | J. Cartwright | K. Schlesier  
**A Shielded Substrate Injector MOS (SSI-MOS) EEPROM Cell**—*Proceedings*, IEEE International Electron Devices Meeting (12/9/84)

M.L.W. Thewalt | E.C. Lightowers | J.I. Pankove  
**Photoluminescence studies of the neu-**

**tralization of acceptors in silicon by atomic hydrogen**—*Appl. Phys. Lett.*, Vol. 46, No. 7 (4/85)

J.H. Thomas III | G. Kaganowicz  
**X-Ray Photoelectron Spectroscopy Analysis of Silicon Oxide Deposited by a Nitrous Oxide Silane Glow Discharge**—*Proceedings*, Materials Research Society Symposium (1985)

J.L. Vossen  
**In-Situ, Low-Damage Techniques for Cleaning Si Surfaces Prior to Metal Deposition**—Presented at the Microelectronic Technology Symposium, North Central Chapter, American Vacuum Society, Plymouth, Mich. (5/85)

L.K. White | Jer-Shen Maa  
**Etch Rate Enhancement of Silicon in CF<sub>3</sub>-O<sub>2</sub> Plasmas**—*Appl. Phys. Lett.*, Vol. 46, No. 11 (1985)

L.K. White | N. Miskowski  
**Topography-induced thickness variation anomalies for spin-coated, thin films**—*J. Vac. Sci. Technol. B*, Vol. 3, No. 3 (May/June 1985)

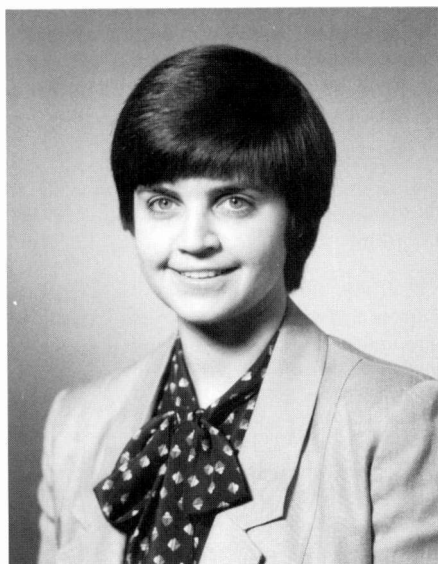
L.K. White  
**Characterization and Simulation of Spin-Coated Resist Contours**—*Proceedings of SPIE*, Vol. 539, No. 26 (1985); Presented at the SPIE Microlithography Symposium on Advances in Resist Technology and Processing II, Santa Clara, Cal. (March 11-12, 1985)

J.K. Wright, Jr. | D. Zarodnansky  
**The Third Drive**—*PC Tech. J.*, Vol. 3, No. 6 (6/85)

R.A. Zang  
**Industrial View of Training New Faculty in Engineering Technology**—Presented at the 1985 Annual Conference of the American Society for Engineering Education, Georgia Institute of Technology, and published in *Computer-Aided Engineering, Proceedings*, Vol. 2, pp. 846-847

# Engineering News and Highlights

## Robin Deal is Manager, Technical Information Systems



**Robin Deal** has been appointed Manager, Technical Information Systems, reporting to Anthony J. Bianculli, Manager, Engineering Information. She is responsible for publishing the *RCA Technical Abstracts* and maintaining the technical abstracts database. Ms. Deal has a Master's Degree in Librarianship from the University of South Carolina, and has a number of years of industrial experience in special libraries, most recently as the librarian at RCA Americom. She is a member of the Alpha Chi International Honor Fraternity, Beta Phi Mu International Library Honor Fraternity, and the Nuclear Records Management Association.

## Staff announcements

### Americom

**William E. Berman**, Manager, CATV Services, announces the appointment of **Frederick A. Horowitz** as Manager, Cable Services.

### Automated Systems Division

**Eugene M. Stockton**, Division Vice President, Engineering, announces his organi-

zation as follows: **Eugene B. Galton**, Manager, Engineering Staff; **Raymond K. Gorman**, Manager, Command and Control Engineering; **Gerard T. Ross**, Manager, Program Operations; **Chris A. Wargo**, Manager, Software Engineering; and **James C. Williams**, Manager, Program Operations.

**Thomas E. Fitzpatrick**, Division Vice President, Vehicle Test Systems, announces his organization as follows: **John M. Anderson**, Manager, Program Operations; **Richard T. Cowley**, Manager, Vehicle Test Systems Engineering; **Henry L. Fischer**, Manager, Vehicle Electronics Systems Engineering; **Thomas E. Fitzpatrick**, Acting Manager, Program Operations; **Richard E. Hanson**, Manager, Program Operations; **Thomas H. Huber**, Manager, Program Operations; and **John F. Martin**, Manager Program Operations.

**David M. Priestley**, Division Vice President, Automatic Test Systems, announces his organization as follows: **Donald M. Bartlett**, Manager, Program Operations; **John H. Groff**, Manager, Program Operations; **John Hallal**, Manager, Program Operations; **Fernando F. Martin**, Manager, Avionics Test Systems Engineering; **James A. Murnane**, Manager, Business Development; **Richard P. Percoski**, Manager, Automatic Test Systems Engineering; and **Walter R. Wadden**, Staff Scientist, Software Systems.

## Consumer Electronics Division

**David J. Carlson**, Manager, Advanced Tuner Development, announces the appointment of **Max W. Muterspaugh** as Principal Member, Engineering Staff.

**James R. Arvin**, Manager, Operations-Components, announces the appointment of **Daniel C. Polson** as Manager, Process Engineering.

## Globcom

**Timothy P. Luken**, Vice President, Management and Business Information Systems, announces the appointment of **William Posnansky** as Director, Applications Development and Support.

## Government Communications Systems Division

**Donald D. Miller**, Division Vice President, Engineering, announces his organization as follows: **Robert K. Henry**, Manager, Software Engineering Skill Center; **Edward G. Tyndall**, Manager, Design Assurance; and **Glenn V. Wild**, Manager, RF and Microwave Skill Center.

## NBC

**Michael Sherlock**, Executive Vice President, Operations and Technical Services, announces the following appointments within his organization: **Maurice H. Greenfield** as Vice President, Management Information Systems; **Frank Accarino** as Director, Network News Technical Services; **Gary Fletcher** as Director, Broadcast Systems Engineering; **Andrew Morris** as On-Air Technical Manager; **Douglas Ridge** as Manager, Systems; **Mark Gutman** as Technical Facilities Manager; **William Hart** as Manager, Electrical Services; **Philip Lanz** as Manager, Systems; **James Ryan** as Director, Network Systems; **William Sacrey** as Manager, Field Purchasing and Office Administration; **Kevin Scott** as Manager, Electronic Maintenance; **Pamela Harris** as Technical Facilities Manager; **Robert Schnibbe** as Director, Office Telecommunications; **Robert Stratton** as Director, Space Allocation and Architectural Design; **Thomas Ahn** as Director, Facilities Projects; **John Arvelo** as Facilities Project Manager; **Caesar Bernardi** as Facilities Project Manager; **Herbert Straub** as Director, Facilities Projects; **Catherine Luongo** as Facilities Project Manager; and **Laurence Thomas** as Facilities Project Manager.

## Patent Operations

**Birgit E. Morris**, Director, Electronic Materials and Devices Patent Operations, announces the appointment of **William J. Burke** as Managing Plant Attorney.

## RCA Service Company

**Nicholas W. Strinkowski**, Manager, AEGIS Support Project, announces the appointment of **Richard J. Simone** as Manager, AEGIS Computer and Display Maintenance, AEGIS Support Project.

## Solid State Division

**Bruno J. Walmsley**, Director, Engineering, Standard IC Products, announces his organization as follows: **Kenneth W. Brizel** as Manager, Engineering—Logic Products; **Charles Engelberg** as Manager, Test Engineering; **Merle V. Hoover** as Manager, Engineering—Computer, Telecommunications and Industrial Products; **Lewis A. Jacobus, Jr.** as Manager, Engineering—Automotive and Consumer Products; and **Sterling H. Middings** as Section Manager, Layout Services.

## Technical Excellence Center

**Anthony J. Bianculli**, Manager, Engineering Information, announces the appointment of **Robin L. Deal** as Manager, Technical Information Systems.

---

## Professional activities

---

### Pritchard in Who's Who

**Dalton H. Pritchard**, Fellow of the Technical Staff, RCA Laboratories, has been selected for inclusion in the Forty-fourth edition of *Who's Who in America*. The aim of this publication is "to provide authoritative and comprehensive biographical data on men and women whose positions in, and contributions to, society have made them subjects of national reference interest."

Mr. Pritchard has also been selected for inclusion in the 1986 edition of *Who's Who in Consumer Electronics*, "the first comprehensive biographical directory to the decision makers in audio, video, computers and personal electronics."

### Brill named Fellow Member

**Yvonne Brill**, Staff Engineer, Astro-Electronics, has been elected a Fellow Member of the Society of Women Engineers

## Degrees awarded

**Joseph Kovacs**, Field Engineer, RCA Service Company, received the BS Degree in Electronic Engineering Technology from Trenton State College.

**Jerry L. Hotmire**, Member of the Technical Staff, Video Component and Display Division, received the BS Degree from the Purdue University School of Engineering and Technology.

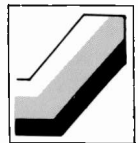
## Branin Fellow of ASQC

**G.J. Branin**, Manager, Product Assurance, Missile and Surface Radar Division, has been elected a Fellow of the American Society for Quality Control. This is in honor of his outstanding contributions to the application of quality control in electronics, and for his exceptional and highly successful efforts to achieve cooperation between industry, government, and academia in the quality sciences.

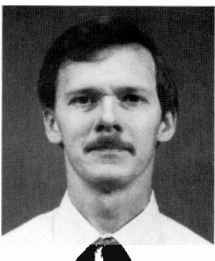
---

## Technical excellence

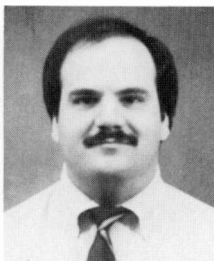
---



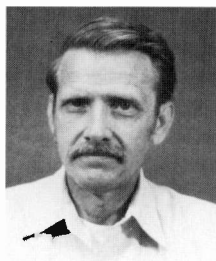
## CE TEC awards



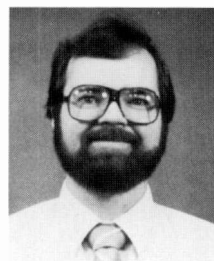
Muterspaugh



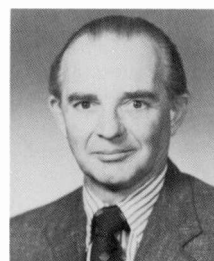
Albean



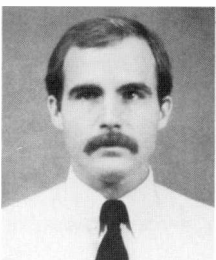
Fraley



Snell



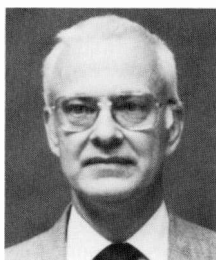
Gibson



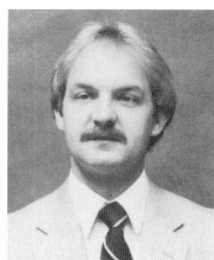
Gilbert



Powell



Hart



Holmes

The recipients of the Consumer Electronics Division 1984 Annual Technical Excellence Awards are: **Ronald C. Collins** and **Dennis E. Culley**, for the design and implementation of an automatic convergence reading system for COTY yokes; **Max Muterspaugh**, **Dave Albean**, **Morgan Fraley**, **Marc Snell**, and **Jim Gibson**, for developing a multi-sound capability for television; **Dan Gilbert**, for designing and installing robotic systems to automatically

unload portable plastic cabinet fronts, backs, and 25-inch console masks from 14 plastic injection molding presses; and **Timothy Holmes**, for the development and implementation of a new ATE system to test the performance of the CTC131 high-voltage transformer system.

The CE first quarter, 1985 Technical Excellence Award winners are **Jack B. Hart**, for the development of a new method to deflash unfired round and oval ferrite cores for S/T yokes, and **Jerry P. Powell**, for the development of a semi-automatic machine used in the critical adjustment of high-resolution yoke/tube combinations.

### VCDD TEC awards

The Video Component and Display Division third quarter, 1984 Technical Excellence Award recipients are: **Richard C. Bauder**, for analysis and prediction of thermal, shock, and vibration performance of the mask/frame configuration in development of the 27-inch square planar color picture tube; **Peter J. Luntz**, for the architectural design, installation, training, and support of a computer-aided design system; **Frank P. Ragland**, for the development of the flat-faced, square-cornered 27VSP color picture tube; and **Martin N. Workman**, for software contributions in the screening and matrix rooms at VCDD production facilities in Scranton and Marion.

The VCDD fourth quarter winners are: **Ernest E. Doerschuk**, for work involving a 12-percent increase associated with the introduction of aluminum-killed steel in the shadow mask manufacturing process; **Donald M. Weber**, for his work on the etching of fine apertures and the manufacturing process for aluminum-killed steel; **George S. Knedeisen**, for work related to increased exhaust speeds and lower exhaust temperatures; **J.L. Werst**, for the development of sheath beam bender magnetizer heads for data display CRT assemblies and color picture tubes; and **Leonard P. Wilbur**, for innovative mechanical design of the shoeless bander and other equipment for new larger picture tubes, including the 27VSP.

### SSD awards

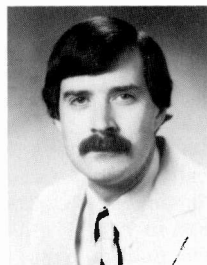
The winners of the 1984 Solid State Division Annual Technical Excellence Individual Awards are **R. Kleppinger**, for wafer particulate reduction, **G. Povenmire**, for improving the QMOS photo process, and **C. VanHorn**, for the interconnection of test equipment.

The recipients of the 1984 SSD Annual Team Award are **M. Blumenfeld**, **L. Goodman**, **R. Pollachek**, and **J. Rauschmayer** for yield improvement in the 128k ROM.

### 1st quarter MSRDR awards



Hudson



Pancoast



Perham



Pruitt

There were four recipients of the Missile and Surface Radar Division first quarter, 1985 Technical Excellence awards: **James L. Hudson** for developing and refining a new technique for measuring complex phase comparator parameters; **Eric T. Pancoast**, for technical leadership in firmware implementation for the ATMAC-II General Surveillance Processor and its inte-

gration into the Advanced Autonomous Array; **Douglas A. Perham**, for outstanding performance as the AN/SPY-1B Radar System integration team leader during critical operational performance evaluation of the system; and **Duard L. Pruitt**, for advancing the state of the art in high-voltage power supply inverter circuit design for very stable power amplification.



Left to right: Charles Engelberg, Joe Legendziewicz, Bruno Walmsley



Left to right: Pete Idell, Ronald Bracken, Frank Kuyan, John Herman

**Myles Castagna** has received the Palm Beach Gardens fourth quarter Technical Excellence Award for developing a unique

wafer auto-calibrating sense system for ion implanters.

The fourth quarter 1984 and first quarter





Left to right: Mike Gianfagna, Vince Alwin, John Herman

1985 Technical Excellence Award winners at Somerville were: **Joe Legendziewicz**, for the design of a novel universal operational amplifier test fixture; **Frank Kuyan**, for the development of a multi-level resist process

using Brewer's ARC for SOS IV; and **Vince Alwin**, for designing, implementing, and simulating a model for the floating substrate and kink effects in the SOS transistor.

## Electronic Publishing Symposium held at MSRD

An RCA corporate symposium held on May 15, 1985 at Missile and Surface Radar Division, Moorestown, NJ, focused on "Electronic Publishing," and specifically on the challenges of in-plant publishing in RCA. Eighty-five attendees, representing 19 RCA business units, participated in the all-day session, which included a one-hour open forum and tours and demonstrations of advanced systems for managing text and graphics.

Don Higgs, Manager, Technical Communication, MSRD, served as Chairman for the symposium. In his introductory remarks he cited a number of statistics to account for industry's growing interest in the financial and operational advantages of electronic publishing:

- The average corporation spends between 6 and 10 percent of its total annual revenues on publishing.
- Corporate publishing accounted for 850 billion pages in 1981 and 2.5 trillion in 1984; 4 trillion pages are projected for 1989.
- The cost of corporate publishing is estimated at about \$200 billion annually—roughly double the total annual revenues of the entire printing and publishing industry.

□ Conversion to electronic publishing yields an average of 30-to 35-percent return on investment, with numbers up to 60 percent for efficiently run organizations.

### Papers presented:

#### In-Plant Photocomposition for the '80s

**R.J. Camlin**, Leader, Text Management and Composition Systems, Missile and Surface Radar Division.

A review of system requirements and equipment configurations available for high-volume, medium-quality in-house publishing, this paper covered the range of input, processing, and output devices available. Also discussed were peripheral equipment, interface devices, and the application of software for increased automation of the processes. The role of personal computers was addressed, in terms of their practical utility in a sophisticated in-house publishing system.

#### Networking—Key to the Use of Computer Power in Information Systems

**J.A. Goodman**, Manager, Information Systems Planning and Computer Services, RCA Laboratories.

This tutorial provided basic information on linking systems, networking, and transfer of data files among systems. The application of modems was described, along with their role in flow control, error control, and binary data handling. The treatment also covered terminology, protocols, and transfer speeds of various systems. Similarities and differences among local-area networks and packet switching networks were described, including a brief discussion of the corporate NipperNet.

### Application of Word Processing to Computerized Engineering Standards

**S.C. Cilla**, Manager, Division Documentation Control Center, RCA Solid State Division.

Solid State Division's approach to a major problem with engineering standards included three principal goals: timeliness, improved accuracy, and reduced page count. The evolution of a computerized specification system was traced from its manually operated origins to the current integrated system including mainframes, word processors, and desk-top terminals. Both timeliness and accuracy goals have been achieved, with a reduction in page count to less than 30 percent of former levels.

### Bridges—Technical Publications Systems and Electronic Office Systems

**J.R. Kiernan**, Director, Policy and Administration Systems, Corporate Staff.

This status report on administrative systems, office systems, and office automation in RCA included a discussion of the relationships and common objectives of technical publications applications and electronic office systems (EOS). Current work on EOS planning was described, with particular emphasis on the impact of support and organizational costs. Also treated were current issues in cost-benefit analysis, and management of RCA's electronic office systems investment.

RCA engineers may obtain a copy of the symposium record by writing to **D.R. Higgs**, MS 108-131, Missile and Surface Radar Division, Moorestown, N.J.

# Want to write for the *RCA Engineer*?

Need some tips?

Our author's guide gets right to the point . . .

If you are writing an article for the *RCA Engineer's* multidisciplinary engineering audience, the 48-page "Guide for *RCA Engineer* Authors" can show you practical ways to attract and maintain reader interest. The material specifically applies to

RCA users. Experienced and novice authors can use many of the universally applicable principles, methods, and examples given here. Each chapter presents a series of Premises, Goals, and Methods that lead you through the writing effort.

The first chapter, "Article Mechanics & Specifications," defines the parts of a complete article package. The second chapter, "Article Content," contains idea starters that will help you to gather the

right information and artwork, organize the material, establish and keep audience interest, and write for the reader. The third chapter, "Writing Style," illustrates by example the five major ways to improve written expressions by making them active, lean, clearly qualified, symmetric, and specific.

Send your request for a free copy of the "Guide for *RCA Engineer* Authors" to the *RCA Engineer* Magazine, Technical Excellence Center, 13 Roszel Road, P.O. Box 432, Princeton, NJ 08540-0432. Call Tacnet: 226-3090.

# Editorial Representatives and Technical Publications Administrators

Contact your Editorial Representative at the Tacnet numbers listed below to plan your *RCA Engineer* article and to announce your professional activities.

\* Technical Publications Administrators, responsible for review and approval of papers and presentations, are indicated here with asterisks before their names.

<b>Advanced Technology Laboratories</b>	<b>Tacnet</b>	<b>National Broadcasting Company</b>	<b>Tacnet</b>
*Merle Pietz Ed Master	Moorestown, New Jersey Moorestown, New Jersey	253-6429 253-6436	*Bob Mausler New York, New York
<b>Aerospace &amp; Defense Staff</b>		<b>New Products Division</b>	
*Theresa Law (Approvals only)	Cherry Hill, New Jersey	222-5319	*Art Sweet Bob McIntyre
<b>American Communications</b>			Lancaster, Pennsylvania Ste Anne de Bellevue
*Anita Labib (Approvals only) Carolyn Powell	Princeton, New Jersey Princeton, New Jersey	258-4346 272-4194	227-6878 514-457-9000
<b>Astro-Electronics Division</b>		<b>Network Services</b>	
*Frank Yannotti Carol Coleman	Princeton, New Jersey Princeton, New Jersey	229-2544 229-2919	*Bill Brown Princeton, New Jersey
<b>Automated Systems Division</b>		<b>Patent Operations</b>	
*Dave Wellinger Dale Sherman	Burlington, Massachusetts Burlington, Massachusetts	326-3435 326-3403	George Haas Princeton, New Jersey
<b>Broadcast Systems Division</b>		<b>RCA Laboratories</b>	
*Harry Green	Gibbsboro, New Jersey	266-3971	*Julie Dann (Approvals only) Eva Dukes
<b>Consumer Electronics Division</b>		<b>RCA Records Division</b>	
*Eugene Janson John Hopkins Larry Olson	Indianapolis, Indiana Indianapolis, Indiana Indianapolis, Indiana	422-5208 422-5217 422-5117	*Greg Bogantz Indianapolis, Indiana
<b>Corporate Information Systems &amp; Services</b>		<b>RCA Service Company</b>	
*Sue Handman	Cherry Hill, New Jersey	222-6242	*Murray Kaminsky Dick Dombrosky Ray MacWilliams
<b>Global Communications</b>		<b>RCA Technical Excellence Center</b>	
*Dorothy Unger	Piscataway, New Jersey	335-4358	*Tony Bianculli (for Corporate Approvals)
<b>Government Communications Systems Division</b>		<b>"SelectaVision" VideoDisc Operations</b>	
*Dan Tannenbaum	Camden, New Jersey	222-3081	*Harry Anderson Indianapolis, Indiana
<b>Solid State Technology Center</b>		<b>Solid State Division</b>	
*Susan Suchy	Somerville, New Jersey	325-7492	*John Schoen Dick Morey Harold Ronan
<b>Missile and Surface Radar Division</b>		<b>Video Component and Display Division</b>	
*Don Higgs Graham Boose Jack Friedman	Moorestown, New Jersey Moorestown, New Jersey Moorestown, New Jersey	224-2836 253-6062 224-2112	Somerville, New Jersey Palm Beach Gardens, Florida Mountaintop, Pennsylvania Somerville, New Jersey Findlay, Ohio
			325-6467 722-1262 327-1473 or 327-1264 325-6168 425-1307
			*Ed Madenford Lou DiMattio Nick Meena J.R. Reece
			Lancaster, Pennsylvania Scranton, Pennsylvania Circleville, Ohio Marion, Indiana
			227-6444 329-1435 432-1228 427-5566

# RCA Engineer

A technical journal published by  
the RCA Technical Excellence Center  
"by and for the RCA engineer"

13 Roszel Road, P.O. Box 432, Princeton, N.J. 08540-0432  
Address correction requested

BULK RATE  
US Postage

PAID

Phila., Pa.  
Permit No. 2906

6SDGC

EJ NOSSEN  
203 ELKINS RD  
CHERRY HILL  
NJ 08034

Printed in the U.S.A.  
Form No. Re-30-4