

# RCA Engineer

Vol. 26 No. 1 July/Aug. 1980

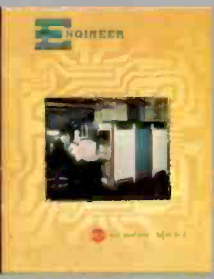

Cover Design: Louise Carr

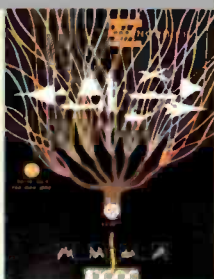
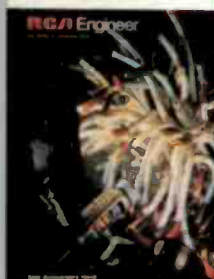
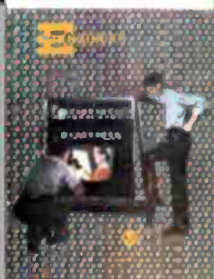
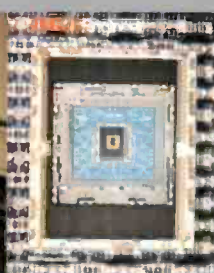
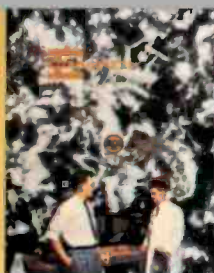
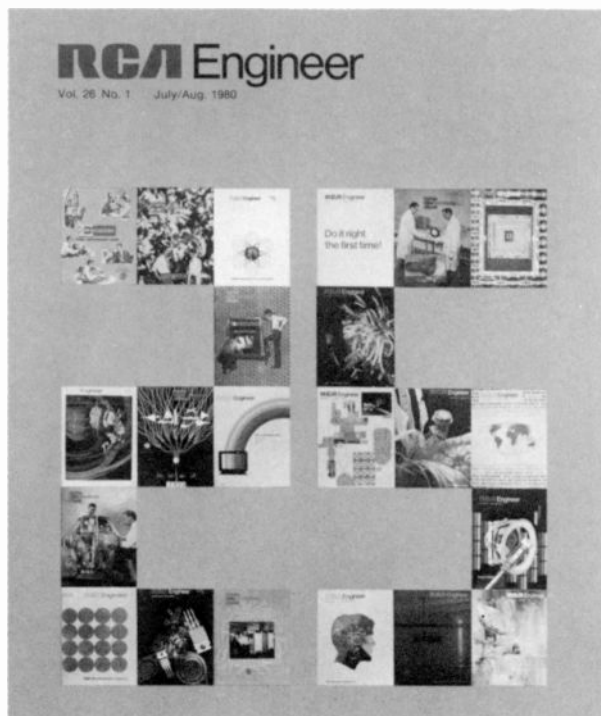

### Twenty-Five Years of the *RCA Engineer*

A twenty-fifth anniversary may be called "silver" because it prompts reflections — on past, present and future. Old tickets, photos, letters and other vaguely remembered things gathered over the years hold rich networks of meaning. On silver anniversaries, people exchange these things as gifts. And there's faith that the intangible, accumulated foundations will support mature but continually renewed future growth.

Our cover is our gift — a photo album to RCA engineers who have literally been the inside story behind twenty-five years of *Engineer* covers. You've used the medium for the exchange of discoveries, problems, solutions and goals. This special issue is certainly no exception.

In his cover message, Bill Hittinger espouses broad-based personal renewal, both on the job and off it. We honor the David Sarnoff Award Winners for their excellence on the job and contributions to the growth of the company (page 4). In this issue, Bill Webster looks back at David Sarnoff's predictions (circa 1955) for the future, then looks ahead to a few of his own (page 8). Ralph Engstrom has gone back in time and traced RCA's engineering evolution. He's read or scanned over 2500 articles in helping to prepare the twenty-five year index to articles in the *Engineer* now at a library near you (pages 7, 38). And authors throughout the company profile multidisciplinary efforts going on in our divisions (pages 10-56). Finally, we feature contributions from the "non-electronic" businesses (pages 57-68).

Your work is important. You talk about it all day long. The *Engineer* helps you to present your work to a wide audience. You can promote personal and professional growth. It's a good feeling — like gift giving. We welcome your articles and ideas. After all, they make the future shine.

# RCA Engineer

A technical journal published by  
RCA Research and Engineering  
Bldg. 204-2  
Cherry Hill, NJ 08358  
TACNET: 222-4254 (609-338-4254)

### RCA Engineer Staff

<b>Tom King</b>	Editor
<b>Mike Sweeny</b>	Associate Editor
<b>Louise Carr</b>	Art Editor
<b>Frank Strobl</b>	Contributing Editor
<b>Betty Gutchigian</b>	Composition
<b>Dorothy Berry</b>	Editorial Secretary

### Editorial Advisory Board

<b>Pete Bingham</b>	Division Vice-President, Engineering, Consumer Electronics Division
<b>Jay Brandinger</b>	Division Vice-President, "SelectaVision" VideoDisc Operations
<b>John Christopher</b>	Vice-President, Technical Operations, RCA Americom
<b>Bill Hartzell</b>	Division Vice-President, Engineering, Picture Tube Division
<b>Jim Hepburn</b>	Vice-President, Advanced Programs, RCA Globcom
<b>Hans Jenny</b>	Manager, Engineering Information
<b>Arch Luther</b>	Division Vice-President, Engineering, Commercial Communications Systems Division
<b>Howie Rosenthal</b>	Staff Vice-President, Engineering
<b>Ed Troy</b>	Director, Operations Planning and Support, Solid State Division
<b>Bill Underwood</b>	Director, Engineering Professional Programs
<b>Joe Volpe</b>	Director, Product Operations, Missile and Surface Radar
<b>Bill Webster</b>	Vice-President, Laboratories

### Consulting Editors

<b>Ed Burke</b>	Administrator, Marketing Information and Communications, Government Systems Division
<b>Walt Dennen</b>	Director, Public Affairs, Solid State Division
<b>Charlie Foster</b>	Manager, Systems and Procedures
<b>John Phillips</b>	Manager, Proposals and Publicity, Automated Systems

•To disseminate to RCA engineers technical information of professional value •To publish in an appropriate manner important technical developments at RCA, and the role of the engineer •To serve as a medium of interchange of technical information between various groups at RCA •To create a community of engineering interest within the company by stressing the interrelated nature of all technical contributions •To help publicize engineering achievements in a manner that will promote the interests and reputation of RCA in the engineering field •To provide a convenient means by which the RCA engineer may review his professional work before associates and engineering management •To announce outstanding and unusual achievements of RCA engineers in a manner most likely to enhance their prestige and professional status.



William C. Hittinger

## Our technological tradition and promise

Anniversaries tend to be delightful opportunities for pausing in our daily pursuits to look back, take stock and speculate about the future. This 25th Anniversary Issue contains all these elements in full measure. It should be a pleasant reading experience.

In taking stock of RCA engineering, we realize the impressive scope of our technical efforts. We encompass a wide range of professional disciplines. Our businesses and markets are international. Because of this variety, an RCA career in engineering holds exciting prospects with opportunities to participate in interesting work.

Today, our profession is critically important to an effort that greatly concerns our nation — maintaining healthy technology through innovation. More people than ever understand that raising our standard of living to match our expectations largely depends on our ability to successfully advance our technologies.

A growing concern is that we as a nation are losing our technological leadership and our traditional productivity advantage to others. RCA is not a loser in these important areas. We have renewed our dedication to technical excellence — our results reflect it. Our investment in research, development and product engineering is higher than ever. We are stating a theme of technological dedication as a “tradition on the move” by displaying examples of our work in many widely read journals. Most importantly, the quality of our products and their acceptance in the marketplace speak eloquently of this dedication.

Members of the RCA engineering community must be worthy stewards of our corporate investment. Our greatest single devotion must be to professionalism that in large measure requires technological currentness. On a wider scale, we need to renew ourselves in pursuing excellence in a world of change.

What better way can we achieve this excellence than to actively read and contribute to the *Engineer*, a publication “by and for the RCA engineer.” This Anniversary issue reminds us all of our technological tradition and our opportunities for a promising future.

A handwritten signature in cursive script that reads "William C. Hittinger". The signature is written in dark ink and is positioned above the printed name and title.

**William C. Hittinger**  
Executive Vice President  
Research and Engineering

# The Diversity of RCA's Businesses

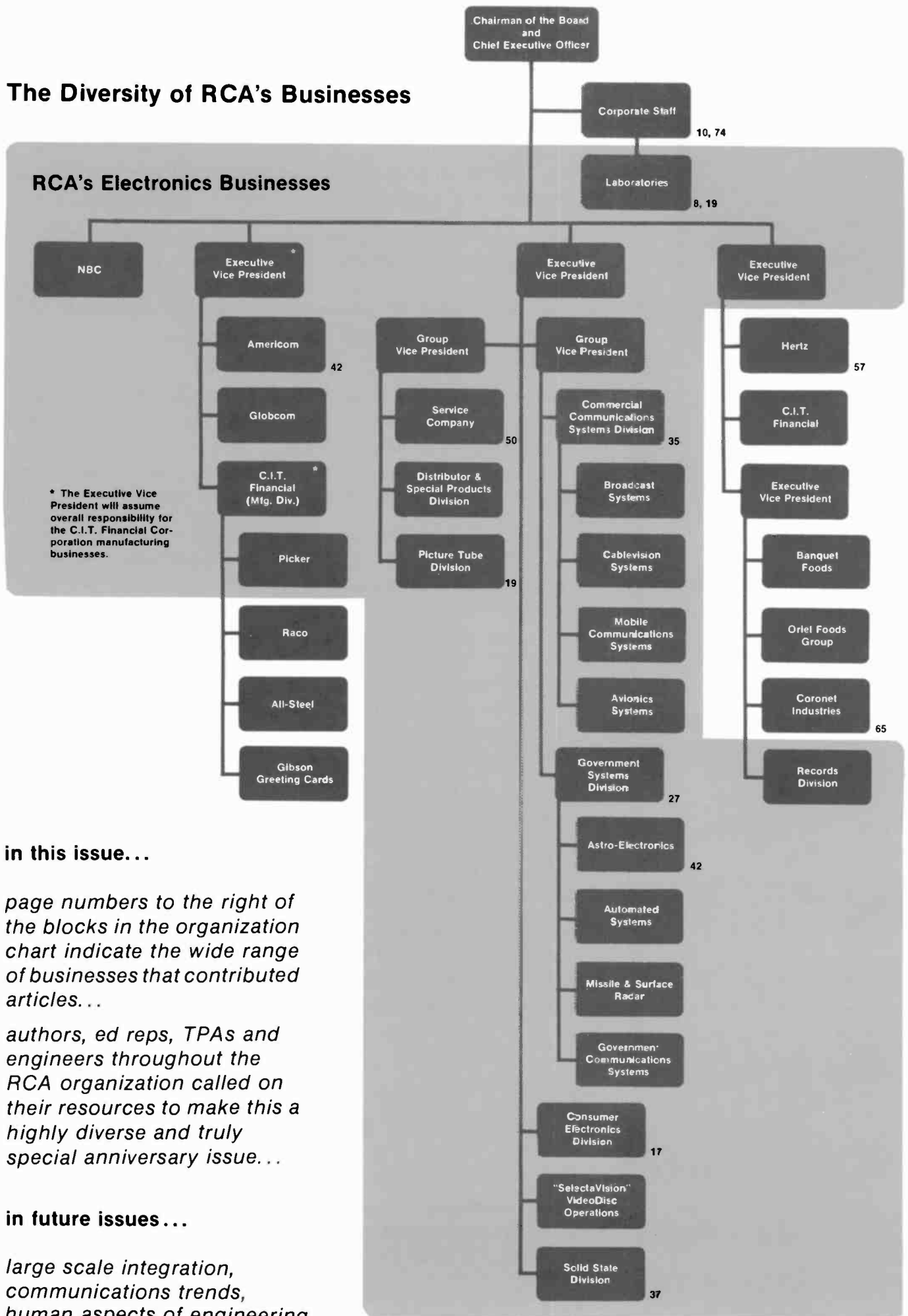

## in this issue...

page numbers to the right of the blocks in the organization chart indicate the wide range of businesses that contributed articles...

authors, ed reps, TPAs and engineers throughout the RCA organization called on their resources to make this a highly diverse and truly special anniversary issue...

## in future issues...

large scale integration, communications trends, human aspects of engineering

# RCA Engineer

Vol 26|No. 1 July|Aug. 80

- present, past and future**
- 4 The 1980 David Sarnoff Awards for Outstanding Technical Achievement
  - 7 *RCA Engineering* evolution  
R.W. Engstrom
  - 8 Twenty-five years from now  
W.M. Webster
  - 10 Technical excellence programs support engineers' viability  
H.K. Jenny
- multidisciplinary engineering efforts**
- 17 Focal point for the eighties  
E. Lemke
  - 19 The Technology Transfer Laboratory — the vital link for picture tubes  
B.F. Williams|M.A. Leedom|F. Van Hekken|J.J. Moscony  
R.W. Shisler|L.E. Potter
  - 27 Advancement and management of technology for Government systems  
D.C. Latham
  - 35 Engineering challenges in communications systems  
A.C. Luther
- RCA electronic businesses**
- 37 RCA Solid State in Europe  
W.A. Glaser
  - 42 The RCA Americom satellite communications system  
J. Christopher|J.E. Keigler
  - 50 RCA Service Company: a review  
R.W. Alnutt
- RCA non-electronic businesses**
- 57 Hertz car rental management systems and services  
B.G. Curry|M. Edelstein|M. Melnyk|P.L. Williams|J.M. Parks  
T.G. Hammett|W.E. Sumner
  - 65 Engineering the carpet business  
H.L. Clement
- general interest**
- 69 Bringing radio to the rural home  
G.F. Rogers
  - 74 Editorial: Voice your ideas  
T.E. King
- departments**
- 76 Patents
  - 77 Pen and Podium
  - 80 News and Highlights

# The 1980 David Sarnoff Awards for Outstanding Technical Achievement



*RCA's highest technical honors have been announced for 1980. Each award consists of a gold medal and bronze replica, a framed citation and a cash prize.*



Noto



Smith

## R. Noto | A.M. Smith

Advanced Technology Laboratories, Government Systems Division, Camden, N.J.

**For outstanding technical contribution in the development and application of automated design techniques for the generation of COS/MOS and CMOS/SOS LSI devices.**

In 1969, as a result of primarily this team's technical expertise and interaction, the first design automation program dedicated to the automatic layout of LSI circuits using COS/MOS technology, then a unique RCA technology, was developed. From 1972 through 1974, the automatic layout capability was extended by Mr. Noto and Mr. Smith to the CMOS/SOS technology. Later the program was extended to the closed geometry CMOS bulk technology (C<sup>2</sup>L), Solid State Division's principal commercial MOS process and technology. In 1974, Mr. Noto and Mr. Smith developed the Multiport 2-Dimensional (MP2D) automatic layout program for LSI and VLSI devices. This third generation automatic layout program lowered initial design costs and design time significantly, and produced chip densities formerly thought to be achievable only with manual layouts. The MP2D program is now a main design tool for generating custom LSI devices in both the military and industrial market areas.

Recently, a very significant breakthrough was accomplished by developing a completely new automatic placement and routing program, called SMP2D (Segmented Multiport 2-Dimensional program), for generating custom LSI devices. This is a fourth generation automatic layout program that represents the first major basic innovation in the automatic layout capability for LSI devices since 1973.

Supporting these innovative achievements is the actual integration of the programs with other Advanced Technology Laboratory and Government Communications Systems design aids into a total design system for digital LSI arrays. Mr. Noto was one of the key contributors to the development, evaluation, and optimization of this CAD (Computer-Aided Design) system.

To implement the design automation software, it was necessary to analyze in depth the characteristics of the RCA COS/MOS and CMOS/SOS processes and to translate this understanding into the creation of a library of validated circuit designs termed "Standard Cells." The nominated team, in conjunction with others, generated this library of handcrafted standard cells, which are reusable, validated LSI array building blocks. The concept of a basic family of circuits blends the area savings derivable from handcrafted custom designs with the high computational rate that characterizes computer programmed design automation techniques, particularly in the automatic layout capability. The result has been a significant reduction in both design time and initial cost, as well as increased circuit density and performance.

These accomplishments have been incorporated into a cost-effective tool termed the "Automatic Placement and Routing (APAR) Standard Cell Technique." With this technique, large numbers of the highly skilled and trained specialists who are in scarce supply and high demand are no longer required. Not only does this result in a substantial reduction in the cost of LSI devices, but more important, many LSI devices can be simultaneously designed throughout the operating divisions by technical staffs of widely varying capability and disciplines.

## A.H. Fortin, Jr. | R.E. Hanson | E.M. Sutphin

Automated Systems, Government Systems Division, Burlington, Mass.

**For outstanding contributions to the design and development of unique and extremely effective simplified test equipment for internal combustion engines.**

The development of RCA's Simplified Test Equipment for Internal Combustion Engines (STE/ICE) is an outstanding example of engineering excellence and team performance. The team's objective was to design a hand-held intelligent test system to be used by less-skilled mechanics to diagnose and isolate troubles in internal combustion engines. From the customer's viewpoint, such a system would replace a multiplicity of existing test equipments and would eliminate all testing by "parts substitution" on the Army's present and future vehicle fleet.

The effort led to STE/ICE, a field-portable, microprocessor-based system for testing automotive and combat vehicles. The STE/ICE system performs static and dynamic tests and measurement on the vehicle engines and on related accessory systems. In addition to measuring pressure, temperature, voltage, current, resistance, starter compression balance, dwell, timing, speed, and vacuum, the system electronically performs a power test on gasoline and diesel engines without the need for an external dynamometer. Fourteen classes of vehicles are supported, ranging from small gasoline-engine-powered vehicles to large combat vehicles powered by diesel and gas-turbine engines.

The Army has stated that STE/ICE will save over \$36 million per year on vehicular maintenance alone. On September 27, 1978, after completion of design and operational test, STE/ICE was type classified "Standard" by the U.S. Army. It is now produced in quantity for organizational maintenance of combat and transport vehicles all over the world.

The RCA team achieved this product through a series of Army- and RCA-sponsored studies, from late 1971 through early 1973, followed by an Army contract to develop the experiment. This included built-in monitoring and GO/NO-GO testing, built-in transducer instrumentation and diagnostic connector, computer-controlled Automatic Testing Equipment (ATE) on vehicles with diagnostic connectors, emission monitoring, and the application of these concepts and techniques to higher echelon maintenance.

Many individuals and groups contributed to the STE/ICE project. Much of this work was exemplary. However, three individuals, both singularly and as a team, demonstrated truly outstanding performance and technical excellence: A.H. Fortin for his micro-computer development and design, and contributions to system architecture; R.E. Hanson for his overall system architecture, algorithm development and system validation; and E.M. Sutphin for his unique electronic circuit development and system validation.



Fortin



Hanson



Sutphin

## R.A. Dischert | R.E. Flory | C.B. Oakley | L.J. Thorpe

RCA Broadcast Systems, Camden, N.J., and RCA Laboratories, Princeton, N.J.

**For an outstanding inter-divisional team effort in the development and design, from concept to final product, of the COSMAC microprocessor-controlled TK-47 automatic studio camera set-up system.**

Through the concentrated effort of this team, a completely new concept has been developed which allows the automatic adjustment of the set-up controls on a television camera by the push of a button. The microprocessor-controlled automatic set-up has been implemented in the newly designed TK-47 Automatic Studio Color Television Camera, and will provide a facility for the customer that gives him more consistent performance at a reduced cost of ownership.

Effort in the automatic control area initially took place in 1972, but the project did not reach the product stage due to the enormous amount of hardware required. Effort was rekindled in 1975 when the emergence of the microprocessor (which permitted software to be used in place of hardware for many tasks) and further use of LSI circuitry made the system feasible.



Dischert



Flory



Oakley



Thorpe

During 1976 and early 1977, members of the team conceived a unique microprocessor-based hardware-software system which permits implementation of a very sophisticated automatic set-up system at very low hardware cost. System feasibility was demonstrated in mid-1977. Two basic patents on the new concept have been issued to members of the team and several more patents on the system are pending.

A camera incorporating a significant portion of the automatic system was completed in time for demonstration at the 1978 National Association of Broadcasters (NAB) Convention. The registration and shading features of the automatic system which were demonstrated made a dramatic impact on the people attending the Convention. Subsequent to NAB, the team made a truly outstanding all-out effort to incorporate additional automatic features in the system and ready it for production. A tightly coordinated effort of personnel and resources at the David Sarnoff Research Center in Princeton and Broadcast Systems in Camden was required in order to bring this innovative idea to fruition.

## H. Blatter | J.B. George | R.M. Rast | C.M. Wine

Consumer Electronics Division, Indianapolis, Ind. and RCA Laboratories, Princeton, N.J.

**For team effort in the conception, design, and implementation of ChanneLock tuning. This cost-effective frequency synthesis-based tuning system played a key role in restoring RCA's leadership in color television.**



Blatter



George



Rast



Wine

A joint CE/Laboratories product development project was begun in the first quarter of 1976. A 1978 introduction of an all-electronic tuning system giving more cost-effective high performance for the total system including tuner was the goal. The project was preceded by two smaller-scale projects: at RCA Laboratories, research into the feasibility of a frequency synthesizer, phase-locked loops for TV tuning; and at Solid State Technology Center (SSTC), development of state-of-the-art 1-GHz prescalers.

In May 1978, RCA marketed ChanneLock tuning, a family of manual and remote-controlled tuning systems each containing a crystal-controlled frequency-synthesizer, phase-locked loop. ChanneLock's fully automatic tuning provides RCA with an industry first feature — no fine tuning ever. It provides more cost-effective remote-controlled tuning systems and permits RCA to pursue more vigorously an increasing consumer trend toward remotes. In 1977, prior to ChanneLock introduction, remote-equipped sets accounted for less than 10 percent of our sales. In 1980, this is expected to increase to 30 percent.

The system's architecture permits a family of product versions, including not only the three versions introduced (keyboard, scan manual and scan remote), but also others which have followed. Human engineering aspects were carefully considered, resulting in easily understood controls and a system that responds rationally. Channels within  $\pm 2$  MHz of nominal in VHF and  $\pm 1$  MHz in UHF are tuned automatically via a patented algorithm using both synthesis and conventional AFT as well as frequency stepping in VHF.

Seven custom ICs were developed for ChanneLock. Six different IC technologies are used; a challenge in system design and yet necessary to achieve the cost and performance goals. The project team worked with four different IC vendors in developing the ICs. The Synthesizer Control IC is the heart of the system, and was designed by members of the project team. The Prescaler IC was designed by SSTC and is the first prescaler in the industry which can be directly coupled to the tuner local oscillator without need for an external discrete buffer amplifier.

ChanneLock is an example of the successful use of multidivisional (CE, Laboratories, Solid State Division and SSTC) and multicompany (RCA, Texas Instruments, General Instrument and National Semiconductor) engineering resources to bring new products to market for RCA.



## RCA Engineering evolution

A contributor to the recently published 25-Year Index to the RCA Engineer found that a glance back can be a look ahead as he reviewed RCA's major technical contributions contained between the covers of the Engineer.

During the past 25 years, I received 150 issues of the RCA Engineer containing more than 2500 papers. Although I normally scanned each journal for items of particular interest to me and wrote a few of the articles myself, I didn't read more than a small percentage of this large collection. During the last several years I was inspired to take a more general interest in reading the RCA Engineer after being appointed to its staff as an editorial representative for the Electro-Optics and Devices Operation in Lancaster. Now, however, as a result of my involvement in this 25-year index, published in collaboration with O. F. Whitehead and D.E. Hutchison, I have developed a very special appreciation of the RCA Engineer.

My work on the subject index required me to scan every article in the entire set — a long and tedious, but rewarding job. I began with Volume I, published in 1955, and continued through the last issue for which I received prepublication prints. Incidentally, I learned to appreciate a good abstract and to deplore the use of undefined terminology, particularly acronyms. It took me much longer to do my part of the job than I had estimated, perhaps because I was frequently stimulated to read entire articles. The most satisfying part of my effort was the opportunity to review the evolution of almost every major electronics development of the last quarter century with pride in RCA's major contributions.

One impressive example is the development of silicon technology. It began with various transistor types, then ICs, LSIs, COS/MOSs and CCDs (if you need identification, see the index). Solar cells and other approaches to the energy problem, sophisticated photolithography, and silicon chips with hundreds of thousands of p-n diodes have been researched. The low-light-level TV camera (Silicon Intensifier Target (SIT) tube), with a bonus of color TV from the moon, resulted from some of this research. And now the microprocessor revolution is controlling functions in automotive braking, ignition, fuel mixture, collision avoidance and electronic diagnostics.

Many other developments (not too numerous to index) were reported: the AEGIS system; liquid crystals; computer technology; Videocomp; superconducting magnets; sophisticated satellites for meteorology; military surveillance; communications and space exploration; and RCA's involvement in TIROS, Nimbus, Ranger and Apollo.

The RCA Engineer provides a readable but technical account of RCA's progress in invention, development and manufacturing. Congratulations to the staff for its persevering effort to motivate, edit, organize and publish. I hope this index may now prove useful as documentation, reference and inspiration.

**Editor's Note:** The 25-Year Index to the RCA Engineer (R.W. Engstrom, indexer; O.F. Whitehead, D.E. Hutchison, editors) surveys development and research at RCA over the past 25 years. The index can help you find specific information, listed by title or by author, that you may already have in mind. Or you can do some discriminating browsing there.

The effort to incorporate previous developments at RCA into new and ongoing work is perhaps the best recycling of resources in the continuing evolution of the company. The RCA Engineer is proud to be a living record of the evolution of RCA. The index documents that record.

The 25-Year Index to the RCA

Engineer is free. All you must do to receive your copy is write to us:

RCA Engineer  
RCA Research and Engineering  
Building 204-2  
Cherry Hill, NJ 08358

For your convenience we've included a list of RCA Libraries which now hold the index. See page 38.

**Ralph Engstrom**, now retired, is serving as staff consultant. Since joining RCA in 1941, Dr. Engstrom has been associated as an engineer, group leader, and engineering manager with various photosensitive devices, including photomultipliers, image tubes, and camera tubes. He has published numerous articles relating to these devices and their applications. He is a Fellow in the American Physical Society, a member of the Optical Society of America and of Sigma Xi.



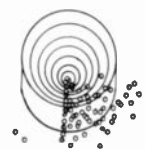

# Twenty-five years from now

*Lines to the future include two-way cable communication, microprocessor-controlled appliances, high-resolution video discs, re-engineered automobiles and more.*

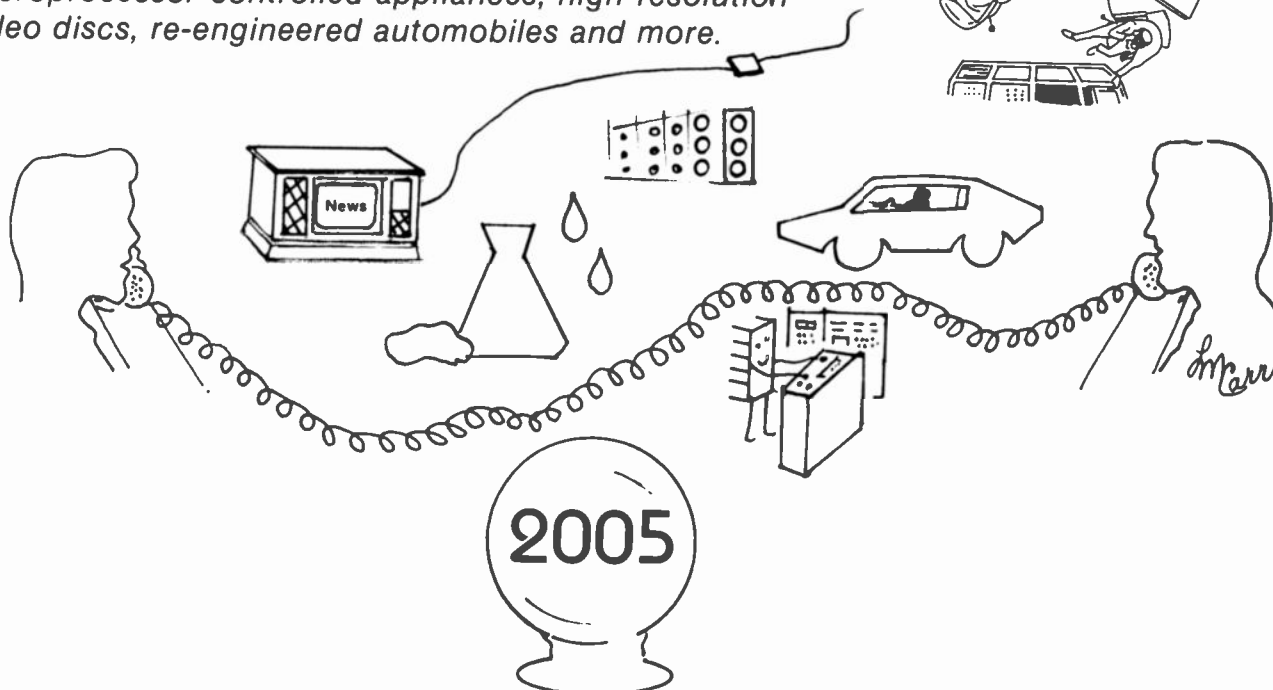

**Abstract:** *Technological change in home entertainment electronics, energy generation, and transportation will proceed more slowly in the next 25 years. But more importantly, sociological and economic pressures will play an increasing role in the selective development of technologies in these areas.*

My assignment is to speculate about the world of 2005—the end of the second twenty-five years of the *RCA Engineer*. To prepare myself for this assignment, I dug out a speech made by General Sarnoff in 1956 predicting some things about the world of 1976. This speech was one of the things that made me swear off making predictions. In fairness, however, General Sarnoff was quite accurate in areas that he knew a lot about, such as television. I will learn from this and limit my comments to two areas: electronics with emphasis on the consumer, and energy including transportation. The main problem is in deciding

what is likely to happen out of the many things that are or may become technically possible. In any event, it is unlikely that I'll worry much in 2005 about my accuracy—so here goes.

## Electronics

### *Home entertainment and television-related things*

Network and broadcast TV will still be with us. But television executives will emphasize news, interview and talk shows, and other formats that depend on immediacy. Also, alternative methods of delivering entertainment, such as pay TV and video disc, will partly displace broadcasting.

Low-cost digital technology will displace analog methods for most video signal processing but not for most transmission to the home. Digital transmission, however, will distribute signals via ground networks and satellites to broadcasters and cable operators.

The digital audio disc based on video disc technology will have a medium-sized

market. But the audio disc will be less popular than the video disc, since most people will prefer the good sound plus the picture.

Nearly every home in urban and suburban America will be connected to cable. And the cable will be two-way, with the upstream direction used for signalling and for low-speed data transmission. Access to channels carrying pay TV will be allowed or denied on a per-program, per-subscriber basis. Cable also will provide the main access to the services and databanks being market-tested today in Europe, Japan and the U.S. I think that the broadcast version of these services (similar in concept to RCA's "Homefax") will be introduced in the 1980s. The systems which give telephone access to many different sources, but at a lower data rate, will be available in the 1980s, too. By 2005, these systems will be largely replaced by a switched system using the TV cable to achieve both the variety and the high data rate. This could be a connection supplied by the telephone companies. However, I think that the economics favor the development via cable. Distribution of these data services together with broadcast TV and pay TV,

Reprint RE-26-1-2

Final manuscript received May 12, 1980.

particularly of live shows such as sports, will share about equally the cable capacity.

With such widespread use of cable and the existing diversity of the broadcast system, I don't see a need in the U.S. for direct broadcast from satellite to home. Although the technology will certainly be available, not enough homes will be without cable or be able to pay for the direct broadcast system. Direct transmission from satellite to home will be a reality in many other countries, however. Where the government owns the broadcasting system and particularly where no other system has yet been built (as in some Third World countries), the economics are quite different and will favor direct transmission from satellites.

A video disc with double the resolution in both the horizontal and vertical directions will be introduced in the mid-1990s. This high-resolution video disc will use an encoding technique that will permit compatibility with older players. Cable TV and probably broadcast TV will follow this lead. And, of course, the pictures will be displayed on a large, flat panel.

I have not put a computer in every home in 2005. Terminals with some intelligence will access the services and data I mentioned earlier. Some people will have fairly sophisticated terminals but I doubt it will be a mass market.

A great deal of intelligence, however, will be built into other things in our homes and autos. Appliances will be under microprocessor control. Discriminating switches will turn on lights, for example, only after sensing the simultaneous presence of darkness and a person. Room thermostats will operate similarly.

## Energy and transportation

By the year 2005, we will have had a war over energy or we will have learned to live with reality. In the first case, it would likely escalate to World War III and all predictions are off.

I believe that U.S. energy needs will be somewhat reduced in 2005 — perhaps by as much as 15 percent of today's usage. More efficient climate control and more efficient transportation, both developed because of rising costs, will be mainly responsible for the reduction.

Use of passive solar heating, better insulation and efficient energy management will be economic realities by 1995. Photovoltaic solar cells will supply about 10 percent of our electrical needs in 2005. Nuclear power plants will supply 30 per-

cent and the rest will be generated mostly by coal. None of these sources will be cheap. One forecast relating to electrical power generation I am sure of — in 2005 Jane Fonda will have her 68th birthday.

There will be new oil and gas found, and liquid fuels will be developed from coal and alcohol. The energy packing-density of liquid fuels will increasingly reserve them for transportation. Gas, both natural and synthetic, will increasingly be used for residential heating because of the in-place delivery system.

The American public will not give up the automobile and the independence it provides. Mass transportation will continue to be used by commuters and for long-distance travel between large cities. Although the railroad system will have to be improved and rebuilt to deliver coal, the consequences will be some shift from roads to rails for goods but not for people. Instead, the autos of 2005 will be two- and four-passenger vehicles (for smaller families) of very lightweight but high-strength construction. The structural concepts used in aircraft construction will be adapted and plastics will replace steel. A comfortable two-passenger car with an empty weight of 1,200 pounds will get 80 miles-per-gallon. The difference between city and highway mileage will decrease because microprocessor-controlled stoplights connected in networks will phase themselves to the traffic needs, not the other way around.

I expect the rate of technological change in the next 25 years will be slower in these areas than it was in the past 25 years. But one cannot anticipate major inventions such as the transistor which completely revolutionized our world and made today's computer technology possible. While other such revolutionary inventions are probable in the next 25 years, we engineers will have plenty to do to develop the technologies we already know about and to put them to profitable use.

## Conclusion

In order to keep all predictors humble, let me remind you of the technical innovations of the past 25 years. In addition to the integrated circuit, solid state memories and the microprocessor mentioned earlier, there were the Salk vaccine, manned space flight, lasers, microsurgery, the heart transplant, the "Pill," and permanent-pressed clothes. Some of these were perhaps predicted in 1955. But, I don't remember.



**Bill Webster**, Vice President, RCA Laboratories, is responsible for directing RCA's central research organization, located at the David Sarnoff Research Center, Princeton, New Jersey. He is also responsible for direction of technical programs at Laboratories RCA, Ltd. in Zurich, Switzerland; RCA Research Laboratories, Inc. in Tokyo, Japan; and RCA's Solid State Technology Center in Somerville, New Jersey.

A leader in the field of solid state physics, Dr. Webster joined RCA Laboratories in 1946 and made numerous contributions to tube and transistor developments. From 1954 to 1959, he was Manager of Advanced Development for the RCA Semiconductor and Materials Division. He returned to RCA Laboratories as Director of the Electronic Research Laboratory in 1959. He was appointed Staff Vice President, Materials and Device Research, in 1966 and has been in charge of RCA Laboratories since 1968. He was elected to his present position of Corporate Vice President in 1969.

Dr. Webster holds many patents in such diverse fields as television, vacuum tubes, gas tubes, circuitry and semiconductor devices. He is a Fellow of the Institute of Electrical and Electronics Engineers, a member of Sigma Xi, and a Member of the National Academy of Engineering. He served in the United States Navy during World War II with the rank of Lieutenant j.g. He has a commercial pilot's license with instrument and multi-engine ratings. He is a Director of Horizon Bancorp and of the Princeton Bank and Trust Co., as well as a Trustee of both The Medical Center at Princeton and The Carrier Clinic Foundation.

And no, that is not a crystal ball on Bill's desk — it's a "Ponder Ball." Bill received the RCA award on October 23, 1973, in recognition of his 20th patent. We hope it turns silver when he gains five more patents.

Contact him at:  
**RCA Laboratories**  
**Princeton, N.J.**  
**TACNET: 226-2453**

# Technical excellence programs support engineers' viability

*Technical excellence programs, pioneered by RCA's Government Systems Division, are expanding in scope and becoming an integral part of the corporation's technical activities.*

---

**Abstract:** *To remain viable throughout his career, the engineer must commit to continual updating. RCA has developed the Technical Excellence Committee (TEC) as an aid in these efforts. The first TEC started over 15 years ago, and TECs are now expanding in both numbers and charter. The current TEC model is described and the status of activities throughout the Corporation reviewed.*

---

Over the last few decades, the electronics state-of-the-art has moved at a tremendously fast rate. Many technologies have been obsoleted before they even had a chance to fully mature. While this rapid movement provides much stimulation and excitement to the engineer, it also presents a challenge to acquire capabilities in new technologies.

Recently, this challenge has greatly escalated. Foreign technology has, in many areas, caught up with the U.S., and in some cases, surpassed it. At the same time, consumer and other customer expectations have been raised substantially, in part due to the effects of rapid cost increases (inflation) and not in small part by the high quality demonstrated by foreign products.

The extent of Japanese superiority in industrial competitiveness has been underpublicized in the U.S. Ezra Vogel points out in detail the solid underpinnings of Japanese technological competition, such as education, continuing thrust for

knowledge, attitude and commitment of its growing technical workforce.<sup>1</sup> As a result, competition has escalated in the areas of product innovation, performance, quality and cost effectiveness.

To compete successfully today requires that the engineer perform effectively in bringing forth an innovative product exhibiting high performance, impeccable quality and high full-life-cycle reliability — and all this at reasonably low costs!

Sounds tough, and it is!

To accomplish this, the engineer needs to:

- Keep his engineering tools sharp to maintain the capability to use what was acquired in engineering school, and to add to that, the new techniques and tools that have emerged since.
- Keep on top of what's going on in his field (worldwide) so as to always be a contributor in the current job assignment.
- Keep up with the peripheral fields so that when the time comes to move into a new technology, this can be done effectively and contributions occur within a reasonable time span. While in the past an engineer could specialize in a certain field and spend his entire career working in that specialty, today obsolescence is forcing changes in technology on a growing percentage of the engineering population.

What can a large company such as RCA, whose technical staff is widely distributed by size, type of engineering, technology and geographical location, do to help its technical professionals stay viable and



competitive? What kinds of programs can operate effectively over such a wide range of conditions? The RCA Technical Excellence Program has been designed to serve this purpose.

## The Technical Excellence Program concept

The overall program is designed to promote and enhance technical competence and is called the Technical Excellence Program. It is a grass-roots program carried out by local Technical Excellence Committees.

No one program or approach exists which assures engineers continuing viability. A challenging job assignment is very important — nothing else keeps him quite as highly motivated and forces him to apply the most effective methods, tools and technologies. However, not all engineers can always be assigned highly challenging tasks. Viability can be supported by many means and an important characteristic of the high performing engineer over his lower performing colleague is believed to be participation in more activities, communicating with more people inside and outside of his activity, reading substantially more, preparing more papers, presentations and patents, making more use of available facilities and services, etc.<sup>2</sup>

The needs of engineers vary somewhat from location to location, depending on the type of work, facilities and services available, peer population and management, etc. It is, therefore, necessary that

---

Reprint RE-26-1-3

Final manuscript received March 19, 1980.

technical excellence activities be tailored to the specific needs of the involved location.

These considerations led to a search for a versatile model for enhancing technical viability. The model chosen represents a shift in responsibility from management to the working level engineer for the development and implementation of plans to enhance technical viability. Organizational behavior research indicates that professional people seek job enrichment and, under proper conditions, take responsibility for managing their fate. Significant accomplishments in the last five years of operation indicate that the model can be effective.

This then is the concept used:

A Technical Excellence Committee (TEC) is made up of a group of working level engineers representing the major engineering activities of their location. Its responsibility includes the development and execution of a variety of programs aimed at enhancing technical excellence. In order to facilitate its work and minimize any overlaps of its efforts with management's prerogatives and responsibilities, the TEC is assigned four broad charter areas:

- Technical Education
- Technical Information
- Professional Activities
- Recognition

Typically, the TEC has between six and twelve members, depending on local organization and size of the engineering community. The members are engineers who are respected by their peers, can represent their activities and have an active interest in participating. They usually serve from one to three years.

Two others are appointed to the TEC. One is a management liaison person whose main task is to act as the linking pin between the TEC and engineering management. He will obtain management support for the various projects and advise the committee as to their charter boundaries. The other is an Industrial Relations (IR) liaison person who can help the TEC members learn how to operate effectively and advise them on IR matters. These two persons are *non-voting* members.

The committee schedules regular meetings, starting on a weekly basis until some programs are underway and then settling into a monthly schedule. The first job is to determine which of the many possible activities has the highest priority for the location. Tables I to IV show some of the typical activities fitting into the TEC charter.

**Table I. TECHNICAL EDUCATION—To provide formal and informal sources of learning of engineering subjects.**

Continuing Engineering Education (CEE) planning of course offerings	Hands-on computer lab
Recommendations for future courses	Technology lectures — regular/irregular
Develop course resource list (internal and external)	Noontime movies/video tapes
Study need for courses and reasons for taking/not taking	Replay of Princeton colloquia
Mini courses — by local instructors	Workshops/brainstorming
	Technical symposia

**Table II. TECHNICAL INFORMATION—To provide knowledge of and access to the sources of pertinent available information.**

Library committee	Technical reference file
Library orientation	Engineering skill register
Computerized reference search	TEC newsletter
Plan for better accessibility of technical literature	Business highlights — circulate to keep updated
Scientific bookmobile visit	Crosstalks — interdepartmental communications and reviews
Engineering forum: a social event with engineering lecture	

**Table III. PROFESSIONAL ACTIVITIES—To encourage activities supportive of engineering professionalism.**

Membership in professional societies	Encourage publication
Participation in activities of professional societies	Encourage patent disclosures
Holding office in professional societies	Encourage technical presentations
Course for PE license	Support of high school science programs
Obtain PE license	Computer clubs, users groups

**Table IV. RECOGNITION—To support and provide recognition of demonstrated technical excellence.**

Technical excellence awards (quarterly, annually, etc.)	Recognition in TEC newsletter
Author recognition (papers, presentations, patents)	Recognition in family news
David Sarnoff awards	Recognition in local papers
Nominations for professional society awards	Recognition for teaching and holding office in professional societies
Nominations for IEEE Fellow	Recognition for educational accomplishments (CEE certificates, degrees, PE license, etc.)

Now let us turn from the concept and review briefly what has been done in the past.

### Historical development

The technical excellence concept is not new. RCA efforts in this area have existed for many years and provide a strong base for today's model.

The David Sarnoff Research Center (DSRC), as the Corporation's center of research and innovation, has been promoting technical excellence in many

ways very actively since its formation in the early 1940s.

In the product divisions, the first technical excellence activity was in the form of the Chief Engineers Technical Excellence Committee (CETEC) at Missile and Surface Radar in Moorestown, New Jersey. In July, 1964, engineering was reorganized in an effort to assist engineers in excelling in their work. CETEC was formed as part of this and today, after 16 years, is alive and well and centers its activities to a large extent on a technical excellence award system.

In the fall of 1965, a technical excellence program was established at what is today's Automated Systems in Burlington, Massachusetts. A technical excellence award program was initiated and a chief engineer's newsletter was issued. Both are still active today.

A technical excellence award system at Government Communications Systems in Camden, N.J., was introduced in 1970 and is still operating. In 1971 Astro-Electronics, in Princeton, N.J., established a TEC which also remains active. Thus, by 1971, all four major Government Systems Division activities had ongoing TECs.

## Current activity

The current TEC model was developed by the Engineering Professional Programs unit of Corporate Engineering in 1976. What is different from past TE efforts is the type of organization previously described—it provides a broader charter and a shift of more of the program identification and planning to the working engineer level. In 1977 a corporate-wide engineering information survey was conducted which explored the engineer's technical information—use habits and needs. The results of this survey reinforced

the need for TEC activities and provided supportive input towards the formation of additional TECs.

Today, there are 14 active Technical Excellence Committees in 13 RCA plant locations and they cover about 70 percent of RCA's engineering force. Table V shows a tabulation of each committee's location and division, current chairman, number of members, management and IR liaison representatives, and year of formation.

In addition to these TECs, several locations are in the formative stages, and it is expected that most RCA engineers will have the opportunity to participate in and

**Table V. This table shows present vital statistics of the TEC network and provides contacts information to the key people. The author acts as corporate coordinator of the network (222-4251).**

<i>RCA-TEC Statistics</i>						
<i>Active TECs</i>	<i>DIV</i>	<i>Chairman and phone TACNET</i>	<i>No. of committee members</i>	<i>Year started</i>	<i>Management Liaison and phone TACNET</i>	<i>IR Liaison and phone TACNET</i>
Bloomington	CE	Mike Cherbak 423-5357	6	1976	Phil McCabe 423-2488	Jim Chrena 423-5294
Burlington	AS	Paul Seeley 326-3095	9	1965	Paul Seeley 326-3095	—
Camden	GCS	John Breen 222-2569	9	1970	John Breen 222-2569	—
Findlay	SSD	Ron Scheckelhoff 425-1465	12	1980	Ray Reutter 425-1370	Tim Jackson 425-1404
Indianapolis	CE	Ken Barr 422-5272	7	1978	Jim Carnes 422-6559	Ed Mackins 422-5160
Indianapolis	REC	Dave Devarajan 424-6109		1979	Dave Devarajan 424-6109	—
Lancaster	SSD	Mike DeVito 227-3638	6	1976	Price Smith 227-2324	Jeff Trullinger 227-2087
Lancaster	PTD	Andy Bowalick 227-3101	9	1976	Jim Miller 227-2412	Jeff Trullinger 227-2087
Marion	PTD	Pat Lehman 427-5445	13	1979	Dennis Headington 427-5663	Milton Shearer 427-5468
Moorestown	MSR	Ralph Rippey 224-2043	14	1964	George Field 224-3306	—
Mountaintop	SSD	Ed Poggi <sup>1</sup> 327-1-395	8	1977	Ed Czeck 327-1-461	Arnie Mrozinski 327-1-385
		Bob Longenberger <sup>2</sup> 327-1-626	9	1977	Fred Lokuta 327-1-384	Arnie Mrozinski 327-1-385
Princeton	AE	Mike Silverman 229-2156	8	1971	Tony Aukstikalnis 229-2262	—
Princeton	LABS	George Haas <sup>3</sup> 226-2491	7	1950	Bob Duncan 226-3355	—
		Joe Blanc <sup>4</sup> 226-2346	2		Bob Duncan 226-3355	—
		Wendy Chu <sup>5</sup> 226-2608	10		Wendy Chu 226-2608	—
Scranton	PTD	Al Tadder 329-1-476	15	1978	Jack Nubani 329-1-499	Paula Killiany 329-1-428

<sup>1</sup> Engineer Committee      <sup>3</sup> Colloquium Committee      <sup>5</sup> Library Committee  
<sup>2</sup> Technician Committee      <sup>4</sup> Seminar Committee

profit from the TE activities in the not too distant future.

TECs vary widely by age, operating manner and type of activity. It is important that each activity be of a grass-roots nature—where the specific needs of the location are identified and addressed.

There has been a large amount of experience gathered and it is important that this is distributed among the active locations. Corporate Engineering provides a coordinative, encouraging and assistive role in recommending to management at locations not covered how such an activity could be initiated to their benefit, and then assisting with start-up and early operation. Active TECs are supported with a Corporate newsletter which informs of the TEC activities and encourages use of those that have proven to be effective.

An annual workshop where the TEC chairmen meet, interact, exchange experiences and develop new programs was initiated in 1979. The model of this corporate-wide interaction is illustrated in Fig. 1.

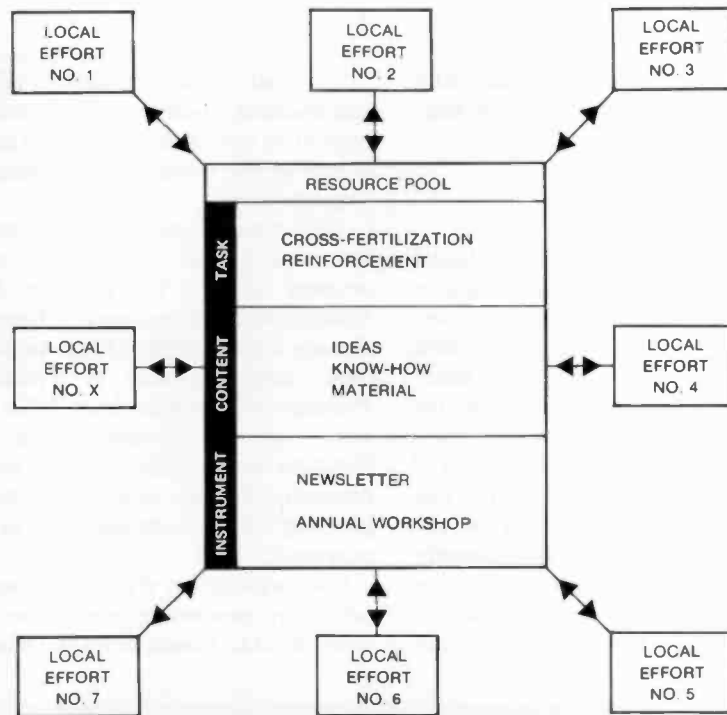

Fig. 1. Corporate Engineering stimulates TEC start-ups, supports ongoing efforts and coordinates the TEC network for effective cross-fertilization.

## TEC members speak out:

### Mike Cherbak, CE, Bloomington:

"The largest challenge of the TE Program is to create awareness, both among engineers and engineering managers, that a development in the form of continuing education and professional involvement is a *requirement* in the progressive electronics industry. Meeting this challenge is a sort of paradox; individuals cannot participate in development without first realizing what development is available. Similarly, individuals cannot realize what development is available (or necessary) without first participating in development programs. It must be someone's charge to intercept this loop and force a realization of our needs. The "someone" is the location TEC and management. The realization of our needs and the individual development will not only improve personal viability in the engineering profession, but also assist RCA in utilizing the state-of-the-art in improving both our product and productivity."

### John Breen, GCS, Camden:

"The TE Program is a superb vehicle for peer and management recognition, and motivation for personal achievement."

### John Bingley, AE, Princeton:

"A very important function of our TEC is to provide a means to help the technical staff keep current in their

fields and related fields by providing after hours education courses and colloquia on current technical topics. Also, we strive to provide recognition for our engineers for outstanding achievement in the form of Technical Excellence Awards."

### Andy Bowalick, PT, Lancaster:

"The TE Program allows me the opportunity to work with several of my fellow associates in shaping the technical environment during and outside of the immediate working day. I enjoy trying to create ways and means of communicating technical awareness in areas within RCA but not necessarily related only to color picture tubes, and outside of RCA that have a direct impact on our daily lives. Several successful techniques have been employed, such as evening dinner forums, afternoon lectures, cafeteria displays and mini-seminars."

### Ken Barr, CE, Indianapolis:

"Indianapolis Consumer Electronics TEC is approximately two years old. In that time a successful education program and lecture series program has been established. The lecture series has been of great value and the lectures are well attended. The most progress has been achieved in establishing complete and rapid communication of current and coming events through the use of the TEC Newsletter."

## Examples of TEC activities

Nothing conveys the value of the TECs better than a sampling of some of their activities.

### Education

TECs participate in determining technical education needs at their location and in planning and organizing available courses. TECs have worked with Corporate Engineering and their local training function in identifying the strong need for computer related (hardware and software) updating and training. A large portion of the new CEE videotape courses cover this field and include, in addition to the theoretical aspects, hands-on laboratory courses which allow the student to practice design and programming. The need and popularity of these courses are

demonstrated by record enrollments, now running at about 2,000 students/year!

The most recently established TECs at manufacturing locations will play a similar supportive role in the planning of courses to support the manufacturing engineering population.

TECs are also assisting in the arranging with universities for *in-plant degree oriented courses*. For example, MSR-Moorestown has arranged a Computer Science Masters Degree Program with the New Jersey Institute of Technology. Presently 80 students from MSR (and some from AE, Princeton and GCS, Camden) are enrolled in this in-plant program. Several other locations are planning or have started such in-plant programs.

Local experts are distributing their expertise by conducting *minicourses*. For example, G.L. Fassett of PTD, Lancaster,

has conducted an Air Gauging Seminar. For maximum effectiveness, he has limited attendance to ten people. This course was presented twice in 1978 and four times in 1979. Other minicourses were conducted at several locations.

### Information

The *technical lecture series* represents a popular TEC event at quite a few locations. The speakers are usually invited from other RCA or outside groups and cover subjects of interest to the host location. Frequency of these lectures is usually one per month. The meetings held at the DSRC in Princeton are called colloquia and are available on videotape. Other TECs rerun those of interest to their locations.

When TECs explore the needs of the engineers, the topic of orientation about

#### Mike DeVito, EO&D, Lancaster:

"Our most valuable accomplishments are:

- Monthly technical *lectures* are presented in cooperation with the Picture Tube Committee. Their main purpose is to provide a mechanism for cross-pollination of technical and non-technical ideas among the technical community. Subjects have ranged from the Switch Tube to the Status of the American Economy.
- The committee periodically *surveys* the technical community to determine what is needed in the area of courses. As a result of these surveys and effort on the part of the committee, changes have been made to the CEE Curriculum. The Vacuum Technology Course was introduced in Lancaster as a result of the committee's effort.
- Once a month a TV *tape of a colloquium* given at the RCA Laboratories in Princeton is presented to our technical community. This gives our people a direct link to the latest technical ideas being presented at Princeton.
- A *newsletter* is used to distribute information or surveys to the technical community."

#### Ralph Rippey, MSR, Moorestown:

"During the sixteen years of existence of the TE Program at Moorestown, the program has been involved in many activities. When consideration is given to all of the activities, the one value that has to stand out is the award given for individual excellence. In an atmosphere where the phrases "a piece of junk" or they don't make them like they did years ago" are so common place, it gives a great sense of pride to feel that there are still areas where

excellence is highly regarded and achieved as part of a normal work environment.

"The awards are an indication, that in the critical eye of his or her peers, an individual has been professionally rigorous and dedicated in seeking a solution to a problem. The awards are not given frivolously, but awards are given regularly which indicates that in the engineering community, excellence can be and is achieved as part of a daily routine. It is this recognition of individual excellence that has been and must continue to be the heart of our Technical Excellence Program."

#### Ed Poggi and Bob Longenberger, SSD, Mountaintop:

"The most valued aspects of our TEC are:

- The committee gets involved in area interest, such as:
  - courses
  - library
  - films
  - small seminars
  - excellence awards.
- Coordination among all of the various groups and the TEC in Mountaintop helps to bring about those programs which are most useful to these groups. This communication link, we feel, has been one of the key functions of the TEC.
- Awards: We had our first opportunity to see an awards presentation this past week. We feel that the recipients were really proud to have received these awards.
- It provides good experience in dealing with other people at your location which are ordinarily not encountered on the job."



what's going on in adjoining activities usually figures high on the priority list. *Crosstalks* are implemented where one activity orients those in other activities. PTD, Lancaster, sends speakers to the outlying plants such as Scranton and Marion to orient the engineers there about what's going on back at the home base. In this case, several technologies have been reviewed in addition to activities.

Some of the crosstalks include *trips* of the activities described. A most successful example of this kind was a bus tour of Marion PTD engineers to the CE Bloomington plant. Not only did this provide the first opportunity for many engineers to see where their product went and how it was used, but probably even more valuable, was the ensuing discussion between CE and PTD engineers which provided the stimulus to many new action items. An indication of success — an even

larger group of Marion engineers plan to visit Bloomington.

### *Professional activities*

Social contacts tend to establish an increased degree of trust which improves communication and working relationship. The *engineering forum* (as developed by the PTD-TEC and now finding increasing use) brings together technical personnel and their spouses for a social hour followed by a dinner with an invited speaker. For example, various members of CE (customer) top management have been speakers at PTD forums.

TECs also plan and encourage increased interaction with the *technical professional societies*. Some of the strongest stimuli to an engineer's career come through contacts with peers in his field. The professional

societies enable this interaction and those who participate in the planning and organization of their societies' activities profit the most in enhancing their reputation, learning and gaining information.

### *Recognition*

One of the TEC's best known activities are the local *technical excellence awards* provided to those individuals who have contributed an outstanding achievement. Despite the substantial effort required in the selection process, this activity has been carried on successfully for over fifteen years and represents one of the major methods of engineer recognition.

To demonstrate management's support of engineers' publishing, many locations conduct annual *author recognition* receptions, for management and engineers who have published, presented papers, taught courses, held offices in professional societies, etc.

There are many other vehicles available for recognition ranging from the engineer's unit to his professional field and community. Despite the many opportunities, there is usually more recognition deserved than awarded leaving many opportunities to be yet explored.

### Sources of support

Closely associated with the technical excellence activities are the following resources available to the engineer:

- A *library network* — with about 28 libraries — large and small, throughout the Corporation, some with computerized reference search capability.
- RCA technical publications issued to support the engineers informational needs and provide him an arena for recognition.

*RCA Review* — a technical journal issued quarterly.

*RCA Engineer* — a journal for and by the engineer issued bimonthly.

*Trend* — a technical news digest issued monthly.

*Technical Abstracts Bulletin* — abstracting all RCA authored papers, reports and patents issued monthly.

*Topical Reprints* — covering papers by RCA engineers.

#### **Dave Devarajan, Records, Indianapolis:**

"I consider that the recognition achievement awards, publicity, etc., is the most valuable element of the TE Program, which presents a forum for recognition of the productive engineer by his peers.

"The Record Division got started with the TE Program only recently and the last several months have not been opportune for much of TE activities. Recognizing the outstanding contributions of engineers and contributing towards an *RCA Engineer* issue on Records are probably the most significant achievements of the past years."

#### **Pat Lehman, PTD, Marion:**

- "The program fulfills the needs of the technical personnel, therefore, fulfilling the needs of the company.
- It allows the technical personnel to express their concerns and to make contributions and changes.
- It rewards them for their contributions and allows them the opportunity for future contributions through courses, lectures, films, and field trips."

#### **Al Tadder, PTD, Scranton**

"The establishment of a library for general plant use has been the single most notable accomplishment of the TEC at the Scranton plant. Although still in a state of infancy, several publications have been added.

"At the present time there are about 300 volumes and a few periodicals in approximately 180 square feet of floor space. It is hoped that more frequent use in the future will provide the justification needed to acquire further publications."

- **Internal Reports** — Company wide  
*TR*—technical reports that usually cover results of a program.  
*EM*—engineering memoranda covering technical information of limited significance and non-technical information.
- **Contract Reports** — covering work done by RCA under contract (government and non-government).
- **Standards/Specifications/Handbooks**— these cover both corporate and divisional materials.
- **Videotapes** — Corporate Engineering Education makes available tapes covering DSRC colloquia, corporate technology symposia and many other topics.
- **Technology Symposia** — organized as needed on technologies of interest to several business units.
- **Educational Courses** — Continuing Engineering Education videotape courses (about 80) as cited in the annual Corporate Engineering Education guide.

Impressive as this list is, the most valuable and valued resource available to the engineer is the outstanding talent of RCA's engineering and management staff—always ready and willing to lend their support.

## Outlook

TECs have been active in some RCA locations for over 15 years and have become integrated into the operating life of their locations. Thus, they represent a part of their regular business operations—not just another razzle-dazzle, here-today/gone-tomorrow gimmick.

The newer TECs, generally operating under somewhat broader charters, are exhibiting a high degree of motivation and innovation. It can be expected that many of their program features will also become integral parts of their businesses and that other locations will consider and adopt their most successful features where applicable.

Finally, there remain a number of locations without TECs, and efforts will continue to explore their needs and assist them in establishing pertinent technical excellence programs.

The next few years should provide increased coverage of technical excellence activities, both by location as well as program content. Looking at what TECs are potentially capable of doing, one would have to say "we've barely scratched the surface!"

## And what does TEC mean to you, the engineer?

Today's engineer, be he in research, product development or manufacturing, finds himself in an environment of increasing complexity and must continually cope with new technologies and facilities. He is less aware, maybe, of the impact on his future by the thousands of intelligent, highly motivated and hardworking engineers in foreign countries intent on scooping him technically and winning his markets.

RCA's technical excellence program represents an opportunity to the engineer in his quest to stay competitive. It is a grass-roots program tailored to his needs, planned and run by him. Its effectiveness is entirely dependent on a pro-active approach—the approach indicative of the true professional.

If you have specific thoughts or recommendations on this topic, contact your local TEC or the author.

## References

1. Vogel, Ezra. *Japan as No. 1, Lessons for America*. Howard Univ. Press (1979).
2. Jenny, H.K., Underwood, W.J., "Engineering Information Survey results, Part 2. High vs. low achievers—how are they different?" *RCA Engineer*. Vol. 23, No. 4 (Dec. 77/Jan. 78).

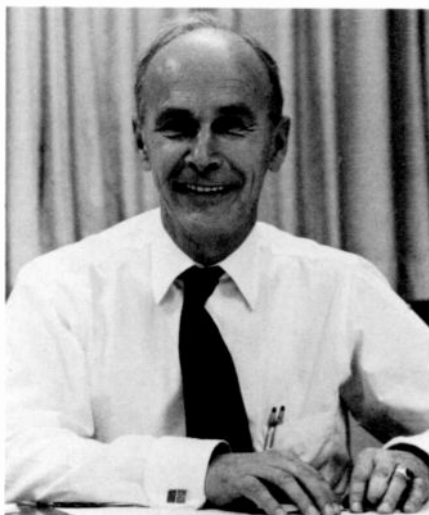

**Hans Jenny** has experience as a design engineer, engineering leader and manager, and Chief Engineer and Operations Manager of RCA's solid-state microwave product line. In his present position as Manager, Engineering Information, he uses this background to assist RCA engineers in their and the Corporation's efforts to remain viable and competitive.

Contact him at:  
**Engineering Information  
Corporate Engineering  
Cherry Hill, N.J.  
TACNET 222-4251**

E. Lemke

*Intermediate engineering development, after basic research but before product design and development, is the*

## Focal Point For The Eighties

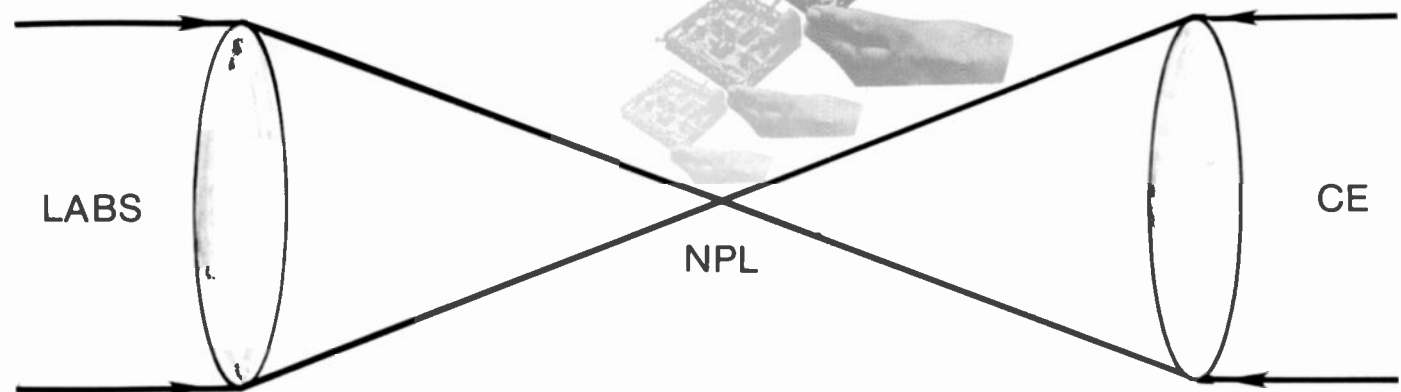

**Abstract:** Today, RCA's Indianapolis-based New Products Laboratory, though only two years old, is making positive improvements on Consumer Electronics Division products by blending the advanced development work at Princeton Research Labs with the practical expertise of the product Design and Development group.

Over 25 years ago, color television was a major new consumer product. Since that time, engineering work on television technology has undergone many perceptible changes.

First, as this major innovation was reaching the marketplace, technical problems and needs for solutions dominated engineers' attentions. Color programming and public interest increased, so work to improve the value, performance and reliability of the product continued.

In the 1960s, engineers began con-

Reprint RE-26-1-4  
Final manuscript received May 12, 1980.

versions to solid state circuitry. It was almost a decade before this transition was complete. During this time television was the dominant video consumer product. Many considered it a mature business which would be sustained by routine improvements in performance and cost reduction.

Then, in the early 1970s, two major forces started changing slowly this perception of video display products as a mature technology. By virtue of these forces, consumer television receivers were recognized as only beginning to evolve in sophistication and expandability. One external force was the growth of worldwide commercial aggressiveness, resulting in strong technical dedication that opened vistas for continuing improvement in the design and development of television and other consumer electronic products. All competitors in the marketplace reacted. Secondly, dramatic advances in materials, semiconductors and other technologies in electronic-related businesses provided the opportunity for synergistic developments in color television.

At RCA a renaissance occurred, as the 70s progressed, meeting these challenges through re-emphasis on innovative approaches to product design, manufacturing and testing. These early efforts have born fruit. Good design and productivity has kept the basic selling price for comparable television receivers fairly constant in the last 15 years; moreover, dramatic improvements have been achieved in the field of performance and reliability. Clearly, continuous technical effort is required for economic viability.

Early on, an assessment of the 80s showed that perhaps the greatest growth of consumer electronic products was yet to come; many of these products involved video information systems that have been RCA's strength in the past.

With the future of consumer electronics now certain, the next step was to establish an organization that could respond effectively to the need for advanced work. This applied not only to engineering but to those areas that engineering would affect such as manufacturing technology, reliability and testing. Up until 1978, the

Indianapolis-based Consumer Electronics Division (CED) Engineering was responsible for near-term development with occasional bursts of advanced work in specific areas. The research activity at David Sarnoff Research Center in Princeton had assumed a greater involvement in responding to CED's needs and was responsible for developmental work with applications in the far future.

As the products became more complex and varied, and as opportunities for new consumer products needed to be explored, company executives decided that an engineering activity dealing specifically with intermediate development could beneficially structure timely programs sandwiched between the Princeton Research Labs activities and CED Product Design and Development activities. This activity was appropriately located in Indianapolis to take advantage of the practical guidance that only the Product Design groups can give because they have close-in experience with the mass-produced products and awareness of their performance. This new group was relatively insulated from the day-to-day tasks of product engineering and, therefore, better able to interact with engineers conducting ongoing research development at the Princeton Labs. This activity bridged the gap between research and close-in product development. New products and improvements could be planned, developed and optimized farther ahead, in an environment stimulated by contemporary product awareness that also incorporated the research technology from the Princeton Labs.

Today, this intermediate advanced development group, the New Products Laboratory (NPL), is two years old. Yet this young organization, nearly fully staffed, has already made positive improvements on CED products. Two to three years ahead of production, the NPL addresses projects involving the traditional television receivers, advanced tuning systems, video products and other potential new consumer electronics products. Equally important, groups develop technology for incorporation in CED products, including both linear and digital integrated circuits, with applications, and other material innovations. The NPL engineers also strive to improve the productivity and accuracy of the design development engineering functions by applying computer methods to the analysis and automation of electrical and mechanical design and testing functions. A major success of the organiza-

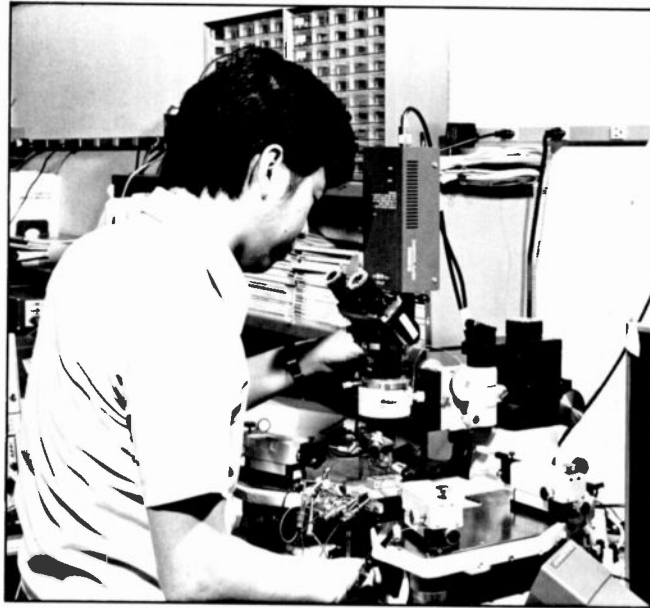

An engineer in the Technology Applications Group of the New Products Laboratory is evaluating an integrated circuit on a probe station.

tion, the frequency synthesis tuning system, originally developed in the Princeton Labs, then worked on by the NPL, is currently in its second year of production (the photograph in our lead illustration shows the frequency synthesis tuning system module being checked). One major task of an advanced development group is to manage engineering personnel so that they clearly recognize problems and new approaches, and know their implications. NPL is being used as a focal point for engineers from either Princeton Labs research departments or Product Design groups so that this proper blend of experience and innovation is maintained. In some cases, Product Design group personnel join NPL to carry out advanced development work, then use their acquired skills on the project into production. This provides additional project continuity.

The new E-line chassis concepts and circuit developments are excellent examples. In this case, Product Design engineers were transferred to the New Products Laboratory and these engineers were subsequently responsible for the product design which is currently in the initial production phase. This family of new chassis is another plateau for CED. They are cost-effective, high-productivity products made possible by the added resources and time due to NPL.

In conclusion, an advanced development department must undergo continual refreshment of ideas and skills to sustain effective performance. Sufficient independence to maintain the discipline of dedicated advanced development work must be balanced by highly interactive work with the product groups. This decade

will challenge us with many changes in consumer product design development and manufacture. Also, products will evolve from greatly expanded applications and developments of digital/microprocessor devices in sophisticated tuning system controls, multi-functional features and other new video-related products.



Eugene Lemke, Chief Engineer, TV Advanced Development, joined RCA & Consumer Products Division in 1955 as a Specialized Engineering Trainee. He has held various management responsibilities dealing with design and development of television receivers. In 1971, he was the recipient of the David Sarnoff Engineering Achievement Award for the team contributions to the internationally successful thyristor deflection system.

Contact him at:  
**RCA Consumer Electronics Division**  
**Indianapolis, Ind.**  
**TACNET: 422-5890**

# The Technology Transfer Laboratory — the vital link for picture tubes

*TTL translates picture tube product-line needs into supportive research programs and research results into practical hardware, thus assuring the PTD a continuing flow of highly competitive new products.*

## Introduction

In the Fall of 1978, RCA Laboratories and the Picture Tube Division jointly announced the formation of the Technology Transfer Laboratory (TTL). Located in Lancaster and under the management of RCA Laboratories, this organization is responsible for "coordinating with The Picture Tube Division advanced developments required in electron guns, aperture masks, yoke technology and manufacturing technology to assure a continuing flow of technological innovations into the Picture Tube Division." During 1979, the TTL was extremely successful in developing its staff, which at present numbers a total of 46 people, close to its intended size.

The formation of the TTL fundamentally represented an increase in engineering for PTD. The organizational structure was designed to maximize the relief of the stress on PTD's total engineering resources generated by PTD's worldwide marketing effort. Problems existed at both the Labs, which is not most effective when dealing with the immediate operations problems, and at PTD, whose own engineering staff was so occupied by the same operations problems that sufficient effort could not be spent on the exploitation of new technologies under development. The charter of the TTL puts it in a position to relieve both of these deficiencies. Drawing experienced personnel from PTD engineering for some of its staff, TTL can provide a realistic advanced development activity for PTD and allow the Labs to focus on longer term efforts. The TTL output is new projects for PTD and new inputs for the Labs.

Reprint RE-26-1-5  
Final manuscript received June 12, 1980.

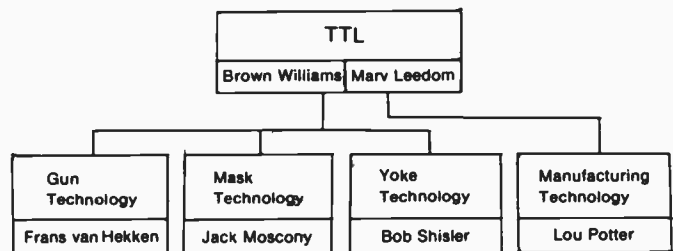

**Fig. 1. The organization of the RCA Laboratories-to-division TTL (Technology Transfer Laboratories), which resides at the Lancaster home location of the RCA Picture Tube Division and its engineering activity.**

The TTL organization is divided into two areas (Fig. 1). The first area contains three groups that are concerned with the product design of picture tubes and yokes. These groups report to B.F. Williams at the Labs. In this area, J.J. Moscony heads the group that is concerned with shadow mask design and processing. R.W. Shisler's group covers development of advanced yoke and yoke tooling. F. Van Hekken heads the group that develops new gun designs from the Labs.

The second area contains one group, headed by L.E. Potter, that is concerned with the manufacturing of picture tubes. This group reports to M.A. Leedom and interfaces with the factories, the Lancaster engineering groups, and the laboratories to transfer new technology from the Labs into PTD.

In the following sections, the specific technical programs of each part of the TTL are reviewed.

B.F. Williams|M.A. Leedom

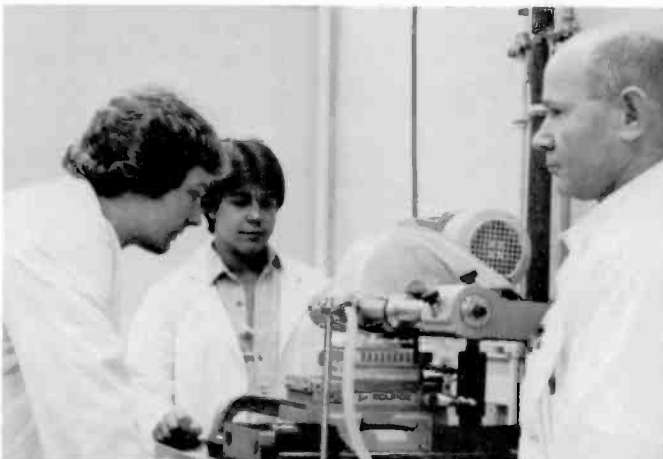
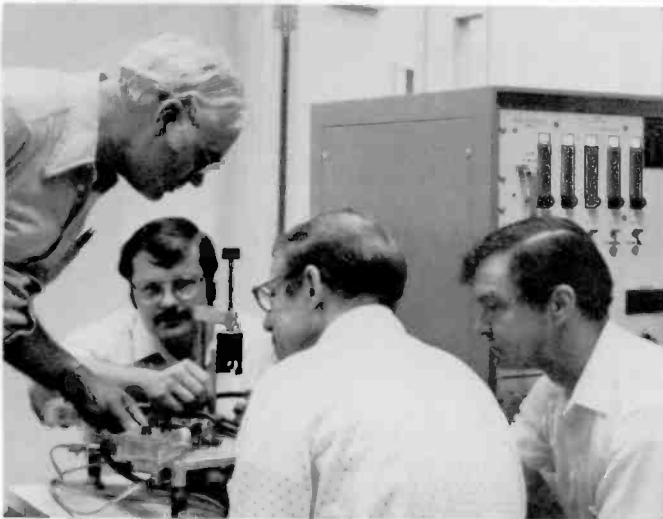

Top: H. McCandless, J. Klufkee, B. Keener and W. Greenwalt reviewing a modification of the TIG welder.

Top: S. Opreško reviewing the data of a sputtering test with S. Farrah.

Bottom: K. Goodman (left) and P. Bransby (middle) at an automatic slicing machine under supervision of Sigmund Villanyi.

Bottom: M. Honegger (left) and C. Brubaker evaluating a new gun.

## Gun technology

The TTL gun group has been given the responsibility for piloting new gun technologies developed at the RCA Labs and which still require extensive product design before transfer into the PTD at Lancaster. By necessity TTL must function in two capacities — these being the actual transfer of technology, followed by a manufacturing scale-up to quantities that are characteristic of a viable product evaluation.

Typically the group functions within the following regime. Ideas conceived either by PTD or RCA Labs that appear to have sufficient merit to warrant investigation are reduced to practice at the Labs to establish plausibility. By joint decision, certain of these ideas are selected for further development. At this point the TTL gun group enacts its charter as coordinator and executor for the needed product innovations of PTD and the efforts of RCA Labs.

To do this effectively requires a knowledge of the constraints that accompany a production scale operation, as well as a high degree of technical expertise, in this case in electron gun design, tube operation and mount manufacture. Depending upon the type of improvement being made, technologies ranging from brazing through sputtering and semiconductor processing may be required. Consequently, the TTL gun group comprises various technical skills which can be used to implement the type of change in mounts.

Consider now the electron gun which consists of a beam-forming region followed by the main lens region. The main function of the gun is to generate an electron beam of controlled diameter and intensity which is used to activate the phosphors on the picture tube face. Because of economic restraints in a changing industry, miniaturization of the gun is desirable. This creates technical problems which include high voltage instability (guns operate in the 20- to 30-kV regime), paraxial

aberration in the main lens (this degrades the spot size), nonuniform cutoff control in the beam forming region (this directly affects receiver cost), temperature instability (performance related) and material selection which affects both mount cost and performance.

Sometimes the problems are independent, while at other times they are directly interactive. In either case changes must be made which affect both performance and cost/reliability tradeoffs. Because of the persistence of some of these problems they are attacked in the following manner. Assume that a solution to a problem in the main lens has been found at the Labs. PTD wants to incorporate it in a new gun design; however, the full potential of this change cannot be appreciated until a matching improvement has been incorporated in the beam forming region. The TTL gun group will take full responsibility to exploit these changes. This includes the following operations: finished mounts are constructed to determine which production

techniques are most practical, the parts are redesigned for ease of manufacture, mounts are produced which contain each of the changes separately, as well as in conjunction with each other. Finally, sufficient quantities of the new mounts are tested to establish reliability and performance characteristics. At this point a joint decision between PTD and TTL is made to determine if the project is product feasible or should be returned to the Labs for further consideration. During all of this, information continues to be monitored by TTL to ensure progress.

Once these changes have been successfully integrated into a mount, manufacturing specifications are drafted by TTL. The second function of TTL now begins, that of transferring the product and its technology to PTD engineering. Because of prior consultation with PTD, this second function can be accomplished with relative ease.

Initially a scale-up operation is carried out where production workers perform those tasks previously done by TTL technicians. This pilot run is done under the combined supervision of PTD and TTL, until such time that the entire process is transferred to PTD. With the transfer complete, the TTL gun group continues to function as an information source for PTD and team effort is maintained which serves to improve the successful change of ideas into dollars profit or product acceptance.

F. Van Hekken

## Mask technology

Three essential internal components of color television picture tubes are the electron gun assembly, the phosphor screen, and the shadow mask. Two types of shadow-mask color picture tube systems are illustrated in Fig. 2. Three electron guns with either triangular or in-line configurations emit electron beams which are scanned across a metal shadow mask. Portions of the beam pass through circular holes (Fig. 2a) or elongated slits (Fig. 2b) in the metal mask and impinge on a phosphor screen containing round dots or vertical lines. The phosphor screen is composed of three different types of phosphor, which under electron excitation emit light in the primary colors, red, blue and green. In ideal operation, the electron beam from each gun lands only on the parts of the screen associated with that particular gun. For example, the beam from the green gun excites only the light emitted by the green phosphor. With respect to that beam, all other parts of the phosphor screen are in the shadow of the mask.

In recent years the design and production of color picture tubes have increasing-

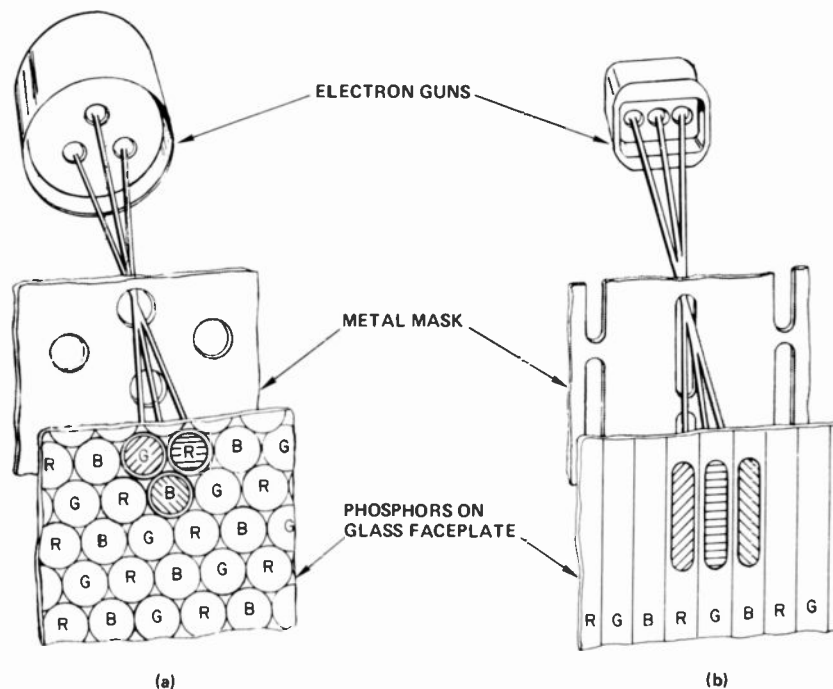

Fig. 2. Two types of shadow-mask color picture tube systems. Three electron guns with either triangular (a), or in-line (b), configurations emit electron beams, which pass through circular holes (a), or elongated slits (b), in a metal mask and impinge on a phosphor screen containing round dots or vertical lines.

ly favored in-line guns employing slit-type masks. As a consequence, RCA manufacturing processes have been developed to meet the requirements of producing the higher technology slit-type masks.

Although it might not appear so initially, the processes required to manufacture masks are quite involved, encompassing countless aspects of photographic, chemical, metallurgical, mechanical and computer engineering skills. The entire mask business is intensely materials and process oriented, thus providing many opportunities for both short- and long-term cost, quality and design improvements. Annually, RCA uses numerous and large quantities of materials in making masks. Some examples include: millions of pounds of high-quality steel, thousands of photographic plates, thousands of pounds of photosensitized resist, tank-car quantities of chlorine gas and thousands of gallons of ferric chloride to name just a few. In addition, many types of equipments have been developed to monitor the physical, geometrical and optical properties of masks while they are being processed and in the finished form. Further, RCA has developed advanced concepts of computer control of the etching process. These observations serve to highlight the broad spectrum of activities associated with shadow mask manufacturing.

Figure 3 shows a cutaway view of an etched mask looking from the screen side. Note the slit width, tie bar and repeat features. It is generally acknowledged that

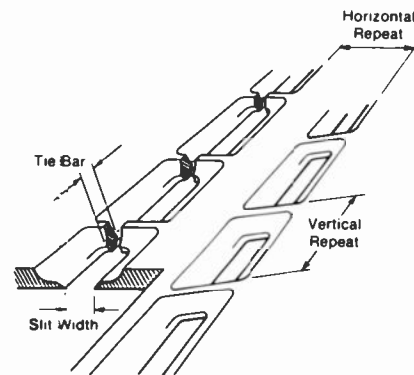

Fig. 3. Schematic cutaway of a slit-type mask.

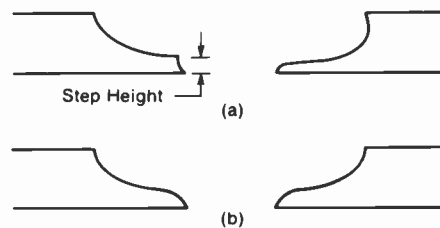

Fig. 4. Masks produced by vertical etching (a) are inferior to those produced using horizontal etching (b). In vertical slits, the solution is trapped in the resist overhang, which gives an undesirable step height, resulting in distorted slits.

RCA gained control of the step height along the length of the slit (Fig. 4), when the conversion was made completely to horizontal etching in 1979. However, there

is still a need to optimize the tie bar geometry with regard to improved beam angle transmission, reduced sensitivity to misregister of the gun and screen slide slits and improved forming properties.

As mentioned previously, there are a number of critical materials whose effectiveness can still be improved. Among these materials are steel, resist and photographic working plates.

Although much progress has been made recently, quality steel remains a material of considerable concern. There is a growing conviction that the "rim steel" of the past no longer can meet the demands of the mask industry. Inclusions, laminations and segregation, which are characteristics of rim steel, account for many scrap masks in higher inspection costs. Another feature of steel which requires constant attention is thickness control. If the thickness varies over a short distance, e.g., thirty feet, by as little as  $\pm 0.1$  mil, difficulty will be experienced in controlling mask transmission. It is anticipated that some of the newer types of aluminum killed and/or interstitial free steels will result in a marked improvement in material defects and that improved gauge control will be realized at the rolling mills.

Photographic plates used in the mask printing operation are an ever-present potential source of mask defects. Imperfections are easily brought about in the gelatin/silver halide emulsion by embedments and scratches. These blemishes can be transferred to the mask, often resulting in obvious visual defects. Frequently, these defects cannot be repaired or if they are repaired, they sometimes return to cause a problem in the tube-making process. The solution to this difficult situation is to significantly reduce or eliminate defects entirely, through some modification to the present photographic plates or by inventing an entirely new printing process. This problem is a formidable challenge for the Mask Technology Transfer Laboratory.

Photoresists by their nature are light sensitive and must be protected from pre-exposure. An RCA-developed resist formula contains casein, sensitized with ammonium dichromate. While this resist has a number of important advantages over the previously used fish-glue resist, it also has the disadvantage of tendency to dark-harden. This means that even in the absence of light, a polymerization reaction occurs in the resist which is time-dependent. Because of unavoidable and uneven delays in the RCA mask manufacturing process, parts being processed are subjected to different hold-times and consequently different degrees of dark hardening. This has an adverse effect on transmission control of the mask. Thus, a solution to the dark-hardening problem would offer greater manufacturing flexibility and

reduce costs by eliminating scrap. The solution may be found in a different sensitizing agent or, perhaps, in a new resist formula based, for example, on polyvinyl alcohol.

In order to further enhance the effectiveness of the TTL mask group, a decision has been made to provide a pilot etch machine capability. There are numerous profitable avenues to explore which have a direct bearing on reducing costs and improving quality. Also, new materials, new mask and artwork concepts and etch factor studies can be pursued without being a burden to the already committed manufacturing lines. But, perhaps the most worthwhile feature of the pilot etch line is the capability of exploring new horizons in process computer control. This presents the estimable goal of making all masks meet the bogie design.

Many advances have been made in shadow-mask manufacturing technology since RCA first introduced the shadow-mask color picture tube 30 years ago. The TTL mask group will help to ensure that RCA remains in the front rank of producers in this highly competitive technology.

J.J. Moscony

## Yoke technology

The TTL yoke group's objective is to take concepts from the RCA Laboratories, prove them and choose the best one that matches PTD's current objectives for the European market. Because of the integral relationship between the TTL and the RCA Labs, information and services are rendered in an efficient and routine fashion. In this context it will be the TTL's responsibility to design and construct necessary engineering tooling, equipment and yoke parts to prove feasibility of the

selected concept to meet production specifications. The TTL will work closely with the PTD in developing a compatible tube, gun and yoke system. Finally, the TTL will help in the initial stages of manufacturing by assisting in the designs of the production equipment and the final yoke production design and processes.

Currently the most promising deflection yoke for the next generation of European product is the pincushionless saddle/toroidal yoke.

In developing a deflection yoke which has a magnetic field eliminating raster distortion without a transformer in the circuit, the vertical magnetic field of the deflection yoke must be widely varied along the cathode ray tube (CRT) axis and the electron beams must be converged. To do so, the TTL is currently investigating two methods using the basic saddle/toroidal yoke technology.

The most favored approach at this time is to wind the vertical coil on the core in a biased or nonradial fashion (Fig. 5). This method has been successfully achieved by the Japanese on 90° and 100° deflection yokes. The TTL has hand wound a 110° yoke yielding optimistic results. An attempt is now underway to machine wind this type yoke for further tests. The key ingredient in this system evolves around a new machine design, which is detailed further on in this article. Another approach to this problem is to shape the yoke field with magnetic pieces. This may be accomplished as the minute changes in the final design of the above yoke configuration or as large pole pieces in a standard radial wind. All of the above are currently receiving the TTL's most concentrated efforts and, at this time, have an excellent chance of becoming the next generation deflection yoke for the European market.

While outstanding yoke designs are imminent, only through an extensive machine design program can the design become a

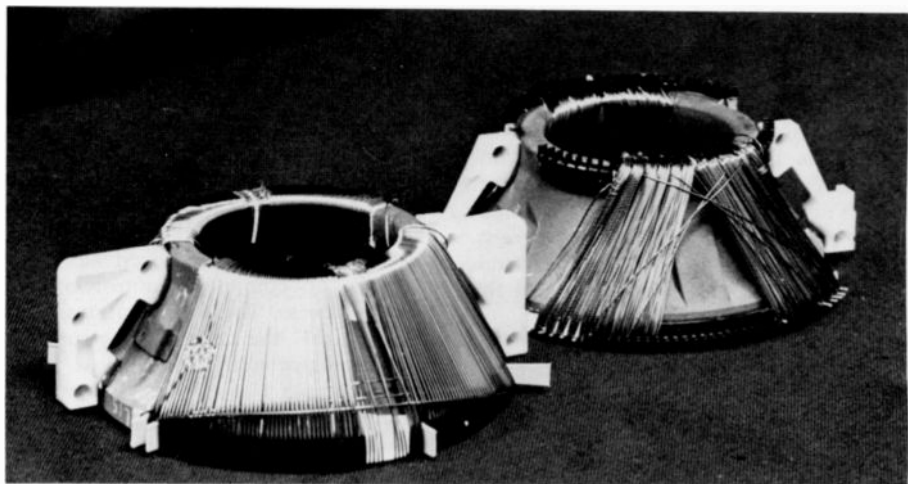
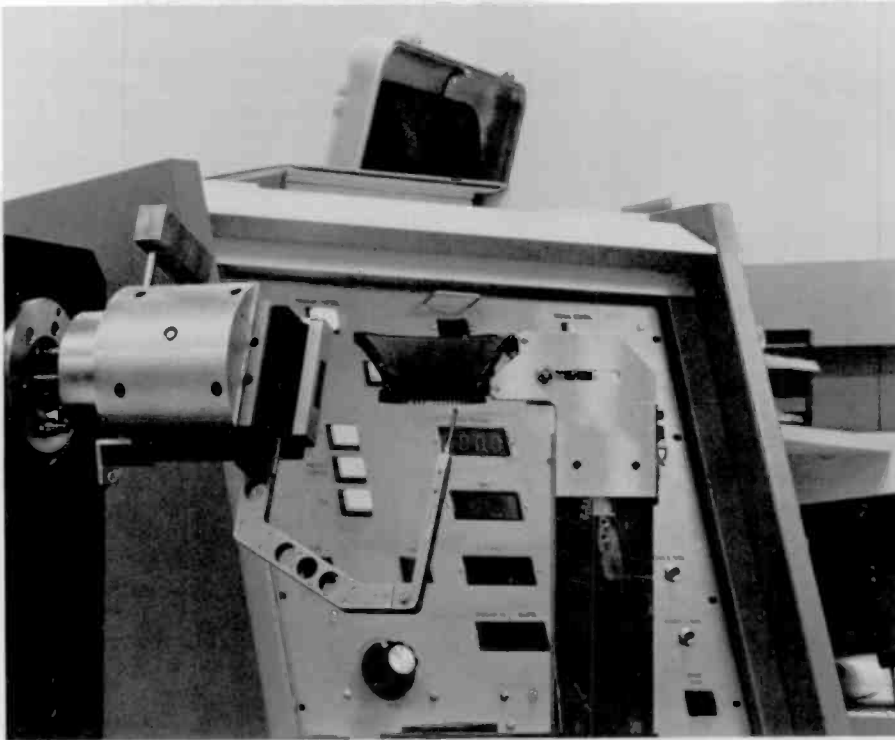

Fig. 5. Standard S-4 radial wind (left), and biased or non-radial wind (right).





Multipath segment winder.

successful manufactured product. As the TTL is setting the pace in new yoke designs it must also design machines to produce, hence our concentrated efforts in equipment support. The following projects are examples of, and show the need for integration of yoke design, equipment design and testing which is incorporated in the TTL yoke group.

*Multipath segment winder*

To be capable of winding the new non-radial coil configuration a micro-processor-controlled, multi-axis winder is under development. The machine consists of three systems: flyer, traverse and control.

1. The flyer system is made up of: flyer and

wire-feed mechanism, motor and control packages and position sensor.

The flyer control package is based on a position-sensing servo amplifier with a resolution of 200 steps/turn. This is driven by a programmable variable-frequency oscillator. This control package enables the flyer to run at constant speed with the capability to start, stop, change speed or direction instantly on command and when halted to hold its position without creeping.

The position sensor consists of four optical sensors watching holes in adjustable discs geared to the flyer. Each is independently adjustable as a machine set-up parameter. The wire-feed mechanism employs an elliptical-path generating system adjustable as a machine set-up parameter. The mechanism includes apparatus for kink and bias generation but these are not currently employed.

2. The traverse system includes: core-holding means, motor and controller. The traverse is a ten steps per degree positioning system. It has a homing feature to determine exactly the starting point for each program. It exercises positioning commands at a rate of 100,000 steps/second which works out to an effective velocity of 1667 rpm (not corrected for ramps). It holds positions without creep until the next command.
3. The control system includes an industrial programmable controller (extended instruction set), a control panel



TTL Yoke group members discussing design: J. Howard, Designer (left); G. Crossshore, Designer (middle); G. Simmons, mechanical engineer—MTS.



R. Kramer, Member, Technical Staff (MTS), and T. Burke, Senior Engineering Technician, investigating new magnetizing techniques.



Technicians M. Grote and K. Sturlangson measuring yoke performance on TTL-designed test stand.

and peripheral equipment. This system uses a "language" based on relay contacts and relay coils which requires some learning by prospective programmers. The CRT loader/monitor, the magnetic tape cassette unit and the hardcopy terminal make up a "development system" typical of the current state of the microprocessing art. The extended

instruction set provides full micro-computer capability with double-precision arithmetic and logic operations and with jump, subroutine and return commands.

### Concept

The flyer runs steadily. Flyer angular position sensors trigger traverse actions to position the core segment to receive the wire. Some sort of wire anchors projecting out from the core surface are anticipated. Up to four inflections in the wire path per turn are available. This system is inherently capable of high-speed operation, making it a reasonable prototype for production machinery. Except for slave motor controllers, there are no logic functions external to the machine controller, making it programmable.

Software is being developed to enable winding in the machine by a process of editing and testing, turn by turn. The resulting software program can then control the machine to wind automatically at high speed.



Controls for the multipath segment winder showing the IPC300 microprocessor.

### Stationary saddle winder

Future saddle-coil development may require the investigation and possible inclusion of some or all of the following:

- Pin windings
- Magnetic ramming
- More complex winding motions
- More complex wire tensioning systems
- Automatic winding cycles.

The rotating winding arbor requires an increasingly busy rotating joint to communicate the various electrical circuits to power the required functions. The cooling air and the pressing blades plus the increasing mass make it more difficult to accelerate it to running speed, balance it against excessive vibration and brake it to a stop. The stationary arbor addresses these problems by eliminating the rotating joints and thereby increasing the winding arbor's potential by the addition of supplemental functions.

R.W. Shisler

## Manufacturing technology

Manufacturing technology is a multidisciplinary field. Picture tubes are very complex products and consequently require a complex technology. In its present state, picture tube manufacturing technology requires skills in glass, mechanics, chemistry, physics, metallurgy, electronics, computer science, automation and others. Research in each of these areas is active at RCA Laboratories (DSRC) to advance the state of the art in picture tube manufacturing and keep PTD in a competitive position in the world market. Optimum coupling of research and manufacturing must be accomplished if maximum benefit is to be obtained from research. Knowing the needs of the division and accurately communicating the information to the Labs and, conversely, understanding the technology developed at the Labs and conveying it to PTD for implementation, are two of the roles of TTL.

TTL has effected technology transfer of several test and measurement systems, process sensors and software development for process monitoring.

### Metal forming

Recent developments in gun design require greater precision in gun parts and assembly. Gun parts (grids, cathodes, etc.)

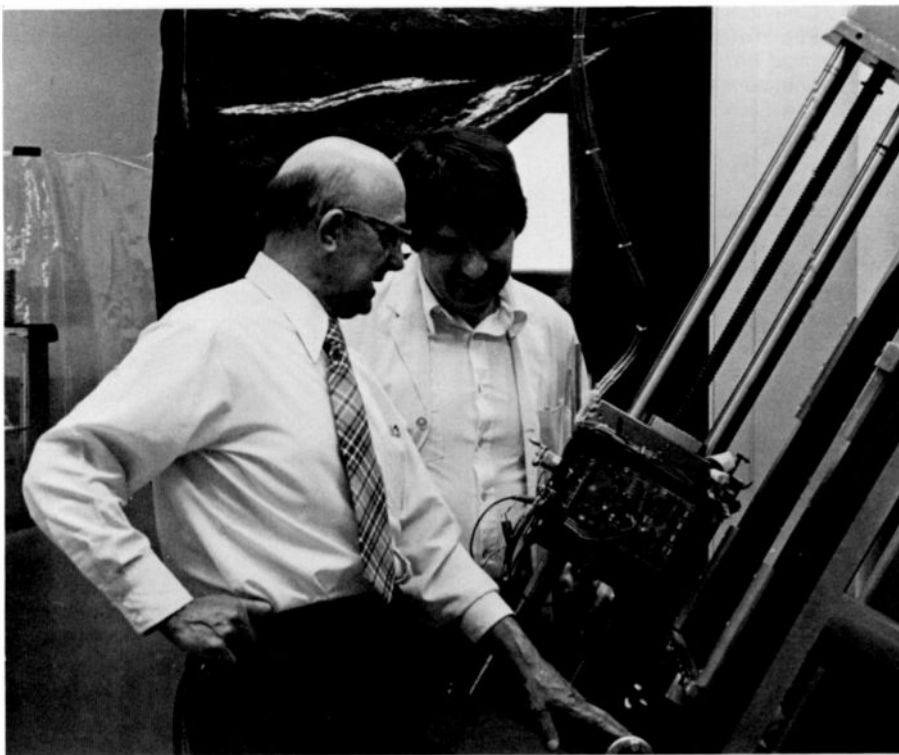

Working plate scanner, initiated in DSRL, refined in TTL Lancaster and built by PTD equipment development in Lancaster.

are formed from strip material in precision dies. These parts are assembled on a precision fixture and bonded together with glass beads. Close tolerance on spacing of grids and alignment of aperture holes is paramount to obtain consistent performance of finished guns. This is more easily accomplished if the parts are precisely made.

Many factors contribute to making precision parts. Process variables such as metal thickness, hardness and ductility in addition to lubrication and die conditions influence the forming process. A cooperative effort among the Lancaster Parts Works (LPW), TTL manufacturing technology group and RCA Labs is directed at monitoring each process variable to determine specific effects on part variations. LPW has made a die using nitrogen cylinders to allow control of clamping pressure. TTL manufacturing technology has developed a thickness gauge to continually monitor strip thickness. RCA Labs is researching die features that contribute to more consistent and accurate part making. TTL manufacturing technology is coordinating this effort to assure that all effort from research to implementation is directed toward a common goal of making precision parts.

#### *Test and measurement systems*

Process control areas such as mask etch and phosphor screening required rapid precision measurements to evaluate the

effectivity of the process or to control the process. RCA Labs has developed three high-speed measuring devices based on a solid state line scanning camera applicable to these areas. The Slit Width Reader is used to evaluate the openings in a shadow mask. This evaluation is used to control exposure time for the photographic process used to place phosphor screens in color picture tubes. The Working Plate Scanner is used to scan the working plates (photo masters) used in the mask etch process to find and mark irregularities that cause faults in finished masks. The Matrix Line Width Reader measures the phosphor line openings and the relation between the openings for red, blue and green phosphors. Each of these devices can resolve 0.0001-inch variations in their respective measurements at speeds required by the process.

The TTL manufacturing technology lab tested the three devices extensively to assure reliable performance when used in a factory test. In areas where reliability is questionable, design changes are made. TTL manufacturing technology continues to give technical support to the device during the in-plant evaluation.

#### *Sensor development*

Automation, be it mechanical manipulation, test or process control, requires a sensing device to indicate the effectivity of the event. Some areas in picture tube manufacturing are restricted in the degree

of automation because the required sensors are not available. Much research at DSRC is addressed to finding sensors that would support automatic finished tube inspection without subjective evaluations. Sensors have been developed for measuring convergence, picture geometrics, and purity. Application of these sensors is being extended by TTL manufacturing technology to detect, position and quantitate blemishes on an operating picture tube in final tests. It is also believed that with this technology, more detailed evaluation can be made of other picture tube parameters.

#### *Process monitoring*

Because work was done at the DSRC Manufacturing Systems and Technologies Research Lab (on computerized Process Control), TTL was able to adapt software to an existing need at PTD in its screening operation. One of the major steps in color picture tube manufacturing is the screening of the three primary color phosphors (green, blue and red) to the front panel. This task is accomplished by an elaborate multi-stage machine using complex photographic processes for each color application. A system is being developed to monitor all of the process variables and thereby give the basis for a complete understanding of the screening process. This system will be computer-based with software designed to accommodate machine indexing.

The major features of the software system are the capturing of selected process parameters in real-time for later analysis and to give on-line readouts of alarm conditions. Additional features are being added to provide for data-logging within each color area of screening and the automatic assignment of alarm limits.

The final inspector will enter test results in real-time via a terminal. This will be used to provide analysis of process variables as they relate to inspection data.

L.E. Potter

## Conclusion

We have outlined some representative efforts underway at TTL. We look to this new organization as an effective two-way link between the Labs and PTD to provide the smoothest and fastest path for the introduction of new technology and products into the Picture Tube Division.

Although TTL is still in its infancy, all signs bode well that it will represent a vital link in assuming the Picture Tubes Division's continuing worldwide business success.

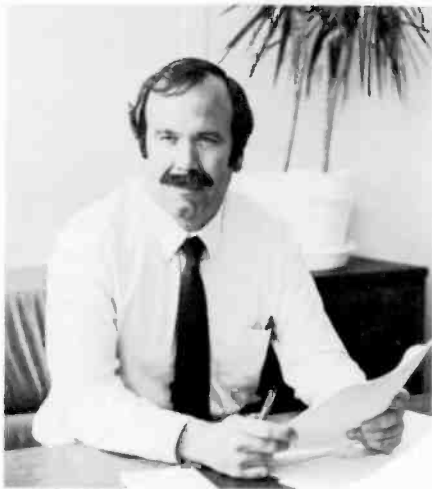

**Brown Williams** is Director, Display and Energy Systems Research Laboratory at RCA Laboratories. Upon joining RCA in 1966, Dr. Williams worked in the area of photodetectors and low-light-level sensing and imaging with emphasis on photoemission, secondary emission, and cold-cathode emission. Several devices developed either by him or under his direction are now parts of active systems. In 1968, he was appointed Leader, Electron Emission Research, and in 1970, became Manager of the Electro-Optics Laboratory. In 1972, Dr. Williams was appointed Program Director for the development of RCA's charge-coupled device imager. In 1973, after returning from a six-month leave in France, he became Group Head, Quantum Electronics Research. In early 1975, Dr. Williams also assumed responsibility for RCA's solar energy studies and became Group Head, Optical Materials and Devices Research.

Contact him at:  
**RCA Laboratories**  
**Princeton, N.J.**  
**TACNET: 226-2535**



**Marv Leedom**, Director, Manufacturing Systems and Technology Laboratory at RCA Laboratories, has spent most of his effort on the VideoDisc program since joining RCA in 1962, in the area of stylus and player design and disc manufacturing. In 1975, he was named Manager of Mechanical

and Instrumentation Technology and in 1978, appointed Director, Electromechanical Research Laboratory and in 1980, appointed Director, Manufacturing Systems and Technology Laboratory.

Contact him at:  
**RCA Laboratories**  
**Princeton, N.J.**  
**TACNET: 226-3064**



**Frans Van Hekken** is manager of the Electron Gun group of the TTL. He joined the Advanced Development group of the Tube Design Laboratory at Lancaster as a Design Engineer in 1952. He was involved in practically all aspects of color picture tube design and product development. In January 1976, he participated in the organization of a new Mount Development department and, in November 1979, he was appointed to his present position.

Contact him at:  
**Technology Transfer Laboratory**  
**Dept. 510**  
**Lancaster, Pa.**  
**TACNET: 227-3206**



**Jack Moscony** is currently Leader Technical Staff, Mask Process and Materials Development Engineering and Acting Manager, Mask Technology Transfer Laboratory. He joined RCA in 1957 and has been active in the areas of materials and process development related to thermoelectric and thermionic energy converters. In 1965, he joined the C & P Laboratory in Lancaster where he has worked on materials and process developments for color picture tubes. Jack has helped in the solution of a broad range of problems including cathode

emission, getters, high voltage stability, metallurgy, phosphor synthesis and shadow mask processing.

Contact him at:  
**Technology Transfer Laboratory**  
**Dept. 510**  
**Lancaster, Pa.**  
**TACNET: 227-2235**



**Robert Shisler** has been manager of the TTL Yoke group since 1978. A former member of the technical staff of the RCA Laboratories, he has worked in most areas of deflection yoke development.

Contact him at:  
**Technology Transfer Laboratory**  
**Dept. 510**  
**Lancaster, Pa.**  
**TACNET: 227-2187**



**Lou Potter**, Manager of the Manufacturing Technology group of TTL, joined RCA in 1946. He worked in the Components Parts Department designing IF/RF coils, printed circuits and tuning subassemblies for radio, TV and military radio systems. He joined Light Communications P.M.O. in 1961, managing the design and manufacture of the ANIPRC-25 (MM) and the frequency synthesizer for ANITRC-97. In 1966, he joined the Manufacturing Systems and Technology Group of RCA Corporate Staff where he developed and promoted advanced manufacturing systems for electronics, frozen foods, and floor and wall covering.

Contact him at:  
**Technology Transfer Laboratory**  
**Picture Tube Division**  
**Lancaster, Pa.**  
**TACNET: 227-2208**

# Advancement and management of technology for Government systems

*Achieving and maintaining technological leadership demand an unremitting commitment to people, planning, technology investment, and capital facilities.*

**Abstract:** *This paper highlights the RCA Government Systems Division's approach to managing the development of technology to support the vast diversity of products and programs evolved to meet Government needs. The role of long range technology planning in GSD's overall business development is reviewed; and present and future thrusts in each of the technological areas essential to sustaining the present rapid growth are described for RCA in general and GSD in particular.*

Research and development lie at the heart of RCA's achievements over a widening sweep of activities. From carefully planned R&D come new concepts, new products, improvements to existing systems, and more competitive new business opportunities. In carefully selected technical areas, R&D is being accelerated within the Corporation's divisions and subsidiaries. This work in the operating units is performed against a backdrop of multi-discipline investigation and experimentation, basic and applied, being carried on at the David Sarnoff Research Center in Princeton, N.J. Company-funded R&D is at a record annual rate of nearly \$378 million, up some 12 percent over the previous year.

RCA's Government Systems Division, with the broad responsibility for the development and production of major systems for military and space applications, specializes in translating

laboratory advances, arising from basic research, into practical hardware and software. We apply technological innovation to solve complex problems — problems of national defense, space exploration, and communications.

GSD programs are many and diverse

The broad range of RCA's sciences and technologies support a vast diversity of products and programs (Fig. 1). GSD is a

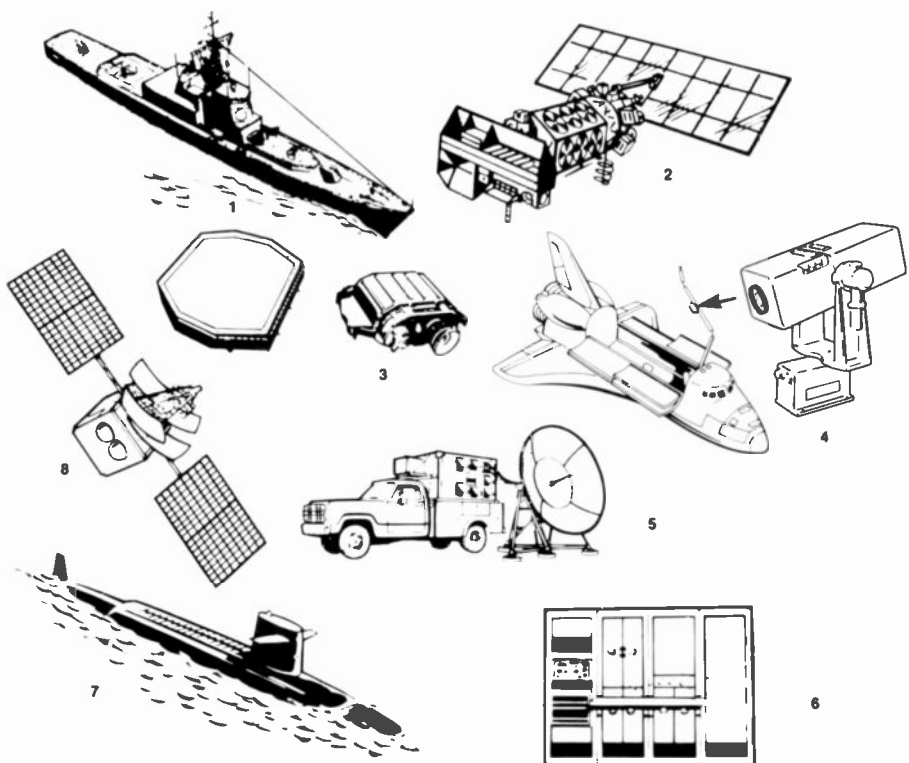

**Fig. 1. RCA Government Systems Division uses its broad technological base in developing a diversity of products and programs: 1. U.S. Navy Aegis Weapon System. 2. U.S. Air Force Defense Meteorological Satellite Program. 3. U.S. Army Laser Rangefinder AN/GVS-5. 4. NASA Closed-Circuit TV for Space Shuttle. 5. U.S. Air Force/U.S. Army Small SHF Satellite Terminals. 6. U.S. Army EQUATE Automated Test Equipment. 7. U.S. Navy Integrated Radio Room for Trident Submarines. 8. RCA Communications Satellite Systems.**

Reprint RE-26-1-6  
Final manuscript received April 2, 1980.

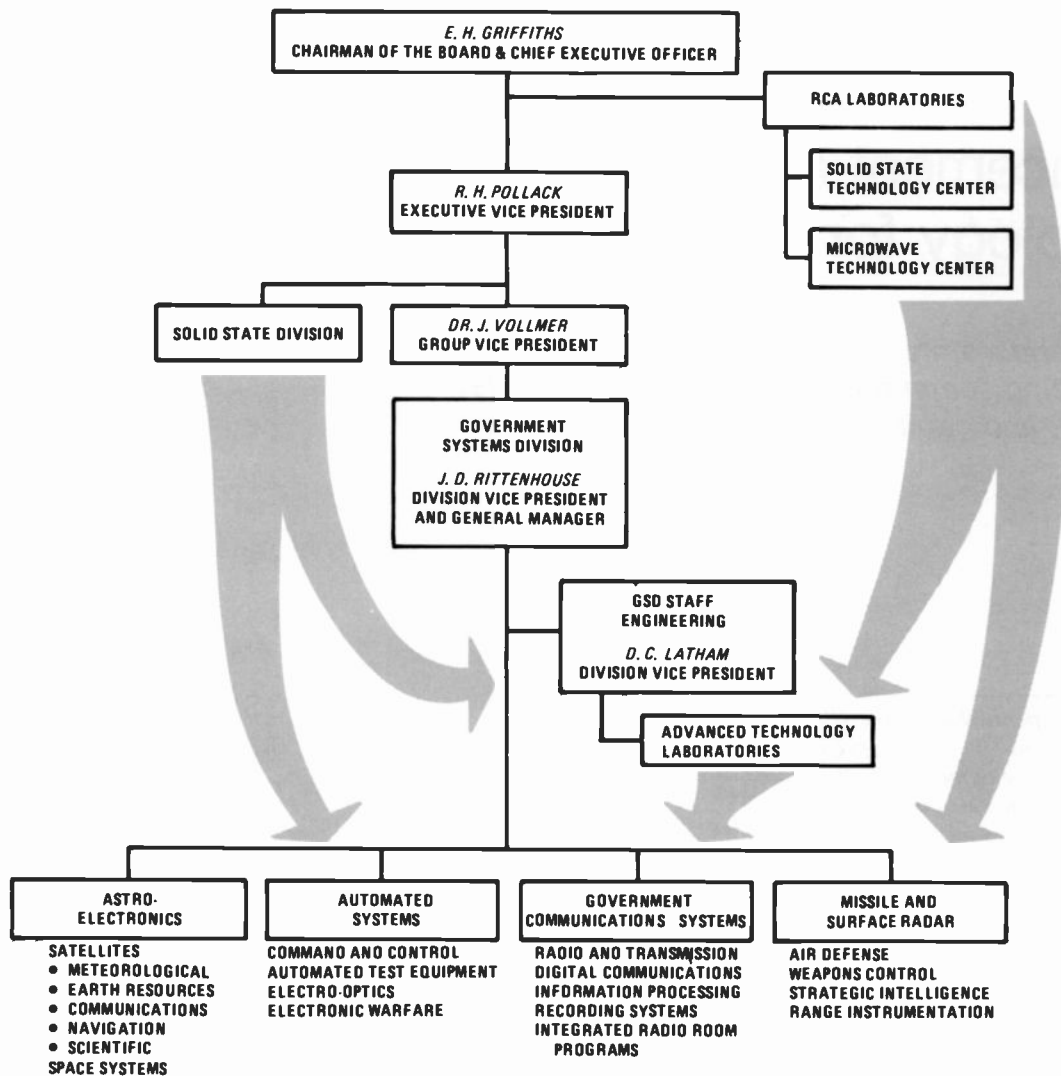

**Fig. 2. Technology development in RCA is corporate-wide.** The GSD business units and staff organization—Advanced Technology Laboratories—work closely with RCA's widespread research laboratories to bring the latest technology benefits to government systems developers.

leader in systems technology. We design, build, deliver, install and service systems from something as small, yet complex, as the AN/GVS-5 hand-held laser rangefinder to the nuclear-hardened, Aegis phased array antennas for the latest U.S. Navy fleet defense cruisers.

We put systems technology on wheels, on ships, on helicopters and airplanes, on missiles and space vehicles.

We operate in space, and in not so much space.

We put up satellites, and we intercept enemy missiles.

We detect vehicles that move, and engine pistons that don't.

We test electronics that fly, and electronics the size of a fly.

We make intelligent terminals, and terminals for intelligence.

We provide systems with large scale

integration, and perform the integration of large scale systems.

We communicate under water, on the water, on land, in the air and in outer space.

We make technology work.

## Technology development is RCA-wide

The generation and development of technology for GSD is pursued in several RCA activities (Fig. 2). In addition to innovative technical efforts in its four business units and the Advanced Technology Laboratories, GSD supports and takes full advantage of the concepts, scientific knowledge, and the availability of advanced devices evolving from the research conducted by the RCA Laboratories, Microwave Technology

Center, Solid State Technology Center and the Solid State Division.

Dedicated RCA Laboratories support programs have been important in ensuring GSD's ability to maintain a technical leadership position. These programs have been formulated in close cooperation with the Laboratories' management and are based upon a mutual understanding of GSD's needs and the Laboratories' capabilities.

## Technology management: the key to success

Technology that is both progressive and innovative is the cornerstone of GSD's continuing growth and profitability. To support the tremendous diversity of products and programs, GSD maintains an

integrated planning and management approach to the development of technology. This approach is presented in the Long Range Technology Plan which examines the technology needs of GSD over the next five years and how they are to be met. The essence of the management challenge is to be sufficiently perceptive on technology evolution and its potential applications in GSD products and systems in order to assure a competitive systems posture two to five years in the future. Further, the management must develop solid technology convictions and be willing to persevere over prolonged periods of time when the "payoff" may be unclear and uncertain. Typically "payoff" may be five to eight years, or longer, in coming.

The Long Range Technology Plan (LRTP) is one element in the GSD's business plans which define our needs as well as Corporate requirements.

### Structure of planning

Planning in GSD is a pervasive and vital factor in effectively competing in the DoD/NASA environment. Since it is a

real-time, on-line effort, planning is dynamic in the rapid technological evolution representative of DoD, NASA and commercial communications satellite environments. For example, solid-state integrated circuits are increasing in complexity roughly by a factor or two each year and we are now able to place tens of thousands of circuit elements on a silicon chip less than the size of your smallest fingernail!

GSD Planning (Fig. 3) has as outputs three principal sets of plans:

- **Long Range Growth Plan (LRGP).** This plan analyzes the 8-Year GSD addressable market and provides the strategic framework for all other planning efforts in GSD. The LRGP permits effective coordination of technology and marketing investments; it enhances the relating of short-term new business opportunities to long-term requirements.
- **Long Range Technology Plan (L RTP).** This plan analyzes our long range technology requirements for successfully addressing the market aperture as defined by our Long Range Growth Plan. The LRTP analyzes the technology re-

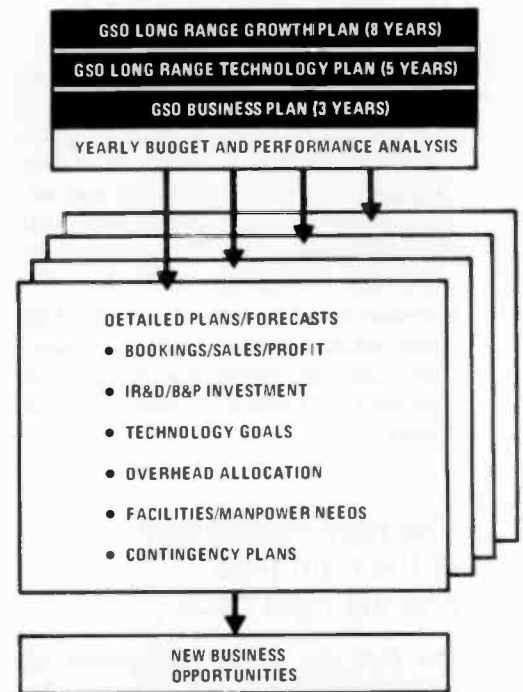

Fig. 3. GSD planning is interrelated to market competition, technology, investment, people, and timing to create unique opportunities.

quirements of the LRGP, and how they are to be met. It features major technology specificity and identifies all

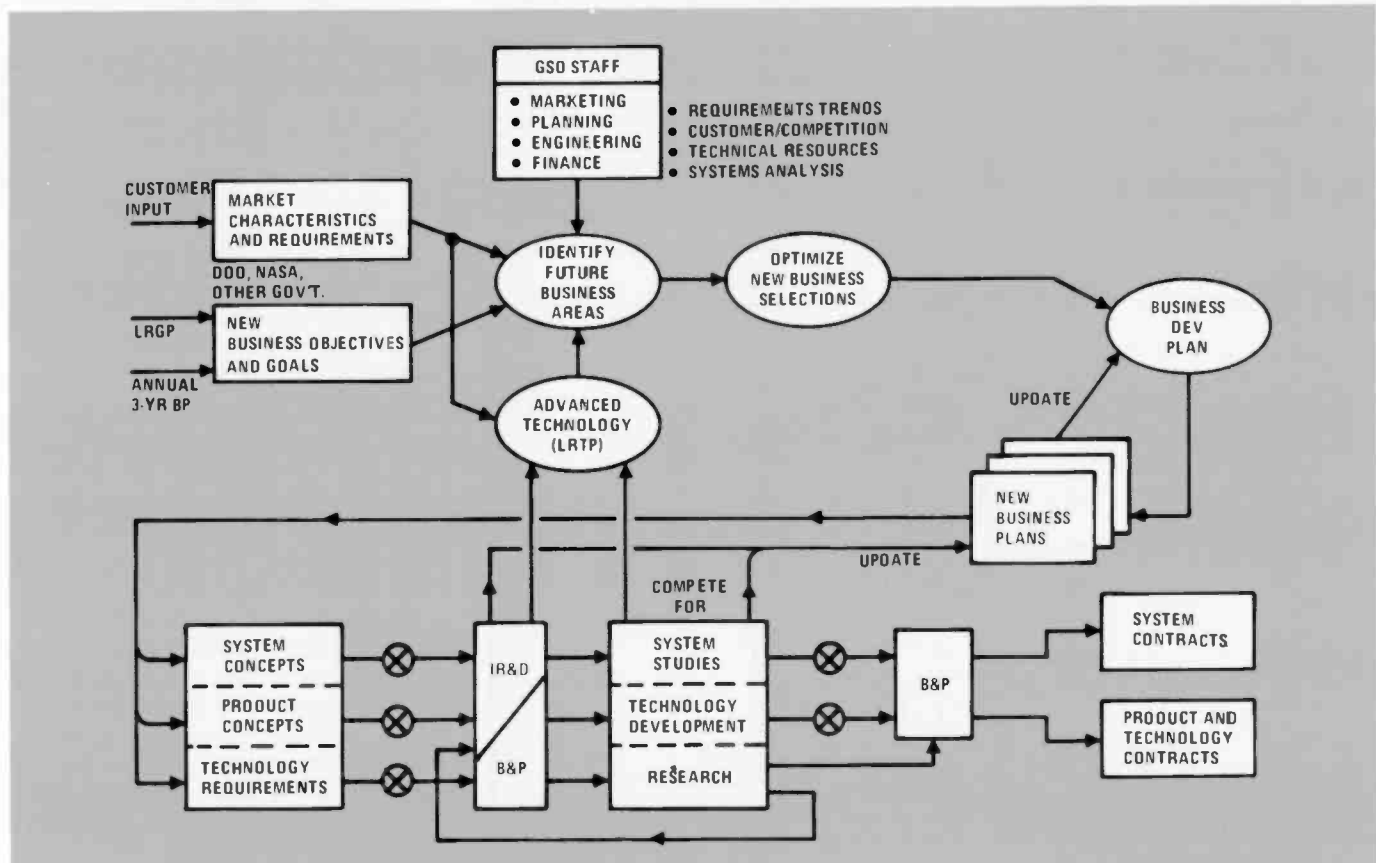

Fig. 4. Integrated planning for GSD Business Development. The Long Range Technology Plan (LRTP) defines and analyzes the advanced technology needs that support the identification of future business areas together with the changing market needs and

the results of IR&D/B&P investigations and R&D contracts. Results of system studies and technique studies plus equipment developments are fed back to keep the LRTP current.

RCA resources required to fulfill the LRGP needs (GSD, RCA Labs, SSTC, MTC, and other RCA divisions). This plan is updated annually to reflect changes in Government needs and advances in technology. The plan is essential for the definition of efforts required for continued technological leadership.

- *Annual 3-Year Business Plan (BP)*. This plan establishes the principal expense, investment and performance budgets and the sales and profit commitment for three years.

## The right technology — at the right time and the right price

The first step in the management of technology demands that we be technological futurists. We must choose prudently and wisely the areas of technological thrust that we will pursue — balancing immediate technical requirements with long-term needs.

Figure 4 illustrates the many factors which influence the planning process and ultimately impact the profit line. The process is dynamic and subject to large uncertainties; and the results will be costly if incorrect judgments are made.

The planning process from the LRTP indicated that a competitive edge in the seven technological areas shown in Fig. 5 is essential to sustaining the growth that GSD has experienced over the past years. Investment in these areas will enable us to

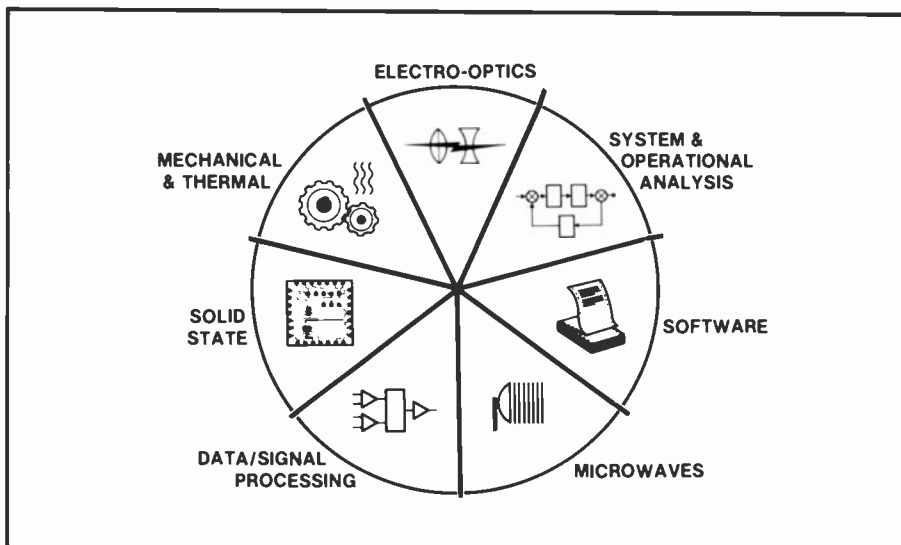

**Fig. 5. GSD technological thrust is in seven areas.** We are pursuing the latest developments in solid-state, microwaves, electro-optics, signal and data processing, software, systems and operations research, and mechanical and thermal technologies to improve and refine the high-technology products we sell to our customers.

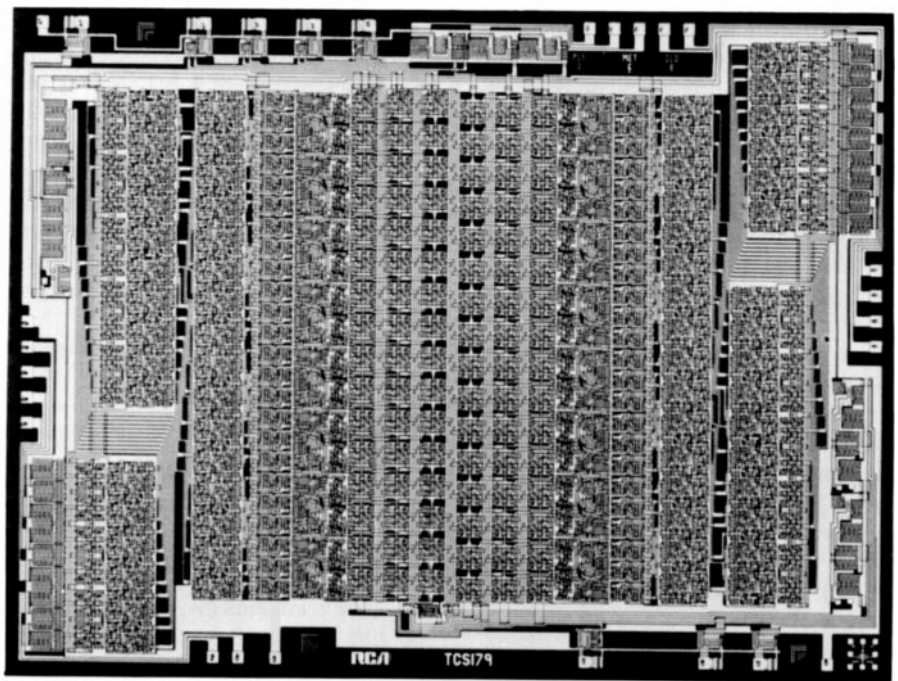

**Fig. 6. High performance CMOS/SOS VLSI chip.** This is one of a family of VLSI circuits being developed for the Advanced Aegis Signal Processor.

offer our customers the right technology at the right time and at the right price.

In the following paragraphs we will summarize GSD's position in each of these technology areas and, where our fortunes are intertwined with other RCA activities, the RCA effort in these areas.

### Solid state devices

Military systems are becoming vastly more complicated, requiring more complex elec-

tronics in order to accomplish their missions. RCA is a leading producer of complex electronic integrated circuits for military systems, and has heavily funded R&D programs (1) to improve our capability in error-free circuit design, (2) to build large chips with good yields, (3) to develop new test methodologies to assure reliability, and (4) to provide programmability to facilitate changes in the field. For example, Fig. 6 illustrates a new CMOS/SOS VLSI circuit, a 32-stage correlator to be incorporated in the Advanced Aegis Signal Processor to perform a binary output summation function. This circuit contains 6150 transistors and operates at 10 MHz at 10 volts.

**CMOS and CMOS/SOS.** We are the industry leader in producing CMOS/SOS low power, very high speed, very dense VLSI arrays, and we have a strong position in bulk CMOS. We produce, within RCA, radiation-hardened bulk CMOS devices which are used extensively in satellites, and we are developing CMOS/SOS components tolerant to much higher dose rates and total dose for the next generation of satellite computers for the Air Force and NASA. Radiation-hardened components will also be used in Communications Security (COMSEC) equipment and elsewhere to meet battlefield survivability.

**GaAs.** RCA is using the evolving gallium-arsenide technology to develop high speed gigabit logic for use in radar and communications systems.



**CCD.** RCA is also a significant producer of CCD components. The CCD process line is used to fabricate custom CCDs for military applications such as channelized receiver systems and radar signal classifiers. A very significant development is the infrared CCD Focal Plane Array sensor based on the Schottky-barrier principle. This technology is being developed (1) to enable identification of tanks and other targets at night and through battlefield smoke and haze, and (2) to guide weapons automatically (see Fig. 7).

### Microwaves

**Phased Arrays.** In microwave systems and devices, GSD is developing advanced phased array antennas for improved target discrimination of multiple, complex targets with reduced susceptibility to enemy jamming. Reduced power, size and cost

will enable derivatives of the Aegis Weapon System to be used on smaller Navy ships. GSD is also developing low cost arrays to add multiple-target capability to instrumentation radars for use on test ranges. And we have developed a low-cost manufacturing technology for the high-volume manufacturing of microwave integrated circuits.

**Reflector Arrays.** GSD uses sophisticated computer programs in the analysis of shaped and multiple-beam reflector antennas for advanced communications satellites. Scale modeling at 30 GHz will simulate lower frequency performance as well as provide the basis for investigating higher frequency applications.

**Electronic Warfare Antennas and Jammers.** For airborne electronic warfare systems in missiles and remotely piloted vehicles (RPVs), we are developing miniature antennas with adaptive sidelobe systems capable of angular measurement

with high accuracy, and we are developing equipment for solid-state power generation.

### Electro-optics

Advanced electro-optics devices and techniques now in development in RCA offer the promise of high-performance systems for Government reconnaissance, surveillance and data- and image-processing systems.

**Line and Area Arrays.** We are developing both visible-spectrum and infrared line and imaging arrays. Our low-altitude, daytime, tactical aerial reconnaissance system called ESSWACS (Fig. 8), developed and successfully flight tested for the Air Force, provides 8000-line resolution across a 140° field of view. Imagery is available within 20 seconds after overflight from a ground laser film recorder. Infrared sensor development now in progress shows great promise of extending ESSWACS to night operation.

**Solid-State Lasers.** RCA is developing solid-state lasers for fiber-optics data link transmitters, film recording and optical-disc digital data recording applications, and advanced military reconnaissance, surveillance systems and target-ranging systems.

**Optical Disc.** Optical disc technology, pioneered at the RCA Laboratories is being vigorously pursued in GSD for digital storage for application to Command, Control and Communications (C<sup>3</sup>) and other information handling systems. GSD has configured a multi-disc recorder/player with 10<sup>13</sup> bit capacity in "juke-box" size (Fig. 9) having 100 discs and providing access to any data in six seconds or one-half second once the disc is in place. Semiconductor laser developments provide the potential for data rates of several hundred million bits per second recording and readout.

**Fiber Optics.** In fiber optics, GSD is beginning to apply the RCA Laboratories-developed fiber optic sources and detectors to Government needs for long transmission links and high-data-rate information transfer.

### Signal and data processing

**Data Processing.** Because of our leadership in VLSI, our advanced LSI computer-aided-design tools and expertise, and strong systems background, GSD is at the forefront of the rapidly evolving field of signal and data process-

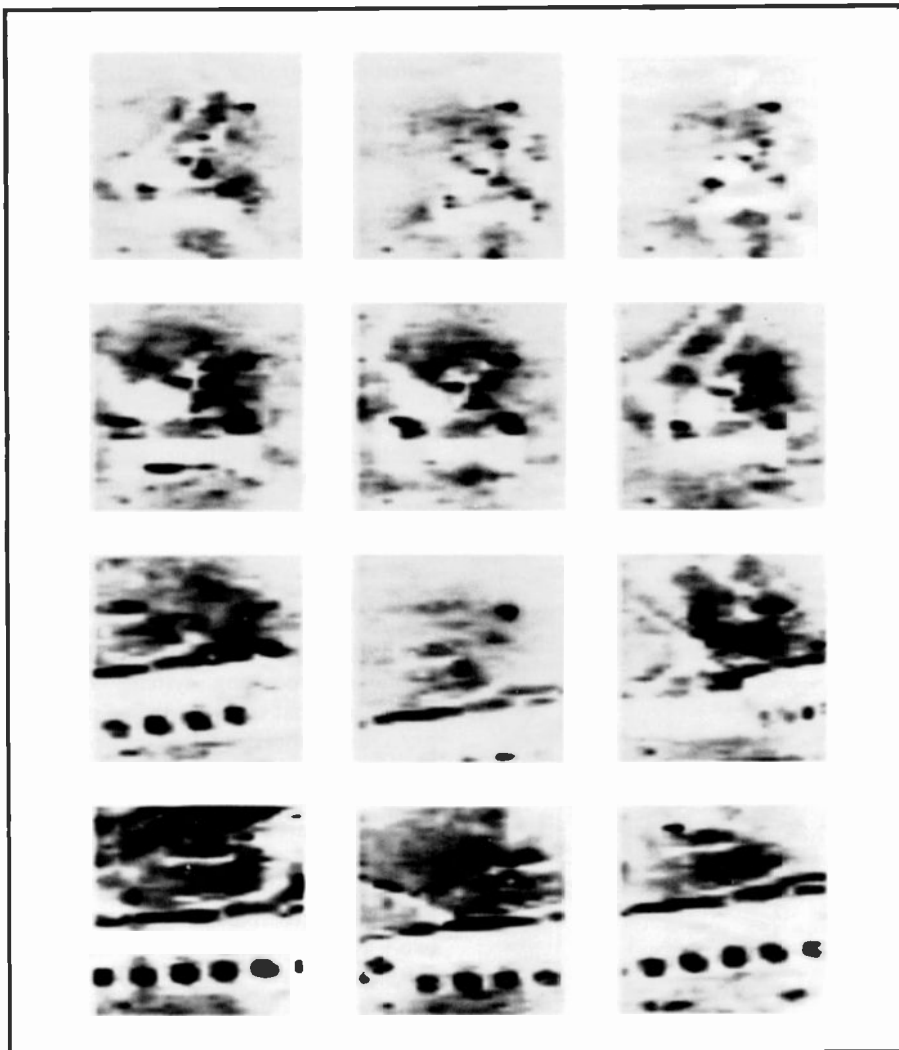
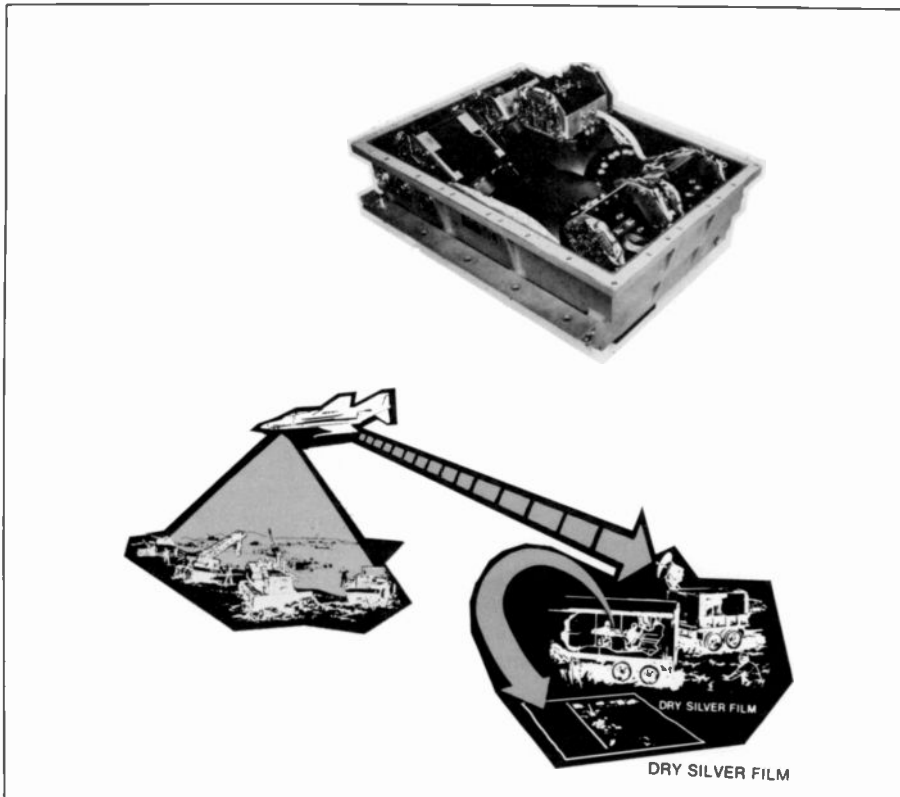

Fig. 7. Thermal image of tank sensed from infrared CCD focal plane array.



**Fig. 8. Electronic Solid-State Wide Angle Camera System.** ESSWACS employs five optically and electronically abutted CCD line-array sensors operating in a "pushbroom" fashion to image a path width of one mile at an altitude of 1,000 ft.

ing. With the successful emulation of the PDP-11/40 minicomputer using three key CMOS/SOS VLSI chip types, GSD has demonstrated the capability to develop CMOS/SOS processors for emulating standard DoD computers like the Army's

AN/UYK-41, the Navy's AN/UYK-20, and the Air Force's AN/AYK-15A. This emulation capability provides the military with a means of upgrading processing capability while preserving their huge investment in existing software.

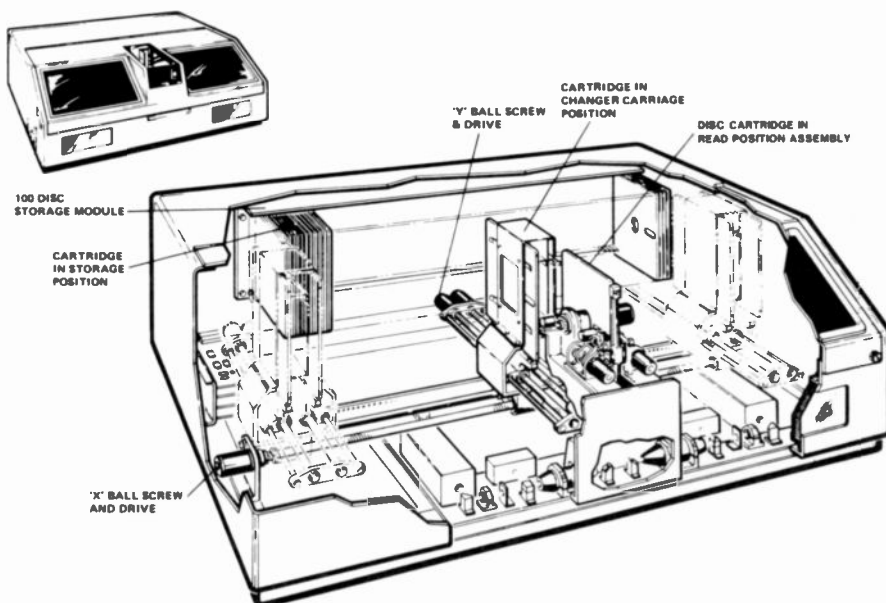

**Fig. 9. "Juke box" multi-disc recorder player configured with  $10^{13}$  bit capacity.** Optical disc technology brings a new level of storage capability for wideband archival digital data.

We are defining a microprocessor architecture to upgrade the ground-programmable spaceborne computer used in the Air Force's DMSP and NASA's TIROS-N series of advanced meteorological satellites, and we are developing a fault-tolerant memory using our 4K CMOS/SOS RAM and error-correcting CMOS/SOS gate universal array.

**Signal Processing.** In signal processor architecture, GSD is continuing the development of its 16-bit-slice CMOS/SOS ATMAC processor (Fig. 10) and its ATMAC-based system applications, and is designing a VLSI programmable pipeline signal processor.

In radar, we are making increased use of distributed computer systems using the greater flexibility and higher performance of advanced microprocessors.

In communications, GSD is using advanced processing technology in signal classification, signal sorting, modulation/demodulation, and classified applications. We are developing a narrow-band speech terminal that converts speech into digital signals, scrambles the signal for security, and compresses the data stream to 2400 bits per second for transmission over standard telephone lines. The terminal weighs only 15 lbs. and uses less than 15 W of power. The small size and power consumption are due to the use of RCA's ATMAC microprocessor to perform all of the encoding, sampling, and decoding functions, and to the use of LSI circuits to perform most of the other terminal functions.

Multi-rate narrowband terminals are also being developed to provide both low-bit-rate and higher-bit-rate, higher quality speech transmission.

## Software

**Support Software.** Increasingly, high performance processing systems have requirements that can be satisfied only with distributed processing. GSD is working on several network topologies and operating system designs *now* to meet this trend. State-of-the-art support software has been developed on classified DoD programs which involve circuit switch technology, high speed crossbars, and systems using two-way messages. Other significant software efforts include (1) operating system work on DMPA, a single-bus portable operating system; (2) microprocessor and microcode work on a single-bus central control radar processor; (3)

software for the MSX-11, a single/multiple-bus nonportable PDP-11 system; and (4) distributed control concepts for the Army's Control and Analysis Center.

**Development Software.** In development software, RCA's work is aimed at designing, and maintaining software for increasingly automated military systems. Higher-order-language development will improve programming efficiency for signal processors. GSD is participating with DoD in the test and evaluation of a common higher order language, ADA, for use in future weapons control systems. Our new software package for the Block 5D-2 generation of the Air Force's DMSP meteorological satellites represents a considerable advancement in spacecraft operational autonomy, memory, fault tolerance and flexibility. And we are developing software for automatic test equipment that will increase test capability while substantially reducing equipment costs.

**Computer-Aided Design.** As the prime developer in the industry of computer-aided-design layout programs for MOS since the early 1960s, RCA has the most complete set of CMOS computer-aided-design resources in the world. We've designed over 350 cell types in ten standard cell families, including the highest density computer-aided-design LSI program in the industry. We've developed the first radiation-hardened standard cell family. And we have used interactive graphic systems extensively for PC card and hybrid circuit design.

Our CAD capability will continue to be used widely in advanced COMSEC programs. CAD-related activities will be important to such programs as Aegis—where CAD for mechanical design and numerically controlled manufacture will shape the horizontal beamformer surface—and the Advanced TIROS-N and DMSP meteorological satellites—where the structural vibrations of the spacecraft will be carefully computer analyzed.

### Systems and operations analysis

In the systems and operations analysis area, GSD technology initiatives are in Command and Control, Requirements Analysis, and Tactical Weapon Systems Concepts and Analysis. Major initiatives are the definition and analysis of the Army All-Source Analysis Center and the tactical command and control of Division and

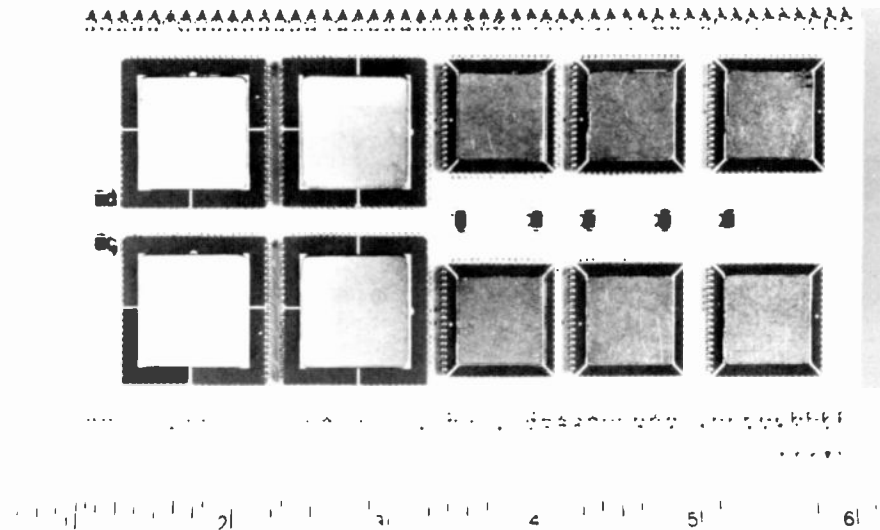

**Fig. 10. Sixteen-bit ATMAC microprocessor and multiplier/accumulator.** Optimized for array-type calculations, ATMAC provides a throughput equivalent to 8 million instructions per second in a typical application. The four ATMAC CMOS/SOS chips consume only three quarters of a watt while operating at full speed.

Corps Assets with maximum use of all-source combat information.

**Command, Control, Communications and Intelligence (C<sup>3</sup>I).** Modern data processing provides the power to make readily available to military commanders, analysts and other decision makers, in their normal working environment, a unique and very automated command and control (C<sup>2</sup>) process. C<sup>2</sup> systems are software intensive with requirements that, by their very nature, change dynamically. The fundamental problems of C<sup>2</sup> are complex and demand the ultimate in systems analysis and definition.

RCA is playing a major role in the important command, control, communications and intelligence (C<sup>3</sup>I) field.

GSD has developed system models that permit the conduct of simulated battles using prescribed C<sup>3</sup>I structures, selected friendly and enemy force levels and deployment, and selected attack and defense tactics to compare and evaluate alternative system configurations. A GSD-developed system, under contract to the U.S. Army, called Control and Analysis Center (CAC), provides the Army Corps and Division battlefield commander with the capability to evaluate and effectively manage his intelligence and electronic warfare assets (Fig. 11). Similar efforts are underway for the Air Force.

**Requirements Analysis.** Requirements Analysis is an important and often overlooked aspect of developing weapon

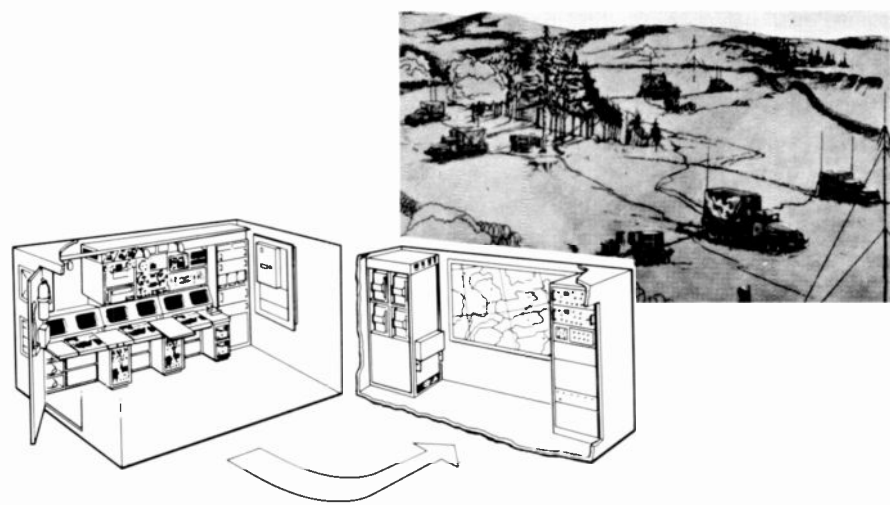

**Fig. 11. Control and Analysis Center housed in standard S-280 shelters and mounted on 5-ton trucks.** CAC will give battlefield commanders more timely and accurate information from their electronic sensors, analysis of the reported data, and the ability to effectively use electronic warfare assets in concert with his combat information resources.

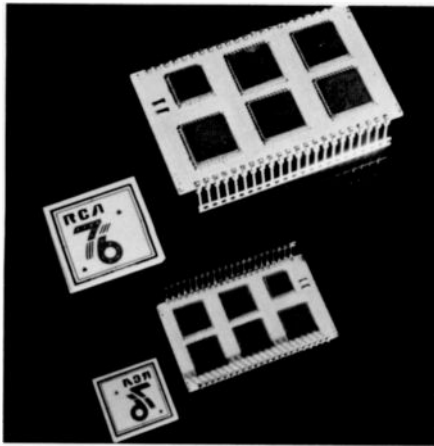

Fig. 12. Ceramic substrate with chips mounted in hermetic chip carriers on both sides.

systems or assessing technology tradeoffs. Through in-depth requirements analysis, we are working to improve the dialogue with our customers in understanding and developing their systems requirements and to evolve new system concepts.

GSD's F<sup>2</sup>D<sup>2</sup> — that is Functional Flow Diagrams and Descriptions — is a structured systems approach for requirements analysis; it is consistent with top-down design philosophy and leads directly to subsystem definitions and assignments, and to lower level interface requirements and functional requirements. It has been used successfully in major system management efforts — most notably RCA's Aegis Weapon System.

*Tactical Weapon Systems Concepts and Analysis.* In this area, GSD uses threat, mission and operations analyses and simulation to examine operational requirements and conceive new weapons systems, or to determine modifications or add-ons to existing systems.

### *Mechanical and thermal technologies*

*Packaging.* In the high density packaging of electronics, GSD has a strong capability in hybrid circuits and is a leader in chip

carrier technology. The hermetic-chip carrier (Fig. 12) enables testing the chip before assembly to the next level, provides space savings as high as five to one compared to conventional dual-in-line packages, and can be replaced easily if chip failures occur after assembly.

GSD is investigating low cost substrates, developing computerized methods of thick film printing, and evaluating state-of-the-art leadless carriers. For expendable payloads, such as communication jammers, we are seeking a 30 percent size reduction in packaging by 1984, and we are designing high-G packaging capable of survival to 16,000 G acceleration.

*Composite Materials.* GSD is investigating advanced composite materials for use in compact, lightweight antennas and mechanical structural elements of satellites and Shuttle equipment. We are improving transport mechanisms for tape and disc recording systems, and dry film processors for laser film recording. And we're configuring sensor gimbal mountings for missile seekers, reducing component size and weight in expendable EW equipments, and interfacing high technology printers and paper handling equipment for electronic message service systems.

*Computer-Aided Manufacturing.* GSD is increasing its investment in three-dimensional interactive design facilities, software programming, and three-dimensional machine tools to improve the design and manufacturing turnaround time, accuracy and repeatability of critical mechanical structures required for antenna and microwave applications.

Numerically controlled machining is favorably affecting advanced antenna design for such applications as Aegis. The ability to economically machine rectangular cavities where formerly holes were drilled makes it possible to integrate the radiating horn aperture with the array support structure. Thermal coupling efficiency and weight of the array are improved, and nuclear survivability is enhanced.



Don Latham is Division Vice President, Engineering, Government Systems Division. Mr. Latham is responsible for coordinating and reviewing the engineering activities of the Division's four business units: Astro-Electronics, Automated Systems, Government Communications Systems, and Missile and Surface Radar. He is also directly responsible for the GSD's Advanced Technology Laboratories. In addition, he directs a staff of senior engineers and technical advisors, and administers the Division's R&D programs.

Before joining RCA in Dec. 1978, Mr. Latham was Director, Research and Engineering, for Martin Marietta Aerospace, Orlando Division.

Contact him at:  
**Government Systems Division**  
**Moorestown, N.J.**  
**TACNET: 224-3717**

### Conclusion

RCA in general and the Government Systems Division in particular are poised in a very favorable position as technology rushes toward the twenty-first century. Our activity extends across a vast array of products, from microminiaturization of very-large-scale integrated circuits to the complete and comprehensive systems of military and space electronics. Our capability is driven by desire to lead in our field, the need to be the very best in every undertaking, the need to innovate. RCA's technology and systems leadership position is no accident; it reflects total commitment to the development and management of technology.

## Engineering challenges in communications systems

*The challenges are to design, standardize, document and manufacture products that are long-lived and serviceable, that "do more" because they incorporate complex state-of-the-art advances demanded by sophisticated customers.*



The Data Nav accessory units allow data from the aircraft's navigation system (waypoints and course lines) to be displayed along with radar images on the weather radar indicator.

---

**Abstract:** *Engineering in the Commercial Communications Systems Division (CCSD) meets many unique challenges, including highly competitive worldwide markets, diverse technology and the needs of capital goods users. CCSD, its products and customers, and specific examples of engineering challenges and their solutions in recent CCSD developments, are outlined.*

---

Intense competition is a way of life for the four major business units of the Commercial Communications Systems Division (CCSD). Although the products from Broadcast Systems, Cablevision Systems, Mobile Communications Systems and Avionics Systems are specialized (see Table I) and usually produced in low to moderate quantities, there is good dollar volume and profit potential that attracts many companies. We face many of the other larger

Reprint RE-26-1-7  
Final manuscript received May 10, 1980.

electronics companies from around the world, as well as a host of smaller specialty companies. These latter companies may address only one or two products, but their position is usually based on unique skills in their specific areas.

All of the usual parameters of competition are important—for example, cost, product performance, product features, reliability and service. Of course, the engineering of the product critically determines these parameters and we look to engineering for our competitive edge.

### Product requirements

CCSD products generally are capital investment items used by our customers in their own businesses. The customer expects high-quality operation and reliability, with minimum maintenance over a long service life so that he can gain returns from his investment. Many RCA radio and TV transmitters operating in the field are over

twenty years old. Therefore, considerations of reliability, serviceability, documentation, parts support and technical service must be paramount.

The long service life of CCSD products in the field also means that the same products should be manufacturable over many years. Over the years there will be different people doing the manufacturing, and the product design and processes should eliminate special requirements and skills, or at least spell them out in a thorough documentation of the product design.

Long manufacturing life leads to careful selection of the materials and parts to be used. We must stick to the parts that will most probably be available over the manufacturing life of the product. We should not have to keep putting engineering into the product to maintain current availability of parts. Of course, this is a tradeoff; it's difficult to predict, when a part first comes on the market, whether the part will still be available years from now.

**Table I. The Commercial Communications Systems Division (CCSD) business units and locations.**

<i>Location</i>	<i>Business Unit</i>	<i>Products</i>
Camden, New Jersey	CCSD Home Office, Broadcast Systems	Televisions cameras and video tape recorders (VTRs)
Meadowlands, Pennsylvania	Mobile Communications Systems	Land mobile communications equipment
	Broadcast Systems	Radio and TV transmitters
Van Nuys, California	Avionics Systems	Weather radar and display equipment
North Hollywood, California	Cablevision Systems	Cable television equipment and systems
Burbank, California	Broadcast Systems	Post-production sound recording equipment
Gibbsboro, New Jersey	Broadcast Systems	TV and FM antennas
Pennsauken, New Jersey	Broadcast Systems	TV systems and mobile units
Isle of Jersey (in the English Channel)	Broadcast Systems	Cameras, VTRs, and mobile units for 625-line markets

The Division Headquarters of the Commercial Communications Systems Division (CCSD) is in Camden, which is also the home office of **Broadcast Systems**, the largest unit. Broadcast Systems manufactures equipment of all types for television and radio program production and broadcasting. RCA broadcast equipment is in virtually every country. In fact, about one-third of Broadcast Systems' business is done with foreign countries. A special manufacturing plant is located on the Isle of Jersey, in the English Channel off the coast of France, particularly to serve the European market and other markets using the 625-line television systems (525-line systems are standard in the United States).

**Avionics Systems** is located at Van Nuys, California. This unit produces avionics products for airline and general aviation aircraft. The principal product is weather radar used, in some form, by all airliners many of the larger business aircraft and some of the smaller general aviation aircraft. Again, this is a

worldwide business, with over 25 percent of the sales overseas.

**Cablevision Systems** is also headquartered in Van Nuys, but the principal manufacturing location is in North Hollywood, California. This unit manufactures and sells equipment for cable television systems, and also installs complete "turnkey" cable television (CATV) systems. In this case, since CATV is largely a U.S. phenomenon, there is little business outside this country, although this may change in the future.

**Mobile Communications Systems** has its home office in Meadowlands, Pennsylvania, about 30 miles south of Pittsburgh. This unit produces land mobile radio equipment used by business and public safety agencies. Several lines of portable, mobile (vehicular) and base station equipment are offered. This also is a worldwide business—about one-quarter is international.

the manufacturing process. In spite of this, it takes vast systems to keep track of all the parts, subassemblies and finished products in manufacturing. For example, the materials operation at Camden handles 14,000 line items each year to support production of Broadcast Systems' cameras and VTR product lines.

Is all this complexity really necessary? Does it indicate a lack of attention to standardizing? Could it be improved? The answer to all questions is "Yes." And that is another challenge to engineering. The product must be complex to meet sophisticated customer needs. Experience in most of CCSD's markets shows that when technology provides the opportunity to do more tasks in less space or at lower cost, the customer often chooses to do more with the product. He does not necessarily want it simpler or lower in cost. Advances such as medium scale integration (MSI) or large scale integration (LSI), for example, have not simplified our products, they have made our products more capable and more reliable.

CCSD engineering and manufacturing activities devote much attention to product standardization; however, a difficult caveat arises when long product life in manufacture is combined with advances in technology. At any time, we will be manufacturing products designed at different times over the last ten years or more. In each case, good standardization exists among products that were designed at the same time, but not between products that were designed at other times. This is because we cannot freeze our design standards for too long without falling behind the state-of-the-art. When designing a product now, we cannot use standard parts that were selected five years ago. We must keep the design standards current. The solution? Design a manufacturing system that can cope with complexity. This is what we have done in CCSD.

## Technology

Since CCSD products are designed to last, the technological content of new designs should be as up-to-date as possible. A good current example is the effect of the microprocessor on CCSD products. In the last three years, microprocessors have been incorporated in color TV cameras, VTRs, weather radar, cable TV distribution systems, and videotape editing systems. In each of these cases, we used the microprocessor to provide additional and sometimes new features in the equipment.

Good judgment is required to achieve reasonable state-of-the-art content in the design without using material which will quickly disappear from the market because few others use it. Remember, since CCSD items are manufactured in small quantities, we have little effect on the market for parts. We are always looking for advanced parts that will be used in large quantities by other businesses with similar needs for long life—computer manufacturers, for example.

## Complexity

Design and manufacturing of CCSD's products might be a snap if it were not for one problem—most of the products are extremely complex. For example, a single color TV camera or video tape recorder (VTR) contains 3,000 different types of parts and a total of 10,000 parts. Design engineers face serious limitations in really meeting a market desire for product variety because they must restrict complexity in

As stated earlier, we (and our customers) were not satisfied with using this technology just to make the same kind of product lower in cost.

The TK-47 color TV camera is a good result of this approach. An 1802 microprocessor in this camera provides a unique control system. All of the variable adjustments for setting up the camera are stored in random access memory (RAM) so that the camera, which has an analog signal system with all the usual analog variables to contend with, has no manual knobs or adjustments. The variable parameters are set up by accessing the RAM through the use of a "Set Up Terminal" which provides for manual adjustment. Once adjusted, the camera can operate through a normal programming session with the "Set Up Terminal" disconnected. This style of operation is not very different from that of conventional cameras; we have just provided a different methodology. The TK-47, however, goes further. Because we can access the variable parameters from a microcomputer, we can now automate the set-up. The "Automatic" option of the TK-47 does just that — a test pattern is called-up in the camera lens, and the computer then takes the camera through all adjustments automatically in only a few minutes. This provides a better adjustment, more consistently and more quickly, than even the most skilled operator could achieve. It solves the TV producer's growing problem of getting enough skilled manpower to operate his equipment.

Our weather radar also shows how we have used advanced technology to "do more." Currently, weather radars are essentially digital devices—the analog return from the radar targets is digitized and stored in RAM. The display is made by reading from RAM at TV scan rates. In essence, the memory is used for scan conversion from a slow radial radar scan to a standard TV scan that provides a high-quality, bright-color display. Adding a microprocessor doesn't do much to this process; however, it opens the door to other uses for the display — and this is the direction that we have taken. Since the weather radar display already occupies a prominent position in the aircraft cockpit, it is natural to think of it as a display for other purposes, including navigation, checklists and system management. On our indicators we have provided a "Universal Digital Interface" which is applicable to a series of accessory units in the "Data Nav" product line. These accessories — all microprocessor-based — allow the radar

The TK-47 Broadcast Color Television Camera (right) operates with more than 100 control parameters stored in a digital memory. The setup control unit (below) allows manual setting of any control parameter, or completely automatic setup of all parameters.



display to be used for the other purposes listed above.

Another microprocessor application is in cable television systems that can operate in a "two-way" mode. "Two-way" cable can return information from the subscriber's home to provide unique services such as home security, pay-per-view

program services, in-home shopping, polling and more. But there is a technical problem with the two-way system which needs to be solved. This is where the microprocessor comes in. Looking at a cable system in reverse, as one must do when considering signals returning to the head end from the subscribers, we see that noise

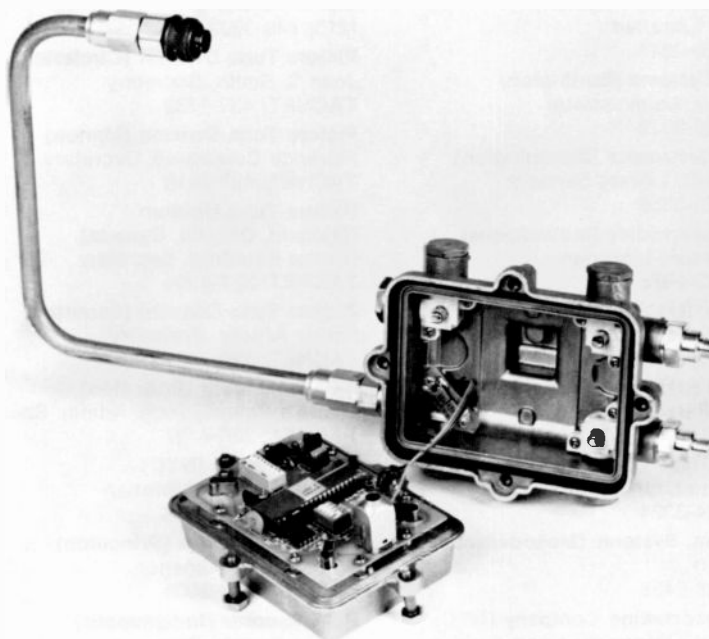

A code-operated switch (COS) provides selective control in "two-way" cable television systems.

will accumulate because signals from all subscribers will be added-up on the return path. This means that there should be a selective way to connect the return path for only a few subscribers at a time. This switching should be controlled from the head end. The control is accomplished by a device called a code-operated switch (COS), placed in the return path of each feeder out on the cable. The COS contains a computer-on-a-chip which allows each COS to be addressed individually by means of a digital code sent out from the head end. When a COS receives its own code, it will connect the return path from its feeder. Again, the microprocessor has provided a new capability.

## The future

In each of the CCSD marketplaces there are clear trends in the present direction of technological advances. For example, highly reliable, low-cost digital LSI circuits will drive broadcasting systems to digital processing of TV and sound signals in the next ten years. In avionics, more electronic displays will be seen in the cockpit. In mobile radio, computer-controlled

**Arch Luther** is Division Vice-President, Engineering, Commercial Communications Systems Division. He joined RCA Corporation in July 1950 in the Broadcast Studio Engineering Department. In 1962 he became manager of the TV Tape Recorder Engineering Department. He directed this department during the development of the TR-70 highband video tape recorder, the TCR-100 video cartridge recorder and many other supporting accessory items. In 1974 RCA received an Emmy Award from the National Academy of Television Arts and Sciences for the development of the TCR-100. In February 1973 he was named Chief Engineer, Broadcast Systems. In May 1978 he became Chief Engineer, Commercial Communications Systems Division, which includes Broadcast Systems, Mobile Communication System, Avionics Systems and Cablevision Systems. In May 1980 he was appointed to his present position.

Contact him at:  
**Commercial Communications System  
 Division  
 Camden, N.J.  
 TACNET: 222-2445**



trunked systems for more efficient use of the spectrum will be used. In cable television, similar digital trends will lead to more programming options for the subscriber and more non-programming services. All of these trends will be

developed using the technology of today and the near future. For CCSD engineers, the challenge is to apply current and emerging technologies to fulfill these developing needs in ways that will advance CCSD's competitive position in its market.

# RCA Libraries Have *Engineer* Index

Call an RCA technical library near you to find out more about the 25-year Index.

**Astro-Electronics (Princeton)**  
 Mary Pfann, Librarian  
 TACNET: 229-2247

**Automated Systems (Burlington)**  
 Veronica Hsu, Administrator  
 TACNET: 326-3322

**Consumer Electronics (Bloomington)**  
 Linda Pritchett, Library Services  
 TACNET: 423-5356

**Consumer Electronics (Indianapolis)**  
 John B. Dickson, Librarian  
 TACNET: 422-5925

**Govt. Comm. Systems (Camden)**  
 Olive F. Whitehead, Manager  
 TACNET: 222-3488

**Laboratories RCA, Ltd. (Zurich)**  
 Dr. Walther Rehwald  
 (01) 52 63 50

**Missile & Surface Radar (Moorestown)**  
 Natalie J. Mamchur, Manager  
 TACNET: 224-3394

**Mobile Comm. Systems (Meadowlands)**  
 Connie Dinch  
 TACNET: 228-6433

**National Broadcasting Company (NYC)**  
 Vera Mayer, VP Information and Archives  
 TACNET: 324-5309

**Picker Corporation (Cleveland)**  
 Yvonne Graham  
 (216) 461-9100  
 Elaine Herzberg  
 (216) 449-3000

**Picture Tube Division (Circleville)**  
 Joan S. Smith, Secretary  
 TACNET: 432-1232

**Picture Tube Division (Marion)**  
 Florence Caracciolo, Secretary  
 TACNET: 427-5410

**Picture Tube Division  
 (Midland, Ontario, Canada)**  
 Martha Bachtrog, Secretary  
 TACNET: 337-1204

**Picture Tube Division (Scranton)**  
 Sandy Arnold, Secretary  
 TACNET: 329-1422

**RCA Americom (Princeton)**  
 Carolyn Powell, Tech. Admin. Spec.  
 TACNET: 258-4197

**RCA Globcom (NYC)**  
 Dorothy Unger, Librarian  
 TACNET: 323-7348

**RCA Laboratories (Princeton)**  
 Wendy Chu, Manager  
 TACNET: 226-2608

**RCA Records (Indianapolis)**  
 Phyllis Proffitt, Secretary  
 TACNET: 424-6147

**RCA Research Laboratories  
 (Machida City, Tokyo, Japan)**  
 S. Mogi, Librarian  
 (0427) 91-0331

**RCA Limited (Middlesex, England)**  
 Mr. A. Smith, Technical Librarian  
 85511

**RCA Service Company (Springfield, Va.)**  
 Margaret W. Rush, Technical Librarian  
 TACNET: 231-1162

**RCA Taiwan Limited  
 (Taoyuan, Taiwan)**  
 Alan Huang, Librarian  
 (030) 322181, x320

**"SelectaVision" VideoDisc  
 Operations (Indianapolis)**  
 Pennie Lumley, Librarian  
 TACNET: 426-3397

**Solid State Division  
 (Findlay)**  
 Lee Cross, Secretary  
 TACNET: 425-1502

**(Lancaster)**  
 Mary Kathryn Noll, Administrator  
 TACNET: 227-2220

**(Mountaintop)**  
 TACNET: 327-1396

**(Somerville)**  
 Barbara S. McCoy, Librarian  
 TACNET: 325-6017



# RCA Solid State in Europe

European markets accounted for roughly 26 percent of total semiconductor industry worldwide sales — RCA has confronted a threefold competitive challenge there.

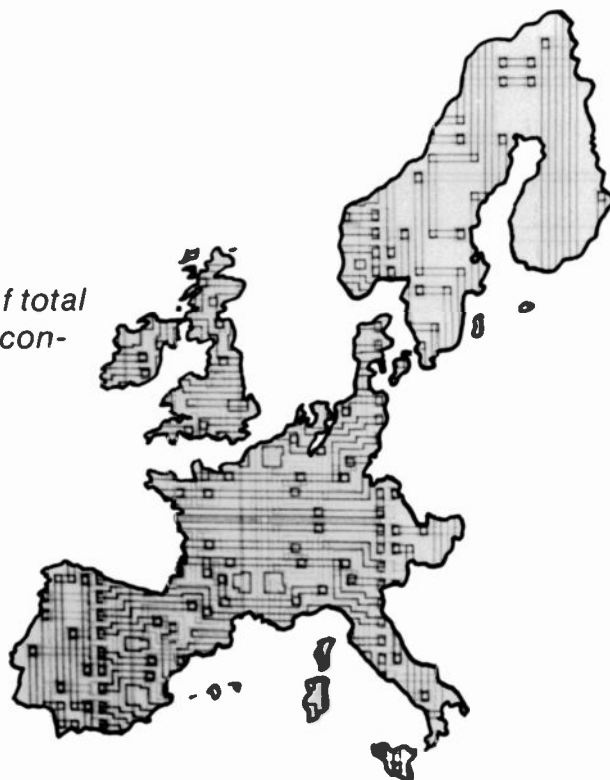

**Abstract:** Building on major opportunities for new and traditional solid-state product lines developed by RCA engineers, RCA's Solid State marketing, sales and applications organization, headquartered in Brussels, has mapped out a strategy to capture the healthy European, Middle Eastern and African electronics markets.

RCA's Solid State Division (SSD) derives one dollar in each five of income from sales in Europe, the Middle East and Africa. Most of those sales come from western Europe. Thus, Europe, with its distinctive nationalistic characteristics and diverse markets, warrants Solid State's attention through a marketing, sales and applications organization dedicated to the special needs of those markets.

With only eight percent of the world's population, Europe (the European land-mass minus eastern-bloc countries) is expected to consume more than 30 percent of 1980 electronic equipment production and more than 30 percent of 1980 electronic component production. Although this component figure represents both active and passive components, the percentage for semiconductors is not significantly different. Total semiconductor industry worldwide sales were better than \$10 billion during 1979, and western European markets bought approximately 26 percent of the total. Table I concisely depicts

Reprint RE-26-1-8 (ST-6919)  
Final manuscript received April 2, 1980.

**Table I. Estimating the 1980 electronics marketplace in Western Europe.**

Population	347 million	8.0% of world
Electronic equipment consumption	\$44.37 billion	30.8% of world
Components consumption (active and passive)	\$10.39 billion	30.9% of world

Sources: *The World Almanac and Book of Facts* 1980; *Electronics* magazine, January 3, 1980; "1980 World Market Survey and Forecast."

western Europe's strength as an electronics marketplace. Table II depicts 1979 industry sales by country in western Europe.

Any current view of world markets must accommodate the probability of an economic downturn. The 1980 estimates of Table I do. We cannot, however, assign a probability factor to the validity of the estimates because of economic uncertainties. Despite such reservations, we can presume that the basic considerations underlying the estimates are valid. For example, consumer electronics sales, particularly of color TV, will be stagnant at best. Computer sales, on the other hand, remain healthy. The communications industry's use of semiconductors will grow significantly despite economic downturns. As indicated in *Electronics* magazine's forecast issue, for example, Algeria plans to spend \$1 billion for communications systems during the next five years. And Egypt has allocated \$17 billion for communications systems through 1999. Thus,

**Table II. 1979 solid-state industry sales by country.**

Country	\$ Billion
Austria	0.045
Belgium	0.067
Denmark	0.033
Finland	0.024
France	0.440
Italy	0.226
Netherlands	0.078
Norway	0.028
Spain	0.060
Sweden	0.098
Switzerland	0.071
United Kingdom	0.474
West Germany	0.971
<b>Total</b>	<b>2.615</b>

Source: *Electronics* magazine, January 3, 1980; "1980 World Market Survey and Forecast."

### 1980 European electronics growth.

	\$ Billion	% Increase vs. 1979	% Increase 1979 vs. 1978
Electronics equipment	44.37	9.6	11.5
Electronic components	10.39	5.6	6.8
Integrated circuits	1.79	14.1	17.1

telecommunications is a major growth business throughout Europe and, indeed, the world. Unlike the United States' situation, much of the European telecommunications industry is government-owned and operated and, therefore, less influenced by economic downturns.

RCA's task in servicing the semiconductor market in western Europe is to maintain the most effective marketing, sales and applications engineering organization possible within the constraints imposed by the many currency/linguistic/cultural differences that coexist within relatively short distances. RCA's organizational method has been to compromise between having a completely centralized headquarters in a single location and having a totally decentralized structure of groups individually servicing national entities. RCA Solid State has sold its products in Europe for more than 25 years. But, until a dedicated organization was established in Sunbury-on-Thames, United Kingdom, in the late 1960s, the service was essentially through distributors in each western European country.

The European headquarters were moved to Brussels in 1978 (Fig. 1). Located only a five minute drive away from the Brussels international airport, the headquarters provide convenient access to the major industrial cities of Europe. Brussels itself offers excellent air-travel and communications facilities. The city is also multilingual and cosmopolitan, and serves as home for the European or world headquarters of more than 1,000 international corporations.

Currently about half (more than 80 people) of our European organization works in Brussels, with the others stationed in sales offices in eight principal cities of the western nations. Our European staff is Pan-European, multinational and multilingual. Although daily business among RCA's nine European offices tends to be conducted in English, intra-office and customer contacts are often in local languages. Various employees can converse in at least 12 languages. Business transactions are conducted in six basic currencies: Deutschmarks, English

pounds, French francs, Belgian francs, Italian lire and U.S. dollars.

RCA Solid State's European sales organization is divided into two major groups, each responsible for a zone or area with approximately half of the European sales volume. Commercial transactions are done in the local idiomatic vernacular. One group, based in Quickborn, a suburb of Hamburg, directly covers customers in northern West Germany (Federal Republic of Germany). Under that sales director's control are offices in Munich (covering southeast West Germany and Austria), Ostfildern (a suburb of Stuttgart, covering southwest West Germany and Switzerland) and Milan (covering Italy and Yugoslavia). The other sales director resides in Brussels, controlling sales offices in Sunbury-on-Thames (covering the United Kingdom and Eire), Paris (covering France), Madrid (covering Spain and Portugal), Brussels (covering Benelux), and Solna, a Stockholm suburb (covering Sweden, Denmark, Norway and Finland). Other countries of western Europe, eastern Europe, the Middle East and Africa are

generally serviced from Brussels through RCA distributors in the local regions. In many cases, these distributors also handle the electronic products of other RCA divisions. Multiple distributor locations throughout western Europe extend RCA's sales coverage far beyond that of the nine sales offices.

The sales groups are supported by product-line-oriented marketing functions and service groups centralized in Brussels. Four marketing teams emphasize product line groupings: discrete power semiconductors; electro-optics and other products; integrated circuits; and memories, microprocessors, microprocessor development systems and single-board microcomputers (Microboards, in RCA's terminology). Table IV shows the products associated with each marketing group. These groups work in consonance with their counterparts at the Solid State Division's world headquarters in Somerville, New Jersey.

The nine regional sales offices and the Brussels-based marketing groups are supported by an applications engineering lab designed to help customers use our components efficiently and cost-effectively in their equipment designs. General support services are also based in Brussels and include distributor marketing, order processing and fulfillment, pricing, product planning, financial services and marketing communications.

The European data communications network (Fig. 2) via satellite permits real-time access to product inventory informa-

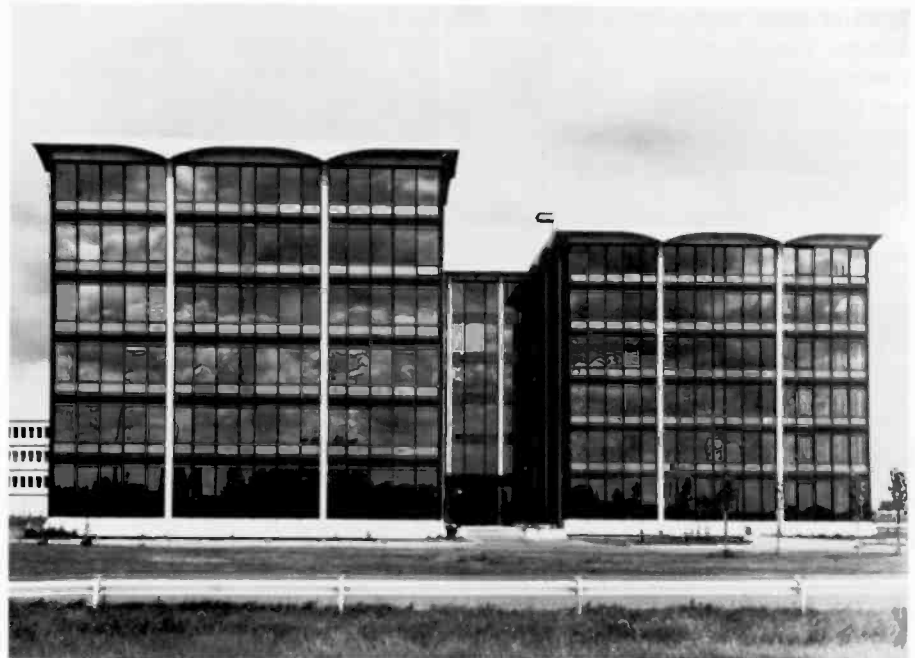

Fig. 1. RCA Solid State European headquarters building.

**Table IV. The solid state product lines.**

<i>Discrete Power Semiconductors</i>	<i>Electro-Optics and Devices</i>	<i>Integrated Circuits</i>	<i>Memories and Microprocessors</i>
• Power transistors	• Camera, Display and Photomultiplier Tubes	• CMOS Logic ICs and Telecommunications Circuits	• CDP1800 COSMAC Microprocessor Family
• Thyristors	• Solid State Electro-Optic Emitters and Detectors	• Consumer Linear ICs	• Memories: CMOS RAMs, ROMs, EPROMs
• Radio frequency (RF) transistors	• Closed-Circuit Video Equipment (CCVE)	• Industrial Linear ICs	• Microprocessor Development Systems
• Specialty hybrids	• Power Tubes	• High Reliability Products	• Microboards (single-board microcomputers)
		• Timekeeping CMOS Chips	

tion and customer order status for the Brussels, Quickborn and Sunbury-on-Thames offices, with dial-up datalinkage for Munich, Ostfildern, Paris, Milan and Solna scheduled for operation before the end of this year. The datalink will afford sales offices and their customers the same access to product availability and order status information that is now available to domestic U.S. offices and customers.

RCA is confronted by the typical threefold competitive challenge in the European semiconductor market. European suppliers such as Philips and Siemens; resident American competitors such as Texas Instruments (TI) and Motorola; and the burgeoning Japanese companies such as Hitachi and Toshiba. In meeting this challenge, we see major opportunities for each of our product lines. We anticipate increasing acceptance for discrete power devices in switch-mode power supplies, high-power amplifiers, motor controls and new products using gate turnoff thyristors (GTOs) and field effect transistor (FET) devices. We look for increasing penetration for integrated circuits (ICs) in telecommunications applications, clocks and other timing circuits, and computer peripherals. RCA's traditional strength in complementary metal-oxide semiconductors (CMOS technology was invented at the RCA Laboratories in Princeton, New Jersey, and introduced to the commercial world by the Solid State Division) benefits from the extensive and continuing growth in industrial markets for CMOS logic, including frit-seal packages for the telecommunications market.

Extensive design-in effort is also in process in Europe using RCA's CMOS CDP1800 microprocessor family. Microprocessor applications are developing for engine controls, specialty small computers, remote controllers and "smart" telephones. The Electro-Optics and Devices segment of the Solid State Division produces and markets TV camera tubes, photomultiplier

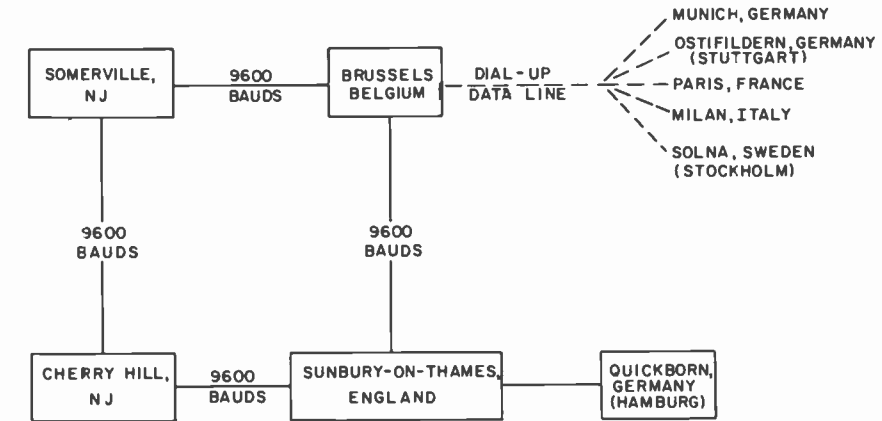

**Fig. 2. European data communications network.**

tubes, solid-state emitters and detectors, optical communications equipment, CRTs, solid-state charge-coupled device (CCD) image sensors, power tubes for radio and TV station transmitters and closed-circuit video equipment (CCVE).

The CCVE product line, TV cameras and associated equipment, is aimed primarily at the surveillance/security market, which is expanding dramatically. RCA did not participate in the business until 1974 and now is one of the largest suppliers in the domestic U.S. market. A new generation of CCVE cameras, the TC2000 family, the industry's first cameras using large-scale integration (LSI) technology, has just been introduced in the European market, meeting European electrical and TV standards.

Building on its traditional strengths in discrete power devices, CMOS ICs, bipolar ICs, in both the consumer and industrial markets, the CDP1800 CMOS microprocessor family, TV camera tubes, photomultiplier tubes and power tubes, complemented by the CCVE products, RCA has mapped a strategy to increase its impact and market share in Europe, the Middle East and Africa. Despite the vagaries caused by floating currency rates, economic swings and nationalistic

tendencies in regional markets, European, Middle Eastern and African projected sales growth, rivaling that in the United States over the next five years, demands our increased presence and constant attention.



**Bill Glaser** joined the RCA Solid State Division in 1961 at Somerville in product marketing. His European assignment as Vice President, Europe, began in July 1979, when he transferred to Brussels from RCA Electronica, Sao Paulo where he was responsible for Solid State Brasil from its start-up in 1975.

His prior assignments included that of Director, Thyristor/Rectifiers. He was also Sales Manager at Lancaster, Harrison and Somerville for various Electronic Components Divisions.

Contact him at:  
**Solid State Division, Europe**  
**Brussels, Belgium**  
**Telex: 61566**

# The RCA Americom satellite communications system

*The authors give insights into current system operation and future system growth.*

---

**Abstract:** *The RCA Americom system of satellites, earth stations, and terrestrial links provides a wide variety of services to the 50 United States for private line voice and data wide band (56 kpbs) data service circuits, video and audio program distribution and special communication services for Alaska and the U. S. Government. System economics dictated technological advancements to minimize costs of launch vehicle and spacecraft designs, resulting in doubled channel capacity via frequency reuse.*

---

## Introduction

The RCA Americom Satellite System (Satcom) has been in U.S. domestic operation since 1973. It gives all 50 states services ranging from private line and message toll service to commercial television and radio, to digital data, and to cable television (CATV). However, the system is not to be considered complete. Recent advances in equipment and services are continuously being added. Satellites of higher reliability, longer life and increased channel capacity are under development for launch in mid-1981. Earth stations with improved radio frequency (rf) characteristics and more efficient modems are being introduced to reduce customer costs and the traffic capacity of each transponder channel.

## System overview

The RCA Americom System consists of a broad network of customer and RCA-owned earth stations, terrestrial

microwave links and central terminal offices (CTO) covering the 50 United States. These are fed by two synchronous orbit 3-axis stabilized satellites which were designed, fabricated and controlled onto orbit by RCA Astro-Electronics. The system is quite complex because of the wide variety of services offered including video and audio program distribution, private line voice and data, service for Alascom which provides basic and special communication services to Alaska, and specialized government voice, video and data services.

From its start in 1973 to the present, system implementation has stressed low cost in order to compete in the commercial market. The prohibitively large capital investment required for start-up using available state-of-the-art launch vehicle and spacecraft designs forced major technological advancements to minimize costs. Private funding of the upgrading of the Thor-Delta launch vehicle to the 3914 configuration and development of a 24-transponder, 907 kg (2000 lb) spacecraft led to the system economics needed. The communications subsystem inaugurated frequency reuse for maximizing C-band capability in orbit, and the spacecraft were the first commercial satellites with power and propellant capacities for continuous operation of all channels for at least eight years on-orbit.

The nearly five-year flight performance to date of the satellites has been quite successful, with the attitude control systems, propellant use and power subsystem performance exceeding specifications. The communications subsystem performance has also been as designed, providing ample signal strength to the respective service areas as shown in the Equivalent Isotropically Radiated

Power (EIRP) contours of Figs. 1 and 2 (Langhans and Lansley, 1977; Braun and Christopher, 1979). (A coupled spot beam to Hawaii provides 26 dBW on twelve channels.) Experience with cross-polarization isolation, including Faraday rotation effects, satellite pointing and drift and earth station misalignments has shown frequency reuse to be a viable approach, posing no significant operational complexity over that of prior 12-transponder satellite systems.

The spacecraft is controlled by two identical Tracking, Telemetry and Command (TT&C) ground stations which offer full redundancy. Again, economics dictated that the Satellite Operations Control Center (SOCC) and TT&C be co-located with major earth stations. The concept selected allows each TT&C station to operate a satellite or remain in hot standby mode while the other station operates both satellites. These stations are equipped with high speed tracking antennas which, used in conjunction with leased facilities in Cannarvon, Australia, and Fucino, Italy, permits the transfer orbit tracking and spacecraft orientation for Apogee Kick Motor (AKM) firing to be performed by RCA.

## Spacecraft design

To achieve the specified 24-channel communications performance over the eight-year life with sufficient reliability within the payload capability of the Delta 3914 launch vehicle, weight optimized designs are employed in five key spacecraft subsystems: antennas, transponder multiplexers, power supply, attitude and velocity control, and the structure. The resultant three-axis stabilized spacecraft design with

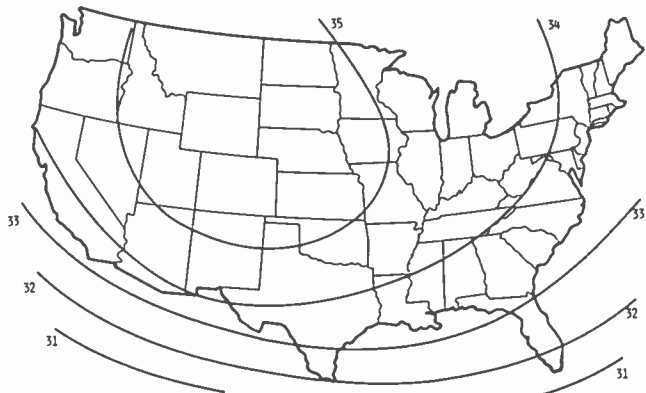

Fig. 1. F-1 EIRP contours.

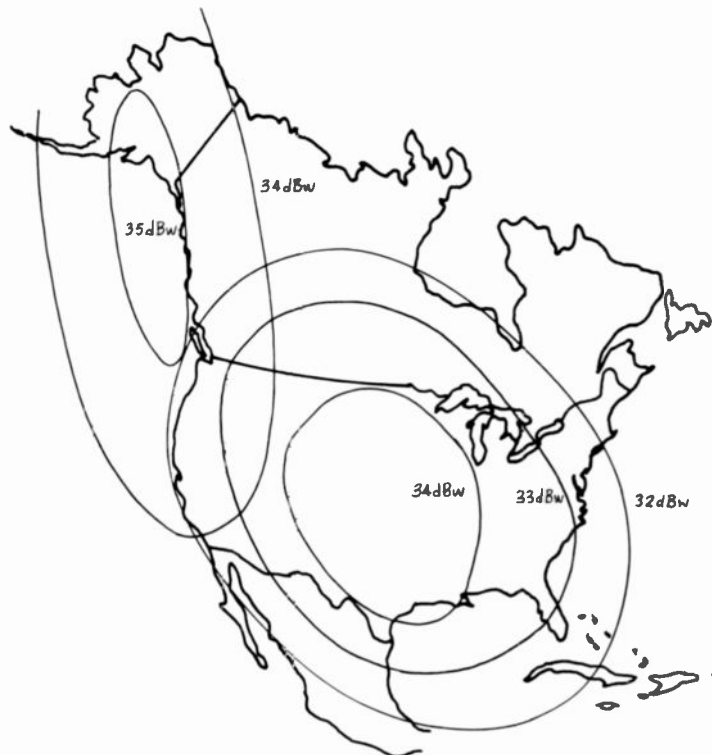

Fig. 2. F-2 EIRP contours.

sun-oriented solar panels provides the maximum power-weight capability to the primary communications payload within the launch vehicle weight and volume constraints (Keigler, 1978). Salient characteristics of the spacecraft are summarized in Table I.

Accommodation of 24 transponder channels within the 500 MHz allocated for commercial service (5.925 — 6.425 GHz earth-to-space and 3.7 — 4.2 GHz space-to-earth), previously occupied by 12 channels in other domestic and international satellite systems, required spectrum reuse. Orthogonal linear polarizations provide maximum isolation between two independent signals at the same frequency and also minimize depolarization through rain. The 24 channels are thus divided into two groups of 12 on each polarization at 40 MHz center-to-center spacing, with an interleaving offset of 20 MHz as shown in the frequency plan of Fig. 3 giving additional isolation between overlapping channels. To satisfy the broad range of traffic types carried by RCA Americom, each of these channels with a 35 MHz useful bandwidth is designed to carry either a full color TV

signal with audio subcarriers (FM-TV), or frequency division multiplex voice circuits (FDM-TV), or frequency division multiplex voice circuits (FDM-FM), or multiple access multiplex voice circuits (FDM-FM-FDMA), or single voice circuit per carriers signals (SCPC), or digital data (MSK-PM), or time division multiple access (TDMA-PM). All of these types of traffic are carried simultaneously by the 24-channel transponder, although the circuit capacity of the multiplex and multiple access channels is somewhat dependent on the traffic types on adjacent co-polarized channels.

### Antennas

The unique antenna design selected to achieve the combined requirements of

gain, beamwidth, polarization isolation, light weight, restricted volume and alignment stability is shown in Fig. 4 (Raab, 1976). Maximum gain and polarization led to separate feed/reflector assemblies for each polarization and for each of the two transponder output ports of each polarization (to avoid the higher insertion loss of contiguous channel multiplex filters). Alignment stability dictated a design with no deployment of any feed or reflector members, and the volume constraint of the Delta fairing resulted in the overlapping reflector configuration. The reflector surfaces are grids of parallel wires embedded in a low-loss dielectric, with the direction of the wires being parallel to the E vector of each antenna; thus, the grids of the two overlapping cross-polarized reflectors are orthogonal. Because these cross-gridded

Table I. RCA Satcom system parameters.

Parameter	Value
Launch Vehicle	Delta 3914
Transfer Orbit Weight	907 kg (2000 lb)
On-Orbit Dry Weight, (Max.)	365 kg (805 lb)
Hydrazine Propellant	102 kg (225 lb)
Apogee Motor Expendables	405 kg (893 lb)
Stationkeeping (8 years)	$\pm 0.1^\circ$ N/S & E/W
Transfer-Orbit Stabilization	Passive, Spin
Synchronous-Orbit Control	Stabilite
Maximum Pointing Error	$0.15^\circ$
Initial Maximum Array Power	770 Watts
8-Year Minimum Array Power	550 Watts
Battery Power (Longest Eclipse)	485 Watts
Total Transponder Channels	24

Parameter	Value
Channel Allocations:	
CONUS	24
Alaska	24
Hawaii	12
Minimum Polarization Isolation	33 dB
Receive Frequency Band	5925 to 6425 MHz
Transmit Frequency Band	3700 to 4200 MHz
EIRP Per Channel:	
U.S./Alaska	32 dBW
Hawaii	26 dBW
G/T:	
U.S./Alaska	$-6 \text{ dB}/^\circ\text{K}$
Hawaii	$-10 \text{ dB}/^\circ\text{K}$
Eclipse Channel Capacity	24

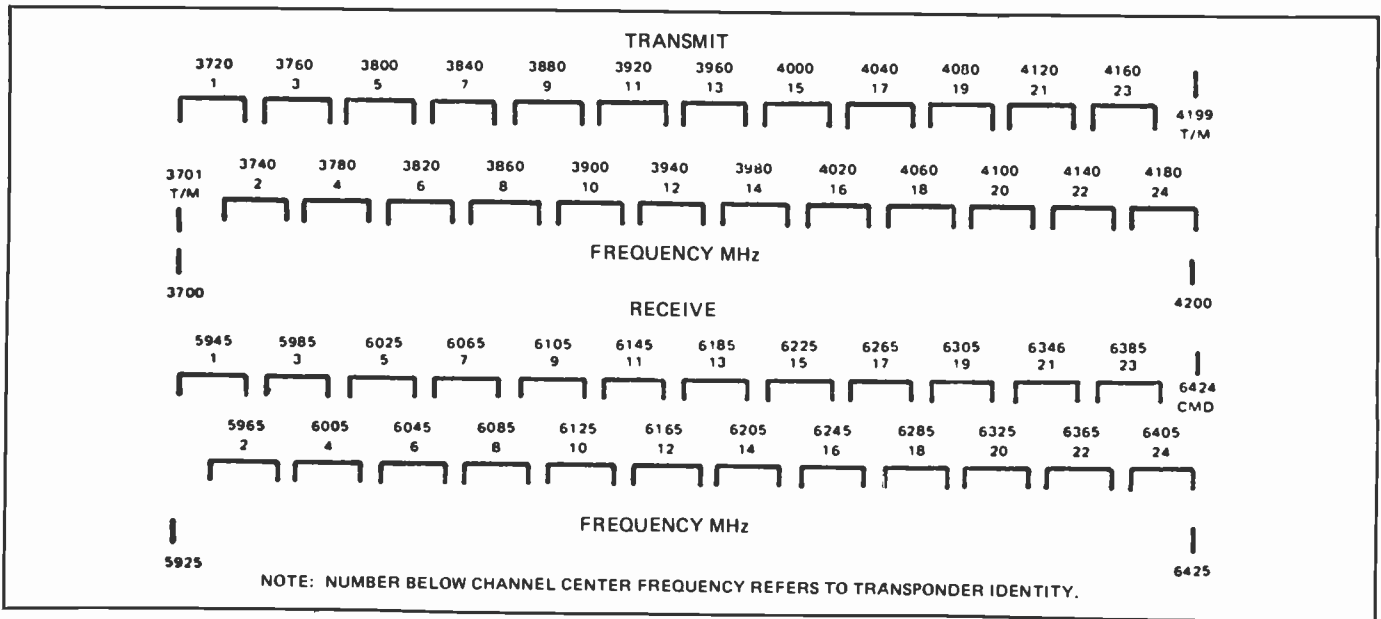

Fig. 3. Frequency allocation plan.

reflectors are virtually transparent to an orthogonally polarized wave and the feeds of each antenna are displaced from the focus of the oppositely polarized antenna, this overlapping cross-gridded design achieves greater than 33 dB isolation between orthogonally polarized waves at the same frequency over the full beam coverage area.

All four feed-reflector pairs generate the same size and gain beams which each cover the lower 48 states and Alaska within their elliptical beam areas. Although the four beams are nominally coincident, the design offers the capability of separately directing the beams to optimize performance to

particular areas as was done before launch on the second flight spacecraft. In addition to the four main beams which serve the 49 continental states, offset feeds in the two west antennas couple a portion of the signals from 12 channels to beams pointed toward Hawaii.

Use of a high strength, lightweight dielectric material for the reflectors and graphite fiber composite (GFEC) for the feed tower, waveguide runs and feed horns results in a weight of only 22.7 kg (50 lb) for the entire four-reflector, six feed-horn antenna assembly, including all of the associated diplexers, orthomode couplers and power splitters.

### Multiplex filters

Both input and output multiplex microwave filters were fabricated of GFEC rather than Invar for minimum weight. Although Invar had been used on all other communications satellites because of its low coefficient of thermal expansion (and thus, frequency stability of the microwave cavities), such filters, even with thin walls, are heavy because of the density of Invar. RCA developed forming and plating processes for lightweight GFEC which achieve the necessary interval smoothness for low r.f. losses while ensuring adherence of the metallic plating to the organic GFEC over the requisite temperature and pressure ranges (Keyes, Kudzia and O'Donovan, 1973). Based upon conventional Chebyshev electrical designs of 8 poles for the input filters and 5 poles for the output, the net weight saving compared to Invar construction for the total of 24 each input and output filters is approximately 15 kg (35 lb). WR-229 waveguide sections comprise the output filters, six of which are mounted on each of four manifolds, while the low-power input filters are fabricated of one-third height waveguide for weight optimization.

### Power supply

A single-axis, clock-controlled shaft drive maintains the 7 m<sup>2</sup> (75 ft<sup>2</sup>) solar array oriented toward the sun, the array area being sufficient to compensate for the seasonal motion of the sun out of the orbit plane. The direct drive brushless motor and

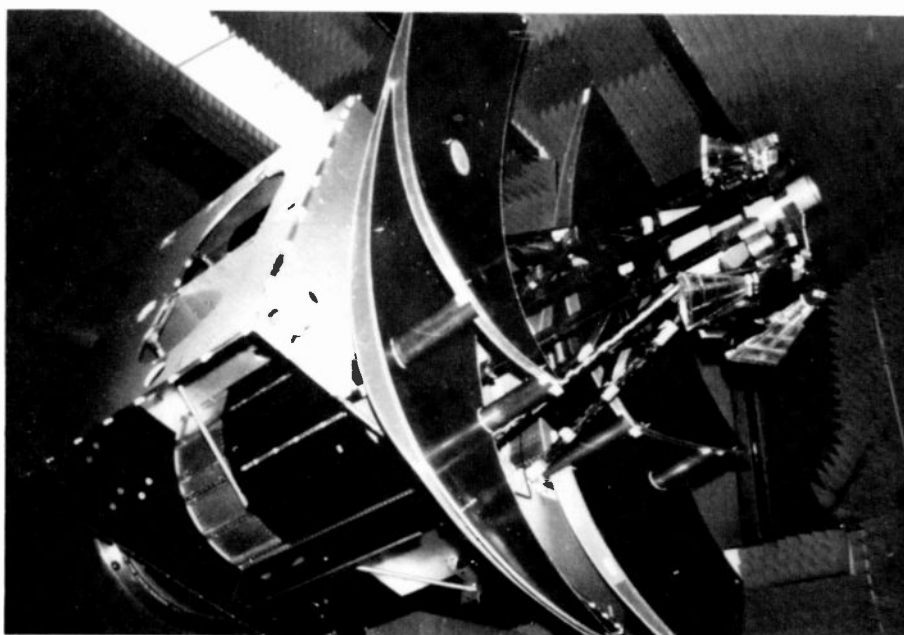

Fig. 4. Antenna assembly.

slip ring assembly can be commanded forward and reverse at both normal orbital rate and at a fast slew rate. Solar array capacity is sufficient to power all 24 transponder channels plus supporting spacecraft subsystems after eight years of cell radiation degradation; similarly, the 36.7 kg (81 lb) of batteries can support a full 24-channel load throughout the maximum 72-minute eclipse duration.

The power subsystem design was adapted from the Direct Energy Transfer (DET) technique developed by RCA for NASA in which current flows directly from the array to the load without any series regulator. Load bus voltage is clamped to 35.5 volts by a shunt control amplifier employing a unique partial shunt scheme which constrains excess array capacity early in life by forcing a mismatch between the two electrical segments of each string of solar cells. Only a fraction of the excess power is thus dissipated within the internally mounted shunt elements. This dissipation can be further reduced upon ground command by offsetting the solar array from the sun line to reduce array power output. During eclipse operations, the load bus is fed directly from the battery without any boost regulator, the bus voltage ranging from 29.5V at the beginning of discharge down to 24.5V at the end of the maximum 72-minute eclipse at full load. Maximum battery performance, in terms of depth of discharge throughout the eight-year mission life, is obtained by a combination of depressed temperature operation, trickle charge during the five month period between eclipses, and reconditioning by deep discharge and fast recharge prior to each eclipse season. Risk of cell back bias or reversal during reconditioning is avoided by individual discharge resistors for each of the 22 cells per battery. Each of the three batteries has its own charge regulator with internal redundancy.

Input converters in each subsystem translate the 24.5V to 35.5V range of the load bus to their specific requirements at constant power and efficiency. Elimination of a central power system series regulator or of a battery boost regulator both decreased spacecraft weight and increased reliability.

## Attitude and orbit control subsystem

A bias momentum type of three-axis body stabilization is employed because of its high reliability with few mechanical mov-

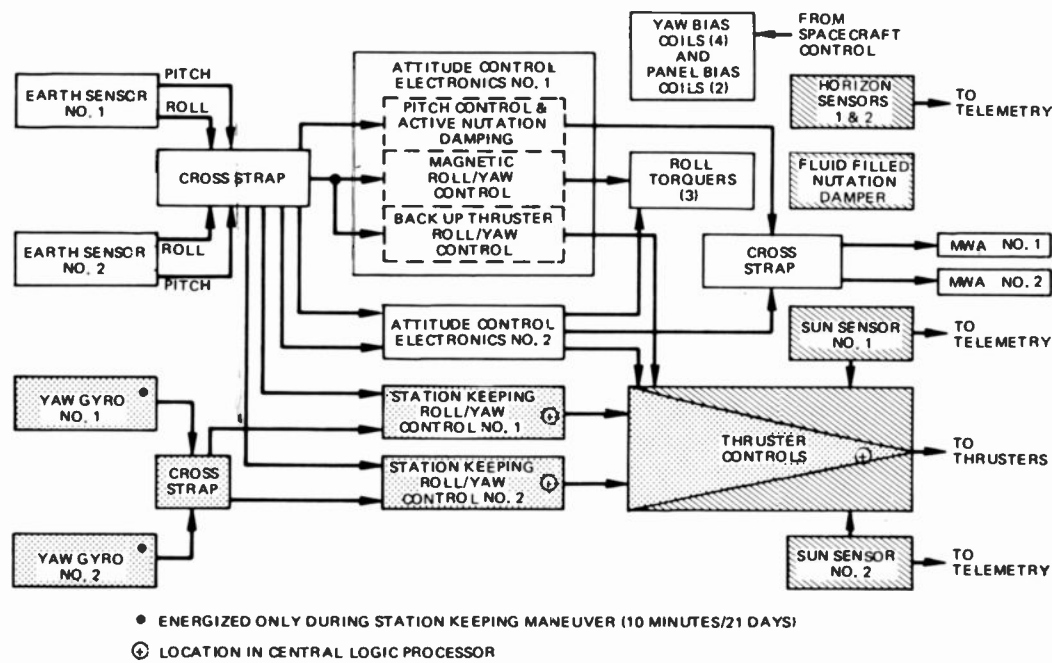

Fig. 5. Attitude control diagram.

ing parts and absence of a yaw sensor (Keigler, Lindorfer and Muhlfelder, 1972). In this Satcom application of the Stabilite® control technique developed by RCA, a single fixed-axis momentum wheel provides precision three-axis pointing of the body-mounted antennas by virtue of the inertial stability of the wheel angular momentum vector plus servo-controlled interchange of momentum between the wheel and the spacecraft body. Maintenance of the wheel momentum vector, and hence the spacecraft pitch axis, parallel to the orbit normal is achieved automatically by magnetic torquing, requiring no expendables or moving parts (Schmidt, 1975). Because of the quarter-orbit interchange of roll and yaw errors due to the inertial stability of the angular momentum vector, both roll and yaw control are thus accomplished by continuously nulling the roll error.

Momentum exchange between the wheel and spacecraft body in response to pitch error signals maintains the desired antenna pointing in the east-west direction, with off-set pointing in  $0.01^\circ$  increments over a  $\pm 5^\circ$  range available by ground command. A component of the roll error signal is also used in the pitch control loop to achieve active nutation damping (Phillips, 1973).

In addition to the primary control loop for long-term operation shown in the upper half of Fig. 5, a second fast response loop shown is activated for the periodic intervals of velocity change or orbit control in both the north-south and east-west directions.

This secondary control loop varies the duty cycle of the four north-pointing thrusters to achieve simultaneously orbit inclination thrusting and active roll-yaw attitude control (Cenker, 1974). For the half hour duration of this maneuver once per month, the gyro shown is energized to furnish a yaw reference to the control logic.

All components of the three-axis attitude control system are duplicated and cross-connected as shown for increased reliability with no single point failure mechanism. Even with this full redundancy, the total attitude control weight is only 25.2 kg (55.5 lb). Minimum weight and no single point failure conditions were also the criteria for the reaction control system design (Balzer, *et al.*, 1976). By combining the inclination and attitude control functions and by using the same thrusters for transfer orbit maneuvers and on-station velocity control, only twelve thrusters are required for a fully redundant system. Within each of the four cross-connected tanks, surface tension webs furnish liquid propellant expulsion from the integrally pressurized system without the risk incurred by elastomeric bladders.

## Structure

In addition to minimum weight, the design criteria for the structure to support the three-axis stabilized spacecraft were: ample area for component mounting and thermal radiators; maintenance of antenna

alignment and pointing accuracy; physical access to components during system testing; and flexibility of equipment layout to accommodate changes in the number, size or weight of components. The resultant large rectangular box structure employs a modular design for ready access to all internal equipment as shown in Fig. 6. A central column of monocoque construction carries the launch loads to the launch vehicle interface and mounts the apogee kick motor within. Except for earth sensors, all of the equipment boxes are mounted on the two large honeycomb panels which face north and south in orbit for efficient radiation cooling. These two equipment panels are integrated and tested electrically before assembly to the central structure; structural integrity and alignment is retained upon subsequent removal and reinstallation of any of the east-west shear panels or the north-south equipment panels. Total weight of this structure, including associated mounting brackets is 49.6 kg (109.3 lb) or only 5.7 percent of the transfer orbit weight of 867.6 kg (1913 lb).

## Earth stations

The terrestrial components of the RCA Americom satellite communications system are as diverse and geographically scattered as the types of services and customers; both RCA-owned and customer-owned stations are employed. Totalling approximately 2500 earth stations at present, as shown in Figs. 7 and 8, the antennas range in diameter from 4.5 to 30 meters. Both cooled and uncooled



Fig. 7. Vernon Valley earth station.

receivers are employed, with noise temperatures varying from 55° to 180° K, while the high power amplifier outputs range from 25W to 3 kW. These characteristics are summarized in Table II. Figures 9 and 10 illustrate this diversity in size, complexity and cost of the earth stations.

In addition to the communications stations, there are two TT&C stations for operational control of the satellites. Located in northern New Jersey (Vernon Valley) and southern California (South Mountain), these two stations are interconnected and interchangeable for full functional redundancy, with each designed to operate four or five satellites simultaneously. Each is equipped with a high speed 13 meter tracking antenna



Fig. 8. Alaskan bush earth station.

which, used in conjunction with leased International Telecommunications Satellite Consortium (Intelsat) terminals in Cannarvon, Australia, and Fucino, Italy, enables RCA to track the satellites during the transfer orbit phase and command them for orientation maneuvers and apogee kick motor firing. Co-location of the TT&C stations with two of the major earth stations achieved economy both of site installation and operations personnel, as well as providing the capability to operate several satellites by using the fixed antennas in addition to the tracking antennas for command and telemetry.

## Services

The various types of services are summarized in Table III along with the achieved service availability.

To furnish long distance telephone facilities and communications services within the state of Alaska plus interconnecting services with the lower 48 states, Americom leases satellite transponders and terrestrial facilities to Alascom, Inc., the long-lines carrier for Alaska. The most significant achievement of the Alascom system has been the provision of telephone and TV service to approximately 200 "bush" communities, some as small as 25 people. Low cost was maintained by employing two video channels in a single 36 MHz transponder and SCPC for the voice circuits.

In the lower 48 states, Americom has constructed a network of earth station and microwave links connected to central terminal offices (CTO) for private leased channel and TV service to New York, Los Angeles, San Francisco, Chicago,

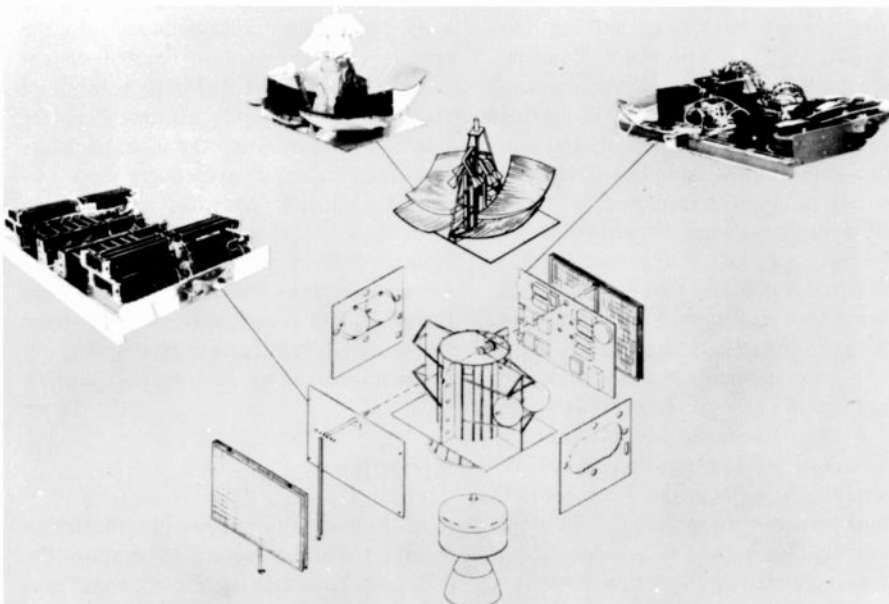

Fig. 6. Structure (exploded view).



**Table II. Earth station characteristics.**

Antenna Size (meters)	Receiver Noise		Transmit Power (W)	Number Installed	Service	Type of Transmission
	Temperature (°K)	G/T (dB/°K)				
13 & 11	55	32	400-3000	16	Commercial	FDM/FM (telephone); FM (TV)
5	120	22	—	2500	TV/RO	FM
11	105	30	75-400	20	Government dedicated, medium capacity data	BPSK & QPSK (data); FM/SCPC (telephone); FM (TV)
10	120	29	400	10	Alaska Midroute	FDM/FM and SCPC
4.5	180	19	25-75	200	Alaska Bush	FM/SCPC, BPSK, SCPC
30	95	39.5	250	1	Alaska Interstate	FDM/FM and SCPC
17	70	36	400	2	Alaska Intrastate	FDM/FM, BPSK, SCPC and FM (TV)

Philadelphia, Houston, Atlanta, Wilmington and Dallas. The CTOs act as a concentration point for local loops originating at the customer premises. At the CTO, the individual circuits are frequency division multiplexed into a single composite baseband for transmission over the microwave link to the earth station where microwave FDM equipment interfaces at the group or supergroup level for transmission to the satellite as a multi-destination r.f. carrier. At the receive end, the groups and supergroups destined for that city are de-multiplexed for transmission to the CTO via the microwave system.

A variety of television services are offered on the RCA Americom System. These range from point-to-point transmissions for the major networks using the major commercial ground facilities, to economical but high quality TV to the Alaskan bush as previously mentioned. The fastest growing market is the cable television program distribution service. RCA provides 20 full transponder channels to the CATV industry on satellite F-2. The Satcom D spacecraft, presently being prepared for launch in June 1981, will be dedicated to this service. More than 2500 customer-owned earth stations, some with antennas as small as 4.5 meters, receive these channels for retransmission to private homes on local CATV cable distribution facilities. RCA Americom provides uplink service for many of these programs, but some customers access the spacecraft using their own transmit stations. For these and network TV services, RCA Americom provides Television Operations Centers (TOC) in New York and Los Angeles to monitor and control incoming and outgoing signals.

In addition to TV program material, some of these channels have additional subcarriers inserted into the TV baseband

for slow-scan pictures, facsimile and studio-to-studio cue channels. A second audio subcarrier can also be inserted on the TV baseband for stereo audio.

Dedicated earth stations on the customer premises are presently serving NASA, NOAA, DoD and other departments of the federal government. RCA Americom pioneered digital transmissions at higher bit rates and lower error rates than had ever been achieved on terrestrial systems. There are presently 28 dedicated earth stations operational, under construction or planned in the Government Services Network. A typical government earth station carrying wideband traffic is designed for a figure of merit of about 30dB/°K. These stations typically provide wideband data services between 56 kb/s and 1.544 Mb/s, but are also used for thin-route SCPC voice grade and television communications and have also been used for Armed Forces recreational and instructional television programming to

locations in Alaska, CONUS and the Panama Canal Zone.

### Future system growth

The high utilization of the currently available Americom channel capacity has necessitated plans for expansion of both the space and earth station segments. Increases in the number of operating satellites and earth stations, as well as in their traffic capacity, are scheduled for introduction over the next few years.

*Satellite Evolution*—Now under construction are two satellites, Satcom D and E, scheduled for launch in mid and late 1981. During the period of transition from expendable launch vehicles to the space shuttle, they will be compatible with both the Delta 3910/PAM and the STS/PAM (Perigee Assist Module, the Spin Stabilized Upper State Delta being developed by McDonnell-Douglas as a



**Fig. 9. Americom network — CONUS.**

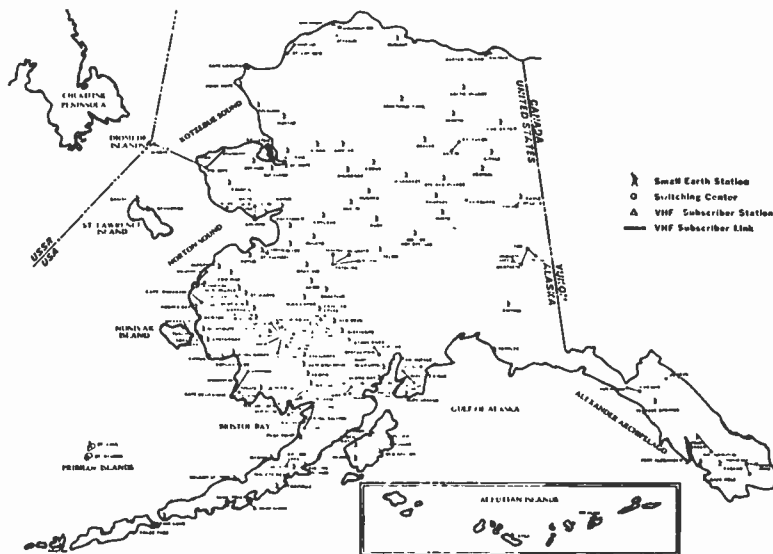

Fig. 10. Americom network — Alaska.

common transfer orbit stage motor assembly for launch by either Delta 3910 or the space shuttle). While retaining the volume limitations of the Delta fairing, this launch configuration has an increase in the minimum transfer orbit weight to 1088 kg (2400 lb).

The additional spacecraft weight is divided among four spare TWTAs, larger capacity batteries, and increased

propellant to achieve ten-year mission life. Each of the four spare TWTAs is associated with six of the transponder channels and can be operated by ground command to replace any one of those six TWTAs as illustrated in the signal switching diagram of Fig. 11. Substitution of 17 A-Hr battery cells for the 12 A-Hr size on F-1 and F-2 will permit operation at lower depth of discharge for enhanced

reliability. Minor improvements in the attitude control system are also included to reduce the number and frequency of ground commands while achieving high antenna pointing accuracy. The additional weight will also permit the spacecraft to carry TWTAs of 2 dB higher power output in six of the channels, which are primarily for Alaskan traffic, plus a 25 percent increase in the stationkeeping propellant load to extend the mission life from eight to ten years. To meet the continued demand for additional channel capacity and provide replacements for the first two satellites upon depletion of their stationkeeping propellant, Americom has selected a second generation satellite design of higher traffic capacity yet lower cost per transponder channel per year. Like the first four, the second generation satellites will be designed, fabricated and controlled into orbit by RCA Astro-Electronics. These new spacecraft will achieve an increase in the EIRP per channel by combination of higher transmitter power and antenna gain from shaped beams. Propellant supply, power system capacity, and component reliability will be sufficient to ensure a ten-year mission life with continuous operation of all channels.

This larger, second generation spacecraft will retain the basic features of its predecessors, namely three-axis body stabilization, sun-oriented solar panels and cross-gridded antenna reflectors for frequency reuse. Increased traffic capacity per channel will be provided by a combination of improved power amplifier linearity, sharper multiplex filter response and higher EIRP. Key to the realization of increased power, linearity and reliability will be the use of solid state power amplifiers (SSPA) in lieu of the conventional traveling wave tube amplifiers for the output stages of the transponder. Recent advances in gallium arsenide field effect transistor (GaAs FET) technology have demonstrated their maturity for space application (Drago, *et al.*, 1979). Without the cathode wearout mechanism of a TWT, the GaAs FET SSPA will greatly improve reliability and channel availability for a ten-year mission. Coupled with the higher transmitter power output, increased antenna gain from shaped beams will result in an EIRP per channel of 35 dBW at beam edge. In order to power the higher power communications payload continuously for ten years, the solar array for the second generation spacecraft will be 11m<sup>2</sup> (120 ft<sup>2</sup>), compared to the 7m<sup>2</sup> (75 ft<sup>2</sup>) of the current satellites.

Table III. Service characteristics.

Type of Service	S/N, dB, or BER	Transmission/Modulation Technique	Availability <sup>1</sup>
Private Leased Channel (PLC) C4 telephone services	50 <sup>2</sup>	FDM/FM	99.83 (incl. local loops) 99.99 (CTO to CTO)
Network NTSC quality TV.			
Video:	56 <sup>3</sup>	FM	99.96
Audio:	65 <sup>4</sup>	FM Subcarrier	
Cable TV (Americom provides uplinks only):	48 - 54 <sup>3</sup> (depends on customer station G/T)	FM	99.99
Program audio; CTO to CTO	55 <sup>4</sup>	FDM/FM	99.95
Dedicated Government C4 telephone and AVD ckt.	43 <sup>2</sup>	SCPC/FM	99.92
Two TV per transponder to Alaska. (Americom provides uplink only.)	48 <sup>3</sup>	FM	99.99
Dedicated SCPC Government data (56 kbps to 15 Mbps)	1x10 <sup>-7</sup>	BPSK & QPSK	99.9
Voice-band PLC data (to 9600 bps) CTO to CTO:	1x10 <sup>-5</sup>	FDM/FM	99.8

Notes:

1. All availabilities are actual measured averages.
2. S/N for PLC service is defined as 0 dBmo test tone to psophometrically weighted noise ratio.
3. S/N for video is defined as peak-to-peak luminance to RMS weighted noise ratio.
4. S/N for audio is defined as peak program level to flat weighted noise ratio.

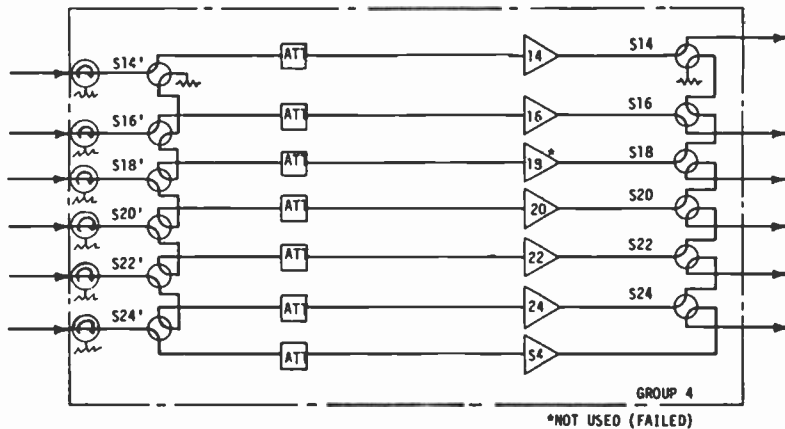

Fig. 11. Redundancy switching network.

## Terrestrial installations

In addition to the voice, data and TV services presently being provided by the Americom system, RCA is planning future service offerings which will expand and diversify its role in the telecommunications market.

Wideband data communications service between customer locations, known as "56 Plus," will be provided by the installation of dedicated 5-meter duplex earth stations located at the customer's offices, or the customer can use RCA stations. These stations will be remotely monitored and controlled from a master station in the commercial earth station system. All data carriers are error-correction coded by a rate 7/8 convolutional encoder and threshold decoder to conserve transponder power. The wideband digital carrier(s) can either be a single wideband data carrier of 56 kbps, or a time division multiplexed digital carrier consisting of any combination of lower data rates or two delta encoded voice-grade channels. Standard performance for this service is a bit error rate of  $1 \times 10^{-7}$  at an availability of 99.95 percent. This availability is achieved by full redundancy of all electronic subsystems with automatic switching to "hot standby" back-up units.

A Selective Multiple Address Radio & Television System (SMARTS) is one of Americom's latest innovations in the video and audio telecommunication market. Americom will install at existing network radio or TV affiliates' studios a receive-only earth station for reception of syndicated programming that has been scrambled for security and controlled by an access code from a central master station. The control system automatically controls remote station access and establishes billings based on usage.

RCA Americom and RCA Laboratories

have undertaken an extensive research program with the aim of realizing multiple video per transponder capability services. Preliminary results of this program indicate that the second generation Satcom spacecraft will indeed have the ability to support two video signals per transponder.

Using receive-only earth stations as small as 3 meters in diameter, radio programming of 5, 8, or 15 kHz bandwidth is being offered for point-to-multipoint radio network distribution. This system has been successfully demonstrated to news and audio program distributors and is now being tested at five locations.

The existing channel capacity of FDM/FM carriers will be increased by as much as 100 percent by compressing the dynamic range of a voice signal in the transmission channel and expanding to its original range at the receiver. A signal-to-noise improvement is attained by the attenuation of channel noise during idle periods which contain no voice activity, resulting in a net compandor improvement of about 12 dB including the increased loading effect of higher average channel level on the baseband. This signal-to-noise improvement can then be decreased to the initial uncompanded level by reducing the FM deviation to allow additional channels to be added to the FDM baseband.

Additional expansion of system channel capacity will also be achieved by increasing the G/T at Americom's commercial stations through upgrading of the receivers. State-of-the-art designs with thermo-electrically cooled parametric amplifiers of approximately 30°K noise temperature are being phased into these main terminal stations.

## References

Balzer, D., Y. Brill, W. Scott, and P. Sing (1976). The monopropellant hydrazine reaction control system for



**John Christopher,**  
Vice-President,  
Technical  
Operations, RCA  
Americom, joined  
RCA Global Com-  
munications, Inc.  
in November, 1973.  
In July, 1974, he  
was appointed  
Director, Space

Systems with responsibilities for the implementation of the Satcom System's space elements.

In July, 1977, he was appointed Vice-President of Technical Operations with responsibilities for Engineering and Operations of Americom's overall terrestrial and space facilities.

Contact him at:  
**RCA Americom**  
**Princeton, N.J.**  
**TACNET: 258-4240**



**John Keigler,**  
Manager, Com-  
munication  
Satellite Systems,  
RCA Astro-  
Electronics (AE)  
joined AE as a  
Systems Engineer  
working on TIROS  
ground equipment  
and secure com-  
munications systems using satellite

relays. Dr. Keigler led the system design team whose work culminated in the RCA Satcom Program. For this effort he received the David Sarnoff Award for Outstanding Technical Achievement.

Contact him at:  
**RCA Astro-Electronics**  
**Princeton, N.J.**  
**TACNET: 229-2848**

the RCA Satcom satellite. *AIAA/SAE Propulsion Conference*, Palo Alto, California, 26 July.

Braun, W., and J. Christopher (1979). EIRP of the Satcom cable television spacecraft *National Cable Television Association Convention*, Las Vegas, Nevada, 21 May.

Center, R. (1974). *AIAA Paper No. 74-294*, 5 August.

Drago, F., J. Hawley, H. Huang, and F. Sechi (1979). *IAF Paper No. 79-310*, 22 September.

Keigler, J. (1978). *ACTA Astronautica*, Volume 5, No. 3-4. Pergamon Press, pp. 219-242.

Keigler, J., W. Lindorfer, and L. Muhlfelder (1974). *Progress in Astronautics and Aeronautics*, Vol. 33. MIT Press, pp. 141-161.

Keyes, L., C. Kudzia, and V. O'Donovan (1973). *RCA Review*, Vol. 34, 506-538.

Langhans, R., and R. Lansey (1977). RCA American Communications System. *Proc. Intelcom '77*, Atlanta, Georgia, 9-15 Oct.

Phillips, K. (1973). *IEEE Trans Aerospace and Electronic Systems*, Volume AES-9, 688-693, September.

Raab, A. (1976). Cross-polarization performance of the RCA Satcom frequency reuse antenna. *IEEE/AP-S Symposium*, Amherst, Massachusetts, 11 October.

Schmidt, G. (1975). *AIAA Paper No. 75-1055*, 20 August.

# RCA Service Company: a review

*Its operations are worldwide in scope and variety.*



---

**Abstract:** *As the service arm of RCA Corporation, RCA Service Company provides support to the systems and equipment manufactured by RCA at RCA's plants and at user locations. It has at the same time broadened its business base to encompass products and services independent of the product lines of other RCA operations.*

---

RCA Service Company is known to many of you in RCA's manufacturing divisions for the support we give to your products and to your customers—in commercial broadcast stations, for example, or in the home, in business offices and institutions, in industry, or at Department of Defense, NASA, or other government installations throughout the nation—and indeed the world. Less well known, perhaps, are the many other products and services aggressively marketed by our Consumer, Technical, and Government Services departments and our international service divisions. While backed by and often made possible through our identification with RCA Corporation, these products and services are essentially unrelated to other RCA operations. Included are such products as interconnect telephone systems, data communications terminals and systems, and support services in such areas as overseas airfield construction, water research, security systems and federally funded manpower programs.

---

Reprint RE-26-1-10  
Final manuscript received June 23, 1980.

## A brief look back

The RCA Service Company's broad franchise is but a reflection on a smaller scale of the growth and diversification that have marked RCA from its beginnings in 1919 as a relatively modest communications firm.

Looking back, for example, to 1955, the year which saw the birth of the *RCA Engineer*, we were organized as RCA Service Company, Inc., a subsidiary of the Radio Corporation of America (Table I). Color television was in its infancy, and our involvement with other home appliances was on the verge of a significant change. Electronics still meant vacuum tubes, not solid state. Government Services consisted largely of a small army of field engineers and instructors supporting a large inventory of post-Korea military hardware at worldwide locations. Our Missile Test Project was two years old and growing. There were yet no intercontinental missiles, no early warning systems. No space race. No war on poverty. By 1980, all of those developments were upon us. Or behind us. And we have responded to them, as has the rest of the corporation, by changing and by growing.

The RCA Service Company of 1955 was originally formed in 1944 in response to the extraordinary demands for support to the government that came with World War II. From 1935 until then we were the Installation and Service Department of RCA Manufacturing Company, Inc. But our roots go deeper than that. They include the service department of the Victor Talking Machine Company, acquired in 1929;

**Table I. RCA in 1955: notes from a time capsule.**

- In 1955, the Radio Corporation of America, under Chairman of the Board David M. Sarnoff and President Frank M. Folsom, employed 80,000 people and achieved its first \$1 billion in sales. Its manufacturing units were organized into RCA Consumer Products, Defense Electronic Products, and Commercial Electronic Products.
- RCA Service Company, Inc., still under its first President, Edward C. Cahill, settled into its new headquarters facility in Cherry Hill, N.J., which it shared with two RCA divisions—RCA Victor Television and RCA Victor Radio and "Victrola."
- Edgar A. Griffiths served as Manager, Budgets and Procedures in RCA Service Company's financial activity.
- Consumer Products Services had 160 TV branches nationwide, which were gearing up to support both expanding color television sales and the broad home appliance requirements of the new alliance between RCA and the Whirlpool Corporation.
- In Florida, Government Service's Missile Test Project grew to over 1100 employees. (It would ultimately peak at over 4000 in the 1960s at the height of support to the NASA program to put man on the moon.)

---

RCA Photophone Company, organized in 1928; Radiomarine Corporation of America, 1927; the National Broadcasting Company, 1926; the Technical and Test Department of RCA, established in New York City in 1921; and the fledgling field service staff that, during the corporation's first year (1919-1920), took up operation of what was formerly the American Marconi Company.

## Today

What follows is a brief look at what RCA Service Company is doing today within its three domestic operations—Consumer, Technical and Government Services—and its International Operations, including the Service Divisions of RCA Limited, United Kingdom and RCA Limited, Canada.

## Consumer Services

Consumer Services comprises both consumer and commercial products and services. It has nearly 5000 employees nationwide. Activities are directed from its Cherry Hill, New Jersey headquarters through four regional offices and fourteen district offices. Its base is a nationwide network of 165 branches.

### *Residential services: TV and appliances*

The service branches install and service RCA TV and other home entertainment equipment and Whirlpool appliances. They perform warranty service for the Consumer Electronics division and offer service plans to owners of television receivers, video cassette recorders (VCRs), and appliances. Over one million such plans are currently in force. Consumer Services has maintained this high level of sales despite continuing improvements in the quality and reliability of newer RCA TV sets, both through sustained marketing of color TV service plans and the rapid expansion of the appliance portion of the business, which now accounts for over 235,000 of the plans in force.

In addition, the demand for service business has been stimulated through the national promotion of guaranteed service on the day promised—or no charge for the TV or appliance service provided.

### *Commercial products: institutional market*

Commercial products for hotels/motels, hospitals and schools—generally referred to as the institutional market—are marketed, installed and serviced through the branches. The product line consists of specially designed TV receivers, master antenna systems, varied communications and control equipment, TV accessories, and telephone systems. RCA is the leading supplier of television sets and electronic systems to the institutional market.



RCA Service Company Headquarters, Cherry Hill, New Jersey.

### *Commercial products: Telephone Systems*

Telephone Systems, which markets through the branches to business and industry as well as the institutional market, represents RCA Service Company's fastest growth area. Growth has been particularly rapid in business telephone systems, as business executives become increasingly aware of the economic benefits and improved features available to them through the purchase or lease of an interconnect telephone system. Servicing is a key selling point in this market, and the ready availability of high-quality installation and maintenance services through the branches has been a major factor in RCA's success with this product line. RCA Service Company also has the flexibility to choose the latest telephone equipment from a wide variety of manufacturers, enabling it to customize telephone systems to meet the specific needs of the individual customer. With a current base of over 500,000 telephone lines installed and expectations of reaching 600,000 by the year's end, RCA has assumed a strong leadership position in the interconnect telephone market.

### *Support functions*

Consumer Services' engineering support requirements include: engineering liaison with RCA Consumer Electronics and other

RCA divisions concerning new product development; review and evaluation of vendor manufacturing and quality control processes; and coordination with manufacturers and vendors to assure compliance with the requirements of regulatory agencies and underwriters.

Other essential functions within Con-

### **Table II. Consumer services highlights.**

#### *Consumer services*

- Residential TV
- Institutional TV
- Video cassette recorders
- Whirlpool appliances
- Service plans
- Interconnect telephone systems
- Master antennas, TV accessories
- Commercial communications/control equipment

#### *Highlights*

- Over 2500 installation/service technicians
- 165 service branches nationwide
- Over 1,000,000 TV/appliance service plans (over 235,000 appliance plans)
- A service call completed every 3 seconds
- A service plan sold every 9.6 seconds
- Over 500,000 telephone lines installed

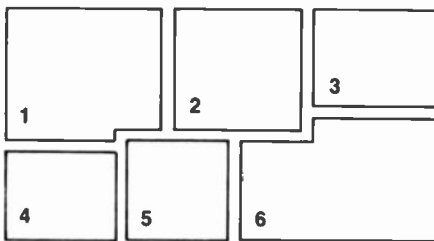

1. Television servicing at RCA Service Company branch. 2. Theater sound system servicing. 3. Mobile radio servicing on-site. 4. Teletypewriter servicing. 5. Electron microscope servicing. 6. Surveillance system console in Canadian bank.

sumer Services are training and technical performance evaluation. Training centers are operated in the Chicago, Los Angeles, New York and Philadelphia areas. They offer ongoing training and refresher courses in TV and VCR repair, along with specialized training in appliance, telephone systems and commercial products installation and maintenance, enabling RCA's technicians to keep pace with advancing technology and new product orientation. Information from each technician's daily time card is computerized for measurement against a nationwide standard; this provides early warning on problem areas and enables counseling and further training to be arranged as needed.

## Technical Services

Technical Services employs nearly 1,000 people in two principal activities — Data Services and Industrial Electronic Services. Its nationwide service operation is headquartered in Cherry Hill, New Jersey and controlled through seven regional offices.

### Data Services

Data Services leases, installs, and services teleprinters and peripheral equipment, and offers third-party maintenance of large-scale reservations and communications equipment for airlines, auto rental companies, financial institutions and other communications-intensive organizations. While the RCA Service Company has serviced teleprinters for many years, Data Services' sales growth is comparatively recent, moving from its status as minor sales contributor ten years ago, to where it now accounts for approximately 70 percent of Technical Services' total sales. It now has over 39,000 terminals under contract.

*Teleprinters, video display terminals and peripheral equipment* from many different manufacturers are offered by Data Services in its lease/service program. The rapidly changing state of the art in communications has required constant review and revision of business and marketing strategies and inventory controls to meet customer needs and assure achievement of profit objectives. In 1976, the GE TermiNet 30, capable of transmitting thirty characters per second (cps) — three times the pace of the slow-speed equipment generally in use at that time — was added to the line. Since then, in keeping with

market demand, three additional highly advanced terminals have been added: the Zentec video display terminal, the Teletype

**Table III. Some technical services highlights.**

#### Data services

39,000 terminals under lease/service contract

19,000 terminals under third-party maintenance contract

400 technicians in 180 cities nationwide

Major customers:

American Airlines	Hertz
Eastern Airlines	Avis
Commodity News Service	Avco

#### Industrial electronics services

Broadcast transmitting and studio equipment

Video tape duplicating

Marine electronics (servicing and sales)

Mobile radio and microwave systems (15,600 units)

Satellite communications earth stations

Theater sound and projection equipment (3200 theaters)

Electron microscopes (over 300 units)

CCTV systems

Surveillance systems

Industrial equipment

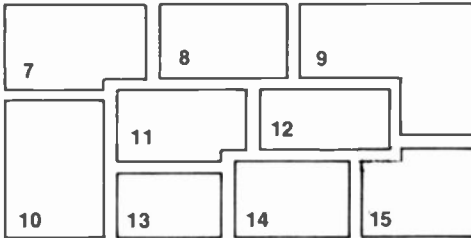
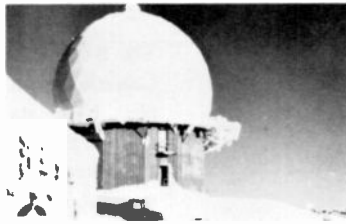
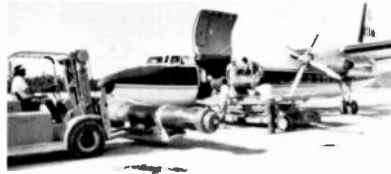

7. Ordnance handling at AUTEF. 8. Torpedo off-loading from AUTEF FH227 aircraft. 9. RCA Aerostat Systems' tethered balloon. 10. Radar maintenance at Eastern Test Range. 11. MPS-36 radar at White Sands Missile Range. 12. BMEWS radomes at Fylingdales, England. 13. AC&W radome at Campion, Alaska. 14. Welding students at Job Corps Center. 15. Air base construction site in the Negev, Israel.

Model 43, and the GE TermiNet 200 which can transmit 200 cps.

*Third-party maintenance* also is provided on a contract basis by Data Services on 19,000 customer-owned data terminals. With this portion of the business growing at 30 percent a year, the RCA Service Company anticipates continuing expansion of its Data Services base throughout the eighties.

Except for the common carriers, such as the telephone companies and Western Union, Data Services maintains the nation's largest field force of data communications technicians — over 400, based in some 180 cities. To maintain the skills of its staff, Data Services conducts an ongoing Technician Improvement Program consisting of performance review and training. New product and refresher training is carried out under training coordinators at seven district offices.

### Industrial electronics services

This Technical Services activity primarily services RCA-manufactured equipment,

along with products that RCA no longer makes, such as marine and theater equipment and electron microscopes. Major equipment lines serviced include Broadcast, Marine, Mobile/Microwave, and Theater and Industrial.

*Broadcast Services*, with one of the largest and most comprehensive service organizations in the broadcast field, installs and maintains all types of radio and TV antenna systems, transmitters and studio equipment, including control consoles, cameras and video tape recorders. Services marketed include contract preventive maintenance, on-call emergency support, and — primarily for nonbroadcast clients — a Chicago-based video tape duplicating service.

*Marine Services* installs and maintains radio, television, sonar, depth-finding and navigation equipment from centers located near key United States ports. A line of navigation and communications equipment is also offered for sale.

*Mobile/Microwave Services* provides contract service for two-way radio systems, including base stations and mobile units, with service provided at customer sites and through mobile drive-in shops. It also installs and services earth stations for satellite communications systems.

*Theater/Industrial Services* installs and

maintains theater sound and projection equipment, including special-effects systems such as Sensurround, used for such films as "Earthquake" and "Battlestar Galactica." With 21 percent of this market — 3200 of the nation's 15,000 theaters — RCA Service Company is number one in the field. It also continues electron microscope servicing, which it pioneered when RCA manufactured the instrument, and currently has over 300 units under contract. Among more recently added activities with excellent growth potential is the installation and servicing of closed-circuit television systems, particularly for surveillance applications.

## International Operations

### RCA Limited (United Kingdom)

The Service Division of RCA Limited, United Kingdom, employing nearly 12,000 people, is organized into the Ballistic Missile Early Warning System (BMEWS) Project. Field Services and Systems Services, plus a new acquisition, RCA Security Systems Limited (formerly Granley Security Systems).

*The BMEWS Project* is in its sixteenth year of operation and maintenance of

**Table IV. Worldwide government services, 1955-1980.**

1955	AAF Microwave Installed <i>Central Europe</i>
1955-62	Army School Instructors (500) <i>Ft. Bliss, Ft. Monmouth Ft. Sill, Redstone Arsenal</i>
1956-59	Troposcatter Installation <i>Labrador, Newfoundland Iceland, Texas Towers.</i>
1955-80	Missile Test Project <i>Florida to Indian Ocean</i>
1958-61	Calibration Depot O&M <i>Chateauroux, France</i>
1958-64	ICBM System Installations <i>Atlas, Minuteman, Titan (CONUS)</i>
1959-80	TRADEX-PRESS Support <i>Kwajalein</i>
1960-63	ComLogNet/AUTODIN Installation <i>Nine centers, CONUS &amp; Hawaii</i>
1960-69	White Alice Communications O&M <i>88 sites, Alaska</i>
1961-69	BMEWS O&M <i>Greenland, Alaska, England</i>
1962-65	Microwave Installations <i>Spain, Turkey/Iran/Pakistan</i>
1964-66	412L System Installed, O&M <i>West Germany</i>
1964-80	Navy Weapons Range O&M <i>Puerto Rico</i>
1966-70	Project Jenny TV Broadcast <i>South Vietnam</i>
1966-80	Navy Test/Evaluation Ctr O&M <i>Bahamas</i>
1966-80	Dept. Labor/Job Corps Program <i>13 centers nationwide</i>
1968-69	STRATCOM Link Testing <i>Southeast Asia, Europe</i>
1968-69	Calibration Depot O&M <i>Moron, Spain</i>
1971-80	NASCOM Engineering <i>Worldwide network</i>
1972-75	DEW Line/NARS/BMEWS O&M <i>Alaska, Canada, Greenland, Iceland, Great Britain</i>
1977-80	AC&W System O&M <i>13 sites, Alaska</i>
1979-80	Air Base Life Support <i>Ramon, Israel</i>
1980	GEODSS Network Installation <i>Korea, Hawaii, CONUS</i>

BMEWS Site III in Fylingdales for the RAF and will participate under its latest contract in that system's modernization.

*Field Services* furnishes technical support to military and civil agencies. It is currently installing a security and surveillance system for the presidential palace

in Egypt. This U.S.-funded effort, like RCA Service Company's current airfield contract in Israel, resulted from the Israeli-Egyptian peace treaty of 1979. Field Services also operates the sea surveillance radars of the British Underwater Test and Evaluation Center (BUTEC) in the Outer

Hebrides and maintains motorways signalling equipment in the Birmingham area.

*Systems Services* is engaged in the supply of mini- and microcomputer-based real-time control systems for the process industries — oil refining, chemicals, and steel — in the northeast of England.

*RCA Security Systems Limited* designs, installs and services intrusion and fire detection systems for the commercial, industrial and residential markets. It has over 17,000 installations, serviced by over 400 employees from 24 branch offices in England, Scotland and Wales.

### *RCA Limited (Canada)*

The Service Division of RCA Limited in Canada employs approximately 300 people. Like its RCA Service Company counterpart in the United States, it furnishes a wide range of consumer, commercial, and industrial services.

*Consumer service branches* situated from the Maritime Provinces to British Columbia install and maintain TV and other home appliances and furnish warranty service on RCA consumer electronics products.

*Commercial systems and services* are marketed in such areas as closed-circuit television, sound systems, and audiovisual systems. CCTV systems for monitoring and surveillance are installed in such locations as industrial plants, banks and transportation facilities. The Service Division constitutes the largest Canadian customer for CCTV systems from the RCA Solid State Division in Lancaster.

RCA Limited also designs and installs such audiovisual systems as language laboratories and radio/TV studio installations for junior colleges, and custom sound systems, including simultaneous translation systems. One recent sound project was for a six-language translation system for the headquarters of the International Civil Aviation Organization in Montreal. RCA also is installing courtroom audio taping systems in Quebec — a new market with nationwide potential.

## Government Services

Government Services furnishes technical, educational, and support services to federal, state and local government agencies and to their prime contractors, including other divisions of RCA. Government Services' 7,000 employees are assigned to RCA and customer locations



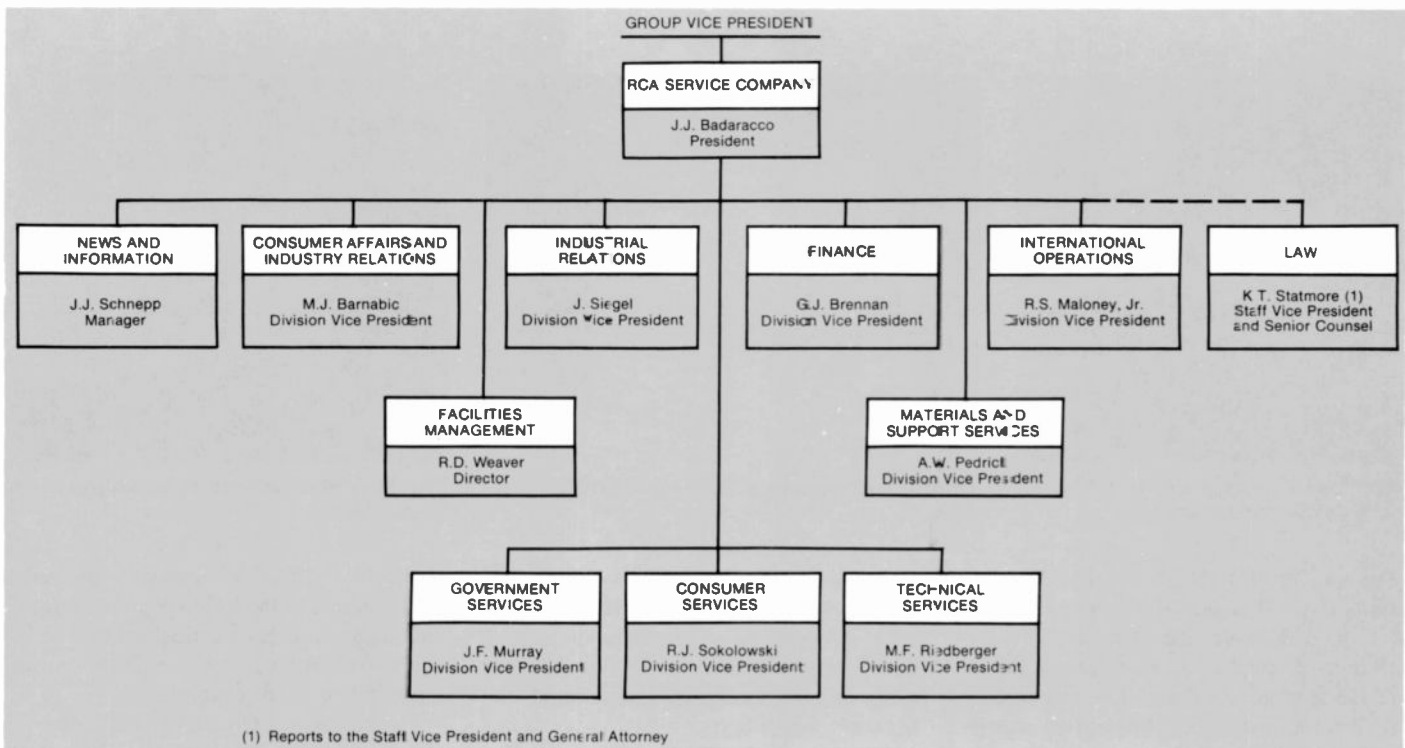

RCA Service Company Organization.

nationwide—and overseas—in support of a broad range of government-funded defense, aerospace and manpower programs.

### Base support services

The newest major undertaking in Government Services, begun in 1979, is its contract for life support services at Ramon, Israel, in connection with the construction of a military air base in the Negev—an outgrowth of the peace agreement between Egypt and Israel. The 400-man RCA workforce furnishes food, housing and custodial services, a fire and security guard force, supply support, and operates the construction base hospital. Additional business of this type being performed within the United States includes housing maintenance at West Point, New York, motor vehicle services at Columbus Air Force Base, Mississippi, and base support services at the U.S. Army St. Louis Area Support Center.

### Education services

This Government Services activity furnishes professional educational services to federal, state and local government agencies. It currently operates 13 residential Job Corps Centers nationwide, making RCA the largest private contractor

to the U.S. Department of Labor for such services. Aggregate RCA staffing at these centers is over 1600. The 6000 students—unemployed or underemployed youths 16 through 21 years of age—are provided basic education, vocational skills training, and social and other life support services essential to prepare them for meaningful employment.

Other Education Services projects include the education and training of juvenile offenders for the State of Pennsylvania at three correctional centers; career development projects for the State of West Virginia; CETA job training and placement services in New York City, which have successfully secured employment for over 5,000 enrollees in the past five years; and the preparation of self-paced curricula for U.S. Army training programs.

### Intracorporate support and field engineering

Government Services continues to provide traditional factory and field engineering, technical training, and documentation support to RCA Government Systems and other RCA divisions. Major programs so supported currently include AEGIS, the Trident Integrated Radio Room, TRADEX-PRESS and a number of secure communications projects.

Other efforts include European field

engineering and operation of a water research facility for the Department of Interior at Wrightsville Beach, North Carolina. In a brand-new undertaking, this group has purchased RCA TK-76 color-television cameras for lease to a broad range of media clients.

### Air Force projects

Government Services continues to operate RCA's Missile Test Project, with over 1200 personnel, headquartered at Patrick Air Force Base and Cape Canaveral, Florida. This program is entering its twenty-seventh year of instrumentation, communications and engineering support to America's weapons testing and space exploration programs.

In newer efforts, this activity has three contracts with the Tactical Air Command for aerial target services, preparing, launching and controlling the flight of pilotless drone aircraft, including PQM-102s, BQM 34s and BOMARC missiles. The Aerostat Systems group conducts R&D and operation of tethered-balloon-borne instrumentation systems; it supports the SEEK SKYHOOK balloon system at Cudjoe Key, Florida, and is preparing another system for delivery to an overseas customer.

Under the GEODSS (Ground-Based Electro-Optical Deep Space Surveillance



**Electronic Fabrication at NASA Langley Research Center.**

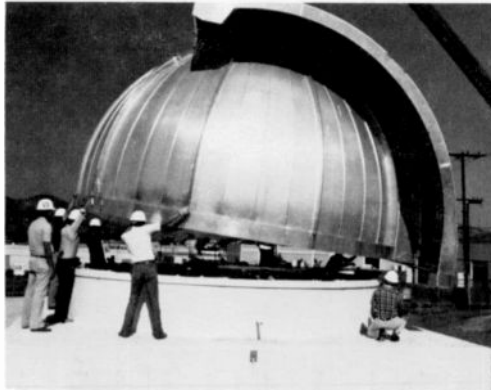

**Optical domes being installed at GEODSS Test Site.**



**Telemetry Maintenance at NASA Kennedy Space Center.**

System) Project, RCA is providing installation and logistical planning to TRW for a worldwide network of tracking stations. Construction is underway at two of the five sites. RCA will be responsible for systems installation, integration, acceptance testing, and follow-on operation and maintenance.

For the Alaskan Air Command, Government Services provides base support and technical maintenance at 13 remote aircraft control and warning stations—a 500-man project entering its fourth year.

### *Army projects*

Major support effort for the U.S. Army continues to be concentrated at White Sands Missile Range, New Mexico, where RCA operates and maintains precision radar systems, calibrates electronic test equipment, and maintains an environmental monitoring and control system. At Fort Bliss, Texas, RCA also maintains and deploys electronic warfare equipments in support of the Air Defense Artillery Threat Simulation (ADATS) program.

### *Navy projects and systems engineering*

Government Services has operated the Navy's Atlantic Undersea Test and Evaluation Center in the Bahamas since it was established in 1966 for the testing of advanced undersea weapons systems. Our 800-man project provides total base and logistics support as well as technical operations and maintenance. Another major Navy project, continuous since 1964, is for support of the Atlantic Fleet Weapons Training Facility, headquartered at

Roosevelt Roads, Puerto Rico. Nearly 300 RCA personnel furnish instrumentation, data processing, communications, and aerial target services for the operational exercising of Naval air, surface, and underwater weaponry.

Our Systems Engineering activity, profiled in the 24th anniversary issue of the *RCA Engineer*, provides a broad range of design, integration, installation, fabrication and other support services—including program management and depot repair—primarily to U.S. Navy customer organizations. Headquartered in Springfield, Virginia, it operates engineering centers at other locations in the United States (and Japan) in support of Navy combat systems, ship and shore electronics installations, and airborne and underwater ASW projects.

### *NASA projects*

Our major NASA support effort is the 380-man project at Kennedy Space Center, which services communications, operational television, and telemetry systems under a subcontract with CSC. Prime contracts with NASA include engineering services for NASA's worldwide communications network (NASCOM); maintenance, fabrication, and repository services at Langley Research Center; and radar, communications, and space shuttle test support at Dryden Flight Research Center.

### **A brief look forward**

The ongoing concern of RCA Service Company management, as recently expressed by President James J. Badaracco at an industry marketing seminar, has been

threefold: effective service delivery, enhancement of the RCA corporate image, and aggressive broadening of the RCA Service Company business base as an independent profit center.

The people of RCA Service Company—in Consumer Services, in Technical Services, in Government Services, and in our international operations—have built a solid record of accomplishment on all three counts over the years. As we look forward to the decade of the 1980s, we anticipate that, with imagination, ingenuity, resourcefulness and adaptability, we can uphold our record and expand on it—both in continued support of other RCA Corporation activities and in pursuit of our own constantly evolving customer base.



**Richard W. Alnutt** is an editor in the Government Services Marketing Department, RCA Service Company. He joined RCA Service Company in 1956, working initially in its Technical Publications activity.

Contact him at:  
**RCA Service Company**  
**Cherry Hill, N.J.**  
**TACNET: 222-5091**

# Hertz car rental management systems and services

The Hertz Corporation extensively uses systems and computer technology. The Operations Research work highlighted by the Fleet Planning models described in the first portion of this package is in the forefront of Hertz's applications. The second section describes Hertz's new Worldwide Reservation System put on new Univac 1100/80 computers in February, 1980. This new system replaces the original Reservation System which was written for RCA Spectra 70/6 computers that served the Corporation for over eight years. The reservation

application and technical nature of the computer in communications equipment are described. Hertz also uses computer technology in distributed minicomputer systems at its major airports throughout the country. All of the systems at Hertz focus centrally on directly supporting Hertz's operational and field management in maintaining Hertz's leadership position in the car rental industry.

— B.G. Curry

M. Edelstein|M. Melnyk

## Operations Research solves fleet-planning problems

*Interactive, computer-based models developed at Hertz make long-term, short-term and immediate supply and demand predictions.*

The car rental business has grown and changed dramatically. Unprecedented demand for rental vehicles, a growing number of companies and intense price competition have transformed this industry into an integral part of the total transportation system in the U.S. Throughout this period, Hertz has maintained and enhanced its position in the marketplace.

There are many reasons for this success. Foremost among them is Hertz management's ability to plan for and re-

spond to ever-changing conditions. Specifically, Hertz management can continuously assess and evaluate fleet requirements versus anticipated demand. Quick response is essential in maintaining the critical balance between supply and demand in the car rental business. Both supply and demand are complex variables, with long-term and short-term dimensions.

Demand depends on overall industry growth, pricing, promotional policies and competitive conditions. In determining demand, Hertz relies on local assessment of the marketplace. Once the demand assessment has been made, supply is treated as a

control variable. Relative to a given demand level, there is an appropriate number of cars needed to satisfy the customers with a high level of service. Because of lead-time and logistical considerations, the process of guaranteeing proper overall supply starts months in advance. Once the correct fleet level is achieved in an area, the next step is to determine appropriate distribution strategies on a day-to-day basis. Finally, local management fine-tunes supply on an hour-by-hour basis during the day.

Much of Hertz's success in addressing the supply problem is due to management tools developed by the Hertz Operations

Reprint RE-26-1-11  
Final manuscript received April 10, 1980.

Research group. These tools are interactive, computer-based models which have been developed jointly with management to address each of the three parts of the fleet planning process—long-term, short-term and immediate.

## The long-term problem—fleet planning

### The problem

Planning for an adequate fleet is a complex process—the proper level and mix must be considered. The proper level depends on local demand, which fluctuates from month to month. The strategy is: fleet up to coincide with the forecasted peaks and valleys which result from seasonality, special events and overall business growth. Too many cars incur unnecessary expense. Too few cars mean lost opportunity and profit. How should deliveries and disposals be timed to achieve a maximum fit with the expected demand pattern?

Hertz has several ways to increase its fleet: purchase, lease, purchase with a buyback arrangement or transfer from another location. When disposal is necessary, Hertz can sell its cars retail or wholesale, transfer them to another location or turn them back to the lessee or dealer. Each of these methods has its benefits and drawbacks. The typical fleet supply strategy will use several of these combinations each month. Finally, these more general timing and method considerations must be translated to specific models of cars.

### The process

The fleet planning model is an analytical tool that helps management develop a vehicle installation and disposal schedule, and it instantaneously evaluates the adequacy of the resulting fleet level. This model is illustrated in Fig. 1. A set of equations establishes the relationships between the fleet- and rental-related variables for each month in the planning horizon. The model then generates the necessary financial and operational statistics which measure the viability of a proposed plan.

For example, a simulated upward change in a demand variable will result in more revenue and greater use of a given fleet level. This may or may not be feasible. Increasing the fleet in a given month may solve a current shortage but create a surplus fleet problem in later months.

Hertz may or may not offset this surplus by selling or otherwise disposing of cars, depending on market conditions. The model readily evaluates these strategies and tradeoffs. A whole series of alternatives can be developed quickly and easily because this is done interactively by computer.

The system greatly facilitates the management review process since standardized *pro forma* documents are produced by the model and are accessible to all levels of management. Suggestions and criticisms are analyzed using the computer. In this mode, the interactive system can process and evaluate management judgments and ideas. As a result, the focus of the planning and review process is on strategy, not on the large number of computations that must routinely be performed to develop a coherent plan for the future.

### The data base

The data used and generated by the model is stored in a data base. Managers can retrieve this information and design reports to meet their specific needs. Senior management can focus on the overall direction of the business by running a division-level report over a specific time frame. Zone managers can rank their cities by a specific criterion to highlight relative performance. Reports can be generated based on actual performance, that highlight trends and identify problem areas.

In addition, a complete description of the current fleet is available for instant retrieval and analysis to assist in the planning process. For example, fleet-age information can be generated to forecast profit and loss for planned car sales. Inventory reports for specific model cars

can be produced to spot imbalances in model and size mix. The instantaneous accessibility to critical current and past information provides a strong foundation for the formulation of strategies.

## The short-term problem—daily planning and distribution

Once the fleet level is determined and fixed in a given time frame, the operational problem of managing the fleet on a day-to-day basis remains.

### The problem

The field operations are set up either as “independent cities” or as “pools.” An independent city owns its fleet of vehicles, and all fleet-related decisions are made by local management. In a pool, the fleet is shared by a group of cities. Each city is run by its own management, but fleet administration is centralized. Distribution and control of the fleet rest with the distribution manager. The distribution manager works closely with each of the cities and the zone manager, who has overall operating responsibility for the pool. Most of the major Hertz field operations are organized as pools consisting of from 2 to 15 cities with fleets of 2,000 to 15,000 cars. The potential for improving fleet use is a major benefit of this set-up since shortages in one city can be filled with another city’s slack.

The distribution process basically consists of three steps as depicted in Fig. 2. The first step is a demand potential and capacity assessment. Before any distribution decision can be made, two critical numbers for each city for each day in the planning horizon must be determined: the number of customers potentially available to Hertz (the demand potential) and the number of cars available for rental (the rental capacity).

The second step is to determine a distribution strategy. The rental capacity estimate is compared to the estimated demand potential in each city to determine which cities have shortages and which have excesses. Appropriate vehicle transfers are then proposed.

The last step is a demand control imposition. If it is concluded that shortages will still remain in some cities, then a recommendation to control demand in these cities is made to the zone manager. Demand can be restricted by limiting

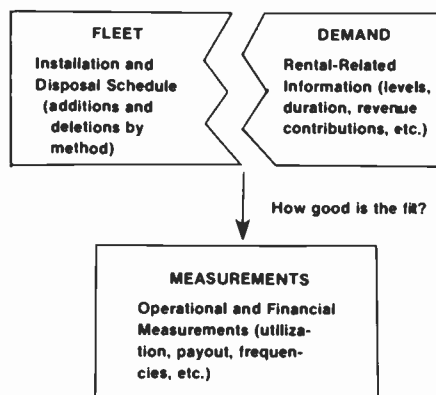
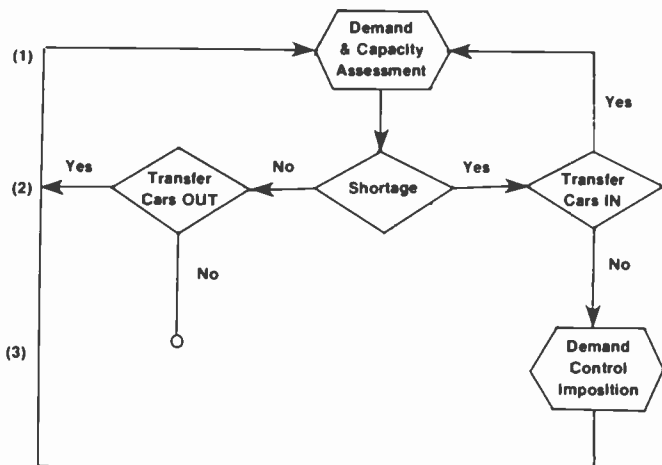

Fig. 1. The fleet planning challenge is to fit the fleet level to the demand curve.



**Fig. 2. Distribution decision process.** Step 1: demand and capacity assessment; Step 2: distribution policy determination; Step 3: demand control imposition.

reservations and/or renting only to customers with reservations.

The most critical determination of all, available capacity, is highly complex and uncertain. New cars are always being installed and other cars being retired. Cars are continuously going in and coming out of shops or being moved from city to city. But more importantly, at any given time, the available fleet is being depleted by new rentals and replenished by vehicles returned from previous rentals. In addition, because of the Hertz "Rent-It-Here, Leave-It-There" policy, current and future rentals can occur anywhere and return anywhere. Therefore, both the impact of distribution-imposed intercity vehicle transfers and the results of customer flow between pool cities must be directly accounted for.

The problem, then, is to accurately forecast the future demand and the fleet availability for each city during each day in the planning horizon. In addition, based on this determination, various transfer or demand control policies must be assessed.

### The process

Figure 3 describes the system flow. Daily, each city manager completes a form that includes actual data from the prior day and projections for future days for his city. This data is telecopied to the distribution manager. He, in turn, inputs this data and some of his own into the daily planning and distribution aid (DPDA) via a timesharing terminal. This data is fed to the model—a set of recursive sequential equations describing the timing of rentals, check-ins and flow between cities.

The model produces a report forecasting

the situation in each city for the coming week. This report lets management distribute the fleet based on the predictions.

A sample report is shown in Fig. 4. In this illustration, city A has anticipated shortages during the middle of the week and on the weekend. City B has shortages predicted for the end of the week. City C

seems to have excess cars throughout the week.

Based on these projections some transfer of cars, from B and/or C to A, seems logical. The question is: how many and when? For example, moving too many cars from B to A on Monday may move up the shortage in city B from Saturday to

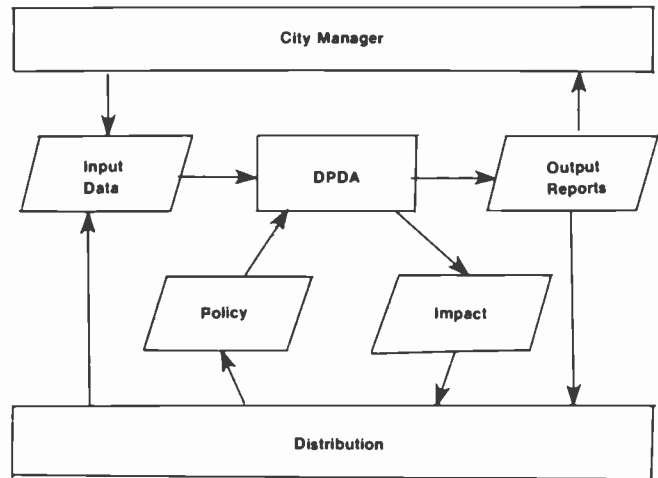

**Fig. 3. Daily Planning and Distribution Aid.** The computer model controls the flow of control information to and from the appropriate levels of field management involved in the short-term planning process.

CITY A	MON	TUE	WED	THU	FRI	SAT	SUN
Idle	527	82	0	0	14	167	0
Check-ins	285	410	518	571	743	274	419
Intercity Transfers	0	0	0	0	0	0	0
Available Fleet	832	492	518	571	767	446	419
Demand Projection	750	700	605	557	600	490	600
Cars Left Over	82	-208	-87	14	167	-44	-181

CITY B	MON	TUE	WED	THU	FRI	SAT	SUN
Idle	80	162	149	122	86	51	0
Check-ins	196	106	92	126	195	107	125
Intercity Transfers	0	0	0	0	0	0	0
Available Fleet	272	264	237	244	296	159	123
Demand Projection	110	115	115	158	245	163	119
Cars Left Over	162	149	122	86	51	-4	4

CITY C	MON	TUE	WED	THU	FRI	SAT	SUN
Idle	80	57	47	31	51	74	71
Check-ins	118	112	100	120	141	97	73
Intercity Transfers	0	0	0	0	0	0	0
Available Fleet	192	167	141	146	189	156	140
Demand Projection	135	120	110	95	115	85	80
Cars Left Over	57	47	31	51	74	71	60

**Fig. 4. The first look.** This chart indicates the magnitude of the distribution problem before any action is taken. Critical shortages occur on Tuesday and Wednesday at City A.

CITY A	MON	TUE	WED	THU	FRI	SAT	SUN
Idle	527	173	54	52	120	291	91
Check-ins	286	432	572	625	761	284	436
Intercity Transfers	90	50	0	0	0	0	0
Available Fleet	923	654	627	677	891	581	527
Demand Projection	750	600	575	557	600	490	500
Cars Left Over	173	54	52	120	291	91	27

CITY B	MON	TUE	WED	THU	FRI	SAT	SUN
Idle	80	97	35	22	29	18	11
Check-ins	196	107	91	111	164	86	91
Intercity Transfers	-65	-50	0	0	0	0	0
Available Fleet	207	150	122	129	208	106	101
Demand Projection	110	115	100	100	190	95	90
Cars Left Over	97	35	22	29	18	11	11

CITY C	MON	TUE	WED	THU	FRI	SAT	SUN
Idle	80	32	23	16	37	57	50
Check-ins	118	113	99	121	138	93	71
Intercity Transfers	-25	0	0	0	0	0	0
Available Fleet	167	143	116	132	172	135	118
Demand Projection	135	120	100	95	115	80	80
Cars Left Over	32	23	16	37	57	50	38

**Fig. 5. Final strategy.** The shortages at City A have been eliminated by transferring the appropriate number of vehicles from City B and City C, as well as controlling demand on Tuesday and Wednesday.

Wednesday or Thursday, with no cars available to alleviate the problem. The net result would only be to transfer the shortage and incur car transfer expenses. On the other hand, some movement is clearly justified due to the projected surplus at B and C for the next few days. The model, because it accounts for the timing of rentals, check-ins and customer flow between city locations, can quickly simulate the impact of any transfer and/or demand control policy and help establish the most balanced solution.

Figure 5 illustrates the final strategy to use the fleet effectively while guaranteeing a high level of service. Note that a substantial number of cars is moved into A from B and C. In spite of this, demand control is needed to keep fleet supply and rental demand in balance. Demand for Tuesday in city A is reduced by 100.

### The data base

A data base develops as a by-product of runs using the model which lets management study in detail the car rental business patterns in any city for any time period. For example, suppose that a proposal to charge the customer for not returning the car to the renting city (a drop-off charge) is

being considered. The system provides a detailed check-in analysis indicating the degree of current customer movement between pool cities. This information is useful in determining when and where the charge should apply. After the drop-off charge policy has been established, the report is used to monitor the policy's impact.

As another example, consider a situation in which the average revenue per rental has declined suddenly for the pool. A rental length analysis report displays length-of-rental statistics for each of the pool cities during the recent period and shows if length of rental or some other factor is responsible.

### The immediate problem — hourly availability

Once a transfer and/or demand control policy has been determined, the focus is on getting through the current day, guaranteeing immediate vehicle availability for arriving Hertz customers.

### The problem

The DPDA provides a picture of total fleet availability versus demand for a given day.

Both of these may have been adjusted as needed to guarantee a car for each expected customer. This overall adjustment now needs to be refined. For example, a contemplated demand control measure at a major airport (limiting reservations, or renting only to customers with reservations) may need to be concentrated in the morning hours when most of the day's rentals take place.

The amount of demand control needed, and for which hours, depends upon the specific hourly rental patterns. In addition, the number and distribution of check-ins for that day needs to be considered since check-ins replenish the available fleet. Finally, other factors affect fleet availability—the number of cars returning from shop maintenance, being newly delivered or leaving the fleet must be evaluated. Without considering these factors, too much business might possibly be turned away. On the other hand, not enough demand control may result in dissatisfied customers who arrive to find no car waiting for them.

### The process

Several times each day, the manager enters data on the current status of his business—the number of available cars, and a forecast of rentals and check-ins for the remainder of the day.

The model uses this input as well as the relative pattern based on rental and check-in flow histories to determine fleet availability hour-by-hour. A sample report is shown in Fig. 6. Note that this report predicted no cars left for rental during the noon hours. This advance notice of an expected shortage allowed local management to remedy the situation by augmenting the fleet with transfers, accelerated repair work in the shop and other supply tactics. As a demand tactic, they could impose appropriate demand control measures. The model quickly evaluated any proposed measures and in an iterative fashion led the manager to the proper mix of available alternatives to develop a final strategy.

### The data base

The data base created by the system allows analysis of customer rental and check-in patterns. This information has been used for a variety of purposes. For example, staff scheduling at the rental counters has to match the frequency of customer arrivals. Similarly, the scheduling of gar-

	Hours	Cars at Start	Check-ins	Adjust.	Available Fleet	Rentals	Cars Left
AM	7:00-8:00	180	20	0	200	43	156
	8:00-9:00	156	17	0	173	53	120
	9:00-10:00	120	17	26	163	63	101
	10:00-11:00	101	15	0	116	64	51
	11:00-12:00	51	17	-5	63	84	-20
PM	12:00-1:00	0	20	0	20	82	-62
	1:00-2:00	0	27	-20	7	19	-12
	2:00-3:00	0	37	0	37	5	32
	3:00-4:00	32	54	30	116	8	108
	4:00-5:00	108	61	0	169	50	119
	5:00-6:00	119	42	0	161	21	140
	6:00-7:00	140	34	0	174	13	161
	7:00-8:00	161	15	0	176	40	136
	8:00-9:00	136	10	0	146	18	128
	9:00-10:00	128	10	0	138	18	120
	10:00-11:00	120	2	0	123	5	118
11:00-12:00	118	2	0	120	6	114	

Fig. 6. Airport hourly activity report for Tuesday. Shortages are indicated between 1:00 a.m. and 2:00 p.m.

agement who clean and wash returning cars and do routine maintenance depends on the flow of returning renters and arriving customers. Enough returning cars have to

be "processed" to satisfy arriving renters. Thus, proper garagemen staffing depends directly on the rates of check-ins versus rentals. A separate subsystem for this

purpose has been developed and used with success.

## Perspective

The traditional role of the computer in a business environment has been to process large volumes of data and produce equally large volumes of reports. The computer models described here provide the station manager at the airport as well as senior management at corporate headquarters with a different perspective—the computer as a daily operating and planning tool.

What has been accomplished is the development of a vigorous analytical framework for decision-making at all levels. Hertz management recognized the need and potential for applying state-of-the-art computer technology to the operating environment. Because management worked closely with the Operations Research group from concept formulation, design, modification, through implementation, a successful effort was assured.

— M. Edelstein/M. Melnyk



Authors from left to right, M. Melnyk, B. Curry and M. Edelstein.

**Bruce Curry** is Hertz's Staff Vice-President for Management Systems and Services (MSS), with worldwide responsibility for Systems and Communications. He joined RCA in 1959 as a systems manager for the Computer Division's Cleveland District. In 1960 he became Eastern Region System Manager and in 1962 went to RCA Cor-

porate Staff where he advanced to Staff Vice-President, MSS, the position he held before going to Hertz in 1970.

Contact him at:  
**Hertz Corporation**  
New York, N.Y.  
TACNET: 330-2100

**Martin Edelstein** joined Hertz in July 1974 as Manager of Operations Research and developed the Operations Research group under Bruce Curry. He is currently the Director of New York Systems with responsibilities for Operations Research and Corporate and Financial Systems. Dr. Edelstein and Mr. Melnyk won second prize in the 1977 competition of the Institute of Management Science for work that is the subject of this paper.

Prior to joining Hertz, Dr. Edelstein was a member of the RCA Corporate Operations Research group in Princeton, New Jersey.

Contact him at:  
**Hertz Corporation**  
New York, N.Y.  
TACNET: 330-2076

**Myron Melnyk** was a participant in the RCA Career Program in Operations Research in 1973, and joined the Hertz Operations Research group in November 1974. He was recently promoted to Manager of the Operations Research Department and is responsible for all Operations activities throughout the Corporation.

Contact him at:  
**Hertz Corporation**  
New York, N.Y.  
TACNET: 330-2094

## Worldwide reservation system means number one service

*A computer and telecommunications system, centralized in Oklahoma, handles over 50,000 telephone calls and disseminates an average of 40,000 reservations and administrative messages each day.*

**The new Hertz Worldwide Reservation System in Oklahoma City was fully implemented in February, 1980. The system uses a Univac 1100/83A tightly coupled multi-processor computer with 2 million words of memory.**

**The sophisticated on-line telecommunications system is designed to handle over 50,000 telephone calls daily and over 10 million car rental reservations per year. The reservations are received from toll-free calls throughout the continental United States, Hawaii and Canada. European reservations are received via RCA's SUN network. Other non-domestic reservations are received by Telex or private lines. A complex telecommunications computer network uses Hertz Number One Club files;**

**processes and prints Hertz billing statements; and provides swift informational assistance for sales systems and other vital sectors of the corporation.**

**The Hertz Number One Club files, processed on the new system, include over 4.3 million members with increases by approximately 50,000 new members each month. The new reservation system is efficient with average response time under 2 seconds and stable with average system availability of over 98 percent for a 24-hour day, 7-day week. The efficiency and accuracy of the computer system is a key element in providing Number One service to Hertz car rental customers.**

**— P.L. Williams**

### Application

The Hertz Worldwide Reservation Computer System is a multipurpose system serving the needs of Hertz Rent-A-Car locations worldwide. The primary function of the system is to accept, process, store and disseminate car rental reservations.

The primary means of accepting reservations into the system is via video display terminals. Over 300 terminals are used primarily for this function. An average of 35,000 reservations are booked daily, Monday through Friday. An average of 8,000 a day is booked Saturday and Sunday. The majority of the terminals are located at the Oklahoma City Reservation Center but the system remotely interfaces with terminals at the Hertz Toronto Canada Reservation Center and the

Woodside Travel Group in Boston, Massachusetts. In the near future the system will interface with video terminals at Amtrak Chicago, Boeing Seattle and Heritage Travel in Cambridge, Massachusetts.

The ARINC network (Aeronautical Radio Inc.) is a major means of accepting reservations from automated airline and other travel industry vendors and executive accounts. The system has a computer-to-computer link with this network between Oklahoma City and Chicago. Messages received from ARINC are edited for proper textual data and formatted into the reservation format, which is forwarded to the rental locations.

The RCA Shared User Network (SUN) transmits reservations requests from Europe and other foreign locations to the Oklahoma City Reservation Center. These requests are received on teletype terminals in the Vendor Input Department. Specially

trained agents in this department manually enter the reservations into the system via video terminals. Reservations from Holiday Inn, Best Western and Amtrak are received in the Vendor Input Department, too. These are manually booked.

The Hertz Reservation System is designed to disseminate reservations to field locations via the most cost-effective communications system(s) available. The basic delivery criterion is that the reservation must be delivered to the counter in sufficient time to allow necessary local processing prior to customer arrival. The current mix includes leased, dedicated low-speed communications lines and teletype terminals, autodial capability, telephone callout, SUN and Telex.

Autodial allows the computer system to dial and connect to terminals in the continental U.S. over telephone circuits. After connection, reservations or other data are transmitted to the connected terminal.



When the message queue for the terminal is empty, the computer system disconnects and dials the next terminal. The system provides the long distance department at the Oklahoma City Reservation Center with reservation data to be called out to small continental U.S. locations over Hertz's WATS circuits. The computer system transmits reservations for Europe and Africa over RCA's store and forward message switching system. Reservations are Telexed to countries where Hertz does not have direct communication. The system formats the reservations which are then automatically punched into paper tape for entry into the Telex system.

The system stores reservations until they are required by the location. Each location can predefine delivery instructions in the computer system. In addition to handling reservation traffic, the system automatically generates a confirmation message to travel agencies which are connected to the system via remote teletype terminals. An overview of the total information flow is shown in Fig. 1.

The system also generates management information reports to field locations based on a predetermined schedule or special condition. These daily reports provide information by customer name (Fig. 2), time of arrival, flight number, vehicle desired and special equipment requests. These reports are intended to both improve efficiency of daily handling of reservations and provide data that will allow planning for future activity. The volume of messages transmitted depends on the day, season and/or special event. Over 40,000 reservations and administrative messages are disseminated to the field daily.

The reservation booking function requires a large amount of supportive information stored in the system which is made available to the agent and system functions on an immediate basis. This information includes Hertz rental locations, communications routings, hours of business, discount percentage, rental rates, flight information, etc. The system can update the various files on an on-line and off-line basis depending on function. The biggest single file on the system is the Number One Club file which contains data on 4 million members.

—J.M. Parks

## Equipment/software

The Univac 1100 multi-processor provides Hertz with a powerful and flexible system

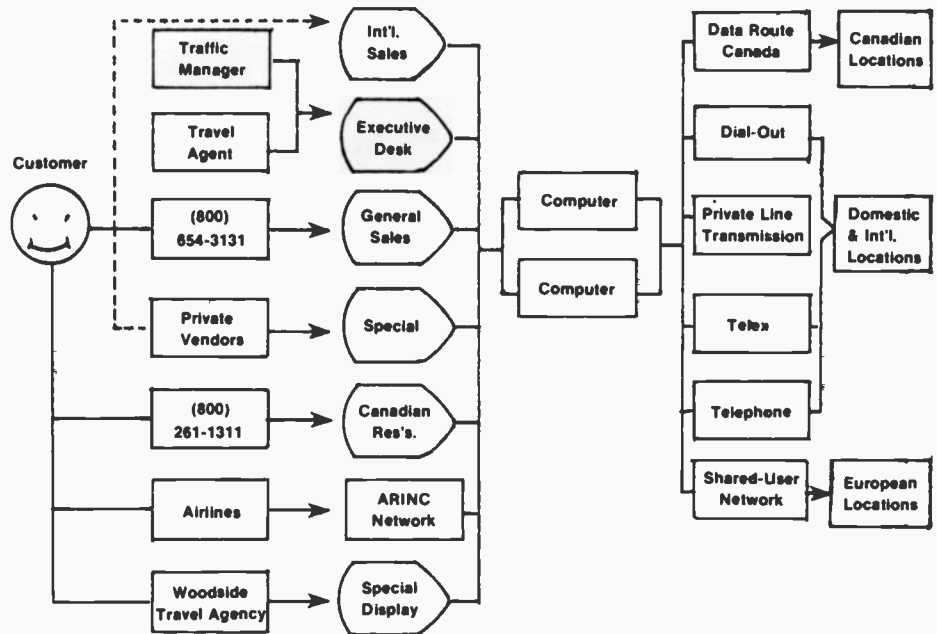

Fig. 1. Information flow of the Hertz Worldwide Reservation Center. Reservations are entered from a wide variety of sources, processed by the Univac 1100/83A computer and are distributed to the appropriate Hertz rental locations, domestic and international.

for responding to the demands of an on-line reservation system. The configuration of the computer hardware may be changed by the system operator at any time, generally without affecting the functional ability of the system. Using system console commands, the operator may direct the system to exclude any particular component. Switches at the system maintenance panel then allow the electrical isolation of that component so that maintenance may be performed. Sufficient equipment may be excluded from the main configuration to run a small test configuration as a

separate computer system for testing new operating system software without affecting the production system. After the test, the equipment may be introduced back into the production system.

The hardware complement is supported by a complete set of software, ranging from the operating system and high-level language compilers, through data-base management and basic mathematical functions. The executive system manages the hardware resources so that user-level programs may operate in real-time, transaction processing, interactive time-

PRIMARY CUSTOMER MANIFEST									
CUSTOMERS NAME	N	C	ARRIVL	INFO	EQUIP	N	LOCATOR #	REMARKS	
	1	T	AL FLT	TIME	REQST	DA			
ADAMS GEORGE		C	CO 0062	0927	MIDSZ	03	122688229	00755996	
BERNSTEIN BOB		C	RW 0001	0939	CMPCT	00	129700753	00840722	
BRANDON D		C	RW 0884	0920	CMPCT	01	129671707	00727042	
BRANTON K		C	DL 0149	0920	CMPCT	01	128630167	00529336	
RIDER C		AA	UNKN	2100	CMPCT	01	133733519	CDP 010169	
ROTE F		RW	UNKN	2100	MIDSZ	07	133715433		
WDS SCHMIT HARVEY		C	AA 0522	2147	CMPCT	02	128745775	00681833	
SOLDAN K		C	WA 0319	2140	MIDSZ	01	129539185	00909300	
WAITERS FRED		AA	0359	2112	DELUX	08	126539246	CDP 024371	
WEINBERG RON		C	FL 0097	2129	MIDSZ	06	131414963	00852261	
*5** DORE E	1	WA	UNKN	2200	DELUX	01	133480236	CDP 074662	
HEINONEN M MR		AA	0359	2220	MIDSZ	03	115674194	CDP 047096	
HOLWAY WESTLAND		DL	1084	2203	DELUX	00	133644575	DLSAN	
ROGERS JAMES	1	AA	0359	2220	CMPCT	04	129674578		
WEINBERG HERMAN	1	C	AA	UNKN	2244	MIDSZ	03	132407362	00663854
GIVEN J		C	AA 0157	2345	CMPCT	10	100570555	00826206	

Fig. 2. A sample management-information report. The Primary Customer Manifest provides the Hertz airport location with an alphabetical listing of customer reservations with airline, flight number and scheduled time of arrival. Special information (such as Five-Star customer or Woodside Travel reservation) is highlighted in the left margin.

sharing or classical batch modes without interference from other system users. This management consists of CPU dispatching, main-memory contents control, peripheral device assignment and mass-storage file space allocation.

CPU dispatching provides multi-programming within the multiprocessor environment by creating a virtual processor for each activity to be performed. This virtual-processor (activity) consists of a copy of all information necessary to be loaded into the registers of a physical processor in order to execute the user program's instructions. A user program initially receives one activity and may create as many additional activities as necessary. The CPU dispatcher simply assigns the highest-priority virtual processor to any available physical processor, leads the registers with their appropriate values, and begins execution at the next instruction location within the user-program. The executive system regains control via interrupt. After processing the interrupt, the dispatcher again selects the highest priority activity. In this manner the activity appears to execute continuously on a single processor when actually it may execute at various times upon each of the three physical processors in the configuration.

Main memory management consists of allocating space to program sections called banks. The programmer divides his program into banks using the system collector (linkage editor) in much the same manner as the classical overlay segmentation was specified, reusing the available program address space for mutually exclusive program instructions and data. The hardware provides for accessing any four banks simultaneously, and for replacing any of the four banks with another from the list of up to 4,095 user-banks or 4,095 system-provided common, banked routines. When a bank is replaced, its contents are preserved so that the next time it is accessed, its contents will be the same as when it was made unaddressable. Each bank may be floated at any memory address by the operating system. The user program is unaware of its actual hardware memory address and may, at various times during its execution, run in different parts of physical memory. Re-entrant program logic and shared (user-managed) data areas are fully supported by the program-bank concept. The run-time libraries of the FORTRAN, COBOL, and PL/1 compilers are provided as common banks, along with a set of general purpose utilities for assembler programming. The compilers



Authors from left to right, B. Curry, J. Parks, T. Hammett, P. Williams and B. Sumner.

**Palmer Williams** is Staff Vice-President, Management System and Services for Oklahoma City. He has been with the Hertz Corporation since June 1972. From January 1966 to June of 1972 he was a member of RCA's Corporate Management Information Systems (MIS) Staff and played a major role in the design and installation of the Shareholder Record's System.

Contact him at:  
**Hertz Corporation**  
Oklahoma City, Okla.  
TACNET: 622-6001

**John Parks** is Director, Systems and Programming at the Hertz Corporation, Worldwide Reservation Center in Oklahoma City. He has been associated with the Hertz Reservation Center since January, 1972. From May 1966 until January 1972, he was employed by RCA Computer System Division in Los Angeles and West Palm Beach, Florida. He has 21 years experience in the computer industry.

Contact him at:  
**Hertz Corporation**  
Oklahoma City, Okla.  
TACNET: 622-6005

themselves, along with the assembler and the system's text editor, are all re-entrant instruction banks and may be shared by any number of users. Certain compilers may be directed to produce re-entrant code for use as common banks.

Management of mass-storage space and peripheral devices is accomplished by the facilities complex. The novice system user is able to use the system with reasonable ease and efficiency through an extensive system of default values, while the systems analyst is able to place files into specific locations on specific devices in order to maximize throughput. Sharing of data files

**Tom Hammett** is Director of Systems Software Support, responsible for all Oklahoma City Data Processing Hardware and vendor-supplied software. Mr. Hammett's experience includes 16 years in data processing systems, of which over 12 years are in large to medium scale on-line data communication systems planning and development. Mr. Hammett has been with the Hertz Corporation, in both Oklahoma City and New York for the last six years. He transferred to Hertz in 1974, from RCA's Corporate Staff, Systems Development.

Contact him at:  
**Hertz Corporation**  
Oklahoma City, Okla.  
TACNET: 622-6003

**Bill Sumner** is Manager of System Performance and Project Control at the Hertz Corporation's Oklahoma City computer facility. He has ten years experience in the design, development and maintenance of operating system software. Prior to coming to Hertz, Mr. Sumner was with Lockheed Electronics Corporation in Houston, Texas.

Contact him at:  
**Hertz Corporation**  
Oklahoma City, Okla.  
TACNET: 622-6259

among any number of users is fully supported.

The Hertz Technical Support Staff designed a number of test packages for the conversion process. The staff served as the control point between Hertz's applications and operations staffs and the Univac support team. The communications handlers were specified by Hertz and custom-written by Univac. A special terminal controller was built by Univac to permit direct access of reservation terminals providing ultra-fast response.

— T.G. Hammett/W.E. Sumner

## Engineering the carpet business

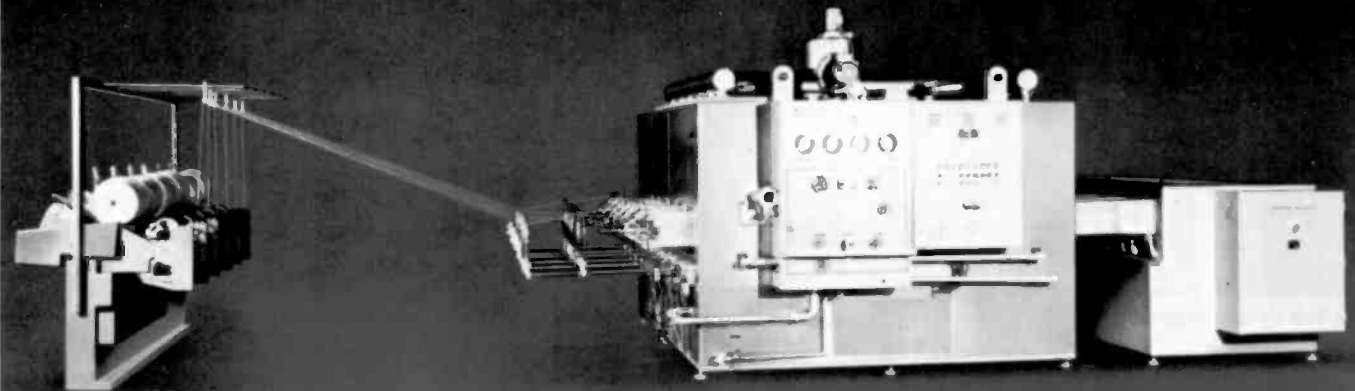

*"Beating the competition with a new approach" is an integral part of Coronet's way of doing business. This demands great flexibility and ingenuity from its engineering group.*

The heat-setting machine (overall view). Yarn enters the machine (right) and is re-wound onto packages (left).

**Abstract:** *Coronet was founded nearly 25 years ago when the new tufted carpet industry was just recognizing its independence. Ever since, the company has faced a variety of tough engineering problems "to get there first with something new."*

Coronet still operates under the basic premise established by its founders some 24 years ago. Its goal, first, last and always, is to serve the marketplace. Merchandising is the rule, and everything else is subservient to this proposition.

The foregoing principle, carried to its logical limit, goes far toward explaining where engineering, as a subgroup, stands in relationship to the total organization. For that matter, it explains where any department, either line or staff, fits into Coronet's scheme of things.

Coronet has always kept staff organizations to an absolute minimum while requiring the maximum degree of creativity in styling, the maximum in mechanization and automation in the

manufacturing processes, and the maximum volume in production in order to satisfy the demands of the marketplace.

At first glance it might seem that these goals are mutually exclusive and that the specific limitation on number would restrict overall performance in function. It has not worked out that way, however, perhaps because Coronet relies heavily on using native intelligence to do more with less. This particular approach is a basic tenet of the tufted carpet industry, and there is more than sufficient historical evidence to support this statement.

### Background

Until after the Second World War, a carpet was a luxury item woven on a loom. Its manufacture was confined to a relative handful of old line carpet companies which were not much given to innovation in creativity, manufacturing methods or merchandising concepts.

The standard product was made of wool. Styling was ultra-conservative, designs were traditional, and the price was high. From the consumer's point of view, the

living room rug was a major purchase, and it was expected to last for a lifetime.

Then came 1950, the year in which (so far as anyone can determine) the first broadloom carpet was made on a tufting machine in Dalton, Georgia. This unmarked event occurred in Dalton because hand tufting had originated in the area some 50 years previously. Around the turn of the century a young woman named Catherine Evans, reviving a pioneer art, made a candlewick bedspread by hand, sewing loops of yarn into unbleached muslin. The loops were then cut with scissors, leaving pile yarns somewhat resembling tufts of grass.

Around 1940, the first "wide" machines, 40 to 48 inches in width, were built for tufting continuous rolls of material for robes, bath sets and cotton rugs, in addition to the basic spreads. Until the arrival of World War II, and despite the lingering effects of the depression, the industry worked overtime to supply demands.

After the war, the demand for tufted products was greater than ever, and in the late 1940s the wider machines, coupled with the postwar availability of synthetic latex, gave new impetus to that segment of

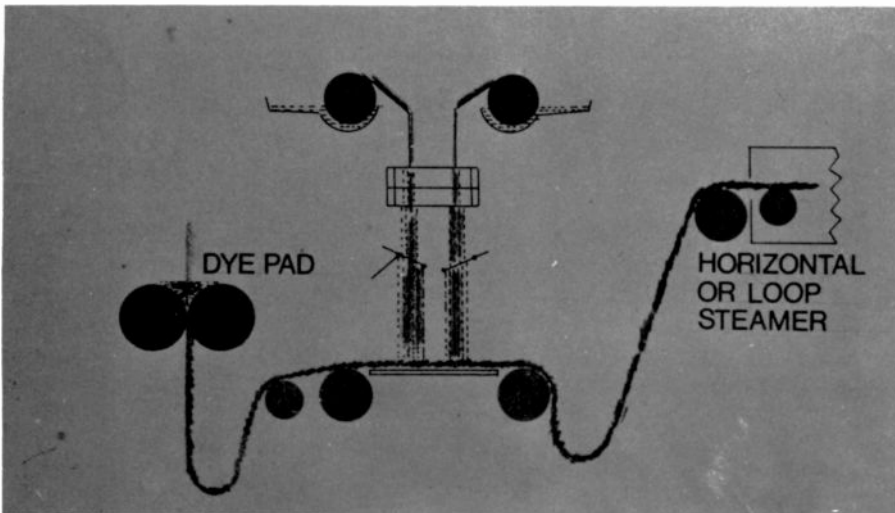

The Tak dyeing process.

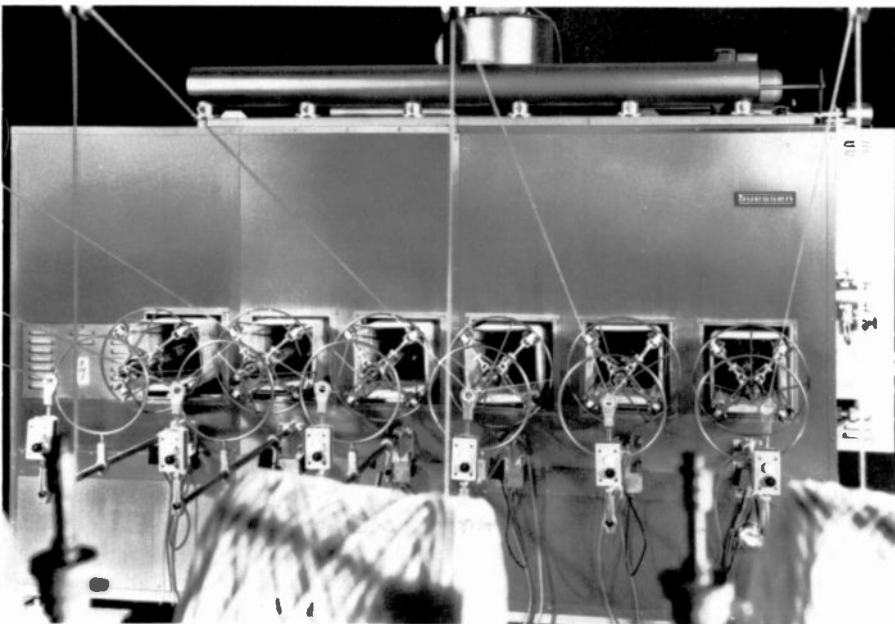

Heat-set yarn emerging from the heat-setting chamber and being wound onto packages in the extreme foreground.

the industry which specialized in tufted rugs. (Latex was the ideal vehicle for binding the machine-inserted tufts to the backing material and for imparting "hand", or a feeling of fullness, to the finished fabric).

In 1950, came the first machines which could tuft carpet up to 12 feet wide in a single pass. The pile yarn in these early broadlooms was mainly cotton, followed in quick succession by rayon and then wool, as tufted met woven in direct competition.

From this almost obscure beginning, the hand tufted bedspread became a popular item and a cottage industry gradually evolved to supply a constantly increasing demand for this unique product. By 1930,

the demand had grown to such proportions that local businessmen were supplying yarn and sheeting to some 10,000 people in northwest Georgia, and in adjacent areas of contiguous states, who hand tufted the spreads in their homes.

But in 1933 came Roosevelt's New Deal and the first wage and hour law. The wage floor for the cottage workers, who had previously plied their needles for 5 to 10 cents per hour, became 32.5 cents, minimum. It quickly became apparent that the labor intensive tufting industry could not support the minimum wage.

In the normal course of events it might be expected that such radical change would either destroy or severely impair the growth of the industry, but neither of these

things came to pass. On the contrary, the minimum wage forced the mechanization and the consequent accelerated growth of the industry.

The local entrepreneurs, who had created the markets, now turned their attention to inventing and building the necessary machines or to modifying available machinery to suit their purposes. They also raised the capital to erect plants and to install the latest versions of the new tufting, dyeing and finishing equipment.

## The founding of Coronet

Coronet was founded in 1956 when the new tufted carpet industry had just begun to recognize its separate existence, and when the entire industry was on the brink of a growth period which would see sales double every five years. For a variety of reasons it was a propitious time to be entering the business, not the least of which was the arrival of synthetic fibers just a short time later.

First came nylon, and the acrylics, followed by polypropylenes and polyesters. These new fibers were intrinsically strong and resilient, dyed well, and had many of the same qualities which had always made wool the ideal carpet fiber. When synthetic yarns were tufted into woven jute backing, to which they were bonded by specially compounded latex, the finished carpet was equal in all respects to a comparable woven fabric.

The synthetic fibers were produced domestically at relatively low cost, and the tufting machine could produce in several minutes what a Wilton, velvet or Axminster loom could produce in an hour. The result of coupling low-cost yarns with high-speed machines was a sudden drop in price. Carpet became a luxury item which almost anyone could afford.

From the day it was founded, Coronet was fortunate in at least two respects. Its founders had no ties to the old line companies, and to that extent had no knowledge of what could or could not be done in making and selling carpet. More importantly, the company was totally oriented to the demands of the marketplace.

The new markets, which now represented a cross-section of the population with its preponderance of younger customers, demanded new styling approaches. This called for the creation of new product lines to satisfy a broad spectrum of taste, and there was a virtual revolution in color. Colors and textures

which the housewives of only a few years ago would have considered daring and outré, were now accepted as a matter of course.

The demand for something new and different became commonplace, and Coronet became adept at changing course and developing new product concepts almost overnight. The ability to sense subtle changes and the hints of new directions in the marketplace became one of Coronet's basic strengths. From the beginning Coronet has been able, with remarkable consistency, to create, manufacture and distribute new products within the span of weeks, and always at the right price.

What was done in the early years is still being done today. Only the scale has changed. Of necessity there is more formality, records are kept on a computer instead of in a hatband, and sometimes you have to take an airplane to travel between plants. But when an obstacle to serving the marketplace arises, you can still go to the chairman of the board for advice and guidance. You are not (usually) the worse off for the experience.

This mode of operation requires a fluid organization with a minimum of fixed boundaries between functions. For various reasons this goes contrary to human nature and conventional wisdom and to work effectively, as it does at Coronet, requires conscious self-discipline on the part of everyone involved. From the inside, it is obvious that this is the way things have to work because rigidity would lead to paralysis in a marketplace which requires the maximum in flexibility.

## Coronet engineering

In relation to various counterparts in RCA, with whom we work quite closely, engineering at Coronet is a many-faceted thing. To Corporate Real Estate and Corporate Product Safety, Coronet engineering is the subsidiary group responsible for both of these activities. To the TACS organization, we are Coronet's telecommunications section. From the point of view of the Facilities staff, we build the plants, install the machinery, and plan and direct the ongoing energy conservation and pollution-control programs.

Joint research and development programs in the field of process engineering have been pursued with RCA Laboratories for a number of years. We are the Coronet group who is always asking for (and getting) invaluable help from the Labs in microwave, spectrographic and heat

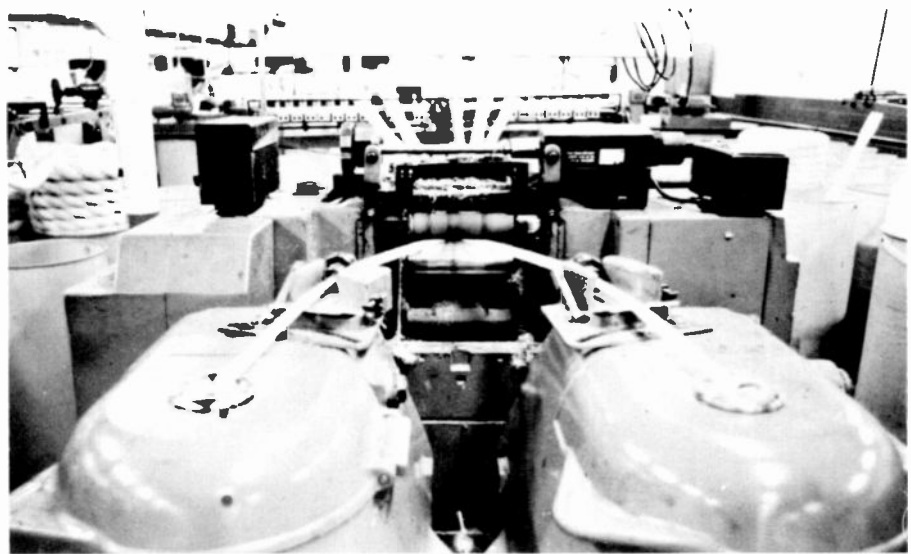

A view of a spinning operation in our Gainesville plant.

transfer technology, to name only several of the areas of joint endeavor. Without the help of the RCA staffs, Coronet engineering would be considerably less effective than it presently is.

Coronet has grown at a phenomenal rate, and there has never been a time when plant construction and machinery installation has come to a standstill. In many instances, new product lines have been created before the equipment to make them has been developed. In other instances the availability of newly-developed equipment has led to the creation of new lines. In either event, engineering works closely with the product R&D and the manufacturing people to assure that Coronet is the first to market the latest styling innovations. Beating the competition with a new approach, sometimes only by several weeks, can carry the market against all comers for months into the future. "To get there first with something new" would be the tone of Coronet's motto, if it had one. It is the guiding principle whether stated or not.

In an effort to keep on top of current developments and to predict what will be available in new processes and equipment for several years to come, engineering keeps close tabs on what is happening in Europe. For the past 20 years, everything really new in yarn manufacturing and in carpet dyeing and finishing equipment has originated there, especially in Germany, Italy and France.

In the fraternity of European machinery manufacturers, Coronet's management is perceived as not only being able to accurately predict trends but, by virtue of its orientation to the market, to create new

trends and tastes. For this reason we are generally able to follow new equipment and processes through the developmental stages and to evaluate their potential impact. By keeping close watch and by periodically renewing contacts in Europe, we have been able to project developments for several years into the future. This is almost an eternity in an industry in which technology changes as fast as changing styles.

## Challenges met

In this particular carpet company, which is always in a state of metamorphosis, a busy and eclectic engineering group seldom has either the time or inclination to survey its challenges or to gauge how it met them. Sooner or later, however, something like the present exercise transpires to force the issue, and some accounting must be made. Selected examples of challenge and response follow:

- During the past decade, Coronet installed more electronically controlled carpet-dyeing ranges than anyone in the industry. Beginning in 1970, with the arrival of the first unit from Germany, engineering directed the basic installation and start-up without any help from the machinery manufacturers. It was necessary to do this in-house because the ranges were modified during installation to suit Coronet's particular styling requirements. All of the installations were done this way, and Coronet maintained its competitive advantage throughout the 1970s. Now, on any given day, these ranges can easily

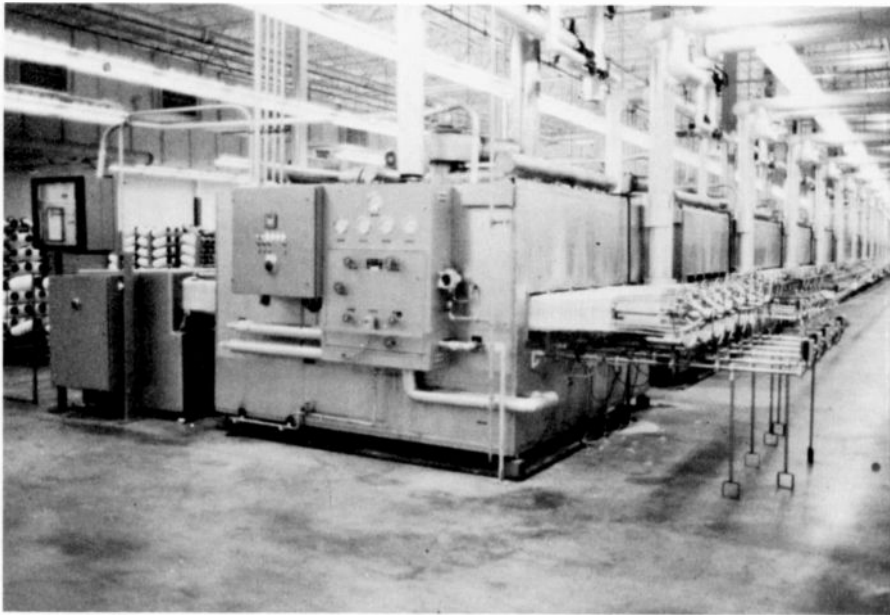

A view of the Suessen heat-setting machines in one of our yarn plants.



**Hubert Clement**, Director Engineering, has just completed 23 years in the carpet industry, the last 10 years of which has been with Coronet. He joined Coronet in 1970, just a year prior to the merger with RCA. He directs all of Coronet's engineering activities, including construction and process engineering as well as real estate and product safety programs. He is very much involved in searching out new equipment and processes, especially overseas, in order to keep Coronet in the forefront of product innovation.

Contact him at:  
**Coronet Industries, Inc.**  
**Coronet Drive**  
**Dalton, GA 30720**  
**TACNET: 723-1410**

produce 20 miles of carpet in an infinite variety of designs and colors.

- Energy has been a problem of long standing. In the early 1970s, we foresaw the possible shortage of natural gas and worked out contingency plans for alternate fuels and firing methods. When the crunch arrived in January of 1977, we were alone, at the time, in substituting petroleum distillates for direct firing in dryers and curing ovens. Everyone else in the industry, if they were prepared at all, had chosen propane as an alternate. At the height of the shortage, propane was as difficult to obtain as natural gas. After a little anxiety at the beginning, Coronet came through the crisis without undue strain.
- In recent years, the rate of inflation has made a shambles of many capital budgets. Some engineering departments have been greatly embarrassed (to say the least) to discover the discrepancy between original estimates and final payments. The problem has been compounded at Coronet because the most expensive machinery comes from Europe, and the dollar has been in a constant and erratic decline against European currencies. In

order to minimize the risks, we in engineering started some years ago to tie up all commitments in firm contracts, to push for early completion of projects and to haggle with our overseas suppliers, for as long as it took, to get commitments and payments denominated in dollars. The record shows the results: we have not overrun a capital appropriation during the past 10 years.

- Continuous heat-setting is the newest and most effective process for permanently fixing the twist in yarn and for maintaining a distinctive surface texture and appearance in carpet. Several years ago, and almost overnight, the demand for continuous heat-set yarn grew in geometric proportions. The only equipment which would do the job was manufactured in France, but delivery times were running from 18 to 24 months. This being totally unacceptable, we began a search, and in a very short time, found a possible substitute in Germany. The equipment was being manufactured to heat treat hand knitting yarns, but it was immediately obvious that it would do an equally good job on carpet yarns. We committed for the manufacturer's entire

production for the coming year, permitting Coronet to outflank the entire carpet industry. Delivery-times of the French machine eventually dropped to less than 2 months.

These are some of the successes. The outright failures have been few, and none has been expensive.

At this date, some 30 years after the first broadloom was tufted, all of the evidence points to another turning point. Some aspects of the future can be seen quite clearly, but others are vague and still unformed. But regardless of what comes next, the past informs us that it will hardly be dull.

# on the job/off the job

G.F. Rogers

## Bringing radio to the rural home

*In the early thirties, radio was far from omnipresent, so an innovative cable system was developed to extend the reception of a single receiver to hundreds of families in a rural area.*

---

**Abstract:** *Surrounded today by many examples of advanced communications technology, we may forget or be unaware that these services have not always been at our beck. Radio, of course, was the medium at the start of the second quarter of this century, at least for urban areas. Rural communities, with their far-flung populations, were another story. This article describes how a unique cable distribution network was developed to extend the reach of radio into several rural counties in northwestern South Carolina in the early thirties.*

---

In the winter of 1930-31, I became dissatisfied with the low-powered uneconomical battery radio set used in my home and reconditioned an old alternating current set. It occurred to me that I might serve from my receiver, a neighbor who had no electric service. By installing a single wire with ground return, I connected the neighbor's loudspeaker to my receiver. The results proved so satisfactory that

Reprint RE-26-1-14

Final manuscript received June 11, 1980.

others became interested and, within a month, the service was extended to seven families. In about four years, 600 homes were being served. This required 400 miles of single-wire transmission lines extending over three counties, with the most distant customer 24 miles from my receiver.

To improve the service and maintain volume and high fidelity tone quality over this rapidly expanding system, an immense amount of development work was required, supplemented by new equipment, adequate test methods, and protective relays.

### The initial system

The first ac receiver used in the system had seven tubes; four type 26, one type 27, one type 71-A, and one type 80. The maximum audio output of this receiver was 0.7 watt, and the sensitivity was so low that it was very difficult to receive even the strongest stations in the daytime. In the winter of 1931-32, I built a superheterodyne receiver using tubes in the 50 series for the r.f. and i.f. stages and a type 47 for the output. The 47 output tube provided a maximum out-

put of 2.5 watts under proper load conditions. However, with all the speakers coupled in parallel through a choke-

**Ed Note:** Anniversaries are milestones for looking ahead and for looking back. We, in the technical community, are aware of the rapid growth and diversity of technology and have seen these changes reflected in the pages of the *RCA Engineer*. In this 25th anniversary issue of the *RCA Engineer*, Bill Webster of the RCA Laboratories takes the role of prognosticator and views the prospects for technology in the next 25 years. It is also appropriate that we get a sense of what the state-of-the-art in electronics was like 25 years before the *RCA Engineer* came into existence. Gordon Rogers, formerly of CE and now retired, takes us back and gives us a sample of innovation and experimentation in the good old days of the 1930s.

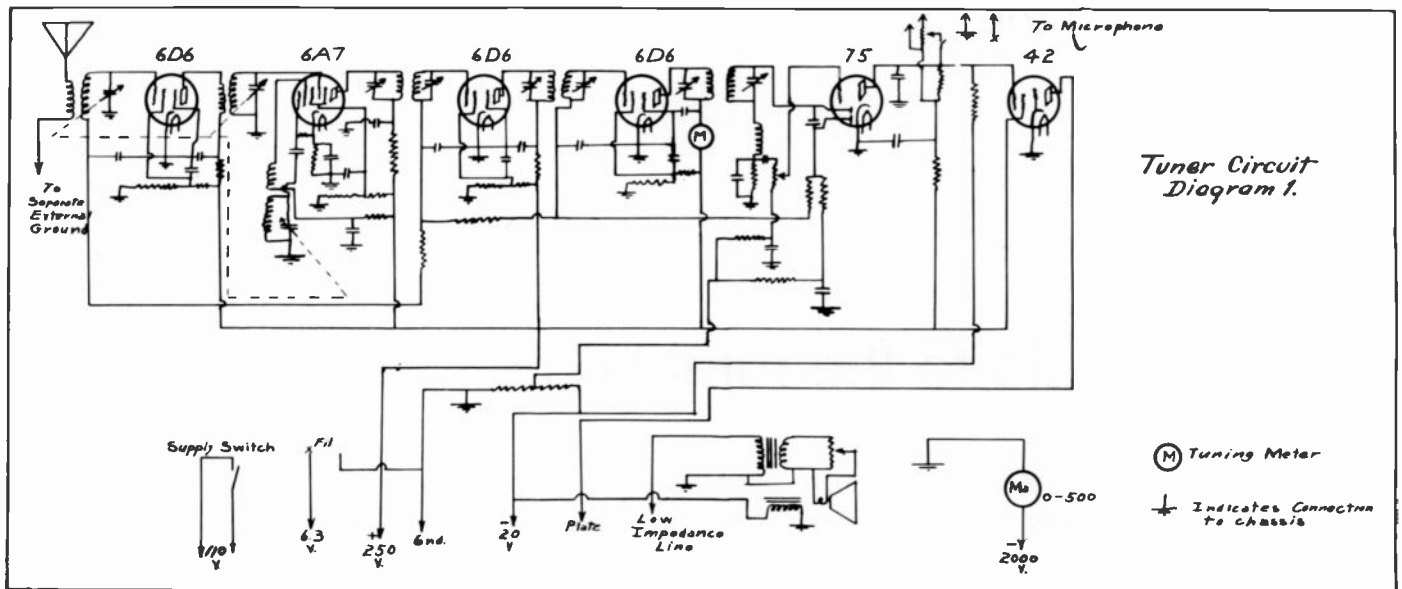

Fig. 1.

capacitor circuit, the load impedance and consequent output were low. About six months later, I installed a single 2A3 triode output tube in place of the 47 pentode and utilized more of the rated output. Precautions had to be taken with this set to prevent the i.f. from getting through to the line from whence it could return to the aerial and cause i.f. feedback.

A little later, the output power was increased to 15 watts by using two 2A3s in push-pull, and a hand-wound output transformer was used to couple them to the line. The power increase and the improved matching impedance made it desirable for each subscriber to have volume control on his speaker. A 10,000-ohm 2-watt potentiometer was used at first; but as the output was increased and the line losses became more important, these controls were changed to 25,000 ohms. This change also eliminated the tendency of the 10,000-ohm controls located on the near end of the line to burn out. Some distortion occurred when using the 25,000 ohm controls, but the listeners were far from critical, and the savings in power was important.

### System expansion and power growth

At this stage, the line was about five miles long and served 15 subscribers. The appearance of magnetic cone speakers, selling at \$2.85, gave a sudden impetus to the growth of the system. Within the next four months, the number of subscribers increased to more than two hundred, at which time the supply of "bargain" speakers ran out.

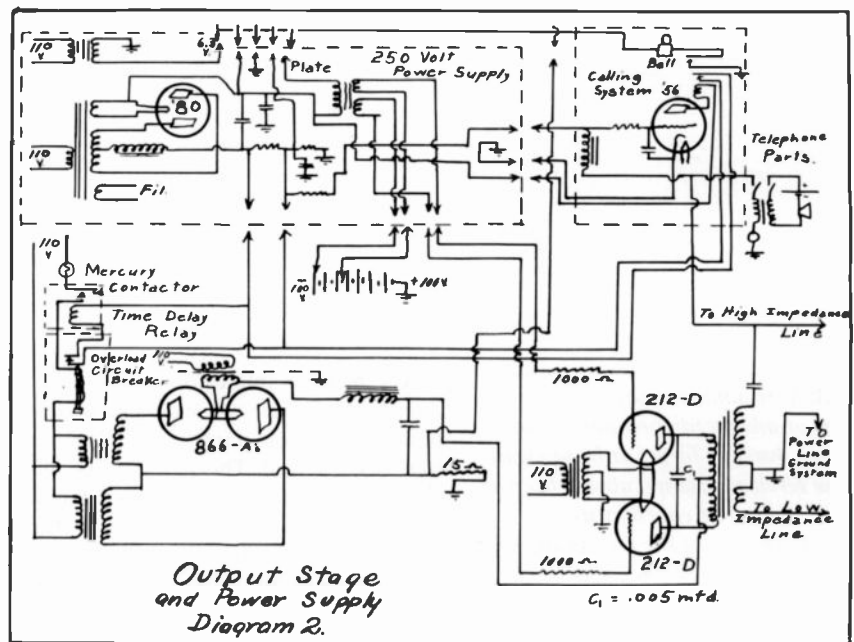

Fig. 2.

This comparatively rapid expansion of the system necessitated frequent changes in the output system, which increased successively from two to four and then to eight 2A3s in push-pull parallel operation, the output power being 15, 30, and 60 watts, respectively. A total of twenty-one tubes were now being used in the receiver.

But, it was soon apparent that 60 watts of audio power was inadequate for operating the two hundred speakers, some of which were now located as much as 15 miles from the radio receiver. Therefore, two 830-B (60-watt) tubes were substituted for the 2A3s in the output stage, operating on a plate voltage of 1000 to 1250 volts. The

2200-volt plate supply transformer, the filament transformer, the filter choke, and the input and output audio transformers were designed for these tubes and wound by hand. The plate supply transformer was dried by being placed in a vacuum, and then impregnated with hot beeswax and rosin under pressure. Previous experience with shorts and burnouts in the higher voltage transformers had indicated the need for such treatment.

The two 830-Bs would not stand up under the service demanded of them, however, and about a year later, two 204-A (500-watt) audio amplifier tubes were purchased second hand. But these also



proved unsatisfactory and were discarded in favor of two 212-Ds, (250 watt tubes). The combined audio output of these tubes ran between 350 and 400 watts. Obsolete 1-kilowatt pole transformers were bought from a local power company and used to supply the plate voltage through two 866-A rectifiers. The filter system had a choke input to reduce noise from the rectifier system. A partially rewound distribution pole transformer was used as the audio output transformer for the 212-Ds.

Next, the tuner was redesigned and brought up to date. It was rebuilt with a 6D6 pentode as the rf amplifier, a 6A7 as the first detector and oscillator, 6D6s in the two i.f. stages, a 75 as the second detector and first audio amplifier, and a 42 as a triode amplifier feeding the grids of the 212-D tubes in Class A prime. Air dielectric capacitors were used to tune the i.f. stages. These designs of the tuner and audio system are shown in Figs. 1 and 2.

## Calling system feature

When the system was in its infancy and only the immediate neighbors were connected, it was desirable to be able to talk to them from time to time. To do this, I developed a switching system which would disconnect the monitor speaker from the output stage and connect it to the audio input. The operator could talk into the speaker, using it as a microphone, and the voltage generated would be amplified by the audio system and fed into the line. When the operator had finished speaking, the speaker was switched back to its normal place in the output and the line was connected to the audio input instead of the output. Anybody on the line could then talk into a speaker and be heard by the operator.

However, the person on the line had no method of talking to the operator unless the operator called first. To attract the attention of the operator, a "calling system" was devised (Fig. 3). The line was isolated from direct current by putting a capacitor, C2, in series with the output winding and one in series with each speaker (Fig. 3) for connections. A negative potential from a dc source was placed on the line through a high-resistance, R2. A type 27 tube was connected to a two-coil magnetic speaker with one coil in the grid lead and the other in the plate lead. The grid return was connected through a filter, (to block the audio) to the line. When a person on the line wanted to call the operator, closing a switch shorted the

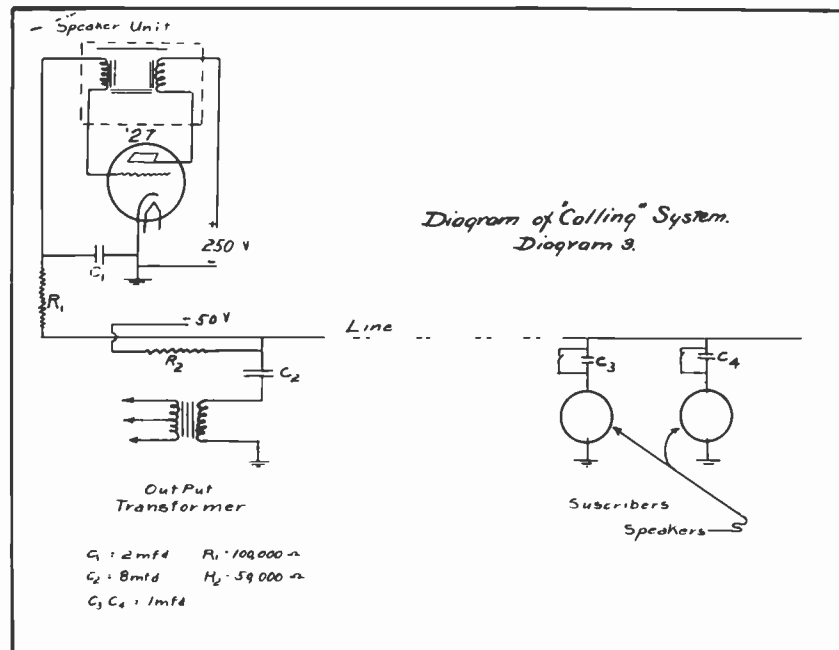

Fig. 3.

capacitor at the caller's speaker. This removed the negative bias from the type 27 tube and permitted it to oscillate at audio frequency due to the coupling of two coils of the speaker unit. The speaker, of course, responded to the fluctuations in plate current and its sound alerted the operator.

As the number of speakers increased, it became more difficult to hear the voice signal. Also, the hum resulting from grounds in the power system was strong enough to drown out the signal. In addition, the number of subscribers had increased to the point where it was not desirable to interrupt the program to speak to a person on the line.

## The cable link

When the line was first started, any kind of wire that came to hand was used, and most of it was rusty iron. As the size of the system increased, a frequent popping sound developed which was caused by current jumping bad connections in the line. This would cause a surge which would feed back into the aerial and the line return. This difficulty was overcome by connecting the grounded side of the first rf transformer to a separate ground from the one used for the chassis and output stage.

When the line extended to about ten miles, the volume at the far end became so low as to be quite unsatisfactory, because of excessive losses in the iron wire. A meeting of all the subscribers past a point five miles distant was called, and it was decided that each person would contribute

one dollar to a fund to replace the iron wire with copper. In this way, five miles of copper wire were put up, using telephone-type insulators. The volume at the distant parts of the line was materially improved. From that time on, all new subscribers were required to pay a one dollar fee toward replacing more of the iron conductors with copper wire (see accompanying map on page 74.)

During the summer months, the static was often so bad, even at night, that it was impossible to receive a satisfactory program. To increase the scope of the service, a "local talent" program was inaugurated — the local talent being quite plentiful during the summer months. A ribbon microphone and pre-amplifier were constructed and connected to the audio input (Fig. 4). A phonograph turntable and pickup also supplemented the home talent program. Many announcements of local interest were made, of which the following are representative: "Mrs. Jones has a cow for sale," and "There will be an ice cream supper at Oak Grove School House at seven o'clock Friday evening. Everybody invited."

## Test methods and equipment

Since all subscribers were required to put up their own lines and purchase and connect their own speakers, it is not surprising that many grounds and short circuits developed, tending to reduce the volume at other speakers. In fact, it was found that under existing conditions, more

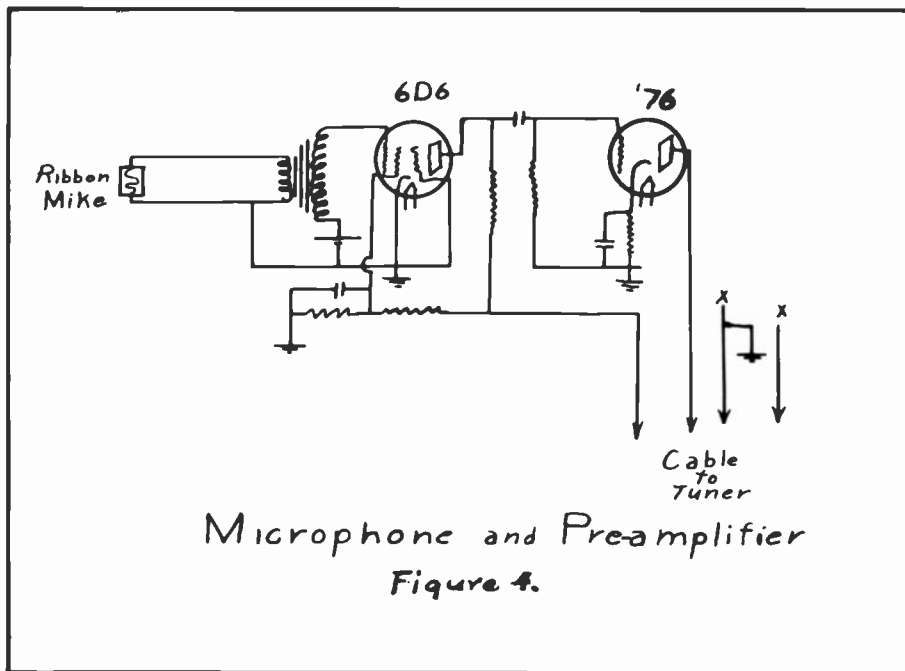

power was dissipated in such grounds than in the speakers themselves. There was also the usual difficulty with broken lines, contact with tree limbs, etc.

As the number of speakers increased, it became necessary to devise some quick method of locating these faults. To do this, a split-core current transformer was made by cutting a slot in the core of an ordinary audio transformer close to the primary winding. The secondary was connected by means of a shielded cable to an audio amplifier in the test car. This amplifier

consisted of a two-stage audio system feeding into an ac voltmeter of the copper oxide rectifier type. The current transformer was mounted on the end of a pole which was normally carried on the side of the test car. When tests were to be made, all subscribers were advised that something was wrong and were asked to turn off their speakers. Then the 110-volt, 60 Hz supply was connected to the line through a resistor. The tests for excessive current along the line were made by raising the current transformer on the pole until

the line slipped in the slot provided for it and observing the calibrated output voltmeter. Although the indications were only approximate, the device was sufficiently sensitive to indicate the current taken by a single speaker and served well to locate ground points.

In one summer, line-loss tests showed that approximately half of the audio power was lost in the first six miles of copper wire. (The majority of the speakers were connected through this line. See map). To reduce this loss and provide greater volume to the more distant points, the six-mile line of wire was changed from a low impedance to a high impedance line, with the audio voltage reaching a maximum of about 800 volts. A transformer at the far end of the line (Five Forks) stepped this down to about 150 volts. This portion of the line was carefully maintained and protected by a relay system. The line was isolated for dc by the use of capacitors, and a constant negative voltage was applied to it through a 100,000-ohm resistor. The line was also connected through a filter system to the grid of a tube. When the line was in good condition, as far as leakage and grounds were concerned, it was maintained at a high negative potential through the 100,000-ohm resistor. This potential, applied to the grid of a tube, prevented the flow of the plate current. If a ground occurred, or if any person touched the line, the resulting flow of the current through the 100,000-ohm resistor lowered the grid voltage on the tube and permitted it to draw a plate current through a relay. The relay opened the primary of the plate supply transformer to the output stage and also closed a signal bell circuit until the fault was removed.

This arrangement was also useful as a signalling device by the tester when calling the sending point from any place on the high impedance line. Even a superficial ground tripped the plate voltage and rang a bell. The person operating the radio then threw a switch which connected a standard telephone transmitter, receiver, and induction coil on the line. The tester also connected a telephone and a two-way conversation between the operator and tester could then be carried on.

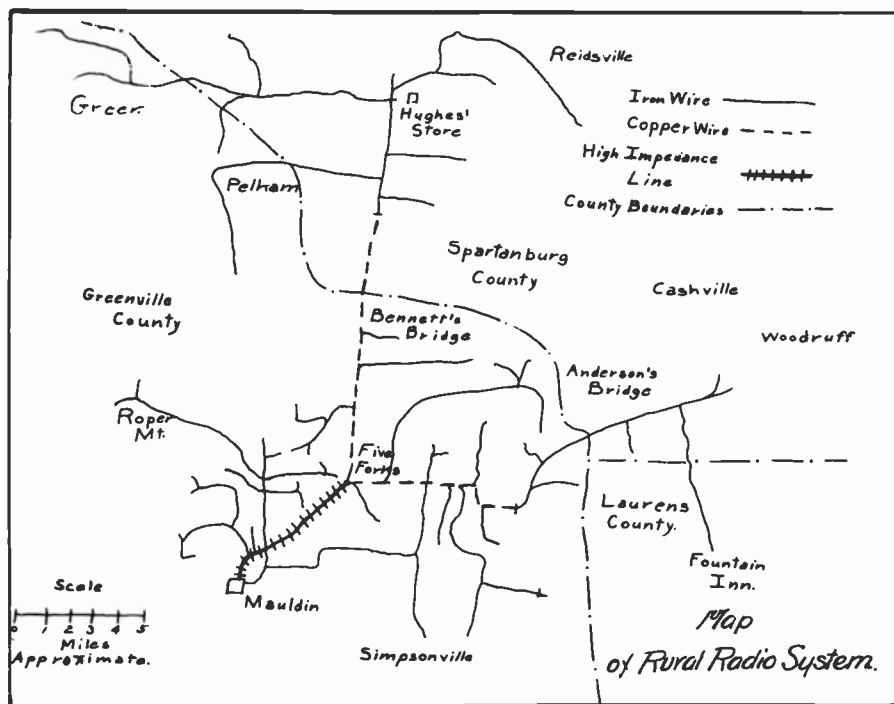

### Tonal quality

Since the very beginning of the system, frequent improvements were made in tonal quality. These included the change from a three-stage transformer-coupled audio system to a two-stage resistance-coupled circuit with pentode output; a change from

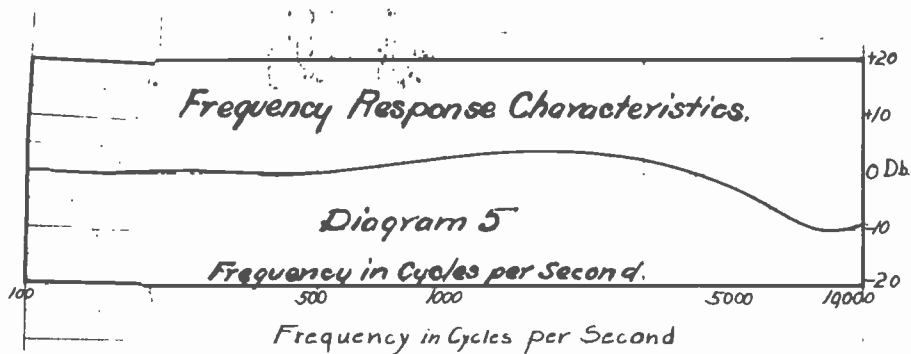

Fig. 5.

pentode output to push-pull triode output; and a change from choke-condenser coupling to transformer coupling of the output. The final system contained only two audio transformers — the push-pull input and the output for the final power stage.

The original output transformer was a partially rewound power transformer. However, a new transformer was designed and wound on the best grade of Allegheny audio iron and treated to exclude moisture. With this transformer in the output stage, the tonal quality surpassed that of any stock radio.

To assist in locating the source of distortion and the causes of low fidelity, a cathode ray oscillograph was constructed around the RCA 906 tube. A beat-note oscillator designed to have a good waveform was also constructed. These two pieces of equipment made possible accurate tests for distortion and fidelity. The results of a test of the frequency characteristics are shown in Fig. 5. In obtaining data for this curve, the oscillograph was used to keep the voltage input constant, as well as for measuring the frequency of the oscillator and checking its waveform.

The following example shows the varied uses to which the oscillograph was put. The output stage had developed a popping noise on high-signal levels, which was caused by either a breakdown in the transformer or a parasitic oscillation in the final stage. By connecting a variable signal voltage to the input of the final stage and observing the waveform in the secondary of the output transformer, it was clear that there was a breakdown in the transformer primary because the break in the sine wave occurred as the secondary voltage approached zero.

## Some problems and their solutions

A few of the difficulties encountered outside the system may be of interest. These

consisted of the usual atmospheric disturbances, leakage on power lines, contacts in electric incubators, and telephone line interference. The latter proved the most difficult to solve. Though the telephone lines and the radio distribution system were no nearer than a quarter mile at any point, the programs appeared on the phone lines. The interference was finally eliminated by feeding the various lines in such a way that the local ground current to one group of lines was balanced by that of the other. Thus, the local ground current was practically zero. This might be compared to an Edison 3-wire system with the local ground as neutral.

The objectionable "hash" caused in the receiver by the 866-A mercury vapor rectifiers was overcome by moving the rectifier system to another room and by using shielding and bypass capacitors.

## Improvements and alterations

An automatic tuning system was added to permit automatic station selection during a twelve-hour period. The tuning device was designed to eliminate the backlash and slight inaccuracies usually associated with such devices. Another change was the use of a wired wireless system operating at about 40 or 50 kHz to permit tying in, *for signal pickup only*, with another system designed and built, but not owned, by the author. This system also permitted the use of repeater amplifiers at any point on the line accessible to the public service power line. This was important when the lines began to approach a length of 25 miles.

Familiarity with the people served by the system over the years served to indicate the value of the system as an educational medium, despite the fact that a large percentage of the programs was anything but cultural in type. Many of the subscribers did not take newspapers, and practically all new customers asked for "Hill-Billy" or "Fiddlin'" programs and music. After several years of reception,

however, they wanted better programs, were more conversant on a greater variety of subjects, and took more interest in outside events.

The combined systems could reach an audience of over 3,000 listeners, and presented distinct possibilities for commercialized advertising.

Although it might seem that there would be dissatisfaction with the program fare, most of the listeners were well pleased and would not part with their "radio." In the 23-mile radius covered by the line, practically 85 percent of the families had speakers.



**Gordon Rogers**, formerly of Consumer Electronics and now retired, joined RCA in 1946 in the Industry Service Laboratory, (ISL), in New York City. ISL provided a consulting engineering service to the licensees of RCA. In 1950, he was made Engineer-in-Charge of the Hollywood ISL and in 1953, of the Chicago ISL. In 1958, Gordon was responsible for the development of citizens band radio transceivers in the Communications Products Department. In 1960, he was made Manager of Advanced Development for the Communication Products Department and in 1963, Manager of Advanced Development for the Home Instruments Division. From 1968 until his retirement he held various managerial positions at CE Video Tape Recorder Engineering, Recorded Video Engineering, and Advanced Development Programs.

He holds 19 U.S. Patents. The most important was filed in 1948 on a system of providing keyed Automatic Gain Control (AGC) for TV receivers. The patent was based on ideas conceived but not used for AGC in the radio described in this article. By 1936 there were at least 12 other similar systems. This paper was presented in 1936 at Clemson College to a meeting of the Southeast district conference of the student AIEE.

# Voice your ideas

## **We want to hear from you.**

*RCA Engineer* is your magazine — by engineers and for engineers. You are its author as well as its reader.

Our editorial decisions are based on what we understand to be your information needs — technical information about RCA, bearing on your job and the jobs of your associates. But it is still your magazine and we need your particular insight to ensure that what we publish is what you need. Contact us in Cherry Hill, or if it is more convenient, talk with your local *RCA Engineer* Editorial Representative. The Ed Reps are listed on the inside back cover of this issue.

## **Use the *Engineer*.**

Engineers are innovators. Every day there are new attempts, advancements, new applications, new technologies. In spite of the specialized nature of engineering, there is much to be gained from a knowledge of activities in related fields.

Every engineer is aware of the importance of staying technically current and of building on the ideas of his colleagues. *RCA Engineer* is a vehicle for interdisciplinary (and inter-divisional) communication.

Read articles outside your specialty. And probe further. Call the author for additional information. Use the references and bibliographies. Find some new ideas. And new people. Enjoy yourself!

In a 1977 survey of 3000 RCA engineers, discussions with associates is ranked first as a source of technical information about RCA — and *RCA Engineer* was next on the list.

Much of RCA's technical heritage is recorded in the 3000 articles which have been published in *RCA Engineer*. To make it easier to access the ideas held in the last 150 issues, we are publishing a *25 Year Index to the RCA Engineer*. You may obtain a copy for your personal use by writing to the *RCA Engineer* editorial office. It will also be distributed to RCA's Technical Libraries for your examination.

## **Take a more active role: Write an article.**

Engineers have a professional obligation to document their work in such a way that their peers and management can readily understand it. Beyond documentation, what are the benefits of preparing an article for publication? Certainly the interchange of ideas can benefit the reader, as we already

have discussed, but the payoff potential is far greater for the author.

- The writer increases his or her communications skills. He rethinks his work and receives the helpful criticism of associates. He has a much better understanding of how to put across his ideas. Then it happens:
- Through publishing his ideas the author has put himself in touch with other professionals. He gains the added perspective of their ideas; and
- the author gains prestige, both for himself and for his company. He is able to do his job better and is better informed.

With this issue the *Engineer* begins its twenty-sixth year as an RCA-oriented technical magazine serving engineer-readers and authors of diverse specialties. We intend to preserve the unique character of the publication and to build on it. We invite your comments, suggestions, questions.



Thomas E. King  
*Editor*

# “ Voices *by and for* ”

## THE PURPOSE OF THE ENGINEER

To large measure, good engineering has assured the continued advance of RCA and the electronics industry. It is to encourage and assist the engineer to perform his complex task with increasing success in the future that this new magazine is dedicated.

*E.W. Engstrom*

Executive Vice-President  
Research and Engineering  
Vol. 1, no. 1, 1955

Members of the RCA engineering community must be worthy stewards of our corporate investment. Our greatest single devotion must be to professionalism that in large measure requires technological currentness. On a wider scale, we need to renew ourselves in pursuing excellence in a world of change.

What better way can we achieve this excellence than to actively read and contribute to the *Engineer*, a publication "by and for the RCA engineer." This Anniversary issue reminds us all of our technological tradition and our opportunities for a promising future.

*W.C. Hittinger*

Executive Vice-President  
Research and Engineering  
Vol. 26, no. 1, 1980

## ON THE VALUE OF ENGINEERS

Engineering is the spearhead into the future and the engineer is the man who leads the way. . . .

*David Sarnoff*

Chairman of the Board  
Radio Corporation of America  
Vol. 2, no. 1, 1956

Given our essential stake in technology, no discipline seems quite so central to RCA's well-being as engineering. . . . I can assure RCA engineers that your contribution has never been more appreciated or needed. . . . The company looks to the engineering community for the products of tomorrow. Technological innovation is a proud RCA tradition.

*E.H. Griffiths*

President  
RCA Corporation  
Vol. 23, no. 1, 1977

Our management is determined to take the steps necessary to ensure growth and corporate vitality by developing innovative new electronic products that will, in some cases, spawn new industries. . . . in an electronic-based company like RCA, a highly skilled and competent technical staff is the primary force that will carry our new products and industries through development, growth, and product improvement to successful maturity.

*H. Rosenthal*

Staff Vice-President  
Engineering  
Vol. 24, no. 1, 1978

## KEEPING TECHNICALLY CURRENT

Our most important asset is KNOWLEDGE.

. . . In spite of the apparently highly specialized nature of engineering today, there are real advantages to be gained from a knowledge of activities in related fields. The *RCA Engineer* continues to provide a most valuable medium for the communication of technical information and I heartily recommend the reading of every article.

*G.H. Brown*

Chief Engineer  
Industrial Electronic Products  
Vol. 3, no. 4, 1958

The growing diversity of technical knowledge within RCA demands improved communications if we are to remain competitive. Each engineer and engineering manager should consider it *part of his professional duty and privilege* to improve these communications through the writing and publication of technical papers and reports.

*C.M. Sinnott*

Director,  
Product Engineering Professional Development  
Vol. 10, no. 1, 1964

We at RCA Laboratories feel that we must cover the entire electronics spectrum, rather than being limited to a few specific themes, to accomplish our objective. . . . Obviously, we can achieve our objective only when we have good two-way communications with the product divisions. And the *RCA Engineer* is one of the Laboratories' and the Corporation's communications tools.

*W.M. Webster*

Vice-President  
RCA Laboratories  
Vol. 20, no. 1, 1974

To keep technically current, you must overcome the very real obstacles and inertia presented by your daily work assignments and direct sufficient time and energy to the task of learning current technology, gaining working knowledge of new engineering tools and techniques as they emerge, and finding ways to use some of this newly gained knowledge.

*H.K. Jenny*

Manager, Technical Information  
Corporate Engineering  
Vol. 23, no. 3, p. 18, 1977

## WHY WRITE?

The engineer who acts like a professional is more apt to be treated as one. . . . The engineer should *communicate often and freely* with his peers. Within his organization, he finds individuals with all the special qualities needed for outstanding group performance. By using their help, and by helping them, he enhances his individual prestige as well as that of his company. Outside his organization, the engineer should publish his work, attend technical meetings in his field and make personal contacts with as many as possible in environments other than his own.

*E.W. Herold*

Director of Technology  
Research and Engineering  
Vol. 22, no. 6, p. 42, 1977

Technical information bearing directly on my job is the most important type of information I need, and having efficient access to it is extremely important to me.

Keeping abreast of the new technology in my field is quite important to my job performance.

*Engineering Information Survey results*

Vol. 23, no. 3, p. 30, 1977

Technical reports and papers are about the only sure way the younger engineers in a Company as large as RCA have of bringing their work to the attention of top engineering management. . . . The responsibility for your development and advancement is entirely yours. Why not start now?

*M.S. Carrington*

Advanced Development Section  
RCA Victor Television Division  
Vol. 1, no. 1, p. 2, 1955

---

# Patents

---

## Astro-Electronics

Eng, K.Y.  
**Redundance system with eight devices for five channels—4198611**

## Advanced Technology Laboratories

Hudson, K.C.  
**Defect detection and plotting system—4197011**

Larrabee, R.D.  
**Power transfer apparatus—4204147**

Scott, R.D.  
**Apparatus for developing photographic images on an emulsion coated film—4198145**

## Automated Systems

Sutphin, Jr., E.M.  
**Filter which tracks changing frequency of input signal—4204171**

## Commercial Communications Systems

Television picture compressor—4204227

Loeb, P.|Magasiny, I.P.  
**Movement detecting apparatus and method—4203063**

Nossen, E.J.  
**Code correlator loop using arithmetic synthesizer—4203002**

## Consumer Electronics

Balaban, A.R.|Steckler, S.A.  
**Frequency divider circuit—4200811**

Craft, J.  
**Intercarrier sound system—4199787**

Harwood, L.A.|Shanley, 2nd, R.L.  
Wittmann, E.J.  
**Predictable automatic brightness control circuit in a video signal image reproducing system—4203131**

Parker, R.P.  
**DC gain controlled amplifier—4198652**

Smith, J.L.  
**Color purity adjusting method—4201932**

Shanley, 2nd, R.L.  
**Predictably biased kinescope driver arrangement in a video signal processing system—4204221**

Torrington, L.A.  
**VideoDisc player—4196906**

## Electro-Optics Division

Faulkner, R.D.  
**Electron discharge device including an electron emissive electrode having an undulating cross-sectional contour—30249**

## Government Communications Systems

Spetgang, I.|Brennan, J.J.  
**Magnetic tape rotary headwheel assembly with venting means—4196457**

## Laboratories

Alphonse, G.A.|Saunders, Jr., W.C.  
**Anti-reflective acoustic wavefront refraction element—4197921**

Anderson, C.H.|Cosentino, L.S.  
**Modulator structure for a flat panel display device—4199705**

Angle, R.L.  
**CCD multiple channel network—4199691**

Aschwanden, F.  
**Tuning circuit with provisions for reducing pulse width jitter—4204173**

Baptiste, B.B.  
**Method of fabricating MNOS transistors having implanted channels—4196507**

Beelitz, H.R.|Preslar, D.R.  
**Method of integrating semiconductor components—4199860**

Carlson, D.E.  
**Article and device having an amorphous**

**silicon containing a halogen and method of fabrication—4196438**

Carlson, D.E.  
**Amorphous silicon Schottky barrier solar cells incorporating a thin insulating layer and thin doped layer—4200473**

Carnt, P.S.|Rutishauser, E.A.|Schiess, J.  
**Encoding and transcoding apparatus for VideoDisc systems—4200881**

Dingwall, A.G.  
**Buried contact configuration for CMOS/SOS integrated circuits—4196443**

Dixon, F.L.|Fox, L.P.|Trachman, E.G.  
**Wiping apparatus and method for a high-density information record—4198060**

Gibson, J.J.  
**Rotating field polarization antenna system—4198641**

Goodman, L.A.  
**Transistor using liquid crystal—4204217**

Hawrylo, F.Z.  
**Method of epitaxially deposited cadmium sulfide—4203785**

Hsu, S.T.  
**MNOS memory device—4198252**

Hsu, S.T.  
**Method of making a planar semiconductor on insulating substrate device utilizing the deposition of a dual dielectric layer between device islands—4199384**

Ipri, A.C.  
**Method of fabricating a narrow base-width bipolar device and the product thereof—4200878**

Kamprath, T.  
**Method of fabricating MNOS transistors having implanted channels—4197630**

Keneman, S.A.  
**Electron multiplier input electron optics—4199702**

Kleinknecht, H.P.|Bosenberg, W.A.  
**Optically testing the lateral dimensions of a pattern—4200396**

Mezrich, R.S.|Vilkomerson, D.H.  
**Ultrasonic wave energy electronic B-scan imaging apparatus—4197749**

Onyshkevych, L.S.  
**Inductance fabricated on a metal base printed circuit board—4201965**

Onyshkevych, L.S.  
**Method and apparatus for trimming resistors—4201970**

Paglione, R.W.  
**Coaxial applicator for microwave hyperthermia—4204549**

Palmer, R.C.  
**Recording/playback apparatus facilitating track skip detection—4198658**

Reichert, W.F. | Huang, H.  
**Semiconductor device having grid for plating contacts—4202001**

Rutishauser, E.A.  
**Overload protection circuit for video amplifiers—4197558**

Rutishauser, E.A.  
**Dual standard VideoDisc player—4204220**

Schnable, G.L. | Fisher, A.W.  
**Method of chemically vapor-depositing a low-stress glass layer—4196232**

Scott, Jr., J.H. | Iprì, A.C.  
**Method of fabricating improved short channel MOS devices utilizing selective etching and counterdoping of polycrystalline silicon—4201603**

Staebler, D.L.  
**Updateable optical storage medium—4202928**

Staebler, D.L.  
**Laser beam apparatus and method for analyzing solar cells—4205265**

Sterzer, F.  
**Hyperthermia applicator—4197860**

Tuma, A.V. | Groeneweg, W.H.  
Harwood, L.A.  
**Brightness control circuit employing a closed control loop—4197557**

Vilkomerson, D.H. | Mezrich, R.S.  
**Pulse-echo ultrasonic wave-energy imaging system incorporating high-angular velocity oscillated transducer—4197751**

Weimer, P.K.  
**Solid state image sensor—4200892**

Weitzel, C.E. | Goodman, A.M.  
**Insulated gate field effect silicon-on-sapphire transistor and method of making same—4199773**

Wu, C.P.  
**Pulsed laser irradiation for reducing resistivity of a doped polycrystalline silicon film—4198246**

## Missile and Surface Radar

Bowman, D.F.  
**Reflectarray antenna—4198640**

## Picture Tube Division

Hughes, R.H.  
**CRT generating three inline beams and having shunts for weakening center beam horizontal magnetic deflection and strengthening vertical deflection—4196370**

Ragland, Jr., F.R.  
**Deflection yoke assembly including a beam positioning magnet arrangement—4198614**

Turner, C.C.  
**Fixture for holding a faceplate and a funnel of a CRT during sealing—4200274**

## "SelectaVision"

Christopher, T.J. | Lin, T.H.  
**FM signal demodulator with defect detection—4203134**

Coleman, C.F. | Stewart, M.C.  
**RF connector assembly including mounting apparatus for a washer-like capacitor—4202594**

## Solid State Division

Ahmed, A.A.  
**Temperature compensating comparator—4198581**

Ahmed, A.A.  
**Integrated injection logic with floating reinjectors—4199776**

Ahmed, A.A.  
**Temperature-sensitive control circuits—4204133**

Dietz, W.F.  
**Side pincushion correction system—30271**

Engstrom, R.W. | McDonie, A.F.  
**Bi-alkali Telluride photocathode—4196257**

Khajezadeh, H.  
**Semiconductor integrated circuit device—4202006**

Month, A. | Benner, T.E.  
**Pick-up tube having bias lighting and controls therefor—4196372**

Rosnowski, W. | Neilson, J.M.  
**Method of diffusing aluminum into monocrystalline silicon—4199386**

Schade, Jr., O.H.  
**Extended-drain MOS mirrors—4199733**

Schade, Jr., O.H.  
**Long-tailed-pair connections of MOSFETs operated in sub-threshold region—4201947**

Zuber, J.R. | Foxman, H.  
**Method of stripping photoresist—4202703**

Zuk, B.  
**Circuits for producing sequentially spaced pulses—4201927**

---

# Pen and Podium

Recent RCA technical papers and presentations

---

To obtain copies of papers, check your library or contact the author or his divisional Technical Publications Administrator (listed on back cover) for a reprint.

## Advanced Technology Laboratories

G.J. Ammon  
**Archival optical disk data storage—SPIE 5th Technical Symposium East, Washington, D.C., Proceedings, (4/7-4/11/80)**

H. Borkan | G.J. Brucker  
**Radiation-hardened CMOS/SOS for space applications—1980 Mission Assurance Conf., Los Angeles, Calif., Proceedings (4/30/80)**

A.F. Cornish | S.E. Ozga | J.E. Saultz  
**CMOS/SOS high-performance processors for future spaceborne missions—1980 Mission Assurance Conf., Los Angeles, Calif., Proceedings, (4/30/80)**

D.A. Gandolfo,  
**Infrared viewing systems—E-O class, Univ. of Penn., (4/17/80)**

R.F. Kenville  
**Digital data storage on optical disc & information display—SID Symposium, San Diego, Calif., Proceedings, (4/28-5/2/80)**

B.W. Siryj  
**An air lubricated thermal processor for dry silver film—SPIE 5th Technical Symposium East, Washington, D.C., Proceedings, 4/7-4/11/80)**

## Automated Systems

L. Arlan  
**Electro-optics products and systems—IEEE Student Chapter, Southeastern Mass. Univ., Southeastern, Mass. (2/80)**

L. Arlan|M.J. Cantella|T.J. Dudziak  
M.F. Krayewsky  
**Thick-film hybrid inspection with a computer-controlled high resolution imaging and storage system**—The Society of Photo-Optical Instrumentation Engineers, Los Angeles, Calif. (2/80)

L. Arlan|R.J. Wildenberger  
**A computer-controlled imaging system for automated hybrid inspection**—'80 ERAD-COM Hybrid Microcircuit Symposium, Ft. Monmouth, N.J. (6/80)

M.J. Cantella  
**Performance and application of Schottky barrier IR focal plane arrays**—Association of Old Crows, Electro-Optical Warfare III Symposium, San Diego, Calif. (4/80)

M.J. Cantella|J.J. Klein, *et al.*  
**Advances in platinum silicide Schottky barrier IR-CCD image sensors**—SPIE Technical Symposium East, Washington, D.C. (4/80)

M.J. Cantella|J.J. Klein, *et al.*  
**A high sensitivity Schottky IRCCD focal plane array**—28th National IRIS Meeting, Seattle, Wash. (5/80)

R.T. Cowley|A. Muzi  
**New generation of test and monitoring systems**—26th International Instrumentation Symposium, Seattle, Wash. (5/80)

H.L. Fischer  
**Microcomputer applications in non-electronic testing**—*RCA Engineer*, (4,5,6/1980)

A.H. Fortin  
**Microprocessing applications in non-electronic testing**—IEEE Student Chapter, Northeastern Univ., Boston, Mass. (5/80)

S.C. Hadden|A.G. Olsson  
**Beyond simple measurements: on-board monitor for vehicle prognosis**—26th International Instrumentation Symposium, Seattle, Wash. (5/80)

F.W. Hohn|M.L. Johnson  
**Military vehicle maintenance**—Boston IEEE Reliability Chapter Spring Seminar, Waltham, Mass. (4/80)

N.L. Laschever  
**ELECTRO 80—its roots**—Editorial for the *IEEE Reflector*, (4/80)

N.L. Laschever  
**IEEE alphabet soup**—Editorial for the *IEEE Reflector*, (5/80)

N.L. Laschever  
**On income and expenses**—Editorial for the *IEEE Reflector*, (4/80)

G.E. Maguire  
**The purchasing viewpoint**—*Purchasing*, (3/80)

F.F. Martin  
**RCA's IR Schottky barrier focal plane**

**array**—U.S./U.K. Imaging Infrared Technology Exchange Conference, Arlington, Va. (3/80)

J.F. McCarthy  
**Broad-based technology at RCA, Automated Systems**—IEEE Student Chapter, University of Lowell, Lowell, Mass. (2/80)

J.P. Mergler  
**A natural command language for C<sup>3</sup> applications**—*RCA Engineer*, (2, 3/80)

E.H. Miller  
**ASAS/SEWS - TCAC**—National Military Intelligence Assoc., Ft. Devens, Mass. (5/80)

J.C. Phillips  
**Creating winning proposals**—28th Annual Technical Writers' Institute, Troy, N.Y. (6/80)

## Avionics Systems

G.A. Lucchi  
**Commercial airborne weather radar technology**—IEEE 1980 International Radar Conference, Arlington, Va., *Record*, (4/28-30/80)

## Commercial Communications Systems

L.V. Hedlund  
**The application of microcomputers in future RCA broadcast quality 1" helical video tape recorders**—NAB, Las Vegas (4/15/80)

A.H. Lind  
**An overview of progress toward the digital plant**—SMPTE, Canada (2/1/80)

Luther, A.C.  
**Engineering challenges in commercial communications systems**, *RCA Engineer*, (8/80)

Thompson, C.R.  
**Recent advances in digital video recording**—SMPTE, Canada (2/1/80)

## Government Communications Systems

D. Hampel  
**Application of VLSI to smart sensors**—American Society for Industrial Security, Springfield, Va. (5/14/80)

A. Kaplan|D. Sherwood  
**MASS—A modular ESM signal processor**—*Jour. of Electronic Defense* and presented at NAECON, Ohio (5/20-22/80)

S.J. Nossen|D.J. Imbesi|D. Hampel  
**A signal processor for communications signal analysis**—NAECON, Dayton, Ohio, *Proceedings* (5/20-22/80)

D.M. Ward  
**State of the art technology & system design requirement for the NATO identification System (NIS)**—NAECON, Dayton, Ohio, *Proceedings* (5/20-22/80)

## Laboratories

D. Botez  
**Cw high-power single-mode operation of constricted double-heterojunction (AlGa)As lasers with a large optical cavity**—*Applied Physics Letters*, Vol. 36, No. 3 (2/1/80)

K.K.N. Chang  
**Collimated electron trajectory in a non-uniform transverse magnetic field**—*RCA Review*, Vol. 40, No. 4 (12/79)

R.S. Crandall  
**Band-tail absorption in hydrogenated amorphous silicon**—*Physical Review Letters*, Vol. 44, No. 11 (3/17/80)

R. Crandall  
**Field dependent quantum efficiency in hydrogenated amorphous silicon**—*Applied Physics Letters*, Vol. 36, No. 7 (4/1/80)

C.A. Deckert|D.L. Ross  
**Microlithography—Key to solid-state device fabrication**—*Journal of the Electrochemical Society*, Vol. 127, No. 3 (3/80)

C.A. Deckert|D.A. Peters  
**Optimization of thin film wetting and adhesion behavior**—*Thin Solid Films*, Vol. 68, pp. 417-420 (80)

E.C. Douglas|R.V. D'Aiello  
**An experimental study of the factors which control the efficiency of ion-implanted silicon solar cells**—14th IEEE Photovoltaic Specialists Conference (1/80)

E.C. Douglas|R.V. D'Aiello  
**A study of the factors which control the efficiency of ion-implanted silicon solar cells**—*IEEE Transactions on Electron Devices*, Vol. ED-27, No. 4 (4/80)

M. Ettenberg|H. Kressel  
**The reliability of (AlGa)As CW laser diodes**—*IEEE Journal of Quantum Electronics*, Vol. QE-16, No. 2 (2/80)

H. Fujita, H. Inoue  
**Concentration quenching of luminescence in a disordered system with dipolar interaction**—*RCA Review*, Vol. 41, No. 1 (3/80)

W.E. Ham|M.S. Abrahams|C.J. Buicchi  
**On the limiting of minimum size of SOS/MOS devices by the microtwins in the silicon**—*Journal of the Electrochemical Society*, Vol. 127, No. 3 (3/80)

P.L.K. Hung|A. Bloom  
**Order parameters of Schiff base azo dyes in nematic liquid crystalline hosts**—*Mol. Cryst. Liq. Cryst.*, Vol. 59, pp. 1-12 (80)



H.P. Kleinknecht|H. Meier (Zurich)  
**Linewidth measurement on IC masks and wafers by grating test patterns—***Applied Optics*, Vol. 19, No. 4 (2/15/80)

W.M. Lee, (Labs)|H.V. Becker (CE)  
**Shear viscosity-temperature-shear rate relations for flame-retardant impact polystyrene melts—***RCA Review*, Vol. 40 (12/79)

H.W. Lehmann  
**Dry etching techniques—***Electronics to Microelectronics* (80)

R. Loudon|J.R. Sandercock  
(Colchester, England|Zurich, Switzerland)  
**Analysis of the light-scattering cross section for surface ripples on solids—**The Institute of Physics (80)

D.H. Pritchard  
**A CCD comb filter for color TV receiver picture enhancement—***RCA Review*, Vol. 41, No. 1 (3/80)

D. Redfield  
**Unified model of fundamental limitations on the performance of silicon solar cells—***IEEE Transactions on Electron Devices*, Vol. ED-27, No. 4 (4/80)

D. Redfield  
**Fundamental limitations on silicon solar-cell efficiency—**14th IEEE Photovoltaic Specialists Conference (1/80)

W. Rehwald (Zurich)|W. Wettling (not RCA)  
**Magnetically tunable ultrasonic transducers for shear waves—***Applied Physics*, Vol. 22, pp. 31-34 (80)

P.H. Robinson|R.V. D'Aiello|D. Richman  
**Epitaxial solar cells on metallurgical grade silicon substrates—**14th IEEE Photovoltaic Specialists Conference (1/80)

D.J. Sauer  
**Design and performance of a CCD comb filter IC—***RCA Review*, Vol. 41, No. 1 (3/80)

G.L. Schnable|R.B. Comizzoli|W. Kern  
L.K. White  
**A survey of corrosion failure mechanisms in microelectronic devices—***RCA Review*, Vol. 40 (12/79)

G.A. Swartz|R. Williams  
**Determination of amorphous silicon solar cell barrier properties by measurement of differential current-voltage characteristics—**14th IEEE Photovoltaic Specialists Conference (1/80)

T. Takahashi  
**Introduction to luminescent glasses—***RCA Review*, Vol. 41, No. 1 (3/80)

T. Takahashi|O. Yamada  
**Fluorescent properties of alkali and alkaline rare earth metaphosphate glass phosphors—***RCA Review*, Vol. 41, No. 1 (3/80)

T. Takahashi|O. Yamada  
**Low-energy cathodoluminescence of alkali yttrium terbium metaphosphate glass—a new AC plasma display—***IEEE Transactions on Electron Devices*, Vol. ED-27, No. 1 (1/80)

T. Takahashi|O. Yamada  
**Luminescence of certain terbium metaphosphate glasses under X-ray excitation—***RCA Review*, Vol. 41, No. 1 (3/80)

R. Williams|R.S. Crandall  
**Carrier generation, recombination and transport in amorphous silicon solar cells—***RCA Review*, Vol. 30 (12/80)

O. Yamada|T. Takahashi  
**Thermal properties of new metaphosphate glasses—***RCA Review*, Vol. 41, No. 1 (3/80)

## Missile and Surface Radar

K. Abend  
**Rational and bandlimited models for spectrum estimation—**10th Annual IEEE Communication Theory Workshop, Cyprus Gardens, Fla. (4/80)

K. Abend  
**Spectrum analysis and resolution enhancement by bandlimited extrapolation—**1980 IEEE International Conference on Acoustics, Speech and Signal Processing (ICAASSP), Denver, Col., *Record* (4/80)

F.G. Adams  
**AEGIS—shield of the fleet—**Featured speaker, 7th Annual Retiree Open House, David Sarnoff Research Center, Princeton, N.J. (6/80)

J.A. Bauer  
**High density LSI packaging with hermetic chip carriers—**1980 Mission Assurance Conference, Los Angeles, Calif., *Proceedings* (5/80)

J.A. Bauer  
**Chip carrier packaging applications—**Biannual IEEE Computer Society Workshop Technical Committee on Packaging (5/29/80), *IEEE Transactions on Components, Hybrids and Manufacturing Technology*, Vol. CHMT-3, No. 1 (3/80)

J.A. Bauer|R.F. Kolc  
**The growth in complexity of chip carrier applications—**NEPCON East, 1980, New York, N.Y. Industrial Microelectronics Conference *Proceedings* (6/80)

J.A. Bauer|R.F. Kolc  
**Growth and application of chip carriers—***Electronic Packaging and Production* (5/80)

F.J. Buckley  
**Standard for software quality assurance plans—**IEEE Trial-Use Standard, ANSI/IEEE Standard 730 (1/80)

F.J. Buckley  
**Software quality assurance management—**Instructor, Software Quality Assurance Course, Drexel University; presented at Boston, Mass. (5/80)

F.J. Buckley  
**Software quality assurance management—**3-day Seminar, Drexel University Continuing Professional Education, Phila., Pa. (4/80)

M.W. Buckley  
**Project management—**Basic Project Management Course IEEE Continuing Education, Toledo, Ohio (5/80)

R.N. Casolaro  
**Wideband transmitter technology for advanced tactical radars—**Tactical Air Surveillance and Control Conference, RADC, Rome, N.Y. (6/80)

J.A. DiCiurcio  
**AN/TPQ-27 precision tracking radar—**1980 International Radar Conference, Washington, D.C., *Record* (4/80)

M. Ducoff  
**Closed-loop angle tracking of unresolved targets—**1980 International Radar Conference, Washington, D.C., *Record* (4/80)

B. Fell  
**Evaluation of radar system detection effectiveness against distributed standoff jamming—**Tactical Air Surveillance and Control Conference Workshop, RADC, Rome, N.Y. (6/80)

D. Greeley|J. Golub  
**Adaptation of MEDUSA to a TAC C<sup>3</sup> air battle simulation—**Tactical Air Surveillance and Control Conference Workshop, RADC, Rome, N.Y. (6/80)

S.D. Gross  
**The effect of clutter upon the performance and design of bistatic radars—**Workshop on Multi-static Radar, RADC (5/80)

J.F. Heimmer  
**Modern fire control technology applied to high-speed surface combatants—**High Speed Surface Craft Exhibition and Conference, Brighton, Sussex, U.K. (6/80)

D.J. Herman  
**Computer program project management as a career—**Rutgers University, Camden Campus (4/80)

R.G. Higbee|J.J. Ratkevich  
**The NIDIR system—performance and economy for range instrumentation—**1980 International Radar Conference, Washington, D.C., *Record* (4/80)

L.E. Kitchens  
**The HR-76 fire control radar—**1980 International Radar Conference, Washington, D.C., *Record* (4/80)

R.F. Kolc  
**Packaging with chip carriers on**

ceramics/printed circuit boards—Institute for Interconnecting and Packaging Electronic Circuits Conference, Orlando, Fla. (4/80)

R.F. Kolc

Computerized thick film printer—Capital Chapter of ISHM (International Society of Hybrid Microcircuits), Washington, D.C. (5/15/80)

J.M. Lucash

Incentives and vendor quality—American Defense Preparedness Association, Third Annual Product Assurance Forum, Ft. Belvoir, Va. (5/80)

L.W. Martinson|R.P. Perry

Signal processing for satellite mapping—*Microwave Journal* (4/80)

W.A. Mulle

R-76, a family of multi-purpose shipboard fire control radars—International Naval Technology Expo, Rotterdam (6/80)

W.A. Mulle

The outlook for shipboard fire control radars—TMS/AIAA Conferences, London, England and Stuttgart, Germany (6/80)

J.T. Nessmith

Instrumentation radar—Chinese Institute of Electronics, Peking, Peoples' Republic of China (6/80)

F.P. Papasso|L. Finkel

Role of phased array GCI radar in the tactical air control system—Tactical Air Surveillance and Control Conference/Workshop, RADC, Rome N.Y. (6/)

J.W. Parnell

The probability of range resolution of closely spaced radar targets—1980 International Radar Conference, Washington, D.C., *Record* (4/80)

W.T. Patton

Low sidelobe antennas for tactical radars—1980 International Radar Conference, Washington, D.C., *Record* (4/80)

R.L. Schelhorn

Fabrication of thick film circuits on co-fired ceramic substrates—Joint Metropolitan Keystone ISHM Symposium, Edison, N.J. (5/80)

R.L. Schelhorn

Manufacturing techniques for the fabrication of low cost thick film—NEPCON East, Industrial Microelectronics Conference, New York, N.Y., *Proceedings* (6/80)

D.P. Schnorr

The role of failure analysis in electronic packaging—Failure Analysis of Structural Metals and Components Seminar, American Society for Metals, Washington, Pa. (5/80)

T.M. Shelton

Testing of properties for soldered leadless

chip carrier assemblies—30th Electrical Components Conference, San Francisco, Calif., *Proceedings* (4/80)

S.M. Sherman

Comparison of pure and doppler-coupled range measurements for prediction—1980 International Radar Conference, Washington, D.C., *Proceedings* (4/80)

D. Staiman

Automating near-field antenna testing for phased-array radars—1980 International Radar Conference, Washington, D.C., *Record* (4/80)

S.A. Steele

Software engineering approaches for embedded computer systems—Third NATO Symposium on Quality and its Assurance, Washington, D.C., *Proceedings* (6/80)

H. Urkowitz

Digital interpolation for reducing straddling losses in detection, estimation and resolution—Seminars in Electrical Engineering, Drexel University, Phila., Pa. (4/80)

R.S. Wang

Program with measurable structure—ASQC 34th Annual Technical Conference, Atlanta, Ga., *Proceedings* (5/80)

M.L. Weisbein

Software product assurance at RCA Missile and Surface Radar—National Computer Conference, Anaheim, Calif. (5/80)

---

# Engineering News and Highlights

---

## Staff Announcements

### Consumer Electronics Division

Alfred Crager, Manager, announces the organization of Test Technology as follows: Larry J. Byers, Manager, Chassis Test Systems; James M. Lawrence, Supervisor, Test Technology Shop; Larry A. Olson, Manager, Integrated Circuits Test Systems; and Larry M. Turpin, Engineering Administrator, Systems Support. Messrs. Byers, Lawrence, Olson and Turpin will report to the Manager, Test Technology.

Arthur Kalman, Manager, Systems Applications, announces the appointment of Peter C. Hill as Manager, Ferrite Engineering.

Robert M. Rast, Manager, Digital Systems, announces the appointment of Scott A. Keneman as Manager, Television Digital Systems/New Products Laboratory.

James R. Smith, Manager, Division Quality Assurance, announces the appointment of James O. Early as Manager, Quality Systems and Procedures.

Bennie L. Borman, Director, Manufacturing Engineering and Technology, announces the appointment of Edward J. Byrum as Manager, Manufacturing Programs.

### Laboratories

William M. Webster, Vice President, announces the organization of RCA Laboratories as follows: Nathan L. Gordon, Staff Vice-President; Joseph P. Johnson, Staff Vice-President, Industrial Relations; Henry Kressel, Staff Vice-President, Solid State Technology; Kerns H. Powers, Staff Vice-President, Communications Research; Richard E. Quinn, Staff Vice-President, Administration; Thomas O. Stanley, Staff Vice-President, Research and Programs; James J. Tietjen, Staff Vice-President, Materials and Components Research; and

William M. Webster, Acting Display Systems Research.

Kerns H. Powers, Staff Vice-President, announces the organization of Communications Research as follows: David D. Holmes, Director, Consumer Electronics Research Laboratory; Bernard J. Lechner, Director, Video Systems Research Laboratory; Joseph H. Scott, Staff Engineer; Fred Sterzer, Director, Microwave Technology Center; Alfred H. Teger, Director, Advanced Systems Research Laboratory; Daniel A. Walters, Director, Communication Systems Research Laboratory.

Richard E. Quinn, Staff Vice-President, announces the appointment of Emil V. Fitzke as Head, Technological Services, and John L. Vossen as Head, Thin Film Technology Research.

James J. Tietjen, Staff Vice-President, announces the organization of Materials and Components Research as follows: Marvin A. Leedom, Director, Manufacturing Systems

and Technology Research Laboratory; **Robert D. Lohman**, Director, VideoDisc Systems Research Laboratory; and **David Richman**, Director, Materials and Processing Research Laboratory.

**David Richman**, Director, Materials and Processing Research Laboratory, announces the appointment of **Robert J. Ryan** as Head, Polymer Processing Research.

**David D. Holmes**, Director, Consumer Electronics Research Laboratory, announces the appointment of **Martin Rayl** as Head, Product Assurance Research.

**Marvin A. Leedom**, Director, Manufacturing Systems and Technologies Research

Laboratory, announces the appointment of **William G. McGuffin** as Head, Instrumentation Systems.

**Israel H. Kalish**, Manager, Integrated Circuit Design and Process Development, announces the appointment of **Roger E. Stricker** as Manager, Technology Transfer.

**David S. Jacobson**, Manager, Custom LSI Products, announces the appointment of **Joseph J. Fabula** as Manager, Production Engineering.

**Emil V. Fitzke**, Head, Technological Services, announces the appointment of **Austin J. Kelley, Jr.** as Manager, Technical Support Services.

## Solid State Division

**Robert S. Pepper**, Vice-President and General Manager, announces the organization of Solid State Division as follows: **Erich Burlefinger**, Division Vice-President, Electro-Optics and Power Devices; **Peter A. Friederich**, Division Vice-President, Industrial Relations; **Walter J. Glowczynski**, Division Vice-President, Finance; **Ben A. Jacoby**, Division Vice-President, Marketing; **Carm Santoro**, Division Vice-President, Integrated Circuits; **Ralph E. Simon**, Division Vice-President, Special Projects; and **Carl R. Turner**, Division Vice-President, Product Assurance and Planning.



### Gaspar is Vice-President, Strategic Planning at RCA Globcom

**Andrew Gaspar** was recently elected Vice-President, Strategic Planning for RCA Global Communications, Inc., reporting directly to Eugene F. Murphy, President.

In his new post, Mr. Gaspar will be responsible for the evaluation and recommendation of new business investments, the direction of in-depth financial and marketing analyses, and the development of specific strategies suitable for major RCA Globcom business ventures. He will also have responsibility for the Guam Telephone Service product line and for development of RCA Globcom business in the Pacific.

Mr. Gaspar has been associated with RCA Corporation since 1973. His most recent position was Director, Electronic Business Development, RCA Corporate Staff.

Before joining RCA, Mr. Gaspar was employed as a digital design engineer with Raytheon Company. During his four years with Raytheon, he designed LSI computers and digital systems in the firm's Missile Systems Division.

A graduate of Columbia University, Mr. Gaspar received the B.S. degree in Electrical Engineering. He also earned the M.A. degree in Business Administration from Harvard University and the M.S. degree from Northeastern University Graduate School of Engineering.



### Sweeny is new Associate Editor of RCA Engineer

**Michael R. Sweeny** joined the staff of the *RCA Engineer* as Associate Editor in June 1980. Previously, Mr. Sweeny was Managing Editor with *Lab World*, a 30-year-old monthly medical magazine for clinical pathologists, owned by North American Publishing Company in Philadelphia, Pennsylvania.

He brings broad publication experience to the *Engineer*, from initial planning through printing and distribution stages, encompassing: manuscript acquisition; article editing; feature writing and technical writing; technical special projects publication including instrument reports, courses-in-print and directories; and magazine production and design.

In 1980 he shared a 1979 American Business Press Jesse H. Neal Editorial Achievement Award for his work on a science article that was selected from a field of over 700 entries. His technical projects for *Lab World* have been cited in a publication by Frost & Sullivan, Inc., a reputable market research firm in the clinical lab marketplace. Mr. Sweeny is a member of the American Medical Writers Association in both the editors' and the writers' sections.

In 1975 he received the B.A. degree, *cum laude*, from Villanova University in the Honors curriculum, with a concentration in English. Early in 1978, intent on pursuing a career in technical communications, he took the B.S. degree in Science from the



### Horen joins Corporate Engineering Education activity

**Robert J. Horen** joined RCA Corporate Engineering as Administrator, Engineering Education Programs in February 1980. In this position, he will be assessing RCA needs in continuing engineering education and implementing courses and programs to meet these needs.

Mr. Horen first joined RCA in June 1965 and was assigned to the West Coast Division in Van Nuys, Calif. He has subsequently spent five years in the U.S. Air Force as Project Officer at the Air Force Weapons Laboratory working in Transient Radiation Effects. Most recently, he was Senior Professor of Electrical Engineering Technology at DeVry Institute of Technology in Phoenix, Arizona. He has been associated with the digital computer curriculum and he's developed and taught courses in microprocessor hardware and software. In addition, he spent six months in 1979 developing a microcomputer capability for the Nigerian Army Signal Corps in Lagos, Nigeria.

Contact Bob at TACNET: 222-5020 in Cherry Hill.

Pennsylvania State University, with over 80 credits in a wide range of science, engineering and mathematics courses.

Contact Mike at TACNET: 222-4255 in Cherry Hill.

## Promotions

### Consumer Electronics

**Billy W. Beyers, Jr.**, from Sr. Member, Engineering to Manager, Digital Products Development.

**Robert P. Parker**, from Member, Engineering, to Manager, Television Digital Applications.

**Ken Schroeder**, from Member, Technical Staff, to Manager, Digital Systems Technology.

### Patent Operations

**Dennis H. Irlbeck**, from Patent Counsel to Senior Patent Counsel.

**Peter M. Emanuel**, from Patent Counsel to Managing Patent Attorney, Consumer Products and Broadcast Equipment.

---

## Obituaries

---

### Paul Rappaport



**Dr. Paul Rappaport** died in Evergreen, Colo., in April 1980. A pioneer in the development of solar cells and an internationally recognized expert on solar energy, Dr. Rappaport retired in 1971 as Director of the Process and Applied Materials Research Laboratory at RCA Laboratories. He became founding Director of the National Solar Energy Research Institute (SERI) in Boulder, Colo.

A native of Philadelphia, he received B.S. and M.S. degrees in Physics from Carnegie Institute of Technology in 1948 and 1949, respectively. In 1974, Arizona State University awarded him an Honorary Doctor of Science degree for his leadership in the development of solar energy. That award was not only for his research in the field, but also for his services as a consultant to government, industrial and university groups concerned with solar energy.

Dr. Rappaport joined RCA Laboratories in 1949. He started working in energy conversion in 1953 and was credited with many "firsts" in materials, devices, and radiation damage aspects of solar cells. He was appointed Head of the Energy Conversion Research group in 1960, an Associate Laboratory Director in 1966, and a Director in 1968.

Dr. Rappaport was on a number of government advisory committees for the National Aeronautics and Space Administration, National Science Foundation, and National Academy of Sciences. A Fellow of the American Physical Society and the IEEE, he was also Editor of the *Journal of Energy Conversion*.

### Chester W. Sall



**Chet Sall**, who was an enthusiastic and effective supporter of the *RCA Engineer* for some 25 years, passed away on February 21, 1980, after a lengthy illness. He joined RCA in 1943 as a member of the Industry Service Laboratory in New York. When this laboratory was disbanded in 1958, he transferred to the Industrial Electronics Products (IEP) Division of RCA in Camden, where he was in charge of a group that prepared instruction books. In 1960 he moved to RCA Laboratories as Technical Editor for Project Pangloss, and in 1961, he became Administrator, Technical Publications for the Laboratories.

A graduate of DePauw University, Chet received a Master's degree from the State University of New York at Albany. He was a charter member of the IRE Professional Group on Engineering Writing and Speech, an organization that evolved into the IEEE Professional Communications Society. Active in the IEEE, he was Editor of *IEEE Transactions on Consumer Electronics* for more than 20 years — a role he continued to fill after his retirement.

In 1958 Chet became the *RCA Engineer* Editorial Representative for IEP, and from 1961 until his retirement in January 1978, he served as the Technical Publications Administrator for the *RCA Engineer*, and Editorial Representative for the RCA Laboratories. For many years, he was the "Dean" and final arbitrator of English usage at the Laboratories. In a note written in 1979, he referred to the reputation for excellence enjoyed by the *RCA Engineer*. This reputation is in no small part due to the efforts of Chet Sall.

### Lowell H. Good



**Lowell H. Good** died in February. Mr. Good retired in 1976 after nearly 35 years with RCA.

A native of Indianapolis, he received an A.B. degree in 1931 and a B.S. degree in 1932, both from Indiana Central College, which awarded him an honorary Doctor of Laws degree in 1964. He received an M.A. degree in Physics in 1933 from Indiana University.

Mr. Good joined RCA in Indianapolis in 1942 and transferred to Camden in 1946. He was named Director of Engineering Utilization, RCA Corporate Staff, in 1957, and Manager, Microelectronics Engineering, Somerville, in 1959. He joined the Communications Research Laboratory at the DSRC in 1963 and was named Administrator, Technical Relations, in 1970.

---

## Professional Activities

### Two RCA engineers named AES Fellows

On May 8, during its 66th annual convention, the Audio Engineering Society awarded Fellowships to two RCA engineers: **Gregory A. Bogantz**, RCA Records Div., "for contributions to the disk technology and record manufacturing quality control."

**J. James Gibson**, VideoDisk Systems Research Laboratory, RCA Laboratories, "for contributions in FM broadcasting technology."

## IEEE honors Dr. William M. Webster



At the Electro/80 convention in Boston, The Institute of Electrical and Electronics Engineers presented the Fredrik Phillips Award to **Dr. William M. Webster**, Vice-President, RCA Laboratories. He was honored for "sustained leadership in the management of research and development."

Dr. Webster has been in charge of RCA Laboratories in Princeton since 1968. In addition, his responsibilities include laboratories in Lancaster, Pa., Indianapolis, Ind., Zurich, Switzerland, Tokyo, Japan, and RCA's Solid State Technology Center in Somerville, N.J.

Dr. Webster joined RCA Laboratories in 1946. He has made numerous contributions

to tube and transistor developments. A leader in the field of solid state devices, he was Manager of Advanced Development for the RCA Semiconductor and Materials Division from 1954 to 1959. He returned to RCA Laboratories as Director of the Electronic Research Laboratory in 1959. He was appointed Staff Vice President, Materials and Device Research, in 1966, and placed in charge of RCA Laboratories in 1968. He was elected to his present position in 1969. Dr. Webster holds many patents in such diverse fields as television, vacuum and gas tubes, and semiconductor devices.

## SID honors three RCA Labs engineers

At Its International Symposium in San Diego, Calif., The Society for Information Display (SID) honored three engineers from RCA Laboratories, Princeton.

**Philip M. Heyman**, Manufacturing Systems and Technology Research Laboratory, was honored with a Special Recognition Award "for significant contributions to video storage and display systems."

**Dr. Robert A. Bartolini** and **Dr. Alan E. Bell** were honored for having presented the "best paper" at the 1979 SID annual conference. Their paper, "High Performance Optical Recording Structures," concerned the design and development of recording media for a high density optical mass storage system at RCA Laboratories in Princeton.

**Werner Kern**, Integrated Circuit Technology Research Laboratory, RCA Laboratories, has been elected Vice-Chairman of the Dielectric and Insulation Division of the Electrochemical Society.

**Robert G. Thomas**, Principal Member, Engineering Staff, Commercial Communications Systems Division, has been appointed Chairman of the IEEE Committee on Audio/Video Techniques.

**Dr. Sidney Ross**, Staff Technical Advisor, Government Systems Division, has been elected president of the board of directors of the American Defense Preparedness Association's Philadelphia Chapter.

**Thomas T. Hitch**, Consumer Electronics Research Laboratory, RCA Laboratories, has been elected President of the Metal Science Club of New York.

**Pierre V. Valembois**, VideoDisc Systems Research Laboratory, RCA Laboratories, has been elected Secretary of the Metal Science Club of New York.

**Dr. Marvin S. Abrahams**, Solid State Devices Laboratory, RCA Laboratories, has been awarded a Senior Research Fellowship at the University of Oxford by the Science Research Council of the United Kingdom. Dr. Abrahams will spend three months at Oxford working in the Department of Metallurgy and Science of Materials.

## technical excellence

### Automated Systems presents Technical Excellence Award

**Walter A. Helbig**, Advanced Technology Laboratories, Camden, N.J., has been recognized by Automated Systems' technical and management personnel for outstanding creativity and diligence in development and delivery to Burlington of ATMAC, an advanced LSI microcomputer.

At a special luncheon to honor Mr. Helbig, Dr. Harry J. Woll, Division Vice-President and General Manager of Automated Systems, presented him with an engraved bronze medallion in recognition of his achievement.

ATMAC will be used by Burlington in the Advanced Autonomous Array, A<sup>3</sup>, Feasibility Demonstration Project. The objective is to develop and apply new LSI array computer technology to data processing of undersea acoustic signals in order to implement a practical, remote, unattended submarine tracking system.

Walter Helbig's contributions covered many key activities in creation and implementation of ATMAC applied to A<sup>3</sup>: initial presentations to user; technical proposal



preparation; specification of processor requirements derived from system needs; development of the processor system with dual processor architecture; circuit design work; development of the software; hardware and software integration, and lead technical person for first laboratory demonstration of a working system.

This accomplishment was achieved successfully because of Walter's professional expertise and innovative skills, as well as his undiminished application of energy and diligence over a period of 21 months.

### Digital Beamforming Symposium held at DSRC

A technical symposium on digital beamforming was held on February 6 at the David Sarnoff Research Center in Princeton. Its purpose was to update attendees on the technology and related applications and provide an opportunity for members of the RCA technical community to meet and exchange information.

Digital beamforming is basic to radar, communications, electronic countermeasures, sonar, and seismic systems. The symposium looked at distributed transducer arrays and spatial signal processing, including on-line synthesis of transmit/receiver beam patterns. Processing of parallel digital signal streams is handled in real time, usually at a very high data rate, and requires vast amounts of signal processing capabilities.

**David Shore**, Division Vice-President, Advanced Programs Development, GSD, led off the program with an introduction to the subject as well as a discussion of the significant impact digital beamforming can

have on RCA products involving arrays of transducer elements.

**Roger Boyell**, Manager, Advanced Underseas Systems Concepts, Advanced Programs Development, served as Chairman of the program and gave a short tutorial on digital beamforming. **Jack Rudnick**, Manager Image Technology Laboratory, ATL, was the program moderator.

The program concluded with an address by **Kerns Powers**, Staff Vice President, Communications Research, RCA Laboratories, in which he examined the implications of digital beamforming to RCA.

Copies of the viewgraphs used in the talks listed below are available in RCA technical libraries. For more information on a specific talk, contact the author.

High-Resolution Microwave Imaging Based on Adaptive Beamforming

**B.D. Steinberg**, University of Pennsylvania

Coherent Sidelobe Cancellers for Phased Arrays

**T. Murakami**, Missile and Surface Radar

Digital Time-Domain Beamforming for a Uniform Linear Array

**W.A. Helbig**, Advanced Technology Laboratories

Doppler Degradation of Array Coherence

**J.W. Betz**, Automated Systems

Determination of Phased Array Element Weights for Null Steering

**H. Waldman**, RCA Laboratories

Modular Interpolation Beamformer

**R.A. McClain**, Advanced Technology Laboratories

Digital Beamforming for Bistatic Radar

**A.E. Ruvin**, Missile and Surface Radar

Component Requirements for High-Performance Radar Digital Beamforming

**L.W. Martinson**, Missile and Surface Radar

The Challenge of Applying Digital Beamforming Technology to Military C<sup>3</sup> Systems

**A. Mack**, Government Communications Systems

Advanced Technology Sonar Systems Through Spatial Signal Processing

**R.L. Boyell**, Advanced Programs Development

## Symposium on Mechanical Engineering held at Astro-Electronics

The first RCA corporate technical symposium for mechanical engineers was held on April 30, 1980 at Astro-Electronics in Princeton. The theme of the symposium was "Mechanical Engineering: Basic Technology for Ever Broader Applications of Electronics."

A reception on the evening of April 29 brought together more than 50 mechanical engineers from the various business units. Bill Metzger, Manager, Mechanical Engineering, Astro-Electronics, the chairman and organizer of the symposium, introduced his planning committee and the speakers, and all participants had an excellent opportunity to communicate and develop new contacts.

The symposium attracted some 80 RCA engineers who were welcomed by Paul Wright, Division Vice President and General Manager, Astro-Electronics, himself a mechanical engineer. Paul pointed out the substantial need for mechanical engineering contributions to our worldwide needs in the areas of energy, environment, quality, and reliability and the increasing need for mechanical engineers in RCA's business units. He considered the symposium an important meeting for both the engineers and the Company.

Copies of the viewgraphs used in the talks listed below are available in RCA technical libraries. For more information on a specific talk, contact the respective author.

*Plastic Parts for Television Receivers — Using the Finite Element Method to Evaluate Part Strength*

—Scott A. Keneman, Consumer Electronics

*Photovoltaic Module Fabrication Technology*

—Peter J. Coyle, Advanced Technology Laboratories

*Artillery-Delivered Sensor Electronic Packaging*

—Miles J. Kurina, Automated Systems

*The Potential Impact of Computer Technology on Mechanical Engineering Productivity*

—Dick Sunshine|C.S. Young, Consumer Electronics

*Robotics*

—Mike Carrell, RCA Laboratories

*AEGIS — Water Cooler Analysis*

—Ralph Pshunder, Missile and Surface Radar

*Input Options for Thermal Analysis*

—M. Weiss, Missile and Surface Radar

*Indoor Antenna Range Design*

—Wayne Harmening, Missile and Surface Radar

*Universal Active Thermal Control for Spacecraft*

—Shan Chhatpar, Astro-Electronics

*Noise Control and Cooling Design for E3A*

*Electronics Cabinet*

—Richard Cahoon, Automated Systems

*Air Lubricated Thermal Processor for Dry Silver Film*

—Dan Siryj, Advanced Technology Laboratories

*Modal Vibration Test of 5D-2 Spacecraft*

—David Chu, Astro-Electronics

*Acoustic Test of the 5D-2 Spacecraft*

—Carl Voorhees, Astro-Electronics

*High Intensity Acoustic Test Chamber for Satellites*

—Jim McClanahan, Astro-Electronics

# Editorial Representatives

Contact your Editorial Representative, at the extensions listed here, to schedule technical papers and announce your professional activities.

\* Technical Publications Administrators, responsible for review and approval of papers and presentations, are indicated here with asterisks before their names.

## Americom

\* Murray Rosenthal Princeton, New Jersey Ext. 4192

## Commercial Communications Systems Division (CCSD)

### Broadcast Systems

\* Bill Sepich Camden, New Jersey Ext. 2156  
Krishna Praba Gibbsboro, New Jersey Ext. 3605  
Andrew Billie Meadowlands, Pennsylvania Ext. 6231

### Mobile Communications Systems

\* Paul Buess Meadowlands, Pennsylvania Ext. 6439  
or 6229

### Avionics Systems

\* Stewart Metchette Van Nuys, California Ext. 3806

### Cablevision Systems

\* John Ovnick North Hollywood, California Ext. 241

## Consumer Electronics (CE)

\* Clyde Hoyt Indianapolis, Indiana Ext. 5208  
Francis Holt Indianapolis, Indiana Ext. 5217  
Chuck Limberg Indianapolis, Indiana Ext. 5117  
Don Willis Indianapolis, Indiana Ext. 5883

## Distributor and Special Products Division (DSPD)

\* Charles Rearick Deptford, New Jersey Ext. 2299

## Globcom

\* Walt Leis New York, New York Ext. 7711

## Government Systems Division (GSD)

### Astro-Electronics

\* Ed Goldberg Princeton, New Jersey Ext. 2544

### Automated Systems

\* Ken Palm Burlington, Massachusetts Ext. 3797  
Jim Carlen Burlington, Massachusetts Ext. 2985  
Gene Gallagher Burlington, Massachusetts Ext. 2975

### Government Communications Systems

\* Dan Tannenbaum Camden, New Jersey Ext. 3081  
Harry Ketcham Camden, New Jersey Ext. 3913

### Government Engineering

\* Merle Pietz Camden, New Jersey Ext. 2161

### GSD Staff

\* Ed Moore Cherry Hill, New Jersey Ext. 5833

## Missile and Surface Radar

\* Don Higgs Moorestown, New Jersey Ext. 2836  
Jack Friedman Moorestown, New Jersey Ext. 2112

## National Broadcasting Company (NBC)

\* Bob Mausler New York, New York Ext. 4385

## Patent Operations

Joseph Tripoli Princeton, New Jersey Ext. 2992

## Picture Tube Division (PTD)

\* Ed Madenford Lancaster, Pennsylvania Ext. 3657  
Nick Meena Circleville, Ohio Ext. 228  
Jack Nubani Scranton, Pennsylvania Ext. 499  
J.R. Reece Marion, Indiana Ext. 5566

## RCA Limited (Canada)

Bob McIntyre Ste Anne de Bellevue (514) 457-9000

## RCA Records

\* Dave Devarajan Indianapolis, Indiana Ext. 6109

## RCA Service Company

\* Joe Steoger Cherry Hill, New Jersey Ext. 5547  
Ray MacWilliams Cherry Hill, New Jersey Ext. 5986  
Dick Dombrosky Cherry Hill, New Jersey Ext. 4414

## Research and Engineering

### Corporate Engineering

\* Hans Jenny Cherry Hill, New Jersey Ext. 4251

### Laboratories

Maucie Miller Princeton, New Jersey Ext. 2322  
Judy Yeast Somerville, New Jersey Ext. 7357

## "SelectaVision" VideoDisc Operations

\* Woody Workman Indianapolis, Indiana Ext. 3235

## Solid State Division (SSD)

\* John Schoen Somerville, New Jersey Ext. 6467

### Power Devices

Harold Ronan Mountaintop, Pennsylvania Ext. 1633  
or 1827  
Sy Silverstein Somerville, New Jersey Ext. 6168

### Integrated Circuits

Fred Foerster Somerville, New Jersey Ext. 7452  
John Young Findlay, Ohio Ext. 307

### Electro-Optics and Devices

John Grosh Lancaster, Pennsylvania Ext. 2077

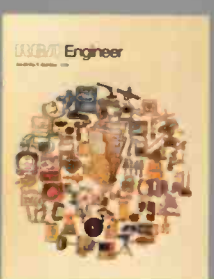
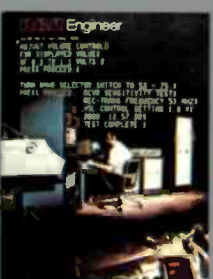
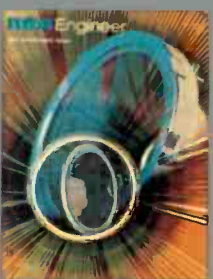
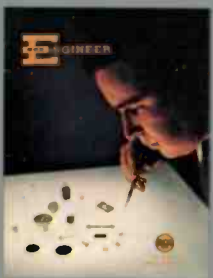
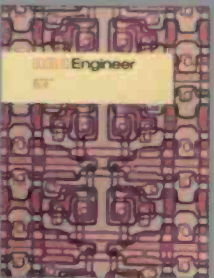
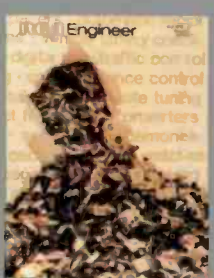
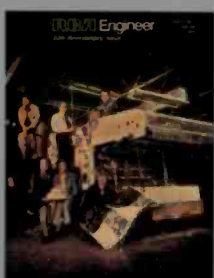
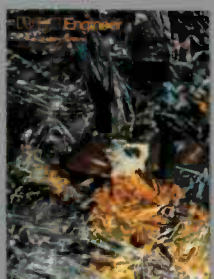
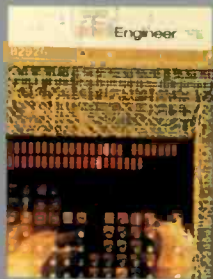

# RCA Engineer

A technical journal published by  
Corporate Research and Engineering  
"by and for the RCA engineer"

Printed in the U.S.A. Form No. RE-26-1

