

# RCA Engineer

Vol 21|No 5 Feb|Mar 1976

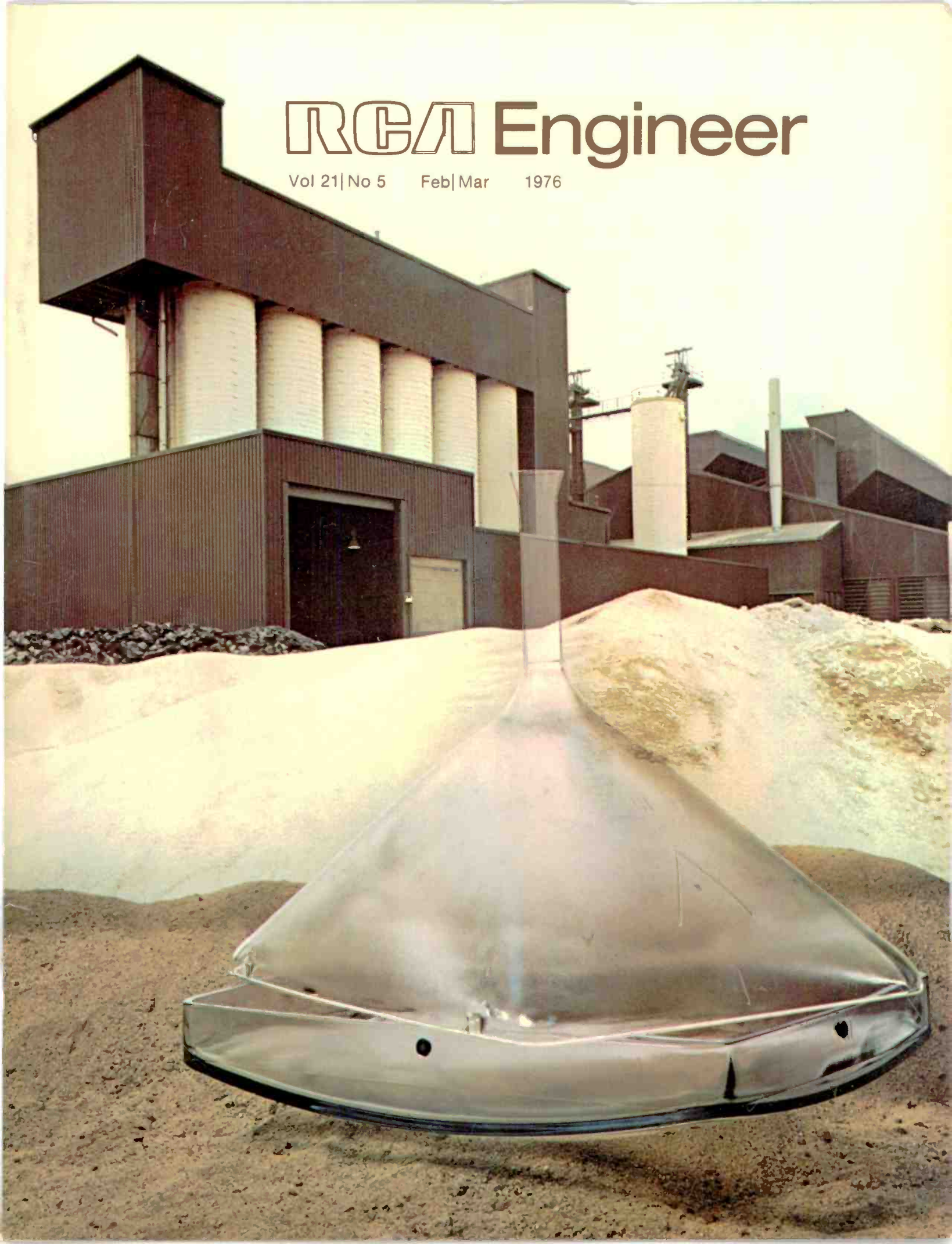

# Manufacturing technology — the onward thrust

In the mainstream of the world-wide picture tube business, technical and management personnel are confronted with the growing dichotomous crunch between inflationary increases in material, labor, and energy costs; and the losses of profit margins that result from competitive pricing pressures. RCA's Picture Tube Manufacturing Division is concentrating on reducing costs by improving the productivity of our labor, the efficiency of our factories, and the quality of our raw materials. We are striving to enhance RCA's unique competitive cost effectiveness through vertical integration by the efficient production of our own glass, masks, phosphor, mounts, stems, metal parts, and coatings. An ongoing program is being formulated to further enhance our product quality and manufacturing efficiency by utilizing computerized process control technology and product flow transfer mechanization.

The cover picture of RCA's Circleville Glass Operation and the technical papers on process control in glass making and picture tube resident engineering in this issue of the *RCA Engineer* tell part of this story. Future issues will enlarge upon the technologists' contributions to RCA's picture tube business with a series of technical manufacturing papers covering the Circleville, Lancaster, Marion, Scranton, Juncos, and Barceloneta operations.

RCA's manufacturing engineers are in a unique position to improve productivity. They work on the production line and are intimately familiar with the process, machinery, human, and cost elements of picture tube manufacturing. Together with the industrial engineer's insight into the basic product flow and transfer requirements and the computer technologists' expertise, a team effort with the Process and Equipment Development engineers is being made to further advance the productivity through mechanization. Simple, reliable, and cost-effective alternate methods of color tube manufacture are being formulated, developed, and implemented. This action program is essential to maintain and enhance the profitability and leadership of RCA in the world-wide picture tube business.



*C. W. Thierfelder*

**C. W. Thierfelder**  
Division Vice President  
Technical Programs  
Picture Tube Division  
Lancaster, Pa.

## RCA Engineer Staff

John Phillips	Editor
Joan Dunn	Art Editor
Frank Strobl	Contributing Editor
P.A. Gibson	Composition
Dottie Snyder	Editorial Secretary
Juli Clifton	Subscriptions

## Editorial Advisory Board

Dr. J. J. Brandinger	Div. VP, Television Engineering, Consumer Electronics
Dr. D.J. Donahue	Div. VP, Picture Tube Div.
R. M. Cohen	Dir., Quality and Reliability Assurance, Solid State Div.
F.L. Flemming	VP, Engineering, NBC Television Network Div.
C.C. Foster	Mgr., Scientific Publications RCA Laboratories
H. Rosenthal	Staff VP, Engineering Research and Engineering
P. Schneider	Exec. VP, Satcom System
Dr. W.J. Underwood	Director, Engineering Professional Programs

## Our cover

focuses on RCA's Circleville, Ohio, plant which manufactures glass parts for color picture tubes. The storage silos (actually located at the rear entrance) hold raw materials to be used in the manufacturing process. The color picture tube face panel and funnel in the foreground are final products of the Circleville glass plant and are used by RCA's Scranton, Pa. and Marion, Ind. plants in the construction of color picture tubes (see R. Schneider's article, p. 3)

Photo Credit: John Semonish and Bruce Hull, Solid State Division, Clark, N.J.

A technical journal published by  
RCA Research and Engineering  
Cherry Hill, N.J.  
Bldg. 204-2 (PY-4254)

• To disseminate to RCA engineers technical information of professional value • To publish in an appropriate manner important technical developments at RCA, and the role of the engineer • To serve as a medium of interchange of technical information between various groups at RCA • To create a community of engineering interest within the company by stressing the interrelated nature of all technical contributions • To

help publicize engineering achievements in a manner that will promote the interests and reputation of RCA in the engineering field • To provide a convenient means by which the RCA engineer may review his professional work before associates and engineering management • To announce outstanding and unusual achievements of RCA engineers in a manner most likely to enhance their prestige and professional status.

## Contents

## Emphasis — manufacturing engineering

<b>Editorial input</b>			2
<b>Cover feature</b>	Circleville glass operations	R.K. Schneider	3
<b>Manufacturing engineering</b>	Computer utilization in a glass-forming operation	G.W. Blair	10
	Picture Tube Division resident engineering	L.F. Hopen   C.E. Shedd	14
	Development of compound for quadradiscs	G.A. Bogantz   S.K. Khanna	17
	SCOPE—the power testing paladin	E. Cutshaw	22
<b>Special</b>	Impressions of technology in China	Dr. J. Hillier	27
<b>General-interest papers</b>	Glass passivation of IC's	W. Kern	36
	Thin metal films	D.M. Hoffman	44
<b>Engineer and the Corporation</b>	Technical education in RCA	Dr. W.J. Underwood	48
<b>General-interest papers</b>	Tungsten-matrix cermolox tubes	R.E. Byram   J.T. Mark	52
	Structured programming	Dr. P.G. Anderson	55
	Microwave parametric amplifier	Dr. R.L. Camisa   B.F. Hitch   S. Yuan	60
	Software cost performance	H.L. Fischer	63
	Epoxy as a die attach in IC's	B.M. Pietrucha   E.M. Reiss	68
	Television applications of PLZT ceramics	B.M. Soltoff	72
	Optical processing of wideband data	G.T. Burton   R.F. Croce	76
	Pulse doppler radar performance	H.H. Behling	80
<b>Engineering and research notes</b>	Microstrip discriminator	A. Schwarzmann	84
	High reliability COS/MOS	E. Reiss	84
<b>Departments</b>	Pen and Podium		86
	Patents granted		88
	Dates and Deadlines		90
	IEEE Fellows		91
	News and Highlights		92

## editorial input

# Transition— a look back, a look ahead

The *RCA Engineer* was started twenty years ago as a journal "by and for" RCA engineers. Throughout those twenty years, the journal has responded to the changing needs of the RCA engineering community.

Initially, the journal emphasized technical information that was fairly easy to read and digest. However, through the early to mid sixties, much of RCA's engineering was directed toward the sophisticated technologies associated with satellites, defense systems, and computers, as well as advanced components and materials developments. These influences tended to make the journal carry articles with increasingly detailed, complex technical content. This direction continued through the late sixties and early seventies. At the same time, many non-electronic businesses became a part of RCA. Profiles of the new subsidiaries and more business-oriented articles were published, and the technical material in the journal continued to follow the complex technology.

The mid seventies will probably be best remembered as a time of economic stress. As a result, recent issues have emphasized product design, process control, design to cost, automatic testing, and manufacturing engineering—subjects that deal with the basic, but always tough, engineering question, "How do I make a better product for less money?"

Thus, change earmarks the history of the magazine. My predecessor, Bill Hadlock, first editor of the *RCA Engineer*, who retired this February, did an excellent job of keeping the journal in step with the changing environment. In fact, Bill's most valuable legacy is an editorial network that is designed to respond to change.

As the journal's new editor, I am particularly appreciative of Bill's example and fully aware of the need for continuing change. Change, as always, to match your interests. After all, you—the RCA engineer— are the journal: its author, its reader, and its personality.

My major goals are to improve readability and usefulness and to produce a journal that more directly mirrors the personality and interests of the RCA engineering community.

To do this effectively, I need, and solicit, your help and advice. Through my years at RCA, I have met many of you, and have always found you to be a fertile and ready source of new ideas and perspectives. Contact me directly or through your Division Editorial Representative (inside back cover). I value your input and will attempt to respond personally.

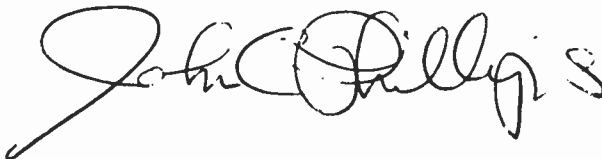

Address correspondence to:

John C. Phillips  
RCA Bldg. 204-2  
Cherry Hill, N.J. 08101

## Circleville glass operations

# Making glass for television picture tubes

R.K. Schneider

RCA started producing glass parts for television picture tubes in 1970, thus becoming the only fully integrated color television manufacturer in the Western Hemisphere. Making glass parts is relatively straightforward: mixing raw materials, melting, forming, processing and shipping. Making glass parts for picture tubes becomes complex, however, due to the requirement for large, dimensionally precise glass pieces that approach optical quality. For example, the typical face panel for a 25-inch picture tube weighs over 27 pounds and measures  $22\frac{1}{2}$  X  $17\frac{1}{2}$  inches and is roughly  $\frac{1}{2}$ -inch-thick at its center; yet the contour must be within 0.017-inch of specification.

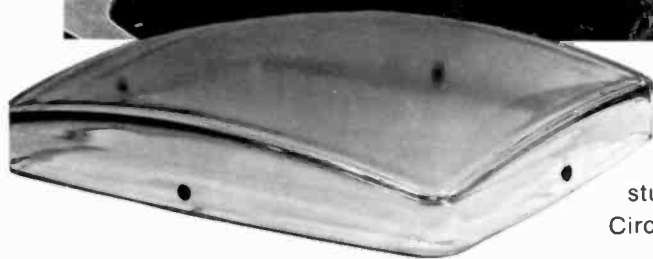
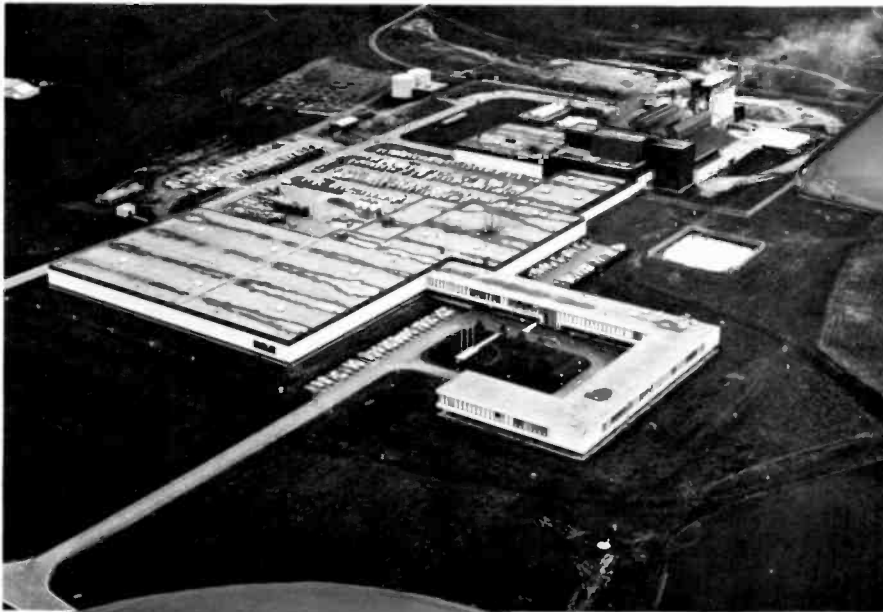

IN THE EARLY DAYS of black-and-white television, RCA considered entering the picture-tube glass manufacturing business. At least two early feasibility studies were made, but for one reason or another, the project did not take place. A 1965 study, however, culminated in the construction of the Glass Plant in Circleville, Ohio.

Construction of the Circleville plant began in September, 1969, and a little over one year later, the first face panels were shipped to RCA's picture tube plant in Marion, Indiana. Since that time, Circleville has established itself as a major supplier of both panels and funnels for RCA's Marion, Indiana; Scranton, Pennsylvania; and Midland, Ontario plants.

Although the Circleville operation is similar in many ways to other glass factories, it has many unique features which set it apart. The stringent quality requirements imposed on the parts, both visually and dimensionally, make this particular glass manufacturing operation a very complex process requiring careful adaptation of conditions, equipment, and techniques. The specialized glasses used for color television picture tube parts are part of a series of glasses developed by the industry over the past years and are formulated so that their properties meet the current requirements of the tube and set maker.



The processes used for making panels and funnels are basically similar although the glass composition and the parts shape are necessarily different. It is interesting to note that RCA uses a "pressing" technique for forming both panels and funnels while other domestic glass manufacturers press only the panel and employ a centrifugal casting or "spinning" process for forming funnels.

The glass parts manufacturing process at Circleville is a "straight-line" flow operation beginning with receipt of raw materials, continuing through batch preparation, melting, forming, hot and cold processing of the formed parts, and ending with the shipment of product at the opposite end of the line. (See the process flow diagram.)

[Editor's note: the numbers in the text refer to the photographs of the glass making operation in this article.]

## Process Flow Diagram



**Robert K. Schneider**, Mgr., Mix and Melt Engineering, Glass Operations, Circleville, Ohio, received the Bachelor of Ceramic Engineering in Glass Technology from Ohio State University in June, 1953. After graduation he joined RCA AS AN Engineering Trainee in the picture tube activity at Marion, Indiana. He has worked on product and process development engineering for both black-and-white and color picture tubes and was engineering leader responsible for glass and metallurgical development at the Marion, Indiana plant. Mr. Schneider helped in planning portions of the Circleville facility and in 1969 was assigned his present responsibilities which involved establishment and operation of the laboratory facilities and the glass making processes. He is a Registered Professional Engineer and a member of the American Ceramic Society.

Reprint RE-21-5-22  
Final manuscript received December 8, 1975.

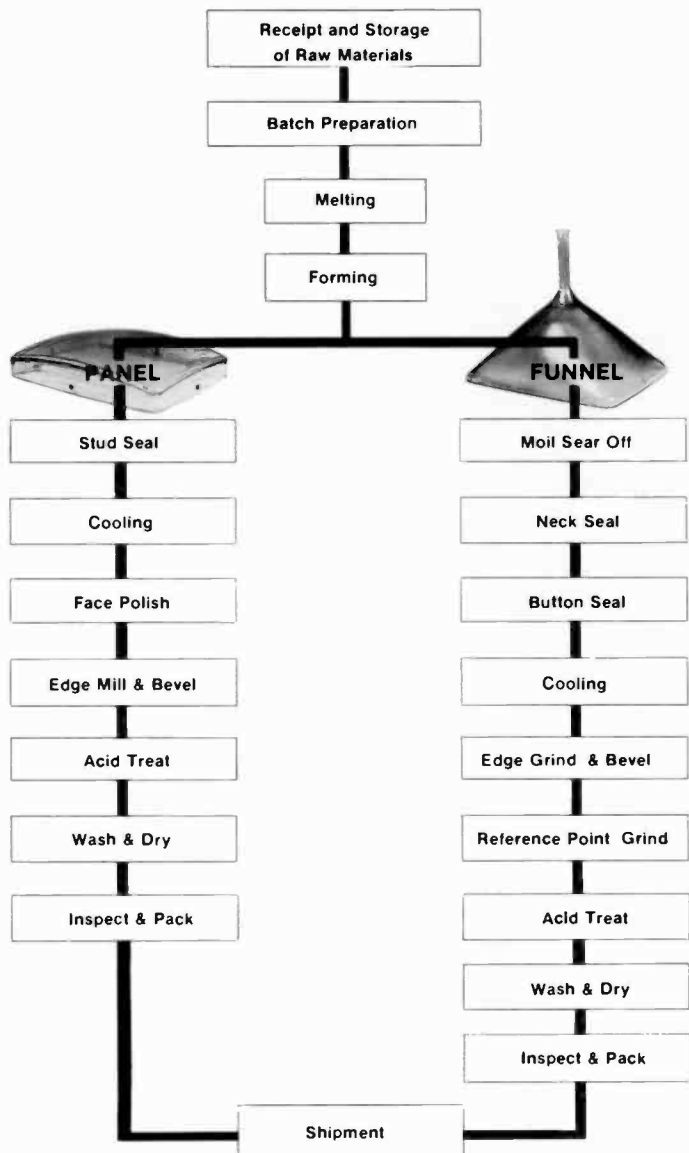



1. Raw material received by rail and stored in silos.

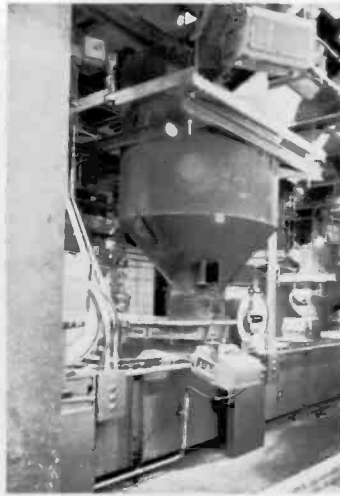

2. Ingredients for making glass are weighed in special "weigh hopper" scales like the one shown above.

Raw materials, all in granular or powder form, are received primarily by bulk shipment in rail cars. **1** Major ingredients are stored in large silos while minor ingredients are stored in bags or drums and then transferred to storage bins as needed. Among the major ingredients common to both glasses are sand, soda ash, pot ash, dolomite, and potassium nitrate. Strontium carbonate is used in the panel glass and litharge in the funnel glass as the primary means of providing the necessary x-ray attenuation properties.

Minor ingredients include oxides of titanium, cerium, antimony, arsenic, cobalt, and nickel.

A quantity of each raw material is weighed out according to a batch formula prescribed so the resultant glass has the stringent physical property characteristics required for color picture tube manufacture. **2** The weighed ingredients are collected and delivered to either the panel or funnel "batch" mixer where they are blended together. **3**

The mixed batch is discharged onto a belt conveyor where a quantity of cullet is added. (Cullet, stored in two separate silos, is crushed glass of nearly the same composition as the glass being made). The batch and cullet are then delivered to storage bins ready to be charged into the respective glass melting furnace. **4** It should be noted that the entire batch preparation system is automatic, being centrally controlled from a single instrument panel and activated upon demand of the furnaces. **5**

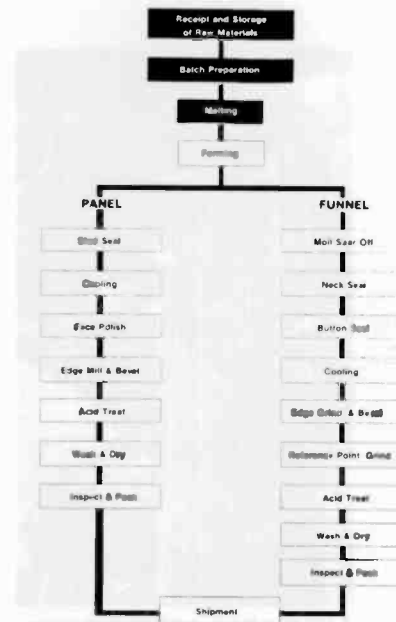

5. Batch is prepared automatically when needed. This central control panel gives the operator a graphic representation of batching operation as it is functioning.

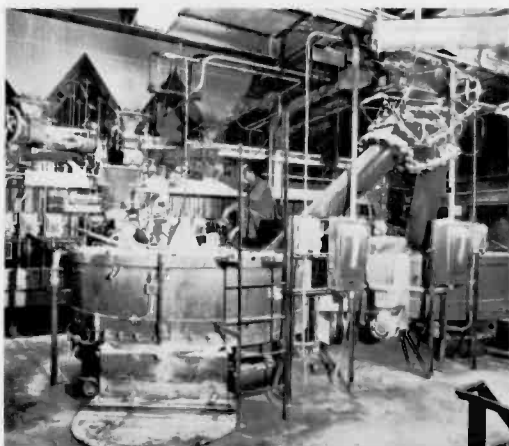

3. Weighed batch ingredients are blended in large pan type mixers.

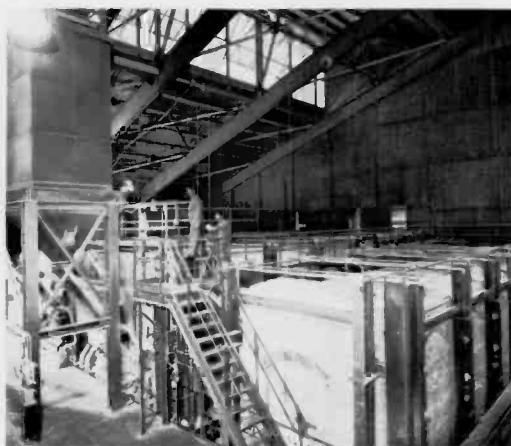

4. Mixed batch is stored in bins ready to be charged into the furnace on demand.

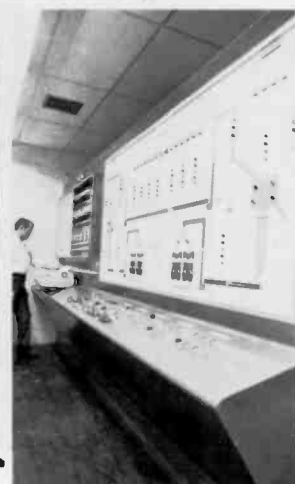

The melting furnaces are typical gas-fired, side-port, regenerative types, in which a large ceramic tank is heated to over 1500°C by the combustion of gas and preheated air over the surface of the glass within the space under the "crown" or roof of the tank. Several hundred tons of glass are contained in the tank allowing adequate melting or reaction time between the charging of the batch into one end and the careful withdrawal of homogeneous glass from the other. The glass, particularly in the case of panels, must be of near optical quality, i.e., essentially no visible defects. This includes not only inclusions, such as minute stones or bubbles, but cords which are the results of inadequate homogenization of striae within the glass melt. These striae have very slight differences in index of refraction and, with certain intensity and orientation, disturb transmitted light in such a way as to distort an image viewed through the panel face. Toward the withdrawal end of the furnace, the glass is cooled so it can be extruded through an orifice, cut into a "gob" and dropped into a mold which is one of eleven mounted on a large circular metal table. **6,7** After a mold receives a gob of glass, the table is quickly rotated into a position where a shaping plunger enters the mold, forcing or "pressing" the hot glass to conform to the contours of the mold on one side and the plunger on the other. **8** The plunger is then withdrawn and, as the table rotates to other positions, blasts of cool air are directed at the glass surface until the part is sufficiently cooled so that it can be removed from the mold without changing shape. The precision to which the shape of these pressed parts, both panel and funnel, must be controlled is almost unheard of in the glass industry considering the overall size and weight of the parts. For example, the panel face contour must be held to within 0.017 inch of specification at all points across what is to become the viewing area. This precise control of contour is necessary so that the critical spacing between the glass and shadow mask can be achieved during the picture tube manufacturing operation. The periphery of both the panel and funnel must be kept within close tolerances to assure that pairs of parts will properly match when selected at random for assembly at the picture tube plant.

After the funnel and the panel are formed, they are processed in somewhat different ways; these processes will be described separately.

### Panel processing

After the pressed panel has been removed from the mold, special metal studs (for holding the tube's shadow mask) are sealed into the sidewall. **9** Then the assembly is sent through a lehr oven where controlled cooling takes place to provide the required degree of thermal stabilization to the glass. The viscosity of



**6.** Hot glass is extruded through an orifice, cut to form a gob and dropped into a mold (for the funnel in this case.)



**7.** Hot glass in funnel mold.

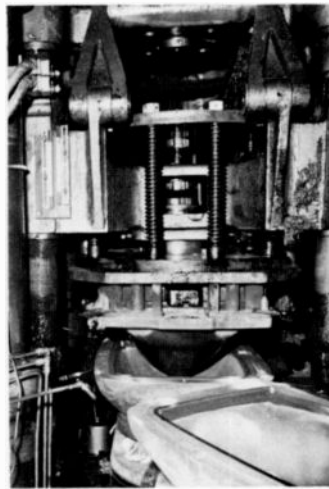

**8.** Pressing the gob takes place when a plunger forces the glass to conform to the mold. The plunger forms the inside contour of the part.



**9.** Metal pins are sealed into the sidewalls of the hot panel.



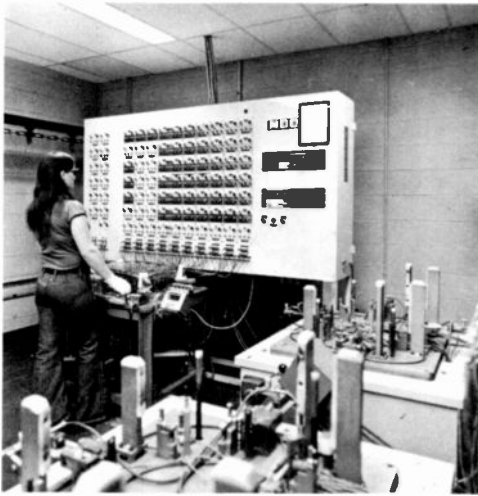

10. The face contour and periphery are carefully gaged.



11. Polishing the outside surface of the panel.

the glass varies continuously from the molten state temperature to that at which it becomes, for all practical purposes, rigid, and perceptible structural adjustments stop. If this lower temperature is reached before the structure of the glass has reached its most stable arrangement, structural change will continue. Although in commercially annealed glass this change is imperceptible at room temperature, it is quite evident at temperatures well below the strain point (the strain point is usually considered to be the temperature below which no permanent structural changes take place within the glass). These changes, if encountered during picture tube manufacture, can be sufficient to alter the contour of the glass panel and thus effect the critical shadow-mask-to-glass registry.

After this lehr treatment, the panels are checked for inside surface contour, periphery, stud location, and visual quality. **10** The results of inspections and gaging throughout the process are important keys to process control for making high quality glass parts.

Since the television picture is viewed through the panel, its outer surface must be ground and polished by a process similar to that used in the preparation of lenses. This allows the picture to be transmitted through the glass without interference or distortion from surface aberrations. **11** The grinding and polishing is accomplished using specially fabricated laps (contoured pads) in several steps utilizing successively finer abrasives. After the face is polished, the edge (which must mate with the funnel when the tube is assembled) is ground flat, **12** beveled to remove sharp edges, and given an acid fortification treatment. Finally the parts are washed, dried, given a final inspection and then packed for a brief stay in the warehouse before being shipped to one of the picture tube plants.

### Funnel processing

The funnel part, after being removed from the mold, undergoes considerably more "hot" processing than the panel. A moil, or solid plug of glass which closes the small end of the funnel, is seared off with a carefully directed and controlled flame. On another machine, a prepared piece of tubing is sealed to this small, now open, end of the funnel. **13** Careful alignment of the funnel and this "neck" tubing is critical during this operation so the part will meet exacting requirements.

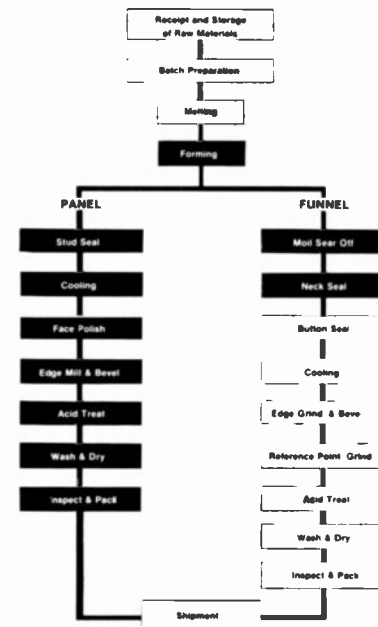

12. The sealing edge must be ground flat.

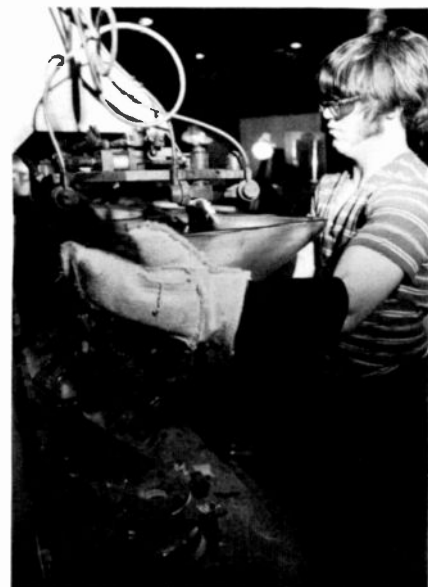

13. A section of tubing is sealed to the funnel to form the neck.



14. A metal button is sealed into the funnel sidewall.



15. Parts are inspected after being cooled in a lehr oven.



16. The seal edge of the funnel must also be ground flat.

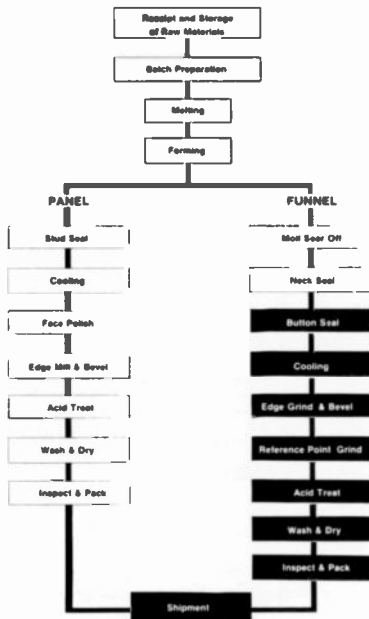

After the neck has been sealed to the funnel, a small metal button shaped part is inserted into the sidewall of the funnel to make provision for the tube's high voltage connection. **14** Immediately after this operation is performed, the funnel is passed through a lehr similar to that used for panels. **15**

Funnels which pass the visual inspection at the cold end of the lehr are transported by conveyor to the finishing operation where the rim of the funnel (which is to be mated with the flat edge of the panel) is ground flat and beveled by using diamond-impregnated metal wheels. **16** Other surfaces around the funnel's rim, which are to be used as reference points during tube making, are ground precisely also. **17** After an acid fortification treatment, **18** washing and drying, the funnels are given final gauging and inspection before packing. As with the panels, the funnels are stored in a warehouse before being shipped to the tube manufacturing plants.

### Mold design, fabrication, and maintenance

A unique feature of the Circleville operation is the provision of complete mold design, fabrication and maintenance facilities at the glass plant. Primary machining of stainless steel castings used for new mold equipment is done on numerically controlled milling machines. **19** Complete facilities to perform necessary grinding, polishing, drilling, and plating operations are also provided in the plant mold shop. **20,21**

After fabrication, each new piece of mold equipment is measured on an automatic measuring machine. **22** All glass-forming surfaces are checked to assure that necessary machining tolerances are maintained. The equipment is then released for use in the glass-forming process.

Throughout its life, mold equipment is routinely returned to the mold shop for cleanup and minor repairs. After each repair, the equipment is remeasured and released. Mold equipment data obtained during these inspections, along with subsequent product data, are used as the base for continual optimization and improvement of current mold equipment designs—a vital step in the production of these high quality, highly sophisticated glass parts.

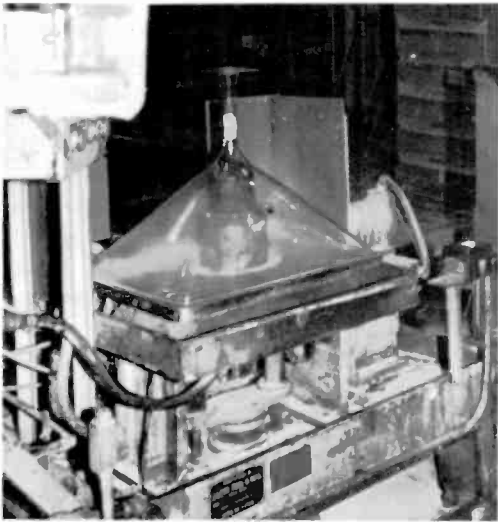

17. Reference surfaces are precisely ground.



18. The ground seal edges are acid treated or "fortified".



19. New mold equipment is prepared by N/C machining.

## Summary

The success of the Circleville Glass Operations represented a significant event in the history of RCA. Today, RCA is the only color television manufacturer in the Western Hemisphere to achieve this degree of vertical integration.

The process used in the production of glass parts for color picture tubes is complex and sophisticated, requiring a meticulous adaptation of conditions, equipment, and techniques. The RCA plant is domestically unique in that a pressing process is used to form both the face panel and the funnel. The operation is further enhanced by having a complete facility for design, fabrication, and maintenance of the mold equipment used in the manufacture of the parts.

Through the support, dedication, and effort of many people, the Circleville operation has become a major supplier of both panels and funnels for the RCA picture tube manufacturing plants.



20. The mold surfaces are carefully polished after machining.



21. Facilities for chrome plating are available for use on certain mold parts.



22. Exacting measurements are made on both mold and glass for use in optimizing mold equipment.

# Computer utilization in a glass-forming operation

G.W. Blair

The RCA Glass Plant at Circleville began the production of glass faceplates and funnels for color television picture tubes in the Fall of 1970. The concept of "distributed computer systems" was chosen as the means of fulfilling the plant computer requirements. Presently, located throughout the plant, there are four computer systems performing process control, quality assurance, engineering, and plant accounting functions. This paper describes these systems and their use in the forming operation for picture-tube faceplates.

COMPUTER SYSTEMS at the Circleville glass plant are being developed around what is referred to as the "distributed computer concept." In this concept, "worker" minicomputers are used for control of the various areas of the production operation. Pertinent data is then transferred from these "workers" to a larger "supervisory" computer also within the plant. The "supervisory" computer is then used for more extensive data analysis and design programs. The "supervisory" computer may then pass data on to yet higher level data processing systems for further analysis.

The Circleville plant produces the glass faceplates and glass "funnels" used to form color-television picture tubes. Such a glass-forming operation involves first, control of the mold equipment used in the forming process and second, control of the forming process itself. This must include the long-term control of quality levels and design modifications to the molding equipment, as well as the more immediate control of process equipment and product acceptance or rejection.

Four computer systems located

throughout the plant are used to fulfill the various operation requirements. One of the systems controls an automatic measuring operation, primarily for mold equipment. Two of these systems are utilized for data acquisition and control on the production floor, and the fourth is the "supervisory" system which is used for extensive quality analysis, mold-design programs, and engineering calculations.

## Glass forming process

Formation or pressing of a picture tube faceplate begins with three basic pieces of mold equipment used to form the glass. These three pieces are the plunger, the mold, and the shell. New pieces of mold equipment are machined, in plant, on a numerical-control (N/C) tape-controlled milling machine. After machining is completed, the machined surfaces are hand polished to remove the marks left by the machining process.

Faceplates are formed on a "modified" Lynch ELP glass press. The press has a hydraulically driven ram on which the plunger is mounted. The ram is located at one station of an eleven-station rotary index table. Eleven molds are positioned on the index table. Through a double indexing of the table after each press cycle and a unit which transfers the shells from

Gary W. Blair, Manager, Technical Computer Applications, Glass Operations, Circleville, Ohio, received the BSEE from Pennsylvania State University in 1963. Mr. Blair's early experience with General Motors Corporation involved the design of sequencing controls for automatic production equipment. In 1965 he joined Corning Glass Works where he was project engineer for the first real-time computer control system installed by that company. From 1968 to 1970 he was affiliated with Struthers Energy Systems, a consulting firm specializing in the design of "total energy systems" for commercial and industrial complexes. He joined RCA at Circleville in late 1970 and has been responsible for plant computer applications planning and implementation since that time.

Reprint RE-21-5-10  
Final manuscript received September 15, 1975.

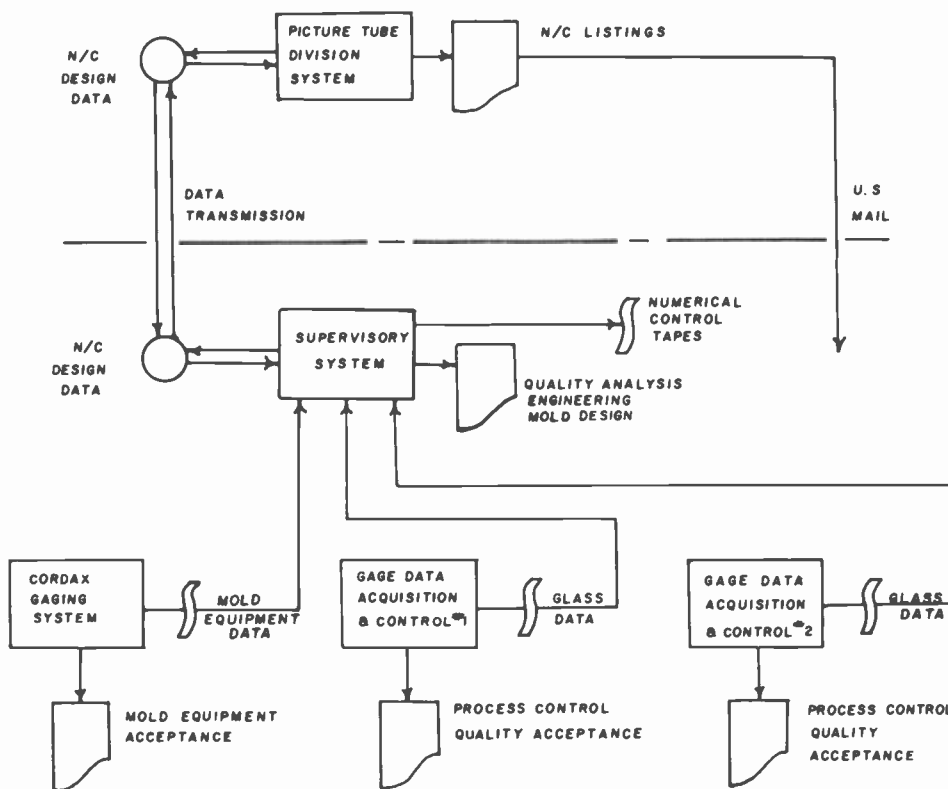

Data flow through the Circleville "distributed computer" system.



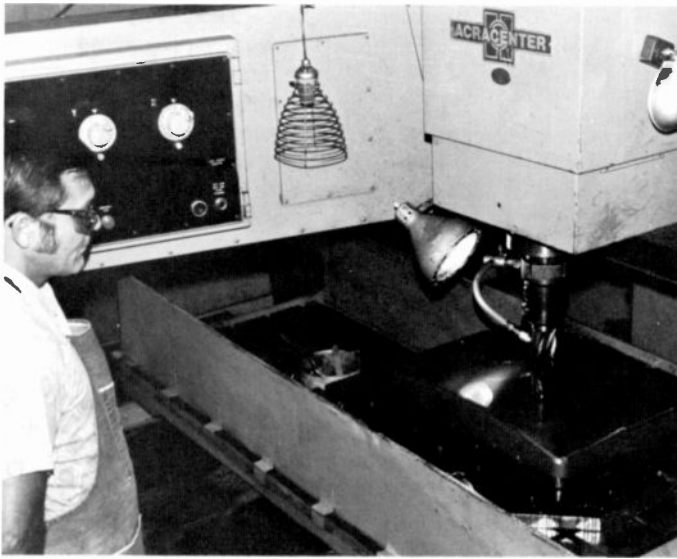

Cutting a plunger on the N/C mill.



Cordax gaging system—measuring the periphery of a shell.

mold to mold, a total of five shells are used on the press. This arrangement provides a total of fifty-five plunger-shell-mold combinations in the faceplate forming process at any given time.

To produce a faceplate, a gob of molten glass (at approximately 1000°C) is dropped into a mold which has a shell seated on top of it. The mold and shell are then indexed into position under the ram. The ram drives the plunger downward, pressing the glass between the plunger and the mold-shell cavity, forming a faceplate. After a momentary dwell at the bottom of the stroke, the ram and plunger are retracted.

After the pressing operation is completed the faceplate remains in the mold for seven indexes of the press table. During this time, air is blown on the faceplate cooling it to approximately 500°C. The shell is lifted from the mold at the third table index after pressing. At the eighth table index, the faceplate is lifted from the press and transferred to a conveyor belt which transports it to the stud sealing area.

There are a number of stud insertion machines in the stud sealing area. Each faceplate is cycled across a stud machine where four metal studs are inserted into the skirt of the faceplate. Insertion is done by heating the metal studs to a temperature of 1200°C and then pressing them into the faceplate skirt.

After the studs are inserted, the faceplates, which have now cooled to a

temperature of approximately 450°C, are placed in an annealing lehr. Through the annealing cycle, the faceplates are brought up to a temperature of 505°C and then slowly cooled to a temperature of 35 to 40°C. This cycle removes the strain created in the glass during the pressing and stud insertion operations.

After annealing, the faceplates are visually inspected and are conveyed to the gage room where the final check of the dimensional characteristics associated with the forming process is made.

## Computer systems

### Cordax gaging system

This system utilizes a Digital Equipment Corporation PDP-8 computer with a 4k core memory and 32k fixed-head disc memory. The computer is interfaced to a Bendix Cordax 3000 measuring machine through a digital input/output system and a 12-bit analog-to-digital converter. The measuring machine may, at operator initiation, be operated in manual mode with the computer acting as a data-acquisition system or in automatic mode with computer control of machine position and data acquisition.

Mold equipment is measured after initial machining on the N/C mill, after hand polishing of the surface, and periodically throughout its life.

Based on initial Cordax data, equipment is either released for operation or returned to the milling machine for surface recutting.

Data acquired on this system is used in two ways: 1) to determine the current status of a piece of mold equipment (compared to dimensional limits) for use in manufacturing and 2) to provide data which can be valuable for product design modifications.

Data output from this system is generated as a hard-copy printout on the system teletype and/or as a paper tape. Paper-tape outputs are taken to the supervisory system where they are input for more extensive data analysis and design programs.

### Gage data acquisition and control systems

Two gage data acquisition and control systems provide data acquisition and control for a faceplate production line, but can be expanded to service a funnel production line. One of the two systems is, in fact, presently being used by a faceplate and a funnel line but only the faceplate line application will be discussed in this paper.

These systems are General Automation SPC-16/65 computers utilizing the RTX-16 real time executive operating system. The primary function of the systems is to provide automatic on-line data acquisition from the production gages and perform immediate analysis required for process control and quality acceptance.

Their secondary function is to gather data



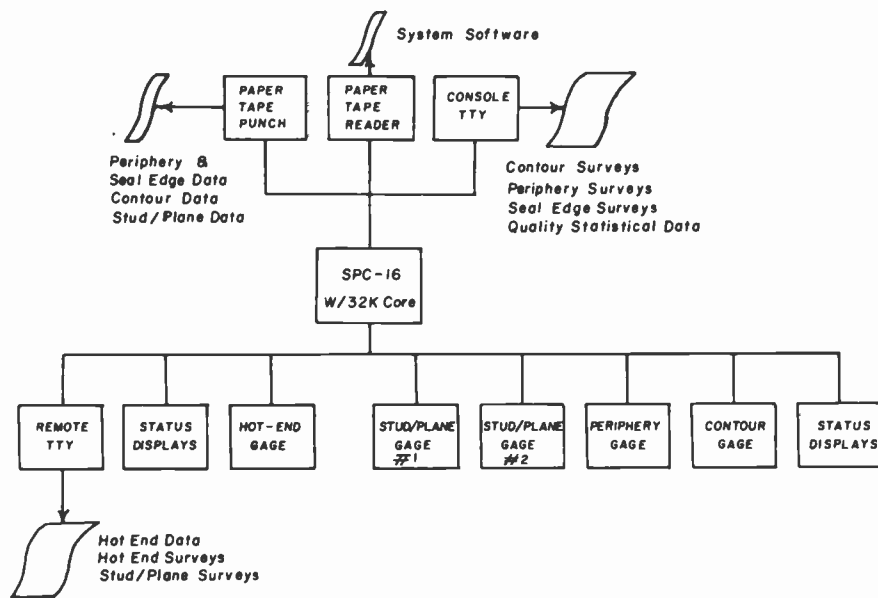

Gage data acquisition and control system layout.

which can be utilized as input to the supervisory system for engineering evaluation, quality assurance analysis, and equipment design modification.

The system hardware consists of a General Automation SPC-16/65 minicomputer with 32k of core memory, hardware priority interrupt structure, real-time clock, power failure detection/auto-re-start interrupts, and hardware multiply and divide. Machine cycle time is 960 ns. Input/output slots are provided for use in interfacing peripheral equipment. A high-speed paper-tape reader (400 char/s) provides system input so that the entire system software can be built using the facilities of the supervisory system. Printed output can be generated on the system console or remote teletype. Data output on paper tape is also available via 75 char/s paper tape punch. A low-level analog input system consisting of a 256-channel multiplexer and 12-bit A/D converter with fixed gain  $\pm 100$  mV to  $\pm 10$  V inputs accepts input signals from the sensors located on the various production gages.

The critical dimensions of a faceplate are the inside contour, the periphery dimensions and thickness, and the location of the studs in reference to the face contour and periphery. To provide data acquisition and control of these functions, data is obtained from a "hot-end" gage located in the stud sealing area

and two stud plane-to-contour gages, a panel contour gage, and a periphery/seal edge-thickness gage located in the gage room.

These systems provide automatic collection and storage of quality acceptance status information for stud plane-to-contour for each stud machine. Through computer-controlled displays located in the gaging and stud machine areas, the status of each stud machine is indicated. Conditions included are 100% inspection required, sampling to maintain acceptance required, or acceptance without inspection.

Data necessary for contour control can be generated for either a single piece of glass or as a summary of up to eleven pieces of glass. The mode of operation desired is selected by a switch on the manual entry box and then the faceplates to be included in the survey are cycled across the contour gage. The output provides the average value and standard deviation for all entries as well as a listing of the worst point and its location on the faceplate for each faceplate gaged. Also included is an estimated percent of product within specification for any gage points where the data statistically indicates less than 99% within specification.

Panel periphery and seal edge thickness data are normally output as a summary of

fifteen faceplates. The average deviation from design for sixteen gaging positions around the faceplate periphery is provided. A listing for each piece is also included in the survey, indicating the shell which produced the piece and the position and value for the worst point on the faceplate.

Data required for analysis beyond the limits of the Gage Data Acquisition and Control System are generated on paper tape by setting a switch on the manual entry box of the gage from which data is to be gathered. Data for weekly quality assurance analysis and for engineering evaluation and mold design modification are obtained in this way. Data tapes thus generated are used as input for the data analysis and design programs on the supervisory computer.

Each gage has an associated manual data-entry box, which can be used to identify the equipment used to process a piece of glass. Data acquisition is initiated by entering the required information into the manual entry box and then depressing a computer scan button. Display lights on the entry box indicate the quality acceptance or rejection of that particular faceplate.

Data for control of stud-sealing machines is generated both at the hot end and the cold end of the Lehr. Surveys can be run utilizing the "hot-end" gage, located in the stud machine area, at any time. To obtain a survey, the operator cycles three pieces of glass from a given stud machine across the gage. The data is accessed by the computer and corrections are made to account for dimensional changes which will occur as the faceplate goes through the Lehr cycle. The output, which is printed on the KSR-35 "hot-end" teletype located in the stud machine area, is then used to determine what control adjustments are to be made on the given stud machine.

At the cold end of the Lehr, a survey of product is made for each stud machine once per hour. To assure that surveys are run for each machine, a computer-controlled display in the gaging area has a light for each stud machine which indicates the time at which a survey is to be run. The surveys from "cold-end" data are printed out on the "hot-end" teletype. This data is then reviewed by the stud-machine operator to verify the precision of the control moves which have been made on the basis of "hot-end" data.

## Supervisory system

The Supervisory System is a General Automation 18/30 computer with 32k of core memory. The system I/O includes a 2.5-million-word removable-pack disc memory, high-speed paper-tape reader (400 char/s), high-speed paper-tape punch (75 char/s), 600 line/min line printer, 500 char/min card reader, magnetic tape transport, and Calcomp 565 Incremental Plotter.

This system provides the capability for extensive analysis of mold equipment, which is not possible on the smaller "worker" systems. A complete mold-equipment data base is maintained on this system. Each time a piece of mold equipment is measured on the Cordax System, the data tapes are entered into the supervisory system. Outputs generated include present deviation from design as well as deviation from original dimensions, deviation from last measurement, and current mold component lifehours. These data are utilized to provide information regarding both wear and distortion effects on equipment throughout its life. Plots of the deviation from design are also provided each time a data tape is processed. A summary of the current dimensions of all operating mold equipment is output each week.

Product data is obtained from the Gage Data Acquisition and Control Systems throughout each week. This data is then processed on the 18/30 System, and is

used to provide overall process quality analysis.

Mold equipment data obtained from the Cordax System for a specific piece of mold equipment and the follow-up data from the Gaging Systems for product produced by the equipment are utilized as inputs to the mold design programs. Through this procedure, product variation from specifications can be assigned to errors in the mold equipment or process variations. These factors are then taken into account in the modification of mold equipment designs. When mold-equipment design modifications are to be made, new design data is output to magnetic tape. This tape is transmitted to Picture Tube Division MIS in Edison, NJ, where the major N/C mold-design programs (which are too large for the plant computer system) are located on a Spectra 70/6 system. N/C tape outputs produced at Edison are output on magnetic tape, and the results are transmitted back to Circleville. Programs on the supervisory system check the magnetic tape data for transmission errors, convert it from 80-character transmission records to N/C mill instructions, and punch it onto Mylar tape. These tapes are used to control the N/C mills in cutting additional mold equipment.

Utilizing cross-operating software, the supervisory system is used to compile and build the software for the Gage Data Acquisition and Control Systems. This allows modifications of those systems to

be developed with a minimum amount of "worker" system downtime. This is a significant advantage since the production lines being serviced by those systems operate on a 24-hour-per-day basis throughout the year.

In addition to being used for the Engineering and Process Control programs discussed above, the supervisory system is utilized as the Circleville plant MIS system. All programs required for plant accounting are processed on this system.

## Looking ahead

The "distributed computer concept" affords a production plant the ability to develop long-range plans for plant computer applications without making capital commitments four or five years in advance. Using minicomputers dedicated to specific applications, an integrated plant system can be implemented in a step-by-step manner, with economic justification satisfied after each step. Initially major emphasis in the Circleville plant had been implementation of those applications where the maximum return could be realized in the minimum time. Future computer systems being considered include direct digital control of the glass press, glass furnace data analysis and control, and automatic production reporting. Enhancements to the existing systems include implementation of real-time operating software for the "supervisory" systems and on-line communications between the "supervisory" system and the "worker" systems.

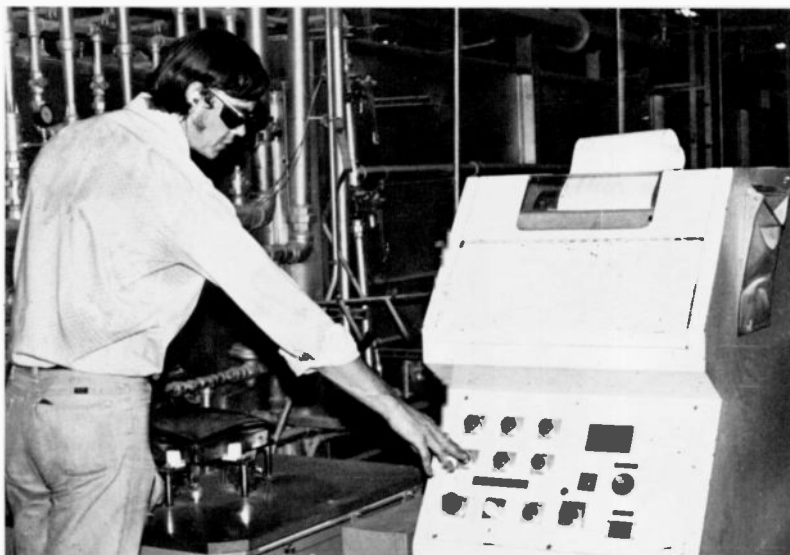

Hot-end gage and remote teletype located in the stud-sealing area. This gage is designed to measure faceplates while the glass temperature is around 450° C. Teletype is enclosed in the gage console for protection from the environment.



Stud-plane-to-contour gage in the gage room. Manual entry box is on the right side of the gage.

# Picture tube division resident engineering

L.F. Hopen | C.E. Shedd

The role of Resident Engineering demands close liaison with the engineering functions of both product design and manufacturing. Resident Engineering must provide the necessary product-design "on-location" support to all manufacturing activities. This requires close cooperation and continuous support of associated manufacturing engineering activities such as plant engineering, quality control, and product safety. The various engineering functions and activities that combine to assure a reliable and high-quality manufacturable product are described.

**RCA** has established and maintained leadership in the design, development, and manufacture of television picture tubes. This leadership in a high-technology industry has resulted in a worldwide licensing arrangement with most of the major manufacturers of television picture tubes. The scope of the

RCA engineering effort to support this worldwide responsibility is far more complex than those of competitive companies who concentrate on more limited market areas.

Reprint RE-21-5-17  
Final manuscript received November 26, 1975.

L.F. Hopen, Mgr., Picture Tube Process and Materials Development Engineering, Lancaster, Pa., received a BSME degree from Washington University, St. Louis, Missouri and has taken post graduate courses with Purdue University, Indiana University and Marion College. He joined RCA in Camden in 1949 and was assigned to the Marion Plant where he served in a variety of engineering and supervisory capacities including Plant Manager. In 1971, he was transferred to France as Operations Manager of Videocolor SA (an RCA joint venture) and in 1972 to Italy as Vice President and General Manager of Videocolor SPA. His current assignment includes Resident Engineering responsibilities at the Marion, Indiana and the Scranton, Pennsylvania picture tube plants.

Clifford E. Shedd, Mgr. of Color Picture Tube Equipment Development, Lancaster, Pa., received his B.S. degree in Industrial Engineering from Penn State University in 1940. He joined RCA in 1946 as an Engineer in the Black-and-White Picture Tube Development area. From 1946 to 1952, he held various lead engineering positions in process engineering for black-and-white, large-size picture tubes. In 1953 he became Manager, Equipment Engineering for Color Television; in 1959, he became Product Engineering Manager of Color Picture Tubes; in 1960, he was made Manager, Process Engineering Equipment Development for color picture tubes. Since 1969, Mr. Shedd has been Manager of Equipment Development for the Picture Tube Division.



Engineering effort in picture tubes can be categorized into four major areas all of which are highly important in achieving the end result of a product which is innovative and competitive for performance, cost, and quality. These areas are:

- 1) Research at RCA Laboratories, Princeton, N.J.
- 2) Picture Tube Division Engineering, Lancaster, Pa.
- 3) Picture Tube Division Resident Engineering
- 4) Plant Associated Engineering including Manufacturing Engineering, Industrial Engineering, Plant Engineering, Quality and Reliability Engineering.

## Role of Resident Engineering

In the classical view of product engineering, the transition from product concept to manufacture would follow the order listed above. In practice, however, the informational flow on new or existing products is multidirectional and utilizes all areas of expertise to reduce the timing and cost of new product introduction or product improvement. This article deals primarily with the contributions of one of the four areas of expertise, the Resident Engineering activity. Resident Engineering is the term used to describe the "on site" technical services and assistance provided by the product engineering activities (Product Support Engineering and Equipment Development Engineering) at the manufacturing plants. It is a vital link in a dynamic high-technology industry where unit cost dictates maximum control and minimum delay in problem solving.

## Product Support Engineering

Resident Product Support Engineering capabilities are structured to provide the basic facilities and skills in many technical areas. These skills areas include:

- Chemical and Physical Laboratory
- Design
- Engineering Standardizing
- Applications, Reliability, and Safety
- Support Activities (Maintenance, Shops, Library, etc.)

The application of such skills to product development and processing is described in the functions and responsibilities listed below:

- 1) *Engineering Standards*—Maintenance of up-to-date Engineering Standards is a

major requirement in the RCA Television Picture Tube Division. The complexity of both the processes and the products requires strict adherence to standardized procedures in order to manufacture RCA product to specification but also to fulfill Technical Aid Agreement commitments to foreign companies. Resident Engineering is responsible for the proper editing, processing, approval review and distribution of standardizing information initiated at the manufacturing location or elsewhere. The Engineering Standards activity at each manufacturing facility works in close cooperation with the central Engineering Standards activity in Lancaster.

- 2) *Laboratory Assistance*—Incoming material inspection experience over years of picture tube manufacture has proven the critical role that assuring high quality materials can play in performance and cost. The Chemical and Physical Laboratory (CPL) performs specified tests on each incoming lot of the more critical materials before their use in production. Non-routine tests are performed as requested or indicated when deviations in materials quality are suspected. The CPL participates in the decision-making process when questions of usability, availability, cost, and product effect must be resolved.
- 3) *Materials Support*—In addition to the regular inspection of incoming materials, Resident Product Support Engineering assists the plant functions in the selection, testing, and vendor approvals for a wide variety of materials used in tube manufacture or in general plant operation.
- 4) *Plant Engineering Support*—RCA plants have responded positively to the increased emphasis on the environmental aspects of plant operation. Support Engineering works closely with the Plant Engineering function to achieve and control plant effluent levels in accordance with Federal and State regulations.
- 5) *Plant Safety Support*—Resident Engineering actively participates and, in many cases provides leadership in safety-related activities such as the Central Safety Committee and the subcommittees involving chemical, electrical, and radiation safety. Members work directly with the Plant Safety Director in the investigating and formulating of plant requirements, and in publishing of safety standards and safety manuals. Additional effort and testing, have been required to monitor plant conditions (air, noise, etc.) for compliance with OSHA standards.
- 6) *Product Safety Support*—The activity in Resident Engineering monitors and tests product for compliance in the major areas of concern for television picture tubes—fire, shock, implosion, and x-radiation. RCA's long-standing commitment to product safety and compliance with existing regulations has resulted in considerable emphasis on continuing effort and coordination at all levels of engineering and management.
- 7) *Direct Manufacturing Support*—This activity accounts for the largest segment of Resident Product Support Engineering. The efforts of this activity can be divided into five major categories:

**Author's note:** Subsequent to the submittal of this article, Dr. D.J. Donahue, Vice President Engineering, Picture Tube Division, announced organizational changes which included a further strengthening of the role of the Resident Engineering activities at the Marion, Indiana and Scranton, Pennsylvania plants. The reorganization established three major Product Engineering activities:

- Process and Material Development (includes C & P Lab)
- Product Design
- Applications, Reliability and Safety.

A functional reporting relationship was established between the above Lancaster activities and their plant counterparts to promote more direct communication and establish a broader base for skills utilization in new products and improvement programs. Engineering support for problem solving at the plants will also benefit from the more efficient utilization of skills. The administrative functions for resident engineering remain the responsibility of the Resident Manager, Product Engineering and Resident Manager, Equipment Engineering.

—Len Hopen

- a) *Process Control:* The monitoring of certain critical areas in the processes for parts and tube making which require specialized laboratory equipment or analysis techniques.
- b) *Process Development:* The development of new or modified in-plant processes required as a result of changes in products, materials, or techniques.
- c) *Product Improvement:* Efforts to improve the product for increased customer acceptance, improved performance, lower cost, or some combination of the three.
- d) *Problem Solving:* The responsibility of working with the manufacturing organization when problem areas develop which require added technical assistance.
- e) *Product Evaluation:* The Applications function evaluates product from a customer point of view on a daily sampling basis. These evaluations include receiver testing, coil room (field-free) testing, life testing under various prescribed conditions, and environmental testing. The results of these tests can trigger significant changes and improvements in the product through Support and Manufacturing Engineering.
- 8) *Sales and Customer Assistance*—The resident Applications Engineering activity evaluates customer receivers, analyzes applications problems, provides defect analyses, and sets up product demonstrations to customers at the request of the Sales or Marketing groups.

## Equipment Development Engineering

The Resident Equipment Development Engineering is also an integral part of the total plant operating structure but

functions under the guidance of Lancaster Equipment Development Engineering. The Resident group shares responsibility for the design, run-in, proper use, and updating of all plant manufacturing equipment. This responsibility includes maintaining equipment design capabilities with continuing emphasis on process improvements, equipment improvements, cost reductions, and flexibility of setup among tube types.

The dynamic nature of the picture tube business requires that the manufacturing operations maintain the capability to produce established types of picture tubes on short notice but at the same time have the expertise and capability to produce new types as they are introduced or revised on an almost continual basis. The Resident Equipment Development Engineering activity plays a key role in the design and installation of new equipment as well as the modification of equipment required for the introduction of new types of picture tubes or the revision of established types. The Resident Equipment Development group designs the fixturing, tooling, gauges, testing equipment and process machines that fall within the areas of expertise of the groups engineers and designers.

Many problems arise on a daily basis. Not the least of these is the maintenance of the specialized tube-making equip-

ment. It is a responsibility of Resident Equipment Development Engineering to provide technical help to the various service departments to help minimize down-time and obtain maximum machine efficiency. Some of the problems may have to do with the equipment itself; others may relate to equipment parts which are no longer available and for which replacement must be devised or fabricated. New sources for replacement parts must be found and the new parts evaluated before replacement is implemented.

Continually, efforts are made to help both Production Engineering and

Product Engineering with production problems on the equipment, or the effects of process variables on the equipment. Through mutual efforts, programs are set up to maintain controls on machine variables and their effect on the product. New product innovations particularly require a great deal of attention during the introductory stages particularly in the implementation of new tube types or processes. Usually, the advent of a new type brings many innovative requirements in terms of new equipment and equipment revisions. Most of the effort, including paperwork, for these new requirements is handled by and through Equipment Development

Engineering. Included are all the work from the basic facility study through the procurement paperwork and finally the blueprints for construction. Then, after the equipment is completed, Equipment Development Engineering is responsible for its inspection and for any subsequent revisions that may have to be made as the results of production shakedown problems.

If the facilities require a major engineering design effort, the requirements are forwarded to the Lancaster Equipment Development Engineering group for design. Upon completion of the design of the new facilities, the plans are submitted to the local factory group for review and, if approved, are released for construction. Upon completion, the equipment is inspected by Resident Equipment Engineering prior to shipment and installation. When production parts are available, an operating run is made to test the equipment with the product it is to manufacture.

The local manager of Equipment Development Engineering functionally reports to the local Plant Manager. He is on his staff and provides assistance in plant layout, facility studies for new tube types, and new processes. He is usually a member of the plant committees such as electrical safety, mechanical safety, laser, radiation, engineering, and education. In addition, members of the Resident Equipment Development Engineering group usually participate in other plant committees responsible for OSHA compliance, energy conservation, and environmental problems, as well as in the plant's suggestion systems and the various cost reduction programs.



Various parts for the electron gun mount are assembled with a special fixture around a revolving work table.

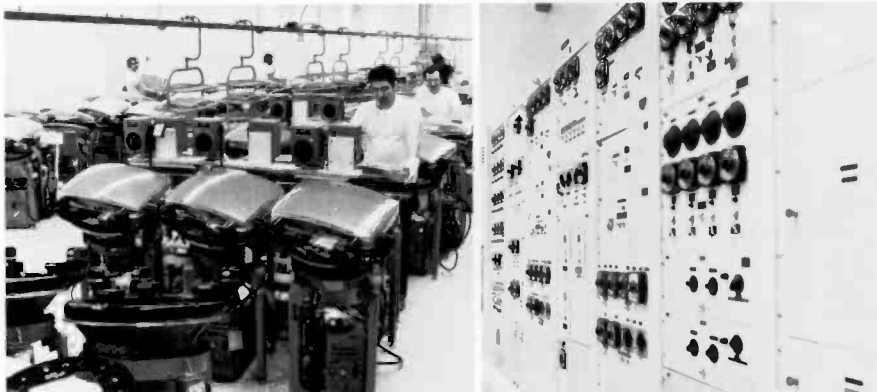

Left, electron-gun mount assembly is checked on a visual comparator. Right, all tubes are final tested before shipment.

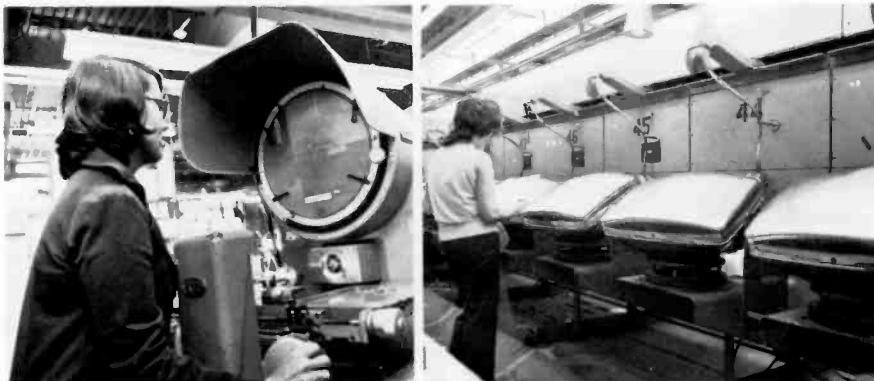

Light-house stands (left) are used to expose phosphors in proper register. Centrally located electrical controls (right) allow the entire phosphor application and exposure operation to be monitored and checked from one position.

## Conclusion

The foregoing material describes the functions and responsibilities of the two constituents of the Picture Tube Division's Resident Engineering Activity—Product Support Engineering and Equipment Development Engineering. Because the responsibilities of the Resident Engineers, both domestically and worldwide, are so varied and yet often so vital to the establishment and maintenance of our manufacturing operations, it is hoped that this article will lead to a clearer understanding of these efforts and an appreciation of their many contributions.



# Development of compound for quadradiscs

G.A. Bogantz|S.K. Khanna

The rapidly expanding use of 4-channel sound requires approximately three times the bandwidth of stereo discs to be recorded on the discrete phonograph record. This increased bandwidth demands a new fineness in the compound from which discrete disc are made. This paper reveals the inadequacy of current stereo record compounds and the extent to which the compound requirements for discrete 4-channel records have been met. It also reveals, in part, the basis for the belief that records are the World's most precise mass-produced product.

THE ADVENT of discrete 4-channel disc records was based upon the extension of the state-of-the-art in recording and record manufacturing in several areas. For the first time in the industry, a commercial record was marketed with fm sound. This innovation was used to super-audibly-impose two additional channels of sound upon the two stereo signals on the two walls of the record groove. The fm carriers are placed at 30 kHz and each is modulated independently of the other. In this way, four channels are recorded upon one record groove, each wall of which carries one stereo baseband signal and one fm signal.

So that a discrete 4-channel disc record played on a stereo system will reproduce all of the sound recorded on the record, it is necessary to record as baseband stereo the sum of the left front and left back audio signals on the left groove wall; likewise, the sum of the right-front and the right-back audio signals is recorded on the right groove wall. In this way, the new records are completely compatible with 2-channel stereo. The difference between the front and back audio signals is recorded on the fm channels respectively. On 4-channel playback, algebraic combinations of these signals produce four discrete channels.

Gregory A. Bogantz, Member, Engineering Staff, RCA Records, Indianapolis, Indiana, worked as Control Engineer at radio station WVNO-FM during high school, and received the BSEE and MSEE degrees from Purdue University in 1969 and 1970 respectively. From 1970 to 1972, Mr. Bogantz worked as service manager of Production Audio Service in Lafayette, Indiana, where he gained experience in the consumer audio equipment field. In January 1973 he joined the staff of RCA Record Engineering in Indianapolis, Indiana, specializing in disc record technology, where he does mastering of all new test and technical series records for RCA custom clients. Mr. Bogantz is currently concentrating on QuadraDisc (CD-4) cutting, processing, and playback, and has published an article on CD-4 pickups. He is co-author of a patent pending on a simplified CD-4 modulating system and a member of the Audio Engineering Society.

Sarwan Kumar Khanna, Senior Rheologist, RCA Records, Indianapolis, Indiana, graduated from Punjab University in India and from Borough Polytechnic in England. He carried out postgraduate research in Polymer Rheology at Cranfield Institute of Technology in England, and was rheologist with Associated Electrical Industries in the United Kingdom. He was senior development engineer with Gulf Oil (Canada) Chemical Division and is now engaged in rheological research in vinyl resins and compounds.

Reprint RE-21-5-3  
Final manuscript received April 9, 1975.



This greater information density was achieved by the use of essentially one-half speed recording and a new cutting stylus design. To pick this information off the record required a new design for the playback stylus. [This stylus is named after the man who developed it, Mr. Shibata]. The Shibata stylus is shaped pyramidically to give better contact with the groove and uses a smaller contact radius to provide better tracing of the waveforms in the groove.

## Goals

While considerable effort was exerted on developing phonograph record compounds with low surface noise, the introduction of the quadraphonic record has placed new demands on wear characteristics due to the decreased wavelengths involved. The extensive wear testing procedure to be described here is the result of weeding through several methods and proposals.

Originally, the intent of the program was to develop a compound which would withstand rather severe playback conditions in order to be compatible with the single inventory concept of stereo-quadraphonic record production. Thus, the new compound would have to withstand playback on rather unsophisticated consumer-type stereo or monophonic phonographs—and be able to render good performance on a CD-4 playback system that the customer may acquire in the future. A little thought will show that this is a pretty rigorous demand to make of an information storage medium like the relatively "soft" vinyl phonograph disc which has traditionally been easily subject to deterioration by simple scuffing and scratching. The first question then becomes, is this requirement realistic? Is it even possible on a practical basis?

Initial testing indicated that this goal may in fact be quite impossible to obtain. We were rather quickly able to determine that existing stereo compounds were totally unsuited to the task on several counts. We had hoped to be able to play a QuadraDisc upwards of 100 times on a consumer phonograph equipped with a 0.7-mil radius conical stylus tracking at about 5-grams—and then be able to get acceptable performance from the disc on a CD-4 playback system. Several questions become immediately obvious

at this point, like *Why 100 plays* and *what is acceptable* quadrasonic performance. But, more about that later. Most stereo compounds failed miserably without having to answer the above questions.

After only five or ten plays on the consumer phono, the quad performance of the disc was unlistenable due to acutely high noise or such a severe carrier loss as to cause the playback demodulator's muting circuitry to activate, disabling the CD-4 function altogether. Another problem with most stereo compounds was unsatisfactory first-play performance on good quality CD-4 playback equipment by means of a Shibata-tipped stylus tracking at 2-grams. This was due to poor molding characteristics and excessive scanning loss and groove deformation during the first pass of the Shibata stylus.

## Review of wearing conditions

At this point we should stop and consider the various conditions under which a disc may be played by a consumer and try to determine a meaningful disc-wear format. Modern playback cartridges can be generally broken down into two major categories, 1) consumer types with relatively high tracking force and conical styli and 2) component quality types tracking at under 3-grams and equipped with conical, elliptical, or Shibata-type styli. The typical conical stylus for stereo playback has a tip radius of about 0.6-0.7 mil. Most elliptical styli have biradial dimensions of about 0.3 mil by 0.7 mil. The smaller dimension is the horizontal scanning radius and the larger the vertical bearing radius.

Henceforth, we will refer to all Shibata-type styli as simply Shibata styli; these include the *Quadrangular*, *Ohata*, *Pramanik* and others. They all have the same essential characteristics of small scanning radii on the order of 0.2 to 0.3 mil and quite large vertical radii of about 3 mil.

We are then faced with four major wear conditions: 1) high-force conical, 2) low-force conical, 3) low-force elliptical, and 4) low-force Shibata.

Without belaboring the point, let us say that after sampling several consumer products and based on past experience we have further defined these categories as:

1) 4.5 gram conical, 2) 2 gram conical, 3) 1.25 gram elliptical, and 4) 2 gram Shibata. Of these, the 4.5 gram conical test is the most severe and the 2-gram Shibata test the least severe. Most of our testing involves these two tests with the other two performed only on compounds which yield satisfactory results on the first tests. We also further specify that the 4.5 gram conical test is done with a consumer-type player and pickup which usually does not incorporate antiskate compensation. The remaining tests are intended to simulate relatively good playback conditions and so are performed on good-quality component-type changers with properly adjusted antiskate compensation.

Consider now one of the questions raised earlier. How many playings must the disc withstand to be considered acceptable? This is certainly a speculative point, but one that should be defined. We felt that a consumer would be likely to play a disc in quad mode probably at least 10 times during its useful life and maybe as many as 25 or more times if he is in the habit of showing off his sound system to friends. Therefore, we want to be able to provide him with minimally about 25 plays with as little degradation as possible. However, to allow ourselves some leeway in meeting this requirement easily, we set out to see if we could achieve upwards of 100 plays without serious degradation. We suspected that the 4.5 gram conical test would be much more severe and frankly did not know initially how many plays should be required of this test. We simply elected to shoot for 100 plays to see if it was possible.

We feel that it is unrealistic to expect a compound to perform well even initially in the quad mode with a conventional conical tip pickup due to the mechanics of the system. A 0.6 - 0.7-mil scanning radius is simply too large to cope with the small carrier wavelengths at the inner diameter of a QuadraDisc, even when the disc is in perfect condition. We, therefore, chose to disregard the quad performance of a disc when played with a standard conical tip, regardless of tracking force and regardless of the number of times the disc had been played. It is our feeling that hardware manufacturers must accept the responsibility of equipping their players with the proper type of CD-4 playback stylus - Shibata. Hence all of our evaluations of QuadraDisc performance

would be based on the use of a Shibata tip during the measurement.

Another important aspect of wearing a disc is the amount of time allowed between successive passes of a given portion of the record. This is a question which has been discussed at length in the literature as it relates to stereo performance, and the general conclusion is that some time should be allowed for vinyl relaxation between plays. Some researchers state that as much as 24 hours should be allowed. Initial tests were conducted using specially equipped changers with timers to allow differing amounts of time delay between playings of a QuadraDisc. We found that there was some variability among compounds, but some did allow a relatively short recuperation time of about ten minutes. Not only was this desirable, it was almost a necessity for our testing program due to the many compound formulations we were investigating. We simply could not afford the time involved in allowing a disc to relax for as much as a day between playings. Since some early formulations showed promise of performing well with only several minutes relaxation time, we chose to make this a requirement of the QuadraDisc formulation. We elected to operate the wear testing changers continuously with a set-down point at the 10-inch (254-mm) diameter. This allowed two advantages. An unworn portion of the 12-inch (305 mm) disc at the outermost diameter would be available for possible future reference after the disc had completed the wear analysis. Starting at the 10-inch (254 mm) diameter allows about 10-minutes playing time for the duration of the record side, so a 10-minute relaxation time is realized between successive passes of any portion of the disc.

Another area of consideration regarding the wearing process itself concerns the maintenance of the wearing styli. It was found that as the wearing stylus begins to develop small flats on its contact faces, record wear actually decreases due to the increased contact area with the groove wall. This was particularly true of the Shibata tips. However, if the stylus becomes excessively worn, the tip can no longer navigate the groove properly and begins chiseling and excessively wearing the disc. It was determined that all styli should be microscopically checked after about 100 plays. Conicals and ellipticals

are rejected when they develop obvious flats that are easily noticed microscopically.

Shibata styli are treated differently. In addition to the microscopic examination, they are fitted to a reference cartridge and turntable and checked using a special test record cut for this purpose. This disc (RCA #RL-1850 Test and Technical Series) is a 30-kHz signal recorded on both groove walls using a constant cutter current over the entire side of the record ending at about a 5-inch (127 mm) diameter. The purpose of the test is to determine the scanning loss of the stylus as its contact radius increases due to wear. With a new Shibata tip operating at 1-gram tracking force (JVC 4MD-20X pickup) both the left and right channels should show less than 3-dB scanning loss from beginning to end of RL-1850. A worn Shibata tip is rejected when it displays greater than 6-dB scanning loss with this test. At this point the wear is usually easily visible under a microscope.

Additionally, we have specified some other conditions on the actual disc-wearing procedure. The changers have been equipped with brushes which dust off the stylus as the arm swings near the armrest during the change cycle. The changers are operated with dust covers in place to keep excessive dust from accumulating on the disc during the wear process. However, the discs are not cleaned in any way before, during, or after the wear process before measurements are performed.

These requirements and procedures have been imposed to simulate as closely as possible the field conditions the discs are likely to encounter. We feel we have avoided being unduly harsh or unrealistically pristine in arriving at these wear conditions.

## Evaluation of record quality

Having discussed a good deal of history leading up to our current procedure, we now describe the actual process of ascertaining the quality level of the QuadraDisc. There are four major tests we use to establish the quality of the disc: 1) carrier level and its loss during wear, 2) spectral analysis of the noise content of the disc, 3) SEM photography of the highly magnified grooves, and most importantly, 4) listening evaluations.

Carrier level is measured using a specially selected low-scanning-loss Shibata stylus fitted to a reference arm and turntable. The pickup is operated at 1-gram tracking force to further reduce scanning loss at the inner record diameters. The output of the cartridge is fed without RIAA de-emphasis to a flat amplifier having 20-dB gain and then to a 24-dB/octave high-pass filter with a turnover frequency of 30-kHz. This allows any portion of the QuadraDisc to be measured since the baseband signal is filtered out leaving only the constant-amplitude fm carrier. The filter output is fed directly to an ac vacuum-tube voltmeter. This step is calibrated using the first band on the "A" side of RCA #12-5-114 as a carrier reference. During testing, the reference stylus must be cleaned very frequently with a dry cotton swab to ensure accurate readings. A number of compounds tested generate considerable residue left in the groove after the wearing process. This can cause gunking of the stylus within one revolution of the disc, resulting in completely false carrier level readings. Obviously, a compound less prone to gunking with wear is desirable.

Real time spectral analysis of the hiss level on the test disc is accomplished with the aid of a modified CD-4 demodulator feeding a Hewlett-Packard 8054-A analyzer connected to an X-Y plotter giving a hard copy of the results. The demodulator has been equipped with switches to deliver any of four signals to the spectrum analyzer: 1) baseband only, 2) demodulated carrier only, 3) demodulated carrier without ANRS noise reduction, and 4) normal CD-4 composite information.

The first two of these are normally used. Curves of the measuring system residual noise, the test disc baseband noise, and the demodulated carrier noise are plotted on one chart. Noise levels are relative to American standard QuadraDisc recorded levels of baseband and carrier modulation as represented by Band I on the "A" side of RCA #12-5-114. Measurements are taken at spirals on the disc where no modulation is present.

The part of the record most subject to wear is the innermost diameter. After the wearing process is complete and all measurements of the disc have been obtained, a half-inch (12mm) circular sample is punched out of the last recorded band on the disc for scanning electron

microscope (SEM) analysis. SEM photographs have proven quite helpful in determining the best practical approach to solving the single inventory QuadraDisc compound problem. More about that later.

With all of the foregoing investigation, we still haven't been able to eliminate the need of actual listening tests in compound evaluation. Defects like *noisy swishes* are dynamic in nature and hard to document efficiently by spectral analysis. There are different types of *tics*, *pops*, and *clicks*, characteristics of certain compounds as they wear, but a *tic-pop* counter cannot distinguish among them. Listening tests were necessary at the very outset of this program to determine where certain noises were coming from on the first play of the disc. It is outside the scope of this paper to discuss in detail here, but it was discovered that most of the noise encountered on the initial play of the disc is related to the metal parts and lacquer processing (matrix operations) rather than to the compound itself. It is absolutely imperative that stampers (a stamper is the metal plate within the press which molds one side of the record) be of superior quality before any judgment of compound quality can be made. The QuadraDisc format is likely to show up deficiencies in record manufacturers' matrix facilities that they have been unaware of in stereo record production.

After a few false starts, we arrived at three audio rating categories: 1) *hissy* noise, 2) sharp shattering breakup distortion, and 3) *tics*, *pops*, *crackle*, and *spatter*. Discs are auditioned on a high-quality reference playback system, and each of the three categories is rated by the following letter grades:

"A" — indicates superior performance with no noticeable defect,

"B" — indicates a slight but noticeable defect,

"C" — indicates a defect that is objectionable, and

"D" — indicates still further degradation, resulting in rejectable performance.

Such a grading system is obviously highly subjective, but several testers have become familiar with it and can provide reasonably consistent results. We have had occasion to test some compounds several times and have been able to get repeatable wear data from the listening test.

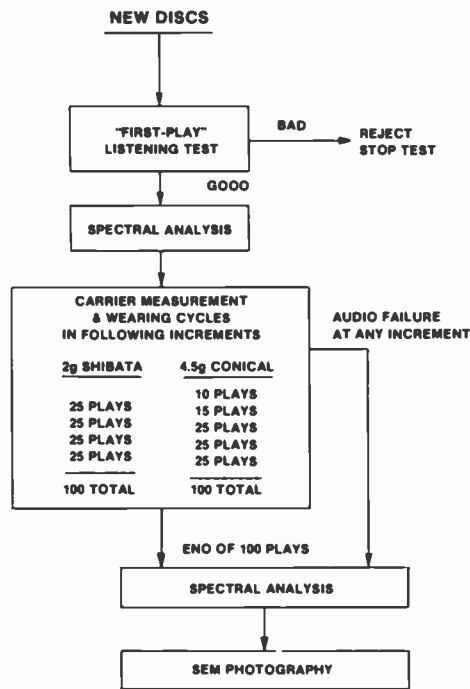

Fig. 1 — QuadraDisc wear testing procedure.

## Wear testing procedure

Having now described each of the tests used in evaluating QuadraDiscs, we will outline the overall procedures (Fig. 1). A new test pressing is first auditioned to determine if it is free enough of initial defects to provide meaningful wear data. Usually one set of stampers of known good quality is used to press all wear test discs. A reference compound of known good first-play quality is pressed from time-to-time to insure that the stampers have not deteriorated. The first-play quality of the new compound can then be matched against this standard compound. Audio ratings are noted for the first play of a new test disc. Carrier level is measured and documented at several diameters. Data are usually taken at the start of the side, the end of the side, and at the last two spirals. Spectral noise plots are then made of the new discs at a spiral somewhere around the 8-in. (203mm) diameter. Usually two discs for each new compound are tested. One goes on the 2-gram Shibata wear tester for 25 plays. The other gets played 10 times on the 4.5-gram conical consumer wear test changer. Carrier levels are again measured and audio ratings given.

The first plays are usually the most telling, and many compounds have been rejected at this point in the test. If the discs have not incurred an audio rating

worse than "C" in any of the three areas of noise, breakup, or crackle, and the demodulator has not automatically muted at any point of the audio test due to excessively low carrier level, the discs go back on the wear testers for 25 more plays (Shibata) and 15 plays (4.5-gram conical). At the end of this sequence the Shibata-worn record has 50 plays and the other has 25 plays total. Carrier level and audio tests are again made. If the discs pass, they go on the wear testers again for another 25 plays each.

This process continues until the discs have been worn by 100 plays. At this time or when a disc has failed the audio test at some earlier point by incurring a "D" audio rating, the spectral noise plots are again made of the same portions originally tested, and the record is prepared for SEM photography.

Compounds that pass the 2-gram Shibata and 4.5-gram conical tests are also run on the 1.25-gram elliptical and 2-gram conical to make sure there are no surprises due to peculiar wearing patterns—and we have been surprised on occasion. Several compounds have passed the 4.5-gram conical test and failed the 2-gram Shibata test. This sounds unlikely at first, but analysis of the SEM pictures indicates the compounds *trenched* badly on both tests, but the Shibata stylus bridged the conical trench well enough the few times

necessary during measurement to yield passable results.

## RCA's QuadraDisc compound

Based on our experience over the past year we feel we have identified the only practical type of compound which satisfies the single-inventory criteria. It is a somewhat *softer* formulation than we had initially expected but with well-defined and controllable elastomeric properties.

The QuadraDisc compound was developed by studying the visco-elastic properties of resins and various additives used during compounding. As analyzed on suitable rheological measuring equipment, the shear rate-temperature-viscosity and melt-elasticity relationship indicates a new range of properties. A critical balance between melt viscosity and elasticity was built into this compound to have good molding characteristics as well as improved wear properties over stereo compounds. New mixing techniques for the manufacture of this formulation had to be developed. The realization of the final properties of the RCA QuadraDisc compound is the result of specific processing procedures required to develop the full benefits of this heterogenous material. Therefore, a mere listing of its ingredients is virtually useless, but for those interested, the formulation is:

Primary resin.....	75.5—80.0%
Secondary resin.....	20.8—16.3%
Carbon black.....	0.2%
Stabilizer.....	2.0%
Antistatic agent.....	1.2%
Modifier (EPO type).....	0.5%
Lubricant.....	0.4%

The general characteristics of a disc pressed with this material are:

- 1) virtually no audible or visible deterioration when played 100 times under ideal quad playback conditions (Fig. 2a), and
- 2) very well-controlled, clean trenching of the sidewalls with virtually no generation of debris due to abrasion and minimal "buttering over" of the high-frequency modulation (Fig. 2b; compare with Fig. 3).

The radius of the trench created by the 0.6 - 0.7 mil conical (or elliptical) stylus is small compared with the 2 - 3 mil vertical bearing radius of the Shibata tip and is effectively bridged by the latter during quad playback. Bridging this trench

allows the Shibata tip to ride on the unworn parts of the sidewalls and deliver a sufficiently high carrier level to the demodulator to produce acceptably quiet quad performance. It is important, however, that the conically worn groove be free of debris which could be tracked by the Shibata stylus resulting in degraded performance. The inclusion of an antistatic agent in the formulation was found to be helpful in meeting this requirement (Fig. 4).

Notice now that we have not actually developed a compound which allows 100 plays with a 5-gram consumer-type conical stylus with little or no deterioration of the carrier modulation. We believe that this is virtually a physical impossibility. It remains to be seen whether future pickups using conical tips of very small radius specially designed for QuadraDisc applications (employing 30-kHz mechanical resonances) will significantly change this opinion. What we have done is to devise a formulation which exhibits very well defined and controllable wearing of the carrier by taking advantage of the difference in the vertical bearing radii between the Shibata tip and all other tips. And second, the compound withstands repeated passes (100) of the Shibata tip without noticeable deterioration. This is not a simple requirement to meet in itself, but it is certainly easier than having to cope with the abrasion of conical and elliptical configurations which (disregarding mechanical resonances) produce between 2 and 4 times the contact pressure respectively at the same tracking force as a Shibata tip.

## Disc production

RCA recently made these findings known to the chemical plants supplying polyvinyl resins and compounds to the record industry. To date, both Keysor-Century and Tenneco Chemical have been able to duplicate the RCA formulation and processing, resulting in compounds that yield essentially the same characteristics.

In addition to the RCA formulation (Fig. 2), the wear nature of other compounds is shown in Figs. 5 and 6. Both of these compounds are currently in use for regular QuadraDisc production by companies other than RCA. The number of plays noted, if less than 100, is the point at which the disc failed the wear test.

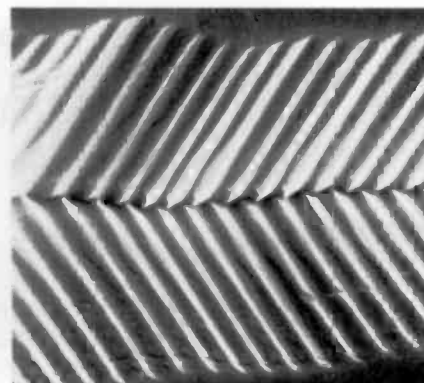
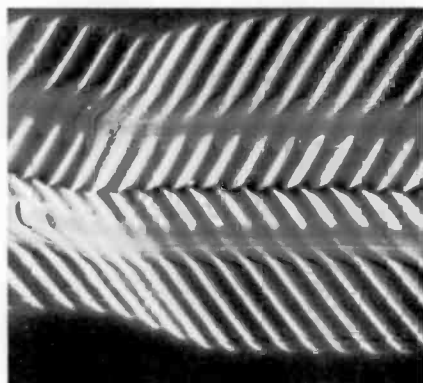

Fig. 2 — QuadraDisc compound after 100 plays—a, left) With a 2-gram Shibata stylus—b, right) With 4.5-gram conical stylus. Notice clean, narrow trenching of the sidewalls.

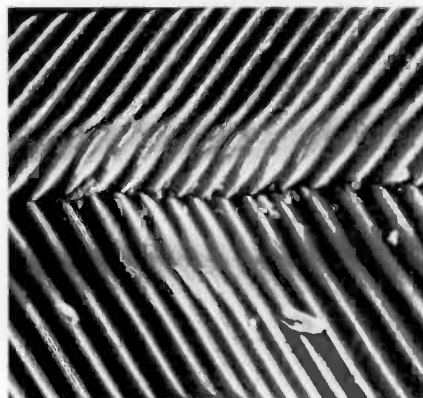

Fig. 3 — Unsatisfactory formation after 25 plays with 4.5-gram conical stylus. Notice "battered over" nature of wear pattern and deep wide trench leaving almost no unworn surface for Shibata tip to scan.

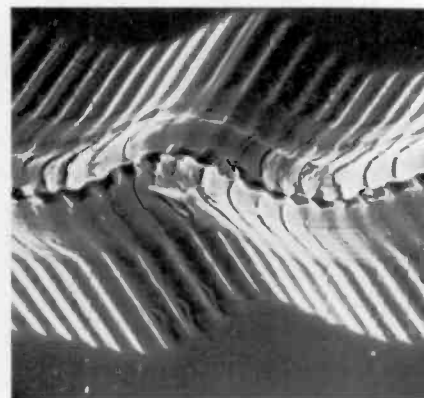

Fig. 4 — QuadraDisc compound without antistatic agent after 100 plays with 2-gram Shibata stylus. Notice debris remaining in groove.

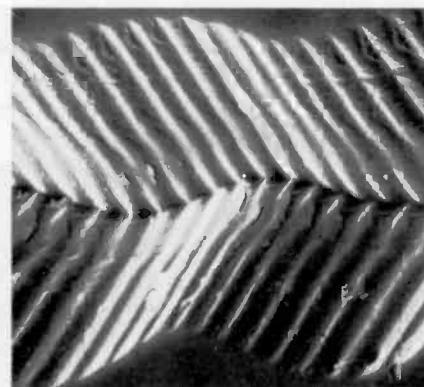

Fig. 5 — Compound C—a, left) After 15 plays with 4.5-gram conical stylus—b, right) After 10 plays with 4.5-gram conical stylus.

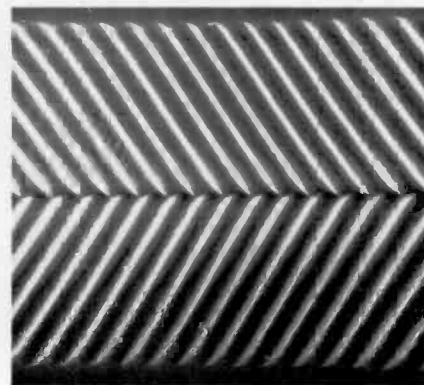
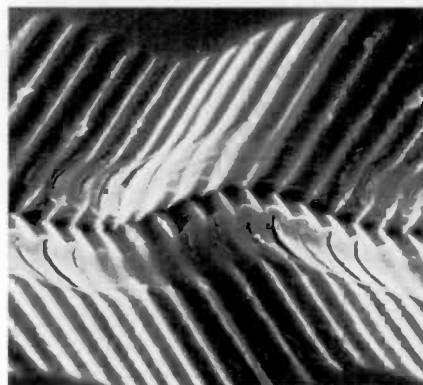

Fig. 6 — Compound B—a, left) After 100 plays with 2-gram Shibata stylus—b, right) After 25 plays with 4.5-gram conical stylus.



# Scope — the power testing paladin

E. Cutshaw

SCOPE is an automatic test system that consolidates most of the previous standard and specialized semiconductor testing requirements into a single high-speed system capable of categorizing and evaluating the millions of SSD power devices. Descriptions of how the system operates, what equipment is included, model test setups and the degree of test system flexibility are given.

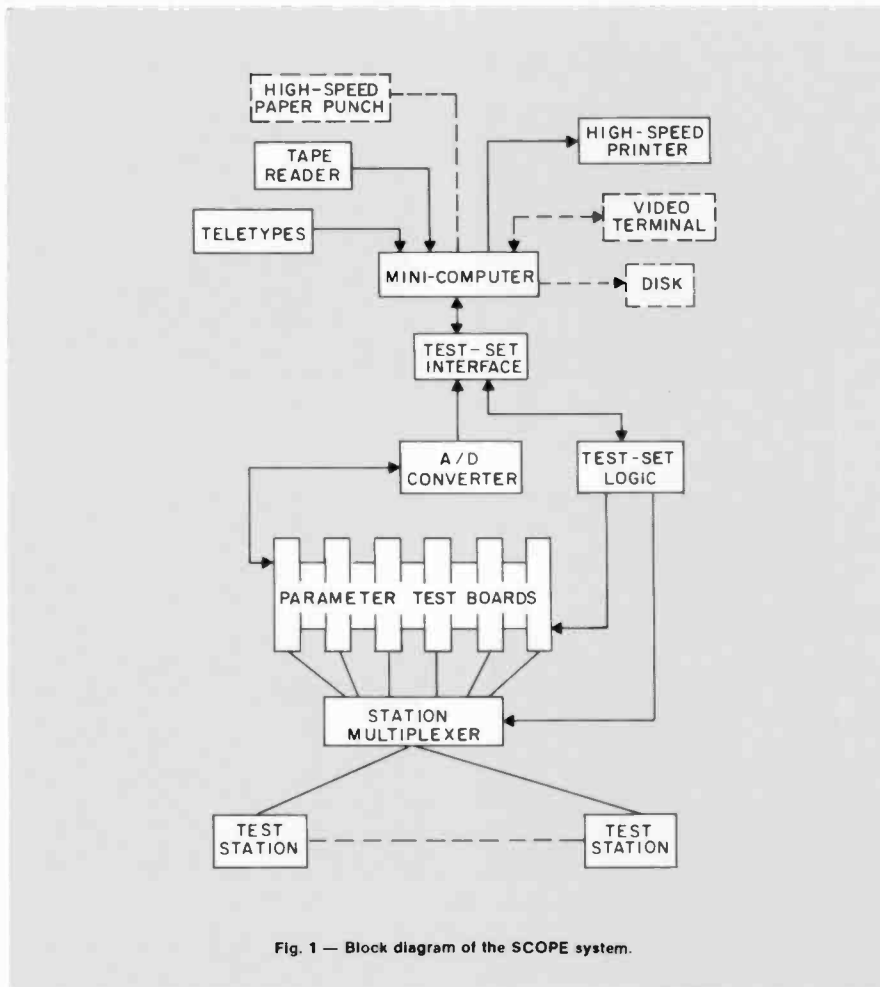

Fig. 1 — Block diagram of the SCOPE system.

SCOPE is an acronym taken from the words semiconductor computer operated parameter evaluation. It is a term used to identify any one of several dozen automatic test systems located in the various Solid State Division facilities. The SCOPE systems are the backbone of the RCA's power semiconductor testing capability. Such systems are used to categorize and evaluate the millions of power semiconductors manufactured

yearly by RCA SSD. RF and Darlington power transistors, bipolar transistors, rectifiers, SCR's, triacs, diacs, power hybrids, and printed circuit modules encompass the SSD manufacturing spectrum. These devices may be examined by SCOPE systems as wafers, pellets and/or in their final packaged form. SCOPE systems are also used in engineering facilities for new product evaluation, competitive evaluation, failure analysis

and, new test-technique development. Each test system is tailored for its particular application without destroying the basic architecture. The SCOPE test systems are capable of most standard parametric measurements and many specialized test procedures.

## In-house system development

Every manufacturer, when product testing is required, is perplexed by the decision, make or buy. When a reputable commercial piece of test equipment is available the obvious choice is to buy. Engineering and developmental costs alone will generally dictate this decision. The option, alas, is seldom this clear cut. This is the case with power semiconductor automatic test equipment.

**E. Cutshaw**, Power Transistor Applications Engineering, Solid State Division, Somerville, N.J., received the BSEE in 1969 from Marquette University. He joined the RCA Solid State Division in 1970 as a Thyristor Application Engineer responsible for customer support and factory testing. In 1971 he transferred to RCA Solid State Division, Mountaintop, Pa., as a Design Engineer in Equipment Development. His responsibilities included computer controlled test set design in the areas of thyristors and printed circuit fabrication. He transferred back to RCA Solid State Division, Somerville, N.J., in 1974 where he is presently responsible for advanced test equipment development and new testing techniques for power semiconductors.

Reprint RE-21-5-18  
Final manuscript received October 18, 1975.

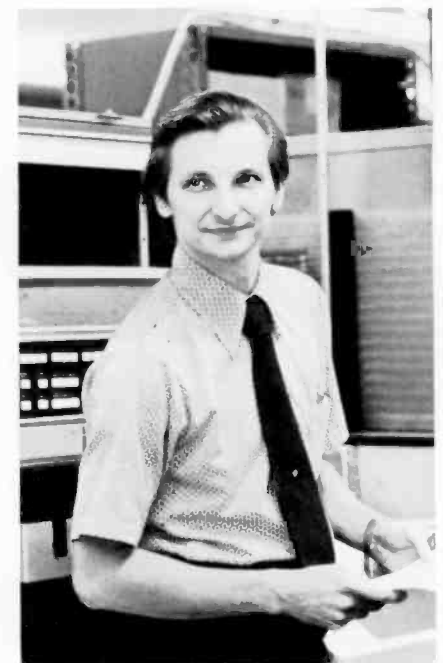

Small-signal transistors, rectifiers and integrated circuits entertain a very large production volume and generally speaking do not require as exotic test equipment as do power semiconductors. This allows commercial test equipment manufacturers to offer a good selection of automatic production testing systems to a profitably sized market. With the impact of power semiconductors several years ago, some of these commercial producers attempted to expand the general capabilities of their small signal systems and exploit the power industry. In RCA SSD their penetration was impotent for several reasons. Primarily the systems offered did not have the testing capabilities of the semiautomatic test sets which were produced in-house before commercial equipment manufacturers had even begun to consider such test sets. Also the technical expertise of product-line design and applications personnel linked with the experience of a mature equipment department is difficult competition for even the most aggressive commercial producers. The advent of the minicomputer coupled with a ready engineering community lead the way to the SCOPE test system. Today RCA still holds leadership in high-speed power-semiconductor automatic testing.

### How SCOPE works

Very well; as a matter of fact, the basic system architecture has not been changed since day one (Fig. 1 is a block diagram of the SCOPE system). The heart of SCOPE, or rather the brain, is a Hewlett-Packard minicomputer. Each system contains 8-K or 16-K words of core memory, in some cases a disk is added. Paper tape is the primary programming medium with teletypes, high-speed printers, video terminals, etc. as peripherals. Several models of the H/P minicomputer are in use as a result of system evolution, however, all test set hardware and software are compatible from set to set. The H/P computer was chosen for its I/O capability, model to model compatibility, vendor support, interest and availability.

The test set interfaces with the computer in the same way as all other peripherals. A priority interrupt I/O bus is the primary intercommunication function in the system. The computer communicates with the test set by way of the test set logic. The test program is transferred to

the test set logic in the form of 16-bit test words which are decoded and distributed to the test boards to establish test conditions and circuit limits. The test set logic interrupts the computer to request test words and to signal that information is ready for transmission by the analog-to-digital converter. Each test board is designed to set conditions and make measurements for a particular type of parameter (leakage, forward drops, betas, etc.). The test set logic establishes timing and controls the station multiplexer. Each test station can request that devices be tested according to a test program which it can remotely select. Test stations may take the form of manual test sockets, wafer probers, pellet handlers, device handlers and hot sockets.

The SCOPE system software consists of an executive program which maintains overall control and interfaces with the

operators in a simple English language conversation. Additional software in the form of test programs and user programs are entered and controlled by the executive program. Fig. 2 is a sample program which can be loaded into a power transistor test system. The first entry is the program name, the second identifies whether the devices are p-n-p or n-p-n. The remaining entries are test names followed by testing conditions which are generated from a schedule of tests for each test system. A sample data logging output for this program is shown in Fig. 3.

The executive software allows up to ten test programs to be active in the test system. Each test program can test and categorize up to 64 different types or categories for each device tested. The executive program allows software counters to be opened up for each of the

```

      *2NXYZ
      NPN
      VCEO
      .1 100
      VCBO
      .1 1000
      VCEB
      .1 100 100
      VCES
      .1 100
      VCEX
      .1 100
      PIB
      5 1 1
      PVBE
      5 1
      PVSAT
      5 .2
      PVBS
      5 .2
      VBEO
      5
      VBEO
      .1 1
      VEBO
      .01 100
      PVCEO
      .1 100
      END
  
```

Fig. 2 (above) — Sample program. Fig. 3 (right) — Sample data logging output.

SCOPE :		DATA SAMPLE					
TESTED TO							
*2NXYZ							
	VCEO	VCBO	VCEB	VCES	VCEX	PIB	PVBE
	100MH	100MH	100MA	100MA	100MH	5 0A	5 0A
			100R		-1 5V	1 0V	1 0V
					10R		
UNIT	V	V	V	V	V	MA	V
1	68.4	93	81.5	81.6	83.5	193	1.00
2	72.1	104	86.0	86.0	93.0	192	1.23
3	70.3	99	83.1	83.2	97.6	193	1.27
4	66.6	76	66.6	66.6	66.7	195	1.20
5	43.9	61	52.9	52.9	52.9	191	1.11
6	8.0	70	61.0	61.1	61.0	157	1.07
7	73.5	104	85.9	85.9	93.9	192	1.11
8	59.5	72	67.2	67.3	67.4	193	1.04
9	37.3	46	37.3	37.3	37.3	192	1.15
10	69.6	97	82.3	82.3	95.3	192	1.08
11	37.4	47	37.4	37.4	37.4	193	1.08
12	38.3	58	49.6	52.2	51.9	192	1.12
13	45.3	53	45.3	45.3	45.3	191	1.08
14	51.8	64	56.1	56.1	56.1	191	1.13
15	71.9	100	85.5	85.5	98.9	192	1.10
16	58.5	68	68.8	68.8	68.7	192	1.09
17	68.5	103	82.9	82.9	91.1	176	1.20
18	35.1	42	35.3	35.3	35.3	192	1.03
19	34.4	45	36.5	36.6	36.5	192	1.11
20	68.8	97	79.7	79.8	54.9	198	1.11

	VBEO	VEBO	PVCEO	PVSAT	PVBS	VBEO
	10A	10MA	100MA	5 0A	5 0A	5 00A
			80US	20A	20A	
UNIT	MV	V	V	V	V	V
1	703	7.9	41.0	.89	1.09	1.27
2	747	9.1	46.9	.88	1.24	1.39
3	703	7.5	88.8	.91	1.29	1.43
4	751	7.1	66.4	.92	1.21	1.35
5	700	8.3	25.8	.89	1.12	1.29
6	696	10.0	30.8	.63	1.11	1.31
7	697	7.2	92.5	.88	1.12	1.31
8	696	7.6	64.6	.90	1.05	1.24
9	760	7.9	33.9	.91	1.16	1.29
10	698	8.2	75.2	.88	1.09	1.26
11	752	8.6	35.9	.91	1.09	1.26
12	697	8.1	29.4	.89	1.13	1.30
13	690	7.1	40.8	.87	1.09	1.24
14	696	7.8	47.2	.88	1.14	1.28
15	702	7.7	48.1	.88	1.11	1.27
16	694	7.1	54.1	.89	1.10	1.25
17	761	9.9	40.0	.72	1.23	1.35
18	691	7.0	31.7	.89	1.04	1.22
19	694	9.7	30.7	.89	1.12	1.32
20	703	7.1	80.3	.94	1.12	1.31

64 types on each test program and allows for quantitative data to be gathered for each type. While product is being tested, it is generally possible for a particular device to meet the requirements of several categories, therefore, each test program allows for up to 64 priorities to be established. If a required number of devices has been generated to a specific type, the operator can simply load a new set of priorities to alter the categorization of product being tested.

While the test system is operating, another form of software, called a user program, can be entered and exercised. User programs are FORTRAN programs which can access the data being taken by the test set. User programs can take data while product is being tested and present it in the form prescribed by the operator. It may be output in the form of raw data, statistical summaries or histogram plots. User programs are also generated for calibration and maintenance operations.

The production software operates in a mode referred to as "by-type": each device to be categorized is tested first to the conditions of the highest priority type until it fails to meet a limit. At this time, further testing is aborted for that priority and the next priority type becomes the criteria. If a test has already been performed for a higher priority, its data will be retained rather than retesting in subsequent lower priorities. Testing continues in this manner until all requirements of a specific type are met.

Testing occurs at the device-under-test station on wafers, pellets, and final packages. Testing is performed either manually or with some type of automatic handler. In the wafer testing area, automatic probers equipped with a small platform to hold the wafer under test and a group of fine test probes increment from pellet to pellet, and by means of precision inkers, identify and categorize good and bad pellets. Each wafer can then be data analyzed for purposes of process feedback, final test yield projection, and categorization for expected distribution requirements in the assembly areas. As a result, only wafers best suited to the current marketing requirements are immediately processed.

After pellet separation, devices can be hand probed manually or tested with a pellet handler which can automatically sort and bin each pellet. Wafer and pellet

testing is somewhat limited as to the type of tests and the conditions of tests which may be performed because of the minimal heat sinking ability of an unmounted pellet under high power testing and the fact that some tests are designed to determine the integrity of the pellet inside the final package. However, by eliminating bad pellets at this stage, no further wasted effort or assembly cost is expended on unusable product.

The final product testing areas take greatest advantage of computerized testing. Power semiconductors in their final packaged form take on many configurations which leads to a complex of mechanical adaptations. Manually operated computer stations make use of a universal six-pin-socket receiver which is flush mounted in the counter top. Six contacts are required to each device under test to accommodate Kelvin sensing. Each terminal of the device under test has two connections, one to carry the forcing function and the other as a non-current-carrying measurement contact. Interchangeable sockets for each package configuration can be plugged into the counter-top receiver. This socket flexibility allows for station versatility and no socket repair downtime. Just behind each socket receiver at each station is a small control console which contains a switch used to select the desired test program and a light emitting diode display which identifies the type number of each device tested so that it can be appropriately binned. A series of lights also indicates the testing condition of each individual station. In addition, manual sockets with heating elements and temperature controllers can be employed to provide high-temperature testing. The concept of high-temperature testing without heating elements in which the device under test is heated internally through high power generation in the pellet is being developed for factory testing. This test method allows standard room-temperature testing of the component followed by self-heating to a prescribed temperature followed by more parametric tests, etc.

Automatic mechanical handlers are used for high-volume final testing and type sorting. Several automatic handlers and a SCOPE test system provide a good marriage requiring only minimal attention, primarily in the loading and unloading of product bins. High temperature automatic handlers containing a handling mechanism inside of a

temperature chamber are also incorporated.

## Claims to fame

The first SCOPE testing system was produced in 1969. Since that time improvements have occurred at an increasing rate as a resulting awareness of the system's versatility developed. Improved testing techniques and the constant addition of more and diverse types of measurements have been incorporated. Among the attributes of the family of SCOPE test systems can be included the following:

- A system concept centering on the test board, which is the key to adaptability for factory requirements. Commercial systems are excitation and instrument oriented making hardware modifications inflexible and expensive and limiting the systems to their original power and sensitivity specifications.
- Software operation under an interrupt structure without which on-line data reduction in a factory environment for engineering purposes would be impractical.
- A FORTRAN based compiler which allows user programming without specific knowledge of how the system actually performs the testing.
- The selection of a high speed analog to digital converter as the data gathering mechanism. The traditional time consuming approach of commercial test equipment manufacturers for data logging is successive go-no-go iterative evaluation.
- Simple English language operating commands.
- "By-type" testing to minimize test time and maximize throughput by performing only the least number of tests necessary to classify to the highest priority by use of automatic software branching.
- Ability to apply several hundred tests per program to a device under test.
- Test programs that can sort up to 64 different type categories; these types can be arranged into any priority order by TTY command.
- Software counters which can be opened, closed, purged and read under TTY command for every type and on each test program.
- Up to 32 test stations which can be multiplexed to one test console.
- Photocell controlled manual test sockets for increased throughput by elimination of pushbuttons while still maintaining operator safety.
- Full Kelvin sensing.
- Typical test time for a single parameter is 10 microseconds.
- 2000-volt leakage and breakdown testing capability.
- 200-ampere forward-current testing capability.

Below: this is a TO-5 package automatic handler, also located in a final testing area.



Below: power-transistor test console in final stages of checkout prior to installation on factory floor.



Above (top): in the final package testing area, automatic handlers are connected to SCOPE test systems for high-volume testing. Above (second from top): manual test stations are used for low-volume selections or where handlers are not yet available. Directly above: automatic vacuum-operated multi-probe sockets such as this are used for printed-circuit testing or SCOPE systems.

Above: wafers are aligned on a movable X-Y table by the operator. The probe then automatically indexes from pellet to pellet, testing and categorizing the wafers. Below: automatic pellet handlers like this one are used in the thyristor product line for the testing and sorting of pellets prior to mechanical assembly.

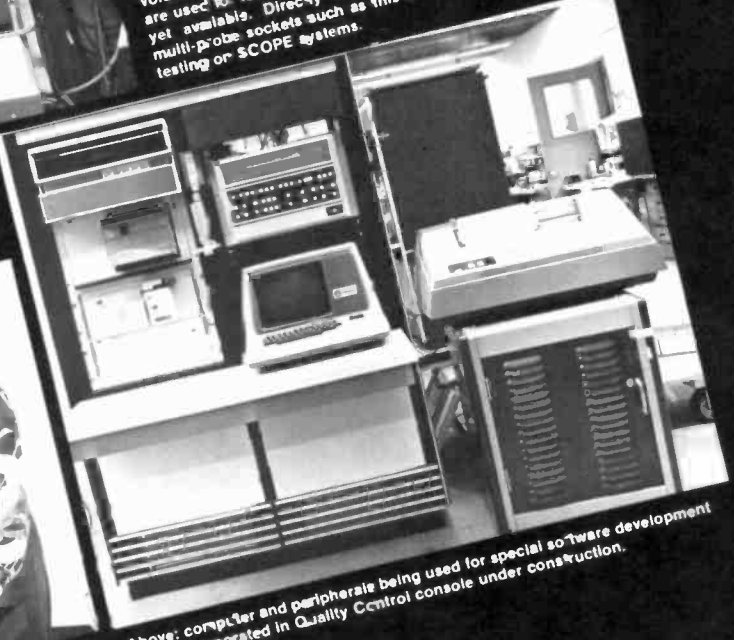

Above: computer and peripherals being used for special software development to be incorporated in Quality Control console under construction.

# SCOPE

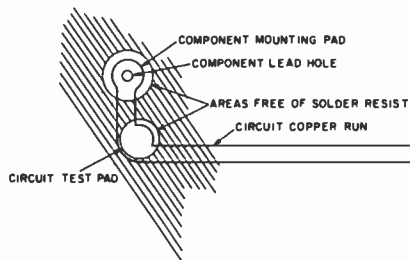

Fig. 4 — Configuration of component mounting holes and test pads.

- High-speed automatic non-destructive IS-B testing capability.
- Automatic ramped high voltage leakage measurement technique which protects even low-voltage product from breakover voltage damage.
- Room and elevated temperature single insertion automatic testing by device under test self heating.

### Variations on a theme

Aside from discrete power semiconductor testing, several SCOPE systems have been modified for multi-pin module testing. This includes power hybrids and printed circuit modules. The testing of this type of product requires parametric measurements on passive components as well as power semiconductors, with a much more complex test-set to device-under-test interface problem.

The test set interfaces with the assembled module at up to 31 test points in the circuit. Since it is advantageous to be able to look at these electrical points in the circuit in a multitude of combinations, the multiplexer makes all points available to all test boards. Also since it is helpful in module repair and diagnosis to perform two- and three-terminal testing, a 3- by 31-pin testing matrix is used to enable each test board to access any node directly through the multiplexer or indirectly through the matrix. The test probes are part of a vacuum-operated mechanical prober which can simultaneously probe all circuit nodes on the copper side of the printed circuit board. A number of steps are taken to ensure reliable operation of this method.

First, a suitable target is provided for each test probe. To avoid probe deflection and poor contact to the circuit board, separate test pads are provided for each circuit node, as shown in Fig. 4. The test pads consist of a blank copper pad coated with solder, as shown in Fig. 5. This type of test pad, which can be easily integrated into the printed circuit board layout with essentially no increase in

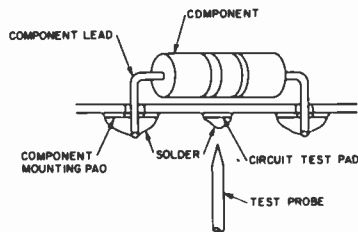
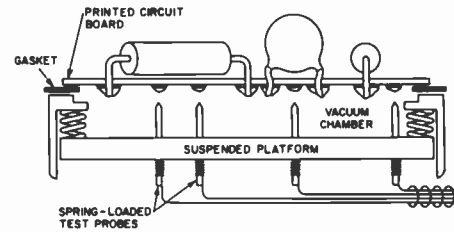

Fig. 5 (above left) — Arrangement of component, test pads, and test probe. Fig. 6 (above right) — Circuit board and test system.



overall cost, provides a reliable circuit contact and a considerable reduction in the necessity for retesting modules rejected for misprobe. The finely pointed and hardened probes that mate with this soft target are spring loaded and suspended in a platform which moves up to make contact with the printed circuit board when vacuum is applied, Fig. 6.

In laying out the test pads, care is given to the maximum deviation of the test probe from its center, printed circuit board inaccuracy, and module alignment with the test fixture. In general, test pads are made as large as possible and located so as to minimize bridging to adjacent copper. Solder resist is used primarily in areas most susceptible to bridging, and is enlarged as much as possible around component mounting pads and test pads. Once a successful contact is made to the circuit board by all test probes, module testing may begin. Some additional advances as a result of module testing include:

- Adaptation of a basic three-lead device testing system to a multi-pin circuit module tester.
- Capacitance measurement using a single pulse as opposed to cumbersome and slow ac techniques.
- Development of an electronic rolling technique to enable components connected to multiple circuit nodes to be measured independently.
- Multiple digital signal output conversion to single analog reading for improved sequential logic testing speed.

### Is this utopia?

Power semiconductor testing is emerging from the dark ages. In the past, primarily because of the high-power levels and critical timing requirements, most power transistor tests were performed on unique pieces of test equipment requiring separate insertions for each parameter. The SCOPE computer controlled testing concept consolidated most of the standard and many of the specialized testing requirements into a high-speed, non-

destructive, single-insertion means of categorizing power semiconductors. It also enabled the use of mass data accumulation and manipulation for improved product visibility.

The types of tests remaining which must still be performed with separate insertions are predominately long duration tests or those impractical for multiplexed testing techniques. The next test-set generation should minimize the majority of these difficulties.

The microprocessor is the next generation of test technology. With it the present minicomputer that controls a hardware-multiplexed test set can be replaced with intelligent test sets which multiplex through software to a minicomputer. The minicomputer role is, then, to supervise rather than operate the test stations. Intelligent stations can now be tailored to test a more narrow range of product with a wider test capability. A single minicomputer will be able to oversee the operation of a large number of intelligent stations and will be freed for use in feeding back information to process control and marketing functions.

Test stations can now act as stand alone testing functions with calculating and decision making abilities. These testing stations may be grouped to an automatic handling mechanism with multiple testing locations for increased throughput. The possibilities are endless and the future holds a challenge for the designer who keeps abreast of the state of the art.

### Acknowledgment

The development of a family of testing systems of this nature is the product of many minds and hands. Particular acknowledgment goes to Hal Ronan for his multitude of technical breakthroughs, and to Vince Grobe for providing the environment; and most importantly to Al Parsons, the originator and pioneer of the SCOPE test system.



# Impressions of technology in China

Dr. J. Hillier

*Editor's Note:* Dr. Hillier, Executive Vice President for RCA Research and Engineering, completed an 11-day visit to the People's Republic of China (PRC) in July 1975. He was a member of a 10-man delegation of Electronic Industries Association executives touring electronics facilities in that country. In this article, Dr. Hillier shares with our readers brief excerpts from portions of his daily diary relating to the PRC technical centers visited. Dr. Hillier's observations and impressions of Chinese technology, including a few suggestions on doing business with the PRC are included herein. For information on Dr. Hillier's observations on the social aspects in the PRC, the readers are referred to the article "China Diary" in the Oct/Nov 1975 issue of *RCA Communicate*.

Dr. James Hillier, Executive Vice President, Research and Engineering, RCA, Princeton, N.J. studied at the University of Toronto, where he received a BA in Mathematics and Physics in 1937, MA in Physics in 1938, and PhD in Physics in 1941. Between 1937 and 1940, while Dr. Hillier was a research assistant at the University of Toronto, he and a colleague, Albert Prebus, designed and built the first successful high-resolution electron microscope in the Western Hemisphere. Following this achievement, Dr. Hillier joined RCA in 1940 as a research physicist at Camden, N.J. Working with a group under the direction of Dr. V.K. Zworykin, Dr. Hillier designed the first commercial electron microscope to be made available in the United States. In 1953, he was appointed Director of the Research Department of Melpar, Inc. returning to RCA a year later to become Administrative Engineer, Research and Engineering. In 1955, he was appointed Chief Engineer, RCA Industrial Electronic Products. In 1957, he returned to RCA Laboratories as General Manager and a year later was elected Vice President. He was Vice President, RCA Research and Engineering, in 1968, and in January 1969 he was appointed to his present position. Dr. Hillier has written more than 100 technical papers and has been issued 40 U.S. patents. He is a Fellow of the American Physical Society, the AAAS, the IEEE, and Eminent Member of Eta Kappa Nu, a past president of the Electron Microscope Society of America, and a member of Sigma Xi. He served on the Governing Board of the American Institute of Physics during 1964, 65. He has served on the New Jersey Higher Education Committee and as Chairman of the Advisory Council of the Department of Electrical Engineering of Princeton University. Dr. Hillier was a member of the Commerce Technical Advisory Board of the U.S. Department of Commerce for five years. He was elected a member of the National Academy of Engineering in 1967.

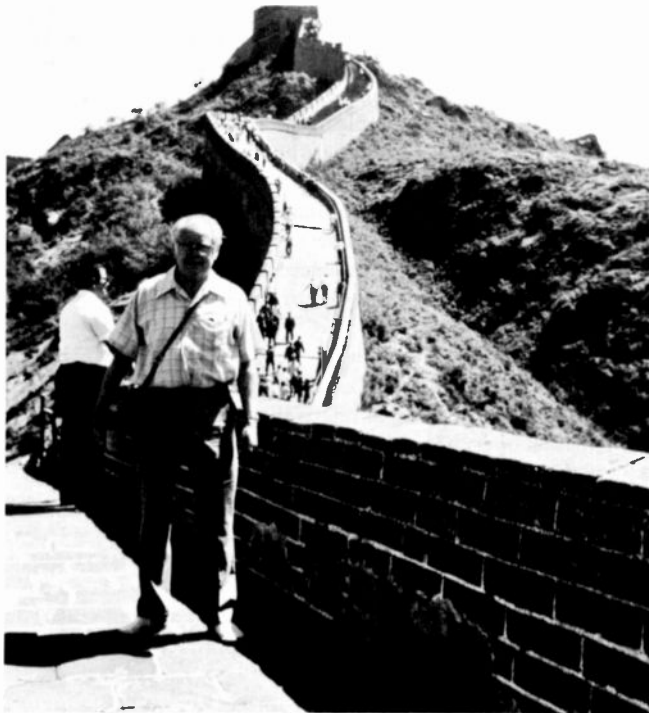

The author near one portion of the 4000-mile Great Wall.

ONE DOES NOT VISIT the People's Republic of China (PRC) without an invitation from the Chinese; this was true in our case. However, the initiative for obtaining such an invitation was taken by the Communications Division of the Electronic Industries Association.

Our Chinese host group was the Machinery Import Export (MACHIMPEX) Corporation, one of several state corporations responsible for all trade between the People's Republic and the rest of the world. More specifically, Import Dept. 4 of Machimpex (which handles all imports of electrical and electronic equipment—and instruments) was our principal point of contact; this Department scheduled our visits while in China.

During our 11-day visit to the PRC, we observed many different kinds of facilities. Formal visits included an institute of technology, a semiconductor research institute, the Central Meteorological Observatory in Peking, the Shanghai Permanent Industrial Exhibition, three electronics manufacturing plants making radio and television transmitters, teletype equipment, telephone carrier equipment, desk calculators and small and medium computers.

## PRC economy and trade policies

Although the PRC appears to be self-sufficient with regard to growing enough food for its population in good crop years—continuation of an adequate food supply for a growing population becomes the central critical theme of the PRC policies; thus, agricultural self-sufficiency is accorded the highest priority. Accordingly, industry is directed to the improvement of agriculture through the production of machinery and chemicals.

Foreign trade includes the acquisition of critical raw materials for production operations and the purchase of food (if needed). The policy is to buy only those items that are critically needed to continue the development of the Chinese economy and those materials and devices required in advance to enable the "start-up" of PRC development and production which can subsequently become self-sufficient. Generally, such purchases fall into four main fields: communications, transportation, electric power and production.

## Research, development and production

The research we witnessed could be described more accurately as development, involving the duplication of known accomplishments of Western research. Such research or development is apparently executed as an educational exercise to learn how to diffuse the knowledge

Reprint RE-2'-5-21. Final manuscript received November 5, 1975.



In a figurine factory in Wu Xi, a girl is painting one part of a small figurine.

and introduce it into production.

The diffusion of knowledge is an integral part of the PRC policy of self-reliance. In theory, there is a built-in compounding that ultimately could have the effect of rapidly accelerating Chinese industrialization.

Concerning the status of PRC technology and production, my observations and impressions must be considered preliminary and tentative. Nevertheless, some observations seem to be consistent—the overwhelming dependence on hand-work, hand-fitting, the absence of intermediate inspection steps, the absence of jigs and fixtures, the absence of mechanical and visual aids, and the mystifying work-flow patterns.

Many integrated circuits are incorporated in production and development equipment. Such IC's are all made in China, apparently produced in quite large quantities. The solid-state devices produced are mainly transistor-transistor logic and P-type metal oxide semiconductor (P-MOS)—and relatively simple circuits of one to few gates. It requires about 100 such devices to make a simple 12-digit four-function desk calculator.

We observed the demonstration of several computers using integrated circuits; the computers were all scientific type machines. The largest computer was capable of a million operations per second with 2 microsecond access time to a 128-k core memory with forty-eight-bit words. The more popular computer provided 110,000 operations/s, a 32-k memory and used 48-bit words. In the areas of research and development, we also saw integrated circuit studies primarily directed to developing the technology of large-scale integration. A computer-controlled machine was used to make masks for large-scale integrated circuits; this was the most advanced setup shown.

We visited several electronics factories and gained a strong impression that they were overreaching their capabilities in trying to put high technology into production. This raised the question as to whether the approach was deliberate, in

order to force attention on the problems, or simply the result of an unawareness of the infrastructure necessary to keep both the throughput and the complexity on positive trends.

### Daily-diary excerpts

Perhaps it will be instructive to the RCA ENGINEER readers in gaining their own impressions, to share with them *daily-diary excerpts* from some of our visits to certain points of interest—selecting only those having some relationship to technical topics:

- First meeting at MACHIMPEX
- Transmitter plant
- Qinghua University
- Seminar at MACHIMPEX
- Semiconductor Research Institute
- Central Meteorological Observatory
- Shanghai Permanent Industrial Exhibition
- Telephone Carrier Equipment Plant
- Computer Manufacturing Plant

---

### First meeting at MACHIMPEX

At MACHIMPEX (about 20 minutes from our hotel) there was very little delay in ushering us into a large conference room furnished by a number of stuffed chairs and sofas that surrounded the room. Shortly after we were seated, Cheng Chi-hsien, Deputy Managing Director of MACHIMPEX, entered with a retinue consisting of several of the people who had greeted us at the airport. We were handed a duplicate list of the people in the meeting room. My copy promptly faded but I succeeded in recording most of the names. In addition to Mr. Cheng there were seven or more managers and interpreters. A Mr. Han was listed as "Staff Interpreter." He played that role throughout our visit. Later he visited the United States as a member of a trade delegation from China. Then he was listed as Deputy Manager, Instruments and Telecommunications, confirming our suspicions that he had greater responsibilities than had been indicated to us.

The meeting opened with greetings, welcomes and small talk regarding how we traveled. Chinese tea was served continuously. Cheng (Deputy Manager) announced that he wanted us to see as much as possible in China in order to *begin* to understand them.

In response to a question, we were given a rundown of the function of their Import Departments. The head office of MACHIMPEX in Peking is relatively small, about 500 people. The policy of operation was described to us in part. Two or three key points were new to me. MACHIMPEX deals with exports and imports only but is only one of two organizations that import machinery and instruments. The other organization was not identified until several days later. The import activity is in reality a purchasing department for the state. The originator of a requirement is the "end user"; requirements are submitted to MACHIMPEX only after the state has approved the purchase.

However, MACHIMPEX can and does work closely with the end

user to advise what is available and to assist in making a selection that will meet the needs. When the end user is not sure how to satisfy a requirement, "friends" from abroad are invited to "clarify specifications". As a result, there are large numbers of invited visits (100-200 per day) of which 50% are concerned with technical services while the other 50% are concerned with technical specifications and discussions. A special point was made regarding the existence of "friends" in many countries, including those where the governmental relations with China had "artificial barriers". The import and export departments of MACHIMPEX seemed to have little communication with each other.

Following this introduction, we were handed copies of an itinerary (it did not fade). In response to questions, we indicated the desire to see specific installations mostly in the telephone switching and transmitting equipment area. Notes were made but there was no commitment. We made known our disappointment regarding large amounts of sight-seeing relative to a few technical visits. Nevertheless, while the basic itinerary was followed, the technical visits desired by the majority of our group were inserted.

## The Peking broadcast transmitter plant

We went to an old looking complex of buildings in North Peking. After passing a guard house, we went into an open area that had a large statue of Chairman Mao plus a large red billboard displaying one of his quotations. We were ushered into a drab second-floor conference room with a long conventional table and two rows of chairs. We were introduced to a Mr. Hsu who was identified as the Deputy Chairman of the Revolutionary Committee of the plant. He quickly introduced a number of people, mostly engineering managers. Mr. Hsu gave us a brief story of the plant which has a thirty-year history. Before liberation, it had about 100 people who assembled radios from imported components. After liberation, development had been rapid, now requiring 4,000 workers to fulfill production targets.

Since the beginning of liberation, low-power radio transmitters were produced. Later, the product grew bigger and quality improved. Now, transmitters of many sizes are produced for many applications. Furthermore, all components are made in China. The highest power is a 700-kW shortwave transmitter! The factory produces several transmitters for hf and ssb telecommunications, a.m./f.m. transmitters, and tv transmitters in 1, 10, and 40 kW sizes (all less than 300 MHz).

The organization was described as consisting of a Chairman and Vice Chairman of the Revolutionary Committee. The committee had 25 members and included representation from all levels elected by the staff, including workers. Below the Revolutionary Committee there appeared to be two levels of management, designated as "group" and "workshop." The organization included 400 technical people.

We were next ushered into a large factory floor that reminded me of Camden of thirty years ago. The space was partitioned down the middle by a row of steel cabinets with open empty shelves over which had been draped a semitransparent light blue cloth material. We were not taken behind the partition. In front of the draped cabinets were rows of simple tables covering an area of about 50 × 200 feet. The tables (work benches) were covered with



Preliminary to Chinese Banquet: Glen Solomon, head of EIA delegation (with camera) is shown with Mr. Hsu (at his left) and Mr. Chang (on his right) plus several key managers from MACHIMPEX.

very clean paper and were brightly lit. About 150 men and women workers were at the tables assembling transmitter sub-assemblies. An amazing variety of tasks was being performed from inserting and soldering components in PC boards—to the final assembly of entire units that obviously fitted transmitter racks. There seemed to be no rhyme or reason to the work flow.

While one-sided printed circuits were used, the density of components was low and hand-soldering of components seemed to be standard. There were a number of strange unidentifiable components; others were cleaned up versions of old technology. One was a three-gang variometer made with windings of what looked like silver-plated wire wound on white ceramic rotors. The workmanship looked good. There were a number of discrete transistors on the boards we saw.

Next we moved past the working group into an area where a number of transmitters were set up for testing. We were shown a 40kW tv transmitter and a 400 kW high-frequency ssb telecommunications transmitter. Few of the transmitters had the final amplifier tubes in them. Only one, a 400-kW transmitter, was being tested but not at anything near full power. The meters indicated about 4-kW. We were told that water vapor cooling was used for the final amplifier tubes; the high-power hf transmitter used "line tuning". This area had *none* of the normal work clutter that one would expect to see in a test operation.

Following this, we were taken to another part of the plant through a machine shop where many fittings were being made on old simple lathes and milling machines. We were taken into a room that was no more than 25 × 25 feet. This was drab and dimly lit. It had two rows of work tables at which about 15 men and women were doing various tasks. Again, there was no pattern to the tasks. One pair of workers was trimming excess gasket material from around a window used in the front of a transmitter cabinet. Another was cleaning glass covers and mounting them on pressure stats. Still another was assembling some type of thermostatic device in a small thermal vacuum bottle. In the middle of this, a pair was threading small holes in some aluminum

cooling vane assemblies and deburring the fins with a hand file. All work pieces in the room were on the tables. There was no indication of any work flow. The room was completely devoid of any sign of work clutter.

It was obvious that everything had been staged for our benefit, except the test area. At first, I was confused and annoyed. However, after several visits my reaction become much more charitable—and I now believe what we saw was an honest representation of the operation in the plant. However, for reasons of pride and efficiency, they had chosen to set up the demonstrations so we could see them quickly without wandering all over a 4,000-man plant, scattered in many small and old buildings.

When we returned to the conference room for the concluding session, there were a number of questions from both sides. The Chinese were anxious to know the size of the highest power transmitter made in the United States. They were informed that the companies represented in our group do not manufacture hf transmitters for telecommunications purposes. We also explained that the trend was to achieve high power by combining smaller units to achieve economy and because it provided redundancy and continuity of service at lower power when one unit failed. This was not fully understood. We learned that tv studio equipment and tv receivers are made in other and separate plants in Peking but were given no details. The plant we visited was reported to be the largest of three or four similar plants in China.

After the visit to Shanghai where I had a working shortwave radio in my room, it occurred to me that the very-high-power hf transmitters were made for jamming purposes. While the Voice of America, the BBC and Australian stations were not jammed (few people in China understand English), a large number of stations in the shortwave bands were being jammed with extremely strong signals.

## Visit to Qinghua University

Qinghua University is a large installation having several large buildings in northern outskirts of Peking. We entered a very large room containing two long rows of overstuffed chairs and sofas facing each other. We were introduced to a Mr. Ma who was identified as the "Responsible Member"; we presumed him to be the member of the Revolutionary Committee who had been given the responsibilities of managing the University.

Mr. Ma introduced Professors Wu and Lee of the Department of Electronics, a Mr. Doc of the Revolutionary Committee, Teacher Lee of the Industrial Automation Department (female) and Student Fu (also female). The University was founded in 1911 and was a school of science and technology. It included, among others, departments of Mechanical Engineering, Industrial Automation, Electronics, Electric Power and Precision Instruments. There are 11 departments in all with 54 specialties. The faculty consisted of 3,000 teachers and 8,000 students. The enrollment increases to 11,000 in the fall.

### Educational system in China

At this point Mr. Ma launched into an ideological description of

the educational system in China and at this University in particular. This was the most lucid and complete description we received. There were many further allusions to this system in the course of our trip. Quoting from Mr. Ma:

*Before the Cultural Revolution the aim of the education system in China was, like in the Soviet Union, not to serve the workers but to train people to be officials "and to be rich". The students, also like the Soviet Union, did not like to go to the factories or the farms for fear of retrogressing. Now, there has been an educational revolution in which the educational system is trying to serve all the people. The educational system must open the door for the whole society to be able to cultivate proletarian successors. Successors must rely on workers and peasants as well as teachers.*

*They have "improved" enrollment and teaching. The students come not from middle school only but from peasants, workers and soldiers, and all have work experience. There is a process by which peasants, workers and soldiers participate in the selection of students for the University. The curriculum must combine theory and practice. It involves three years of study and is established to be uniform all over China. There are now four standards that must be met before a student is accepted:*

- 1) *The student must be "oriented" to serving the people.*
- 2) *Must have two years of work experience.*
- 3) *Must have a middle school education.*
- 4) *Must be healthy.*

*Before the Cultural Revolution, the University did not pay attention to service to the workers and therefore tended to develop a new bourgeoisie. During their studies, students now go to farms where they work in the fields. An organization was established in the University that combines teaching, science, research and production. Twenty-five small factories are part of the University. They produce fifty products. The University also has 80 research projects in which the students participate as they acquire scientific book knowledge. [Mr. Ma used as an example the development of a step-and-repeat camera and several computers.] The students with this knowledge are expected to go into work situations where they will diffuse their knowledge as rapidly as possible.*

*Examination procedures have also been restructured. The examination questions are derived from current research and production problems rather than from texts. The examinations are open book and open discussion sessions. The student is rated on the basis of his analysis of the problem.*

The University has other operating modes in place. There is a branch that provides practical training. There is also a spare time school attended by factory workers of Peking. Students will also "do research" for local plants. Some become teachers in the countryside. He pointed out that one basic concept in this system is to make sure that there is no difference in status of mental and manual work (In several subsequent visits I began to believe that the last sentence might be a simplistic translation. It was clear that technical competence is valued and results in relatively high salaries—even more than many general managers. On the other hand there seems to be a real effort to prevent the formation of an intelligentsia or any other elitist group).

### Semiconductor research

On the tour we visited the semiconductor research activities dedicated to large scale integration. We first went into a small room where four or five girls were bonding IC's (with aluminum wire). Here, there was some staging; each girl seemed to have only one or two circuits and they were all different. There was a 128-stage shift register, a circuit that was claimed to have 1000 transistors. However, we were not shown where or how they were produced. The circuits shown were all P-MOS. In response to a question we were told that Qinghua was also working with TTL,  $1^2L$ , and DTL. However, much to my surprise none of the group appeared to have heard of charge-coupled devices (CCD).

We were shown a homemade ion implantation machine purported to be 100 kV. We could hardly believe this; the insulation was not sufficient and moreover the voltmeter had a full scale reading of 30 kV.

### Machine shop

From the semiconductor area we went to a machine shop described as one of the small factories. It was an area of about 10,000 square feet in which there were many old-fashioned manually operated lathes and milling machines. There were also several types of gear-hogging machines. This was obviously an operating shop. We were told that parts of milling machines were being made there. From the work pieces and new parts lying around I believe it would be more complete and accurate to say that they were refurbishing the spindle heads of conventional milling machines. There were large numbers of obviously used heads piled around. The production parts appeared to be primarily stepped spindles and several types of gears. In the back of this shop we were shown two milling machines, one large, one small, that had electronic consoles; these were described as research projects on numerically controlled machines.

### Library

The final visit at the University was to the library where we met a delightful stereotype of an old-fashioned Chinese librarian. He proudly showed us two enormous reading rooms, empty at this point because of vacations, and a number of small ones in which several people were working. In addition to the ubiquitous racks of Mao teaching and current propaganda, he showed us that he had most of the technical journals from the rest of the world. However, wherever I was able to see what was being read by the people in the reading rooms, it was always in Chinese.

The librarian then took us back of the book shelves where some of his 3000-year-old special treasures were laid out on a row of tables. Outstanding among these was a set of bone inscriptions—the oldest evidence of Chinese civilization I have ever seen. There were also examples of calligraphy from a mammoth encyclopedia of Chinese knowledge that was written hundreds of years ago.

### Research programs

After the library visit, we returned to the large conference room for final discussion (and more tea). The only new information that came out at this session concerned the method of determining the research program; the program seemed to have three parts:

- 1) A part determined by the State.
- 2) A part that is research done jointly with factories (also presumably controlled by the State).
- 3) A part that was discretionary on the part of the University.

The program is definitely all applied research. Related basic research is done by the Scientific Academy. However, basic or pure research is also combined with relevant production. Unfortunately, this last comment was not explained further. The programs in Qinghua University and in the factories associated with it were considered as trial production; if successful, the production would go into regular Peking factories.

Mr. Ma made the point that his goal is in accordance with the teachings of Mao to increase output from the factories so that the University would be completely self-supporting.

### Seminar at MACHIMPEX

We were taken to MACHIMPEX (to an outbuilding labeled "Meeting Rooms" in English) where 33 Chinese were assembled. The plan was for the whole group to meet for introduction and welcome and then to separate into two groups—telephone and telecommunications (when the group used the term "telecommunications" I learned that they used it strictly for communications *other* than the telephone, telex or data communications; on the other hand, earth stations appeared to be considered as telecommunications). The groups were separated with the telephone group going to another room with about 15 of the Chinese including Mr. Hsu. Before he left, Mr. Hsu made a point of greeting me as though to apologize for not being able to be in two places at once. I took the opportunity to give him a complete set of the brochures on broadcast equipment. Campobasso, Gifford, Johnson, and I stayed with Sodolski who acted as moderator for the following talks:

- Campobasso covered microwave systems for use in private systems, railroads, and pipelines, and earth stations.
- Gifford covered power line carrier systems and teletype equipment.
- Johnson covered the mobile line of his company, including Citizen's band and their applications.
- I covered the broadcast equipment area and the RCA domestic satellite.



The official delegation of EIA executives (l to r): J.T. West of Western Electric; Dr. Hillier of RCA; R. Sanders of GTE; E.F. Johnson of E.F. Johnson Co.; J. Redmond of General Dynamics; R.P. Gifford of General Electric; John Sodolski representing EIA; and T.A. Campobasso of Collins Radio, Rockwell International; Glen Solomon (IBM) of EIA Board of Governors and head of the delegation is taking the picture. Lynn Ellis of ITT was not present.

## Semiconductor Research Institute

We went a short distance north of the hotel to an old area of Peking where the Semiconductor Research Institute is located. We were welcomed with tea and cigarettes by a Mr. Liu who told us that the Semiconductor Research Institute was under the Academy of Sciences and was established in 1960. The total staff is 900 of which 400 are research workers; others are staff and workers. The work is distributed in several 4- and 5-story buildings, some of which were converted dormitories.

The Director of the organization heads a Party Committee but experimental work is determined by department heads with approvals. The Institute is divided organizationally into seven departments:

- 1) Materials Science—studying silicon, gallium-arsenide, gallium-hosphide.
- 2) Integrated Circuits and Hybrids—emphasis on LSI processing—they do not make masks for factories but do for tests).
- 3) Reliability of IC's.
- 4) MOS.
- 5) Microwave Semiconductors.
- 6) Instrumentation for all Departments.
- 7) Semiconductor Laser.

In addition there is a small factory (or model shop) to process mechanical parts for all departments. For the past 15 years, emphasis has been on self-reliance (or self-sufficiency). Therefore, most instruments are homemade; a few instruments are imported (we noticed one or two from Hungary).

Mr. Chen was to guide us through the laboratories. We were told that we would be shown work on Impatt diodes, mixer diodes, Gunn effect, S/C laser measurement, and materials.

We were taken first to the microwave solid-state devices laboratory where we were shown some apparatus supposed to be testing the power conversion loss and noise characteristics of a Schottky mixer diode. The microwave plumbing was quite conventional—I learned later that it was Japanese. There was a local oscillator with an attenuator and a noise source feeding to the diode. The noise source was a homemade apparatus with a microwave switch feeding a stub line or detector. There were two chart recorders on which previously made charts were left. The pens were lifted on both recorders and were moving in some way that was not explained. One was supposed to be power and the other a noise measurement. The power handling capability of the diode was stated to be 50 mW.

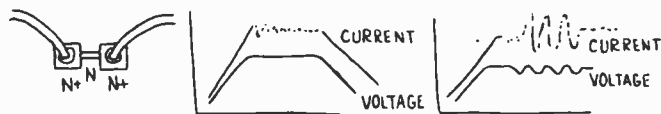

Traces were observed (center) on a sampling scope of an Impatt or Gunn-effect diode (left). An onset of avalanche effect (right) was to occur with increased voltage.

The second laboratory had what was described as an Impatt diode but later seemed to be Gunn-effect diode. We were shown the device under a microscope and observed traces on a sampling scope. When the voltage was raised there was supposed to be the

onset of an avalanche effect. They claimed that it was working at 200 MHz but could go to 2 GHz.

The next stop was the Materials Research where we were shown apparatus for making "dislocation free" GaAs. The apparatus consisted of a tube (quartz) of two diameters. The larger diameter contained a boat (of quartz) in which there was some gallium. The smaller tube contained broken pieces of arsenic. The materials were claimed to have purities of 0.01 ppm. These were heated to 450°C and 610°C respectively to react on a seed crystal introduced; the dislocation free GaAs was produced by moving the oven along the tube. They claimed electron densities of  $1 \times 10^{15}$  and electron mobilities of 7000 at 300K and 30,000 at 80K.



The smaller tube contained broken pieces of arsenic.

We were shown an epitaxial reactor using dry ( $-70^\circ\text{C}$  dewpoint) Hydrogen  $\text{AsCl}_3$  under controlled temperatures (not indicated). The apparatus looked crude and actually not used. They did not explain the Ga source or show us how the GaAs substrate was placed. Samples of the epitaxial layers seemed to be put on the natural surface of the original crystal. We were shown what was claimed to be a diffusion source that gave greater uniformity of diffusion for GaAs. The translation became impossible at this point so I am not really sure of what we were being shown. The main point appeared to be the use of an "arsenosilica" film.

We were shown a computer said to be homemade and used for computer aided design. The computer had boards on which were placed a number of ceramic packaged IC's—but judging from the number of leads these could only have been the simplest of circuits. The computer had a speed of 100,000 operations per second and an 18-k memory (24 bits per word). Its outputs were 5- and 7-hole paper tapes and a numerical printer (about 20-column). It became evident later that this machine was producing paper tape to control a mask-making machine based on what they called the "building block system". The machine was a reducing projector in which a selected "building block" on a custom master was moved into a specified position in the projector. The mask being exposed was on an x-y table also positioned accurately before the exposure was made by flashing a discharge type of lamp. All functions in this machine were under control of the computer-generated paper tape.

Although we were shown mask-making apparatus, we did not see an actual picture, mask or other indication of the type of integrated circuits being developed.

## National Meteorological Observatory

We were taken to the National Meteorological Observatory where a Mr. Lee, the Director of the Observatory, welcomed us and briefed us on the operation. The task of the central office of the National Meteorological Service is the large-scale forecasting for all China with special emphasis on disaster warnings. There is an emphasis on communications since global meteorological



information is collected, plotted and redistributed through this office. Since 1970, there has been an automatic picture transmission system in operation for the facsimile transmission of weather maps. In addition, this office has equipment to receive pictures from the ESSA 3 and 4, and the NOAA-8 weather satellites. These cloud pictures were used as one of the tools in forecasting. High-frequency radio and wire lines still provide the backbone of the communications system.

Mr. Lee pointed out that China is a developing country—a member of the Third World and that, in spite of their many developments in their field, China does not meet the needs of their national defense and economy. He feels, in comparison with other parts of the world, their facility is “backward”. (By now I was expecting that we were to be impressed—and we were.)

We were taken first to some large rooms where a large battery of old and slow teletype machines (with paper tape punches) were bringing in weather data from some 200 reporting stations in China and from a number of other countries by radio or wire. The operators were retransmitting the data to forecasting centers around the country. The same information was used to plot weather maps for all of China in the central office (we were not shown this operation). Maps were distributed in China by facsimile. Frequency shift keying, approximately 1000Hz to 2000Hz, was used to transmit a map in 21 minutes. In the facsimile room, we were shown some new single-sideband receivers (all solid state) that gave four channels of frequency shift keying at each frequency. We were shown also a new facsimile printer made in China—all solid state. (We were not shown this equipment in operation).

In another room, we were shown the equipment for receiving cloud pictures from weather satellites. This consisted of three receivers and three drum photo-recorders, all of Chinese manufacture. These looked very workmanlike and compact.

The final visit was to the computer room where we saw a typical computer made in China. This machine was described as doing 70,000 operations/s and having a memory of 32-k with 48-bit words. They claimed to require 30 programmers and to use ALGOL-60 as the language. The room had a row of five standard

racks that were kept closed. There were four smaller cabinets that had large drums associated with them. Two of the drums were connected and apparently operating. The other two drums were not connected; the drums were about 18 inches in diameter by 24 inches high. This was the only type of drum we saw on any of our visits in China. As far as I could tell, the computer was used exclusively for massaging the weather data into a pressure isobar map.

## Shanghai permanent industrial exhibition

The Shanghai permanent industrial exhibition contained a rather complete representation of all the types of products made in the Shanghai region. It was in a complex of fairly modern large buildings near the downtown area of Shanghai. The buildings covered about 100,000 square feet and contained two more or less independent exhibits—industrial and consumer products. The buildings were on a grand scale but austere and plain. Even discounting the fact that this was a showplace exhibiting products at the leading edge of the PRC's capabilities, it was still very impressive. In the machine tool area—size, precision, and automation were being stressed. Selected exhibits that impressed me were:

- A precision-gear grinding machine for spur gears up to two meters in diameter.
- Several numerically controlled machines including an 8-bit lathe, a milling machine with 53 cutters in a lazy susan that were removed, placed in the spindle and returned on command.
- Several large presses — a 250-ton press for large, powder metallurgy parts, a 30-ton punch press, and a 12,000-ton forging press.
- A pantograph-controlled, precision-spark-etching machine for cutting complex patterns in thick steel plate.

Part of the exhibit was dedicated to indicating their accomplishments in shipbuilding area. By models, they made the point that 38 ships—cargo and tankers—of over 10,000 tons load capacity had been built in Shanghai since Liberation. Included were samples of electromechanical and electronic marine gear such as automatic helms and radar (40-mile range). In another section there were large numbers of examples of textile machines



Consumer Electronics Exhibit at the Shanghai Permanent Industrial Exhibition. A mixture of monochrome television sets, transistor radios and multiband tube radios were shown.



The computer exhibit at the Shanghai Permanent Industrial Exhibition.

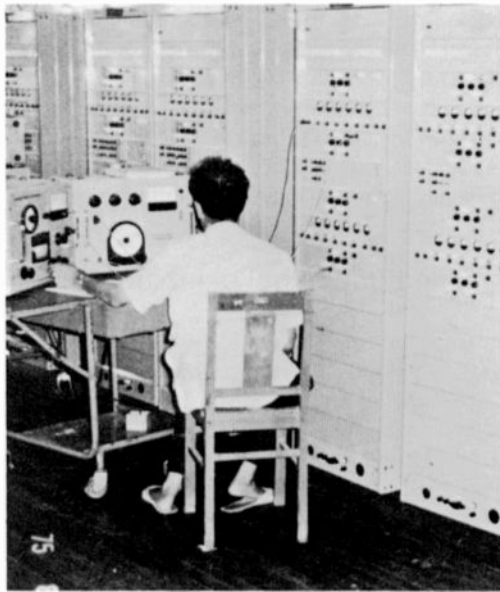

Final test of racks of telephone communication equipment at a factory in Shanghai (photo by courtesy of J. West).

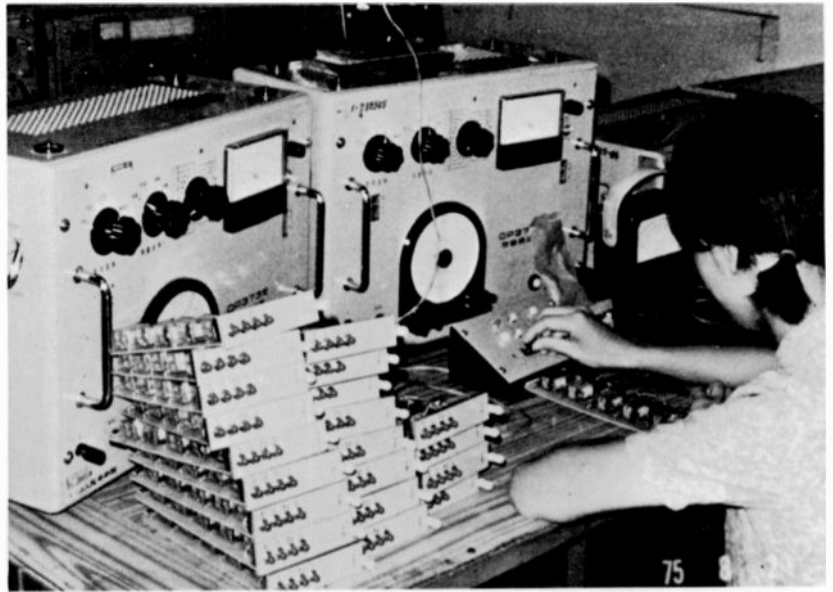

Testing modules for telephone carrier equipment at a factory in Shanghai (photo by courtesy of J.T. West, Western Electric).

including several automatic loom and knitting machines. Another exhibit had many working models of different types of automotive and diesel powered equipment. Hand farming tractors, automatic rice-planting equipment, diggers and front-end loaders, large dump trucks, large and small trucks, busses and automobiles are examples.

There was an electronics section with computers, measuring equipment, oscilloscopes and medical electronics (including a large isotope scanner that plotted the results in color). The electronic home instruments consisted of transistor radios, black-and-white television, large shortwave radios like the one in my hotel room and some audio components. Some "see yourself" black-and-white cameras and monitors were set up in various parts of this exhibit.

All in all, this exhibition was very worthwhile. Even after appropriate discounting it still is clear that the PRC is developing a solid and diversified industrial base that must be factored into any consideration of future trends in world trade.

### Telephone carrier equipment plant

A Mr. Cheng, who was Deputy Director of the Carrier Plant (I suspect a subdivision of the total plant), was the chairman. The plant had 300,000 square feet with 2,000 workers. There was an additional 100,000 square feet for dormitories. Mr. Chen was in effect the Chief Engineer and a Mr. Tu, the Manufacturing Manager. Most of the other people in the room seemed to be technical, including several women.

Our first visit was to a shop making parts and material subassemblies for teletype machines. Without question, this was a real operating plant. There was a great variety of lathes, milling machines and grinders in operation. In the quick walk through, it was not possible to get any feel for the organization of the shop or the work flow (the impression, however, was that there was little organization to the work flow). The final product was a slow teletype machine of about 1940 vintage. At the end of this tour we were shown an operating unit of a more modern machine that was

described as semielectronic and operated at variable speeds from 50 to 100 baud. It had a paper tape punch attachment.

We were then taken through the carrier equipment factory. This appeared to be primarily the assembly and alignment of modules for carrier-type telephone systems. These were assembled in large racks as repeater or terminal stations. There appeared to be a 12-channel system for open-wire lines and 60-channel systems for cable. The final test location was emphasized.

Superficially, this all seemed very similar to many plants I have visited in RCA in Broadcast Equipment. However, there were several indications that things were not well in this plant (the throughput was very low).

At the concluding tea ceremony, we learned that all the components in the carrier systems were made in China. Capacitors, coils, printed boards and ferrites were made in this plant. Transistors, resistors and relays were made in other plants. The Chinese asked if our more modern designs of teletypewriters could have less mechanical complexity. They were told that whenever possible mechanical functions were replaced by electronics and where mechanics were necessary there were many methods of both lowering cost and increasing reproducibility and reliability. The use of die-casting and of powder metallurgy technology instead of hand machining were given as examples. In another part of this discussion the telephone experts in our group indicated that carrier systems—particularly the 60-channel variety—were no longer made in the U.S. This was largely due to the excessive labor required to balance the circuits at installation.

In the course of this visit and discussion, I began to wonder if the manufacturing process in China was limited by the excessive number of hand operations, the concomitant human errors that occur in series throughout production and the apparent absence of testing according to reliability statistics. In other words, can complex carrier systems or large-scale computers be effectively put into serial production from a "cottage industry" base, even when the development engineering is very good.

## Computer manufacturing plant

A Mr. Hsu, who was the Deputy Director of the factory, gave us the initial briefing. The computer manufacturing plant we visited made desk-top calculators, medium and small general purpose digital computers, and some industrial computers for numerically controlled machines. The plant had 900 workers. It included dining rooms, clinics and nurseries, a technical school and a part-time college. Mr. Hsu made a point that this factory was a participant in Mao's diffusion of technology principle. He described what he called 3-in-1 combination groups. For instance, he described collaboration with high schools, universities and research institutes by the leaders, technicians (technical personnel) and workers. All the collaboration was with institutions in Shanghai. Some university students were working in the plant at all times.

The main targets of the factory were design, assembly, testing and debugging. All the components were designed and manufactured by component plants in Shanghai. The principal users of the computer products were research institutes, factories, and universities.

Our first stop on this tour was a small room containing a number of automatic magnetic-memory-core testing machines. The cores were 0.8-mm O.D., 0.6-mm I.D. and were fed to the magnetic testing head by a conventional vibrating feeder. The specific tests were not described. The tested cores were automatically discharged to either of "go or no-go" boxes. We then went to a larger room where a number of workers, mostly women, were stringing the cores in memory planes. This was a truly hand operation with no mechanical or visual aids. The basic memory module was a single plane with 72,000 cores strung in groups of 4,000. The memory module was exercised and tested by what was apparently conventional hardware but did not seem to have automatic fault indication (the translation fell apart at this point).

The next stop was at an assembly area for the desk-top calculators. This was a conventional, simple four-function calculator with no memory. It was floating point with a large, (1 cm high) bright 12-digit fluorescent display. The display was made of 12 individual tubes plugged into sockets. The electronics consisted of seven printed circuit boards (about 3 inches  $\times$  6 inches) that plugged into an array of sockets in the base of the rear of the calculator. Each of the boards had up to 18 IC's in small-ceramic, dual in-line packages mounted in two rows along the top edge. We were told they were Chinese made P-MOS IC's. Later we were told that some of these calculators were sold in the regular stores but, surprisingly the price varied from \$500 to \$1000, the only example of a variable price that we encountered in the PRC.

We were then taken through the component insertion and soldering operation for the computer boards. Again, the component leads were hand-soldered. In this area there was a new flow-soldering machine (imported from Canada). It had obviously been set up very recently and was in the debugging phase. The results obtained from it in the demonstration for us were very poor. From there we went to the final test of their type TQ-16 small-size digital computer. It was described as being a 110,000 operations/s machine with a 32-k word memory with 48 bits per word (40-bit mantissa and 6-bit exponent) and a 2 microsecond

access time. It was a floating point machine and used 24-bit instructions. Its peripherals consisted of a double paper-tape reader with photo-sensing, a teletypewriter, a drum-type line printer with speed of 120 lines/min, magnetic tape units that looked like copies of IBM tapes of 15 years ago (they claimed 20 bits/mm) and the same magnetic drums we had seen at the Meteorological Observatory in Peking.

In still another room we were shown their largest TQ-6 machine. It was claimed to have  $10^6$  operation/s, a 128-k word memory with 48-bit words (40-bit mantissa and 8-bit exponent). The peripherals were the same except that the printer was supposed to be 1200 lines/min. There was also an x-y plotter that was demonstrated by drawing the outline of a ballet dancer. The plot was about two feet square and the figure was completed in about 75 seconds. The printer was demonstrated by the common trick of making it draw a pattern. This time it was a Mao saying in Chinese characters. The printer did not seem to be going anything like 1200 lines/min.

After this we returned to the conference room for the concluding discussion. We learned that the IC's in the computers were TTL's and had one to several gates per package. The TQ-16's were being produced in dozens of units per year. The larger TQ-16 was first produced in 1974 and a few per year were being made. Future designs would use LSI's but these were in the experimental stage.

Here, as in other visits, one could not escape being impressed with the basic technical progress. On the other hand, there seemed to be unarticulated concerns regarding the manufacturing technologies, processes and procedures. The apparent lack of inspection and quality control seemed in contradiction with the high content of hand labor in the total manufacturing process. The compounding of undetected human errors in their production systems cannot help but reduce the throughput of the finished product.

---

## Conclusion

Let me conclude with a few pointers concerning the treatment that first-time U.S. visitors to the PRC might expect:

- Important business will not be discussed with the newly arrived first-time visitor to the PRC. He must spend some time beginning to understand the PRC.
- The visitor must show some indications that he can think objectively about the PRC.
- The visitor must establish credibility with his hosts with regard to his competence in his position.
- The visitor must be sensitive to the fact that the conventional wisdom of U.S. business with its accompanying jargon is an anathema to the Chinese.
- Great importance is put on personal relationships. . .
- It must be recognized that it takes patience to do business in the PRC.
- Finally, the visitor should learn something of the *structure* of the language. The objective is not to learn to converse (that takes a lifetime) but to learn how to formulate his English so that it can be translated easily and unambiguously.

# Glass passivation of IC's by chemical vapor deposition

Werner Kern

Operating principles, performance capabilities, and limitations of chemical vapor deposition (CVD) reactor systems are described for producing glassy overcoats of silicon dioxide and phosphosilicate passivation layers for metallized silicon integrated circuits. Reactor systems now available include horizontal tube types, rotation units, and continuous processing systems. The design of an in-house-built rotary reactor is described in detail, and specific recommendations are made for the construction of associated gas flow equipment. In addition, the functions and advantages of CVD passivation overcoats are discussed, and critical factors in their deposition are pointed out.

**G**LASSING and glass passivation are commonly used terms to denote the process in which a glass-like, amorphous, inorganic dielectric layer is formed over the surface of a completed microcircuit wafer for environmental protection. The sequence for glass passivation consists of deposition of the dielectric layer over the entire surface of the device wafer with completed metallization patterns, followed by photolithographic delineation to remove glass from the central region of bonding pads and from scribe-line areas. Typical deposited films are 0.5- to 2- $\mu\text{m}$  thick.

Most modern integrated circuits (ICs) are metallized with aluminum. A compatible glass passivation process must therefore be performed under conditions where the maximum processing temperature is below the *Al-Si* eutectic temperature (577°C) to avoid alloying or metallization melting problems. Similar considerations hold for metallization systems involving gold. Chemical vapor deposition (CVD) of dielectric films at low temperature (300 to 500°C) is ideally suited to fulfill these requirements. Reactive sputtering, rf sputtering, and plasma deposition techniques can also be used for depositing dielectric layers in certain applications where the IC devices are not degraded by such treatments.

Glassing of microcircuit wafers was originally used to provide mechanical protection against scratches of the soft aluminum interconnect lines. Vitreous silicon dioxide (*SiO<sub>2</sub>*) prepared by CVD was applied first as the passivating glass, and is still being used by a number of IC manufacturers. However, to provide

effective protection, a *SiO<sub>2</sub>* film thickness incompatible with the aluminum metallization would be required, and cracking of the oxide film would result, with consequent problems of device reliability. Many device manufacturers, recognizing these shortcomings, have substituted more compatible lower-stress films of binary silicate glasses, especially phosphosilicate glass (PSG) films, for the more highly stressed *SiO<sub>2</sub>* layers.

The main objective of this paper is to survey the CVD reactor systems and equipment now available for low-temperature deposition of passivation overcoats, and to examine the principle of operation and the capabilities and limitations of these systems. In addition, the types, functions, and benefits of passivation coatings are briefly reviewed. Important aspects of film deposition are noted indicating the relationship of CVD parameters, film growth and properties.

## Types, functions, and benefits of passivation coatings

### Types of passivation coatings

Passivation coatings are widely used to improve the performance and reliability of silicon devices of various types, ranging from discrete mesa-type diodes and transistors to complex planar integrated circuits — and including both hermetic and plastic-encapsulated devices.

Passivation coatings may be classified as primary when in direct contact with the single-crystal silicon from which the device is fabricated, and as secondary when separated from the device by an

underlying dielectric layer. The primary passivation layer provides good dielectric properties, low-surface recombination velocity, controlled immobile-charge density, and device stability at elevated temperatures under bias or operating conditions. The secondary passivation layer provides additional stability in various ambients and serves as getter, impurity barrier, or mechanical shield. A comprehensive survey paper<sup>1</sup> presented elsewhere reviews the entire field of silicon device passivation and may serve as a source of general background material in the present paper.

This paper deals specifically with the application of CVD for producing passivating and protective layers suitable for overcoating aluminum-metallized silicon semiconductor devices in finished wafer form. The two materials of major importance in overcoat passivation are *SiO<sub>2</sub>* and PSG deposited by thermally activated oxidation of the hydrides. These materials can be deposited in high quality at the low temperature prerequisite with aluminum-metallized silicon devices; functional requirements are summarized in Table 1. A schematic cross-section of a typical IC with overcoat passivation is shown in Fig. 1.

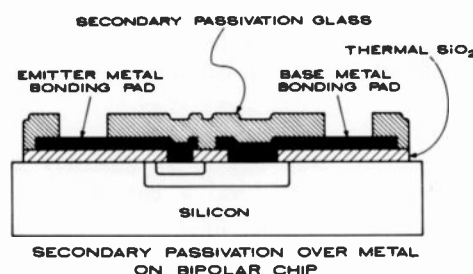

Fig. 1 — Schematic cross-section of a typical bipolar IC with CVD overcoat passivation (not to scale).

### Uses and benefits of glass passivation overcoats

Primarily, passivating overcoats provide protection against scratching of the vulnerable interconnect metallization during chip handling, ensure immunity of effects of loose conductive particles in hermetic packages, improve device stability in various ambients, lower susceptibility to metal corrosion and electromigration, and reduce effects of ion motion on the device surface. PSG has, in addition, alkali gettering capability which is of great importance in passivation and stabilization of devices, and exhibits less stress (tensile) than layers of CVD *SiO<sub>2</sub>*. The effectiveness of PSG for

**Table I — Functional requirements of IC passivation overcoat layers.**

No.	Functional Requirements
1	Mechanical and chemical protection for metallization interconnects
2	Diffusion barrier or gettering agent for ionic contaminants and other external impurities
3	Good adherence to metallization and primary passivating layers
4	Low stress from all causes
5	Good chemical and physical stability
6	Low defect density
7	Inertness toward metallization and other structural device components
8	High dielectric strength and electrical resistance
9	Low dissipation factor
10	Low mobile or trapped charge density
11	Isolation of electrical charge effects external to semiconductor
12	Sufficiently matching thermal expansion with device component materials
13	Reduce or maintain semiconductor surface state density
14	Moderately high dielectric constant to contain junction fringing field
15	Ease of preparation and subsequent processing
16	Ease of formability into patterns by photolithography and etching
17	Compatibility with plastic encapsulating materials.

gettering alkali ions is particularly advantageous for MOS ICs because of their increased surface sensitivity as compared with that of digital bipolar ICs.

Alkali gettering capability is also of great importance for devices enclosed in ceramic packages that are sealed by fusion of glass frits. These frits usually contain large amounts of sodium which is emitted during fusion into the ambient of the package enclosure. Encapsulating plastic formulations are also a source of ions and other impurities that must be prevented from penetrating into the sensitive device regions. A summary of benefits and advantages achieved by IC

**Table II — Benefits of IC glass passivation by CVD overcoat layers.**

No.	Benefit
1	Gettering or immobilizing of harmful alkali ions (in the case of PSG)
2	Decreasing instabilities due to surface ionic drifts or horizontal surface-ion migration
3	Protection against metal corrosion
4	Suppression of electromigration susceptibility
5	Suppression of defect formation in aluminum metallization
6	Reducing penetration of moisture, gases, and chemical species from the outside, including components from the plastic encapsulating material forming the package
7	Quenching of fast states to lower leakage currents
8	Improved protection against high-energy electromagnetic radiation
9	Mechanical scratch protection during wafer and dice processing
10	Prevention of shorts from loose conducting particles in hermetic packages
12	Compatibility with many types of thin-film resistors used on ICs
13	Other benefits including general increase in device reliability and yield due to decreased failure rate and susceptibility to electrical instabilities.

glass passivation by CVD overcoat layers for the vast majority of IC types is presented in Table II. It is clear from these considerations that passivating overcoat layers constitute an important step in manufacturing ICs of high reliability and improved performance.

## Preparation of passivation overcoats

### Chemical vapor deposition

Chemical vapor deposition is a process by which gases or vapors are chemically reacted, leading to formation of a solid-phase reaction product on a substrate surface. Activation of the chemical reac-

**Werner Kern**, Member of the Technical Staff, RCA Laboratories, Princeton, N. J., received his education in chemistry at schools in Switzerland and the U.S.A., including the University of Basle and Rutgers University. His thesis, published in 1947, was on the chromatographic isolation and characterization of fluorescing polynuclear hydrocarbons which he discovered in soil. He was analytical research chemist with Hoffmann-LaRoche in Switzerland until 1948 when he transferred to their research division in New Jersey to develop radioactive tracer methods for biochemical applications. In 1958 he joined Nuclear Corporation of America where he became chief chemist directing applied research in nuclear radiation chemistry. He joined RCA Electronic Components and Devices Division in 1959 primarily to investigate semiconductor processes by radiochemical methods. He was project scientist and consultant on several research projects, and was in charge of radiological safety. Since 1964 he has been at RCA Laboratories as a Member of the Technical Staff specializing in semiconductor process research, chemical vapor deposition technology, and the development of new analytical methods for characterizing dielectric films. In 1974-1975 he has been project scientist for two government-sponsored research contracts on integrated circuit glass passivation. Mr. Kern is a member of the American Chemical Society, the Electrochemical Society, the Research Honorary Society of Sigma Xi, and Geological Society of New Jersey, and is listed in American Men and Women of Science. He is author or co-author of over 50 scientific publications and holds four U.S. patents. He received an RCA Achievement Award in 1966 for his work in integrated circuit process research. Mr. Kern is the recipient of the T. D. Callinan Award for 1971 of the Dielectrics and Insulation Division of the Electrochemical Society, in recognition of his pioneering work in chemical vapor deposition research. He received a 1973 RCA Laboratories Outstanding Achievement Award for his team contributions to glass passivation of silicon device structures.



Reprint RE-21-5-7  
Final manuscript received August 11, 1975.

This work was in part supported by the Air Force Materials Laboratory, Wright-Patterson Air Force Base, Ohio, under Contract No. F33615-74-C-5146. Portions of this paper were presented verbally at NAECON '75, and an extended summary on CVD reactors was included in the Proceedings volume.

**Table III — Advantages and disadvantages of CVD techniques for preparing passivation overcoat layers.**

No. Advantages	
1	Low deposition temperature
2	High chemical purity of deposited layers
3	Wide choice of compositions
4	Ease of preparing a variety of layered structures
5	Desirable physical and chemical film properties
6	Ease of thickness control
7	Good uniformity of film thickness and composition
8	Good adherence to oxides and aluminum
9	High-resolution patterns can be readily formed in layers by photolithography
10	Economical and practicable on a production scale
11	Process can be automated
No. Disadvantages	
1	Particulate impurities from the reaction are formed and must be minimized
2	Toxicity of reactants requires safety measures
3	Accurate control of gas flows and deposition temperature is needed

tion is most commonly effected by heating of the substrate. CVD is employed extensively in semiconductor device technology, for example, in the epitaxial deposition of single-crystal semiconductors, silicon nitride impurity-barrier films, oxide and nitride dielectric films, doped oxide layers as diffusion sources, silicate glasses for passivation, and, in some instances, metal films as conductor elements.

Theoretical and practical aspects of chemical vapor deposition processes have been treated extensively in several recent reviews<sup>2-11</sup>. The advantages and disadvantages of the CVD technique for device glassing are listed in Table III.

**Basic CVD hydride reactions**

The basic process for depositing  $SiO_2$  films from silane and oxygen at low

temperatures (250° to 550°C) was reported in 1967.<sup>12</sup> The exact details of this thermally activated, surface-catalyzed, heterogeneous branching-chain reaction are complex,<sup>13</sup> but the overall reaction can be expressed as:

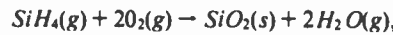

but under some circumstances it may proceed as



The reaction favored depends strongly on deposition temperature and silane concentration,<sup>12-16</sup> and probably also on the oxygen-to-hydride ratio and variations in reactor geometry.

Phosphorus can be incorporated into the oxide layers as an oxide of phosphorus by the reaction of phosphine with oxygen:

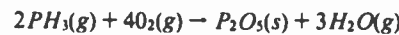

Cooxidation of  $PH_3$  with  $SiH_4$  forms PSG.<sup>16-30</sup>

**Effects of CVD parameters on film growth and properties**

The exact conditions used in the CVD process for  $SiO_2$  and PSG films can critically affect important film properties. Primary CVD parameters that affect deposited film properties must be carefully optimized and controlled; such parameters are listed below in their approximate order of importance:

- 1) Substrate temperature of deposition
- 2) Oxygen-to-hydride ratio
- 3) Hydride flow rate
- 4) Silane-to-phosphine ratio
- 5) Nitrogen flow rate
- 6) Geometry of reaction chamber and gas inlet/outlet configurations
- 7) Wall temperature of reaction chamber or gas disperser
- 8) Cleanliness of CVD system and purity of gases
- 9) Nature and cleanliness of substrates surface
- 10) Surface topography of substrate

We have investigated in considerable detail the effects of these factors on film deposition rate, film uniformity, and film composition (in the case of PSG). In summary, it can be generalized that even though the mode of operation may differ greatly for various types of CVD reactor systems, the basic CVD parameters underlying oxide and glass film formation by gas phase oxidation of the hydrides at temperatures below 500°C are, in principle and often semiquantitatively, applicable to all systems. The most critical factors determining PSG composition and film quality are substrate temperature of deposition, oxygen-to-hydride ratio, silane-to-phosphine ratio, and hydride flow rate. These factors must be controlled and optimized for a given CVD system by analysis of the film product obtained.

The CVD process should be directed in a fashion conducive to heterogeneous gas-phase nucleation to produce clear, glassy films free of defects. Homogeneous gas-phase reactions produce particulate con-

**Table IV — Effects of CVD key parameters for preparing PSG films.**

DIRECTION OF ARROWS INDICATES RELATIVE INCREASE OR DECREASE  
 \ STRONG; < SLIGHT; — NONE

CVD PARAMETERS	EFFECTS ON FILM		
	DEPOSITION RATE	PHOSPHORUS CONTENT	INTRINSIC STRESS
HYDRIDE FLOW RATE $\frac{SiH_4 + PH_3}{Time}$ ↑	↗	—	↗
HYDRIDE RATIO $\frac{PH_3}{SiH_4}$ ↑	↘	↗	↘
OXYGEN RATIO $\frac{O_2}{SiH_4 + PH_3}$ ↑	↘	↗	↗
DEPOSITION TEMPERATURE T ↑	↘ H L	↘	↘
DILUENT GAS FLOW RATE $\frac{N_2}{Time}$ ↑	↘	—	—

H = HIGH, L = LOW OXYGEN RATIO



taminants and must be suppressed by application of suitable techniques, such as cooling of the reactor walls,<sup>22</sup> use of high diluent gas flow rates,<sup>22</sup> addition of selective inhibiting agents,<sup>31</sup> or utilization of close-space reactor designs.

The essential effects of CVD key parameters on PSG film deposition rate, phosphorus content, and intrinsic film stress are shown in Table IV. This schematic also allows one to predict, at a glance, what results can be expected on combining the various parameters, or how to compensate an effect by increasing or decreasing the relative magnitude of some of the other factors. Quantitative results have been presented elsewhere,<sup>32</sup> and will be discussed in detail in a forthcoming paper.<sup>33</sup> Even though the exact reaction mechanism of film formation is quite complex and is influenced by many variables, the optimized preparation of high-quality  $\text{SiO}_2$  and PSG films for IC overcoat passivation is a CVD process well suitable for large-scale production.

#### Compatibility of deposition temperature with metallization

The theoretical maximum temperature for processing devices metallized with aluminum is limited by the melting point of the eutectic formed between silicon and aluminum ( $577^\circ\text{C}$ ). In practice, however, the maximum temperature during glass deposition is held below  $500^\circ\text{C}$  because solid-state reactions between aluminum and silicon begin to exert degrading effects in many sensitive devices at approximately  $500^\circ\text{C}$ . Some reaction of aluminum with  $\text{SiO}_2$  or PSG can be detected in certain devices at temperatures as low as  $400^\circ\text{C}$ , forming a thin intermediate layer of aluminosilicate, but normally this presents no serious problems when proper etching techniques are used in delineation of the glass layer to expose the bonding pads and scribe lines.

Problems associated with corrosion, edge effects, stress, and expansion mismatches between aluminum and the passivation overcoats have been discussed<sup>1</sup>. An up-to-date bibliography of many other related aspects of aluminum and other metallization for silicon devices became available recently.<sup>34</sup>

#### Layer combinations

Combinations of PSG and  $\text{SiO}_2$  layers

can offer distinct advantages over any one single layer. Structures consisting of  $\text{SiO}_2$  over PSG, or of  $\text{SiO}_2$ /PSG/ $\text{SiO}_2$ , can be readily prepared by CVD techniques, often in one continuous operation, simply by regulating the hydride input in the gas stream.<sup>22</sup> A thin ( $1000\text{-\AA}$ ) CVD  $\text{SiO}_2$  top layer over the phosphosilicate main layer of  $0.6\text{-}$  to  $1.5\text{-}\mu\text{m}$  thickness is desirable for improved photoresist adherence and consequently improved pattern etching definition, unless organo-silane adhesion-promoting agents are used. The composition of PSG layers used in industry is generally in the range of 2 to 5 wt % P (or 2 to 5 mol %  $\text{P}_2\text{O}_5$ ).

### Survey of CVD reactor systems and equipment

#### Requirements for reactor systems

A CVD system for depositing passivating films of the type described must provide equipment that accomplishes the following functions<sup>2,4,8,10,35</sup>

- 1) transport, meter, and time the diluent and reactant gases entering the reactor;
- 2) provide heat to the site of reaction, namely, the substrate material being coated, and control this temperature by automatic feedback to the heat source; and
- 3) remove the by-product exhaust gases from the deposition zone and safely dispose of them.

The reactor system should be designed to fulfill these three primary functions with maximum effectiveness and simplicity of construction. It must consistently yield glass films of high quality; good thickness and compositional uniformity from wafer to wafer and from run to run; and high purity with a minimum of structural imperfections such as pinholes, cracks, and particulate contaminants. For research applications, these requirements are usually quite sufficient, but for large-scale production applications the system should, in addition, perform with high throughput, be simple and safe to operate, and be easy to maintain routinely. Labor-saving automation<sup>36</sup> and computerization are attractive additional options that can be well worth the increased capital cost in reducing labor costs, resulting in net savings. Similar considerations concern the capital cost of the equipment, which ranges from less than \$3,000 for an in-house built research or pilot production unit to over \$70,000 for a high-capacity production system.

The capital cost must be carefully evaluated in terms of the system's actual product output, operator and maintenance labor required, consumed gases, power consumption, and parts replacement cost.

A considerable degree of sophistication and refinement has been engineered into present-day commercial reactor systems, emphasizing maximum product throughput, improved process control, and convenience and economy in processing and equipment maintenance. Various techniques for process automation have been developed, including full computer automation with separate digital control of each of the various parameters such as temperature control, gas composition, and timing sequence. Heating is usually effected by resistance-heating techniques, and operation is at nominally atmospheric pressure. Provisions have been made in several of the commercial reactors for cooling of the reactor walls or the gas distributor to suppress homogeneous gas phase nucleation.

#### Basic types of reactors

Reactors can be classified in essentially four main categories, according to their gas flow characteristics and principle of operation:

- 1) Horizontal tube displacement flow reactors.
- 2) Rotary vertical batch-type reactors.
- 3) Continuous reactors employing premixed gas flow fed through an extended area slotted disperser plate.
- 4) Continuous reactors employing separate, nitrogen-diluted oxygen and hydride streams that are directed toward the substrate by laminar flow nozzles.

The schematic diagrams presented in Fig. 2 show the basic features of these four types. Each system and its variants are briefly discussed and exemplified. Data on commercially available equipment to be described were derived from information supplied by the manufacturer rather than by experimental studies by the author other than inspection of the equipment.

#### Horizontal displacement flow reactors

Horizontal tube reactors consisting of an elongated quartz tube of circular or

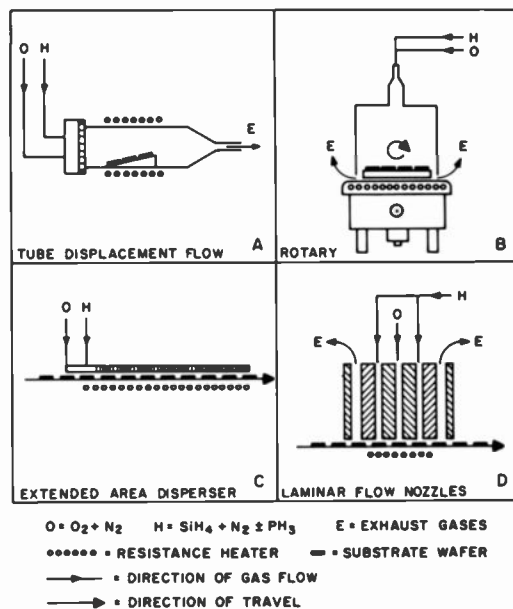

Fig. 2 — Operating principles of the basic types of CVD reactors for preparing passivation overcoat layers: a) horizontal tube displacement flow reactors, b) rotary vertical batch-type reactors, c) continuous reactors employing premixed gas flow fed through an extended area slotted disperser plate, and d) continuous reactors employing separate, nitrogen-diluted oxygen and hydride streams that are directed toward the substrate by laminar flow nozzles.

rectangular cross section, as used in high-temperature semiconductor processing, were the first types used in CVD of oxides at low temperature. The diluent and reactive gases are continually being supplied, and are usually mixed and dispersed at the point of entry into the tube. The mixed gas stream passes over the heated substrates which rest on a tilted wafer carrier. Heat may be supplied resistively from outside the tube or from within the wafer carrier. Displacement-type forced laminar gas flow of this type features a low degree of gas mixing, requiring careful optimization of the gas dynamics to obtain good film uniformity in thickness and composition. Critical factors affecting film uniformity are substrate positioning, temperature profile of the deposition zone, geometry of reactor, and exhaust configuration. Several types of CVD systems based on horizontal displacement flow reactors are commercially available. A schematic of the basic system is shown in Fig. 2a.

A horizontal, internally resistance-heated flow reactor manufactured by Applied Materials Technology, Inc.<sup>a</sup> has a capacity for ten 5-cm-diameter wafers per batch. Cycle time for a 5000-Å-thick  $SiO_2$  deposition is approximately 15 minutes.

a) AMS-2600 Silox System, Applied Materials Technology, Inc., 222 San Ysidro Way, Santa Clara, CA 95051.

Uniformity of film thickness is specified as typically  $\pm 7.5\%$  within a wafer,  $\pm 10\%$  from wafer to wafer within a run.

A tubeless horizontal production reactor of entirely different design is manufactured by Thermco<sup>b</sup>. It utilizes a resistance-heating block with the gases introduced across its width to minimize depletion of the gas reactants moving across the heating platen. The gas delivery system has provision for bi-directional gas entry/exhaust. The unit has a loading capacity for 27 five-cm wafers and a deposition rate capability of 1000 Å/min. The film uniformity within a wafer is  $\pm 5\%$ , and  $\pm 10\%$  from wafer to wafer.

A developmental close-spaced horizontal cold-wall reactor has also been described.<sup>37</sup> A high-velocity stream of the premixed gases passes over the resistance-heated substrate wafers parallel to their surface. The reactor can accommodate 28 wafers of 5-cm diameter.

#### Rotary vertical batch reactors

In rotary vertical reactors for batch processing, the substrate wafers are placed on a plate rotating above a resistance heater (Fig. 2b). The reaction

b) Thermco Thor II Oxide Reactor, Thermco Products Corp., Box 1875, Orange, CA 92667.

chamber consists of a cylindrical, conical, or hemispherical bell jar that may have provisions for cooling. The gases enter through single or multiple inlets from the top or side of the belljar, pass over the substrates, and exit at the bottom of the chamber below the rotating plate. The incoming gases mix gradually with the partially reacted gas before passing over the substrates. Intentional changes in gas composition therefore proceed gradually (rather than abruptly as in the case of horizontal flow reactors); this behavior for the present application is advantageous, particularly when double layers (PSG +  $SiO_2$ ) with a graded interface are desired. The geometry of the reaction chamber and the configurations of the gas inlet and exit openings are critical in attaining the most effective gas flow dynamic conditions required for producing uniform deposits.

Construction and performance of a reactor of this type designed for research applications was described previously<sup>38</sup>. The unit consists of gear-driven discs heated by conduction from a hotplate. Planetary motion of the substrates promotes maximum uniformity of the film deposits by thermal and gas dynamic averaging effects over a wide range of operating conditions.

A modified single-rotation reactor we have built for research and pilot production is described below in some detail, since it exemplifies a relatively simple and inexpensive in-house built unit. Five wafers of 5-cm diameter can be coated simultaneously with a uniformity that is indistinguishable by visual inspection ( $\pm 2\%$  at 1- $\mu\text{m}$  film thickness) from wafer to wafer, if the nitrogen diluent flow is properly balanced. Nine wafers can be coated simultaneously if thickness uniformity is less critical. Very high deposition rates (up to 1  $\mu\text{m}/\text{min}$ ) can be obtained, although these are not normally used.

A photograph of this unit with a glass bell jar as reaction chamber is presented in Fig. 3. A commercial high-temperature hotplate (or electric stove element) serves as a heat source. A 1.4-cm-thick, 20-cm-diameter disc of aluminum alloy 6061 is used as sample stage. A small depression in the center of the disc aids in positioning it freely on a support pedestal machined of a thermally insulating ceramic (*AlSiMag* 222). The pedestal fits in a rotating steel shaft which extends

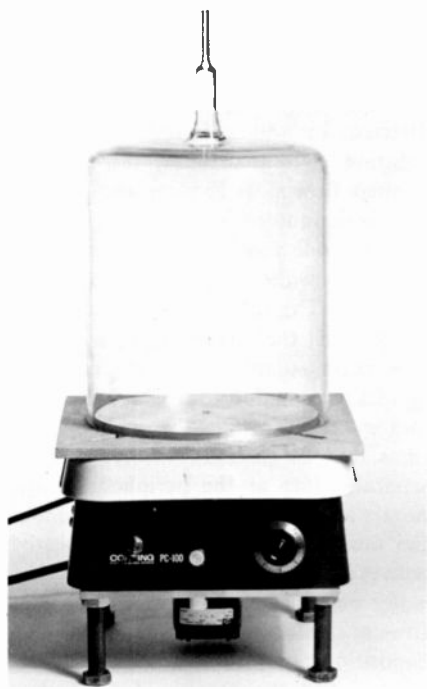

Fig. 3 — Single-rotation vertical CVD reactor (diameter of the glass bell jar is 22 cm).

through the center of the hotplate directly to an instrument motor. A mica-insulated bypass in the heater ribbon can be made to provide sufficient clearance for the shaft, as indicated in Fig. 4. The disc rotates at 6 rpm above the hotplate top, with a clearance of 2 to 3 mm. Construction details are defined and shown schematically in Fig. 4. A chromel-alumel thermocouple serves as temperature sensor for the rotating substrate plate. The thermocouple wires are insulated by a ceramic tube and are inserted through the hotplate from below, extending through a small opening in the Pyrocera top toward the rotating metal disc, but without touching it. The thermocouple signal is relayed to an automatic temperature controller which regulates the temperature of the hotplate. The rotary disc temperature is also monitored independently, prior to deposition work, using calibrated bimetallic surface thermometers.

The deposition chamber shown consists of a Pyrex bell jar of 25-cm height and has an outside diameter of 22 cm. The geometry of the single gas inlet on top of the bell jar is clearly visible in Fig. 3. Alternatively, a water-cooled, double-walled, stainless-steel chamber of similar dimension has been used for cold-wall CVD studies. The deposition chamber

rests on a Transite plate that has four symmetrically located slots ( $13 \times 38$  mm) serving as exit openings for the exhaust gases. The entire apparatus is placed in a chemical exhaust hood whose air intake is regulated to avoid excessive air drafts, so as not to cause thermal disturbance of the hotplate's temperature equilibrium.

The oxide and glass deposits accumulating on the aluminum substrate disc should be removed periodically by immersion in diluted  $HF$ , followed by flushing with deionized water. Occasional mechanical cleaning with steel wool and detergent followed by immersion in concentrated  $HNO_3$  for three to five minutes and thorough rinsing with deionized water is recommended. To avoid warping of the symmetrically machined plate on extended use at  $450^\circ C$ , it is simply inverted after cleaning when repositioning it on the support pedestal. This will effectively nullify the slight sagging that might otherwise occur.

Several important considerations should be noted for designing and constructing the gas-handling equipment associated with in-house built units. Heliarc-welded and leak-checked stainless-steel tubing is recommended for hydrides of high con-

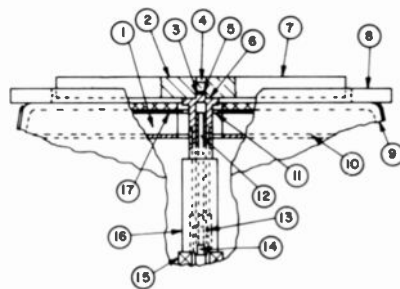

1. Heater assembly with cut out clearance hole for shaft.
2. Aluminum alloy rotating disc ( $1.5 \text{ cm} \times 21 \text{ cm}$ ).
3. Centering insert of ceramic support pedestal.
4. Centering recess on both sides of disc.
5. Bushing.
6. Ceramic support pedestal and sleeve drive.
7. Surface of rotating disc for substrates.
8. Transite reaction chamber support plate.
9. Pyrocera hotplate top.
10. Backing plate.
11. Output for heating element.
12. Steel tubing centering shaft.
13. Boston sleeve coupling (#GR4).
14. Hexagonal socket heat cap screw.
15. Thrust bearing (Aetna F-1).
16. Stainless steel sleeve-drive to motor shaft.
17. Mica insulation with cut out clearance hole for shaft.

Fig. 4 — Sectional view of essential construction details for single-rotation CVD reactor shown in Fig. 3.

centration (greater than five percent). Leak-tested polyethylene tubing is advantageous for oxygen, nitrogen, and diluted hydrides, particularly in the terminal parts of the installation where flexibility and quick removability for clean-up is important. Metering of the hydride gases is best done with calibrated mass flowmeters and controllers. Float-type flowmeters are perfectly adequate for oxygen and nitrogen. It is very important to have provision for nitrogen purging of the entire hydride line system, including the pressure regulators back to the source tanks, to be able to remove residual hydrides after deposition work is terminated at the end of the day, or to use nitrogen flow during setup to conserve expensive hydride gases. A schematic of a typical gas flow system is shown in Fig. 5. Additional recommendations, including valves, temperature measurement, and safety considerations were noted in previous publications.<sup>12,24,38,39</sup> A variety of gas flow control panels is now available commercially<sup>4</sup> or can be obtained custom built for any desired requirements.<sup>4</sup>

A commercial rotary, resistance-heated vertical reactor system for semi-continuous operation is sold by Unicorp, Inc.<sup>5</sup> It features premixed gas input through four tubes inside the conical deposition chamber for uniform distribution, and has separate stations on a carrier disc for wafer loading/unloading, preheating, deposition, and cooldown. Up to seven 5-cm wafers can be accommodated per station. The maximum oxide deposition rate is  $1700 \text{ \AA}/\text{min}$ , with a conservatively estimated overall uniformity of  $\pm 5\%$ .

An oxide reactor featuring two planetary systems arranged concentrically was described in 1971<sup>40</sup>. In this complex reactor, the driver element is a cylinder rotating within an annular spacing between a circular inner resistance-heated block and an outer heater ring. The gases are dispensed in a counter-rotating array to ensure good mixing of

c) For example, Matheson Gas Products, P.O. Box 85, 932 Paterson Plank Rd., East Rutherford, NJ 07073.

d) For example, Tylan Corp., 4203 Spencer St., Torrance, CA 90503.

d) For example, Tylan Corp., 4203 Spencer St., Torrance, CA 90503.

e) Rotox-60, Unicorp Inc., 625 N. Pastoria Dr., Sunnyvale, CA 94086.

f) Oxide Reactor 315 (no longer manufactured), Materials Research Corp., Orangeburg, NY 10962.

the gas flows, resulting in a thickness uniformity of  $\pm 1.5\%$ .

Vertical CVD reactor systems with rotating gas feed over a stationary, resistance-heated plate are manufactured by Phoenix Materials Corporation<sup>g</sup>. Units for processing either 26 or 70 five-cm wafers are available.

A vertical cold wall reactor system by HLS Industries<sup>h</sup>, featuring a periphase gas injection arrangement that introduces the gases into the reactor through two concentric wall sections, was described recently. Low gas depletion losses and elimination of static boundary conditions result in uniform deposits<sup>41</sup>.

### Continuous reactor systems

Application of continuous processing concepts to CVD reactor systems makes large-scale production of oxide and glass films possible at a lower operating cost than that of batch-type reactors, especially if combined with automation that is particularly suitable for such systems. A CVD processor of this type is manufactured by Applied Materials Technology, Inc.<sup>i,42</sup> The substrate wafers are moved

g) Phoenix Materials Corp. Vapor Deposition Systems, 500 and 1500 Series, M.R. 10, Kittatiny, PA 16202.

h) Univax Reactor Model 100-60-30, HLS Industries, 762 Palomar Ave., Sunnyvale, CA 94086.

i) AMS-2000 Continuous Silox Reactor, Applied Materials Technology, Inc., 2999 San Ysidro Way, Santa Clara, CA 95051.

conveyor-fashion on Inconel trays through the reactor at constant speed. Heating is by radiation from a resistance heater. The nitrogen, oxygen, and hydride gas streams are combined before entering the manifolds to the slotted disperser plate from which the gas mixture passes by laminar flow over the wafers. The cross-flow gas dispersion and the relatively close spacing (approximately 1 cm) of the substrate to the water-cooled, extended area disperser plate minimize undesirable homogeneous gas phase nucleation. Wafer-to-wafer uniformity of film thickness is better than  $\pm 5\%$ , with unusually low densities of particulate inclusions and pinholes. The machine has a throughput capacity of 400 five-cm wafers/h with a 1- $\mu\text{m}$ -thick  $\text{SiO}_2$  deposit. A schematic is shown in Fig. 2c.

In nozzle reactors, separate streams of nitrogen-diluted hydrides and oxygen impinge on the substrate surface where they mix and react, forming the oxide or glass films. The effects of numerous nozzle geometries on the resulting oxide deposition pattern has been examined in detail by several investigators<sup>43,44</sup>. An open horizontal circular compound nozzle was empirically found most desirable, with the deposition occurring where the heated moving wafer intersected the unconfined jet of the reacting gases, while the exhaust gases were removed by a pump. Uniformity of  $\pm 5\%$  was obtained across a five-cm wafer<sup>43</sup>.

A commercially available continuous

reactor system based on nozzle-type gas dispersion is manufactured by Pacific Western Systems, Inc.<sup>j</sup>. In this unit the nitrogen-diluted oxygen and hydrides are directed to the substrate surface as separate streams flowing through the laminar flow slots forming the nozzles. The water-cooled nozzle array unit is four-cm wide and 25-cm long, extending over the width of the heater block assembly. The space between the nozzle array and the wafer surface during deposition is only about 2.5 mm and defines the reaction zone where the gases mix and react forming the oxide or glass films. Exhaust gases are removed through separate slots at the periphery of the nozzle array. The wafers traverse under the nozzle unit on a resistance-heated conveyor plate at a variable speed. The wafer plate (18 cm  $\times$  41 cm) accepts 21 five-cm wafers. Unusually high film deposition rates are obtainable with this system, and the density of particulate impurities in the film deposits is low. The thickness uniformity for  $\text{SiO}_2$  films is  $\pm 5\%$ , with a deposition of 1  $\mu\text{m}$  at a rate of 6.3 cm/min travel speed. Figure 2d depicts schematically the construction of this type of nozzle reactor.

A continuous nozzle reactor system is also marketed by Chemical Reactor Equipment, Inc.<sup>k,46</sup> A high-velocity nozzle is used, through which the gases are mixed and impinged over a relatively small area of deposition surface. A continuous mode of operation results from the reciprocating motion of the substrate under the nozzle. A five-nozzle system is capable of depositing 0.5- $\mu\text{m}$   $\text{SiO}_2$  films on up to 350 five-cm wafers per hour, with excellent uniformity.

### Summary and conclusions

Chemical vapor deposition has become the most widely used technique for producing glassy passivating layers over aluminum-metallized semiconductor devices, particularly complex planar silicon bipolar and MOS integrated circuits for both hermetic or plastic encapsulation. The most commonly used passivating overcoat layers are  $\text{SiO}_2$  and phosphosilicate glass, singly or in combination, deposited by oxidation of the

j) PWS Model 2000 Vapor Deposition System, Pacific Western Systems, Inc., 855 Maude Avenue, Mountain View, CA 94040. It is now available from Applied Materials, Inc. (AMS-1000 Silox Reactor System).

k) CRE 1101, 1103, 1105, Chemical Reactor Equipment, Inc., 1080 HE Duane Ave., Sunnyvale, CA 94086.

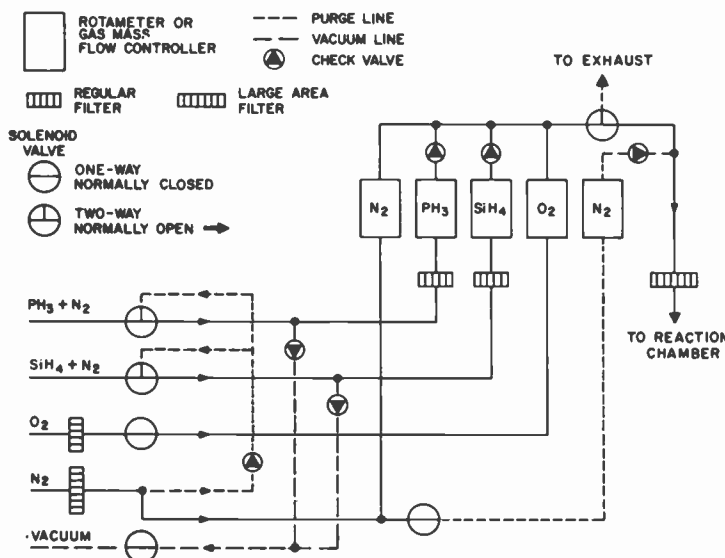

Fig. 5 — Schematic of an automated gas flow and metering system for CVD of silicon dioxide and PSG films. Less expensive mass flow meters or inexpensive rotameters with high-accuracy flow control needle valves can be substituted for the electronic mass flow controllers, especially in the case of the nitrogen and oxygen lines. The vacuum lines can be omitted if two-stage gas regulators with provisions for purging are used at the hydride source cylinders.

nitrogen-diluted hydrides at a substrate temperature ranging from 325 to 450°C.

The functions of passivation coatings have been defined, and the uses, benefits, and advantages of CVD overcoats for improving device reliability have been discussed and shown to be highly effective.

The preparation of passivation overcoats by CVD techniques has been reviewed and referenced. The most critical factors determining film deposition rate, PSG composition, and overall film quality are substrate temperature of deposition, oxygen-to-hydride ratio, silane-to-phosphine ratio, and total hydride flow rate. These factors must be controlled and optimized for a given CVD system by analysis of the film product obtained. The CVD process should be directed in a fashion conducive to heterogeneous gas phase nucleation to produce clear, glassy films free of defects. Homogeneous gas phase reactions produce particulate contaminants and must be suppressed. Even though the exact reaction mechanism of film formation is quite complex, and is influenced by many variables, the optimized preparation of high-quality  $\text{SiO}_2$  and PSG films for IC overcoat passivation is a CVD process well suited to large-scale production.

A considerable variety of CVD reactor systems for preparing  $\text{SiO}_2$  and PSG passivating overcoats is now available, including horizontal tube-types, rotation reactors, and continuous processing units. We have categorized and described the design, operation, and capability of these systems, which encompass designs from relatively simple to sophisticated automated concepts.

An example of an in-house built rotary vertical batch-type reactor we designed and have used successfully for several years has been described in detail, and specific recommendations for the construction of associated gas-handling and flow control equipment has been made.

It was concluded that even though the principle of operation differs greatly for various types of systems, the basic CVD parameters underlying oxide and glass film formation by gas phase oxidation of the hydrides at temperatures below 500°C is in principle, and often semiquantitatively, applicable to a wide variety of systems.

## Acknowledgments

I would like to thank Dr. G. L. Schnable for many valuable comments and for critically reviewing the manuscript. A. W. Fisher contributed significantly to the design of the rotary CVD reactor, and R. D. Vibronek proficiently carried out much of the experimental CVD work.

## References

1. Schnable, G.L., Kern, W., and Comizoli, R.B., "Passivation Coatings on Silicon Devices," *J. Electrochem. Soc.* 122, 1092 (1975).
2. Powell, C.F., Oxley, J.H., and Blocher, J.M., Jr., Eds., *Vapor Deposition*, (John Wiley & Sons, New York, 1966).
3. Feist, W.M., Steele, S.R., and Ready, D.W., "The Preparation of Films by Chemical Vapor Deposition," in *Physics of Thin Films*, Vol. 5, Hass, G. and Ithun, R.E., Eds., (Academic Press, New York and London, 1969), pp. 237-314.
4. Campbell, D. S., "The Deposition of Thin Films by Chemical Methods," in *Handbook of Thin Film Technology*, Maissel, L. I., and Glang, R., Eds., (McGraw-Hill Book Company, New York, 1970), pp. 5-1 to 5-25.
5. Amick, J. A., and Kern, W., "Chemical Vapor Deposition Techniques for the Fabrication of Semiconductor Devices," in *Chemical Vapor Deposition*, Blocher, J.M., Jr. and Withers, J.C., Eds., Second Int'l Conf., The Electrochem. Soc., Inc., New York (1970), pp. 551-570.
6. Chu, T. L., "Dielectric Materials in Semiconductor Devices," *J. Vac. Sci. Technol.* 6, 25 (1970)
7. *RCA Review, Special Issue: "Chemical Vapor Phase Deposition of Electronic Materials," RCA Review* 31, No. 4 (1970).
8. MacKenna, E. L., "Chemical Vapor Deposited Dielectrics Properties and Deposition Methods," *Proc. 1971 Semicond./IC Proc. and Prod. Conf.*, pp. 71-83, Ind. and Sci. Conf. Management, Chicago, Ill. (1971).
9. Chu, T. L., and Schmeltzer, R. K., "Recent Advances in the Chemical Vapor Growth of Electronic Materials," *J. Vac. Sci. Technol.* 10, 1 (1973).
10. Blocher, J.M., Jr. and Withers, J.C., Eds., "Chemical Vapor Deposition" (International Conferences): Second Int'l Conf. The Electrochem. Soc., Inc., New York (1970); Glaski, F. A., Ed. — Third Int'l Conf., The American Nuclear Society, Hinsdale, Ill., (1972); Wakefield, G. F., and Blocher, J. M., Jr., Eds. — Fourth Int'l Conf., The Electrochem. Soc., Inc., Princeton, N.J. (1973); Blocher, J. M., Jr., Hintermann, H. E., and Hall, I. H., Eds. — Fifth Int'l Conf., The Electrochem. Soc., Inc., Princeton, N.J. (1975).
11. Tietjen, J. J., "Chemical Vapor Deposition of Electronic Materials," in *Ann. Rev. Mat. Sci.*, Vol. 3 (1973), Huggins, R. A., Bube, R. H., and Roberts, W., Eds., published by *Annual Reviews*, pp. 317-326.
12. Goldsmith, N., and Kern, W., "The Deposition of Vitreous Silicon Dioxide Films from Silane," *RCA Review* 28, 153 (1967).
13. Emeleus, H.J., and Stewart, K., "Oxidation of the Silicon Hydrides," *J. Chem. Soc. (London)*, Part 1, 1182 (1935).
14. Chu, T. L., Szedon, J. R., and Gruber, G. A., "Silica Films by the Oxidation of Silane," *Trans. Met. Soc. AIME* 242, 532 (1968).
15. Strater, K., "Controlled Oxidation of Silane," *RCA Review* 29, 618 (1968).
16. Baliga, B. J., and Ghandi, S. K., "Growth of Silica and Phosphosilicate Films," *J. Appl. Phys.* 44, 990 (1973).
17. Kern, W., and Heim, R. C., "Chemical Vapor Deposition of Silicate Glasses for Semiconductor Devices," *Electrochem. Soc. Ext. Abstr.* 5, No. 1, pp. 234-235 (Spring 1968).
18. Fisher, A.W., Amick, J.A., Hyman, H., and Scott, J.H., Jr., "Diffusion Characteristics and Applications of Doped Silicon Dioxide Layers Deposited from Silane ( $\text{SiH}_4$ )" *RCA Review* 29, 533 (1968).
19. Fisher, A. W., and Amick, J. A., "Diffusion Characteristics of Doped Silicon Dioxide Layers Deposited from Premixed Hydrides," *RCA Review* 29, 549 (1968).
20. Strater, K., and Mayer, A., "Oxidation of Silane, Phosphine and Diborane During Deposition of Doped-Oxide Diffusion Sources," in *Semiconductor Silicon*, Haberecht, R. R., and Kern, E. I., Eds., (The Electrochem. Soc., Inc., New York, 1969), pp. 469-480.

21. Iokuyama, T., Miyazaki, T., and Horieuchi, M., "Low-Temperature-Deposited Glass for Passivation of Semiconductor Devices," in *Thin Film Dielectrics*, Vratny, F., Ed., (The Electrochem. Soc., Inc., New York, 1969), pp. 297-326.
22. Kern, W., and Heim, R. C., "Chemical Vapor Deposition of Silicate Glasses for Use with Silicon Devices — I. Deposition Techniques," *J. Electrochem. Soc.* 117, 562 (1970).
23. Kern, W., and Heim, R. C., "Chemical Vapor Deposition of Silicate Glasses for Use with Silicon Devices — II. Film Properties," *J. Electrochem. Soc.* 117, 568 (1970).
24. Kern, W., and Fisher, A. W., "Deposition and Properties of Silicon Dioxide and Silicate Films Prepared by Low-Temperature Oxidation of Hydrides," *RCA Review* 31, 715 (1970).
25. Schlacter, M. M., Schlegel, E. S., Keen, R. S., Iathlaen, R. A., and Schnable, G. L., "Advantages of Vapor-Plated Phosphosilicate Films in Large-Scale Integrated Circuit Arrays," *IEEE Trans. Electron Devices ED-17*, 1077 (1970).
26. Schnable, G.L., "Glass Passivation of Integrated Circuits by Chemical Vapor Deposition of Oxide Films," *IEEE 1971 Int'l Conv. Digest*, pp. 586-587 (1971).
27. Shibata, M., and Sugawara, K., "Deposition Rate and Phosphorus Concentration of Phosphosilicate Glass Films in Relation to  $\text{O}_2/\text{SiH}_4 + \text{PH}_3$  Mole Fraction," *J. Electrochem. Soc.* 122, 155 (1975).
28. Shibata, M., Yoshimi, T., and Sugawara, K., "Deposition Rate and Phosphorus Concentration of Phosphosilicate Glass Films in Relation to  $\text{PH}_3/\text{SiH}_4 + \text{PH}_3$  Mole Fraction," *J. Electrochem. Soc.* 122, 157 (1975).
29. Wong, J. and Ghezzi, M., "Vapor Deposition of High  $\text{P}_2\text{O}_5$  Content Binary Phosphosilicate Films on Silicon," *J. Electrochem. Soc.* 122, 1268 (1975).
30. Wahl, G., "Chemical Vapor Deposition of  $\text{SiO}_2$  and Boron- and Phospho-silicate Glasses by the Reaction of  $\text{SiH}_4$ ,  $\text{B}_2\text{H}_6$  or  $\text{PH}_3$  with Oxygen," in *Chemical Vapor Deposition*, Blocher, J.M., Jr., Hintermann, H.E., and Hall, I.H., Eds. — Fifth Int'l Conf., The Electrochem. Soc., Inc., Princeton, N.J. (1975), pp. 391-406.
31. Middlehoek, J. and Klinkhamer, A.J.,  $\text{SiO}_2$  Deposition Using Mixtures of  $\text{SiH}_4$  -  $\text{O}_2$  and A," in *Chemical Vapor Deposition*, Blocher, J.M., Jr., Hintermann, H.E., and Hall, I.H., Eds. — Fifth Int'l Conf., The Electrochem. Soc., Inc., Princeton, N.J. (1975), pp. 30-42.
32. Kern, W., "Chemical Vapor Deposition Techniques for Glass Passivation of Semiconductor Devices," *Proc. IEEE 1975 National Aerospace and Electronics Conf.: NAECON 75 Record*, pp. 93-100 (IEEE Cat. No. 75CH0956-3-NAECON).
33. Kern, W., et al., to be published.
34. Vossen, J.L., Stephens, A.W., and Schnable, G.L., "Bibliography on Metallization Materials and Techniques for Silicon Devices," Monograph #2, Thin Film Division, American Vacuum Society (1974).
35. Hammond, M.L., "Thin Film Preparation by Chemical Vapor Deposition," (Abstract), *J. Vac. Sci. Technol.* 10, 268 (1973).
36. Benzing, W.C. and Fisk, R., "Automation in CVD Wafer Processing," *Solid State Technology* 18, No. 1, 30 (January 1975).
37. Mayer, A., Strater, K., and Puotinen, D.A., "Manufacturing Techniques for Controlled Deposition and Application of Doped Oxides," *Tech. Rpt. AFML-70-TR-191* (September 1970).
38. Kern, W., "Apparatus for Chemical Vapor Deposition of Oxide and Glass Films," *RCA Review* 39, 525 (1968).
39. DeNicola, J.A. and Mastropiero, R.D., "Design and Maintenance of High Purity Gas-Handling Systems," *Solid State Technol.*, 15, No. 2, 51 (February 1972).
40. Wollam, J., "Equipment for the Chemical Vapor Deposition of Ultra-Uniform Silicon Dioxide Films," *Solid State Technol.*, 14, No. 12, 72 (December 1971).
41. "Cold Wall Semicon Reactor," *Circuits Manufacturing*, 14, 47 (November 1974).
42. Benzing, W.C. Rosler, R.S. and East, R.W., "A Production Reactor for Continuous Deposition of Silicon Dioxide," *Solid State Technol.* 16, No. 11, 37 (November 1973).
43. Flaschen, S.S., Evitts, H.C., and Black, J.R., "Large Area Semiconductor Surface Passivation Production Refinement Program," DA-36-039-AMC-02280(E), *Final Tech. Rep.* (1965), (Motorola, Inc.).
44. Barry, M.I., "A Continuous Process for the Deposition of Silicon Oxide from the Oxidation of Silane," in *Chemical Vapor Deposition*, Blocher, J.M., Jr. and Withers, J.C., Eds., — Second Int'l. Conf., The Electrochem. Soc., New York (1970), pp. 595-617.
45. "Vapor Deposition Unit is Modular," *Electronics*, 47, 138 (September 5, 1974).
46. "Danish Firm offers Vapor System," *Electronic News*, page 60, (June 5, 1972).

# Structure and properties of thin metal films

D.M. Hoffman

The properties of vacuum-evaporated thin metal films are directly attributable to the conditions of preparation. Among these parameters are residual atmosphere, rates of evaporation and deposition, purity of source material and evaporant, substrate temperature, and cleanliness. Some of the reasons for variation of the properties of films from those of bulk metals are discussed as well as ways of minimizing these effects. Illustrations focus on metals used in crystal coating, e.g., gold, chromium, and silver.

THE SUBJECT of the structure and properties of thin films fills many volumes<sup>1,2</sup> of learned papers. There have been a number of excellent reviews on the subject. This paper presents a very brief overview of the field as it pertains to thin metal films of up to 1 micrometer thickness and specifically to those metals commonly used in quartz crystal coating, e.g., gold, chromium, and silver. By noting the effects of deposition parameters on the structure and properties of these films, the reader may develop some appreciation of the reasoning behind the procedures developed for the manufacture of thin-film devices.

Some of the desired properties of these films are:

- Good adhesion to the substrate under various conditions of temperature, atmosphere, and stress
- Stable electrical conductivity or resistivity
- Bulk density—low porosity

Principal problem areas affecting the properties of thin films are:

- The substrate and interaction with it
- The structure of the film
- The density of the film
- Stresses in the film

The deposition parameters affecting all of the above areas are:

- Substrate material
- Film material
- Substrate temperature

- Deposition rate
- Gas pressure
- Gas composition

## Adhesion

Adhesion involves the interaction between substrate and film interface. D. Mattox<sup>3</sup> and B. Chapman<sup>4</sup> have recently written excellent discussions of the subject which are briefly summarized here. The four types of adhesion are: (Fig. 1):

- Mechanical
- Interfacial
- Intermediate layer
- Interdiffusion

Mechanical adhesion occurs where macroscopic substrate roughness provides a mechanical locking of the film and a larger surface area for bonding. It can be enhanced by mechanical abrasion such as polishing, lapping, or sand or glass blasting of the substrate. Chemical etching or ion bombardment can be used as well. Excessive roughness and self shadowing<sup>5</sup> can, however, cause loss of adhesion by producing uncoated areas or voids and vacancies in the film.

In interfacial adhesion, the film and substrate meet at a well-defined interface. Obviously, any interference with this interface, or any contaminating layer whether superficial dirt or an undesired oxide layer will degrade the adhesion. Proper cleaning and maintenance of the clean surface until deposition is of paramount importance. Many treatises have been written on the subject of substrate cleaning, where there seem to be as many "correct" procedures as authors. Holland's<sup>6</sup> excellent discussion of the subject points out the use of solvent cleaning and/or chemical cleaning to remove organics; low power ultrasonics with solvent or detergent; final vapor degreasing in iso-propyl alcohol which, interestingly, offers very nearly as clean surfaces as glow-discharge cleaning.

It should be recalled that at  $10^{-6}$  Torr only one second is required to form a monomolecular layer of residual gas on the substrate. The elapsed time between cessation of cleaning and the onset of deposition must be very short in order to ensure a clean surface. One obvious solution is to work under ultra-high vacuum conditions where longer working times are possible. A more generally practicable method is to vacuum bake or use a glow-discharge cleaning immediate-

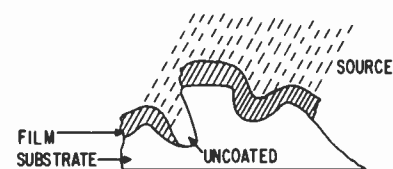

## Mechanical

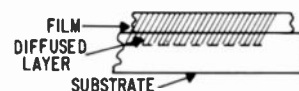

## Interdiffusional

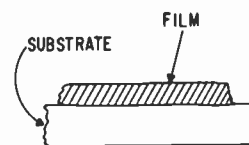

## Interfacial

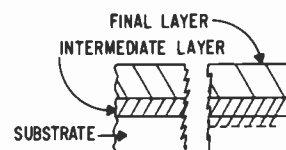

## Intermediate Layer

Fig. 1 — Types of adhesion: mechanical, interdiffusional, interfacial, and intermediate layer.

ly prior to depositions. Neither of the latter methods guarantees an "absolutely" clean surface because of the time limitation described. A system may be baked and purged in an inert gas to minimize residual gas components such as  $H_2O$  or  $O_2$  which can cause undesirable reactions.

Since the properties of thin metal films are a function of the amount and kind of contamination present, an "absolutely" clean surface is not always desirable. Intermediate layer adhesion requires a bonding layer between the film and substrate. This consists of compounds of the materials with each other and/or the residual gases. A natural intermediate oxide forms between metals such as Al or



Cr and the oxygen in glass. Colbert<sup>7</sup> has reported that metal films adhering strongly to silica-containing substrates can be produced by deposition of very thin intermediate layers of metallic oxides, sulphides, selenates and phosphates, silver chloride, and magnesium fluoride. The oxides were obtained from an oxygen glow discharge of an evaporated material. A reactive evaporation, evaporation in a "high" partial pressure of a desired gas, could also be used.<sup>21</sup> Intermediate oxide layers can be attained by depositing oxygen active metals such as *Ti*, *Cr*, *Mo*, and *Ta*. These can then be coated with metals adherent to them. This is the basis of the widely used *Cr-Au*, *Ti-Au*, and *Ta-Au* systems.

Interdiffusion of the film and substrate is widely used in the semiconductor industry to produce contacts on silicon for various devices. All of the transition metals such as *Ti*, *Zr*, *Hf*, *Nb*, *Ta*, *Cr*, *Mo*, *Fe*, *Ni*, *Co*, etc., can be used, as can the noble metals *Pt*, *Rh*, *Pd*, etc., other than *Au* and *Ag*. The latter form undesirable eutectics with silicon. Diffusion during deposition can occur with proper choice of substrate temperature. In most operations, however, a diffusion step is used after deposition.

## Structure

### Substrate temperature

At low temperatures, film structure

depends on the bond character of the film material. Typical metals, e.g., *Cu*, *Al*, form crystalline layers even at liquid helium temperature.

With increasing substrate temperatures, the size of the crystallites increases and number of lattice faults decreases. The effect of substrate temperature on crystallite size has been measured by Fleet<sup>8</sup> for nickel on glass or fused silica. Fig. 2 illustrates the change in average size from 60 Å at 25 °C to 1000 Å at 350°C.

### Condensation rate

Thun<sup>9</sup> has demonstrated, for 1000 Å *Cr* films, that grain diameter at 25°C was independent of rate from 10 to 500 Å/sec (Fig. 3). At higher substrate temperature, grain diameter remained constant up to a threshold beyond which it began to decrease with increasing rate. He postulates that the high mobility surface atoms were buried before they could reach ordered lattice sites. Similar results were reported by Campbell<sup>10</sup> for *Au* and Sennett and Scott<sup>11</sup> for *Ag*.

For a fixed condensation rate and substrate temperature, the crystal size is dependent upon the film thickness. Initially, an increasing crystal size is obtained followed by a gradual decrease to constant average diameter of about 100 Å for *Ni* and *Au* (Fig. 4). Blakely,<sup>12</sup> shows

Dorothy Hoffman, Thin Film Technology, RCA Laboratories, Princeton, N.J., received the BS in Chemical Engineering from Rensselaer Polytechnic Institute and the MS in Chemical Engineering from Bucknell University. After a year with the General Electric Research Laboratory in Schenectady, she joined the International Resistance Company in Philadelphia, where as research engineer and later as head of process development she played a major part in the development of the evaporated metal film resistor. In 1962 she joined RCA as a member of the Technical Staff in the Astro-Electronics Affiliated Laboratory at the David Sarnoff Research Center. Since 1967 she has been in charge of the Engineering Service Thin-Film Technology Group, working with evaporated films of many materials. Mrs. Hoffman, past President of the American Vacuum Society, is a member of the Society of Women Engineers, and a member of the Engineers' Club of Philadelphia. She is past President of the Engineering and Technical Societies Council of Delaware Valley. She has published many papers and holds several patents on evaporated films.

Reprint RE-21-5-9

Final manuscript received August 15, 1974.

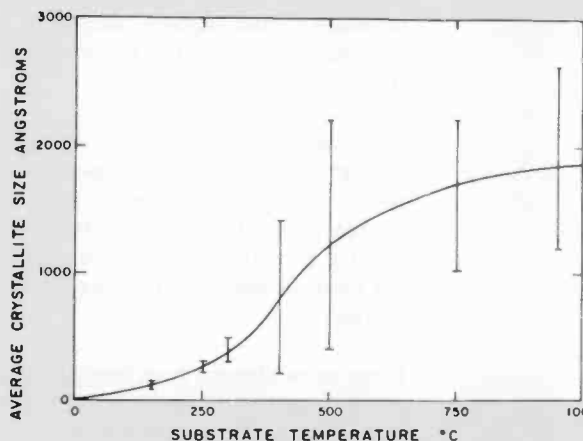
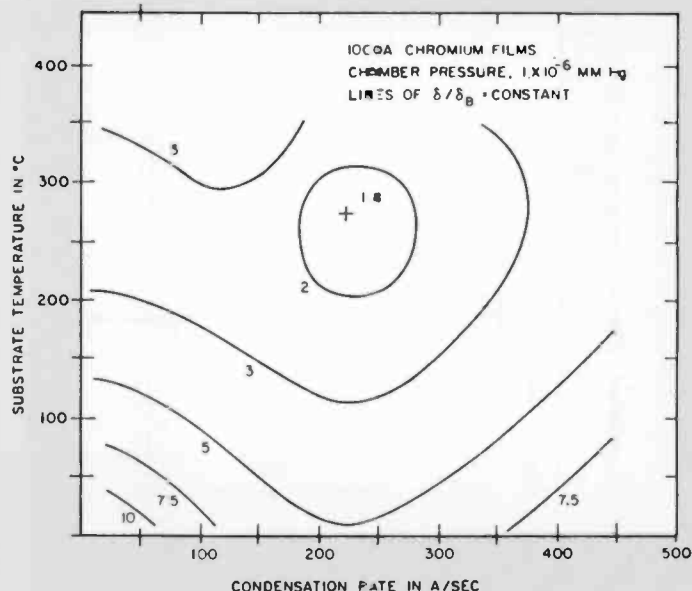

Fig. 2 (above) — Crystallite size in 500-Angstrom-thick nickel films as a function of substrate temperature.<sup>18</sup> Fig. 3 (right) — Variation of specific resistivity with substrate temperature and condensation rate.



that *Au* films deposited at 40°C consist of grains that extend from one surface to the other. This has also been observed in *Al* films.<sup>13</sup>

### Annealing

Annealing may cause large changes in crystallite size. Blakely,<sup>12</sup> observing carbon-coated *Au* films at 600°C in an electron microscope, indicated that two stages of aggregation occurred. The first was recrystallization to a stable grain structure and then separation of grains along stationary grain boundaries. This may leave voids between some crystallites. Grimpl<sup>14</sup> has observed an amorphous *Au* film between the islands.

If a film is annealed at a temperature higher than the deposition temperature, resulting grain sizes are much smaller than those found in films deposited at the higher temperature.

### Residual gas atmosphere

Adsorbed gas atoms lead to decreased surface mobility and small grain size. Trapping of gas atoms results in porous, highly disordered films. Formation of chemical compounds may occur at higher substrate temperatures where gases of greater chemical affinity are present.

The effect of residual gas on highly active metals may be illustrated by chromium films. Reaction with  $O_2$  or  $H_2O$  in the

residual atmosphere causes chromium oxides to form. These segregate at the grain boundaries and result in a hard film that has a lower electrical conductivity, more negative temperature coefficient of resistivity, and a brownish optical transmission rather than the blue found in "pure" *Cr* films.<sup>22,23</sup>

### Density

Where, because of low substrate temperature, low mobility exists and residual gases are present, a density lower than bulk is often obtained. The great majority of structural faults are concentrated at grain boundaries. Many metals exhibit a density maximum at substrate temperatures between 150° and 300°C.

A density maximum is observed for variation in condensation rate.<sup>9</sup> At very low rates, the low nucleation rate and long mean-free time of the surface atoms permit preferential growth and thereby rough films with relatively loose packing. With increasing rates the film density and smoothness increase up to the threshold described previously.

X-ray diffraction indicates that the density within crystallites is almost that of the bulk metal. The low density of films must then arise from voids in discontinuous films or high concentrations of impurities, e.g., oxides, as well as vacancies at the grain boundaries in continuous films.

### Stress

Stress in thin films consists of two components:

- 1) *Thermal Stress.* Thermal stresses are based on differences in thermal coefficients of expansion between film and substrate at deposition temperature and temperature of interest. Actual measurements are difficult because of problems in measuring film temperature. Thermal stress varies widely with substrate temperature and materials involved. The effects can be large and either tensile or compressive. They can be controlled in some cases by choice of film and substrate material. For metals on quartz, the thermal stresses in the film are tensile at room temperature.
- 2) *Intrinsic Stress.* Intrinsic stress is believed to arise from film contamination and incomplete ordering of the structure during growth. We can expect, therefore, a dependence upon thickness, condensation rate, deposition temperature, residual gas, etc.

Average stress in thick films is relatively independent of film thickness. Measurements<sup>15</sup> on some 1000-Å thick films have shown that stress does not appear to depend strongly on substrate material.

Measurement of internal stresses in *Au* films on room-temperature quartz, measured by Kinbara<sup>16</sup>, indicates that the films consist of a 1000-Å thick base layer of inhomogeneous stress and a superposed region of uniform stress. For deposition temperatures between -150°C and +200°C metals commonly deposit in tension. With increasing substrate temperature, the deposition stress decreases, often linearly, and goes to compression at higher temperatures<sup>15</sup> (Fig. 5).

Some influence of the deposition rate on average stress has been reported for permalloy<sup>17</sup> and copper<sup>18</sup> where the stress increases with rate up to some saturation at rates of ~70 Å/sec. No strong effect has been observed by others over a 20% change.

Large stress changes have been observed in films prepared in vacuum systems without cold trap especially with annealing, but the stresses in films deposited in low-water-content systems are not very sensitive to moderate changes in gas pressure. There is some evidence that the deposition atmosphere affects film stress. Compression stress was found in *Al* films deposited at over  $10^{-4}$  Torr<sup>19</sup> and in

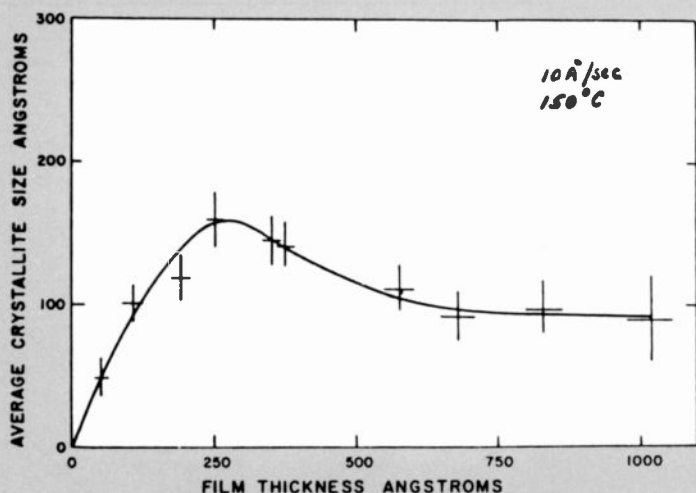

Fig. 4 — Crystallite size in nickel films as a function of film thickness.<sup>15</sup>

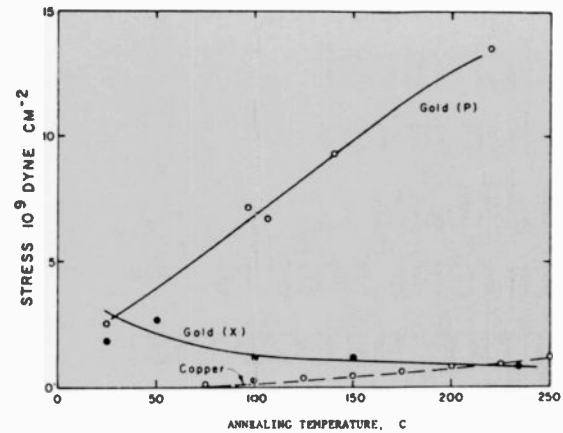
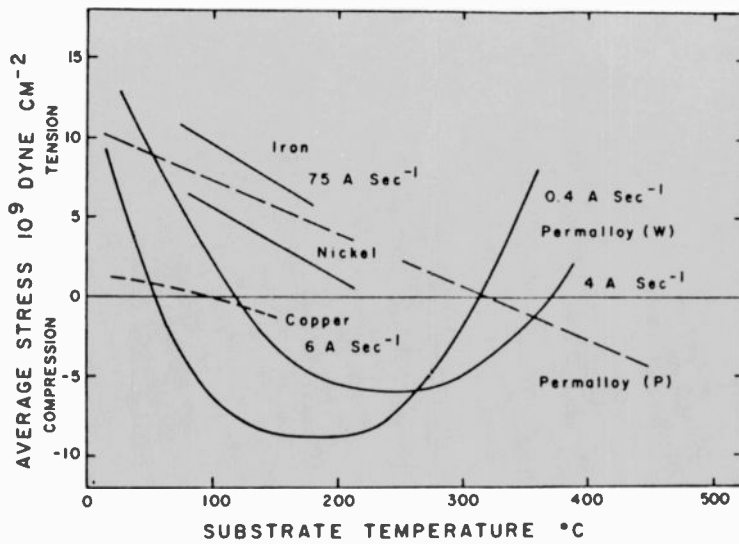

Fig. 5 (left) — Average stress as a function of substrate temperature. Permalloy (P) is total stress measured at room temperature. Other data are intrinsic stress values.<sup>15</sup> Fig. 6 (above) — Stress annealing in gold and copper.<sup>16</sup> Shown above are X-ray (X) and circular-plate (P) experiments.

copper films aged in air at room temperature.<sup>20</sup> In both cases this was attributed to oxide formation within or on the surface of the films.

Irreversible changes in intrinsic stress occur upon an extended anneal. Lattice effects are reduced and recrystallization occurs. Annealing data for gold<sup>16</sup> is shown in Fig. 6. Widely differing results between x-ray and mechanical bending deflection measurements indicate a stress relief with the grains but an increase in stress in the highly disordered grain boundary areas.

## Conclusion and recommendations

We have seen that the following conditions are necessary for obtaining satisfactory metal films:

- 1) Cleaning of substrate to provide proper conditions for adhesion.
- 2) Maintenance of surface cleanliness until film is deposited.
- 3) Provision of intermediate layer where necessary. This can be an oxide, a metal, or other nucleating agent.

The effect of deposition parameters on the film structure are summarized below:

- 1) Crystallite size is independent of deposition rate up to 500 Å/sec. but increases markedly with increasing substrate temperature. Grains generally are the thickness of the film.
- 2) Film density and smoothness increase with condensation rate up to the threshold described.
- 3) For many metals, a density maximum may be obtained at substrate temperatures

between 150°C and 300°C.

4. The presence of adsorbed gases generally causes smaller grain size and porous, highly disorganized films. It also leads to films of lower density than that of bulk.
- 5) Annealing may cause grain growth which is not as large as that obtained by deposition at the same substrate temperature.
6. Thermal stresses may be controlled by judicious choice of film and substrate material.
7. Intrinsic stresses appear to be independent of substrate material. They arise from film contamination and structural disorder during growth. Compressive stresses may occur due to oxide formation at the surface or within the film.
- 8) Stress tends to decrease with increasing substrate temperature and increase with rate up to about 70 Å/sec. Stress relief within the grains occurs with extended anneal while an increase in stress occurs within the grain boundary areas.

In order to obtain films with characteristics of the bulk metal, it is necessary to deposit onto a "clean" substrate held between 150°C to 300°C at rates of the order of 70 Å/sec. Smooth, maximum density film should result. These can be annealed to provide some stress relief.

On the other hand, a vast array of useful films can be made by carefully controlling the position, amount, and chemical nature of the "dirt" or contamination incorporated into the film.

## References

1. Hass, G. (ed.); *Physics of Thin Films*, Vol. 1-7, (Academic Press, N.Y.).
2. Maissel, L.I.; and Glang, R. (eds.); *Handbook of Thin Film Technology*, (McGraw-Hill; 1970).

3. Mattox, D.M.; "Thin film metallization of oxides in microelectronics," *Thin Solid Films*, Vol. 18, (1973) pp. 176-186.
4. Chapman, B.N.; "Thin film adhesion," *J. Vac. Sci. Technol.*, Vol. 11 (1974) p. 106.
5. Kern, W.; Vossen, J.L.; Schnable, G.L.; "Improved reliability of electronic devices through optimized coverage of surface topography," *11th Annual Proceedings on Reliability Physics* (IEEE, New York, 1973).
6. Holland, L.; *Properties of Glass Surfaces* (Wiley; 1964).
7. Colbert, W.H.; Weinrich, A.R.; and Morgan, W.L.; British Patents Nos. 605 871-605 872, 605 873, 605-874 (1948).
8. Fleet, S.G.; Mallard Res. Lab. Rep. 466 (1963).
9. Thun, R.E.; "Structure of Thin Films," *Physics of thin films* (G. Hass, ed.), Vol. 1, (Academic Press, New York, 1963).
10. Campbell, D.S.; Stirling, D.J.; and Blackburn, H.; "A study of the structure of evaporated lithium fluoride," *Phil. Mag.* Vol. 7, (1962) p. 1099.
11. Sennett, R.S.; and Scott, G.D.; "The structure of evaporated metal films and their optical properties," *J. Opt. Soc. Am.* Vol. 40 (1950) p. 203.
12. Blakely, J.M.; "Mechanical properties of vacuum-deposited gold films," *J. Appl. Phys.* Vol. 35, (1964) p. 1756.
13. Palatnick, L.S.; YaFuks, M.; Boiko, B.T.; and Pariskii, V.B.; "Electron diffraction investigation of the substructure of fine aluminum condensates with the 'microbeam' method," *Fiz. Metal, i Metalloved.* Vol. 11 (1961) p. 864; *Phys. Metal Metallog.* (USSR) English Transl. Vol. 11 (6) (1964) p. 44.
14. Grimpl, M.L.; McMaster, A.D.; and Fuschillo, N.; "Amorphous oxide layers on gold and nickel films observed by electron microscopy," *J. Appl. Phys.* Vol. 35 (1964) p. 3572.
15. Hoffman, R.W.; "Mechanical properties of thin condensed films," *Physics of Thin Films* (G. Hass and R.E. Thun, eds.; Vol. 3; Academic Press, New York; 1966).
16. Kinbara, A.; *Oyo Butsuri* Vol. 30, (1961) p. 496.
17. Weiss, G.P.; and Smith, D.O.; "Isotropic stress measurements in permalloy films," *J. Appl. Phys.* Vol. 33 (1962) p. 1166S.
18. Horikoshi, H.; Ozawa, Y.; and Hasunuma, H.; "Stress in evaporated copper films," *Japanese J. of Applied Phys.*, Vol. 1 (1962) p. 304.
19. Murbach, H.P.; and Wilman, H.; "The origin of stress in metal layers condensed from the vapour in high vacuum," *Proc. Phys. Soc. (London)* B66 (1953) p. 905.
20. Halliday, J.S.; Rymer, T.B.; and Wright, K.H.R.; "An electron-diffraction examination of thin films of lithium fluoride and copper prepared by vacuum evaporation," *Proc. Roy. Soc. (London)* A225 (1954) p. 548.
21. Hoffman, D.M.; and Coutts, M.; *J. Vac. Sci. Technol.*, to be published.
22. Hoffman, D.M.; and Riseman, J.; "Resistance-temperature characteristics of evaporated chromium films," *Trans. of 4th National Symposium on Vacuum Tech.* (1957; Pergamon Press).
23. Hoffman, D.M.; and Riseman, J.; "Evaporated chromium films on hot substrates," *Trans. of 6th National Symposium on Vacuum Tech.* (1960; Pergamon Press).

## Engineer and the Corporation

# Technical education in RCA: current status — future directions

Dr. W.J. Underwood

A series of studies conducted in 1973 and 1974 has shown that RCA's internal technical education program reaches an effective cross-section of engineers and is useful to them in their jobs. In the future, the engineers would like the education to be more applied, shorter, and more self-regulated. The direction of the internal education program has already been altered to be responsive, and possible new future directions involving a larger personal development concept for engineers are taking shape.

**RCA** has long been active in offering in-house training to its technical community. During-hours programs, after-hours programs, formal courses, seminars, colloquia, "film theaters," workshops—all have played a part in the effort to maintain a viable technical competence. The primary organizational responsibility for such activity rests with the Training group in Industrial Relations.

In 1967, an adjunct unit was established on RCA's Corporate Engineering staff to prepare and disseminate formal *technical* courses in video tape format. Because of its corporate position, its exclusive technical focus, and its video tape format, the new unit could attract and make available outstanding teaching talent to numerous geographically separated engineering departments. It functions, therefore, as a cooperative effort between the technical and Industrial Relations communities. Descriptions of the educational technology of this unit have been published elsewhere.<sup>1-4</sup>

Figures 1, 2, and 3 summarize the unit's activity in terms of number of courses, enrollments, and number of classes.

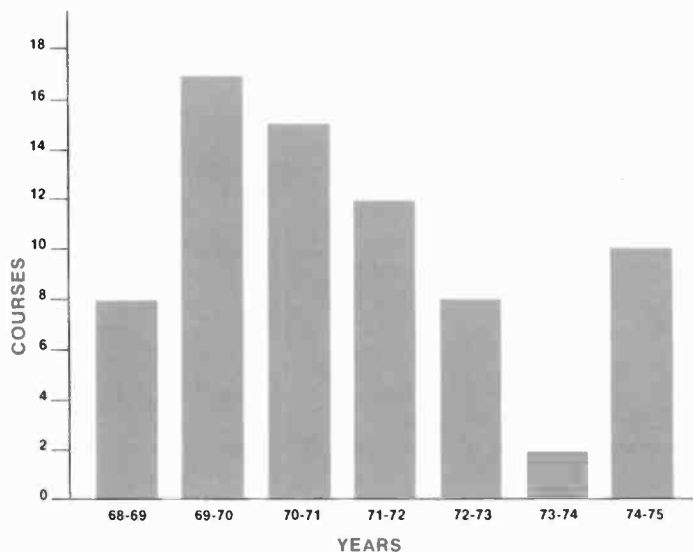

Fig. 1 — Number of new courses added to the video tape inventory by year. (Remakes and revisions are not indicated.)

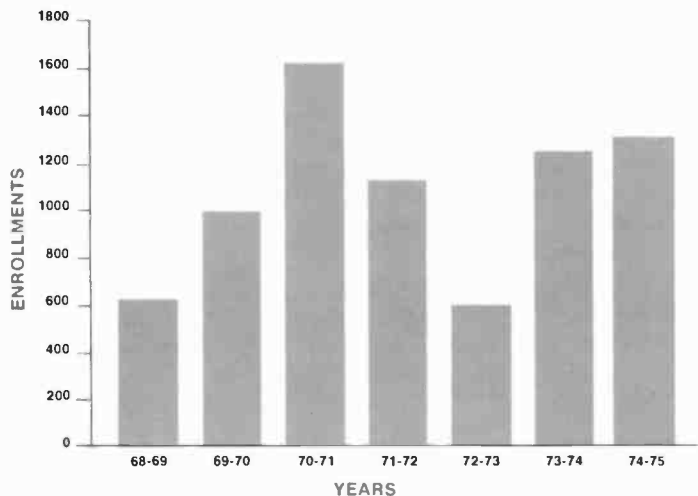

Fig. 2 — Number of enrollments by academic year.

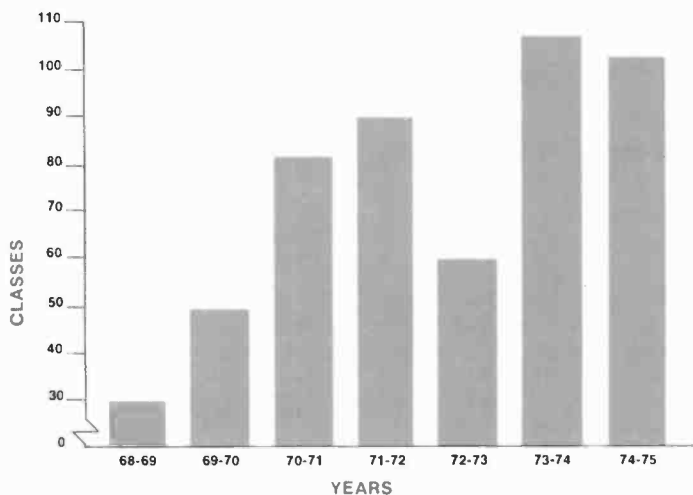

Fig. 3 — Number of separate classes by academic year.

The general impression regarding the work of the Corporate Engineering Education unit over the eight years of its existence is favorable. However, in 1973 and 1974 a series of studies were completed to probe in more detail the unit's relevance and effectiveness. Several findings from those studies have had considerable impact internally and may have importance elsewhere. They are described in this paper, and their probable effect on the future is discussed.

### Job application

An initial study sought to discover the extent to which engineers applied the knowledge and skills gained from the video tape education program. Questionnaire responses were obtained from 135 scientists, engineers, and technologists. These respondents had completed a video tape course six to ten months prior to receiving the questionnaire, allowing that length of time for job application. They were asked to indicate the extent of job application and to provide an example of it or to explain why no or very little application had occurred.

A very conservative interpretation of the responses indicated that 64% had made substantial use of the course material in their work. Typical of examples given are:

"the *Fourier Transform* was used to predict the output purity of a microwave tube. Substantial circuit simplification and cost reductions were achieved."

"I design power supplies for airborne and space applications. The course helped me to utilize digital control circuits in switching regulators."

Another 14% indicated that they expected to use the course material in their work in the near future, but had not done so in the time interval surveyed.

The number reporting job application is gratifying. It becomes even more significant when the following are taken into account:

- Job relevance is not a matriculation requirement.
- The reasons most frequently given for lack of job application were:
  - Took the course for broadening into a new field.

- Took the course as prerequisite for another which is applicable.
- Was applicable, but I subsequently changed jobs.
- Not enough time has elapsed.

It is concluded from the survey that most participants select courses in the expectation of job relevance and are able to find significant application to their jobs.

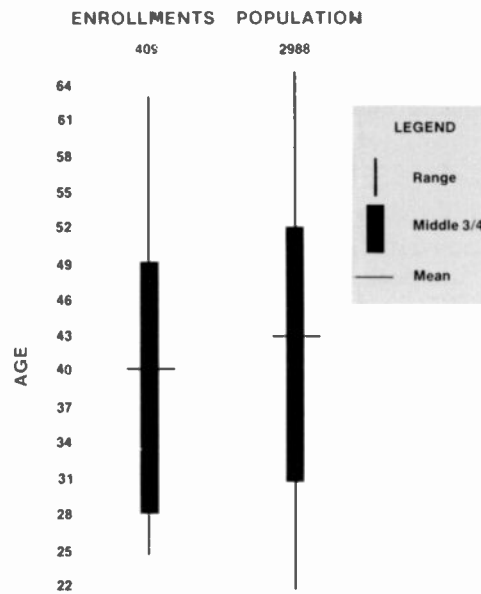

Fig. 4 — Age distribution of course enrolments and a relevant engineering population.

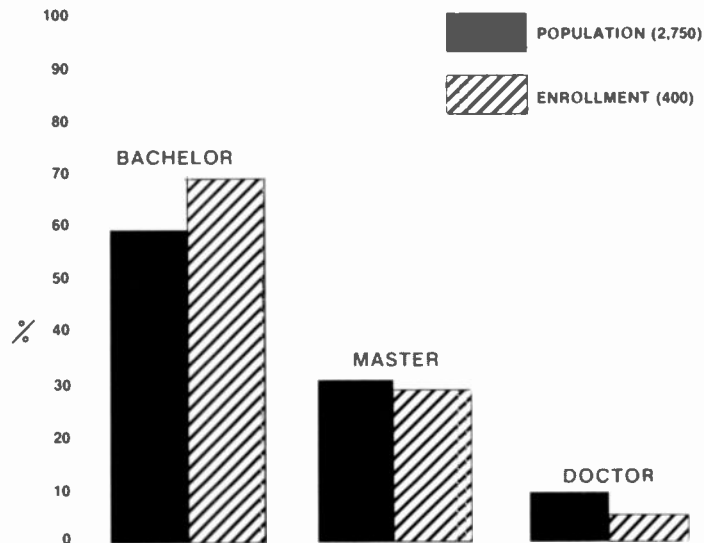

Fig. 5 — Distribution of educational levels of course enrolments and a relevant engineering population.

Table 1 — Percentage of course enrollment and a relevant engineering population by performance ratings.

	Performance rating		
	Lower 1/3	Middle 1/3	Upper 1/3
Enrollments (70)	4	60	36
Population (400)	5	63	32

### Enrollment distribution

A second study was undertaken to determine what segment of the engineering population at RCA enrolls in the video tape courses in respect to age, degree, and performance. The results are summarized in Figs. 4 and 5 and Table 1. These comparisons show that dis-

tributions of age, degree, and performance rating among enrollments are very similar to those in the population. We regard this as the optimum condition.

### General study

A third and rather extensive study sought answers to several questions among which were these:

- What methods do engineers rely on to remain technically viable and which of these to they believe are most effective?
- What factors make it difficult for engineers to remain technically viable?
- What changes in our in-house education program would be helpful?

About 300 engineers and engineering supervisors from seven different engineering departments were interviewed for two hours in groups of four to six. Respondents were judgmentally selected for a population of 2,000 as being representative.

Table II answers the question concerning updating methods used by engineers. Preliminary interviews identified ten

methods as most prevalent. These ten methods were then ranked by the respondent groups—first in terms of *most frequently relied on* and then in terms of *most effective*.

Technically *challenging work*, *informal discussions* with colleagues both inside and outside the company, and *reading* were ranked one, two, three, respectively, against both criteria. *Education* in the form of seminars, lecturers, meetings, and formal courses was next in effectiveness. However, learning from *vendor/customer contact* was reported as used more frequently than education.

Table III shows a rank ordering of factors which make is difficult to maintain technical viability.

Lists of inhibiting factors have been the object of several studies. Factors located in the job, in the organization, and in the person have been identified.<sup>5</sup> The factors ranked by respondents in this study place *job pressure* highest. They define this primarily as a lot to do in a given time which results in a "rushed" feeling. It is

Table III — Inhibiting factors

MOST	Job pressure
	Lack of reward
	Outside interests
	Lack of organizational importance
	Technically non-challenging work
	Lack of adequate formal courses
	Personality
	Lack of adequate resources
	Complexity of the technology
LEAST	Age

inhibiting due to "no time to study" and/or "too tired to study." Job pressure would probably be classified as an organizational factor as would *lack of reward* which placed second. Reward was defined as both tangible (salary increase, promotion) and intangible (compliment). Ranked third is a more personal factor, a preference to devote time to family, community, hobby, etc., rather than to technical updating activities. Fourth is clearly an organizational factor, *lack of organizational importance*. This factor refers to tangible signs of importance or lack of importance. It was aptly put by Gray,<sup>6</sup> "...the engineer gets a tough hassle if he...asks for an hour or two a week off to take a course...gets his head chopped off if he can't travel right in the middle of exams...is castrated if he tries to take a day off to study for finals..." In fifth position is the degree of technical challenge in the job. Respondents were in near unanimous agreement that *job pressure* is the most inhibiting factor and that *age* is the least inhibiting factor.

Responses concerning how our in-house educational program could be more helpful were especially enlightening. The most frequent recommendation and the one most emphatically expressed concerned theory versus application. The respondents urged us to

"stop competing with the colleges and make your courses highly applied." They explained further, "Use just enough theory to make application intelligent, but concentrate on practical examples of actual applications—focus on how-to-use-it." We were accused

Table II — Updating methods.

Most relied on		Most effective
Challenging work	MOST ↑ ↓ LEAST	Challenging work
Informal discussion		Informal discussion
Reading		Reading
Vendor/customer contact		Seminar/lecture/meeting
Formal courses		Formal courses
Seminar/lecture/meeting		Planned job rotation
Competitor analysis		Vendor/customer contact
Design review		Design review
Trade show/convention		Competitor Analysis
Planned job rotation		Trade show/convention

**REA**

# Engineering Education

Computer Fundamentals ■ Che  
ng, and Logic Circuits II ■ Feer  
s ■ Complex Variable ■ Phase Attenu  
s ■ Applied Heat Transfer ■ Shoc  
s II ■ Semiconductor Devices ■ Che  
igital Computer Fundamentals ■ Che  
itching, and Logic Circuits II ■ Feer  
s I ■ Complex Variable ■ Phase Attenu  
s ■ Applied Heat Transfer ■ Shoc  
ics ■ Pulse, Switching, and  
n Mathematics ■ Applic  
Statistics ■ Device Phys  
ts ■ Pulse  
ering

conomic Analysis ■ Accounting for Engine  
Chemical Theory and Practice I ■ Thick  
ogic Circuits II ■ Feedback Theory and  
Complex Variable ■ Phase Attenuation  
ics ■ Modern Phys  
ic Analysis ■ Accr  
il Theory and Pra  
Feedback Theor  
Complex Variable ■ Phas  
Statistics ■ Applied f  
ern Physics II ■ Sen  
hemical Theory an  
uits II ■ Feedback  
Complex Variable  
Statistics ■ App  
II ■ Semiconduc



"your courses now emphasize theory with application used to help understand the theory. Turn it around; in that way, you would fill a gap not already filled by the colleges. Courses should be tailored specifically to RCA's particular needs and practices."

Another strong recommendation was made concerning the length of courses. Respondents expressed considerable difficulty attending a class schedule of twelve to fourteen weeks. Much more acceptable would be shorter courses of something between one and five weekly sessions. A related recommendation was for split time. Most respondents did not prefer either all company time or all personal time.

There were several requests for some form of self-study material. The possibility of an individual being able to choose his own time and place for study was appealing.

## Future directions

Several conclusions drawn from the above studies will guide our direction for at least the next five years.

- We will continue the video-tape format. It is an acceptable, cost effective, and flexible medium. At this time, we use black-and-white format on one inch, open reels. We see no need for color. We do expect to convert to three-quarter-inch cassette.
- We will give much greater emphasis to application. This process has already commenced, and we have discovered that emphasizing application requires a very different and much more difficult procedure.
  - An advance field study is made among representative samples of potential students and of informed people working in the subject. This effort is to determine how a subject should be focused, structured, slanted, etc., to make it most relevant and useful to the design engineer. Also, this search locates examples of applications and potential instructors.
  - Syllabus preparation is more often a committee project than an individual one.
  - Team teaching is used more often.
  - More time is devoted to student exercises, especially "hands on" experiences where possible.
- Instead of concentrating on just the "big winners", we are searching for four- to eight-session "minicourses." It has been possible to pull sections from long courses, and with some filling, produce useful educational modules.

- A new experimental project, termed *Engineering Monographs*, is being developed as a series of short tutorials on single concepts (e.g., *Fourier Transform*) for use as a refresher or as a reference. The *Monographs*, which consist of an audio cassette with printed visuals and a written supplement will be stocked in company libraries or at other central points in engineering departments. An engineer can listen to the audio while following the visuals by which the essential characteristics of the subject will be introduced. The written supplement can then provide additional depth or breadth. At present, this is our answer to requests for self-study material. More elaborate self-study is under consideration.
- Engineering departments are being encouraged to establish a regular program of seminars. These are envisioned as group discussions stimulated by an expert who can be either from within RCA or the outside. The object is to enhance colleague discussion—one of the more effective updating methods.
- Consideration is being given to a program for granting Continuing Education Units (CEUs). The primary purpose would be to give continuing education more stature in the engineering organizations.

These directions are a change from our past. They are responsive, we believe, to what we learned from our series of studies. If there's a message here for educators, it must be that educators can become obsolete. Our constituents will let us know about it, if we ask.

Engineering management have been most interested in the results of the studies. In some aspects, their expectations were confirmed; in others, they were surprised. Overall, the results have tended to increase management's commitment to provide opportunities sufficient to insure technical depth, breadth, and currentness. In some instances, new programs were commenced (e.g., a regular technical seminar series). In others, more extensive use was made of internal education courses. One division appointed an engineering manager at each of its several locations to be responsible for insuring effective use of technical education, both internal and external.

This increased commitment has opened the door for consideration of a larger personal development concept than just education. An attempt is being made to integrate a variety of activities that now operate rather independently, e.g., technical libraries, professional society activities, internal recognition and achievement award programs, publica-



Dr. William J. Underwood, Director, Engineering Professional Programs, Corporate Engineering Staff, Cherry Hill, N.J., manages a group of activities having corporate responsibility for technical education, technical publication, and technical information services. His background combines engineering and behavioral science. He received the BSEE from West Virginia University and the MEd in group dynamics and the EdD in organizational studies from Temple University. His previous position in RCA concerned management and organization development in corporate Industrial Relations. He holds membership in IEEE, ASEE, ASTD, American Psychological Association, and is a charter member in the International Association of Applied Social Scientists.

Reprint RE-21-5-20

Final manuscript received June 24, 1975.

Copyright 1976 by the Institute of Electrical and Electronics Engineers, Inc. Reprinted, with permission, from *IEEE Trans. on Education*, Vol. E-19, No. 1, February 1976.

tion and presentation activities, and education programs. These share the common aspect of being useful to maintaining technical viability. It appears that a gain in synergy is possible if each activity can be effectively related to the others. Experimentation will be required and management support will make this possible. Such an integration, if it can be achieved, could be the most important future direction of all.

## References

1. Biedenbach, J.M.; "Continuing engineering education by video tape," *Journal of Continuing Education and Training* (May 1971) pp. 23-25.
2. Biedenbach, J.M.; "Continuing engineering education utilizing video tape," *Engineering Education* (May/June 1971) pp. 886-7.
3. Biedenbach, J.M.; "Industrial video tape applications to continuing engineering studies programs," *IEEE Transactions on Education* (Nov 1970) pp. 186-9.
4. Biedenbach, J.M.; "The RCA continuing engineering education program," *RCA Engineer* (Oct/Nov 1969) pp. 186-9.
5. Kaufman, H.G.; "Obsolescence and professional career development," *AMACOM*, 1974.
6. Gray, I.; "Book review: Obsolescence and professional career development," *IEEE Engineering Management Society Newsletter*, (May/June 1974) p. 29.



A2950 — 50 kW



A2960 — 500 kW



A2975 — 100 kW

# Tungsten-matrix cermolox tubes

R.E. Byram | J.T. Mark

The development of long-range deep-search radar has created a need for power tubes capable of operation at pulse lengths up to several milliseconds. To meet this need, RCA is developing a series of long-pulse gridded tubes using tungsten-matrix cathodes for improved efficiency and ruggedness, as well as reduced power demands. One application for these tubes is in phased-array radars where many tubes are operated at moderate power ratings; the necessary phase shifting is accomplished at a lower power level.

**T**O MEET THE NEED for long-pulse tubes, RCA is developing a series of gridded tubes using tungsten-matrix (or tungsten-dispenser) cathodes.<sup>1</sup> Compared with the nickel-matrix-oxide and thoriated-tungsten types now in use, the new tubes represent improvements in three areas: better efficiency, reduced power requirements, and increased ruggedness. The new tubes can produce pulses from 1 to 5 ms in duration at normal duty, and from 10 to 20 ms at reduced duty.

Three tube types are presently in development for pulse-modulator service:

- The RCA A2950 is rated for 50 kW of peak power input,
- The RCA A2975 for 100 kW, and
- The RCA A2960 for 500 kW.

## Advantages of tungsten-matrix cathode

The key to long-pulse operation in these tubes is the cylindrical tungsten-matrix cathode impregnated with barium aluminate. This construction offers several advantages, particularly in military application:

- 1) Arc-resistant operation at high pulse currents,
- 2) No pulse breakup
- 3) No pulse droop,
- 4) Very long life at moderate temperatures, and
- 5) Rugged construction.

### Arc resistance and no pulse breakup

The tungsten-matrix cathode (Figs. 1 and 2) has a smooth, machined metallic surface. This smooth surface reduces high-voltage gradients at the cathode surface and provides for excellent resistance to arcs.

The metallic emitting surface has a very low internal resistance. It is free of self-heating effects and does not form an interface layer. These factors prevent internal arcing (and possible gas evolution) at high pulse currents; they also eliminate the pulse breakup sometimes experienced in the conventional nickel-matrix-oxide cathode tubes with age. Furthermore, unlike the nickel-matrix-oxide cathode, loosely sintered particles cannot break off and cause interelectrode shorts. Also, the cathode coating cannot peel, which is a problem with sprayed cathodes.

### No pulse droop

The pulse-emission and dc-emission capabilities of the tungsten-matrix cathode are essentially the same. The pulse length and emission level are thus not limited by the cathode, but by the allowable dissipation of the other electrodes in the tube. For this reason, no droop in emission occurs with long-pulse operation.

Reprint RE-21-5-11  
Final manuscript received December 2, 1975.

### Long life

The tungsten-matrix cathode is not damaged by gas-ion bombardment, nor is it affected by electrons returned to the cathode due to transit-time effects at the higher frequencies. Provided the tungsten-matrix cathode is not operated at too low a temperature, it is less prone to poisoning by residual gas than oxide cathodes because barium and barium oxide are constantly replenished from the barium aluminate impregnate which fills the entire volume of the tungsten-matrix.

A cathode brightness temperature of 1050°C is high enough to prevent poisoning by residual gas, and yet is a moderate temperature for a tungsten-matrix cathode. At this temperature, cathode emission remains constant and provides for a very long tube life, even under conditions of high cathode loading. Using test diodes at cathode current densities as high as 10 A/cm<sup>2</sup>, constant emission for thousands of hours has been reported, and verified, at RCA.

In the new series of RCA tubes, the dc cathode-current density is held to 200 to 250 mA/cm<sup>2</sup> of cathode area. This figure is double the usual rating for a nickel-matrix-oxide cathode, but it is moderate indeed for a tungsten-matrix cathode. At this level of dc emission, and at the cathode operating temperature being used, the life expectancy of the cathode itself is 50,000 to 100,000 hrs. RCA traveling-wave tubes using tungsten-matrix cathodes are exhibiting 10,000 to

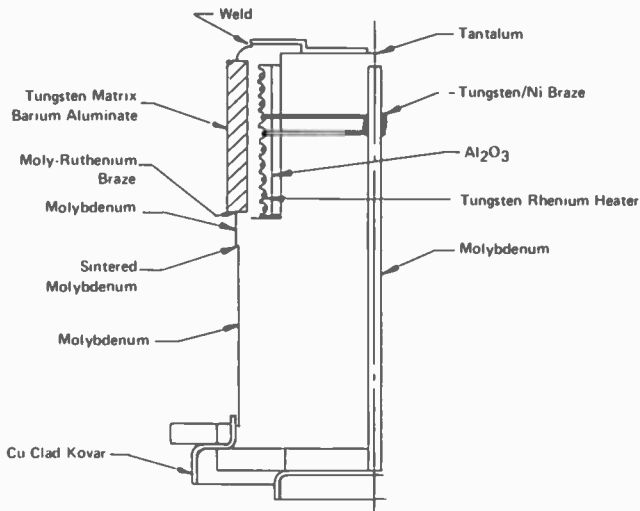

Fig. 1 — Cross section of the heater-cathode assembly used in the RCA A2960. The cathode is a cylindrical tungsten matrix impregnated with barium aluminate. The heat dam, which supports the tungsten-matrix cathode, is made of molybdenum. The heater spool and the heater-spool lid are of tantalum. These are the parts that provide mechanical support for the tungsten-rhenium heater and the associated high-alumina heater retainer ceramic. Tantalum and molybdenum parts are used rather than the more conventional nickel parts because of the operating temperature of the tungsten-matrix cathode (about 1050°C brightness temperature).

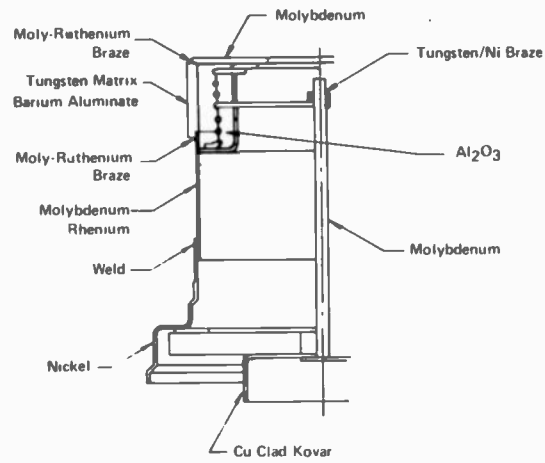

Fig. 2 — Cross section of the RCA A2975 cathode; the RCA A2950 cathode is of similar construction. In both of these types, because of the sequence of manufacturing operations, which requires the entire heater-cathode assembly to be exposed to a hydrogen-atmosphere brazing furnace, no tantalum is used; all parts associated with the cathode are of molybdenum or a molybdenum-rhenium alloy.

15,000 hrs of life, and one European manufacturer of gridded tubes has reported cw dynamic life in excess of 16,000 hrs—and the tubes are still operating.

#### Rugged construction

Many of the advantages that have been outlined for the tungsten-matrix cathode also apply to the thoriated-tungsten filamentary cathode. The tungsten-matrix cathode is much more efficient, however, as only one-fourth to one-half the filament power is needed for equivalent emission levels. The tungsten-matrix cathode is also much more rugged than the thoriated-tungsten filament, and is not susceptible to breakage under anticipated environmental conditions or in shipment. Tubes of the A2950 type have been vibrated to 5- and 10-g levels, with random inputs to 5000 Hz, for periods up to 4.5 hours with no shorts and no damage, and with very low noise levels indicated.

#### Grid-screen construction

All three of the new RCA tetrodes are of the proven RCA Cermolox construction, with the grids and screens simultaneously produced by electrical discharge cutting. The result is perfect alignment of the grid and screen wires. The RCA A2960 makes use of molybdenum for the grid and screen wires, while the A2950 and A2975 have grids and screens of a copper alloy.

Robert E. Byram, Senior Eng., Regular Power Products Design and Applications Engineering, Solid State Division, Lancaster, Pa., received the BSEE from M.I.T. in 1949 and joined RCA in Lancaster that year. He received the MS in Physics from Franklin and Marshall College in 1973. Mr. Byram's initial engineering assignment was the design and development of a beam-power tetrode for use in mobile communications systems. He was also responsible for the design of a very-high- $\mu$  triode used in a shunt regulating circuit to regulate the 27,000-V supply in early color tv receivers. A special anode design used in this tube was later granted a U.S. Patent. Mr. Byram has had several years experience in applications engineering of both power tubes and gas tubes. At present, he is engaged in design and development engineering of a series of gridded power tubes using impregnated tungsten matrix cathodes. Mr. Byram is a member of Sigma Pi Sigma and is a registered professional engineer in the State of Pennsylvania.

John T. Mark, Eng. Ldr., Regular Power Products Design and Applications Engineering, Solid State Division, Lancaster, Pa. received the BS in Radio Engineering from Valparaiso Technical Institute in 1950 and joined RCA in Lancaster that year. Since joining RCA Lancaster 25 years ago, Mr. Mark has developed a vast amount of experience in the design, fabrication, and testing of transmitter and test equipment, regular- and super-power tubes, and ultra-high-vacuum equipment, and in laser tube design, and systems and applications technology for gas lasers and power tubes. In 1958 Mr. Mark was assigned the responsibility for the Matterhorn Project. As the Project Engineer, he was responsible for the direction and control of the C-Stellator Vacuum System, a thermonuclear fusion research machine. Later, he served in the same capacity for the Mark I Aerospace Systems Environmental High Vacuum Chamber, the world's largest simulator. Mr. Mark has eleven U.S. patents and has written numerous papers. He is a member of the Standards Committee and the program committee for the American Institute of Physics, the Committee for Establishing a Glossary of Terms for the American Vacuum Society, the IEEE, and the International Association of Vacuum Scientists and Technicians.

Authors Byram (left) and Mark.

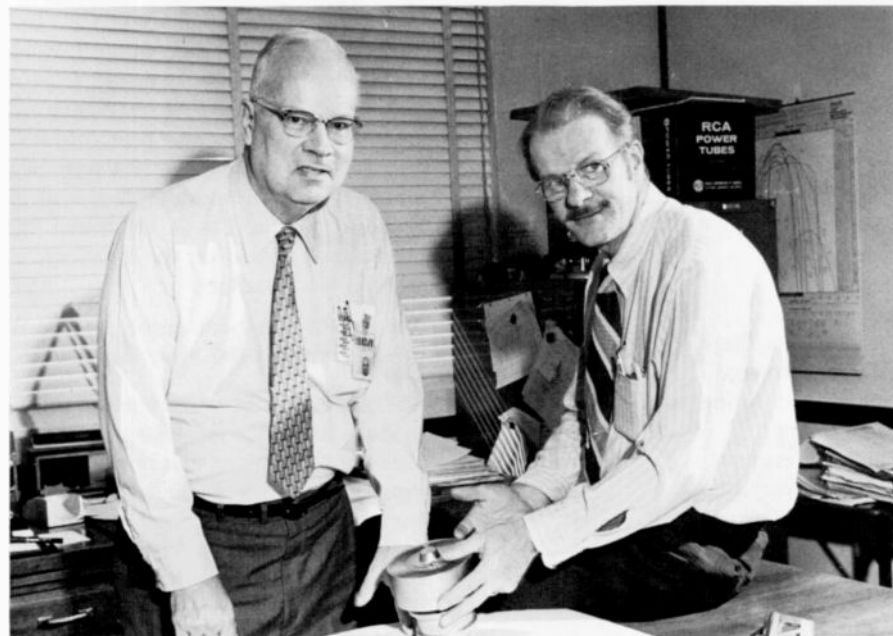

**Table I — Typical operation of A2950 tube in pulse modulator service: rectangular waveshape pulses, duty factor of 0.01, and a pulse width of 1000 microseconds.**

DC plate voltage	3,000 V
DC grid-No. 2 voltage	800 V
DC grid-No. 1 voltage	-120 V
Peak positive grid-No. 1 Voltage	25 V
Peak plate current	10 A
DC plate current	100 mA
DC grid-No. 2 current	10 mA
DC grid-No. 1 current	50 mA
Load resistance	180 ohms
Useful dc peak power output at peak of pulse	18,000 W

**Table II — Typical operation of A2975 tube in pulse modulator service: rectangular waveshape pulses, duty factor of 0.01, and a pulse width of 1000 microseconds.**

DC plate voltage	4,000 V
DC grid-No. 2 voltage	1,000 V
DC grid-No. 1 voltage	-250 V
Peak positive grid-No. 1 voltage	320 V
Peak plate current	20 A
DC plate current	200 mA
DC grid-No. 2 current	25 mA
DC grid-No. 1 current	35 mA
Load resistance	100 ohms
Useful dc peak power output at peak of pulse	40 kW

**Table III — Typical operation of A2960 tube in pulse modulator service: rectangular waveshape pulses, duty factor of 0.01, and a pulse width of 1000 microseconds.**

DC plate voltage	20,000 V
DC grid-No. 2 voltage	1,500 V
DC grid-No. 1 voltage	-400 V
Peak positive grid No. 1 voltage	50 V
Peak plate current	25 A
DC plate current	250 mA
DC grid-No. 2 current	15 mA
DC grid-No. 1 current	20 mA
Load resistance	680 ohms
Useful dc peak power output at peak of pulse	425 kW

**Table IV — Typical operation of A2960 tube used in a pulsed rf amplifier.**

Frequency	400 MHz
Pulse width	2 ms
Duty factor	5 %
DC plate voltage	11,000 V
Pulse grid-No. 2 voltage	1,500 V
DC grid-No. 1 voltage	-250 V
DC plate current during pulse	7.7 A
DC plate current	0.39 A
DC grid-No. 2 current	7 mA
DC grid-No. 1 current	19 mA
Output circuit efficiency	85 %
Drive power at peak of pulse	2.3 kW
Useful power output at peak of pulse	40 kW

## Typical operation as hard-tube modulator

In pulse-modulator service, the A2950, the smallest of the three tubes, is rated for 5000 V of plate voltage and 10 A of peak plate current at 0.01 duty and a 1-ms pulse width. Table I summarizes the typical operating characteristics for this tube used as a pulse modulator switching 18 kW of peak power in the load.

The A2975 is rated for 5000 V of plate voltage and 20 A of peak plate current under the same conditions. Table II lists the typical pulse-modulator service characteristics with the tube switching 40 kW peak power in the load.

The largest tube, the A2960, is rated for 20,000 V of plate voltage and 25 A of peak plate current, again at 0.01 duty and 1-ms pulse width.

Table III gives typical pulse-modulator service characteristics for the A2960. In this case, a peak power of 425 kW is being switched in the load.

## Life results

Varied life experience has been accumulated for the A2950 and A2975 in pulse-modulator service and in rf service, and for the A2960 in pulse-modulator service.

As a hard-tube modulator, the A2950 has been run for 3000 hrs at a peak plate current of 13 A with 1-ms pulses at 0.01 duty. In rf service, the A2950 has been operated for 18,000 hrs in 30-MHz cw service; dc plate current was 1 A and power output was 1 kW, both of which are double the values obtained from a nickel-matrix-oxide tube of equivalent size. The A2950 has also been operated over 5000 hrs in the visual IPA stage of a commercial tv transmitter in actual tv broadcasting use. The A2950 heater has been cycled on and off for 20,000 cycles with no heater failure.

The A2975 has been tested at 2.5-kW power output at 100 MHz for 5000 hrs.

The A2960 has been operated in pulse-modulator service for 4500 hrs under a variety of conditions that simulated random pulse-width radar. Pulse width varied from 1 to 4 ms and peak currents from 10 to 25 A. The A2960 heater was cycled 12,000 times without failure.

Life tests of all three tubes are continuing.

1300 MHz  
50 MHz Bandwidth @ -1 dB Double-Tuned  
Screen-Pulsed Cathode-Drive  
2000 Microsecond Pulse, 5% Duty

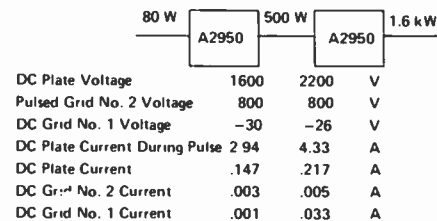

**Fig. 3 — Two A2950 tubes used in pulsed broadband-rf amplifier application.**

## RF operation

In addition to pulse-modulator service, which has been stressed up to this point, this new series of tubes is also useful in pulsed-rf-amplifier service. Fig. 3 shows a chain of two A2950 tubes providing broadband operation similar to that required in one section of a radar system that has been under consideration.

Table IV shows typical operation of the A2960 in pulsed-rf amplifier service where it provides 40 kW of pulsed power output at up to 400 MHz with a 2-ms pulse width.

Many other operating conditions are possible, of course; however, limits on allowable inputs and plate currents at various duty factors and pulse widths must be observed.<sup>3,4,5</sup>

## Conclusion

Tungsten-matrix cathodes can be successfully utilized in gridded tubes. Tubes with this type of cathode provide many advantages in both long-pulse and high-voltage service for military radar systems.

## References

1. A general description of the tungsten-matrix cathode may be found in the following references: Levi, R.; "New Dispenser Type Thermionic Cathode," *J. Appl. Phys.* Vol. 24, (Feb. 1952) p. 233; and "Improved Impregnated Cathode," *J. Appl. Phys.* Vol. 26 (May 1955) p. 639.
2. Kohl, W.H.; *Handbook of Materials and Techniques for Vacuum Devices* (Reinhold Publishing Corp., 1967)
3. Haas, G.A. and Thomas, R.E.; "Work Function Distribution Studies of Pressed Matrix Cathodes," *J. Appl. Phys.* Vol. 38 (Sept. 1967) p. 3969.
4. Additional information is contained in an earlier version of this paper presented at the 11th Modulator Symposium sponsored by the IEEE Advisory Group on Electronic Devices, New York, September 18, 1973.
5. RCA Application Note AN-4887 "Tungsten Matrix Cathodes for RCA Cermolox Tubes".
6. Developmental Data Sheet—RCA Type A2950.
7. Developmental Data Sheet—RCA Type A2960.
8. Developmental Data Sheet—RCA Type A2975.

# Adapting structured programming to existing systems and languages

Dr. P.G. Anderson

Structured programming has been suggested as one of the most promising techniques for improving computer program reliability. Its disciplined approach to coding control-flow structure produces clear, understandable program elements that can be combined to construct large programs. This approach contrasts sharply with the standard practice of employing open-ended control figures that permit program flow complexity to grow unchecked. The Structured Programming Adaptor (SPA) introduces a workable approach to applying the advantages of structured programming to a wide variety of existing systems and languages.

TRADITIONAL computer programming techniques are becoming less and less effective for coping with the intricacies of very large, complex system requirements. Too often, the software produced is full of errors and impossible for anyone but the original author to comprehend (and then only barely). Each piece of these complex programs is intimately tied to every other piece so that changes have unforeseen secondary effects, thereby causing the need for other changes, with more unforeseen secondary effects. . . , *ad infinitum*. Thus, instead of yielding to continual refinement and improvement, these programs simply grow in complexity until they reach a point at which there is no alternative but complete replacement.

A primary cause of the tendency toward complexity is the use of *ad hoc* control sequencing in which the logic flow jumps everywhere, almost randomly, making it nearly impossible to understand the purpose of any one section of the program.<sup>1</sup> Recently, software researchers have identified a key distinction between such complicated software and easy-to-understand, high quality software. They have found that better programs are constructed of nested program sections, with each section having one entry point, one exit point, and a very simple control flow. This is called structured programming.

There are several ways to take advantage of the benefits of structured programming. One approach is to use a modern, high-level programming language (e.g., ALGOL and PL/1), with the control

structures of structured programming built in. However, the real-time processing requirements of many system projects can make such languages an impossible luxury. Then too, the computer selected may not have these languages available, e.g., a modified first- or second-generation computer. Some systems can be programmed only in a dialect of Fortran or an assembly language which does not have the desired control structures. Some assembly languages don't even permit the stylistic freedom needed to produce readable programs.

Another way of achieving the benefits of structured programming is to impose a discipline for coding conventions to simulate the structured programming figures; structured programming is, after all, only concerned with program topology, not implementation details. However, this approach has the dangers inherent in all externally imposed conventions. In addition, the simulation used may often obscure those very aspects of the program that are to be clarified.

The best way to achieve proper language (coding) utilization, obtain lucid programs, and relieve some programming drudgery is to use a preprocessor that will incorporate structured programming control features. This Structured Programming Adaptor, or SPA concept, provides users with the power and expressivity of structured programming without the loss of computing efficiency usually attributed to higher-level languages. This paper describes the advantages of structured

programming and the implementation techniques involved in its application. The Structured Programming Adaptor is then introduced as a working tool for broad application of these techniques to all levels of programming.

## Elements of structured programming

The basic control structures usually chosen for structured programming are the *alternative*, given by IF-THEN-ELSE (Fig. 1), and the *loop*, given by WHILE-DO (Fig. 2). These two control structures

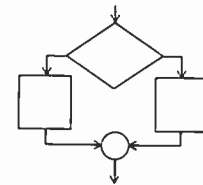

Fig. 1 — IF - THEN - ELSE.

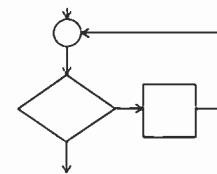

Fig. 2 - WHILE - DO.

are sufficient to write any algorithm that can be expressed using conditional GO TO statements.<sup>2</sup> However, since they are sometimes felt to be too restrictive, some more general structures are added, such as DO-UNTIL loops (Fig. 3) and CASE statements (Fig. 4). One investigator has

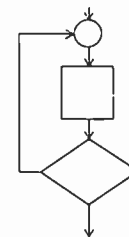

Fig. 3 - DO - UNTIL.

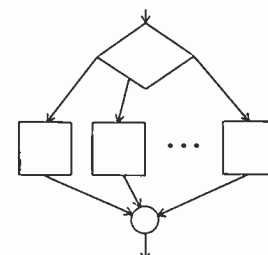

Fig. 4 - CASE.

even suggested using a SEARCH loop structure (Fig. 5) which is reminiscent of

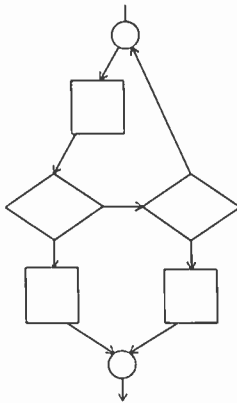

Fig. 5 — SEARCH.

an electrical bridge circuit, unlike the others which are more like series-parallel circuits. SEARCH gives a loop with two exits. It is used, for instance, to look up an entry in a table and take exit 1 when the entry is found, and exit 2 when the table is exhausted without the entry being found.

With the structured programming discipline, one constructs large interesting programs by nesting the control structures within each other. That is, any of the closed control structures may be placed wherever a rectangle is shown in the diagrams (Figs. 1 through 5). Also, these structures may be strung together in a linear sequence of program steps. In fact, the SEQUENCE (Fig. 6) is often treated

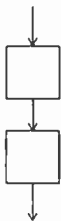

Fig. 6 — SEQUENCE.

as one of the basics for structured programming. This nesting is in contrast to the method of producing large, interesting, complicated (and unreliable) programs by inserting conditional jump instructions in a program from anywhere to anywhere. Structured programming has no requirement for such jumps or the corresponding statement labels at the conceptual level; of course, at the most detailed level, the computer instructions are conditional jumps.

Reprint RE-21-5-12  
Final manuscript received September 16, 1974.

## Reliability of structured programs

Programs produced within the structured programming discipline are more reliable than those developed with *ad hoc* control sequencing. There are several reasons for this improved reliability.

First structured programs require more extensive design effort before they can be coded. So the purpose and the workings of programs are better understood before details are decided. Experienced programmers using structured techniques for the first time find that the programming process takes more time than do standard methods. But because of the early investment in making the design more complete, there are fewer inconsistencies to patch up at the end of the project. The entire process actually takes less time.

In addition to designing the major data structures, the programmer must also design the control flow and not just code in conditional jumps to somewhere to be determined later. Complete control structures are not made for such loose ends, and postponed coding decisions take a different form in structured programs. In a structured program, we may find a "stub" such as the following:

```
IF condition THEN
  BEGIN
    COMMENT: "worry about this later"
  END
```

In this case, the program flow is understood and the details can easily be filled in later. Contrast this with the following:

```
IF condition THEN GO TO Label999
  •
  •
  •
```

Label999: COMMENT: "worry about this later"

In the second example, the flow of control is disturbed, the code to be supplied is out of the context of its purpose, and clarity (and therefore reliability) suffers. The same idea applies to flow charts, for which program details take up several pages. Instead of off-page connectors, flow chart process boxes are substituted that contain short narrative descriptions and a reference to another page. Each page of flow charting contains one entering arrow and one exiting arrow (see Figs. 7 and 8).

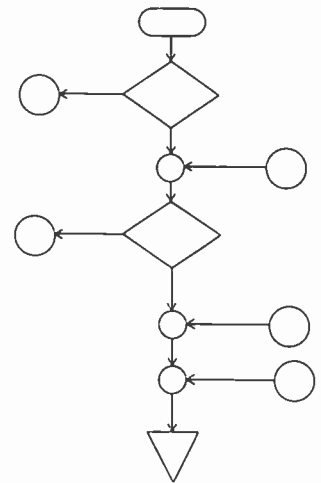

Fig. 7 — Off-page connectors.

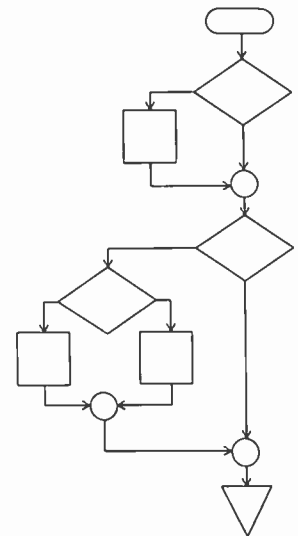

Fig. 8 — Off-page connectors replaced by off-page modules. (The details for the rectangles are given elsewhere.)

The staging of events in which one first sketches out an entire system and then fills in the details to an ever finer degree is known as the "top-down" approach. This is the approach generally seen in problem solving—we recognize it as "divide and conquer." Structured programming offers a similar approach to computer programming.<sup>3</sup> Top-down programming permits communication between program implementers and their management or their customers. The highest level—the forest—is constructed first and can be discussed independently from the postponed details—the trees. Since a program that is constructed top-down is always a whole entity that is being gradually fleshed out, there is never a conglomeration of unrelated parts that needs to be integrated. And it is well recognized that the integration phase of large software systems is the longest and



most unpleasant part of the entire production process.

Because they are built by nesting, structured programs have a natural hierarchy. A program is composed of component pieces; each piece is composed of its subpieces; and so on. A small set of primitive control structures is used to make larger components out of several small ones. The number of subcomponents of each component need not exceed "the magical number seven plus or minus two".<sup>4</sup> This gives the simplicity people generally require to understand a complex system. Whether naturally occurring systems are naturally hierarchical is an issue for specialist metaphysicians. What counts for us is, that's how they are described.

Structured programming gives programs all the advantages of hierarchical systems. This includes the possibility of a bottom-up approach as well as a top-down approach. One can construct and use stable subassemblies—pieces that have an identity of their own. One can modularize and use modules that are modifiable and replaceable. One can also infer characteristics of the whole from characteristics of its pieces, such as cost, resource utilization, and proof of correctness.<sup>5</sup>

### Using structured programming

Structured programming techniques can be used in any programming language; the design discipline remains unchanged. All that is needed is to encode the basic control structures (Figs. 1 and 2) using the conditional branch instructions of the language. In other words, structured programming is language-independent. It has to do only with the underlying topology of a program.

It is certainly preferable to write programs in a modern higher-level language with the control statements of, say, ALGOL or PL/I. But we cannot always take advantage of such systems. Often the computer system we are working with is not equipped with such language support (e.g., very old or very new or very special-purpose computers). The application may also demand programming at the detailed machine-language level, since the stylized code produced by most compilers is considered unwieldy or unable to perform the desired function (e.g., bit or address manipulation). Or one may be

obliged to maintain an existing system written in a lower-level language.

In those cases, even though the abstract discipline of structured programming can still be followed, a great deal of the benefit is lost. Code in high-level languages can be indented to show the nesting of control structures, so the program flow can be clear to readers. Top-down programming can be done, but it is not very easy to block out a large program in terms of program stubs in a lower-level language. And it is a totally frustrating experience to attempt to simulate the desired control structures, making unique but meaningless statement labels, and guaranteeing that the structures are all properly nested.

### A solution to "unstructured languages"

Instead of cursing the darkness—or more likely, ignoring it altogether—we can apply a form of a preprocessor to improve our lower-level languages. The preprocessor developed at MSRDC is called "SPA" for Structured Programming Adaptor. In developing SPA, we identified the constructions missing from our programming languages (which were assembly languages and Fortran IV) and also some "syntactic sugar" deemed worthwhile. The language PL360 provided some suggestions here, as will be seen.<sup>6</sup>

Elementary assembly language instructions are specified in a functional notation, with a function name and an argument list enclosed in parentheses, as in the following sequence of three operations:

```
LE(F4,X); AE(F4,DELTA); STE(F4,X)
```

As this indicates, a sequence of such operations can be written on a single card separated by semicolons. As in SNOBOL 4, a card boundary is also treated as a semicolon. In this way, a short sequence of simple steps that is thought of as a group can be written on a single line to convey that notion.

Statement labels can be written as usual; they start in the first column of a statement, that is, either in card column one or immediately following a semicolon. Blank cards may be freely used to improve program readability; they break a program listing up into "paragraphs."

Comment cards follow the rule of the target language for the preprocessor; they are usually denoted by a special character in card column one.

### Structured programming primitives in SPA

The control structures are provided by compound statements such as the following:

```
IF condition THEN
    statement
ELSE
    statement
and
WHILE condition DO
    statement
```

The statement is either a simple function-type operation, or an IF or a WHILE compound statement, or a sequence of statements preceded by a BEGIN statement and followed by an END statement. Comments may be placed after the words THEN, ELSE, DO, BEGIN, and END;

---

Dr. Peter G. Anderson, Software Design and Development, Missile and Surface Radar Division, Moorestown, N.J., received the BS in Mathematics in 1962 and the PhD in Mathematics in 1964, both from MIT. He served on the faculty at Princeton University and in 1965 joined the RCA Computer Division's Systems Programming Department to work on the development of the Fortran system for the Spectra 70 computer line. His special interest in that and subsequent compiler development activities was object code optimization. In September 1971, Dr. Anderson joined the Computer Science Faculty of the New Jersey Institute of Technology as an Associate Professor. His research interests include the software engineering areas of higher level programming languages, software reliability, and programming methodology; computerized conferencing; and combinatorial mathematics, especially graph theory and topology. He is currently working with MSRDC's Software Design and Development Department in addition to his work with NJIT.



such a comment is terminated by semicolon or the end of the card. The condition used in both control structure statements depends on the target machine architecture. If the conditional transfer instructions of the machine are based on a condition code setting or the sign of an accumulator, then some very simple conditions are chosen. For example, "IF = THEN" or "IF < THEN". For machines with single accumulators used for comparisons, the condition may take the form

IF [left-symbol] *relation* [right-symbol]  
THEN

If the left-symbol is present, the variable named is loaded into the accumulator; if the left-symbol is omitted, the accumulator is left unchanged. If the right-symbol is omitted, the test is based on the sign of the accumulator; if the right-symbol is given, then a comparison (possibly in the form of a subtraction) is generated. There is a wide range of possibilities here. For machines such as the 360 with many types of comparisons, the first letters of the left-symbol and right-symbol can be used to direct which type of comparison to generate: RR, RX, SS, half-word, full-word, double or single precision floating point, etc.

Many computers are equipped with special instructions for incrementing an index register and conditionally jumping based on the result. To take advantage of these "DO-loop" instructions, the condition in a WHILE statement has some other possibilities. The "DO-loop" is specified by building the condition with a keyword followed by the necessary parameters to set up and step through the loop. For example,

WHILE UPS, [n [,m]]DO

is used on the DDP-124 computer to employ a loop using the JXI (jump index incremented) and JIX (jump on index). If *n* is present, the index register is loaded with  $-n$ ; if *m* is present, the looping is accomplished by adding *m* to the index register and jumping on negative via the JIX instruction; if *m* is absent, the JXI instruction is used, which adds one to the index register and then jumps on negative.

An example of the SPA assembly language coding style is shown in Fig. 9. This is a portion of a Fast Fourier Transform program written to run on the Honeywell DDP-124 computer.

```

LDX(32,1); STX(DX,1)
LDX(0,1); STX(ANGL,1)

WHILE UPS,32,2 DD
  BEGIN
  LDA(L,1); LDB(L+1,1); JST(CXMP); STA(L,1); STB(L+1,1)
  LDA(ANGL); ADD(=2); STD(ANGL ANGL = ANGL + 2)
  ADX(-32,1); JST(BFLY); ADX(32,1)
  END
• SUM THE ABSOLUTE VALUES OF THE REAL AND IMAGINARY
• PARTS TO FORM THE FINAL ANSWER. PUT THE FINAL ANSWER
  IN THE FIRST 32 WORDS OF THE INPUT ARRAY.

LDX(-64,1); STX(ST4,1)
WHILE UPS,64,2 DD
  BEGIN
  LDA(L,1); ANA(=03777777); STA(L,1)
  LDA(L+1,1); ANA(=03777777); ADD(L,1)
  STX(ST3,1); ST4 LDX(=,1); STA(L,1)
  ADX(1,1); STX(ST4,1); ST3 LDX(=,1)
  END

JMP*(FFT EXIT EXIT EXIT EXIT EXIT EXIT EXIT)

```

Fig. 9 — The last stage of a Fast Fourier Transform (on 32 points) for the Honeywell DDP-124 computer.

```

SUBROUTINE FFT ( LIST, NFFT )
COMPLEX LIST ( NFFT ), FAC, MOD, CIS
INTEGER STEP, WIDTH, SKIP

CALL BITREV ( LIST, NFFT )
STEP = NFFT / 2; WIDTH = 1; SKIP = 2
WHILE STEP > 0 DD
  BEGIN
  NUB = 1
  WHILE N = 0, NFFT-1, STEP DD
    BEGIN
    FAC = CIS ( N, NFFT )
    WHILE I = NUB, NFFT, SKIP DD
      BEGIN
      J = I + WIDTH
      MOD = FAC * LIST ( J )
      LIST ( J ) = LIST ( I ) - MOD
      LIST ( I ) = LIST ( I ) + MOD
      END
      NUB = NUB + 1
    END
    STEP = STEP / 2; WIDTH = WIDTH * 2; SKIP = SKIP * 2
  END
RETURN

```

Fig. 10 — A Fast Fourier Transform written in SPA-Fortran style.

```

WHILE NULCYC DROPS REMAIN DD
  TRY MANY TIMES TO FIND A READY TASK.
  EACH TRY WHICH FAILS DECREASES THE NULL COUNTER BY ONE.

  BEGIN
  WHILE TCBREG < :TBLEN DD
    SEARCH TCB TABLE FOR A READY TASK.
    BEGIN
    IF A FOREGROUND TASK IS READY, ENTER IT.
    BEGIN
    SET UP ALL WORK REGISTERS AND ENTER TASK.
    END
    END
    BEGIN
    A BACKGROUND TASK IS READY, ENTER IT.
    END
  END
  HAVE FOUND NO READY TASK, INCREMENT THE NULL COUNTER.

```

Fig. 11 — An example of logical-level program documentation produced automatically from a SPA-written program.

The SPA idea applies to languages such as Fortran IV as well as to assembly languages. In this case, the SPA idea provides a test bed for proposals for linguistic reform. (Since complaining about the inadequacies of Fortran IV is a favorite sport, one may as well do it right.) The SPA additions to Fortran IV are shown by example in Fig. 10, another Fast Fourier Transform program. To appreciate the enhanced reliability of such a programming style, notice how easily one can prove that the program does not have an infinite loop.

The input program to SPA can be written in highly structured programming style with indentation to indicate the program nesting structure. SPA takes care of producing correctly aligned input to satisfy the rules of the target language.

Because SPA-written programs are structured programs whose composition is by means of nesting, these programs can be edited automatically to show their structure: namely, every statement of the program is at a certain depth of nesting; that statement should appear on a listing beginning at the tab position corresponding to the depth. For instance, a statement at depth  $n$  should begin in position  $3n$  on a listing. In this way, much of the cosmetics of a program can be maintained automatically.

SPA-written programs also provide a form of automatic documentation aid. It has been noticed that program descriptions written in a pseudo programming language in structured programming style are just as suitable as flow charts for documentation. This pseudo flow charting can be achieved by selectively listing a SPA-written program. The lines listed for documentation are the program comment lines and the SPA keyword lines (IF, WHILE, BEGIN, and END). Documentation can be done completely by printing all the keyword lines, or selectively by printing only the lines under a predetermined depth of nesting. Of course, any such document can be edited after it is automatically produced. The notoriously ubiquitous attitude of programmers toward documentation is partially explained by the observation that the program itself is their most carefully described algorithm—so why should they describe the whole thing all over again in another language?

Higher level programming languages

have not been successful in fulfilling their promises as self-documenting programs; the level of detail in program listings is much too high. Proper documentation is supposed to guide the reader from the forest to the trees. The SPA automatic documentation idea does just that. Fig. 11 shows an example of such documentation. This is taken from a task dispatcher for a real-time operating system written for the Univac 1616 (AN/UYK-15). The periods at the beginnings of some lines indicate comment lines; lines without periods at the beginning are SPA keyword lines.

## Implementation of SPA

The first version of the SPA processor was implemented using SNOBOL 4 running on an interactive timesharing network. SNOBOL 4 was chosen, of course, because of the ease with which character string information is manipulated. The facility of recursive subroutines was also heavily utilized in order to process the nested structures. By constructing different versions of initial values, we were able to use essentially the same SPA processor for different languages enhanced by structured programming constructions. Using this technique, we had both a Fortran-IV and an ULTRA-16 version (the ULTRA-16 is the assembler for the Univac 1616 which is also known as the AN/UYK-15).

Because SNOBOL 4 permits character string data to be used as code we were able to include a macro definitional facility as part of the SPA. This gave programmers a macro language with the same power as that of the host SNOBOL 4 system.

A later version of SPA has been written in PL/1. PL/1 has the necessary recursive subroutines and enough string handling machinery to do the job. Of course, we did sacrifice the macro feature as well as the expressive ease of the SNOBOL 4 version, but in the exchange we gained enormously in speed.

Because of the expressivity of SNOBOL 4, we were able to implement the initial versions of SPA with little coding effort, giving us an experimental program rapidly. Because of the experimental nature of the effort (initially we wanted "something like PL360"), we changed our minds several times before we were pleased with what we had. SNOBOL 4 facilitated this

experimentation more than any other language would have. When the PL/1 version was coded to do what the SNOBOL 4 version did, the broad or logical outline of the new SPA was the same as the previous one. The concept had been debugged before the difficult programming was even started.

SNOBOL 4 has a reputation of being a "fun" language with no application in a production environment. It is easy on programmers and hard on computer resources (time and core space). But since it is so easy on programmers, so expressive, and so powerful, it can be used to check out concepts and global design decisions for production programs that are to be eventually coded in more efficient languages.

Through breadboarding, electrical engineers can discover properties of their designs that can be applied to give them greater reliability. Programmers can also profit from similar "quick and dirty" implementations of their designs.

## Conclusions

The benefits of structured programming can be fully realized even by programmers who need to work in assembly languages. Moreover, the structured programming style can be applied on a wide variety of languages by using a preprocessor. Programs written in such a style are easy to document by automatic means.

It is hoped—and expected—that some form of the language techniques exhibited herein will be used by the assemblers of the future. This will bring clarity, and therefore high-reliability programs, to the broad spectrum of computer users.

## References

1. Dijkstra, E.W.; "GOTO Statement Considered Harmful," *CACM*, Vol. 11, No. 3 (March 1968) pp. 147-148.
2. Bohm, C. and Jacopini, G.; "Flow Diagrams, Turing Machines, and Languages with only two Formation Rules," *CACM*, Vol. 9, No. 5 (May 1966), pp. 366-371.
3. Wirth, Niklaus; "Program Development by Stepwise Refinement," *CACM*, Vol. 14, No. 4 (April 1971) pp. 221-227.
4. Miller, George A.; "The Magical Number Seven, Plus or Minus Two; Some Limits on our Capacity for Processing Information," *The Psychological Review*, Vol. 63, No. 2 (March 1956) pp. 81-97.
5. Simon, H.A.; *The Sciences of the Artificial*, Cambridge, M.I.T. Press (1969) pp. 87-107.
6. Wirth, Niklaus; "PL360, A Programming Language for the 360 Computers," *Journal of the ACM*, Vol. 15, No. 1 (Jan 1968) pp. 37-74.

# Microwave metal-insulator-semiconductor varactor parametric amplifier

Dr. R.L. Camisa|B.F. Hitch|S. Yuan

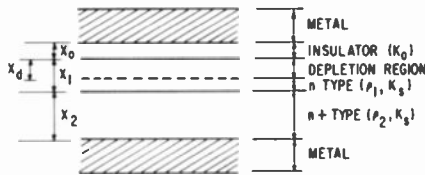

Fig. 1 — Metal-insulator-semiconductor one-dimensional cross section.

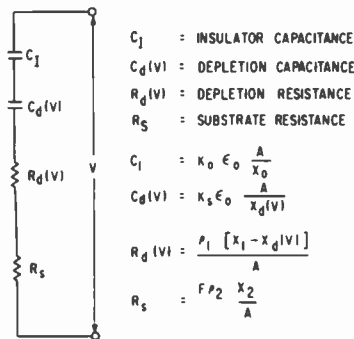

Fig. 2 — MIS approximate equivalent circuit.

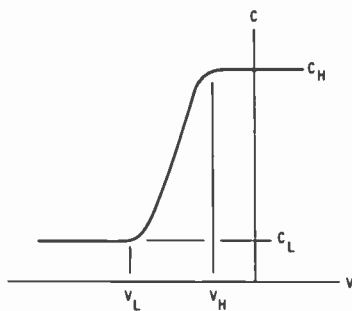

Fig. 3 — MIS varactor characteristics.

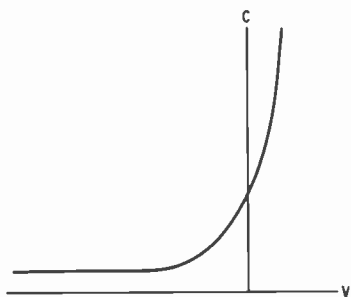

Fig. 4 — Junction varactor characteristics.

Parametric amplifiers using junction or Schottky barrier varactors have excellent noise figure performance, but have proved quite unstable in practice unless elaborate and costly stabilizing circuits were employed. The unique properties of metal-insulator-semiconductor varactors make possible param designs with inherent gain stability with respect to pump power so that pump stabilizing circuits may be reduced or eliminated. In this paper, S-Band parametric amplifiers using MIS varactors are described.

THE metal-insulator-semiconductor (MIS) structure was first proposed in 1959 by J.L. Moll<sup>1</sup> for a "Variable Reactance with Large Capacity Change." This device was called a surface varactor because when reversed biased, a depletion region forms at the insulator-semiconductor interface. In 1972, Müller<sup>2</sup> presented a microwave MIS upper-sideband up-converter whose performance compared favorably with step recovery diodes. In 1973, Camisa, Hitch, and Yuan<sup>3</sup> developed a 4-bit phase shifter at 3.5 GHz using MIS varactors. Marquardt and Schiek<sup>4</sup> have presented results of a uhf param using MIS varactors, although no noise figure or bandwidth information was given. In this paper, physical mechanism of MIS varactors will be described. Theoretical and experimental behavior of a microwave MIS varactor parametric amplifier are also presented.

## MIS theory

Figs. 1 and 2, respectively, show a cross section of an MIS varactor and its equivalent circuit.  $C_1$  is the capacitance of the insulating layer and  $R_s$  is the spreading resistance of the N+ layer.  $C_d$  and  $R_d$  are associated with the depletion region in the N layer.

For a large negative bias, the capacitance is approximately constant at a minimum value,  $C_L$ . At large positive voltages, there is no depletion and the capacitance equals the insulator capacitance  $C_I$  (or  $C_H$ ). For intermediate bias voltages, the capacitance exhibits a sloping curve between these two limits as in Fig. 3. This is in contrast to the junction (or Schottky)

varactor  $C-V$  curve of Fig. 4 whose  $C-V$  curve continues to display a sharp upward slope with increasing bias. Also, the forward bias region must be avoided in a junction varactor since the dc current flow would cause noise figure degradation. This is avoided in an MIS varactor since the insulator prevents dc current flow. Hence, the full range of capacitance can be used. It is these two distinctions, the  $C-V$  curve shape and the absence of dc current, that make the MIS varactor attractive in parametric amplifier applications.

## Device design and fabrication

The MIS devices were fabricated on an N on N+ silicon ( $\epsilon_r = 11.8$ ) wafer. The N-layer resistivity was 0.36 ohm-cm, and the thickness was 0.6  $\mu\text{m}$ . After surface preparation, 800Å of  $\text{SiO}_2$  ( $\epsilon_r = 3.9$ ) was grown on the surface in a dry oxygen atmosphere. Aluminum metallization was deposited on the oxide and photoetched to produce an array of 2-mil-diameter dots for the top electrodes. The wafer was then scribed, and individual chips were mounted in coaxial pin packages. A paramp was constructed on a 25-mil alumina substrate ( $\epsilon_r = 9.6$ ). The design is similar to that of Bura, et al.<sup>5</sup>

## Parametric amplifier analysis

In an analysis similar to that of Penfield and Rafuse,<sup>6</sup> the gain of a parametric amplifier can be defined as a function of the ratio  $C_1/C_0$ , where  $C_0$  is the dc component at the fundamental pump frequency. Fig. 5 shows how the computed value of  $C_1/C_0$  varies with pump voltage swing at various dc bias voltages.

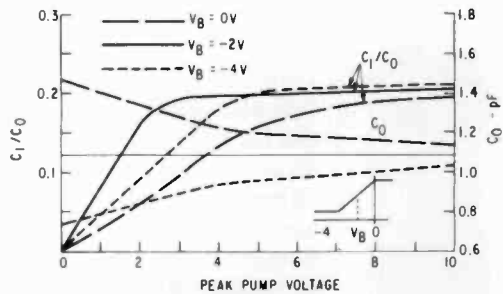

Fig. 5 —  $C_1/C_0$  and  $C_0$ , as functions of pump voltage swing for various bias levels, in an MIS varactor with 2:1 capacitance ratio.

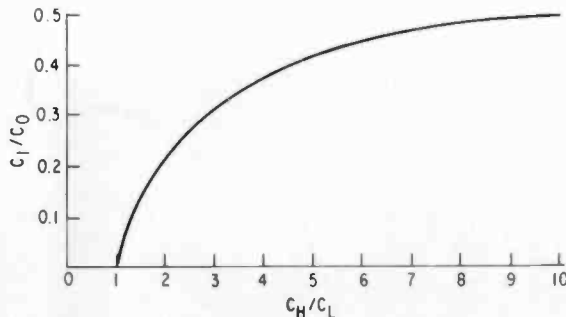

Fig. 6 —  $C_1/C_0$  as a function of MIS varactor capacitance ratio  $C_H/C_L$ .

An idealized piecewise linear curve, like the one shown was assumed for a varactor with approximately 2:1 capacitance variation ( $C_H/C_L$ ). A sinusoidal pumping voltage was also assumed. Due to the unique  $C-V$  curve of the MIS device,  $C_1/C_0$  (and hence, gain) eventually becomes constant with pump power. The graph shows that for a bias voltage midway between the knees of the  $C-V$

curve ( $-2V$  in the case shown), the ratio  $C_1/C_0$  approaches a constant value at lower pump voltages than for other values of bias. Hence, the midway point is the optimum bias point for minimum pump power. Fig. 5 also shows that  $C_0$  varies with pump voltage for bias voltages other than optimum. This variation causes the amplifier response to shift in frequency, even in the pump voltage

range where gain is fairly constant. Such a frequency shift is also present in parametric amplifiers using junction or Schottky varactors. Thus at the optimum bias point, two important advantages are present: gain is constant as a function of pump power, and frequency shift with pump power is eliminated. Fig. 6 shows how the limiting value of  $C_1/C_0$  varies with  $C_H/C_L$ .

**Dr. Raymond L. Camisa**, Microwave Technology Center, RCA Laboratories, Princeton, New Jersey received the BEE, MEE, and PhD degrees from the City College of the City University of New York in 1965, 1969, and 1975, respectively. From 1966 to 1967 he was a member of the technical staff at the RCA Advanced Communications Laboratory, New York. While there he worked on microwave filters, low-noise parametric amplifiers, and microwave integrated circuit techniques. From 1967 to 1970 he was with Wheeler Laboratories, Inc., Great Neck, L.I., where he was part of a group developing a microwave integrated circuit receiver for IFF applications. Specifically, he developed various MIC components including low-noise transistor amplifiers, frequency multipliers and filters. From 1970 to 1974 he was a part-time lecturer at the City University of New York teaching courses in electromagnetic theory, electronics, and microwave measurements. At the University he also worked as a graduate research assistant investigating the use of MIS varactors in microwave networks. During the same period, he was a consultant to Wheeler Laboratories and the RCA Advanced Communications Laboratory. In 1974 Dr. Camisa joined the Microwave Technology Center at RCA Laboratories,

Princeton, N.J. His responsibilities include research on GaAs field-effect-transistor device technology and linear amplifier development.

**Benjamin F. Hitch**, Advanced Communications Laboratory, GCASD, Somerville, New Jersey, received the BSEE degree from the University of Tennessee in 1967, and joined RCA's Communication Systems Division (CSD) the same year. From 1967 to 1970, Mr. Hitch worked primarily on HF and power amplifiers and related equipment. Since 1970 his work has been in the microwave integrated circuits area. In 1972 he was co-recipient of a CSD technical excellence award for his work on the SHF Small Satellite Terminal Program. For the last two years he has worked on the applications of MIS devices, especially to phase shifters.

**S. Yuan**, Advanced Communications Laboratory, GCASD, Somerville, New Jersey, received the BSEE from the University of California at Berkeley in 1952 and

the MSEE from Columbia University in 1956. From 1953 to 1955, he worked for RCA on the development of broadcast equipment, and from 1957 to 1963 he was a senior engineer with the electronics division of Curtis Wright Corporation and a member of the electronic research laboratory staff at Columbia University. From 1963, when he rejoined RCA, to 1966, his work was in the area of solid-state rf techniques. He became a Leader, Advanced Communications Laboratory, Government Communications and Automated Systems Division, Somerville, N.J., in 1966, with responsibility for the development of circuits such as uhf amplifiers, uhf/vhf voltage-controlled oscillators, phase comparators, and crosspoints using beam-lead diodes for switching matrices. He is the co-inventor of a balanced mixer circuit that can alleviate high-order intermodulation and crossmodulation distortion. His work on frequency multipliers has resulted in a theoretical analysis for predicting the efficiency of an XB multiplier as a function of the nonlinear coefficient and in an experimental model of the multiplier which yields a 10% efficiency "octupler" (500 MHz to 4 GHz). Mr. Yuan is a member of the Chinese Institute of Engineers, Tau Beta Pi, Eta Kappa Nu, and Phi Tau Phi.

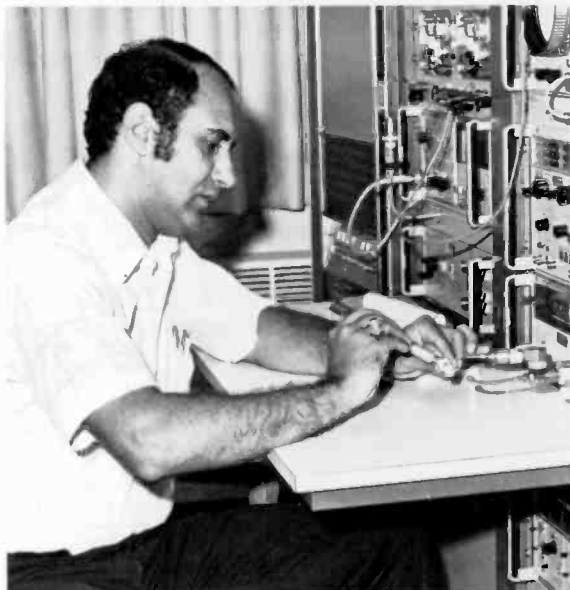

Camisa

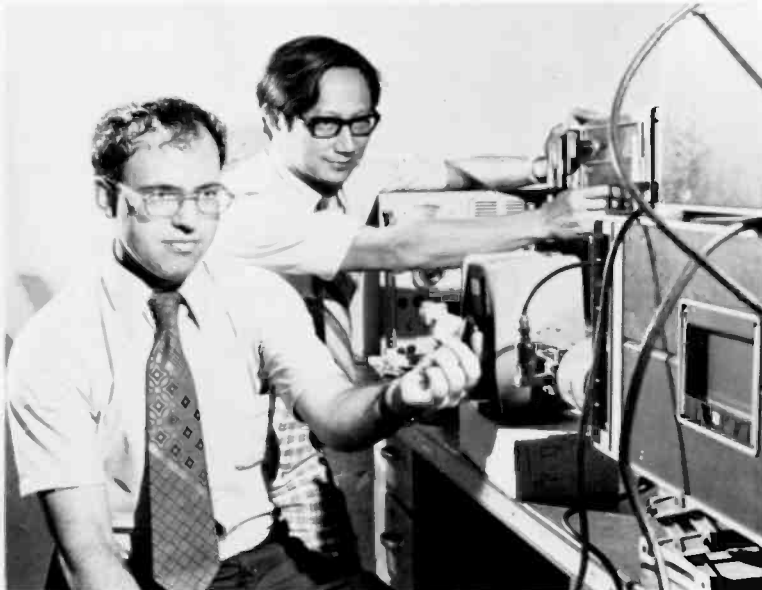

Hitch (left) and Yuan.

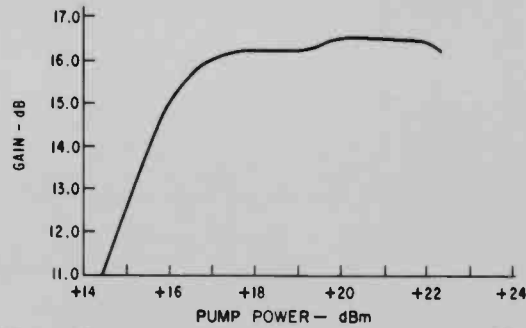

Fig. 7 — Measured gain vs. pump power characteristics for an MIS paramp.

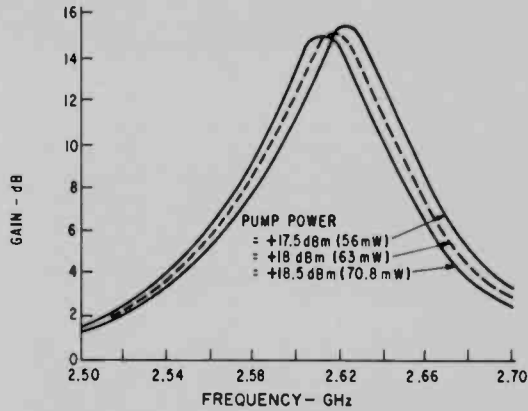

Fig. 8 — Passband characteristics of the 1.5% bandwidth paramp at various pump levels.

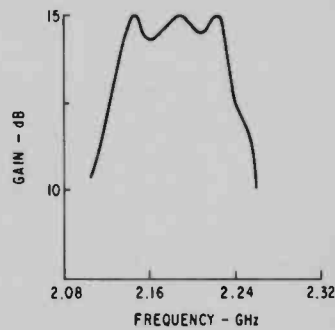

Fig. 9 — Passband characteristics of the 4% bandwidth paramp.

Table 1 — Performance characteristics of MIS paramps.

	Paramp No. 1	Paramp No. 2
Signal frequency	2.6 GHz	2.2 GHz
Pump frequency	8.6 GHz	9.3 GHz
Pump power	+18 dB	+24.3 dBm
Gain at 25°C	16 dB	15 dB
Bandwidth (3 dB)	40 MHz	100 MHz
Noise figure	2 dB	
1-dB compression at output	-29 dBm	
Gain at 0°C	16 dB	
Gain at +65°C	11 dB	

## Experimental results

The experimental paramp operated at 2.6 GHz with an 8.6-GHz pump. Fig. 7 shows that the gain remains constant within 0.5 dB as the pump power is varied over a 5-dB range. Note that as a rule, the gain of a junction varactor parametric amplifier increases by 0.5 dB for a 0.1-dB increase in pump power. The passband characteristic of Fig. 8 illustrates the frequency shift with varying pump power which was mentioned earlier, indicating bias was not at optimum for this case. The 3-dB bandwidth was 1.5%, or 40 MHz. The noise figure, measured at a pump level of +18 dBm was 2.0 dB.

Another paramp was developed with a signal frequency of 2.2 GHz and the pump was 9.3 GHz. The 3-dB bandwidth of this paramp was approximately 100 MHz (or 4%). The passband characteristics of this paramp are shown in Fig. 9.

## Summary

The performance characteristics of the two MIS paramps are shown in Table 1. MIS diodes have demonstrated good performance in parametric amplifier designs. Their unique properties provide an inherent gain stability with respect to pump power which offers potential reduction in the cost and complexity of paramp systems. These properties are also applicable to up-converters.

## Acknowledgment

The authors wish to thank A. Mikelsons for his help in constructing and testing the circuits.

## References

- Moll, J.L.; "Variable Capacitance with Large Capacity Change," 1959 IRE WESCON Convention Record, PT-3, pp. 32-36.
- Muller, J.; "An Upper-Sideband Up-Converter Using MIS Varactors," *IEEE Journal of Solid State Circuits*, Vol. SC-7, No. 1 (Feb. 1972) pp. 43-50.
- Casima, R.L., Hitch, B.F., and Yuan, S.; "Microwave Metal-Insulator-Semiconductor (MIS) Varactor Phase Shifter," *RCA Review*, Vol. 36, No. 2 (June 1975) pp. 296-315.
- Marquardt, J., and Schiek, B.; "An Even C-V Characteristic Parametric Amplifier Using MIS Varactors," *Proceedings of the IEEE* (Nov. 1969) pp. 2076-7.
- Bura, P., Camisa, R., Pan, W.Y., Yuan, S., and Block, A.; "Design Considerations for an Integrated 1.8-GHz Parametric Amplifier," *IEEE Transactions on Electronic Devices* (July 1968) pp. 486-490.
- Penfield and Rafuse; *Varactor Applications*, MIT Press, 1962.



# Automatic test equipment software cost performance

H.L. Fischer

Automatic Test Equipment (ATE) software is an example of the improving trend in software productivity. ATE programming costs have decreased as much as 100:1. The decrease is a result of experience, improved hardware, and utility and operating system software. Utility and operating software has become a major factor in new ATE system development. It is demanding an advanced level of software understanding by ATE engineers.

**H**ISTORICALLY, software has been underrated, treated as a necessary evil, and considered of secondary importance. The result: Software projects were late, some were never delivered, and many that were delivered did not perform according to specification.<sup>1</sup> System development and support costs were higher than expected and rose rapidly as software increased as a percent of the total system. Available management capability was long on experience with hardware systems while short on experience with software systems. By 1961, however, papers began appearing on the subject of software management.<sup>2</sup>

Software, it was recognized, is not unlike hardware in that it represents the deliverable end item of a process which can be well defined.<sup>3</sup> By the mid sixties, leading universities were teaching in a new field, computer science; and engineers were using the computer in the daily routine of solving classroom and laboratory problems. By the late sixties, people began to analyze the science of programming in order to organize and discipline the implementation phases of software development.<sup>4,5,6,7</sup> Software transcended from witchcraft to an engineering discipline in just over a decade. The new methods of software generation have proven to be more manageable, more productive and the results more easily maintained. In addition there are experienced, skilled personnel available to manage the implementation. Software costs have decreased from ten and fifteen years ago and will continue to decrease as the new methods become more widely implemented.

The purpose of this paper is to identify factors that have increased software

productivity (decreased programming costs). Types of ATE software and the state of their development are introduced, followed by a review of application program cost performance during the past 15 years. Programming cost factors are identified. The impact of utility and operating system software on ATE is highlighted. Emphasis is on current developments in utility and operating system software, an area that has presented problems to many ATE developers in the past.

## Types of ATE software

There are three generic, interrelated types of ATE software: utility software, operating system software, and application program software.

— Utility software includes the tools for generating operational and application programs, and includes compilers, assemblers, file maintenance programs, debugging aids, update aids, and programming automation software. Many of these programs come bundled with the ATE computer and are an important cost factor in the selection of computer hardware.

— The operating system software manages the allocation of resources and services such as memory, processors, stimuli, measurement, and control. The operating system correspondingly includes the programs that manage these resources such as monitor, schedule, file management, and supervisory control programs.

— The application programs or test programs are unique to the units under test (UUTs). They exercise the inputs and

Henry L. Fischer, Mgr., Product Design, Automated Systems Division, Burlington, Mass., received the BS in Electrical Engineering from Tufts University in 1952. In 1963, he assumed responsibility for coordinating and directing the entire programming effort on Multi-system Test Equipment programs for the U.S. Army. In this regard, he played a key role in the development of all software and checkout aids, procedures, and techniques for automatic test and system self-test for the MTE, DIMATE, and LCSS Systems at RCA. He co-authored the *Program Design Handbook for Automatic Test Equipment*, 1968, and the *Avionic Design Guide for VAST Compatibility*, 1970. He has supervised activities encompassing compilers, time-shared systems, interpreters and interactive real-time systems incorporating new programming technologies. Recent development programs include: real-time, multi-programmed test operating systems for jet engine accessory testing, ATLAS Compiler and Run Time Operating System for third generation ATE systems, and hardware and software for the Army's automotive vehicular test programs. He is a Registered Professional Engineer in Massachusetts and member of the IEEE and Sigma Xi.

Reprint RE-21-5-1

Final manuscript received September 6, 1974.



outputs of the UUT to check performance, align, adjust, calibrate, and fault isolate.

## How ATE software developed

First generation ATE had card or paper tape input with little or no utility software. The hardware was an assemblage of individual functional boxes. Test programs were coded in machine or assembly language. Programmers with predominantly mathematical backgrounds, lacked the training to cope with the testing interface. As a result, first generation ATE required a very complex engineering/programming process involving many interdisciplinary functions, as shown in Fig. 1. Confusion and conflict existed between the different technical disciplines, each with its unique terminology, biases, and misunderstandings. Costs were understandably high and management difficult.

Second-generation systems contained computers that performed simple control and data processing tasks. High-order test language compilers and simple operating systems were introduced, simulators were tried, mostly unsuccessfully, and test programs were compiled on large off-line computers. Small test systems appeared with on-line interpreters. Integrated measurement devices and wide band synthesizers were used. The high-order language made it possible to eliminate the specialized computer programmer function from the test program preparation process (see Fig. 1); and the newly developing skills of the ATE test engineer included test analysis and design. The test engineer often developed a deeper understanding of the UUT than an individual on the original design team. Test program quality improved greatly; and faults were being detected correctly 100% of the time and isolated correctly 95% of the time. A

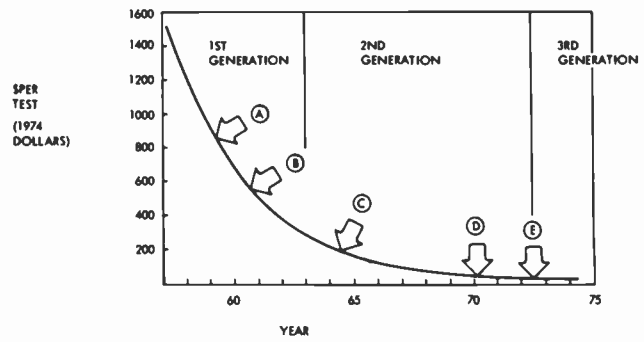

Fig. 2 — ATE test programming cost trend for high-quality software (100% fault detection; 95% fault isolation).

handbook was written<sup>8</sup> to disseminate the breadth of information on the test program generation process.

Third generation systems are heavily supported by utility and operating systems software to synthesize stimulus, analyze responses, control the system, and support test program preparation. RCA's test systems are also compatible with automatic programming systems for digital UUTs. The ATE test engineer as test analyzer has become obsolete. The design engineer models the unit under test for auto-test design. D-LASAR automatically programs the test design. (D-LASAR is an automated test design program for digital logic.) The ATE processor is used to translate the D-LASAR output to executable code. No validation is required. However, automatic programming for analog UUTs is less available and widespread use is still several years off.

## Cost experience in application software

The largest software investment is in application programming. Application software costs often exceed hardware costs on large support programs. It is unfortunate that these costs are identified with the unit cost of ATE, when in

actuality they are part of the non-recurring costs associated with each unit under test. Understandably the major cost reduction in ATE software has been made in the application programming area.

Overall, a 100:1 cost improvement has been achieved in digital UUT test software and a 20:1 improvement in analog UUT software over the 15 years of ATE development. This trend is illustrated in Fig. 2.

These cost figures were derived from actual RCA ATE program experience over a 15-year span. The figures have been normalized to a 1974 cost base to account for inflationary influences on engineering salaries, services, and materials. A test is a single completely designed and validated operational test step which includes signal connection, measurement, evaluation, decision, and resulting action (*i.e.*, operator communication and/or program branch). This measurement criteria has not changed over the years. The data was extrapolated from five major programming efforts representing hundreds of UUT test programs on all types of electronic equipments, and it closely resembles the industry trend.

Obviously the more mature and experienced ATE manufacturers have lower cost experience over a given time period than relative newcomers to the industry.

A large increase in productivity occurred (A) when an accurate standard of communication between the test designer and the programmer was developed. This standard in one case was a combination functional flow chart and timing diagram that ensured test functions were un-

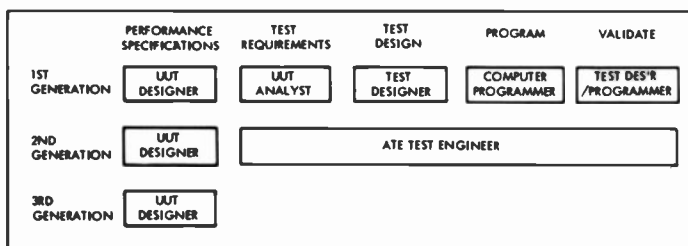

Fig. 1 — Evolution of the engineering programming process.

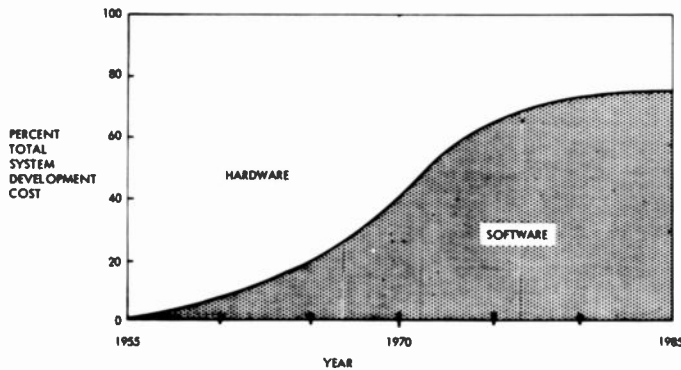

Fig. 3 — ATE hardware/software development cost trend (excludes application software).

ambiguously described. Its rigid, simple format resulted in a structured design that was easily reviewed and controlled.

Further cost improvement (B) resulted when the test analysis function was combined with test design. A major cost efficiency (C) was experience when the High-Order Test language compiler was introduced. Lesser improvements followed mostly as a result of increased engineer experience, interactive terminals and other production efficiencies. Computer aided circuit analysis (D) provided minor cost improvement in the early 70's and finally automated programming (E) made a major contribution to lower software costs.

### Hardware/software cost relationship

The improvements in application programming cost are principally the result of improved utility and operating system software. Utility and operating software has become a major factor in modern ATE development. Already accounting for 50% of RCA's third generation system costs, (see Fig. 3), the percentage of software cost will increase further as hardware becomes cheaper and software labor more expensive. Overall, however, system costs have dropped significantly, and will continue to drop as hardware size and complexity decreases, and as our ability to manage and produce software increases.

RCA's third generation ATE (System 3) is an example of the significant departure from previous ATE architecture. System 3 makes extensive use of recent developments in minicomputer hardware and software to make reductions in hardware size and complexity and to increase software productivity.

System 3 software features include:

- ATLAS language
- Virtual memory
- Automatic calibration
- Sampled-data measurement techniques
- Computer generated stimulus
- Automatic test generation for digital logic
- "Universal pin" programmable interface
- On-station programming and editing
- Complete arithmetic package
  - All math functions
  - 16-decimal-digit precision
  - Boolean operators

### Software cost factors

Various factors influence the speed and effectiveness of producing software. Dr. Boehm of Rand Corporation<sup>9</sup> identified those shown in Table 1.

*Computer system response* is the ease in which a user can make software corrections. *Variations in individual performance* varies as a function of training, experience, job-knowledge, and proficiency. *Programming languages* are

designed for different applications and should be selected carefully. Smaller computers with less powerful instruction sets tend to gain more productivity from high-order programming languages than large computers. *Software development criteria* refers to the design ground rules which programmers follow, e.g., the requirement for efficient code, memory conservation, prompt completion of task, etc. *Learning curve* is the experience gained on the job or with the problem. *Structured programming* is the development of a simple, logical structure partitioned into self-contained modular blocks. *Computer saturation* occurs when 85% of the CPU or memory capacity is reached. Programming costs increase exponentially after this point. The recommended computer capacity is 50% more than absolutely necessary. *Software responsiveness* is being aware of user needs and considering them in the design process.

Two factors that effect software productivity that have not yet been mentioned are: (1) Top-down programming, which is the integration of programming while it is being developed starting with the executive and control modules at the top and expanding to the functional modules at the bottom, and (2) a chief programmer team which is a small functionally specialized and skilled software engineering team.<sup>5</sup>

### Cost experience in utility and operating system software

Management's control over the cost factors described in the previous section has a high degree of influence on software

Table 1 — Factors affecting software cost.

Factors	Improvement
Computer system response	20%
Variations between individuals	26:1
Programming languages	3.5:1
Software development criteria	f (Criteria)
Learning curve	2:1 (single experience)
Structured programming	3:1
Computer saturation	
Software responsiveness	

cost. Fig. 4 is a prediction of a likely future trend in software productivity.<sup>9</sup> Overlaid are productivity figures from recent RCA software experience, (circles), and from model software programs outside the realm of ATE, (triangles).

The upper and lower bounds represent a generally accepted range of coding complexity. Each point on the plot has a letter inserted indicating the relative complexity of the programming task, i.e., e, s, and d. Easy coding (e) generally has few interactions with other system elements (e.g., support software). Standard coding (s) has some interactions with the other system elements (e.g., functional software), and difficult coding (d) has many interactions with other systems elements (e.g., control elements).<sup>5</sup> Software productivity generally changes by a factor of two with each step in complexity.

The plotted points in Fig. 4 indicate that ATE software has kept pace with productivity predictions and with the performance of better-known software efforts outside ATE. The paragraphs that follow discuss these programs and identify cost factors relating the results indicated.

System H is RCA's real time, multi-station, multi-programmed test system for jet engine fuel controls and hydraulic accessories. The 10 000 words of System H operating system software fall in the difficult category. When System H computers were selected, the bundled real time executive software had not yet matured and mastery of the CPU and its real time executive (not only what it did, but how) was essential. The effort meant added work, and an understanding and

appreciation of executive system design concepts. System H software productivity of 10 words of code per man day was relatively high considering that concepts of structured programming were only beginning to be used, and a satisfactory high order language was not available. Software productivity factors were:

*Positive*

- High computer system response
- Selected key individuals
- Software responsiveness

*Negative*

- Machine language
- Computer hardware/software maturity
- Software learning curve
- Computer saturation

The use of FORTRAN as the base for the System H test programming language is of passing interest. FORTRAN was extended to include test-oriented System H statements. These English-like statements paralleled FORTRAN syntax and resemble the terminology of hydraulic test. Using an existing compiler proved to be highly successful, and at an investment of several man-months of engineering, was very cost effective.<sup>10</sup>

System 3 is a general-purpose electronic test system. The coding is standard complexity consisting primarily of utility software operating under the computers executive system. Eight man years were applied to develop the 150 000 words of executable code. Two of the eight man years were devoted to the development of an adapted ATLAS language and an ATLAS compiler/interpreter. This is in contrast to twelve man years expended on a second generation test language compiler, or a six-fold improvement. The improvement is attributed to several fac-

tors: (1) The computer was developed by two skilled ATE engineers with state-of-the-art programming experience. Programmer support was not required, and the problems of communication and control were virtually non-existent; (2) the use of ALGOL facilitated structured design and high-order language efficiency; and (3) the design was implemented interactively on a video terminal which facilitated editing and quick turn-around.

One man year covered all of the other utility software, e.g., text editor, panel interface handler, D-LASAR translator, etc. The remaining five man years were spent on run time software for signal synthesis, signal analysis (Fast Fourier Transform) and device handlers including digital, LF, RF, pulse, universal pin programmable interface, and common equipment interfaces.

System 3 overall software productivity averaged 70 words of code per man day. Software productivity factors were:

*Positive*

- High-order language
- Top engineering personnel
- Computer system response

*Negative*

- Disc saturation
- Cassette response

Using an all engineering staff instead of a programming staff for ATE utility and operating system software has proven to be a cost effective practice.

IBM's OS/360 and Honeywell's MULTICS (Multiplexed Information and Computing Service, developed jointly by Bell Labs, G.E., and Project MAC of MIT) are large computer utilities in the very difficult coding category. They are shown on the plot in Fig. 4 as points of reference. OS/360 took 2 000 man years to build in assembly language according to Computerworld. MULTICS took 200. Prof. John Donovan of MIT stated that MULTICS was first used by MIT students after 50 man years of development; however, 200 man years was applied to the current system containing 1 000 000 words of procedure code (300 000 lines of PL/1)<sup>11</sup>. MULTICS was referred to as an operating system of the future because of the techniques that were used in its development. Software productivity factors included:

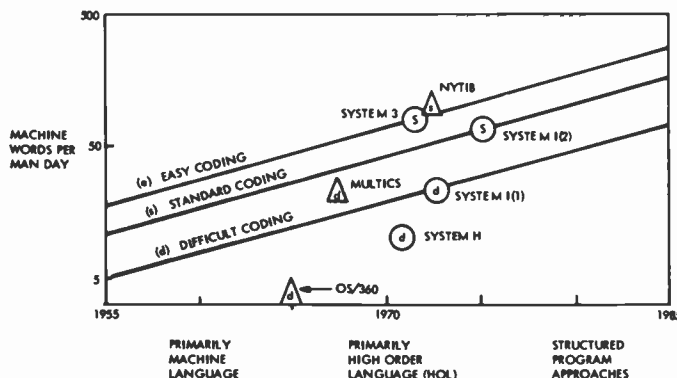

Fig. 4 — Milestones in software productivity

- High-order language
- Computer system response
- Structured design

System I is a portable automatic test system for testing internal combustion engines. It contains a task oriented operating system and interactive software<sup>12</sup>. The coding level is difficult. The system demonstrated the feasibility of computer based diagnosis of Army vehicles with built-in diagnostic connectors. An average assembly level programming efficiency of 25 instructions per man day was achieved by a four-man chief programmer team in only two months. This software system is a highly structured hierarchy of modules, as shown in Fig. 5. The modules average 50 instructions. Each module is self-contained with its own data structure, internal linkages, and accessing and modifying procedures. Calling sequences are part of the module, and design decisions are inherent in the module instead of distributed throughout the system. The system is self-integrating. Each module executes within the context of the total system sharing common procedures and stack facilities existing higher in the hierarchy.

System I software developed is an excellent example of top-down structured programming. The effort was highly productive even though programming was in machine language. Software productivity factors are:

#### Positive

- Computer system response
- Chief programmer team
- Structured top-down programming

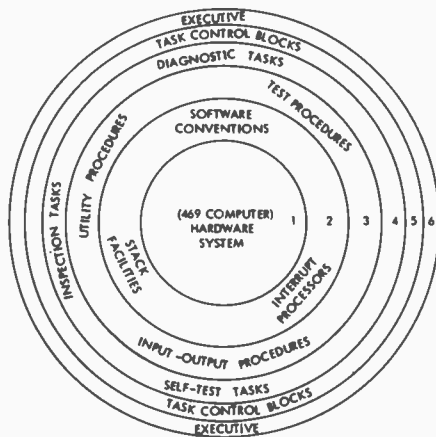

Fig. 5 — System I software hierarchy

- All engineering staff

#### Negative

- Assembly language
- Learning curve

Phase 2 of the System I program developed vehicle performance and fault diagnosis software. This standard level of coding is being produced at a rate of 50 words per man day.

NYTIB is IBM's New York Times Information Bank system.<sup>5</sup> It is a chief programmer team experiment with more rigorous control of "GO-TO free" programming. NYTIB is standard level coding and gave results similar to those experienced in System I. Dr. Mills, who is responsible for many of the procedures IBM used, stated at the IEEE Colloquium on "Software for the Engineer" in Lexington, Mass., Feb. 7, 1974, "structured programming is the mental process of programming itself. Using structured programming will result in: 3:1 more production; 10:1 less errors; and 2:1 less size."

Software productivity factors included:

- Chief programmer team
- Structured "GO-TO free" top-down programming
- Software responsiveness

## Conclusion

The fundamental methodology of developing cost effective software is not new. The principles have been used by engineering management for years. Yet it was not obvious, not even to the engineering manager, when his project was heading into software trouble. Recently (1969-1973) Dijkstra, Mills, Liskov, Baker, and others have been effective in their analysis and solution of the problem. Fundamentally the problem is one of relating program text (design) with execution (code). The solution is a structured, step-wise development of programs, expanding functional specifications into text. Software should be conceptually simple and the text easily coded. The result is a design that helps keep track of what is being done, reduces the problem of mental verification, and improves management control.

Selecting the right people for the job is the most important factor in increasing

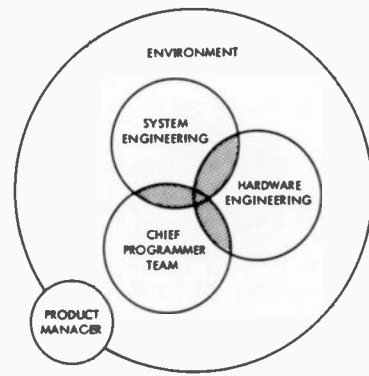

Fig. 6 — ATE engineering team organization.

software productivity. Establishing the proper environment for them to work in, including the tools and procedures to work with, is the other.

The ATE System is best engineered by three interdisciplinary teams. Each team, as illustrated in Fig. 6, must have overlapping knowledge of the other's engineering skills. Team members are proven performers, experts in their field, and usually include selected new engineers. Management provides the catalyst, lets people know what is expected of them, stages the environment that will allow it to happen, and accounts for their performance.

## References

1. Van Roekens, P.N.; "Problems Associated with Implementation of Software Systems," IEEE Colloquium on Software for the Engineer, Lexington, Mass., Feb. 7, 1974.
2. Hosier, W.A.; "Pitfalls and Safeguards in Real-time Digital Systems with Emphasis on Programming," *IRE Transactions on Engineering Management*, Vol. EM-8 (June 1961) pp. 99-115.
3. Bellcomm, Inc., *Management Procedures in Computer Programming for Apollo-Interim Report*, TR-64-222-1, Nov. 30, 1964.
4. Dijkstra, E.W.; "Structured Programming," *Software Engineering Techniques*, Buxton, J.N. and Randell, B. Ed. (Oct. 1969) pp. 84-88.
5. Baker, F.T.; "Chief Programmer Team Management of Production Programming," *IBM Systems Journal*, Vol. 11, No. 1, 1972.
6. Mills, H.D.; "How to Write Correct Programs and Know It," IBM, Federal Systems Division, FSC 73-5008, Jan. 1973.
7. Liskov, B.H.; "Guidelines for the Design and Implementation of Reliable Software Systems," AD-757 905, Mitre Corp., Feb. 1973.
8. "Program Design Handbook for Automatic Test Equipment", RCA Corporation Report CR-68-588-30, Burlington, Mass., June 1968.
9. Boehm, B.W.; "Software and Its Impact: A Quantitative Assessment," *Datamation* (May 1973) pp. 48-59.
10. Fischer, H.L. and Vallance, A.F.; "A FORTRAN Solution to a Higher Order Test Language Requirement," *IEEE Proceedings on Automatic Support Systems Symposium*, Nov. 1972.
11. Corbato, F.J., Clingen, C.T., and Saltzer, J.H.; "MUTICS: The First Seven Years," *Honeywell Computer Journal*, Vol. 6, No. 1 (1972) pp. 3-14.
12. Teixeira, N.A., Pradko, F., Sarna, D., and Garland, P.; "Diagnostic Instrumentation for Military Vehicles," *Society of Automotive Engineers*, 730658, June 1973.

# The reliability of epoxy as a die attach in digital and linear integrated circuits

B.M. Pietrucha | E.M. Reiss

The implementation and advantages of epoxy die-attach are described with special emphasis given to areas of mechanical integrity and product stability. A recent special test program indicates that the epoxy die-attach process results in a reliable product.

**D**URING the past fifteen years the increased use of epoxy (Ref. 1) has resulted in the growth of the number of available sources. This study is confined to the evaluation of a one-part-conductive epoxy which has been used since 1966 in the manufacture of both linear and digital I.C.'s, by both the bipolar and MOS technologies.

It is easy to understand the growing acceptance by electronic component manufacturers of this die-attach system, since when it is compared to the conventional eutectic mount it offers the following advantages.

1. The device temperature does not exceed  $200^{\circ}\text{C} \pm 10^{\circ}\text{C}$  during the die-attach process.
2. The integrity of the die-attach is not a function of the back surface of the semiconductor, thereby eliminating the need for special operations; i.e., the evaporation of gold onto wafers.
3. The efficiency of the die-attach operation.

higher die-attach yield (approaching 100 percent), and the adaptability of the method to mechanization result in a lower cost than eutectic mounting.

Despite these advantages, the use of an epoxy die-attach system in high-reliability applications caused the following concerns:

1. Integrity of the die-epoxy package system. For example, would the effect of hundreds or thousands of temperature cycles result in the die separating from the package?
2. The effect of by-products or side effects of the epoxy on the reliability of the finished device. If the device experienced temperatures, would the epoxy continue to decompose, and would the outgassing products result in latent failures?
3. Are the process controls well enough defined to prevent defective product from being manufactured? (process controls are included as Appendix A).

As a result of these concerns, users of high-reliability devices in both industry

**Bernard M. Pietrucha**, Associate Member Technical Staff, High Reliability Engineering, Solid State Division, Somerville, N.J., received the BSEE in 1967 and the MSEE in 1973, both from the Newark College of Engineering. From 1967 to 1971, he served with the U.S. Air Force as a project engineer with the Satellite Control Facility, and as a launch controller on both Air Force and NASA space programs at Vandenberg Air Force Base. In 1971-72 he was awarded both a teaching fellowship and a research assistantship at Newark College of Engineering where he investigated deposition of silicon nitride films using a carbon dioxide laser as an energy source for evaporation. He joined the RCA Solid State Division in 1973 as a member of the High Reliability Integrated Circuits Technical Staff. Mr. Pietrucha is a member of the IEEE.

**Eugene M. Reiss**, Manager, High Reliability IC Engineering, Solid State Division, Somerville, N.J., received his BS in Chemistry and MBA in Management from Fairleigh Dickinson University in 1957 and 1971, respectively. In 1959 he joined RCA where he worked on the development of high-speed switching transistors. In 1965, Mr. Reiss joined the newly formed integrated-circuits department and engaged in the manufacture of linear and digital devices. His assignments included process improvements in the diffusion and photochemistry areas. In 1966 he was named Leader for the Spectra 70 circuits. Since 1972 he has directed the High Reliability IC Engineering department and has been heavily involved in space applications of C/MOS devices.

Authors Pietrucha (left) and Reiss.



Reprint RE-21-5-6  
Final manuscript received January 15, 1975.



and the military have been reluctant to use parts with an epoxy die-attach system. This view is reflected in military documents, such as the MIL-M-38510 general specification, which specifically prohibit the use of an epoxy die-attach. This study evaluates each of these concerns. Both the mechanical integrity and lifetime of die-epoxy package systems are evaluated under varying levels of stress.

## Description of epoxy used for mounting

The epoxy evaluated in this paper is a one part, thermosetting, conductive paste; the filler is silver. This epoxy was chosen because of the good thermal conductivity of the silver. Thermal conductivity was considered since the epoxy is used in mounting both bipolar and MOS devices.

The mechanical and physical properties of the epoxy are:

Thermal Conductivity	140×10 <sup>-4</sup> Cal/s cm °C
Electrical Resistivity	5×10 <sup>-4</sup> ohm cm
Percent Resin	14.5 - 15.5%
Percent Silver	69 - 71%
Total Solids	84 - 86%

The epoxy is a proprietary resin with a phthalic anhydride catalyst. The solvent is a butyl cellosolve compound.

## Test program

The test program for evaluation of device integrity and product stability was designed to address two major concerns:

1. Does the epoxy provide a stable die-to-package interface capable of withstanding thermal and mechanical stress?
2. Does epoxy contribute any detrimental element to the environment within a hermetically sealed integrated-circuit package?

Both questions require specific attention since uncertainties in either area could severely affect reliability of the finished product.

## Mechanical evaluation

A random sample of 200 type 4001 CMOS devices composed of product manufactured over a ten-week period was selected for study (Ref. 2). These parts were subjected to the test program out-

Table I — Mechanical screen sequence.

Constant Acceleration	60,000 G's, Y1 Direction, 1 Minute
Temperature Cycle	-65°C to 200°C, 10 Minutes at Extremes, 100 Cycles
Constant Acceleration	60,000 G's, Y1 Direction, 1 Minute
Temperature Aging	No Bias, 1000 Hours, 200°C
Temperature Cycle	-65°C to 200°C, 10 Minutes at Extremes, 100 Cycles
Constant Acceleration	60,000 G's, Y1 Direction, 1 Minute

lined in Table I. At the conclusion of the test sequence, 20 devices were opened and examined for mechanical integrity. A visual examination was performed to evaluate die orientation, corrosion of the metallization system, and silver migration. A shear test was then performed by applying a force of 1000 grams to the side of the chip. No corrosion of the metallization or silver migration was noted and all devices passed the shear test. (While several packages were broken during decapping, the breaking also fractured the chip and the chip pieces were still attached to the ceramic substrate). Test results are summarized in Table II.

Table II — Mechanical screen results.

Inspect For	Results
Die Orientation	Correct
Metallization Corrosion	None Observed
Silver Migration	None Observed
Shear Test	No Die Removed Intact

## Determination of outgassing products

Outgassing of epoxy has been a major concern of both manufacturers and users of epoxy-mounted integrated circuits and hybrid systems. An improperly vented curing oven could prevent solvent from being carried away from the devices during cure, and this might result in surface contamination of the mounted components. There is also concern that outgassing of cured epoxy within a sealed device could present a reliability hazard.

To determine the time required to properly release the organic solvents and allow the epoxy to stabilize, a thermogravimetric analysis was performed on uncured epoxy at temperatures of 175°C, 200°C, 225°C, and 250°C. This

analysis was performed using a thermal analyzer which, in isothermal operation, measures the weight of a material as a function of elapsed time. The system utilizes a semi-micro balance to precisely measure the weight loss of a small sample (30 to 100 milligrams) to minimize the problems associated with heat transfer in a larger mass. The results of this analysis indicate that after 20 minutes at temperatures below 200°C the epoxy stabilizes at a figure approximating its total percent solids, and outgassing ceases. At temperatures above 200°C the epoxy continues to outgas, as shown in Fig. 1. The normal curing cycle for the one-part epoxy during production is two hours at 200°C.

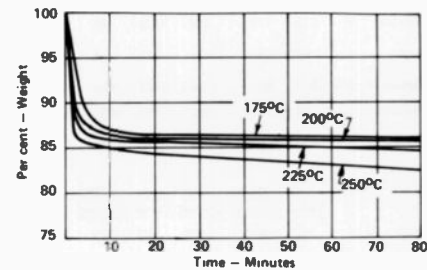

Fig. 1 — Thermogravimetric analysis (isothermal).

Based on the results of this analysis, test cells were prepared to determine the outgassing products of the epoxy, again at the four temperatures of 175°C, 200°C, 225°C, and 250°C. The test-cell matrix is shown in Table III. Twelve test devices were prepared for each temperature. Four packages contained dummy chips mounted in epoxy (no wire bonding); these packages were cured for two hours, tack welded, pre-sealed baked for four hours, and sealed in a sealing box with dry N<sub>2</sub> atmosphere. Four more packages prepared with dummy chips mounted on uncured epoxy were sealed in the sealing box with no cure or bake. Four additional packages were sealed empty to provide a control cell. Each cell of twelve devices was then baked at its respective temperature for four hours. At the completion of the four-hour bake,

Table III — Outgassing test cells (N = 48).

	175°C	200°C	225°C	250°C
Cured Epoxy Mount	4	4	4	4
Uncured Epoxy Mount	4	4	4	4
Empty Package	4	4	4	4

three devices from each cell were submitted for analysis by mass spectrograph.

The gas ambient in a device package can be analyzed accurately by mass spectrometer if the device is sealed in a hermetic unit attached directly to the inlet system of the mass spectrometer and pierced *in vacuo* after a suitable evacuation of the entire system. The sensitivity of the mass spectrometer used in the tests described is high enough to permit reporting of test results accurate to 5 parts per million in most devices.

Table IV — Spectrographic analysis (175°C to 25°C) of gaseous content of sealed packages in PPM.

	175°C			200°C		
	Cured	Uncured	Control	Cured	Uncured	Control
Hydrogen	830	775	795	617	870	870
Oxygen	210	175	140	7625	45	200
Argon	90	133	122	515	118	275
Carbon Dioxide	810	900	1700	2141	950	5000
Methane	30	125	280	119	1600	475
Ethane	N.D.	36	75	95	145	410

	225°C			250°C		
	Cured	Uncured	Control	Cured	Uncured	Control
Hydrogen	650	670	739	900	780	690
Oxygen	45	290	9157	70	105	300
Argon	125	320	736	140	180	85
Carbon Dioxide	3200	4000	2399	4200	8500	800
Methane	200	610	112	400	900	22
Ethane	106	455	N.D.	150	700	N.D.

The analysis indicated no significant difference in the quantities of hydrogen, oxygen, argon, carbon dioxide, methane, and ethane between the cured epoxy and uncured epoxy, and the control (empty packages) for each temperature range, Table IV. A mixture of butanes, butenes, propanes, and propenes was detected but could not be quantified. These same spectral lines were noted during analysis of a sample of epoxy heated to 250°C. The analysis did not reveal any concentration of ionizable compounds emitted from the epoxy that would contribute to surface contamination.

The remaining twelve devices (one from each cell) were submitted for analysis of

Table V — Water vapor content in PPM.

	Bake Temperature			
	175°C	200°C	225°C	250°C
Cured	N.D.	N.D.	N.D.	N.D.
Uncured	< 100	< 100	200	4900
Empty Package	N.D.	N.D.	N.D.	N.D.

N.D. = None Detected

water content so that in the event of failure of any of the cells during stress testing some correlation between water content and failure rate might be drawn. Water vapor was only detected in the cell containing uncured epoxy, Table V.

### Effects of outgassing on device stability

Following the determination of the nature of the environment within the hermetic package, a program was undertaken to evaluate the effects of these elements on device performance. Three test cells of 4007 CMOS integrated circuits were chosen because these devices consist of 3 PMOS and 3 NMOS transistors on a single chip — two complementary pairs with the third pair connected as an inverter. The presence of only six transistors greatly simplifies parametric evaluation. Additionally, the CMOS devices are surface sensitive and respond readily to contamination of the surface.

The first cell consisted of units which were epoxy mounted, cured, and sealed. A second cell was mounted eutectically and processed in an identical fashion. The final cell was epoxy mounted with no cure or bake of any kind and was used to assess the effects of uncured epoxy on the performance of the device. This third cell provides a "worst-case baseline" for evaluation; however, devices would not normally be mounted in this manner.

An initial test group of 24 devices (eight devices per cell) was placed in a 250°C oven with bias voltages applied by means of the circuit shown in Fig. 2. Parametric data was recorded at times of 4, 8, 12, 54, 124, and 196 hours. A second group of 24 devices was then placed in the chamber and tested identically for 600 hours. The combined test results show zero failures

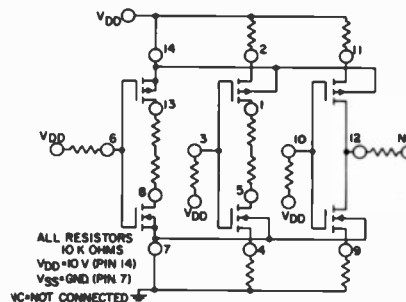

Fig. 2 — Bias stress-test schematic diagram.

in both the cured- and uncured- epoxy test cells. The eutectic-test cells showed one failure. Histograms of leakage current for both zero-hour and 600-hour down periods indicated no significant parameters shifts in any of the three cells, Fig. 3.

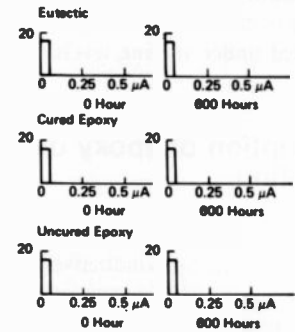

Fig. 3 — Leakage-current histograms.

Since these tests were time terminated, acceleration factors (Ref. 3) were calculated on the assumption that the first failure was about to occur in the epoxy cell. An activation energy of 1.1 eV (Ref. 4) for silicon integrated circuits was used in the Arrhenius equation, based on data generated for bipolar devices and supporting data for CMOS (Ref. 5).

$$R(T) = A \exp(-E/kT) \quad (1)$$

where  $R(T)$  is the failure rate at a given temperature  $T$ ,  $A$  is the scale factor,  $E$  is the activation energy in electron-volts,  $k$  is Boltzman's constant ( $8.63 \times 10^{-5}$  eV/°K), and  $T$  is temperature (°K).

To determine the acceleration factor,  $F$ , let

$$F = R(T_2)/R(T_1) \quad (2)$$

where  $R(T_2)$  is the failure rate at temperature  $T_2$  and  $R(T_1)$  is the failure rate at temperature  $T_1$ .

From Eqs. (1) and (2);

$$F = \frac{A \exp(-E/kT_2)}{A \exp(-E/kT_1)} \quad (3)$$

But  $F$  is also inversely proportional to the ratio of the times to first failure, so that

$$F = t_1/t_2 = \exp[E/k(1/T_1 - 1/T_2)] \quad (4)$$

$$\text{or } t_1 = t_2 \exp[E/k(1/T_1 - 1/T_2)]$$

where  $t_2$  is the time to first failure at  $T_2$  and  $t_1$  is the time to first failure at  $T_1$ .

Table VI — Time to first failure using calculated acceleration factors.

Temperature	Time (Approximate)
150°C (423°K)	180,000 Hours
125°C (398°K)	$1.2 \times 10^6$ Hours
100°C (373°K)	$1.08 \times 10^7$ Hours
85°C (358°K)	$4.5 \times 10^7$ Hours
55°C (328°K)	$1.2 \times 10^9$ Hours
25°C (298°K)	$6 \times 10^{10}$ Hours

Using Eq. (4), the calculated time to first failure at 55°C would be  $1.2 \times 10^9$  hours. The time to first failure at other values of temperature is given in Table VI, and plotted in Fig. 4.

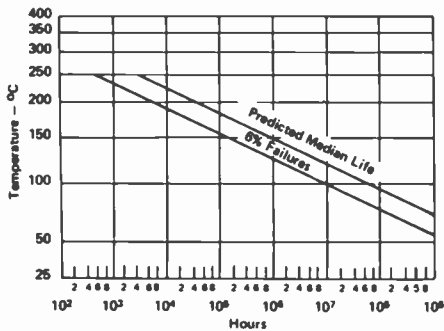

Fig. 4 — Predicted life distribution of epoxy mounted devices.

To estimate the median life of the sample at 250°C, the distribution of failure was assumed to be log-normal with  $\sigma = 1.3$  (Refs. 3,4). Again, the first failure was assumed imminent at 600 hours. A line constructed for a sample size of 16 is shown in Fig. 4. The constructed line indicates a time to median failure of at least 4000 hours at the 250°C level.

The fact that there were no failures attributable to the epoxy after 600 hours indicates that epoxy (even uncured) does not affect the stability of the device at the 250°C temperature. The small sample size and the number of failures in the eutectic cell are not sufficient evidence to prove the superiority of the epoxy mount. However, under the test conditions described, the epoxy provided an environment which did not degrade the reliability of the device.

Table VII — Reliability estimates at various temperatures.

Temperature	Failure Rate (%/1000 Hrs.)
125°C	0.011
100°C	0.0013
55°C	0.000012

Failure-rate estimates at 125°C, 110°C, and 55°C at 60 percent confidence, assuming one failure and using the acceleration factors calculated, are shown in Table VII. Field data (Ref. 6) supporting these estimates is shown in Table VIII; the data was taken from four satellites using epoxy-mounted devices and presently in earth orbit. The demonstrated failure rate of 0.013% per 1000 hours compares favorably with the calculated values in Table VII.

Table VIII — Field usage data on epoxy mounted integrated circuits.

Name of Satellite	OSCAR-6	ITOS	O/F	AE
Time in Orbit	14 Months	20 Months	3 Months	
Number of Units	90	42	2400	
Test Hours	985,500	613,200	5,256,000	
Number of Failures	0	0	0	
Failure Rate (%/1000 Hrs.)	0.092	0.145	0.016	
MTTF (Hours)	1,080,000	680,000	6,080,000	

Total Failure Rate = 0.013%/1000 Hrs.  
MTTF = 7,400,000

## Conclusions

Mechanical screening has shown that epoxy provides a positive die-to-substrate interface capable of withstanding a high degree of thermal and physical stress. Silver migration and metallization corrosion were not observed during the visual inspection.

Histograms of leakage parameters show that outgassing of epoxy does not affect the stability of an integrated circuit, even after 600 hours of exposure to temperature stress. There was no significant degradation in the leakage parameters during test.

Analysis of outgassing constituents reveals no substantial concentrations of ionizable compounds which might contribute to contamination-type failure mechanisms.

## Recommendations for further work

Variations in gas analysis techniques utilizing mass spectrometry can produce conflicting results (Ref. 7) when analyzing the ambient gases present in an integrated circuit package.

Refinements are required in this area which would analyze only the gases present and exclude the products which are desorbed from the mount and the

package in vacuo. There is some question whether vapors desorbed during analysis in vacuo would be present in the vapor phase while the package was still hermetic. Another unexplored area is analysis of solids which might condense within the package after stress testing. This technique could provide a more definitive indication of the environment within the package.

## Acknowledgments

The authors gratefully acknowledge the contributions of D. Masakowski, J. Zuber, C. Whelan, H. Foxman, F. Reiss, M. Vincoff, J. Schoen, and V. Fowler of the Somerville, N.J. Technical Staff, S.A. Decker of the Harrison, N.J. Technical Staff, and High Reliability Technical Staff at Findlay, Ohio.

## References

- Kelly, S., Synderman, S.: *Epoxy Die Bonding Catches On*. Electronic News, December 18, 1972; p. 23.
- Vincott, M.N.: *Reliability of Chip Silver Epoxy System*. RCA COS MOS Integrated Circuit Reliability Data, 1970.
- Reiss, F.: *RCA Private Communication*.
- Zierdt, C.H.: *Procurement Specification Techniques for High Reliability Transistors*. Proceedings of the Thirteenth Annual Symposium of Reliability, Washington, D.C.: 1967, p. 388.
- Whelan, C.: *RCA Private Communication*.
- Vincott, M.N.: *RCA Private Communication*.
- Thomas, R.W. and Moore, B.A.: *Unique Reliability Analysis Capability*. Rome Air Development Center, New York, 1973.

## Appendix A: Process controls

Vigorous incoming inspections are performed on incoming lots of epoxy in addition to stringent process controls. The vendor supplies a Certificate of Compliance with each lot certifying that the requirements for adhesion, thermal conductivity, and electrical conductivity are met. The incoming inspection verifies the silver, resin and total solids content in addition to the viscosity. Each lot is identified by the vendor by a unique number and expiration date; special handling procedures have been established to assure that the epoxy is not used beyond this date.

The in-process controls consist of the monitoring of oven temperature and purging-gas flow rate by both manufacturing and quality-control personnel. Control charts showing both action and absolute limits are posted. After die-attach, a sample of units is subjected to a shear-test force of forty grams. Each device is visually inspected for proper application of the epoxy.

# Television applications of PLZT ceramics

B.M. Soltoff

The electrically controllable properties of PLZT ferroelectric ceramic devices can be exploited for use in television systems as variable neutral density filters, as selective spectral filters, and as light gates in a system for stereoscopic viewing.

EXISTING spacecraft television systems use a rotating color-filter wheel for spectral separation and a motor-driven iris for exposure control. These mechanical elements compromise reliability and limit lifetime. Under a NASA contract,\* the Astro-Electronics Division has investigated a solid-state electro-optic filter as a possible replacement for these mechanical functions.

\*The work described was performed by the Astro-Electronics Division under contract NAS 9-13549 to NASA, Johnson Space Center.

Bert M. Soltoff, Project Manager, Astro-Electronics Division, Princeton, N.J., received the BSEE from Drexel Institute of Technology in 1956 and the MSEE from the University of Pennsylvania in 1964. Mr. Soltoff has been associated with television and related equipment for 18 years. He is presently the Project Manager for ERTS/Shuttle/SEOS sensor programs. Mr. Soltoff joined RCA in 1962 and transferred to AED in 1963. In 1968, he was assigned as the Manager, Camera Development, where he initiated the design and development of the high resolution Return Beam Vidicon Cameras used for surveillance on the Earth Resources Satellites. In 1969,

The birefringent properties of ferroelectric ceramics offer a viable electrically controllable alternative to the mechanical functions. PLZT (polycrystalline lanthanum-modified lead zirconate titanate) ceramic provides significantly increased transparency compared to previously available materials,<sup>1</sup> and also overcomes the traditional limitations of single-crystal ferroelectric materials (i.e., limited size, non-uniformity, and small electro-optic effect). Ceramic composition 9065 (9/65/35, La/Zr/Ti ratio) was

he directed the development of a miniature color tv camera for space applications. During this period, he also directed the development of the video multiplexer and sequence generator for the RBV system. From 1956 to 1962, he worked for the Philco Corporation on television systems, first for the Research Division and later for the Commercial Engineering Section. Mr. Soltoff is a member of the IEEE, the Technical Group on Broadcast and Television Receivers, and the planning committee of the Aerospace and Electronic Systems Society.



Author, Bert Soltoff, demonstrating the "stereo" goggles used for the stereoscopic television application described in this paper.

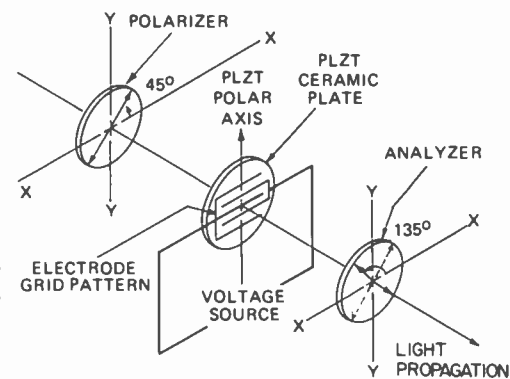

Fig. 1 — Solid-state electro-optical filter configuration. With no voltage applied, the PLZT plate is isotropic, and the polarizers are crossed at 90°, effectively blocking the light path. Voltage applied to the PLZT plate causes linear rotation of the incident light, and thus controlled light transmission.

used for the experiments. The test samples are 1.5-inch in diameter and 0.010-inch thick.

The improved characteristics, in conjunction with suitable polarizers, enable the assembly of a neutral variable light-control gate of wide dynamic range. Operation as a spectrally selective filter can be achieved by extending the control range into one of the higher orders of Newton's series,<sup>2</sup> or by designing a compound optical network for a better pass-band shape factor. Finally, the rapid response time of the PLZT permits the assembly of a stereoscopic television viewing system which presents very low interference to normal vision and permits observation over a large viewing area.

## Variable density filter

The elementary filter configuration is shown in Fig. 1. The polished PLZT plate, interposed between two crossed polarizers, is operated in the transverse mode by voltage applied to narrow electrodes deposited as an interdigitated array on the ceramic wafer. [In the transverse mode, the optical axis of the PLZT plate is perpendicular to the direction of light propagation.] Unpolarized light at the system input is selectively filtered by the polarizer to provide linearly polarized light at 45° to the X-X axis. This light passes through the PLZT and impinges on the analyzer whose optical

Reprint RE-21-5-13

A version of this paper, coauthored by William E. Perry of NASA-JSC, was presented at the IEEE Symposium on Applications of Ferroelectrics at Albuquerque, New Mexico, on June 11, 1975.

axis is at 90° to the polarizer (135° to the X-X axis). In the absence of an electric field, the PLZT plate is isotropic, and the polarizer and analyzer act as 90° crossed polarizers to effectively block transmission of light (*off* state). Application of an electric field causes the PLZT ceramic plate to become anisotropic in a controlled manner. When the potential is adjusted to provide half-wave retardation, the plate provides 90° linear rotation of the incident light and thus maximum light transmission (*on* state) through the analyzer.

For lower potentials, elliptic polarized light is obtained from the PLZT plate output and the analyzer selects a vector portion. Controlling the operating potential between the *on* and *off* states permits use of the PLZT plate as a voltage-dependent variable-density filter.

The electrode pattern contains fingers 0.003-in. wide, spaced 0.040-in. apart. This provides a reasonable tradeoff between ease of fabrication, transmission loss due to electrode size, and required operating potential. Best results were obtained from direct evaporation of gold on chrome.

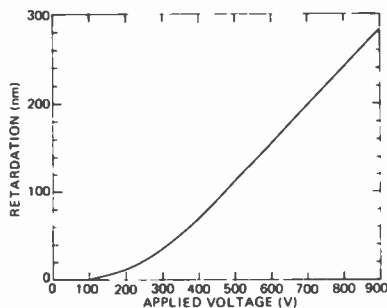

Fig. 2 — Birefringent retardation as a function of applied dc voltage.

Fig. 2 shows the retardation range as a function of voltage, measured on sample plates. The breakdown potential for air dielectric (as exists on the PLZT surface) is on the order of 25 V/mm; halfwave retardation (750 V) can be achieved well before surface breakdown occurs with the 0.040-inch spacing.

#### Light-control for tv camera

In an automatic light control system (Fig. 3), the amplified output of the camera sensor is detected and compared to a fixed reference to develop an error signal. The amplified error signal is used to

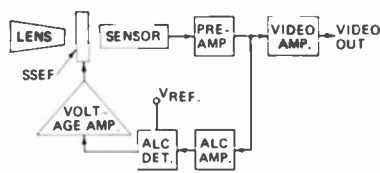

Fig. 3 — Automatic light control scheme for tv camera application.

control the transmission of the filter, and thus the exposure of the camera sensor. This technique is particularly suitable for sensors which have no inherent gain-control mechanism, such as a silicon vidicon.

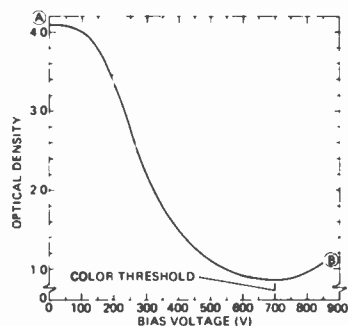

Fig. 4 — Filter density vs. voltage.

Measured control range is shown in Fig. 4. A range in excess of 1000:1 has been obtained (change in optical density greater than 3). Maximum attenuation is established by the quality of the polarizers (type HN-32 were used for the measurements). Of greater importance is the minimum attenuation which is established by the effective transmission of the polarizers in a parallel mode, coupled with the insertion loss of the electroded PLZT ceramic plate. The index of refraction of PLZT is relatively high ( $\approx 2.5$ ), thus resulting in significant reflection losses ( $\approx 30\%$ ) at the air/PLZT interface.

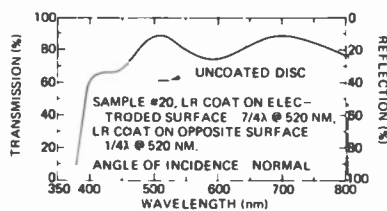

Fig. 5 — Transmission loss of PLZT wafer coated to reduce reflection losses.

Anti-reflection coatings may be applied to minimize the surface reflection loss. Preliminary tests conducted using  $ThF_4$  coatings indicated significant reduction of losses can be achieved. Fig. 5 shows the transmission results achieved on a sample

plate with one side coated  $7\lambda/4$  at 520 nm, and the other side coated  $\lambda/4$  at 520 nm. Based on this data, and the capabilities of current polarizers, an effective *on* transmission of 20% should be achievable.

#### Spectral filter operation

The intensity  $I$  transmitted by a birefringent plate between parallel polars is given by:

$$I = I_o B \cos^2 \pi (n_1 - n_2) t \nu \quad (1)$$

where  $I_o$  is the incident intensity,  $B$  is a factor that is essentially independent of  $\nu$ ,  $n_1$  and  $n_2$  are the refractive indices for the two orthogonal polarizations in the medium,  $\nu$  is the wave number (the reciprocal of the vacuum wavelength of the light, proportional to the optical frequency), and  $t$  is the thickness of the plate. The intensity,  $I$ , plotted as a function of  $\nu$ , represents the spectral response function of the array, and can be made to have a maximum at any desired wave number  $\nu_o$  if the thickness and/or the birefringence of the plate are adjusted so that:

$$(n_1 - n_2)t = m/\nu_o \quad (2)$$

where  $m$  is any integer. The value of  $m$  used to make an array with a transmission maximum at  $\nu_o$  is called the *order* of the filter. Filters with large values of  $m$  have the desirable property that their transmission decreases rapidly as  $\nu$  departs from  $\nu_o$ . However, they suffer from the drawback that the adjacent maxima are more closely spaced than with filters with lower orders. The colors produced by simple filters of this sort are actually quite different from pure spectral colors. When attempting to approximate the visible spectral hues with a simple filter whose value of  $\nu_o$  can be "tuned" over the range of visible wavelengths, the best subjective impression is obtained with a filter having parallel polars and  $m = 2$ . For  $m = 1$ , the transmission peak is too broad; for  $m = 3$  and higher, the adjacent transmission peaks in the visible produce unsaturated colors. The colors produced by an  $m = 2$  filter represent the visible spectrum fairly well, except that a satisfactory green is not obtained.

It is possible to make filters whose transmission decreases rapidly as  $\nu$  departs from  $\nu_o$ , without degradation from closely-spaced adjacent maxima, if

more than one birefringent element is employed. Arrays of many parallel polarizers, interspersed by birefringent plates whose retardations increase in a powers-of-two series, have been used as monochromatizing filters with a very narrow spectral passband.<sup>3</sup> The presence of many polarizers will introduce excessive losses. Narrow passband filters have been described<sup>4</sup> that utilize a multiplicity of birefringent plates and as few as two polars.

A filter that closely approaches any specified spectral response can be produced by incorporating a sufficient number of birefringent plates between two polars. Optical network synthesis techniques can provide a wide variety of spectral responses using a number of identical birefringent plates.<sup>5</sup> If the birefringence of each plate in the network is changed by the same amount, then the shape of the spectral response function is retained but the periodicity is changed, so that the positions of the transmission peaks are shifted. Provided the spectral bandwidth and insertion loss can be reasonably low, such a tunable filter can replace the rotating color wheel in a field-sequential television system by shifting the birefringence during the vertical blanking interval. Review of a number of synthesized networks shows that a system with two identical active plates provides a close approximation to the desired response, and has a response given as:

$$I = (I_0/9) [3 + 4\cos 2\pi (n_1 - n_2)t\nu + 2\cos 4\pi (n_1 - n_2)t\nu] \quad (3)$$

This function has the narrowest principal peak that is allowed for a two-plate filter, but is not as free of subsidiary maxima as are other allowed functions.

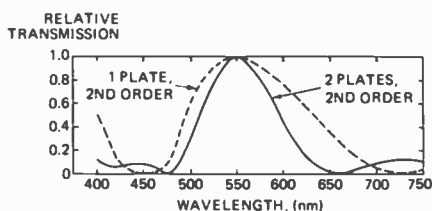

Fig. 6 — Spectral response, 2 plate vs 1 plate.

Fig. 6 shows the spectral response for the synthesized two-plate network, compared to a single-stage second-order filter. The two-plate configuration and optic angles are shown in Fig. 7. Each

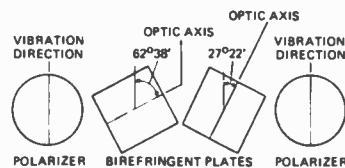

Fig. 7 — Disassembled representation of two-plate optical network.

plate is required to shift 520 nm, with an initial bias (which can be provided by a passive retarder) of 830 nm. Tests on a model of this filter verified the improved spectral purity available.

## Stereoscopic television

Existing stereoscope television systems have used various means for displaying the third dimension. Differences lie primarily in the viewing concept; all rely on similar binocular camera techniques which may use dual cameras or a single camera with an optical splitter. Displays have generally taken the form of adjacent images, with image separation maintained through polarizers, or anaglyph filters worn by the viewer.

These viewing systems distort the viewer's vision when he looks away from the television display to perform other functions. Reflective hood systems suffer from image fusion time and view position constraints. A field-sequential stereo television system using a pair of PLZT light gates for solid-state switching of the visual path overcomes these problems.<sup>6</sup> Standard television equipment may be used with little additional equipment to produce the stereoscopic system. The system may be used in space exploration and habitation operations such as rendezvous and docking of space vehicles, remote instrumentation control, and remote gathering of visual data.

Fig. 8 shows the system configuration. Two cameras are shown for convenience of illustration; a single camera can also be employed with an electro-optic shuttering system. The scene is viewed by the left and right cameras, separated by the normal interocular distance and yawed to provide the desired convergence angle.

The video output signals from the left and right cameras represent the left-eye and right-eye view of the object, respectively, as sensed in stereoscopic perspective. These signals are time-division multiplexed on a field basis by a synchronized

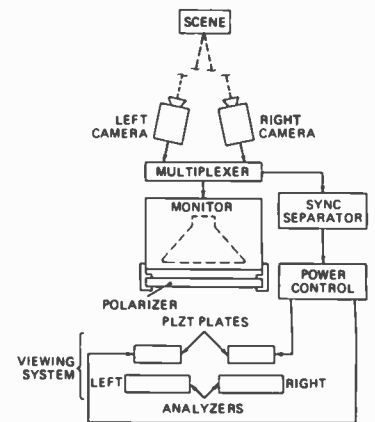

Fig. 8 — Field sequential stereo television system.

multiplexer with, for example, the odd-field signal of the left camera sampled alternately with the even-field signal of the right camera. The video output signal from the multiplexer is a sequence of odd-field signals from the left camera alternating with even-field signals from the right. These correspond to a sequence of alternating left-eye and right-eye stereoscopic views of the object. In all other respects, the multiplexed video output signal is similar to the composite signal of either camera, and is fully compatible with other television requirements. The multiplexer is transmitted to a standard television monitor with attached polarizing screen, where the left and right images of the object are alternately displayed at a 60-Hz broadcast rate.

The viewing system uses a pair of PLZT plates and associated analyzers as on/off filters in a pair of goggles worn by the viewer (Fig. 9). The filters are actuated alternately, in synchronism with the displayed video, by the power control circuit. In this manner, first one eye of the viewer sees the screen of the monitor while the other eye is blocked, then the other eye sees the screen while the first eye is blocked.



Fig. 9 — Stereo television goggles.



The control circuit is triggered by the sync separator which detects the odd/even field information and accordingly triggers the power control to enable the left-eye optical path *on* when the displayed image is from the left camera. Similar triggering of the power control occurs for the signals from the right camera. As a result, the viewer's left eye sees, in rapid sequence, left-camera images, and the right eye sees right-camera images. The switching of the views occurs rapidly enough, with otherwise-standard television components, so that normal persistence of vision leaves the viewer with the impression of continuous screen image exposure for each eye. Thus the viewer experiences a true stereoscopic reproduction of the object. Since the transmission of the PLZT filter is optically neutral, the system may be used to reproduce both color and monochrome stereoscopic images.

Since the viewer's goggles include only electro-optic elements and analyzers, he experiences only minor visual degradation when looking away from the monitor. The analyzer, in this case, blocks that part of the ambient light that is naturally polarized perpendicular to the polarization axis of the analyzer. This effect will be the same as a light shade of polarized sun glasses, and adequate light will always pass through to the viewer's eyes in these situations.

The viewing system is particularly advantageous in cases where the viewer must observe both the monitor and other controls in performance of some task. For example, an astronaut piloting a spacecraft which is to rendezvous and dock with another space vehicle may view a three-dimensional televised view of the docking structure and also be able to observe internal gauges and controls required in piloting the craft.

The multiplexer function can be implemented using a conventional special-effects generator operating in a vertical split-field mode. By using a trigger rate equal to one-half the vertical sync frequency, the vertical split will alternately select full vertical fields of video.

The power switch block diagram is shown in Fig. 10. The PLZT wafer represents a reactive load with a capacity of about  $0.015 \mu\text{F}$ . A ringing circuit using L1 (1 H) in conjunction with the PLZT capacitance generates the control

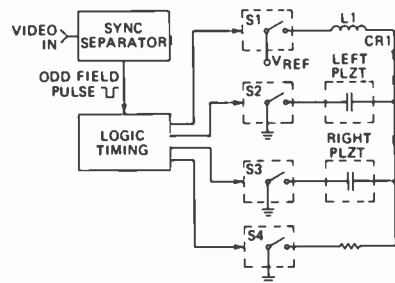

Fig. 10 — Power switching for stereo tv application.

voltage. Transistor switches S1 through S4 are enabled during the vertical blanking interval. S4 discharges the PLZT element during the first half of the interval. Charging is accomplished by closing S1 in conjunction with S2 or S3 (for left or right channel selection) during the second half of the interval. CR1 disconnects the charging path after full potential is reached. The logic timing (implemented with CMOS logic) generates the required control pulses, synchronized by the sync generator output. The entire power control system requires less than one-half watt of power, and is designed for battery operation.

### Ruggedized filter holder

The basic PLZT wafer is delicate, and subject to damage by handling. To provide protection and ruggedness, a holder assembly was designed which encapsulates the wafer in Dow-Corning 93-500 elastomer. This material is optically transparent and compliant so as not to mechanically strain the PLZT. The holder is made in three pieces, as shown in Fig. 11. Front and rear polarizers (or clear glass plates) are bonded into the outer pieces. The middle section is recessed to hold the PLZT element. Electrical connection to the interdigitated electrodes is accomplished by ultrasonic bonding of several 0.001-in. lead wires between the wafer finger rings and external contacts, to provide a solid mechanical connection. After the three

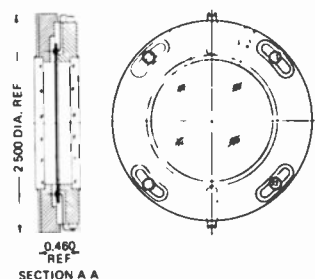

Fig. 11 — Ruggedized bonded holder assembly.

parts are assembled and optical axes aligned, the interior cavities are vacuum encapsulated with the 93-500 material. This provides a moisture barrier and mechanical protection. In addition, the absence of an air path provides significant improvement in high-voltage breakdown ability. Units of this construction have been successfully operated at 1800V.

### Conclusion

Electro-optic properties of PLZT ceramics provide a versatile means for light control where low power, wide-dynamic range, and rapid response are required. The maximum available light transmission in the *on* state (typically about 20%) is the only significant restriction on the device application. Improvements anticipated in associated polarizers, together with optimum anti-reflection coding selection, show promise of 30 to 35% transmission.

Incorporation of the device as a light control unit should be considered in conjunction with sensors such as silicon vidicons, and charge-coupled imagers which have no inherent gain control mechanisms. The other applications described in this paper should provide several imaginative usages for this versatile device.

### Acknowledgment

The author acknowledges the contribution of M. Kravitz in the area of circuit design; F. Hubit, who performed most of the required fabrication and test measurements; and Dr. A. Miller, of the DSRC, for analytic studies of the applications.

### References

- Haertling, G.H., and Land, C.E.: "Recent Improvements in the Optical and Electro-optic Properties of PLZT Ceramics", *IEEE Transactions on Sonics and Ultrasonics*, Vol. SU-19 (1972) pp. 269-280. Also published in *Ferroelectrics*, Vol. 3 (1972) pp. 269-280.
- Delly, J.G.: "Microsonics, Color Key" *Industrial Research*, Vol. 15, No. 11 (Oct. 1973) pp. 44-50.
- Lyot, B., *Ann d' Astrophys*, Vol. VII (1944) p. 31.
- Evans, J.W.: "Lyot Filters", *Journal of the Optical Society of America*, Vol. 39 (1949) pp. 229-242.
- Chang, I.C., et al., "Optical Network Synthesis Using Birefringent Crystals, Pt I," *Journal of the Optical Society of America*, vol. 54, No. 10, (October 1964) pp. 1267-1279. Pt. II, *ibid*, Vol. 55, No. 7 (July 1965) pp. 835-841. Pt. III, *ibid*, Vol. 56, No. 7 (July 1966) pp. 943-951. Pt. IV, *ibid*, Vol. 56, No. 7 (July 1966) pp. 952-955. Pt V, *ibid*, Vol. 56, No. 12 (Dec. 1966) pp. 1746-1754.
- NASA Technical Brief No. B74-10223.

# Optical processing of wideband data

G. T. Burton | R. F. Croce

This paper describes optical equipment for wideband data recorded at frequencies up to 100 MHz. Bulk processing at high resolutions — and Fourier plane filtering and processing concepts — are described.

**E**LECTRON-BEAM and laser-beam recorders are presently used to record wideband signals on film at base-band bandwidths as wide as 100 MHz. The processor described here produces a two-dimensional Fourier transform of the recorded data in a system having a time bandwidth product of  $10^6$  to produce in the Fourier plane a resolution  $< 100$  Hz. The processor employs a hybrid concept in that it uses the parallel input and pre-processing capability of an optical system to perform operator assisted pre-screening and data reduction while allowing additional data manipulations and decision making functions to be handled by a computer operating on the reduced data.

The optical processor with its ability to instantaneously form a two-dimensional Fourier transform of input data — which may contain on the order of  $10^6$  resolution elements — is better suited than a computer system for performance of the preliminary data reduction operation; a computer would require prohibitively long processing times and large memory banks to perform the same transform operation. On the other hand, once the data is reduced, the computer becomes efficient in performing the complex data analysis, interpretations which might involve several data iterations using non-linear, as well as linear algorithms.

The optical processing system used in the configuration of Fig. 1 is a spectrum analyzer presenting (in the frequency output plane) the two-dimensional Fourier transform of the recorded time-

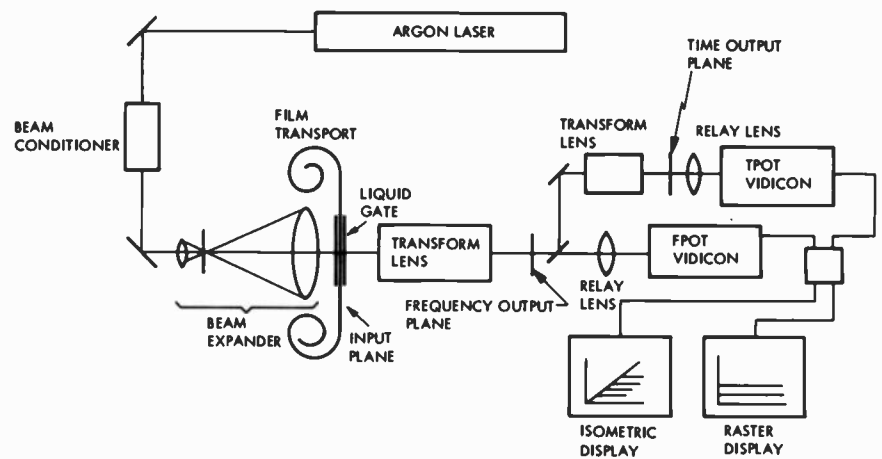

Fig. 1 — Processor configuration.

amplitude information presented at the input plane — while also presenting a filtered replica of the input information at the time output plane.

The processor system implemented consists of an air cooled argon ion laser which produces 44mW at 4880Å, beam conditioner, variable diameter beam expander, variable speed capstan drive film transport, liquid gate, 70mm and 35mm transform lenses, knife edge filters and output transducers. The outputs from the transducers are displayed on an isometric and raster display. Fig. 2 pictures this equipment. Fig. 3 depicts the rack console containing the isometric and raster display, all the control electronics associated with the laser, film transport, sensor transducers and displays.

The system is capable of accepting for processing, information recorded on 16-, 35- and 70-mm film strips produced using either an electron beam recorder (EBR), or a laser beam recorder (LBR). Various real-time input systems such as recently improved PROM devices, deformable thermoplastic, oil films and bubble devices have also been considered for incorporation into the processor and can be implemented within the present configuration. Methods for using these media — especially a photoconductive thermoplastic device — in the Fourier plane to perform the filtering and image enhancement are also being evaluated.

## Processor concepts

The distribution of information in the frequency or Fourier plane is directly dependent on the organization of the data in the input plane. In the illustration of

Fig. 4, the time amplitude information is recorded in a raster format having a line period,  $T_r$ . If the recording is accomplished with the film moving at velocity  $v_f$ , the spacing of the raster lines is  $d$ , where  $d = v_f \times T_r$ . For recorded data to be analyzed over a baseband extending from 0 Hz to a frequency,  $f_m$ , the number of information cycles per raster line is  $n = f_m \times T_r$ . Defining  $w$  as the active width of the film, the number of resolution elements per unit length along a raster line becomes  $n/w$ . The optical processor, with an aperture length,  $a$ , has an input plane acceptance aperture having an area equal to  $a \times w$ , the total number of cycles contained in the aperture or the time bandwidth product of the system is  $N = (a/d) n$ . Note that as the acceptance aperture of the Fourier transform lens increases, so does the time bandwidth product.

The transform of the data recorded in the format of Fig. 4 to a Fourier plane representation is as shown in Fig. 5. Only the upper right-hand quadrant of the Fourier plane is represented in the figure, although in the assembled processing system the complete plane is formed. For the orientation presented, coarse frequency loci are developed with coarse frequency gradations extending along the vertical axis and fine frequency gradations extending along loci lines that are nearly parallel to the horizontal axis. If a single tone were recorded at a frequency between 0 and  $f = 1/T_r$ , that frequency would be transformed to a point on the first locus line above the fine frequency axis. Frequencies higher than  $1/T_r$  are transformed to higher order loci lines which are equally spaced in the vertical direction in the Fourier plane.

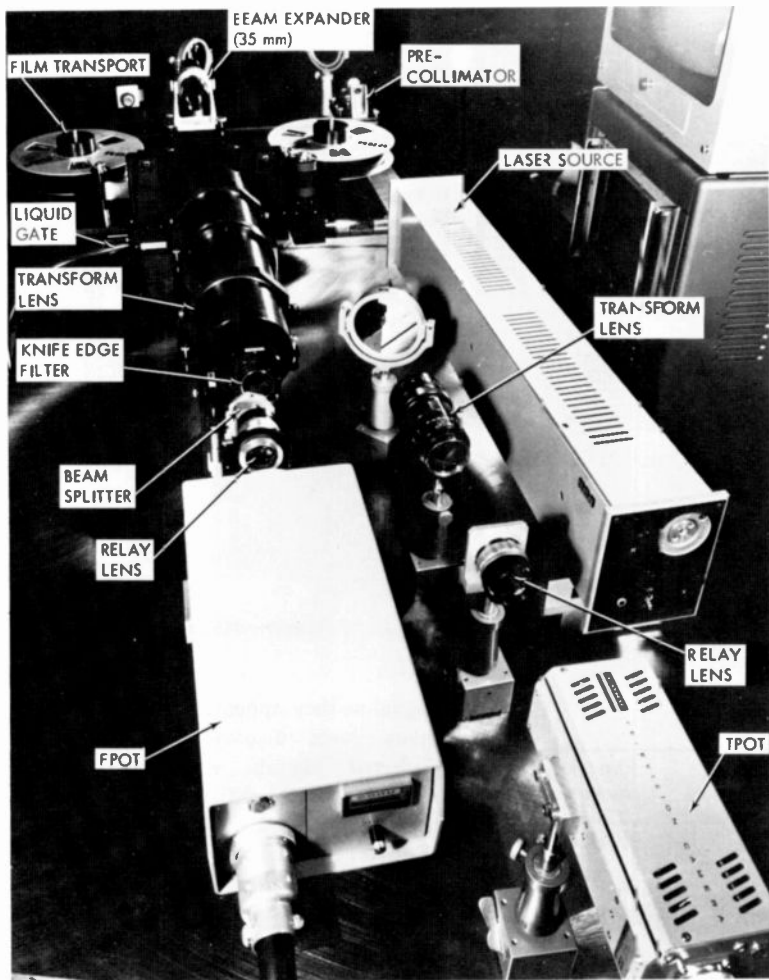

Fig. 2 — Optical assembly.

The coarse frequency axis in the Fourier plane has a limiting resolvability equal to the extent of the fine frequency axis  $f_r$ . The fine frequency axis can in turn be resolved to  $f_m/N$ , where  $N$  is the time bandwidth product and is dependent on the aperture width. An overall resolvability at the Fourier plane greater than one part in  $10^6$  is possible in the present implementation under the assumption that the recorder and recording material do not limit resolution. The resolution at the display is determined by the magnification of the relay optics from the Fourier plane to the optical sensor plane—and the resolution of the "Frequency Plane Output Transducer" (FPOT); the latter converts from the optical signal at the transform plane to an electrical signal suitable for driving this display. The sensor in this system is a 1225-line vidicon camera.

Reprint RE-21-5-8  
Final manuscript received April 28, 1975.

This work was sponsored by the Rome Air Development Center, Griffiss Air Force Base, New York (Contract F30602-73-C-0235) under the supervision of Mr. Al Jambardino and Mr. W. Czyeycki.

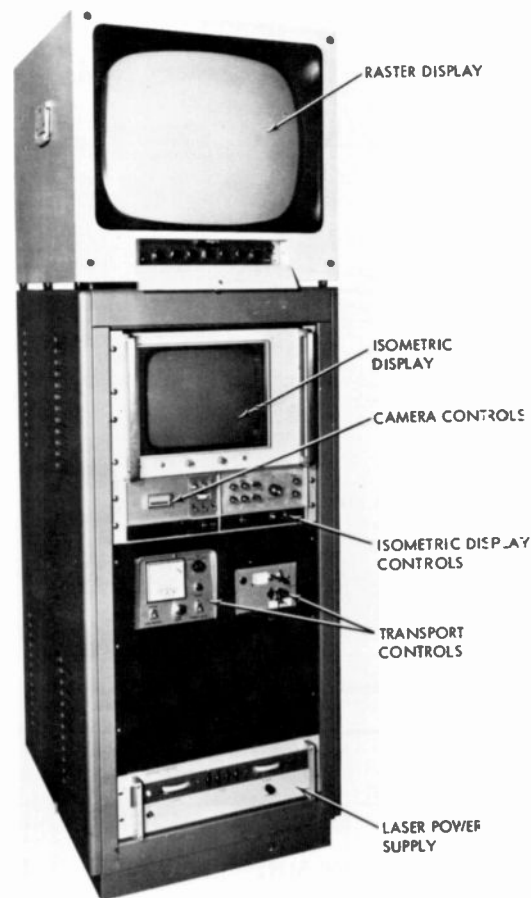
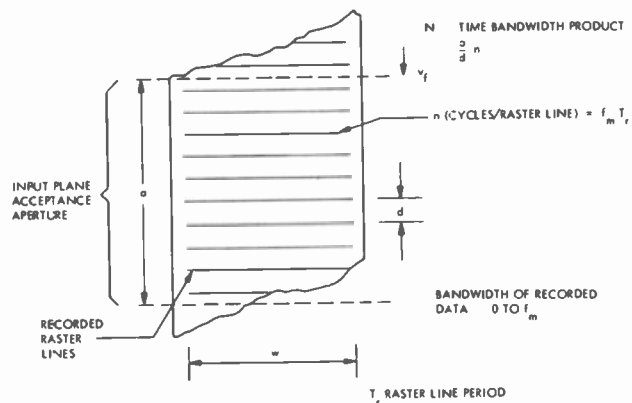

Fig. 3 — Electronics rack assembly.



INPUT DATA FORMAT  
Fig. 4 — Input data format.

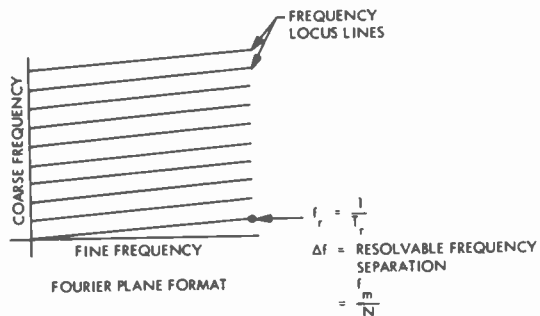

Fig. 5 — Fourier plane format.

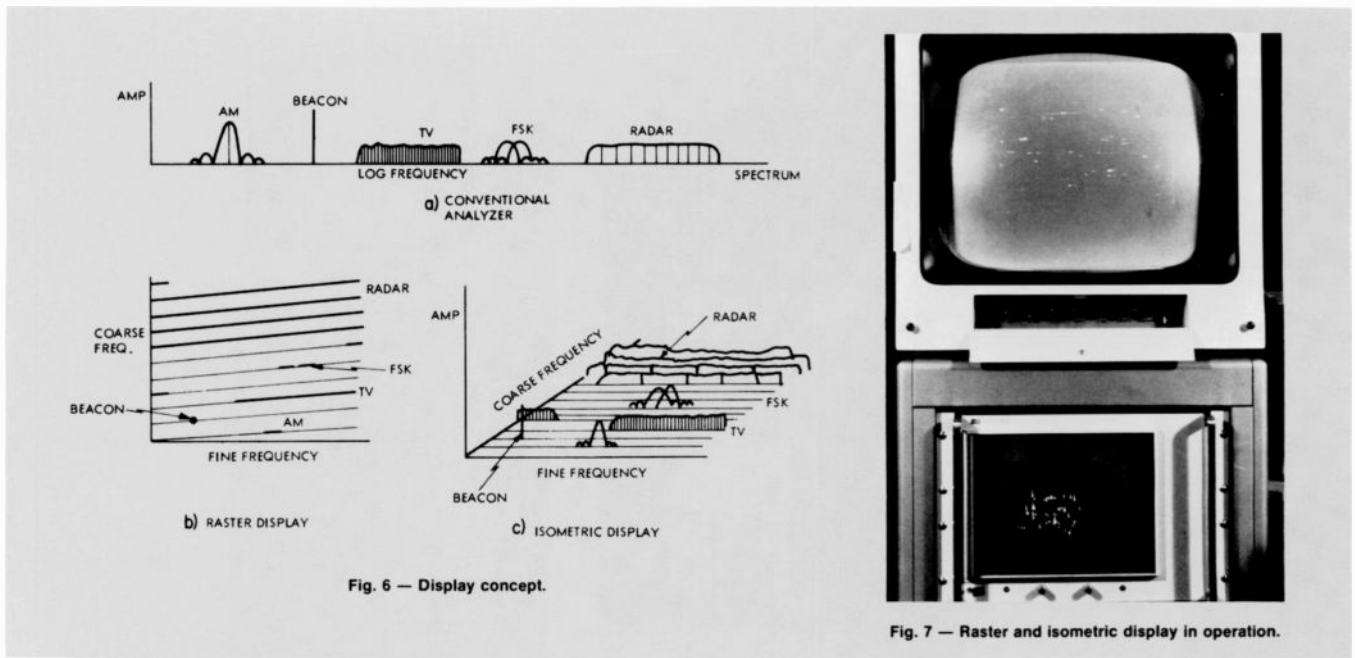

Fig. 6 — Display concept.

Fig. 7 — Raster and isometric display in operation.

Table I — Performance specifications for wideband optical processor.

Data format	Recorder bandwidth	Raster rate	Coarse freq. resolution	Fine freq. resolution
16mm	100 MHz	15.7 kHz	15.7 kHz	25 Hz*
35	100 MHz	75 kHz	75 kHz	54 Hz**

\*  $\Delta f < 5$  Hz for 96mm aperture length  
 \*\*  $\Delta f < 20$  Hz for 96 aperture length

### Representative signals

A pictorial representation of how some time domain signals of known frequency characteristics appear on the raster and isometric display is shown in Fig. 6. In Fig. 7, the actual displays are shown in operation. Table I lists the system performance specifications.

During the course of the program, various radar signatures were analyzed which had been recorded on 35-mm film using an EBR. The 35-mm film had the physical data formats indicated in Fig. 8a and the EBR recorded electrical spectrum indicated in Fig. 8b. Note that the recorded format contains two separate recording channels, each having a 30MHz bandwidth. During recording the received radar signals were passed through a mixer stage where they were converted to one of the baseband EBR recording channels.

The conversion from the input plane to

the Fourier transform plane is obtained by converting the input electrical frequencies to spatial frequencies,  $f_s$ . In doing this,  $R$ , the raster line rate, is given as 75 kHz; and the scan width,  $W$ , is 28 mm. The expression for radial distance,  $l = \lambda F f_s$ , is then used;  $\lambda$  of the argon laser equals 4880 Å— and the focal length  $F$  of the transform lens is 864 mm for this program.

In the expression above,  $l$  is defined as the radial distance in the transform plane from the optical axis. A vertical displacement (shown in Fig. 8c) corresponds to a modulating frequency along the width of the scan lines in Fig. 8a—while a horizontal displacement in the transform plane corresponds to the spatial occurrence of frequencies across the scan line. The resulting spatial extent of the information in the Fourier plane (only the upper right half plane is shown for simplicity) is shown in Fig. 8c.

The frequency characteristics of the

signal as they appeared in the transform plane were displayed and screened. Selected signals were subsequently filtered using the variable slit. The filtered spectrum was transformed by the second Fourier transform lens, imaged onto the vidicon camera and displayed. In this way, the original time input plane was reconstructed but only for those time signatures corresponding to the spatial frequency passed by the filter function. This resulted in greatly increased signal-to-noise ratio for the signals of interest and allowed the extraction of signal PRF and pulse width by direct measurements in the time domain. Note that the appearance of raster scan lines, film transport scratches or unwanted signals such as recorder pilot tones are eliminated in the filtering process.

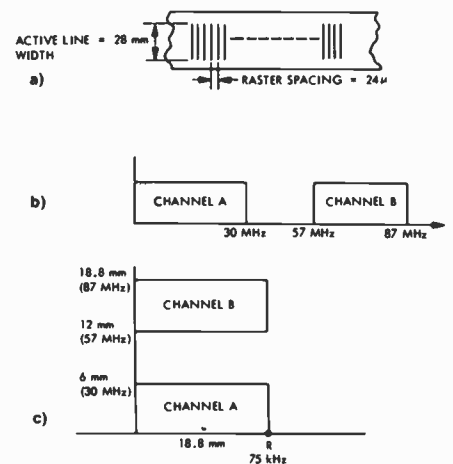

Fig. 8 — EBR recorder format and Fourier plane distribution.

The types of signals which are of interest include spread spectrum, frequency hopping (e.g., frequency shift keyed systems or frequency agile radars), amplitude-modulated and frequency-modulated signals. Examples of various signal types processed are shown in Fig. 9. Two signals are shown, a single spread spectrum pulse in Channel B and a sequence of spread spectrum pulses operating at various carrier frequencies in Channel A.

While the requirement that prompted the development of the hardware of Fig. 2 was one which required the processing of 100 MHz signals, the system can readily be adapted to the processing of low-frequency signals (such as sonar information) by adjusting the recorder line period  $T_R$  so as to maintain the number of information cycles in the input aperture and hence the time bandwidth product. It is also possible to multiplex and display a number of smaller bandwidth channels simultaneously.

The equipment described in this paper will ultimately allow not only the display of the frequency and filter time planes, but also conversion of the reduced data to time amplitude signals which may be digitized for further computer processing. A system for doing this is shown in Fig. 10. The image dissector in the time plane allows for accurate raster line tracking while the storage tube operates on the Fourier plane in a line snatching mode. Other devices such as large format vidicon cameras and photodetector arrays can also be used with some advantages, but this method offers a compromise between size, complexity, cost and processing rate while maintaining full system resolution.

## Summary

The optical processor display presentations produced during this program demonstrated: high time-bandwidth product of the order of  $10^6$ ; bulk processing of wideband data at high resolution; Fourier plane filtering to enhance time domain signatures; and direct spectrum analysis in the Fourier plane.

## Acknowledgments

The authors wish to thank Mr. R. Tetrev of the Advanced Technology Laboratories for his contributions to the isometric display.

This work was sponsored by the Rome Air Development Center, Griffiss Air Force Base, New York (Contract F30602-73-C-0235) under the supervision of Mr. Al Jambardino and Mr. W. Czycycki.

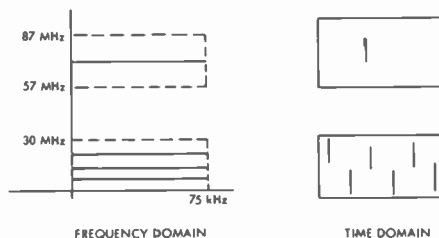

Fig. 9 — Sample radar signatures.

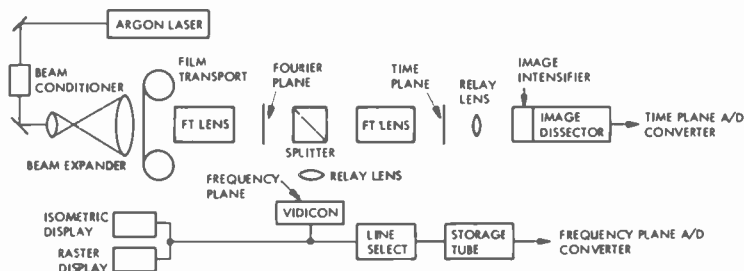

Fig. 10 — Extended processor configuration.

**Gardner T. Burton**, Mgr., Coherent Optics and Display System Development, ASD, Burlington, Mass., has been responsible for the direction of the development of techniques for holographically storing and retrieving digital and image information and for the development of optical signal processing and pattern recognition systems. He has been active in this area since 1969. From 1967 until 1969 he was a Leader of an Electro-Optics Group concerned with the development of laser beam image and video recorder systems. Prior to 1967 Mr. Burton was responsible for the development of the electronics and overall systems integration of the RCA Ideographic Composing Machine used for the composition of Chinese text on photographic film. He developed an automatic exposure control system for night aerial cameras using image intensifier tubes, and has extensive experience in the application of aperture response techniques to the analysis and design of electro-optic systems. He has evaluated methods of synchronizing binary data transmission systems in noisy environments, modulation methods for transmitting pictorial information at high data rates, and techniques for reading printed documents automatically. He has developed circuitry for digital logic operations, IF and Video Signal Processing in noisy environments and FM modulation and demonstration systems for magnetic video tape recorders.

**Richard F. Croce**, ASD, Burlington, Mass., received the BEE from Manhattan College in 1962. He continued his studies at New York University while serving as a Senior Electronics Lab instructor at Manhattan College and received his MEE degree in 1963. Since joining RCA, Mr. Croce has been involved with the design and development of an ICW radar range tracker and a three-tone radar tracker associated with the landing and docking radars, respectively, in the Lunar Module (LM) on the APCLLO Program. Mr. Croce has also investigated the Q-switch properties of singly and doubly doped neodymium YAG laser rods which resulted in the delivery of a ranging and guidance laser system. He participated in the development of a light-weight GaAs diode laser rangefinder and has investigated the energy transfer time from the chromium to the neodymium ions in double doped YAG lasers. Recently, he has made contributions to programs involving a holographic multi-color moving-map display, methods for holographically storing and retrieving a miniaturized data base, and pattern recognition systems using parallel processing logic techniques. He is presently involved in programs to apply coherent processing techniques to the problem of two dimension pattern recognition and image-enhancement systems.



# Pulse doppler radar performance in clutter environment

Dr. H.H. Behling

Performance of a pulse doppler radar system, designed and developed as an airborne aft-warning system against airborne targets, can be seriously degraded by ground clutter entering the same resolution cell occupied by the target echo. The design of receiver threshold detection circuits under these conditions becomes a critical item, since threshold levels must be high enough to avoid false alarms, but kept low enough to be compatible with the requirement of a low cross-section target-detection capability at long ranges. A computerized program is used to determine the necessary threshold increase as a function of aircraft and radar parameters for each resolution cell of interest; furthermore, the amount of detection degradation, wherever applicable, is computed. The usefulness of the clutter computation program was evidenced by flight tests performed with tailwarning radars to which this program was applied.

H. H. Behling, Senior Engineering Scientist, Automated System Division, Burlington, received his PhD in Physics in 1937 from the University of Jena. Dr. Behling was employed at the Telefunken Company in Berlin and Ulm, Germany, where he served as microwave group leader during and after the war. During this period, he supervised design of receivers, radar equipment, and multiplex communications systems. From 1954 to 1958, he worked in the broadcast studio section of RCA on the design and fabrication of test equipment for color television transmission. In 1958 he transferred to the Airborne Systems Division, where he worked on the design and development of equipment used in advanced radar, satellite, and ECM-systems. Most recently, he was responsible for systems and error analysis on the LEM-Rendezvous radar. He was engaged in analytical work concerning multifunction radar systems. He also designed and developed an experimental VHF-Radar for Foliage Penetration and performed a clutter computation on a digital computer for the Pulse-Doppler Radar. Further work included computer aided design of circuits in the Expendable Jammer. He was presented papers on the computation of noise figures, the performance of low noise input circuits, broad band amplifiers, filter networks, and FM-modulators. He also is co-author of the Handbook of High-Frequency Techniques edited by H. Meinke and F.W. Gundlach, Springer Verlag Berlin, 1968. Dr. Behling is a member of Sigma Xi and IEEE.



A PULSE DOPPLER radar has been designed and built by the ASD-Burlington activity as an effective countermeasure defense for special airborne applications. Installed in the tail section of an aircraft, the tail warning set (TWS) must be capable of providing fast response detection of closing threat missiles or aircraft. Mission requirements postulate an extremely low false alarm rate, so that special attention must be paid to the critical design area of the threshold detection circuits to satisfy the requirements imposed in the latter, to respond to relatively weak returns from genuine targets and, on the other hand, to be nonresponsive to signals from false targets.

Ground areas reflecting energy in the same resolution cell occupied by a genuine target represent false targets, and the echoes returned are called *clutter echoes* or simply *clutter*. The objective of the work described in this paper is to

determine the amount of clutter entering the resolution cells, so that a threshold desensitization program can be devised to satisfy the requirement of low false-alarm rate, and simultaneously permit only the absolute minimum degradation in target detection capability.

## Typical clutter spectrum

Fig. 1 illustrates the typical appearance of the clutter spectrum in an airborne tailmounted pulse-doppler radar. The clutter spectrum is distributed about each PRF-line and consists of three major portions: the mainbeam clutter, the sidelobe clutter, and the altitude return. Generically, the latter belongs in the sidelobe clutter category, but differs from it significantly in peak power level and spectral shape. Both the relatively high power level and the narrow width of the altitude return are due to specular reflections from ground areas beneath the aircraft with essentially zero doppler shifts. In contrast, the sidelobe clutter is considerably lower in power level due to the non-specular scattering mechanism that produces it and occupies a band ranging from  $f_0 - 2V/\lambda$  to  $f_0 + 2V/\lambda$  about each PRF-line. In general, the sidelobe spectrum is non-flat, but shaped by the antenna sidelobe pattern.

The mainbeam clutter spectrum is essentially shaped by the mainbeam pattern; its spectral location depends upon the antenna axis orientation relative to that of the aircraft velocity vector. The mainbeam clutter spectrum produced in a tailmounted radar consists of components that are doppler shifted in the negative direction relative to the carrier and PRF-lines.

Since targets producing negative doppler shifts (targets with opening velocities and also those with essentially zero relative velocities) do not constitute a potential

Reprint RE-21-5-14  
Final manuscript received April 28, 1975.

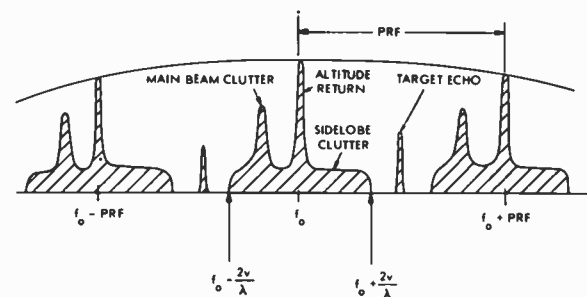

Fig. 1 — Typical ground clutter spectrum in an airborne tailmounted radar.



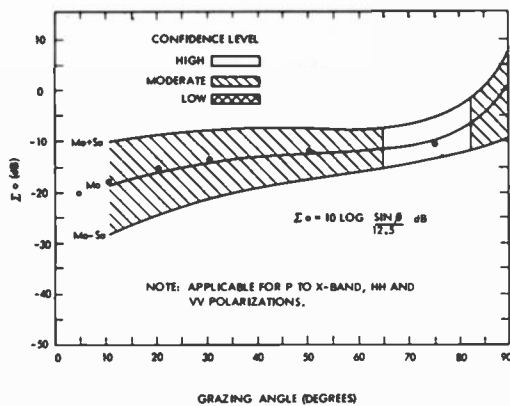

Fig. 2 — Grazing angle dependence of "farmland" clutter (10° to 90°).

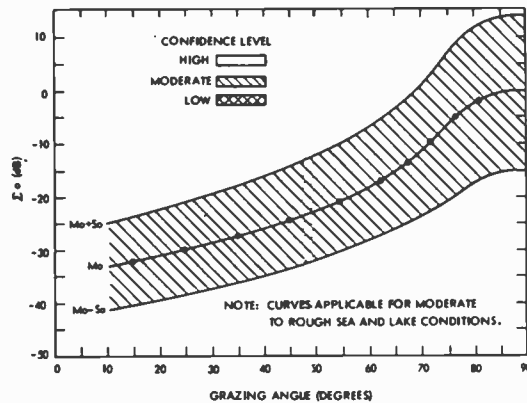

Fig. 3 — Grazing angle dependence of "sea/lake" clutter (10° to 90°).

threat to the aircraft—signals in frequency bands with zero or negative doppler shifts, including the main beam clutter and the altitude return, are suppressed in the receiver by a crystal filter. Therefore, the only remaining clutter competing with the target return is the sidelobe clutter spectrum ranging from  $f_o + f_L$  to  $f_o + 2V/\lambda$ , where  $f_L = 2V_L/\lambda$  and  $V_L$  represents the lower limit of target velocities covered by the radar.

When target closing velocity exceeds the aircraft velocity, the target return must compete with thermal receiver noise only. Since the thermal noise power density in a well designed radar receiver is essentially constant and gain variations in the receiver can be held at a tolerable minimum, the design of threshold detectors (circuits distinguishing small target returns from random noise and simultaneously keeping false alarm rates below a certain limit), is relatively uncomplicated compared to that of clutter-limited detection techniques. Therefore, only the latter will be given further consideration.

### Subclutter visibility and threshold increase

To provide sufficient subclutter visibility, *i.e.*, permit detection of low-speed targets with a closing velocity less than the ground velocity of the radar platform, special attention must be paid to the problem of minimizing the gain of the antenna sidelobes.<sup>1</sup>

The minimizing process, however, is limited by theoretical and practical considerations, so that even after a thorough optimization process, the clutter power can exceed the thermal noise power in the lower doppler channels by several orders

of magnitude. Therefore, the threshold level in these channels must be increased just enough to avoid false alarms, but should be as low as possible to maintain adequate subclutter visibility.

In general, the clutter power received by the radar in a particular doppler channel is a function of various parameters, such as antenna sidelobe gain in a certain angular region, terrain reflection properties, antenna axis orientation, aircraft velocity, altitude, and range. Clutter power can vary drastically when one or more of these parameters are changed. For this reason, clutter computations are performed to determine the necessary threshold increase under various flight conditions; when properly implemented, such threshold increases result in near optimum performance relating to an adequate subclutter visibility combined with a low false alarm rate.

### The clutter model

A vast amount of data collection and processing was performed by the IIT Research Institute, Chicago, to develop a clutter model<sup>2</sup> by using experimental data taken over the years from 1945 to 1968 by more than 20 different investigators and agencies and by consulting numerous reports dealing with this matter. The model is briefly described below. The *Parameter Dependence Model* defines the backscattering cross section per unit area of terrain as a function of basically three parameters:

$$\sigma_o = F(T, \phi, \lambda)$$

where

- $T$  = terrain category
- $\phi$  = grazing angle
- $\lambda$  = radar wavelength

Four broad terrain categories have been

identified: 1) sea/lake, 2) farmland, 3) woodland, and 4) desert. It has been found that the first three categories are practically independent of the radar band; furthermore, there is no difference whether horizontal-horizontal or vertical-vertical polarization is used.

Mountains and cities cannot be modeled using any of the four categories, due to their structural ruggedness which does not permit the kind of scattering that produces distributed clutter.

The clutter cross sections of the first three categories (the most significant for a majority of applications) can be represented as a function of the grazing angle only. Figs. 2 and 3 show the models for the categories farmland and sea/lake, respectively, which have been used frequently in the computations.

The parameters  $M_o$  and  $S_o$ , appearing on the labels of the curves, are defined as statistical parameters associated with the *underlying probability law* briefly discussed below.

Distributed clutter can be looked upon as being produced by a spatial continuum of independent scatterers, and the resulting radar return can be modeled as a narrow-band Gaussian process. The mean power of this process depends only upon the physical size of the scattering area and can be characterized by the backscattering cross section per unit area of illuminated ground,  $\sigma_o$ .

However, irregular variations of the terrain reflectivity cause  $\sigma_o$  to vary accordingly when the radar platform moves through greater distances. Therefore, the model must reflect the spatial variations

of  $\sigma_o$  in terms of statistical parameters, such as mean value and standard deviation.

The spatial variations of  $\sigma_o$  suggest the introduction of an additional degree of randomness. First-level randomness is associated with the scattering phenomenon of an area involving a large number of small and independent scatterers, resulting in a narrowband Gaussian process of the clutter return; second-level randomness treats the statistical parameters themselves as random variables, so that the overall process can be considered as being non-stationary.

From experimental data (used to establish the model), it was found that the probability density function of the process could be expressed by the log-normal distribution

$$P(\sum_o) = (2\pi S_o^2)^{-1/2} \exp[-(\sum_o - M_o)^2 / 2S_o^2]$$

where

$$\begin{aligned} \sum_o &= 10 \log_{10} \sigma_o \\ M_o &= \text{mean value of } \sum_o \\ S_o &= \text{standard deviation of } \sum_o \end{aligned}$$

The cumulative probability that the variable  $\sum_o$  does not exceed a particular value  $\sum_o^*$ , is therefore

$$\begin{aligned} P(\sum_o \leq \sum_o^*) &= \int_{-\infty}^{\sum_o^*} P(\sum_o) d\sum_o \\ &= (2\pi S_o^2)^{-1/2} \int_{-\infty}^{\sum_o^*} \exp[-(\sum_o - M_o)^2 / 2S_o^2] \end{aligned}$$

For example, the probability that  $\sum_o$  exceed  $M_o - S_o$ ,  $M_o$ ,  $M_o + S_o$  is 15.87%, 50%, and 84.13%, respectively.

## Application of the clutter model in the computations

From the previous discussion it would appear that the curves labeled  $M_o + S_o$  or even hypothetical curves with  $M_o + \alpha S_o$  ( $\alpha > 1$ ) should be applied in the simulations to achieve the required low false alarm rate. However, the TWS-resolution cell is several orders of magnitude larger than the cell size applicable during the experiments that led to the development of the clutter model in its present form.<sup>3</sup> Therefore, the TWS-resolution cell involves a large number of smaller cells with different  $\sum_o$ 's, whereby the latter are normally distributed. The standard deviation of  $\sum_o$  involving  $n$  samples is inversely proportional to  $n^{1/2}$  [ $n$  = number of elementary cells within the TWS-resolution cell] and approaches zero when  $n$  is large. Therefore, the mean clutter characteristic was selected and applied in the computations; see curves in Figs. 2 and 3 labeled  $M_o$ .

## Clutter computations

The basic signal processing chain configuration of the TWS is shown in Fig. 4. The received r.f. signal is converted to i.f., amplified, range gated and passed through a crystal filter which suppresses altitude and main lobe clutter. The filter bank, following the crystal filter, involves  $N$  filters of individual bandwidths  $B$  and covers the target velocity range of interest. The lower doppler channels may contain clutter, the upper channels only thermal noise. The output of each filter is applied to a detector/integrator/threshold circuit. An alarm signal is initiated when the signal level exceeds the threshold.

The computation of the threshold increase involves the determination of the clutter/threshold ( $C/T/2$ ) ratio:

$$C/T = (G_{SL}/G_E)(\sigma_L/\sigma_T)(R_T/R_G)^4$$

- $G_{SL}$  = gain of the sidelobe that illuminates the ground area and produces clutter
- $G_E$  = antenna gain at edge of required coverage
- $\sigma_c = (\sigma_o)(A)$  = effective clutter cross section
- $A$  = illuminated area that reflects clutter energy
- $\sigma_T$  = target cross section
- $R_T$  = threshold range = range at which target of cross section  $\sigma_T$  at beam edge can be detected in thermal noise with a given detection probability and false alarm rate
- $R_G$  = range corresponding to the range gate position ( $R_G \leq R_T$ ).

$G_{SL}$  and  $\sigma_c$  are complex functions of aircraft and system parameters, including velocity, altitude, range, antenna orientation, etc. The geometry to compute  $\sigma_c$  or  $A$  is shown in Fig. 5.

The areas  $A_n$  and  $A_n'$  ( $n = 1, 2, 3, \dots$ ) that reflect clutter energy in the same doppler filter and range gate as the target are limited by the so called isodops, representing loci of constant velocity (or doppler shift) and, range circles.

An individual area  $A_n$  or  $A_n'$  lies between two isodops, corresponding to the bandwidth of an individual doppler filter, and two range circles, essentially corresponding to the leading and trailing edges of the range gate.

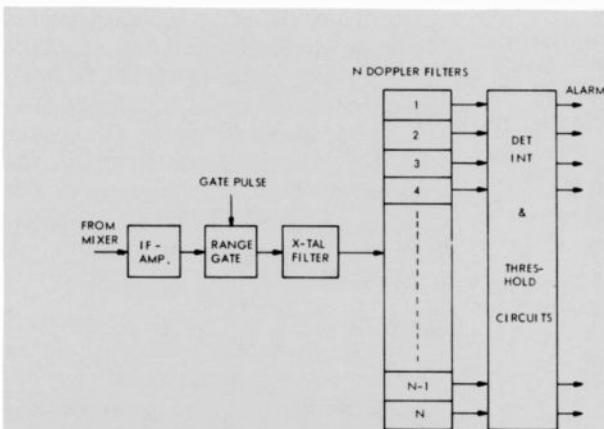

Fig. 4 — Simplified receiver and signal process block diagram.

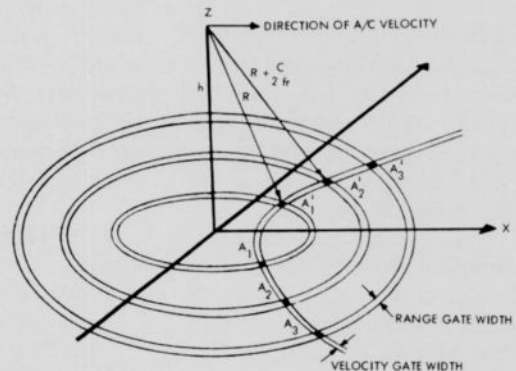

Fig. 5 — Isodops and range circles.

Table I — C/T ratio, threshold increase and threshold difference as functions of resolution cell index (doppler channel and range).

Range (ft) channel	C/T (dB) Range (ft)			TI (dB) Range (ft)			$\Delta = TI - 10\log(R_T/R_G)^4$		
	2500	4500	6500	2500	4500	6500	2500	4500	6500
1	24.2	8.0	0.7	29.7	13.7	7.1	11.5	5.7	5.5
2	15.3	0.53	-13.2	20.8	6.2	0.7	2.6	-1.8	-0.9
3	12.0	0.1	-6.6	17.6	6.7	2.5	-0.6	-1.3	0.9
4	13.8	1.1	-6.0	19.4	7.5	2.8	1.2	-0.5	1.2
5	15.7	8.3	1.0	21.2	14.0	7.4	3.0	6.0	5.8

Table II — Detection probability (in percent) as a function of resolution cell index.

Doppler channel	Range (ft)		
	2500	4500	6500
1	~0	9	10
2	61	99+	99+
3	99+	99+	95
4	93	99+	93
5	51	8	9

$A_2, A_2', A_3, A_3'$ , represent areas that return second-time, third-time,—around echoes, but their contributions in the present situation are negligible compared with the energy reflected by  $A_1$  and  $A_1'$ .

To preserve a specified false alarm rate in the presence of clutter, the receiver detection threshold must be increased by an amount  $TI$ , which is computed as follows: The ratio  $T/(C+N)$  must be raised by  $TI$  such that

$$\{T/(C+N)\} (TI) = T/N$$

$$TI = (T/N) [(C+N)/T] = [(C+N)/N] = [(C/T) + (N/T)] / (N/T)$$

where  $C/T$  is the result of the computer evaluation and  $T/N$  is the pre-integration signal-to-noise ratio required to detect a target at maximum range (threshold range) at beam edge with a specified probability of detection and false alarm time.

### Typical computations results of clutter computations

As a typical example, Table I shows the results of computer runs to determine  $C/T$  and the required threshold increase  $TI$  for the conditions listed below.

Antenna:	dielectric rod, pointing down by 16 deg.
Aircraft parameters:	Velocity 850 ft/s. Altitude 1000 ft
Range gate centers:	2500 ft, 4500 ft, 6500 ft.
Doppler channels:	1) 135 - 270 (ft/s) 2) 270 - 405 3) 405 - 540 4) 540 - 675 5) 675 - 810
Terrain model:	farmland

The  $T/N$  ratio for a 99% probability of detection and a false alarm time of 30 hours was +5.5 dB and the threshold range 7144 ft. The last column lists the threshold difference  $\Delta$  in dB between  $TI$  and a threshold increase that can be permitted without loss in target detection capability at a particular range. For ranges of 2500 ft, 4500 ft, 6500 ft, and a threshold range of 7144 ft the permissible threshold increases are 18.2 dB, 8.0 dB, and 1.6 dB respectively.

Flight tests performed with tailwarning sets installed in strategic aircraft and utilizing threshold increase programs of the kind just described do indicate the usefulness of the simulation program.

For resolution cells in Table I where  $\Delta$  is negative, the detection probability exceeds 99%, and conversely for those with a positive  $\Delta$  - value, the detection probability is lower than 99%. The loss in detection probability can be estimated from curves<sup>4</sup>, which are graphs of the probability of detection versus signal-to-noise ratio for fixed values of the false-alarm probability.

Table II shows the equivalent detection probability in percent for each resolution cell of the above example.

### Correlations of computations and flight test results and other applications

Clutter computations have been performed pertaining to tailwarning sets to be installed in strategic and tactical aircraft with a different antenna system in each radar. Matrices of threshold increase and target detectability as functions of resolution cell index have been computed in a manner similar to that shown in the above example for different aircraft velocities, ranges, altitudes, antenna pointing directions and aircraft attitudes (roll).

Flight tests performed with tailwarning sets installed in strategic aircraft and utilizing threshold increase programs of the kind just described do indicate the usefulness of the computations program. Further applications of the computations program include the following major areas:

- Comparison of different antennas systems concerning subclutter visibility and determination of critical areas of the sidelobe patterns that need improvement.
- Computation of the mainbeam clutter return to determine the spectral purity requirement of the transmitter in the spectral region occupied by the lower doppler channels.
- Spectral analysis of the clutter return in a particular channel to determine the effect of foldover on the spectral density in the post detection filters as function of the signal frequency relative to the center of the doppler filter.

### Acknowledgments

Thanks to K.E. Utley for his very helpful suggestions and discussions on the subject matter, for the preparation of the tables in this paper, and for all his efforts involved in the reduction process and tabulation of a vast amount of clutter data, which contributed significantly to the success of the program.

### References

1. Honda, H. "Low Backlobe Antenna for Airborne Missile-Warning System". *RCA Engineer*, Vol. 18, No. 5 (Feb - Mar 1973).
2. Greenstein, L.J. et. al. "A Comprehensive Ground Clutter Model for Airborne Radars". IIT Research Institute, Chicago, Ill. Sept. 15, 1969, AD NO. 861913L.
3. Greenstein, L.J. et. al. "ORT Clutter Model", *Overland Radar Technology Program Contract F33615-67-C-1387*, IIT Research Institute, March 22, 1968.
4. Barton, D.K., Hanson, V.G.; "Radar Signal Detectability Calculator". *Lecture II of IEEE Boston Series on Modern Radar Theory*, Oct 1972.

### Author's Note

Details of the configurations mentioned in this paper and the clutter computations are available from the author upon request.

# Engineering and Research Notes

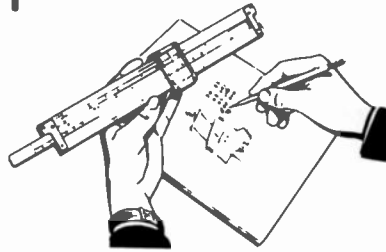

## Microstrip discriminator

Alfred Schwarzmann  
Missile and Surface Radar Division  
Moorestown, N.J.



The microstrip discriminator shown in Fig. 1 includes a microstrip-coupled structure of the odd-mode-dominant type. The coupled structure has three narrow strip-like conductors (1, 2 and 3) closely spaced from one another. The strip-like conductors are spaced by a dielectric substrate (4) from a ground conductor (5) covering the bottom surface of the substrate. Frequency-modulated rf signals at microwave frequencies are applied at one end (Port 1) of the center strip-like conductor. The remaining two strip-like conductors (2 and 3) are closely spaced from strip-like conductor (1) near the opposite end.

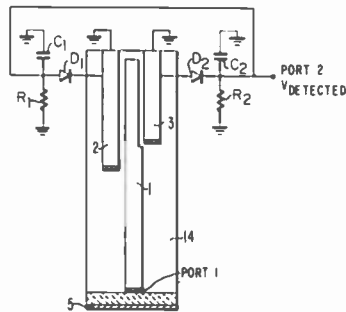

Fig. 1 — Microstrip discriminator.

Strip-like conductor (2) is a quarter wavelength long at a frequency lower than the center carrier frequency of the rf signals applied at Port 1. Strip-like conductor (3) is a quarter wavelength long at a frequency above the center carrier frequency of the rf signals applied at Port 1. Strip-like conductors (2 and 3) are coupled to ground at their ends near end 1b of strip-like conductor (1).

A first detector diode  $D_1$  has its cathode terminal coupled to strip-like conductor (2), and its anode terminal coupled to the output terminal (Port 2). A second detector diode  $D_2$  has its anode terminal coupled to strip-like conductor (3), and its cathode terminal coupled to the output terminal (Port 2). A resistor  $R_2$  and capacitor  $C_2$  form a low-pass network. Similarly, a resistor  $R_1$  and capacitor  $C_1$  form a second low-pass network. The low-pass network may be selected to pass signals lower than about twice the deviation frequency.

If the frequency of the applied signal at Port 1 is lower than the center carrier frequency, more of the rf power is coupled to the longer strip-like conductor (2) than to conductor (3), providing more rf power for detection to diode  $D_1$ . The resultant output at Port 2 is positive. If the frequency of the applied signal at Port 1 is higher than the center carrier

frequency, more of the rf power is coupled to the shorter strip-like conductor (3), providing more rf power for detection to diode  $D_2$ . The resultant output at Port 2 is positive.

To increase the amount of voltage change for deviation in frequency from the carrier frequency (sensitivity), the tap points along the strip-like conductors (2 and 3) can be moved away from the grounded end. Further, this sensitivity can be altered by adjusting the value of resistors  $R_1$  and  $R_2$  and the coefficients of coupling between the strip-like conductors (1, 2, and 3).

Reprint RE-21-5-5|Final manuscript received April 11, 1975.

## High reliability COS/MOS IC's — qualified to MIL-M-38510, Class A

E. Reiss  
Solid State Division  
Somerville, N.J.



The term *high reliability* as applied to integrated circuits covers a broad spectrum of reliability classes. These classes were originally defined by device manufacturers (based on test methods described in MIL-STD-883, a compendium of quality and conformance tests) and later were standardized by the government. Today, there are both in-house- and government-defined reliability classes. The contents of in-house programs vary with the manufacturer. The government program, referred to as MIL-M-38510, consists of a general specification for a detailed specification. The general specification applies to all technologies, such as TTL, ECL, linear and CMOS; the detailed specification delineates the requirements for a circuit function within a technology.

The purpose of the MIL-M-38510 program is to achieve standardization among integrated-circuit suppliers and to assure delivery of devices whose long-term life will satisfy the requirements of the system for which they are intended. Three reliability classes—A, B, and C—are described in MIL-M-38510. Class A devices are of the highest reliability level and are intended for critical applications where replacement of components is not practical. RCA COS/MOS devices were the *first devices of any technology* to be approved as Class A. Class B and C devices are those intended for applications in which reliability is important but in which components can be replaced.

In summary, then, devices are manufactured in accordance with the MIL-M-38510 (general and detailed) specification, which includes portions of the MIL-STD-883 test method. The device class is determined by the level of inspections, screening, and conformance testing to which the devices are subjected.

### Qualification and conformance testing

The accelerated stress tests delineated in MIL-STD-883, Method 5005 (tests that subject devices to stress levels greater than those normally experienced in a typical application) consist of: Group A, Electrical; Group B, Package and Internal Mechanical Strength; and Group C, Indicators of Long Term Reliability for Package and Die (Table I). [Ed. note: Class A, B, C, refers to reliability level; Group A, B, C, refers to test type. Do not confuse the two.] Both qualification devices and a sample of devices from the production line are subjected to this series of accelerated tests. The tests performed on the qualification devices are called qualification tests; the tests performed on production-line devices after a specific type has been qualified are called conformance tests. Electrical end-point limits for the tests are defined by MIL-M-38510 and are more demanding of CMOS than of TTL. DC parameters are measured at  $-55^{\circ}\text{C}$ ,  $+25^{\circ}\text{C}$ , and  $+125^{\circ}\text{C}$  and, depending on circuit

**Table I — MIL-STD-883 test.**

Group A	Group B	Group C
Static tests 25, -55, 125°C	Physical dimensions	Thermal shock
Dynamic tests 25, -55 125°C	Resistance to solvents	Temperature cycling
Functional tests 25°C	Internal visual & mechanical	Moisture resistance
Functional tests -55, 125°C	Bond strength Solderability Lead integrity	Seal Mechanical shock Vibration variable frequency Constant acceleration Seal Salt atmosphere High-temperature storage Operating-life test

**Table II — Failure rate — 60% confidence level.**

Total devices tested	2,693
Total inoperable failures	3
Total device hours	2,963,000
<i>Temp.</i>	<i>Failure rate</i>
125°C	0.143%/1000 hrs.
55°C	0.020%/1000 hrs.
25°C	0.006%/1000 hrs.

complexity, require between 80 and 120 individual tests at each temperature. Additionally, parametric drift is limited to 10 nA for  $I_{on}$  (gates); 40 mV for low-level output voltage,  $V_{OL}$ ; and 80 mV for high-level output voltage,  $V_{OH}$ . Five device types have been tested to date and shown to be qualified as MIL-M-38510 Class-A devices; twenty additional device types are now under test.

**Qualification test data**

Qualification data has been generated on COS/MOS types CD4019A, CD4011A, CD4013A, CD4027A and the CD4001A. The data generated from the Group B qualification tests indicates excellent package integrity. There was one failure in a total of 729 devices tested.

Group C data indicates only two failures of a total of 1504 devices tested. Considering that the end-point measurements require that minimum drifts be maintained over the entire military operating range (-55°C to +125°C) during 80 to 120 individual measurements, this data indicates excellent device stability.

Subgroup C5 defines a 125°C accelerated operating-life stress test and is considered to be one of the better indicators of long-term stability. Data gathered during the qualification runs indicates no degradational or inoperable failures during 645,000 device hours of test. A *degradational* failure occurs when a device drifts outside the parametric limit defined above. An *inoperable* device is a device that does not function according to its truth table.

**Conformance test data**

In addition to the qualification devices tested, Group A, B, and C tests are periodically performed on production-line samples. Again, this testing is referred to as conformance testing. In the first half of 1975, over 2.3 million device hours of 125°C accelerated-stress testing were completed on a wide variety of circuit functions, from gates to MSI's; there were only five degradational failures and three inoperable failures. The test results indicate that devices produced on the production line certified to MIL-M-38510 standards are reliable. It should be noted that the certified COS/MOS wafer-fabrication area is jointly used for the production of high-reliability and standard wafers.

**Failure rate**

The combination of qualification data and conformance data results in a significant number of device hours from which a failure rate can be calculated, Table 11. Since the data was generated at an accelerated temperature of 125°C, the failure rate is derated to 55°C and 25°C, a more typical operating range for satellites, the intended application area for the devices tested.

**Field-usage data**

Data generated from four satellites having over 2500 CD4000A-series devices on board corroborates the results achieved through accelerated stress testing. As of June 15, 1975, over 34-million device hours have elapsed without a single inoperable failure, Table III.<sup>1</sup>

**Conclusions**

The qualification of RCA COS/MOS devices to MIL-M-38510, Class A, demonstrates the capability of these devices to be used in critical applications. Field-use data from four satellites supports the excellent qualification and conformance test results. Additionally, the periodic auditing of the manufacturing facility by two government agencies provides assurance that procedures and practices will be reviewed with reliability in mind.

**References**

1. Vincoff, M. and Schnable, G.: "Reliability of Complementary MOS Integrated Circuits," *IEEE Trans. on Reliability* (Oct. 1975).
2. Gallace, L.J. and Whelan, C.D.: "Accelerated Testing of COS MOS Integrated Circuits", S1-6379, Solid State Division (April 1975).

**Table III — Field-usage data CD4000A series.**

	Name of satellite		
	OSCAR 6	ITOS D/F	Atmospheric Explorer
Time in orbit (months)	32	43	18
Number of units	90	42	2,400
Device hours	2,073,600	1,300,320	31,104,000
Number of inoperable failures	0	0	0
Failure rate—60% confidence level	0.044	0.07	0.0031
Total device hours	34,477,920		
Failure rate — 60% confidence level	0.0026%/1000 hrs.		



# Pen and Podium

Recent RCA technical papers and presentations

Both published papers and verbal presentations are indexed. To obtain a published paper borrow the journal in which it appears from your library or write or call the author for a reprint. For information on unpublished verbal presentations write or call the author. (The author's RCA Division appears parenthetically after his name in the subject-index entry.) For additional assistance in locating RCA technical literature contact RCA Technical Communications, Bldg. 204-2, Cherry Hill, N.J. (Ext. PC-4256).

This index is prepared from listings provided bimonthly by RCA Division Technical Publications Administrators and Editorial Representatives—who should be contacted concerning errors or omissions (see inside back cover)

Subject index categories are based upon standard announcement categories used by Technical Information Systems, Bldg. 204-2, Cherry Hill, N.J.

## Subject Index

Titles of papers are permuted where necessary to bring significant keyword(s) to the left for easier scanning. Authors' division appears parenthetically after his name.

## SERIES 100 BASIC THEORY & METHODOLOGY

### 105 Chemistry

organic, inorganic, and physical.

**DC GLOW DISCHARGE, The deposition of tin oxide films from a** — D.E. Carlson (Labs,Pr) *Journal of Electrochemical Society*, Vol. 122, No. 10 (10/75) pp. 1334-37.

**DIELECTRICS, Chemical etching of** — W. Kern (Labs,Pr) Symposium on Etching, Electrochemical Society Meeting, Washington, DC, (5/2-7/76) Extended abstracts, *ECS*, Vol. 76-1 (5/76).

### 125 Physics

electromagnetic field theory, quantum mechanics, basic particles, plasmas, solid state, optics, thermodynamics, solid mechanics, fluid mechanics, acoustics.

**INTERFACE between an insulator and an electrolyte, Structure and energy of the** — R. Williams (Labs,Pr) *RCA Review*, Vol. 36, No. 3 (9/75) pp. 542-550.

### 130 Mathematics

basic and applied mathematical methods.

**ADLER's generalized equation for interaction of oscillators with injected signals, Computer simulation of** — H.H. Behling (ASD,Burl) *IEEE Proceedings* (10/75) pp. 15-22.

**FINITE ELEMENT analysis, State of the art of** — R. Pschunder (MSRD,Mrstn) Princeton Univ., Princeton, NJ (12/11/75).

### 135 Information Theory and Operations Research

codes, modulation methods, signal processing, communication theory; game theory, queueing theory; computational linguistics, decision theory.

**SIGNAL PROCESSING applications, CMOS/SOS developments for** — W.F. Gehweiler, J.I. Pridgen (ATL,Cam) 9th Annual Asilomar Conference, Pacific Grove, CA (11/11-13/75) *Symposium Proceedings*.

### 140 Circuit and Network Theory

methods for circuit synthesis and analysis, network topology, equivalent circuit methods.

**SYNTHESIZER technique, A new high resolution, single-loop** — R.J. Bosslaers (ASD,Burl) Conf. on Automatic Support Systems for Adv. Maintainability, Westbury, New York (10/28-30/75).

### 150 Environmental and Human Factors

influence of physical environment and/or human users on engineering design, life support in hostile environments.

**EMP-INDUCED TRANSIENTS, on integrated circuits, Effect of** — E. VanKeuren (GCSD,Cam) *IEEE Proceedings on Electromagnetic Compatibility*, (10/7/75) p. 3A II.

**NUCLEAR SURVIVABILITY, A self-triggered circumvention technique for** — R.J. Hendrickson, E. VanKeuren (GCSD,Cam) Symposium on Vulnerability and Survivability of Surface & Aerial Targets, *Proceedings*, Vol. 1 (10/21/75) pp. 6-23.

### 160 Laboratory Techniques and Equipment

experimental methods and equipment, lab facilities, testing, data measurement, spectroscopy, electron microscopy, dosimeters.

**CALORIMETER for VHF-UHF power measurements** — J.H. Bowen (MSRD,Mrstn) *Q.S.T. Journal of American Radio Relay League*, Vol. 59, No. 12, (12/75) pp. 11-13.

**PHOSPHOR COATINGS by luminescence thermal degradation, Analysis of** — S. Larch, J. Gerber (Labs,Pr) *Analytica Chimica Acta* (1975) pp. 329-331.

### 170 Manufacturing and Fabrication

production techniques for materials, devices and equipment.

**CHEMICAL VAPOR DEPOSITION of transparent electrically conducting layers of indium oxide doped with tin** — J. Kane, H.P. Schweizer, W. Kern (Labs,Pr) *Thin Solid Films*, Vol. 29 (1975) pp. 155-163.

**SEPARATING COMPLETED DIODES from semiconductor wafers, Simple method for** — J. Klatskin, A. Rosen (Labs,Pr) *Journal of the Electrochemical Society*, Vol. 122, No. 11 (11/75) pp. 1565-66.

**VAPOR DEPOSITION, Chemical processes in** — V.S. Ban, S.L. Gilbert (Labs,Pr) *Journal of the Electrochemical Society*, Vol. 12, No. 10 (10/75) pp. 1384-91.

### 175 Reliability, Quality Control and Standardization

value analysis, reliability analysis, standards for design and production.

**RELIABILITY Predictions** — M.L. Johnson (ASD,Burl) State of the Art of System Assurance Technology (Fall Lecture Series) Boston IEEE Reliability Chapter, Bedford, MA.

### 180 Management and Business Operations

organization, scheduling, marketing, personnel.

**CONTRACTS MAN, Profit and the — getting the contract** — R.S. Miller (GCSD,Cam) *Profit and the Contracts Man* (A Limited Ed. Course Manual, Fed. Publs., Inc.) Sect. A (10/8/75) pp. A 1-65.

**INVENTORY RETURNS, Computerized management of** — D. Mishra, J.C. Pearson, A. Dogar (Record Div,Ind) AIEE 1975 Systems Engineering Conference, Stardust Hotel, Las Vegas, Nev. (10/75).

**LOGISTICS management, Industrial** — J.W. Hurley (MSRD,Mrstn) Logistics Systems (Threepart course) Temple University (10/20/75 — 11/75 — 12/8/75).

**PROJECT MANAGEMENT** — M.W. Buckley (MSRD,Mrstn.) Univ. of Delaware, Newark, DE (12/4-6/75).

## SERIES 200 MATERIALS, DEVICES, & COMPONENTS

### 205 Materials (Electronic)

preparation and properties of conductors, semi-conductors, dielectrics, magnetic, electro-optical, recording, and electro-magnetic materials.

**AG-SiO films, Surface Plasmons in granular** — E.B. Priestley, B. Abeles, R.W. Cohen (Labs,Pr) *Physical Review B*, Vol. 12, No. 6 (9/15/75) pp. 2121-2124.

**CdSe, Speed of response of photocurrents in** — H. Kiess, B. Binggeli (Labs,Pr) *RCA Review*, Vol. 36, No. 3 (9/75) pp. 485-98.

**FeBO<sub>3</sub> by Brillouin scattering from thermal magnons, Investigation of** — W. Jantz, J. Sandercock, W. Wetting (Labs,Pr) 21st Annual Conference on Magnetism and Magnetic Materials, Philadelphia PA (12/9-12/75).

**GRANULAR METAL FILMS, Tunneling conductivity in** — B. Abeles (Labs,Pr) *RCA Review*, Vol. 36, No. 3 (9/75) pp. 594-620.

**(In, Ga)P, Dislocations in vapor-grown compositionally graded** — M.S. Abrahams, C.J. Buicocch, G.H. Olsen (Labs,Pr) *Journal of Applied Physics* Vol. 40, No. 10 (10/75) pp. 4259-70.

**MIXED-OXIDE WO<sub>3</sub>, MoO<sub>3</sub>, electrochromic films and the nature of the color center** — B.W. Faughnan (Labs,Pr) Electrochemical Society Meeting, Washington, DC (5/76).

**OPTICAL AND ELECTRICAL effects** — D. Redfield (Labs,Pr) *Journal of Electronic Materials*, Vol. 4, No. 5 (1975).

**SIMPLICITY IN THEORY: an anecdotal account of current injection in solids — in tribute to Albert Rose** — M.A. Lampert (Labs,Pr) *RCA Review*, Vol. 36, No. 3 (9/75) pp. 444-68.

**SiO<sub>2</sub> films, Hole photocurrents and electron tunnel injection induced by trapped holes in** — R.J. Powell (Labs,Pr) *Journal of Applied Physics* Vol. 40, No. 10 (10/75) pp. 4557-63.

**III-V COMPOUND materials and devices, Directions in** — C.J. Nuese (Labs,Pr) Seminar, Wright-Patterson Air Force Base, Dayton, OH (12/16/76).

### 210 Circuit Devices and Microcircuits

electron tubes and solid-state devices (active and passive); integrated, array and hybrid microcircuits, field-effect devices, resistors and capacitors, modular and printed circuits, circuit interconnection, waveguides and transmission lines.

**CHARGE-COUPLED DEVICES, Basic concepts of** — W.F. Kosonocky, J.E. Carnes (Labs,Pr) *RCA Review*, Vol. 36, No. 3 (9/75) pp. 566-93.

**CHARGE-COUPLED DEVICES for gigabit recording applications** — D.A. Gandolfo, A. Boornard, L.J. Nicastro (ATL,Cam.) *Proceedings* (11/11-13/75) Electro-Optical Systems Design Conference, Anaheim, CA.

**CHEMICALLY VAPOR-DEPOSITED FILMS for microelectronics** — W. Kern (Labs,Pr) National Bureau of Standards, Gaithersburg, MD; (1/8/76). Invited Lecture.

**GUARD LAYER DESIGN in COS/MOS structures, Surface doping using ion implantation for optimum** — E.C. Douglas, A.G.F. Dingwall (Labs,Pr) *IEEE Transactions on Electron Devices*, Vol. 22, No. 10 (10/75) pp. 840-857



**LINEAR AND DIGITAL ICs**, Introduction to operation, fabrication, application of — M.P. Rosenthal (Global, NY) *Understanding Integrated Circuits*, Hayden Book Co., Rochelle Park, NJ (11/75).

**MICROSTRIP CIRCUITS and enclosures**, Mechanical design of — D. Olivieri (MSRD, Mrstn) *Microwave Journal* (11/75) pp. 32, 33, 34, 36, 37 and 72.

**RESISTORS**, High-power density, thin-film — T. Faith (AED, Pr) IEEE Electrical/Electronic Insulation Conf. (Also *IEEE Trans. on Part. Hybrids, and Packaging*), Boston, MA.

**TRANSISTOR for 14/12 GHz communication satellite transponders**, A low-noise microwave-frequency — A.B. Bell, G. Lo (RCA Ltd., Ste Anne) Canadian IEEE Conference, Toronto, Canada (10/75).

## 215 Circuit and Network Designs

analog and digital functions in electronic equipment; amplifiers, filters, modulators, microwave circuits, A-D converters, encoders, oscillators, switches, masers, logic networks, timing and control functions, fluidic circuits.

**MULTIPLIER, CMOS/SOS Serial-Parallel** — D. Hampel, K. McGuire, K. Prose (CCSD, Cam) *IEEE Journal of Solid-State Circuits*, Vol. SC 10, No. 5 (10/75) pp. 307-313.

**RF PULSE MEASUREMENT techniques and picture quality** — Dr. K. Praba (CCSD, Cam) IEEE Broadcast Symposium (2/25/75) *IEEE Transactions*.

**TRANSVERSAL FILTER design and application in satellite communications** — Dr. K. Feher (RCA Ltd., Ste Anne) Midwest Symposium on Circuits & Systems, Concordia University, Montreal, Canada (8/75).

**TRAPATT diode arrays, integrated** — A. Rosen, H. Kawamoto, J. Klatskin, E.L. Allen, Jr. (Labs, Pr) *Journal MIT* (10/75) pp. 841-843.

## 220 Energy and Power Sources

batteries, solar cells, generators, reactors, power supplies.

**EPITAXIAL SILICON SOLAR CELLS** — R.V. D'Aiello, P.H. Robinson, and H. Kressel (Labs, Pr) 1975 IEDM, Washington, DC (12/1-3/75).

**EPITAXIAL SOLAR CELLS on silicon EFG ribbon substrates** — H. Kressel, R.V. D'Aiello and P.H. Robinson (Labs, Pr) *Applied Physics Letters*, Vol. 28, No. 3 (2/11/76) pp. 157-159.

**SOLAR-CELL capacitance** — A.R. Moore (Labs, Pr) *RCA Review*, Vol. 36, No. 3 (9/75) pp. 551-65.

## 225 Antennas and Propagation

antenna design and performance; feeds and couplers, phased arrays; randomes and antenna structures; electromagnetic wave propagation, scatter, effects of noise.

**ANTENNA ARRAYS**, Size and performance trade-off characteristics in multiple — Dr. M.S. Siukola (CCSD, Cam) IEEE Broadcast Symposium (9/25/75) *IEEE Transactions*.

**ATMOSPHERIC PROPAGATION EFFECTS on a laser ship mast detector** — H.C. Curtis (AED, Pr) Int'l. Telemetering Conference, Silver Springs, MD.

## 240 Lasers, Electro-Optical and Optical Devices

design and characteristics of lasers, components used with lasers, electro-optical systems, lenses, etc. (excludes: masers).

(AIGe) As heterojunction LED for fiber-optic communications, A new edge-emitting — H. Kressel, M. Ettenberg (Labs, Pr) *Proceedings of the IEEE* (9/75) pp. 1360-61.

**CHARGE-COUPLED IMAGERS**, Method for varying gamma in — P.A. Levine (Labs, Pr) ISSCC 76, Philadelphia, PA (2/19/76) *Conference Digest*.

**GRATING COUPLING between low index fibers and high index film waveguides** — J.M. Hammer, R.A. Bartolini, A. Miller and C.C. Neil (Labs, Pr) 1976 Integrated Optics Conference, Salt Lake City, UT (1/12/76).

**HETEROEPITAXIAL SEMICONDUCTING FILMS**, The electrical characterization of — W.E. Ham (Labs, Pr) *Heteroepitaxial Semiconductors for Electronic Devices* Chapter VII, Edited by G.W. Cullenand, C.C. Wang (Springer-Verlag).

**HETEROJUNCTION STRUCTURES to optical devices**, The application of — H. Kressel (Labs, Pr) *Journal of Electronic Materials*, Vol. 4, No. 5 (1975).

**HOT ELECTRON transport**, A criterion for the onset of — R.S. Crandall (Labs, Pr) *RCA Review*, Vol. 36, No. 3 (9/75) pp. 531-41.

**INFRARED IMAGING with monolithic, CCD-addressed Schottky-barrier detectors**: theoretical and experimental results — E.S. Kohn (Labs, Pr), S.A. Roosild, F.D. Shepherd, A.C. Yang (AF Labs) 1975 Int. Conf. on the Application of Charge-Coupled Devices, San Diego, Calif. (Oct. 1975); *Conf. Proceedings* (1975) pp. 59-69.

**IRICON: a passive infrared camera tube** — S.V. Forgue, L.D. Miller, J.O. Schroeder (Labs, Pr) *IEEE Trans. on Electron Devices* Vol. Ed-22, No. 10, (10/75) pp. 904-910.

**MODERN OPTICS — the impact of the laser** — R.A. Bartolini (Labs, Pr) Seminar, East Stroudsburg State College, East Stroudsburg, PA; (12/75).

**MULTIPLEXED TWISTED NEMATIC DEVICES**, The effect of surface orientation on the operation of — L.A. Goodman, D. Meyerhofer, S. DiGiovanni (Labs, Pr) S.I.D. Symposium, Washington, DC (4/75) *IEEE Transactions on Electron Devices*.

**PbO VIDICON**, An approximate model of the beam-blocking contact in a — A.M. Goodman (Labs, Pr) *RCA Review*, Vol. 36, No. 3 (9/75) pp. 408-24.

**PHOTOMULTIPLIERS for high temperature applications** — D.E. Persyk, J.L. Ibaugh, A.F. McDonie, and R.D. Faulkner (PTD, Lanc) 1975 Nuclear Science Symposium, Sheraton Palace Hotel, San Francisco, CA (11/19-21/75).

**SEMICONDUCTOR LIGHT SOURCES for fiber optical communication**, Reliable — H. Kressel, I. Ladany, M. Ettenberg and H.F. Lockwood (Labs, Pr) 1975 IEDM, Washington, DC (12/1-3/75).

**SENSORS**, From camera tubes to solid-state — P.K. Weimer (Labs, Pr) *RCA Review*, Vol. 36, No. 3 (9/75) pp. 385-407.

**STRIPE WAVEGUIDES and coupling modulators of lithium niobate-tantalate** — W. Phillips, J.M. Hammer (Labs, Pr) 1976 Integrated Optics Conf., Salt Lake City, UT (1/12-14/76).

**VIDICONS**, Semiconductor heterojunction — C.R. Wronski (Labs, Pr) *RCA Review*, Vol. 36, No. 3 (9/75) pp. 425-43.

## 245 Displays

equipment for the display of graphic, alphanumeric, and other data in communications, computer military, and other systems, CRT devices, solid state displays, holographic displays, etc.

**FIBER-OPTIC INTENSIFIER SCREEN for topography**, An X-ray sensitive — R.W. Smith (Labs, Pr) *RCA Review* Vol. 36, No. 3 (9/75) pp. 632-37.

**PATTERN meaningfulness and pattern detectability** — R.J. Mezrich (Labs, Pr) *RCA Review*, Vol. 36, No. 3 (9/75) pp. 621-631.

## 250 Recording Components and Equipment

disk, drum, tape, film, holographic and other assemblies for audio, image, and data systems.

**LASER LINE PRINTER**, Design considerations for a dye transfer — R.D. Scott (ATL, Cam) Electro-Optical Systems Design Conference, Anaheim, CA (11/11-13/75) *Symposium Proceedings*.

**LASER RECORDER**, How to specify a — R.F. Kenville (ATL, Cam) Electro-Optical Systems Design Conference, Anaheim, CA (11/11-13/75).

**VIDEO TAPE RECORDER**, Design and manufacturing considerations for a new quadruplex — J.R. West, G.S. Moskovitz (CCSD, Cam) University of Southern California (10/8/75).

**ANNULAR ARRAY IMAGING**, Progress in — D. Vilkomerson, B. Hurley (Labs, Pr) *Acoustical Holography*, Vol. 6.

**ULTRASONIC wavefronts**, System for visualizing and measuring — R.S. Mezrich, K.F. Etzold, D.H.R. Vilkomerson (Labs, Pr) *Acoustical Holography*, Vol. 6.

## 280 Thermal Components and Equipment

heating and cooling components and equipment, thermal measurement devices, heat sinks.

**THERMAL CONTROL LOUVER system by computer simulation**, Analysis of the response of a bimetal-actuated — R. Mancuso (AED, Pr) 8th AIAA/NASA/ASTM/IES Space Simulation Conf., Washington, D.C.

## SERIES 300 SYSTEMS, EQUIPMENT, & APPLICATIONS

## 310 Spacecraft and Ground Support

spacecraft and satellite design, launch vehicles, payloads, space missions, space navigation.

**AEROSAT Problems**, Present — C.R. Hume, J. Chaumeron (AED, Pr) 6th U.S. — European Conf., Monte-Carlo, Monaco.

**TELEVISION SYSTEMS for remote manipulation** — L. Freedman, W.H. Crooks, P.P. Coan (AED, Pr) Human Factors Soc. Ann. Meeting, Dallas, TX.

## 315 Military Weapons and Logistics

missiles, command and control.

**REMOTELY PILOTED VEHICLE** — D. Shore (MSRD, Mrstn.) Greater Omaha AFCEA Chapter, Omaha, NE (10/21/75).

**TRANSFERRING USABLE INFORMATION to the military maintenance man** — M.L. Johnson, C.F. Matthews (ASD, Burl.) Boston Chapter, Society of Logistics Engineers, Hanscom Field Officer's Club (2/4/75).

**TRANSFERRING USABLE INFORMATION to the military maintenance man** — M.L. Johnson, C.F. Matthews (ASD, Burl.) 11th Int'l. Logistics Symposium, Valley Forge, PA (8/15-19/76).

## 320 Radar, Sonar, and Tracking

microwave, optical, and other systems for detection, acquisition, tracking, and position indication.

**RADAR multipath and resolution techniques** — S.M. Sherman (MSRD, Mrstn.) (Complex-Angle Monopulse (Lecture 7); Multipath Application of Complex-Angle Monopulse (Lecture 8) *Microwave Journal*, Boston, MA (10/22-24/75).

## 325 Checkout, Maintenance, and User Support

automatic test equipment, (ATE), maintenance and repair methods.

**BUS MAINTENANCE**, Application of automatic test equipment to — J.M. Laskey, R. Barry (ASD, Burl.) *SAE Fleet Week* 9/75.

**DIAGNOSIS of internal combustion engine faults through remote sensing**, Non-contact — S.C. Hadden, L.R. Hulls, E.M. Sutphin (ASD, Burl.) 1976 Automotive Engineering Congress and Exposition, SAE, Detroit MI (2/23-27/75).

**EQUATE Atlas implementation and Future Expectations** — R.E. Turkington (ASD, Burl.) IEEE 1975 Automatic Support Systems Symposium, Westbury, New York (10/28-30/75).

## 340 Communications

industrial, military, commercial systems, telephony, telegraphy and telemetry, (excludes: television and broadcast radio).

**TIMING RECOVERY TECHNIQUE for burst modem application**, A new symbol — Dr. K. Feher (RCA Ltd., Ste Anne) Canadian IEEE Conference, Toronto, Canada (10/75).

**TRANSMISSION TRENDS**, Simultaneous digital/analog radio and cable — Dr. K. Feher (RCA Ltd., Ste Anne) World Telecommunication Forum, Geneva, Switzerland (10/75).

## 345 Television and Broadcast

television and radio broadcasting, receivers, transmitters, and systems, television cameras, recorders, studio equipment.

**TELEVISION TEST WAVEFORMS**, Measuring and interpreting transmitted — T.M. Gluyas (CCSD, Cam) AFCCE, Washington, DC (12/18/75).

## 360 Computer Equipment

processors, memories, and peripherals.

**MICROPROCESSORS** in consumer markets — R.O. Winder (Labs.Pr) *Computer*, Vol. 9, No. 1 (1/76) pp. 39-40.

## 370 Computer Programs (Scientific)

specific programs and techniques for scientific use, computation, simulation, computer aided design.

**MOS design automation** — W.F. Heagerty (ATL.Cam) Hardened Guidance & Weapon Delivery System Conference, Baltimore, MD: (10/23/75).

**STANDARD CELL TECHNIQUES** for computer-aided design of LSI arrays — A. Smith (ATL.Cam) IEEE SOS Technology Workshop, Lake Tahoe, CA (9/17-19/75).

## Author Index

Subject listed opposite each author's name indicates where complete citation to his paper may be found in the subject index. An author may have more than one paper for each subject category.

## RCA Laboratories

Abeles, B., 205  
Abrahams, M.S., 205  
Allen, Jr., E.L., 215  
Ban, V.S., 170  
Bartolini, R.A., 240  
Binggell, B., 205  
Bulocchi, C.J., 205  
Carlson, D.E., 105  
Carnes, J.E., 210  
Cohen, R.W., 205  
Crandall, R.S., 240  
D'Aiello, R.V., 220

DiGiovanni, S., 240  
Dingwall, A.G.F., 210  
Douglas, E.C., 210  
Ettenberg, M., 240  
Etzold, K.F., 255  
Faughnan, B.W., 205  
Forgue, S.V., 240  
Gerber, J., 160  
Gilbert, S.L., 170  
Goodman, A.M., 240  
Goodman, L.A., 240  
Ham, W.E., 240  
Hammer, J.M., 240  
Hurley, B., 255  
Jantz, W., 205  
Kane, J., 170  
Kawamoto, H., 215  
Kern, W., 105, 170, 210  
Kless, H., 205  
Klatzkin, J., 170, 215  
Kohn, E.S., 240  
Kosonocky, W.F., 210  
Kressel, H., 220, 240  
Ladany, I., 240  
Lampert, M.A., 205  
Larach, S., 160  
Levine, P.A., 240  
Lockwood, H.F., 240  
Meyerhofer, D., 240  
Mezrich, R.J., 245, 255  
Miller, A., 240  
Miller, L.D., 240  
Moore, A.R., 220  
Neil, C.C., 240  
Nuese, C.J., 205  
Olsen, G.H., 205  
Phillips, W., 240  
Powell, R.J., 205  
Priestley, E.B., 205  
Redfield, D., 205  
Robinson, P.H., 220  
Rose, A., 205  
Roosild, S.A., 240  
Rosen, A., 170  
Sandercock, J., 205  
Schroeder, J.O., 240  
Schweizer, H.P., 170  
Shepherd, F.D., 240  
Smith, R.W., 245  
Wilkomerson, D., 255  
Weimer, P.K., 240

Wettling, W., 205  
Williams, R., 125  
Winder, R.O., 360  
Wronski, C.R., 240  
Yang, A.C., 240

## Solid State Division

Faulkner, R.D., 240  
Ibaugh, J.L., 240  
McDonie, A.F., 240  
Peryak, D.E., 240

## Global Communications, Inc.

Rosenthal, M.P., 210

## Record Division

Dogar, A., 180  
Mishra, D., 180  
Pearson, J.C., 180

## Missile and Surface Radar Division

Bowen, J.H., 160  
Buckley, M.W., 180  
Hurley, J.W., 180  
Olivieri, D., 210  
Pschunder, R., 130  
Sherman, S.M., 320  
Shore, D., 315

## RCA Limited

Bell, A.B., 210  
Feher, Dr., K., 215, 340  
Lo, G., 210

## Automated Systems Division

Barry, R., 325  
Behling, H.H., 130  
Bosselaers, R.J., 140  
Hadden, S.C., 325  
Hulls, L.R., 325  
Johnson, M.L., 175

Laskey, J.M., 325  
Matthews, C.F., 315  
Sulphin, E.M., 325  
Turkington, R.E., 325

## Astro-Electronics Division

Chaumeron, J., 310  
Curtis, H.C., 225  
Coan, P.P., 310  
Crooks, W.H., 310  
Faith, T., 210  
Freedman, L., 310  
Hume, C.R., 310  
Mancuso, R., 280

## Government and Commercial Systems Division

Hampel, D., 215  
Hendrickson, R.J., 150  
McGuire, K., 215  
Miller, R.S., 180  
Prost, K., 215  
VanKeuren, E., 150

## Commercial Communications Systems Division

Gluyas, T.M., 345  
Moskovitz, G.S., 250  
Praba, Dr., K., 215  
Siukola, Dr., M.S., 225  
West, J.R., 250

## Advanced Technology Laboratories

Boornard, A., 240  
Gandolfo, D.A., 210  
Gehweiler, W.F., 135  
Heagerty, W.F., 370  
Kenville, R.F., 250  
Nicastro, L.J., 210  
Pridgen, J.I., 135  
Scott, R.D., 250  
Smith, A., 370

## Patents Granted

to RCA Engineers

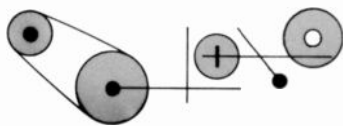

## Laboratories

**Method for vapor-phase growth of thin films of lithium niobate** — B.J. Curtis, H.R. Brunner (Labs., Zurich, Switz.) U.S. Pat. 3911176, October 7, 1975.

**Two color information record** — R.E. Flory (Labs., Pr.) U.S. Pat. 3911453, October 7, 1975.

**Intercharged readout of charge stored in charge-coupled image sensing array** — P.A. Levine, J.E. Carnes (Labs., Pr.) U.S. Pat. 3911467, October 7, 1975.

**Color picture/sound record** — E.O. Keizer (Labs., Pr.) U.S. Pat. 3911476, October 7, 1975.

**Optical fiber to planar waveguide coupler** — J.M. Hammer (Labs., Pr.) U.S. Pat. 3912363, October 14, 1975.

**AC deformable mirror light valve** — W.R. Roach (Labs., Pr.) U.S. Pat. 3912370, October 14, 1975.

**Color image intensification and projection using deformable mirror light valve** — I. Gorog, A.H. Firester (Labs., Pr.) U.S. Pat. 3912386, October 14, 1975.

**Microstrip carrier for high frequency semiconductor devices** — A. Rosen, J.F. Reynolds (Labs., Pr.) U.S. Pat. 3913040, October 14, 1975.

**Method of making a transmission photocathode device** — H. Kressel (Labs., Pr.) U.S. Pat. 3914136, October 21, 1975.

**Process for forming transition metal oxide films on a substrate and photomasks therefrom** — J. Kane, H. Schweizer (Labs., Zurich, Switz.) U.S. Pat. 3914515, October 21, 1975.

**Voltage regulator for deflection circuit** — G. Forster, H. Keller (Labs., Zurich Switz.) U.S. Pat. 3914653, October 21, 1975.

**Gated oscillator having constant average DC output voltage during on and off times** — C.R. Carlson, I. Gorog, P.M. Heyman (Labs., Pr.) U.S. Pat. 3914711, October 21, 1975.

**Crystals for recording phase holograms** — J.J. Amodei, W. Phillips (Labs., Pr.) U.S. Pat. 3915549, October 28, 1975.

**Method for determining an accurate alignment of a laser beam** — K.G. Hernqvist (Labs., Pr.) U.S. Pat. 3915574, October 28, 1975.

**Stabilized autocatalytic metal deposition baths** — N. Feldstein, J.A. Weiner (Labs., Pr.) U.S. Pat. 3915717, October 28, 1975.

**Photomask bearing a pattern of metal plated areas** — N. Feldstein (Labs., Pr.) U.S. Pat. 3916056, October 30, 1975.

**Asymmetrically excited semiconductor injection laser** — I. Ladany, D.P. Marinelli, H. Kressel, & V.M. Cannuli (Labs., Pr.) U.S. Pat. 3915339, October 28, 1975.

**Temperature-compensated surface-propagated wave energy device** — M. Toda,

S. Osaka (Res. Lab., Tokyo, Japan) U.S. Pat. 3916348, October 28, 1975.

**Frequency-encoded focussed image hologram record** — M.T. Gale (Labs., Zurich, Switz.) U.S. Pat. 3917378, November 4, 1975.

**Protection Circuit** — S. Weisbrod (Labs., Pr.) U.S. Pat. 3917980, November 4, 1975.

**Charge transfer circuits** — P.K. Weimer (Labs., Pr.) U.S. Pat. 3919468, November 11, 1975.

**Automatic target control system for a television camera tube** — D.P. Dorsey, W.E. Rodda, R.S. Filson (Labs., Pr.) U.S. Pat. 3919472, November 11, 1975.

**Loop controller for a loop data communications system** — N.F. MAXemchuk (Labs., Pr.) U.S. Pat. 3919484, November 11, 1975.

**Electroluminescent cell with a current limiting layer of high resistivity** — J.J. Hanak (Labs., Pr.) U.S. Pat. 3919589, November 11, 1975.

**Automatic peaking apparatus** — J.P. Bingham (Labs., Pr.) U.S. Pat. 3919714, November 11, 1975.

Method of making a semiconductor device — R.H. Dean (Labs., Pr.) U.S. Pat. 3920861, November 18, 1975.

Field emitting device and method of making same — J.D. Levine (Labs., Pr.) U.S. Pat. 3921022, November 18, 1975.

Frequency multiplier circuit — D.E. Mahoney (Labs., Pr.) U.S. Pat. 3921056, November 18, 1975.

Method of bonding two bodies together — J.D. Knox (Labs., Pr.) U.S. Pat. 3921885, November 25, 1975.

Method for coating ferrous-metal mask for cathode-ray tube — G.S. Lozier (Labs., Pr.) U.S. Pat. 3922394, November 25, 1975.

Method of making a semi-transparent photomask — G.L. Schnable, N. Feldstein (Labs., Pr.) U.S. Pat. 3922420, November 25, 1975.

Circuit for producing odd frequency multiple of an input signal — W.G. McGuffin, R.W. Burgen (Labs., Pr.) U.S. Pat. 3922593, November 25, 1975.

Electroluminescent semiconductor device — J.I. Pankove (Labs., Pr.) U.S. Pat. 3922703, November 25, 1975.

Liquid crystal compositions — C.S. Oh, E.F. Pasierb (Labs., Pr.) U.S. Pat. 3923685, December 2, 1975.

Method of making an optical waveguide — M.T. Duffy, D.J. Channin, J. M. Hammer (Labs., Pr.) U.S. Pat. 3924929, December 2, 1975.

Noise cancelling magnetic antenna for use with watercraft — K.H. Powers, L.L. Stetz, Jr. (Labs., Pr.) U.S. Pat. 3913107, October 14, 1975; Assigned to the U.S. Government.

Heat sinks for microstrip circuit — H. Kawamoto (Labs., Pr.) U.S. Pat. 3908188, September 23, 1975; Assigned to the U.S. Government.

Noise suppression arrangement for communication receivers — H.G. Schwarz (Labs., Pr.) U.S. Pat. 3671867; Assigned to the U.S. Government.

Method of fabricating an apertured mask for a cathode-ray tube — H.B. Law (Lalos, Pr.) U.S. Pat. 3923566, December 2, 1975.

## Solid State Division

Relaxation oscillator having stable pulse width — P. Goodheart, A.C. Sheng (SSD, Som.) U.S. Pat. 3911377, October 7, 1975.

Signal comparison circuits — R.H. Isham (SSD, Som.) U.S. Pat. 3012942, October 14, 1975.

Direct current protection circuit — R.P. Fillmore (SSD, Som.) U.S. Pat. 3912977, October 14, 1975.

Voltage regulator circuit with relatively low-power consumption — R.P. Fillmore, (SSD, Som.) U.S. Pat. 3913006, October 14, 1975.

Current proportioning circuit — A.J. Leidich (SSD, Som.) U.S. Pat. 3914684, October 21, 1975.

Feedback amplifier — J.Craft (SSD, Som.) U.S. Pat. 3914704, October 21, 1975.

Differential amplifier — B. Zuk (SSD, Som.) U.S. Pat. 3916333, October 28, 1975.

Modulator — H.A. Wittlinger (SSD, Som.) U.S. Pat. 3916346, October 28, 1975.

System for eliminating substrate bias effect in field effect transistor circuits — R.C. Heuner, D.K. Morgan, G.W. Steudel (SSD, Som.) U.S. Pat. 3916430, October 28, 1975.

Bipolar integrated circuit transistor with lightly doped subcollector core — H. Khajezadeh (SSD, Som.) U.S. Pat. 3916431, October 28, 1975.

Black ceramic body — L.F. Hart, R.L. Buttle (SSD, Som.) U.S. Pat. 3918982, November 11, 1975.

Alternating current line voltage supply isolation using deflection system output transformer — W.F. Dietz (SSD, Som.) U.S. Pat. 3920892, November 18, 1975.

Biasing current attenuator — A.A. Ahmed (SSD, Som.) U.S. Pat. 3921013, November 18, 1975.

Operational transconductance amplifier — C.F. Wheatley, Jr., H.A. Wittlinger (SSD, Som.) U.S. Pat. 3921090, November 18, 1975.

Amplifier protection system — M.V. Hoover (SSD, Som.) U.S. Pat. 3924159, December 2, 1975.

Target mounting structure for use in camera tube — S.A. Ochs (SSD, Lanc.) U.S. Pat. 3919582, November 11, 1975.

Radiant energy device mount — D.B. Kaiser (SSD/EOD, Lanc.) U.S. Pat. 3916336, October 28, 1975.

Quartz to glass seal — R.D. Faulkner (SSD/EOD, Lanc.) U.S. Pat. 3923189, December 2, 1975.

## Consumer Electronics

Composite printed circuit board — L.P. Thomas (CE, Indpls.) U.S. Pat. 3912849, October 14, 1975.

Stylus arm pivot — M.E. Miller (CE, Indpls.) U.S. Pat. 3912857, October 14, 1975.

Electromagnetic radiation filter for coaxially fed hot chassis television receiver — G.W. Carter, S.E. Hilliker (CE, Indpls.) U.S. Pat. 3913038, October 14, 1975.

Timing signals for velocity error correction — C.D. Boltz, Jr. (CE, Indpls.) U.S. Pat. 3914542, October 21, 1975.

Controllable reference supply for television tuners — W.W. Evans (CE, Indpls.) U.S. Pat. 3914696, October 21, 1975.

Detachable pickup arm magnetic coupling — B.K. Taylor, W.H. Garlin (CE, Indpls.) U.S. Pat. 3917903, November 4, 1975.

Signal translation using the substrate of an insulated gate field effect transistor — J.B. George (CE, Indpls.) U.S. Pat. 3924192, December 2, 1975.

Electronic oscillator — J. Craft (CE, Som.) U.S. Pat. 3924202, December 2, 1975.

Automatic luminance channel bandwidth control apparatus responsive to the amplitude of color image information — L.A. Harwood (CE, Som.) U.S. Pat. 3924266, December 2, 1975.

## Commercial Communications Systems Division

Four-wire conference circuit — L.F. Goeller, Jr. (CCSD, Cam.) U.S. Pat. 3912867, October 14, 1975.

Signal sensing for film projectors — A.E. Jackson, G.A. Singer (CCSD, Cam.) U.S. Pat. 3915566, October 28, 1975.

Multinomial processor system — D. Hampel, R.W. Biasco (CCSD, Cam.) U.S. Pat. 3922536, November 25, 1975.

## Automated Systems Division

Phase locked loop including an arithmetic unit — R.J. Bosselaers (ASD, Burl.) U.S. Pat. 3913028, October 14, 1975.

Staircase waveform generator — H. Logemann, Jr. (ASD, Burl.) U.S. Pat. 3919649, November 11, 1975.

## Picture Tube Division

Plural-beam color picture tube with improved magnetic convergence structure — J. Evans, Jr. (PTD, Lanc.) U.S. Pat. 3916244, October 28, 1975.

Purity adjustment for color display system — R.L. Barbin (PTD, Lanc.) U.S. Pat. 3916437, October 28, 1975.

Densitometer for measuring average aperture diameter — G.S. Gadois (PTD, Lanc.) U.S. Pat. 3918815, November 11, 1975.

Method of degassing a cathode-ray tube prior to sealing — F.S. Swacki (PTD, Scranton) U.S. Pat. 3922049, November 25, 1975.

Method for applying organic polymeric coating composition to ferrous-metal surfaces — B.K. Smith (PTD, Lanc.) U.S. Pat. 3922395, November 25, 1975.

## Special Contract Inv.

Dyeing station in an apparatus for continuously dyeing fibrous material — B.M. Childers, C. Fesperman, Jr. (Cor. Ind., Dalton, GA) U.S. Pat. 3913359, October 21, 1975.

## Graphic Systems

Electronic identification system — R.J. Klensch (IS, Dayton, NJ) U.S. Pat. 3914762, October 21, 1975.

## Electronic Components

Device and method for restoring cathode emission in a thermionic electron tube — H. Kozicki (EC, Atlanta, GA) U.S. Pat. 3915533, October 28, 1975.

## Advanced Technology Laboratories

Complementary field-effect transistor amplifier — W.F. Gehweiler (ATL, Cam.) U.S. Pat. 3914702, October 21, 1975.

## Missile and Surface Radar Division

Antenna scanning — R.W. Howery (MSRD, Mrstn.) U.S. Pat. 3916415, October 28, 1975.

Approximator for square root of sums of squares — J.A. Lunsford (MSRD, Mrstn.) U.S. Pat. 3922540, November 25, 1975.

Insertion phase trim method — L.J. Lavedan, Jr. (MSRD, Mrstn.) U.S. Pat. 3911380, October 7, 1975; Assigned to the U.S. Government.

Accurate normalization for a monopulse radar — D.N. Thomson (MSRD, Mrstn.) U.S. Pat. 3921173, November 18, 1975; Assigned to the U.S. Government.

## Government Communications Systems Division

Frequency measurement by coincidence detection with standard frequency — E.J. Nossen, E. R. Starner (GCSD, Cam.) U.S. Pat. 3924183, December 2, 1975.

## Palm Beach Division

Embossed character reader — E.H. Del Rio (PBD, Palm Beach Gardens) U.S. Pat. 3917925, November 4, 1975.

Web advance mechanism — K.D. Peters (PBD, Palm Beach Gardens) U.S. Pat. 3921879, November 25, 1975.

## Avionics Systems Division

Digital feedback relay controller — G.A. Jones (ASD, Van Nuys) U.S. Pat. 3922587, November 25, 1975.

Low voltage bus-operated overvoltage protection system — F.C. Easter (ASD, Van Nuys) U.S. Pat. 3916262, October 28, 1975; Assigned to the U.S. Government.

## APC Corp.

Thermoplastic heat responsive fire vent apparatus — E.S. Naidus (APC Corp., Hawthorne, NJ) U.S. Pat. 3918226, November 11, 1975.

## Astro-Electronics Division

Satellite propellant management system — R.J. Lake, Jr. (AED, Pr.) U.S. Pat. 3923188, December 2, 1975.

## RCA Limited

Fabry-Perot polarization laser beam modulator — A.L. Waksberg (RCA Ltd., Montreal) U.S. Pat. 3918007, November 4, 1975.

High-resolution digital generator of graphic symbols with edging — R.J. Clark (RCS Ltd., Montreal) U.S. Pat. 3918039, November 4, 1975.

Peak voltage detector circuits — R.T. Griffin (RCA Ltd., England) U.S. Pat. 3921010, November 18, 1975.



## Dates and Deadlines

### Calls for papers —be sure deadlines are met

**Ed. Note:** Calls are listed chronologically by meeting date. Listed after the meeting title (in bold type) are the sponsor(s), the location, and deadline information for submittals.

**JAN. 30 - FEB. 4, 1977 — Power Engineering Society Winter Meeting (PE)** Statler Hilton Hotel, New York, NY **Deadline info:** (paper) 9/1/76 to IEEE, 345 East 47th Street, New York, NY 10017.

**FEB. 1977 — Low-Noise Technology (Special Issue of the) IEEE Transactions on Microwave Theory and Techniques** **Deadline info:** (paper) 4 copies 6/1/76 to Jesse Taub, AIL Division of Cutler-Hammer, Walt Whitman Road., Melville, NY 11746.

**MARCH 22-25, 1977 — ELECTRO (EEE International Convention)** IEEE, ERA Americana Hotel, Coliseum, New York, NY **Deadline info:** (Sessions) 7/22/76 to W. C. Weber, Jr., ELECTRO, Suite 1108, 3600 Wilshire Blvd., Los Angeles, CA 90010.

**MAY 25-27, 1977 — 1977 Spring Meeting & Star Symposium - SNAME "Energy Research in the Oceans"** **Deadline info:** (abst) 400-500 words — 15 copies to RADM N. Sonenshein, USN (Ret.), Assistant to the President, Global Marine Development, Inc., 4100 MacArthur Blvd., Newport Beach, CA 92660.

**AUG. 24-26, 1976 — Product Liability Prevention Conference (R et al)** Newark College of Engineering, Newark, NJ **Deadline info:** (paper) 11/1/76 to John Mihalasky, Newark College of Engr., Newark, NJ 07102.

**SEPT. 13-15, 1976 — The Spirit of Standardization (SES)** Chalfonte-Haddon Hall, Atlantic City, NJ **Deadline info:** (abst) 200-500 words 3/1/76 to J. J. O'Donnell, Program Chairman, Sperry Univac - M.S. 1A-E4-109, P.O. Box 500, Blue Bell, PA 19422.

**SEPT. 29 - OCT. 1, 1976 — Ultrasonics Symposium (SU)** Annapolis Hilton Hotel, Annapolis, MD **Deadline info:** (ms) 7/1/76 to P.H. Carr, AFCLR, LG Hanscom Field, Bedford, MA 01730.

**OCT. 11-14, 1976 — Industry Applications Society Annual Meeting (IA, Chicago Section)** Regency Hyatt O'Hare, Chicago, IL **Deadline info:** (abst) 3/8/76 to R.V. Wachter, Aluminum Co. of Am., 1501 Alcoa Bldg., Pittsburg, PA 15219.

**OCT. 13-15, 1976 — Software Engineering Conference (C)** Jack Tar Hotel, San Francisco, CA **Deadline info:** (ms) 4/15/76 to C.V. Ra, Dept of EE & Computer Sci.

**OCT. 13-15, 1976 — Software Engineering Conference (C)** Jack Tar Hotel, San Francisco, CA **Deadline info:** (ms) 4/15/76 to C.V. Ramamoorthy, Dept of EE & Computer Sci., Univ. of Calif., Berkeley, CA 94720.

**OCT. 19-21, 1976 — System Designs Driven by Sensors (AIAA)** Pasadena, CA **Deadline info:** (abst) 4 copies 3/1/76 to Dr. Robert Greenberg, Department of Defense Research and Engineering, Washington, DC 20301.

**OCT. 21-22, 1976 — Canadian Communications & Power Conference (Canadian Region, Montreal Section)** Queen Elizabeth Hotel, Montreal, Quebec, Canada **Deadline info** (A&S) 3 copies 3/1/76 to J.J. Archambault, CP/PO 958, Succ. "A", Montreal, Que. H3C 2W3 Canada.

**OCT. 25-26, 1976 — Joint Engineering Management Conference (EM, EIC et al)** Hyatt Regency Hotel, Toronto, Ontario, Canada **Deadline info:** (paper) 6/30/76 to K.L. Coupland, Ministry of Colleges & Univ., 60 Sir William's Lane, Islington, Ont. Canada M9A 1V3.

**NOV. 6-10, 1976 — Engineering in Medicine & Biology Conf. (EMB, AEMB)** Sheraton Hotel, Boston, MA **Deadline info:** (abst) 4/15/76 to AEMB Suite 1350, 5454 Wisconsin Ave., Chevy Chase, MD 20015.

**NOV. 28 - DEC 3, 1976 — Joint Cryogenic Meeting at 1976 ASME Winter Annual Meeting** Statler Hilton Hotel, New York, NY **Deadline info:** (abst) 300 words 1/30/76 (draft ms) 4/20/76 (final drafts) 6/30/76 to Prof. Leonard Wendel, Dept of Chemical Engr., Lehigh University, Bethlehem, PA 18015 and Prof. Geoffrey G. Haselden, Dept. of Chemical Engr., University of Leeds, Leeds LS2 9JT, England.

**DEC. 1-3, 1976 — Decision and Control — Adaptive Processes (CS, SIAM)** Sheraton Sand Key, Clearwater Beach, FL **Deadline info:** (A or MS) 4/1/76 to Earl Barnes, IBM TJ Watson Res. Ctr., POB 218, Yorktown Heights, NY 10598.

**DEC. 6 - 10, 1976 — Submillimeter Waves and Their Applications (IEEE)** San Juan, Puerto Rico **Deadline info:** (ms) 8/1/76 to K.J. Button, MIT, Nat'l. Magnet Lab., Cambridge, MA 02139.

### Dates of upcoming meetings —plan ahead

**Ed. Note:** Meetings are listed chronologically. Listed after the meeting title (in bold type) are the sponsor(s), the location, and the person to contact for more information.

**APRIL 12-14, 1976 — Acoustics, Speech & Signal Processing Int'l Conference (ASSP, Phila. Section)** Marriott Hotel, Phila., PA **Prog info:** Thomas Martin, Threshold Tech, Route 130, Union Landing Rd., Cinnaminson, NJ 08077.

**APRIL 20-22, 1976 — Computer Software Engr. Reliability, Management Design (ED, R)** Caesars Palace, Las Vegas, NV **Prog info:** J.H. Martin, SS Draper Lab., 75 Cambridge Parkway, Cambridge, MA 02142.

**APRIL 22-24, 1976 — Milwaukee Symposium on Automatic Computation & Control (SMC, Milwaukee Section, Univ. of Wisc.)** Milwaukee, Wisc. **Prog info:** Warren Koontz, Rm. 2A-208, Bell Labs., Whippany, NJ 07981.

**APRIL 26-27, 1976 — Southeastern Symposium on System Theory (C, et al)** Univ. of Tenn., Knoxville, Tenn. **Prog info:** T.W. Reddoch, Div. of EE, ERDA, Washington, DC 20545.

**APRIL 26-27, 1976 — Pittsburgh Conference on Modeling and Simulation (SMC, Univ. of Pitts., ISA)** **Prog info:** W.G. Vogt-M.H. Mickle, 348 Benedum Engr. Hall, Univ. of Pittsburgh, Pittsburgh, PA 15261.

**APRIL 26-28, 1976 — Electronic Components Conference (PHP, EIA)** Jack Tar Hotel, San Francisco, CA **Prog info:** J.H. Powers, Jr., IBM-System Pmts. Div. Dept., 1D4, Bldg. 414-700, Hopewell Junction, NY 12533.

**APRIL 27-29, 1976 — Optical Computing Int'l Conference (C, et al)** Capri, Italy **Prog info:** D. P. Casasent, CMU, Dept. of EE, Pittsburgh, PA 15213.

**APRIL 27-29, 1976 — Circuits and Systems Int'l Symposium (CAS, VDE)** Technical Univ., Munich, Germany **Prog info:** Alfred Fettweis, Lehrstuhl für Nachrichtentechnik, Univ. of Bockhum, PO 2148, D-4630 Bochum, F.R. Germany.

**APRIL 29-30, 1976 — Appliance Technical Conference (IA et al)** Purdue Univ., W. Lafayette, IN **Prog info:** R.G. Leonard, R.W. Herrick Labs., Purdue Univ., W. Lafayette, IN 47907.

**MAY 1-6, 1976 — 78th Annual Meeting and Exposition (ACS) Convention-Exposition Center, Cincinnati, OH** **Prog info:** The American Ceramic Society, Inc., 65 Ceramic Drive, Columbus, OH 43214.

**MAY 3-6, 1976 — Offshore Technology Conference (OEC et al)** Astrohall, Houston, TX **Prog info:** OTC, 6200 N. Central Expressway, Dallas, TX 75206.

**MAY 3-7, 1976 — Subscriber Loops & Services International Symposium (COM, Region 8, IEEE, UKRI Section et al)** London, England **Prog info:** A.G. Hare, Head of TSS8 PO Telecommunications Hqds., Rm 702, Cheapside House, London EC2 England.

**MAY 5-7, 1976 — Carnahan Conference on Crime Countermeasures (AES, Univ. of Kentucky)** Univ. of Kentucky, Lexington, KY **Prog info:** J.S. Jackson, Dept. of EE, Univ. of Kentucky, Lexington, KY 40506.

**MAY 11-14, 1976 — ELECTRO (IEEE International Convention) (IEEE, ERA)** Boston Sheraton Hotel & Hynes Audit., Boston, MA **Prog info:** W.C. Weber, Jr., ELECTRO, 31 Channing St., Newton, MA.

**MAY 16-19, 1976 — Industrial Power Conference (ASME)** Memphis, TN **Prog info:** Maurice Jones, Director, Public Relations, ASME, 345 E. 47th St., New York, NY 10017.

**MAY 17-19, 1976 — General Engineering Conference (ASME)** St. Louis, MO **Prog info:** Maurice Jones, Director, Public Relations, ASME, 345 E. 47th St., New York, NY 10017.

**MAY 18-20, 1976 — Aerospace & Electronics Conference (NAECON)** (AES et al) Dayton Conv. Ctr., Dayton, OH **Prog info:** J.E. Singer, NAECON 76, 140 Monument Ave., Dayton, OH 45402.

**MAY 24-26, 1976 — Plasma Science Int'l Conference (NPS et al)** Univ. of Texas, Austin, TX **Prog info:** E.J. Powers, Dept. of EE, Univ. of Texas at Austin, Austin, TX 78712.

**MAY 24-26, 1976 — Lubrication Symposium (ASME)** Atlanta, GA **Prog info:** Maurice Jones, Director, Public Relations, ASME, 345 E. 47th St., New York, NY 10017.

**MAY 25-27, 1976 — Laser & Electro-Optical Systems (CLEOS)** (QE Council, OSA) Town & Country, San Diego, CA **Prog info:** M.E. Rabedeau, IBM-F 55/015, San Jose, CA 95193.

**MAY 25-28, 1976 — Int'l Symposium on Multi-Valued Logic (C, ACM/ICS, Utah State Univ. et al)** Utah State Univ., Logan, UT **Prog info:** Z. Vranesic, Dept. of EE, Univ. of Toronto, Toronto, Ontario, Canada M5S 1A4.

**MAY 27, 1976 — Trends and Applications: Micro and Mini Systems (C, Washington Section, NBS)** Nat'l. Bureau of Standards, Gaithersburg, MD **Prog info:** J.W. Benoit, MITRE Corp., Westgate Res. Park, McLean, VA 22101.

**JUNE 7-10, 1976 — National Computer Conference (C, AFIPS)** New York, NY **Prog info:** Stanley Winkler, IBM Corp., 18100 Fredrick Pike, Gaithersburg, MD 20760.

**JUNE 8-10, 1976 — Power Electronics Specialists Conference (AES)** NASA Lewis Res. Ctr., Cleveland, OH **Prog info:** Forest Golden, Gen'l. Elec Co., Box 30, W. Genesee St., Auburn, NY 12021.

**JUNE 14-16, 1976 — Electrical Insulation Int'l. Symposium (EI)** Queen Eliz. Hotel, Montreal, PQ, Canada **Prog info:** E.O. Forster, Exxon Res. & Engrg. Co., POB 45, Linden, NJ 07038.

**JUNE 14-17, 1976 — Applied Mechanics Conference (ASME)** Salt Lake City, UT **Prog info:** Maurice Jones, Director, Public Relations, ASME, 345 E. 47th St., New York, NY 10017.

**JUNE 14-16, 1976 — International Microwave Symposium (MTT)** Cherry Hill, NJ **Prog info:** Martin Caulton, RCA, Princeton, NJ 08540.

**JUNE 14-16, 1976 — Int'l Conference on Communications (CSCB)** Marriott Motor Hotel, Philadelphia, PA **Prog info:** Ralph Wyndrum, Bell Labs., Whippany Rd., 1B306, Whippany, NJ 07981.

**JUNE 14-18, 1976 — Quantum Electronics Int'l Conference (ED, MTT, AIP et al)** RAI Congress Ctr., Amsterdam, The Netherlands **Prog info:** O. Svelto, c/o H.J. Frankena, Dept. Applied Physics, Lorentzweg 1 Delft Netherlands.

**JUNE 15-18, 1976 — Jt. Int'l. Magnetics & Magnetism & Magnetic Materials Conf. (INTERMAG & M<sup>2</sup>) (MAG, AIP)** Pittsburgh Hilton Hotel, Pittsburgh, PA **Prog info:** H.C. Wolfe, AIP, 335 E. 45th St., New York, NY 10017.

**JUNE 21-24, 1976 — Summer Annual Meeting (ASME)** Quebec City, Que. **Prog info:** Maurice Jones, Director, Public Relations, ASME, 345 E. 47th St., New York, NY 10017.

# Two RCA men elected IEEE Fellows

The two RCA men cited herein have been honored for their professional achievements by being elected Fellows of the Institute of Electrical and Electronics Engineers. This recognition is extended each year by the IEEE to those who have made outstanding contributions to the field of electronics.

## Walter F. Kosonocky

For contributions to solid-state logic memory, and imaging.



Dr. Kosonocky, received the BSEE and MSEE from Newark College of Engineering in 1955 and 1957, respectively, and the ScD in Engineering from Columbia University in 1965. From June 1955, he has been employed at RCA Laboratories, where after one year as a Research Trainee, he became a Member of the Technical Staff and since that time he has been doing research on new solid-state devices and circuits. Since the spring of 1970, Dr. Kosonocky has been working on the study of performance limitations of CCD's and the development of charge-coupled devices for image sensing, memories, and signal processing applications. This work has included studies of device performance limitations (interface trapping, fringing field drift, free-charge transfer, noise, and low light level imaging) and the development of processing technology for surface and buried channel CCD's, input and output techniques, and new structures for CCD image sensors and digital memories. Dr. Kosonocky received two RCA Laboratories Achievement awards in 1959 and 1963, and was awarded a David Sarnoff Fellowship for the academic year 1958-1959. He has published 24 technical papers, and has been issued 23 U.S. patents. Dr. Kosonocky is a member of Tau Beta Pi, Eta Kappa Nu, Sigma Xi, the American Ordnance Association, a Senior Member of IEEE, and a member of the IEEE Solid State Circuit Committee.

Dr. Sherman received the BA and the MA in Physics in 1934 and 1939, respectively, and the PhD in Electrical Engineering in 1965, all from the University of Pennsylvania. He served in the US Army Signal Corps and Air Forces from 1942 to 1946 where he led the development of two airborne fire control radars deployed during and after World War II. Since 1955 Dr. Sherman has been directly associated with the Systems Engineering organization of RCA Missile and Surface Radar Division in supervisory and staff positions. His assignments and responsibilities have been devoted principally to system analysis and system concepts for sensor development and application. He was responsible for major portions of the TALOS Land Based Weapon System and the Ballistic Missile Early Warning System. He also proposed basic concepts from which the theory and practice of radar signature analysis (space object identification) has evolved. In recent years he has devoted considerable effort to analysis and concept formulation for advanced radar systems. Two of the areas in which he has gained recognition are theory and application of wideband radar, and low-angle radar propagation problems. His "Complex-Angle Monopulse" technique has gained wide acceptance in the radar community as a useful approach to correcting low-angle multipath errors. Dr. Sherman is a member of Phi Beta Kappa, Sigma Xi, and Pi Mu Epsilon.

## Samuel M. Sherman

For contribution: to radar systems engineering and signal processing.



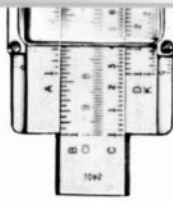

## American Ingenuity: 200 years of engineering

### National Engineer's Week (Feb. 22 — 28, 1976)

The National Society of Professional Engineers is sponsoring National Engineer's Week (Feb 22 — 28, 1976) using a bicentennial theme: "American Ingenuity: 200 years of engineering". The NSPE began sponsoring National Engineers Week in February, 1951. The purpose of the Week is to familiarize the public with the work of engineers and to honor outstanding members of the profession. The week of George Washington's birthday is traditionally observed because the first President was a trained land surveyor and a designer of roads, fortification, and other structures. He also had the educational background of a civil engineer in the 18th century.

## Awards

### RCA Limited

The first award winners of RCA Limited's new Technical Excellence Program were announced recently in Montreal.

Two groups of engineers in Aerospace and Government Systems were granted team awards. They are:

- **M.W. Altman, B. Dinsdale, G. Dziub, E. George and C.M. Kudsia** "for the development of the GFEC Multiplex Assemblies for the SATCOM 24 Channel Transponder; and
- **R. C. Baxter, P.Y. Chan, J.M. Keelty, P. Oldfield and N. Whittaker** "for the development of the 2GHz Ranging Transponder for CTS".

Two awards were also granted in Communications Systems. They are:

- **Dr. S.C. Acharyya, A. Grosswindhager, J. Labelle and L.A. Mora** "for the development of Modular Design Earth Station Ground Communications Equipment utilizing MIC Techniques".
- **J. Barkwith** "for Project Engineering of the Haiti Small Earth Station."

### Service Company



**Adolph E. Hoffman-Heyden**, Manager, Radar Systems Analysis, RCA Service Company, Patrick Air Force Base, Florida,

was recently honored by the Florida Institute of Technology at a testimonial dinner.

The award was for his significant accomplishments in the field of pulse radar technology. He was presented a plaque appointing him a lifetime faculty member of the Institute.

Throughout his more than 20-year association with RCA Service Company, Mr. Hoffman-Heyden has been engaged in efforts to improve the tracking accuracy of pulse radar instruments in support of missile and space vehicle testing.

### Astro-Electronics Division



**Dr. Alvin W. Sheffler**, of Astro-Electronics Division's Mechanical Engineering Department received an Engineering Excellence Award in recognition of his outstanding contributions to the structural design analysis of the RCA Satcom spacecraft which AED has built for RCA Global Communications Inc. and RCA Alascom Inc.

Dr. Sheffler was cited by **Dr. Warren Manger**, Chief Engineer, for "demonstrating outstanding leadership in the solution of some extremely difficult technical problems. As a consequence, his efforts have advanced RCA's technical reputation in the area of spacecraft design."

## Degrees granted

**Pang-Ting Ho**, Microwave Technology Center, RCA Laboratories, Princeton, N.J., recently received the PhD in Electrical Engineering at Rutgers University.

**Donald C. McCarthy**, Process and Applied Materials Laboratory, RCA Laboratories, Princeton, N.J., received the BS in Chemistry at Rutgers University.

## Missile and Surface Radar Division

Chief Engineer, **J.C. Volpe** recently announced the Technical Excellence Award winners for the second half of 1975:

**R. Lieber and G.M. Sparks** individual awards for systems effort on the AN/TPQ-27.

**J.A. Lunsford and L.W. Martinson** individual awards for the development of an advanced signal processing system for video bandwidth reduction.

**J. Liston** for technical expertise and creativity in developing and applying special analytical tools for solving radar system problems.

**F.E. Ogle** for engineering, software design and principal implementation of the AABNCP antenna system operational computer.

**E.W. Veitch** for creativity and competence in developing the AEGIS Tactical Executive System.

**T.E. Anderson and W.I. Smith** a joint award for design and development of a klystron anode modulator for CCSD's UHF tv transmitters.

**D.C. Drumheller** for technical accomplishments and leadership as senior software engineer on the APPLICON project.

**W.A. Harmening** for concepts, development and design of a new approach to precision steering mechanisms for laser system applications.

**A.G. Chressanthis, C.J. Hughes and G.S. Oakes, Jr.** individual awards for development and validation of a new approach to moving target indication for the EDM-3C AN/SPY-1A radar.



## A.G. Chressanthis receives 1975 excellence award

A.G. Chressanthis received MSRDC's annual technical excellence award for 1975 for his consistently high level of technical performance on the AEGIS EDM-3C MTI experiments conducted in USS Norton Sound, and in particular for his performance leading up to and during the final at-sea data gathering mission in early November 1975. His contributions to the evaluation of the clutter lock conceptual design by translating test results into required corrective equipment modifications were outstanding. His technical efforts yielded a clutter lock loop concept that successfully demonstrated satisfactory performance in land, sea, and transitional clutter under a multitude of sea states and land topological configurations.



W.I. Smith



D.C. Drumheller



W.A. Harmening



A.G. Chressanthis



R. Lieber



G.M. Sparks



J.A. Lunsford



L.W. Martinson



J. Liston



F.E. Ogle



E.W. Veitch



T.E. Anderson



C.J. Hughes



G.S. Oakes

## On site graduate program at Mountaintop

In the fall of 1974, a new concept in the area of Graduate Education was instituted at Mountaintop. With the cooperation of Wilkes College Graduate School, Wilkes-Barre, Pennsylvania, a Graduate Program in Physics was established for technical staff, with the classes being presented at the plant for the convenience of the employees enrolling in the program. Now in its second semester, this program appears to be a success.

Twice each week, Dr. John Orehtsky, Professor of Physics at Wilkes College, travels to the Mountaintop Plant to teach this semester's course offering "Solid State Devices," to the eleven staff members currently enrolled. Last semester the course offering was "Topics in Mathematical Physics."

The employees enrolled in this program have the added flexibility of using the in-plant classes to supplement additional courses taken at Wilkes College, or they may choose to obtain all the requirements for an advanced degree from the courses offered at the Plant each semester.

## Zappasodi and Collins win first place in packaging competition

G.G. Zappasodi and F.P. Collins of Packaging Activity in Commercial Communications Systems Division, Camden, N.J., won first place in the "plastics (cushioning) packages" competition of the 1975 Packaging and Handling Competition, sponsored by the Society of Packaging and Handling Engineers.

The entry was a molded polystyrene container for shipping 2-way radio systems. The simple two-piece package designed by Messrs. Zappasodi and Collins replaces some 30 corrugated containers of various sizes used in the past.



Zap Zappasodi (left) and Skip Collins holding their SPHE award plaques. On the table is the molded polystyrene package that won the award. This ingenious design permits packing any size radio and any combination of accessories in the same molded styrene pack.

G.G. (Zap) Zappasodi is Manager of Packing Design, Broadcast Systems, CCSD, Camden, N.J. He received the BSIE in 1950 from Penn State. He joined RCA in 1957 in the Radio & "Victrola" Engineering department. In 1958 he was appointed Manager, Packing Design for the newly formed Industrial Electronic Products Division. Since that time he has been responsible for packaging and materials handling of all Commercial products in the Broadcast Division. Mr. Zappasodi is active in the Society of Packaging and Handling Engineers and is presently National Materials Handling Chairman for that organization. He is also active in ANSI and ASME committee work on Standards in Packaging and Materials Handling.

F.P. (Skip) Collins is a Packing Designer in Broadcast Systems, CCSD, Camden, N.J. He began with RCA in 1951 upon graduation from Camden County Vocational School where he specialized in the sheet metal trade. He completed night courses in drafting while employed in the factory. In 1954 he became a draftsman and progressed to a junior packing designer in 1958 and finally a senior packing designer in 1961. Mr. Collins was awarded a "Best of Show" trophy at the National Packaging competition of the Society of Packaging and Handling Engineers in 1965.





Jenny named Manager, Technical Information Programs

**Hans K. Jenny** has been appointed Mgr. Technical Information Programs. His responsibilities include those areas concerned with RCA's Technical Communication Programs, Technical Publications, Technical Information Systems and the Minorities in Engineering Program (MEP). Technical Information Programs is part of Corporate Engineering, Cherry Hill, N.J.

Hans K. Jenny, received the MSEE from the Swiss Federal Institute of Technology in 1943 where he was subsequently active as assistant professor doing research on low-noise behavior of microwave tubes. He joined the RCA Tube Division in 1946 as a microwave tube design engineer. Starting in 1950 he held various engineering management positions concerned with microwave tubes and solid state devices. In 1966 he became Operations Manager, Microwave Solid State Operations in Harrison N.J. From 1972 - 1975 he was Senior Technical Advisor to the Industrial Tube Division in Lancaster, Pa. and joined the Engineering Professional Programs activity in Cherry Hill in 1975. Mr. Jenny is a Fellow of the IEEE.

### Professional activities

**Dr. Gerard A. Alphonse**, Information Sciences, RCA Laboratories, Princeton, N.J., has been named to the National Science Foundation Advisory Committee for the Electrical Sciences and Analysis section of the NSF Engineering Division. The Committee advises the NSF on the impact of its research support programs, reviews and evaluates proposals or projects, and undertakes special studies.

**Harold G. Behl**, Missile and Surface Radar Division, AEGIS SM-2 Test & Evaluation, West Coast Test Site, has been appointed to the National Technical Committee on System Effectiveness and Safety, American Institute of Aeronautics and Astronautics.



Phillips named Editor, *RCA Engineer*

**John C. Phillips** has been appointed Administrator, Technical Communication Programs, and Editor, *RCA Engineer*.

John Phillips received the BA in Mathematics from Rutgers in 1970 and has done graduate work in Communications. He has sixteen years of technical communication experience, fourteen with RCA. For the past seven years, he was Associate Editor, *RCA Engineer*. Before that, he was an Engineering Editor at the Astro-Electronics Division. Mr. Phillips is a Member of the IEEE and Past President of the Group on Professional Communications. He is a member of the Rutgers Honor Society.



W.O. Hadlock retires

**W.O. (Bill) Hadlock** retired in February, culminating 41 years of service in the radio-electronics business, 29 of them with RCA. Mr. Hadlock is probably best known for his work as Editor of the *RCA Engineer*. His service in that capacity spans 20 years, to the start of the journal in 1955. During that time, he was also Manager of Technical Communications, with responsibilities for the Corporate papers and reports programs, and *RCA Trend*, as well as the *RCA Engineer*. From 1947 to 1955, he was with the Broadcast Systems Advertising Department where he worked on TV station plans, promotional programs for Broadcast products, and industrial advertising. He was also Editor of *Broadcast News*. Prior to 1947, he was with the General Electric Company. Mr. Hadlock received the BSEE from Clarkson Institute of Technology in 1934. He is a Senior Member of IEEE and is active in the Group on Professional Communications.

### Globcom hosts Drafting Coordination Committee Meeting



RCA Globcom played host for the semi-annual meeting of the RCA Corporate Drafting Coordination Committee in November. Those attending included (clockwise) John Feeley, Manager of Facilities and Maintenance; James Hepburn, Vice President of Operations, and Frank Micara, Supervisor of Drafting, all from RCA Globcom. Also Al Skavicus, Engineering Services Manager, Automated Systems Division; John W. Geler, Administrator, Corporate Standards, Engineering, Cherry Hill; William Wilson, Drafting Manager, Astro-Electronics Division; Jim Woodward, Standards Engineer, RCA Limited; Clifford Hoffer, Drafting Leader, Commercial Communications Systems; and Raymond Fitzmaurice, Standards Engineer, Corporate Standards, Engineering, Cherry Hill.

RCA Review, December, 1975		
Volume 36, Number 4		
<b>Contents</b>		
Spontaneous-Emission-Rate Alteration by Dielectric and Other Waveguiding Structures .....		J.P. Wittke
The Physics of Electrical Charging and Discharging of Semiconductors .....		H. Kless
Measurement of the Effective Photoelectron Emission Energy .....		L.A. Ezard
MTF Measurements of an Image Tube Electron Lens .....		L.A. Ezard
Ultra-Thin RF Silicon Transistors with a Copper-Plated Heat Sink .....		H.S. Veloric, A. Presser, and F.J. Wozniak
Wideband Signal Recording on Film Using (AlGa) As CW Injection Lasers .....		J.E. Roddy
The Chl <sub>r</sub> p Z-Transform—A CCD Implementation .....		G.J. Mayer
	<b>DOMESTIC</b>	<b>FOREIGN</b>
1-year .....	\$6.00	\$6.40
2-year .....	10.50	11.30
3-year .....	13.50	14.70

## Staff announcements

### RCA Communications

**Howard R. Hawkins**, President, RCA Communications, announced the election of **Ben W. Agee** as President and a Director of RCA Alaska Communications, Inc., Anchorage.

### RCA Americom

The Board of Directors of the newly established subsidiary company, RCA American Communications, Inc., (RCA Americom), elected the following officers, to become effective when RCA Americom becomes operational: **Philip Schneider**, President, and **Harold W. Rice** Vice President, Operations.

### RCA Global Communications, Inc.

**Valentine Arbogast**, Vice President, Leased Services has announced the organization as follows: **Thomas J. Buiço**, Manager, Leased Services Sales; **Robert D. Mollehnauer**, Manager, Major Systems and Press Accounts; **Lawrence P. Cambridge**, Manager, Leased Services Administration; **Paul B. Silverman**, Manager, Data Services Development; **Notis M. Kotsolios**, Manager, Leased Services Engineering; **Notis M. Kotsolios**, (Acting) Manager, Leased Services Design and Implementation; **Warren Schulhafer**, Manager, Technical & Administrative Services; **Dan A. Patrizzo**, Manager, Technical Support; and **John Terry**, Manager, United Kingdom.

**Gil A. Beltran**, General Manager, Computer Switching Systems, has announced the organization as follows: **Russel E. Blackwell** as Manager, Computer Programming; **Samuel A. Thompson**, Manager, Computer Projects; **Gil A. Beltran**, (Acting) Manager, Computer Systems Marketing; and **Patrick C. Keilty**, Manager, Mini-Plus Marketing.

### Industrial Relations

**George H. Fuchs**, Executive Vice President, Industrial Relations has announced that **George A. Fadler** will assume responsibility for the Materials Activity, and **Donald O. Corvey**, Staff Vice President, Materials, will report to Mr. Fadler. Mr. Fadler will continue to report to the Executive Vice President, Industrial Relations.

### Corporate Engineering

**Dr. William J. Underwood**, Director, Engineering Professional Programs, has appointed **Hans K. Jenny** as Manager, Technical Information Programs.

**Hans K. Jenny** has announced the staff of Technical Information Programs as follows: **Doris E. Hutchison**, Administrator, Technical Information Systems; **John C. Phillips**, Administrator, Technical Communication Programs and **Frank J. Strobl**, Administrator, Technical Publications.

### Picture Tube Division

**Joseph H. Colgrove**, Division Vice President and General Manager, Picture Tube Division, has announced the organization as follows: **Wellesley J. Dodds**, Director, Quality, Product Safety and Reliability; **D. Joseph Donahue**, Division Vice President, Engineering; **William G. Hartzell**, Division Vice President, International; **Donald L. Gilles**, Division Vice President, Industrial Relations; **Robert B. Means**, Division Vice President, Domestic Marketing; **Stanley N. Roseberry**, Division Vice President, Finance; **Stanley S. Stefanski**, Division Vice President, Manufacturing; and **Charles W. Thierfelder**, Division Vice President, Technical Programs.

**Stanley S. Stefanski**, Division Vice President, Manufacturing, has announced the organization as follows: **John M. Fanale**, Director, Glass Operations; **Richard H. Hynicka**, Director, Mask and Mount Operations and Lancaster Manufacturing; **David O. Price**, Director, Materials; **Douglas H. Sparks**, Manager, Operations Planning and Industrial Engineering; and **Stanley S. Stefanski**, Acting, Manufacturing.

**Charles W. Thierfelder**, Division Vice President, Technical Programs, has announced the organization as follows: **Richard C. Allen**, Director, Materials and Industrial Engineering; **John W. Hensley**, Manager, Plant Engineering; **Arthur W. Hoeck**, Director, Finance; **Lawrence A. Kameen**, Director, Industrial Relations; **Clifford H. Lane**, On-Site Director; **Joseph J. McHugh**, Director, Tube Manufacturing; **Richard L. Spalding**, Director, Manufacturing Engineering; **John F. Stewart**, Director, Equipment Engineering; **Frederick C. Weisbach**, Director, Design and Construction; and **R. Howard Zachariason**, Director, Components Manufacturing.

**Clifford E. Shedd**, Manager, Equipment Development, has announced the organization as follows: **Leonard M. Clutter**, Manager, Resident Equipment Engineering—Marion; **Edward A. Gronka**, Manager, Resident Equipment Engineering—Scranton; **William R. Miller**, Manager, Electrical Design and Development; **James W. Axmacher**, Engineering Leader, Test Equipment; **Theodore C. Loser, Jr.**, Engineering Leader, Process Control; **Keith D. Scearce**, Administrator, Turnkey Project; **N. Roger Thornton**, Manager, Project Engineering; **John W. Palmer**, Administrator, Facilities and Planning; **C. Norman Yunginger**, Administrator, Facilities and Planning;

**Morris R. Weingarten**, Manager, Mechanical Design and Development; **Raymond A. Alleman**, Engineering Leader, Process; **Frank D'Augustine**, Engineering Leader, Cap Preparation; **Richard A. Lambert**, Engineering Leader, Materials and Process; and **Marinus VanRenssen**, Engineering Leader, Precision Design and Gauging.

**David D. VanOrmer**, Manager, Product Development, has announced the organization as follows: **Albert M. Morrell**, Manager, Tube Development; **Ralph J. D'Amato**, Engineering Leader, Advanced Design; **Richard H. Godfrey**, Engineering Leader, Product Design; **Gerald J. McCauley**, Manager, Engineering Standards; **Lewis I. Mengle**, Engineering Leader, Laboratory Test Equipment; **Albert M. Morrell**, Acting, Prototype Equipment; **Richard A. Nolan**, Manager, Pilot Development Shop; **John E. Eberle**, Manager, Pilot Production Center; **Glenn R. Fadner**, Engineering Leader, Tube Fabrication; **Francis P. Farkas**, Manager, Machine Shop; **David D. VanOrmer**, Acting, Mount Development; **Paul R. Andorn**, engineering Leader, Equipment; **Martin K. Brown**, Engineering Leader, Fabrication; and **Frans VanHekken**, Engineering Leader, Design.

**Leonard F. Hopen**, Manager, Process and Materials Development, has announced the organization as follows: **Austin E. Hardy**, Manager, Panel Process Development and Laboratories; **David T. Copenhafer**, Engineering Leader, Analytical Laboratory; **Alan C. Porath**, Engineering Leader, Screening Development; **Louis C. Riedlinger, Jr.**, Engineering Leader, Colorimetry Laboratory; **Martin R. Royce**, Engineering Leader, Phosphor Development; **Leonard F. Hopen**, Acting, Masks, Materials and Finishing Development; **Charles T. Lattimer**, Engineering Leader, Materials Development; **Charles T. Lattimer**, Acting, Finishing Development; **John J. Moscony**, Engineering Leader, Mask Development; **Robert E. Salveter**, Manager, Marion Resident Engineering; **Robert E. Benway**, Manager, Marion Resident Product Development; **Richard W. Osborne**, Manager, Marion Resident Applications, Reliability and Safety; **James A. Stankey**, Manager, Materials and Process Development; **Yonichi Uyeda**, Manager, Scranton Resident Engineering; **George T. Ashenbrenner**, Engineering Leader, Scranton Resident Applications, Reliability and Safety; **Louis J. DiMattio**, Engineering Leader, Scranton Resident Product Development; **William J. Kerzic**, Manager, Special Services; and **Robert J. Murray**, Engineering Leader, Process and Materials Development. [\*Messrs. Benway and DiMattio receive technical direction from **David D. VanOrmer**, Manager, Product Development. \*\*Messrs. Ashenbrenner and Osborne receive technical direction from **Robert L. Barbin**, Manager, Applications Reliability, and Safety.]

**Robert L. Barbin**, Manager, Applications,

(Staff announcements — cont'd)

Reliability and Safety, has announced the organization as follows: **David C. Ballard**, Engineering Leader, Reliability and Safety; **Robert L. Barbin**, Acting, Customer Coordination; **William R. Menges**, Engineering Leader, Specification, Test, and Evaluation; and **William A. Sonntag**, Engineering Leader, Receivers, Components and Services.

## Consumer Electronics

**Harry Anderson**, Division Vice President, Manufacturing Operations, has announced the appointment of **Cortland P. Hill** as Director, Manufacturing Technology and Services.

**John M. Wright**, Chief Product Design Engineer, Television Engineering has announced the appointment of **Perry C. Olsen** as Manager, Vendor Contacts and Measurements.

## RCA Laboratories

**William M. Webster**, Vice President, RCA Laboratories, has appointed **Nathan L. Gordon** Staff Vice President, Systems Research Laboratory.

**Nathan L. Gordon**, has announced the appointment of **Jack Avins** as Staff Scientist in the Systems Research Laboratory.

**Richard E. Quinn**, Manager, Mechanical and Instrumentation Technology, has appointed **Marvin A. Leedom**, Manager, Mechanical and Instrumentation Technology.

**Paul Rappaport**, Director, Process and Applied Materials Research Laboratory has announced the appointment of **Jon K. Clemens** as Head, Signal Systems Research, Process and Applied Materials Research Laboratory.

**Emil V. Fitzke**, Manager, Technological Services, has appointed **Austin J. Kelley** as Manager, Instrument Center

## Patent Operations

**Glenn H. Bruestle**, Director, Electronic Components and Materials, Patent Operations has announced the appointment of **Birgit E. Morris** as Managing Patent Attorney and **Arthur E. Wilfond** as Patent Counsel.

## Promotions

### Astro-Electronics Division

**B. Cohen** from Jr. Engr. to Mgr., Systems Effectiveness Safety (H.L. Wuerffel)

**J. Hoffman** from Mgr., Graphic Arts Production to Mgr. Information Svcs. (J. Mackin)

## Alaska Communications, Inc.

**K.L. Anderson** from Engrg. Assoc. to Sup., Outlying Area (K.L. Laing, Mgr., Anchorage Outlying Areas)

**E.L. Braunston** from Sr. Engrg. Assoc. to Mgr., Trans. Engineering (E.C. Hall, Mgr., Sys. Engrg., Anchorage)

**J.R. Martin** from Logistics Support Specialist to Mgr., Pipeline Adm. & Logistics (A.F. Perkins, Mgr., Pipeline Engrg., Anchorage)

**P.A. Schilling** from Sr. Engineer to Mgr., Plant Ext. Engrg. (E.C. Hall, Mgr., Sys. Engrg., Anchorage)

**R.B. Sharp** from Sr. Engrg. Assoc. to Supervisor, Circuit Provision (B.M. Snodgrass, Mgr., Plant Services, Anchorage)

**F.E. Whiton** from Sr. Engr. to Mgr., Pipeline Radio Systems Engrg. (A.F. Perkins, Mgr., Pipeline Engrg., Anchorage)

## Global Communications, Inc.

**L. Kamins** from Sr. Mbr. to Engrg. Ldr., Technical and Administrative Services (W. Schulhafer, Mgr. Leased Svcs)

**N. Fatseas** from Princ. Mbr. to Ldr., Radio Engrg. (E. Doherty, Mgr., Radio Engrg.)

## Commercial Communications Systems Division

**R. Marks** from Mbr. Engrg. Staff to Ldr., Engrg. Staff (B. Autry, Meadow Lands)

## Solid State Division

**E.J. Chabak** from Mbr., Tech. Staff to Ldr. Tech. Staff (L. Zampetti, Mountaintop)

## RCA Service Company

**M.E. Mattheiesen** from Field Support Engrg. to Ldr., Instrumentation Systems (G. Berube, Range Measurement Systems, Antigua)

**T.V. Tolman** from Field Support Engrg. to Ldr., Instrumentation Systems (G. Berube, Range Measurement Systems, Grand Bahama Islands).

## Missile & Surface Radar Division

**W. Atwood** from Ldr., Engrg. Sys. Proj. to Mgr., Projects (R.W. Howery, WCS/FCS Proj. & ORTS C/P, Moorestown)

**A. Barresi** from Time Study Engr. to Ldr., Mfg. Methods (J. Ervin, Mfg. Tech.)

**D. Fuerele** from Sr. Mbr. Engrg. Staff to Ldr., Engrg. Sys. Proj. (J. Haake, Weapon Sys. Software Develop.)

**S. Paskow** from Mbr. Prog. Mgmt. to Ldr., Engrg. Sys. Proj. (W.E. Scull, Test Plng.)

## Madenford is TPA for Picture Tube Division



**Dr. D.J. Donahue**, Division V.P., Engineering, Picture Tube Division, has appointed **Edward K. Madenford** Technical Publications Administrator for Picture Tube Division. In this capacity, Mr. Madenford is responsible for the review and approval of technical papers; for coordinating the technical reporting program; and for promoting the preparation of technical papers and presentations.

Mr. Madenford is presently Administrator, Picture Tube Engineering Administration at Lancaster. He received the BS in Business Administration from Lehigh University, Bethlehem, Pa.

He joined RCA Lancaster in 1954 and served as Cost Estimator, (1954-56); Administrator, Standard Cost Data—Super Power Tubes (1956-64); and Administrator, Picture Tube Engineering Administration (1964 to present). Mr. Madenford has been an *RCA Engineer* Editorial Representative since 1964.

## Nubani named Scranton Ed Rep



**John S. Ignar**, Plant Manager, Scranton Plant, has appointed **Jack I. Nubani** as Editorial Representative for the Scranton Picture Tube Plant. Editorial Representatives are responsible for planning and processing articles for the *RCA Engineer*.

After receiving the BS in Engineering from Michigan State University in 1952, Mr. Nubani joined RCA in January of 1953 as a trainee and became area engineer the same year at the Marion plant. During his years at Marion, he served in various engineering capacities. In 1966, he was transferred to the Scranton plant as an Engineering Leader. He assisted in the start ups of the Mexican, Thorn, Videocolor, and Circleville Glass plants. In 1971, Mr. Nubani was promoted to Process and Production Engineering Manager, which position he presently holds.

# Editorial Representatives

The Editorial Representative in your group is the one you should contact in scheduling technical papers and announcements of your professional activities.

## Government and Commercial Systems

**Astro-Electronics Division** I.M. SEIDEMAN\* Engineering, Princeton, N.J.

**Automated Systems Division** K.E. PALM\* Engineering, Burlington, Mass.  
A.J. SKAVICUS Engineering, Burlington, Mass.  
L.B. SMITH Engineering, Burlington, Mass.

### Commercial Communications Systems Division

#### Broadcast Systems

W.S. SEPICH\* Broadcast Systems Engineering Camden, N.J.  
R.E. WINN Broadcast Systems Antenna Equip. Eng., Gibbsboro, N.J.  
A.C. BILLIE Broadcast Engineering, Meadow Lands, Pa.

Mobile Communications Systems

F.A. BARTON\* Advanced Development, Meadow Lands, Pa.

Avionics Systems

C.S. METCHETTE\* Engineering, Van Nuys, Calif.  
J. McDONOUGH Equipment Engineering, Van Nuys, Calif.

### Government Communications Systems Division

A. LIGUORI\* Engineering, Camden, N.J.  
H.R. KETCHAM Engineering, Camden, N.J.

### Government Engineering

M.G. PIETZ\* Advanced Technology Laboratories, Camden, N.J.

### Missile and Surface Radar Division

D.R. HIGGS\* Engineering, Moorestown, N.J.

## Research and Engineering

### Corporate Engineering

H.K. JENNY\* Technical Information Programs, Cherry Hill, N.J.

### Laboratories

C.W. SALL\* Research, Princeton, N.J.

## Solid State Division

J.E. SCHOEN\* Engineering Publications, Somerville, N.J.  
H.R. RONAN Power Devices, Mountaintop, Pa.  
S. SILVERSTEIN Power Transistors, Somerville, N.J.  
A.J. BIANCULLI Integrated Circuits and Special Devices, Somerville, N.J.  
J.D. YOUNG IC Manufacturing, Findlay, Ohio  
R.W. ENGSTROM Electro-Optics and Devices, Lancaster, Pa.

## Consumer Electronics

C.W. HOYT\* Engineering, Indianapolis, Ind.  
R.J. BUTH Engineering, Indianapolis, Ind.  
P.E. CFOOKSHANKS Television Engineering, Indianapolis, Ind.  
F.R. HOLT Advanced Products, Indianapolis, Ind.

## RCA Service Company

J.E. STEOGER\*, Consumer Services Engineering, Cherry Hill, N.J.  
R. MacWILLIAMS, Marketing Services, Government Services Division, Cherry Hill, N.J.  
R.M. DOMBROSKY Technical Support, Cherry Hill, N.J.

## Distributor and Special Products Division

C.C. REARICK\* Product Development Engineering, Deptford, N.J.  
J.N. KOFF Receiving Tube Operations, Harrison, N.J.

## Picture Tube Division

E. K. MADENFORD\* Engineering, Lancaster, Pa.  
J.H. LIPSCOMBE Television Picture Tube Operations, Marion, Ind.  
N. MEENA Glass Operations, Circleville, Oh.  
J.I. NUBANI Television Picture Tube Operations, Scranton, Pa.

## RCA Global Communications, Inc.

W.S. LEIS\* RCA Global Communications, Inc., New York, N.Y.  
P. WEST\* RCA Alaska Communications, Inc., Anchorage, Alaska

## NBC, Inc.

W.A. FOWARD\* Staff Eng., Technical Development, New York, N.Y.

## RCA Records

J.F. WELLS\* Record Eng., Indianapolis, Ind.

## RCA Ltd

W.A. CHISHOLM\* Research & Eng. Montreal, Canada

## Patent Operations

J.S. TRIPOLI Patent Plans and Services, Princeton, N.J.

## Electronic Industrial Engineering

J. OVNICK\* Engineering, N. Hollywood, Calif.

\*Technical Publications Administrators (asterisked \* above) are responsible for review and approval of papers and presentations

**RCA** Engineer

A TECHNICAL JOURNAL PUBLISHED BY CORPORATE TECHNICAL COMMUNICATIONS  
"BY AND FOR THE RCA ENGINEER"

Printed in U.S.A.

Form No. RE-21-5