Communications capital

To the earthbound pedestrian gazing upward in mid-Manhattan, or to an airborne traveller taking a flying look at the city from above, RCA is an unmistakable presence in New York. In bold block letter-forms, our modernized RCA trademark thrusts skyward from atop the 850-foot high RCA Building in Rockefeller Plaza. More than a corporate sign, it serves too as a beacon which, if no other landmark were visible, would still inform the stranger that he is in New York and, therefore, in the very center of worldwide communications.

From the day of our founding, and throughout our fifty-year history, RCA has been part of New York. In that short span of time, we've grown into a vast multinational enterprise, one of the world's great common carriers of thought and the acknowledged leader of the information industry. This accomplishment, by itself, is a major reason why New York ranks as the global capital of communications.

Thanks in large measure to the many-faceted skills of our RCA engineers, we make a significant contribution to New York in many ways—as broadcaster, communications carrier, technical educator, purveyor of sophisticated electronic products and information systems, supplier of electronic and non-electronic services, and socially responsible citizen as well.

It is especially gratifying, therefore, to find this issue of *RCA Engineer* featuring many of our activities in New York. As it does so, let me take the occasion to offer my own salute to RCA engineers, not only in New York, but throughout the world, for all that they are doing to help improve the quality of life wherever people work and live.



Robert W. Sarnoff
Chairman of the Board
and President
RCA
New York, N.Y.

RCA Engineer Staff

Editor

Associate Editor

Editorial Secretary

Design and Layout

Subscriptions

Consulting Editors

Technical Publications Adm.,
Electronic Components

Technical Publications Adm.,
Laboratories

Technical Publications Adm.,
Corporate Engineering Services

Editorial Advisory Board

Staff VP, Personnel Adm.

Mgr., Quality and Reliability
Assurance, Solid State Div.

VP, Engineering, NBC
Television Network

Mgr., Technical Information
Services, RCA Laboratories

Manager, Consumer Products
Adm., RCA Service Co.

Div. VP, Technical Planning
Electronic Components

Chief Engineer,
Record Division

Chief Technical Advisor,
Consumer Electronics Div.

VP, Engineering and
Leased Systems,
Global Communications, Inc.

Director, Corporate
Engineering Services

Chief Engineer,
Graphic Systems Division

Manager, Engineering
Professional Development

Chief Engineer,
Government Engineering

Our cover

The modern RCA trademark atop the RCA Building at Rockefeller Plaza is the central symbol in this unusual skyline view of New York City. **Photo credit:** Dave Hecht, RCA Records.

RCA Engineer

A technical journal published by
RCA Corporate Engineering Services 2-8,
Camden, N.J.

RCA Engineer articles are indexed
annually in the April-May issue and
in the "Index to RCA Technical Papers."

• To disseminate to RCA engineers technical information of professional value • To publish in an appropriate manner important technical developments at RCA, and the role of the engineer • To serve as a medium of interchange of technical information between various groups at RCA • To create a community of engineering interest within the company by stressing the interrelated nature of all technical contributions • To help publicize engineering achievements

ments in a manner that will promote the interests and reputation of RCA in the engineering field • To provide a convenient means by which the RCA engineer may review his professional work before associates and engineering management • To announce outstanding and unusual achievements of RCA engineers in a manner most likely to enhance their prestige and professional status.

Contents

Editorial input	Metrics and RCA	2
Engineer and the Corporation	Metrication	K. M. McKee 3
National Broadcasting Co.	Color mobile unit for every TV station	C. M. Eining 8
	NBC television field operations	C. W. Ackerson 13
	Video edging	R. J. Butler 16
	NBC Radio Network facilities and operation	S. T. Aed 19
	New television studio for the Tonight Show	O. S. Paganuzzi 22
	Burbank computer operation	K. D. Erhardt 28
RCA Records	In the recording studio—keeping pace with change	J. M. Woram 34
	New York recording studios	J. E. Volkmann A. Stevens 36
	The case for four channels	J. Pfeiffer 43
RCA Global Communications, Inc.	Alaska communications system	J. Sellers 48
	Data, voice, and television services	L. Donato 52
	Hot line voice/ data system	S. Solomon 55
	Pulantat earth station	J. Walsh TinWin 58
	International and satellite transmission	W. Phillips 62
RCA Institutes	The evolution and development of RCA Institutes	H. Fezer 64
General interest papers	New schlieren light valve for television projection	Dr. J. A. vanRaalte 70
	High-performance FM receivers using high-gain integrated-circuit IF amplifiers	T. J. Robe L. Kaplan 74
	Integrated circuits for RF and IF service	H. M. Kleinman 80
Notes	Estimating failure rates for MSI and LSI integrated circuits	M. S. Plesher 86
	Drill Chuck for a wire-wrap tool	J. F. Kingsbury 87
Departments	Pen and Podium	88
	Patents Granted	90
	Dates and Deadlines	91
	News and Highlights	92

Mr. Ken McKee's excellent article on "Metrication" provides, for the first time in the pages of the *RCA Engineer*, an insight to the metric conversion program now in progress in England and presents many important and not widely publicized points of history. Ken's account is objective and forthright with ample clues to the problems and complexities involved in changing the measurement practices of a great nation.

One major problem far from solved concerns threaded fasteners. The United Kingdom joined with Canada and the United States in 1948 in the adoption of the ABC unified threads now universally used in Canada and USA. After 20 years, however, as Mr. McKee points out, large volume usage of the older British 'BA' threads persists in England. As part of the program to metricate in Great Britain, British companies are now asked to change to still another thread standard. It is understandable that opposition exists and likely that many years will pass before metric threads gain popular acceptance in England.

On the people side of the program, Ken McKee explains that one of the responsibilities assigned to the relatively new British Metrication Board is that of "preparing the public for the change." Many Britishers consider this a formidable task that should have received far more attention before the program was launched. Evidences of political controversy born of a sense of frustration among many who feel they were not adequately consulted about a change of such magnitude appear frequently in the British press and are causing the government to reconsider some of the extremes in the scope of the transition.

In the United States the National Bureau of Standards is engaged in

an in-depth measurements study reaching into every sector of the economy. The work, the first of its kind ever undertaken, is in its third and last year and scheduled for completion in August 1971. At that time the Secretary of Commerce plans to submit to the President and the Congress a detailed report revealing the findings of the study. It is anticipated that the data made available in the Secretary's report will provide valuable guidance to the Nation and to RCA in establishing future measurement policy.

Until events of the future dictate a reappraisal, RCA's continuing practice is to use those units of measure which are well established, implemented, and universally understood in each of the many locations in which RCA operates. This applies to metric units in international locations as well as to the customary units in the United States and Canada. In some applications, a combination of both metric and customary units is used when such a combination better serves customers in the intended market area.

Accounts of the experiences of our good friends in England and reports such as that by Ken McKee featured in this issue of the *RCA Engineer* are regarded as the most valuable type of input for the investigation in USA.

Editorial acknowledgement: Thanks to S. H. Watson, Manager, Corporate Standardizing, for this *Editorial Input*. Mr. Watson is eminently qualified to discuss the metric situation in the U.S. Recently, at the invitation of the Secretary of Commerce, he became a member of the National Metric Advisory Panel, and at the request of the Managing Director of the American National Standards Institute, he is serving on the ANSI Metric Advisory Committee. In addition, Mr. Watson represents the Industrial Electronics Division of the Electronic Industries Association on the EIA Metric Study Panel, and as chairman of the EIA Engineering Policy Council, he was instrumental in establishing the EIA Metric Group.

This issue: Special thanks go also to W. A. Howard of NBC, R. Andrews of RCA Records, and W. Leis of RCA Globcom who were responsible for much of the planning and coordination that made this "New York" issue a reality.

Future issues

The next issue of the *RCA Engineer* features consumer electronics. Some of the topics to be discussed are:

Microelectronics in consumer products

Monolithic integration of color TV receivers

Solid-state black-and-white TV design

New-generation color-TV receiver

Single-vidicon color TV cameras for home use

Homefax

Modular concepts in TV design

Beam lead technology

Discussions of the following themes are planned for future issues.

Computers

Displays, optics, photochromics

Graphic systems

Systems programming developments

Computer peripherals

Advanced Technology Laboratories

Mathematics for engineering

Video playback systems

Metrication

K. M. McKee

The basic metric system holds little mystery for scientists and engineers. For nearly a century, all fundamental scientific work has been published using metric units. Over this period, the system has evolved from units founded on simple definitions of length, mass, and time to present day coherent SI units specially designed to meet the needs of engineers and ever advancing technology. It has taken two generations for metrication to achieve general international acceptance. While the extent of its use varies widely from nation to nation, the pace of adoption by advanced as well as less developed nations has quickened. Beginning with the proposals of a dozen scientists 180 years ago, the system has now grown to become the international language of measurement.

TO UNDERSTAND THE BASIS OF METRICATION and the variety of units used in the measurement world of today, we have to go back in time to the 18th century. In England prior to the eighteenth century, all measurement units were based on natural dimensions chosen quite independently of one another. The foot was the length of an average man's foot and the yard the length of a man's arm. Such units had the advantage of being easily visualised and, for many trades, offered a ready means of rough checking. Longer distances between places were measured in miles, a mile originally being 1000 double paces. An acre was the unit of land measurement and represented the area one man could cultivate on his own. There was then rarely any need to inter-relate these units, but when this eventually occurred, it is not really surprising that awkward relationships arose and remain to this day:

1,296 square inches = 1 square yard
43,560 square feet = 1 acre

While there was no co-ordinating authority, regional divergences developed. An instance of the confusion that existed as recently as 1904 appears in a report by Mr. Isaac Connell, then Secretary of the Scottish Chamber of Agriculture:

"According to district the stone of hay or straw may be 8, 14, 22, 22½ or 24 lbs. For example in Caithness and Sutherlandshire the standard is 28 lbs, in Ross-shire 14 lbs, in Invernesshire 23 lbs, in Berwickshire, Roxburghshire, Nairn & Morayshire 23 lbs, in Dumfriesshire and Berwick Town 24 lbs."

For many centuries England too had several pounds in use by a variety of trades: Tower, Troy, Mercantile, Avoirdupois—and all different.

National standardization has since ironed out local but not international differences. On a transatlantic flight to New York some years ago, a US jet was refuelled at London with US instead of British gallons. The engines cut out over the Atlantic 500 miles short of its destination. Similar errors have also been recurring between British and American quarts, pints, and gills, since England adopted the 10 lb ale gallon in 1824, and the United States adopted the British Excise wine gallon in 1832. In absence of an agreed standardizing authority, the same words in the same language of measurement can clearly come to represent substantially different quantities.

The metric system emerges

The chaotic state of regional weights and measures and the general turbulence after the French Revolution, caused the National Assembly of France in 1791 to appoint the celebrated mathematician Lagrange and eleven other outstanding men from the French Academy of Sciences to revise the whole French measurement system. The scientists recommended the unit of length to be one ten millionth of the Earth's quadrant and called it the *metre* from the Greek *metron*—a measure. A new and important feature of the system was that the ratios between units, their multiples and sub-multiples, were powers of ten. At first, all the fundamental units were based on dimensions occurring in nature. Later it was decided to establish fixed

The Engineer and the Corporation

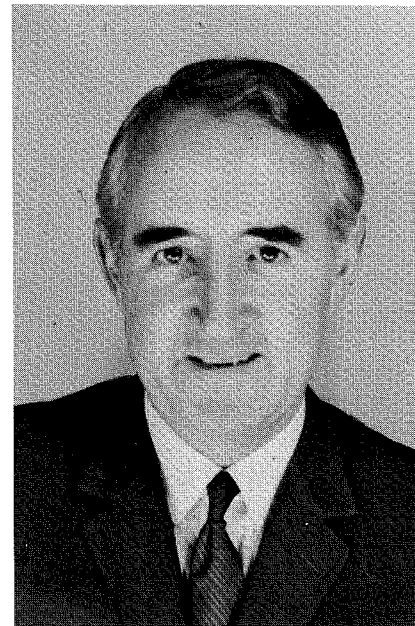

Kenneth M. McKee, Mgr.
European Technical Relations
RCA International Ltd.
London

graduated in 1949 from Queens University with the BSc in electrical and electronic engineering. Prior to this, he served with Royal Signals in the British Army and received a commission in 1941. He was in command of communications units on active service with 2nd Army from D-day through to Berlin. Promoted to the rank of Captain, he later served in Palestine and Egypt, becoming Chief Instructor at the Middle East School of Signals, Cairo, in 1946. On completion of his University studies, he joined EMI Research Laboratories in England and was responsible for the design and development of studio film recorders and telecine. Three years later, he was engaged in the technical marketing of EMI's range of broadcast & industrial TV products. In this capacity, he was transferred to the Far East and assisted in establishing television in Thailand. While there, he became Extra-mural Lecturer in Electronics at Chulalongcorn University, Bangkok. Two years after his return, he joined the United Shoe Machinery Group to introduce automatic production systems into the UK electronics industry. In 1959, he took up his present position with International Licensing in support of RCA's technical operations in Europe. Mr. McKee is a Member of the Royal Television Society, a Member of the Institution of Electronic & Radio Engineers, and a Fellow of the IEE.

standards, for example, the platinum-iridium metre bar, which could be copied with greater ease and accuracy than the units could be determined from natural parameters.

The metric system became legal in France in 1801 but it took forty years to become obligatory. Eighty years after inception, it had been adopted by seven other European States, and the governments of several other countries (including the United Kingdom and the United States) had made its use legal. This led to the establishment of the first permanent international standardising authority, the *Conférence Générale des Poids et Mesures* (CGPM). The *Convention du Metre* signed in 1875 by seventeen states also established the laboratories of the Bureau International des Poids et Mesures at Sèvres near Paris.

Growth in the adoption of the metric system in the nineteenth century was stimulated by the scientific activity in leading centres of research in Europe. The great advances made in scientific knowledge were built on the collaboration of scientists all over the world. Experiment and measurement were the very essence of progress in uncovering the underlying pattern of natural processes. The scientist's need was for a logical and international language of measurement, in which the results of his work could be expressed and understood by fellow scientists everywhere. The attractions of the metric system were obvious, so much so that by the turn of the century, metric units were used almost exclusively for scientific measurement.

CGS absolute and practical units

The measurement language adopted by the scientists favoured three primary units: the *centimeter*, the *gramme*, and the *second*. These units were found to be convenient for benchtop experiments by scientists who were then mainly physicists and chemists. A whole series of derived units was added, such as the dyne, erg, and calorie, to form the CGS system. Certain local 'dialects' developed in the course of time, but the system remained intact as the measurement language of the laboratory for over a century.

The discovery by Gauss in 1833 that magnetic fields could be measured in

the fundamental units of mechanics opened the way for all electromagnetic and later electrostatic quantities to be defined in terms of the basic metric units of length, mass, and time. Thirty five years later, the British Association formally recommended linking mechanical CGS units to these 'absolute' electrical units. Unfortunately, the size of many of the latter units was found to be unsuitable for engineering use, so the Association proposed an additional "practical" system, consisting of the *Volt*, *Ampere*, *Ohm*, and *Farad*. The practical units were arranged to be exact multiples of CGS absolute electromagnetic units. The British Association units were adopted internationally some thirteen years after in 1881.

Engineers found not only the CGS absolute electromagnetic and electrostatic units inconvenient, but the centimeter, gramme, and their derivatives were generally too small for most purposes. To overcome the objections, the metric "technical" system was devised, employing the *metre*, *kilogramme-force*, and *second*. The kilogramme-force was equivalent to the pound-force in the British gravitational system. Since gravity varies by about 0.5% over the Earth's surface, units of force can only be equated to units of weight for low accuracy work. Higher accuracies in gravitational systems involve an artificial "standard" gravity with a fixed value of g arising where forces are other than gravitational. A scaled-up replica of the CGS system for engineers was introduced at a later date, known as the MTS system, standing for *metre*, *tonne-mass*, and *second* system. The tonne (or metric ton) is a name for the megagramme and is still used in metric countries today. Both these "engineering" systems have since been superseded, but many of the units continue in use.

Difficulties also arose in the accurate determination of the absolute electrical CGS units, which resulted in the introduction of the *International Ohm*, *Ampere*, *Volt*, and *Watt*. The International Ampere was defined in terms of the current required to deposit a stated weight of silver in grammes from a solution of silver nitrate. The International Ohm was the resistance of a specified column of mercury at the temperature of melting ice. The Volt

and Watt could then be readily derived from the Ohm and Ampere. The International Units were for all purposes intended to be equal to the British Association's practical units defined in terms of CGS absolute units. Great care was taken to ensure accuracy, but in due course, improved measurement techniques showed up second order discrepancies in the original figures. With the demand for ever-increasing precision, it became apparent that the International Units could no longer be regarded as equal to British Association practical units, or related in any simple way to CGS absolute units.

Giorgi's MKS system

An historic event occurred in 1904, though few realised its significance at the time. A young Italian engineer Giovanni Giorgi read a paper to the 6th International Electrical Congress at St. Louis, Mo., in which he pointed out that by taking the metre, kilogramme, and second as primary units, a complete and logical system could be formed for mechanical units that would include the CGS practical units. Moreover, if a fourth electrical unit were added, an absolute system of units embracing electrical as well as mechanical technology could be evolved. Giorgi suggested the ohm for the fourth primary unit, but the ampere has subsequently been chosen for what has become famous as the MKSA system.

Giorgi's proposals attracted little attention for many years but growing interest by scientists and engineers twenty three years later eventually resulted in the International Electrical Commission setting up a committee to study MKS. It was not until 1935 that the International Electronics Conference (IEC) unanimously recommended the MKSA system for electrical engineers. Since World War II virtually all other international engineering and scientific committees including the *Conférence Générale des Poids et Mesures* (CGPM) have one by one endorsed this decision.

SI and coherence

The CGPM meets in Paris every six years to provide an international forum for all engineers and scientists concerned with metric measurement. It was a remarkable coincidence that

at the "decimal" tenth meeting in 1954 a step was taken that has had far-reaching consequences in the development of the metric system. Two further primary units were added to those of the MKSA system: the *kelvin* as the unit of temperature and the *candela* as the unit of luminous intensity. With only these six basic units, a series of units was simply and logically derived with the object of meeting the requirements of all technologies. At the 11th meeting of the CGPM, it was decided to call it "Système International d'Unités", which can be abbreviated to SI in most languages.

The SI units have all the desirable features of previous metric units and in addition have the important advantage of being coherent. A system is coherent if, when any two unit quantities are multiplied or divided, the resultant quantity is in the appropriate units of the system, without the introduction of a special numerical factor. For instance, the product of volts and amperes to give watts is coherent. An acre, on the other hand, is a non-coherent unit as it cannot be directly obtained by the product of any two units of length. Coherence simplifies calculations, improves accuracy, and lightens the burden of arithmetic—particularly in engineering.

Derived SI units

Derived SI units are based on the primary units and not on multiples or submultiples of primary units. Hence, the unit of force is the *newton*, which is the force producing an acceleration of 1 metre/sec² on a mass of 1 kg. The unit of energy is the *joule*, produced in the work done by a force of one newton moving one metre. The unit of power is the *watt*, equivalent to a rate of working of one joule per second. All forms of energy are measured in the same units, so that the joule and watt are the SI thermal and electrical, as well as the mechanical, units of energy.

It may strike some engineers as strange that the *watt* has become a mechanical unit. The *horsepower* had a very real value in the early days of steam and internal-combustion engines in enabling the user to visualize how many horses an engine would replace. Nowadays, with aeroengines rated in ten thousands of hp and the extensive use

of tiny fractional-hp motors, the relevance of the term has largely been lost. Furthermore, the use in Europe of metric horsepower, whose 'horse' develops about 10 watts less power, has added an element of ambiguity.

There is only one SI unit for a particular measurement, but one which is infinitely adjustable in magnitude by the use of the well known decimal prefixes. The CGPM recommends that where the size of derived units has to be altered in this way, the prefix should be applied to the numerator, and not to the denominator. For example, the unit of pressure is the newton per square meter and is very small. A million-times multiple is frequently needed, so this should be expressed as MN/m² rather than N/mm², although the two are actually identical.

The simplicity and coherence of SI units enable engineers to calculate more rapidly with less effort and with less dependence on tables, slide rule, and the computer. It is worth noting two chance short cuts. The acceleration due to gravity, which is 9.81 m/sec² can be rounded up to ten for the quick mental calculations so often used by engineers. Secondly, normal atmospheric pressure can be taken as 100 kN/m² (or 100kP). It will be appreciated that in changing to SI units, some equally useful approximations in previous systems will inevitably be lost.

There are two SI supplementary units, the *radian (rad)* as the unit of plane angle and the *steradian (sr)* as the unit of solid angle. These are often employed in mechanics in association with the first three primary units. The thermodynamic unit of temperature is the *kelvin*, while the practical unit has become the *degree celsius* in place of *centigrade*. The change of name to celsius was made principally because a grade in several major European countries is one hundredth of a right angle, and a centigrade a hundredth part of this unit.

The International Standards Organisation approved in 1967 and issued in 1969, ISO Recommendation R1000 which provides the rules for the use of SI units. A list of the derived SI units having special names is shown in Table II. The unit of pressure, the *pascal*, and the unit of magnetic flux,

Table I—The six SI primary units.

Quantity	Unit	Symbol
length	metre	<i>m</i>
mass	kilogramme	<i>kg</i>
time	second	<i>s</i>
electric current	ampere	<i>A</i>
temperature	kelvin	<i>K</i>
luminous intensity	candela	<i>cd</i>

Table II—Derived SI units with special names.

Quantity	Unit	Symbol
frequency	hertz	$Hz = 1/s$
force	newton	$N = kg\ m/s^2$
pressure	pascal	$P = N/m^2$
work, energy, heat	joule	$J = N\ m$
power	watt	$W = J/s$
electric charge	coulomb	$C = A\ s$
electric potential	volt	$V = W/A$
electric capacitance	farad	$F = A\ s/V$
electric resistance	ohm	$\Omega = V/A$
electric-conductance	siemens	$S = 1/\Omega$
magnetic flux	weber	$Wb = V\ s$
magnetic flux density	tesla	$T = Wb/m^2$
inductance	henry	$H = V\ s/A$
luminous flux	lumen	$lm = cd\ sr$
illumination	lux	$lx = lm/m^2$
temperature	celsius	$^{\circ}C = K - 273.15$

Table III—Metrication status of the larger metric countries.

Afghanistan	UMS	Laos	UMS
Algeria	UMS	Lebanon	UMS
Angola	UMS	Libya	UMS
Argentina	UMS	Malagasy	UMS
Australia	CSI	Malaysia	UMS
Austria	LSI	Mali	UMS
Belgium	PSI	Mauritania	UMS
Bolivia	UMS	Mexico	UMS
Brazil	LSI	Morocco	UMS
Bulgaria	LSI	Mozambique	UMS
Ceylon	CSI	Nepal	LSI
Chad	UMS	Netherlands	PSI
Chile	ASI	New Zealand	CSI
China	UMS	Nigeria	UMS
Columbia	UMS	Norway	PSI
Congo	UMS	Pakistan	CSI
Costa Rica	UMS	Paraguay	UMS
Czechoslovakia	LSI	Peru	UMS
Denmark	PSI	Philippines	UMS
Ecuador	UMS	Poland	PSI
Eire	CSI	Portugal	PSI
Ethiopia	LSI	Rumania	LSI
Finland	LSI	Saudi Arabia	UMS
Formosa	UMS	Somalia	UMS
France	LSI	South Africa	CSI
Germany East	LSI	Spain	PSI
Germany West	LSI	Sudan	UMS
Greece	UMS	Sweden	UMS
Greenland	UMS	Switzerland	PSI
Guatemala	UMS	Syria	UMS
Hungary	PSI	Taiwan	UMS
Iceland	UMS	Tanzania	LSI
India	PSI	Thailand	PSI
Indonesia	UMS	Tunisia	UMS
Iran	ASI	Turkey	ASI
Iraq	ASI	UAR	ASI
Israel	ASI	UK	CSI
Italy	PSI	Uruguay	UMS
Japan	PSI	USSR	PSI
Jordan	UMS	Venezuela	LSI
Kenya	CSI	Vietnam	UMS
Korea	LSI	Yugoslavia	LSI

Legend

LSI—passed legislation making SI the only legal system of measurement.
 PSI—using metric system, and preparing to make SI the only legal system.
 ASI—using metric system, and officially approved ISO/R1000 on SI.
 CSI—not using metric system, but in process of changing to SI.
 UMS—using metric system for normal measurement and business.

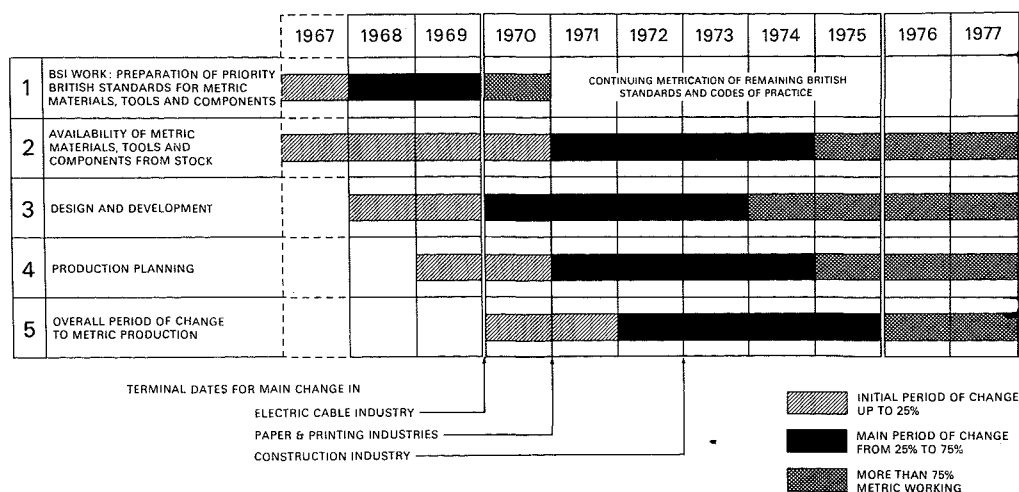

Fig. 1—Basic British programme for adoption of the metric system in engineering.

the *siemens*, have neither as yet received full international acceptance. All the remaining derived SI units have compound names made up from combinations of the units in Tables I and II (e.g., metre per second or ampere per metre). In course of time, it is probable that names of other great scientists and engineers will replace the more cumbersome SI unit names.

International acceptance of SI

Over the past fifteen years, many countries have set up committees to study, in depth, the implications of international metrication on their own economies in the light of benefits and costs to be expected on changing over. An increasing number have reached a decision in favour of adopting SI over periods ranging up to ten years. There are, at present, 134 countries either using or committed to the metric system. Over a third of these are very small states indeed. Table III indicates the SI status of the larger nations, which will interest readers concerned with products for sale on international markets.

Although the majority of metric countries have formally endorsed the change to SI, some SI units are still quite unfamiliar. In almost every case, units from previous metric systems continue legally in use. France has had SI legislation since 1961, but also allows certain non-SI units from the CGS system including the *mille* (nautical mile), *noeud* (knot), watt hour, calorie, litre, dyne, erg and bar. Germany

introduced its SI implementation order in March 1969, which permits the *grad* (angle), *tonne bar*, *poise*, and watt hour. It is apparent that even the advanced metric countries have some way to go before metrication to SI is complete.

Pros and cons of metrication

Estimates can be prepared on the cost to a nation of metrication, but it has been found difficult to obtain convincing figures. There is no doubt, however, that the more industrialised the country, the larger the number of measuring instruments, precision machines and tools of every kind it possesses. Hence, the greater will be the cost and the importance of the decision to change-over. Serious consideration has also to be given to the even less tangible costs of *not* changing, in the loss of future trade with and to metric countries.

Probably the most rewarding indirect benefit from metrication is the opportunity it affords to reduce variety. By reshaping standards, it becomes possible to cut down size ranges and eliminate superfluous types. Take the case of fasteners: no less than 214 screw-thread forms exist and 834 symbols in the various languages of the industrial nations are needed to define all these threads. In England, where there are five threads, an internal report of a large electronics company shows that 7,000 different screws on the company list could be reduced to 200 with the adoption of ISO metric

threads. One of the five thread forms is the British Association thread, which in itself offers an example of the scope for rationalization.

The BA thread is the standard for small nuts and bolts used in tens of millions daily by the UK electrical and electronics industries. The size 0 BA is just under 1/4 inch in diameter and sizes go down to about 1/16 inch diameter at 10 BA, making a total of eleven sizes within this narrow range. Most manufacturers decided long ago to stock only even-number BA sizes; others, for some reason, preferred odd numbers. Suppliers thus have to make and carry stocks of eleven sizes, where six would suffice. The ISO metric thread has only five choices within the same range. Extending this type of rationalization to all components, it is easy to visualise how production runs can be lengthened, designs and assembly simplified, stocks pared down, with a consequent reduction in unit costs.

National metrication programmes

Once the government of a country has decided to adopt the metric system, a decision has to be reached on the length of the change-over period. A programme then must be prepared indicating the timing of the change for each sector of the economy. Some of the more advanced countries recently have planned the change to take place over ten years, that is from the initial issue of metric standards to over 75% metric production. Programmes of this type developed by the Government of the United Kingdom will tend to set the future pattern for other nations changing over from imperial units.

In 1968, the UK Government established the guideline date of 1975 for metrication by the country as a whole. Committees representing all interests concerned in a particular sector of the economy have been established to identify problems and work out programmes against the guideline date. The programme chart for the British engineering sector is shown in Fig. 1. A Metrication Board has been formed to stimulate, oversee, and co-ordinate sector planning, and also to be responsible for preparing the public for the change. Finally, in 1971, legislation will have been passed specifying met-

ric units and enabling the legal changes to be made covering all sectors.

Partial and complete metrication

Each sector comprises a vast number of companies producing an extensive range of products. Company top management has the responsibility of deciding when and how to introduce metric designs so as to minimise costs, gain maximum advantage from rationalisation, and at the same time achieve a high level of metrication by the guideline date. In certain instances, it is initially more viable to aim at reaching a stage of metrication rather than complete metric redesign in a single step. The following stages of metric conversion can usually be attained either separately or combined with minimal additional effort:

- 1) Dual dimensioning of drawings without change of design to enable metric tools and instruments to be used in production, and in technical literature for product sales to metric countries.
- 2) A partial redesign to include ISO metric fasteners, where previously inch-unit fasteners were used.
- 3) A partial redesign to provide interfaces in metric units (e.g. mountings, flanges, connectors, etc.) which will allow operation with metric products.
- 4) A partial redesign to permit the use

of OEM-supplied metric components and sub-assemblies.

Partial metrication allows the gradual introduction of metric working without premature write-off of costly tooling. It is however only to be regarded as an interim measure, even if, in the interests of economy, the process has to be extended over a period of years. Every opportunity has to be taken to design a fully metric product when the previous design needs to be replaced because profitability has declined, or it has become technically obsolete. The outline network analysis (Fig. 2) illustrates the typical procedure for introducing a metric product in a modern plant.

World metric trends

We have traced the growth and evolution of the metric language of measurement from its origins in the 18th century with Lagrange's commission of twelve distinguished scientists through to the 20th century's International System of Units based on Giorgi's proposals. What will happen now? Even the leading metric nations are not, at present, using the SI vocabulary exclusively. Over the next decade, it can be expected that the

majority of metric countries will fully adopt SI units and the remnants of previous systems will eventually drop completely out of use. There is also little doubt that large international corporations, whose manufacturing and marketing operations span metric countries on all five continents, will be a major influence in bringing about standardisation of units and measuring techniques. By agreement between the world's standardising authorities such as the CGPM, ISO, and IEC, the range of coherent SI units is likely to be extended and periodically modified to meet technological needs over the next century.

References

1. *Face to Face with Metrication*, Report of the Proceedings of BSI Standards Conference (Sept 22-23, 1969).
2. *Going Metric* Reports on Council of Industrial Design Seminar London (Feb 1969).
3. *The Adoption of the Metric System in the Electrical Industry*, BSI Publication PD6427 (Jan 1969).
4. *The Adoption of the Metric System in Engineering*, BSI Publication PD6424 (July 1968).
5. *Rules for the Use of Units of the International System of Units and a Selection of the Decimal Multiples and Sub-Multiples of the SI Units*, ISO Recommendation R1000 (1st Ed., Feb 1969).
6. Anderton, P. and Biggs, P. H. *Changing to the Metric System*, Conversion factors, Symbols & Definitions (HMSO, 1969).
7. Hvistendahl, H. S. *Engineering Units and Physical Quantities* (Macmillan, 1964).

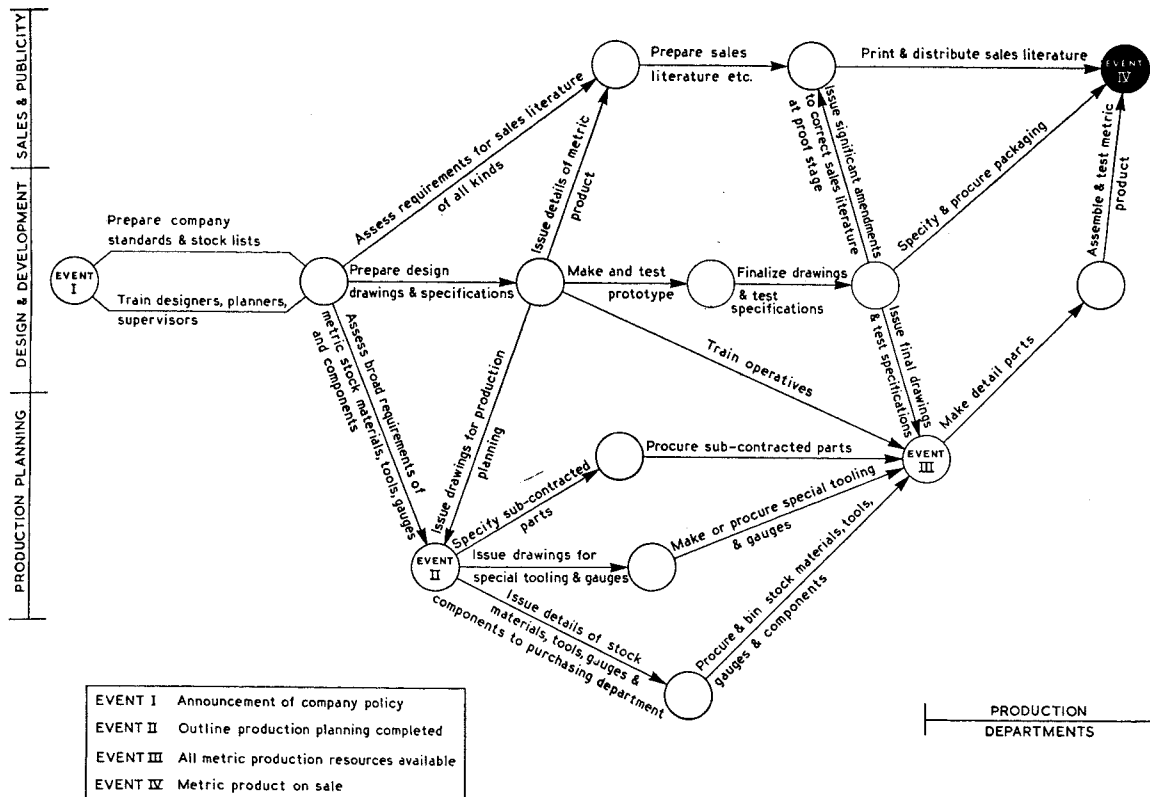

Fig. 2—Analysis of the introduction of a metric product.

Color mobile unit for every TV station

C. M. Eining

The design and construction of color television mobile units for today's fast growing field requirements takes the engineer into many fascinating areas not usually encountered in studio design and construction. Gross vehicle weight, load distribution, tire loading, suspension systems become familiar terms. Heating and air-conditioning requirements also are different in many respects. To get a closer look at these facets of design and construction, let us examine in some detail the evolution of a group of four color mobile units of three distinct types developed and built by the engineering staff of WMAQ-TV in Chicago. One or more of these types should meet the field needs of almost any television station or network.

Charles M. Eining, Supervisor
Technical Operations
WMAQ-TV, NBC
Chicago, Illinois

joined KVOR, Colorado Springs as a part-time transmitter and studio engineer in 1938. He received the BA in Physics from Colorado College in 1943. After training at Northwestern University, he was commissioned in the Naval Reserve and sent to Radar School at Harvard and MIT, graduating in 1944. He then attended Submarine School in New London, Connecticut, and after graduation in September 1944 served aboard submarines in the Pacific until World War II ended. Until May 1946, his ship was engaged in experimental work for the Naval Underwater Sound Laboratory, New London, in which work he participated. He built KRDO, Colorado Springs, and was its first Chief Engineer. He joined KOA, Denver, in 1947 (then an NBC-owned station) and transferred to Chicago in 1950. He worked as MCR Engineer, Technical Director and became Video Tape Supervisor in 1960. He has been in his present position since 1965, at which time he started building mobile units as project engineer. He is active in civic affairs in his home village and recently received a Distinguished Citizen award in recognition of his contributions. He is a member of the Chicago Section, Society of Motion Picture and Television Engineers, and serves on the Board of Managers of this organization.



IN 1956, WNBQ, Chicago (now WMAQ-TV) became the "world's first all-color TV station" with film and live camera facilities to maintain full-color programming. Color video tape was added in 1959, as the equipment became available. The program climate in Chicago at that time was such that there was very little interest in field activity, and a six-camera monochrome unit represented our only mobile capability. This was used primarily for originating Network sports programs, and saw little use for the local station. This situation continued until 1965, when a compact, self-powered, monochrome Video Tape Unit was constructed.

CG-1 and CG-2

For several years, we had recognized the need for a small compact mobile unit that could go into the field on a moment's notice and move rapidly to the scene of a disaster, fire, riot, or other news event. It should have its own power generating equipment and video tape recorder, and be capable of taping in motion. When the TR-5 tape recorder came along, we decided the time had come to go into the hardware stage. The result is shown in Fig. 1.

The vehicle is a 1966 Ford Econoline Window Van, and has a five kilowatt air-cooled engine generator to supply power for equipment, air-conditioning, and limited lighting. Audio is single channel, with automatic gain control. The tracks from the side door allow two men to safely remove the video tape recorder. The equipment cabinet

also is removable, so the equipment may be taken into a high-rise building for taping.

In early 1967, we obtained a three-vidicon color camera, and so colonized this unit. This camera was recently modernized with plumbicons and is still in use, although in a different vehicle (Fig. 2). This unit was constructed by a sister station at the same time as ours was built, and subsequently was purchased by us. It now carries the designation CG-1. CG-2 had a 3-Plumbicon Backpack Portable camera installed in the fall of 1968. Except for the different cameras, the two mobile units are virtually identical. Normal technical staffing on either unit is two men. One operates the camera, the other is a combination video-audio-VTR engineer. If taping is done in motion, a driver is added. The staffing is augmented as the requirements increase. An audio engineer is added for other than one-mike pickups, and a lighting engineer for other than simple lighting.

Since these units were rather unique at the time, it took several months before they were put to other than experimental use. After the "play" period, the units were heavily scheduled, as their flexibility became recognized. The one unit has been airborne in a C-119, gone on a weekend cruise on a Destroyer Escort, and acted as its own king-sized dolly—up and down aisles at a boat show. It has been used extensively as a wild-footage getter for documentary programs, with the individual pieces electronically edited to a composite reel at the studios. At the present time, one

Reprint RE-16-4-2
Final manuscript received May 26, 1970.

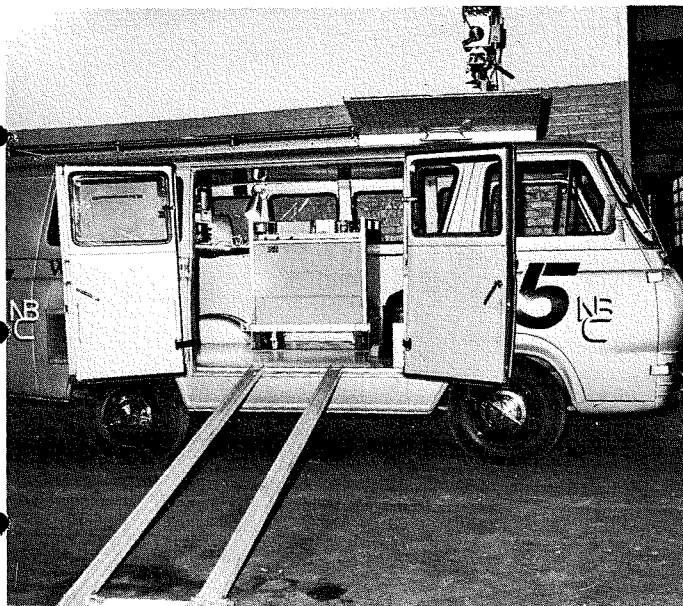

Fig. 2—CG-1 compact mobile unit with Cohu color camera.

Fig. 1—CG-2 compact mobile unit with Cohu color camera.

of these units is assigned to gather stories for the Noon News Show. Since most newsworthy events happen in the civic and governmental offices after 9:00 or 10:00 a.m., there frequently is not time for film processing before the Noon News. Tape may be passed to a motorcycle messenger for delivery to the studios, while the unit goes on to another location. The present record for this type unit at our station, is nine stories at nine different locations in seven working hours.

CG-3

Our next venture was a big one in all respects: size, capabilities, and facilities represent state-of-the art. The CG-3 was designed as a major facility, with complete capability for network sports coverage—probably the most demanding routine program requirement in existence today. This “unit” is actually in two parts, each part a thirty-five foot semi-trailer, each custom built, each with a stainless steel exterior (Fig. 3). Air bag suspension is used on each vehicle. The “B” unit acts as a carryall for the cameras, tripods, pan heads, dollies, cables, mikes, and the many items that are needed for a large pickup. There is also a video tape room in the front.

Looking at the “A” or control unit first, the vehicle is air-conditioned by two four-ton units mounted in the skirt compartments just forward of the wheels. These air conditioners have hot-gas bypasses so the compressors do

not cycle on and off; thus large variations in power load are avoided. These air conditioners also have 12 kW of electric heating each.

Forward of the air conditioner on the curb side, is the broadcast services panel with audio, video, interphone, studio address, and squawk-box terminations. Also located here are interconnection facilities for marrying systems with other units, and this will be discussed later. On the street side is a similar compartment where all telephone terminal equipment is located with lug strips and other connectors installed by the telephone company. This compartment is reserved entirely for their use.

Interior layout

Starting at the front of the vehicle (Fig. 4), the monitor housing has sixteen monochrome monitors, two color monitors, and a monochrome off-the-air receiver. The storage area contains a file cabinet for instruction books and blueprints, with coat hanging space above. Immediately to the rear is a console for the Technical Director, the Director, and a drop-leaf table for the Producer. The next console provides work space and communications for the Technical Supervisor and the Associate Director. The audio area is elevated eight inches to allow the audio engineer and his assistant a better view of the monitors. The audio patch rack is in back of the audio engineer next to the wall, and the other two racks in this row contain the main and auxiliary video switching systems. The next row of racks house

the Rbodium frequency standard, three sync generators, pulse and video distribution amplifiers, and the Transmission Engineer's monitoring, switching and communications equipment. There are no dead-back racks; all equipment is accessible from rack front or back. The rear-most area is the video control area.

Before building this unit, mock-ups were made of all areas to obtain optimum layout of equipment and to study human engineering factors. We feel the slight additional expense involved was more than justified by the end results.

Video

The CG-3 has five Plumbicon color cameras installed, with space and facilities for a sixth. At present, a monochrome camera, used for titles is installed in the sixth position (Fig. 4). This area is located in the rear of the vehicle. There is a color monitor for each pair of cameras, and each is switchable by a 22-input switcher. The leading video engineer also has a vectorscope available.

Video from the cameras is routed to the auxiliary switching system and then to the main program switching system. The auxiliary switcher is a 22 in—10 out INC reed relay crossbar, with SCR-controlled overlap switching. Six outputs are used as follows:

- 1) Insert camera selection, and emergency program switching.
- 2) Video tape feed isolation bus.



Fig. 3—CG-3 color mobile unit.

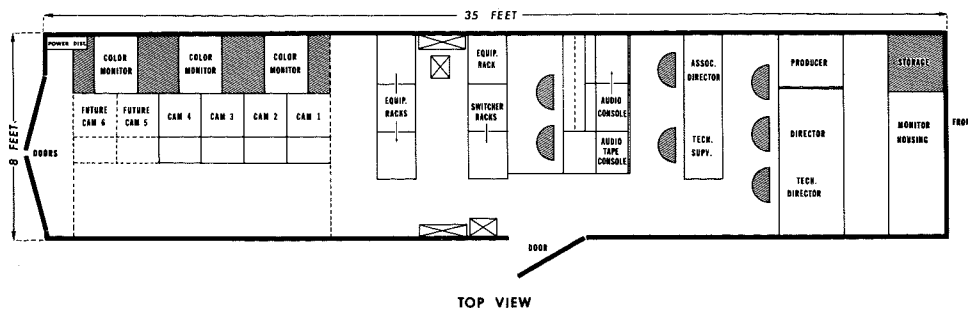

Fig. 4—CG-3 mobile unit interior layout.

- 3) Transmission engineer monitor and scope switching.
- 4), 5), and 6) Video control color monitor switching.

The main switching system is a relay-type switcher. Basically it is a two-bus switcher, with a lap dissolve function between the two buses. A and B effects buses are provided, with choice of 29 different wipes, spotlight, additive and non-additive mix, and insert effects. Three isolated video tape feed buses are also provided, two on the main switcher, and the third from the auxiliary switcher. The insert camera-emergency switching bus of the auxiliary switcher is also located on this panel.

For purposes of adding titles to pictures, we have provided an "instant insert" mixer just prior to switcher output. The insert camera bus provides one input to this mixer and the switcher the other input. The title, which can be colonized and black edged is then inserted or taken out by a single alter-

nate-action pushbutton, without having to use the effects buses at all. This relieves the Technical Director of a considerable amount of strain in a fast-paced sporting event.

Audio

The audio installation is built around ten four-channel remote amplifiers. This provides facilities for thirty-two microphone inputs, plus regular and emergency program amplifiers. Ten nemo inputs with individual level-set controls and preview keys are provided. Utility amplifiers with input combining networks and isolated outputs with individual level setting for each input and output complete the program audio setup. Reel and cartridge tape recorders are provided.

Communications

Probably the greatest challenge to any group building a major mobile unit is laying out an adequate communications

system. A unit such as CG-3 involves a large production and engineering crew which must also communicate surely and swiftly with the outside world. Typically, twenty-five to twenty-eight people may be involved at a remote location, plus others at the studio control point and also Telco personnel. A full breakdown of the communications facilities in CG-3 is beyond the scope of this paper; however, a brief rundown of the systems is in order.

There are three basic systems of communications in CG-3:

- 1) Interrupted Feedback/Studio Address/Cue (IFB/SA/CUE)
- 2) Squawk Box
- 3) Interphone and Telco PL

IFB/SA/CUE system—This system is basically for production use although the Technical Director and audio and video engineers are cross-connected into this system. There are interrupted feedback circuits to handle six different inputs, a requirement which is seldom needed, but very important when needed. Such a requirement might arise when production control for a group of pickup points is centered in CG-3. An election, Inauguration, state funeral, or a space shot may require such facilities. The SA function of this system allows talk from the unit to two separate remote communication boxes for instructing talent or for like purposes. The cue system is fed to all cameras, and may be used for program orders, in event of failure of the normal camera PL or Interphone system.

Squawk box—This system is an engineering system of intercommunications, and connects the Technical Director, lead video engineer, audio, VTR, Transmission Engineer, and two remote points.

Interphone and Telco private line system—This is the largest system of communications; it interconnects completely all personnel at the remote location, both production and engineering, who have any need for communication with others. The telephone company communications are also tied into this system. Not all stations on the system have access to all other stations, but are set up on a need-for-access and on a priority basis.

Although we have not used it in this fashion, CG-3 is designed so the video

consoles in the rear may be removed, leaving a large area with three switchable color monitors. By the addition of a long table and chairs, a "command post" setup is available for coordinating a large number of incoming feeds. In this configuration, the unit could act as a regional switching and communication center for such an event as coverage of a national election.

CG-3B

The CG-3B unit (Fig. 5) is best described as a cargo (or carryall) Video Tape Unit, and it is still under construction at this time. It is a support unit that carries cameras, lenses, tripods, dollies, cables, microphones, and all the many items that go into a major television coverage effort. It is fully heated and air-conditioned, with facilities equal to CG-3A in these respects. There are hydraulic lift gates at the rear and side doors so the heavy items may be unloaded with ease.

The rear room of the vehicle (Fig. 6) is compartmented to hold the many individual items of cargo. The front portion of this unit is the video tape room, which provides space for two video tape machines, with space available for a Slo-Mo disk. After cargo is cleared out, the rear of the vehicle may be used for title camera or video-graph setup. A technical maintenance workbench is also in this area.

A third function of the carryall is crew comfort. Coverage of a baseball game or golf match in a broiling sun, or a football game in sub-freezing weather is difficult enough under the best conditions, and we attempt to provide the best conditions. The following are provided:

- A 110 gallon capacity stainless steel water tank, foam insulated underneath the floor between the air conditioners.
- A coffee urn
- A water cooler
- Ten gallon electric hot water heater.
- Two wash basins, hot and cold water.
- A jet-aircraft-type toilet.

We feel we have done a little innovating in this area. Anyone who has been extensively in mobile unit operations can tell many stories of personal discomfort due to the lack of facilities to support basic human needs. Why should a man have to hike a couple of hundred yards on a golf course to get

a drink of water, or a longer distance for a cup of coffee? We don't think he should. As far as our sanitary facility is concerned, the manufacturer claims sufficient capacity to support the daytime needs of a twenty-five man crew for thirteen days before servicing is necessary.

CG-4

Now, let's look at another type of color unit, an expansion of our compact video tape unit concept; This one is not quite so compact (Fig. 7). This is a two-plumbicon-camera unit with a high-band tape machine (equipped for electronic editing) with its own generator for power, heat, air-conditioning, and program lighting.

The vehicle is custom, the chassis being built to our specifications by the Jay Madsen Corporation, Bath, New York. This chassis has air bag suspension (instead of conventional springs), air brakes, a 534-cubic-inch industrial V-8 engine, a six-speed-forward automatic transmission and power steering. The body is also custom, and was built by Gerstenschlager, Wooster, Ohio. It has

two three-ton air conditioners with hot-gas bypasses, and eight kW of electric heat. A thirty kilowatt generator supplies power for technical, air-conditioning, and lighting use. Looking at the floor plan (Fig. 8) we find the generator in the left rear, the air conditioners in the right rear, and cargo space in between. Two TK-44A cameras, each with two hundred feet of camera cable, may be carried in heated condition, for rapid setup and taping when arriving on location. Just forward of this area is the monitor bridge, which also holds the power panel, the audio monitoring speaker, and the sync generator. Below this bridge, on the right side of the vehicle, is the audio console, with two video consoles next to it. There is still space for a third video console. On the left side, just forward of the audio and video consoles, is a TR-60 tape machine with an electronic editing facility. Forward of this, and elevated ten inches above the floor in the center of the vehicle is the Technical Director-Director console. This console contains the entire electronics and control head of a 12-input, pre-set Grass Valley switcher which program buses with cutbar and

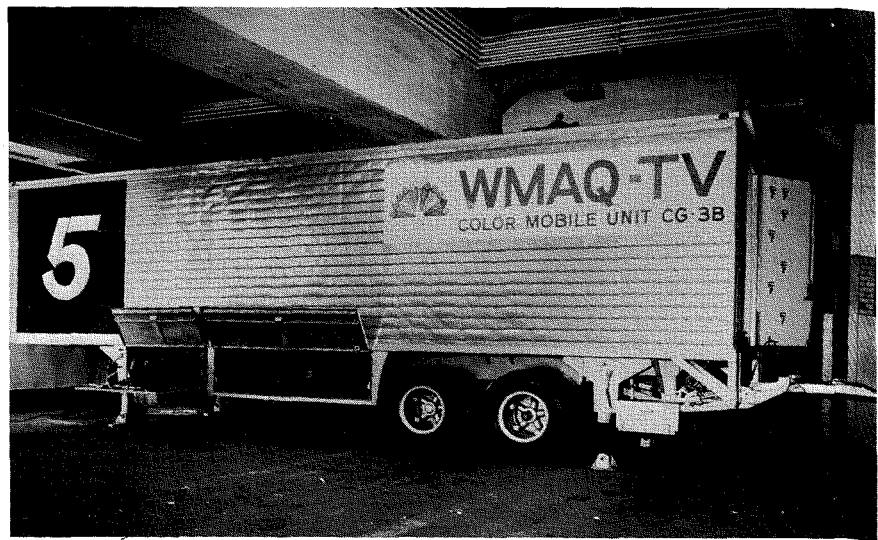

Fig. 5—CG-3B (carryall) showing hydraulic lift gate on rear. A similar gate is on the side.

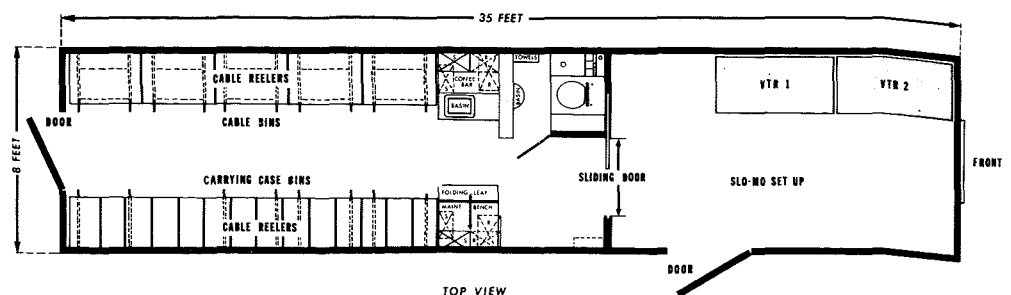

Fig. 6—CG-3B interior layout.



Fig. 7—CG-4 exterior.

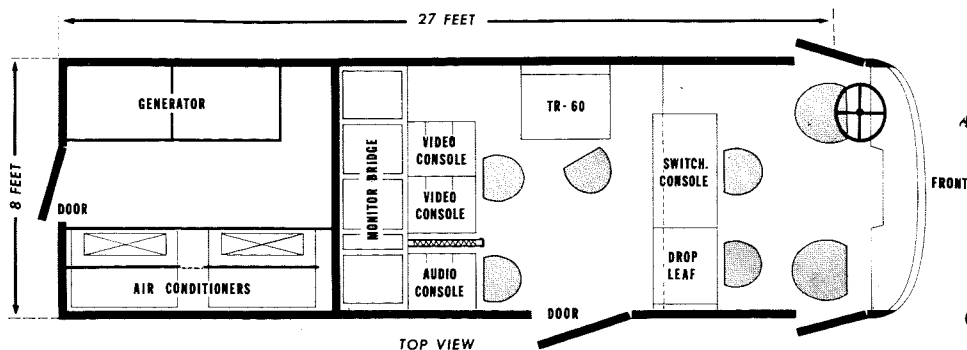

Fig. 8—CG-4 interior layout.

flip-flop switching. It also includes two special-effects buses and a special-effects package with spotlight and positioner. Communications for the Technical Director and Director are also integral in this package. This mobile unit is designed to be readily stripped, so the equipment may be moved into a building. Audio and video consoles may be taken out by removing two bolts in each. Four bolts hold the video tape machine and the switching console. With the exception of the video tape machine, the equipment is light enough to be removed by manpower without mechanical aid.

The audio console consists of two four-channel remote amplifiers, and is set up so one amplifier sub-masters the other so seven inputs are available. This console also contains an audio oscillator for test purposes. Being added is interrupted feedback.

The roof of the vehicle has a subway-grill-type roof plate. By the use of "J" bolts, it is possible to mount trainable seats and cameras or microwave dishes for taping or microwave operations in motion. Also provided is space for a thirty-foot pneumatically operated mast with remote control head for a microwave dish. This last item is planned for future installation.

Marriage capability

With a group of mobile units such as described, the technique known as "marriage," is frequently used, whereby a number of units are used, and one unit switches all cameras and tape machines as necessary. Normally, the sync generators of the slave units are gen-locked to the primary unit. Audio is usually handled by the primary unit.

Connectors are provided on each unit for communications and for camera tally light switching.

Divorce capability

Once in a great while, a larger number of one- and two-camera pickups is desired, such as election night coverage of multiple campaign headquarters. Our overall planning of mobile capability allows this in one form or another. CG-2, with its single camera, has the sync generator and communications system mounted in the console. The console may be lifted out of the vehicle by removing two bolts. This package, plus a remote audio amplifier and a color monitor then constitutes one remote setup.

The large unit, CG-3, has its cameras packaged in double, double and single, or single camera consoles. The single package is interchangeable with the one in CG-2 or those in CG-4. The double camera consoles may be switched with mechanically interlocked pushbutton switcher, although we are planning something a little more sophisticated for the future.

Our concept of readily removable cameras is being carried one step further. As we replace our thirteen-year-old TK-41 studio cameras with TK-44A's, they are being packaged in the same console as those used in field, with communications internal, but without sync generators. By stripping mobile units of cameras, sync generators, and remote amplifiers and by utilizing studio cameras as well, we can come up with combinations to meet a large variety of situations. Our goal, of course, is to make maximum utilization of expensive equipment, and not having a

camera sit idle in the studio when it may be needed badly in the field.

Future mobile unit design considerations

As recently as four years ago when we built our first video tape mobile unit, the choice of vehicle, air conditioners, and engine generators was very limited. Now, however, there is a variety of small van-type vehicles on the market, with considerably beefed up weight-carrying capacity. Foam insulation kits and interior finish are available at reasonable prices. Roof-mounted air conditioners are available with the evaporator and condenser in the roof package. Two of these units may be supplied by a compressor, which is driven by the truck engine, without overheating the engine even when parked. This reduces the power drain necessary from the engine generator, and power becomes available for additional lighting. Engine generators are available in smaller, better sound-insulated packages which can slide out on built-in tracks for servicing. It is interesting to note that most of these developments seem to be a result of the great upsurge in motor home and camper ownership.

As far as equipment is concerned, there are many attractive items on the market. Cableless RF cameras would certainly increase our mobility and coverage. Multiple RF mikes would increase audio mobility. A lightweight, miniature, quadraplex, high-band tape machine is available. With this new hardware, we are looking forward in the near future to rebuilding our single-camera units. The state-of-the art has advanced so much in the past four years since they were built, that they are looking very obsolete to us!



Clayton W. Ackerson, Mgr.
NBC-TV Field Operations
National Broadcasting Company
New York, N.Y.

is a graduate of Air Force Technical School; he studied Radio and Television Engineering at Capital Radio and Engineering School, and physics and mathematics at New York University and State University Farmingdale, New York. Mr. Ackerson was employed in the Communications Department of American Airlines in New York from 1939 to 1951. He joined NBC in 1951 as a TV Maintenance Engineer, and has worked in all phases of TV Broadcasting with NBC: maintenance, field operations, and installation and design. He was appointed to his present position August, 1966.

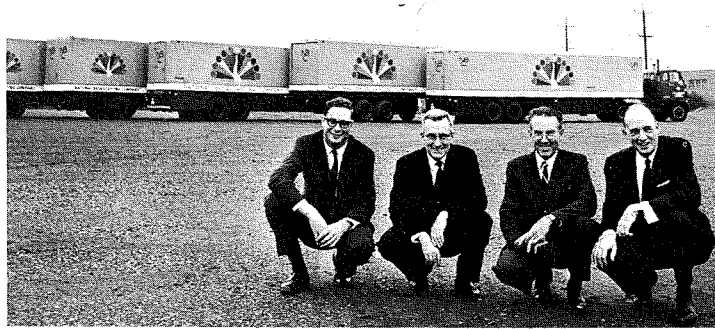

NBC television field operations

C. W. Ackerson

The television broadcast industry is highly competitive and extremely challenging—a fact which hardly comes under the heading of unusual news. That which is unusual, however, concerns the increasingly high premium the business is placing on the logistical know-how and technical amumen of the people directly involved in live originations from sites outside the normal television studio.

Fig. 1—Above right, a fleet of NBC mobile units used for remote pickups across the Nation. Most of these units are 40-ft trailers custom built for NBC. In the foreground, left to right, are Alan Fendrick, William Trevarthan, Sherman Atwood, and Alan Walsh.
Fig. 2—Below, NBC color camera at the Super Bowl Game in Miami 1969.



IN 1969 the National Broadcasting Company did more than two hundred pickups. These pickups ran a wide gamut of production importance, from spot news coverage involving one camera, to the multi-camera treatment of Network golf matches, World Series Baseball, Super Bowl Football, space shots, news of all kinds, parades, political happenings, and a variety of other events which involved the major movement of equipment and personnel to the site of the action.

The increasing emphasis by all Networks on live field television is producing problems which constantly arise to plague crews and supervisory personnel. Logistically, the pace and demands of in-the-field television production involve a staggering amount of equipment. Moving this equipment often creates problems, even though the NBC-TV Network has at its disposal major amounts of field equipment located mainly in four widely scattered geographical areas of the country: New York, Burbank, Chicago, and Washington, D.C. (Fig. 1).

The major articles of equipment located at these four distribution centers consist of twelve tractor-trailers, eight

Reprint RE-16-4-3
Final manuscript received May 20, 1970.

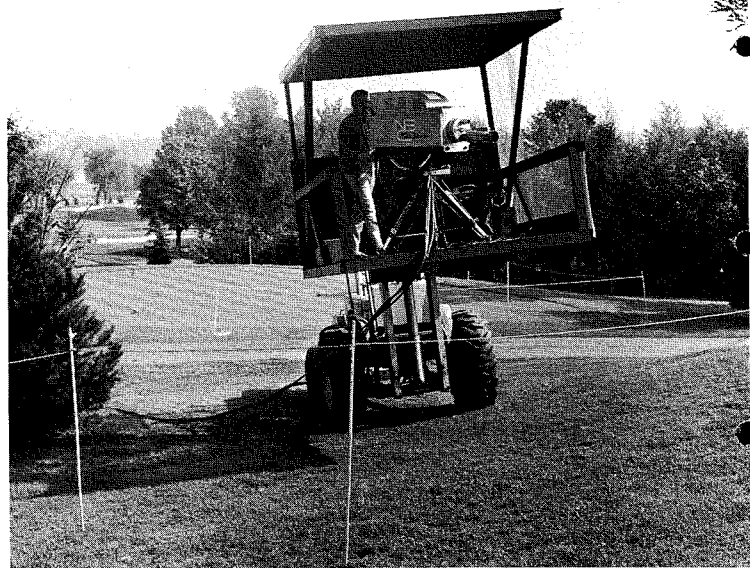

Fig. 3—Above, a portable, back rack, RF-connected camera used at Firestone Country Club in Akron, Ohio by NBC field crew.

Fig. 4—Right, NBC color camera on a fork lift at Firestone Country Club at Akron, Ohio.

Fig. 5—Facing page, left, platform constructed for NBC color camera to cover the 18th hole at the Firestone Country Club, Akron, Ohio.

Fig. 6—Facing page, right, a one-camera RF-connected mobile unit used to follow parades or for quick on-the-spot coverage of News events as they happen.



miscellaneous trucks, forty color cameras, twenty miles of camera cable, forty miles of audio cable, two hundred video monitors, twelve video tape recorders, four video disc recorders, and two hundred fifty microphones. Despite this vast accumulation of equipment, there are times when it becomes necessary to augment this stockpile by renting from outside vendors.

Football

With the emphasis on Network sports continuing to show a steady increase, maximum and unique engineering efforts are needed at an accelerated pace. The Super Bowl Football Game, which was telecast exclusively by NBC in January, 1969, offers a case in point (Fig. 2). This prestigious sporting event was covered by thirteen color cameras, two video tape machines, three video disc recorders, two audio tape recorders and forty video monitors, operated by forty-eight engineers. The normal football game coverage uses less than half this amount of equipment and personnel. To accomplish the Super Bowl pickup, it was necessary to use two of our regular mobile units, with all production being done from one control area.

The two major problems concerned the ability to communicate with all persons involved with the operation: Producer, Director, Technical Director, Cameramen, Video Tape and Disc

Operators, Video Control Operators, Audio Control Engineers, Lighting Director, Maintenance Engineers, Sideline Camera Vehicle and Sideline Microphone Operators. The ability to communicate immediately with each person involved while on the air was probably the most important single factor for a successful production. The second major problem was the method used to switch all the cameras. To meet the demands for program continuity, it was necessary to preview all cameras and select the proper one in program sequence, to establish various effects (split screens, etc.), to insert graphics, to select any of the cameras for either the two video tape machines (for instant replay) or the three video disc recorders (for instant replay, stop action, or slow motion). The program also had to be fed from the tape or disc facilities. In short, the switching system had to be capable of eighteen separate inputs and eight program outputs.

Golf

In sports, a golf match is a most complex pickup, mainly because of the large area that must be covered with cameras and microphones (Figs. 3, 4, 5), but also because of the extremely complicated communications requirements. All cameras must be raised: some are on fixed platforms from 6 to 40 feet above the ground, and some cameras are on fork-lift trucks with

the ability to move on the course and to be elevated to at least 28 feet. One-hundred-foot cranes are also used as camera platforms. For communications, two separate walky-talky systems are used for scoring and information. One channel has a base station with ten moving stations that accompany each foursome and report the stroke-by-stroke progress of each player. The other channel is for scoring only, for all eighteen holes, even though only the last five holes of play on our live telecasts are covered.

Skiing

The Federation International Skiing (FIS) Championships which was held early this year, is an example of programming originating outside of NBC facilities. Equipment and personnel were supplied by European broadcasters. The Alpine events were held in Val Gardens in the Dolomites of Northern Italy. The government-owned network (RAI) constructed a complete broadcast facility in Ortisei, Italy, for this event. The broadcast center consisted of two three-camera color studios, six color video tape recorders, one slow-motion recorder, two color film chains, film processing and editing facilities, and all communication facilities. The broadcast center also functioned as an audio and video distribution center for all subscribers. Remote units were then rigged at each ski site (five separate



locations) and were connected via microwave to the broadcast center. Due to heavy snow conditions, camera platforms and camera cables were installed during November, 1969, to be used during February, 1970. Each remote unit was equipped with five or six cameras. The FIS scheduling of events prevented the use of the mobile units in more than one location, except where both men's and ladies' courses ran parallel, as at the slalom courses. NBC arranged for unilateral time at each remote location—for camera usage either before or after the event, depending on lighting conditions and availability of equipment. This enabled NBC to have talent on camera which was video taped at the broadcast center. The entire event was then video taped in each case and edited for playback later. Due to different broadcast standards used in the United States and Europe, all edited tape playbacks from both Italy and Czechoslovakia were routed through London and the BBC Standards Converter. The conversion was from 625 line PAL to 525 line N.T.S.C.

The Nordic Events were held in the Bysoke Tatry Mountains in Eastern Czechoslovakia, 25 miles from the Polish border. Slovak Television supplied the broadcast facilities with augmentation of equipment from ORF in Vienna, Austria. With this arrangement, the same cameras (four in number) could be used for both the

70-meter and the 90-meter Jumping Competition by simple camera shifting. Duplicate cables had been installed prior to the heavy snowfall. On one occasion, lines for video and audio were set up from Czechoslovakia to Milan, Italy, which was the closest video recording facility to Val Gardena. The Nordic Event was video taped in Milan and hand carried to the Ortisic broadcast center (four hours by train and 30 minutes by car). This, along with other program material from Val Gardena, was edited into a show and played back to the United States from Italy. The final week of competition took place in Czechoslovakia. The Jump, Cross Country Races, and the closing ceremonies were all recorded, edited, and played back to the United States from this location via the London BBC Converter.

Parades

Of the six parades presented by NBC Television during the year, three honored the Apollo 11 Astronauts in New York, Chicago, and Los Angeles. These parades were combined broadcasters' pools and the New York parade-pool host was NBC. The equipment used was two two-camera mobile units, one five-camera unit, one helicopter, and one one-camera unit (Fig. 6) that followed the parade at all times. In addition, there were fifteen single-camera locations and five

microwave positions (one for the helicopter and four for the mobile unit traveling with the parade). The Astronauts were in New York approximately three hours, and were on camera for almost the entire time.

For the Apollo 11 capsule recovery in the Pacific Ocean, NBC had the task of bringing to the public viewer the actual landing ceremony of the Astronauts. The ship used for this recovery was the Aircraft Carrier *U.S.S. Princeton*. Onboard *Princeton* was a complete NBC color mobile unit, a separate power generator, a complete satellite transmitting ground station, a complete radio mobile unit, and a crew of forty-two production and engineering personnel. The equipment was placed on board in San Diego, California, and the crew boarded at Hawaii. The mission was a thirty-eight day operation.

Weather

The weather is one factor in Field Operations that the Engineering Department can do little about. In the summer we fight heat, wind, and rain. The heat we have been able to overcome, but rain and wind we just live with. In winter, we have wind again, plus rain, snow, sleet and temperatures to 20° below zero. Doing a football game one Sunday in Buffalo in December and the following week doing a game in Miami, calls for a bit of ingenuity.

Video edging

R. J. Butler

For more pleasing and more readable title inserts in a television presentation, a video-edge capability has been added to certain video switchers used by NBC. This paper describes the development and design of the video-edge equipment and highlights some of the technical and economic tradeoffs inherent in the use of this equipment in the TV studio.

TO MORE EASILY UNDERSTAND how a video edge is created, a short review of a standard insert is necessary. The terms *insert*, *self-key*, and *matting* are all synonymous and are, in effect, equal to a video-operated electronic switch (Fig. 1). In general, there are three inputs to the unit: the A input connected to the normal closed terminal of the switch; the B input connected to the normally open terminal of the switch; and the keying input which operates the switch. It is standard that a positive-going signal at the keying input will cause the switch to transfer from the normally closed contact (A) to normally open contact (B). When operated in the insert or self-key mode, the B input and the keying input are tied together. This arrangement will automatically produce an insert output which will be mostly A except at those times when the B input is positive or white.

Since there is additional processing required in the video path which connects the B input signal to the actual switching function, it is normal for the switching voltage to be slightly delayed in relation to actual B video. Left uncorrected, this delay would result in a displacement between the cutout created by the switching voltage and the B video signal that should fit into the cutout. Fig. 2 shows the

additional trim delays that bring the video signals at the terminals of electronic switch back into line with the switching-voltage. Had the delays not been corrected, the video to be inserted would have been fore-shortened at the horizontal leading edge and would have been outlined at the back edge as shown in Fig. 3.

As Fig. 3 indicates, a border can be created by simply mistiming the switching voltage in relation to the video signal at the terminal of the electronic switch. This procedure has certain drawbacks, such as reduction of the size of the insert material and a border only on the horizontal leading or trailing edge. The best solution is to create a switching voltage which begins before and ends after the arrival of true video at the B terminal of the electronic switch. If, for instance, the insert video is a set of letters making up a title, the switching voltage can be considered as the same title video with wider letters (Fig. 4). If an outline is required which also edges the top and bottom of the title, the switching signal will be composed of the same letters but in this case they will be both wider and higher than the original B video input.

Video delay to produce outlined inserts

The switching signal, although a close replica of the B video input, is not of



Robert J. Butler, Director
Engineering Planning and
Equipment Development
National Broadcasting Company
New York, New York

studied Electrical Engineering at New York University and joined the RCA Service Company in February 1947. He was transferred to the National Broadcasting Company in March of 1952 and has worked in all phases of color studio development. Mr. Butler was appointed Project Engineer in the NBC Engineering Planning and Equipment Development Group in October of 1966. He was named Director of the group in 1969.

identical character. The original tie between the B video input and the keying input must be separated by an additional amount of processing which will perform three necessary operations:

- 1) Modify of the original B video to produce a switching signal that is wider and higher than the original geometry of the B signal.
- 2) Add an appropriate delay to true B video signal so that its arrival time on the electronic switch will be centered within the switching signal, and
- 3) Steps 1) and 2), which are accomplished by video delay, will cause unwanted sync delay which must be cancelled by the additional video processing equipment.

If the smallest picture element is to be edged by a switching signal generated from the matrixing of the original element, nine delayed replicas of the original element would be required. Fig. 5a shows the geometric

Reprint RE-16-4-13
Final manuscript received July 15, 1970.

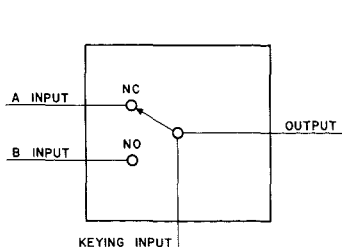

Fig. 1—Video insert amplifier.

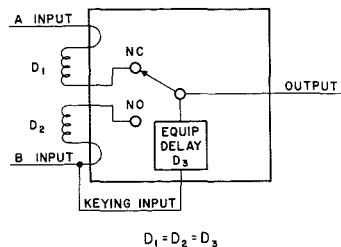

Fig. 2—Video insert amplifier with keying delay compensation.

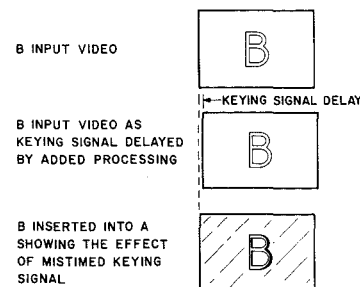

Fig. 3—Uncorrected video delay results in substandard edge and insert.

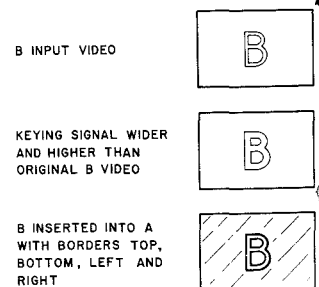

Fig. 4—Corrected video delay.

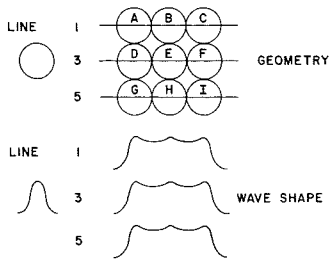

Fig. 5a—A 9-element matrix can outline the smallest picture element.

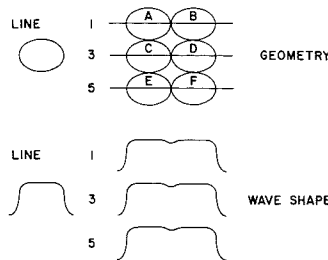

Fig. 5b—A 6-element matrix where the picture element is larger than two times border width.

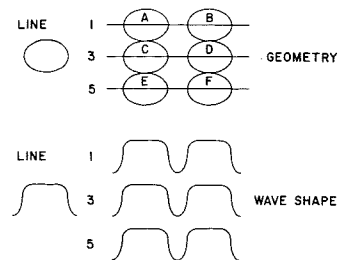

Fig. 5c—A 6-element matrix where the picture element is smaller than two times border width.

arrangement of these signals and their delay status is listed as follows:

- A—Undelayed (original location of B video)
- B—delayed by 1 picture element
- C—delayed by 2 picture elements
- D—delayed by 1 horizontal line
- E—delayed by 1 horizontal line + 1 picture element (new location of B video)
- F—delayed by 1 horizontal line + 2 picture elements
- G—delayed by 2 horizontal lines
- H—delayed by 2 horizontal lines + 1 picture element
- I—delayed by 2 horizontal lines + 2 picture elements

The number of required matrix signals to produce a switching signal can be reduced if the size of the smallest picture signal to be edged has a width equal to or larger than twice the outline which is to surround it. This situation is shown in Fig. 5b and the delay status of the six signals involved are as follows:

- A—undelayed
- B—delayed by twice border width
- C—delayed by 1 horizontal line
- D—delayed by 1 horizontal line + twice border width
- E—delayed by 2 horizontal lines
- F—delayed by 2 horizontal lines + twice border width

Many factors govern the size of the horizontal outline but the most important is the proportionality between the vertical edge and the horizontal edge. For practical reasons, one vertical line (two interlaced lines) per field was chosen as the amount of the vertical edge. If the horizontal edge is to be proportional to a vertical edge of one line per field, the following formula can be used to calculate the correct width of the horizontal edge:

$$\frac{\text{No. of lines of edge}}{\text{No. of picture lines per field}} = \frac{X}{(\text{Picture time in 1 hor line}) (0.75)}$$

Substituting the appropriate numbers in the formula yield a horizontal border width $X = 164$ nanoseconds:

$$1/242 = X/39.75 \mu s$$

If we remember the rules for a six-element matrix, the picture signal is delayed by exactly twice the border width (Fig. 5). It is easy to see that unless the picture to be edged has a width of at least the amount of the delay, unwanted serrations will occur in the reconstructed waveform (Fig. 5c). A $2T$ pulse which has a width of 250 nanoseconds represents the narrowest signal which can pass the 4-MHZ-band limit imposed by the tv transmitter. A border width of 164 nanoseconds surrounding a $2T$ pulse would result in a reconstructed 6-element switching signal with unwanted serrations because overlap of the matrixed elements would not be complete (Fig. 5c). For many reasons, not the least of which was the fact that unwanted serrations in a 6-element matrix could only occur when the narrowest possible signal was being processed, a compromise border width of 140 ns was chosen.

Implementation of 6-element matrix

The original B video signal is delayed and matrixed to produce a geometrically larger signal for switching as shown in Fig. 6. The first unit in the B path is a splitting amp; it in turn supplies video to a series of $1H$ -delay lines and a non-additive mixer (NAM). The output of the NAM is a combination of a $2H$ -delayed signal, and a zero-delayed signal. All outputs of the NAM and $1H$ -delay lines are unity level and 75-ohm source terminated. The resistive matrix at the input to the clipping amp is composed of two 75-ohm resistors in series respectively with the output of the $1H$ -delay line and the output of the NAM amplifier. Arranged in this fashion, the unterminated cable which also connects to the input of the clipper amp looks back into a source impedance of 75 ohms. All signals ar-

iving at the clipper amp input will travel down the cable, reflect back, and be absorbed by the correct terminating impedance of the source. The echo created by the unterminated cable at the input of the clipper amp has the effect of widening the original video signal. The waveshapes of Fig. 6 show this widening and the various level conditions that can result. The function of the clipping amplifier is to restore the peak level of the output signal back to the same level as originally supplied by the B switcher output. The switching signal now arriving at the insert amp is both higher and wider than the original B video input. To place the original B video correctly in the center of the newly constructed switching signal, the B video must be delayed by half the vertical delay— $1H$ —and by half the horizontal delay—one border width. Although cable delay $D1$ and $D2$ are of the same length, $D2$ acts as if it were twice as long as $D1$ because it is unterminated. Cable delay $D1$ therefore correctly positions the B video signal in the center of the switching signal.

Luckily, the border width chosen helps in solving the color phase problem which would naturally result when delaying the B video signal by $1H$. The odd-harmonic relationship between subcarrier and line rate result in a 180° color phase shift of the B video if passed through an exact $1H$ -delay line. The addition of $D1$ in

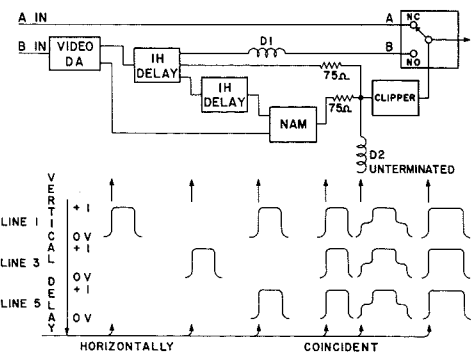

Fig. 6—Implementation of the 6-element matrix.

series with the $1H$ -delay line serves two purposes:

- 1) To center the B video within its borders, and
- 2) To cancel the unwanted phase shift resulting from the use of a $1H$ delay line.

Operational considerations

An edging capability will be an add-on feature to an existing switcher. Video timing within the switcher must be maintained even though a serious modification of the effects path is to take place. Economically speaking, video edging is quite expensive: its cost is about equal to the cost of a complete effects amp. Therefore, if there is any way to make the added edge equipment do double duty, its expense is less painful. In arriving at a functional arrangement of edging equipment, all the above factors were taken into consideration. The results are shown in Fig. 7.

The area within the dotted lines is the edge package. Physically, it consists of two $3\frac{1}{2}$ " rack frames. The $1H$ and $2H$ delay lines make up the first unit. The second unit is further modularized and contains as sub-modules:

- 1 video amplifier
- 1 sync generator
- 1 color lock
- 1 insert amp (used as NAM)
- 2 processing amps
- 1 module containing 16 miniaturized DPDT relays
- 1 power supply

The circuits shown outside of the dotted lines represent, in part, equipment which might be found in a standard video switcher. At the top

of the drawing, the effects A and B amplifiers represent the output of two switching busses, which would normally feed directly into the effects #1 amplifier. In a similar manner, effects C and D shown at the bottom of the drawing would normally be routed directly to the effects #2 amplifier. Introduction of the edge package allows additional processing to be added to the B path if desired, or to the D path on an either/or basis. The function of the two-by-one relays located at the right of the drawing is to allow appropriate transfers of video inputs to the effects #1 or #2 amplifiers when edge processing is requested. K1, interlocked with the two-by-one relays, routes the input to video amplifier (DA) and on to edge processing. The processing amplifiers, which are in series with both the B delayed video and the matrixed switching voltage, work in conjunction with the sync generator and color-lock modules to restore correctly timed sync and blanking to the output video signals. In addition, the processing amplifier in series with the matrixed switching voltage serves as the clipping amp required to normalize levels. As the waveforms of Fig. 6 show, the gain of this amplifier should be 2 to 1 and have a white clip capability so that peak level does not exceed unity as compared to the edge-package video input.

Ideally, the edge package should be located as close to the existing effects equipment as possible. Even with close proximity, hookup cable length

becomes a problem. After experience in installing this type equipment, it became apparent that to preserve color phase and border width, the value of the $D1$ delay which ideally would be one-half cycle of subcarrier (140 ns) should be increased $1\frac{1}{2}$ cycles of subcarrier (420 ns). This increase in the $D1$ delay allows for hookup cable delays and limited modification of horizontal border width. Added delays, $D3$ and $D4$, are now necessary to position the switching voltage to the new location of the true B video.

Control additions

Three logical inputs must be addressed to the edge package from the Technical Director's operating console:

- 1) Assignment of the edge equipment to either effects #1 or effects #2.
- 2) Edge-on or edge-off.
- 3) Color-on or color-off.

Many times the video signal which is to be edged originates from a black-and-white electronic character generator. It is sometimes desirable under these conditions to tint the white letters by adding subcarrier to the true B video. This function is accomplished in the edge package by relays K5 and K6. Operation of these relays is interlocked with the assignment function, and will route subcarrier from the color lock module through appropriate video pads to the normal termination of the B or D video signal at the effects amp input.

External logic prevents the operation of the edge on or color on push-buttons unless the assigned effects amplifier is in the insert mode. When in the insert mode, if edge on is operated, the inserted material will drop two interlaced lines and shift to the right by $1\frac{1}{2}$ cycles of subcarrier.

Conclusions

To date, six edge packages have been installed in four different switchers. The problems which arose were not so much the creation of the proper signals but the integration of these signals into the already existent system. Our experience indicates that with the exception of the color tinting all functions performed by equipment shown in Fig. 7 must be provided when providing an edge capability.

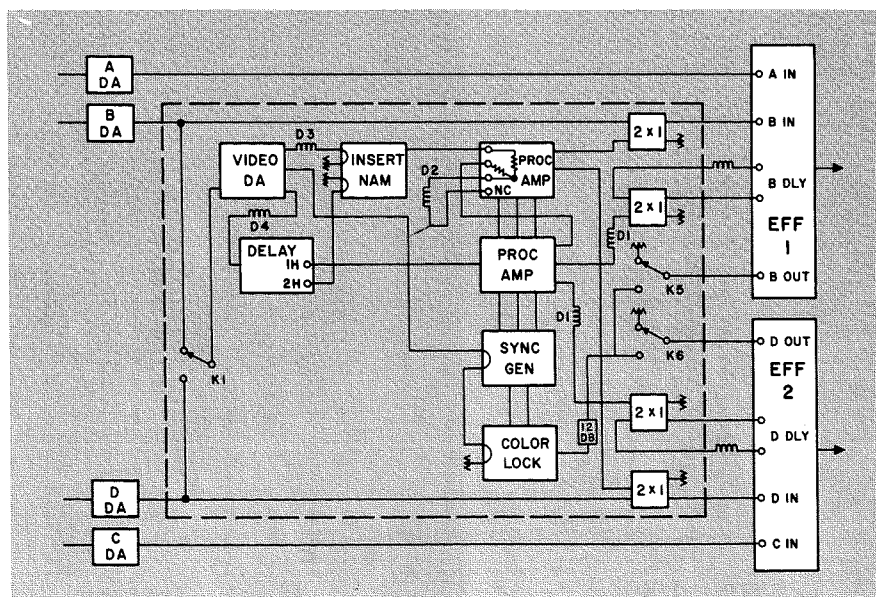
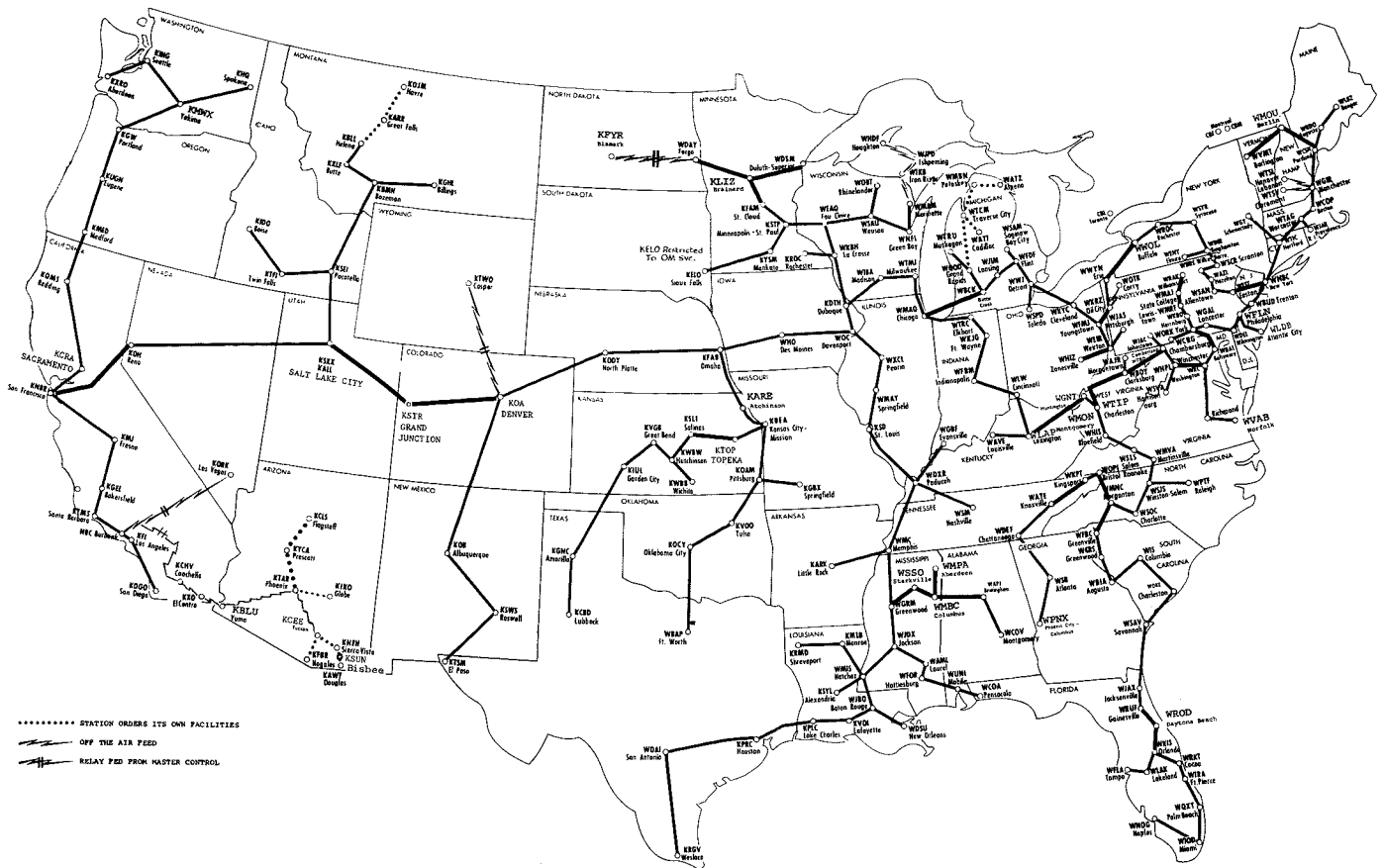

Fig. 7—Complete video-edge package.



NBC Radio Network facilities and operation

Sammie T. Aed

A properly designed plant, whether network or local, is one which is technically modern and compact, yet can expand programming without physically changing the present facilities. Such is NBC's Radio central facility in New York's Radio City. This is the facility which services the NBC Radio Network, the "hub of the wheel" that distributes programming throughout the United States. The supporting "spokes" lead from/to Washington D.C., Cleveland, Chicago, and San Francisco for further dissemination. The operation is set up in such a way that a simple turn of a key makes any of the supporting spokes the hub, or the central feed point for the Network.



Sammie T. Aed, Director
Radio Division Engineering
National Broadcasting Company
New York, N.Y.

graduated from Capitol Radio Engineering Institute, Washington, D.C. in 1947. During U.S. Army tenure (1942-1945), he attended Yale University. From 1947 to 1962, Mr. Aed served in Engineering for WGAY-AM/FM Silver Springs, Maryland; WEAH Arlington, Virginia; and WMAL Washington, D.C. He joined the American Broadcasting Company in New York in 1962 as a Studio Engineer and in 1963 was appointed Director of Engineering/Program Operations, Radio Network for ABC. Mr. Aed joined NBC in his present position in 1969.

THE NEW YORK STUDIO COMPLEX (Fig. 1) consists of three control areas—Studios 5A, 5B, and 5C—plus two supporting tape areas—5C Tape and 588 Tape. Each studio is independent of the others, though identical in structure, and each possesses the flexibility of utilizing the facilities of the others, singly or totally.

Individually, each technical area functions separately or is, in itself, a complete station operation. For example, the audio engineer in 5A may set up a three-way program conversation with London, Berlin, and Rome correspondents merely by switch selection.

Reprint RE-16-4-4
Final manuscript received June 19, 1970.

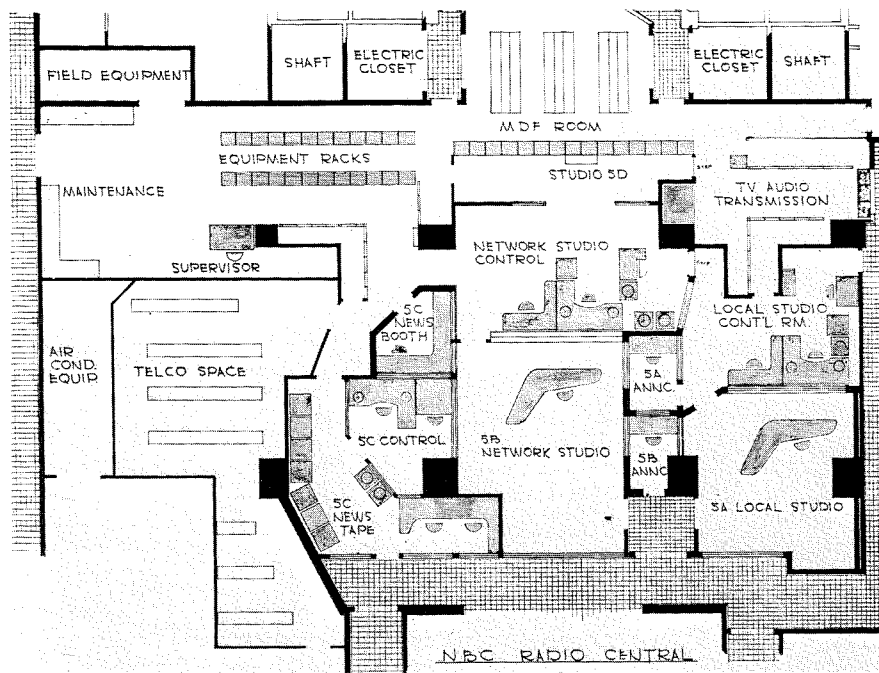

Fig. 1—Layout of NBC Radio Central, New York, showing studio, news, tape, maintenance, and equipment areas.

The correspondents in each location can hear the other two without causing feedback, while the engineer is recording the conversation. Simultaneously, 5C can be feeding a live show to the network, and 5B can be recording a live studio show.

In addition, Studio 5A is used for recording, interviews and news specials, such as space shots and elections. Studio 5B (Figs. 2 and 3) is scheduled primarily on weekdays to handle recordings and interviews; on weekends it is solely devoted to "Monitor" feeds

to the network. This leaves Studio 5C as the prime news origination point.

As an added service to our affiliated stations, we utilize the "hotline" alerting device. This "hotline" pulse, when activated in New York, is detected by the affiliated stations' "hotline" receiver (Fig. 4), and operates an alarm, buzzer, or light—or it may be used to start a recorder. These "hotlines" are coded and are bulletin alerts or program information announcements. This, basically, is our operating radio plant.

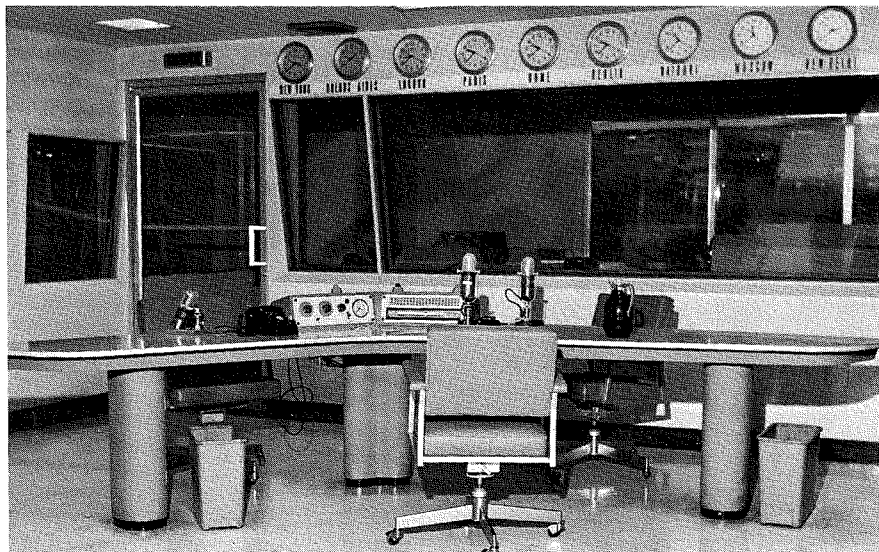

Fig. 2—Studio 5B in Radio Central, typical of studio in these facilities.

The word *radio* has many meanings, including "the transmission of information"; hence, the air studios performing this function must have support. For news, this support is supplied by 5C Tape and Studio 520 Tape Edit Room (Figs. 5 and 6). These handle the recording, collation, and editing of overseas reports, tape and live reports from correspondents, inputs from affiliates, and telephone feeds. The tapes and reports are processed, edited, and made into cartridges for use on upcoming newscasts. In addition, school desk units (Fig. 7) have been installed which allow news editors to hold two-way conversations with our foreign and domestic correspondents besides serving as the communications funnel between all operating areas.

Additional support is supplied by our Field Operations, or Remotes, in such areas as Apollo launch or recovery sites, political conventions, etc. as well as that supplied on a regular basis by NBC in Washington, D.C., covering the White House, Capitol Hill, and other major Government sources. Further support is provided in the form of originating from our owned stations in Cleveland, Chicago, and San Francisco.

Simplicity of operation? Sounds like it—yet not so simple. Engineers are ever standing by, recording incoming feeds from overseas, cross-country, locally, and all is in readiness for the News Department to decide which segment of a recording will be used in a newscast. This means that one feed, or as many as eight, can be recorded and supplied to News at one time. But this is what makes the "news" ever changing and updated—a ready combination of old and new.

"Monitor" is a different story. This institution has been on the air fifteen years and is broadcast weekends only (a total of nineteen hours) culminating each week in approximately 80 hours of preparation of unknown numbers of hours and volumes of recordings and field jobs to make the presentation timely, interesting, and entertaining. This does not take into account the additional effort involved with "current news and events" which may be injected at any point at the

request of News as these events happen. "Monitor" programs, due to the volume and complexity of material, require separate editing areas. Four edit rooms are located in Recording. The edit rooms are booked by "Monitor" producers 10 to 12 hours daily for tape processing, commercial dubbing, and promotional material.

All of this seemingly special care helps bring a superior product to the listener, as evidenced by the Peabody award winning program "Second Sunday" and such highly regarded programs as "Emphasis," "Perspective in the News," and Joe Garagiola's "Sports." NBC Radio, New York, devotes the talents of 31 engineers in six technical operating areas to service 222 affiliated stations. This type of service to our affiliates includes News, Religion, and Public Service. The painstaking expertise of the NBC New York radio engineering operation affords these affiliates—and ultimately the public—timely, reliable, and technically sound broadcasting.

To insure this reliability and faithful transcription, the power supplies, amplifiers, and console functions must necessarily have redundancy. Even the cartridge and reel tape machines are terminated in easily removed blue-ribbon plugs for rapid equipment interchange, as may be required. Maintenance, therefore, is simple and fast, hence, less costly.

The philosophy of NBC Radio Engineering can be summarized as the ability to handle a variety of functions utilizing a minimum of operating facilities enabling maximum distribution of a superior product, and this is accomplished through the same basic means of the industry we serve—communications. The communications wheel turns as each spoke (Washington, D.C., Cleveland, Chicago, and San Francisco) functions as a radial to the hub (New York). Further expanded, the present ease of inter-communications between department and facilities essentially confirms that NBC's flagship facility is indeed "a properly designed radio plant . . . affording the capability of expanded programming without physically changing its present facilities."

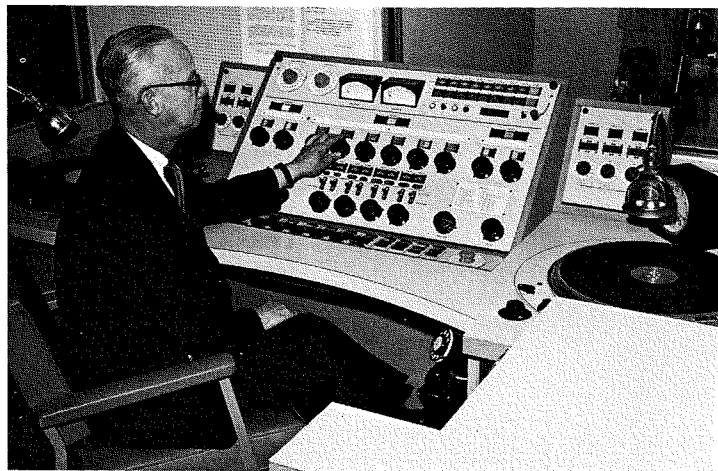

Fig. 3—Studio 5B Control Room; there are four custom-built consoles of this type.

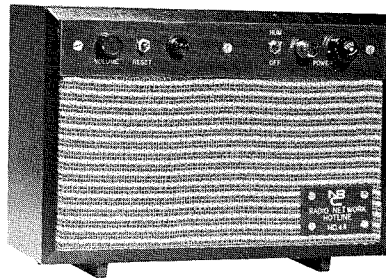

Fig. 4—Hot line receiver; each affiliated station has one of these for fast news alerts.

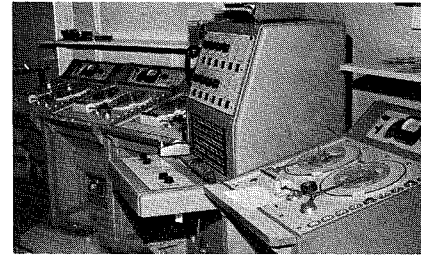
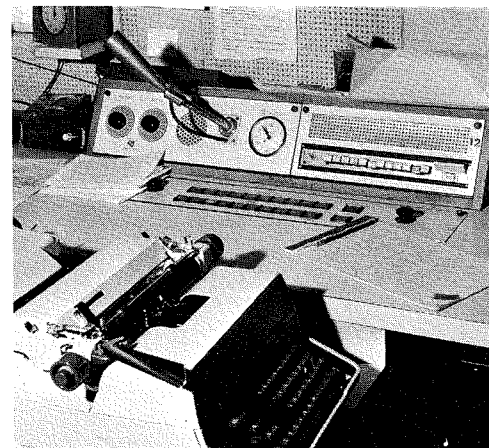

Fig. 5—5C tape facilities; overseas news reports are taped and edited here for on-the-air use.



Fig. 6—588 tape-edit room used for news.

Fig. 7—The NBC school desk where all overseas contacts are made with new reports for news reports.



New television studio for the Tonight Show

O. S. Paganuzzi

Since 1962, Johnny Carson has hosted NBC's *Tonight Show* from Radio City Studio 6B, a studio with a proud heritage in broadcasting. Ed Wynn, Milton Berle, and Bob Hope are only a few of the performers that have appeared in this studio. Converted from one of the original radio studios, 6B has been modified a number of times—from radio to TV, from monochrome TV to color—but it was not until Johnny's long-term residency that it was decided in 1969 to completely rebuild the studio.

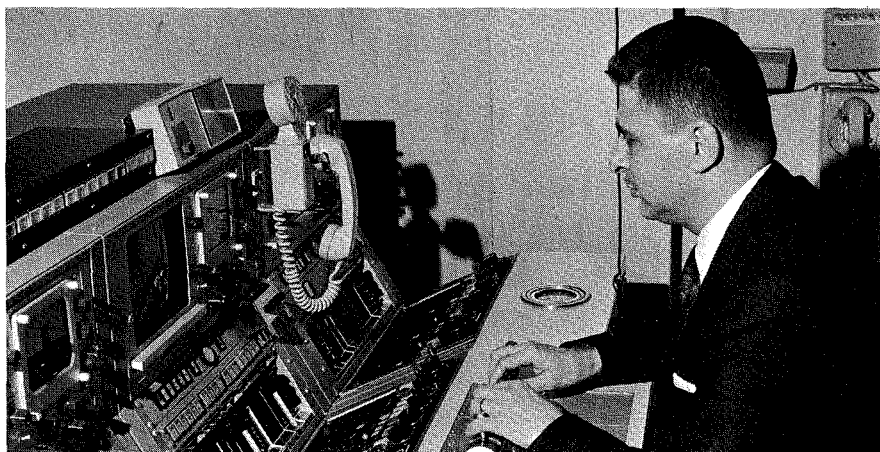

O. Stephen Paganuzzi, Director
Broadcast Systems Engineering
National Broadcasting Company
New York, N.Y.

received the AB in Physics from Columbia University in 1949. After two years experience in design and production of electronic equipment, he joined NBC as a TV Maintenance Engineer. During this period he assisted in the original installations of monochrome and color film vidicon systems and early system development in color video tape. He also worked with the Facilities Design group during various system installations. In 1960, he became a Facilities Design Engineer and worked on

the design of the telecine film system in New York and Chicago, video tape improvements, TV News and Special Events facilities, TV audio systems, the reconstruction of the present NBC Network Radio Plant and Mobile Unit communications facilities. He coordinated the design of TV Studios 3A and 3B in Radio City and became a Facilities Design Project Engineer in 1968. Recently he has supervised the design of Studio 6B in Radio City, the WNBC local radio plant, a N.Y. Telecine audio and video monitoring system and a special events studio in Washington. Mr. Paganuzzi was recently promoted to Director of Broadcast Systems Engineering.

ALTHOUGH studio 6B is not the largest studio in Radio City, its size is such that it readily allows for the many broadcasting demands of today's TV studio, especially providing the audience reaction intimacy required by the *Tonight Show*. It has a playing area of approximately 2700 square feet and an audience seating capacity of 250 persons. These figures represent an increase of approximately 35% in playing area and 3% in seating capacity over the former studio layout. In addition, the entire project was completed with a studio out-of-service time of 4½ months. This necessitated a rigid construction schedule, much pre-planning and total cooperation from all involved.

As shown in the architectural layout (Fig. 1), the control complex consists of three main areas: production (or tv) control, audio control, and video control. During a show, production control is "the center of action" from which the director coordinates the entire show. However, this control room is also capable of handling "special events" presentations (conventions, elections, etc.) where it is necessary to coordinate additional outside locations in relation to the studio operation. This is normally done by the producer sitting at the console directly behind the director. Of necessity, many communications and monitoring devices are built into these consoles to facilitate the coordination effort.

Video

The heart of the video system is a vertical-interval type switcher (Fig. 2) adapted to NBC operational requirements. It contains nine output buses

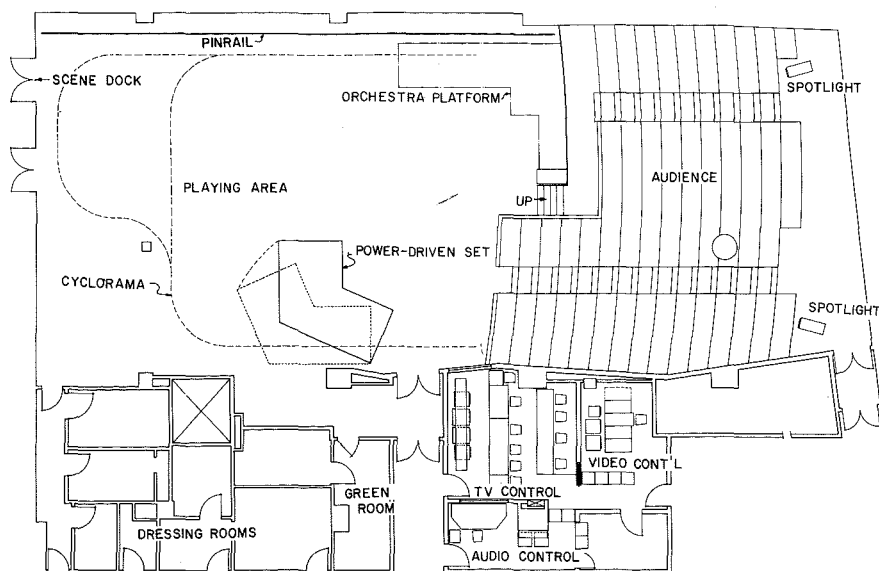

Fig. 1—Studio 6B layout.

providing seventeen inputs and one effects re-entry. A delegate switch provides the capability of substituting two more effects re-entries (normally used as previews) for two of the primary entries.

An additional tenth bus is provided as a preview; however, this is a small switcher, completely separated from the main unit. Thus, if the main switcher fails, the preview switcher may be substituted on the program bus. Its normal function as a preview allows it to be continuously monitored prior to emergency use.

All of the video switchers designed by NBC are operated by pushbutton-addressed control relays. The relays, in turn, route trigger pulses to the proper video cross-points. This system has been utilized to facilitate custom design. Every switcher built by NBC is basically the same—only the control logic need be modified for specific installation requirements. This method of design simplifies the incorporation of such features as Preset-Program switching “flip-flop,” double Preset operation for Black or Insert-Over-Program, search-Preset-remote-start, Lap lever controls with no mechanical direction (they *always* dissolve from Preset to Program), and many control lockout features for the prevention of operational errors (such as an attempt to dissolve between non-synchronous inputs).

All inputs to the switcher are of a composite-video nature, and the switcher is essentially “free-floating” with reference to time base. The Effects equipment is fed from an externally locked sync generator making possible the processing of a signal not synchronous with the Radio City time base. It is also possible to operate one of the cameras from this generator thus allowing inserts into *any* time base on the Program Bus (Superlock operation).

The cameras used in this studio are latest design plumbicon types with controls mounted in a specially designed low silhouette console. Note the “joystick” central control position providing one-man operation (Fig. 3). These controls allow fingertip changes of both pedestal and gain (as well as preview pushbutton access) on all four cameras from one central loca-

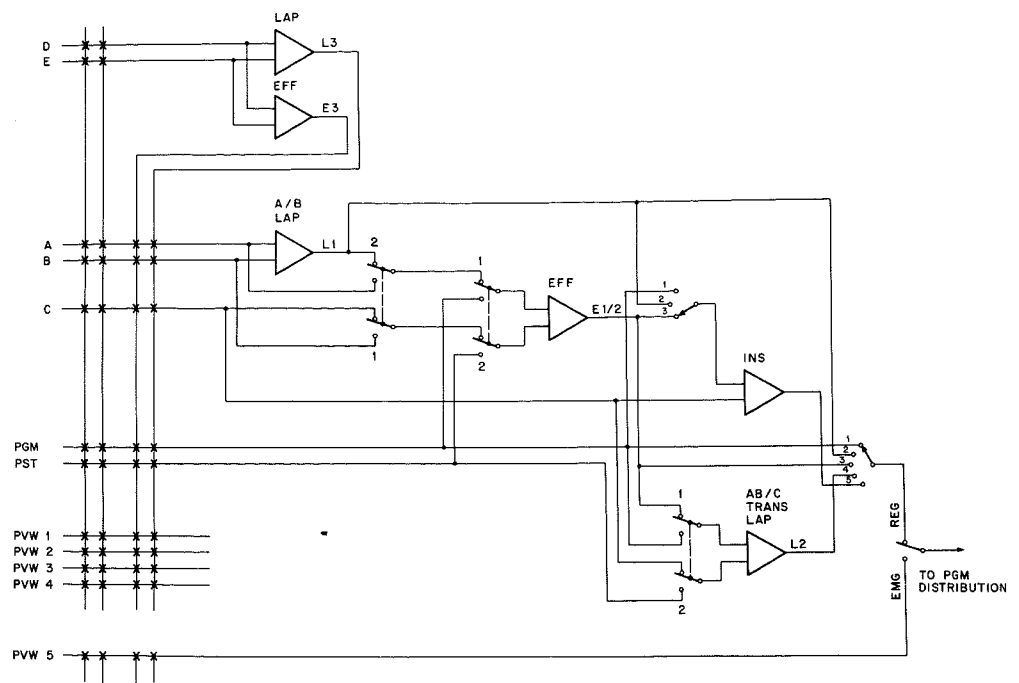

Fig. 2—Simplified block diagram of the video switcher.

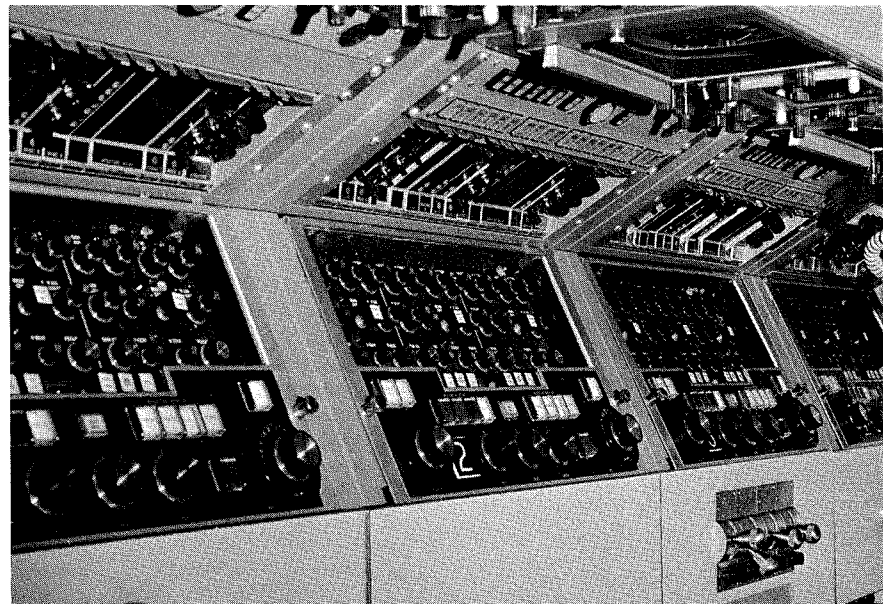

Fig. 3—Video control console; the “joystick” central control position is located in the lower right-hand corner of the photo.

tion. Though seldom used, remote “paint pots” are also provided for the video operator. All of the colorplexers and power supplies are mounted to the left of the video operator in a rack bay which additionally provides a video patch area, chroma-key amplifiers, video distribution amplifiers, pulse distribution amplifiers, and test equipment.

In conjunction with the switching equipment, the sensitivity and stability of the cameras allows video effects

which were highly impractical a few years ago.

A camera-cable patchboard is provided within the control area to allow any of the floor cameras to plug into a floor outlet with proper video console control (Fig. 4). A camera-tally-assignment panel makes it possible to feed camera video into any position on the switcher with the camera tally following the proper pushbutton. This panel provides the additional capability of separating any camera position

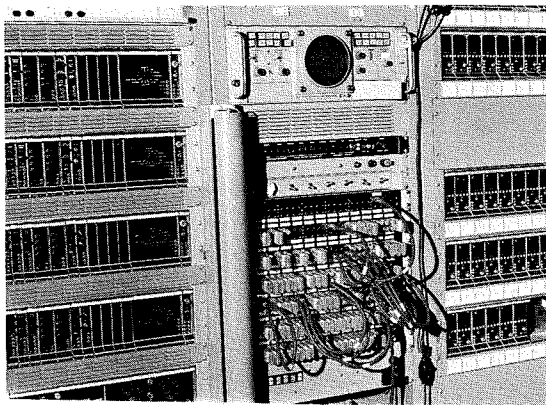

Fig. 4—Rack-mounted equipment for camera control located in the video control room.

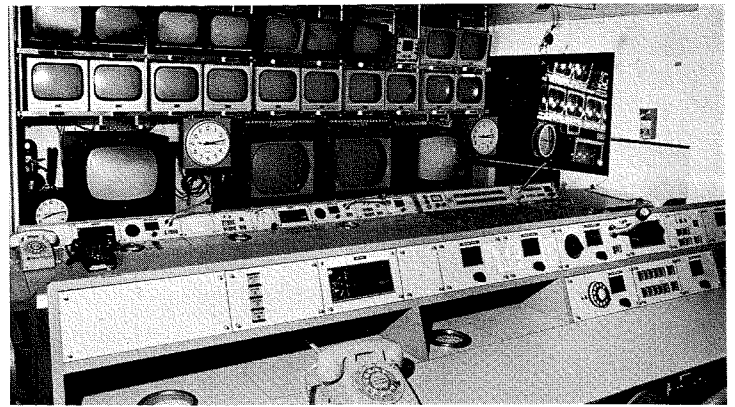

Fig. 5—Control room as viewed from the program director's and producer's desk.

communications panel from normal studio operation and allowing direct connection to a remote studio. Thus, a camera from 6B may be "borrowed" for use in any pre-selected area.

Monitoring

One of the areas requiring careful consideration in the design of any studio complex are the monitoring functions—audio and video. Today's production groups involve many people with diverse requirements for putting a show together. Studio 6B has provision (in addition to the normally required audience facilities) for unique patching audio and video to fourteen floor (stage) outlets. These floor outlets exist over and above the normal requirements for floor speakers (PA), headset monitoring, communications, cue lights, and special feeds and are all grouped together with the microphone input trunks into a Broadcast Service Panel (BSP). Seven of these locations are provided about the floor area.

Within the production control room (Fig. 5), one waveform monitor and nineteen video continuity monitors (one per input plus three special) are mounted on hanging shelves for total viewing. Color monitors (21 in.) are provided on the Program and Preset bus outputs as well as two large monochrome monitors for Program (Channel output) and Preview monitoring. To avoid confusion in the identification of a particular program source, tally-light readouts are provided above the Program and Preset monitors as well as monitor shelf identification placards (white illuminated) below each continuity monitor. These

placards turn red as a particular source achieves on-air status.

For audio, four self-contained positions have been provided within the production consoles which allow monitoring of twenty-four normal in-plant feeds plus six patchable feeds from the central equipment area. In conjunction with this thirty-point system, four additional cue amplifiers have been mounted on panels to provide four positions for ten-point incoming line monitoring. Note in Fig. 5, the continuous rails provided in the turret of the director and producer console and the pawl-lock fasteners at each corner of the inserted panels. As each of the panels is a plug-in modular type, they may be moved left or right in the console turret for maximum operator convenience.

A Program and Preset speaker is provided in the control room ceiling for quality monitoring, the dual provision allowing simultaneous Program and Preview capability.

The audio-booth program speaker is a high quality type, but in addition, a smaller preview speaker is provided. The video-booth program speaker is of the same quality as the audio preview but a smaller existant type allows monitoring of an associated studio to which one of the 6B cameras might be assigned.

Audio and video monitoring also extends out to the lighting bridge, the famed "Green Room" and all other dressing rooms associated with the 6B studio. These dressing room feeds are interruptable from the control room or floor manager patch-in position to provide an Actor's Call System. The

call system defeats any monitoring volume control settings in the various locations so that a stage call will come out of the speakers at a preset level.

The transcription turntable (TT)/tape area (Fig. 6) is also provided with a program speaker which is interrupted by footswitch cueing of the turntables. Note the wall mounting of the RT-21 tape machines over the turntables. Each of the tape machines has its own built-in cue amplifier for audio monitoring. In addition, two nine-inch monitors are provided on swing shelves for convenient TT/tape viewing or for viewing at the audio console. Patchable wall outlets are provided at the audio position. Built into the audio console (Fig. 7), in line with his volume indicators, two 9 inch video monitors (Program and Preset) are provided for the audio man.

In the audience area, nine 23-in. monitors are suspended by steel cable wound on power-driven winches mounted in the ceiling. This method of raising and lowering the monitors plus a rotatable yoke hanger provide ease of maintenance and full freedom of monitor orientation. The audience PA system is of the low-level type; i.e., many small speakers are hung above the audience just above reach giving full coverage with lower speaker level than the normal theatre system. In addition, the speakers are "sectorized" into groups allowing levels to be lowered to follow a handheld mic in the audience area. A PA operator sits in the audience to coordinate the entire effort.

Audio

The audio console (Fig. 7) is a com-



Fig. 6—Portion of the audio control equipment, including transcription turntables and tape machines.

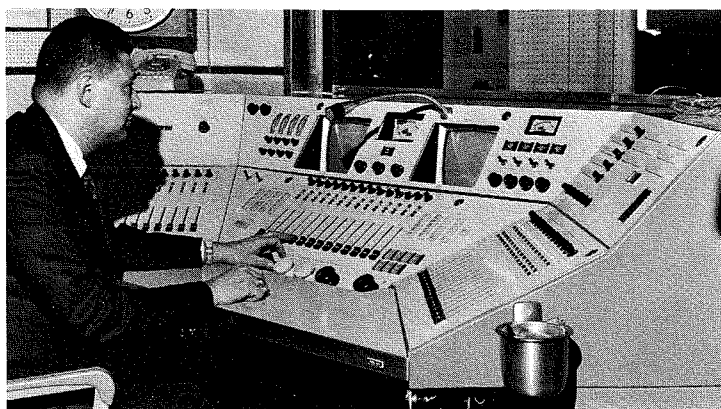

Fig. 7—Audio control console.

pletely customized unit built to NBC specifications. Following video techniques, the console is built in two equipment racks and remotely controlled from the console. This includes relay switch operation and LDR faders. This compact packaging provides an extremely low noise console and simplifies layout and wiring.

The audio routing through the console is straight-forward. Forty-two microphone faders are provided which may be delegated to any of five submasters. These in turn are routed through a microphone master fader. Each fader has an associated Echo Send fader which is delegated when the preamp is assigned. An eighteen-position job switcher allows selection of incoming remote feeds with a sixth submaster for level control. Should a nineteenth button be pressed, the remotes are routed through the control relay logic of the video switcher thus providing audio-tracking-video; a simplified block diagram of the audio system is shown in Fig. 8.

As auxiliary equipment, two echo trunks, four microphone equalizers, four compressors, two effects filters and various coils, pads and spare faders are provided for patch-in use. The effects filters are fed through an effects relay system designed to track preset camera inputs to the video program bus. The net result allows such effects as a telephone conversation with the "off-camera" end of the conversation filtered to sound like the receiving end of a telephone. Of necessity, the switching between both ends of the conversation would occur too rapidly for the audioman to fol-

low with the filter insertion—thus, the use of relays.

Of particular interest is the mix-feed system used in Radio City. Many times it is important that a return monitoring trunk to a particular location consist of total or partial program without the location itself mixed in. This is especially necessary when remote speaker monitoring is required because acoustic feedback through a "hot" microphone would result. The sources for the mix-grid originate from the console submasters (including the remote submaster) and are fed to two mix-assignment panels: one for the PA system, and one for the outgoing lines. Individual pushbuttons (backed by high isolation) allow any mix combination of the seven submasters to be sent out to the system locations.

Communications

The ability for an entire tv production group to act as a team rests solely on the calibre of the system communications. Physical proximity, where practical, allows immediate verbal and visual cueing. These considerations were made as part of the architectural layout. But there are many additional locations outside of the control room area that also require communication: cameras, remotes, video tape, film, master control, etc. Individual locations also make different demands on the methods of communications used with the areas: headset, speaker, two-way, one-way, etc. For this reason three distinct communications systems are incorporated in Studio 6B: Intercom, Interphone, and IFB/SA/CUE (Interrupted Feed Back/Studio Address/Cueing System).

The IFB/SA/CUE system is related to the mix feed audio setups previously mentioned. Each of the mix outputs is routed through an interrupt relay panel prior to connection to an outgoing line, studio trunk, or plant distribution trunk. This, then, allows interruption of a monitoring feedback to any location with a verbal cue from any of three control positions.

Within the same panel are the relays providing the amplified studio address capability normally used when rehearsing a show (or "on air" if desired). Proper muting relays are incorporated to prevent feedback when in "on air" or rehearsal modes. Operating positions are provided for both engineering and production.

The Cueing System (again incorporated within the same panel with IFB and SA) operates selectively from either the director or producer microphone. A direct tap from either microphone is provided allowing everything spoken into these mic's to be heard at three locations: an audio console speaker, studio wall outlets, or the modulation input to a cue transmitter. This low frequency transmitter allows a stage manager complete freedom when walking throughout the staging area and yet provides (by means of a small portable receiver) continuous cueing from the control room.

As noted on the single lines, each of these systems (IFB/SA/CUE) is directly related; therefore, the combination provided by the single panel excludes duplication of equipment.

The intercom system provided is primarily used when lighting the studio. During setup, it provides "hands-off"

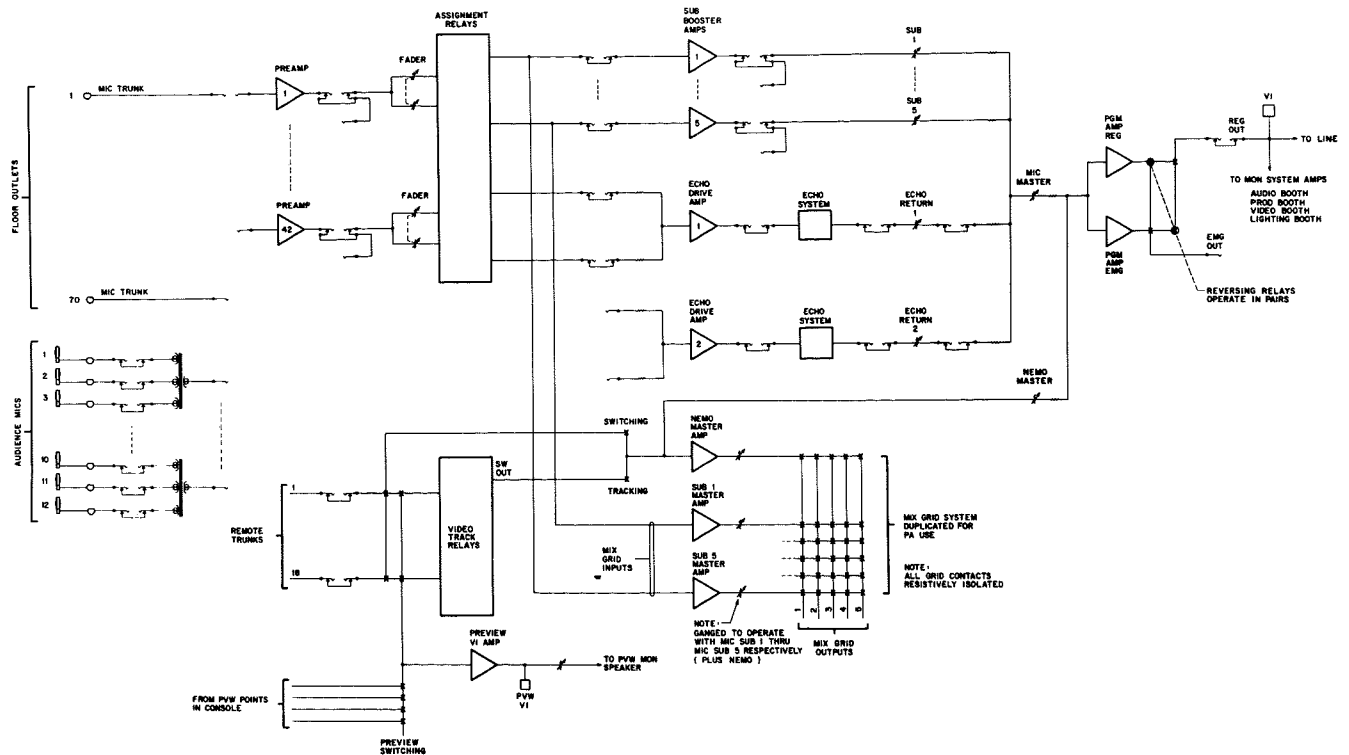

Fig. 8—Simplified block diagram of the audio control system.

operation between the Lighting Booth and the floor; during show time, it provides fast communication between the Lighting Director (or Technical Director) and the Video Booth.

The interphone system is one of the most important, as it provides primary communications with the cameras. As seen on the interphone block diagram, a relay panel allows crosspoint access from any operating position to various operations buses. All headset positions are amplified in both the transmit and receive directions by means of small individual amplifiers. Transmitter battery (for the carbon microphones) is isolated from the outgoing line so that each position provides balanced isolated, "dry" circuit audio to the relay panel. Thus, all interphone circuits are handled as normal audio pairs. Compensation for levels due to changes in loading on any specific bus is done at each position by means of a volume control.

Lighting

The lighting booth is located within a portion of the studio staging area. However, it is built within the upper half of the studio providing for a commercial staging area on the floor below. The floor area of 305 square feet provides room for a 60-position dimmer board (18 no-dim and 42 12-

KW SCR dimmers) a 335-load circuit patch panel, a main remote-control console, and a ten-preset auxiliary console. The patch panel is shown in Fig. 9.

The lighting grid consists of split batten load pigtail assemblies hung from power-driven rope sets. Additional pipes hung between the lighting battens provide room for more lamp hangers, or function as utility hangers for overhead speakers, production scenery, etc.

Stage illumination is provided by a combination of incandescent and quartz lamps, although the majority of lamps are of the quartz variety. Although the dimmer board capability is more than adequate for orthicon-camera lighting, a slight reduction from past practice has been made due to the use of plumbicon tubes; how-

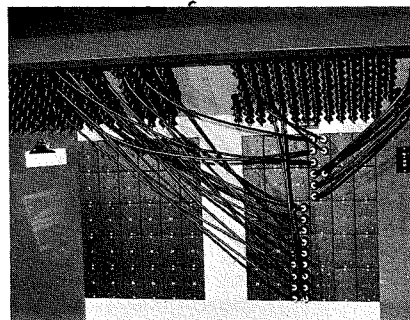

Fig. 9—Lighting patch panel.

ever, this reduction is not significant due to the present practice of "stopping-down" the cameras for increased depth of field.

In addition to the stage illumination, provision has been made to dim the "house lights" as in standard theatre practice.

Air conditioning

It has been found that variation in studio heat loads make it almost mandatory that each studio in Radio City have its own supplemental air conditioning plant. The use of transistorized equipment has reduced the heat loads to such an extent that cooling is primarily applied for set lighting and "people" load purposes.

A chilled water and fan unit supplies the additional cooling necessary for audience comfort and contributes to front-stage cooling. The control complex and backstage are fed from the regular Radio City central air conditioning system. However, normal air would produce too low a control room temperature when the studio was standing by; therefore, each of the control rooms has a supply duct heater with its own thermostat.

For economic reasons, the cooling fan unit is installed as part of the return grid for the studio area. The proxim-

ity of the fan would cause acoustic noise within the studio were it not for an intricate baffle system to reduce both fan noise and air rush.

Production aids

In addition to technical power, general lighting power, stage lighting power, and air conditioning power, two panels are provided on the studio floor for the distribution of special effects (stage) power. These panels allow the operation of stoves, refrigerators, etc. on the studio floor, but also provide for rear projection devices. Note the large double doors at the rear of the staging area providing access into the scene dock. These, in addition to scenery movement, allow a rear projector to be located in the dock area (off the staging area) for on-stage rear-screen projection.

As an aid to the technical personnel, two ducts (one for low level distribution; one for high level) completely encircle the playing area. These ducts provide the feeders for the broadcast service panels. Running parallel to these ducts is a ladder track on which camera cables are run. This track provides an easy method for dressing

temporary cables off the floor for any special production requirement.

An applause sign is hung from a motor driven batten on the grid thus making it simple to raise or lower the sign as desired.

Two Dyna-beam platforms are provided at the rear of the audience with sufficient headroom to allow theatre-type spot lighting.

Architectural

To provide the audience with the "theatre look" and yet satisfy the production needs and economics of TV broadcasting, the architectural features were given careful consideration. The walls below the duct work encircling the studio were covered with 2-inch pressed fiberglass panels providing durability, decor, and acoustic quality. Above the duct work, 2-inch insulating fiberglass batts with a vinyl textured overlay were set in clip frames. This construction allows an extremely simple installation covering all pipe runs and yet provides easy access to these pipes.

The ceilings are of the suspended grid type with all illuminating fixtures

flush to the surface (even the stage work-lights are recessed). This construction again provides easy ceiling access with a good appearance and allows for grid maintenance.

New theatre seats were installed in the audience area and carpeting was installed up the aisles, throughout the rear audience entry and along the rear wall of the seating area.

Conclusion

This studio was designed with the *Tonight Show* in mind, but the facilities installed make possible the production of many different formats. The equipment installed was "state-of-the-art," but certainly improvements are forthcoming rapidly. The next studio to be constructed will have new facilities and methods incorporated, but all have been built upon the knowledge and experience gained from their predecessors.

There is no doubt that the planning that went into this studio has produced the result desired—total integration and efficiency with a unitized custom look.



Burbank computer operation

K. D. Erhardt

For the past five years, the NBC Television Network in Burbank has used a computer to store, retrieve, and process program information for switching three television channels. The programs for each day are fed from a variety of sources, including live studios, film chains, and video tape recorders. With this system, the events required for the entire day can be organized and entered into the computer in advance. An executive program directs the computer to make tests of the program information as it is entered from a keyboard and just prior to air time. As a result of the operation, equipment and manpower needs have been reduced and program switching errors have been reduced significantly.

FOR NBC, television on the West Coast began in a location in Hollywood which originally had been used as a Network radio studio. But those facilities soon became inadequate for the scale of operation required for television. Property was purchased in Burbank with room to expand, and initially two larger studios were built for West Coast program originations. At this point (1952) all programs were fed through switching points in Hollywood where the film facilities and the manually controlled switching systems were located, and the sequences of program materials for broadcast were assembled and distributed by the Hollywood facility.

With the advent of Color Television in 1954, more new facilities for both live and film originations were built in Burbank. Gradually, the majority of the programming shifted to Burbank, eventually reaching the point where a new switching system was needed to release outgoing material from that point.

The work begins

Planning was underway at this point to move the whole operation to the Burbank location, so the dimensions of the switching problems received much study. The program channels to be fed were well established. They were the KNBC local station transmitter, the Pacific Coast NBC Television Network, and Telco lines feeding programs to NBC East Coast. The sources of television programs to those channels would be a large assortment of studios, video tape machines, film

cameras, cartridge audio tape machines, announce microphones, etc.

Assembling, switching, and distributing the programs just before the move to Burbank involved the use of three studio control rooms, two in Hollywood and one in Burbank. The studios in Hollywood had 5 and 4 film chains, respectively, and the studio in Burbank had 6 color film chains; the total number of film chains was 15. In addition, there was a Master Control Room in Hollywood which switched between the studios to feed the three outgoing channels, and in Burbank there was a Tape Central switching point which had 8 inputs and 4 outputs for preselection of video tape machines before airing them either through one of the studios or through the Master Control Room.

Until now, the assembly switching of programs being fed to the Pacific network and to station KNBC was done through separate control rooms, each of which had the necessary film chains for its operation. On occasions, when it was necessary to divide the Pacific network into smaller regions and feed different program or commercial materials to the different regions, a third control room would be required.

The new Burbank Switching Central was designed so that with no increase in personnel, it could do the Master Control switching functions previously done in Hollywood and eliminate the Tape Central switching point and its staff, taking over its functions directly.

The new Switching Central was placed in service in the spring of 1962. The output switching was done manually by loading information for each channel into preset relays, then putting the

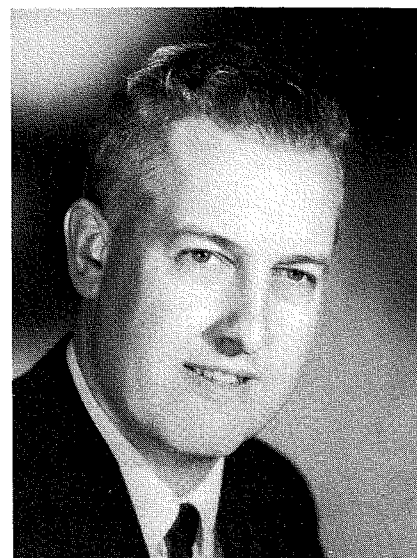

Kenneth D. Erhardt, Mgr.
Film Technical Operations
National Broadcasting Company
Burbank, California

earned the Bachelor of Science in Electronics and Radio Engineering at California State Polytechnic College in June of 1950. Since then he has done post graduate studies in Computers and Electronics at U.C.L.A. Mr. Erhardt joined NBC radio in San Francisco in 1950, transferred later the same year to the NBC Television Network in New York. From 1951 to 1953, he took part in field testing the RCA/NTSC color television system. From 1953 to 1954, he worked in the NBC development laboratory in New York on color film pickup devices. In 1954, he was transferred to Burbank to aid the opening of NBC's Burbank Color facility. From 1963 to 1966, he worked with NBC and Control Data Corporation engineers in developing, installing, and placing into operation the computer controlled automatic switching system at Burbank. Mr. Erhardt is a member of SMPTE and, at present, is serving a second term on the Board of Managers of the Hollywood Chapter. For the past seven years, he has been a member of the Color Committee of the SMPTE.

preset event on the air by using an enable pulse. Design of this system anticipated the addition of a computer to effectively add additional preset levels to the mechanical relay system and do other tasks to aid the operator.

One other preparatory step was taken before the computer was installed. By making small additions to the facilities in one of the Burbank control rooms, the release of programs and inserts which were common to both KNBC and the Pacific Network were combined in one Control Room effecting further savings in equipment and manpower.

The project is completed

In March of 1966, the computer switching facility was placed in operation. Again, no extra people were

required in the technical area where it was located and the last control room and part of its staff was released from continuous on-the-air service.

Completion of the computer-operated Switching Central facility made possible the following comparison:

<i>Prior operational requirements</i>	<i>Computer-controlled requirements</i>
15 film chains	10 film chains
3 control rooms	Switching central
Tape central	
Master control room	

Manpower requirements were similarly reduced.

The nature of outgoing feeds

KNBC channel

KNBC is on the air from Sign On (6AM) to Sign Off (1AM). Signal sources include all sources which originate programs to the Pacific Network, video tape, film, studios, and network lines plus additional sources which feed only the KNBC channel, tapes, films, etc. which are broadcast at times when the Pacific Network is not being fed.

Pacific channel

This channel is on the air whenever the Pacific Network stations are being fed, normally 7 AM to 3 PM; certain closed circuit feeds from 3 PM to 4:30 PM; 6 PM to 7 PM, 7:30 PM to 11 PM and 11:30 PM to 1 AM. Signal sources will be films, video tapes, studios, and network lines.

East channel

The East channel is on the air when program material is being fed to the East Coast: mainly news material for various news programs which originate in the East, live sports events from the West, etc. Sources will be most often the output of a studio—occasionally video tape machines, rarely a film chain, sometimes incoming remote lines.

Important to the economics of the situation is the fact that KNBC is one station of the Pacific Network. Programs broadcast on those two channels can originate from the same signal sources in closely alternated sequences. This reduces the total number of pieces of equipment and manpower required to service the two

channels compared to what would be required if the switching systems were separate.

Dimensions of the switching problem

Sources of signals to the switching grid are:

	<i>Signal sources</i>	
	<i>Video</i>	<i>Audio</i>
10 Studios	10	10
10 Film Chains each multiplexed with 35mm, 16mm, and slide projectors	10	20
19 Video Tape Machines	19	19
5 Nemos (incoming lines)	5	5
2 Network lines	2	2
2 Live Cameras	2	0
2 Slide Scanners (Standby Fax)	2	0
1 Black and silence position	1	1
2 Announce Microphones	0	2
2 Audio Tape Cartridge Machines	0	2
1 Test Input	1	0
<i>Total signal inputs</i>	<u>52</u>	<u>61</u>

There are three output switching channels which are fed out of the plant and are computer controlled. Four additional switching busses are used within the plant and are manually switched.

The computer hardware

The problem at hand is basically one of on-line control of a real-time process. Accordingly, the selection of the specific computer to use was narrowed to those types which have characteristics designed for that application.

Briefly, characteristics needed for on-line process control are:

- 1) Instruction list with many flexible logic manipulations,
- 2) Adequate speed,
- 3) Short word length,
- 4) Multilevel priority interrupt system,
- 5) Medium size, random access, non-volatile memory,
- 6) Large random-access contact closure output interface,
- 7) Large random-access input interface, and
- 8) Only simple hardware arithmetic operations.

The computer selected, after much research of those available, was the Model 636 made by Daystrom. (Daystrom was acquired by Control Data Corporation while the project was in progress) The Model 636 is a stored-

program general-purpose digital computer. Solid-state circuitry is used throughout for stable operation using a minimum of power and producing little waste heat. Self-contained core-memory storage is available in modules of 4096 words to a maximum of 32,768 15-bit-plus-parity words; the NBC application uses 20,480 words. Drum memories may be added, but were not required in this case.

Memory lookup cycles and transfer operations are parallel operations. Most other arithmetic, logic, and similar operations are done serially in multiples of 17 μ s. The number system used in the hardware is binary, with two's complement arithmetic. The binary point is fixed, and the clock rate is 1 MHz.

The instruction list contains 131 different commands. A distinctive feature of the Model 636 is the Partial Operand Command. When this command immediately precedes an instruction using information from memory as an operand, it causes any desired portion of the operand to be used rather than the whole word. This feature speeds the action of unpacking information stored in specially packed formats.

Another feature of this computer is the availability of stored register counting circuits which use "external memory access time," which means that these counters do not use any time of the central processing circuits but are always available to the programmer for timing operations. Counters are used in several places in the NBC Executive Program.

Since the principal interface of the computer is through the keyboard and relay system of the switching central facility, only three pieces of peripheral hardware are used: a tape punch and reader which are mounted in the main computer cabinet, and an electric typewriter through which the computer writes a log of operations it is asked to perform.

The switching central keyboard, keyboard readouts, and monitor housing need considerable description since they are the principle man-machine interface in this system.

The keyboard (Fig. 1) has an array of buttons to allow the following

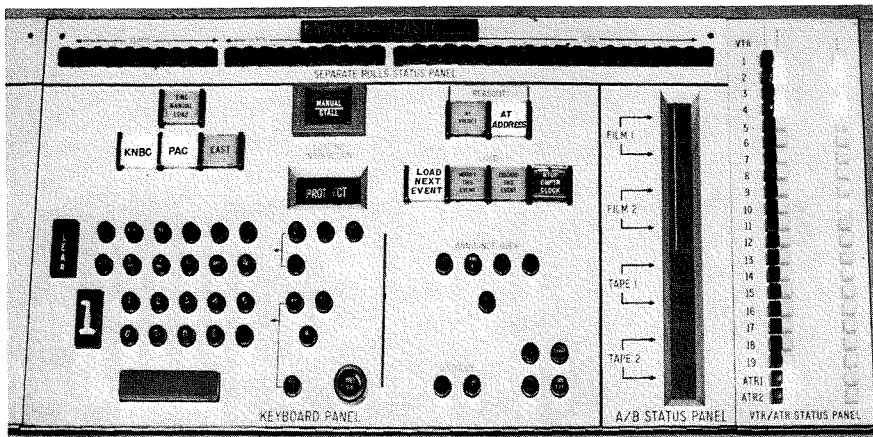

Fig. 1—Switching-central keyboard.

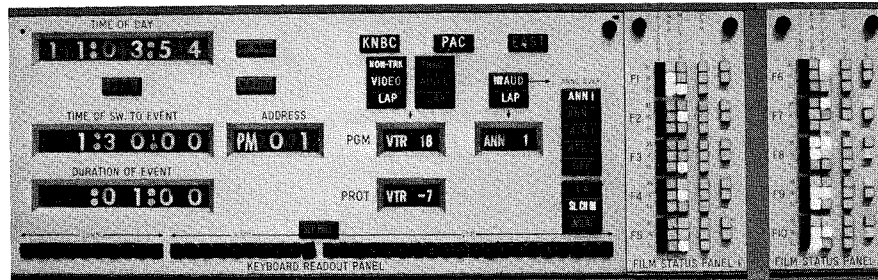

Fig. 2—Keyboard readout panel.

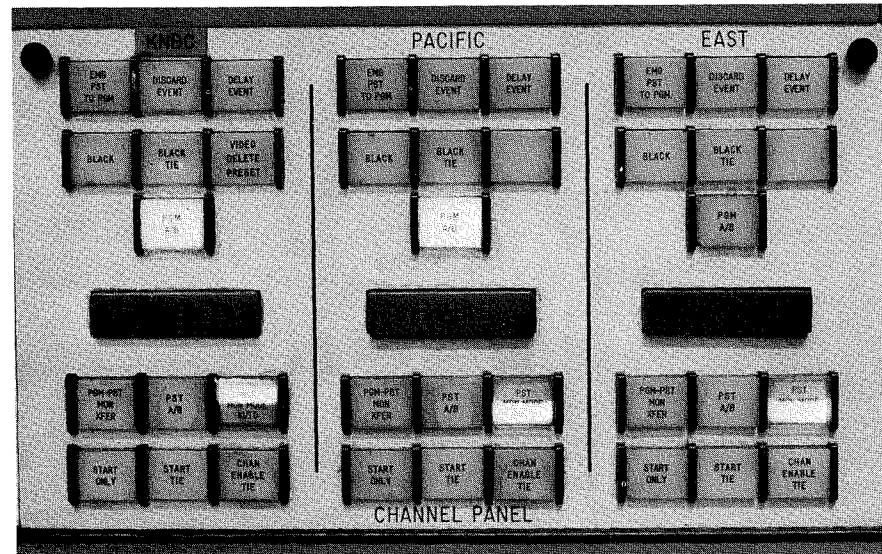

Fig. 3—Operator's panel.

descriptors to be entered into computer memory for later use in on-the-air switching:

- 1) Channel used—KNBC/Pacific/East
- 2) Time—
 - a) Actual clock time of day (AM or PM)
 - b) Interval time (time duration of an event)
- 3) Category — studio/film chain/video tape/etc.
- 4) Numbers
- 5) Special factors—
 - a) Lap dissolve

- b) Insert
- c) Audio over
- d) Slide change inhibit
- e) Commercial audio
- f) Audio over off
- g) Separate roll
- h) Protection copy
- i) Video source
- j) Audio source
- k) Black
- l) Load next event
- m) Discard this event
- n) Modify this event
- o) Readout at address
- p) Enable bar

As the switching central operator presses the buttons needed to describe an event, the computer program organizes the information for storage and retrieval and simultaneously displays it on the keyboard readout panel (Fig. 2). If the information so displayed appears correct, then the operator depresses the ENABLE bar, and the computer stores that event and blanks out the display panel in preparation for loading a following event.

At any time during the day, any event loaded in the computer may be called out for display on the keyboard readout panel by asking the computer to Readout at Address (using the Channel and Time of day as the Address). While an event is displayed on the panel it may be discarded or modified by pushing appropriate buttons. This will result in the keyboard display being modified to agree with buttons pushed. When satisfactory, another press on the enable bar will result in the computer replacing the old event with the new information. If a following event has already been loaded, the computer will step to it and display descriptors of that event. Successive events may be displayed simply by repeatedly pushing the enable bar while having the READOUT AT ADDRESS button active.

Channel panels

On the console at the operating position is a panel (Fig. 3) with separate controls for each outgoing channel. Part of the controls on this panel work through the computer and part of them operate only the relay system. The following functions are performed through this panel:

Through the computer:

- 1) ENABLE—Placing events on the air which have previously been entered into preset relays.
- 2) DISCARD EVENTS—Discards the event at the preset level.
- 3) DELAY EVENT—Prevents all events loaded with real-time starts from occurring automatically. The operator can still make the events occur by using the manual controls.
- 4) START ONLY—When pushed, this button causes the computer to output a roll pulse to the next rolling device down the list of events on its channel.
- 5) START TIE—When operated along with other CHAN START TIE buttons, this control causes each channel so setup to receive a start pulse when any START button is operated.

- 6) CHAN ENABLE TIE—When this and other CHANNEL ENABLE TIE switches are operated, this switch causes each such channel to receive a channel-enable pulse when any one of their ENABLE bars is operated.
- 7) PGM A/B—Reverses air and protection copies of program sources.

Not through the computer:

- 1) Black—Momentarily switches both audio and video to black to delete undesired material.
- 2) Black Tie—Connects black function to a tie bus so that two or more channels can be switched to black by pushing one button.
- 3) Video Delete Preset—Sets up a special effect device to delete a portion of the picture which might have lettering across it.
- 4) Emergency Preset to Program—Interchanges the Audio and Video Program and Preset Amplifiers in the channel path to allow a failed amplifier to be most quickly by-passed.
- 5) PGM PST Transfer—Interchanges the program and preset monitors while depressed to allow comparison of A & B copies of programs on the color program monitor. (Preset monitor is monochrome.)
- 6) Preset A/B—Reverses A and B copies of program at preset level so that when enabled, the copy aired on the next enable pulse will be that which was loaded as B copy.
- 7) Preset Monitor Mode Automatic—When in the preset condition, the preset monitor always displays the preset event. In the automatic mode, if there is a B copy running, the preset monitor displays the B copy except for the 10 seconds just preceding the next event when it switches to preset to display prerolls of films or tapes.

Software

Space (and your patience) does not permit a complete description of the software generated for this project. The logical processing of information from computer loading through possible modifications, on air switching, and final logging will be described to point out some of the complex, inter-related situations.

As mentioned earlier, the total memory used in the Model 636 computer is 20,480 words. Of this total, approximately 16,000 words are used to store the executive program which is permanently stored in memory. The executive program consists of various sub-programs, tied together by the multi-level priority interrupt feature of the Model 636. All sub-programs are not of equal comparative importance at any given time. For example,

typing the output log has a lower priority than outputting an on-the-air switch, so the sub-routine for typing will be interrupted by a demand to switch.

Consider the sequence of program events listed in Table I.

Assume that the computer memory contains the executive program, that it is running, and that there are previously loaded events at the on-the-air program level on each of the three outgoing channels.

To load the 8:00:00AM event for the KNBC channel into the computer, the operator would first depress the READOUT AT ADDRESS and the KNBC channel buttons on the keyboard loading panel (Fig. 1).

Prior to the first button being pressed, the computer would have been operating in the 0-level subroutine which deals with "housekeeping" functions, such as operating the typewriter, checking the events ahead (in this case there are none) to see if any actions are required, etc. Once each second, upon receiving a signal that a new clock time is available from the NBC digital clock, a check would be made to see if any relays should be set at that time; if so, another subroutine is entered to set those relays. Checking the clock time has priority level 10 and outputting the relays has levels 12 and 13—which are all higher-level-priority functions than housekeeping; thus, the computer will cease its housekeeping until the higher priority items are finished.

When the READOUT AT ADDRESS button is pushed, a level-7 priority-interrupt signal is generated which pulls the program out of the housekeeping level of programs and simultaneously puts a true signal on one wire of an input word. The computer then enters a subroutine which searches a particular group of input words corresponding to the interrupt signal which was true

to find which button was pushed. That button will then determine which routine the computer will enter to use the information. In this case, it will initiate a program for searching memory and will output a signal to light the button which was pushed. But this is not enough information to describe an event.

A similar series of computer program events will be triggered when the Next, the operator must enter the time KNBC channel select button is pushed. of the event just ahead of the place he wishes to load a new event, in this case, the on-the-air event. Each number button he presses will interrupt the computer 0-level housekeeping routine and cause it to determine what button was pushed, then take appropriate action to use the information. In the case of time digits, the numbers will enter the time readouts at the least significant column and be moved to the left as each successive number is loaded.

Once the time is loaded, enough information is available to the computer for it to search, which it will do when the keyboard ENABLE Bar is pressed. The search routine will locate, in bulk storage, the event requested, unpack it from the format in which it was stored, and display all descriptors for the event on the keyboard readout panel (Fig. 2).

After checking the display on the panel to confirm that it is the event just before the place to load the new event, the operator will push the LOAD NEXT EVENT button. The computer will then branch to a group of sub-routines which will first blank the keyboard display panel, advance the address number display by one digit, and initialize the subroutines for loading events. The operator will then proceed to push buttons describing the new event. After checking the display for correctness, he will push the ENABLE bar, and the computer will

Time	KNBC Channel		Pacific Channel		East Channel
	Video	Audio	Video	Audio	Video Audio
8:00:00AM	S1-1	Ann. 1	Nemo 5	Nemo 5	Black
8:00:15AM	F2-35	F2-35			
8:01:15AM	VTR 2	VTR 2			
8:02:00AM			SL-2	ATR-1	

Table I—Typical sequence of program events.

store the information, packed in a special format for later retrieval. The same procedure will be used for loading each of the events listed.

The list of all events loaded is tightly packed and leaves no vacant spaces between events. Simple events requiring little space use a small-size format. Events with more information in them will start with the same short format, then add another increment of memory space to contain the additional information. When events must be added between previously loaded events, the computer has an intricate subroutine to perform which moves the information (located where the new event should be) to the end of the current list, then adds information. In turn, at the end of the new information, an address is added to lead the searching program back to the original sequence of stored events.

The format in which the information is stored in bulk is designed for optimum information density but is not convenient for quick use when switching. For that purpose, the computer forms three tables of the next ten events on each channel; these are called look-ahead tables. Events are placed on the air from this table and a *0-level*-priority routine reloads the table with new events to keep it full. The look-ahead tables store the information in a format for quick inspection, whenever a time pulse (1 each second) arrives, to determine what action is required on that second.

As the 8:00:00AM time approaches, the computer examines the look-ahead table for coming events. A slide is called for from film chain #1 on the KNBC channel at 8:00:00AM; so 10 minutes or ten events (whichever is less time) before the event is due, the computer checks to see which projector is multiplexed into film camera #1. If it finds that the slide projector is not multiplexed to the camera, it checks to see if either of the other projectors on film camera #1 has a picture on the air on any channel. If this is not so, another test is made to see if any other event between now and 8:00:00AM uses a picture from film chain #1. If not, the computer outputs a pulse to change the multiplexer on film chain #1 to face the slide projector. A short-interval timer

is set at this time also. When it overflows and generates an interrupt, the computer checks the status wires to find out whether the multiplexer responded to the pulse. If so, fine; if not, a second pulse is transmitted and checked; if this one fails also, a device-warning light comes on and an audible alarm is given to the operator. The same checking will be done for the events on the look-ahead table for the Pacific and East Channels.

Whenever an event goes on the air, the computer checks the look-ahead table to find the next event and outputs that event into the preset relays for the appropriate channel. It also checks to ensure the relays were set properly.

When the 8:00:00AM time arrives, the computer checks the event at preset against requirements. If they are correct, it outputs an enable pulse to each channel which has an event called for at that time. Again, it checks to find out whether the scheduled relays operated. If not, it sets off alarms.

Basically, the same manipulations are performed as each event approaches airtime. If a rolling device such as a video tape machine or motion picture projector is the picture source coming up, the computer checks ahead and outputs a start pulse to the device 5 seconds before airtime for film or 10 seconds for videotape. Once again, checks are made to determine whether the device responded to the pulse. If a rolling device fails to start, a second try is made and checked. If that fails too, then the computer will not switch to the failed source. A start pulse will be sent at the scheduled air time. If that one succeeds then the device will go on the air. If that last try fails, a check will be made to see if a duplicate protection copy was loaded and if it is rolling; if so, the protection copy will be put on the air. As before with the multiplexer, when a device fails to respond, red tally lights are lit and a warning signal is sounded.

There is a remote possibility that the status wire was what failed and the device is operating properly, but the computer cannot determine this. For reasons such as this, the operator can always override the computer logic and manually switch to the event.

If any event is blocked from computer switching for whatever the reason and the operator does nothing about the situation, the computer will discard the failed event 1 second before the next event is due to occur. This prevents losing a string of properly prepared events because of the failure of one ahead.

Notice that in the Pacific Channel, the 8:02:00AM event needs slide projector #2. But 35-mm projector #2 is in use on the KNBC channel from 8:00:15 to 8:01:15. This means that the #2 multiplexer cannot be switched to the slide projector until 8:01:15, when F2-35 leaves the air on KNBC. The computer will detect this situation and will light the warning light to alert the operator but will not set off the audible alarm since it is not an urgent problem.

Following each instance of either loading or switching an event on the air, the computer will have stored descriptions of the events and, during *0-level* priority time will type out a log of information about the events.

The example described above showed that each event start time was known ahead of time. Such is not always the case. Sometimes only sequences of events are known. Sometimes the events occur in bursts, such as station breaks in a sporting event. In that case, the lengths of the components of the station break are known but not the start time of the first one. The computer will accept event loads in all combinations of these situations. If it has a start time, it will use it. If it has component lengths, (interval times) but no initial start time, the enable bars will be lighted to tell the operator that he must manually start the next event. Once that is done the computer will count down through the interval times, making subsequent switches when due. If no times at all are loaded, then each event will be queued through the preset bus and the operator will have to manually switch each event when he is directed to do so.

Many of the most frequently encountered requirements and situations in broadcasting have been described in the foregoing. Additional features less often encountered include the follow-

ing which are implemented by activation of extra buttons when loading the descriptors for an event into the computer:

a) *Lap dissolves*—Often, it is desirable to effect a slow transition from one signal source to another rather than a sudden cut. This can be done with both sound and picture. A special button is provided for VIDEO DISSOLVE and another for AUDIO DISSOLVE. If neither of these buttons are pushed when loading an event, the transition will be by a sudden cut. Either or both buttons may be used to activate the dissolve action on picture and/or sound.

b) *Slide Changes*—The computer will output a change slide pulse to a slide projector automatically in the following two cases:

- 1) The slide picture has been on the air and is replaced with another picture source; or
- 2) An on-air slide change is desired (e.g., in a sequence of slides from the same projector).

If it is desired that a slide remain in position after it leaves the on-air condition so that it can be aired again later, then a SLIDE CHANGE INHIBIT button must be pressed to stop the computer from following its general rule described in 1) above.

c) *Audio over*—To mix two sound sources (such as in making an announcement over a music source), the AUDIO OVER button is pressed. When this is done, the original sound source is lowered in volume and the added source is used at full level. This condition must be released when it is finished by using the AUDIO-OVER-OFF button.

d) *Insert*—Sometimes picture material such as addresses or phone numbers must be superimposed over background material. Another separate INSERT button is operated along with the event naming the source of the insert material. This added information causes the computer to switch to the special effects amplifier which mixes the two signals.

e) *Separate rolls*—Occasionally, it is desirable to have the computer start a rolling device but not switch to it immediately. This situation is handled by using a feature called "Separate Rolls". This feature may be added to another event or loaded separately.

f) *Delay event*—Under some conditions, an event which was originally loaded to occur at a definite clock hour must be delayed past that time. When this happens, the operator presses the DELAY EVENT button, one for each channel on which delay is needed. If the need for delay goes away before the originally scheduled time, the DELAY EVENT button may be released, and the programming returns to normal. If the DELAY EVENT button is still activated at event time (including pre-rolls), the

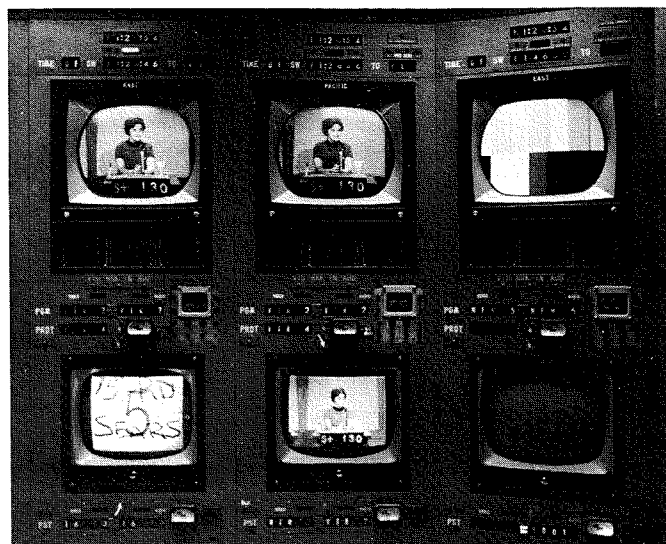

Fig. 4—Channel air monitors, preset monitors, and monitor readouts.

computer treats the events as being loaded without times on them. The operator then must start rolling devices and ENABLE the events to place them on the air.

g) *Monitor housing readouts*—For each channel, the time of day, the time of (or to) the next transition, the sources of audio and video on the air, the protection source (if there is one), and the video and audio sources at preset are displayed on readouts located above, below, and between the Channel Air and Preset Monitors (see Fig. 4).

h) *Punched tape loading*—Normal loading of the computer is by pushing buttons as described above. The computer, once loaded, can punch a tape of the events previously loaded and, at a later time, can be reloaded faster by using a special sub-routine which reads the information on punched tape into memory just as it was when the tape was made.

i) *Stalls*—A part of the 0-level program is a self-check routine. If this check indicates anything amiss, the computer will disconnect itself from the relay system, sound a stall alarm, then wait for the operator to locate the cause of the trouble. The operator then must operate the switcher manually until such time as the computer is put back in service.

Operating experience

The computer operation has met expectations. Total down time for the past two years has been less than 1% of total hours. This even includes down time caused by intentional shut-downs for reasons other than system failures. Manpower has been saved in the switching point operations. This is especially true when simultaneous feeds having different sources must be fed to the outgoing channels.

Since better planning of program operations must be done to allow time for loading the computer, there are fewer errors caused by lack of information. In addition, there are fewer human switching errors because each event can be tested in advance.

Conclusions

Careful planning of layout, coupled with programming of a computer to accomplish the repetitive mechanical tasks associated with a television switching operation, results in a large saving in equipment and personnel. People are more effectively employed for the tasks requiring judgement.

Operating mistakes are effectively reduced by allowing operators more time to perform the number of manipulations required to produce a continuous chain of program events and by enabling them to check their work ahead of actual on-the-air switching.

Computer systems are already in use which aid pre-broadcast planning and extend beyond the switching function to print bills for program producers and sponsor clients. The computer operation at NBC in Burbank was one of the pioneers in a field which can only expand during the 1970's.

Acknowledgments

The author wishes to acknowledge the invaluable help in preparation of this paper supplied by Mr. John R. Kennedy and Mr. John Frishette, both of the NBC Technical staff in Burbank.



In the recording studio— keeping pace with change

J. M. Woram

Recording technology has had to keep pace with changes in both the art and the science of sound reproduction. In this paper, the author discusses the historical changes in recording techniques and the role of the recording engineer in capturing a musical experience.

THERE ARE still many people around who were born before the airplane—people whose children have reached the moon, and whose grandchildren may work upon its surface. It requires no special gift of perception to recognize the pace at which technology accelerates. Over four centuries after Leonardo Da Vinci sketched his flying machines, the Wright Brothers successfully sustained theirs in flight. It took only another 50 years for man to reach the moon.

Concepts unknown a few years ago will be obsolete tomorrow. Change now is taken as a matter of daily routine. Of course, not all technologies advance at a space-age pace. Presum-

ably, new developments in the reproduction of sound will never take the headlines away from space ventures, despite the continuing public interest in things recorded. But what about the technology of the recording studio? What sort of changes have taken place since the early days of the wax cylinder?

As change was applied to the recording studio, the wax cylinder gave way to the 78-rpm disc, which was in turn succeeded by the long playing record—first in mono, then in stereo; presently, experimentation is continuing in creating four-channel recordings for use in the home. Thus, concerning technological developments in sound recording, about all we can safely predict for the future is, “there’ll be some changes made.”

Progress in sound reproduction

At the recording studio, the recording engineer has had to keep pace with these changes. Years ago, the recording process was reasonably straightforward. A musical group would come to the studio and gather around a megaphone. Eventually, the megaphone was replaced by a microphone and the wax cylinder by the disc. In those days, there was little margin for error. The musicians had to know their parts thoroughly, and the engineer had to have the correct balances established *before* recording began. Any technical or artistic fluffs, and the complete performance would have to be scrapped, the disc replaced with a fresh one, and a new performance started. The engineer had to be in complete command of the situation at all times—especially during the crucial final seconds.

With the introduction of tape, the tension in the studio may have lessened somewhat. Now it was possible to salvage an almost perfect performance by replacing the mistakes with retakes. As the first splice was made, a new technology—tape editing—was born. The engineer was now able to shift some of his responsibilities from “on session” to “after session”.

New skills were required of the engineer. While recording, he had to know what work could be deferred, and what had to be re-done on session. It was still necessary to establish the right balances during the actual recording, and if splices were to be made later, the engineer would have to be sure the various takes mated without distracting changes in tempo or level.

With the arrival of stereo, again new concepts were introduced. Previously, the recorded sound was recorded to, and reproduced from, a point source. Now, a left-to-right dimension was possible, and instrumental balance could be distributed spacially. The difficult task of combining all instruments onto one track was eased by the addition of a second track. The engineer now had a new working tool. Like many new tools, it introduced challenges as it eliminated old problems. The record industry went through a “ping-pong” phase until the novelty of stereo wore off, and recording personnel learned how to exploit the potentials of the new sound.

Multi-track recording

At first, it may seem pointless in progressing beyond two track recording, since the finished product must eventually be reduced to just two tracks for home use. In fact, much of the classical repertoire is still recorded two track since this format captures what is usually a straightforward performance of a work.

However, the Pop Scene is an entirely different matter. Here, the finished product may bear little resemblance to the "reality" of a concert hall performance. Some of the best (and a lot of the worst) records contain sounds that would be difficult, if not impossible, to produce in real-time performance, and the pop product has assumed a reality all its own. It is not restricted to whatever can be accomplished during a single recording session.

Obviously, new tools and skills had to be developed to meet the new requirements. One of the new tools is the multi-track tape recorder. A typical machine is capable of recording independently on sixteen separate tracks; and there is a very good reason for using so many tracks. Now, a recording may be done in "layers". This is especially desirable with contemporary rock groups in which each member may play more than one part. After the first session is over, additional

parts may be added on the remaining tracks.

Another advantage is that now the so-called sweetening session (the addition of a large string or brass section) may be done later. Often, the basic work of recording guitars, drums, and bass may take a relatively long time as different guitars, drum patterns, microphones, etc., are tried. It would be expensive to hire a string and brass section to sit around in the studio while the rock musicians figure out their parts. With multi-track, these players do not have to be called in until after the basic tracks are completed.

Modern recording techniques

Thus, the role of the engineer has had to change to meet the new demands. Now, in addition to being concerned with what is going on in the studio at the moment, the engineer must also take into consideration the previously recorded material and make provisions for whatever will be added later on. To maintain synchronization between all parts, the musicians must be able to hear what was recorded previously, yet this earlier material should not be picked up again by the microphones now in use. Accordingly, earphones are used, and the engineer feeds a blend of old (already recorded) and new material to the musicians

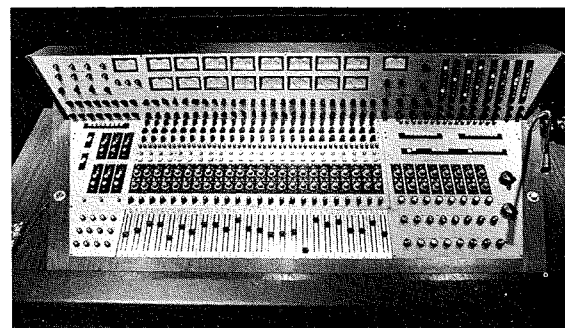

A modern multi-track recording console. The unit contains some 800 operating controls and indicator displays. In addition, there are almost as many patching points available for special applications.

while recording the new material onto the unused tracks of the tape machines.

For this type of recording, new consoles have been designed and constructed. They provide, in addition to recording facilities, for the simultaneous feeding back of the previously recorded material.

Sophisticated monitoring systems have been developed to meet the new requirements. For example, while any track is being recorded, it is "new material", and is monitored from the studio. As soon as the recording on that track is completed, it becomes "old material" and must now be monitored from the tape machines, and microphones assigned to one track must be switchable to any of the other tracks as the need arises.

Conclusion

We have come a long way from the megaphone and the wax cylinder, and the recording engineer has had to keep pace with the continuing change in equipment and recording technique. Recording has always been a precarious balance between art and science, and there are few rule books. Depending on the circumstances, the engineer may be called upon to make musical or electronic adjustments. As our recording technology advances, newer tools are placed at his disposal, allowing more and more flexibility in capturing and storing a musical experience. No doubt, the future will require new skills, but no matter what changes are made, listeners can look forward to better and better sound, probably far beyond anything Edison had in mind when he first recorded "Mary Had a Little Lamb" nearly 100 years ago.

John Woram

Recording Engineering
RCA Records
New York, N.Y.

studied Music Theory at Columbia University and studied Voice in Italy for two years. He also attended RCA Institutes where he studied Audio Electronics. Mr. Woram joined RCA Records in 1959 as a Quality Control inspector, became a recording technician in 1965, and a recording engineer in 1968. Mr. Woram serves as a committeeman for the New York section of the Audio Engineering society and writes a monthly column for *db* magazine. He is an instructor at the Manhattan School of Music and is an advisor to the Citizen Exchange Corps which exchanges films and tapes with groups in the Soviet Union and the Eastern European Countries.



New York recording studios

J. E. Volkmann | A. Stevens

The acoustical environment of the recording studio and its associated monitoring control room has been a most important link in the sound recording and reproduction chain from microphone-to-ear. It has gone through several cycles of live-to-dead and back again over recent decades. The present trend in rock and pops music continues toward a "dead-dead", echoless, or free-field environment; and if the pendulum follows its regular course, it will swing to a "live-live" requirement which is occasionally heard in pops sound effects today. The newly designed studios being used by RCA Records in New York can accommodate several changes in the thrust of recorded music, since the reverberation can be changed as much as 2.5:1.



Fig. 1—The 44th Street entrance to the RCA Studio complex. This photograph was taken at night when many of the recording sessions occur.

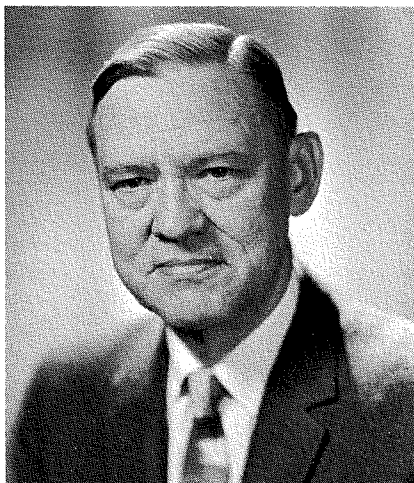

John E. Volkmann
RCA Laboratories
Princeton, N. J.

received the BS in 1927 and the MS in 1928, and the Professional Degree in Engineering Physics in 1940 from the University of Illinois. Since then he has worked continuously with RCA in the field of acoustics, specializing in the development and application of large-scale auditorium loudspeakers and stereophonic sound systems, as well as consultant on architectural, electronic, and acoustic problems. He has contributed to the solution of innumerable projects including: stereo sound systems for Radio City Music Hall, Hollywood Bowl, recording acoustics for Walt Disney's *Fantasia*, custom loudspeakers for New York World's Fairs of 1939 and 1964-65, and Jones Beach Marine Stadium. After joining the Technical Staff of RCA Laboratories in 1960, he served as consultant on the acoustic design of all of RCA's new recording

studios including RCA Italiana's 364,000 cu. ft. Studio A. He likewise was consultant on the RCA "pops" studios in Hollywood, Nashville, Chicago, Montreal, and the new RCA Variable Acoustic Studios described in this paper. Now officially retired, he has continued in the field of acoustic consulting for RCA as well as for Disney World in Florida and the John F. Kennedy Center, Washington, D.C. In 1962 he received the RCA Achievement Award for "Advances in the Development of Architectural Acoustics"; and, in 1967, the John H. Potts Memorial Award from the Audio Engineering Society for "elegant application of acoustic principles in the development of large-scale loudspeakers and sound systems." Mr. Volkmann is a Charter Member and Fellow of the Acoustical Society of America, and a Fellow of both the Society of Motion Picture and Television Engineers and the Audio Engineering Society. He is a registered Professional Engineer in New York State.

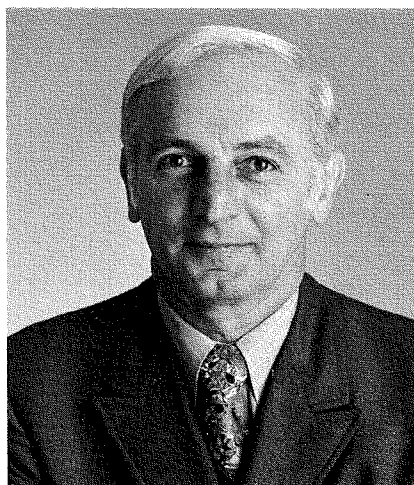

Alan Stevens, Mgr.
Facilities and Operations Engineering
RCA Records
1133 Avenue of the Americas
New York, N. Y.

received the Bachelors and Masters degrees from Temple University and attended Drexel Institute of Technology. Mr. Stevens initially joined government service in Civil Engineering, and later transferred as an aeronautical engineer into research where he was chief engineer for design and construction of turbine test station and served as technical adviser to architects and engineers on design requirements for the Turbine Laboratory. In 1955, he joined a consulting engineering firm and was assigned as project manager covering

building expansion program for RCA. Mr. Stevens joined RCA Records in 1957 as general plant engineer responsible for Facilities and Plant Engineering. He was assigned to prepare an engineering study of recording facilities to update design of recording studios and related auxiliaries. He was jointly responsible for the design of the world's largest recording studio for RCA, Italy, and was also responsible for the design and construction of new recording facilities in Chicago, L. A., and Nashville and, most recently, in New York, as well as new studio facilities for Argentina, Canada, Mexico and Spain. In his present position, Mr. Stevens is responsible for plant engineering facilities, record engineering, and international manufacturing and engineering services.

IN 1969, RCA Records in New York City relocated to a new studio complex at 1133 Avenue of the Americas (Fig. 1); the complex consists of four large studios and two small studios with their respective control rooms, nine tape-mastering rooms, seven lacquer-cutting rooms, associated editing rooms, tape transfer rooms, engineering shops, and other necessary operating facilities. Two overdub studios with their control rooms were added to meet the high demand of rerecording, thus relieving the major recording studios for commercial and custom recordings.

The reasons for relocating were:

- 1) To improve the acoustic environmental conditions since the old stu-

Reprint RE-16-4-16

Final manuscript received October 12, 1970.

- 2) To consolidate the RCA Records home office into one location instead of four separate buildings;
- 3) To be closer to music publishers, thus increasing RCA's opportunities for hit products.

Intricate specifications covering the basic acoustic requirements of the new studios were developed from extensive acoustic studies and from experience gained over several years in the new RCA studios at Hollywood, Nashville, Chicago, Montreal, and Rome. These specifications detailed the size, shape, materials, optimum reverberation times, reflection and sound absorption coefficients, transmission loss, vibration isolation, and other acoustical criteria; they were reviewed at several stages during the studies with various

members of the engineering, operating, and producing staffs.

Variable acoustics—often the designers dream—had in the past been considered an unnecessary luxury, but to capture the wide range of sounds currently in vogue—ranging from Hard Rock and Rhythm and Blues to Country and Western and Classical—variable acoustics became a real economic necessity and a key requirement of the new studios.

Probably the most striking features of the studio complex are the fantastically changeable dimensions of the two large studios—A and B. Movable panels on walls and ceiling provide variable reverberation times adjustable over a range of approximately 2.5 times, from 0.8 to 1.8 seconds for Stu-

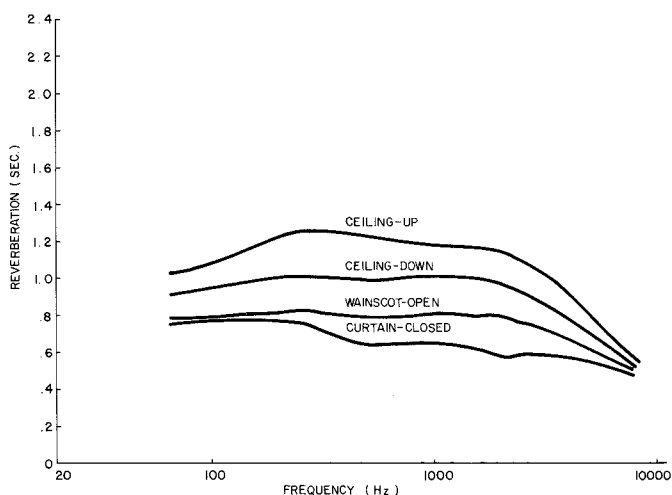

Fig. 2—Preliminary reverberation characteristics for the maximum and minimum reverberation times in Studio A (taken before final adjustment of the ceiling absorption).

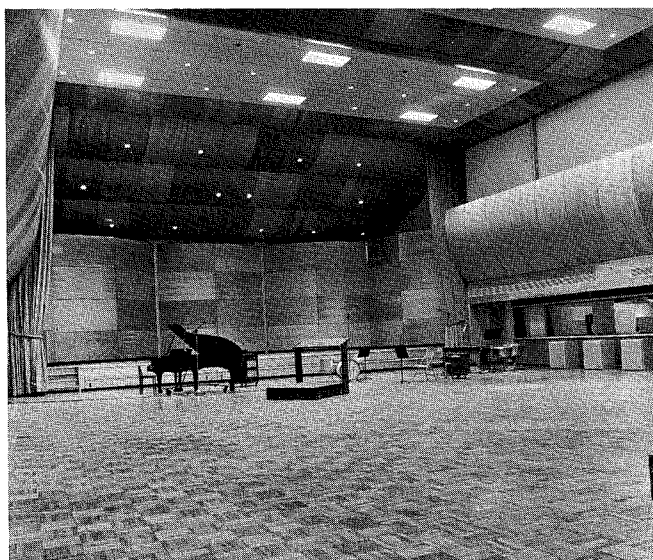

Fig. 3—The platform end of Studio A, showing the convex wood panels of the stage ceiling and walls in a "flared" position to form an orchestra or choir shell. Note that the ceiling in the studio proper is raised to full height, approximately 10 ft. above the side-wall horizontal convex wood panelling. Under the wood panelling is the control room window which is convex to match the wall treatment contour.

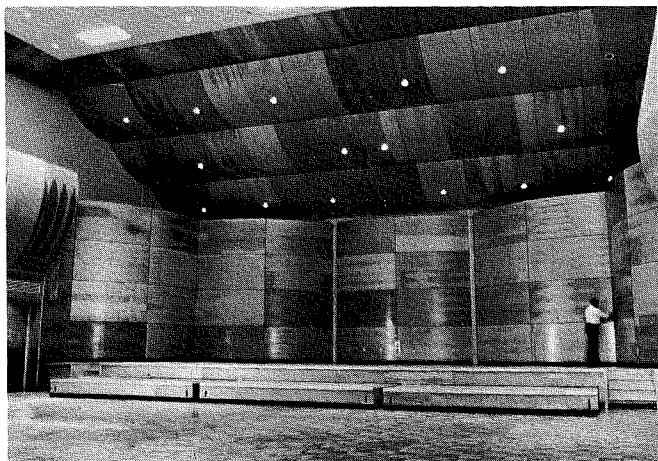

Fig. 4—Closeup view of the platform shell with wood panels in "flared out" position.

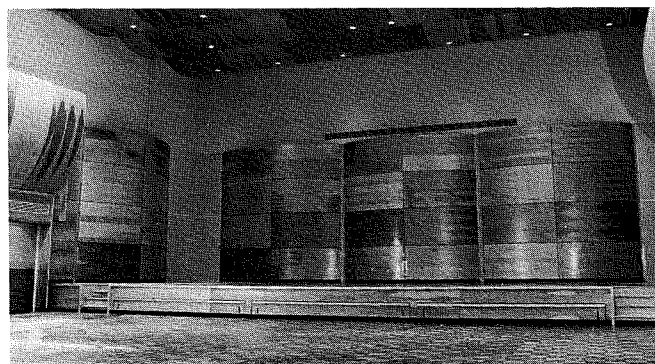

Fig. 5—Convex panels in "flat" position.

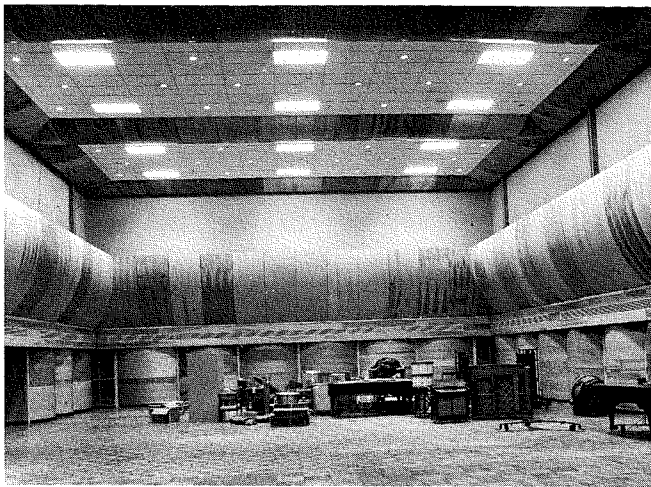

Fig. 6—Looking toward the wall opposite the platform in Studio A showing the ceiling sections raised to full height. Each of the three main ceiling sections has six fixtures distributed over the middle or absorptive area (0.8 coefficient) and a perimeter consisting of reflective convex wood panelling 4 ft. wide (0.2 coefficient). This illustration also gives a better view of the 8-ft-high horizontal convex plywood panelling covering the middle section of the walls. This horizontal panelling is hinged at the lower edge and may be lowered in individual 8-ft-wide sections by means of manually operated winches.

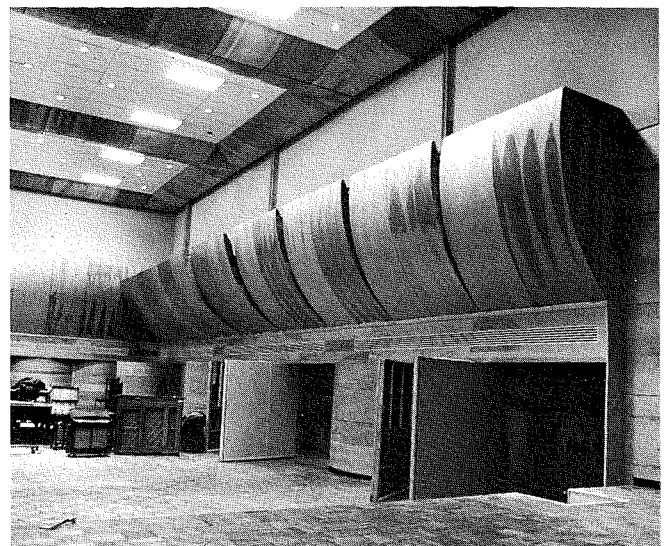

Fig. 7—The three types of adjustable acoustical elements in the main portion of Studio A: the lower hinged vertical wainscot panels for separating the direct sound sources and for controlling the local environment around them; the middle hinged horizontal wall panels for controlling the first or early reflections; and the movable ceiling sections for controlling the later diffuse reverberations.

dio A and 0.56 to 1.4 seconds for Studio B. The provisions for variable acoustics in both studios extends not only to the adjustability of reverberation time but to the control of the first or early reflections by adjusting the wainscot and lower wall panels that form the local acoustic environment around the musicians and microphone pickup areas. However, in the future,

variable acoustics offering a 5:1 or even a 10:1 change in reverberation time may be required. Probably, such reverberation enhancement can be achieved only through the use of active electronic or synthetic room acoustics.

The three large studios—A, B, and C—are housed in a separate thirteen-story structure, mechanically isolated

from the main office building, but linked communication-wise at the 4th, 7th, and 10th floors. Extreme care was taken in the construction of studios and its related facilities to ensure that no sound is transmitted from one studio to another and that sound generated by the air-conditioning system and electrical distribution does not interfere with the recordings. A noise



Fig. 10—Sections of the Studio A ceiling at three intermediate heights.



Fig. 11—One of the many combinations of adjustment possible with the three types of adjustable acoustical elements in the main portion of Studio A. These include the ceiling stepped, the middle wall panels staggered, and the wainscot panels opened at random.

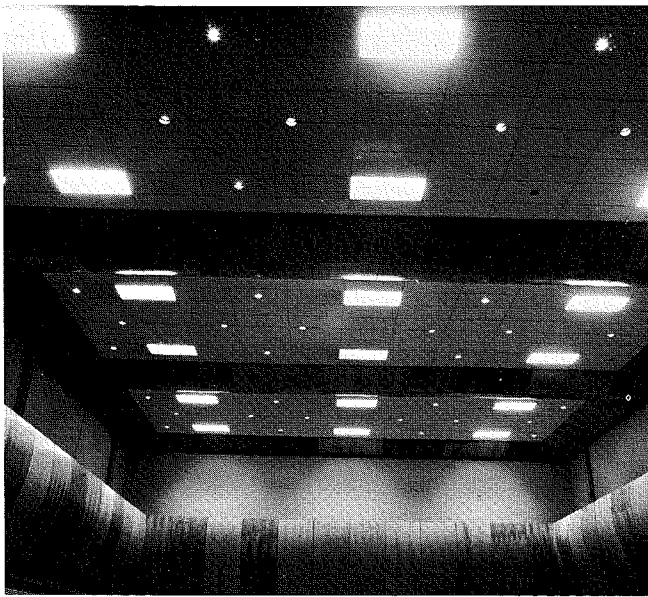

Fig. 8—Studio A ceiling at maximum height.



Fig. 9—Studio A ceiling at minimum height.

criterion of not greater than NC 20 was specified for the interior of all studios, control rooms, tape-mastering rooms, and reverberation chambers. [An NC 20 rating corresponds approximately to the equal loudness contour of the ear at 20 dB above the threshold of hearing, or approximately 30 dBa on a standard ASA sound level meter.]

Studio A

The variable acoustic design features of the new Studio A—the largest in the complex—are shown in Figs. 2 through 11. The design was chosen to fit the all-purpose requirements of this stu-

dio; it can handle the livelier reverberation requirements of classical sounds as well as the “dead” echoless requirements of pop sounds.

The structural shell of Studio A is 100 ft × 60 ft × 34 ft while the interior dimensions are 95 ft × 56 ft × 29 ft. The ceiling consists of four huge movable sections or panels, each 24 ft × 56 ft, that individually can be lowered or raised approximately 10 ft, thereby varying the reverberation time of the studio as well as by changing the sound absorption. In other words, the great flexibility offered by the *adjustable absorption*, the *adjustable shape*, and the

adjustable volume provisions permit practically complete control of the *initial direct*, the *early reflected*, and the *later reverberant components* that make up the complex sound energy waves picked up by the microphones.

Below the horizontal panelling in the wainscot area are the 8 ft × 8 ft convex wood panels that are each hinged as a door. The backside of these wainscot panels are treated with absorptive (0.8 coefficient) glass cloth-faced fiberglass panels of 2 lb/cu ft density and are convexly contoured, to blend with the front side appearance. When the wainscot panels are open, the absorptive side is exposed; when they are

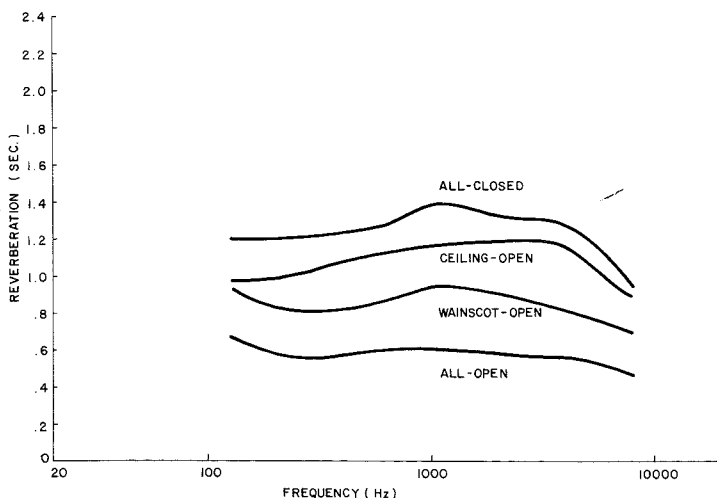

Fig. 12—Reverberation characteristics for the maximum and minimum reverberation times in Studio B.



Fig. 13—View of Studio B showing the three types of adjustable acoustical elements used: the lower hinged verticle wainscot panels, similar to panels used in Studio A for the purpose of separating the direct sound sources; the middle hinged, horizontal wall panels, also similar to panels used in Studio A for controlling the first or early reflections; and the uppermost hinged wall panels at the ceiling junctures for controlling the later diffuse reverberations. Also shown is the suspended ceiling of glass-cloth-faced fiberglass panels (absorption coefficient is 0.8).



Fig. 14—General view of the studio with the uppermost hinged ceiling corner panels lowered, completely exposing the absorptive backside of the panels.

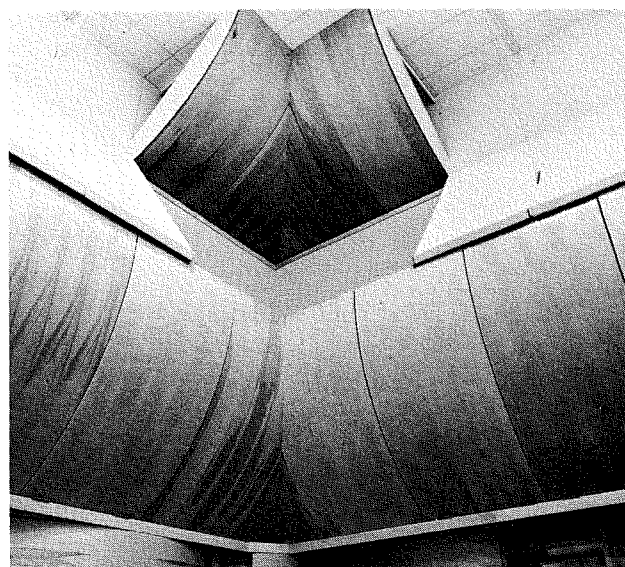

Fig. 15—Closeup view of one of the ceiling corners.

closed the reflective side is exposed. In addition to controlling reverberation, these planes function acoustically as “gobos” to control the local acoustic environment.

Another feature of interest is that provisions also have been incorporated in the basic studio acoustic design for the addition of active reverberation enhancement.

Thus studio A with the other studios in the complex provides the size and flexibility to meet any type of recording from the classical (Opera) to Hard-rock (Psychedelic). The changes in the acoustic treatment can be made within minutes.

Studio B

The variable acoustic design features of Studio B are shown in Figs. 12 through 19. This studio is the second largest in the complex and, like Studio A, is of the general-purpose type. Since it is smaller and has a shorter reverberation time than Studio A, it will be used more frequently for semi-classical and pop recordings. The structural shell of Studio B is 75 ft × 50 ft × 34 ft and has interior dimensions of 72 ft × 47 ft × 27 ft.

Studio C

Studio C has a structural shell of 75 ft × 50 ft × 30 ft, and an interior of 72 ft × 47 ft × 24 ft. It is similar in

size to the large RCA studios that have been so successful in Hollywood, Nashville, Chicago, and Montreal. Although the arrangement of convex plywood panels differs from the earlier studio design, the proportion of reflective panels versus absorptive panels and the reverberation time of 0.5 seconds remain the same. Figures 20, 21, and 22 show the design features of Studio C. Note that the entire ceiling is absorptive (0.8 coefficient) and that two thirds of the wall area is absorptive and one third reflective (convex plywood). Note also that the convex panels are disposed alternately in the vertical and in the horizontal to give

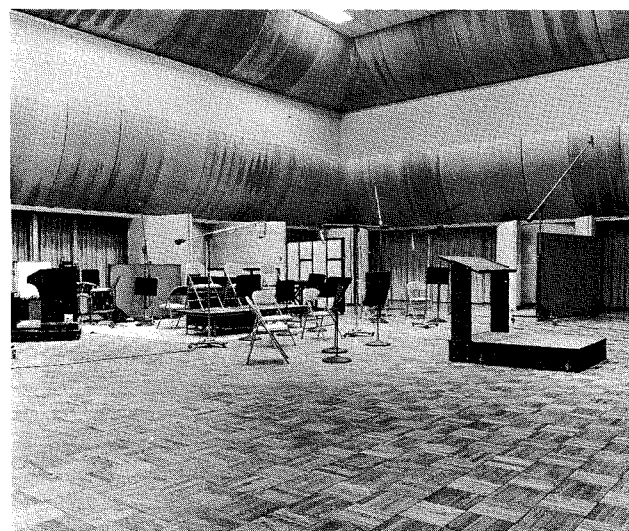

Fig. 18—A setup for recording in Studio B.



Fig. 19—Recording console in the studio B control room.

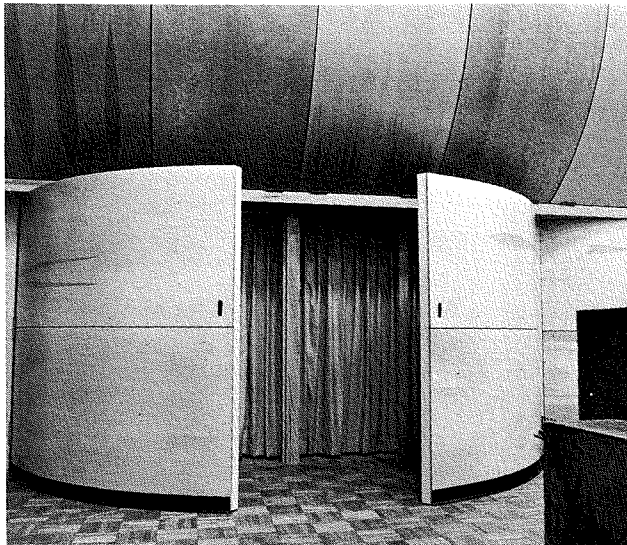

Fig. 16—Closeup of two wainscot panels partially opened along one wall.

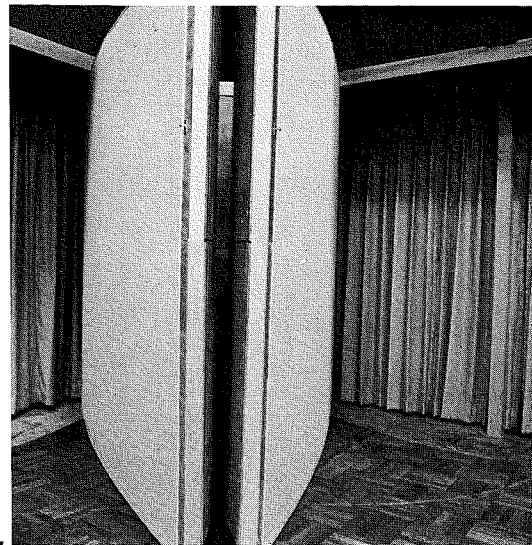

Fig. 17—Closeup of two wainscot panels opened in one corner.

a more diffuse and optimum reflection environment.

Studio D

Studio D has a structural shell of 40 ft × 27 ft × 22 ft and an interior of 39 ft × 24 ft × 15 ft (see Fig. 23). Note that the general configuration and location of intermediate convex plywood wall panelling and ceiling corner panelling is similar to that in Studio B. This studio is intended not only for rock and pop recording sessions but for experimental studies and unexplored areas in reverberation enhancement, multi-channel stereo, and free field recordings. The reverberation time for Studio D is approximately 0.35 seconds.

Studio E

Studio E is a small overdub-type of contemporary studio used for voice and overdub recording; see Fig. 24.

Control and tape mastering rooms

It is most important that the control rooms and tape-mastering rooms have the same acoustic treatment and sound environment. This assures that the producer will have the same listening conditions and quality in the tape-mastering room as those produced during the original recording in the Control Room.

Fig. 25 shows the interior outline of a typical wall section for all of the con-

trol rooms and tape mastering rooms. Every effort has been made to make the acoustics of these rooms similar with respect to uniform acoustic response, reverberation characteristics, flat absorption characteristics, and resonance-free characteristics. The reverberation has been set at 0.25 second. For uniform control of the distribution characteristics of the direct sound energy radiation, the loudspeakers in the control room and tape-mastering rooms are set on an arc of 8 ft radius with center located at the engineers listening position.

Conclusions

Provisions in the new studios for the



Fig. 20—General view looking toward a corner adjacent to the control room in Studio C.



Fig. 21—Closeup view of a recording setup in Studio C with convex panels in background.



Fig. 22—Studio C Control Room with engineer at recording console.



Fig. 23—Studio D looking toward the control room.

separation and control of the *three basic room acoustic energy components: initial direct, early delay, and later decay components*, we feel, is a definite step toward the goal of good acoustics in sound recording—true 3d reproduction on multi-channel stereo-acoustic systems. Hopefully, the new RCA studio complex with its variable acoustical environment and its “tri-wave-energy” concept in studio acoustic design will serve not only to extend the scope of the pop and rock artist but also offer the classical musician fresh

opportunities for achieving greater spatial or room acoustic realism and auditory or directional perspective in the new multi-channel recording of traditional and modern compositions.

Acknowledgment

The authors wish to acknowledge the help and encouragement extended them in the early stages of this tremendous project by all of their associates and management. We wish to express particular thanks to Messrs. Howard Eitelbach and John Pfeiffer for their

comments on basic requirements during the initial planning stages; to Fred Werfel and Alan Ballantine on follow-up and assistance during the construction and shakedown period; to Rex Isom, R. C. Moyer, Robert Breed, and A. J. May on Monitoring Loudspeaker Systems and console design; and to Mr. W. H. Dearborn for his continuous support and executive guidance during the project. Also, grateful acknowledgment is made to the Directors at the RCA Laboratories for use of the acoustical measuring facilities.



Fig. 24—Studio E—a typical overdub studio.

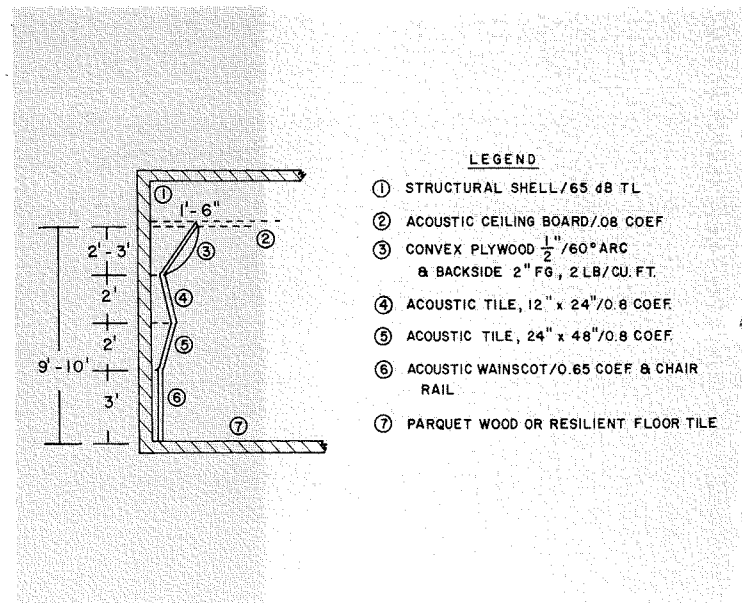

Fig. 25—Interior outline of the wall sections for control rooms and tape mastering rooms.

The case for four channels

J. Pfeiffer

The home musical event ranges from bathroom baritone to Junior's piano lessons to loudspeaker energy from packaged products parading under claims of "realistic" music reproduction. Realism in the former is all too evident, while in the latter it has been sadly absent. Sounding real is not always sounding right, but if it sounds right, it must sound real. The technology and subjective judgment leading to loudspeaker music have increasingly suggested the right sound, not only through refinements in hardware and techniques, but by adding sound information which strengthens the subjective impression. Examining these additives leads to the rationale of creating an appropriate atmosphere of sound in which the home listener and his musical choice can be realistically embedded. The case for projecting four channels of coherent sound possessing the essential sonic clues experienced in the live event is built on this rationale. Recording criteria have been tested and subjective benefits observed. The critical press has favorably received the few commercial examples on four-channel open-reel tape. But if the breeze is to become an industry tornado, it depends on the engineers' contribution to system quality, convenience, and pricetag—and on the judgments of the author's side of the fence in planting the sound characteristics to bloom subjectively into real musical reproduction in the home.



John F. Pfeiffer, Executive Producer
Classical Labels
RCA Records
New York, New York

obtained his formal musical education at Bethany College, Lindsborg, Kansas, and the University of Arizona in Tucson. Given preliminary technical training in the U.S. Navy from 1941 to 1945, he returned to the University of Arizona and obtained the B.S. in Electrical Engineering in 1949. During 1955-1957 he took graduate work in electrical engineering at Columbia University, New York City. Mr. Pfeiffer joined RCA in July, 1949, as an engineer in Camden and New York. Joining the Artists and Repertoire Department of RCA Records in 1950, he has been producing Red Seal records up to the present time. Combining his technical and musical training, he acted as Audio Administrator for Red Seal Recordings between 1962 and 1967. Mr. Pfeiffer has produced the recordings of such artists as Jascha Heifetz, Vladimir Horowitz, Wanda Landowska, Arturo Toscanini, Leopold Stokowski, the Philadelphia, Boston, and Chicago symphony orchestras, and numerous other instrumentalists, vocalists, and musical groups. He has published articles on musicians, music, electronic music, and other technical-musical subjects in various recording industry magazines, the *New York Times* and RCA's *Electronic Age*. Mr. Pfeiffer is a composer of electronic music with a record released under the Victrola label of *Nine Images*, a television ballet, a film score, and a Master's Thesis ballet. He is a member of IEEE, the Acoustical Society of America, Audio Engineering Society, MARAS, ASCAP, and various honorary engineering and musical fraternities.

THE LATEST WIND stirring the recording industry's resources, the engineer's resourcefulness, and the music lover's dollar is a kind of three-D stereophony variously tagged Quadrasonic, Tetrasonic, Surround-Sound, Wrap-Around—plainly an effect in search of a name. But a valid, psycho-acoustical effect nevertheless and a solid, logical evolution of fidelity in phonographic descriptions of sonic events.

The quest for sonic realism

As the basis for all better mousetraps, the habits or appetites of the mouse dictate the lure, while mechanistic sophistication provides a new or better means to the end. Musically, our mouse is the human auditory psyche, and its appetite for natural sonic satisfaction has made its human host susceptible to the diverse claims of "realism," starting with the Edison cylinder and continuing relentlessly to the present. The technical community has variously but consistently recognized the appeal of linearity in transducing a live sonic event into the living room, as evidenced by the whopping misnomer of the industry's popular title, "high fidelity." Stereo unleashed re-energized claims of "truer truth" in reproducing a real live musical event in the home.

Reprint RE-16-4-6
Final manuscript received July 13, 1970.

But exaggerated claims aside, industry efforts have refined the production of sound in the listener's environment, using the auditorium (concert hall, opera house, Broadway theater, night club, etc.) as the reference point. The facsimile has approached realism partially by shoring up the linearity of the technical components in the transmission line between the performance and the home listener. But it seems closer to the real thing mostly because technology has added information which more nearly duplicates the live field of stimulus. It has recognized that even though there is a remarkable difference between a live musical experience and one possible to obtain in the home, the same auditory mechanism must be dealt with and the listener's perception must be the basis for the illusion of a live event. The consumer of recorded products wants not only the music of his choice, he wants a vivid illusion of the event happening in an optimum live surrounding, plus the intimacy which reveals the detail, separation, the clarity and balance which is virtually impossible in the live encounter. And more and more, he is getting it all.

The refinement of recording and playback components, the development of imaginative recording techniques and the vast improvement of disc and tape processing increased consumer satisfaction of monophonic reproduction.

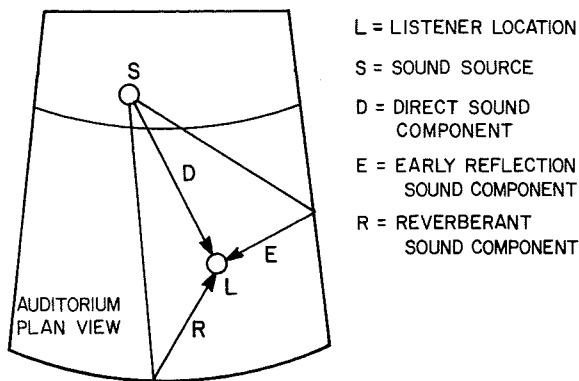

Fig. 1—Auditorium listening conditions. Each vector represents a multiplicity of sound-wave vectors (for each of the three sound components) which create the solid sound field within the enclosed space.

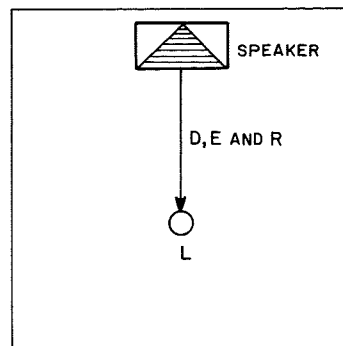

Fig. 2—Monophonic home listening. All sound components emerge from same direction creating totally unrealistic sound experience. Acoustics of the room are a strong influence on total sonic impression.

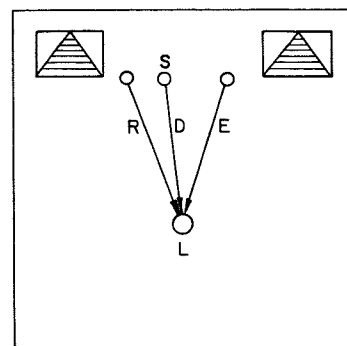

Fig. 3—Standard stereo home listening. Interactions of two channels can produce virtual or phantom sources of direct, early reflection, and reverberant components, but sources are limited in direction to space between speakers.

But when all this progress was applied to two discrete, coordinated channels, the realism quotient increased geometrically. And consumer response quickly turned almost exclusively to stereo.

Stereo is a mighty step toward realism, because it furnishes more sonic information to help the listener imagine that he is experiencing a complete sonic event. This follows from the basics of auditory perception. The brain compares information fed to it by two independent sources (the ears) and arrives at some amazing conclusions about the sound, its source, and its environment; (it has other sensory and psychological clues which influence these conclusions, but the primary data is aural). The direction from which a sound is coming can be perceived from interaural phase and intensity differences, and therefore the spatial distribution of the component sounds in a complex is recognized. The volume magnitude of a normal enclosure which an observer occupies can be appreciated by the multiplicity of intensity, phase, and frequency spectrum differences between the signals arriving at the two ears from the direct and reflected sounds. His proximity to the origin of the sound (intimacy or, in recording parlance, "presence") and his location relative to a wall or a large obstacle can also be judged (Fig. 1). The quality, balance, dynamic contrast, and other features of perceived musical sound are vitally influenced by enclosure characteristics and the auditor's loca-

tion in it, and they are evaluated by the brain's two-signal comparison. And he has the remarkable ability conditionally to reject unwanted sounds in a complex fabric of sonic activity in favor of some thread of it.

All of this happens normally, unconsciously, and vitally in naturally encountered musical situations; and each feature of it has become integral to the judgment that the listener is observing such an event.

Limitations of mono reproduction

Monophonic reproduction of music, although capable of giving the impression of a recognizable musical performance, limits realism to the perceptual space of the listening room. Its acoustic properties contribute strongly to the total stimulus since auditory perception is fed only in-phase and equal intensity information from the single speaker, and all other concomitant information is reflected from the surfaces of the listening room. Any similarity one finds between monophonic reproduction of music and the sound of a live event is a tribute to his imagination, recollection, and ability to reject sonic information which conflicts with his musical enjoyment (see Fig. 2).

Limitations of standard stereo reproduction

Standard stereophonic reproduction can enhance the illusion of observing a live event by projecting recorded phase and intensity differences similar

to those one would experience under those conditions. But even though the complete sonic description of the event can be recorded, it is reproduced to the home listener in a kind of two-dimensional fashion (Fig. 3). Perception of the spatial distribution of original sound sources is limited by the lateral separation of the two speakers; instrumental and vocal textures sound shallow because they cannot be normally separated from their reflections. The acoustical contribution of the auditorium appears highly distorted since all the reflections and the reverberation envelope emerge from the same direction as the direct sound: the entire sonic body is compressed into a single plane. In addition, if the listener moves from the single ideal observation position, the balance, spatial distribution and sound quality can change radically. Even head motions can put wings on presumably fixed sound sources. And the acoustical properties of the listening room still color and condense directional sounds. This all contradicts a realistic sonic experience. While the step from mono to stereo moved the listener from an isolation booth with one sonic window to one with an open wall, he is still isolated perceptually, and he's vividly aware of it.

Theoretically perfect reproduction would be possible by locating two ideal microphones one head's width apart at a desirable location in the auditorium, recording the signals with perfect linearity and separation and reproducing them through perfect

headphones—a kind of radical stretching of the pinna. But our head-phoned listener would shortly find himself conscious of being strapped in that auditorium seat and his head locked in the deadly vise of the rigidly unmoving microphones. And another contribution to the perception of a live event steps forward—a kind of auditory focusing obtained through lateral and vertical head motions. It collects familiarly informative phase and intensity data. Frequent use of this motion in a real situation strengthens, confirms, clarifies, reassures in reaching conclusions about sonic events—a kind of redundancy in the communicative link.

Sonic effects and listener perception

All this suggests that for convincing realism a field of sound should be provided in a listening room which possesses the essential sonic clues one gets on the scene of a viable sound event. To determine what they are, the total sound can be divided into the basic energy components which inform an observer in any enclosure: 1) the direct sound from the source; 2) the first or early reflections, and 3) the reverberation envelope which follows; see Fig. 1.¹ Their balance and character change with location in an auditorium, but their arrival time, duration, and frequency parameters determine the sonic effects the listener perceives. His field of stimulus is appealing if the proportion of these components is pertinent to the sonic experience he wants or expects. Generally, he wants the direct sound to emerge constantly from the zone of interest with the degree of clarity, definition, and balance to allow him to distinguish musical elements without excluding any contribution; he wants a sense of intimacy with the musical source which is obtained if the time difference between the arrival of the direct sound and its first major reflection is small (considered to be less than 20 milliseconds); and he wants appropriate reverberation arriving from every direction to give a sense of magnitude—fullness—to the sound, blend discrete elements of it, enhance dynamic contrast, and avoid a sense of abruptness.

And now consider the tricks played on our home listener's sonic psyche in standard stereo reproduction to make him believe that the space between his two speakers contains a continuity of sound. His sensory apparatus tells him this because the critical components of sound which he would receive in an auditorium are recorded and blended with critical judgments being made under essentially home listening conditions. That is, a translation from auditorium to living room listening is made by capturing phase and intensity information of the direct sound, the first reflections and the reverberant envelope, and mixing the signals to create the desired home listening effect.

Recording in a normal auditorium, the effect is first judged in the recording monitor room by engineer and producer. After editing for the desired performance, the transfer from the multiple track original to the two-channel master tape crystallizes the effect through judgments made under small room listening. Balance changes between the sound components are possible at this point—depending on how exclusively they were recorded—because each microphone collected different proportions of all the components. The techniques required to produce a desired effect are widely different for the variety of recording environments and types of music encountered. In general, only the direct component is recorded under commercial studio conditions, and environmental contribution is synthesized at the mix-down stage by artificial reverberators and delay loops. But the three normal elements of the total sound are always present in some proportion to produce the desired contact with realism in home listening. As it has been pointed out, however, it's a realism defeated by the single plane of the perceived sound.

Sonic expansion through four-channel reproduction

But if two channels can create a convincing plane of sound, consider four channels of different stereophonic content recorded from the same performance and fed to diametrically opposite speakers around the perimeter of a listening area. It follows from stereo analysis that each possible combina-

tion of two speakers can produce an apparent plane of sound. And every point within each plane will have an element of it in every other plane. Because of our perceptual mechanism, all the elements of an apparent sound within each plane will contribute to our final spatial localization of it, and there can be an infinity of such virtual or perceptual points of sound. We will, therefore, experience a solid field of sound distributed according to the location and relative balance of the microphones used in recording it. If the recording contains a stereophonic balance of the basic sound components properly proportioned in their time relationship and intensities based on this four-channel small room listening, the reproduced field will have the characteristics of the original. An acoustic environment different from that of the listening room will thus be created (Fig. 4).

If the evidence of our ears is any criterion—and it is really the only one—four channels carrying these signals are necessary and sufficient to reproduce a foreign sonic ambience in a listening room. The new ambience can mask the influence of many of the acoustic properties of the listening room. One can move about the field and experience sound changes he would expect in a live situation. He no longer feels pinned to one ideal listening location and head motions

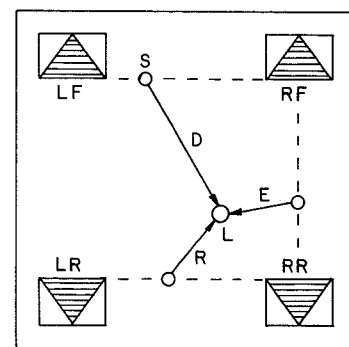
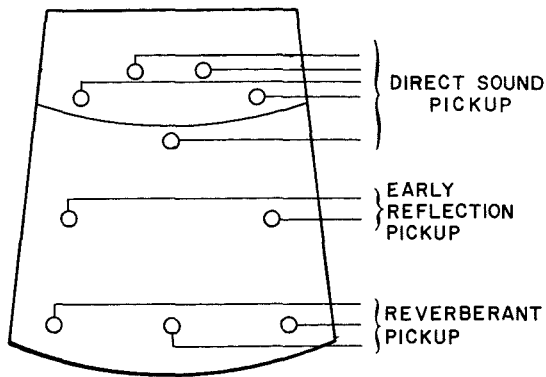
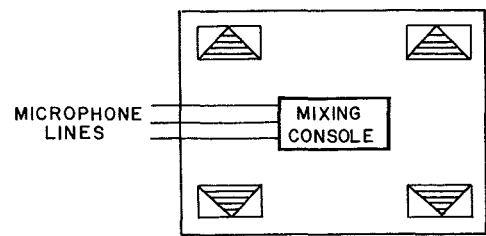

Fig. 4—Four-channel home listening. Speakers arranged left-front (LF), right-front (RF), left-rear (LR) and right-rear (RR), carrying phase and amplitude information of the three sound components recorded from the auditorium. Stereo channels LF and RF produce virtual sound source S; RF and RR provide virtual source of early reflection E; RR and LR produce virtual reverberant sound R. All vectors correspond in direction and amplitude to those of Fig. 1. The four channel reproduction of sound can, therefore, duplicate auditorium listening conditions.



a) Microphones placed to collect each of the three sound components with separate prominence.



b) Effectiveness of microphone placement and balance of signals is judged under small-room listening conditions.

Fig. 5—Recording for four-channel reproduction.

tend to produce appropriate focusing and localizing effects.

For an image of customary listening experiences, the direct sound is recorded to emerge prominently from the front of the listening area with the sound of the sources stereophonically balanced for clarity, definition, and appropriate spatial distribution. Reflection and reverberant signals are disposed throughout all four channels in appropriate phase and intensity to furnish the environmental information. Typically, this is done by locating microphones to capture stereophonic information in three general zones of the recording environment: 1) close to and oriented toward the sound source, 2) at an appropriate distance from the source and oriented toward a large, principal reflecting area, and 3) at a greater distance with omnidirectional orientation where reverberant sound predominates (Fig. 5).

Greater creative flexibility for the recordist

Choosing proper microphone locations and the level balance between them can move the listener into a spatial setting which complements the sonic message being recorded. Although this is largely a matter of subjective judgment, classical music can generally be divided into 1) music composed for performance in small auditoriums (chamber music and most orchestral music preceding the Romantic period—about 1850), 2) that written for large hall performance (including most Romantic and modern music—opera, oratorio, religious music), and

3) that written for large or small halls but benefiting from a special acoustical condition. Popular music is associated with theater, night club, large auditorium and, currently, with amplified instrumental and vocal sounds converging on cramped areas at violent levels from several directions. Four-channel recordings of these forms made in their ideal settings can, of course, show the proper sonic dimensions. But by recognizing the perceptual role each basic component plays, the recordist can, within limits, tool up a single auditorium to produce a wide variety of spatial properties.

Synthesis of realistic effects through time delay, artificial reverberation, and a versatile mixing console can create the desired ambience for deliberately dry recording studios and compensate for unsympathetic recording environments. These same tools can generate a plausible and even spectacular result from recordings made originally for standard stereo. But capturing all the essential information from the natural environment is the best source of convincing realism in home listening.

As might be expected, such a system also affords the creative talent of recording engineer or producer (and, ultimately, composer, arranger, and performer) a flexible system to produce new home listening experiences with sonic patterns totally different from any live event. By isolating the direct sound of instruments or voices on individual tracks while reserving four for environment signals, or synthesizing them, the mix-down (to four

master tracks) can place featured musical elements at any point in the sound field or move them in the course of the selection in any desired way. Instruments can be disposed around the listener in any manner, moved about the field, changed in perspective—an unlimited variety of new effects are at the disposal of creative judgment. But the ability to transport the listener into musically sympathetic space which enhances the quality of instrumental and vocal sounds is the primary benefit of the system.

Listening room acoustics and playback system efficiency will possibly modify the frequency and transient response of the original recording, but critical time parameters and the directional balances will be largely unaffected. The listener may not be able to identify the sound of a particular auditorium, but he will certainly know that his listening room no longer confines his perceptual space, and that the new acoustic setting finally puts the home musical event into the proper perspective.

Present and future of the four-channel medium

Even though four-channel magnetic tape offers the most accessible medium for these recordings, multiplexing systems are being explored to convert the existing two-channel disc, tape, and FM broadcast systems to dispense four discrete channels of information. On a commercial level, the inevitable question arises concerning the dollar sign ahead of an improved product—is the consumer going to feel he's getting his money's worth? To those who

have heard good examples of this system, there is no doubt that the improvement over standard stereo is at least as great as stereo over mono. With that and our tendency to invest in improvements of our sensory world, plus the history of the shift from mono to stereo in less than a decade, the answer would seem quite simply positive. The proviso is that the cost difference between two and four channels is commensurate with the jump from one to two. Even though stereo was not universally adopted until the disc system was perfected, the tape story today has a radically different profile from the mid-50's when stereo was first introduced commercially on tape. The eight-track cartridge and four-track cassette have assumed prominent roles. Open-reel tape systems have improved quality at lower speed and cost. Modifying all the tape systems to accept current stereo and new four-channel pre-recorded tapes is not a major mechanical or electrical problem. A compatible multiplex system of high quality for disc, tape, and broadcast is much more complex, and the "when" and "how much" are good questions. In any event, technical sophistication can appease the appetite with an acceptable pricetag.

The specs are simply: maximum channel separation with maximum but equal channel quality. It has been suggested that the channels projecting signals from the rear (or normally back-oriented) speakers can be reduced in quality because of the predominance of frequency-and transient-limited reflective components. But all four channels are confronted with creating a complex field of sound, each carrying all three sound components in varying proportions. As in every phonographic experience, perceived fidelity increases with channel quality.

Conclusion

Realism draws on the perception of the entire person's senses as well as his psychological state, but a forceful emphasis on the primary objective of the realistic experience can create a kind of sensory substitution. For instance, the current emphasis on presence, spatial distribution, and other sonic details in a musical recording can substitute conditionally for the lack of visual and psychological clues

associated with the real situation. With four-channel environmental recording, critical sonic aspects of the real experience are present along with the information of current recordings, and other sensory experiences connected with the live event are relegated to a position of even less importance.

The development of this sound stimulus, which might briefly be described as a kind of sonic hologram, is consistent with the efforts of today's technology to move a discriminating public to a sensory environment of its own choice. It is an experience of wonder and aesthetic rewards to hear music of your choice when and where you wish and to have sound which moves the walls of your listening room to the dimensions of Carnegie Hall, a Broadway theater, La Scala Opera House, Bolshoi Theater, or the Electric Circus—even to domains of imagination.

Bibliography

Directional Perception

Deatherage, B. H., and Hirsh, I. J., *J. Acoust. Soc. Am.*, Vol. 31 (1959) pp. 486-492.

Handbook of Experimental Psychology, Ed. Stevens, S. S., "Basic correlates of auditory stimulus" (Wiley, N.Y., 1951) pp. 985-1039.

Taylor, C. A., *The Physics of Music Sounds* (American Elsevier Publ. Co., N.Y. 1965).

Wallach, H., Newman, E. B., and Rosenzweig, M. R., "The Precedence Effect in Sound Localization." *Amer. J. Psychol.*, Vol. 52, 315-336 (1949).

Beardslee, D. C., Wertheimer, M., *Readings in Perception* (D. Van Nostrand Co., N.Y., 1958).

Pieron, H., *The Sensations* (Yale Univ. Press, 1952).

Concert Hall Acoustics

Beranek, L. L., *Music, Acoustics and Architecture* (Wiley, N.Y., 1962).

Schroeder, M. R., *Science*, Vol. 151, No. 1355 (18 March, 1966).

Backus, J., *The Acoustical Foundations of Music* (W. W. Norton, N.Y., 1969).

Stereo Analysis

Bauer, B. B., "Phasor Analysis of Some Stereophonic Phenomena", *IRE Transactions on Audio*, A4-10 (Jan.-Feb., 1962) pp. 18-21.

Four Channel

Feldman, L., "Quadrasonics On-The-Air", *Audio* (Jan., 1970).

Whyte, B., "4 Channel Disc and Broadcast", *Audio* (Jan., 1970).

Fantel, H. H., "Audio Basics—Quadrasonic Stereo," *Stereo Review* (Feb., 1970).

Berger, I., "Four Channel Sound is Here, Sort of", *Sat. Rev.*, (29 Nov., 1969) p. 77.

Klein, L., "The Four-Channel Disc", *Stereo Rev.* (Jan. 1970).

Cunningham, J., "Tetrasonic Sound", *db* (Dec., 1969).

Reference

1. Volkmann, John E., "Electronic Room—Acoustic Fundamentals," *Journal of the Acoustical Society of America*, Vol. 35 (1963) p. 786.

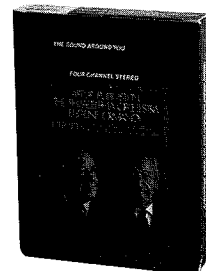
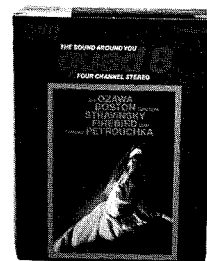
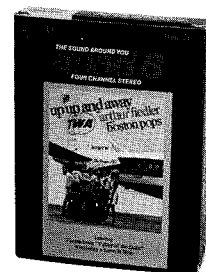
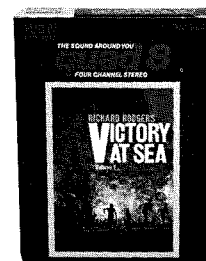
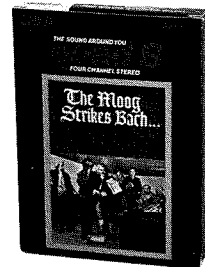
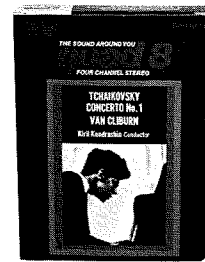



Alaska communications system

J. D. Sellers

RCA Global Communications, Inc. was selected by the U.S. Air Force to be the Purchaser of the Alaska Communication System (ACS). The ACS is a network of long-haul circuits covering a large portion of the State and is made up of microwave radio, open wire, undersea cable and several hundred thousand miles of circuits leased from the military, the Canadian National Telephone and American Telephone and Telegraph Company. RCA Alaska Communications, Inc., was formed to own and operate the ACS as a Commercial Common Carrier for the State of Alaska. RCA Alascom will install new microwave facilities to increase the number of long haul circuits, introduce Direct Distance Dialing capability to the State and bring telephone service to many communities in Alaska not now served. RCA Alascom will also participate with COMSAT Corporation to bring Alaska regular satellite communications for the first time and has proposed a 29% reduction in the rates of long distance calls.

"The President today approved the sale of the Air Force operated Alaska Communication System to RCA Global Communications..."

THOSE WORDS, contained in a June 1969 White House Press release, launched RCA on one of its most ambitious ventures in recent years. RCA agreed to purchase the Alaska Communication System from the United States Air Force, and operate it as a Commercial Common Carrier in the State of Alaska.

In its offer, RCA agreed to pay the Air Force \$28.4 million for the ACS facilities, and to invest an additional \$27.6 million in new facilities to upgrade overall service, to provide new services to the citizens of the State of Alaska—all this at a substantial reduction in long-distance telephone rates.

ACS facilities

The Alaska Communication System is a network of long-haul circuits cover-

Reprint RE-16-4-12
Final manuscript received June 15, 1970.



John D. Sellers
Chief Engineer
RCA Alaska Communications, Inc.
Anchorage, Alaska
received the BSEE from the University of Miami in 1950. Mr. Sellers joined RCA with the Missile Test Project group in 1954 and later served as Manager of Communications Systems Projects. He later transferred to the RCA International Division where he served as Area Manager in Iran for CENTO. From 1965 to 1969 he was an Engineering Supervisor for the RCA Service Company at the White Sands Missile Range and is presently Chief Engineer, RCA Alaska Communications, Inc. in Anchorage, Alaska. Mr. Sellers is a Professional Engineer.

ing a large portion of the State of Alaska and is made up of microwave radio, open wire lines, undersea cable and several hundred thousand miles of circuits leased from the U.S. Air Force and the Canadian National Telephone Service. The bulk of the ACS facilities are contained in Toll Centers located in the four major cities of Alaska: Juneau the State Capital, Ketchikan in Southeastern Alaska, Fairbanks in the center of the State, and the largest in Anchorage, also the largest city in the State. The major facilities are shown in Figs. 1 and 2.

History of ACS

The ACS was formed in 1900 by the U.S. Army Signal Corps to provide communications between the widely

separated military posts located all over the Territory. It was also deemed in the public interest that since these facilities were the only ones existing, commercial traffic could also be passed over the network.

By 1904, construction had progressed to a point that in-service facilities included 2,128 miles of undersea cable, which provided the first "All American" communications connection of Alaska with the lower 48 states; 1,497 miles of land lines and what is believed to be the first commercial wireless telegraph system in North America (a link 107 miles long bridging an over-water gap in the network). Of the many people participating in these projects, one of the most well-known was the late Brig. General

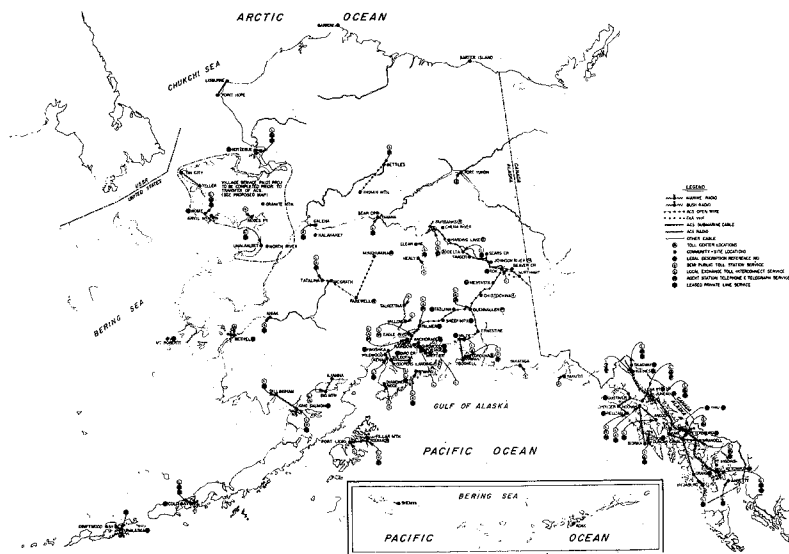

Fig. 1—Purchased communications facilities.

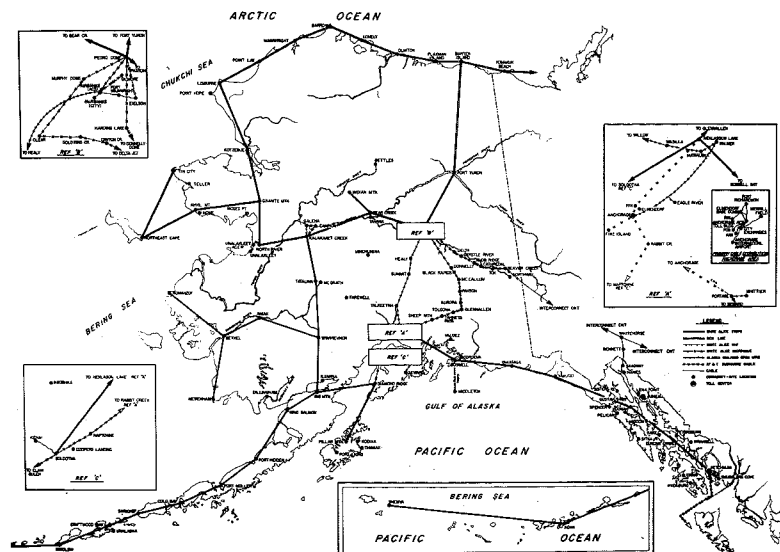

Fig. 2—Other interconnecting communications systems.

"Billy" Mitchell, then a Lieutenant in the Signal Corps.

Over the years, the system was expanded to include service to more communities and additional circuits were required to meet the growing commercial communications needs of Alaskans and today includes some 560,000 circuit miles and four major Toll Centers at Anchorage, Fairbanks, Juneau and Ketchikan.

The ACS was turned over to commercial use almost entirely with the advent of the construction of such military networks as the White Alice Communications System and Blue Grass.

The system was operated by the U.S. Army Signal Corps until 1962 when responsibility for its operation was transferred to the United States Air Force Communications Service.

A special office to negotiate the sale of ACS to RCA and coordinate the transfer of the system from Government ownership has been set up in AFCS with headquarters at Richards-Gebaur AFB in Missouri, and other support offices in Seattle and Anchorage.

RCA Globcom has established a wholly owned subsidiary company, RCA Alaska Communications, Inc., which will become the owner and operator of ACS at the time the facilities are transferred from the U.S. Government to RCA.

RCA Alascom is an Alaskan Company incorporated in Alaska and staffed by Alaskan citizens.

Improved communication facilities for Alaska

In evaluating the telecommunications needs of the State of Alaska, and how best to satisfy these requirements, RCA has planned a major service improvement program. These plans include not only the facilities necessary to increase the capacity of installed systems to meet immediate and future demands, but also construction of new systems to provide service to many communities totally without communications at the present time. An overview of this improvement program is shown in Fig. 3.

The problems involved in implementing Alascom's improvement plans can best be introduced by posing the

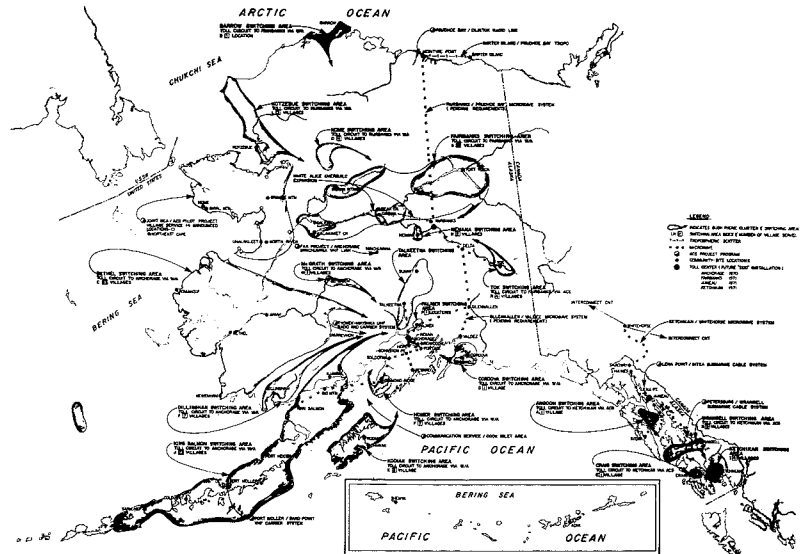

Fig. 3—Proposed long-line system improvement.

questions: How can good telecommunication services be provided to the citizens of a state twice the size of the State of Texas with a total population of less than that of El Paso, and do so at a cost the citizens can afford and still afford a reasonable profit to the owner?

RCA Alascom's improvement program for Alaska consists of three major phases:

- 1) Expansion of facilities required to provide additional service for the 1970 "Busy Season" (as might be expected, the peak of traffic occurs during the Alaska's summer months);
- 2) A major construction program to expand facilities to provide for the traffic growth estimated for the late 1970 through 1972 period, introduction of new services including such features as access to the nationwide direct distance dialing network and extension of regular telephone service to many villages totally without communication service today; and
- 3) Development of a fundamental plan for a total integrated Alaskan communications network for the mid 1970's and beyond, including satellite earth stations.

Also included in RCA Alascom's overall development plans are provision of improved data service.

The program for expanding the long-haul facilities to meet the Busy Season of 1970 includes the installation of equipment to provide more than 400 new voice channels for use in the inter- and intra-state networks. Approximately 200 of these circuits will be included in two separate new microwave systems, while the remainder will be provided by installing

additional multiplex equipment on existing microwave and tropospheric-scatter radio systems. RCA Alascom is also installing a new tropo system some 300 miles above the Arctic Circle, to bring vitally needed communication circuits to Alaska's North Coast. These facilities are required to support the tremendous oil exploration activity presently under way in the Prudhoe Bay area. Provision of the long-haul facilities also requires that interconnection facilities with local telephone companies be expanded. These expansions are also in the process of implementation by RCA Alascom.

RCA Alascom's major construction program covers the time period through 1972, and is designed not only to further expand and modernize the long distance communications network, but also to introduce new services to the residents of the State.

One of the largest undertakings in the construction program is the installation of equipment to automate the switching of the long distance circuits. This will allow telephone subscribers in Alaska to dial their own long distance calls for the first time. The capability to automatically record information required for subsequent billing of the toll calls is also being provided. This automation facility will improve the efficiency of operations and be an important factor permitting RCA Alascom to offer a 29% reduction in the cost of long-distance telephone rates. This system is scheduled to be fully operational in 1971.

Another major part of the construction program is the implementation of the "Bush Phone" system. This system will extend regular telephone service to 142 villages remotely located from major population centers. Transmission will be accomplished by a combination of satellite microwave, tropospheric-scatter VHF, and UHF radio links to isolated villages. Most of these remote villages have no telephone service at the present time, while the few that have service can only be contacted with about 30% reliability. The "Bush Phone" program will require approximately three years to complete in its entirety.

A new microwave system is presently under construction in Southeastern Alaska by RCA Alascom. This system will extend circuits from Juneau to Sitka and Angoon and will later be expanded to extend service to Petersburg and Ketchikan. At the time of the completion of the system to Ketchikan, an undersea cable installed in 1957 will be abandoned with resulting decreased maintenance costs.

RCA Alascom is also installing a 36-channel tropospheric scatter radio system from Barter Island in Alaska's Beaufort Sea to Frontier on Alaska's North Slope in the Prudhoe Bay area. This system, installed some 300 miles

north of the Arctic Circle, will provide much needed service to the oil exploration fields on the North Coast of Alaska by interconnecting the Frontier terminal with U.S. Government facilities at Barter Island where they will be extended southward through the military network. While the tropo system is not large nor technically complex, it is located in one of the harshest of environments: temperatures of -70° F with winds up to 100 miles per hour are not uncommon in the winter months.

The majority of system expansion to meet the 1970 Busy Season requirements will be obtained by adding channeling equipment to existing military TD-2 and tropospheric radio systems. While this sounds simple and should be a straightforward engineering task, the job is complicated by the fact that these systems are owned by the U.S. Air Force, controlled by the Defense Communications Agency, and operated by an industrial company under contract to the Air Force. Permission to install commercial equipment on a military communication system for operation by private industry at a reasonable profit while reimbursing the military for a fair share of the operating costs of the military system has required extensive negotiations between RCA and the military.

Probably the most exciting communications improvement underway in the State at the moment is the introduction of commercial satellite communications to Alaska. An earth station has been installed in Talkeetna, Alaska, approximately 100 miles north of Anchorage, jointly by RCA Alascom and Comsat. This station, placed into service in July, 1970, makes network television available to Alaska for the first time on a regular basis. It also provides as many as 132 voice-grade telephone channels to interconnect Alaska with the lower 48 states and the Pacific area through INTELSAT III and later INTELSAT IV. The earth station is interconnected to the Anchorage Toll Center by a three-hop, high-capacity microwave system operated by RCA Alascom.

New services

Of the many new services introduced to the State in 1970, the first was Telex. This service permits a subscriber to contact other subscribers in many parts of the world for exchange of teleprinter messages and is charged for on a time-used basis. Also, improved data service to the many users of data transmission facilities will be provided.

RCA Alascom's future

Alaska's motto this year states that "Alaska Looks to the Future," and RCA Alascom intends to provide the efficient and economical communications service required by the State to accomplish their plans for progress. Toward this end, Alascom has undertaken a program which will result in a totally integrated communication system on a statewide basis.

These plans include a network of modern, high speed communications facilities including satellite earth stations at the major population centers interconnected also by high capacity terrestrial links and a number of smaller earth stations having a receive-only capability for educational television. This system will be installed to support the communication needs of Alaska including not only the commercial requirements, but those of the military as well.

The foregoing just touches lightly on programs underway in Alaska by RCA. We are just beginning; and like the State, RCA is also "on the move."



Fig. 4—Oil drilling rig on Alaska's north slope.

Data, voice, and television services

L. G. Donato

Data, Voice and Television Services (DVTS)—a section of RCA Global Communications, Inc.—provides some of the most sophisticated services offered by the RCA subsidiary. These include program service, facsimile service, datel, executive *Hot Line*, interpolated voice data, intercontinental television service, and alternate or simultaneous voice record services.

IN 1932, a separate section of RCA Globcom was devoted exclusively to the handling of international addressed program transmissions for the broadcasters; this section—now known as Data, Voice, and Television

Reprint RE-16-4-10
Final manuscript received June 10, 1970

Services (DVTS)—today provides extensive services for commercial users, the press, and the government. The transmission media has been expanded from the high frequency radio links first used to include cable and satellite facilities. The common denominator of these services is bandwidth—all use 3 kHz or greater. The activities of the DVTS are described, in general, in Fig. 1 and, in some detail, in the paragraphs that follow.

Program service

There are three main functions of the program service. The first is the reception of addressed commentaries by overseas network correspondents. In this case, RCA Globcom provides a two-way circuit with the distant end, enabling broadcasters to talk to, cue, and actually use the material from their correspondent covering a newsworthy event.

The second function, the transmission of news and sporting events to overseas destinations, includes such broadcasts as may originate from the *Voice of America*, the *United Nations* or the transmission of baseball and sporting events to the Caribbean and South American areas.

The third function, the reception of overseas broadcasts, generally scheduled at regular intervals, is an extremely important source of network news. Examples of signals monitored include those from the BBC London, Radio Peking and Radio Moscow. We, incidentally, were one of the first to receive and monitor the signals from Russia's first satellite—Sputnik.

It might be interesting to note that during space shots, RCA Globcom provides radio circuits from the re-

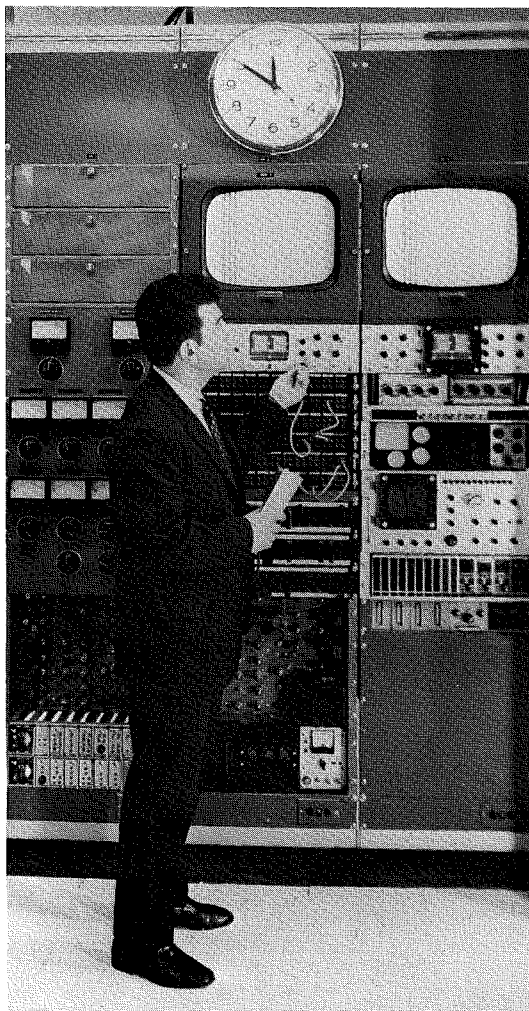

The first color TV reception from outer space was transmitted to Japan via RCA Globcom facilities. Technician Bruno LaBella checks equipment before Apollo 10 program reception.

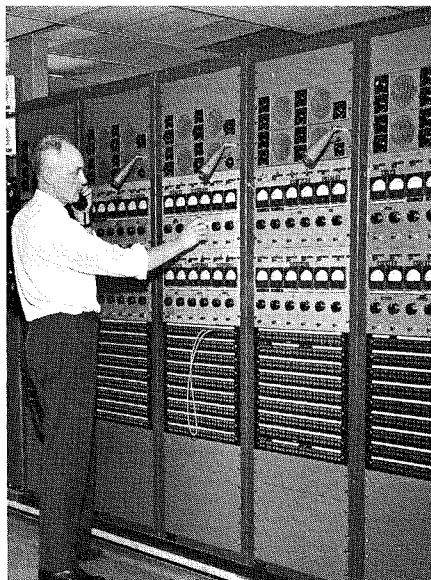

Through the leased-channel control racks shown above, RCA Globcom provides services for commercial users, the press, and government.

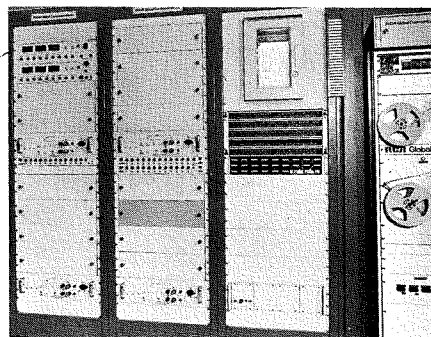

This control office concentrator at RCA Globcom in New York provides *Hot-Line* services for 25 subscribers.

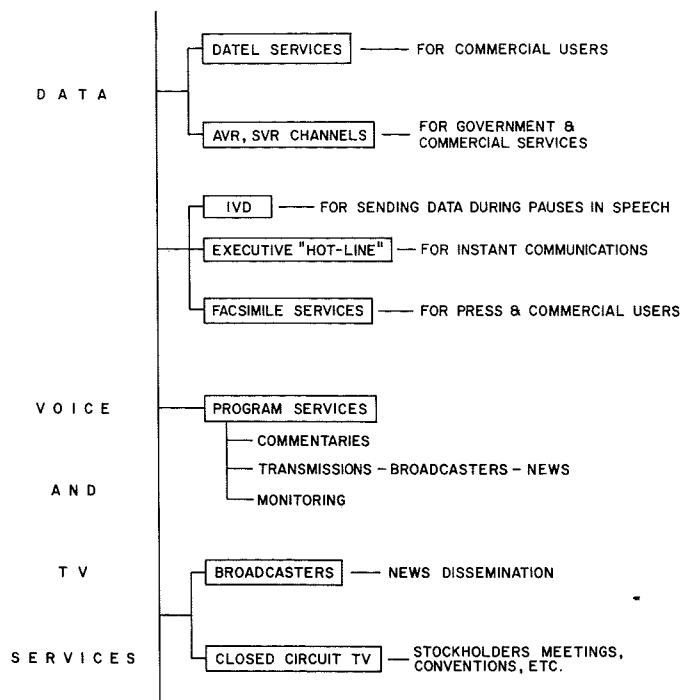

Fig. 1—Activities of Data, Voice, and Television Services.

covery ship involved. These circuits are used by broadcasters for live commentaries and by the press to transmit photos of recovery operations, minutes after the event takes place.

Facsimile service

Facsimile service provides the press, or any commercial user, a means of transmitting or receiving photographs, drawings, sketches, or documents to or from an overseas point. We operate approximately fifty such circuits on a worldwide basis. Pictures addressed to private individuals are received on film, developed, printed, and hand delivered by messengers. We do, however, have private lines to the larger press organizations. A picture from Paris, for example, is usually received by RCA Globcom and fed electrically to the Associated Press or United Press International. The agency, in turn, can feed its domestic network, resulting in simultaneous reception at many locations throughout the United States—all within a matter of minutes. One of the major advantages of the facsimile service is its inherent ability to transmit error-proof documents. Facsimile offers the only method of transmitting signatures, diagrams, and languages (such as Japanese) in original form.

Datel

Another interesting form of service provided is called *datel*. An overseas

circuit is provided, customer to customer, for the exchange of high-speed data or facsimile. The service is "on demand" and is charged for on per-minute basis. In the New York City area, customers are provided with private tie lines, free of additional charge. Connections to customers anywhere in the United States are handled via Western Union broadband circuits, at no additional charge to the customer.

Basically, a customer calls RCA Globcom and asks to be connected to an overseas party. Once the connection is established, the charges begin and the customer exchanges data, using voice for cue and control of his transmission. Using the latest type of facsimile equipment, a customer can transmit a full page document in approximately four minutes. Data can also be transmitted at rates varying from 600 to 3600 bits per second. If requested, RCA Globcom will lease and also maintain the necessary facsimile or data equipment.

Executive hot line

The two newest additions to the services offered are *Executive Hot Line* and *Interpolated Voice Data*. *Hot Line* provides business-man with an immediate connection to a designated overseas point. By merely lifting the handset on a specially provided telephone, a business-man in New York can establish immediate contact with



Louis G. Donato, Mgr.

Data, Voice and Television Services
RCA Global Communications, Inc.
New York, New York

assumed his present position in January 1961. His work at RCA Globcom, for the past 29 years, has centered around its broadband offerings. He attended Brooklyn College, and graduated from RCA Institutes, where he majored in Communications. While on military leave from the company he was stationed at the War Department Radio Receiving Station at LaPlata, Maryland, where it was his responsibility, as a chief, to maintain worldwide communications. Mr. Donato is an active participant in the joint carrier television committee, and assigned to several C.C.I.T.T. study groups.

an associate, eliminating the time consuming chore of placing calls through switchboards or dialing long numerical sequences. In addition to voice communication, the "Hot Line" can also accommodate various forms of high-speed data communications.¹

Interpolated Voice Data

Interpolated Voice Data (IVD), utilizes a private voice-record channel (3 kHz), for the simultaneous transmission and reception of voice and data or voice and facsimile information. It is a major milestone in communications, since it permits customers to obtain total circuit utilization. RCA Globcom provides the electronic units associated with the service, such as a buffer unit, which converts high-speed data; an information storage and speed conversion unit; specially designed channel multiplexing equipment; a digital facsimile unit, and a telephone instrument, which is used for voice communication. The customer supplies information input/output devices, such as data terminals and facsimile equipment. Basically, the system permits high-

speed data transmissions to take place simultaneously with voice conversations. The data actually becomes interpolated with the voice information. During pauses in the voice conversation, data is transmitted, in bursts, to the receiving end. Specially designed RCA Globcom equipment, connected to the circuit, separates the voice from the data or facsimile portion and sends each form of information to the appropriate receiving equipment.

Intercontinental television

As mentioned previously, in 1932 RCA Globcom started handling audio information from overseas points. In 1965, with the development of the commercial satellite communications system, video was added. Television broadcasters throughout the world use the service for news, sports, or special events. The role of DVTS is to provide a complete service for the customer by ordering all circuit facilities from the origin to the final destination of the TV program, and also to maintain a high technical standard for the audio and video signals. The programs may require complex routings, involving connections between the earth stations and the broadcasters. To make arrangements for these connections, extensive use is made of the worldwide telegraph and telex networks of RCA Globcom. This is an extremely valuable asset when dealing with broadcasters having urgent TV requirements. For example, the Apollo moon walk was handled through the New York DVTS facilities and provided live coverage of the event to millions of viewers throughout the world.

The service is not limited to broadcast applications. Closed-circuit TV for commercial use is becoming increasingly popular for linking conventions, stockholders' meetings, medical conferences, and similar gatherings. For example, a special two-and-a-half hour program originating at the Houston and San Antonio, Texas, NASA Space Centers was transmitted via DVTS closed-circuit TV facilities from New York to Davos, Switzerland. There it was displayed on a theater size screen at the 1970 Convention Hall of the 18th International Congress for Post Graduate Medical Instruction of the

West German College of Physicians. In addition to the 2,000 doctors viewing the program at Davos, another 25,000 doctors followed the proceedings by simultaneous projections in auditoriums in ten West German, Austrian and Swiss cities. Pictures were described by the delegates as sharp and bright with accompanying flawless sound.

Alternate voice record (AVR) and Simultaneous voice record (SVR) channels

The greatest expansion in DVTS has been in the area of AVR and SVR leased channels. In both cases, a customer contracts to lease a 3-kHz channel on a 24-hour/day basis, and the channel is designed specifically for his needs. For example, a customer has the option of using either voice or data or facsimile and simultaneously operating several teletypewriter channels.

One of the most important technical requirements is of channel equalization. The transmission of high-speed data or facsimile will succeed only when channels are fully equalized for delay and amplitude. Normally, equalization is performed at the receive end; however, in cases where this cannot be done, equalization or predistortion is performed at DVTS. A typical

configuration is shown in Fig. 2, the channel leased by Swiss Air.

The primary function of the system permits computer interrogation of reservations available on scheduled flights. The controlling computer, located in Zurich, singularly poles one of three locations in sequence. Each location containing approximately 26 visual display reservation agent units. The data transmission rate is at 2400 bits/s, and utilizes the 800- to 2400-Hz portion of the channel. Operating simultaneously are five 74-baud teletype channels utilizing the lower and upper portions of the frequency spectrum. The median frequencies are 540 and 660 Hz at the low end [and 2700, 2820 and 2940 Hz at the high end]. Several of these channels are further extended to Copenhagen. It is interesting to note that three of these channels operate through AIRCON (Automated Information and Reservations Computer Oriented Network) an RCA Globcom message switching system that permits automatic switching to any one of 45 domestic Swiss Air offices. By means of selective polling, these stations are permitted to send to any other Swiss Air station on the system.

Reference

1. Solomon, S. M., "Hot Line Voice/Data system," in this issue describes the Executive Hot Line Service in some detail.

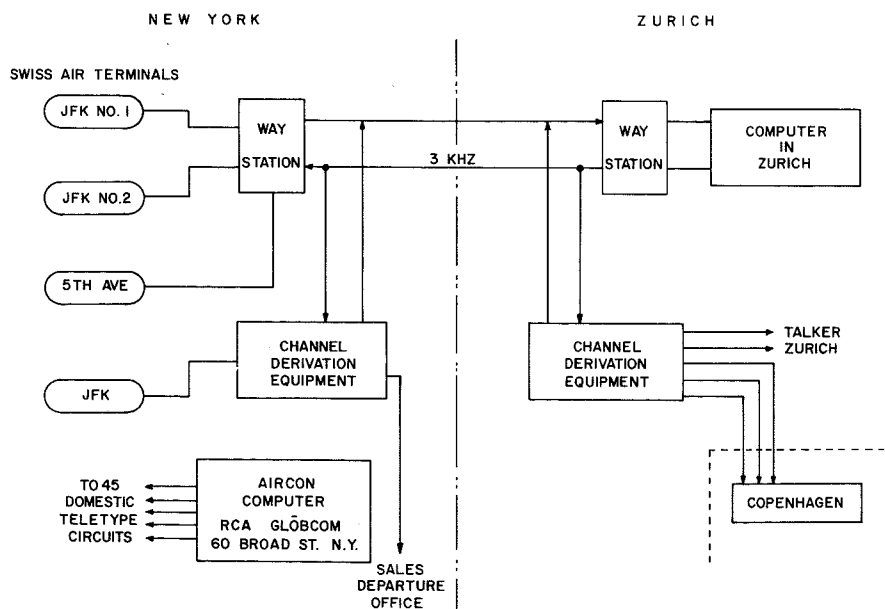

Fig. 2—AIRCON—Automated Information and Reservations Computer Oriented Network—for Swiss Air.

Hot Line voice/data system

S. M. Solomon

The *Hot Line* voice/data system, a new service provided by RCA Globcom, is presently in operation between New York City and San Juan, Puerto Rico. The system provides subscribers, on demand, the use of a conditioned voice-grade overseas channel for alternate voice/data communication. Neither dialing nor pushbuttons are required, and establishment of the connection is almost instantaneous. Once the connection is made, the parties at either or both ends can talk in complete privacy. If desired, a conference can be set up at either end or at both. In addition, with the use of modern transmitting and receiving equipment, the system can be used for high-speed data service. RCA Globcom plans to extend this service in the near future to Europe, South America, and the Far East.

THE INTERNATIONAL voice/data *Hot Line* marks a totally new concept in international, shared voice-record communications. The *Hot Line* makes possible, at any time of day, instant voice/data communications between local and overseas subscribers. It differs from previous services in that the shared voice circuit eliminates the need for subscribers to place calls to designated overseas points through special telephone operators, or to dial long numerical sequences: simply by lifting the handset of his telephone, a subscriber can immediately establish a connection with a designated overseas correspondent.

The system is a combination voice/data facility, and can accommodate various forms of record and high-speed data communications. Information input/output devices such as data terminals, teleprinters, and equipment for transmitting facsimile can be interconnected with the system.

As part of the service, RCA Globcom provides the subscriber with up to 10 desktop telephones designed especially for internal and external communications. All telephones are equipped with selector buttons. One telephone serves as the master station, with the capability of switching from voice to data mode, or to any or all *Hot Line* extensions located in the subscriber's office (or elsewhere). Each extension has its own operative selector buttons that permit their users to participate in conference calls and to notify other stations when the system is in the data mode. Moreover, the master station and its extensions are capable of communicating, either individually or col-

Reprint RE-16-4-9

Final manuscript received June 8, 1970

lectively, with the master station and all extensions at the overseas end.

Another feature available in the *Hot Line* service is a *priority* extension for, say, the subscriber's chief executive officer. This extension is absolutely private, and enables the user to preempt the system for voice conversation which cannot be monitored.

Although the system has been designed to provide immediate connections between terminals under normal traffic conditions, there is the possibility that, during peak loads, all overseas trunks might be busy at the same time. In this event, another feature, termed *camp-on*, enables the calling party to place his handset back on-hook, yet keep his call active.

Still another feature is incorporated in the *Hot Line* service. From the moment the called party picks up his telephone and establishes the connection, until the call is terminated, elec-



Stanley M. Solomon, Ldr.
Switching and Computer Engineering
RCA Global Communications, Inc.
New York, N.Y.

received the BEE and MEE from New York University in 1948 and 1959, respectively. He has done additional postgraduate work at Columbia University. From 1959 to 1968, Mr. Solomon was with the Defense Advanced Communications Laboratory of RCA Defense Electronic Products, New York, where his area of concentration was digital communications and switching equipment. He joined RCA Global Communications, Inc. in 1968, and is presently engaged in the development of the *Hot Line* voice/data communications system. Mr. Solomon is a Member of IEEE and Eta Kappa Nu, and is a Licensed Professional Engineer in New York and New Jersey.

tronic impulse counters record the length of time the subscriber is using that particular circuit.

System description

The *Hot Line* Voice/Data System is shown in Fig. 1. The system comprises two Central Office line concentrators and Subscriber terminal equipment. Each Central Office line concentrator (Fig. 2) is fully automatic and capable of working with a similar switching system. The concentrators provide the means for an RCA Globcom sub-

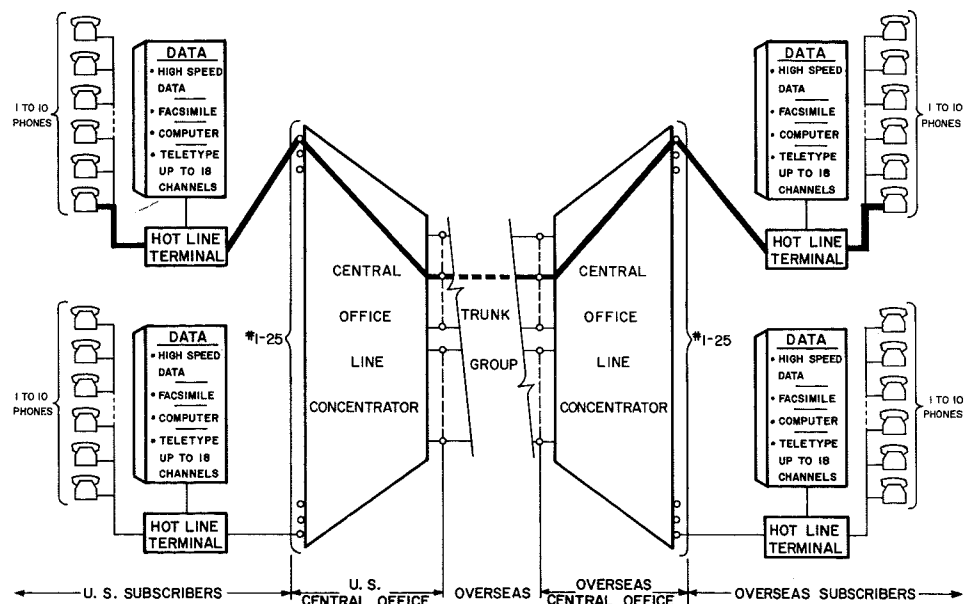

Fig. 1—System configuration.

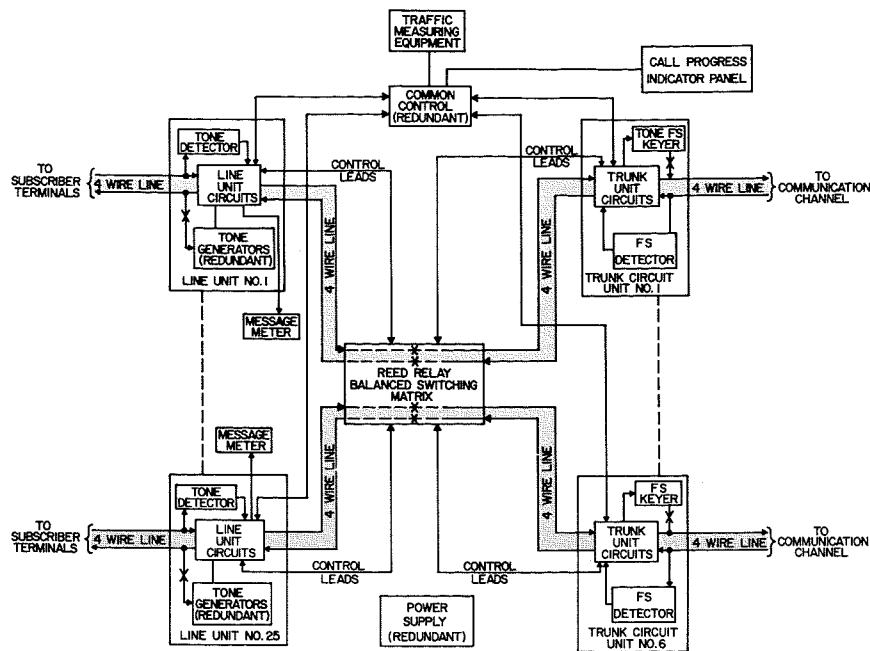

Fig. 2—Hot Line concentrator voice data functions.

subscriber at one terminal to connect to one, and only one, subscriber at the other terminal. All transmission paths are on a 4-wire basis.

Each Subscriber terminal equipment (Fig. 3) can accommodate up to 10 telephones, in addition to the data terminal. Additional, off-premises extensions, can be provided, if desired.

Line concentrator equipment

The line concentrator includes the following (Fig. 2):

- Switching network and associated control
- Line and trunk circuits and associated terminating equipment
- Signaling and supervisory equipment
- System monitoring equipment
- Message-rate metering equipment
- Traffic analysis equipment

Each concentrator is designed for continuous operation. Single-component

failure in any subsystem or common circuit will not cause a complete failure of the Central Office.

Switching network and associated control

The switching network provides the capability of interconnecting line and trunk terminations on a 4-wire, full-duplex basis, and is designed to connect any line to any trunk, but not line-to-line, or trunk-to-trunk.

Line and trunk terminations

At each concentrator, all line and trunk circuits terminate in a 4-wire, voice-grade communications channel. Line circuits are designed on the basis of a non-metallic path between Subscriber terminals and a concentrator, while trunk circuits are non-metallic paths between concentrators. This design can also function in the event a metallic path exists between Subscriber terminals and a concentrator.

One of the two concentrators is the "prime" unit. This feature prevents the possibility of a "double seizure," which occurs when *Hot Line* subscribers at either end of the system attempt to initiate simultaneous calls. The feature is optional, and is accomplished by strapping.

Signaling and supervision

Signaling between concentrators is on an AC basis as shown in Fig. 4. Digital codes (see Fig. 5) are transmitted via frequency-shift keys to provide correct transmittal of information, and to insure against wrong-number transmittal, wrong connections, or double connections. Signaling between the Subscriber terminal equipment and the concentrator is based on on/off AC.

Supervision between Subscriber Terminal Equipment and the Concentrator, and between Concentrators, is also on an AC basis.

Signals directed to the subscriber are incorporated in each concentrator. Ring-back, ring-forward, and camp-on signals are integrated in the line circuits or common equipments.

The proposed Standard of Audible Tones, specified in CCITT Document APIII-84, is used as a guide for the frequencies, power levels, and repetition rates of the tones sent by the concentrator to the Subscriber terminal equipment, except for the cadences of *ring-back* and *ring-forward*: these are 2-second-on and 2-second-off signals. The camp-on signal is the equivalent of an *all-circuits-busy* (reorder) tone.

Camp-on

Camp-on is provided in each concentrator, and is used to permit the calling party to reserve a trunk in the event that all trunks are busy when he tries to initiate a call. During the camp-on sequence the call cannot be completed if the calling party either remains off-hook or goes on-hook then back off-hook.

Whenever all trunks are busy, the camp-on equipment sends the calling party a camp-on signal (all-circuits-busy tone). This alerts the calling party of the "busy" condition, and of the fact that he can go back on-hook

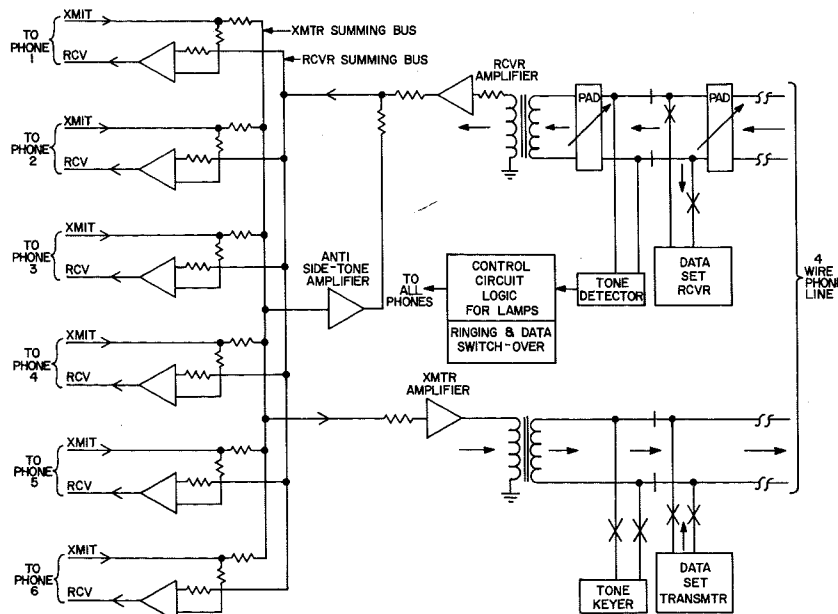

Fig. 3—Hot Line subscriber terminal functional diagram.

without "losing his place in line." Once back on-hook, he is kept aware of his camp-on status by visual illumination of a voice lamp.

When the first trunk circuit becomes available, the camp-on equipment seizes the trunk, and enables the concentrator to ring the calling party.

Once the calling line has been located, the control logic within the concentrator applies ring-forward to the calling line for a specific timed interval (adjustable for each subscriber from 30 seconds to 1 minute). If the calling party does not answer within this time frame, the call is timed-out, and the stored camp-on request is erased. If the calling party does answer within the time frame, the call is then processed normally by the concentrator.

Message and traffic metering

Message metering is used to extract billing information, and is accomplished by the use of impulse-type counters incorporated in the line-circuit terminations. These counters show usage rate, and advance at 6-second intervals. Metering starts whenever a connection is established (both terminals connected and both handsets off-hook); it terminates when the connection is terminated. Message metering shows only those calls originated by a subscriber connected to that particular line circuit.

The traffic-metering equipment assembles data for traffic flow, line and trunk usage, and trouble recording. Traffic recording equipment is also incorporated. This equipment provides information indicating the number of times that the equipment and all trunks are busy, the duration of calls as well as camp-on mode, and the time of day that the calls take place.

Call description

Call initiation

To initiate a call, the calling party lifts his handset, thereby generating a service request to his associated concentrator. If a trunk is available, the Local Central Office (calling office) selects the trunk and signals the Remote Central Office (called office), identifying both the calling and called parties. Each Central Office then makes the proper connection between the associated line and trunk circuits. A ring-forward signal is then sent to

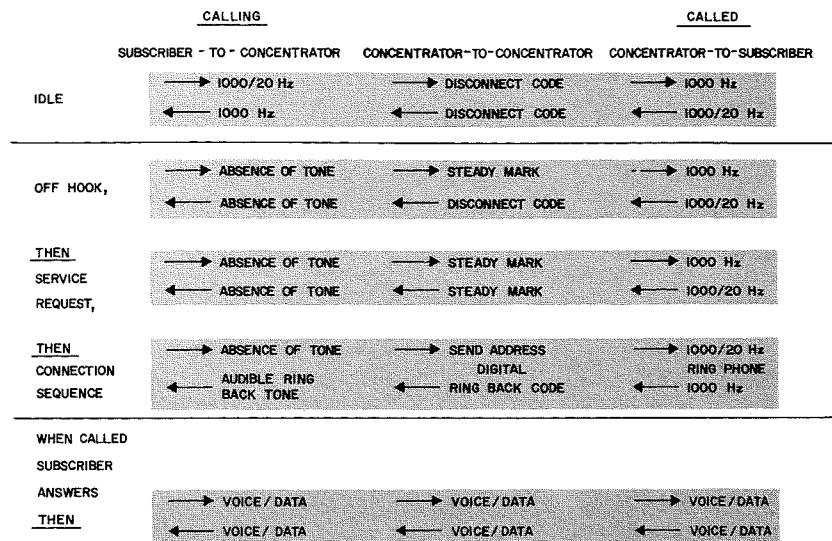

Fig. 4—Call-sequence diagram.

the called party; ring-back is sent to the calling party from the Remote Central office.

Trunk busy

This situation has already been covered under the topic of camp-on.

Called party does not answer

If the called party does not answer within the timed interval, the Remote Central Office times out the call and terminates both the switched connection to the called party and the trunk-circuit connection; the trunk is thus idle again, and available for another call. The calling party is then signaled by a steady tone, and he reverts to the on-hook condition.

If the calling party goes back on-hook during the timed interval before the called party answers, the call is terminated and the ringing signal ceases.

Called party answers

If the called party answers within the timed interval, the ringing signal is tripped, and the voice connection is established.

Call termination

Either the calling or called party can terminate the call by going back on-hook.

Future plans

Each Central Office line concentrator, in the initial configuration, comprises 25 subscriber lines connecting to any one of six trunks, on a 4-wire transmission basis. In the expanded configuration, 12-trunk capacity will be available. The expansion can be accomplished by means of inserting additional plug-in boards in the concentrator: the proper wiring already exists. In the initial configuration, vacant trunk circuits are "busy."

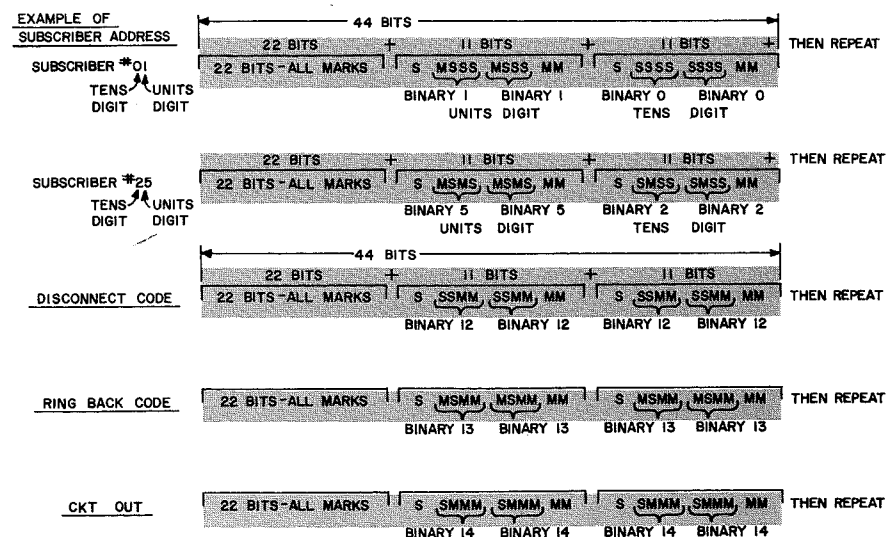
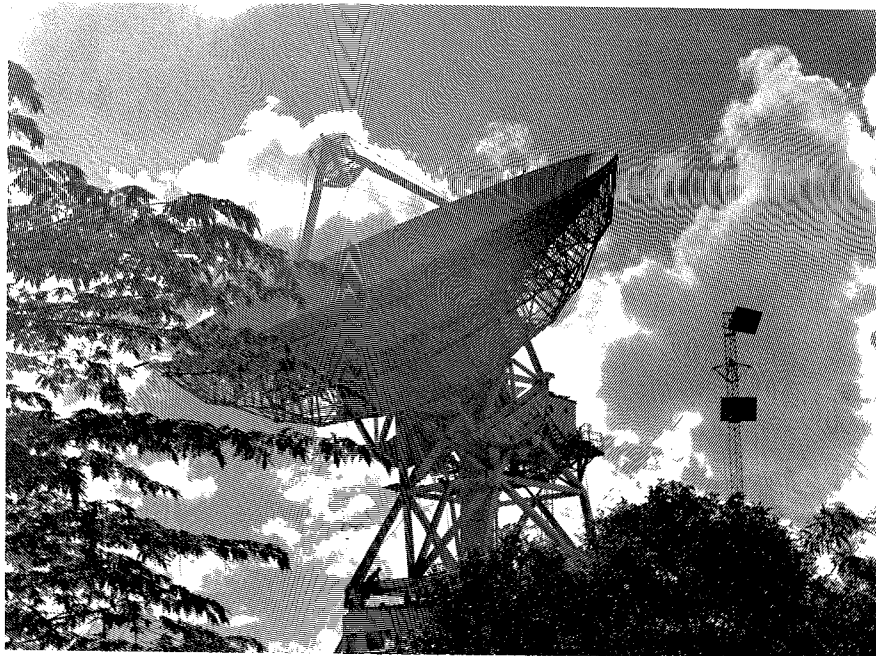

Fig. 5—Trunk signaling and supervision codes: digital codes frequency-shift keyed at 150-baud rate. Mark frequency=2580 Hz; space frequency=2700 Hz.



Pulantat earth station

J. M. Walsh | Tin Win

The satellite communications earth station at Pulantat on the island of Guam provides vital communications circuits for the Department of Defense and expands public-message telephone service in the Pacific. The 98.4-ft. diameter Cassegrain antenna has a power output of 5000 Watts. It is designed to withstand winds up to 210 mi/h. The station transmits 60 FDM-FM voice channels over the 5925-MHz to 6425-MHz band, and receives 60 voice channels from five separate earth stations over the 3700-MHz to 4200-MHz band. It is being expanded to 132 channel capacity. This paper describes the technical planning, engineering design, and construction of a spaceage earth station on an island in the South Pacific.

Tin Win, Manager

Satellite Engineering

RCA Global Communications, Inc.

New York, N.Y.

received the BEE from Rensselaer Polytechnic Institute in 1958. From 1959 to 1966, he worked in Wireless Division, Burma Post and Telecommunications Department. In July 1966, he joined the Engineering Department of RCA Global Communications, Inc. as a Design Engineer where he worked on various HF, VHF and microwave projects. He was promoted to Group Leader in 1968 and directed the engineering design activities for the Guam Earth Station project from its inception to its completion. Mr. Win became Manager, Satellite Engineering, in 1970 and is now responsible for satellite communications engineering. He is a member of the IEEE, Radio Communications Committee.

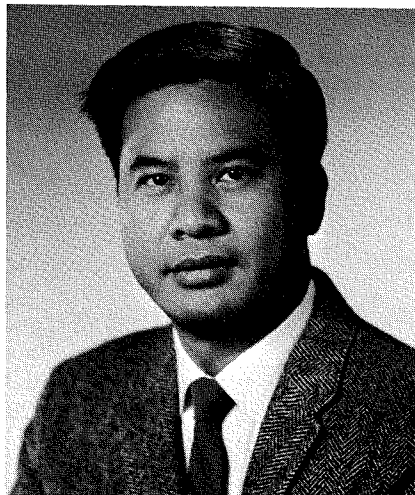

James M. Walsh, Director

Satellite, Radio and Facilities Engineering

RCA Global Communications, Inc.

New York, N.Y.

received the BEE from Manhattan College in 1943. After military service, Mr. Walsh joined RCA Communications, Inc. as a Jr. Design Engineer. From 1946 to 1956, he was involved with plant design of radio stations and antenna installations; from 1956 to 1957 he was Administrative Assistant to the Vice President & Chief Engineer; from 1957 to 1960 he was Manager, Terminal Facilities-Installation Design; from 1960 to 1967 he was Manager, Terminal Plant Engineering; and from 1967 to 1970 he was Manager, Satellite & Radio Engineering. Mr. Walsh recently was promoted to his current position in which he has engineering responsibility for installation and construction of satellite earth stations, radio, and building facilities throughout the RCA Globcom system. Mr. Walsh directed the engineering efforts for the installation of the temporary Thailand transportable satellite earth station as well as for the Guam earth station project. He is a licensed Professional Engineer of New York State, a member of the Space Communications Committee of the IEEE, and a member of CCIR and AFCEA.



SINCE THE EARLY DAYS OF ECHO, TELSTAR, RELAY AND SYNCOM, RCA engineers have devoted much time and effort to translating these pioneer experiments in satellite communications into the reality of services for the public, industry, and government. In April of 1965, when EARLY BIRD ushered in the era of commercial satellite communications, RCA was already fully committed to this new mode of global communications. In October of 1963, RCA Victor, Ltd. began the design for the construction of Canada's experimental communications satellite earth station at Mill Village, Nova Scotia; thus, Canada became an important member of the community of nations contributing to the advancement of the technology of commercial satellite communications. During 1966, RCA Global Communications, Inc. filed with the FCC a joint application with other common carriers for authority to construct and operate a satellite earth station at Woodland Georgia. This further established the firm position of RCA Globcom in the business of satellite communications.

In October of 1966, the Thailand Department of Post & Telegraph

Reprint RE-16-4-11

Final manuscript received June 23, 1970.

awarded a contract to RCA Globcom to provide, install, and operate a transportable earth station and associated two-hop microwave link at Sriracha, approximately 50 miles southeast of Bangkok. The station was placed in commercial operation in April, 1967, for approximately a one-year period. Thailand became the first country in Southeast Asia to inaugurate commercial service via satellite. RCA Globcom thus gained valuable first-hand experience in operating and managing a satellite earth station.

Guam

Guam, the largest and southernmost of the Mariana Islands, is located at latitude 13° 28' North, and longitude 144° 45' East. It is 30 miles long, 4 to 11½ miles wide, and 212 square miles in area. It has been subjected to many typhoons with velocities as high as 210 miles per hour. Guam and the adjoining islands are rapidly being developed by private and industrial interests. In addition, Guam is a key military base for the Southwest Pacific area. As a result, substantial additional circuits are required for public message, Telex, telephone, and leased-channel services. Thus, Guam is an important hub for transpacific communications, with submarine cables extending as follows:

- 142 voice circuits to Hawaii (3,842 n. miles)
- 138 voice circuits to Japan (1,403 n. miles)
- 128 voice circuits to Philippines (1,470 n. miles)

- 160 voice circuits to Australia (2,999 n. miles)
- 80 voice circuits to Hong Kong (2,060 n. miles)

The cables to Australia and Hong Kong are owned by the British Commonwealth partners. The former cable can be interconnected at Australia to an 80-voice circuit cable (5,537 n. miles) to Hawaii via New Zealand. The latter cable can be extended 1,975 n. miles to Singapore via Borneo.

RCA position

RCA Global Communications, Inc. was in a unique position on Guam, having operated telephone and telegraph communications facilities there during the past two decades via radio and cable systems. The Guam-Hawaii Transpacific Cable is a most important cable link, since both termination points are capable of being interconnected to several other cables going to other parts of the world. RCA Globcom predicted early saturation of these communication facilities. While there is an alternate cable route available to Guam via the British Commonwealth cables, extending between Hawaii and Guam via Australia and New Zealand, costs would be greater than for satellite operation, resulting in higher rates to the public. These factors established the urgent requirement for an earth station on Guam. Accordingly, RCA Globcom filed an application with the FCC on March 4, 1968 for authorization to construct the Guam Earth Station by relocating the Thailand transportable earth sta-

tion and providing a new 98-to-100-ft-diameter antenna system. This application received support from the Department of Defense. Shortly thereafter, ITT World Communications, Inc. and Western Union International, Inc. agreed to participate with RCA Globcom in this undertaking. The RCA Globcom application was amended to add ITT Worldcom and WUI as parties, to reflect expanded channel requirements, and a decision to provide all new equipment for the earth station.

Planning phase

On August 5, 1968, RCA Globcom issued a request for proposals to fourteen technically qualified and experienced contractors—domestic and foreign—to design, engineer, supply, construct, install, and test on a turn-key basis, a complete satellite earth station facility on Guam. The station was to be capable of transmitting 60 FDM-FM voice channels and receiving a total of 60 voice channels from three separate earth stations. The station would also be capable of expansion to 132 channels. Options for color/monochrome TV receiving and transmitting facilities, for the fourth and fifth receive carriers, for commercial power, and for a no-break power system, were also obtained.

Meetings were held with each of the contractors who responded to the request, to discuss in detail the technical contents of their proposals. At these meetings, the contractors were en-

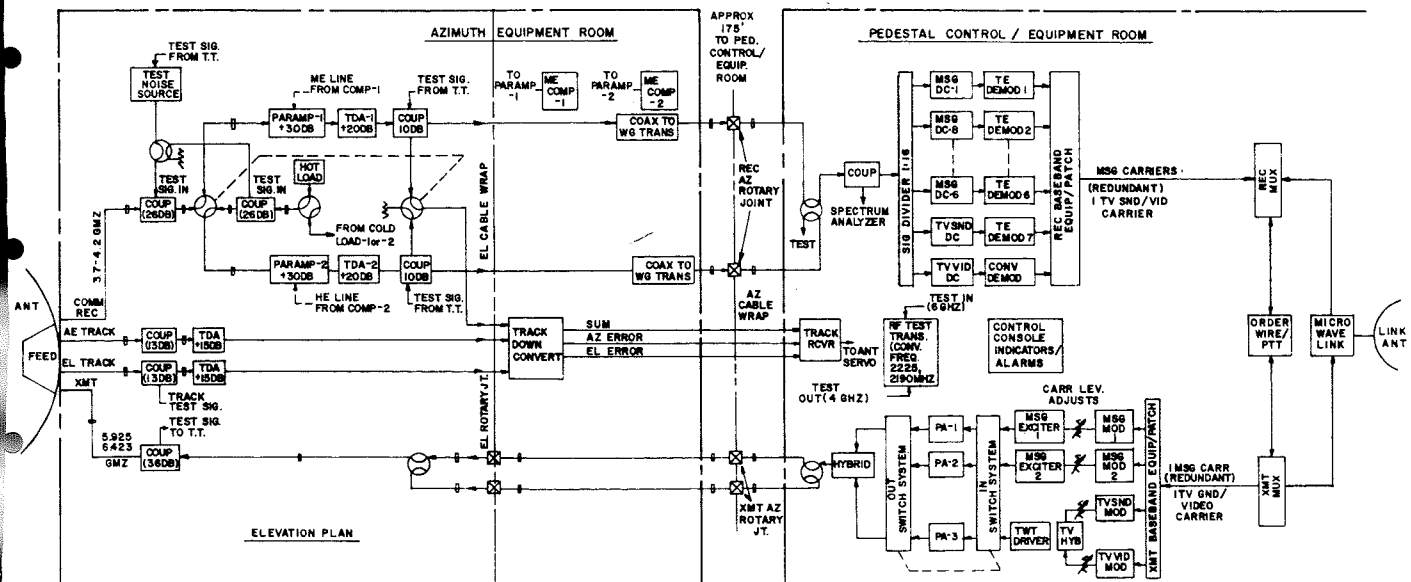

Fig. 1—System block diagram.

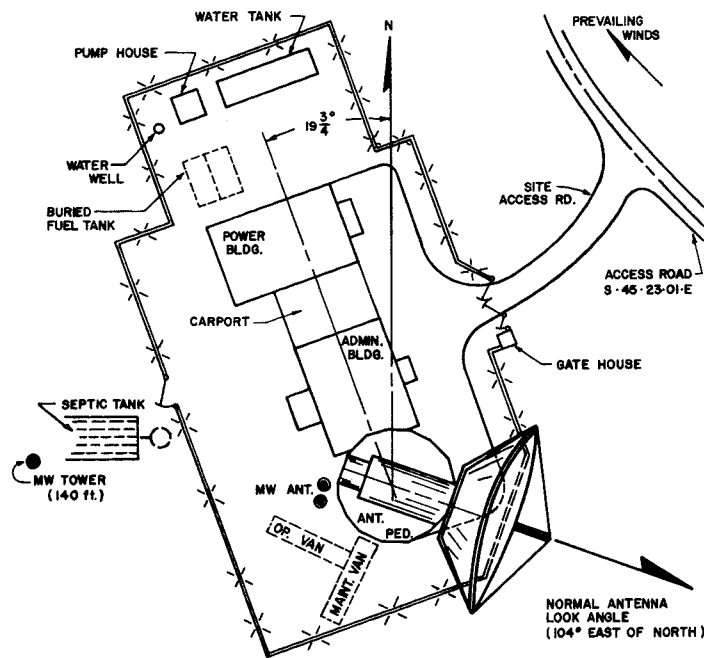

Fig. 2—Earth station site plan.

couraged to revise, improve, and standardize their technical specifications and reduce costs. The revisions were re-examined and the evaluation continued.

On April 8, 1969, the contractors were invited again to review the technical specifications for the Guam earth station prepared by RCA Globcom, and also to resubmit and revalidate their proposals.

On May 15, 1969, the Defense Communications Agency (DCA) awarded RCA Globcom a contract to supply a 48-kHz channel between Hawaii and Guam by November 1, 1969, for alternate use for voice and wideband applications. To furnish these facilities, and to meet the critical operation date, RCA Globcom proposed the construction of an earth station on Guam to be accomplished in two phases:

Phase I would provide for a 48-kHz wideband satellite channel, expandable to 24 channels, utilizing on an interim basis major portions of the electronic equipment in the RCA transportable earth station available from the Thailand installation; and the procurement and erection of a new 98.4-ft-diameter antenna system and low-noise receiver system.

Phase II would provide for completion of the permanent earth station and removal of transportable earth station facilities.

Performance characteristics

The general performance characteristics of the permanent earth station are

contained in Table I. A simplified diagram of the earth station system is shown in Fig. 1; the site plan is shown in Fig. 2. The earth station is capable of transmitting 60 voice channels on one carrier, and receiving a total of 60 channels distributed among five carriers. It is being expanded to 132 voice-channel capacity. The station is also capable of transmitting and receiving both color and monochrome TV programs. The operating control in the antenna pedestal, with equipment and facilities, and a contiguous administration building are shown in Fig. 3. The total combined floor area is approximately 3600 sq. ft. Road, fence,

site development, landscaping, and other station facilities are provided.

Since time was of the essence, the FCC authorized RCA Globcom, Comsat, ITT Worldcom, and WUI to issue a limited letter of intent to ITT Space Communications, Inc., the RCA Globcom recommended contractor, to proceed with portions of the Phase I program. At the same time, the carriers were advised to come to an agreement on engineering approach and technical design prior to the FCC issuance of a construction permit. Ownership, management, and operation of the station also had to be resolved, as did site selection, RFI problems, location of microwave systems and roads, and power and construction problems. Intensive negotiations produced agreement among the carriers, and paved the way for full effort on the construction program.

The Pulantat Earth Station is jointly owned by RCA Globcom (34%), ITT Worldcom (8%), WUI (8%), and Comsat (50%). RCA Globcom is the Operations Manager; Comsat is the Systems Manager. As Operations Manager, RCA Globcom directed the construction and operates and maintains the earth station.

Construction

The construction portion of Phase I proceeded rapidly, in accordance with a tight but coordinated schedule. The foundation for the 98.4-ft-diameter LTV antenna system was the most

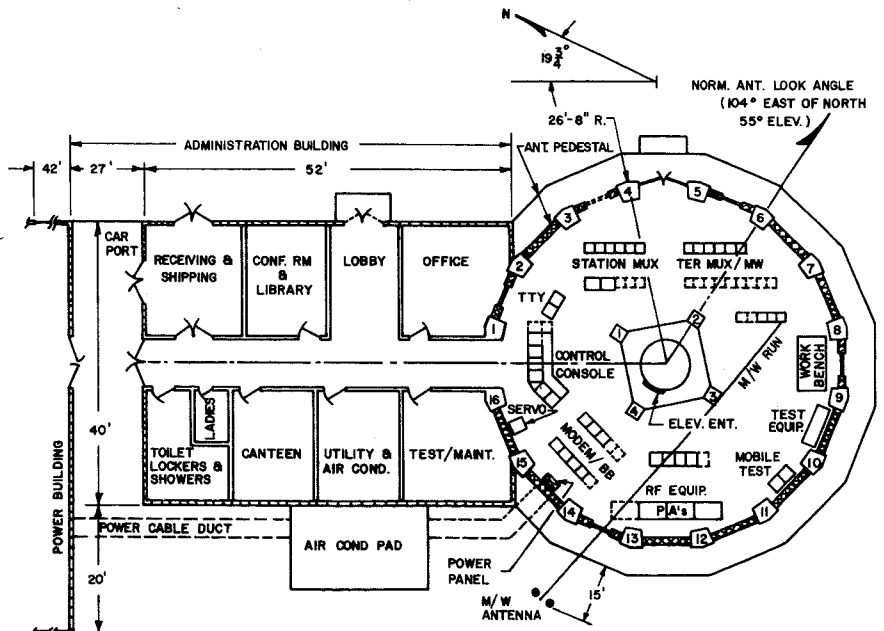

Fig. 3—Equipment facilities layout.

critical item, as antenna erection depended on timely completion of the base. The steel for the antenna was fabricated while this was under way, and was shipped by air and sea to be available on-site as needed.

The Power building was constructed to meet the beneficial occupancy date of August 29, 1969 and, as promised by RCA Globcom, on-site power was available on September 8. The Thailand transportable earth station and diesel generators arrived on schedule, and were located at the Pulantat site. A training program for the operational and maintenance staff was initiated immediately, and, as a result of all

Table 1—General performance characteristics.

Type of antenna	Cassegrain fed, elevation-over-azimuth mount, with wheel and track
Diameter of shaped main reflector	98.4 ft
Focal length	34 ft
Pointing accuracy:	
Normal (0.03)	30 mph steady wind to 45 mph gusts (3 sigma)
Degraded (0.06)	45 mph steady wind to 70 mph gusts (3 sigma)
Tracking accuracy:	
Normal (0.01)	30 mph steady wind to 45 mph gusts (3 sigma)
Degraded (0.02)	45 mph steady wind to 70 mph gusts (3 sigma)
Operate in any position	75 mph steady wind
Drive to stow position	80 mph steady wind
Axis drive for both elevation & azimuth:	
Slew	
Velocity	0.3°/sec.
Acceleration	0.3°/sec. ²
Tracking	
Velocity	0.002 to 0.3°/sec.
Acceleration	0.01°/sec. ²
Azimuth angular limits:	
Operational	± 170°
Maximum	± 172°
Elevation angular limits:	
Operational	0°—90°
Maximum	-2°—92°
Survival in stow	210 mph winds
Operational frequency	
Bands:	
Transmit	5925 to 6425 MHz
Receive	3700 to 4200 MHz
Antenna gain:	
Transmit	63.0+20log (f/6) dB
Receive	60.3+20log (f/4) dB (f is frequency in GHz)
Receiving system G/T	41.5+20log ₁₀ (f/4) dB
Power output at antenna feed	5000 Watts
Emission:	
Interim	5,000 F9
Permanent	40,000 F5/F9 maximum per carrier
Maximum deviation:	
Interim	± 2.28 MHz
Permanent	± 15 MHz
Minimum deviation:	
Interim	± 300 kHz
Permanent	± 300 kHz
Equivalent isotropically radiated power	100 dBW
Equivalent isotropically radiated power in horizontal plane	45 dBW/4 kHz
Polarization capability	Linear with any orientation and circular

this, the operational target date for Phase I of November 1, 1969 was met.

During construction, authority to proceed with Phase II work to complete the permanent Pulantat Earth Station was granted by the Federal Communications Commission on August 1, 1969. The work was subsequently released to the general contractor. The Pulantat Earth Station became fully operational in May, 1970.

Microwave links

In addition to the responsibility for construction of the earth station, RCA Globcom has sole responsibility for the design, procurement, installation, operation, and maintenance of the two microwave terrestrial links (Fig. 4) from the originating/terminating points of the signals to the earth station, as follows:

1) A one-hop microwave link between the earth station and the Naval Communication Station (NCS) at Finegayan (12.4 miles). The microwave antenna system at the earth station site comprises a periscope configuration utilizing a combination of a 4-ft-diameter parabolic antenna and a flat, 8x12-ft rectangular reflector. The parabolic antenna dish is situated on the perimeter of the Operating Control Building approximately 12 ft above ground, and is aligned with the 8x12-ft reflector installed on a 140-ft tower. The electrical separation between the antenna and reflector, as well as the physical dimen-

sions of these radiators, have been chosen to enhance the system gain and reliability. The periscope antenna system works in conjunction with a 6-ft-diameter parabolic antenna installed on the terminal building of the NCS.

2) A line-of-sight microwave link between the earth station and the RCA Globcom Central Operating Office (CTO) in Agana. This system incorporates a passive repeater to circumvent high-elevation terrain. The passive repeater is a flat, 8x12-ft, rectangular reflector used in a far-field electrical configuration. The reflector is mounted on a 100-ft tower located approximately 0.4 miles from the CTO; 3.8 miles from the earth station. A periscope antenna system is installed at the earth station similar to that described above for the microwave link to the NCS. On the CTO building, a 6 ft. parabolic antenna is installed to complete this system.

Competitive bids were requested from various manufacturers for the microwave equipment, with an in-service operational date to satisfy the critical test and operational schedules established for the earth station (Phase I). The microwave equipment is an RCA Type CW-60, with hot-standby facilities. The microwave system operates in the band 6575 to 6875 MHz, and is designed to handle long-term projected traffic loads. Cable restoration plans were developed to incorporate submarine cable backup facilities via the Guam microwave and earth station systems.

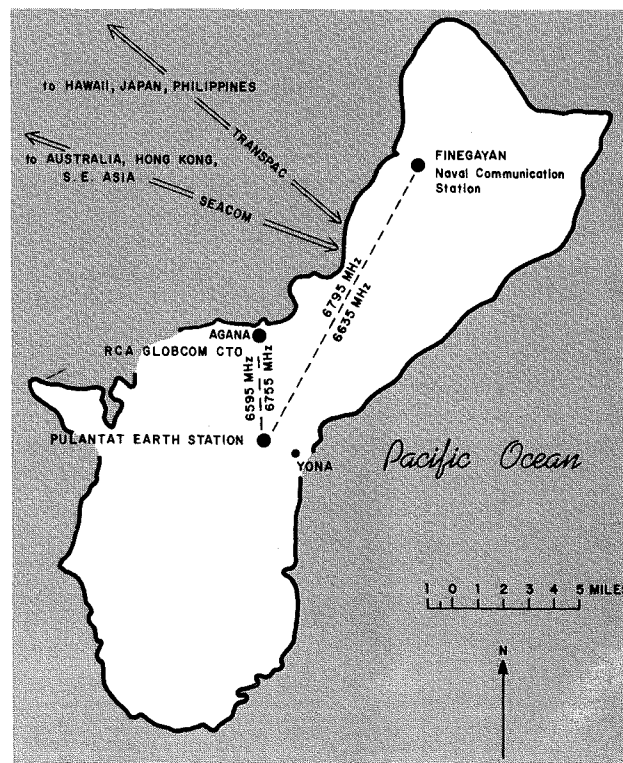
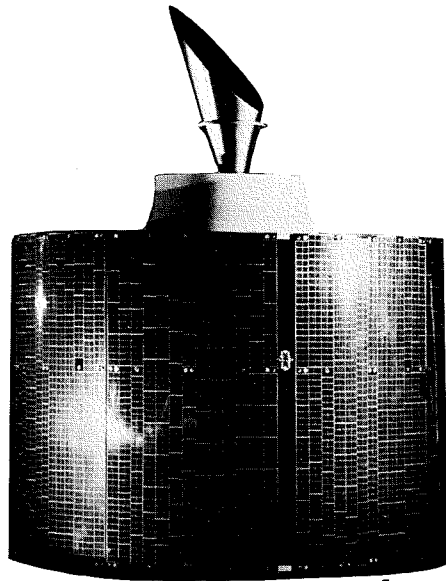

Fig. 4—RCA Type CW-60 microwave terrestrial links on Guam.



International and satellite transmission

W. C. Phillips

With the advent of synchronous (or fixed orbit) satellites to receive and re-transmit television signals, International Television system standards (such as SECAM, PAL, and NTSC) have been brought together to be, at times, transmitted in both directions simultaneously. The transmission, technical evaluation, and standards conversion of these signals from an operational viewpoint, will be discussed in this article.



Warren C. Phillips, Mgr.
TV Network Transmission Operations
National Broadcasting Company
New York, N.Y.

studied Electronic Engineering at RCA Institutes, New York and joined NBC in March, 1945 where he has worked in all phases of Television Technical Operations. He was assigned to RCA Color development group in 1951 and he operated in all phases of color TV development—Field and Studio groups. In 1968, Mr. Phillips was appointed Manager of Studio Master Control and Network Transmission. He presently represents NBC on the Network Transmission Committee and this Satellite Technical Operation Committee.

THE MODERN GEO-STATIONARY SATELLITE, such as the multi-channel INTELSAT 3-F2 shown above, is a far cry from the 1962 TELSTAR variety. Being in a synchronous orbit, it orbits the earth in a stationary position relative to a given receiving location on the Earth. However, small variations of the gravitational field of the Earth, Sun, and the Moon create slight longitudinal and latitudinal drifts of the satellite. The technique used to compensate for these slight variations is referred to a "station keeping." Propulsion jets located on the satellite, controlled by RF signals from an Earth station, correct this drift. It is interesting to note here that the East-West (longitudinal) station keeping is relatively large and rapid. The North-South (latitudinal) station keeping, maintaining the orbit close to the plane of the Equator, becomes more important as the satellite ages. Ten times the amount of station-keeping propellant is used for latitudinal

Reprint RE-16-4-7
Final manuscript received May 28, 1970.

changes than is used for longitudinal movements. This station-keeping requirement [using fuel store aboard the satellite] plus the progressive deterioration of solar panels [the cell structure used to convert sunlight to electric energy] limits, to a large extent, the usable life expectancy of the satellite to about five years. Further advances in design and operation could extend this life expectancy in future satellites to seven to ten years.

Operational problems

The satellite, as used in the broadcaster's daily operations, can present special technical operation considerations. For example, film news stories are often transmitted from London to New York via the 3-F6 Satellite, with the transmitting station at Goonhilly Downs, West country of England and the receiving station at Etam, West Virginia. This type of transmission is usually pre-taped at NBC-New York during the open Network time between 5:30-6:30 PM EAST, and used as part of the Huntley-Brinkley News show. Fig. 1 shows a typical routing of the signal. This film is transmitted to NBC in 525/60 NTSC Color Standards. Due to monetary considerations, the satellite is *ordered up* to NBC-NY approximately ten minutes before usage. A two-way Production Co-ordination Circuit is provided between BBC in London and Broadcast Operation Control at NBC-NY to coordinate the start and stop time of the satellite service, plus any program coordination of the incoming film or multi-film packages. The tv master control, at the same time, is using that ten minutes prior to program time for technical evaluation of the incoming signal. Their main concern is monochrome vs chrominance level, phase shift, and the signal-to-noise ratio.

Signal to noise and phase shift improvements

The latest satellites have improved immensely over the earlier 1967/1968 variety. Signal-to-noise ratio is the most dramatic improvement to the general viewer. For example, it often is difficult to determine, on a color monitor, the difference in a color-bar signal being generated in London and our own "in house" color-bar presentation. Phase shift has also improved.

No longer do we have the severe burst-to-chroma phase errors of the early days.

Signal location identification

The problem of identification of the exact origination of a satellite test signal is still with us. For instance, we at NBC master control would assume that the color bars were coming from the BBC studios in London. It may be that they are, in fact, originating in Paris, Rome, or Cologne and that BBC in London was only the transmission gateway for this test signal. Precise signal location identification must be accomplished by the use of some form of internationally agreed upon vertical internal test signal that will differ in some form from country to country. This would allow technicians to pinpoint technical problems with greater accuracy and conserve expensive satellite usage.

Audio considerations

At this point, let us assume that the video quality has been checked technically and found to be acceptable. We now must check the accompanying audio for level and distortion. As the audio that is transmitted with the picture, via satellite, is diplexed on picture carrier, the synchronization of

picture to sound is not a problem. They both travel the same electrical path—80,000 km. However, when a back-up or emergency audio signal via terrestrial facilities is required, a definite lip-sync problem exists due to the shorter (4500 km) electrical path (*underseas cable*) facility. This terrestrial signal now must be delayed to match the satellite audio signal. A variable-delay audio tape (*continuous loop*) device is used for this requirement. This means that all terrestrial audio circuits that carry the same audio content as the satellite-diplexed audio must be delayed approximately $\frac{1}{3}$ to $\frac{1}{2}$ second.

Sync problems

Our next technical consideration is the horizontal and vertical phase relationship of the synchronizing pulses. Here, a very interesting phenomena occurs. The satellite itself, although in a geo-stationary condition, is not standing still with relation to the Earth. As discussed earlier in this article, there are certain longitudinal and latitudinal movements of the satellite. This condition creates a definite *doppler effect* which is very evident in the subcarrier frequency (3.579.545 MHz NTSC specification). As this effect is present in all geo-stationary satellites, it is impossible to phase the horizontal

and vertical sync of our tv plant pulse system to the satellite sync component due to the constant frequency change of the incoming satellite subcarrier.

This means that all live incoming satellite pickups, unless used as a gen-loc source, will cause a picture roll during video switching time. This, of course, is aggravated when fed to video tape, due to a 4 to 7 second machine sync lock-up time requirement. Gen-loc is not always possible. Why? Most of the time, satellite inserts are of short duration, 5 to 10 minutes. If NBC in NY is in a gen-loc mode at that time, loc will be lost as the satellite feed is dropped, causing severe sync problems to the entire plant. Remember, satellite pickups are bought on a minute-by-minute basis, and cannot be held just to supply sync pulses for the entire program period.

Solutions to the sync problem

Two solutions to this problem can be considered. First, NBC pretapes as much satellite material as possible. This allows the video tape machine to be synchronized and phased on playback into the show, eliminating rolls and break-up. This system, of course, loses the *live* feeling and is not the most desirable. The second solution is to use an all-electronic translator. This device could receive a 525/60 NTSC color signal from a satellite and electronically convert the incoming sync to coincide with plant sync. The satellite video feed could then be handled as any other plant sync. Dissolves, inserts, and switches would no longer be a problem. A step further would be to have this video translator be a standards converter as well. We now could receive PAL, SECAM, or NTSC color from any area of the world and handle this as a standard NTSC plant sync-locked signal.

This translator/standards converter concept is being considered at NBC. Several methods and types of equipment are being studied by our Engineering Department. I feel confident that before too long, this device will be available for our daily operations. The AT&T Company has already been alerted via the STOC and NTC Committees and are studying the problems that will exist in the transmission of the PAL—SECAM color system over existing terrestrial facilities.

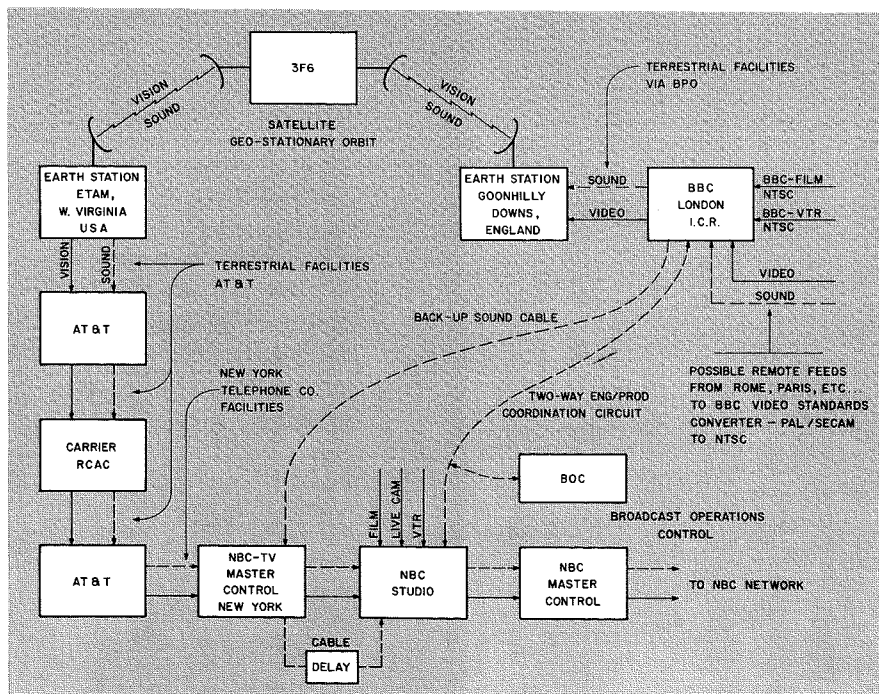

Fig. 1—Signal routing between NBC Master Control in New York and the BBC studios in London.

The evolution and development of RCA Institutes

H. Fezer

From its original concept as a school to train wireless operators, RCA Institutes has evolved during the past 60 years into a many-faceted organization. Training and education is provided across a wide spectrum, from artisan to graduate engineering level. The number of students has risen from a handful in 1909 to 20,000 in 1969.

WHEN Guglielmo Marconi's wireless telegraph burst upon the scene at the beginning of this century, a new method of communication, capable of spanning the oceans, was born. But the practical application of this revolutionary invention required training for a skill never before needed. Hence, in 1909, the Marconi Institute was established to train the new breed of wireless operator. David Sarnoff—among the first in this novel occupation—became a member of the faculty in the early days of this school.

The instruction was devoted to the training of shipboard and shore-station marine telegraphy operators to meet the rapidly growing need for this new skill. Great drama was a part of this occupation in many instances. Possibly the best-remembered event is the loss of the "unsinkable" Titanic in 1912, when David Sarnoff spent many hours at his station on top of the Wanamaker Building, receiving and relaying news of the gigantic disaster.

In the aftermath of World War I, the U.S. government, concerned that wireless communication had been under the control of a foreign power (Great Britain), sought the formation of an American company to provide the desired control in the event of a future emergency. This resulted in the formation of the Radio Corporation of America in 1919; the Marconi Institute became a part of RCA and was renamed Radio Institute of America. In 1929 the school was incorporated as a wholly owned subsidiary of RCA, under the name "RCA Institutes". Presently, instruction is offered by seven operating

divisions, each serving specific needs of industry, the government, and the public at large. The seven divisions that make up RCA Institutes are:

- Resident School
- Home Study School
- TV Studio School
- Institute for Professional Development
- RCA Technical Institute
- International Operations
- Institute for Custom Education

Board of Technical Advisors

All of the educational and training programs of RCA Institutes require the approval of the Board of Technical Advisors. The Board not only functions in an "advise and consent" capacity, but also keeps the school abreast of new technological developments. Members of the Board are distinguished scientists, engineers, and managers representing various technical research and educational activities of RCA. The Board meets quarterly to consult on current and proposed educational programs of RCA Institutes. Dr. Alfred N. Goldsmith, Honorary Vice President and Senior Technical Consultant of RCA, serves as Chairman of the Board of Technical Advisors.

Resident School

The Resident School is situated at 320 West 31st Street in New York City. It occupies a four-story building with 113,000 square feet of air-conditioned classrooms, laboratories, offices, a technical library, a cafeteria, and lounges. This facility provides classroom instruction to approximately 4,000 students in day and evening classes.

The Resident School offers several educational programs to the public on both the college and occupational



RCA Institute headquarters in New York City, providing classroom instruction to approximately 4,000 students in day and evening classes.

levels. The most advanced program at the Resident School is the college-level Electronics Technology T-3 Program. This two-year engineering technology curriculum, which stresses communication and computer technology, is accredited by the Engineers' Council for Professional Development. Graduates of the T-3 Program are principally employed as "engineering technicians"—a title encompassing a wide variety of industrial occupation categories such as research aide, technical aide, engineering aide, and associate engineer. Many graduates of the T-3 Program elect to continue their education towards a baccalaureate degree. Advanced Standing credit is given at many colleges and universities, including the Massachusetts Institute of Technology, Polytechnic Institute of Brooklyn, Yale, Columbia, and New York University.

On the occupational level, the Resident School offers an 18-month program titled "Electronics Circuits and Systems (V-7)" and a 9-month program in TV Servicing. These shorter curricula are designed to prepare the student for occupational specialities as an electronic technician or TV serviceman.

The school also offers many special programs ranging from industrial electronics to computer programming. In addition, bilingual teachers provide instruction in Spanish to assist Hispano-American students. Graduates of RCA Institutes are in great demand by industry for all types of specialized positions. In the last five years, the Resident School has supplied industry with over 3,000 trained personnel. Of a recent graduating class, over 90% of the students were offered jobs through the school's Placement Office even before graduation. The Placement Office maintains strong ties with industry and has over 100 different companies re-

cruiting at the school, including such bluechip giants as Bell Labs, General Electric, IBM, RCA, Western Electric, and Zerex.

The role of the technician in industry has become increasingly important. The nation's need for broader utilization of engineering manpower, coupled with the "technological explosion," provides technicians with greater opportunities for more responsible work. Graduates of the school are employed around the globe installing, operating, and maintaining electronics equipment ranging from computers and missile instrumentation to radio and TV broadcasting and receiving units. Many work in laboratories assisting scientists or engineers with vital research and development activities. Much of the technician's work is concerned with testing new devices, taking electrical measurements, monitoring data, recording data, and analyzing the results. Some jobs may be more specialized, involving design, breadboarding, and testing of experimental circuits.

Although the school's administration recognizes the value of a broad education, the Resident School's educational programs necessarily focus on specialized technical subjects. The curricula are, therefore, devoted mainly to technical courses, enabling the student to gain the degree of competency and depth of understanding required by industry.

The explosion of new scientific knowledge makes it imperative to maintain all curricula up to date. The programs are revised frequently according to industry's needs. Major revisions in curriculum are made at intervals of about five years, and in some cases sooner when technological developments demand a faster change. Minor revisions of course, are made continually. Instruction is given in both classroom and laboratory sessions. Each laboratory is equipped with a variety of test equipment, components, specially constructed chassis for instructional purposes, and commercial equipment. For some classes, more than \$75,000 worth of electronic apparatus is needed to equip a single laboratory. Laboratory manuals are prepared by the Resident School's instructional staff. Textbooks used in classrooms are standard texts, ranging in level from occupational to

collegiate, and, in some cases, authored by Resident School instructors. Extensive use is made of audio-visual aids and demonstrators.

The programs are carefully planned so that the student progresses in logical stages from simple concepts to complicated circuitry. In the T-3 Program, extensive use is made of mathematics on the calculus level. Coordination of classroom and laboratory work enables the student to apply his newly acquired theoretical knowledge to practical problems related to design, development, and operation of electronic apparatus.

All of the Resident School's educational programs of study are approved by both the Board of Technical Advisers and the New York State Department of Education. In addition, the school and all of its instructors are licensed by the New York State Department of Education.

Composition of the student body

The Resident School student body represents a great diversity of socioeconomic and geographic backgrounds. Students come from a majority of the states in America and from countries throughout the world. The present enrollment includes 760 students from 77 foreign nations. The proportion of foreign students at Institutes (about 20%) is one of the highest in an American technical institute, college, or university.

In addition to the self-sponsored domestic and foreign students, the Resident School has students sponsored by various federal, state, municipal, and private agencies, including students of various age groups, who are sponsored under the Federal Manpower Development Retraining Act. Commissioned and non-commissioned officers sponsored by the U.S. Coast Guard enroll in the T-3 Program to obtain the highly technical background required by the increasing use of complex and sophisticated ship and shore electronics equipment. Handicapped students attend under sponsorship of the Divisions of Vocational Rehabilitation of several neighboring states. The United States Agency for International Development sponsors foreign students in its continuing program of providing technical assistance for developing countries.

The intermixing of ages, cultures and nationalities, which is characteristic of the school, deeply influences the life of each student. Through association, students are exposed to a wide variety of cultural values that broaden their interests concurrently with their technical development. The result is an academic environment, unusual for its diversity, that acts to inculcate in the student the principles of successful human relationships and enriches his educational experience.

Composition of the faculty

In the more than a half-century of its existence, the Resident School has developed a philosophy growing out of the experience of its faculty and administration, and one to which its entire operation is attuned. The core of this philosophy is the conviction that, given certain prerequisites, human beings of diverse ages and backgrounds can and will work together effectively, thereby growing in knowledge, skill, and maturity far beyond normal expectations.

The first prerequisite is a faculty of mature individuals possessing superior technical knowledge, enthusiasm for their subject, skill in the art of teach-

Harold Fezer, Director
Educational Services
RCA Institutes, Inc.
New York, New York

received the EE in 1933 from the Ingenieur Schule, Konstanz, Germany. Mr. Fezer held various positions in industry before becoming an instructor at RCA Institutes in 1945. In 1950, he became Senior instructor in charge of the Evening School. In 1954, Mr. Fezer was appointed Director of Training in the Resident School and advanced to the position of Director in 1958. He was appointed to his present position in September 1970. Mr. Fezer is a Member of ASEE and IEEE.

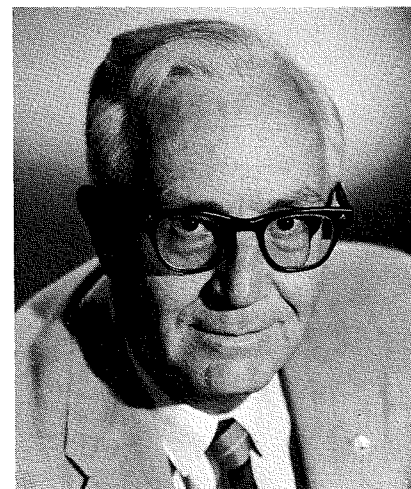

ing, sensitivity to the problems of the students, and conscientious concern for their progress. Such a faculty functions best with the guidance of an administration of similar qualities and experience. The faculty of RCA Institutes consists of highly qualified personnel with extensive practical background. The majority of the faculty members have earned baccalaureate or higher degrees. Every instructor is required to have industrial experience to be licensed. Teaching assignments are made on the basis of the individual faculty member's special training and talents.

Faculty morale, enthusiasm, and effectiveness are incident to the administrative climate. The administration's continuing search for more effective methods of teaching, rapid assimilation of new knowledge into the curricula, and emphasis on self-appraisal, are evidence of a policy stressing excellence.

The second prerequisite is an atmosphere that brings out the best effort of each student. It is well recognized that students learn in proportion to the effort that they can be stimulated to exert. The faculty, therefore, makes heavy demands on the time, the mental resources, and the character of our students.

A Third essential is a curriculum devoted almost exclusively to technical subjects, enabling the student to focus on his major interest. The school recognizes that many technically oriented students have yet to be convinced of the value of cultural studies, and, therefore, lack the motivation to pursue them with profit. By directing the student's efforts along paths on which he can make the most rapid progress, he is equipped in the shortest possible time with the superior technical knowledge that will gain him both respect and the means of rewarding self-support.

These three criteria are, therefore, regarded as prerequisites to a more complete self-development. We have observed that our students mature and broaden their interests concurrently with their technical development. In part, this results from association with mature instructors and fellow students; in part, it results from the student's growing sense of competence in his

chosen field, which sharpens his awareness of his place in our society. By the totality of their experience, RCA Institute graduates have acquired far more than technical knowledge. They have acquired confidence in themselves, confidence in the future, and a determination to continue their self-improvement.

Home Study School

The Home Study School was organized in 1948 and became the second major division of RCA Institutes. Its original objective was to help industry obtain a greater number of TV servicemen required in a rapidly expanding field. In response to the need of the RCA Service Company, a TV servicing course was prepared by staff members of RCA Institutes. Soon thereafter, this course was offered to the general public. It was discovered, however, that many who wished to work in TV servicing did not have adequate training in electronics fundamentals. A basic electronics course was introduced to meet this need for the many throughout the country who could not avail themselves of Resident School instruction. In a few years, thousands of students were engaged in these studies with the Home Study School.

The growth of the Home Study School paralleled the growth of the electronics industries. By 1963, its curriculum had expanded to include courses in color TV, communications, transistors, automation and industrial electronics, automatic controls, digital techniques in industry, nuclear instrumentation, drafting, and computer programming. Some tens of thousands of students are engaged in pursuing study in these areas and thousands are graduating each year.

The reputation of RCA Institutes' home study curriculum spread through-

Home-study student using an oscilloscope to test the transistorized AM receiver he has assembled.



out the world, and thousands of students from many foreign countries have enrolled during the past decade. In addition, industry and governmental agencies seeking trained, skilled technicians, have turned to Home Study to help meet this need.

The rapid growth of knowledge, skills, and understanding in electronics has motivated the school to review its course material periodically. As a result, almost no course now offered completely resembles in content that which was offered in the early and middle 1960's. New and revised courses in color TV, semiconductors, digital electronics, solid state technology, communications, and computer programming have recently been introduced. The courses have been written by experts and, in many cases, teachers in electronics. As an example of modern presentation of material, programmed instruction techniques are used in the basic electronics and computer programming courses to facilitate learning.

In some of the courses, the theory lessons are accompanied by experiment lessons and kit construction. In this way, the student has his understanding of the theory strengthened and reinforced by laboratory work at home. In addition, he develops manipulative skills as he experiments and constructs several pieces of practical equipment, such as a multimeter, signal generator, oscilloscope, and a breadboard, transistorized, super-heterodyne, AM radio receiver. In the TV courses, he can also construct a black-and-white or a color TV receiver.

In the basic courses, Industrial Practices Lessons enable the beginning student to put the theory he learns into practice quickly, at home and on the job. For those students already working in electricity or electronics, advanced courses are offered by the Home Study School to help them keep up-to-date with new technology. In this way they gain security in their present work and gain additional knowledge and competency to move toward better paying positions.

In addition to its location in New York City, the Home Study School has offices in Mexico City where courses are offered in Spanish. Spanish-speaking students in the United States, Mex-

ico, Central, and South America and elsewhere may study electronics in their native tongue. The Mexico City school supplies them with study materials and technical services. Meeting local demand, classroom instruction has been added recently to serve those students who desire to be instructed in this manner. For the convenience of our Canadian Students and to eliminate costs and delays due to custom duties, the Home Study School courses are offered by RCA Ltd., Montreal. The success of home study is dependent on the acceptance of the philosophy by individuals and industry leaders that there are many ways to obtain an education or training in any subject. Studying at home, guided by well-prepared material and instructors, at one's own pace, is one of the more effective ways of accomplishing that objective.

TV Studio School

The RCA Institutes TV Studio School was opened to the general public in January of 1961 and became the third major division of RCA Institutes. Its function is to provide training in television production, directing and studio operations. Originally created to serve the needs of radio and TV network management, which it still does, its major concern is to serve the general public. In a fully equipped TV studio, located at 1600 Broadway, New York City, students gain practical experience on broadcast equipment. Every student, upon completion, has handled all studio facilities, such as cameras, sound booms, audio console, turntables, tape machines, video switcher, and telecine projection. Students also gain experience in the setting up of lights and scenery for a variety of shows. Another requirement is that each student direct formats for simple and complex dramatic shows employing professional actors. Classroom lectures, given by instructors who are professionals in their respective fields, prepare the student in other areas as well. For example, make-up, costuming, sales, and graphic arts are topics given by guest instructors.

The total length of the course is 375 hours. Approximately 150 hours are spent in the studio; 150 hours are in classroom lectures; and the remaining 75 hours stress film-editing techniques.



Staging of a television program at the TV Studio School.

Since film plays an important role in the broadcasting industry, students obtain practical experience in editing 16mm film for broadcasting. Although 16mm film news editing is their major effort, features and documentaries are also included in their training. The course is conducted in both day and evening sessions. The student completes the day program in 15 weeks, attending 25 hours each week. The evening student attends on an average of $8\frac{1}{3}$ hours a week, attending two nights one week, and three nights on the alternate week for 45 weeks. The educational requirement for admittance is a high school diploma.

Students come from all parts of the world. In addition, many organizations have used the TV Studio School facilities. Management people from the three major networks as well as many local stations in New York and throughout the country have sent their personnel for special programs. Colleges have also sent those students taking communication arts courses for a highly intensified, practical program.

The graduate is fully qualified to seek employment in the commercial broadcasting field and in educational TV. Advertising agencies, production houses, CATV and other closed circuit installations employ the TV Studio School graduate.

Institute for Professional Development

In 1964, the Institute for Professional Development, (IPD) located at Clark, N.J., became the fourth division of RCA Institutes. Initially a department in the Resident School, it began by offering educational programs to three different groups of engineering personnel: the engineering graduate with a firm background in fundamentals but

lacking experience in applied engineering; the engineer transferred to a new job and needing more specific design information in the new field; and the experience engineer who is interested in keeping up with the state-of-the-art. The typical educational background of the participants encompasses the following: 68% have as their highest degree a bachelor's; 21% a master's; 8% a doctorate.

The educational programs currently being offered are:

Logic design (5 days)—provides the numerical and matrix tools required to select the most straightforward, practical approach to digital circuit design. The Mahoney Map and designation numbers are thoroughly covered.

Digital systems engineering (5 days)—provides an overview of contemporary engineering techniques for systems design. Control circuits, memory system types, and interfacing of hardware are examined.

Digital communications (5 days)—develops the practical design criteria of digital communication hardware. Various modulation techniques and optimum coding schemes are presented. The practical applications of information theory in the field of digital communications are also explained.

Integrated circuits, bipolar and MOS (3 days)—emphasizes the selection and specification of circuit types. The standards and specifications used in industry are examined. The design limitations in both linear and digital types are discussed.

Optical systems engineering (5 days)—offers new and practical approaches to optical systems design for both engi-

Engineers examining integrated-circuit samples at the Institute for Professional Development.

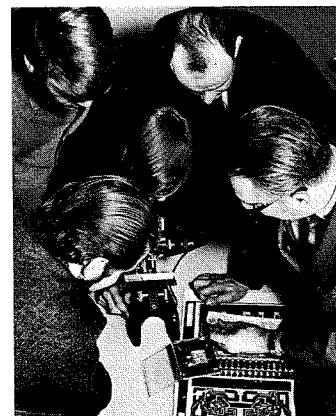

neers and physicists. First and third order of geometrical optics are handled via the direct method. The modern, matrix approach to polarized light is thoroughly developed.

The characteristics of these programs differ markedly from those offered by universities. Where the university programs are theoretical, IPD emphasizes practical applications. University programs stress principles where IPD stresses techniques. IPD programs are more specialized; consequently, this may be viewed as a vertical-type educational program as compared to the traditional horizontal-type program. The objective of these programs is to increase the productivity of the engineer when he returns to his job. Consequently, the school's goals are short-ranged in comparison to that of the university.

These programs require a highly structured, fast presentation. This is accomplished by utilizing a dual lecture approach. The principal instructor sits at a projecturn and presents the subject matter systematically. During the presentation, a second instructor serves as a monitor. He carefully observes the reaction of the class to the concepts being taught. If he notices any perplexity or lack of comprehension, he politely interjects, at an appropriate moment, another approach to the idea or principle being developed. His support must be carefully timed to reinforce the efforts of the principal instructor without destroying the continuity of the presentation. Comment is offered only when it will enhance the presentation and improve the understanding of the subject being taught. The role of each teacher is interchanged periodically to provide a change of style and pace while maintaining the continuity of the presentation.

Lecture notes are uniquely designed to relieve the student of much of the burden of note-taking. The right-hand page of the note book is reserved for student comments in conjunction with the material as it is presented in outline form on the left-hand page. All drawings and visuals shown on the overhead screen are also reproduced in the lecture notes. This permits a rapid but methodical presentation of the material with the student modifying the notes to his personal understanding.

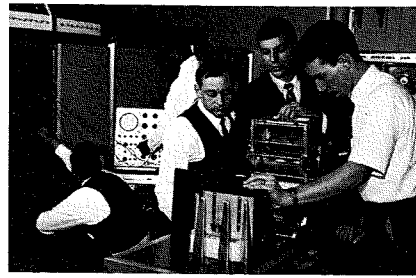

Computer training at RCA Technical Institute.

Each course is developed in consultation with the RCA Institutes' Board of Technical Advisers. In addition, numerous contacts are made with engineers in many companies to determine the course content. After all the preliminary research has been completed, the material is assembled by the same people who will present the program. The seminars are offered at 24 locations throughout the U.S. on a regular schedule. Banquet and convention facilities of hotels and motels are used for the presentation. The programs are also offered to various customers at their own facilities.

Industrial organizations sending participants to IPD seminars number over 1,000. Universities also send a number of professors, department heads, and research people. Over 100 government agencies have sent participants, including a large number from the U.S. Navy and the National Aeronautics and Space Administration. In short, the programs offered by IPD center on the new and expanding technologies. They are prepared to increase the productivity of the engineer in several highly specialized areas within a relatively short period of time. Over 3,000 engineers are expected to attend the courses offered by IPD during 1970.

RCA Technical Institute

In 1960, the Electronic Data Processing Service Division (EDPS) of RCA formed the EDPS Adult Education School in Cherry Hill, N.J. The purpose of the school was training in the repair and maintenance of electronic data processing machinery. In 1961, the name of this training organization was changed to RCA Technical Institute. In 1966, the school became the fifth division of RCA Institutes. In September of 1969, the Technical Institute opened an extension school in Upper Darby, Pa.

The curriculum of RCA Technical Institutes emphasizes computer technology. Most students are enrolled in the one-year Electronic Computer Systems Program. The objective of this program is to train high school graduates for careers as electronics technicians in the computer industry. The course material includes basic electronics, logic circuitry, an introduction to computer machine language, and extensive laboratory training in computer circuits, with experience in wiring computer logic projects in the school's computer laboratory.

Another of the programs offered is Basic Electronics, which is 400 hours in length and covers basic electronics theory and the fundamentals of trigonometry and algebra. Both the Electronic Computer Systems and the Basic Electronics programs are offered in the day school.

In addition to the electronics-oriented day school courses, evening and Saturday courses in computer programming are offered. Fundamentals of Digital Computer Programming Course provides an introduction to programming language using the RCA 301 Assembly Language as a Model. This program is taught 6 hours a week for 16 weeks. After finishing this course, the student may go on to the Advanced Programming (COBOL) or the Spectra 70-IBM 360 Basic Assembly Language Programs. These programs run 60 and 120 hours, respectively, and qualify the student as a junior programmer or trainee.

The programs offered by RCA Technical Institute are approved by the Veterans Administration, the Manpower Development and Training Authority, and the New Jersey State Rehabilitation Commission. The school is licensed as both a Technical School and Business School by the New Jersey State Department of Education, and the Department of Education, Commonwealth of Pennsylvania.

The total enrollment of the school is approximately 750 students, 70% of whom are enrolled in the Electronic Computer Systems Program. The instructors, who have many years of experience in their respective fields, attend regular cross-training sessions in the courses offered to insure that accurate and standard course materi-

als are covered. Cross-training provides an excellent opportunity for instructors to review and discuss course material continually and to make changes whenever necessary. Students are prepared for job placement by review tests, lectures on proper dress and conduct for interviews, and practice interviews with teachers sitting in as interviewers. After counseling on weak points, the students are ready for actual interviews with industrial recruiters. Various companies are invited to talk to classes which are about to graduate. Each class, before graduation, has the opportunity of talking with representatives of several companies, such as IBM, RCA, General Electric, Sperry Rand, and Honeywell. The students are tested and interviewed by the companies for jobs as computer technicians and for other related jobs. The Technical Institute prides itself in its excellent placement record: 95% of graduating students were successfully placed in jobs in 1969. The placement services are offered to graduates of the school, regardless of how long ago they graduated.

The 11 classrooms, 3 laboratories, and administrative offices occupy 12,700 square feet of RCA's Cherry Hill building complex. The Upper Darby School has 5 classrooms, 2 laboratories, and cover a total area of 4,600 square feet.

International Operations

International Operations was established in 1970 and became the sixth operating division of RCA Institutes. It was created primarily to fill two important needs of foreign governments, industries, and organizations:

- 1) Develop technical education and school management programs.
- 2) Act as consultants in modernizing existing technical educational systems.

Representing RCA Institutes' worldwide educational resources, the division has undertaken a number of specific educational and business activities. Focusing on all levels of scientific and technical fields of specialization. International Operations is presently involved in:

- 1) Consultation and educational project planning.
- 2) Educational program and systems design.

- 3) Educational project development and management.
- 4) Designing, procuring, and installing school laboratory and shop equipment, ETV Systems, and audio-visual aids.
- 5) Training instructors in modern teaching techniques.
- 6) Establishing and licensing foreign-based home study operations.

Active in most every part of the world, including Europe, Africa, Central and Latin America, and the Far East, the division recently provided effective guidance in the development of a new and modern telecommunication training and research institute in the Middle East.

A study completed for a private organization for the establishment of a Polytechnic Institute in Europe has been accepted, and RCA Institutes is now negotiating with the organization and a foreign government for its implementation. It provides for RCA Institutes to act as managing consultants in the establishment of the Polytechnic Institute, which will specialize in eight disciplines: electrical; mechanical; chemical; metallurgical; naval; agricultural; business administration; and industrial arts. The Polytechnic Institute will concern itself primarily with three levels of achievements; high school diplomas; technical certificates; and college degrees.

It is expected that RCA Institutes' International Operations will gain greater recognition as foreign countries come to realize the importance of high-quality technical education for their people.

Institute for Custom Education

The Institute for Custom Education, located in New York City, became the seventh operating division of RCA Institutes in 1970. Originally known as the School of Special Programs, it was established in 1967 as a department of the Resident School. It provides specialized education and training to government, industry, and other groups interested in upgrading their technical, sales, or management personnel. Each training program is designed specifically to satisfy the operational requirements of the sponsoring agency; and its technical level and method of presentation are adjusted so as to be consistent with the prior experience and training of the participants.

Instruction may be conducted at the school's facility or at a location designated by the customer.

Past clients have included such organizations as Admiral Corp., Western Union International, Hoffman La-Roche Corp., the U.S. Army Signal Corps, Westinghouse Corp., the Federal Government under the Manpower Development Training Act, the National Alliance of Businessmen, and the National Broadcasting Company.

Past training programs have included all areas of electronics, ranging from basic electronics and radio and TV servicing for economically underprivileged individuals to semiconductor devices, advanced theory and design procedures of communications equipment, and computers. Specialized audio-visual programs have been developed in various areas of electronics, including basic electronics, semiconductor devices, and motor and generator trouble-shooting, wiring, and repair.

The outstanding staff of training specialists is capable of devoting its experience and know-how to provide training in various modes and on various levels from the most basic material to highly complex areas in circuitry and equipment. The mode can be in the programmed format, accompanied by slides and workbook; it can be in the format of lectures and demonstrations; it can be hands-on in a specially designed laboratory; or, in consultation with the client, in a form most suited to the needs of his personnel requiring indoctrination, upgrading, or updating. Considered one of the most versatile and flexible operations of RCA Institutes, the Institute for Custom Education now includes training programs for clerk-typists, stenographers, and teletype operators.

Students at an Institute for Custom Education classroom being trained as radio-TV repairmen.



New schlieren light valve for television projection

Dr. J. A. van Raalte

A new television projection system is described. The heart of this system is a deformable reflective target (light valve) consisting of a thin metal film supported in close proximity to a glass substrate. In operation a video-modulated electron beam scans the target and deforms the metal film analogously to the intensity of the video signal. These deformations control the amount of light from a schlieren projector that falls on the screen. The mechanical and electrical performance of the deformable target and operation of a specially designed off-axis, reflective schlieren projector are discussed. Display results for the total system are presented.

LARGE-AREA, PROJECTION TELEVISION DISPLAYS have not yet found wide usage in the consumer market due to unattractive compromises of complexity, performance and cost of available systems. Standard kinescopes are practically limited to sizes below $\sim 0.2 \text{ m}^2$ (25 in. dia.)

Commercially available projection systems fall into two categories: light-generating and light-controlling (light-valve) systems. Light-generating systems such as projection kinescopes are generally dim; they require high voltage operation and complex optics due to the isotropic emission of the phosphor; and they are costly. The best projection display is produced by a light valve, such as the eidophor:¹ here an external light source is spatially modulated by an oil film which is rippled inside a cathode ray tube. However, this system has been plagued by complexity, high cost, and cathode deterioration due to the presence of the oil film in vacuum. Recently an improved version of the eidophor system² was announced that is said to have extended life in a sealed-off tube but it is still costly.

This paper describes a new light valve aimed at producing a bright, large-area television display. This system uses an electron-beam-addressed deformable target similar to one described earlier by Auphan³ that contains no organic materials and therefore promises long life in a simple sealed-off tube.

Target

The light-valve target consists of a thin metal film stretched over a sup-

Reprint RE-16-4-14

Final manuscript received April 29, 1970

port grid in close proximity to a glass substrate as shown in Fig. 1. The size of the target ($5 \times 5 \text{ cm}^2$) and the support-grid-spacing (50 to 100μ) are chosen to produce standard television resolution or better using commercially available electron guns (RCA 5TP4). The use of an electron gun with better resolution and a finer target structure would provide better resolution or similar resolution in smaller targets. A larger target, on the other hand, would require larger optics in the projector, thereby making it more expensive.

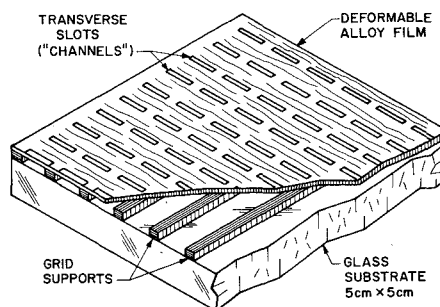

Fig. 1a—Light valve target construction.

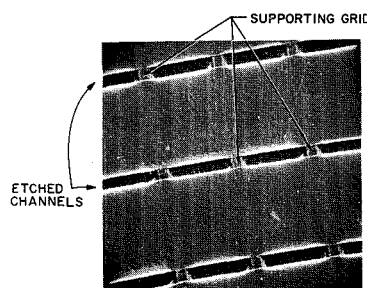
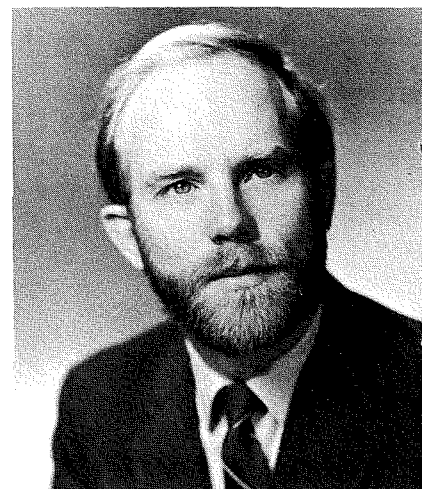

Fig. 1b—Electron micrograph (500 X) of actual target.

In operation, an electron beam whose intensity is modulated by the video signal scans the target as it would the



Dr. John A. van Raalte, Head
Displays and Device Concepts Research
Consumer Electronics Laboratory
RCA Laboratories
Princeton, N.J.

received the SB and SM from the Massachusetts Institute of Technology in 1960. Subsequently he began his doctoral research under Professor A. R. von Hippel in the Laboratory for Insulation Research at M.I.T. He was awarded the Engineer's Degree in 1962 and received the PhD in 1964; his doctoral thesis was entitled: "Conduction Phenomena in Rutile Single Crystals." Dr. van Raalte joined the David Sarnoff Research Center in July, 1964, as a Member of the Technical Staff. Since then he has conducted research in the areas of electro-optic materials, plastics, glasses, liquid crystals and their applications to display and recording functions. He was appointed to his present position in September of this year. He is a member of Tau Beta Pi, Eta Kappa Nu, Sigma Xi, the American Physical Society, the IEEE, and the AAAS. He was awarded a 1969 RCA Laboratories Achievement Award for the development of the TV projection system described in this paper.

phosphor screen in a kinescope. The electron beam penetrates the metal film and deposits charge on the glass substrate in proportion to the intensity of the video information at each location. This charge electrostatically attracts and deforms the metal film as shown in Fig. 2. The schlieren projector converts the amplitude of the resulting deformation into an analogous brightness on the screen. As in any light valve, the highest screen brightness and contrast is achieved by maintaining the light-valve condition until it is updated by the beam: for standard television the deformation of the metal film must decay in $1/30 \text{ sec}$. A faster decay results in loss of contrast and brightness; a longer decay produces a stored image.

Schlieren projector

In the absence of modulation, the target appears as a specular mirror surface. Consequently a reflective schlieren projector was designed as

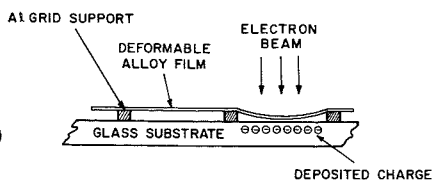

Fig. 2—Deformable target operation

shown in Fig. 3. Light from a 500-watt xenon-arc source is collected efficiently and concentrated at the second focus of an integral ellipsoidal collection mirror. The light is subsequently collimated to illuminate the target uniformly at an angle; the target is fabricated on the inside of the glass faceplate of the cathode ray tube.

In the absence of target deformation, the reflected light is again focussed by the projection lens onto an opaque stop—no light reaches the screen. Whenever a part of the deformable film is rippled by the electron beam, the light incident on the film is deflected past the stop and imaged by the projection lens as a bright spot on the screen. The prism placed close to the target is used to transform the target-plane into an image-plane perpendicular to the optic axis; this arrangement produces depth-of-focus correction for the off-axis system and removes distortions as well as color aberrations.

The operation of the projector can be explained as follows. Whenever the target is undeformed and mirror-like, the light source is imaged onto the stop; as long as the stop is as large or slightly larger than the image of the source, all the light is blocked. As the target surface is tilted, the light is deflected and part of the imaged source misses the stop. Increasing the tilt of the target causes more light to miss

the stop, thereby increasing the screen brightness until all the light reaches the screen. At this point, the screen brightness saturates with continued deflection until finally the deflected light misses the projection lens altogether. This is illustrated in Fig. 4a.

In actual operation, each target element deforms parabolically as will be discussed in greater detail later and does not simply tilt (see Fig. 2). Thus, the light incident on a single metal picture element is deflected over a range of angles determined by the curvature of the element. Light incident on the central portion of each element is not deflected and remains blocked by the stop. However, as the deformation is increased, the sides of each element are tilted further producing a gradual increase in the brightness of the corresponding spot on the screen. Thus, as shown in Fig. 4b, the screen brightness is a monotonic function of the target deformation producing a gray-scale display. The maximum in screen brightness is reached just before the light deflected by the most tilted sides of each target element (near the grid support) begins to miss the projection lens.

Simple geometrical arguments can be used to show that the fraction of the light incident on each target element in this system is proportional to the area under the curve of Fig. 4a. In a properly designed projector incorporating a low f -number projection lens (e.g., $f/1.7$) 50 to 80% of the incident light, depending on the degree of collimation, can be modulated to fall on the screen thus making the display brightness primarily dependent on the luminosity and collection efficiency of the light source. We have achieved

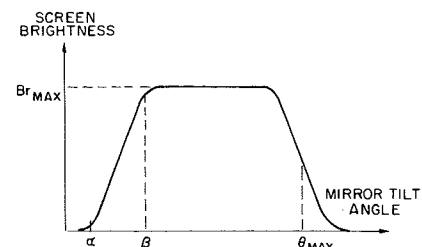

Fig. 4a—Screen brightness versus tilt of target plane: $\alpha \approx$ amount by which stop size exceeds source size; $\beta \approx$ collimation angle of incident light; and $\theta_{max} \approx$ acceptance angle of projection lens.

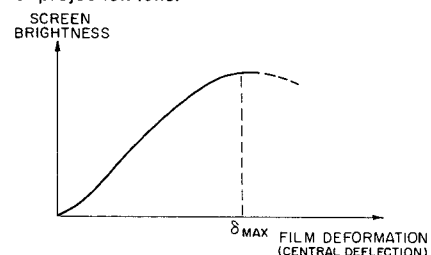

Fig. 4b—Screen brightness versus target deformation: δ_{max} = central deflection of target element required to produce maximum screen brightness.

200 to 300 lumens output from a 500 watt xenon-arc without using critically designed optics.

Target dimensions

The target dimensions have been chosen largely for convenience. The spacing between adjacent grid support lines defines a resolution element in one direction and must be small enough to allow standard television resolution; 50 to 100 μ spacings have been used on 5×5 cm² targets.

The height of the grid supports must be sufficient to keep the deformable metal film away from the substrate surface under the most severe deformation. For parabolical deformation—a very good approximation to the actual situation—the central film deflection is

$$\delta_{max} = \theta_{max} l / 4 \quad (1)$$

where θ_{max} is the acceptance angle of the projection lens ($\sim 18^\circ$ for our $f/1.7$ lens) and l is the grid spacing. Thus, δ varies between 3 and 6 μ for 50 to 100 μ elements and the grid support is usually made 1 to 2 μ higher.

The deformable metal film must be thin enough to be readily penetrated by the electron beam. The penetration depth depends on the film density:⁴ a 20 kV beam can penetrate at most 0.8 mg/cm² corresponding to 3 μ of Al or 9000Å of Ni or Cu. In practice, we make the film thinner (e.g., 2000 to 4000Å of Ni) to allow the beam to

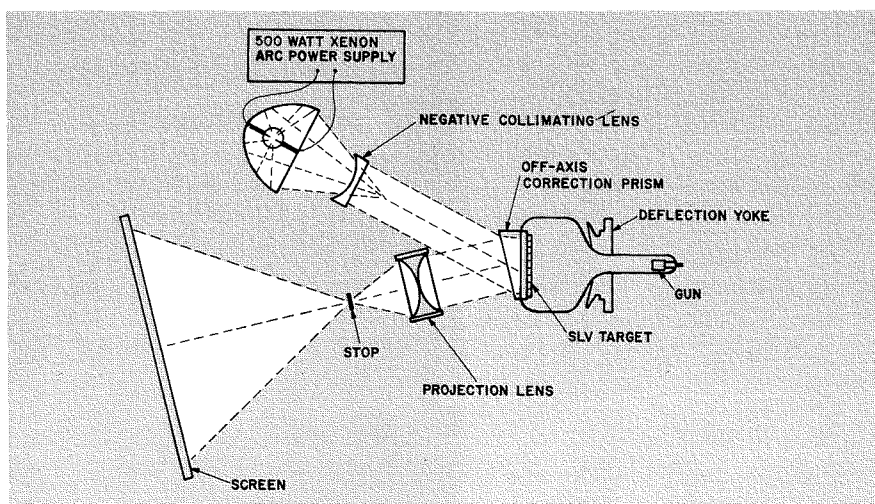

Fig. 3—Off-axis, reflective schlieren projector

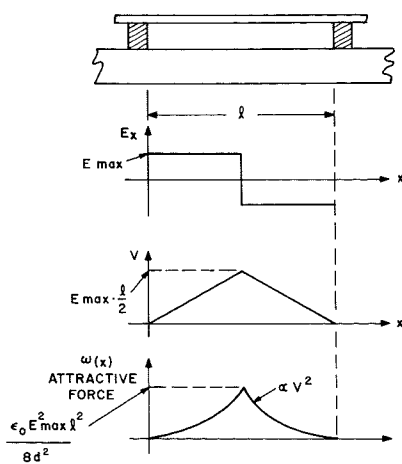

Fig. 5—Electric field, voltage and electrostatic load distributions along substrate surface for optimum deformation.

penetrate more efficiently; in fact, the optimum film thickness is determined by its mechanical properties, as discussed later in the paper.

It is possible to segment the film in the direction perpendicular to the support grid, as shown in Fig. 1. This uniquely defines a resolution element in the other direction but is not necessary; 50 to 100 μ dimensions have been used here as well.

Electrical performance

The metal film is deformed electrostatically by the electron-beam charge that is deposited on the glass substrate below. The attractive force due to a uniform charge Q is equal to the derivative of the stored energy:

$$F = \frac{\partial W}{\partial d} = \frac{\partial [Q^2/2C]}{\partial d} = \frac{\partial [Q^2 d / 2\epsilon_0 A]}{\partial d} = \frac{Q^2}{2\epsilon_0 A} \quad (2)$$

where C is the capacitance of the element; ϵ_0 is the dielectric constant of vacuum; A is the area of the element; and d is the spacing between the film and the substrate (grid height).

Thus, the load is proportional to the square of the deposited electron charge (Q^2) and independent of grid height (d), making the operation insensitive to small variations in grid height.

As shown in Fig. 2, the electron beam deposits a uniform charge under each element. The induced voltage between deformable metal film and substrate tends to be uniform as in a parallel-plate capacitor. However, the induced voltage also appears along the substrate surface between the center of

the element and the metallic grid supports where it must go to zero. In operation, there is a maximum surface field intensity (E_{max}) that the substrate surface can support which limits the maximum induced voltage to a value (as shown in Fig. 5):

$$V_{max} = E_{max} l / 2 \quad (3)$$

This potential distribution does not correspond to a uniform charge distribution because some of the deposited charge has been discharged towards the grid supports. In fact, this discharge mechanism is a nondestructive voltage regulator that prevents overvoltage (i.e., overmodulation and possible destruction of the metal film). Consequently, the load on the film is also not quite uniform (Fig. 5), but is concentrated at the center of the element where it will do most good. The resulting deformation can be determined from principles of statics⁵ by balancing the electrostatic load and elastic restoring forces in the film:

$$y = \frac{\epsilon_0 E_{max}^2}{2T_0 d^2} \left[\frac{l^2 x^2}{8} - \frac{l x^3}{6} + \frac{x^4}{12} - \frac{l^4}{64} \right] \quad (x \geq 0) \quad (4)$$

where T_0 is the tension in the metal film at its center; y is the film deflection from its original position; x is the distance from the film center towards the grid support; and ϵ_0 , d , l , E_{max} are as defined previously.

For small deformations, as is the case here, the deformation is essentially parabolic and the third and fourth power terms in x may be neglected. This calculation assumes a thin elastic membrane with no appreciable bending moments; a similar calculation can be made including bending moments⁶, but these are found to be unimportant for film thicknesses less than 1 to 1.5 μ .

The maximum tension in the film—also quite uniform for these small deformations—can be expressed in terms of the limiting field intensity along the substrate and the maximum tilt of the film at its supported edges (equal to half the acceptance angle of the projection lens = $\theta_{max}/2 \approx 9^\circ$ for a $f/1.7$ lens):

$$\left. \frac{dy}{dx} \right|_{x=l/2} = \frac{\theta_{max}}{2} = 9^\circ \quad (5)$$

and from Eq. 4:

$$T_0 = \epsilon_0 E_{max}^2 l^3 / 7.54 d^2 \quad (6)$$

The strain in the film ($e = \sigma/E$), determined by the stress⁵ ($\sigma = T_0/t$) can

also be determined from the geometrical shape of the deformation (relative elongation of the film: $\Delta l/l$). Equating these two quantities we find that:

$$\sigma = \frac{T_0}{t} = \frac{\epsilon_0 E_{max}^2 l^3}{7.54 d^2 t} = \frac{\Delta l}{l} E = 0.008 E \quad (7)$$

where σ is the tensile stress in the film; e is the strain in the film; E is the modulus of elasticity of the metal film; t is the thickness of the metal film; and Δl is the total elongation in the film.

This means that the maximum elastic deformation of the metal film is:

$$e = \Delta l/l = 0.008 = 0.8\% \quad (8)$$

The maximum film thickness that can be deformed optimally is thus determined by the limiting field intensity at the substrate (Eq. 7):

$$t = \frac{16.6 \epsilon_0 E_{max}^2 l^3}{E d^2} \quad (9)$$

This value is typically lower than the limit set by the requirement that the film be easily penetrated by 20-kV electrons.

Metal film properties

It may be interesting to bring these formulae into perspective by putting in some typical numbers. This will point out another very interesting application for this system, namely to measure the mechanical properties (stress, strain, modulus, and yield strength) of films that are not easily handled otherwise. Furthermore, the great number of elements ($> 10^5$) on each target provides some statistical information about the spread and uniformity in these parameters.

Using Eqs. 3 and 8, we find

$$V_{max} = \left[\frac{0.015 E t d^2}{\epsilon_0 l} \right]^{1/2} \approx 5000 \text{ volts} \quad (10)$$

where we have used actual values for a target whose film thickness was experimentally found to be optimum according to Eq. 9:

$t = 2000 \text{ \AA}$ film thickness of Ni

$d = 5 \mu$ grid height

$l = 70 \mu$ grid spacing

$\epsilon_0 = 8.85 \times 10^{-12} \text{ f/m}$

$E = 30 \times 10^6 \text{ psi} = 2 \times 10^{11} \text{ N/m}^2$ typical for Ni.

This corresponds to a maximum field intensity along the substrate surface:

$$E_{max} = \frac{2V_{max}}{l} = 1.4 \times 10^8 \text{ V/m} \quad (11)$$

which indeed must be near the dielectric strength of the surface.

Since the induced voltage also appears across the much shorter distance between the substrate surface and deformable film, one might wonder whether the maximum induced voltage is limited by field emission. The electric field intensity perpendicular to the substrate surface

$$E_{\perp} = \frac{V_{max}}{d} = \frac{5000}{5 \times 10^{-6}} = 10^9 \text{ volts/m} \quad (12)$$

must be close to that required to rip electrons out of the substrate, but the logical consequence that optimum film thickness should be proportional to grid spacing is not borne out experimentally. Thus, while we cannot exclude the possibility of field emission, we have no conclusive evidence that it occurs.

The response time of the metal film to the induced voltage is very fast ($< 1 \mu\text{s}$) due to its small inertia. The requirement that the deformation relax in a frame time therefore requires that the charge leak off towards the conducting support grid in $\sim 1/30$ sec. This dielectric relaxation time (τ) is determined by the substrate resistivity (ρ) and some geometrical factors of the target:)

$$\tau = RC \approx \rho \epsilon_0 l / d \quad (13)$$

Therefore, the resistivity must be

$$\rho = \tau d / \epsilon_0 l = 3 \times 10^8 \Omega\text{m} = 3 \times 10^{10} \Omega\text{cm} \quad (14)$$

for standard television. This corresponds closely to the resistivity of commercial soda-lime glass; in operation, we normally heat these substrates to $\sim 50^\circ\text{C}$ to achieve the desired charge decay time constant.

The electron-beam current requirements for "off-the-air" operation can be found assuming that about half the charge leaks off in one frame time: the beam must then charge the whole area to $V_{max}/2$ (in practice the substrate area is $\sim 4 \times 4 \text{ cm}^2$). The beam must supply this charge thirty times per second:

$$I = \frac{Q_T}{\tau} = \frac{C_T V_{max}}{2\tau} = 210 \mu\text{A} \quad (15)$$

where Q_T is the charge deposited by the beam in a frame time; τ is 1/30 sec; and C_T is the capacitance of the processed target area.

This value agrees well with the experimentally determined peak-current requirement to produce a uniform

white field; a different choice of film parameters or dimensions can be chosen to alter this value.

The maximum load required to deform the metal to its optimum value:

$$\omega_{max} = \epsilon_0 V^2_{max} / 2d^2 = 4.5 \times 10^8 \text{ N/m}^2 \approx 44 \text{ atm.} \quad (16)$$

This value is not the average (due to the variations in the load), but it attests to the great strength of the metal film and explains why mechanical vibrations cause no problems for the film.

In effect, then, a simple calibration or calculation can be used to relate the screen brightness to the deformation or film strain for any given projector. By noting the value of brightness where a sufficiently thin film fails, the yield strength is determined. A sufficiently thick film, on the other hand, will not fail since the load is limited by the maximum allowable field strength in the substrate (Eq. 9); this maximum field strength or maximum induced voltage is determined by measuring the electron beam current and charge decay time. Knowledge of the deformation, maximum voltage and film thickness then define the stress, strain, and modulus of elasticity of the film. This technique can be used to evaluate mechanical and elastic properties of extremely thin films, as well as their fatigue properties, and to relate these to fabrication techniques, grain size, impurities, composition, etc.

Results

Many deformable light-valve targets have been tested to prove these concepts and to optimize the various parameters and elastic properties of the deformable metal film. Many evaporated alloy films (*Al-Cu*, *Cu-Al*, *Cu-Zn*, *Al-Zn*, . . .) have been evaluated, as well as several electroplated *Ni* films. The electroplated films have the advantage that the structural properties can be varied and compressive or tensile stresses built in by adjusting the temperature, *pH*, plating rate, or geometry, or by adding suitable hardeners, wetting agents, or brighteners to the plating bath.⁷

A typical projected image from this light valve is shown in Fig. 6. Several small defects are visible—these are caused by dirt or dust in the various processing steps. Since each inopera-

tive target element produces a point-defect in the projected display a high degree of target perfection is needed. This is likely to require clean-room facilities for target processing, similar to those now commonly used in the integrated-circuit industry. We have achieved "off-the-air" displays for several hours at output levels of 200 to 300 lumens with contrast ratios of 15:1 to 25:1. Additional work is being done to further optimize the processes and to evaluate the trade-offs available between projector design (sensitivity to deformation), life of the target, and display contrast which is presently limited by the supporting grid structure.

Acknowledgment

The author is indebted to V. Christiano, W. Gorkiewicz, J. Harrison and C. Dobin for their contributions to this project. The support of Dr. J. J. Brandinger throughout the project is also gratefully acknowledged.

References

1. Baumann, E., "The Fischer Large-Screen Projection System," *J. of the British Inst. of Radio Engrs.*, Vol. XII, No. 69 (1952).
2. Good, W. E., "A New Approach to Color Television Display and Color Selection Using a Sealed Light Valve," *Proc. of the National Electronics Conference*, Vol. XXIV, No. 771 (1968).
3. Auphan, M., "Proprietes des Feuilles Tres Minces de Glucinium, Leurs Applications a la Modulation de la Lumiere & a la Television," *L'Onde Electrique*, Vol. 36, No. 1040 (1956).
4. Whiddington, R., "The Transmission of Cathode Rays Through Matter," *Proc. Roy. Soc. (A)*, Vol. 86, No. 360 (1912); Whiddington, R., "The Transmission of Cathode Rays Through Matter," *Proc. Roy. Soc. (A)*, Vol. 89, No. 559 (1914); Gentner, K., "Uber die Energieabsorption von Schnellen Kathodenstrahlen," *Annalen der Physik*, 5. Folge, Band 31, 407 (1938).
5. Timoshenko, S. and MacCullough, G., *Elements of Strength of Materials*, (Van Nostrand Co., N.Y.).
6. *Ibid.*, pp. 122, 171, 172.
7. Sodeberg, K. G., and Graham, A. K., "Stress in Electrodeposits—Its Significance," *34th Annual Proceedings, Amer. Electroplating Soc.*, (1947) pp. 74-95; Phillips, W. M., and Clifton, F. L., "Stress in Electrodeposited Nickel," *34th Annual Proceedings, Amer. Electroplating Soc.*, (1947) pp. 97-110.

Fig. 6—Light-valve display.



High-performance FM receivers using high-gain integrated-circuit IF amplifiers

T. J. Robe | L. Kaplan

This paper describes the advantages of the IC approach to FM receiver design and discusses two areas requiring careful attention. One of these areas involves the provision of sufficient selectivity in a single component; the other deals with stabilization of the gain stage when the gain is concentrated in a small area. The performance of a breadboard FM receiver using the IC approach and composed of a commercial FM tuner, a filter, and a single integrated-circuit IF amplifier is described.

MOST MODERN FM receivers consist of a series of separate stages of gain and selectivity, cascaded one after another. This design remains the most practical in tube and transistor receivers.

The selectivity stages are double-tuned transformers carefully designed to provide proper termination for the gain stages. Gain is usually limited by the stability of the tube or transistor used. A practical finished system of the design shown in Fig. 1 represents a considerable effort in parts specification and parameter testing. Performance can vary from poor to outstanding—depending on the skill, integrity, quality of components, and quality control used in manufacturing the circuit.

Significant improvements in the performance of the system in Fig. 1 are realized by replacing each active device (gain block) with an integrated circuit (IC) in which gain is obtained through the use of a differential amplifier. The differential-amplifier configuration offers better limiting characteristics than the single-ended tube and transistor stages.

Fig. 2 illustrates a new concept in the design of FM IF amplifiers in which the selectivity and gain functions are provided in single lumped elements. For example, where the system in Fig. 1 utilizes four discrete stages, each stage providing 20 dB of gain, the new system would have to provide 80 dB of gain with one stage for equivalent

performance. Similarly, where the system in Fig. 1 utilizes four stages with a total of eight tuned circuits to obtain the required selectivity, the improved system would have to provide equal selectivity with one lumped selective component.

In AM/FM receivers, in which the application of automatic gain control (AGC) to the AM portion is a basic requirement, the single high-gain stage specifically designed as a limiter is replaced by a sub-system such as that shown in Fig. 3. For the system in Fig. 3 to perform similarly to those in Figs. 1 and 2, some redistribution of gain and selectivity is required. In addition, because the AM signal bypasses the limiting gain stage, the overall gain of the AM portion will probably be less than that of the FM portion; however, AM gain should still be sufficient to provide satisfactory performance.

Cost advantages of the lumped approach

The lower parts count in a lumped system results in cost reduction in three major areas, as follows:

- 1) Lower assembly and inventory costs;
- 2) Less component interaction and, therefore, little (if any) alignment costs and fewer line rejects; and
- 3) Fewer parts to specify and test at incoming inspection.

Performance advantages of the lumped approach

The lumped approach also offers significant performance advantages over the distributed-gain approach of Fig.

1. The use of differential amplifiers in the integrated circuit provides superior limiting characteristics as compared to the distributed approach. An example of a monolithic integrated-circuit design intended for FM IF-limiter applications is shown in Fig. 4. The IF portion of this circuit, the RCA-CA3043, consists of four differential amplifiers in cascade. Each differential pair is isolated from the succeeding pair by a common-collector stage used as a buffer. The final differential pair is powered by a constant-current transistor.

The input side of each differential amplifier operates as a common-collector stage; the output side operates in the common-base mode. Both sides are supplied by a constant-current source. The magnitude of the load impedance on the output side is adjusted so that, with the available current, saturation is never reached. The input side can never be saturated because there is no collector load. Limiting is always symmetrical; the limiting level is dictated only by the available current. Because saturation is avoided, the effective junction capacitance varies very little with signal level, and incidental phase modulation due to amplitude changes is negligible.

Integrated monolithic construction also makes practical the inclusion of internal regulation and decoupling in the IF stages. Thus with integrated-circuit systems, the equipment manufacturer is assured that, regardless of line-voltage variations, the active devices within the integrated circuit are always operating at optimum voltage

Reprint RE-16-4-19.
This paper appeared previously in the *IEEE Transactions on Broadcast and TV Receivers*, (Sept 1968).

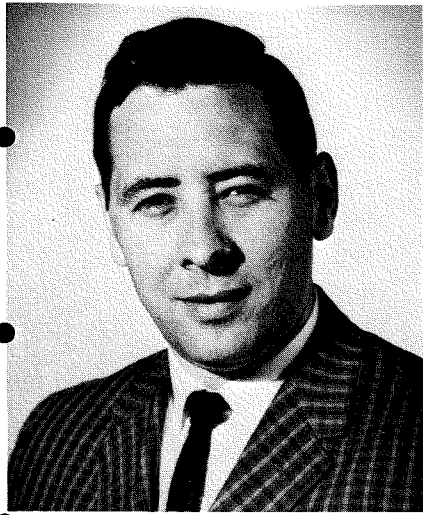

F. J. Robe

Linear Integrated Circuit Design
Solid State Division
Somerville, New Jersey

received the BSEE in 1957 and the MSEE in 1964, both from Newark College of Engineering. From 1957 to 1960, Mr. Robe was a Radar Maintenance Officer in the U.S. Air Force. In 1960 and 1961, he was a design engineer with ITT Laboratories where he contributed to the design of the DRONE control console and airborne power supplies. Mr. Robe joined RCA in 1962 and worked on the development, specification, test, and application of low noise VHF-UHF transistors. Recently, he has been assigned to the development, specification, test, and application of linear integrated circuits for consumer applications.

and current. Other features that can be built into the IC include FM detector diodes and some audio amplification. In tube and transistor receivers, such features as decoupling, regulation, detector diodes, and audio amplification must be designed and fabricated separately by the equipment manufacturer. Integrated circuit systems are also more reliable because there are fewer interconnections on the printed-circuit board.

In spite of the advantages realized with the use of high-gain integrated circuits, there are two areas that require careful design: stability and providing selectivity in a single component.

Selectivity

One problem in the lumped approach is that of constructing a filter that has a 3-dB bandwidth wide enough for stereo and skirt selectivity sharp enough for alternate-station rejection.

The degradation of the signal-to-noise ratio in FM stereo reception may make it advantageous in some cases to design for a somewhat narrower bandwidth than that normally required for stereo reception, particularly if the rate of attenuation is low and the bandwidth widens appreciably as the signal level is increased. Because the stereo signal-to-noise ratio is seldom adequate at signals below 25 μ V, the 3-dB bandwidth can be less than the theoretical minimum of 270 kHz at such signal levels. If the rate of attenuation is high, the bandwidth widening is less, and little advantage can be gained by designing to a narrower bandwidth.

Receiver passband requirements are dictated by the audio modulating frequency and the deviation of the transmitted carrier from the center frequency. In standard FM broadcast, the monaural bandwidth at the 3-dB points should be 220 kHz; however, stereo reception requires a bandwidth of about 270 kHz. For lowest distortion in the detected audio, the phase response should be as linear as possible over the passband. In addition, the skirt selectivity should be as sharp as possible beyond the desired cutoff frequency. Because transmission frequencies in a given locality are normally not closer than 400 kHz, the attenuation at a frequency 400 kHz away from the intermediate frequency of 10.7 MHz is used as a measure of the quality (quality factor) of the selectivity of the system.

Bandwidth and selectivity in a system are largely determined by the filter used. The passive filters available to the designer can be separated into three broad categories: crystal, ceramic, and inductance-capacitance (LC).

Crystal filters

Crystal filters are those that use one or more crystals in conjunction with one or more inductance-capacitance tuned circuits. The bandwidth requirement in FM is considered to be wide for a crystal filter, but some circuit designs employing crystal filters have been successfully produced. A typical crystal-filter response curve is shown in Fig. 5. Even with the extraneous response on the high side, this filter is very attractive from a performance standpoint because its phase response is

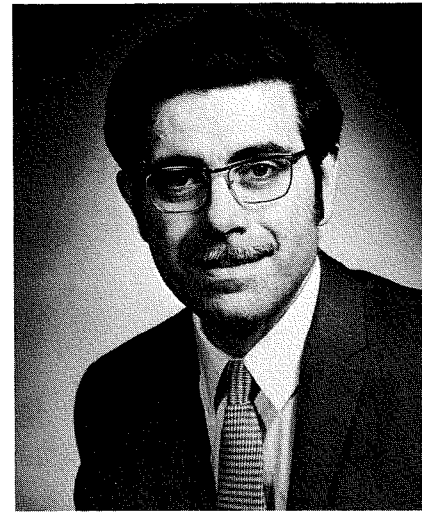

L. Kaplan

Linear Integrated Circuit Design
Solid State Division
Somerville, New Jersey

received the BS in Physics (with Honors) from Rutgers University in 1955. He received the MS in Engineering from Newark College of Engineering in 1969. After completing the RCA training program in 1955, Mr. Kaplan was assigned to the RCA Tube Division in Harrison, N.J. as an applications engineer. His primary work was in the development of tubes for audio, power output, and TV deflection applications. In 1960, he joined Raytheon Co. to work on storage tube applications. From 1961 to 1963, Mr. Kaplan worked on the design of high-volume consumer sound equipment for Westinghouse. From 1963 to 1965, he worked on display systems at Lockheed Electronics Co. where he advanced to project engineer. Mr. Kaplan returned to RCA in 1966, where he has been doing applications work on integrated circuits and MOS transistors.

linear, its bandwidth is adequate, and it has sharp skirt selectivity and low insertion loss. However, crystal filters are expensive and even at quantity prices their cost usually rules them out for most home-entertainment applications.

Ceramic filters

Ceramic filters (trapped-energy filters) now being manufactured in Japan show promise of good performance in FM systems. Filters of this type are essentially electromechanical devices in which a piezoelectric effect is obtained in a manmade material: lead zirconate titanate. Ceramic filters are presently available in several forms and can be purchased complete and packaged in a case which typically measures 20×12×11 mm. The frequency tolerance of these filters is \pm 80 kHz. Thus, in a production situation, the mixer output transformer and discriminator transformer would require some slight alignment. Matching to the

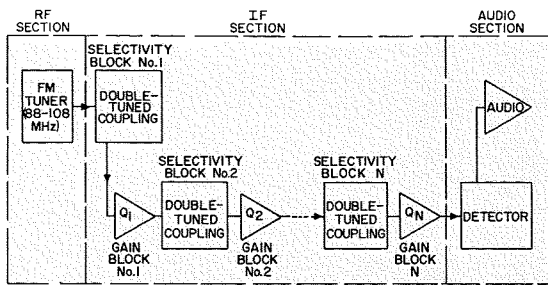

Fig. 1—Block diagram of FM receiver using separate stages of gain and selectivity.

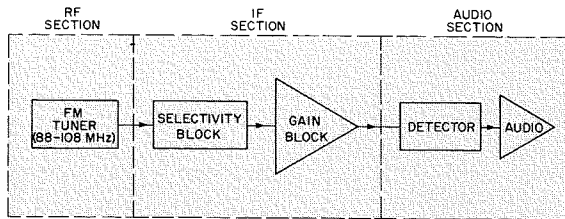

Fig. 2—Block diagram of FM receiver using lumped gain and selectivity elements.

mixer output transformer requires some form of resistive loading at the input to the filter to avoid excessive bandwidth narrowing effects.

Like the conventional crystal filter, the ceramic filter has an inherent spurious response problem; however, by careful attention in the design, the extraneous response may be effectively suppressed, and response curves similar to that shown in Fig. 6 may be obtained.

Single-section ceramic filters may be obtained in a package of very small volume. Typical dimensions are less than $\frac{1}{4} \times \frac{1}{4} \times \frac{1}{2}$ in., plus leads. Each section has a typical 3-dB bandwidth of 200 kHz, with a 20-dB bandwidth of 500 kHz. There is no rejection beyond about the 25-dB point; at this point, the response degenerates into a series of peaks and valleys of varying amplitude depending on the individual unit. When two sections are cascaded, the background response is suppressed to about 50 dB, but the bandpass shape depends on the center frequency of the units chosen. The insertion loss of each section is about 5 dB and is cumulative.

A standard production distribution yields units with center frequencies from 10.6 to 10.8 MHz. These units are color-coded into groups with center frequencies 50 kHz apart ± 35 kHz. By cascading two units, one from each of two adjacent groupings, it is possible to obtain reasonable bandwidth and suppression. All attempts thus

far to cascade three or more units have been unsuccessful because of multiple peaks appearing in the response and high insertion loss.

The packaged ceramic filters available now appear to be capable of providing, with the help of the mixer output transformer, the desired selectivity for an FM receiver. However, the insertion loss of 10 to 12 dB detracts from overall receiver gain. Single-section ceramic filters have less tractable problems, and, in spite of their apparent low cost, may precipitate production difficulties which could have been avoided by another approach.

LC Filters

With the aid of modern network theory and computers, a complete series of design charts has been developed to describe LC filters capable of almost any physically realizable transfer function.¹ It is possible to select, in the passband, from maximally flat (Butterworth), Equiripple (Tchebycheff), or minimum-time-delay (Bessel) designs. Bandwidth and rate of attenuation outside the passband determine the number of poles required. The Tchebycheff configurations offer the best rate of attenuation outside the passband, but are poorest in phase linearity. The opposite is true of the Bessel filters, while the Butterworth types (maximally flat) yield compromise values.

It is one thing to calculate a set of parameters for a given bandpass filter, but quite another to fabricate the filter given a handful of practical components and a size limitation. The practical unloaded Q 's attainable in

the inductors place at least two constraints on the design. If the Q 's are low and the desired overall bandwidth narrow, it may be impossible to achieve the desired response within a given number of poles. Alternatively, the losses may build up to such an extent that the insertion loss is intolerable. The most favorable unloaded Q 's are generally obtained on toroidal cores of high- Q ferrites. Many turns are required to obtain the optimum quality factor, with the result that the operating impedance is of the order of several thousand ohms. Therefore, matching networks are required at input and output ends to satisfy stability requirements of both the tuner and the IF amplifier.

The high operating impedance level makes the effects of stray capacitance coupling more apparent and complicates the control of the mutual coupling elements. Because toroidal cores offer the highest possible unloaded Q values, a logical configuration for the filter is one in which all the inductors are identical and grounded at one end. Each inductor would be resonated by an appropriate shunt capacitance, and the mutual coupling would be capacitive and inductive and would control the bandpass shape.

As the above discussion shows, the design, fabrication, and alignment of LC filters are best left to the filter specialists if economy and success are to be achieved. Results measured with two types of LC filters are shown in Fig. 7. The broken curve was obtained with a five-pole laboratory design which included inductors with unloaded Q 's of 120. The solid curve was obtained with a four-pole filter incorporating

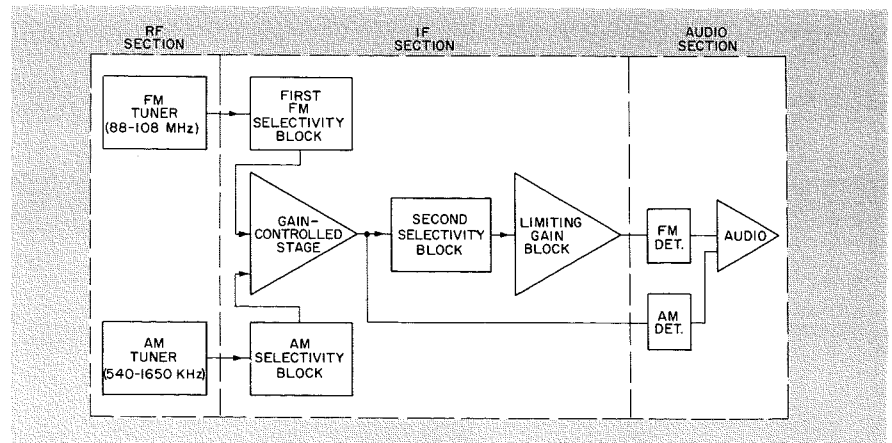

Fig. 3—Block diagram of AM/FM receiver.

inductors with unloaded Q 's in excess of 300. The differences in bandpass, skirt selectivity, and insertion loss are apparent. In general, it is possible to add sections (when the unloaded Q 's are greater than 300) to obtain improved selectivity at the expense of approximately 1.5 dB of insertion loss per section. When high- Q high impedances are used, it is also possible to obtain the desired coupling between sections without discrete capacitors.

The general practice in the construction of RF units for FM tuners is to include a double-tuned transformer in the output circuit of the mixer transistor. This transformer, when coupled to the filter, enhances the selectivity of the system beyond the values shown in the curves of Figs. 5, 6 and 7. Sample selectivity data are given later, with the description of an experimental receiver. Of the three types of filters presently available, the LC types show most promise from the viewpoint of cost and control within the circuit.

Designing for stability

The high-gain integrated-circuit IF amplifiers used in the experimental receiver described later are designed to operate without external feedback. Negative feedback can be used as a gain-control mechanism; however, its effectiveness has not yet been established. Positive feedback must be avoided if the amplifier is to remain free of spurious oscillations. The concentration of a high dynamic gain across a small input-output separation magnifies the problem of isolating the high-level output signals from the low-level input. In addition, direct coupling of several cascaded stages on the IC chip requires the use of a large amount of internal negative DC feedback. Careful bypassing of the feedback point must be provided externally to eliminate the effects of this feedback at the intermediate frequency. Accordingly, the design of IF amplifiers using high-gain integrated circuits consists mainly of optimizing the printed-circuit (PC) board layout and component connections to reduce external feedback, determining the source and load terminations for stability, and assuring effective bypassing of the internal negative feedback.

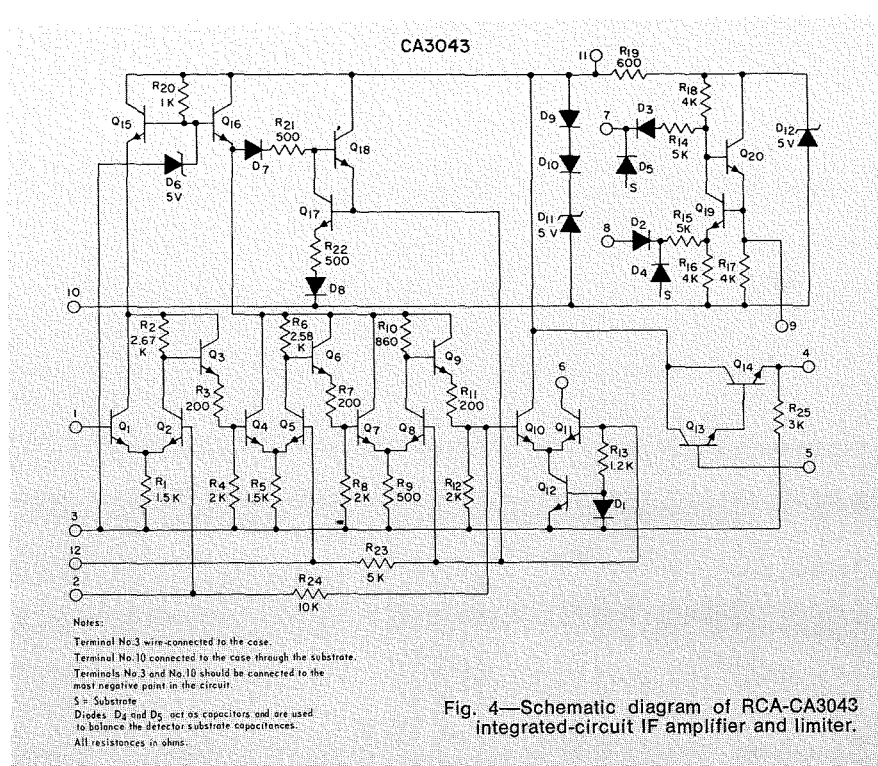

Fig. 4—Schematic diagram of RCA-CA3043 integrated-circuit IF amplifier and limiter.

External Feedback

The principal sources of external feedback on the PC board are mutual impedance and capacitance coupling of the input and output circuits. Mutual impedance coupling occurs when the input return current and the output, or higher-level return currents, flow through a common impedance, as illustrated in Fig. 8. The loop gain $A\beta$ for this circuit is given by

$$A\beta = \frac{E_f}{E_e} \approx \frac{I_n Z_c}{E_e} = \frac{g_m E_c Z_c}{E_e} = g_m Z_c$$

For negligible feedback, the loop gain must be much less than 1; therefore the tolerable common impedance is of the order of one-tenth the transconductance (g_m) of the device. The transconductance to the point of greatest ground return current (i.e., to the last emitter follower of the integrated circuit) is of the order of 0.03 mho for the RCA-CA3041 and CA3042 integrated circuits and 0.25 mho for the CA3043. The total transconductance for each of these types is higher, but the output currents circulate in the differential amplifier and therefore do not have a ground return path. For this reason, the allowable common impedance should not be more than 0.4 to 3 ohms, depending on the IC type. Fortunately, the low- and high-level return currents in the inte-

Fig. 7—Typical response curves for two types of LC filters.

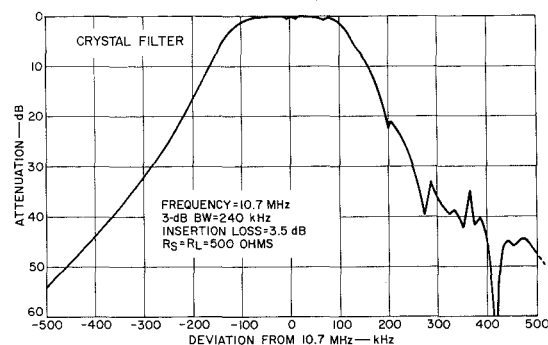

Fig. 5—Typical response curve for a crystal filter.

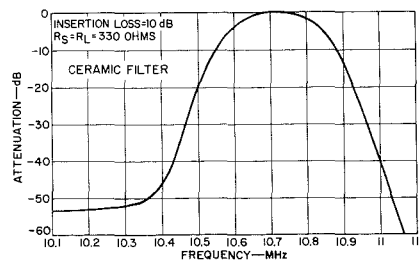
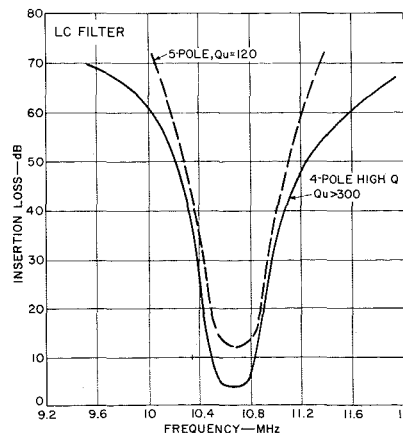

Fig. 6—Typical response curve for a ceramic filter.



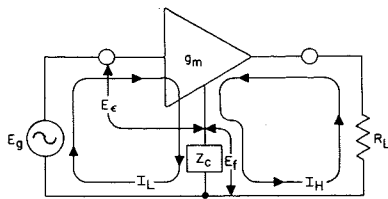

Fig. 8—Return current paths.

grated circuit do not emerge from a common terminal as in a single transistor stage; however, care must still be taken in returning the separate terminals to the PC board ground plane to assure that a common impedance is not produced on the board.

In general, the best way to avoid producing common impedance is to return a particular terminal to a point on the board closest to its source of signal current. For example, the input return (terminal 2 on the CA3043; terminal 3 on the CA3041 and CA3042) should be bypassed to a location on the board which is physically near the input signal source (terminal 1, as shown in Fig. 9). The high-signal-level return current (I_H), on the other hand, must be returned to the positive terminal of the power supply (terminal 11 on the CA3043; terminal 14 on the CA3041 and CA3042). This higher-level current can return to the power supply through one or a combination of several paths: internally through the voltage regulator, externally through a power-supply bypass capacitor, or externally through the power supply by way of the power leads. It is the portion of I_H which returns to the power supply externally which can cause feedback problems. Capacitor C_{B1} in Fig. 9 bypasses the power-supply terminal directly to the high-current return and represents the proper way to bypass the supply. With the arrange-

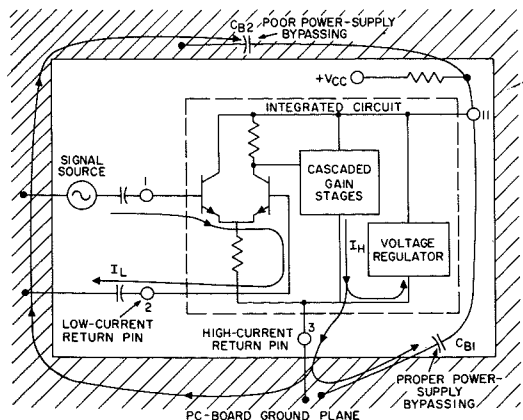

Fig. 9—Connections for input and output current returns.

ment shown, the return current can flow directly from terminal 3 to terminal 11 without passing through a section of the ground plane common to the low-level return current (terminal 2). The power-supply bypassing arrangement including C_{B2} in Fig. 9 is particularly poor because currents flowing through C_{B2} to the power supply must pass around the board and could, depending on layout, pass through a path common to the terminal 2 return current. It would be better to use no bypass at all than to use the one positioned as C_{B2} .

The second source of external feedback, and possibly the most troublesome, is stray capacitance from the high-level collector terminal to the input, terminal 1. This capacitance consists of the sum of the capacitance of the integrated circuit and stray capacitance from the printed-circuit board. Typical device feedback capacitance is 0.0005 pF for the CA3043 and 0.02 pF for the CA3041 and CA3042. If reasonable care is taken in layout design, PC-board stray feedback capacitances of the order of 0.001 pF should be obtainable. Thus, the total circuit feedback capacitance for the CA3043 in a TO-5 package is approximately 0.0015 pF, and for the CA3041 and CA3042 in a dual-in-line package is approximately 0.02 pF.

The circuit feedback capacitance in combination with the forward transadmittance y_{21} of the integrated circuit and the terminating conductance determine the stability of the amplifier. The stability criterion for an active two-port amplifier is given by²

$$g_1 g_2 > \frac{1}{2} |y_{12} y_{21}| (1 + \cos \theta) \quad (1)$$

where g_1 and g_2 are the total node conductances at the input and output nodes respectively, y_{21} is the integrated-circuit forward transmittance, y_{12} is the total circuit reverse transadmittance (assumed to be composed entirely of the feedback capacitance described above), and θ is the sum of the y_{12} and y_{21} phase angles. Eq. 1 indicates the minimum $g_1 g_2$ product required for stable operation of high-gain IC's.

The RCA-CA3043 in a TO-5 package operating at 10.7 MHz has the following values:

$$\begin{aligned} y_{21} &= 6 / +80^\circ \text{ mhos} \\ y_{12} &= \omega C_f / -90^\circ = (67 \times 10^6) \\ &= 10^{-7} / -90^\circ \quad (1.5 \times 10^{-15}) / -90^\circ \\ \theta &= +80^\circ - 90^\circ = -10^\circ \end{aligned}$$

The minimum $g_1 g_2$ product at 10.7 MHz is then given by

$$g_1 g_2 \geq \frac{(6)(10^{-7})(1.98)}{2} = 0.6 \times 10^{-6} \text{ (mhos)}^2$$

Because this conductance product is much greater than the product of the IC input and output conductances, it can be assumed that $g_1 g_2$ is the product of the source and load conductances g_s and g_L . If the load resistance were 2000 ohms ($g_L = 0.5$ millimho), the maximum allowable source resistance would be 830 ohms ($g_s = 1.2$ millimhos). A practical, well-designed circuit incorporating the CA3043 would employ a conductance product higher than 0.6×10^{-6} to reduce bandpass skewing and to provide for device interchangeability.

For stable operation of the RCA-CA3041 and CA3042 in a dual-in-line package at 10.7 MHz, calculations are as follows:

$$\begin{aligned} y_{21} &= 1.2 / +80^\circ \text{ mhos} \\ y_{12} &= (67 \times 10^6) (2 \times 10^{-14}) / -90^\circ \\ &= 1.34 \times 10^{-6} / -90^\circ \text{ mhos} \\ \theta &= -10^\circ \end{aligned}$$

$$\begin{aligned} g_s g_L \text{ (min)} &= \frac{(1.2)(1.34 \times 10^{-6})(1.98)}{2} \\ &= 1.6 \times 10^{-6} \text{ (mhos)}^2 \end{aligned}$$

PC board layout

The computations shown above illustrate the careful printed-circuit-board layout design required (particularly with the CA3043) if stray feedback capacitance is to be minimized so that full advantage can be taken of the high gain of the integrated circuit; Fig. 10 illustrates several techniques for minimizing this capacitance. The methods illustrated include the following:

- 1) Maximum separation of input and output terminal metallization;
- 2) Division of the IC pin circle by a strip of ground metal that connects the normally grounded terminals 3 and 10;
- 3) Isolation of the input and output terminals by surrounding them with ground metal shields.

In addition to minimization of stray feedback capacitance, it is important that lead protrusions of components connected to the input and output metal lands be kept as short as possible to avoid the introduction of stray capacitance above the surface of the board. The 0.0015-pF capacitance discussed above was made possible by use of all the layout techniques dis-

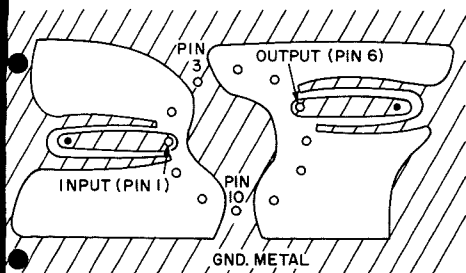

SHADED REGIONS ARE PC-BOARD METAL AREAS

Fig. 10—Techniques for minimizing stray feedback capacitance.

cussed. The capacitance could be reduced further, possibly by a factor of two, by locating a bottom shield approximately one-quarter inch from the printed circuit and directly over the IC pin circle.

Fig. 11 shows a photograph of a PC board layout for the CA3043. The positioning of the bypass capacitors on terminals 2 and 11 reduce common impedance coupling. The board shown was operated with a load impedance R_L of 3000 ohms and a source impedance R_S of 400 ohms and was free from oscillation.

Bypassing chip negative feedback

The DC stabilizing feedback on the integrated-circuit chip must be carefully bypassed externally to avoid gain reduction at the intermediate frequency. The largest amount of DC feedback exists at terminal 2 of the CA3043; as discussed above, terminal 2 should be bypassed close to the input signal source. Every effort should be made to reduce the impedance of the bypass to less than 1 ohm as experimentation has shown that a 1-ohm resistor placed in series with the bypass can reduce the IF gain by approximately 3 dB. The value of the bypass capacitor depends somewhat on the lead length of the bypass; for bypass lengths of approximately $\frac{1}{2}$ inch, a value of 0.01 to 0.02 μF seems best.

Experimental receiver

An experimental receiver was constructed using only a commercial FM tuner, an LC filter, and an RCA CA3043 with a discriminator transformer, as shown in Fig. 12. The $1\frac{1}{2} \times \frac{7}{8} \times$

$\frac{5}{8}$ -inch LC filter was designed to operate with source and load impedance of 500 ohms. The output of the filter was terminated in a 470-ohm resistor connected between terminals 1 and 12 of the CA3043. Terminal 12 was bypassed to ground; and, because the output of the filter is DC-isolated, it was connected directly to terminal 1. At the tuner end, matching was accomplished by use of a capacitive tap on the transformer secondary winding to reduce the impedance to the 500-ohm level.

Performance data for the experimental receiver are given in Table I. The AM rejection is not included, but has been measured as approximately 58 dB. The 20-dB quieting sensitivity was measured at 2 μV at the antenna; 30-dB quieting sensitivity was measured at 3 μV . The 3-dB limiting sensitivity was reached at 7 μV . The selectivity curve for the receiver shows that the 60-dB rejection points are reached at 304 kHz from the desired frequency; the 3-dB bandwidth at small-signal levels is better than 220 kHz.

Table I—Performance data for experimental receiver shown in Fig. 12.

Performance data

20-dB quieting sensitivity	= 2 μV
30-dB quieting sensitivity	= 3 μV
3-dB limiting sensitivity	= 7 μV
Total harmonic distortion	
225- μV input	= 0.35%
10- μV input	= 1.3%

Selectivity (Tuner + Filter)

3-dB bandwidth	= 223 kHz
6-dB bandwidth	= 305 kHz
20-dB bandwidth	= 399 kHz
40-dB bandwidth	= 486 kHz
60-dB bandwidth	= 608 kHz

Conclusions

Integrated-circuit IF amplifiers are available with sufficient gain at 10.7 MHz to perform the entire IF amplifier-limiter function required in a good-quality FM receiver. The designer must, however, exercise care in the layout of the printed-circuit board and in the location of certain components on the board so that maximum gain is achieved.

The breadboard receiver described demonstrates that acceptable commercial performance can be obtained with receivers constructed according to

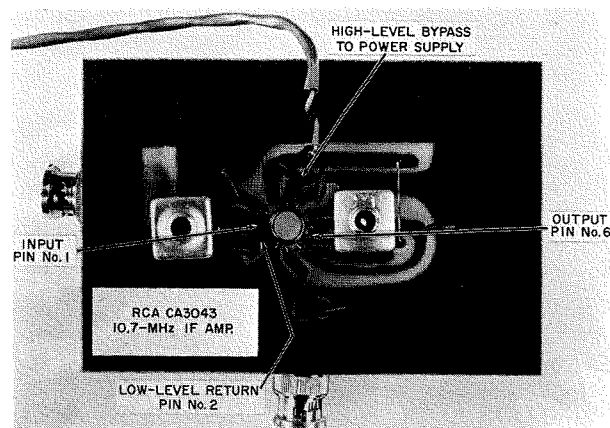

Fig. 11—Printed-circuit-board layout for CA3043.

the lumped-gain, lumped-selectivity approach. The performance demonstrated, while not equal to that obtained in the most expensive discrete-component FM receivers, is more than adequate. Of the three types of filters (crystal, ceramic, and LC) that are presently available, the LC type shows most promise from the viewpoint of cost, insertion loss, and accurate prealignment.

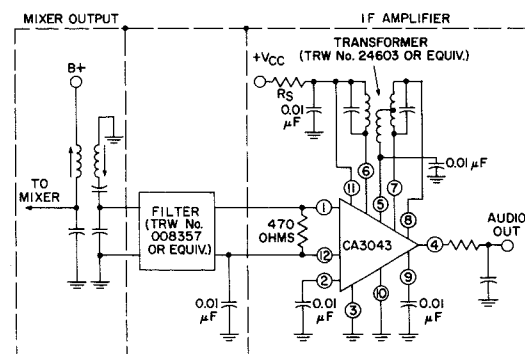

Fig. 12—Schematic diagram of experimental FM receiver using a commercial FM tuner, an LC filter, and a CA3043 with a discriminator transformer.

Acknowledgment

The authors thank S. Harris and F. Radler of TRW Components Division for their valuable assistance in the fabrication of the LC filter described in this paper, and C. F. Wheatley, V. Zuccharo, and T. Griffin of RCA for their valuable aid in acquiring the information presented.

References

1. "Electrical Filters", White Electromagnetics, Inc., Rockville, Md.
2. Santilli, R. A., "RF and IF Amplifier Design Considerations", *IEEE Transactions on Broadcast and TV Receivers* (Nov 1967).

Integrated circuits for RF and IF service

H. M. Kleinman

This paper discusses linear integrated circuits for IF and RF service: what they are, why they are used, and how they perform. Included also is a description of the general characteristics of these circuits and some of the prospects for future developments.

RF AND IF LINEAR INTEGRATED CIRCUITS (LIC's) represent a major part of the linear integrated-circuit market. Twenty percent of all LIC's sold are classified as RF/IF amplifiers. By the end of 1969, twenty-eight domestic manufacturers of IC's had announced integrated circuits specifically designed and characterized for RF or IF service. A total of 87 types representing versions of 32 circuits are available in this category; another 86 types representing different circuit configurations are available in the category of wideband amplifiers.¹

These circuits range in complexity from basic differential amplifiers (with or without biasing elements), such as the RCA CA3028, to highly complex subsystems of 50 to 100 components. Fig. 1 shows the more complex RCA-CA3065, which includes a three-stage amplifier-limiter, detector, audio pre-

amplifier, electronic attenuator, and regulated power supply. The simplest types are represented by the "703" type IC's shown in Fig. 2. Circuits of the simpler type occupy little chip area and have a minimum number of leads. These circuits, therefore, are economical to produce and relatively inexpensive; however, they are relatively inflexible. The "703" series is intended only for non-automatic-controlled amplifier-limiter service within its frequency range. The highly complex IC's also tend to be single-purpose devices. The CA3065, for example, is designed as a TV sound IF system and is also suitable for any FM service below 20 MHz; however, its use to provide other functions is limited.

Between these extremes in circuit complexity there are a great many IC's which can perform many functions. For example, the RCA-CA3005 shown in Fig. 3 can be used as a differential RF amplifier, a cascode RF amplifier

Reprint RE-16-4-20 (ST-4327)
Final manuscript received July 18, 1970.

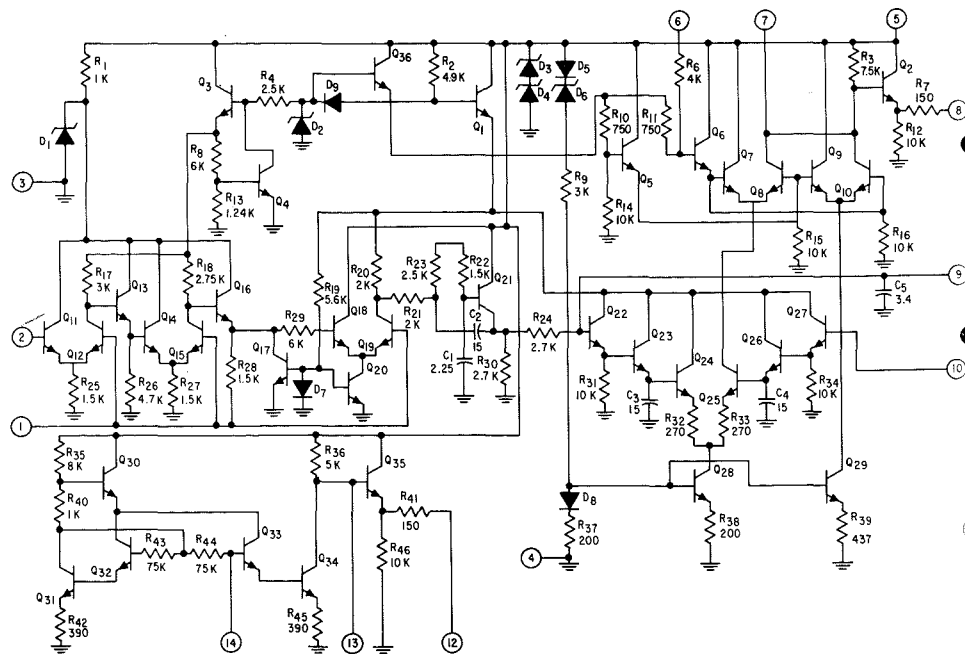

Fig. 1—RCA-CA3065 integrated subsystem (all resistances are in ohms).

(with or without agc), an autodyne converter or self-oscillating mixer, a balanced mixer, or a limiter amplifier, and is also useful in many areas outside of the RF/IF area. The RCA-CA3028A and CA3053 provide similar performance capabilities at a lower price.

What are IF and RF IC's?

With such a wide variety of structures and complexities, it is difficult to define IF and RF IC's. For the three circuits shown in Figs. 1 through 3, the only obvious common feature is the high-frequency communication service for which they are intended.

Examination of the "703" and CA3005 schematic diagrams in Figs. 2 and 3 reveals that no load resistors are used. Load resistors of any kind, and diffused resistors in particular, are deliberately omitted because they are major limiters of bandwidth. Fig. 4 shows interstage network of a direct-coupled amplifier which might be used in an integrated circuit, along with its equivalent circuit. The voltage gain G_V from the base of transistor Q_1 to the base of transistor Q_2 is given by

$$G_V = g_m R_L' \quad (1)$$

where g_m is the transconductance and R_L' equals the parallel combination of R_{out} , R_L , and R_{in} . Because R_{out} is usually much greater than either R_L or R_{in} , R_L' may be expressed as follows:

$$R_L' = \frac{R_L R_{in}}{R_L + R_{in}}$$

For maximum voltage gain, R_L is made much larger than R_{in} , and R_L' is approximately equal to R_{in} . Because the load resistor is in parallel with some capacitance, a low-pass filter is formed at the output. The cut-off frequency f_{co} of this filter is given by

$$f_{co} = [2R_{in}(C_{out} + C_{in})]^{-1} \quad (2)$$

By use of typical values for integrated circuit transistors, cut-off frequency f_{co} is estimated between 5 and 10 MHz, which is satisfactory for IF service. However, the resistors in the circuit are not ideal resistors. The diffused resistor is an integral part of the grounded silicon wafer from which it is isolated by back-biased diodes, as shown in Fig. 5a. Because the back-biased diodes act as capacitors, the resistor functions, in effect, as shown in Fig. 5c and adds considerable high-frequency loss to the circuit. If R_L has a high value to provide high voltage gain, the resistor occupies a large area and its effective capacitance to ground can be as high as 20 pF. Thus, high load-resistance values can reduce

K. M. Kleinman
Linear Integrated Circuit Applications
Solid State Division
Somerville, New Jersey

received the BSEE and MSEE from MIT. He joined RCA in 1957. He is presently responsible for evaluating devices, developing test equipment, establishing test specifications, and preparing technical data for commercial data sheets and application notes for both consumer and non-consumer linear integrated circuits. Mr. Kleinman has been granted three U.S. patents and has published several articles. He has received two RCA Engineering awards. The first was a divisional team award in 1963 for the development of devices and circuits which introduced the era of commercially practical solid-state audio amplifiers. The second was the 1966 David Sarnoff Team Award in Engineering for the development of the first commercial high voltage silicon power transistor.



circuit response to 1.5 to 2 MHz and, consequently, limit performance.

In RF circuits, therefore, load resistors are omitted and, where high gain is required, a multistage amplifier with low-gain stages is used. This approach is demonstrated in the CA3065 shown in Fig. 1, which uses three voltage-gain stages to provide 70 dB of low-frequency gain.

Why use IC's in RF or IF service?

Performance, size, cost, and reliability are the primary reasons for use of IC's. In some systems, particularly in military or aerospace environments, performance must be maintained over a temperature range of -55 to $+125^\circ\text{C}$. The designer of a system using discrete devices can provide any degree of performance in this range by selection of components and by use of compensating devices such as diodes and positive- or negative-temperature-coefficient resistors in the circuit. The user of integrated circuits, however, can select a single device, such as the RCA-CA3002 IF amplifier which includes all the compensation required to provide constant gain over the de-

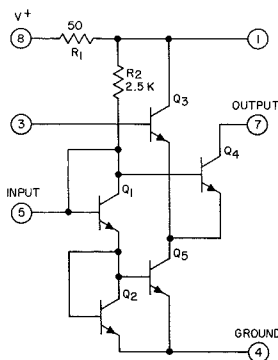

Fig. 2—The "703" basic integrated-circuit IF amplifier.

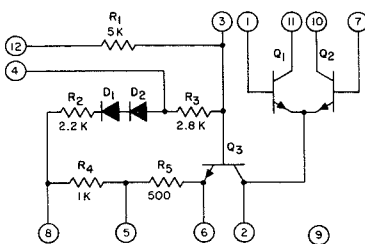

Fig. 3—RCA-CA3005 flexible building block.

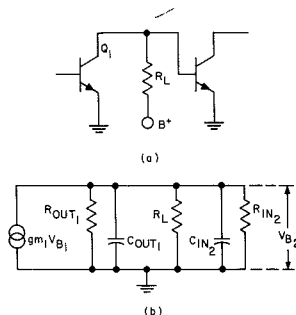

Fig. 4—a) Transistor interstage network and b) its equivalent circuit.

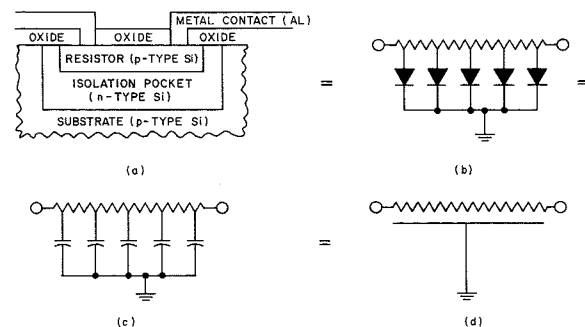

Fig. 5—Integrated-circuit resistor and its equivalents.

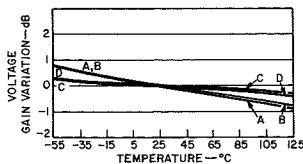

Fig. 6—Gain as a function of temperature for an integrated IF amplifier.

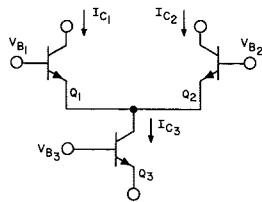

Fig. 7—The IC building block: the differential amplifier with a constant-current transistor.

sired temperature range. Fig. 6 shows the variation in gain with temperature of a CA3002 operated to provide a gain of 27 dB at 1 MHz at 25°C. The change in gain is less than 0.5 dB at either extreme of the temperature range.

For true equipment reliability, repair should also be simple and rapid. The concentration of functions in a few integrated circuits, instead of in a large number of discrete components, makes diagnosis and replacement of a defective component much easier.

The differential amplifier—universal IC building block

Circuit designers have always favored

differential amplifiers for many applications. In LIC's, these amplifiers have become an almost universal component. Fig. 7 shows the basic differential-amplifier configuration. Transistors Q_1 and Q_2 form the differential pair. Transistor Q_3 is usually referred to as the constant-current source. The total current in the circuit is established by adjusting the base voltage V_{B3} and establishing the collector current I_{C3} . The voltages on the bases of transistors Q_1 and Q_2 can then be used to adjust the proportion of collector current I_{C3} flowing in either of the upper transistors. If transistors Q_1 and Q_2 are well matched, I_{C1} will equal I_{C2} when base voltage V_{B1} equals V_{B2} .

Because collector current I_{C2} is proportional to I_{C3} and to the difference between base voltages V_{B1} and V_{B2} , it can be assumed that this circuit can perform subtraction and multiplication, in addition to straight amplification. The circuit can, in fact, perform a wide variety of functions, including operation as an automatic-gain-controlled amplifier, a limiter, a balanced mixer, an autodyne converter, a modulator, and a product detector.

Amplifier characteristics

If a single signal voltage is applied to the base of transistor Q_1 , with the

bases of the other two transistors AC-grounded and the load placed in the collector of Q_3 , the result is the circuit on Fig. 8a. Because the output impedance of the grounded-base transistor Q_3 is high, all of the emitter current in Q_1 flows into the emitter of Q_2 , and the result is a common-collector amplifier driving a common-base amplifier. At fairly low frequencies, the voltage gain G_V is given by

$$G_V = g_m R_L = \frac{I_{C3} R_L}{104} \quad (3)$$

where the collector current I_{C3} is the total current drawn by the stage.

Although this gain is only one-quarter of that available from a single transistor drawing the same current, the limitation is not as it appears. In the first place, the value of R_L is limited by the output impedance of the amplifier stage. Because the output impedance of the common-base transistor Q_2 is several times larger than that of a single common-emitter stage, higher values of R_L are practical.

More important, however, is the reduction in feedback that accompanies this configuration. The maximum stable gain of a tuned amplifier is limited by the capacitive or inductive feedback between input and output.

An approximate formula for the maximum usable power gain (MUG) is given by

$$\text{MUG} = \left(\frac{2g_m}{2\pi f C_{fb}} \right) K \quad (4)$$

where K is a skew, usually assumed to be between 0.2 and 0.4. If the g_m is about 60,000 micromhos, a feedback capacitance of 1-pF will limit MUG to 16 dB at 100 MHz.

The differential configuration can provide a reduction in feedback capacitance C_{fb} of 150 times at low frequencies and thus nearly eliminate this source of gain limitation. Fig. 9 shows the feedback capacitance reduction ratio as a function of frequency for a typical amplifier.

Fig. 8b shows another configuration in which the signal is inserted at the base of transistor Q_3 with the load in the collector of Q_2 . If the bias on transistor Q_1 and Q_2 is set so that Q_1 is OFF ($I_{C1}=0$), the result is a common-emitter amplifier driving a common-base amplifier, or a "cascode" config-

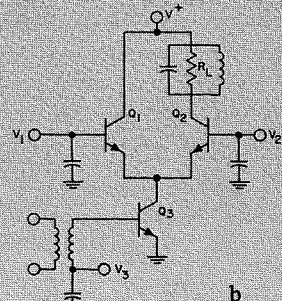
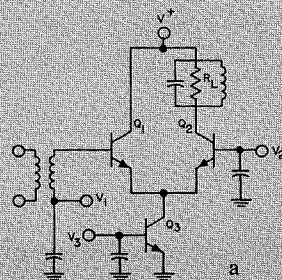

Fig. 8—Tuner-amplifier configurations of the basic differential amplifier.

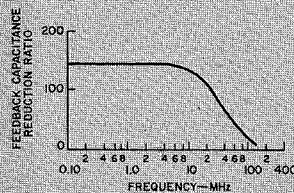

Fig. 9—Reduction in feedback capacitance by use of a differential amplifier.

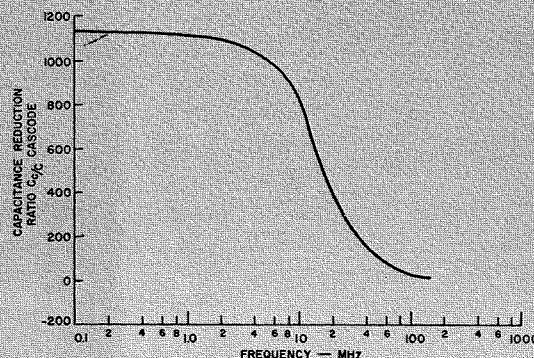

Fig. 10—Reduction in feedback capacitance by use of a cascode amplifier.

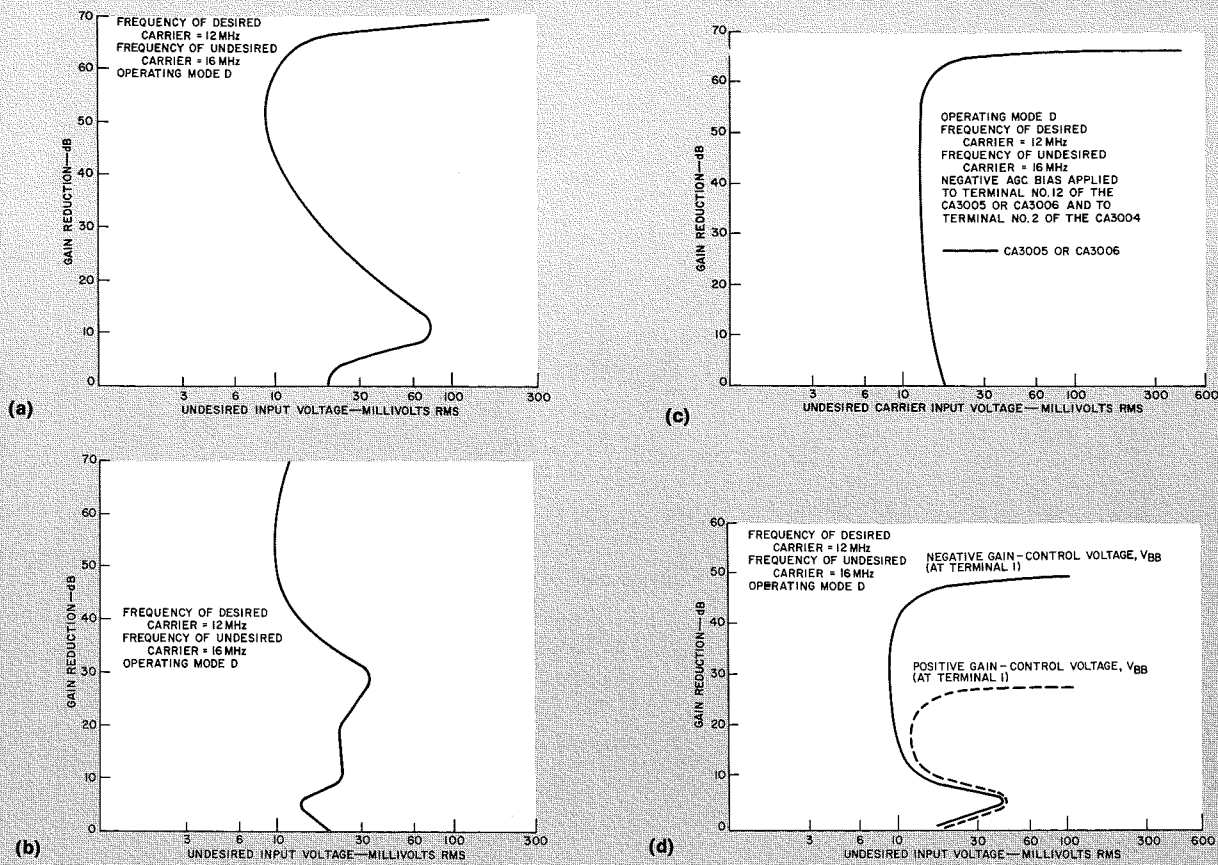

Fig. 11—AGC characteristics of the basic IC amplifiers using CA 3005: a) cascode mode with negative AGC applied to the base of transistor Q_3 ; b) cascode mode with AGC applied to turn on transistor Q_1 ; c) differential amplifier operation with AGC applied to base of Q_3 ; d) forward and reverse AGC.

uration. This configuration provides even better isolation between input and output than the differential mode. As a result, feedback capacitance can be reduced more than 1000 times, as shown in Fig. 10.

Gain and noise figure are important parameters in RF and IF amplifiers. On the other hand, signal-handling capability is also of major significance in all systems. Signal-handling capability may be evaluated from the distortion of a modulated signal or by investigation of the crossmodulation or intermodulation produced when a strong undesired signal and a weak desired signal are present at the amplifier input. Because all of these effects are related, a study of one produces a good picture of the way an amplifier can handle large signals.

The AGC capability is also important in amplifier performance. This capability is related to dynamic range because signal-handling capability is affected by the operating point of the amplifier. The curves shown in Fig. 11 relate the AGC capability and crossmodulation performance of the CA3005 (shown in Fig. 3) at 12 MHz.

Fig. 11 shows the AGC characteristics for both the differential and cascode modes of operation for different methods of AGC. Fig. 11a shows a cascode mode with negative AGC applied to the base of transistor Q_3 . Transistor Q_3 is cut off to reduce the g_m and thereby reducing gain. This curve is similar to that obtained with a single transistor except that more AGC is available because of the reduction in feedback which provides a feed-forward path when AGC is applied.

In Fig. 11b, the amplifier is operated in the cascode mode and AGC is applied to turn on transistor Q_1 (i.e., positive-going voltage is applied to the base of Q_1 or negative-going voltage to the base of Q_2). At maximum gain, all the collector current from transistor Q_3 flows in Q_2 and into the load. As transistor Q_1 turns on, some of the collector current I_{c3} is diverted into Q_1 , and the AC current in the load is reduced. Eventually, all of the current flows in transistor Q_1 and any output signal is the result of stray coupling. Signal handling is not affected much by this type of AGC, because the operating point of transistor Q_3 does not change.

Fig. 11c shows a differential amplifier operation in which AGC is applied to the base of transistor Q_3 . Because Eq. 3 shows that the gain is proportional to collector current I_{c3} , AGC is expected. The shape of the g_m curve with differential input voltage does not change appreciably as transistor Q_3 is cut off; therefore, the signal-handling capability is very uniform until cutoff is reached. This curve applies only when the collector currents I_{c1} and I_{c2} are balanced.

In the differential mode, the crossmodulation characteristics are quite different depending on whether the input transistor Q_1 is turned further ON (forward AGC) or cut off (reverse AGC). Fig. 11d shows forward and reverse AGC, respectively.

Limiter performance

A differential amplifier driven by a constant-current transistor is probably the optimum circuit configuration for bipolar transistor limiters. The advantage of such circuits is that collector saturation of either differential-pair transistor Q_1 or Q_2 can be avoided be-

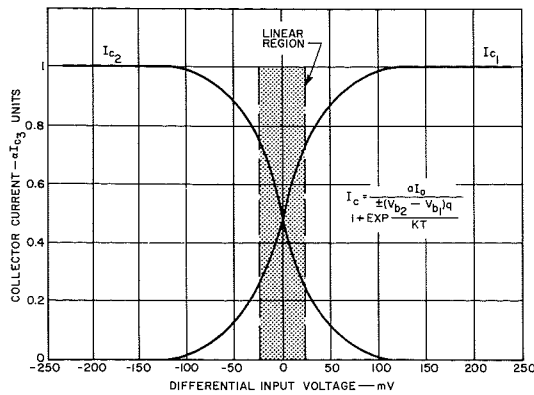

Fig. 12—Limiting characteristic of a differential amplifier.

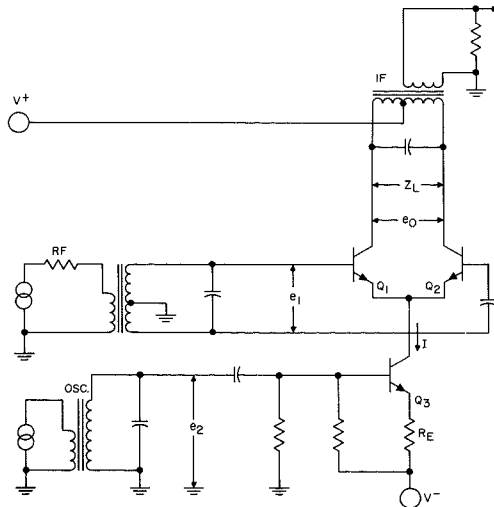

Fig. 13—Typical balanced mixer using an integrated differential amplifier.

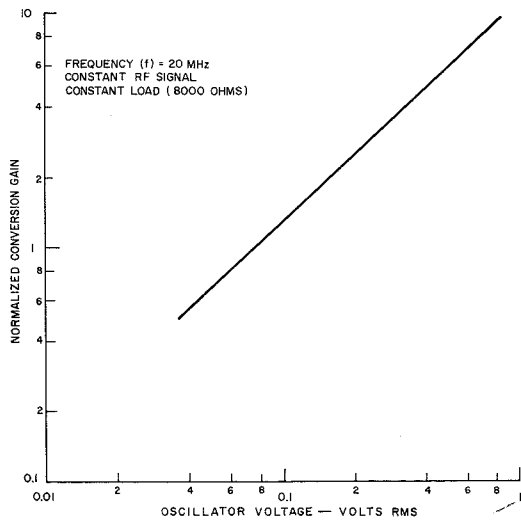

Fig. 14—Conversion gain as a function of oscillator voltage.

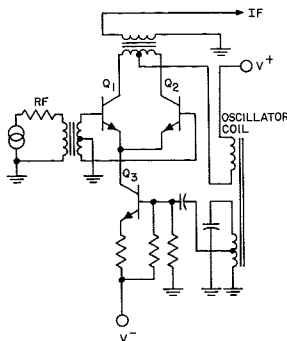

Fig. 15—A self-oscillating mixer (autodyne converter) derived from the mixer of Fig. 13.

cause the peak-to-peak current swing in the output is controlled by the current set by Q_3 . Fig. 12 shows this characteristic. When the peak-to-peak current swing is known, the load resistance can be selected to assure that the collector voltage of transistor Q_2 never swings below the base voltage. With this restricted voltage swing, the output resistance and capacitance of the limiter are reasonably constant, and the tuning characteristics of the load are not degraded.

Mixer capabilities

The differential amplifier is extremely desirable as a mixer as well as an amplifier. In addition, the differential amplifier easily converts to autodyne converter, modulator, or product-detector service.

Fig. 13 illustrates a typical mixer configuration. The oscillator is applied to the base of transistor Q_3 , while the RF signal is applied to the differential pair (either single-ended or balanced drive may be used). The use of a center-tapped load allows the common-mode oscillator signal to be cancelled in the secondary of the load transformer. The DC bias between the bases of transistor Q_1 and Q_2 may be adjusted to cancel the oscillator voltage completely. If this adjustment is made, the circuit may be used as a balanced modulator in which the differential signal is the modulating signal and the signal on transistor Q_3 is the carrier. In the circuit shown, an emitter resistor is included in the emitter of Q_3 to improve the circuit linearity with

respect to the oscillator signal. The more nearly sinusoidal the oscillator current in transistor Q_3 , the better the rejection of spurious responses in the mixer. The balanced nature of the RF portion also helps to reduce the generation of these responses by providing cancellation of even harmonics of the RF signal.

Table I shows the spurious response performance for various incoming frequencies. As the injection level is reduced, the improvement in the spurious-response performance is accompanied by a corresponding reduction in conversion gain which is directly proportional to injection voltage over the range shown in Fig. 14. This circuit will also perform very well in the autodyne converter configuration, as shown in Fig. 15. In this circuit, the current flowing in the oscillator tank circuit is independent of the RF signal because all of the current in the collector of Q_3 must flow to the V_{cc} supply. The circuit, therefore, is not susceptible to the oscillator pulling and blocking which occur in single-transistor autodyne converters.

The universal IC?

The preceding discussion has shown that an IC which encompasses a basic differential amplifier can perform most of the RF and IF functions in a communications receiver. The inclusion of bias components, such as those contained in the CA3005 shown earlier, provides a building block to which the equipment manufacturer need only add tuned circuits and some RF bypass

Table I—Response of CA3005 mixer to spurious harmonics.

Frequency	Signal freq., f_x (MHz)	V_{osc} at term. 3 (rms volts)	Diff.-freq. output (dB) relative to $f_o - f_x$	V_{osc} at term. 5 (rms volts)	Diff.-freq. output (dB) relative to $f_o - f_x$	V_{osc} at term. 5 (rms volts)	Diff. freq. output (dB) relative to $f_o - f_x$
$f_o - f_x$	1.0	1	0	0.7	0	0.3	0
$2f_x - f_o$	1.159	1	-53.1	0.7	-53.1	0.3	-54.9
$2f_o - 2f_x$	1.329	1	-76.1	0.7	—	0.3	—
$2f_o - 2f_o$	1.988	1	-75.5	0.7	—	0.3	—
$2f_o - f_x$	2.659	1	-31.7	0.7	-35	0.3	-39.7
$2f_x - 3f_o$	2.813	1	-79.6	0.7	—	0.3	—
$f_x - 2f_o$	3.977	1	-31.7	0.7	-35	0.3	-39.7
$3f_o - f_x$	4.309	1	-35.8	0.7	-59.3	0.3	-74.7
$f_x - 3f_o$	5.627	1	-38.5	0.7	-57	0.3	-74
$4f_o - f_x$	5.977	1	-38.9	0.7	-63	0.3	—

$f_o = 1.659$ MHz; V_{osc} = oscillator injection voltage.

All blank spaces indicate difference-frequency output more than 80 dB below the $f_o - f_x$ output.

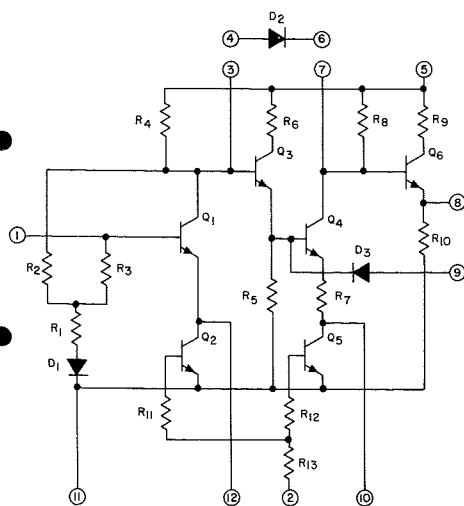

Fig. 16—The RCA-CA3023: a higher level of integration that does not use the differential-amplifier structure.

capacitors to complete a stage. This type of circuit, however, does not represent a very high level of integration and, therefore, is not as economical as more complex structures.

The RCA-CA3076 shown in Fig. 16 represents a higher level of integration and illustrates the building-block nature of the differential amplifier. This wideband limiter amplifier features a voltage gain of 80 dB at 10.7 MHz in a typical circuit. Four differential amplifiers comprise the amplifier. The last stage uses a constant-current transistor Q_{12} to provide optimum limiting, while the other stages require only resistor-current sinks. These stages are coupled by the emitter followers Q_3 , Q_6 , and Q_9 which provide level shifting and impedance matching. The remaining circuitry supplies proper operating voltages for the amplifier and provides needed decoupling to prevent instability which might be caused by coupling in the power supply.

The greatest economic advantage is achieved by integration of a system. One example is the RCA-CA3065 shown in Fig. 17. Designed to operate from the sound take-off at the video detector in a TV receiver, this circuit provides full limiting for input signals above 200 μ V RMS, and can drive a high-voltage output transistor directly. The photograph shown in Fig. 18 illustrates the completeness of the integration. This board contains the entire sound system except for the volume control, output transistor, output transformer, and loudspeaker.

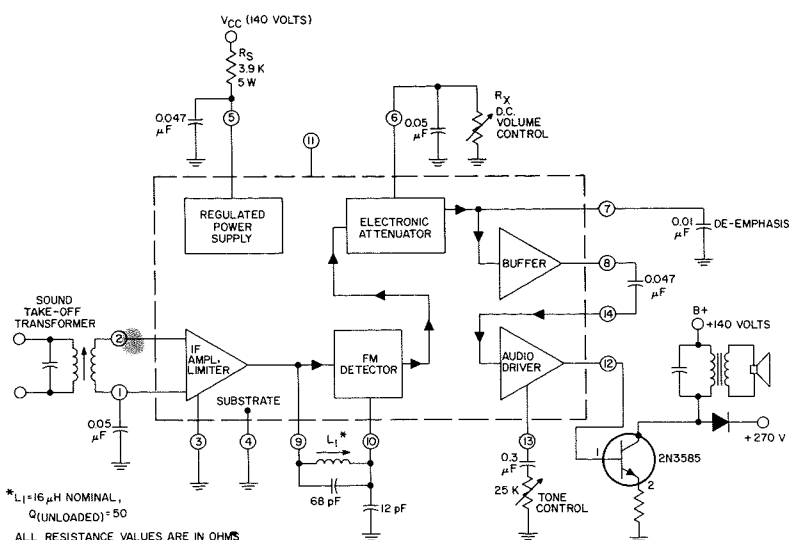

Fig. 17—Schematic of an integrated sound system for a hybrid TV receiver.

What's coming?

The techniques which will provide orders of magnitude of performance improvement in RF and IF IC's are already known. Techniques such as dielectric isolation to replace the P-N junctions that isolate components in conventional monolithic IC's with silicon-oxide layers have been made commercially but are in very limited use. Beam-lead technology promises improvements by use of heavy lead structures so that substrates can be etched away and circuit elements isolated by air. In this case, techniques of handling and supporting these structures must be found. The answer to this problem may be a technique which uses a plastic film as a base on which IC chips are mounted. This film supports the chips during etching and also provides external connections.

However, most RF/IF functions will continue to be provided by conventional monolithic techniques, and new

circuit designs will push performance to much higher levels. A three-stage, all-transistor IC has been designed which provides gain of 43 dB with a 3-dB bandwidth of nearly 400 MHz and a gain stability of ± 0.3 dB over the entire military temperature range.

The MOS field-effect transistors have much better overload and crossmodulation characteristics than bipolar devices. Compatible processes exist today that allow the fabrication of field-effect and bipolar transistors on the same chip. Although these techniques have been used primarily in the operational-amplifier field, where the high input impedance of MOS devices makes them attractive, application of these transistors in RF circuits will follow rapidly.

Reference

1. From *D.A.T.A. BOOK LINEAR INTEGRATED CIRCUITS*, Spring 1970, D.A.T.A., Orange, N.J.

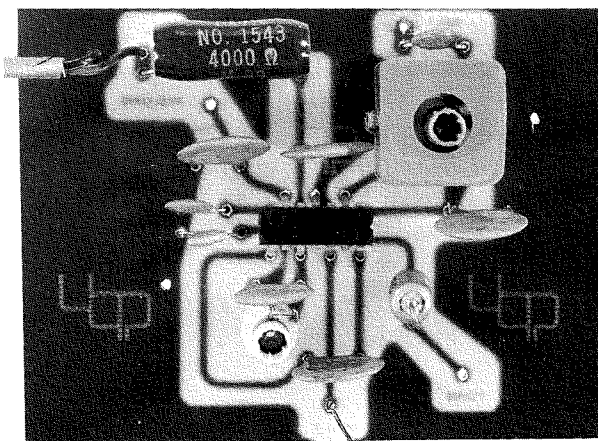
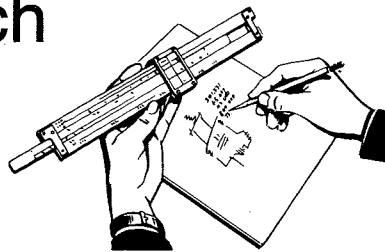

Fig. 18—A complete TV sound system (tube and integrated circuit removed for clarity).

Engineering and Research Notes

Brief Technical Papers
of Current Interest



Estimating failure rates for MSI and LSI integrated circuits

M. S. Plesher
Reliability Engineering
Astro-Electronics Division
Princeton, New Jersey



Reprint RE-16-4-18 | Final manuscript received June 18, 1970.

At present, IC manufacturers calculate failure rates on the basis of total unit-hours of testing and on the total number of failures. Differentiation as to complexity (i.e. chip size, circuit complexity, or number of bonds) is not made. Often because the data generated on a specific device is not sufficient to demonstrate the true failure rate [data limited failure rate], an IC manufacturer or user will often combine data from many different device types. Justification for the combining of data is made on the basis of "structurally similar devices manufactured using identical processes." The failure rate derived from this combined data is then applied to all device types within the family. For example, the same failure rate has previously been used for a dual gate unit, as well as a triple gate and a quad gate within the same family. When a new device is obviously more complex than a previously manufactured device and insufficient reliability testing has been performed on that new device to generate a realistic failure rate, there is no known accepted method for estimating the inherent failure rate, except by performing additional testing and generating more unit-hours of test data on the device itself.

If the data taken on less complex devices is maintained on the basis of specific failure mechanisms and expressed in terms of a *time-weighted-base*, normalized failure rates can be generated and used to estimate a failure rate for a more complex device. The failure mechanism categories proposed are as follows:

1) *Bonds*—Failures involving bonds or bond wires (such as open bonds due to mechanical separation, open bonds due to chemical corrosion, and broken bond wires) shall be considered in this category. The *time-weighted-base* for this category shall be *bond hours*; e.g., a 14-lead monolithic IC tested for 1,000 hrs would generate 28,000 bond-hours of data and a 22-lead monolithic IC tested for 1,000 hrs would generate 44,000 bond-hours of data. The normalized failure rate for this category would be expressed as *bond failures per bond-hour*.

2) *Chip size*—Failures related to chip sizes (such as oxide defects, cracks, and chip-mount failures) shall be considered in this category. The *time-weighted-base* for this category would be *mil²-hours*; e.g., a 50-by-50-mil chip tested for 1000 hrs would generate 2.5 million mil²-hours of data, while a 100-by-100-mil chip tested for 1000 hrs would generate 10 million mil²-hours of data. The normalized failure rate for this category would be expressed as *chip defects per mil²-hour*.

3) *Circuit complexity*—Failures related to circuit complexity (such as open metalization, opens at an oxide cut out or oxide step, and photolithographic and diffusion defects) shall

be considered in this category. The *time-weighted-base* for the category should ultimately be either *active-junctions-hours* or *oxide cut-out hours*. However, for this paper, *gate-hours* is used. The calculation is straightforward: (number of gates) \times (number of test hours) = gate-hours. The normalized failure rate for this category would be expressed in *failures per gate-hour* and eventually in *failures per active-junction-hour* or *failures per oxide-cut-out-hour*.

4) *Constant*—There will naturally be some failures (such as contamination, hermetic seals, and scratches) that will not fall into one of the preceding three categories. This data will not be weighted or normalized and the failure rate will be expressed as *failures per unit-hour*. If the failure rate for this category proves too high, a new category may be indicated.

Sample problem

To demonstrate how this technique might be applied, the following problem is proposed and a solution based on the technique described is offered: a 100-gate equivalent circuit with 8 inputs and 12 out-puts is constructed by the following two methods:

Method I—The 100-gate equivalent circuit is constructed from 25, quad, two-input, COS/MOS gates¹ (4 gates in a single package) and a glass-epoxy printed-circuit board. The quad gate is a standard circuit with a demonstrated failure rate of λ_A failures per hour, is built on a 50-by-50 mil chip and is packaged in a 14 lead package. For this analysis, the failure rate of the PC board and external solder joints are assumed to be much lower than the failure rate of the quad gates and therefore will be neglected.

Method II—The 100-gate equivalent circuit is constructed of a single, custom-designed, 100-gate, MSI, COS/MOS IC. This 100-gate circuit is new, is built on a 100-by-100-mil chip, and is mounted in a 22-lead package (8 inputs, 12 outputs, V_{DD} , and ground). No failure rate for this circuit has been established.

What is the inherent reliability for the 100-gate equivalent circuit constructed by each of the above methods? What is the relative ratio of failure rates, the greater failure rate as compared to the lesser failure rate?

Obviously, the failure rate for the circuit using 25 quad gates would be just 25 times the failure rate of a single quad gate circuit; i.e., $25\lambda_A$ failures per hour. The failure rate for the 100-gate MSI device, however, is not as obvious. The lower limit would be the failure rate of a single quad gate, λ_A . The upper limit is much more difficult to estimate, and may even exceed 25 times the failure rate of a single quad gate; i.e., if the failure rate for each failure category is non-linear.² For this example, and until such time as actual data can be analyzed, the failure rate for each category will assume to be either linear or constant.

Using data from RADC,³ which "is a listing of those predominant integrated circuit failure mechanisms with the percent contribution being an average of what is representative for the industry as a whole" the failure rate for the quad gate (λ_A) was weighted, normalized, and used to estimate the failure rate for the 100-gate MSI circuit. These calculations are shown in Table I.

Failure rate calculations

The solutions to the above problems are as follows:

- 1) The failure rate for construction method I is $25 \lambda_A$ failures per hour.
- 2) The failure rate for method II is rounded to $8 \lambda_A$ failures per hour.
- 3) The ratio of failure rates I:II is approximately 3:1.

Conclusions

The intention of this paper is only to illustrate the principles of weighting and normalizing IC reliability data; it is recog-

nized that the assumptions made will have to be verified by the review and reduction of existing reliability data. Only as existing data is analyzed and reliability data on MSI and LSI data is generated, will the open questions be answered; and only then will the areas which remain vague be defined more clearly such as

- 1) The generation of a more complete definition of failure modes within each failure mechanism category;
- 2) The determination of whether the existing categories are satisfactory or are more categories required;
- 3) The determination of failure rates for each category; and
- 4) The determination of whether failure rates are linear or non-linear within each category.

In addition, the general usefulness of this technique must be explored, applications must be discussed by the users, and standards for data taking must be developed by the IC manufacturers.

References

1. The power dissipation of cos/MOS IC's is so low (typically nW per gate) that the total power dissipation of a 100-gate circuit does not significantly raise the junction temperature above that of a quad gate. Therefore, the effect of power dissipation can be neglected in this example.
2. At this point, no data has been analyzed. Analysis may show that the failure rate within a failure category may actually be non-linear, e.g. the ratio of the bond per bond-hour failure rate between a 56-bond device and a 28-bond device may not be 2.0 but may be 1.8 or 2.5, etc. Likewise the ratio of the chip defects per mil-hour between a 50-by-50 mil device and a 100-by-100 mil device may not be 4.0 but may be 3.8 or 4.5, etc. This non-linearity may be due to a relaxation of inspection criteria to increase yields of complex devices, fatigue of the inspection, learning, thermal dissipation or some other physical phenomenon.
3. O'Connel, E. P., "An Introduction to MIL-STD-883 Test Methods and Procedures for Microelectronics", Rome Air Development Center, Griffiss Air Force Base, N.Y. 13440.

Table I—Failure-rate calculations.

	Quad gate				100-Gate MSI				
	Failure rate mechanism category	Failure rate constituent failures/ hour	Weight	Normalized failure rate Value	Units	Failure rate constituent failures/ hour	Weight	Normalized failure rate Value	Units
Bonds	33%	0.33 λ_A	28 bonds	0.0118 λ_A	bond failures/bond hour	44 bonds	0.5186 λ_A		
Chip size	25%	0.25 λ_A	2,500 mil ²	0.001 λ_A	chip defects/ mil ² -hour	10,000 mil ²	1.000 λ_A		
Circuit complexity	25%	0.25 λ_A	4 gates	0.0625 λ_A	failures/ gate-hour	100 gates	6.250 λ_A		
Constant	17%	0.17 λ_A	N/A	0.1700 λ_A	failures/ device-hour	N/A	0.1700 λ_A		
Totals	N/A	λ_A					7.9386 λ_A		

Drill chuck for a wire-wrap tool

John F. Kingsbury
Graphic Systems Division
Dayton, N.J.

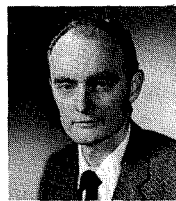

Reprint RE-16-4-18 | Final manuscript received October 14, 1970.

Anyone who has had to modify printed-circuit boards in the field has found that using a high-speed drill often burns the printed circuit board and that slow-speed drills are not always available. This note describes a modified wire-wrap-tool bit and

a modified pin vise that function as a miniature drill chuck for a wire-wrap tool. Wire-wrap tools are readily available in shops, laboratories, and field areas in AC or battery-powered models. When equipped with the converted bit and pin vise, they become useful as a drill. The chuck accommodates miniature drill bits, making the wire-wrap tool especially useful in model shops or field locations for rework and modification of printed circuits or construction of breadboards. Its relatively slow speed of rotation insures no burning of circuit boards.

Fig. 1 shows the drill-chuck accessory separately and as it appears when mounted in a wire-wrap tool. The conversion is easily made as shown in Fig. 2, which illustrates the wire-wrap tool bit, the bit sleeve and pin-vise alterations.

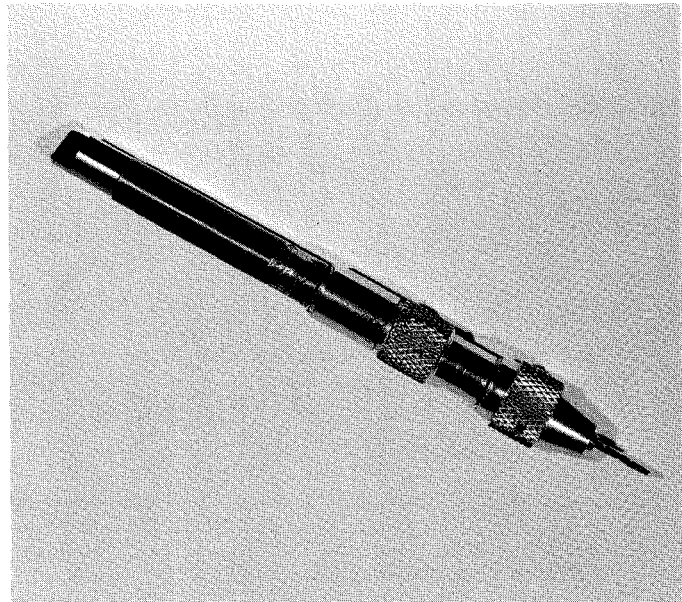
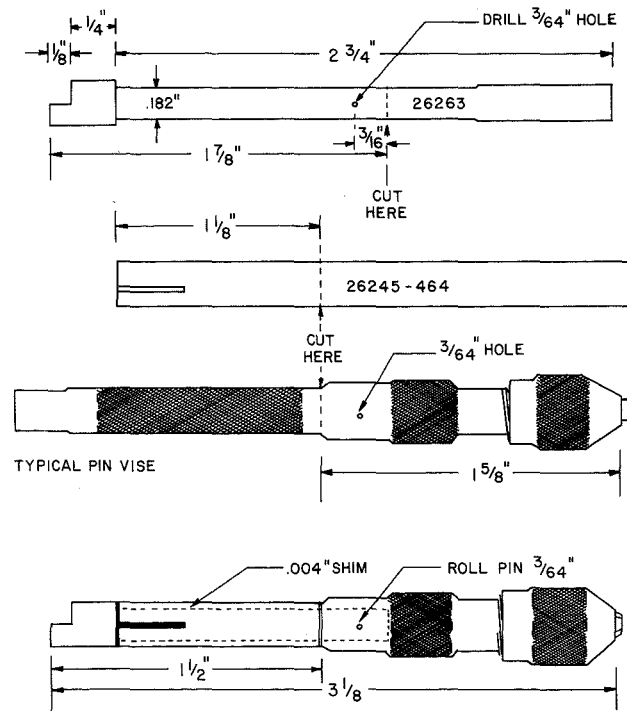
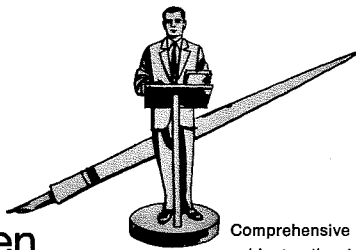

Fig. 1—Drill-chuck accessory for a typical wire-wrap tool.



ASSEMBLED DRILL CHUCK BIT

Fig. 2—Wire-wrap tool drill-chuck accessory; the bit, sleeve, and pin-vise are cut, modified, and assembled to form the wire-wrap drill-chuck accessory.



Pen and Podium

Comprehensive subject-author index to Recent RCA technical papers

Both published papers and verbal presentations are indexed. To obtain a published paper, borrow the journal in which it appears from your library, or write or call the author for a reprint. For information on unpublished verbal presentations, write or call the author. (The author's RCA Division appears parenthetically after his name in the subject-index entry.) For additional assistance in locating RCA technical literature, contact: RCA Staff Technical Publications, Bldg. 2-8, RCA, Camden, N.J. (Ext. PC-4018).

This index is prepared from listings provided bimonthly by RCA Division Technical Publications Administrators and Editorial Representatives—who should be contacted concerning errors or omissions (see inside back cover).

Subject index categories are based upon the Thesaurus of Engineering Terms, Engineers Joint Council, N.Y., 1st Ed., May 1964.

Subject Index

Titles of papers are permuted where necessary to bring significant keyword(s) to the left for easier scanning. Authors' division appears parenthetically after his name.

ACOUSTICS

TRI-WAVE STEREO ACOUSTICS—J. E. Volkmann (Labs, Pr) Mtg. of the Audio Engineering Soc., New York City; 10/15/70

VARIABLE ACOUSTIC STUDIOS, RCA's—J. E. Volkmann (Labs, Pr) Mtg. of the Audio Engineering Soc. New York City; 10/14/70

AIRCRAFT INSTRUMENTS

VOICE WARNING DETECTION Techniques to Helicopter Aids, Application of Army—J. Burnett (EASD, Van Nuys) GOMAC Digest.

AMPLIFICATION

ELECTRON-BEAM INJECTED TRANSISTOR AMPLIFIER (EBIT), Fabrication of an—R. K. Search, M. Freeling, H. J. Wolkstein, S. Ponczak (EC, Harrison) IEEE Conf. on Electron-Device Techniques, New York City; 9/23-24/70

TRAVELING WAVE AMPLIFIER Using Thin Epitaxial GaAs Layer—R. H. Dean, A. B. Dreeben, J. F. Kaminski, A. Triano (Labs, Pr) GOMAC Conf., Ft. Monmouth, New Jersey; 10/6-8/70

PULSE AMPLIFIER, Development of a Monolithic 25-Ampere—V. Organic, R. Wayner, A. Lichowsky (EASD, Van Nuys) Gov. Microcircuits Application Conf.; 10/7/70; Washington, D.C.

CIRCUITS INTEGRATED

Al₂O₃ COS/MOS INTEGRATED CIRCUITS Using Plasma Anodization, Fabrication of—P. E. Norris, C. W. Benyon, J. Shaw (Labs, Pr) GOMAC, Ft. Monmouth, New Jersey; 10/6-8/70

CROSSTALK CHARACTERISTICS of Shielded Wiring and Printed Circuit Track, Comparison of—J. A. Wissner (CSD, Camden) Audio Engineering Soc. New York; 10/13/70

HYBRID CIRCUITS, New Processing Technologies of—J. A. Amick (Labs, Pr) 8th Technical Conv. on Electronic Components; Reggio Calabria, Italy; 9/20-27/70

IC's for Microwaves R. B. Schilling (SSD, Som) Electronics World; 7/70

COMMUNICATION, DIGITAL

MULTI-BIT DELTA MODULATION, Comparison and Design Criteria for—M. Hecht (AED, Pr) Symp. on Picture Coding N. Carolina State Univ.

COMMUNICATIONS COMPONENTS

FMTD DEMODULATOR, A Universal Threshold Extending—M. M. Gerber (CSD, Camden) IEEE Trans. on Communications Technology Vol. COM-18, No. 4; 8/70

OSCILLATORS, High-Power K-Band Silicon Avalanche-Diode—S. G. Liu, J. J. Risko, K. K. N. Chang (Labs, Pr) Proc. of the IEEE; Vol. 58, No. 6; 6/70

OSCILLATOR from L- to C-Band, High-Power Microstrip Avalanche-Diode—S. G. Liu, J. J. Risko (Labs, Pr) IEEE Int'l Electron Devices Mtg., Washington, D.C.; 10/28-30/70

SOLID STATE EXCITER for Amplifier AM Broadcast Transmitters—D. A. Sauer (CSD, Camden) IEEE, Fall Symp., Washington, D.C.; 9/25/70

COMMUNICATIONS SYSTEMS

MOBILE RADIO SYSTEM, A Dynamic Space Division Multiplex—H. Staras, L. Schiff (Labs, Pr) IEEE Trans. on Vehicular Technology; Vol. VT-19, No. 2; 5/70

RADIO RELAY BASEBAND DIVERSITY SYSTEMS, Analysis of—K. Feher (Ltd, Mont) Fifth Biennial Symp. on Communication Theory and Signal Processing; 8/24-26/70; Kingston, Ont.

COMPUTER APPLICATIONS

DIGITAL CONTROL of a CRT Phototype-setting System—S. Racilit (GSD, Dayton) Computer Design; 11/70

COMPUTER STORAGE

COS/MOS PARALLELED PROCESSOR ARRAY—A. Alspa, E. Dingwall (ASD, Bur) IEEE J. of Solid State Circuits; Vol. SC-5, No. 5; 10/70

MOS MEMORY Travels in Fast Bi-Polar Crowd—E. J. Boleky, J. R. Burns, J. E. Meyer, J. H. Scott (Labs, Pr) Electronics; Vol. 32, No. 15; 7/20/70

CONTROL SYSTEMS

CLOSED LOOP DYNAMICS of a Dual-Spin Spacecraft, Linearization of the—K. T. Phillips (AED, Pr) AIAA Guidance and Control Conf.; Conf. Paper Santa Barbara, Calif.

DISPLAYS

ALPHANUMERIC DISPLAY, Two-Color—K. C. Adam (EASD, Van Nuys) Information Display; Vol. 7, No. 7; July/Aug 1970

HOMEFAX: A Consumer Information System—W. D. Houghton (Labs, Pr) Soc. for Motion Picture and Television Engineers, New York City; 10/5-7/70

MATRIX DISPLAY Techniques—B. J. Lechner (Labs, Pr) Information Display Tutorial, Polytechnic Institute of Brooklyn; 9/15/70

STORAGE-DISPLAY TUBES, Recent Developments in Cathodochromic—P. Heyman, I. Gorog, B. Faughnan (Labs, Pr) IEEE Int'l Electron Devices Mtg., Washington, D.C.; 10/28-30/70

DOCUMENTATION

TECHNICAL JOURNALS Look to the Future—D. B. Dobson (ASD, Burl) Soc. of Technical Writers and Publishers Seminar on "The End of Communicating; The Impact of Technology," Boston, Mass.; 10/23/70

ELECTRO-OPTICS

ELECTRO-OPTICAL SYSTEMS Automatic Testing of—R. Welter, A. Berens (ASD, Burl) ASSC Record; 10/70

ENERGY CONVERSION

CONSTANT-TEMPERATURE HEAT PIPES, Experimental Operation of—W. E. Harbaugh, G. Y. Eastman (EC, Linc) Intersociety Energy Conversion Engineering Conf.; Las Vegas, Nevada; 9/21-25/70

HYBRID THERMOCOUPLE Development Program—A Status Report—L. P. Garvey, R. Straight (EC, Harsn) Intersociety Energy Conversion Engineering Conf.; Las Vegas, Nevada; 9/21/25/70

LITHIUM-CONTAINING SOLAR CELLS, Room-Temperature Stability of—T. H. Faith, J. Corra, A. G. Holmes-Siedle (AED, Pr) IEEE Photovoltaic Specialists Conf; Proc. of Conf.; Seattle, Wash.

SILICON-GERMANIUM AIR-VAC CONVERTER Development, Status of—R. E. Berlin (EC, Harsn) Intersociety Energy Conversion Engineering Conf.; Las Vegas, Nevada; 9/21-25/70

SODIUM/NICKEL HEAT PIPES, Development of High-Performance—R. A. Freggens, R. W. Longsdorf (EC, Linc) Intersociety Energy Conversion Engineering Conf.; Las Vegas, Nevada; 9/21-25/70

ENVIRONMENTAL ENGINEERING

PHOTOMULTIPLIER COOLING, Generating Cold Gas for—J. Gerber (Labs, Pr) Review of Scientific Instruments, Vol. 41, No. 7; 7/70

VISCOELASTIC DAMPING to Improve Performance of (Horizontal) Vibration Test Fixture, The Application of—E. J. Setescaak (AED, Pr) 41st Shock and Vibration Symp. Shock and Vibration Bulletin No. 41; 10/27-29/70; USAF Academy; Colorado Springs, Colorado

GEOPHYSICS

SEA SURFACE TEMPERATURE, Passive Microwave Radiometric Measurements of—D. G. Shipley, K. J. Torok (AED, Pr) 1970 IEEE Int'l Conf. on the Ocean Environment; Conf. Digest; Panama City, Fla.

NATURAL ATMOSPHERIC DISTURBANCES—Lightning & Static Electricity—Hill/Spec (RCASVCo, Cherry Hill) Conf. in San Diego, Calif. 9/10-11/70

GRAPHIC ARTS

ELECTROSTATIC COMPUTER PRINTING—D. A. Ross (Labs, Pr) EASCON Annual Conf, Washington, D.C.; 10/26-28/70

GRAPHIC ARTS, Impact of Electronic Composition in the—J. Vragel (GSD, Dayton) STWP/Boston U. Seminar; 10/23/70

HOLOGRAPHY

DIODE LASERS to Recover Holographically Stored Information, Use of—A. H. Firester, M. E. Heller (Labs, Pr) J. of Quantum Electronics, Vol. QE-6, No. 9; 9/70

STORAGE of Holograms in a Ferroelectric-Photoconductor Device—S. A. Keneman, G. W. Taylor, A. Miller, W. H. Fonger (Labs, Pr) Applied Physics Letters; Vol. 17, No. 4; 8/15/70

LABORATORY TECHNIQUES

ANALYZING CERAMIC-METAL SEAL FAILURES, Microscope Techniques for—T. F. Berry (EC, Harsn) IEEE Conf. on Electron-Device Techniques; New York City; 9/23-24/70

ELECTRON BEAM PUMPED Semiconductor Lasers and Other High Excitation, Apparatus for Studying—F. H. Nicoll (Labs, Pr) Review of Scientific Instruments; Vol. 41, No. 8; 8/70

ETCHING of SILICON with Hi-HF Mixtures, Low-Temperature Gaseous—E. R. Levin, J. P. Dismukes, M. D. Coutts (Labs, Pr) 7th Int'l Congress on Electron Microscopy, Grenoble, France; 8/30-9/5/70

INSTRUMENTATION (A Review), Selected Topics in—R. E. Honig (Labs, Pr) Triennial Int'l Conf. on Mass Spectroscopy, Brussels; 9/3/70

LOCAL MAGNETIC FIELDS by Scanning Electron Microscopy, Examination of—M. D. Coutts, E. R. Levin (Labs, Pr) 7th Int'l Congress on Electron Microscopy, Grenoble, France; 8/30-9/5/70

PHONON SPECTROSCOPY Through Spin Lattice Coupling—C. H. Anderson, E. S. Sabisky (Labs, Pr) Colloque Ampere, Bucharest, Romania; 9/1-5/70

LASERS

ARGON LASER Amplifiers and Oscillators, A Comparative Analytical Study of the Performance of—I. Gorog (Labs, Pr) Quantum Electronics Conf.; Kyoto, Japan; 9/7-10/70

CHALCOGENIDE SPINEL Magnetic Semiconductors—K. Miyatani (Labs, Pr) Kotal Butsuri; Vol. 5, No. 4 & 5; 1970

ELECTROLUMINESCENT II-VI Heterojunctions—A. G. Fischer (Labs, Pr) Int'l Conf. on Heterojunctions, Budapest, Hungary; 10/10-17/70

ELECTRON EMISSION FROM GaAs, GaP, AND RELATED COMPOUNDS, Recent Development—B. F. Williams, A. G. Sommer, D. G. Fisher, J. J. Tietjion, R. E. Enstrom, M. S. Abraham (RCA, Labs, Pr) Int'l Symp. on GaAs and Related Compounds; Aachen, Germany; 10/5-7/70

FABRY-PEROT STRUCTURE Al₁Ga_{1-x}As Injection Lasers with Room-Temperature Threshold Current Densities of 2530 A/cm²—H. Kressel, F. Z. Hawrylo (Labs, Pr) Applied Physics Letters, Vol. 17, No. 4; 8/15/70

GaAs INJECTION LASER ARRAYS, High Average Power—P. Nyul, A. Limm (SSD, Som) Electro Optical Systems Design Conf., New York City; 9/22-24/70

He-Cd LASERS Using Re-Circulation Geometry—K. G. Hernqvist (Labs, Pr) Int'l Quantum Electronics Conf., Hyoto, Japan; 9/7-10/70

INFRARED PHOTOCATHODE APPLICATIONS, Vapor Growth of Ga_{1-x}In_x Alloys for—R. E. Enstrom, D. Richman, J. Apper, D. G. Fisher, A. H. Sommer, B. F. Williams (Labs, Pr) Third Int'l Symp. on Gallium Arsenide, Aachen, Germany; 10/5-7/70

INJECTION LASERS, Recent Progress in—R. Glucksmann (SSD, Som) Electro Optical Systems Design Conf; New York City; 9/22-24/70

LUMINESCENT PROPERTIES of GaN—J. I. Pankove, J. E. Berkeyheiser, H. P. Maruska, J. Witke (Labs, Pr) Solid State Communications, Vol. 8; 1970

MAGNETIC CHROMIUM SPINELS, Optical Transitions Between Spin-Polarized Bands in—H. W. Lehman, G. Harbeke (Labs, Pr) Int'l Conf. on Magnetism, Grenoble, France; 9/14-19/70

PHOTOMULTIPLIERS for Laser Detection—A Review of Recent Programs—H. R. Krall (EC, Linc) Third Annual Conf. on Laser Studies of the Atmosphere; Ocho Rios, Jamaica; 9/9-12/70

PHOTOCOMPOSITION SYSTEM, A CRT Graphic—I. Finn (GSD, Dayton) EASCON, 10/27/70; Electrography Session.

PHOTOMULTIPLIERS for Laser Ranging D. E. Perysk (EC, Linc) EOSD Conf.

PHOTOMULTIPLIERS for Laser Ranging—D. E. Perysk (EC, Linc) Electro Optical Systems Design Conf; New York City; 9/22-24/70

PULSED INFRARED SOURCES, Using GaAs Arrays as—W. F. DeVilbiss (SSD, Som) Electro Optical Systems Design Conf.; New York City; 9/22-24/70

RARE-EARTH-DOPED OXYSULFIDES for GaAs-Pumped Luminescent Devices—PN Yocum, J. P. Wittke, I. Ladany (Labs, Pr) AIME Mtg.; New York; 9/2/70

TRANSPORT PROPERTIES of HgCr₂Se₄ at Ferromagnetic Resonance—M. Todd (Labs, Pr) Applied Physics Letters; Vol. 17, No. 1; 7/1/70

VERY LOW THRESHOLD GaAs and Al-GaAs Injection Lasers, Properties of—H. Kressel, F. Z. Hawrylo, H. F. Lockwood (Labs, Pr) IEEE Int'l Electron Devices Mtg.; Washington, D.C.; 10/28-30/70

VISIBLE-LIGHT-EMITTING P-N JUNCTIONS in AlAs, The Preparation of—C. J. Nuese, A. G. Sigai, M. Ettenberg, J. Gannon, S. L. Gilbert (Labs, Pr) Applied Physics Letters; Vol. 17, No. 2; 7/15/70

MANAGEMENT

PROJECT MANAGERS, How to Train—I. Brown (AED, Pr) First Western Space Congress; Proc. Santa Maria, Calif.; 10/27-29/70

MATHEMATICS NONLINEAR KLEIN-GORDON EQUATION, Solutions in the—R. Hirota (Labs, Pr) Physical Soc. of Japan, Tokai Univ., Hiratsuka, Japan; 9/23-27/70

OPTICS

QUANTUM LIMITATION to Vision—A. Rose (Labs, Pr) Soc. for Photographic Scientists and Engineers; Colloquium on Image Amplification, New York City; 5/18/70

QUANTUM LIMITATIONS to Vision—A. Rose (Labs, Pr) Soc. for Photographic Scientists and Engineers Seminar; Los Angeles; 9/17/70

QUANTUM LIMITATIONS to vision at low light levels—A. Rose (Labs, Pr) Image Technology, Vol. 12, No. 4; June/July 1970

TEMPERATURE CONTROLLED Multiple Cavity Narrow Bandpass Special Filter—R. Mark, D. Morand, S. Waldstein (ASD, Burl) Applied Optics; Vol. 9, No. 10 p 2305-2310; 10/70

PLASMA PHYSICS

ANISOTROPIC PLASMA PRESSURE and the Dielectric Sensor—T. W. Johnston (LTD, Mont) J. of Plasma Physics Vol. 4, Pt. 2; 5/70

UPPER HYBRID RESONANCE by Satellites, Detection of the—I. P. Shkarofsky (LTD, Mont) Plasma Waves in Space and in the Laboratory; Vol. 2, Edinburgh Univ. Press; 1970

PROPERTIES, ATOMIC

GROUND STATE ENERGY of Free Excitons in Group IV and II-V Semiconductors, on the—W. Czaja (Labs, Pr) Swiss Physical Soc. Mtg., Basel, Switzerland; 10/16-18/70

PHONON TRANSPORT, The Role of Dispersion and of Relaxation Time Approximation for—R. Klein, R. K. Wehner (Labs, Pr) Swiss Physical Soc. Mtg., Basel, Switzerland; 10/16-18/70

SOFT PHONON MODE and Coupling in Sb₂Se₃ Mode—G. Harbeke, E. F. Steigmeier, R. K. Wehner (Labs, Pr) Swiss Physical Soc. Mtg., Basel, Switzerland; 10/16-18/70

PROPERTIES, MOLECULAR

CHEMICAL DIFFUSION in Al₂O₃, Thin Films Vapor Deposited on Single Crystal Silicon Substrates—M. Schieber, K. H. Zaininger (Labs, Pr) Conf. on Crystal Growth & Epitaxy from Vapor Phase, Zurich, Switzerland; 9/23-26/70

CHROMIUM SULFO-AND SELENO-SPINELS, Crystal Growth and Characterization of—H. von Philipsborn (Labs, Pr) Conf. on Crystal Growth & Epitaxy from the Vapor Phase, Zurich, Switzerland; 9/23-26/70

DEFECT GENERATION in Silicon—D. J. Dumin (Labs, Pr) IBM East Fishkill, Solid State Seminar; 10/16/70

DISSOCIATION of the Eu³⁺ Charge Transfer State into Eu²⁺ and a Free Hole in Y and La Oxysulfides—C. W. Struck, W. H. Fonger (Labs, Pr) Silver Jubilee Symp. on Molecular Structure & Spectroscopy, Ohio State Univ., Columbus, Ohio; 9/8-12/70

EPITAXIAL SEMICONDUCTOR LAYERS, Growth Defects in—E. R. Levin, M. D. Coutts (Labs, Pr) 7th Int'l Congress on Electron Microscopy, Grenoble, France; 9/14-19/70

GALLIUM PHOSPHIDE from Gallium Solution in an Open Flow System, The Growth and Properties of—B. J. Curtis (Labs, Pr) Mtg. of the British Association for Crystal Growth; 9/9-11/70

HETEROEPITAXIAL GERMANIUM AND SILICON, The Interdependence of the Electrical Properties and the Defect Structure in—D. J. Dumin (Labs, Pr) 18th National Symp. of the American Vacuum Soc., Washington, D.C.; 10/20-23/70

LIQUID CRYSTALS: Structure and Properties of Mesomorphic Compounds—J. Castellano (Labs, Pr) Technical Association of Pulp and Paper Industry, Minneapolis, Minnesota; 9/25/70

MONONITRIDES of Sc, Y, and the Rare Earth Elements, Epitaxial Growth in—P. Dismukes, W. M. Yim (Labs, Pr) Conf. on Crystal Growth and Epitaxy from the Vapor Phase, Zurich, Switzerland; 9/23-26/70

STATE OF SURFACE COVERAGE During the Epitaxial Growth of Silicon on Spinell—G. W. Cullen (Labs, Pr) Electrochemical Soc. Mtg., Atlantic City, New Jersey; 10/4-9/70

RF SPUTTERING Processes—J. L. Vossen (Labs, Pr) American Soc. of Metals, 10/16/70

SEMICONDUCTING MONONITRIDES of Sc, Y, and the Rare Earth Elements, Vapor Deposition of—J. P. Dismukes, W. M. Yim, J. J. Tietjen, R. E. Novak (Labs, Pr) Conf. on Crystal Growth and Epitaxy from Vapor Phase, Zurich, Switzerland; 9/23/70

SILICON ON SAPPHIRE AND SPINEL, The Preparation and Properties of Chemically Vapor Deposited—G. W. Cullen (Labs, Pr) Conf. on Crystal Growth & Epitaxy from the Vapor Phase, Zurich, Switzerland; 9/21-25/70

SINGLE-CRYSTAL Bi₂Ti₂O₁₂, The Growth of Large—A. D. Morrison, F. A. Lewis, A. Miller (Labs, Pr) *Ferroelectrics*; Vol. 1, No. 2; 5/70

SINGLE CRYSTAL GROWTH OF CdCr₂-In₂S₄ (x=0-2)—F. Okamoto, T. Oka (Labs, Pr) Physical Soc. of Japan, Tokai Univ., Hiratsuka, Japan; 9/23-27/70

SYSTEM Nb₂Sn₂-Sb₂ and the Density of States Model for—L. J. Velard (Labs, Pr) *J. of the Physics and Chemistry of Solids*; Vol. 31, 1970

THERMAL ANNIHILATION of Stacking Faults in GaAs, Mechanism of—M. S. Abrahams, C. J. Buiochi (Labs, Pr) *J. of Applied Physics*; Vol. 41, No. 6; 5/70

VAPOR-PHASE GROWTH of Several III-V Compound Semiconductors—J. J. Tietjen (Labs, Pr) Annual Mtg. of the American Vacuum Soc., Washington, D.C.; 10/20/70

VAPOR-PHASE GROWTH of Several III-V Compound Semiconductors—J. J. Tietjen (Labs, Pr) Conf. on Crystal Growth and Epitaxy, Zurich, Switzerland; 9/24/70 Cleveland, Ohio; 10/19/70

PROPERTIES, SURFACE

A1₂O₃ FILMS Prepared by Electron Beam Evaporation of Hot Pressed Al₂O₃ in Oxygen Ambient—D. Hoffman, D. Leibowitz (Labs, Pr) 17th National Vacuum Soc. Symp., Washington, D.C.; 10/20-23/70

ELASTIC SURFACE WAVES: Thin-Film Transducers and Layered-System Dispersion—F. Schnitzler, L. Bergstein, L. Strauß (Labs, Pr) *IEEE Trans. on Sonics & Ultrasonics*; Vol. SU-17, No. 3; 7/70

PHONON INTERFERENCE in Thin Films of Liquid Helium—C. H. Anderson, E. S. Sabisky (Labs, Pr) Department of Physics, Univ. of Massachusetts, Amherst, Mass.; 10/2/70

SONIC-FILM BORAM—R. Shahbender, L. Onyskevych, H. Kurlansk (Labs, Pr) GOMAC, Ft. Monmouth, New Jersey; 10/6-8/70

PROPERTIES CHEMICAL

ANHARMONIC CRYSTAL, Adiabatic and Isothermal Elastic Constants of an—R. K. Wehner, R. Klein (Labs, Pr) Swiss Physical Soc. Mtg., Basel, Switzerland; 10/16-18/70

ELECTROLESS NICKEL PLATING BATHS—Properties and Characteristics, New Room Temperature—N. Feldstein (Labs, Pr) Electrochemical Soc., Atlantic City, New Jersey 10/4-9/70

ELECTROLESS NICKEL PLATING BATHS, Potentiometric Analysis of Hypophosphite in—N. Feldstein, T. S. Lancsek, J. A. Amick (Labs, Pr) *Analytical Chemistry*, Vol. 42, No. 8; 7/70

ELECTROLESS PLATING, Anionic Inhibition in—N. Feldstein, P. R. Amodio (Labs, Pr) *J. of the Electrochemical Soc.*, Vol. 117, No. 9; 9/70

ELECTROLYTIC REMOVAL of P-Type GaAs Substrates from Thin, N-Type Semiconductor Layers—C. J. Nuese, J. J. Gannon (Labs, Pr) *J. of the Electrochemical Soc.*; Vol. 117, No. 8; 8/70

SELECTIVE ELECTROLESS PLATING Techniques: A Survey—N. Feldstein (Labs, Pr) *Plating*, August 1970

PROPERTIES ELECTRICAL

CHARGE TRANSPORT in n-Type CdCr₂Se₄ Mixed-Conduction Model for—A. Amith, L. R. Friedman (Labs, Pr) *The Physical Review B*, Vol. 2, No. 2; 7/15/70

HALL MOBILITY and Carrier Concentration in Silicon-on-Sapphire, Temperature Dependence of the—D. J. Dumin, E. C. Ross (Labs, Pr) *J. of Applied Physics*; Vol. 41, No. 7; 6/70

Hg_{1-x}Zn_xCr₂Se₄, Magnetic, Optical, and Electrical Properties of—T. Takahashi, K. Miyatani, K. Minematsu (Labs, Pr) Physical Soc. of Japan, Tokai Univ., Hiratsuka, Japan; 9/23-27/70

RAMAN SCATTERING by Magnons in Rare Earth Metals—M. Inoue (Labs, Pr) *J. of the Physical Soc. of Japan*; Vol. 29, No. 1; 7/70

Si₃N₄-SiO₂ STRUCTURES, Charge Storage Effects in—E. C. Ross (Labs, Pr) Gordon Research Conf., Tilton, New Hampshire; 9/1/70

SILICON-ON-SAPPHIRE, Superlinear Current Density vs Electric Field in p-Type—E. C. Ross, G. Warfield (Labs, Pr) *J. of Applied Physics*; No. 6; 5/70

SINGLE-CRYSTAL Bi₂Ti₂O₁₂, Electrical and Optical Switching Properties of—G. W. Taylor (Labs, Pr) *Ferroelectrics*; Vol. 1, No. 2; 5/70

PROPERTIES, MAGNETIC

Ag-In DOPED CdCr₂Se₄, Magnetic Field Effects on—M. Toda, S. Tosima (Labs, Pr) Physical Soc. of Japan, Tokai Univ., Hiratsuka, Japan; 9/23-27/70

HEXAGONAL CHROMIUM CHALCOGENIDES MCr₂X₄ (M=Fe, Pb, Eu, and Dr; X=S and Se), Magnetic Properties of—K. Miyatani, F. Okamoto, Y. Wada, M. Kojima, T. Harada (Labs, Pr) Physical Soc. of Japan, Tokai Univ., Hiratsuka, Japan; 9/23-27/70

HEXAGONAL PbCr₂S₄ STRUCTURE, Magnetic Semiconductor Properties of Compounds Having the—F. Okamoto (Labs, Pr) Int'l Conf., on Magnetism, Grenoble, France; 9/14-19/70

Hg_{1-x}Zn_xCr₂Se₄, Magnetic, Optical, and Electrical Properties of—T. Takahashi, K. Miyatani, K. Minematsu (Labs, Pr) Physical Soc. of Japan, Tokai Univ., Hiratsuka, Japan; 9/23-27/70

HgCr₂Se₄, Magnetic Semiconductor Properties of—K. Miyatani, K. Minematsu, T. Takahashi, P. K. Baltzer (Labs, Pr) Int'l Conf. on Magnetism, Grenoble, France; 9/14-19/70

MAGNETIC PHASE TRANSITIONS—K. Miyatani (Labs, Pr) Symp. on Phase Transitions of Materials, Meguroku, Tokyo, Japan; 10/29-30/70

PROPERTIES, OPTICAL

CdCr₂Se₄, Optical Properties of—K. Miyatani, S. Osaka, F. Okamoto (Labs, Pr) Physical Soc. of Japan Mtg., Tokyo, Japan; 10/1-3/70

FERROMAGNETIC CdCr₂Se₄, Photoconductivity in—S. B. Berger, A. Amith (Labs, Pr) Int'l Conf. on Magnetism, Grenoble, France; 9/14-19/70

HgCr₂Se₄, Optical Properties of—K. Miyatani, S. Osaka, T. Takahashi (Labs, Pr) Mtg. of the Physical Soc. of Japan, Tokai Univ., Hiratsuka, Japan; 9/23-27/70

Hg_{1-x}Zn_xCr₂Se₄, Magnetic, Optical, and Electrical Properties of—T. Takahashi, K. Miyatani, K. Minematsu (Labs, Pr) Physical Soc. of Japan, Tokai Univ., Hiratsuka, Japan; 9/23-27/70

MAGNETIC CHROMIUM SPINELS, Optical Transitions Between Spin-Polarized Bands in—H. W. Lehmann, G. Harbecke, H. Pinch (Labs, Pr) Swiss Physical Soc. Mtg., Basel, Switzerland; 10/16-18/70

OPTICAL ABSORPTION of GaN—J. I. Pankove, H. P. Maruska, J. E. Berkeyheiser (Labs, Pr) *Applied Physics Letters*, Vol. 17, No. 5; 9/1/70

SINGLE-CRYSTAL Bi₂Ti₂O₁₂, Electrical and Optical Switching Properties of—G. W. Taylor (Labs, Pr) *Ferroelectrics*; Vol. 1, No. 2; 5/70

RADAR

CHIRP RADAR SYSTEMS, Sidelobe Suppression in—S. Honickman (Labs, Pr) URSI Mtg., Ohio State Univ., 9/15-17/70

RADIATION EFFECTS

A1₂O₃ COS/MOS, Long-Term Radiation Effects in—F. Micheliotti, F. Kolondra (Labs, Pr) GOMAC, Ft. Monmouth, New Jersey; 10/6-8/70

ANNEALING of Electron Bombardment Damage in Lithium-Containing Silicon—G. J. Brucker (AED, Pr) 1970 IEEE Conf. on Nuclear and Space Radiation Effects; *IEEE Trans. on Nuclear Science*; San Diego, Calif.

CMOS LOGIC NETWORKS, Long-Term Effects of Radiation on—A. G. Holmes-Siedle, W. J. Poch, (AED, Pr) 1970 IEEE Conf. on Nuclear and Space Radiation Effects; *IEEE Trans. on Nuclear Science*; San Diego, Calif.

HARDENING SILICON SOLAR CELLS Against the Radiation Environment, Recent Advances in—M. Wolf, G. Brucker (AED, Pr) 1970 IE CEC; Las Vegas, Nevada

INSULATOR FILMS, Radiation Effects in—K. H. Zaininger (Labs, Pr) Gordon Research Conf., Tilton, New Hampshire; 9/1/70

RECORDING

PRODUCING UNPLAYABLE TAPES, The Complete Art of—R. N. Hurst (CSD, Camden) Videotape Producers Assoc.; New York

SPACECRAFT TAPE RECORDER, Long Life—R. Miller, R. J. Treadwell (AED, Pr) EASCON; Washington, D.C.; 10/26-28/70

RECORDING, AUDIO

MODULAR AUDIO CONSOLE for Broadcasting and Recording, The Design of a New—W. F. Hanway (CSD, Camden) Audio Engineering Soc.; New York 10/13/70

RELIABILITY

HOMEFAX: A Consumer Information System—W. D. Houghton (Labs, Pr) Soc. for Motion Picture and Television Engineers, New York City; 10/5-7/70

SELF-SCANNED IMAGE SENSORS Based upon Buckner-Brigade Scanning—M. G. Kovac, P. K. Weimer, F. V. Shallock, W. S. Pike (Labs, Pr) IEEE Int'l Electron Devices Mtg., Washington, D.C.; 10/29-30/70

RELIABILITY

GENERALIZED MIL-STD-499 PROGRAM, An Evaluation of a—A. C. Spear (ASD, Burl) Conf. on Quality Control Statistics in Industry; Rutgers Univ.; New Brunswick, N.J.; 9/12/70

PRODUCT ASSURANCE ACTIVITY—A Program Office Viewpoint, Life Cycle of—V. R. Monshaw (AED, Pr) 8th Conf. on New Horizons in Reliability and Quality; Harpur College, Binghamton, N.Y.; 10/24/70

SOLID-STATE DEVICES

ADAPTIVE FERROELECTRIC TRANSFORMER—A Solid-State Analog Memory Device—J. H. McCusker, S. S. Perlman (Labs, Pr) IEEE Trans on Electron Devices, Vol. ED-17, No. 7; 7/70

EPITAXIAL SILICON on Low Aluminum-Rich Spinell, MOS and Vertical Junction Device Characteristics—K. H. Zaininger, C. C. Wang (Labs, Pr) *Solid-State Electronics*; Vol. 13, 1970

GUNN DEVICES—F. Sterzer (Labs, Pr) Conf. on New Microwave Components; Stockholm Sweden; 9/14-16/70

MICROWAVE Power Transistors—H. C. Lee (SSD, Som) Univ. of Michigan Short Course; 8/10/70

MOS TRANSISTORS on Insulating Substrates, The Effective Mobility of—E. J. Boley (Labs, Pr) IEEE Int'l Electron Devices Mtg., Washington, D.C.; 10/28-30/70

POWER SWITCHING, Solid-State—G. D. Hanchett (SSD, Som) Hudson Division Convention of American Radio Relay League, Tarrytown, N.Y.; 10/17-18/70

SILICON DEVICES, Refractory Metal Systems for—J. A. Amick (Labs, Pr) Materials Engineering Congress and Exposition, American Soc. of Metals, Cleveland, Ohio; 10/12/70

THYRISTORS for Power Switching Applications—J. Yellin (SSD, Som) RCA Distributor Seminars; 9/15-17/70

SPACE COMMUNICATION

SIGNAL PROCESSING TECHNIQUE to Reduce Transmission Bandwidth Requirement—F. J. Blaciewicz (AED, Pr) First Western Space Congress; Proc; Santa Maria, Calif.; 10/27-29/70

TRIANGULATION THEORY, A Colligation of—C. A. Johnson (RCA SvCo, Cherry Hill) Institute of Navigation

SPACE NAVIGATION

ITOS-1, Earth Oriented Satellite—W. J. Haneman (AED, Pr) First Western Space Congress; Proc; Santa Maria, Calif.; 10/27-29/70

ITOS-1 (TIROS M) Design and Orbital Performance—A. Schnapl (AED, Pr) 21st Congress of the Int'l Astronautical Federation; Constance (German Federal Republic) 10/4-10/70

TIROS/ESSA/ITOS Spacecraft to Launch Vehicle Compatibility—H. Van Elkan (AED, Pr) First Western Space Congress; Santa Maria, Calif.; 10/27-29/70

WEATHER SATELLITE for the Radiation Environment—A Case History, The Design of—A. G. Holmes-Siedle, W. J. Poch (AED, Pr) British Interplanetary Main Conf. 1; London, England

TELEVISION BROADCASTING

TELEVISION Today and Yesterday—V. K. Zworykin (Labs, Pr) Institute of Television Engineers of Japan, Tokyo, Japan; 10/9/70

TV TRANSMITTER RF DEMODULATORS and the Home Receiver, Performance Comparison of—W. L. Behrend (CSD, Camden) IEEE, Fall Symp., Washington, D.C.; 9/25/70

TELEVISION EQUIPMENT

LOW LIGHT LEVEL TELEVISION Techniques—R. J. Gilda (ASD, Burl) *Applied Optics*; Vol. 9, No. 10; 10/70

TV IMAGE STABILIZATION, Open Loop—J. W. Dubbury (ASD, Burl) *IEEE Reflector*; 10/70

TRANSMISSION LINES

FIELD DISTRIBUTION in a Waveguide Loaded with a Thin Slab of InSb—K. Suzuki, R. Hirota (Labs, Pr) *Proc. of the IEEE*; Vol. 58, No. 6; 6/70

TUBES, ELECTRON

IMAGE ISOCON, The New—E. M. Muselman (EC, Linc) Univ. of Rhode Island Summer Program; 8/12/70

RCA IMAGE INTENSIFIERS, Recent Advancements in—R. G. Stoudenmire (SSD, Som) Laser Industry Assoc. Annual Conf., New York City; 9/22-24/70

SILICON INTENSIFIER TARGET (SIT) Camera Tubes, Low Light Level Performance of—R. L. Rodgers (EC, Linc) EOSD, Conf.

STORAGE-DISPLAY TUBES, Recent Developments in Cathodochromic—P. Heyman, I. Gorog, B. Faughnan (Labs, Pr) IEEE Int'l Electron Devices Mtg., Washington, D.C.; 10/28-30/70

THERMAL CURRENT FILAMENT Formed from a Uniformly Avalanche Junction, The Time Development of a—R. A. Sunshine (Labs, Pr) IEEE International Electron Devices Mtg., Washington, D.C.; 10/28-30/70

TUBE COMPONENTS

AD-CONDUCTOR CATHODE—K. G. Hornqvist (Labs, Pr) IEEE Conf. on Electron Devices, New York City; 9/23-24/70

CERAMIC-METAL SEALS for Traveling-Wave Tubes, High-Reliability Ruggedized—T. F. Berry, F. B. Skrobinski (EC, Harsn) IEEE Conf. on Electron-Device Techniques; New York City; 9/23-24/70

Author Index

Subject listed opposite each author's name indicates where complete citation to his paper may be found in the subject index. An author may have more than one paper for each subject category.

ASTRO-ELECTRONICS DIVISION

Balcewicz, J. F. space communication
Board, J. E. space navigation
Brown, I. management
Brucker, G. J. radiation effects
Brucker, G. J. radiation effects
Corra, J. energy conversion
Faith, T. J. energy conversion
Hecht, M. communication, digital
Holmes-Siedle, A. G. spacecraft
Holmes-Siedle, A. G. radiation effects
Holmes-Siedle, A. G. energy conversion
Miller, B. P. spacecraft
Miller, R. recording
Moshaw, V. R. reliability
Phillips, K. T. control systems
Poch, W. J. spacecraft
Poch, W. J. radiation effects
Schnapf, A. spacecraft
Setescak, E. J. environmental engineering
Shipley, D. G. geophysics
Torok, K. J. geophysics
Treadwell, R. J. recording
Van Elkan, H. spacecraft

AEROSPACE SYSTEMS DIVISION

Alaspa, A. computer storage
Berens, A. electro-optics
Dingwall, E. computer storage
Dobson, D. B. documentation
Dubbury, J. television equipment
Gildea, R. J. television equipment
Mark, R. optics
Morand, D. optics
Spear, A. C. reliability
Waldstein, S. optics
Welter, R. electro-optics

COMMUNICATIONS SYSTEMS DIVISION

Behrend, W. L. television broadcasting
Gerber, N. M. communications components
Hanaway, W. F. recording audio
Hurst, R. N. recording
Sauer, D. A. communications components
Wissner, J. A. circuits integrated

ELECTROMAGNETIC AVIATION SYSTEMS DIVISION

Adam, K. C. displays

Burnett, J. aircraft instruments
Lichowsky, A. amplification
Organic, V. amplification
Wayne, R. amplification

ELECTRONIC COMPONENTS

Berlin, R. E. energy conversion
Berry, T. F. laboratory techniques
Berry, T. F. tube components
Eastman, G. Y. energy conversion
Freeling, M. amplification
Freggens, R. A. energy conversion
Garvey, L. P. energy conversion
Harbaugh, W. E. energy conversion
Helvy, F. A. tube components
Krall, H. R. lasers
Lewis, T. tube components
Longsdorf, R. W. energy conversion
Muselman, E. M. tubes, electron
Pearce, R. K. tube components
Pearce, R. K. amplification
Perysk, D. E. lasers
Perysk, D. E. lasers
Ponczak, S. amplification
Rodgers, R. L. tubes, electron
Sikora, R. tube components
Skrobinski, F. B. tube components
Straight, R. energy conversion
Wolkstein, H. J. amplification

GRAPHIC SYSTEMS DIVISION

Finn, I. graphic arts
Raciti, S. computer applications
Vragel, J. graphic arts

LABORATORIES

Abrahams, M. S. lasers
Abrahams, M. S. properties, molecular
Amick, J. A. circuits integrated
Amick, J. A. properties, chemical
Amick, J. A. solid-state devices
Amith, A. properties, optical
Amith, A. properties, electrical
Amodio, P. R. properties, chemical
Anderson, C. H. laboratory techniques
Anderson, C. H. properties, surface
Apper, J. lasers
Baltzer, P. K. properties, magnetic
Benyon, C. W. circuits integrated
Berger, S. B. properties, optical
Bergstein, L. properties, surface
Berkeyheiser, J. E. lasers
Berkeyheiser, J. E. properties, optical
Bolek, E. J. solid-state devices
Bolek, E. J. computer storage
Bulocchi, C. J. properties, molecular
Burns, J. R. computer storage
Castellano, J. A. properties, molecular
Chang, K. K. N. communications components
Coutts, M. D. laboratory techniques
Coutts, M. D. properties, molecular
Cullen, G. W. properties, molecular
Curtis, B. J. properties, molecular
Czaja, W. properties, atomic
Dean, R. H. amplification
Dimskues, J. P. laboratory techniques
Dimskues, J. P. properties, molecular
Dimskues, J. P. properties, molecular
Dreeben, A. B. amplification
Dumin, D. J. properties, electrical
Dumin, D. J. properties, molecular
Dumin, D. J. properties, molecular
Enstrom, R. E. lasers
Eltenberg, M. lasers
Faughnan, B. displays
Faughnan, B. tubes, electron
Feldstein, N. properties, chemical
Firester, A. H. holography
Firester, A. H. G. lasers
Fischer, D. G. lasers
Fong, W. H. holography
Fong, W. H. properties, molecular
Friedman, L. R. properties, electrical
Gannon, J. J. properties, chemical
Gannon, J. J. lasers
Gilbert, S. L. lasers
Gerber, J. environmental engineering
Gorog, I. displays
Gorog, I. tubes, electron
Gorog, I. lasers
Harada, T. properties, magnetic
Harbeke, G. properties, optical
Harbeke, G. properties, atomic
Harbeke, G. lasers
Hawrylo, F. Z. lasers
Heller, M. E. holography
Hernqvist, K. G. tube components
Hernqvist, K. G. lasers
Heyman, P. displays
Heyman, P. tubes, electron
Hirota, R. transmission lines
Hirota, R. mathematics
Hoffman, D. properties, surface
Honickman, S. radar
Honig, R. E. laboratory techniques
Houghton, W. D. displays
Houghton, W. D. recording, image
Inoue, M. properties, electrical
Kaminski, J. F. amplification
Klein, R. properties, atomic
Klein, R. properties, chemical
Kohn, E. S. tube components
Kojima, M. properties, magnetic
Kolondra, F. radiation effects
Kovac, M. G. recording, image
Kressel, H. tube components
Kressel, H. lasers
Kurlansik, H. properties, surface
Ladany, I. lasers
Lancsek, T. S. properties, chemical

Lechner, B. J. displays
Lehmann, H. W. properties, optical
Lehman, H. W. lasers
Leibowitz, D. properties, surface
Levin, E. R. laboratory techniques
Levin, E. R. laboratory techniques
Levin, E. R. properties, molecular
Lewis, F. A. properties, molecular
Liu, S. G. communications components
Lockwood, H. F. lasers
Lukas, H. P. properties, optical
Maruska, L. P. lasers
McCusker, J. H. solid-state devices
Meyer, J. E. computer storage
Micheletti, F. radiation effects
Miller, A. holography
Miller, A. properties, molecular
Miyatani, K. properties, magnetic
Miyatani, K. properties, electrical
Miyatani, K. properties, magnetic
Miyatani, K. properties, optical
Miyatani, K. properties, optical
Miyatani, K. lasers
Minematsu, K. properties, electrical
Minematsu, K. properties, magnetic
Minematsu, K. properties, optical
Morrison, A. D. properties, molecular
Nelson, H. tube components
Nicoll, F. H. laboratory techniques
Norris, P. E. circuits integrated
Novak, R. E. properties, molecular
Nusse, C. J. lasers
Nusse, C. J. properties, chemical
Oka, T. properties, molecular
Okamoto, F. properties, molecular
Okamoto, F. properties, magnetic
Osaka, S. properties, optical
Pankove, J. I. properties, optical
Pankove, J. I. lasers
Perlman, S. S. solid-state devices
Pike, W. S. recording, image
Pinch, H. properties, optical
Rajchman, J. A. general technology
Richman, D. lasers
Risko, J. J. communications components
Risko, J. J. communications components
Rose, A. optics
Rose, A. optics
Rose, A. optics
Ross, D. A. graphic arts
Ross, E. C. properties, electrical
Sabisky, E. S. properties, surface
Sabisky, E. S. laboratory techniques
Schieber, M. properties, molecular
Schiff, L. communications systems
Schmitzler, P. properties, surface
Scott, J. H. computer storage
Shabbender, R. properties, surface
Shaw, J. circuits integrated
Shallcross, F. V. recording, image
Signal, A. G. lasers
Sommer, A. H. lasers

Staras, H. communications systems
Steigmeier, E. F. properties, atomic
Sterzer, F. solid-state devices
Struss, L. properties, surface
Struck, C. W. properties, molecular
Sunshine, R. A. tubes, electron
Suzuki, K. transmission lines
Takahashi, T. properties, optical
Takahashi, T. properties, optical
Takahashi, T. properties, magnetic
Taylor, G. W. holography
Taylor, G. W. properties, electrical
Taylor, G. W. properties, optical
Tietjen, J. J. properties, molecular
Tietjen, J. J. tube components
Tietjen, J. J. properties, molecular
Tietjen, J. J. properties, molecular
Toda, M. lasers
Toda, M. properties, magnetic
Tosima, S. properties, magnetic
Triano, A. amplification
Vieland, L. J. properties, molecular
Volkmann, J. E. acoustics
von Philipsborn, H. properties, molecular
Vossen, J. L. properties, molecular
Wada, Y. properties, magnetic
Wang, C. C. solid-state devices
Warfield, G. properties, electrical
Wehner, R. K. properties, chemical
Wehner, R. K. properties, atomic
Williams, B. F. lasers
Wilke, J. P. lasers
Yim, W. M. properties, molecular
Yocom, P. N. lasers
Zaininger, K. H. radiation effects
Zaininger, K. H. solid-state devices
Zworykin, V. K. television broadcasting

LIMITED, MONTREAL

Fehér, K. communications systems
Johnston, T. W. plasma physics
Shkarofsky, I. P. plasma physics

SERVICE COMPANY

Hill geophysics
Johnson, C. C. space communication
Spec geophysics

SOLID STATE DIVISION

DeVilbiss, W. F. lasers
Glocksman, R. lasers
Hanchett, G. D. solid-state devices
Lee, H. C. solid-state devices
Limm, A. lasers
Nyul, P. lasers
Schilling, R. B. circuits integrated
Stoudenhoffer, R. G. tubes, electron
Yellin, J. solid-state devices

Patents Granted

to RCA Engineers

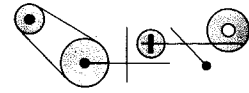

As reported by RCA Domestic Patents, Princeton

AEROSPACE SYSTEMS DIVISION

Use in an Automatic Testing System of a Simulator of an Article Being Tested for Testing the Testing System—H. W. Silberman (ASD, Burl) U.S. Pat. 3,541,440; November 17, 1970

Apparatus for Measuring Low Voltages and Currents with Amplifier Protective Means—E. Sarkisian, N. J. Amdur (ASD, Burl) U.S. Pat. 3,541,462; November 17, 1970

ASTRO-ELECTRONICS DIVISION

Satellite Communications Systems—S. Gubin (AED, Htsn) U.S. Pat. 3,541,553; November 3, 1970

Digital Spectral Line Identifier—W. W. Lee (AED, Htsn) U.S. Pat. 3,531,207; September 29, 1970

Electronic Shutter—A. D. Cope (AED, Htsn) U.S. Pat. 3,525,806; August 25, 1970

ELECTROMAGNETIC AND AVIATION SYSTEMS DIVISION

Integrated Power Output Circuit—A. Lichowsky (EASD, Van Nuys) U.S. Pat. 3,544,860; December 1, 1970

Momentary Retaining Translation Means for Multiple Switches—K. C. Gaspar (EASD, Van Nuys) U.S. Pat. 3,544,738; December 1, 1970

Magnetic "Pen" for a Graphic Tablet—L. A. Jones, R. B. Goyer (EASD, Van Nuys) U.S. Pat. 3,532,817; October 6, 1970

Electromechanical Coupling—J. C. Meagher (EASD, Van Nuys) U.S. Pat. 3,542,284; November 24, 1970

CONSUMER ELECTRONICS

Keying Circuit—J. M. Kresock, T. W. Burrus (CE, Indpls) U.S. Pat. 3,541,235; November 17, 1970

Automatic Beam Current Limiting Using Reference Current Sources—E. W. Curtis (CE, Indpls) U.S. Pat. 3,541,240; November 17, 1970

Circuit for Eliminating Spurious Modulation of the Subcarrier Frequency Oscillator in a Color Television Receiver—L. A. Cochran (CE, Indpls) U.S. Pat. 3,541,241; November 17, 1970

Lock-On Prevention in Transistor Deflection Circuits—J. A. McDonald, T. J. Christopher (CE, Indpls) U.S. Pat. 3,544,811; December 1, 1970

Spurious Oscillation Suppression in Transistor Deflection Circuits—J. A. McDonald, T. J. Christopher (CE, Indpls) U.S. Pat. 3,544,810; December 1, 1970

Color Television Receiver—D. H. Willis (CE, Indpls) U.S. Pat. 3,535,437; October 20, 1970

Noise Immune Video Circuits—J. N. Pratt, G. E. Anderson (CE, Indpls) U.S. Pat. 3,535,444; October 20, 1970

Capstan and Flywheel Arrangement for Magnetic Tape Transport—D. R. Andrews (CE, Indpls) U.S. Pat. 3,537,332; November 3, 1970

Television Tuner Cast Housing with Integrally Cast Transmission Lines—R. D. Brand (CE, Indpls) U.S. Pat. 3,538,466; November 3, 1970

Magnetic Tape Cassette Player Apparatus—C. E. Rose (CE, Indpls) U.S. Pat. 3,532,293; October 8, 1970

Video Recording and Reproducing Apparatus Utilizing a Single Track on a Magnetic Tape for the Luminance and Color Information Components of a Color Television Signal—H. R. Warren (CE, Indpls) U.S. Pat. 3,542,946; November 24, 1970

ELECTRONIC COMPONENTS

Ion Bombardment of Insulated Gate Semiconductor Devices—T. G. Athanas, D. M. Griswold (EC, Som) U.S. Pat. 3,540,925; November 17, 1970

Video Circuits Employing Cascoded Combinations of Field Effect Transistors with High Voltage, Low Bandwidth Bipolar Transistors—W. M. Austin (EC, Som) U.S. Pat. 3,541,234; November 17, 1970

Sputter Ion Pump—W. G. Henderson, J. T. Mark (EC, Lanc) U.S. Pat. 3,540,812; November 17, 1970

Heat Exchanger for High Voltage Electronic Devices—G. Y. Eastman (EC, Lanc) U.S. Pat. 3,543,841; December 1, 1970

Grid Support for Electron Tubes—F. G. Hammersand, W. A. Novajovsky (EC, Lanc) U.S. Pat. 3,544,831; December 1, 1970

Traveling Wave Tube with Evaporated Nickel Attenuator Coating and Method of Manufacture Thereof—B. Ross (EC, Som) U.S. Pat. 3,544,832; December 1, 1970

Logic Circuit—B. Zuk (EC, Som) U.S. Pat. 3,539,823; November 10, 1970

Conductive Coatings of Tin Oxides—D. W. Roe (EC, Lanc) U.S. Pat. 3,537,890; November 3, 1970

Apparatus for Electroplating a Ribbon—R. J. Green (EC, Som) U.S. Pat. 3,537,971; November 3, 1970

D.C. Restoration Circuit with Arc-Over Protection—A. L. Limberg (EC, Som) U.S. Pat. 3,535,436; October 20, 1970

Method of Making Photoemissive Electron Tubes—R. M. Matheson, F. A. Helvy (EC, Lanc) U.S. Pat. 3,535,011; October 20, 1970

Semiconductor Wafer Transporting Jig—R. C. Shambelan (EC, Som) U.S. Pat. 3,544,862; October 20, 1970

Centrifugal Testing Apparatus—J. Paul (EC, Som) U.S. Pat. 3,534,595; October 20, 1970

Gain Controlled Amplifier—J. R. Harford (EC, Som) U.S. Pat. 3,538,448; November 3, 1970

Integrated Circuit Amplifier Biasing Arrangement—J. Avins (EC, Som) U.S. Pat. 3,531,657; September 29, 1970

Signal Translating Stage—S. A. Steckler (EC, Som) U.S. Pat. 3,531,730; September 29, 1970

Superconductive Magnet Construction—J. J. Drautman, Jr. (EC, Som) U.S. Pat. 3,543,908; October 13, 1970

Electrical Circuit for Providing Substantially Constant Current—A. L. Limberg (EC, Som) U.S. Pat. 3,534,245; October 13, 1970

High Current Transistor Amplifier Stage Operable with Low Current Biasing—A. L. Limberg (EC, Som) U.S. Pat. 3,534,279; October 13, 1970

Semiconductor Devices Having Soldered Joints—J. Ottendorf, F. P. Jones (EC, Som) U.S. Pat. 3,532,044; October 6, 1970

High Input Impedance Solid State D.C. Amplifier Suitable for Use in Electrical Measurement—S. Krasitschnu (EC, Som) U.S. Pat. 3,532,983; October 6, 1970

Memory Employing Transistor Storage Cells—B. Zuk (EC, Som) U.S. Pat. 3,533,087; October 6, 1970

Control Circuit for Memory—A. K. Rapp (EC, Som) U.S. Pat. 3,533,088; October 6, 1970

GRAPHIC SYSTEMS DIVISION

Optical Field Correction Devices for an Electronic Photocomposition System—J. C. Schira (GSD, Dayton) U.S. Pat. 3,540,361; November 17, 1970

Photocomposing Apparatus—H. E. Hayner (GSD, Dayton) U.S. Pat. 3,530,780; September 29, 1970

GOVERNMENT COMMUNICATIONS SYSTEMS DIVISION

Single Wire Crosspoint Switching Circuit with External Signaling—J. M. Walter, F. D. Rando (GCS, Camden) U.S. Pat. 3,541,515; November 17, 1970

Receiver Gain Control System Providing Negative Resistance Stabilization—J. W. Daniel Jr. (GCS, Camden) U.S. Pat. 3,544,902; December 1, 1970

Device for Generation of a Self-Acting Fluid Bearing—D. D. Maxson (GCS, Camden) U.S. Pat. 3,534,893; October 20, 1970

High Efficiency Single Turn Magnetic Head—A. J. Foster (GCS, Camden) U.S. Pat. 3,535,466; October 20, 1970

Servo System—A. C. Luther, R. G. Breed (GCS, Camden) U.S. Pat. 3,542,950; November 24, 1970

LABORATORIES

Electro-Optical Scanner—M. E. Mol (Labs, Pr) U.S. Pat. 3,541,247; November 17, 1970

Electro-Optical Compositions and Devices—J. E. Goldmacher, J. A. Castellano (Labs, Pr) U.S. Pat. 3,540,796; November 17, 1970

Line Terminating Circuits—R. A. Gange, P. Hsieh (Labs, Pr) U.S. Pat. 3,541,475; November 17, 1970

Memory System with Defective Storage Locations—R. A. Gange (Labs, Pr) U.S. Pat. 3,541,525; November 17, 1970

Color Temperature Correction Controlled by the Color Killer and Color Oscillator—C. J. Hall, R. Peter (Labs, Switz) U.S. Pat. 3,541,242; November 17, 1970

Superconductors—P. R. Sahn, F. D. Rosi (Labs, Pr) U.S. Pat. 3,544,316; December 1, 1970

Multi-Head Magnetic Transducer—J. J. Hanak (Labs, Pr) U.S. Pat. 3,544,982; December 1, 1970

Polarization Controlled Photochromic "Write-In" System—J. J. Amodei (Labs, Pr) U.S. Pat. 3,535,021; October 20, 1970

Identification Circuit for Phase Alternating Line System Operation of Color Video Tape Recordings—P. S. Carnit, T. E. Bart (Labs, Switz) U.S. Pat. 3,538,244; November 3, 1970

Method for Poling Bismuth Titanate—M. Hopkins, A. Miller (Labs, Pr) U.S. Pat. 3,531,779; September 29, 1970

Threshold Gate Circuits—K. R. Kaplan (Labs, Pr) U.S. Pat. 3,532,897; October 6, 1970

Display Circuit Including Charging Circuit and Fast Reset Circuit—B. J. Lechner (Labs, Pr) U.S. Pat. 3,532,811; October 6, 1970

Shift Circuits Including Threshold or Other Logic Gates and Having Multiple-Phase Shift Pulses Applied to Each Stage—R. O. Winder (Labs, Pr) U.S. Pat. 3,552,991; October 6, 1970

Microminiature Electrical Component Having Indexable Relief Pattern—W. Kern (Labs, Pr) U.S. Pat. 3,543,106; November 24, 1970

Transitory Hologram Apparatus—H. J. Gerritsen, H. S. Sommers, Jr. (Labs, Pr) U.S. Pat. 3,542,452; November 24, 1970

Light Pen Operating with Remote Graphic Display—J. C. Miller, C. M. Wine (Labs, Pr) U.S. Pat. 3,543,240; November 24, 1970

RCA RECORDS

Cartridge Debris Trap—W. R. Isom (Rec, Indpls) U.S. Pat. 3,537,710; November 3, 1970

Pressure Roller Construction—W. R. Isom (Rec, Indpls) U.S. Pat. 3,537,661; November 3, 1970

RCA LTD

Digital Logic Circuit for Deriving Synchronizing Signals from a Composite Signal—W. Steinberg (Ltd, Canada) U.S. Pat. 3,532,810; October 6, 1970

RCA SERVICE COMPANY

Timing System for Readout of Stored Data—C. C. Spagnoli, B. W. Binkley, D. C. Lavallee (ServCo, Cherry Hill) U.S. Pat. 3,542,286; November 24, 1970

Professional Meetings

* Dates and Deadlines

Be sure deadlines are met—consult your Technical Publications Administrator or your Editorial Representative for the lead time necessary to obtain RCA approvals (and government approvals, if applicable). Remember, abstracts and manuscripts must be so approved BEFORE sending them to the meeting committee.

Calls For Papers

APRIL 5-6, 1971: **USNC/URSI-IEEE Spring Meeting**, Statler Hilton Hotel, Washington, D.C., USNC/URSI, 6 IEEE Groups cooperating. **Deadline info: (abst) 1/25/71 to: IEEE, 345 East 47th Street, New York, N.Y. 10017.**

APRIL 26-28, 1971: **25th Annual Frequency Control Symposium**, Shelburne Hotel, Atlantic City, N.J., Solid State and Frequency Control Division, Electronic Components Laboratory, U.S. Army Electronics Command, Ft. Monmouth, N.J. **Deadline info: (sum) 15 copies (at least 500 words) 12/15/70 to: Director, Electronic Components Laboratory, U.S. Army Electronics Command, Attention: AMSEL-KL-SP (Mr. J. M. Stanley), Ft. Monmouth, N.J. 07703.**

MAY 11-13, 1971: **Sixth Region Technical Conference**, Woodlake Hotel, Sacramento, Calif., Region 6, Sacramento Sect. **Deadline info: (abst) 12/1/70 (ms) 3/1/70 to: Ronald Soohoo, Univ. of Calif., Dept. of EE, Davis, Calif. 95616.**

MAY 16-20, 1971: **International Microwave Symposium**, Marriott Twin Bridges Motor Hotel, Washington, D.C., G-MTT. **Deadline info: (papers) 2/4/71 to: R. V. Garver, Harry Diamond Labs., Conn. & Van Ness St., Washington, D.C. 20438.**

MAY 17-20, 1971: **Spring Joint Computer Conference**, Convention Ctr., Atlantic City, New Jersey, IEEE Computer Society, AFIPS. **Deadline info: (papers) 1/4/71 to: AFIPS Hqds., 210 Summit Ave., Montvale, New Jersey 07645.**

MAY 24-26, 1971: **IEEE Power Engineering Society Power Industry Computer Applications Conference**, Statler Hilton Hotel, Boston, Mass., IEEE Power Engng. Society. **Deadline info: (abst) 10/15/70 (papers) 1/8/71 to: P. L. Dandeno, Hydro Elec. Pwr. Comm. of Ontario, 620 University Ave., Toronto, Ont. Canada.**

JUNE 1-3, 1971: **Electrical & Electronic Measurement & Test Instrument Conference**, Skyline Hotel, Ottawa, Ontario, Canada, G-IM, Ottawa Section. **Deadline info: (abst) 1/15/71 to: F. L. Hermach, B-162 Metrology Bldg., NBS, Washington, D.C. 20234.**

JUNE 14-16, 1971: **International Conference on Communications**, Queen Elizabeth Hotel, Montreal, Quebec, Canada, G-Com Tech, Montreal Section. **Deadline info: (ms) 1/1/71 to: W. C. Bengier, Northern Elec. Co. Ltd., POB 3511, Station C, Ottawa 3, Ontario, Canada.**

JUNE 27-JULY 1, 1971: **Design Automation Workshop**, Shelburne Hotel, Atlantic City, New Jersey, IEEE Computer Society, ACM, SHARE. **Deadline info: (abst) 1/4/71 to: R. B. Hitchcock, Jr., IBM, Box 218, Yorktown Hgts., N.Y. 10598.**

JULY 18-23, 1971: **IEEE Power Engng. Soc., Summer Meeting & Int'l Symp. on High Pwr. Testing**, Portland Hilton Hotel, Portland, Oregon, IEEE Power Engng. Society. **Deadline info: (papers) 2/15/71 to: International Symposium on High Power Testing, IEEE, Miss Dianne Goldfinger, 345 East 47th Street, New York, N.Y. 10017, for additional information please contact: Dr. E. W. Greenfield, College of Engineering Research Division, Washington State University, Pullman, Washington 99163.**

JULY 20-23, 1971: **Conference on Nuclear & Space Radiation Effects**, New England Ctr. for Continuing Ed., Durham, New Hampshire, G-NS, Univ. of New Hampshire. **Deadline info: (papers) 2/15/71 to: T. M. Flanagan, Gulf Radiation Tech., POB 608, San Diego, Calif. 92112.**

AUG. 11-13, 1971: **Joint Automatic Control Conference**, Washington Univ., St. Louis, Mo., G-AC, AAC. **Deadline info: (papers) 1/8/71 to: Dr. John Lewis, Department of Electrical Engineering, The Pennsylvania State University, University Park, Pennsylvania 16802.**

AUG. 17, 18, and 19, 1971: **High Frequency Generation and Amplification—Devices and Applications**, Cornell Univ., Ithaca, New York, School of Electrical Engineering, Cornell University. The office of Naval Research in cooperation with: IEEE, Circuit Theory Group, Electron Devices Group, Microwave Theory and Techniques Group. **Deadline info: (abst) 5/1/71 three copies single spaced to: Professor Lester F. Eastman, Program Chairman, School of Electrical Engineering, Cornell University, Phillips Hall, Ithaca, New York 14850.**

AUG. 23-28, 1971: **European Microwave Conference**, Royal Inst. of Tech., Stockholm, Sweden, G-MTT, Region 8, Swedish Acad. of Engng. Sci., IEE, et al. **Deadline info: (syn) 3/1/71 (abst) 7/15/71 to: H. Steyskal, European Microwave Conf., Fac 23, 104 50 Stockholm 80, Sweden.**

AUG. 24-27, 1971: **Western Electronic Show & Convention**, San Francisco Hilton & Cow Palace, San Francisco, Calif., Region 8, WEMA. **Deadline info: (session proposals) 3/1/71 to: WESCON Office, 3600 Wilshire Blvd., Los Angeles, Calif. 90005.**

SEPT. 6-10, 1971: **London International Network Theory City Univ.**, London, England, G-CT, IEEE UKRI Section, IEE, IERE, City Univ. coop. **Deadline info: (papers) 3/10/71 to: G. S. Brayshaw, City Univ., St. John St., London E. C. 1 England.**

SEPT. 7-10, 1971: **Conference on "Displays"**, Univ. of Loughborough, Loughborough, England, IEE, IEEE UKRI Section, IERE et al. **Deadline info: (syn) 14/14/70 (papers) 4/1/71 to: IEE, Savoy Place, London W. C. 2 England.**

SEPT. 14-16, 1971: **Int'l Conf. on Engineering in the Ocean Environment**, Tower & Country Hotel, San Diego, Calif., Oceanography Coordinating Comm. & San Diego Section. **Deadline info: (abst) 3/30/71 to: Maurice Nelles, Bissett-Berman Corp., 3939 Ruffin Rd., San Diego, Calif. 92123.**

SEPT. 19-23, 1971: **Joint Power Generation Technical Conference**, Chase Park Plaza Hotel, St. Louis, Missouri, IEEE Power Engng. Society, ASME, ASCE participating. **Deadline info: (ms) 5/7/71 to: R. L. Coit, Westinghouse Elec. Corp., Lester P. O., Philadelphia, Penna. 19133.**

SEPT. 21-23, 1971: **Conference on Infra-Red Techniques**, Univ. of Reading, Reading, England, IERE, IEEE UKRI Section, IEE, Inst. of Phys. & Phys. Society. **Deadline info: (syn) 1/31/71 (papers) 4/30/71 to: IERE, 8-9 Bedford Square, London W. C. 1 England.**

SEPT. 27-30, 1971: **IEEE Power Engineering Society Tech. Conf. on Underground Distribution**, Cobo Hall & Hotel Pontchartrain, Detroit, Michigan, IEEE Power Engng. Society. **Deadline info: (papers) 3/1/71 (abst) 9/30/70 to: B. E. Smith, Virginia Elec. & Power Co., POB 1194, Richmond, Va. 23209.**

OCT. 18-22, 1971: **Region 8 Convention (EUROCON)**, Palais de Beaulieu, Lausanne, Switzerland. **Deadline info: (abst sum) 4/71 to: Andreas Rannestad, Norwegian Def. Res. Est., POB 25, N. 2007 Kjeller, Norway.**

OCT. 25-29, 1971: **Jt. National Conference on Major Systems**, Disneyland Hotel, Anaheim, Calif., G-SMC, ORSA. **Deadline info: (abst) 1/1/71 (papers) 6/15/71 to: F. J. Mullin, MS R3/2054, TRW, 1 Space Park, Redondo Beach, Calif. 90278.**

NOV. 3-5, 1971: **Northeast Electronics Research & Engineering Meeting**, Sheraton Boston Hotel, War Mem. Aud., Boston, Mass., New England Sections. **Deadline info: 7/2/71 to: IEEE Boston Office, 31 Channing St., Newton, Mass. 02158.**

JUNE 12-17, 1972: **1972 (5th) Congress of the International Federation of Automatic Control**, Paris, France. **Deadline info: (abst) 3/1/71 (ms) 7/15/71 to: submit abstracts and papers through AACR by sending them to one of the following individuals, any of whom can provide further information: Applications: Dr. Winston L. Nelson, Bell Telephone Labs., Inc., Whippany, New Jersey 07981; Bio Systems: Dr. Ken Bischoff, School of Chemical Engineering, Cornell Univ., Ithaca, New York 14850; Components: Prof. George A. Etzweiler, Electrical Engineering Dept., Pennsylvania State University, University Park, Penna. 16802; Education: Prof. Stephen J. Kahne, Electrical Engineering Dept., University of Minnesota, Minneapolis, Minnesota 55455; Space: Dr. John A. Aseltine, 1617 Via Zurita, Palos Verdes Estates, California 90274; Systems: Prof. Herman R. Weed, Electrical Engineering Dept., Ohio State University, Columbus, Ohio 43210; Theory: Dr. Bernard Friedland, SINGER-General Precision, Inc., 1150 McBridge Avenue, Little Falls, New Jersey 07424.**

AUG. 21-26, 1972: **13th International Congress of Theoretical and Applied Mechanics**, Moscow State University, Moscow, USSR. **Deadline info: (sum) 3/15/72 to: Prof. G. K. Mikhailov, Leningradskii Prospekt 7, Moscow A-40.**

Meetings

JAN. 25-27, 1971: **AIAA 9th Aerospace Sciences Meeting**, New York, N.Y. **Prog info: AIAA, 1290 Ave. of the Americas, New York, N.Y. 10019.**

FEB. 8-10, 1971: **AIAA Tactical Missiles in Transition Meeting**, Houston Air Force Base, N. Mex. **Prog info: AIAA, 1290 Ave. of the Americas, New York, N.Y. 10019.**

FEB. 9-11, 1971: **Aerospace & Electronic Systems Winter Conv.**, Biltmore Hotel, Los Angeles, Calif., G-AES, L.A. Council. **Prog info: R. J. Parks, Jet Propulsion Lab., 4800 Oak Grove Dr., Pasadena, Calif. 91103.**

FEB. 17-19, 1971: **AIAA Integrated Information Systems Conference**, Palo Alto, Calif. **Prog info: AIAA, 1290 Ave. of the Americas, New York, N.Y. 10019.**

FEB. 17-19, 1971: **Int'l Solid State Circuits Conference**, Sheraton Hotel, Univ. of Penna., Phila., Penna., SSC Council, Phila. Section, Univ. of Penna. **Prog info: R. W. Webster, Texas Instruments, POB 5012, Dallas, Texas 75222.**

MARCH 1-3, 1971: **Int'l Symposium on Fault Tolerant Computing**, Huntington Sheraton Hotel, Pasadena, Calif., IEEE Computer Society, Jet Prop. Labs. of Cal. Tech. **Prog info: W. C. Carter, IBM Research Ctr., Yorktown Heights, N.Y. 10598.**

MARCH 1-3, 1971: **Particle Accelerator Conference**, Pick Congress Hotel, Chicago, Illinois, G-NS, NBS et al. **Prog info: L. C. Teng, National Accelerator Lab., Box 500, Batavia, Illinois 60510.**

MARCH 10-12, 1971: **AIAA 6th Aerodynamic Testing Conference**, Albuquerque, N. Mex. **Prog info: AIAA, 1290 Ave. of the Americas, New York, N.Y. 10019.**

MARCH 15-17, 1971: **AIAA Space Shuttle Development Testing and Operations Conference**, Phoenix, Ariz. **Prog info: AIAA, 1290 Ave. of the Americas, New York, N.Y. 10019.**

MARCH 22-25, 1971: **IEEE International Convention & Exhibition**, Coliseum & N.Y. Hilton Hotel, New York, N.Y. **Prog info: J. H. Schumacher, IEEE, 345 E. 47th St., New York, N.Y. 10017.**

MARCH 31-APRIL 2, 1971: **Reliability Physics Symposium**, Stardust Hotel, Las Vegas, Nev., G-R. **Prog info: O. D. Trapp, Fairchild Semiconductor, 464 Ellis St., Mountain View, Calif. 94040.**

APRIL 5-6, 1971: **Southeastern Symposium on System Theory**, Georgia Inst. of Tech., Atlanta, Georgia, IEEE Computer Society, G-AC, Georgia Tech. **Prog info: C. O. Alford, School of EE, Georgia Institute of Tech., Atlanta, Ga. 30332.**

APRIL 5-6, 1971: **Rubber & Plastics Ind. Technical Conference**, Holiday Inn, Akron, Ohio, G-IGA, Akron Section. **Prog info: Chet Blumenauer, Unroyal Inc., 154 Grove St., Chicopee Falls, Mass. 01021.**

APRIL 12-15, 1971: **National Telemetering Conference**, Washington Hilton Hotel, Washington, D.C., G-AES, G-Com-Tech. **Prog info: H. B. Riblet, Johns Hopkins Univ., 8621 Georgia Ave., Silver Spring, Md. 20910.**

APRIL 13-15, 1971: **Conference on Frontiers in Education**, Quality Hotel Central, Atlanta, Georgia, G-Education, G-MMS, ASEE, Atlanta Section. **Prog info: W. L. Hughes, Oklahoma State Univ., Stillwater, Okla. 74074.**

APRIL 13-15, 1971: **Symposium on Applications of Walsh Functions**, Naval Research Lab., Washington, D.C., G-EMC participating, NRL, Univ. of Maryland. **Prog info: H. F. Hamuth, Dept. of EE, Univ. of Maryland, College Park, Md. 20742.**

APRIL 13-16, 1971: **International Magnetics Conference**, Denver Hilton Hotel, Denver, Colorado, G-MAG. **Prog info: Geoffrey Bate, IBM Corp., Boulder, Colorado 80302.**

APRIL 19-20, 1971: **Power Conditioning Specialists Conference**, Jet Propulsion Lab., Pasadena, Calif., G-AES. **Prog info: IEEE, 345 East 47th Street, New York, N.Y. 10017.**

APRIL 19-21, 1971: **AIAA/ASME 12th Structures, Structural Dynamics, and Materials Conference**, Anaheim, Calif. **Prog info: AIAA, 1290 Ave. of the Americas, New York, N.Y. 10019.**

APRIL 19-21, 1971: **Off-Shore Technology Conference**, Astorhall, Houston, Texas, TAB Oceanography Coordinating Committee et al. **Prog info: H. S. Field, Geophysical Res. Corp., 136 Mohawk Blvd., Tulsa, Oklahoma 74106.**

APRIL 19-22, 1971: **Israel Convention of Electrical & Electronics Engineers**, Tel-Aviv Fair Grounds & Sheraton Hotel, Tel-Aviv, Israel, IEEE Israel Section et al. **Prog info: IEEE, 345 East 47th Street, New York, N.Y. 10017.**

APRIL 20-21, 1971: **Electric Process Heating in Industry Technical Conference**, Pfister Hotel, Milwaukee, Wisconsin, G-IGA, Milwaukee Section. **Prog info: Fred Pycroft, Phila. Elec. Co., 211 S. Broad St., Phila., Penna. 19105.**

APRIL 21-23, 1971: **AAS/AIAA Variable Geometry of Expandable Structures Conference**, Anaheim, Calif. **Prog info: AIAA, 1290 Ave. of the Americas, New York, N.Y. 10019.**

APRIL 24-29, 1971: **73rd Annual Meeting & Exposition**, Conrad Hilton Hotel, Chicago, Ill. **Prog info: The American Ceramic Society, Inc., 4055 North High St., Columbus, Ohio 43214.**

APRIL 26-28, 1971: **Region III Technical Convention**, Univ. of Virginia, Charlottesville, Virginia, Region III. **Prog info: E. W. Hutton, General Elec. Co., Waynesboro, Va. 22980.**

APRIL 26-28, 1971: **Region III Thermodynamics Conference**, Tallahoma, Tenn. **Prog info: AIAA, 1290 Ave. of the Americas, New York, N.Y. 10019.**

APRIL 26-28, 1971: **Conf. on the Management of Transmission & Distribution Systems**, London, England, IEE, IEEE UKRI Section. **Prog info: IEE, Savoy Place, London, W.C. 2 England.**

APRIL 26-29, 1971: **ASMA/AIAA Habitability in Space Stations Meeting**, Houston, Texas. **Prog info: AIAA, 1290 Ave. of the Americas, New York, N.Y. 10019.**

APRIL 26-30, 1971: **Southwestern IEEE Conference & Exhibition**, Rice Hotel, Albert Thomas Conv. Ctr., Houston, Texas, SWIEEEO, Houston Section. **Prog info: D. R. Williams, Dept. of EE, Univ. of Houston, Houston, Texas 77004.**

MAY 3-6, 1971: **Ind. & Comm. Power Sys. & Elec. Space Heating & Air Conditioning Jt. Technical Conference**, Detroit Hilton Hotel, Detroit, Michigan, G-IGA, S. E. **Prog info: T. L. Schaller, Allen-Bradley Co., 1491 N. Harding St., Indianapolis, Indiana 46207.**

MAY 4-5, 1971: **Appliance Technical Conference**, Sheraton Chicago Hotel, Chicago, Illinois, G-IGA, Chicago Section. **Prog info: Vic Petchul, Dana Chasub Inc., York St. at Park Ave., Elmhurst, Ill. 60126.**

MAY 10-12, 1971: **Electronic Components Conference**, Statler Hilton Hotel, Washington, D.C., G-PMP, EIA. **Prog info: E. Moss, Mallory Capacitor Co., 3029 E. Washington St., Indianapolis, Ind. 46206.**

MAY 10-12, 1971: **AIAA Joint Strategic Missile Sciences Meeting (Classified Secret)**, U.S. Naval Academy, Annapolis, Maryland. **Prog info: General Chairman, Dr. Richard Hartunian, Aerospace Corp., 1111 Mill Street, San Bernardino, Calif. 92408.**

MAY 12-14, 1971: **Electron, Ion, and Laser Beam Technology Conf.**, Univ. of Colorado, Boulder, Colorado, G-ED, AVS et al. **Prog info: IEEE, 345 East 47th Street, New York, N.Y. 10017.**

MAY 17-19, 1971: **Aerospace Electronics Conference**, Sheraton Dayton Hotel, Dayton, Ohio, G-AES, Dayton Section. **Prog info: IEEE Dayton Office, 124 E. Monument Ave., Dayton, Ohio 45402.**

MAY 25-27, 1971: **AIAA 1st Annual Urban Technology Meeting and Technical Display: "Cities—1976"**, New York Coliseum, New York, N.Y. **Prog info: Dr. Herbert Fox, Chairman, New York Section AIAA, Chairman, Dept. of Aero/Mech Technology, New York Institute of Technology, Old Westbury, N.Y.**

JUNE 2-4, 1971: **Conference on Laser Engineering & Applications**, Washington Hilton Hotel, Washington, D.C., IEEE Quantum Elec. Council, OSA. **Prog info: D. E. Caddes, Sylvania Elec. Sys., Electro-Optics Organ., Mountain View, Calif. 94040.**

JUNE 8-7, 1971: **Chicago Spring Conf. on Broadcast & TV Receivers**, Marriott Motor Hotel, Chicago, Illinois, G-BTR, Chicago Section. **Prog info: Donald Ruby, Zenith Radio Corp., 6001 W. Dickens Ave., Chicago, Ill. 60639.**

JUNE 7-8, 1971: **Symposium on Applications of Ferro-Electrics**, IBM Res. Ctr., Yorktown Hgts., N.Y. & Holiday Inn, White Plains, N.Y., G-SU. **Prog info: L. E. Cross, Penn. State Univ., State College, Penna. 16802.**

JUNE 8-10, 1971: **Conference on Aerospace Antennas**, London, England, IEE, IERE, IEEE UKRI Section. **Prog info: IEE, 2 Savoy Place, London W.C. 2 England.**

JUNE 14-18, 1971: **AIAA 7th Propulsion Joint Specialist Conference**, Salt Lake City, Utah. **Prog info: AIAA, 1290 Ave. of the Americas, New York, N.Y. 10019.**

JUNE 21-23, 1971: **AIAA 4th Fluid and Plasma Dynamics Conference**, Cabana Hyatt House, Palo Alto, Calif. **Prog info: Arnold Goldberg, Head, Flight Sciences Laboratories, P.O. Box 3981, Seattle, Washington 98124.**

JULY 5-8, 1971: **8th International Shock Tube Symposium**, London, England. **Prog info: AIAA, 1290 Ave. of the Americas, New York, N.Y. 10019.**

Call for Educational Exhibits

AUG. 25-27, 1971: **1971 IEEE International Geoscience Electronics Symposium**, Washington, D.C., Geoscience Electronics Group of the IEEE. **Deadline info: Individuals and companies are invited to submit a comprehensive description of exhibits demonstrating Geoscience Electronics Hardware no later than 1 April 1971.** Any supporting information, such as illustrations, can be submitted with the description to aid the committee in making their selection. to: Mr. Charles F. Getman, Exhibits Chairman, 1971 IEEE International Geoscience Electronics Symposium, U.S. Naval Oceanographic Office, Engineering Services Division, Washington, D.C. 20390.

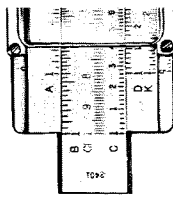

S. H. Watson retires

Samuel H. Watson, Manager of Corporate Standardizing for the past 26 years and an RCA employee for 48 years, has recently retired. Mr. Watson began his engineering career with the General Electric Company, Schenectady, New York, as a graduate of the G. E. Engineering School. In 1929, he transferred to RCA in Camden, and engaged in product design and field engineering on automotive and aircraft receivers. During the war years he served as a mechanical project engineer on military communications equipment, including altimeters and radar. He was appointed Manager of the Corporate Standardizing function in 1944. He currently represents RCA on the Company Member Council of the American National Standards Institute (ANSI). He

was a member of the Council Administrative Committee from 1947 to 1948, and again from 1950 to 1953. He was chairman of the Council in 1949 and again in 1942.

He is a Senior Member of the IEEE and a charter member and Fellow of the Standards Engineers Society.

In November 1960, Mr. Watson was chosen "Personality of the Month" by the staff of the *Magazine of Standards*, published by ANSI. He was awarded the ANSI Standards Medal in December 1962. This is an annual award given to an individual who has served the voluntary standards movement through leadership in the actual development of standards. Mr. Watson was the U.S. representative to the ISO TC/10 Committee on Drawings at the meeting held in Geneva, Switzerland, in December 1962; chairman of the U. S. delegation to the meeting held in Moscow, USSR, June 1967. In October 1967, he was appointed chairman of the Electronic Industries Association (EIA) Engineering Policy Council, the management and policy body of EIA Engineering Department. Mr. Watson is currently a member of the following metric advisory committees: the American National Standards Institute Metric Advisory Committee; the National Metric Advisory Panel of the Dept. of Defense; the EIA Metric Study Panel.

Recently, Mr. Watson received the Leo B. Moore Award of the Standards Engineering Society (see p. 94). He has also contributed the "Editorial Input" for this issue (p. 2).

RCA Alascom applies for authority to establish communications satellite station

RCA Alaska Communications Inc., today filed a request with the Federal Communications Commission for authority to establish and operate a ground station that would make Alaska the first state to utilize satellites for intrastate communications. **Howard R. Hawkins**, President of RCA Alascom, said the satellite earth station would be located at Lena Point, Alaska, near Juneau. He indicated that estimated cost of the facility would be \$1.5 million and that the station would provide additional circuits for telephone service, two-way television transmission and expanded voice/record services. The station would also make possible the first live television between the Juneau/Sitka area and other parts of Alaska and the south 48 states.

RCA Alascom was granted authority by the Alaska Public Utilities Commission on August 31, 1970, to acquire the Alaska Communication System and furnish long lines telecommunication services for Alaska by any available method or technology. [See the paper by John D. Sellers,

Chief Engineer, RCA Alascom, in this issue—p. 48] That authorization included permission to provide intrastate service via satellite. Therefore, only FCC approval is required for RCA Alascom to establish the earth station.

Equipped with a 32-foot antenna, the Lena Point station would be connected to the Juneau telephone toll center by an existing microwave route which has a present capacity of 300 voice circuits. This link is being upgraded and expanded by RCA Alascom to provide two-way television transmission capability. Also connecting at Lena Point would be an existing microwave system to Hoonah and a new microwave system to Angoon and Sitka, each with a capacity of 600 voice circuits and two-way television transmission capability.

The earth station is designed to supplement the backbone network between the major urban centers in Alaska. It also would provide additional direct paths to the south 48 states and alternate routing



Engelbrecht named Director, Solid State Technology Center

Rudolf S. Engelbrecht, formerly head of the Electroacoustics Department at Bell Laboratories, Holmdel, N. J., has accepted a position with RCA Corporation as Operations Director, Solid State Technology Center.

Recently established at Somerville, N. J., the technology center serves RCA's diversified needs for solid state components and integrated circuits. It conducts joint development programs with the company's equipment and apparatus divisions, particularly in the information and communications fields, and forward-looking programs for the various product areas in the Solid State Division. In his new capacity, Mr. Engelbrecht will report to **William C. Hittinger**, Vice President and General Manager of the Solid State Division.

During his 17 years with Bell Labs, Mr. Engelbrecht was responsible for a variety of exploratory solid state development programs involving high-frequency, high-speed devices and circuits. In this field, he has published numerous papers and been granted over 15 U. S. and foreign patents. A Fellow of the IEEE, Mr. Engelbrecht is chairman of the Professional Group on Electron Devices and past chairman of the International Solid State Circuits Conference.

with terrestrial facilities. The Lena Point station would operate with the stations at Talkeetna, Alaska and Jamesburg, California or Brewster Flat, Wash. and with other Alaska stations as they are installed. The RCA Alascom application to the FCC calls for the Lena Point earth station to operate with the Intelsat IV communications satellite, pending establishment of a domestic satellite system. Station design would also permit operation with Intelsat III or other alternative satellite systems.

New graduate degree program for RCA engineers

Dr. James Hillier, Executive Vice President, Research and Engineering, David Sarnoff Research Center, Princeton, N. J., has announced the implementation of a new graduate education program to enable RCA engineers to obtain an accredited Master of Science Degree in Electrical Engineering at any RCA location on a completely flexible schedule. Formal academic recognition of the program has been granted by virtue of an agreement recently concluded between RCA and the Florida Institute of Technology at Melbourne, Florida.

The program combines the resources of RCA's Continuing Engineering Education (CEE) video tape instructional system with the Off-Campus Residence Program of Florida Institute of Technology. Because of the recognized high quality of the CEE instructional system, the RCA courses are offered interchangeably with the established on-campus courses which constitute the regular Florida Institute of Technology graduate program. This is the first complete Master's Degree Program offered anywhere utilizing the video tape medium.

In announcing the new program to his engineering colleagues, Dr. Hillier said, "I know you share with me the feeling of rising pressure to 'stay with it' technically as we move into this new decade. With the doubling of knowledge every few years (some say as few as five), and the staggering rate at which new technology is applied, our products become rapidly more complex, and our competition more sophisticated. The need for an engineer to maintain his technical and professional competence in the seventies is more pressing than ever before.

"You, as a professional man, have of course the ultimate responsibility for your own self-improvement. However, RCA as a company has long recognized the importance to its competitive product businesses of keeping its engineering talent current to high standards. Such programs as the David Sarnoff Fellowships, in-plant after hours programs, the Tuition Loan and Refund plan, and the recent Continuing Engineering Education (CEE) program have all played an important role in helping our engineers improve their effectiveness. But the enrollment has been

small by comparison with what I consider satisfactory."

Dr. Hillier then urged RCA engineers to consider carefully how the MSEE may benefit them in their professional careers.

The new program, in brief, operates as follows: a residence period, consisting of two days of intensive review and examination during the summer months for each three-credit course, is required by Florida Institute of Technology. For the 1970-71 year, the review and examination center will be located at the Tradewinds Residence Hall, located at Melbourne, Florida.

Tuition charges, payable by the student at the time of the residence period, are reimbursable through the Company Tuition Loan and Refund Policy. Textbooks, study guides, and video tapes are furnished by Corporate Engineering Services, Camden, N. J.

The MSEE program was offered beginning in November of 1970. Additional information may be obtained from Dr. J. M. Biedenbach, Building 2-8, Camden, New Jersey.

Three RCA men admitted to N.J. Bar

Peter Abruzzese, Siegmund Silber, and Raymond Smiley—all Members of the Patent Department—recently passed the New Jersey Bar Examination and were sworn in to practice before the New Jersey Supreme Court and the U.S. District Court for the District of New Jersey. In addition, Mr. Silber was admitted to the court of Customs and Patent Appeals in Washington, D.C., and was also appointed to the N.J. State Bar Committee for Conservation and Ecology.

Mr. Abruzzese acquired the degree of Juris Doctor from Seton Hall Law School in June of 1970. He received the BSEE from Newark College of Engineering in 1964 and did graduate work at Rutgers University. He joined RCA as a Member of the Patent Staff in June, 1969.

Mr. Silber is a 1970 graduate of Fordham University's School of Law. Prior to attending Law School, he attended Massachusetts Institute of Technology, received the BA from Columbia University, and the MA from Yeshiva University's Graduate School of Humanities. He joined RCA as a Member of the Patent Staff in September of 1970.

Mr. Smiley received the Juris Doctor degree from Temple Law School in 1969. He is also a member of the D.C. Bar and registered to practice before the U.S. Patent Office. Mr. Smiley received the BSEE from Case Institute of Technology in 1969, and the MBA in Industrial Management from the Wharton School, University of Pennsylvania, in 1965. He joined RCA as a member of the Patent Staff in January 1969.

Additionally, Joel Spivak, also a member

of the Patent Department, was admitted to the court of Customs and Patent Appeals in Washington, D.C.

RCA solid-state wideband amplifiers move into TWT market

As a result of research and development work at RCA Laboratories in Princeton, a new product line of solid-state transferred electron amplifiers (TEA's) are being offered to military, industrial and commercial markets. The new microwave devices will be aimed at specific markets now using traveling-wave tubes. Other market opportunities such as communication, airborne phased-array radar and electronic countermeasures systems will result due to their small size and low voltage requirements (below 20 volts).

While solid-state transferred-electron oscillators (TEO's) have been replacing klystron-type tubes in many microwave systems, solid-state amplifiers did not follow until recently because of inherent limitations in frequency, saturated power output, linearity, bandwidth and dynamic range. These limitations have been overcome.

Continuous-wave linear amplifiers are available in C-, X-, and Ku-band frequencies (i.e. 4-18 GHz) with instantaneous bandwidths of 4 GHz or more.

The new devices make use of the negative-resistance characteristic of transferred electron devices to obtain stable broadband amplification. Normally, these devices are operated at two to three times the threshold voltage. Measurements of negative resistance from 6 to 12.4 GHz for a single device have been recorded and the actual upper limit is unknown.

The individual amplifier devices are fabricated from n-type epitaxial sandwich structures that are grown by a vapor-hydride transport process. The thickness of the n-layer is chosen so that the transit-time frequency lies within the amplifier pass band. At X-band frequencies (i.e., 8 to 12.4 GHz) a layer thickness near 10 microns is used with super-critical doping.

An outstanding advantage that TEA's offer over conventional TWT's is system simplicity by virtue of the fact that these devices will operate from simple DC power supplies of 20 volts or less. TEA's also lend themselves to direct integration into total systems. One of the most interesting features of this amplifier is the projection that has been made on instantaneous bandwidth. Calculations have indicated the potential of achieving multi-octave instantaneous bandwidths with a single amplifier.

These amplifiers have a number of properties that make them particularly suited for solid-state replacement of traveling-wave tubes in many systems. First, they are stable and truly linear. A noise figure of approximately 15 dB in X-, C-, and Ku-band and a dynamic range of over 70 dB for near octave bandwidths have been measured. The third order intermodulation distortion has been measured and found to be comparable to TWT's.

RCA interest in the new amplifier arose over a year ago when two scientists—Barry S. Perlman and Dr. Thomas Walsh—were doing research on transferred-electron (or Gunn) oscillators at the Microwave Applied Research Laboratory in Princeton, N.J. under the guidance of Dr. Fred Sterzer, Laboratory Director.

Awards

Communications Systems Division

Bernard M. Trachtenberg of Government Communications Systems received an individual Technical Excellence Award for the contributions to the Lunar Communications Relay Program.

Astro-Electronics Division

Eleven engineers of the Astro-Electronics Division received NASA awards for "technical contributions reported to NASA . . . determined to have significant value in the conduct of aeronautical and space activities." The engineers are: **A. S. Cherdak, J. S. Douglas, E. A. Goldberg, R. C. Greene, T. J. Furia, C. A. Berard, W. T. Farrell, C. R. Peek, W. T. Bisignani, W. B. Garner, and A. P. Crossley.**

Al Aronson of the Electro-Mechanical and Power activity received the Engineering Excellence for October, 1970, for his work on Infrared Sensors.

Martin Hecht of the Communications and Data Processing activity received the Engineering Excellence Award for November, 1970, for his work in frequency compensation in A/D converters.

Government Engineering

K. R. Keller of Defense Microelectronics in Somerville received a NASA Award for publication of a NASA Technical Brief on "Reducing Contact Resistance at Semiconductor to Metal or Aluminum to Metal Interfaces."

Joseph Tripoli receives Barenkopf Award

Joseph S. Tripoli, a member of the Engineering Products group of Patent Operations, Princeton, N.J., has received the Barenkopf Award from Temple University School of Law. The Barenkopf Award is given annually to the senior student in the Evening Division with the highest scholastic rank and includes a full tuition scholarship for the senior year.

Mr. Tripoli has been attending Temple Law School since 1967. He joined the RCA Missile & Surface Radar Division in Moorestown as an engineer in 1965, following his graduation from the City College of New York. In 1969 he transferred to Patent Operations at the DSRC.

Watson receives Leo. B. Moore Award

S. H. Watson, Manager, Corporate Standardizing, Corporate Engineering Services, was presented with the Leo. B. Moore Award of the Standards Engineers Society. The award, consisting of a gold medal and citation, is made annually "for highest achievement, extraordinary contribution, and distinguished service in the field of standardization and its professional advancement through original research and writing, creative application and development, or professional and public service."

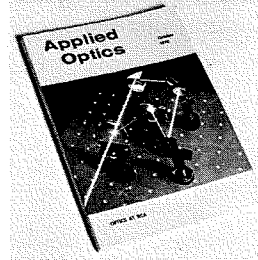

Applied Optics features RCA

The October 1970 issue of *Applied Optics*, published by The Optical Society of America, contains 18 papers and an introduction dealing with optics research and development at RCA. Guest-edited by **J. P. Wittke** of RCA Laboratories, the 188 pages represent current optics work throughout RCA.

RCA Review, December 1970
Chemical Vapor Phase Deposition of
Electronic Materials

Foreword

L. R. Weisberg and G. W. Cullen

Semiconductors

Low-Temperature Vapor Growth of Homoepitaxial Silicon D. Richman, Y. S. Chiang, and P. H. Robinson

Heteroepitaxial Growth of Germanium and Silicon on Insulating Substrates D. J. Dumin, P. H. Robinson, G. W. Cullen, and G. E. Gottlieb

Vapor-Phase Growth of Several III-V Compound Semiconductors J. J. Tietjen, R. E. Enstrom, and D. Richman

The Preparation of Ternary and Quaternary Compounds by Vapor Phase Growth B. J. Curtis, F. P. Emmenegger, and R. Nitsche

Vapor Growth of (II-VI)-(III-V) Quaternary Alloys and Their Properties W. M. Yim, J. P. Dismukes, and H. Kressel

Vapor Deposition of Semiconducting Mononitrides of Scandium, Yttrium, and the Rare Earth Elements J. P. Dismukes, W. M. Yim, J. J. Tietjen, and R. E. Novak

Vapor Phase Growth of Magnetic Semiconducting Spinels H. L. Pinch and L. Ekstrom

Superconductors

Compounds and Alloys for Superconducting Applications R. E. Enstrom, J. J. Hanak, and G. W. Cullen

Insulators

Deposition and Properties of Silicon Dioxide and Silicate Films Prepared by Low-Temperature Oxidation of Hydrides W. Kern and A. W. Fisher

Vapor Deposition of Characterization of Metal Oxide Thin Films for Electronic Applications C. C. Wang, K. H. Zaininger, and M. T. Duffy

Preparation, Properties, and Applications of Chemically Vapor Deposited Silicon Nitride Films M. T. Duffy and W. Kern

Deposition of Aluminum Oxide Films from Organo-Aluminum Vapor Compounds M. T. Duffy and W. Kern

Interface Properties of Chemically Vapor Deposited Silica Films on Gallium Arsenide W. Kern and J. P. White

The *RCA Review* is published quarterly. Copies are available in all RCA libraries. Subscription rates are as follows (rates are discounted 20% for RCA employees):

	DOMESTIC	FOREIGN
1-year	\$4.00	\$4.40
2-year	7.00	7.80
3-year	9.00	10.20

Staff announcements

Missile and Surface Radar Division

Philip A. Piro, Division Vice President and General Manager has announced the organization of Missile and Surface Radar Division as follows:

Charles C. Botkin, Manager, Cobra Mist Program; **George J. Branin**, Manager, Product Assurance; **Dudley M. Cottler**, Chief Engineer, Engineering Department; **Ronald V. Donato**, Plant Manager, Moorestown Plant; **James J. Dougherty**, Manager, Materials; **Wesley R. Frysztacki**, Manager, Strategic Systems Department; **Richard J. Hall**, Manager, Microcircuit Department; **George J. Honeyford**, Manager, Moorestown Personnel; **Sidney G. Miller**, Manager, Ballistic Missile Defense Program; **Edward W. Petrillo**, Manager, Operations Control; **Joseph M. Seligman**, Manager, Range and Tactical Systems Department; **Howard G. Stewart**, Division Vice President, Marketing; and **Joseph C. Volpe**, Manager, MFA Program.

Aerospace Systems Division

John R. McAllister, Division Vice President and General Manager has appointed **William H. Price, II**, Manager, Tactical Systems Marketing.

Astro-Electronics Division

C. S. Constantino, Division Vice President and General Manager has appointed **Leo Weinreb**, Manager, Color Camera Project.

Consumer Electronics

Barton Kreuzer, Executive Vice President has appointed **W. Thomas Collins**, Manager, Consumer Affairs, Consumer Electronics.

Electronic Components

Joseph T. Cimorelli, Division Vice President and General Manager, has appointed **Matthew M. Bell**, Manager, Equipment Design and Development, Receiving Tube Division.

Government and Commercial Systems

Andrew F. Inglis, Division Vice President and General Manager has appointed **Adron M. Miller**, Manager, Administrative Services, and **Vroman W. Riley**, Manager, Cable Systems, Communications Systems Division.

RCA Service Company

Joseph F. Murray, Division Vice President, Government Services, has appointed **William F. Given**, Division Vice President, Field Projects.

Operations Staff

Richard W. Sonnenfeldt, Staff Vice President, Special Projects has appointed **Frederick O. Ziegler** Director, State Liaison.

CSD Announces New Organization

All technical product line planning, design and development operations of the RCA Computer Systems Division were combined, effective Oct. 30, 1970, into a single Systems Development organization, reporting to **L. E. Donegan, Jr.**, Division Vice President and General Manager. The new organization (see organization chart) brings together Engineering, Systems Programming, and Product Planning, realigned in logical systems, hardware products, and software product groups—each operating under entrepreneurial management.

In addition to Systems Managers and Product Managers, the new organization also includes several supporting groups. Each Systems and Product Manager heads a profit center and is responsible for developing the part of the product line assigned to him and for assuring that it produces planned revenue, profit, and share of market.

Division Vice President
and
General Manager
L. E. Donegan, Jr.

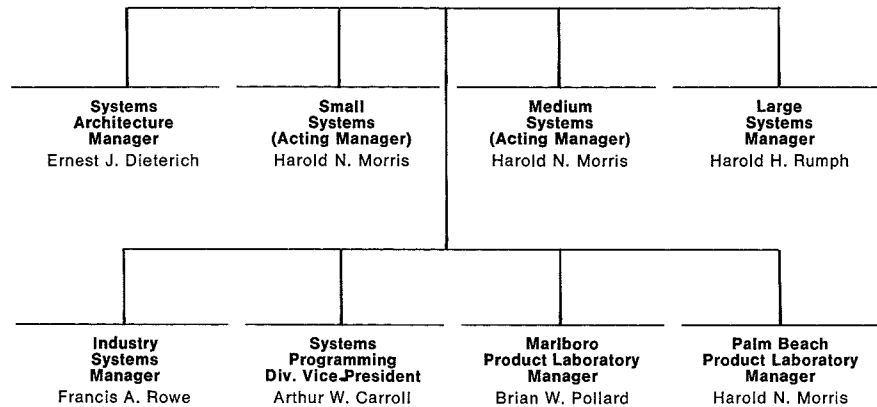

Organization Chart—Computer Systems Division, Systems Development Organization.

Professional Activities

Missile Test Project

The Instrument Society of America's Canaveral Section recently received the Society's KATES award for its 1970 annual report. The report was compiled by **James A. Kibling** of the Missile Test Project.

J. W. Van Cleve, Manager, RCA Missile Test Project Mainland Instrumentation, and **K. J. Starzinger**, Manager, Operations Control, have been elected to positions with the Cape Canaveral Section of the American Institute of Aeronautics and Astronautics. Van Cleve will serve as the section's Secretary and Starzinger will serve as a Council Member to the Board.

Corporate Engineering Services

Fred Oberlander, Administrator, Corporate Standardizing, recently received a Certificate of Recognition from the U.S. Army Electronics Command and industry co-sponsors, "for his valued services and contributions as a member of the Annual Wire and Cable Symposium Committee from January 1969 to December 1970." The citation further stated that "his professional leadership in the establishment of the technical program, and wholehearted participation in the many organizational activities, have contributed materially to the sustained success of this Symposium."

Communication Systems Division

James H. Goodman of Government Communications Systems is presently serving as chairman of the Philadelphia chapter of the IEEE group on Reliability. Mr. Goodman was recently notified by the Reliability Group's Administrative Committee that his "chapter's activities during 1969-70 were considered particularly

meritorious, warranting the special recognition accorded by Group Chapter Awards."

Computer Systems Division

Stephen P. Young, Senior Member of the Technical Staff, Design Automation Section, Marlboro, Massachusetts, has been appointed editor of the Computer Aided Design News section of the IEEE magazine, *Computer*, which is published bi-monthly for the membership of the IEEE Computer Group. This is an association of IEEE members with professional interest in the field of computers. *Computer* was formerly published under the title of *Computer Group News*.

Industrial Tube Division

Jules M. Forman and **A. Month** were two of three panel speakers from industry to

give talks on 11/3/70 at the new Willow Street Vocational Technical School located in the southern part of Lancaster County. Mr. Forman's presentation was on the subject of "Technology" in general and the electronic technology field in particular. Mr. Month discussed the vocational environment and its value for high school students with special emphasis on the field of related engineering technology.

J. M. Forman and **P. G. Bedrosian**, represented the Industrial Tube Division at the JEDEC JT-16 Committee Quarterly Meeting. JT-16 is an Electronic Industries Association (EIA) Committee that is responsible for the formulation and monitoring of Government Standards and Specifications applicable to all electron tubes under the cognizance of JEDEC.

Clip out and mail to Editor, *RCA Engineer*, #2-8, Camden

RCA Engineer

Have we your correct address?

If not indicate the change below:

Name _____ Code* _____

Street or Bldg. _____

City and State or Plant _____

*Please indicate the code letter(s) that appear next to your name on the envelope.

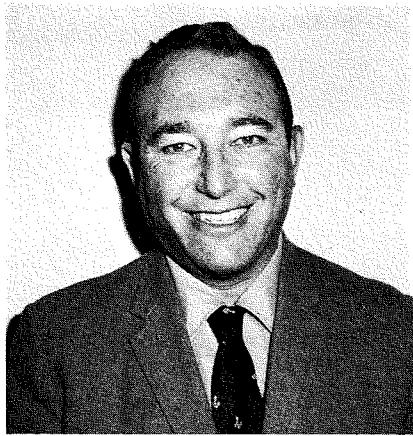

R. M. Cohen named to RCA Engineer Advisory Board

William C. Hittinger, Division Vice President and General Manager, Solid State Division, recently appointed **Robert M. Cohen** a Member of the *RCA Engineer* Editorial Advisory Board, representing the Solid State Division. The Editorial Advisory Board provides counsel and guidance to the editorial staff and assists in long-range planning of editorial activities.

Mr. Cohen joined RCA in 1940 at the Electron Tube Division plant in Harrison, N. J. He was engaged in various design and development positions in receiving tube engineering and was appointed Engineering Leader, New Product Development, in 1950. In 1953 he became Manager, Semiconductor Applications Engineering Laboratory, in the Harrison plant. He moved to the newly established Somerville facility in 1955 as Manager, Entertainment Product Development, and in 1961 was named Manager, Engineering, for the Commercial Semiconductor Operations Department. In 1967 he became Manager, Quality and Reliability Assurance, for the Solid State Division. Mr. Cohen received the BSEE from the Newark College of Engineering. He is a Fellow of the IEEE, has published numerous technical papers and is the holder of eight U. S. patents. He is a member of JEDEC Council of EIA.

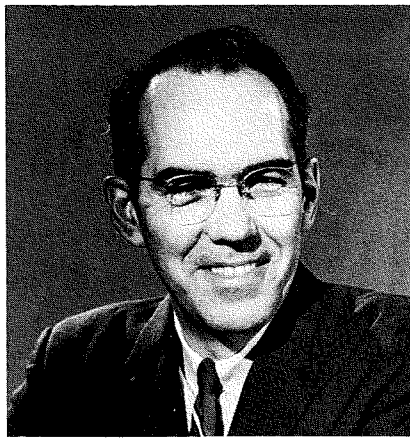

Louis Elbert is new Ed Rep for Systems Programming

Louis D. Elbert has been appointed Editorial Representative for Systems Programming, Computer Systems Division. In this capacity Mr. Elbert will be responsible for planning and processing articles for *RCA Engineer* and for supporting the Corporate-wide technical papers and reports program.

Mr. Elbert's career in the computer industry has been with software development. Starting in 1955 as a Machine Accountant in the Navy he designed and implemented data processing systems for personnel, financial, material procurement, and inventory control applications. In 1959 with the Insurance Company of North America he supplied technical assistance for coding and design of insurance report programs. In 1960 he collaborated in the design and implementation of Univac's first COBOL Compiler. He joined RCA in 1961 with RCA Advanced Programming in Pennsauken, New Jersey, assigned to software compiler and assembler design. He moved to Palm Beach in 1963 as Leader design and implementation of software for RCA 2201, returning to Cherry Hill in 1964 to become Leader Service Routines and Assembly Systems. In 1965 he became Manager of Utility Systems and later Manager Conversion and Utility Systems. In 1969 he moved to a position as Staff Planner for conversion and data

base systems in Communications and Conversion Systems. In 1970 he was Manager Systems Programming Standards until his recent promotion to Staff Systems Programming, Computer Systems Division in Cinnaminson, New Jersey. Prior to entering the computer industry, he spent seven years as a seminarian in the Society of Priests of the Sacred Heart. He is active in the Association of Computer Machinery, having served as Newsletter Editor. He is currently coordinator of Special Interest Groups for Delaware Valley Chapter ACM.

Bruce Shore receives Author Award

At its Eleventh Annual Authors-Teachers Luncheon, the New Jersey Association of Teachers of English conferred its Author Award on **Bruce H. Shore** of RCA Corporate Public Affairs for his book, *The New Electronics*. The book, which provides an informative overview of solid state electronics, was described in some detail in the *RCA Engineer*, Vol. 16, No. 2 (Aug/Sep. 1970).

ALERT/71 to replace ALERT

ALERT, the RCA computer-based system for automatically notifying engineers and scientists of technical information sources pertinent to their current work, has been operational for over a year. Based on this operating experience, a new and improved current awareness service—ALERT/71—has been developed.

Some key features of ALERT/71 are:
—More extensive and pertinent data base against which profiles can be matched.

—Full abstracts of items matching an interest profile will be available as output in most cases; users can obtain their ALERT/71 notices in more than one format.

—Author's affiliations, organizations sponsoring the work, translation status for foreign materials, and other identifying information will be more complete on ALERT/71 notices.

—Data bases for ALERT/71 are more thoroughly indexed for searching; more relevant material will be identified by the computer profile-matching process.

—More options will be available to the ALERT/71 user as to what basic classes of information are to be searched for a given profile, thus reducing non-relevant output.

Information on the new system is being distributed to present ALERT users, RCA libraries and engineering and research groups during January and February. For more information, contact Technical Information Systems, Corporate Engineering Services, Bldg. 2-8-1, Camden, N. J., PC 3119.

Clip out and mail to Editor, *RCA Trend*, Bldg 2-8, Camden, N.J.

RCA Trend

Are you receiving TREND?

If not, supply the following information:

Name _____ Code* _____

Immediate Supervisor _____

Division _____

Plant Location _____

*Please indicate the code letters that appear next to your name on the *RCA Engineer* envelope.

Editorial Representatives

The Editorial Representative in your group is the one you should contact in scheduling technical papers and announcements of your professional activities.

Government and Commercial Systems

Aerospace Systems Division

Electromagnetic and Aviation Systems Division

Astro-Electronics Division

Missile & Surface Radar Division

Government Engineering

Government Plans and Systems Development

Communications Systems Division

Commercial Systems

Industrial and Automation Systems

Government Communications Systems

Information Systems

Computer Systems Division

Magnetic Products Division

Memory Products Division

Graphic Systems Division

Research and Engineering

Laboratories

Electronic Components

Receiving Tube Division

Television Picture Tube Division

Industrial Tube Division

Technical Programs

Solid State Division

Consumer Electronics Division

RCA Service Company

RCA Global Communications, Inc.

National Broadcasting Company, Inc.

RCA Records

RCA International Division

RCA Ltd.

Patents and Licensing

	Engineering, Burlington, Mass.
	Engineering, Van Nuys, Calif.
	Engineering, West Los Angeles, Calif.
	Engineering, Princeton, N.J.
	Advanced Development and Research, Princeton, N.J.
	Engineering, Moorestown, N.J.
	Advanced Technology Laboratories, Camden, N.J.
	Defense Microelectronics, Somerville, N.J.
	Advanced Technology Laboratories, Camden, N.J.
	Central Engineering, Camden, N.J.
	Engineering Information and Communications, Camden, N.J.
	Chairman, Editorial Board, Camden, N.J.
	Mobile Communications Engineering, Meadow Lands, Pa.
	Professional Electronic Systems, Burbank, Calif.
	Studio, Recording, & Scientific Equip. Engineering, Camden, N.J.
	Broadcast Transmitter & Antenna Eng., Gibbsboro, N.J.
	Engineering, Plymouth, Mich.
	Engineering, Camden, N.J.
	Palm Beach Product Laboratory, Palm Beach Gardens, Fla.
	Marlboro Product Laboratory, Marlboro, Mass.
	Instructional Systems Engineering, Palo Alto, Cal.
	Service Dept., Cherry Hill, N.J.
	Systems Programming, Riverton, N.J.
	Development, Indianapolis, Ind.
	Engineering, Needham, Mass.
	Engineering, Dayton, N.J.
	Research, Princeton, N.J.
	Chairman, Editorial Board, Harrison, N.J.
	Receiving Tube Operations, Woodbridge, N.J.
	Receiving Tube Operations, Cincinnati, Ohio
	Television Picture Tube Operations, Marion, Ind.
	Television Picture Tube Operations, Lancaster, Pa.
	Industrial Tube Operations, Lancaster, Pa.
	Microwave Tube Operations, Harrison, N.J.
	Engineering, Harrison, N.J.
	Solid State Power Device Engr., Somerville, N.J.
	Semiconductor and Conversion Tube Operations, Mountaintop, Pa.
	Semiconductor Operations, Findlay, Ohio
	Solid State Signal Device Engr., Somerville, N.J.
	Chairman, Editorial Board, Indianapolis, Ind.
	Engineering, Indianapolis, Ind.
	Radio Engineering, Indianapolis, Ind.
	Advanced Development, Indianapolis, Ind.
	Black and White TV Engineering, Indianapolis, Ind.
	Ceramic Circuits Engineering, Rockville, Ind.
	Color TV Engineering, Indianapolis, Ind.
	Consumer Products Service Dept., Cherry Hill, N.J.
	Consumer Products Administration, Cherry Hill, N.J.
	Tech. Products, Adm. & Tech. Support, Cherry Hill, N.J.
	Missile Test Project, Cape Kennedy, Fla.
	RCA Global Communications, Inc., New York, N.Y.
	Staff Eng., New York, N.Y.
	Record Eng., Indianapolis, Ind.
	New York, N.Y.
	Research & Eng., Montreal, Canada
	Staff Services, Princeton, N.J.

* Technical Publication Administrators listed above are responsible for review and approval of papers and presentations.