

BROADCAST NEWS

VOL. NO. 86 DECEMBER, 1955

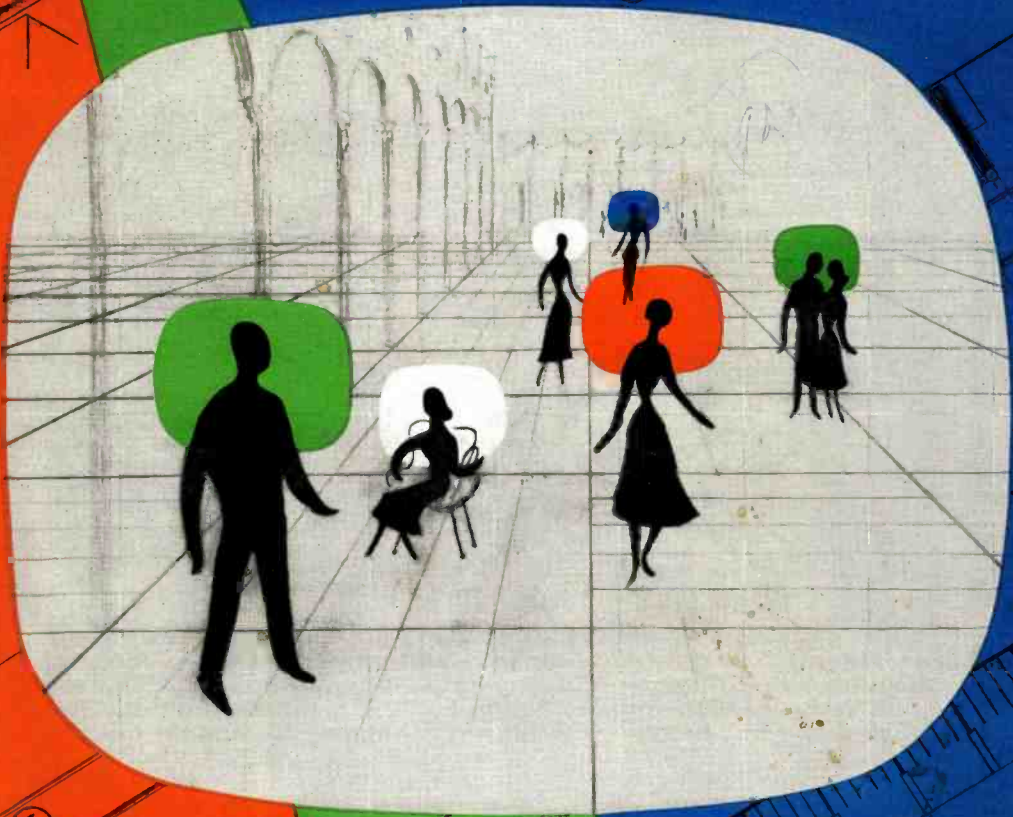

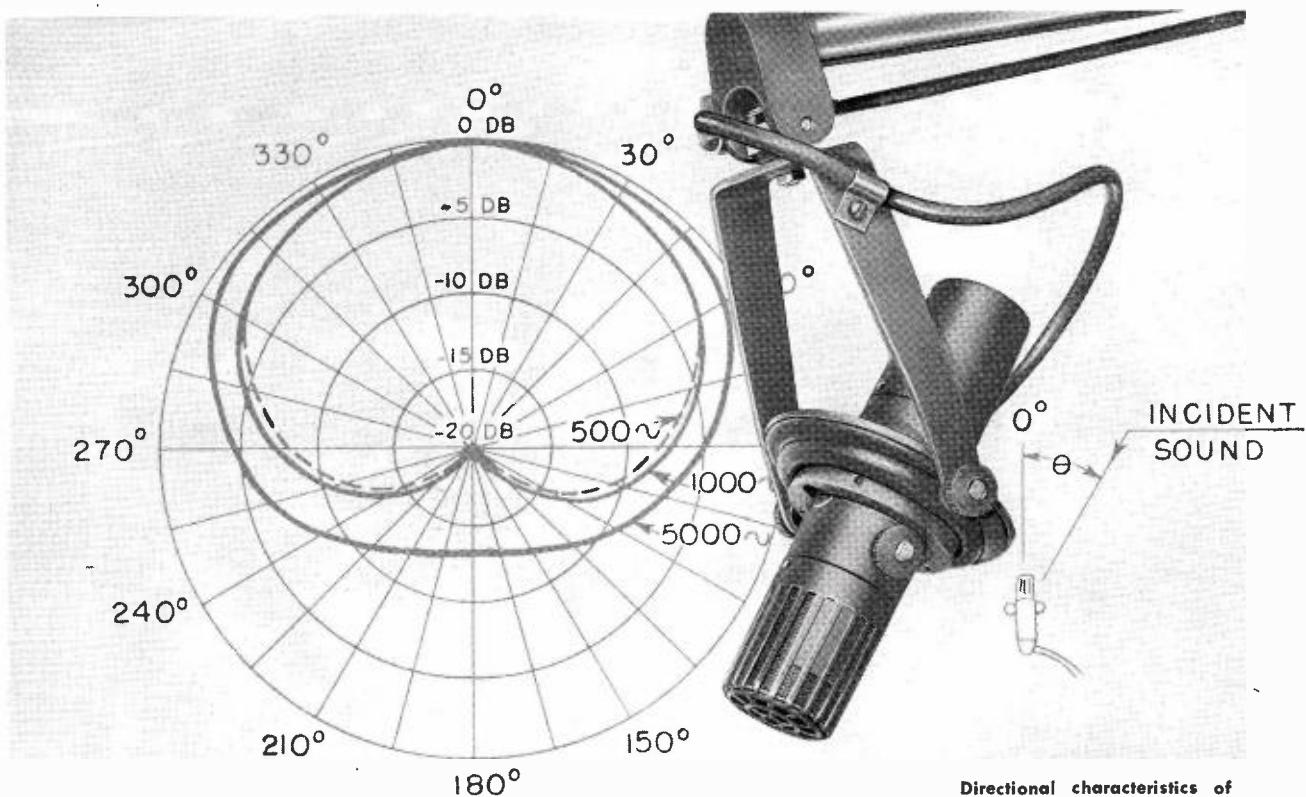

Directional characteristics of the BK-5A Microphone about the vertical axis.

Order Now...

RCA's NEW BK-5A UNIAXIAL MICROPHONE

Today's most versatile sound pickup unit

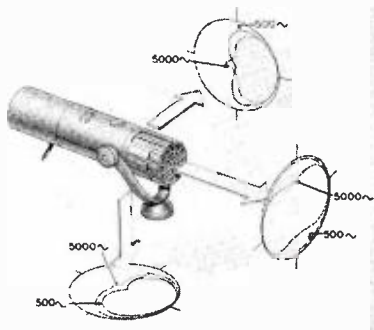

DIRECTIONAL CHARACTERISTICS about the major axis. At low frequencies the pickup pattern is a true cardioid. At 5000 cps and above, the pattern becomes fan shaped.

The RCA Uniaxial Microphone meets the increasing need for a high-quality ribbon microphone with superior directional characteristics. This microphone is truly uniaxial; its direction of maximum sensitivity has been designed to coincide with the major axis of the microphone. The BK-5A is built for simple and sure handling when mounted on a boom. Its improved shock mount effectively isolates microphone from

boom support and does not itself generate any noise, thus assuring noise-free handling. Sensitivity to wind is also reduced. Premium performance, classic styling and ease of handling will assure years of successful application.

Ask your RCA Broadcast Sales Representative for complete information. In Canada, write RCA VICTOR Company Limited, Montreal.

FEATURES OF RCA TYPE BK-5A MICROPHONE

- ★ Uniaxial feature simplifies microphone and camera placement
- ★ Improved directional characteristics with wide pickup angle
- ★ High quality reproduction to 15,000 cycles
- ★ Small and lightweight for TV boom operation
- ★ Sturdy construction with blast filter to reduce effect of violent noises
- ★ Exceptional shielding for operation in high hum fields
- ★ Wind screen available for outdoor use or fast-panning shots
- ★ No rubber bands to replace, with new shock mount
- ★ Improved longer-life flexible cable

Pioneers in AM Broadcasting for Over 25 Years



BK-5A Microphone with Wind Screen and new, improved Boom Mount.



BK-5A mounted on Type 91-C Desk Stand.



**RADIO CORPORATION
of AMERICA**

ENGINEERING PRODUCTS DIVISION

CAMDEN, N. J.

THE COVER for this issue illustrates a new concept in studio design formulated by Sol Cornberg of NBC. Some of the elements of this automation approach can already be seen in the Home show, and since they are quite unique, these ideas should certainly serve to stimulate thinking when planning future studios.

Vol. No. 86	December, 1955
-------------	----------------

BROADCAST NEWS

published by

RADIO CORPORATION OF AMERICA
ENGINEERING PRODUCTS DIVISION CAMDEN, NEW JERSEY

PRICE *In continental U.S.A. --- \$4.00 for 12 issues*
 In other countries ----- \$5.00 for 12 issues

CONTENTS

PLANNING TV MICROWAVE SYSTEMS	8
JOHN WENTWORTH'S BOOK ON COLOR TELEVISION IS OFF THE PRESS!	23
WNBQ TO BE FIRST ALL-COLOR STATION	24
NEW DUAL-CHANNEL CONSOLETTA <i>by E. J. Meehan</i>	28
SPACE CONTROL PRODUCTION AREA <i>by Sol Cornberg</i>	30
WQED—FIRST COMMUNITY EDUCATIONAL TV STATION	48
SIX STATIONS BACK ON AIR IN RECORD TIME AFTER FIRE AND FLOOD DAMAGE	60
WEBB MAKES RAPID STRIDES	64

“RCA PIONEERED AND DEVELOPED COMPATIBLE COLOR TELEVISION”

Copyright 1955, Radio Corporation of America, Engineering Products Division, Camden, N. J.

PRINTED
IN
U.S.A.

RCA AMPLI

RCA *Ampliphase* RCA

**50-KW AM
AIR COOLED!**

**New RCA 50-kilowatt
AM Transmitter BTA-50G**

DESIGNED WITH
AMPLIPHASE MODULATION

HOW IT WORKS!

To produce phase-to-amplitude modulation in the BTA-50G, a carrier wave is developed by a common exciter. This carrier wave is then split and fed to two separate amplifier chains through phase-shift networks that establish a carrier phase difference. These two signals are controlled so that each maintains a prescribed phase relationship with the other in accordance with the intensity of modulating signal. This controlled phase relationship enables the separate 25-kilowatt amplifiers, when feeding their outputs into a combining circuit, to produce a maximum level 50-kilowatt amplitude modulated signal.

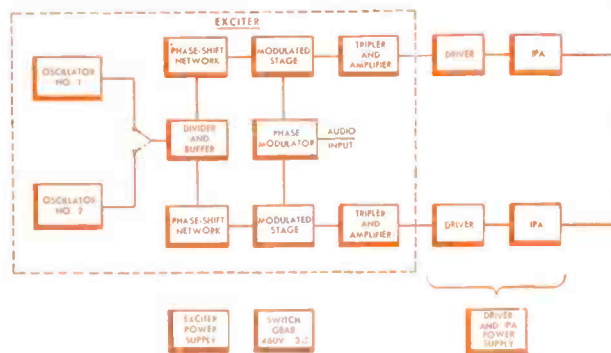

SIMPLIFIED BLOCK DIAGRAM—BTA-50G TRANSMITTER

PHASE

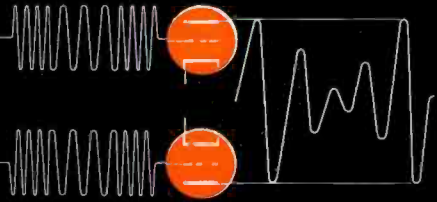

A new concept in AM Broadcasting!

... introduced in RCA's revolutionary new 50-KW AM transmitter

Here is the most significant forward step in AM transmitters since RCA introduced high level modulation—an entirely new 50-KW transmitter using Ampliphase Modulation. Newest and finest in RCA's long line of distinguished AM transmitter designs, it is further proof of RCA leadership in the broadcast equipment field.

Ampliphase cuts transmitter floor space and operating costs by substantial margins. The BTA-50G is housed in four cubicles. It does away with half of present power tubes . . . along with bulky components such as modulation transformers,

reactors and accessories. It requires no underfloor trenches, costly water cooling systems, external blowers. And there's no lost air-time—because the 50-KW Ampliphase is remarkably easy to install while your present transmitter is in operation. Then, in most cases, you may keep your old unit as a stand-by.

For complete technical details . . . and for information on the surprisingly low price . . . call your RCA Broadcast Sales Representative. In Canada, write RCA VICTOR Company Limited, Montreal.



FACTS ABOUT RCA'S NEW 50-KW AM

- Takes less than 80 square feet of floor space. No underfloor trenches required.
- Lowest operating cost of any 50-KW AM transmitter.
- Half the tube cost of other 50-KW AM transmitters.
- Uses famous Long-Life RCA 5671 P.A. tubes.
- No Modulation transformer required.
- Completely air-cooled with internal blowers—no air intake ducts necessary.
- Low distortion, excellent frequency response.
- Splatter-free modulation provided by new Ampliphase design.
- Designed to permit remote-control operation.
- New simplified circuitry. Extremely stable operation.

PIONEERS IN AM BROADCASTING FOR OVER 25 YEARS



RADIO CORPORATION of AMERICA
ENGINEERING PRODUCTS DIVISION

CAMDEN, N.J.



NEW BQ-2A 3-SPEED TURNTABLE designed specifically for 33½, 45 and 78 RPM operation. Low in price, but retaining highest performance characteristics. Simple, sure-fire drive mechanism with self-compensating rim drive. Smooth half-turn starting at any speed for easy cueing.



BQ-70F DELUXE, 3-SPEED TURNTABLE. Newest edition of RCA's famous 70-series transcription turntables. Photo shows installation of Universal Tone Arm for Vertical and Lateral standard groove transcriptions and a lightweight tone arm for 45 and 33½ fine-groove recordings.

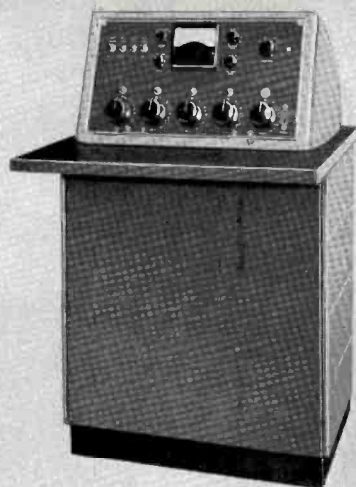

BC-4A AUDIO CONTROL. This new unit provides adequate control and switching for one studio, control booth, two turntables, network, 2 remotes, and tape recorder. Addition of a second BC-4A doubles facilities, permits dual-channel operation. Ideal audio sub-control for TV stations.

Everything in Audio

Pictured on these pages are just a few of the units—from the most complete line of professional audio equipment for AM, FM and Television.

Application-engineered to fit every Broadcast audio pick-up and reproduction situation in the station, this comprehensive line includes...microphones and microphone accessories...turntables...tape recorders...amplifiers...loudspeakers...custom-built equipment...plus hundreds of other audio items needed to meet each

and every station requirement.

RCA audio equipment is imaginatively designed to exceed present-day station requirements—competitively. It makes possible new techniques in program handling—offers a new basic approach to greater operation economy. Ask your RCA Broadcast Sales Representative for complete technical information. In Canada, write RCA Victor, Ltd., Montreal.



BC-2B STUDIO CONSOLE. "Low-boy" console offers deluxe, operation-proved features usually found in custom-built equipment—but at a standard "package" price. Includes complete high-fidelity speech input provisions for 2 studios, announce booth, 2 turntables, 5 remotes, and network.

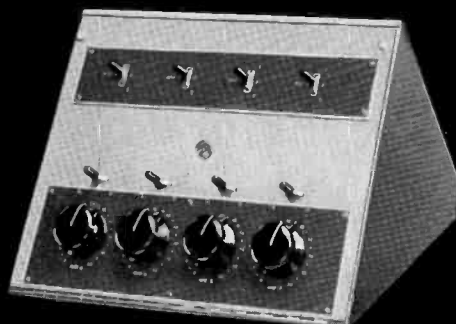

BCM-1A AUXILIARY MIXER CONSOLE. For large AM and TV studios. It triples the microphone inputs of the BC-2B—up to 16 microphones can be connected—8 can be used simultaneously. Enables you to "block-build" as required.

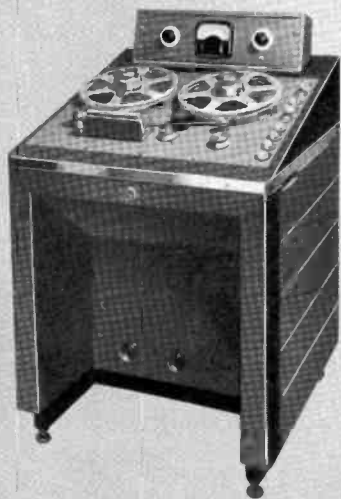

RT-12B PROFESSIONAL TAPE RECORDER (CONSOLE TYPE). Same as RT-11B and includes all the design features of the rack-mounted unit—but is ideal for use near the RCA Console or turntables in control rooms or studios where rack space is not available.

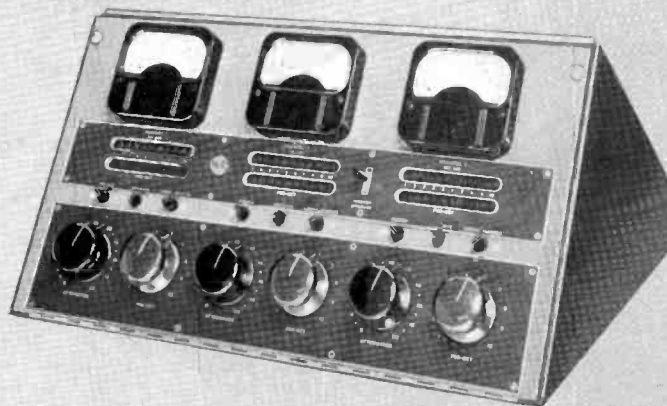

BCS-11A MASTER SWITCHING CONSOLETTA. For broadcast stations requiring master switching facilities for three channels. Can be used for pre-set master switching—up to 10 program sources.

...for AM or TV!

FREE technical brochures on RCA Broadcast Audio Equipments—from your RCA Broadcast Sales Representative. Ask for the bulletins you desire by the numbers given below:

ITEM	NUMBER
BC-4A Audio Control	B .1112
BC-2B Studio Console	B .1100
BCM-1A Auxiliary Mixer Console	B .1108
BCS-11A Master Switching Console	B .1116
BQ-1A Turntable	B .1616
BQ-70F Deluxe, 3-speed Turntable	B .1600
RT-11B Professional Tape Recorder for Rack Mounting	B .1700
RT-12B Professional Tape Recorder (Console Type)	B .1700
BTC-1B Transmitter Control Console	2J 8256

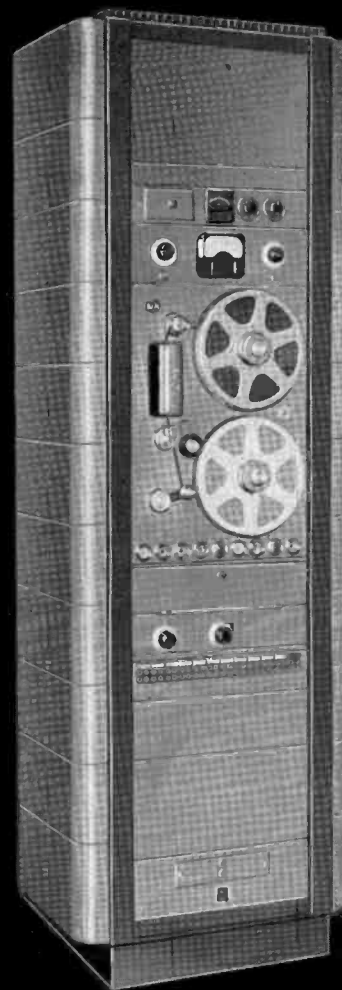

PIONEER IN AM BROADCASTING FOR OVER 25 YEARS



RADIO CORPORATION of AMERICA
ENGINEERING PRODUCTS DIVISION

CAMDEN, N. J.



BTC-1B TRANSMITTER CONTROL CONSOLE. Handles all audio mixing and transmitter switching for AM station operation. Add-a-unit design does away with obsolescence—enables you to add control turrets and desk sections as your station grows.

RT-11B PROFESSIONAL TAPE RECORDER FOR RACK MOUNTING. Designed for applications where precision timing and reliability are prime factors. RT-11B provides push-button control, automatic tape lifters, quick starts and stops in 1/10 second, and easy cueing.

NEW...

RCA

All New Type

10,000 WATTS



With High Quality Sound Channel

*Good Color
Performance
Depends on These
Specifications*

- Power Output . . . 1 Watt, Nominal.
- Differential Gain (Linearity) . . . 0.5 db max.
- Differential Phase Distortion (at 3.58 mc) . . . less than 1%.
- Amplitude Frequency Response . . . Flat within 0.5 db 60 cycles to 6 mc.
- Synchronizing Signal Compression . . . Negligible.
- Low Frequency Square Wave Response . . . Less than 1% tilt at 60 cycles.

For descriptive literature on this newest of microwave systems or help in planning your microwave setup, consult your RCA Broadcast Sales Representative.

MICROWAVE

High-Power

TVM-1A designed for Color TV

(Best for Monochrome, too)

ERP AT 7000 MC

The TVM-1A is the only microwave equipment designed specifically as an integral part of a complete color TV system . . . from color originating equipment to color receivers. Whether you're a monochrome or color user, you will appreciate these special advantages:

HIGH POWER

An increase of 10 in transmitter power and about 3 db in receiver sensitivity offers 20 times the power margin of the popular RCA TTR-TRR series of microwave equipment. This means greater operational reliability with an increased fading margin.

SOUND DIPLEXING

Included in the TVM-1A system is high quality audio channel for the simultaneous transmission of sound along with picture

information. This sound channel is well within FCC requirements for a studio-to-transmitter link (STL).

TRANSMITTER AUTOMATIC FREQUENCY CONTROL

Transmitter AFC offers exceptionally good frequency response and highest stability. It is especially useful in multihop operation with unattended repeater stations.

TRANSMITTER PICTURE MONITORING

This facility assures an actual high quality "air" signal. It simplifies trouble shooting procedures and is also extremely useful in the operation of unattended repeater stations.

RCA Pioneered and Developed Compatible Color Television



RADIO CORPORATION of AMERICA
ENGINEERING PRODUCTS DIVISION

CAMDEN, N.J.

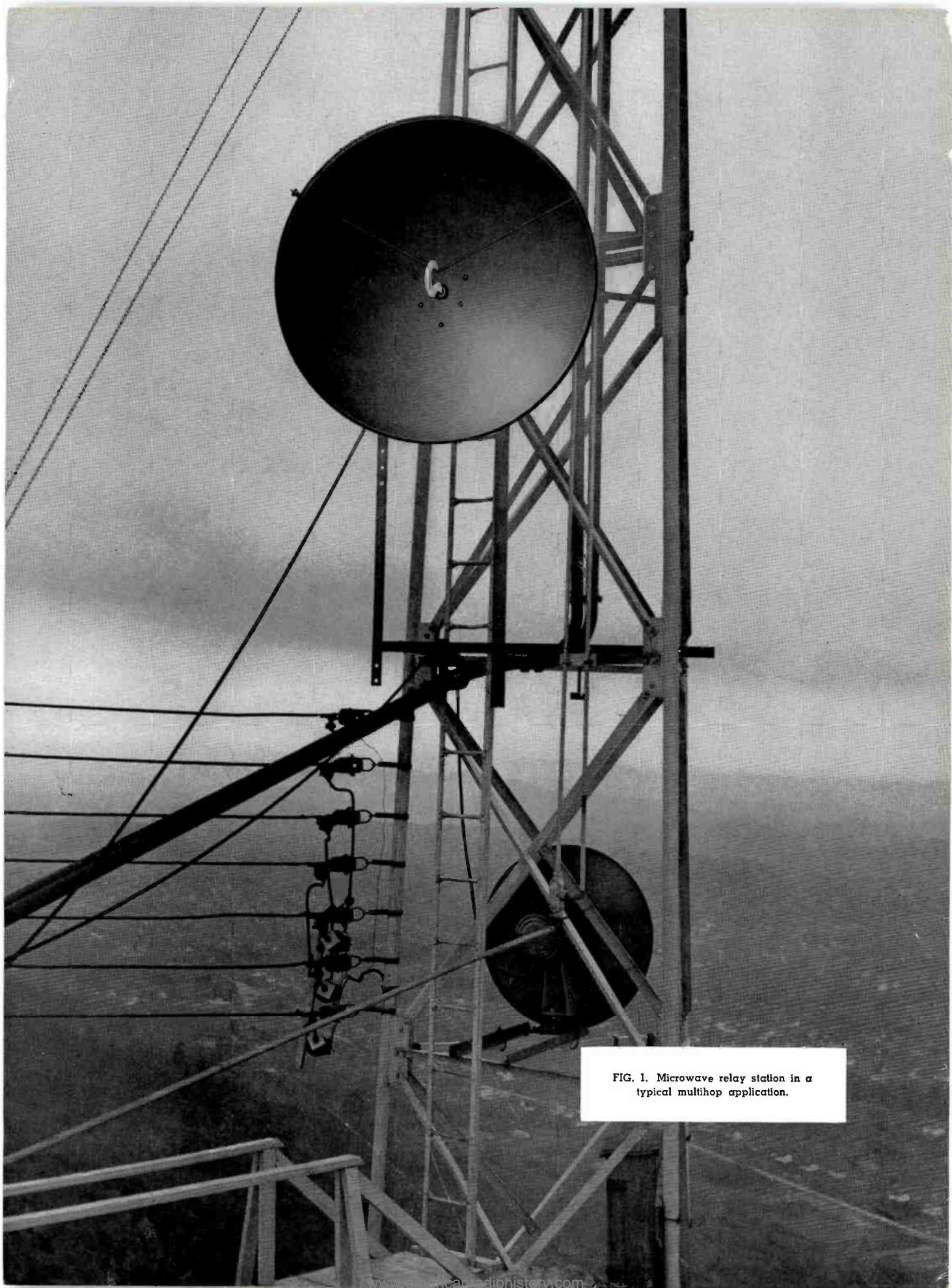

FIG. 1. Microwave relay station in a typical multihop application.

PLANNING TV MICROWAVE SYSTEMS

How to Select Suitable Sites, Determine Antenna Heights and Propagational Reliability for Both Single and Multihop Systems; Also Selection of Towers, Buildings, and Power Accessories

Unlike most types of television equipment, microwave relay systems depend on a transmission path which is only partly controllable by the user. The over-all performance of the system is affected not only by the equipment itself, but also by the path over which it must be operated. To take advantage of the many excellent features of the RCA TVM-1A Microwave Relay equipment, it is essential that the installation be carefully planned. It is in the initial planning that the station engineer assumes a major role in determining requirements based upon local terrain conditions and microwave principles.

The microwave planning information contained in this article is an accumulation of many years' experience by RCA engineers in designing and installing microwave systems for both broadcast and general communications use. By using this information, the station engineer can determine what electrical and physical factors will influence the performance of his proposed system. He can determine what antenna heights will be necessary to give most reliable performance; and what antenna or passive reflector sizes should be used. And finally he can plan a system with optimum performance for his particular needs.

Equipment and Its Application (See Fig. 1)

The complete RCA microwave system, TVM-1A, is comprised of a relay transmitter used with a relay receiver. This combination results in a highly directional wideband relay link especially suited to the transmission or reception of television video signals, color or monochrome. Such a system has the following important applications:

- (1) As a fixed video link between studio and TV transmitter.
- (2) For field or portable pickups.
- (3) As an unattended repeater station, when distances or obstacles necessitate one or more additional links to reach the picture signal destination.

This RCA television microwave equipment is particularly suited for use in multihop systems for serving small-city television stations and community antenna systems. The use of the TVM-1A equipment in this manner introduces additional planning factors which result from the operation of systems in tandem and from the fact that the relay points are ordinarily unattended. These factors are discussed in the section devoted to multihop systems, page 15.

A description of the RCA TVM-1A Microwave Equipment and a discussion of its advanced features important to the planning of microwave systems can be found on page 22.

Fundamentals of Microwave Propagation

Microwave energy is popularly assumed to travel from transmitter antenna to receiver antenna in a "beam" similar to that emitted by a searchlight. Actually, the situation is somewhat more complicated since the amount of energy received is affected by:

- (1) The proximity of the earth which diffuses or scatters part of the energy from the beam and which may reduce the signal received, even though a "line-of-sight" path exists between the transmitting and receiving antennas.
- (2) Reflections from the surface of the earth which may arrive at the receiver

in-phase or out-of-phase with the direct signal, thus reinforcing it or cancelling it.

- (3) Variations in density of the earth's atmosphere which cause the path of the beam to bend and which, under certain conditions, may cause fading.
- (4) Diffraction over or around obstructions.
- (5) Foliage, the density of which varies with the seasons, causing diffusion or scattering.
- (6) Open water or marsh land, which causes varying degrees of reflections.

For optimum results, it is necessary to plan the microwave system so that the effects described above will be minimized.

Fresnel Zone

To minimize loss of signal due to absorption by the earth, it is necessary to provide more than "line-of-sight" clearance. A significant amount of the received energy, in effect, traverses other than a straight-line path. The region in which most of the useful energy is concentrated is called the Fresnel Zone, as illustrated in Fig. 2. In theory, this region should be free of all obstructions; in practice, it has been found desirable to provide greater clearances for longer paths, while smaller clearances may be used for the shorter ones. Recommended clearances are given in the section devoted to antenna heights.

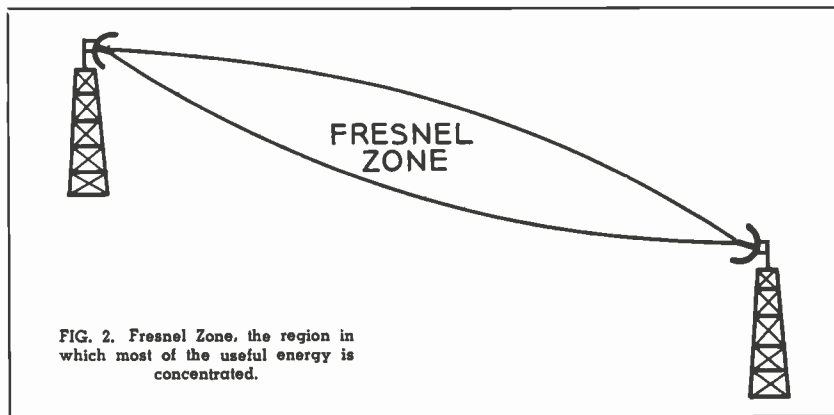

Owing to the extremely short wavelength of microwave radiation, the surface of the earth is ordinarily a poor microwave reflector. Furthermore, such reflected energy usually is scattered diffusely so that very little of it reaches the receiving antenna. Occasionally, however, the nature of the terrain will be such as to produce a strong reflected signal. This occurs on over-water paths or when the terrain is smooth, highly conducting and free of vegetation (certain desert areas).

Fading

Terrain producing strong reflected signals is always undesirable and should be avoided whenever possible. When the path-length difference between the direct and reflected waves is such that the two arrive out of phase, cancellation occurs and will produce a deep fade. Since the path-length difference may be changing constantly due to changes in atmospheric conditions, such paths are usually subject to severe fading. Special techniques such as high-low siting which is discussed later have been developed to avoid these effects.

If the atmosphere were perfectly homogeneous, energy from the transmitting antenna would travel in a straight line to the receiver. Due to variations in density, however, the path of the energy is refracted or bent. This can result in fading of the whole signal for a number of reasons, for example:

- (1) The whole Fresnel Zone may, in effect, be bent downward in the middle of the path so that energy is diffused or scattered from the beam.
- (2) The beam may be bent so far upward that it misses the receiving antenna entirely.
- (3) Multipath transmission may occur within the diffracting medium due to sudden changes in density of adjacent layers.

Nearly all paths are subject to some fading from atmospheric effects. Therefore, it is customary to make a fading allowance when planning microwave systems. In most parts of the country a standard fading allowance can be used with reasonable accuracy and will therefore be assumed.

In a few regions, particularly those which are subject to frequent periods of humid or stagnant air where wind velocities are less than five miles per hour, more severe fading can be expected. The presence of ground fog, in particular, is often an indication of fading conditions. The most prevalent fading regions are found in the

tropical and sub-tropical zones. It is desirable to make a special engineering analysis of any proposed paths in such areas.

Use of This Planning Guide

In planning a TV microwave relay link, the engineer must determine fundamentally these questions:

- (1) What are the electrical and physical factors which will limit system performance?
- (2) What antenna heights should be used?
- (3) What antenna or passive reflector sizes should be used?
- (4) If unusual propagation or antenna-siting conditions exist, what special steps should be taken to insure satisfactory operation? (Problems of this nature should be referred to competent authorities.)

This Guide will permit the user to determine the answer to the first three of these questions except when unusual conditions exist. It can be said that unusual conditions exist:

- (1) Where it is impossible to provide sufficient antenna height to maintain the path clearance indicated in Fig. 3.
- (2) Where the path is over water or over smooth terrain which might produce strong reflections. The terrain may be considered smooth if variations in height all along the path are less than 75 per cent of the first Fresnel Zone radius computed at the center of the path (see Fig. 4).
- (3) Where the path length is greater than 10 miles and atmospheric conditions are conducive to unusually severe fading as described in the section on fading (page 10).

Site Selection

Sites for microwave stations should always be chosen to provide adequate line-of-sight transmission paths if reliable operation is to be insured. At the same time, attention must be given to the system requirements and to operational convenience. System requirements will be more fully considered in the section on multi-hop systems.

As a first approximation, sites should be selected which are not more than 20 to 30 miles apart unless the topography of the intervening terrain is such that adequate clearances over a longer path may be obtained. Potential sites should be located on a topographic map of the district. A topo-

graphic map is a graphic representation of the configuration or shape of a portion of the earth's surface. If more than three stations are to be used in the system, the methods outlined in the section on multi-hop systems should be strictly observed.

If the sites selected satisfy these requirements, their merits should be evaluated from an operational standpoint. Preferably, the sites should be level and accessible to vehicles and a commercial power line should be within reasonable distance. Power regulation should be inherent or otherwise provided by automatic devices.

Path Survey

Having made preliminary site selections, the terrain over which the path passes should be analyzed. Where maps are available and are of known accuracy, they may be used for this purpose; otherwise, a rough physical survey of the path must be made. During this survey, a note should be made of the height of any prominent obstacles, either natural or man-made. The general characteristics of the terrain, such as density of foliage, large bodies of water, swampy areas, rocky or sandy soil, should be noted. A physical inspection of the sites should always be made before attempting to erect stations at locations chosen on the basis of map or aerial-survey information.

Calculation of Antenna Height

The first step in the calculation of transmitting and receiving antenna heights is to obtain an accurate profile of the ground level along the transmission path. This can be done by a number of methods. Where accurate topographic maps are available, they provide a simple and satisfactory means of obtaining the terrain profiles.

A bulletin entitled "Topographic Maps" as well as maps for specific areas may be obtained by addressing inquiries to the United States Geological Survey, Washington 25, D. C., or to Denver 15, Colorado, for maps of areas west of the Mississippi.

Where accurate maps are not available, a physical survey of the path should be made. This can be done with accurately calibrated sensitive altimeters which are properly adjusted in accordance with the barometric pressure and referred to a known point or bench mark. This is known as the American Paulin system. A line joining the two sites is drawn on a county highway map and the altitude measured at each point where the line crosses a road. Elevations between roads can be estimated but critical obstructions should be measured exactly.

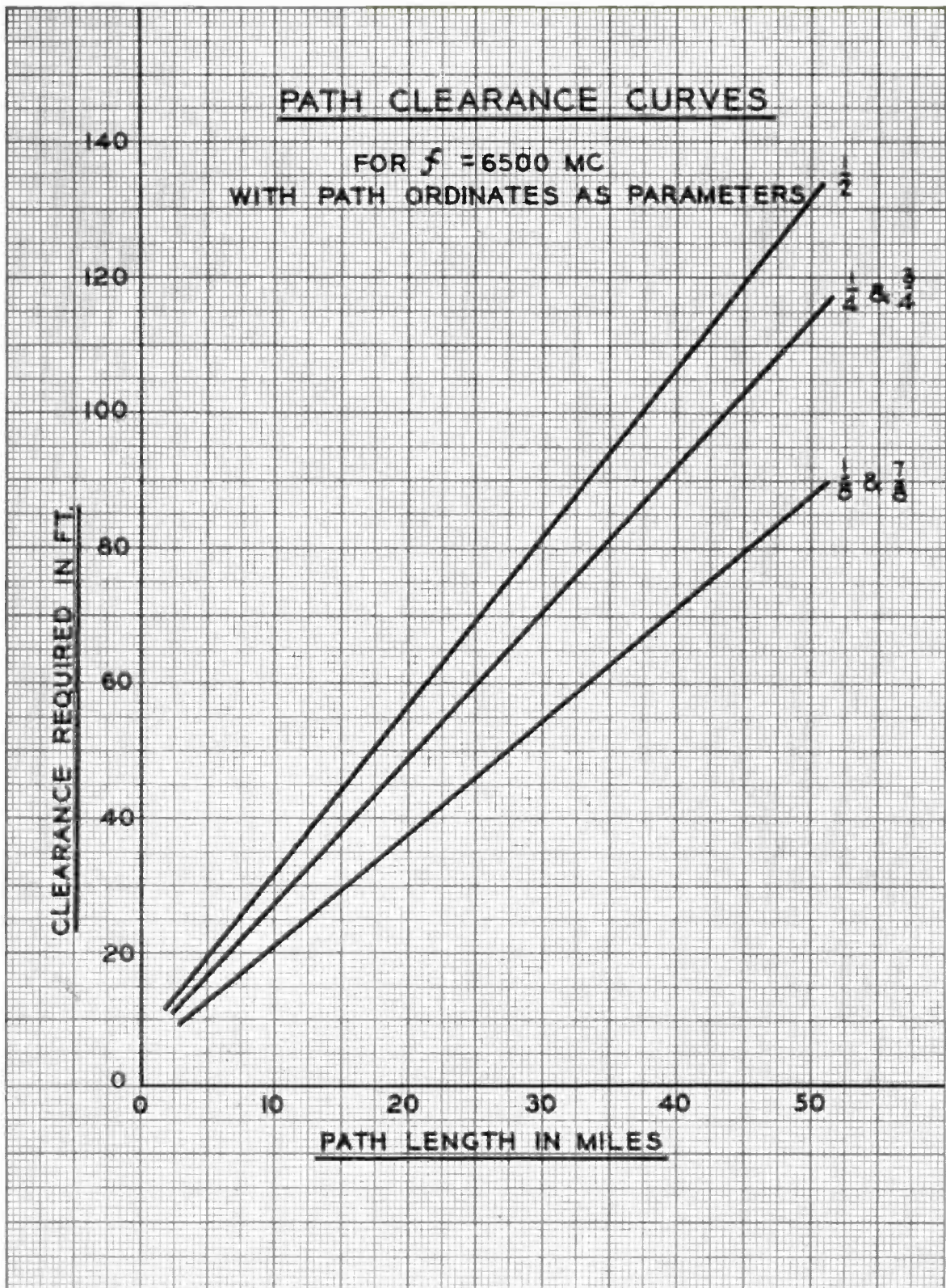

FIG. 3. Path clearance curves showing clearance values over a series of path lengths. Curves show clearances at the $\frac{1}{2}$ -point, $\frac{1}{4}$ and $\frac{3}{4}$ -points and $\frac{1}{8}$ and $\frac{7}{8}$ -points.

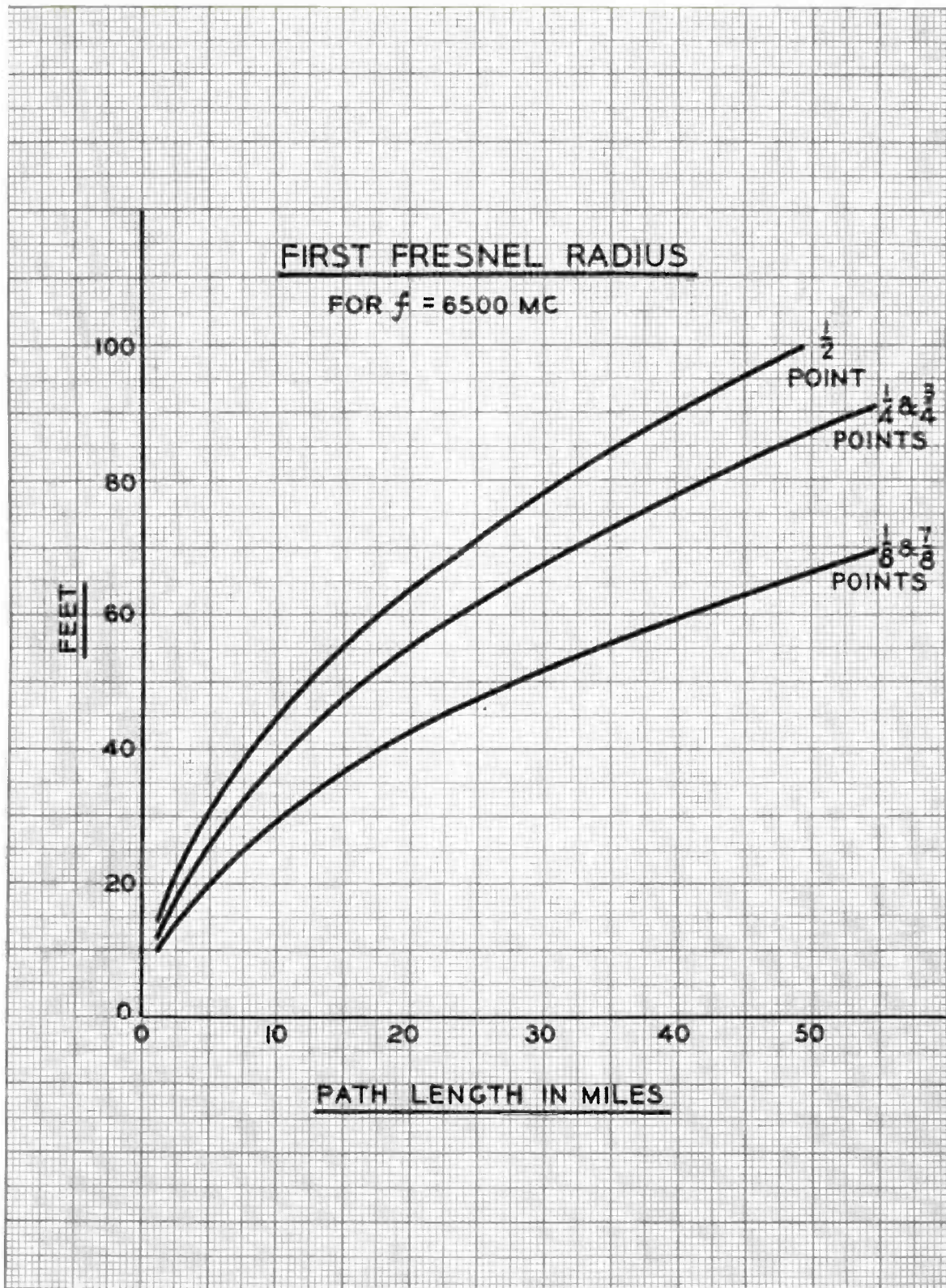

FIG. 4. First Fresnel radius curves for various path lengths.

More elaborate methods of surveying may be used including conventional civil engineering techniques or the use of an aircraft-mounted absolute altimeter. However, their expense makes the use of simpler systems desirable whenever possible. The importance of a sufficiently accurate survey cannot be overemphasized and judgment must be exercised to insure that adequate data are obtained.

Multipath Signals

Attention should at this time be given to the possibility of multipath signals caused by reflections from the earth's surface. Such reflections are negligible when operating over irregular terrain such as encountered in rolling countryside. They become increasingly objectionable over smooth terrain. If the use of paths over smooth terrain is unavoidable, the expedient of high-low siting of stations should be used whenever clearances permit. This condition is illustrated in Fig. 5.

In Fig. 5, top, the path of the reflected signal is appreciably longer than the direct path and the reflected signal is therefore subject to greater variations (phase shift) relative to the direct signal.

Figure 5, bottom, shows that paths of the direct and the reflected signals are geometrically more equal in length. Since the point of reflection is near the low end, the signals are subjected to essentially the same propagation conditions. In many instances, the use of this technique will necessitate an additional repeater station. An economic evaluation may indicate it more expedient to find an alternate transmission path.

Over-Water Paths

Over-water paths should be avoided if at all possible. When such paths must be used, high-low siting of stations may prove useful. Another technique which is sometimes useful is to take advantage of the natural screening provided by terrain obstructions or by buildings.

Using an obstruction to reduce the reflected signal requires careful analysis, since the angle of approach of the reflected and direct rays is very small. This is not too apparent on the distorted scales used in preparing path profiles.

In case the path length is short enough to assume very little beam bending, the direct ray obstruction loss will be negligible. However, as the distance increases, this loss will become more significant due to the greater diffraction medium. This results in a lower net gain, but fading stability can be improved. Figure 6 shows a typical instance in which protection is available.

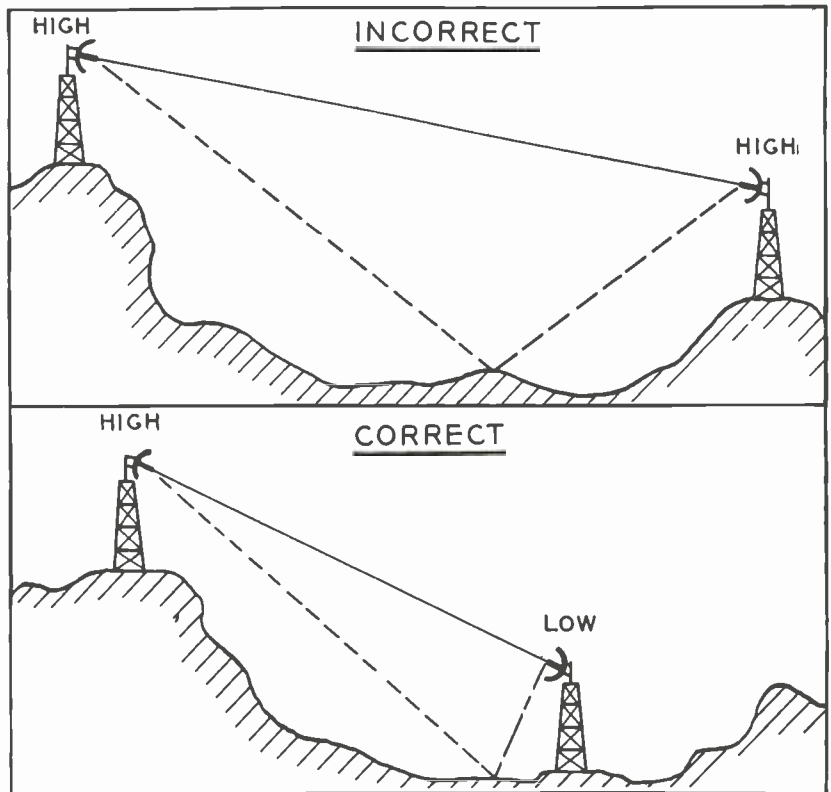

FIG. 5. Siting of stations over smooth terrain (see text for correct interpretation).

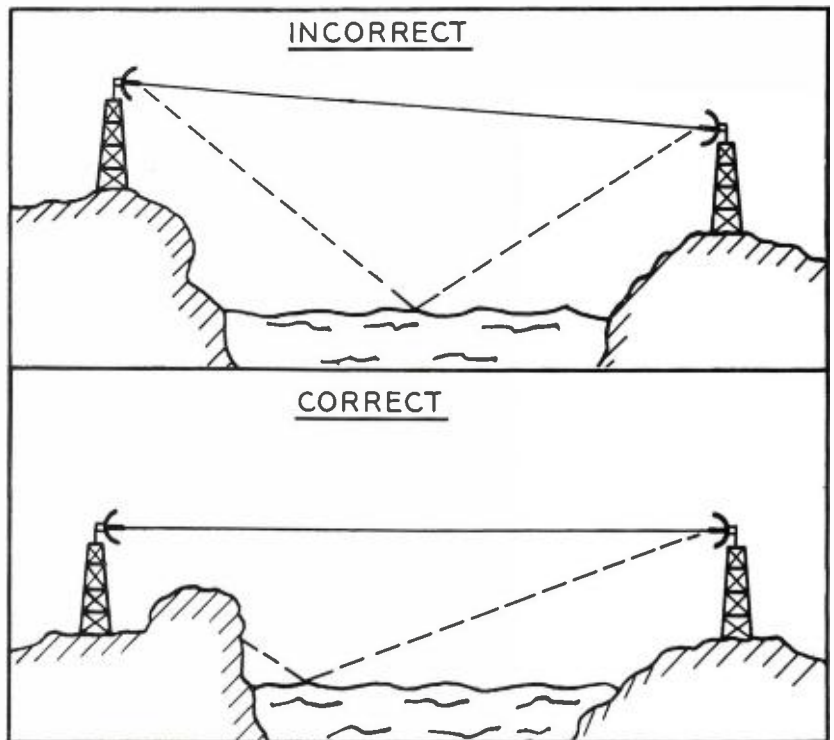

FIG. 6. Siting of stations over water.

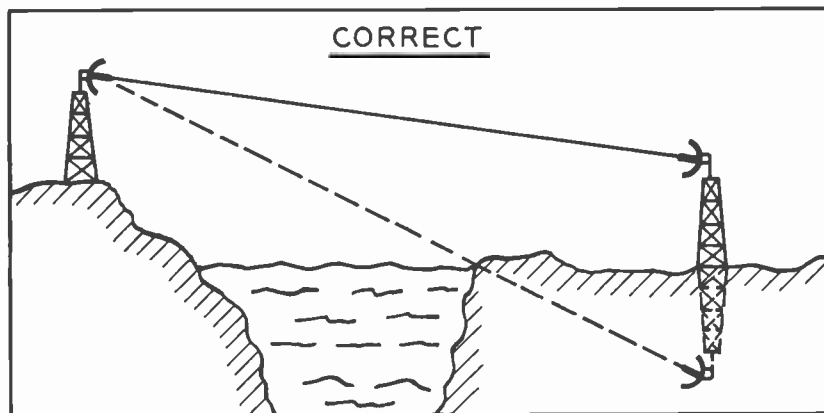

FIG. 7. Correct siting for a part water—part land path.

Circuits working over a path which is part land and part water should have station sites so located that the multipath point of reflection is located on the land portion of the path and as near to one station site as possible. This condition is illustrated in Fig. 7.

The multipath point of reflection can be determined with reasonable accuracy by extending the beam to the image of the antenna and noting the point where it enters the earth's surface.

Path Clearance Requirements

As a final consideration before drawing the clearance zone on the path profile, an assessment should be made of the prevailing weather conditions over the various routes in the system.

According to the anticipated weather and general features of the terrain, the values for the clearances, as obtained from Fig. 3, should be multiplied by a factor which can be obtained from the tabulation given in Table I.

As a general guide, it may be assumed that the terrain which the microwave path crosses is "broken" if the variations in profile height all along the path are greater than 75 per cent of the first Fresnel Zone radius computed at the center of the path. (Refer to Fig. 4, first Fresnel Radius.)

In broken terrain, ground reflections will not cause excessive interference with the direct signal providing that the profile irregularities are located at random intervals along the path.

TABLE I

Path clearance correction factors according to anticipated weather and general features of the terrain.

Path Length	Nature of Terrain	Weather	Multiply Path Clearance, Fig. 3, By
Up to 18M	---	----	1.0
18 to 28M	Broken	Normal Air Turbulence	1.0
18 to 28M	Smooth	Normal Air Turbulence	1.25
29 to 40M	Broken	Normal Air Turbulence	1.25
29 to 40M	Smooth	Normal Air Turbulence	2.0
18 to 28M	Broken	Ground Fog Prevalent	1.25
18 to 28M	Smooth	Ground Fog Prevalent	1.5
29 to 40M	Broken	Ground Fog Prevalent	1.75
29 to 40M	Smooth	Ground Fog Prevalent	2.25

Having determined the required correction factor for the path clearance ordinates, the corrected zone may be drawn on the path profile.

Path Profile

The elevations, including the height of obstructions, should now be drawn on special 4/3 earth's-radius graph paper. Figure 8 shows a typical microwave path drawn on profile paper. In the absence of more specific information, a fixed allowance of 50 feet should be made in rural areas for trees, low buildings and other obstructions when these are not known. In urban or metropolitan areas, suitable allowance must be made for tall buildings. This can ordinarily be done by visual inspection.

When plotting elevations on this paper, note that only one vertical scale can be used with a given horizontal scale. Suitable pairs of values are shown at the bottom of the graph. Also note that the middle of the path should be located at the center of the graph.

At the end of each path, insert vertical lines to scale to represent the chosen antenna tower and join the tops of the lines with a straight line to represent the direct radio path. Divide this path into sections representing $\frac{1}{8}$, $\frac{1}{4}$, $\frac{1}{2}$, $\frac{3}{4}$ and $\frac{7}{8}$ of its total length. At these points, measure at right angles distances representing the clearances appropriate to the path length.

At this point refer back to Fig. 3 and note that the graph shows the required clearances at these section points for paths of varying lengths. The path clearance zone may be drawn by completing the curve delineated by the section clearance points as illustrated in Fig. 8.

Path Length

The range of a microwave relay system is determined by the permissible signal-to-noise ratio. Calculation of this ratio for a given path is a rather complicated procedure, involving consideration of antenna size, transmitter power, path length, fading, receiver noise figure, system bandwidth and other factors. With the TVM-1A equipment transmitting a standard video signal, these calculations can be reduced to a simple graphical method.

Figure 9 is a plot of signal-to-noise ratio which can be expected from the TVM-1A equipment operating normally over paths of different lengths and under a given set of conditions. These conditions are shown in the upper right-hand corner of Fig. 9 together with correction factors to be used in the event that the actual conditions are different.

How to Determine Parabolic and Passive Reflector Sizes and System Propagational Reliability

Example:

1. A profile plot was made and adequate clearances were obtained as indicated in the preceding section.
2. Path length—20 miles.
3. Distance from passive reflectors to parabolic reflectors mounted on the ground—150 feet.
4. A propagation reliability of 99.9 per cent is expected.

Refer to Fig. 9 and note that at a path length of 20 miles the signal-to-noise ratio exceeds minimum acceptable signal-to-noise by 12 db for 99.9 per cent of the time. This represents a system using 6-foot dishes without passive reflectors. Thus, a correction factor, for passive reflectors and/or smaller parabolic reflectors, of -12 db can be applied and the signal-to-noise will still exceed the minimum acceptable value 99.9 per cent of the time. Refer to Fig. 10 and note that at a reflector height of 150 feet a combination of a

4-foot parabola and 4x6-foot reflector at one end and a 4-foot parabola and 6x8-foot reflector at the other end will result in a correction factor of -8 db plus -3.7 db which equals -11.7 db, or the minimum acceptable signal-to-noise will be exceeded slightly more than 99.9 per cent of the time. If the economics warrant, the reliability can easily be increased by utilization of 6-foot parabolic reflectors and 6x8-foot passive reflectors. The correction factor for two reflectors is -3.6 db. Thus the reliability will be greater than 99.99 per cent.

The curves have been calculated allowing a factor of 6 db for tube aging. With new tubes and optimum equipment adjustment, this degree of improvement should be achieved over and above that indicated.

The signal-to-noise ratio scale on the left-hand side of Fig. 9 is based on an arbitrary reference for which 0 db represents the minimum signal-to-noise ratio which will result in a picture of sufficient quality to be acceptable during periods of fading.

The curves indicate random noise only and do not include a-c hum which is relatively independent of path length. They also assume 100 per cent equipment reliability (no equipment failure).

Propagational Reliability

Inspection of these curves indicates that the possible range of the equipment is largely determined by the reliability of the transmission path required. Then, if one is satisfied with 99 per cent reliability, the range of the TVM-1A equipment suitably installed is in excess of 50 miles; if 99.9 per cent reliability is required, the range is reduced to approximately 33 miles; while a requirement of 99.99 per cent would reduce the range further to 23 miles. The range can be increased somewhat by the

use of parabolic reflectors larger than 6 feet, upon which the foregoing figures are based.

As an indication of the reliability represented by these percentages, the corresponding number of hours of outages per year are tabulated below. Ordinarily, most of these outages occur during 3 to 4-hour intervals at about sunrise and sunset.

<u>Per Cent Reliability</u>	<u>Hours Outages per Year</u>
99.0	87.6
99.9	8.7
99.99	0.87

Multihop Systems

The high power, stability, excellent transmission characteristics and operational features of the RCA TVM-1A equipment make it well suited for use in multihop systems of moderate length. This section is devoted to a description of the engineering principles which should be followed in planning such systems.

Location of Multihop Sites

Unlike single hop systems where the transmitter and receiver location are ordinarily fixed by the terminals of the circuit,

the intermediate relay points in a multihop system can frequently be selected to take advantage of the natural terrain features. This flexibility increases the responsibility of the designer, since the choice of optimum sites requires a careful study of construction costs, land costs, site accessibility, power availability, and other factors.

Because outage time due to fading is cumulative in a multihop system, it is usually desirable to use shorter paths than the longest which could be employed in a single hop system. If the path lengths are too short, on the other hand, the possibility of outages due to equipment failure and signal distortions are increased because of the large number of hops required. Path lengths in the order of 20 to 30 miles are recommended for the TVM-1A microwave equipment in multihop service as a compromise between these requirements.

Certain obvious physical considerations must be kept in mind in selecting sites. These include accessibility under all types of weather conditions, availability of power, CAA restrictions and the suitability of the soil for tower foundations and guy anchors.

In a system containing more than two hops it is customary to use two transmitting frequencies with the same frequency

FIG. 8. A typical microwave path drawn on profile paper.

PROF
 BASED ON 1.33X

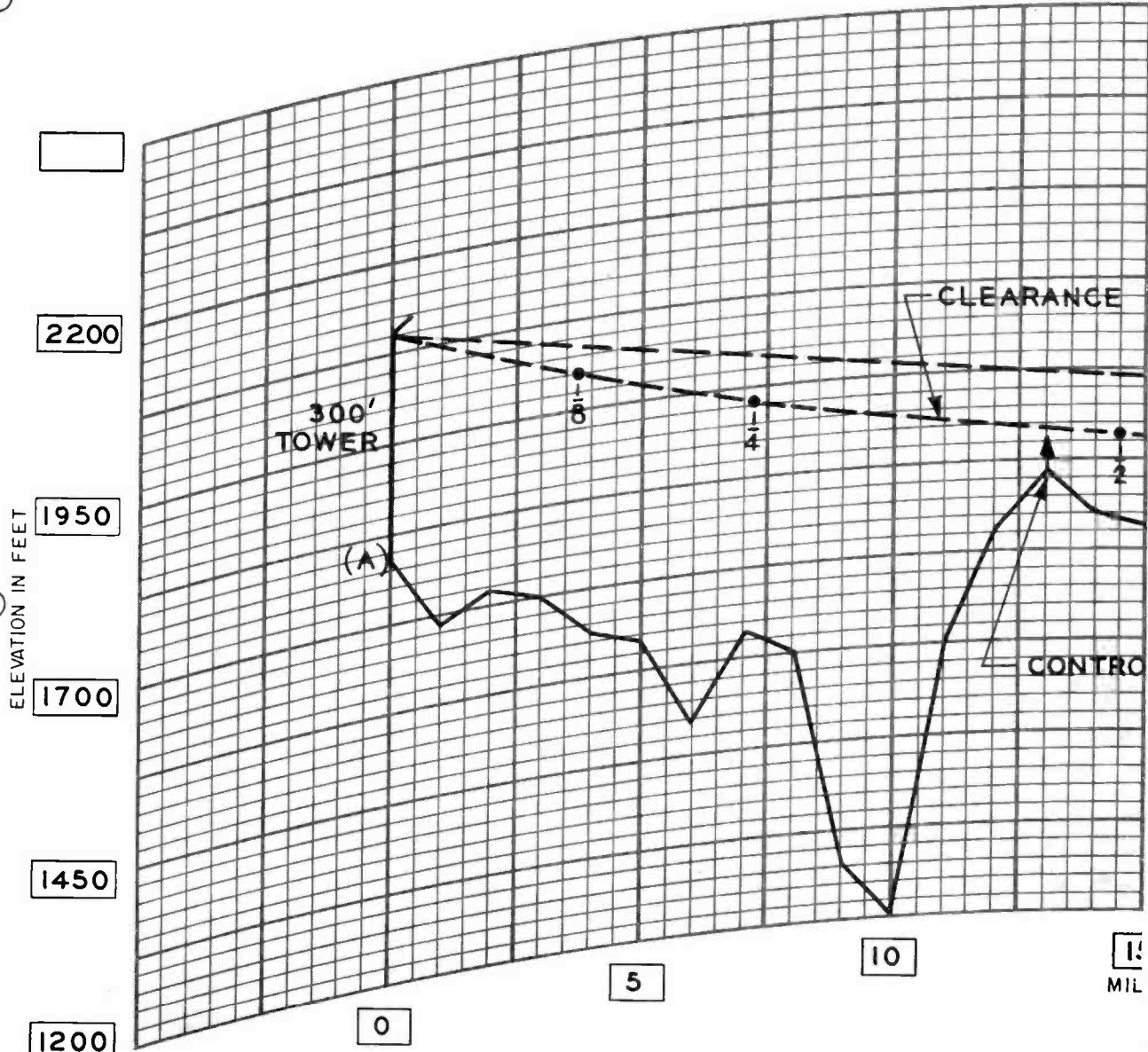

FROM (A) MARIENVILLE, PA.
 TO (B) MILLEN SCHOOL, PA
 SOURCE DATA TOPOGRA

MAJOR SCALE DIVISIONS	
HORIZONTAL	VERTICAL
5 MILES	250 FEET
10 MILES	1000 FEET

PROP. _____ ENGR. _____
 CUSTOMER _____

FILE
EARTH'S RADIUS

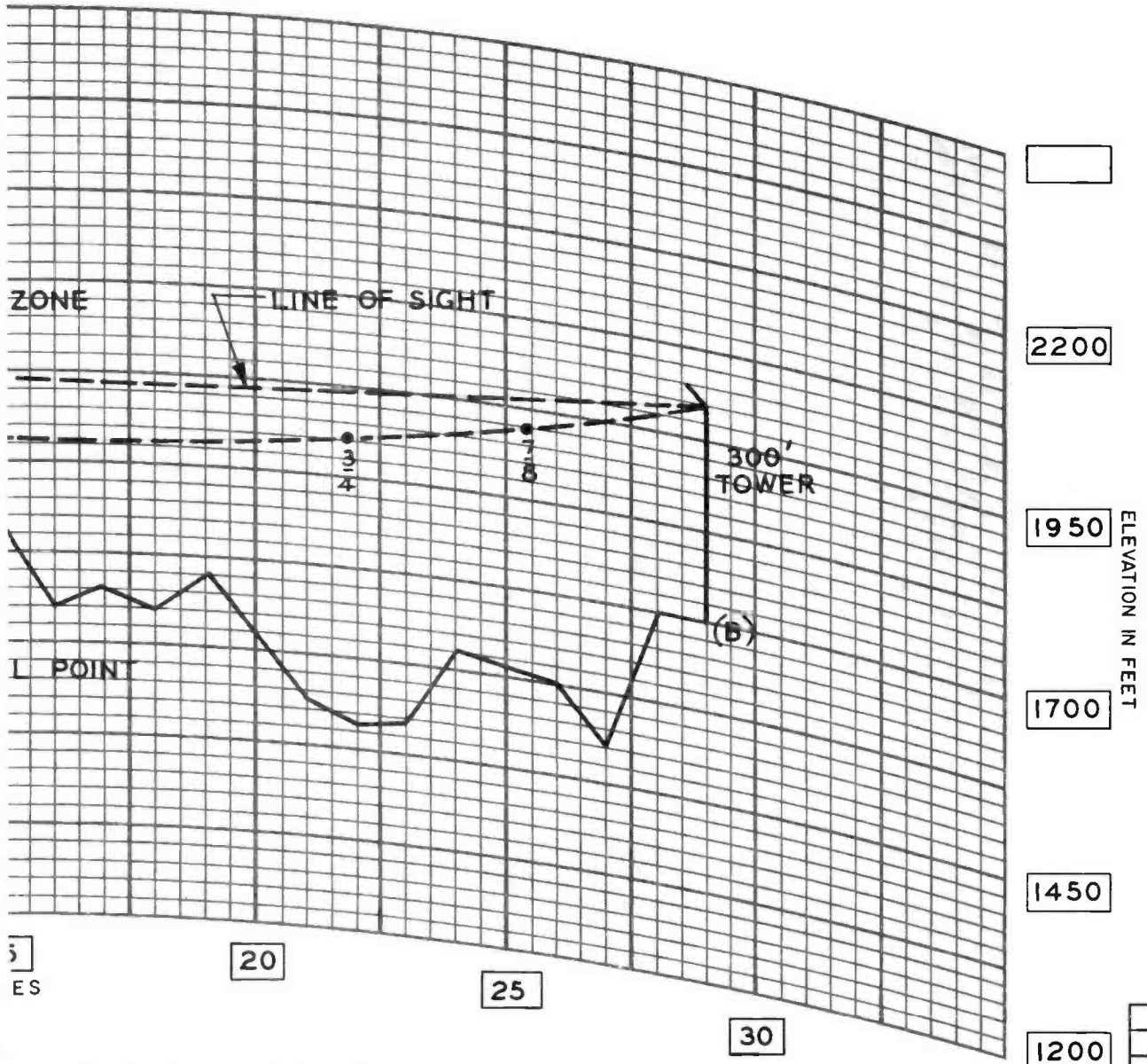

LAT. $41^{\circ} 28' 40''$ LONG $79^{\circ} 5' 45''$
 LAT. $41^{\circ} 3' 25''$ LONG $79^{\circ} 6' 25''$
 PHYSICAL MAP

DATE _____

RADIO CORPORATION OF AMERICA CAMDEN, NEW JERSEY	
B	

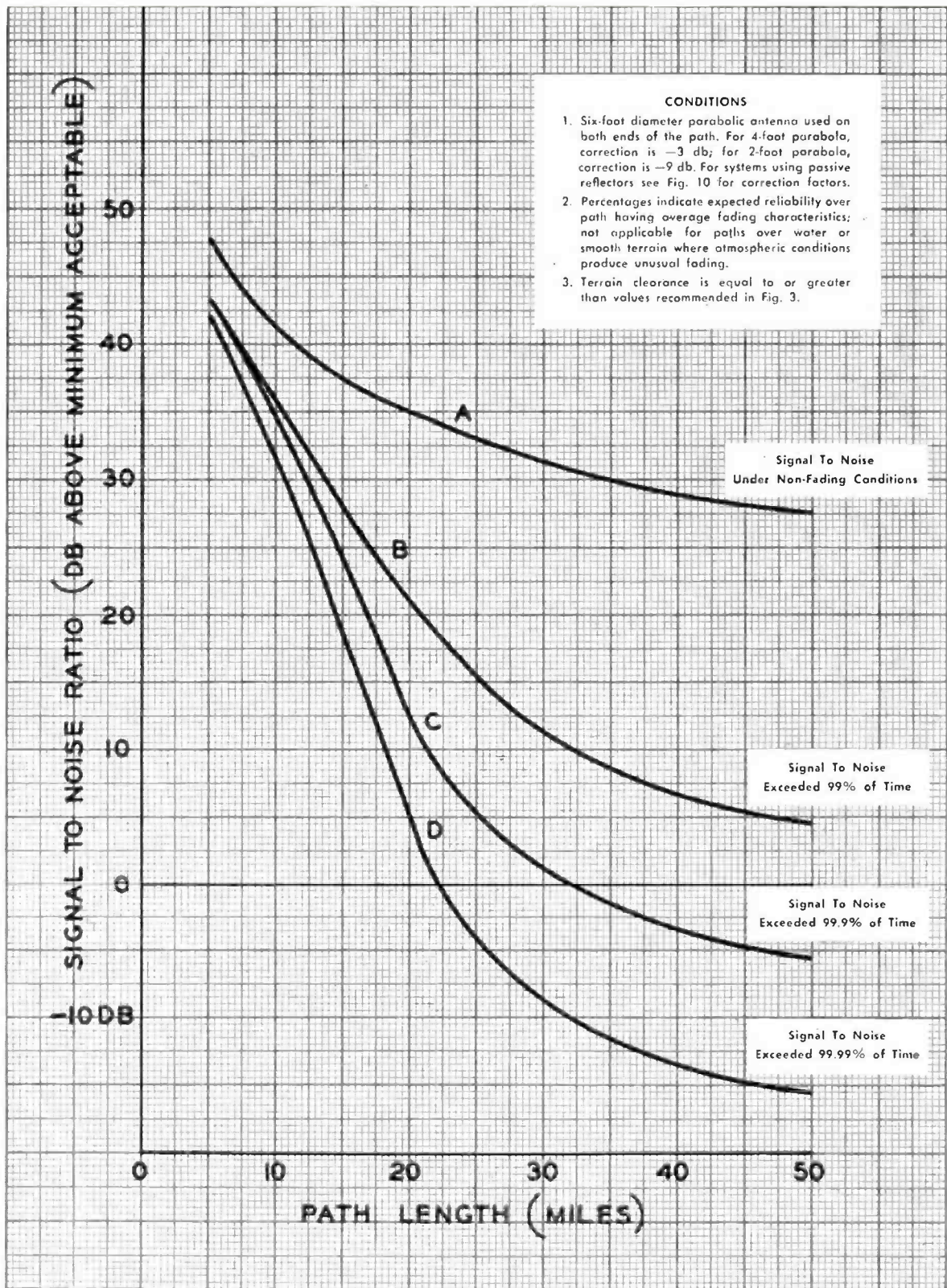

FIG. 9. Signal to random noise ratio curves for RCA TVM-1A Microwave equipment. (See Note, page 21.)

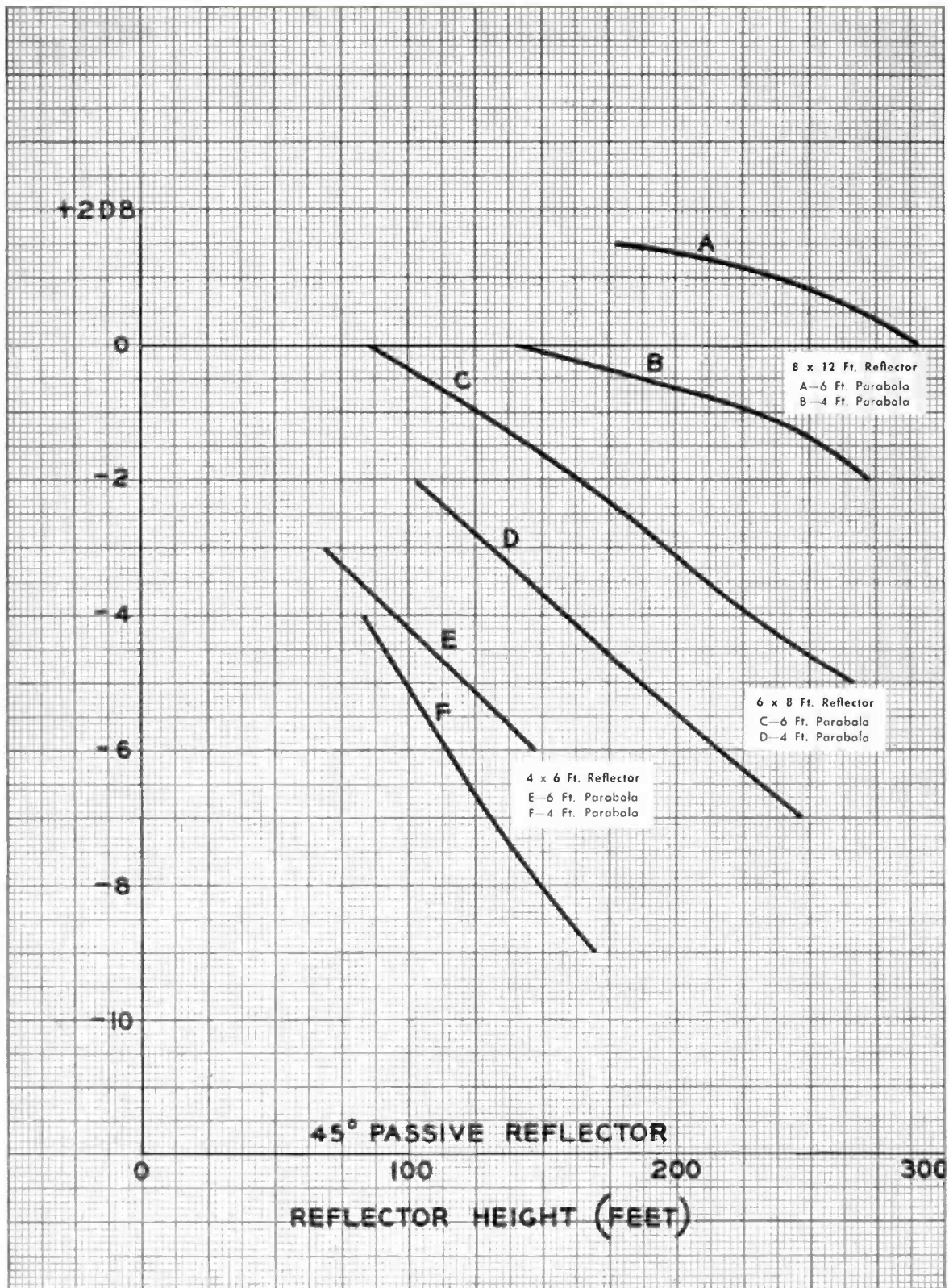

FIG. 10. Correction factors to be applied to signal to random noise ratio in systems using passive reflectors.

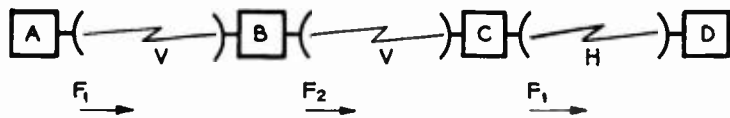

FIG. 11. A multihop system using two alternating frequencies to avoid interference.

being used on alternate hops as shown in Fig. 11. This is required because of the possibility of the signal from the repeater transmitter entering the receiver at the same location.

Although a line-of-sight path would not ordinarily exist over the distance covered by a multihop system, certain atmospheric conditions may cause abnormally long-distance transmission to occur. If the sites are in line, this might cause interference known as overshoot as shown in Fig. 12. In such cases it is advisable to locate site D so that a line drawn from site A to site D is at least 4 degrees from a line drawn from site A to site B, or, alternatively, so that a line drawn from C to D is at least 4 degrees from the line A to D. Both of these conditions are shown in Fig. 13.

Antenna Polarization

Polarization of antennas in a microwave relay system is an effective means of reducing the possibility of interference. With opposite polarizations approximately 20 db of rejection can be obtained. This would involve, for example, using horizontal polarization for the A transmitter and vertical polarization for the C transmitter. See Fig. 13. An electromagnetic wave is linearly polarized when the electric field lies wholly in one plane containing the direction of propagation.

The unwanted overshoot signal is now considerably attenuated since less power is radiated in the direction of the station subjected to interference. In addition, the gain of the receiving antenna at the station will be reduced when receiving an off-beam signal.

For a high-grade circuit, the level of the overshoot signal should be at least 30 db below that of the desired signal. This

amount of protection can often be obtained by the judicious use of terrain features, even when the stations are virtually in a straight line, provided that the overshoot path A to D in Fig. 12 is not less than 50 miles in length.

As a safe rule, however, it is wiser to obtain the required protection by means of antenna directivity since the overshoot signal is subject to erratic propagation conditions. The signal may, during periods of abnormal propagation, arrive at D comparable in strength to the direct signal transmitted from C.

System Reliability

Statistics of the local power utility should be studied to determine if the frequency of storm or other outages is higher for a given area than over a potential alternate route. It is desirable to keep a record of the occurrence of such outages and their duration if an accurate estimate of the performance of the microwave equipment alone is to be made.

Preventive maintenance will be essential to maintain the equipment in first-class working condition. With present equipment designs, metering facilities are built in or are conveniently accessible with a multipurpose instrument. Therefore, such maintenance is neither difficult nor expensive.

Propagation Reliability of Multihop Systems

In a multihop system, if the signal-to-noise ratio on any of the hops drops below the minimum acceptable value, the signal-to-noise ratio of the entire circuit will, of course, be below the minimum.

To calculate the total outage time for the entire system, conservative design prac-

tice requires the assumption that none of the individual hop outages will occur simultaneously. This means that the over-all outage time is the sum of the outages of the individual hops. Thus, if a system has three hops each with a reliability of 99.9 per cent, the individual outage time would be 0.1 per cent. Therefore, the total outage time would be 3 times 0.1 per cent or 0.3 per cent and the over-all system reliability would be 99.7 per cent.

Signal Distortion

The extremely low signal distortion of the RCA TVM-1A microwave system makes it particularly suitable for multihop service. Each link in a multihop system may add distortion to the signal. This is particularly true with respect to amplitude frequency response, differential gain distortion and differential phase distortion.

Conservative design practice requires the assumption that the over-all distortion of the system may be as great as the sum of the distortions specified for single hops. For example, the specified tolerance on differential phase shift for the TVM-1A equipment is 1 degree. Thus, the possible differential phase shift error for a three-hop system is three degrees.

In practice, the total distortion will probably be less since there is the possibility of the distortion canceling. Also, it is unlikely that all the equipments will be operating at the limit of their tolerances.

Equipment Considerations for Multiple Hop Applications

Since most relay points are unattended, a number of special equipment problems arise which will now be considered.

Radiation Switch

FCC policy requires that the carrier be turned off during periods when no modulating signal is present. It is preferable, however, to leave the transmitter operating continuously in order to improve tube life, increase the system stability and reduce the possibility of equipment failure.

To solve this problem, the TVM-1A microwave equipment is provided with a radiation switch consisting of an attenuator inserted in the waveguide feed which makes it possible to shut off the transmitter. For unattended points, this switch can be actuated by a relay controlled by the AGC voltage of the receiver at the same location. In this way, the entire system can be turned on and off from the transmitting end of the circuit.

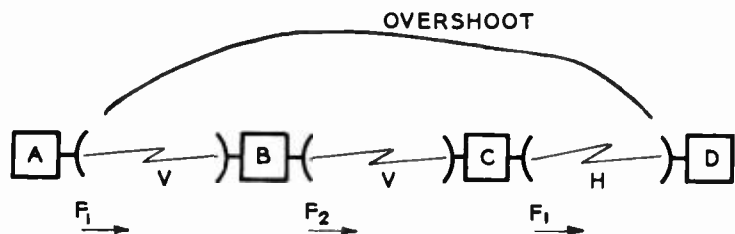

FIG. 12. The same system showing a possibility of interference because of overshoot.

Stabilizing Amplifier Use

Locating a stabilizing amplifier at the receiver terminal of a multi-hop system is recommended procedure. This is good practice in single hop systems and is even more useful in a multihop system. The stabilizing amplifier will greatly reduce any hum introduced by the system and will also minimize transient surges which may occur during periods of rapid fading.

Towers

The selection of the proper tower for the support of the antenna system involves several factors of major importance, of which tower twist and deflection rigidity are paramount. The factors of safety, wind and ice loading, load supporting ability, lighting, grounding system and painting must also be considered. The specifications as given in the RETMA Tentative Standards Proposal on Microwave Towers and Mechanical Characteristics for Microwave Antennas and Passive Reflectors are recommended as a basis for determining tower requirements.

The height of the tower and the obstructive area of the parabola and/or reflector will be determined by the path calculations. Additional information relative to the climactic conditions and the nature of the soil will be necessary. The normal single-hop TV relay will ordinarily use the existing facilities of the broadcast station. However, the unattended repeater station tower requirements will always require individual analysis.

Automatic Tower Light Control

Unless the tower lights are to be left on continuously and are observed by a responsible individual and the failures reported locally to the CAA, a photoelectric cell control relay must be provided to turn the lights on and off. The controls for these lights must have contacts which initiate a failure-alarm signal to some attended

location. Before finally choosing a site, a check should be made with the nearest CAA office to determine the specific local requirements for lighting.

Buildings

The buildings can be any of three basic types: prefabricated steel; poured concrete; or cinder block. The building must be well ventilated, yet waterproof and vermin-proof. Automatically operated vent fans help to maintain proper operating temperatures inside the building.

The concrete building and the cinder-block building are more expensive than the prefabricated metal building, but they do have the advantages of being tighter, provide better heat insulation and are sturdier in appearance. They provide better protection from hunters and vandalism and the slab concrete roof is excellent protection against falling ice.

When a gasoline-driven generator is installed, it is recommended that the building be provided with a firewall between the power room and the equipment room. The firewall provides protection in case of gasoline fire and also prevents corrosive battery fumes from entering the equipment room.

Auxiliary Power

Every effort should be made to locate the relay station close to a good source of commercial power. However, even the best of power lines, especially those in rural areas, are subject to interruption. Therefore, if utmost reliability is necessary, an auxiliary power unit will be needed.

A 3.5-kw gasoline-driven power unit is desirable for unattended repeater stations. This will provide power for the TVM-1A equipment, interior lights, test equipment, soldering iron and tower lights.

The generator must be provided with an automatic transfer panel to sense the loss

of the main power, crank the gasoline engine, transfer the r-f equipment's power leads to the auxiliary generator and return the equipment back to its normal source of power after the source has been restored for at least 15 minutes.

If the time required for switching of this type cannot be tolerated, then a continuous power unit having an a-c motor, an a-c generator and a gasoline engine connected to it with a solenoid-operated clutch can be provided.

In locations where no primary power is available, two motor-generator sets with automatic changeover facilities are usually installed.

Conclusion

The fundamental principles of microwave propagation have been set forth and the kind of information an engineer must possess to successfully plan a microwave system have been described. How to obtain this information has been demonstrated through the use of simplified graphs, which adequately serve for cases in which no unusual conditions are encountered. To complete this article there appears on the following page a short description of RCA Type TVM-1A Microwave equipment which is designed for both color and monochrome operation and can be used for single or multihop installations.

NOTE: The minimum acceptable signal-to-noise ratio under fading conditions as used on the graph, Fig. 9 is based on numerous subjective measurements made by RCA and others (*Perception Television Random Noise* by P. Mertz, Journal of SMPTE, January 1950; *Quality Rating of Television Images* by P. Mertz, A. D. Fowler, H. N. Christopher, Proceedings of IRE, November 1950). Under this condition the noise will be visible but not sufficiently severe to destroy the commercial usefulness of the picture. While a higher signal-to-noise level is required for normal non-fading conditions, the minimum level as shown can be tolerated for short periods of time.

FIG. 13. Locating multihop sites and polarizing antennas to avoid overshoot interference.

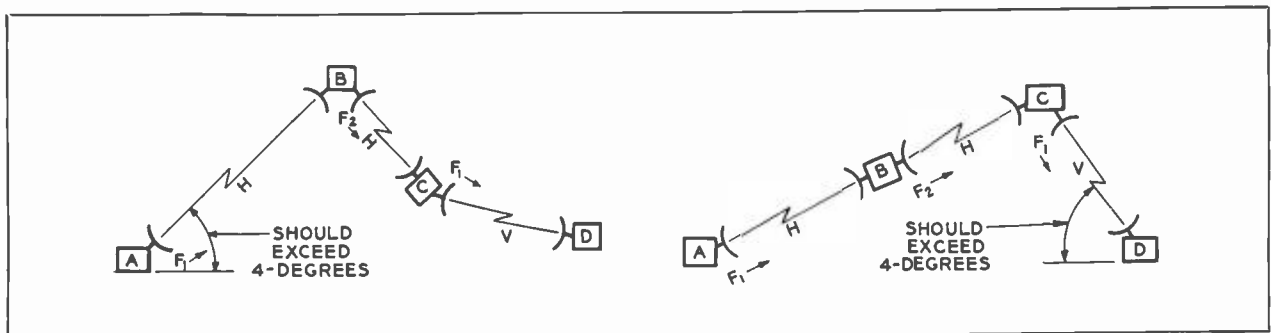

New Microwave Equipment Offers Superior Performance and Planning Benefits for Both Monochrome and Color Use

The TVM-1A equipment was designed to take advantage of the latest advances in electronic circuitry and components with the objective of producing the finest possible television relay equipment. Some of its more important features as compared with older designs are the following:

- (1) One-watt transmitter power output—ten times that previously available. This permits the use of the equipment over longer paths and increases its reliability over any given path.
- (2) Completely re-designed microwave plumbing, i-f amplifier and discriminator to achieve the maximum attainable in linearity of frequency response and minimum distortion.
- (3) Transmission distortions affecting color performance have been greatly reduced. RCA is the only manufacturer of television relay equipment which also manufactures a complete line of

television studio and transmitting equipment. This unique position has made it particularly aware of the necessity of making the distortion in each equipment as low as possible so that the cumulative distortion of the entire system will be within the required tolerance. Thus, "Good for Color" in RCA equipment means not only that the single equipment will pass color satisfactorily, but also that its contribution to over-all system distortion will be small enough so that the complete system can be "Good for Color".

- (4) Operates not only in the television relay band (6875-7125 mc), but also in the common carrier band (5925-6425 mc) and the fixed and mobile band (6425-6875 mc).
- (5) Radiation switch permits transmitter to operate continuously and without

radiating during "off-air" hours when there is no modulating signal. This avoids problems created by equipment warm-up if the transmitter is turned off to comply with FCC requirements.

- (6) Transmitter picture monitor available as an optional accessory.
- (7) Transmitter afc, which stabilizes the transmitter frequency with respect to an Invar cavity, is available as an optional accessory. This unit, together with the excellent linearity and low distortion of the system, makes it suitable for unattended multi-hop operation.
- (8) Excellent system linearity and low distortion greatly reduces cross-modulation between video and audio signals when using the sub-carrier type of multiplexing. This results in an excellent signal-to-noise ratio in the audio channel.

Equipment necessary for a single microwave link is shown below. A variety of mounting equipment is available for a multitude of applications.

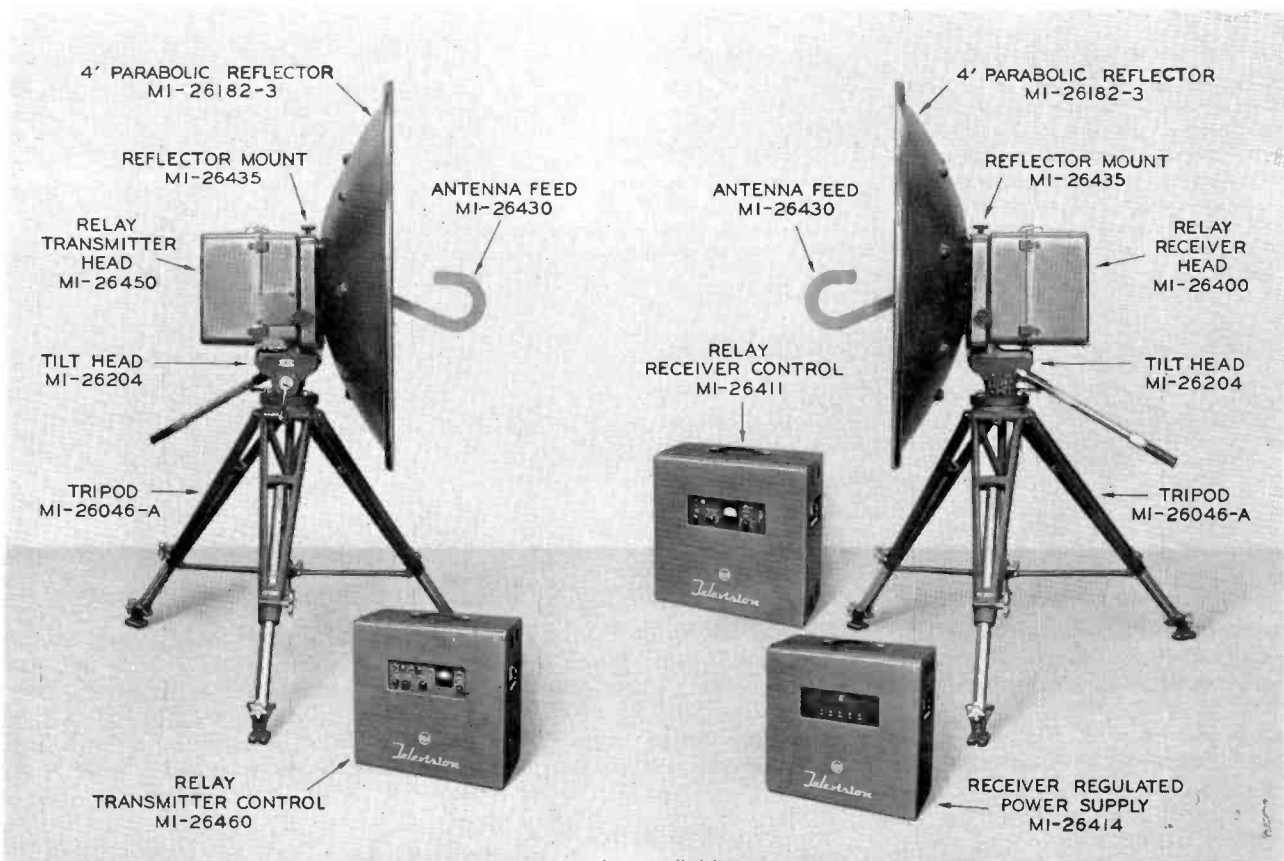

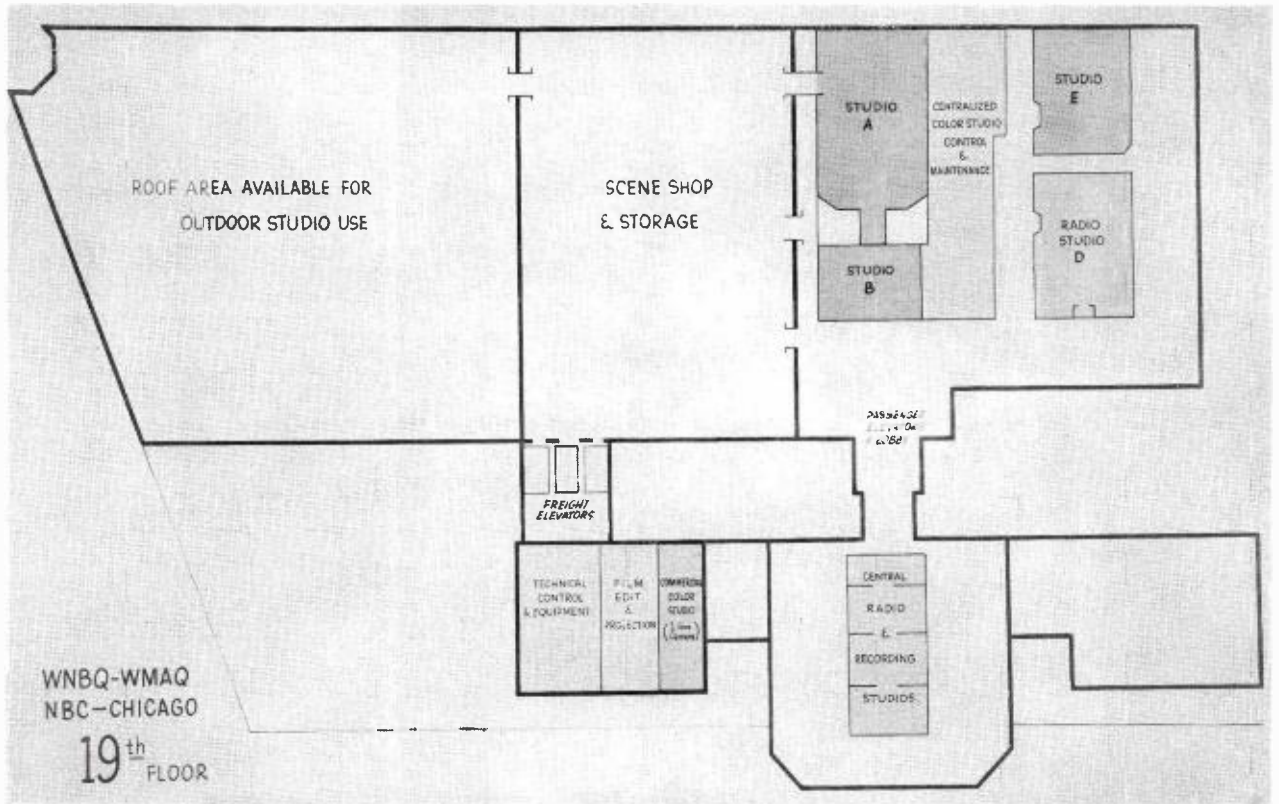

FIG. 2. Floor plan of WNBQ-WMAQ studio on 19th floor of Merchandise Mart, Chicago. All TV studios (A, B, E and the small "commercial" studio) are being converted for all-color operation. Scenery shop is being built on roof adjacent to studios. Additional roof area is available for outdoor shots.

to produce them in quantity. We built color studios and put more and more color programs on the air.

"Network color, which we pioneered, is now well established . . . but we know that network service must be supplemented by good local color programs. That is the next step that must be taken to make color television a full and complete service. That is the step we are taking now."

A "Model" Color Station

Both General Sarnoff and Charles R. Denny, who described the details of the WNBQ conversion for the press, emphasized that it was RCA's and NBC's intention to make WNBQ a "pilot" color operation, and to make all the know-how gained in its construction and operation available to other television stations.

In describing the new WNBQ color studios, Mr. Denny, who is Vice President in charge of NBC-owned stations, pointed out that they will "incorporate all the techniques NBC has learned in network operations, but will be specifically planned to

meet the specialized requirements of local programming." This will be good news to other TV stations because it means that the WNBQ installation will be similar in layout and operating setup to that of an independent station (rather than the grand-scale arrangements of a network studio plant). Thus lessons learned at WNBQ will be applicable elsewhere. It is planned to make all experience gained at WNBQ, including problems of installation, production, programming and maintenance, as well as operating costs, available to other stations for their guidance.

Although the changes described by Mr. Denny are quite extensive, it is significant that WNBQ will be able to make these alterations without loss of studio time, without shuffling its entire operation, and without major changes in the structure of the building. For stations worrying about the changeover to color this should be a reassuring sign.

Target Date—April 15

The color conversion work at WNBQ is

already well along. Two color cameras, one film and one live, are already operating, giving WNBQ some immediate local color. According to Mr. Denny it is expected that the complete all-color installation will be finished and operating by April 15. This, it will be noted, is just in time for the NARTB Convention (Hilton Hotel, Chicago, April 16-20). Open house will be held at the station during that week for all broadcasters who care to inspect the world's first all-color operation.

WNBQ'S Color Studio Plans

Fairly extensive studio and equipment changes will be required for all-color operation at WNBQ. As described by Charles R. Denny, these changes include (a) replacing all black and white equipment with color equipment, (b) conversions of four existing monochrome studios for color operation, (c) installation of additional air conditioning and lighting equipment in these studios, and (d) erection of prop and storage shop adjacent to the present studio area.

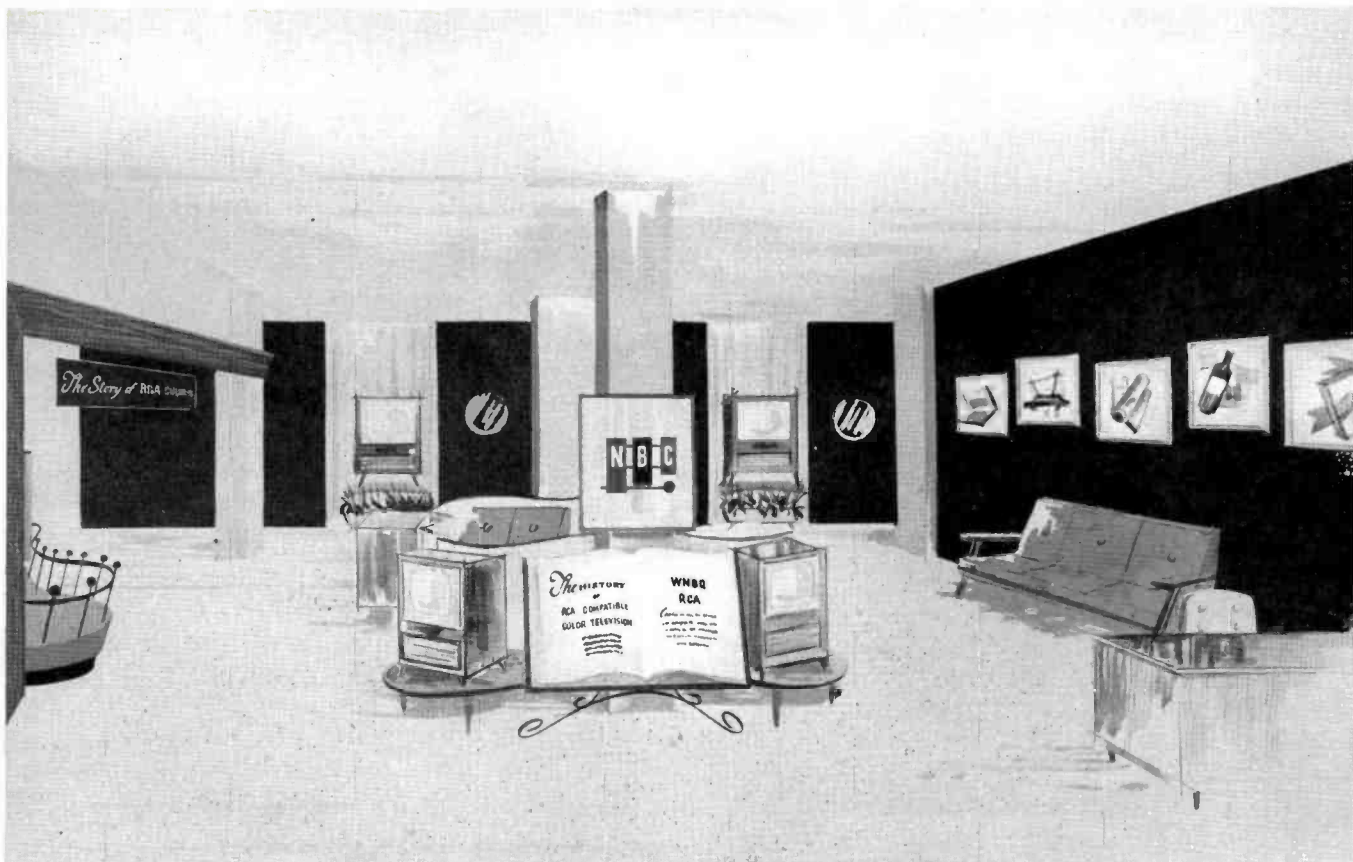

FIG. 3. An artist's sketch of the reception room of WNBQ on the 20th floor of the Merchandise Mart as it will look when remodeled as an "Exhibition" depicting history and growth of television.

A floor plan of the 19th floor of the Merchandise Mart is shown in Fig. 2. The area which the NBC stations, WNBQ and WMAQ, have occupied for many years¹ is at the right. This area is in a "penthouse" which rises above the main 18-story part of the building. Thus it is presently surrounded by a considerable area of unused roof space. NBC has leased 50,400 square feet of this area. A large "Scene Shop and Storage Room" will be erected in the space immediately adjacent to the present studio area. The balance of the leased roof space, to the left of the scene shop, will be available for future expansion and for outdoor studio use.

Studios A, B, E and the small "commercial" studio (at the bottom of the plan, next to the film room) are now used for monochrome programming. All of these will be converted for exclusive color operation. This involves clearing out the black

and white equipment and installing color cameras, special color lighting equipment, and additional air conditioning.

Present Studios A and B will be joined by cutting a corridor through as shown in Fig. 2. This will provide a large operating area for shows using a multiplicity of sets and requiring continuous camera action from one to another.

Color control equipment to serve all color studios will be located in a "centralized color studio control and maintenance" area located between the two large studios. This area will be divided into control room, equipment room and maintenance shop. Placing these three functions in a single area is an innovation which will make maintenance easier and contribute to operating efficiency. For example, a defective camera can be wheeled directly into the maintenance area for quick and easy servicing.

Color Production Plans

While complete details of WNBQ's color programming plans have not yet been an-

nounced it has been indicated that all of WNBQ's regular local shows will be changed over to color. To provide for these the walls of the large studio (combined A and B studios) will be lined with permanent sets (Fig. 1) for The City News Desk, Clint Youle's Weather Map, a modern kitchen, and numerous other sets which are regular recurring scenes in the daily programming of WNBQ.

The small "commercial" studio next to the film room is presently used for staging "live" commercials, news, weather reports, and small single-camera shows not requiring movement of props. A small studio of this sort is very handy because it makes it possible to insert "live" spots between network shows and to stage small short-duration local shows without the inconvenience, and cost, of firing up one of the large studios. Jules Herbuveaux, WNBQ's manager, is very enthusiastic about this unique little studio. With its conversion to color he plans to make it one of the features of WNBQ's color operation. It is interesting to note that this studio was the first orig-

¹ "Chicago NBC Studios", by Harold C. Vance. BROADCAST NEWS, Vol. No. 3, April 1932.

inating point for "Kukla, Fran and Ollie." If Jules Herbuveaux has his way it may well become famous again—this time for pioneering in Color—Chicago style!

WNBQ's Color Equipment

A total of five color studio camera chains will be installed, initially, by WNBQ. These will be the new RCA TK-41A's with the greatly improved, and smaller-sized processing amplifier. One of these cameras will be permanently installed in the "commercial" studio. The other four will be capable of working in either of the two large color studios. All five will be con-

trolled from the control area where a master control desk using standard RCA console and monitoring equipment will be installed.

Two complete RCA 3-V Color Film Camera Chains with associated projectors will be installed in the film room in place of the present iconoscope chains.

Color For Visitors

So that the residents of Chicago and visitors to the city will always be able to see color television in operation, WNBQ is planning a color exhibit on the 20th floor surrounding the upper part of the new color

studio. The exhibit area will be entered from the elevators and will appear as shown in Fig. 3. It will have color receivers that are constantly operating. Even when WNBQ may be carrying a black and white network program, these receivers will carry a special demonstration color pickup from the new studio.

Leading from this exhibit area is a wide corridor which overlooks the large color studio. This will be converted into a giant viewing room from which visitors can look down on operations in the color studio. (Fig. 4.)

FIG. 4. Color television programs seen simultaneously in the studio and on color receivers will be an attraction in the observation gallery which will open off of the reception room in the remodeled WNBQ headquarters. Through the windows at the right visitors will look on rehearsals and broadcasts in the large color studio. On the color receivers at left they will be able to watch the broadcasts.



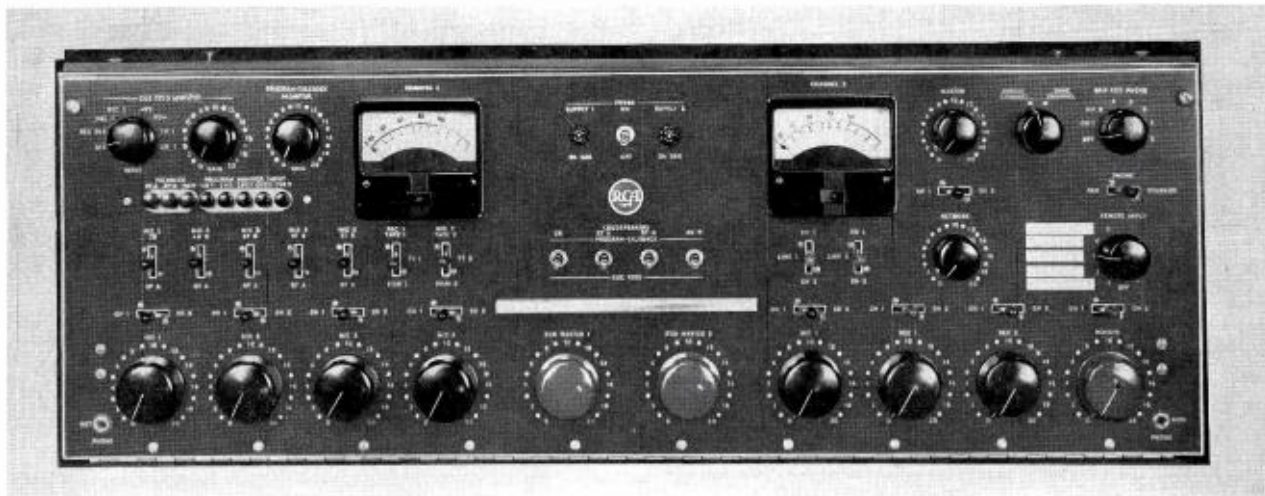

NEW DUAL-CHANNEL CONSOLETTA

Uses Modular Construction With Printed Wiring
 Features "Split-Mixer" Fader, 22 Inputs and Script Shelf
 in Unusually Compact Design

To meet increasing requirements in all types of broadcast stations for added flexibility and increased efficiency, there has been developed the new RCA Type BC-6A Dual-Channel Console. Many stations operating today have felt the need for simultaneous operation of delayed and "on-air" broadcast facilities in order to obtain more efficient operation and to provide more complete service to the listening audience. With the new BC-6A Console, such flexibility has been attained in a small, compact, and fully integrated package scarcely larger than the conventional BC-2B equipment.

Although the BC-6A has been designed to provide two-channel operation, it has strong additional appeal in that it is also a "split-mixer" single-channel console since control of all inputs can be handled by one or both master gain positions. By the term "split-mixer", it is meant that the assignment of fader outputs may be split if desired between either of the two mixers feeding the sub-masters. The sub-masters are, in turn, controlled by the master fader. When used in the single channel mode of operation, both VU meters will follow the one output signal.

From the very beginning of the BC-6A design, functional operation was given

By **E. J. MEEHAN**

Sales Coordinator, Radio Equipment
 RCA Broadcast Department, Camden, N. J.

major consideration. Little used controls, for example, are mounted between the two VU meters directly above a small shelf. This shelf permits placing of script or program material in the center of the control panel at a functionally correct location, eliminating a great deal of the inconvenience formerly required to survey the entire operating position. At the same time the announcer's copy is located in the most convenient and logical position (see Fig. 1).

The console is entirely self-contained with all amplifiers, control facilities and power supplies housed in a single unit, suitable for mounting on a flat-top desk. The housing is similar in style and appearance to the BC-2B, BCM-1A and BCS-11A consolettes. The amplifiers and power supplies are common to the entire new line of RCA consolette equipment. Switching and control circuits are basically similar to those used in existing consolette designs.

Improved performance and circuit simplicity have been made possible through elimination of pre-amplifier output trans-

formers and program monitor input transformers. Modular construction has been applied throughout the design. All amplifier circuitry is produced by the dip-solder etched wiring technique.

The BC-6A has nine high-level mixing channels and will handle a total of 22 separate inputs through these nine positions. There are two program channels which feed either one or both program lines as well as two monitoring channels—one for program monitoring and talkback; the other, for feeding background to the studios and for cueing.

It is possible to add the RCA BCM-1A Auxiliary Mixer to obtain up to eleven additional inputs. This equipment is styled to match the BC-6A housing.

Another feature of the BC-6A is the use of two identical power supplies, each of which powers one channel. Greater reliability is thus provided in that one channel will always remain in operation in the event of failure in either power supply.

A circuit diagram of the BC-6A consolette is shown in Fig. 2. It will be noted that there are ten microphone inputs, any five of which may be used simultaneously. There are also six inputs for recorded sound, any two of which may be used

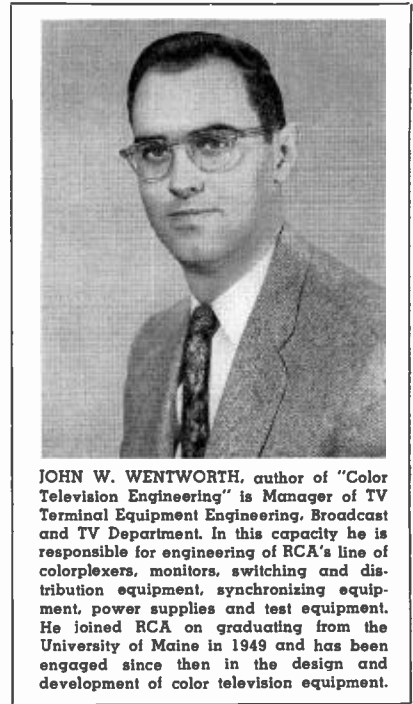
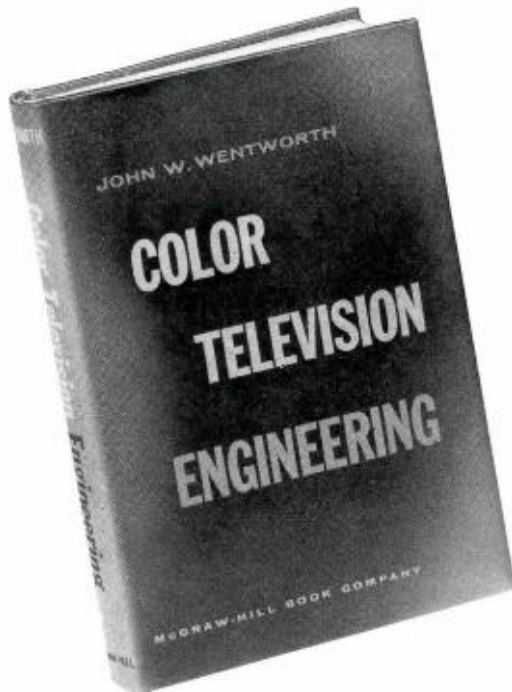

JOHN W. WENTWORTH, author of "Color Television Engineering" is Manager of TV Terminal Equipment Engineering, Broadcast and TV Department. In this capacity he is responsible for engineering of RCA's line of colorplexers, monitors, switching and distribution equipment, synchronizing equipment, power supplies and test equipment. He joined RCA on graduating from the University of Maine in 1949 and has been engaged since then in the design and development of color television equipment.

JOHN WENTWORTH'S BOOK ON COLOR TELEVISION IS OFF THE PRESS!

That's right! It's not a rumor, it's not a promise, it's a fact. The first copy of "Color Television Engineering",* by John Wentworth, reposes on our desk this very minute. And by the time this issue of BROADCAST NEWS is out, many of our readers will have their copies.

For those who have not yet obtained a copy we are happy to report that this book is exactly what most of us were waiting for—a really good book on color which the average station engineer can read and understand. And we're extra pleased to note that the emphasis is on color *transmission* (which, of course, is the specialty of most BROADCAST NEWS readers).

That Wentworth's book is notable for making a tough subject understandable will come as no surprise to the hundreds of station engineers who have attended RCA's color seminars. Probably every one of these engineers vividly remembers John's absorbingly interesting talk on color television systems. A dynamic and forceful speaker, and a born teacher, John always "makes it seem easy". That he also makes it highly interesting is adding icing to the cake—but it's so! And it's especially good

* Published by McGraw-Hill, New York; Price \$8.00.

to find that he writes as well as he speaks.

"Color Television Engineering", as explained in the preface, was compiled by Mr. Wentworth from lecture notes he used in presenting an "after-hours" course in color television engineering at the Camden plant of RCA. What Mr. Wentworth does not say in his preface is that this course has been one of the most popular courses ever to be made a part of RCA's training for its own engineers. Inaugurated in the winter of 1950-51, it has been given every year since and has been attended by hundreds of RCA and NBC engineers. For these engineers it served as a basic introduction to color television theory.

In the book, as in his course, Mr. Wentworth has assumed that his readers are already familiar with monochrome TV. But he makes no such assumption regarding color theory. Instead, he starts at the very beginning with an extended treatment of the physical and psychological aspects of color. From this he leads into colorimetry and then into the principles of color reproduction. Approximately the first third of the book is given over to this general instruction in color fundamentals.

Having fully and adequately established the reader's knowledge of color the author

then plunges rapidly into the principles of color transmission. The pace is fast but (fortunately for the average man) the treatment is largely non-mathematical. Block diagrams are used extensively and the steps from monochrome to color are explained in terms most station engineers are used to.

The final part of the book describes apparatus and circuits for color television. The emphasis is on equipment which has been commercially produced and proven by usage in the field (rather than one-of-a-kind laboratory models of doubtful practicality). Camera systems, sync generators, processing amplifiers, film cameras, colorplexers and encoders, monitors—all the numerous equipments which go to make up a television station installation are described in detail. There are also chapters on color television receivers and color test equipment.

All in all this is one of the best technical books we have ever read; certainly it is by far the best on color television. It will be especially valuable to station engineers because it emphasizes the things they need to know, and speaks to them in their language. The editor of BROADCAST NEWS personally recommends this book.

WNBQ TO BE FIRST ALL-COLOR STATION

NBC Converting Its Chicago Station For Origination Of All Local Live Programs In Color

Station WNBQ of the National Broadcasting Company in Chicago will be the first all-color television station in the world, it was announced on November 3rd by Brig. General David Sarnoff, Chairman of the Boards of the Radio Corporation of America and NBC (Fig. 1).

General Sarnoff made the announcement at the Colonial Theatre in New York City during a unique press conference which marked the first intercity use of closed circuit color television for such a purpose. On the stage with General Sarnoff was the New

York press. The Chicago press gathered at the WNBQ studios in the Merchandise Mart where Jules Herbuveaux, Manager of WNBQ, was host.

"I am proud to be able to tell you that RCA and NBC are going to make WNBQ in Chicago the first all-color television station in the world," said General Sarnoff. "The present black-and-white equipment will be completely replaced with new color equipment. This means that in addition to the broadcasting of network color programs all local live television programs originating

at WNBQ will be in color. It means that about 10 hours of color television programs will be broadcast daily by WNBQ."

A Color "Milestone"

In explaining the background and significance of NBC's step in "colorizing" Chicago, General Sarnoff reiterated his conviction that the future of television lies in color, and added: "That is why RCA and NBC from the first have undertaken to break through the black-and-white curtain. We undertook to manufacture color receivers and color tubes and we are now set up

FIG. 1. Artist's sketch of WNBQ's large studio as it will look when converted for color. Sets for weather, news, cooking and other regularly scheduled programs will be located around the walls of the studio. Visitors will be able to look down into the studio from a balcony level observation gallery along one side of the studio.

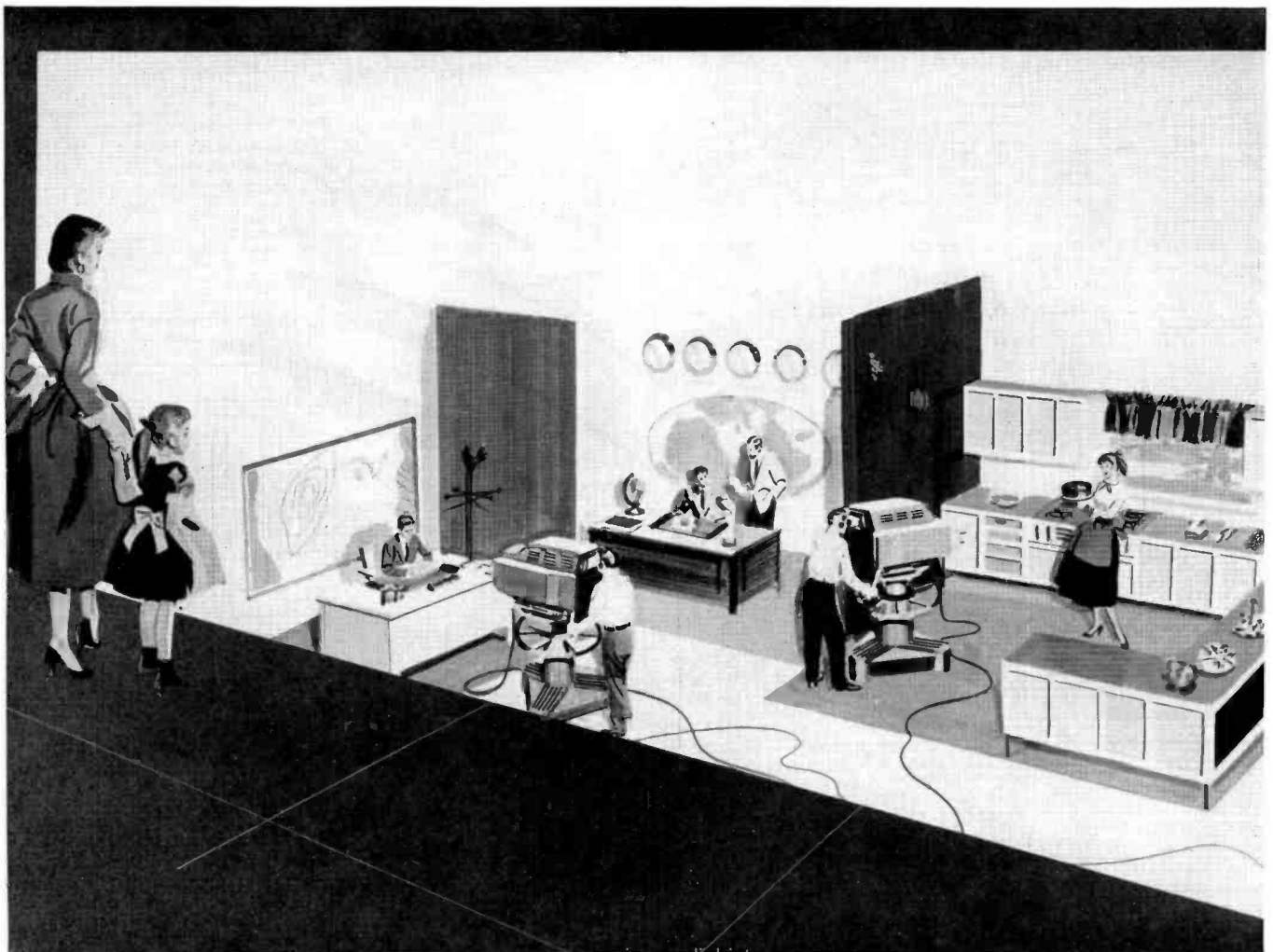

simultaneously; for example, two tape recorders, two turntables and two film projectors could be connected into these positions and any two used simultaneously. There are also five remote lines which may be used one at a time, one network line and three cue lines.

Regarding outputs, there are two complete program channels which may be connected to either or both lines; two external monitor outputs, one for each channel; five speakers and five remote lines.

Over-all gain of the system from microphones or turntable to program line is 108 db while microphone or turntable-to-speaker gain is rated at 127 db.

In the BC-6A a total of twelve printed pre-amplifiers is utilized. Three of these amplifiers are operated as boosters and the other nine, as basic input equipment. The booster amplifiers differ from the pre-amplifiers only in the assembly of the resistors in the output stage. Miniature tubes are used wherever possible in the design with a 68 db signal-to-noise ratio measured across the entire system.

Harmonic distortion in the program channel varies at 18 dbm output from 1 per cent at 30 cps to 0.5 per cent at 15,000 cps. The program channel is flat within 1.5 db from 30 to 15,000 cps while the monitor channel for the same frequency range is rated at 2 db at 8 watts output.

As a result of increasing station requirements, the speaker-muting and warning-

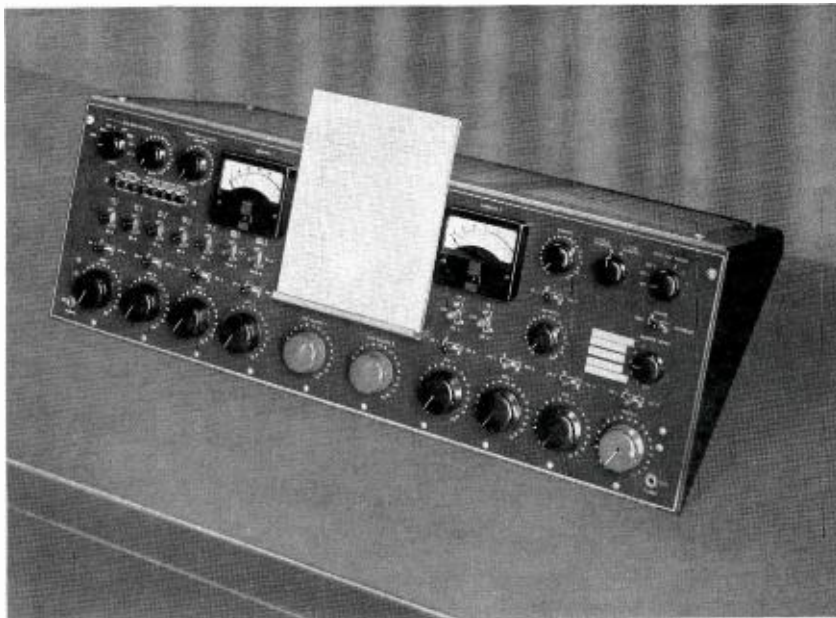

FIG. 1. Operational view of BC-6A Dual-Channel Console showing functional location of program material on convenient script-holder.

light circuits have been increased in the BC-6A to include the microphone selector switches. Improved wipe-type positive contact switches have been incorporated in order to reduce servicing to a minimum, over a long period of continuous operation.

It is believed that the BC-6A console, after two complete years in the design and development stage will now provide a new standard of operating flexibility in audio control application and permit an increased degree of efficiency in station operation.

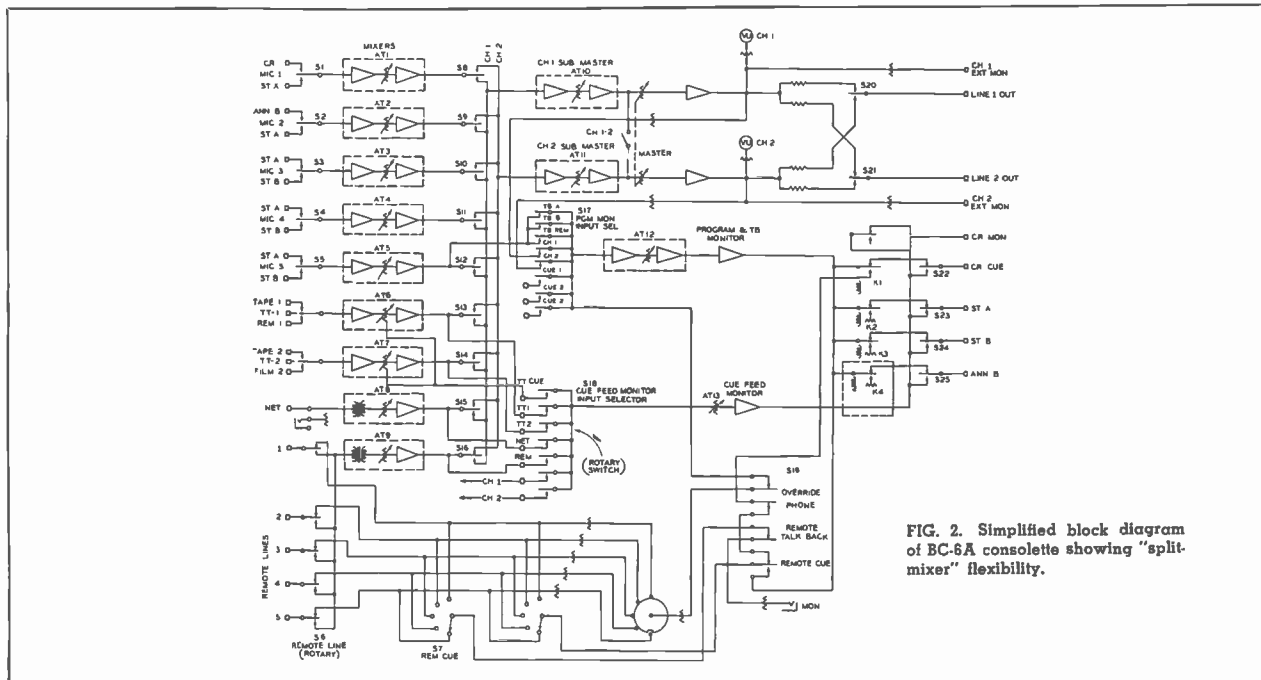

FIG. 2. Simplified block diagram of BC-6A console showing "split-mixer" flexibility.



SPACE-CONTROL

Sol Cornberg is the scholar turned business executive, the artist who has made his canvas a television screen. He first studied the theatre, wrote an authoritative book on stage lighting, and turned to television because he believes in it.

"Television," he says, "is at present a science, and few understand the semantics of it. But make no mistake about this—it will become an art form."

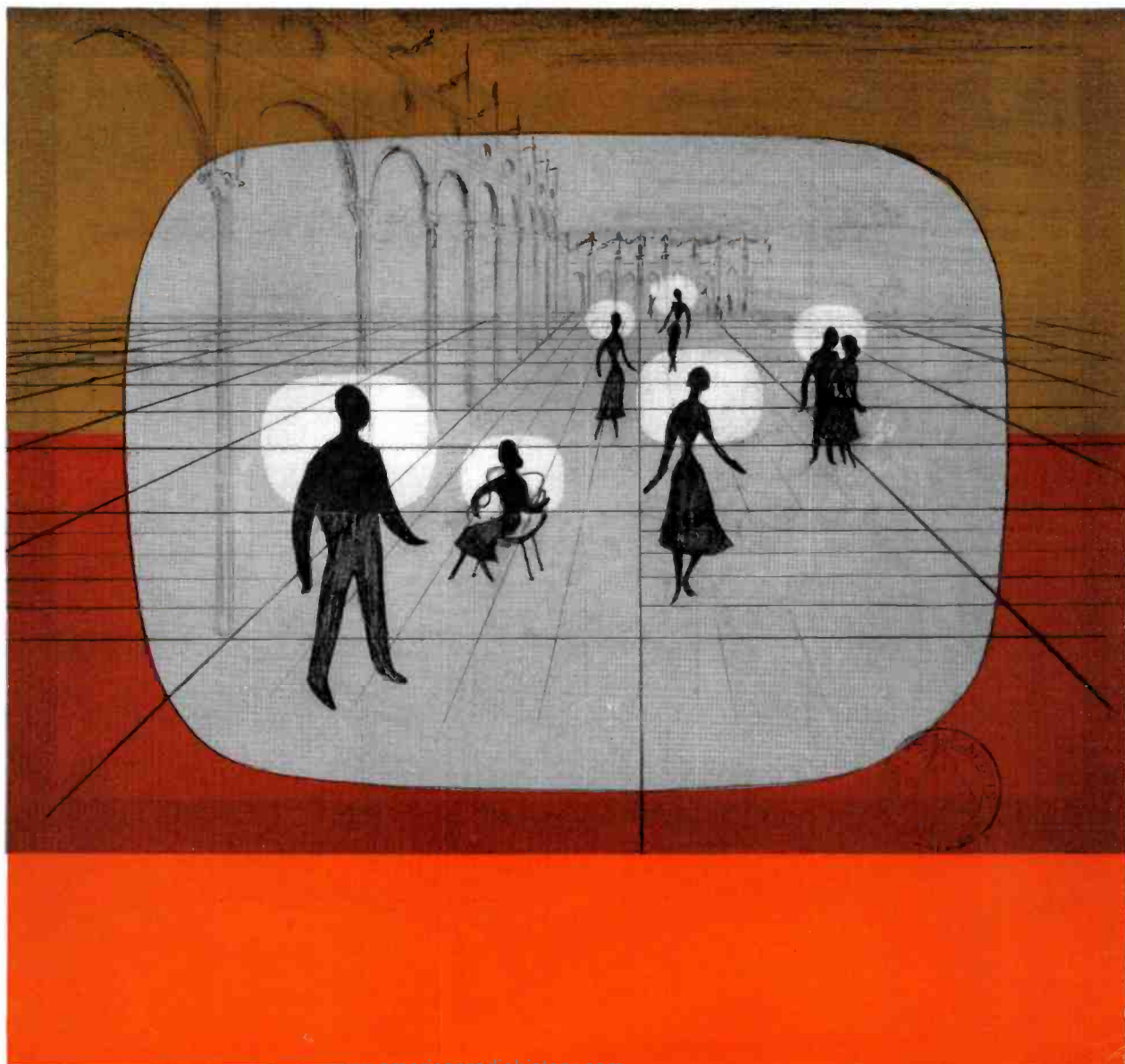

PRODUCTION AREA

by **Sol Cornberg**
Director, Studio and Plant Planning
The National Broadcasting Company
New York City

**a new concept
of studio planning
that is built
around people
and the program
in order to bring a
more intimate and
more perfect picture
to the viewer**

Television studios from their beginnings were redos of existing spaces which had been designed for other purposes. Understandably, redesign was focused on the well-being of microphones and television cameras. The work space of the artist and his well-being were secondary. As the art of making pictures and picking up voice simultaneously was perfected, attentions were focused on the creative aspects of the medium—"the man with the message."

A departure was made in thinking relative to design with the construction of the HOME Studio. Here, primary attentions were given to focusing on *things*, that they might be better handled and better shown.

The SPACE-CONTROL production area comes to focus on people, putting all equipments, equipments maintenance, and equipments operation in their proper time and place. A concept as far reaching as this has a dual purpose:

Drawings by William Riggs, Gunther. Bill Drake. Stuart Boughton.

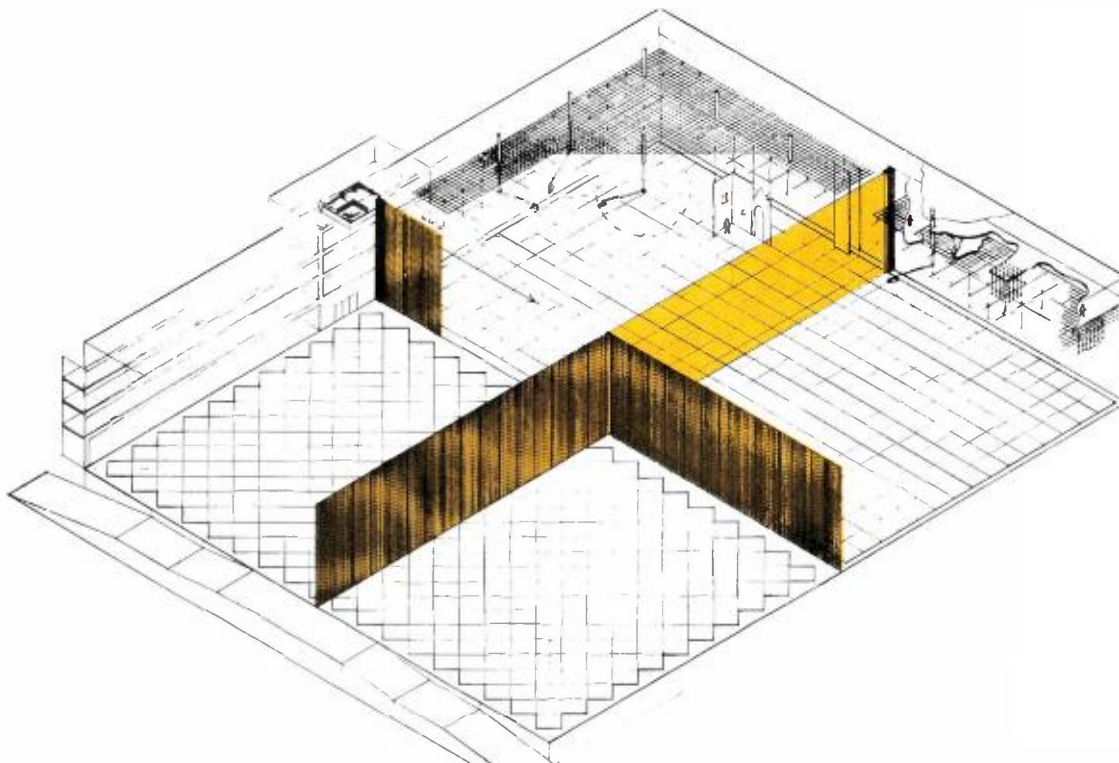

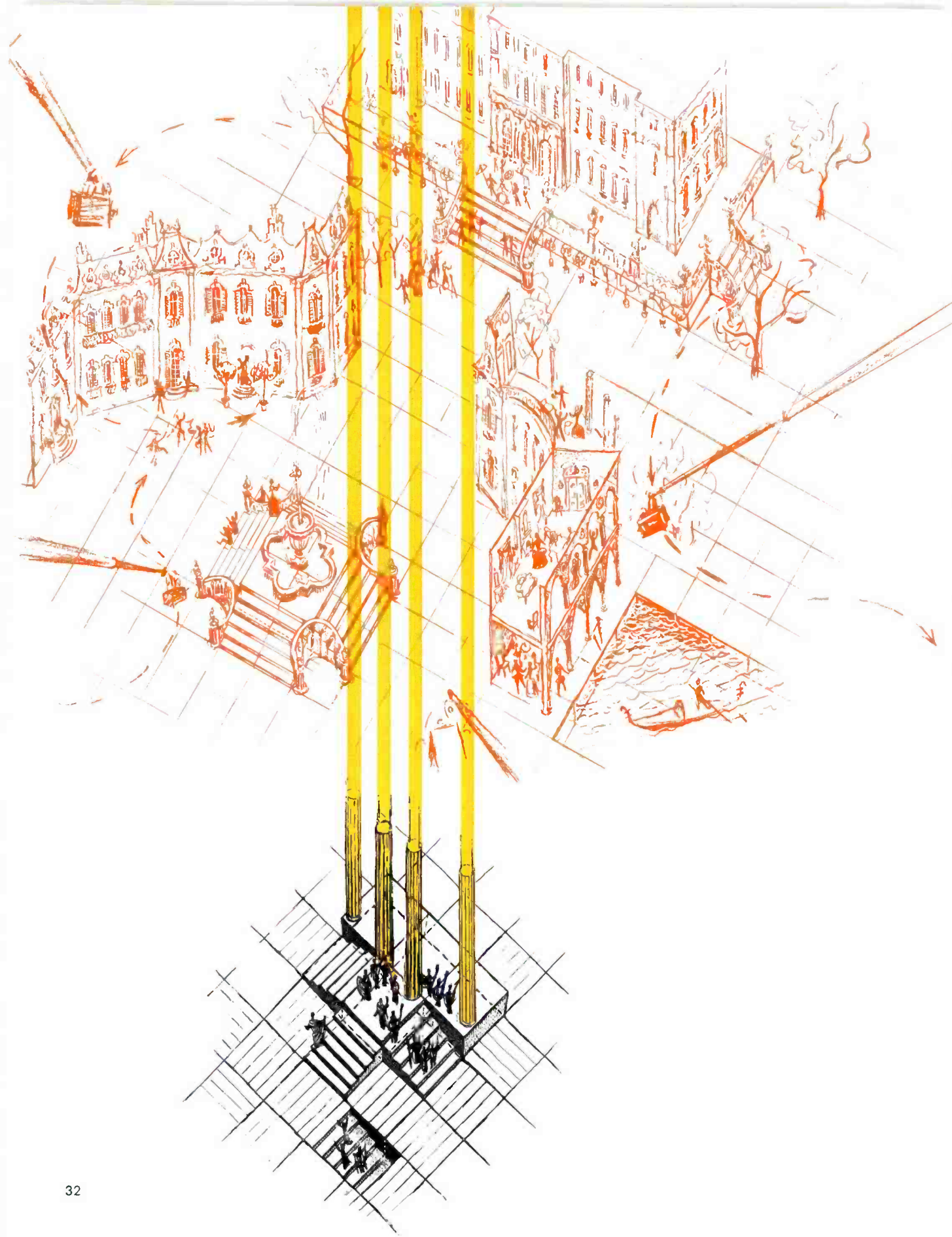

(1) To present the “man with the message” better than he has ever been presented before, whether his message be entertainment, education or information. To allow him complete freedom of movement by causing all facets of the television show production area, space, equipments, or audience, to be subservient to his needs and to be purposeful on behalf of the fulfillment of his mission.

(2) To minimize the number of “in studio” preparation hours required for the presentation of air time, enabling the manufacture of more air hours in fewer clock hours. (Video tape would bring this ideal to maximum operating efficiency through minimum overtime hours.)

This makes it possible to think in terms of lesser capital investment, increased rate of amortization, and minimum operating costs to meet program load. It is conceivable that one SPACE-CONTROL production area could be expected to manufacture two or more one-hour air shows within a given twenty-four clock hours.

Being the ultimate in automation (to make automatic) of space and equipments, existing practice is encompassed, creative thought is materialized, function is established, immediate purpose is fulfilled. In meeting all production needs of entertainment, information, or education, and their basic components—tragedy, comedy, the intime or scope—the SPACE-CONTROL production area will “*continue to search*” for form which may be imposed architecturally on other premises in the interests of a specific, i.e., tragedy, comedy, the intime or scope.

THE PLANT

The plant is one work space which is divisible into four individual work areas by the use of remotely controlled retractable, collapsible, pneumatic, sound-isolating membrane (or walls).

The plant or any part of it, when used individually, will be a rectangle approximately forty-two feet high. Mathematically, the rectangle will contain the circle, the triangle, or the square. Architecturally, the rectangle will lend itself to greater variation more efficiently and hence more economically, than any other shape.

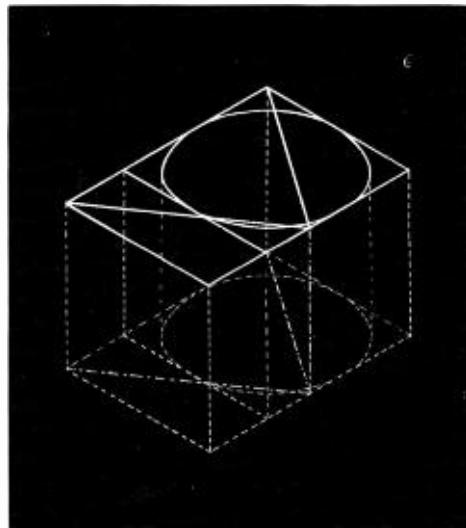

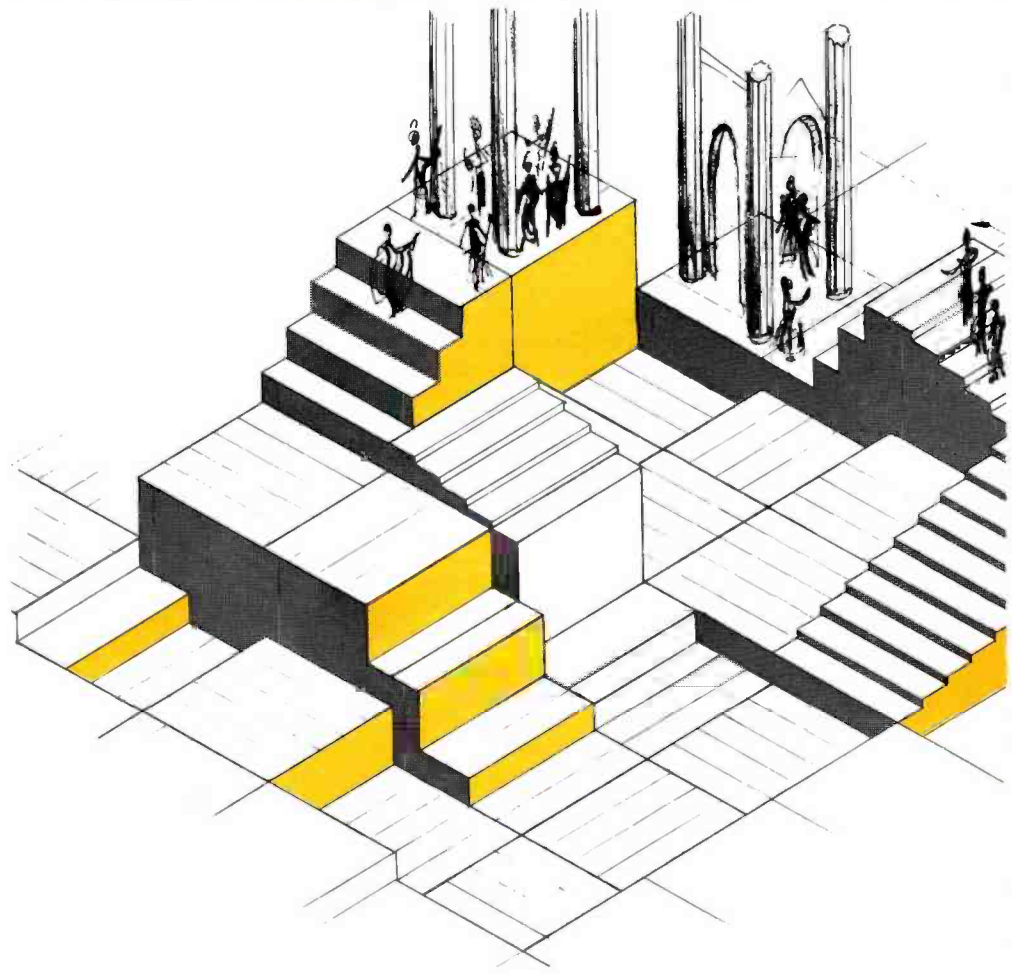

THE WALLS

The movable walls are conceived on the air mattress or inflatable raft principle, made up in sections approximately twenty feet long by forty feet high and eight inches thick. It is felt that the inflatable material may be so treated as to give complete sound isolation and correction.

The walls are mounted on tracks in the ceiling and are electrically chain driven. The sections interlock prior to being inflated. The floor mating is accomplished by a shape using the basic principle of the octopus in its movements. Once the wall section is in position, it is inflated. As it inflates, it seals itself at the top against the header containing the track, side to side with the adjoining partitions, and with the floor achieving a complete bond, a light and sound barrier between two spaces.

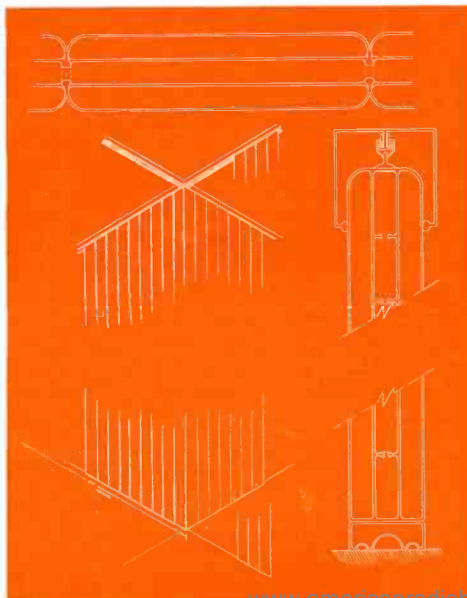

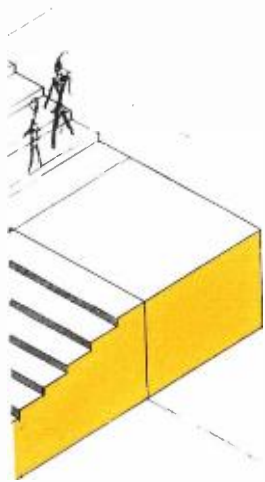

THE FLOOR

The floor, with wood walking surface, is hydraulically controlled. Ten foot by ten foot units may be raised or lowered six feet from mean level, or revolved 360 degrees in either direction. Each of these units is composed of five, two by ten foot segments. Each of these segments may be raised six feet while parallel to the floor, or may be tilted from end to end or side to side independently.

The floor configuration here described is a variant of a plan designed and engineered by George Izenour of Yale University.

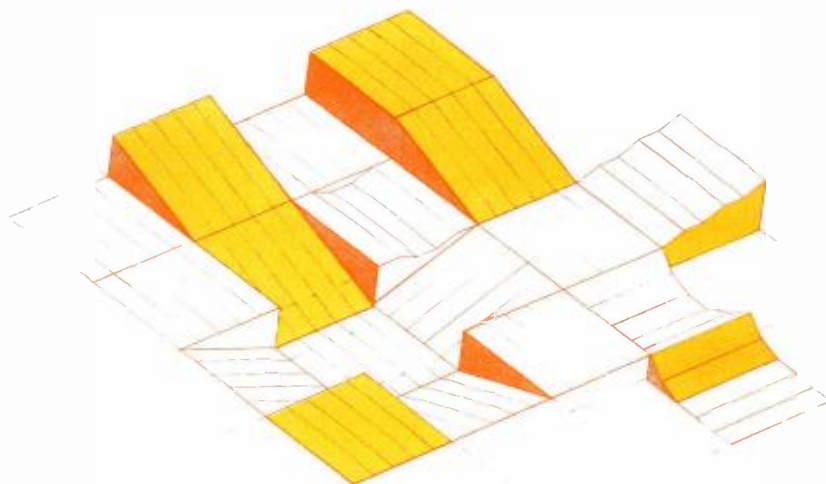
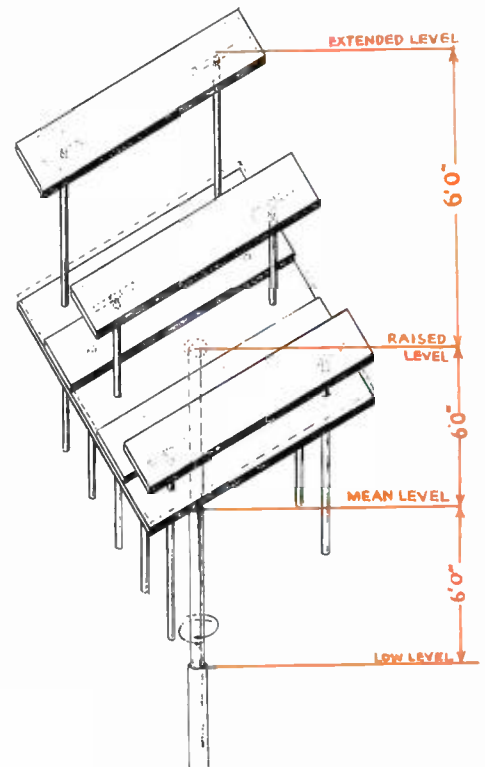
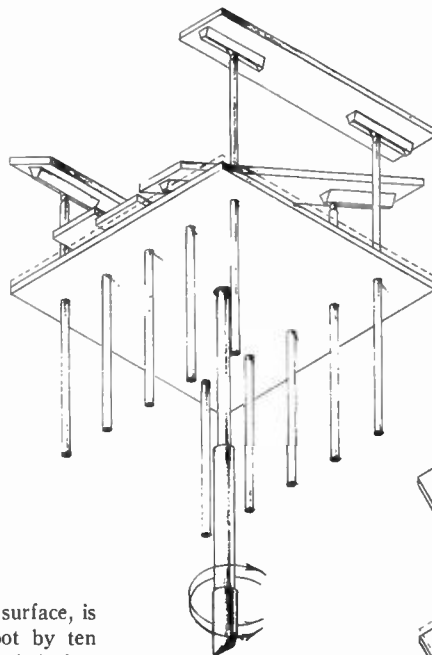

THE CEILING

The ceiling supports apparatus for the functioning of (1) cameras; (2) lighting equipments; (3) microphones; (4) flying of scenery, drapery, and associated materials; (5) articulated trackage for wall shaping; and (6) sound-isolation membrane. The ceiling over the SPACE-CONTROL production area not only supports the items here mentioned for operational purposes, but allows for the raising into it of cameras, lighting equipments, microphones, and materials handling equipments for maintenance and repair purposes. Maintenance and repair may go on in the floors above the studio area while other activity is going on in the studio, with no interference from one craft to another due to necessity for use of the same square footage or cubage at the same time. Operationally, the only personnel other than the actors, producers or directors, required on the studio floor would be for the handling of scenery, props, furniture and costumes.

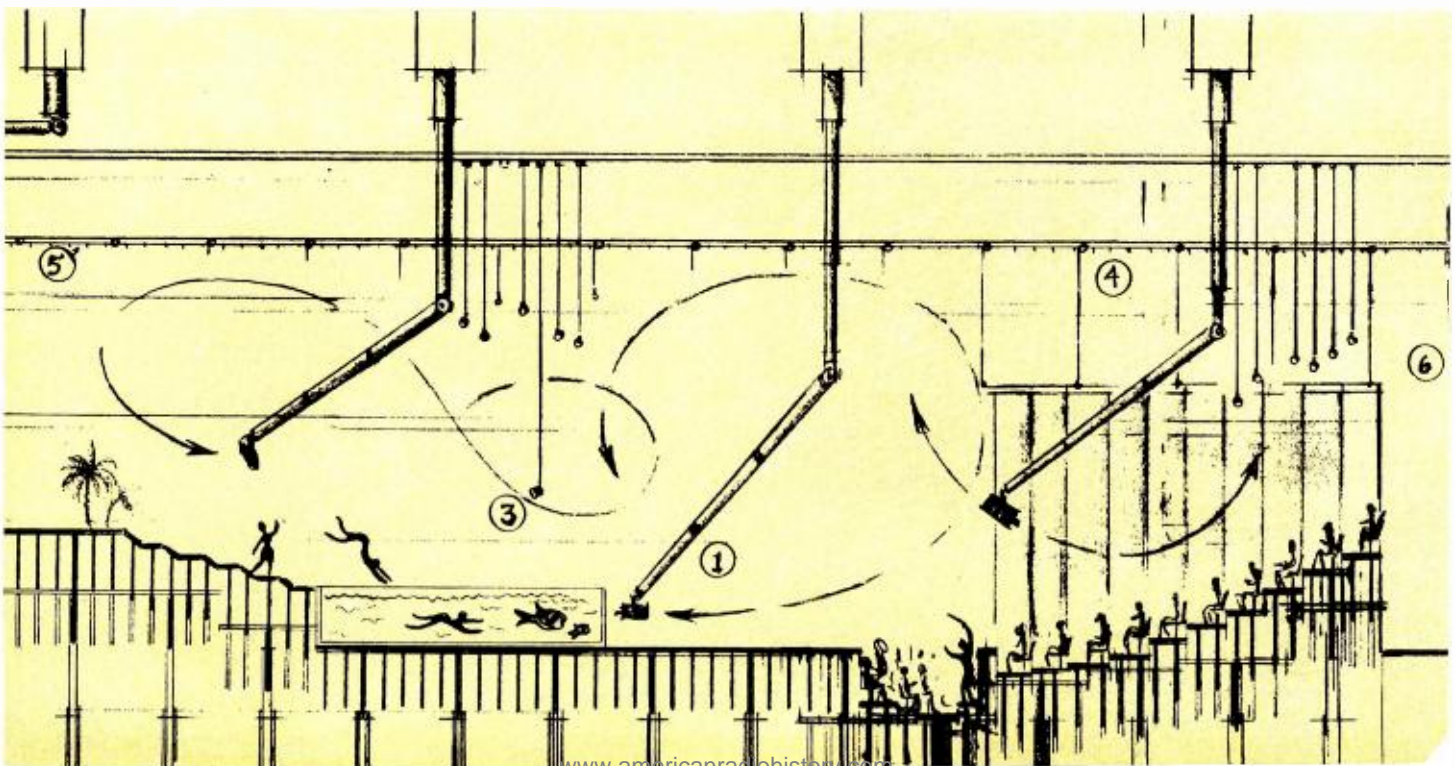

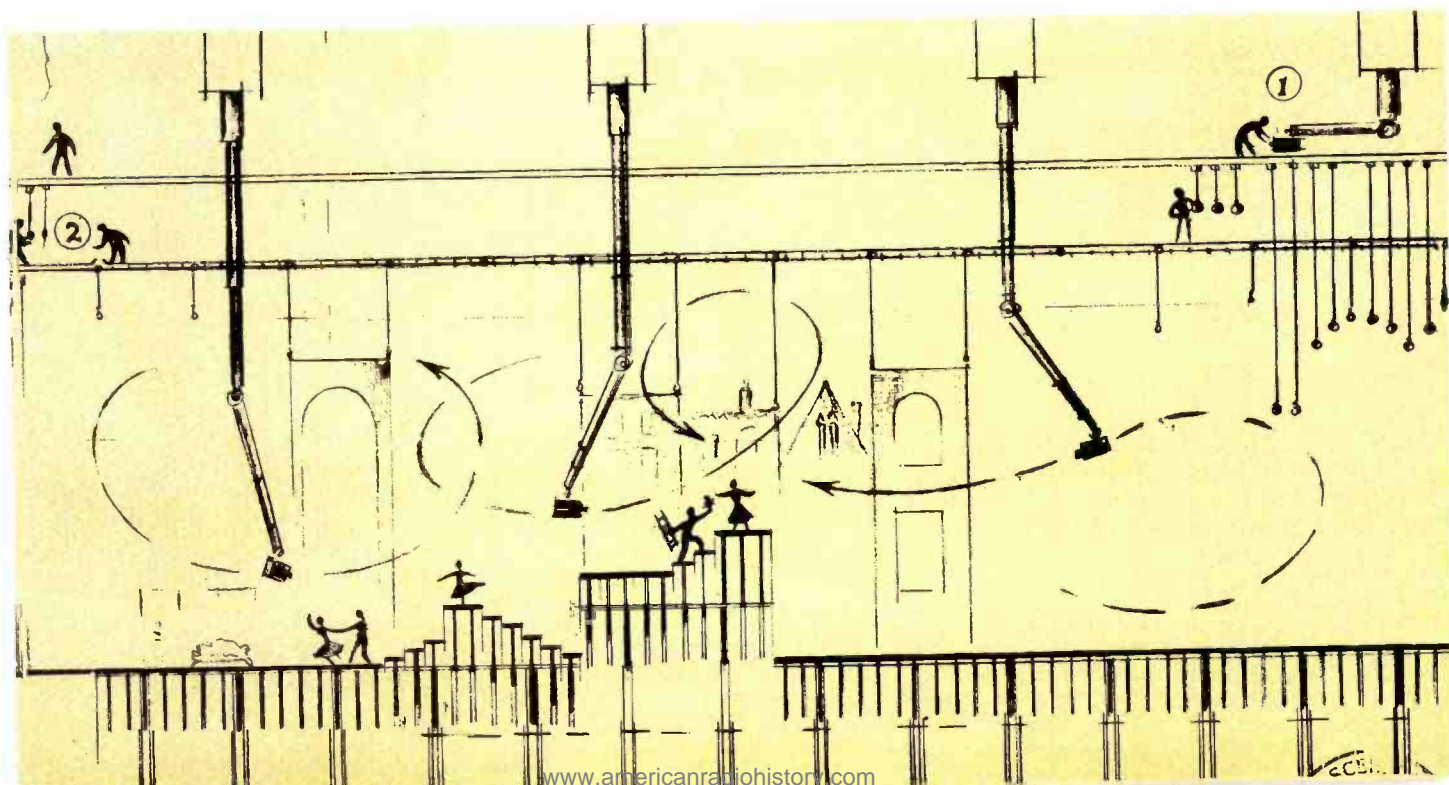
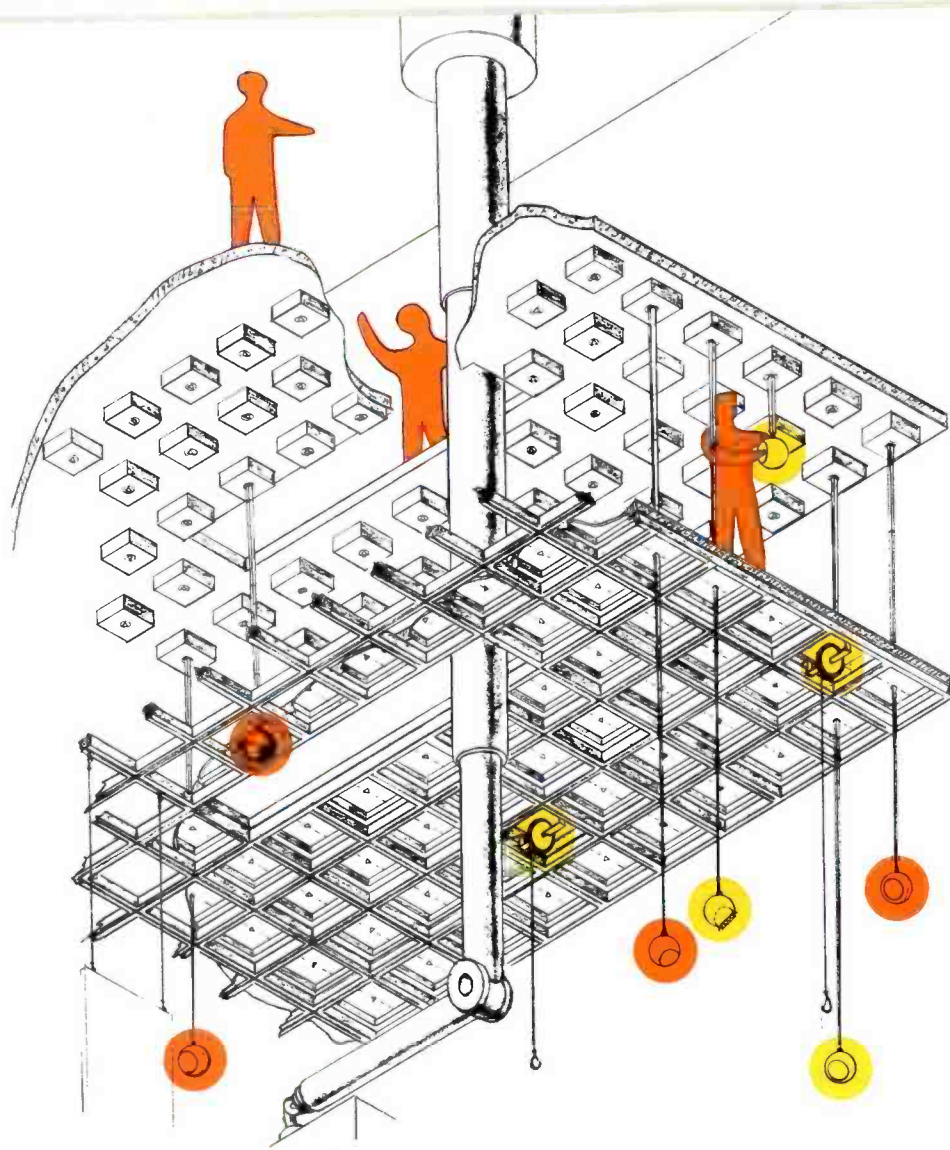

1 Cameras

The cameras are ceiling mounted on remotely controlled hydraulic booms which allow for the pinpointing of the camera in the cubage formed by the ceiling, the floor and the maximum extended length of the boom. This boom is so designed and mounted that its elbow will raise and lower to relate to raising and lowering of other equipments. Each boom will allow its camera to revolve 370 degrees in either direction and have its circumference in the extended position perpendicular to the adjacent aerial camera. This pattern of overlapping circles will be repeated throughout the work space.

Built into the boom are automatic safeguards relating to safety of personnel and protection of equipment. A speed reducer would slow the rate of rotation in ratio to extension. A sensory device would stop the boom before it could come into contact with animate or inanimate objects.

The camera and boom will be raised into the studio ceiling (upper level) where all functions of test pattern, maintenance and repair will take place.

The basic principle is enunciated in the aerial camera which is in operation in the NBC HOME show studio, on 67th Street, in New York City.

2 Lighting

The lights remotely controlled in all their functions—raise, lower, pan, tilt, focus, dim, frame, color, on and off, are installed on a saturation basis on two foot centers making vertical movement of equipments unnecessary. These would be raised into the studio ceiling (lower level) for servicing and maintenance.

The lighting units are based on the following concept:

The lamp filament which is used in lighting equipments today was designed as an all purpose lighting source and gives off its rays in all directions 360 degrees in all planes of the sphere equally. Manufacturers have labored in design and construction of reflectors, housings, and lenses which would encourage the rays to focus in one direction only, with the consequent and inevitable losses of light, as against current consumed, as high as 55 or 60 percent.

The lights here are based on the concept and laboratory model now functioning of a light emitter which causes light to flow in one direction only from a filament approximately one-quarter inch in diameter. Energy is carried to this light source by radio frequency (no cable required). The potential here is from one radiator strung around the four sides of the studio at the highest point possible (close to the ceiling) from which all lighting fixtures would be energized.

The consequent dollar savings as of conduit, copper, plugs, and connectors and the man hours of installation required in initial construction as well as maintenance and operation is incalculable.

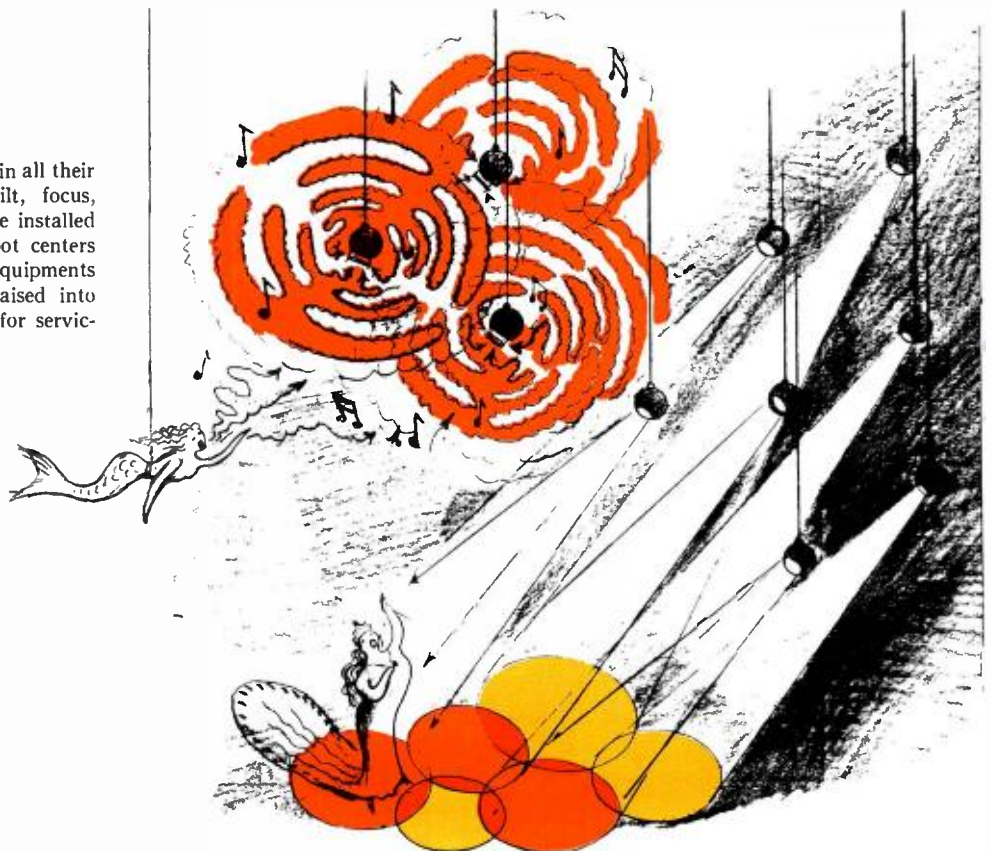

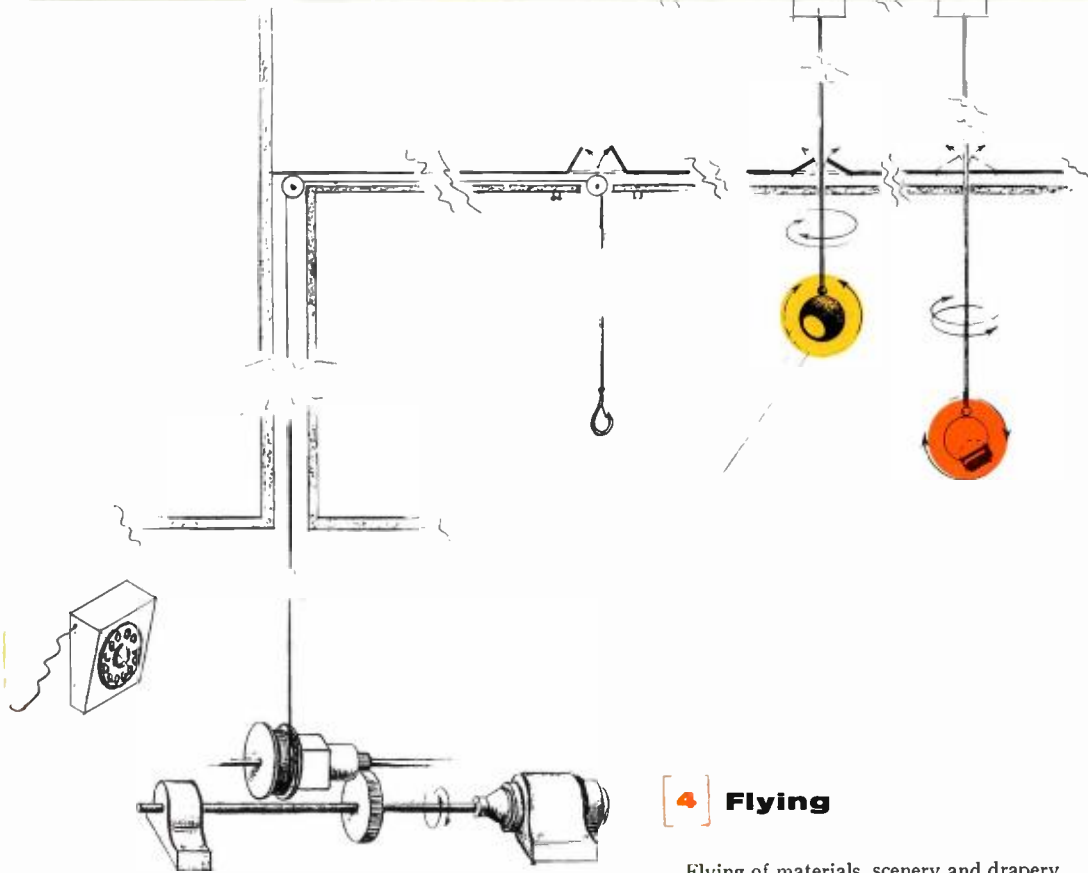

The unidirectional filament permits use of comparatively small housing with mechanical dimming built into each unit. The r-f energy carrier is part of the solution to the very real problem of distribution in our culture, be it information, supply or energy.

The basic control principle is enunciated in the remote control lighting installation which is in operation in Studio 8G, RCA Building, New York City.

3 Microphones

All performer audio is picked up by wireless microphones worn by the individual performer so that complete freedom of movement on the part of the performer is permitted. Where this is impractical, the lighting fixture which has the ability to raise, lower, pan, and tilt may have a microphone fastened to its face and serve a secondary purpose though not necessarily simultaneously with its first function. Under this condition microphones spaced over the playing area would impose contiguous overlapping circles of pick-up.

4 Flying

Flying of materials, scenery and drapery, etc. would be in the form of remotely, electrically controlled individual points installed on a saturation basis. These points would be operated from a console position containing dialing cross-connect potential. This dialing will permit the grouping together of any number of points for simultaneous operation as well as variable speed control.

These points would be powered by drive shafts and magnetic clutching devices installed in the basement of the building with cables running up through a false wall and bearing on only two sheaves in the ceiling for each line. The advantage of positioning these equipments in the basement are manifold: (a) they permit of mounting heavy equipments on a concrete floor in the basement, rather than supporting these weights on steel overhead, with considerable savings in costs relating to building steel sizes for the support of these equipments; (b) they allow for maintenance of equipments without interference with other activity in the studios; (c) noise of these equipments can be isolated in the basement area and therefore result in less expensive installation; and (d) the liability to personnel, as of equipments overhead, is reduced.

The basic principle in remotely controlled hoisting equipments is enunciated in the electrically, individually controlled hoists which are in operation at the NBC Brooklyn Studio, Brooklyn, New York.

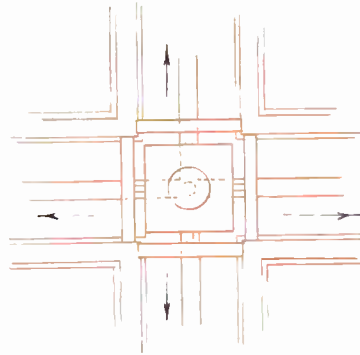

WALL SHAPING

Wall shaping around potential live audience seating areas is accomplished through the use of articulated tracks which allow for the movement horizontally in any direction of wall surfaces. These wall surfaces may then conform to the shape of the seating for a particular production. (This configuration has been designed and engineered by Mr. Izenour.)

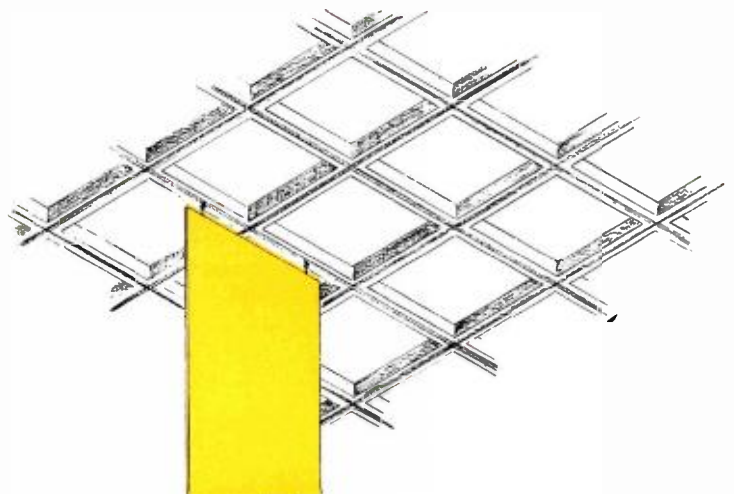
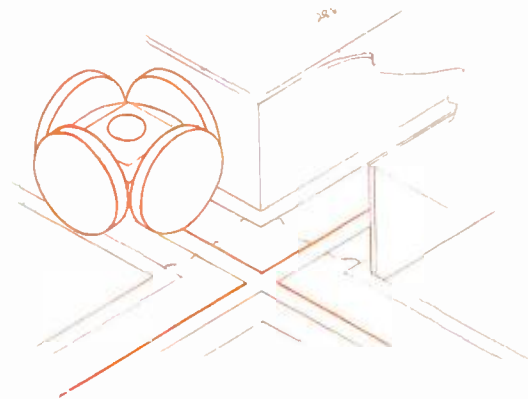
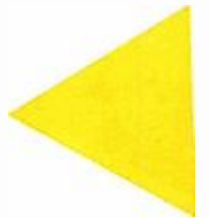
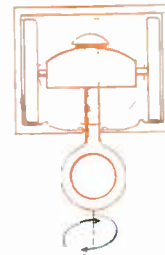

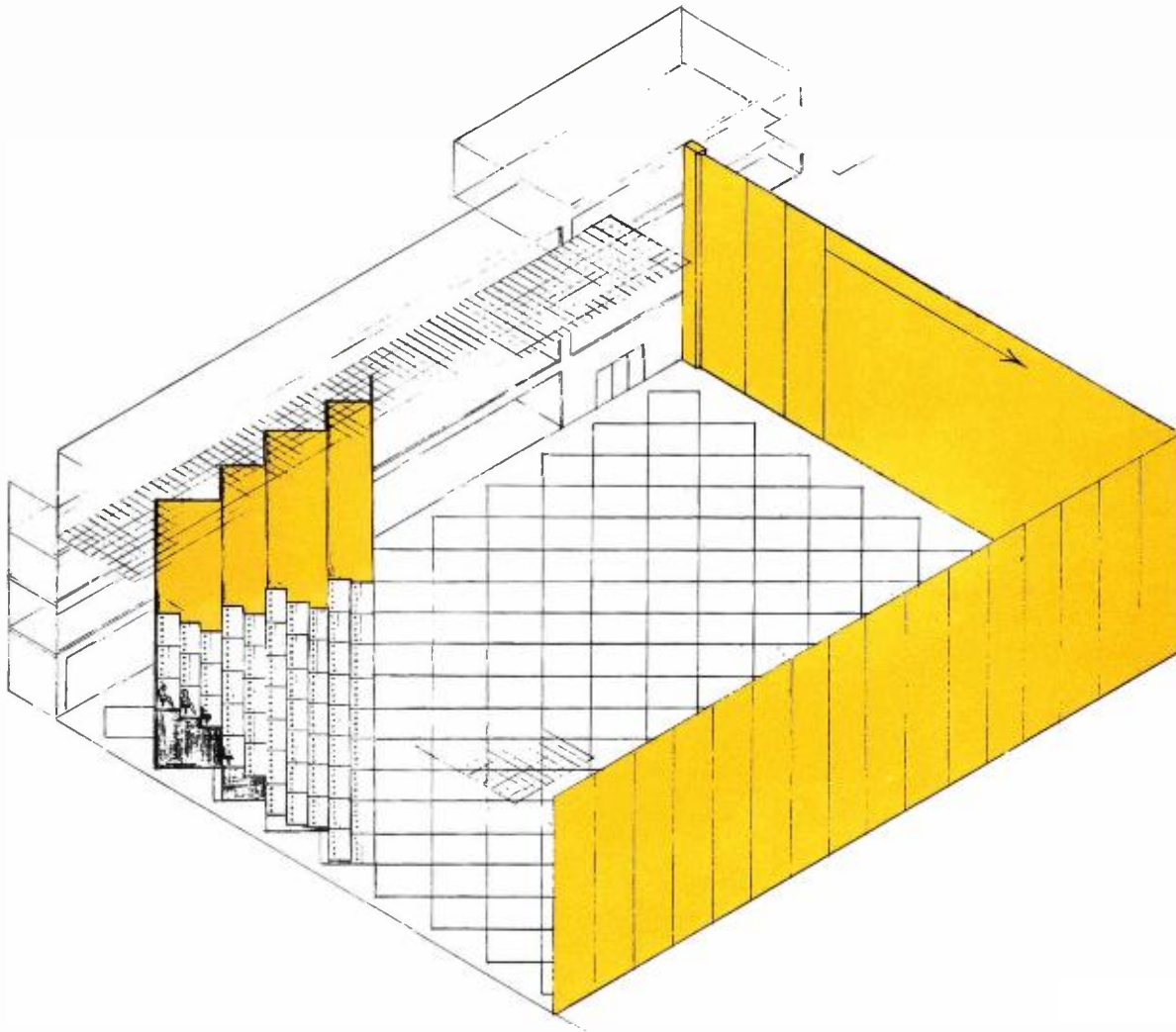

Hydraulics are implied as the operating energy for a number of equipments mentioned to this point. Some study has been made and will continue in the area of pneumatics as an operating energy. This would take a stem from the aircraft industry which is thinking in these terms, specifically to overcome the problem of loss of driving fluid while in flight and the possibility of replenishing it from the atmosphere if it were pneumatic. This thought seems germane to our problem.

PROJECTION

Front and rear projection are available to the industry and are possible of use in the area.

Rear projection in development form is making it possible to think in terms of one

and one-half square foot of picture for one foot of picture throw. Magnification of source filament prior to light passing through condensers and size of objective relating to size of filament is making this kind of thinking possible.

A rear projection screen has been seen which permits of high picture quality, minimum hot spot, minimum fall-off at edges of picture, and the ability to repair in place when damage is done.

Vistascope, a method of fore-ground projection, has been available and should be made possible of use by show personnel.

Both of these are "tools of the trade" which are usable within the SPACE-CONTROL production area.

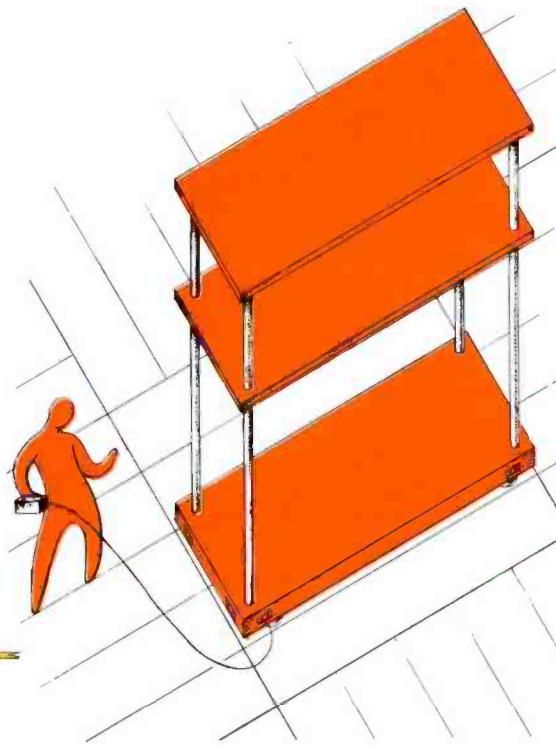
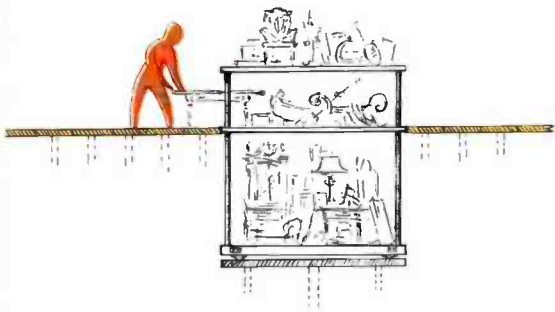
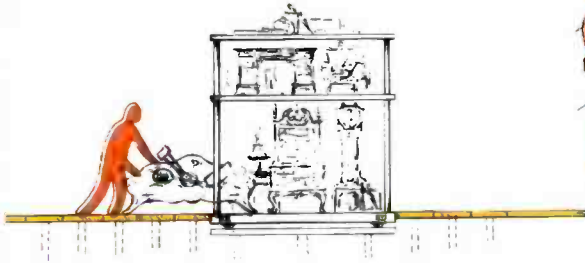
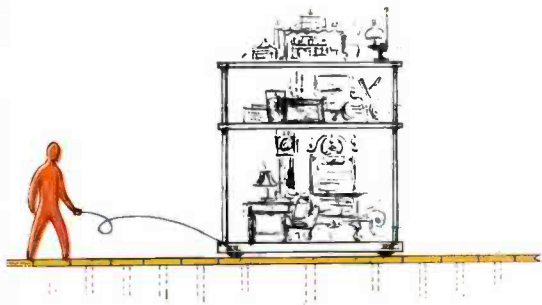

MATERIALS HANDLING

Materials—scenery, furniture, props—must be moved in and out of the production area. This is accomplished by the use of self-powered remotely controlled materials wagons. These wagons are of minimum sizes, four by ten feet, to conform with two of the two by ten foot hydraulically operated floor sections, and may be interlocked to form larger units. The wagons would key into the floor for positioning, via the machine-tapered sockets, and permit for lowering into the floor so that materials—furniture, for example—may be slid onto them rather than lifted with the potential hazard of breakage or, of more significance, injury to personnel. When loaded, the floor is brought back to mean level and the wagon accompanies the operator out to the materials marshalling area.

Further, the wagon may be interlocked in larger sections and used as movable playing areas with scenery, furniture and props in place.

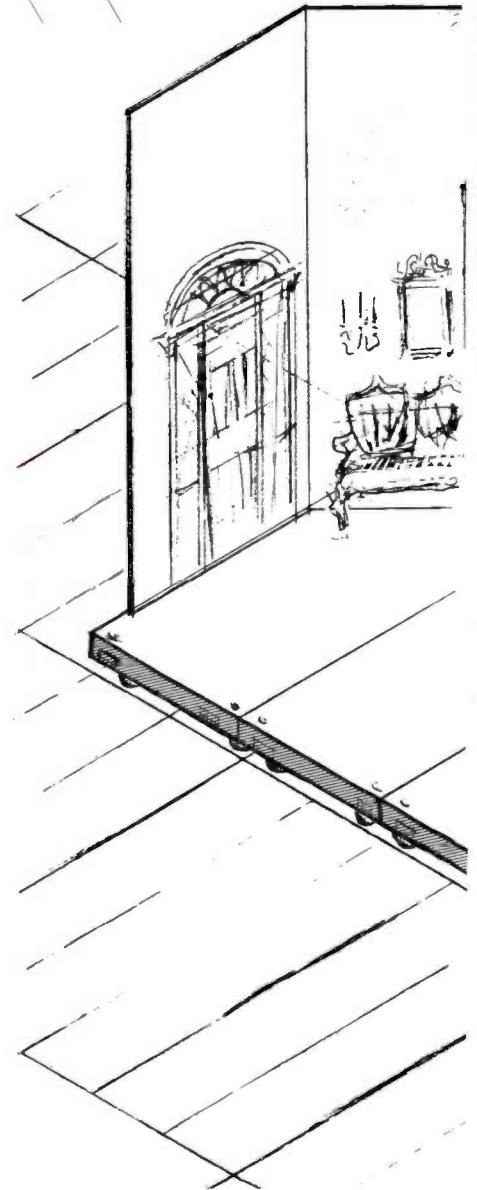

TRUCKING

Off street trucking arrives at two ends of the playing area and may either back into loading docks on the exterior of the building, or drive into the production stages.

DRESSING ROOMS

Dressing rooms are on stage level under the control towers on two sides of the playing area.

THE PUBLIC

The public; audience for live television production purposes and for tour purposes, is accommodated in this plan.

CLIENTS AND PERSONNEL

Space is included in this plan for client accommodation as well as instructional areas where personnel may be up-graded and teaching take place during an actual production with no interference between the two.



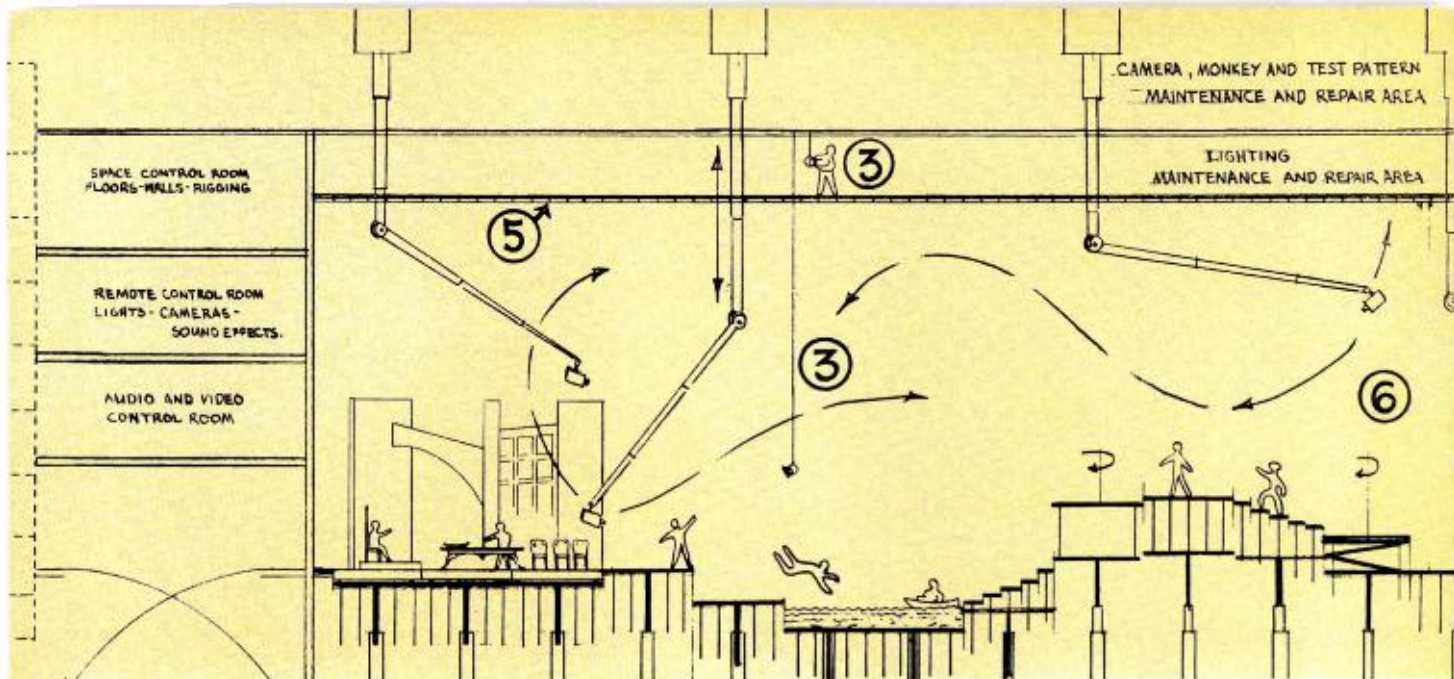

CONTROL TOWER

The control towers, one at each side of the playing area, are so designed and equipped that they may service one, two, three or four playing areas, independently or simultaneously. The lower level of the control tower (one level above mean studio floor level) is given over to the producer, director, technical director, audio and video control.

The second level of the control tower is given over to the following:

- (1) Camera boom positioning.
- (2) Camera control; that is, pan, tilt, turret flip, focus, and iris control.
- (3) Lighting control. Television requirements in total number of foot candles as well as flexibility of control have resulted in a point of diminishing return as far as intensity control, cross-connect, and console sizes are concerned. Bulk, weight, heat

AUTOMATION

This is accomplished by a model, complete in every detail, that allows for the simulation of all configurations of the SPACE-CONTROL production area: floor, walls, lights, cameras and flying devices. This configuration may be established in the model as the result of pre-planning on the part of the producer, director, designer, and technical operations personnel. The attitudes are checked in the model and when all creative personnel involved are pleased, a single button is pushed and

generation, and operating personnel requirements are out of proportion to the return. The control system must allow for the positioning in all its aspects of the lighting fixtures. Determination of intensity levels, permit of electronic cross-connect and electronic recording so that any lights in whatever position for a given scene may be recalled.

(4) Sound effects are also controlled from this level. The console here being an extension from a space in the plant dedicated to the art of sound effects and from where all sound effects to all working areas are piped.

The third level of the control tower is given over to remote control of floor, walls, and scenery flying equipments for operating purposes. These operations are conducted on a one-tenth scale operating model of the SPACE-CONTROL production area.

the building hunts the positions required for a specific production as dictated by the model. When this production is complete, a single button neutralizes the building and the next production moves into the operating position. Operationally, vidicons strategically placed throughout the area would carry information of the condition of the production area to the various control tower levels at all times. The SPACE-CONTROL production area's attitudes may be recorded on tape or electronic calculator for re-use at any future date.

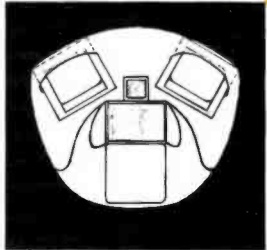
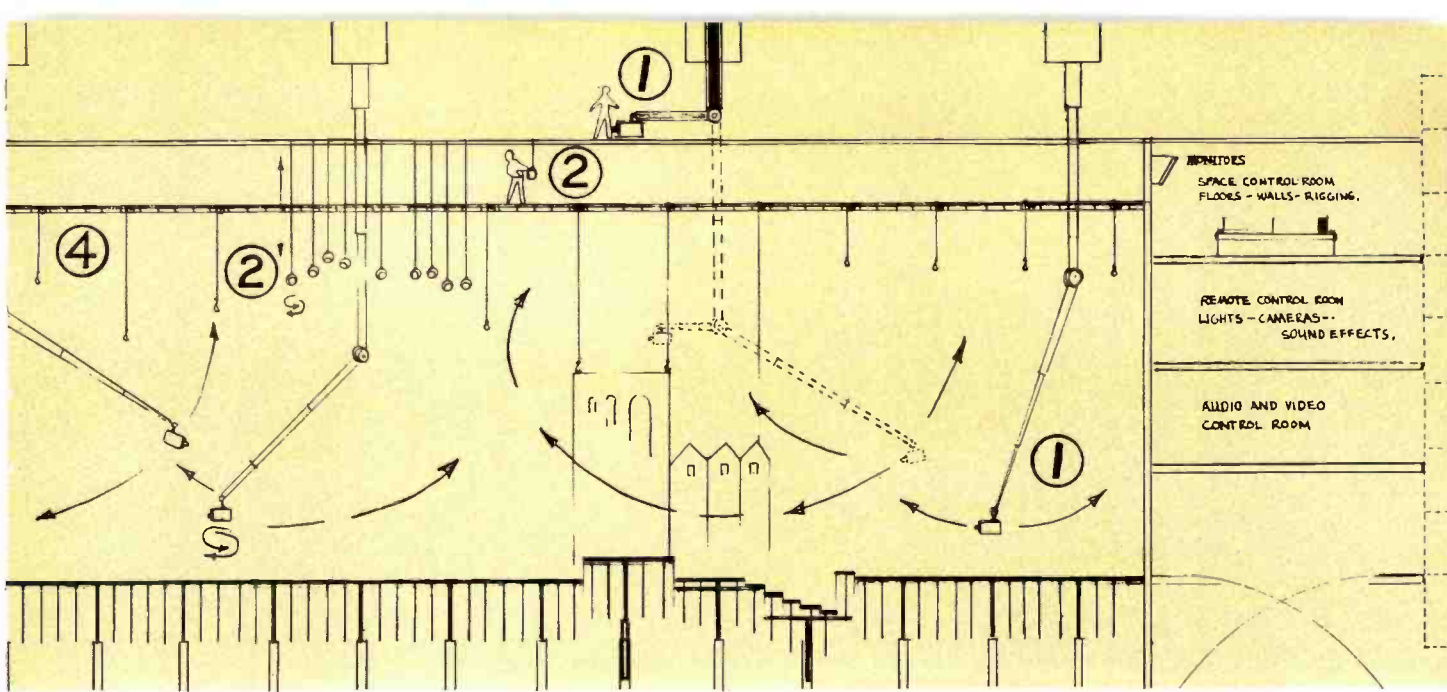

DIRECTOR'S CONSOLE

The director will function from a self-propelled console on the stage during rehearsal. From the console he will be in communication with the technical director in the control room, and will be able to see camera pictures as they come into the control room and are passed on through the technical director to him. The console will also include a script roll device which will consist of script having been typed on color corrected paper in roll form, rolling from side to side over a frosted translucent back-lighted glass. Finger tip control will enable the forward or backward movement of the script or a clock mechanism will keep it rolling against time.

The director from his console position will never be more than a few steps away from personal contact with the performer whom he must inspire, and he will once more be as he should—the fountainhead for focus on great performance and quality content.

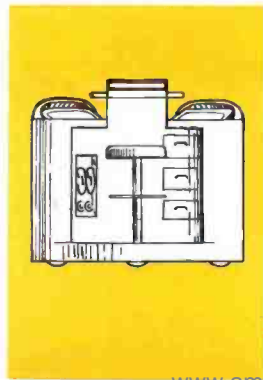

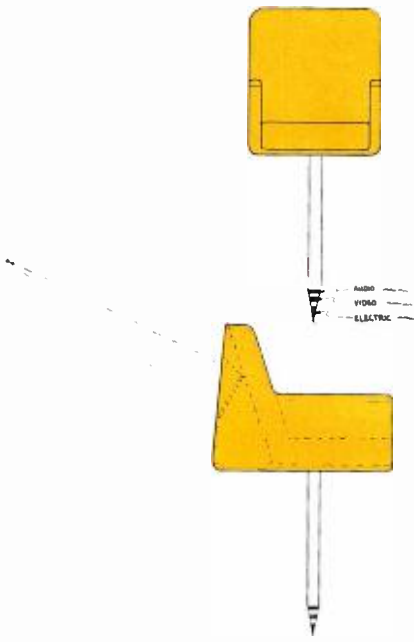

THE SEATING ARRANGEMENT



A plush, revolving seat or group of seats may be placed anywhere in the studio and faced in whichever direction is desired. The seats, on a center support only, would fit into a machine-tapered self-closing socket flushed into the wood floor on two foot centers throughout the production area.

Each seat would ride on a machine-tapered pin which would further serve to carry program audio to speakers, video to electro-luminescent screens, and electric current to walking lights, all of which can be built into the back of each seat. The seats may be placed at will in any part of the production area. The sockets on two foot centers would carry electrical service to music stand lights and to electrical instruments. This seating and floor flexibility allows for the lowering of the orchestra and orchestra pit in direct proximity to the live audience and the "man with the message": comic, salesman, or educator.

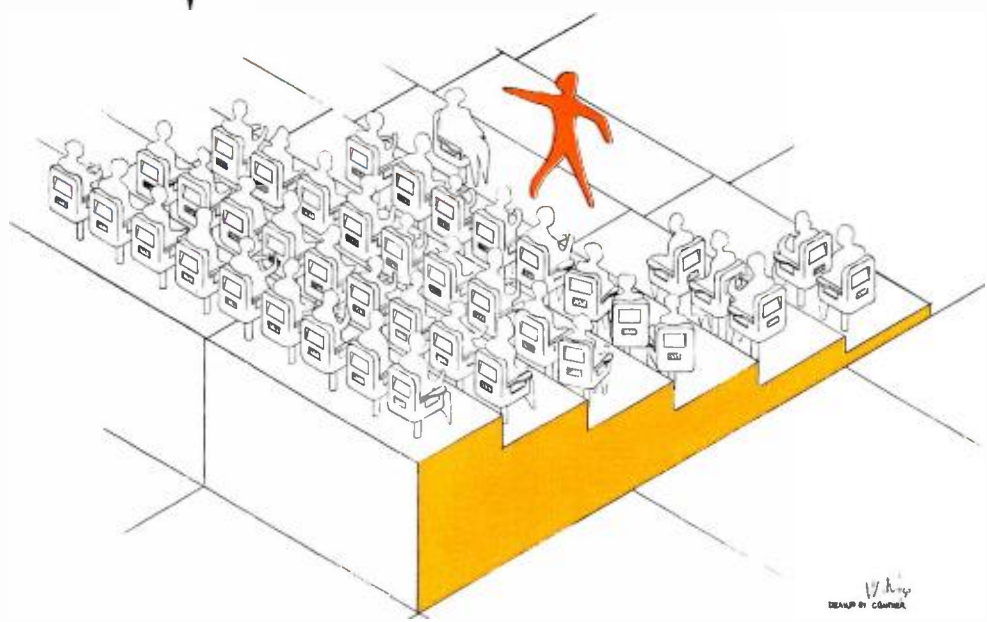

W. H. H. 1942
DESIGNED BY CHAPMAN

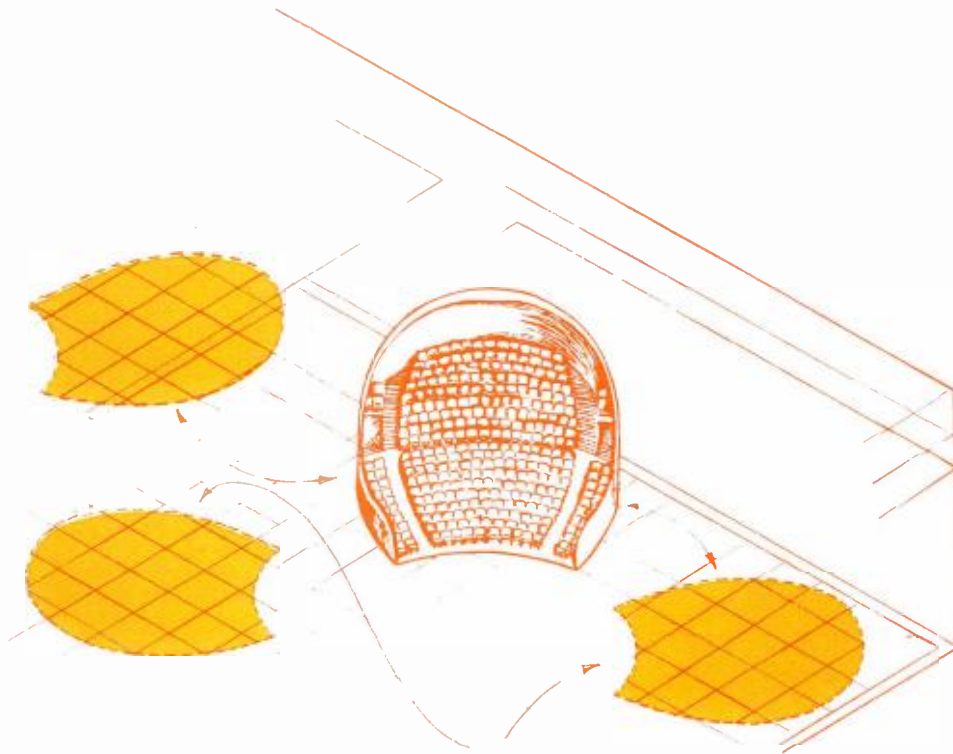

THE AUDITORIUM

The SPACE-CONTROL production area is envisioned as being sufficiently large that it would house a moving, or movable, auditorium seating approximately 270 people. This auditorium would have the extreme feeling of comfort and warmth, embryonic safety. The auditorium could be brought in to the SPACE-CONTROL production area at will so that all the advantages of the area would be at the command of the production which felt it needed this intimate audience relationship in order to present the best possible picture of quality programming to the home viewing audience.

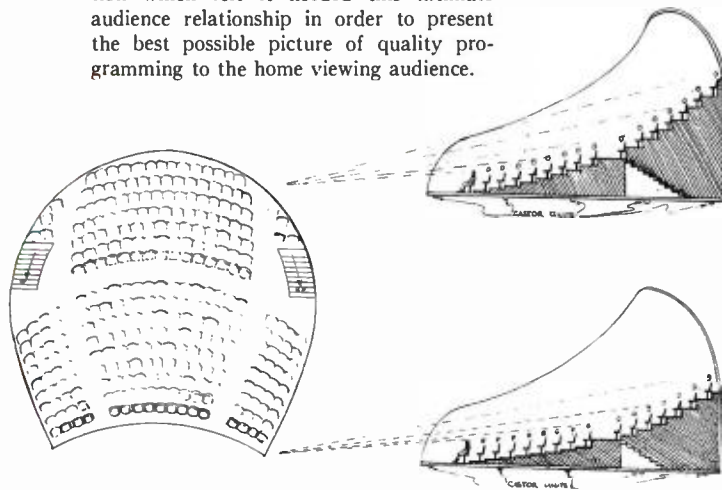

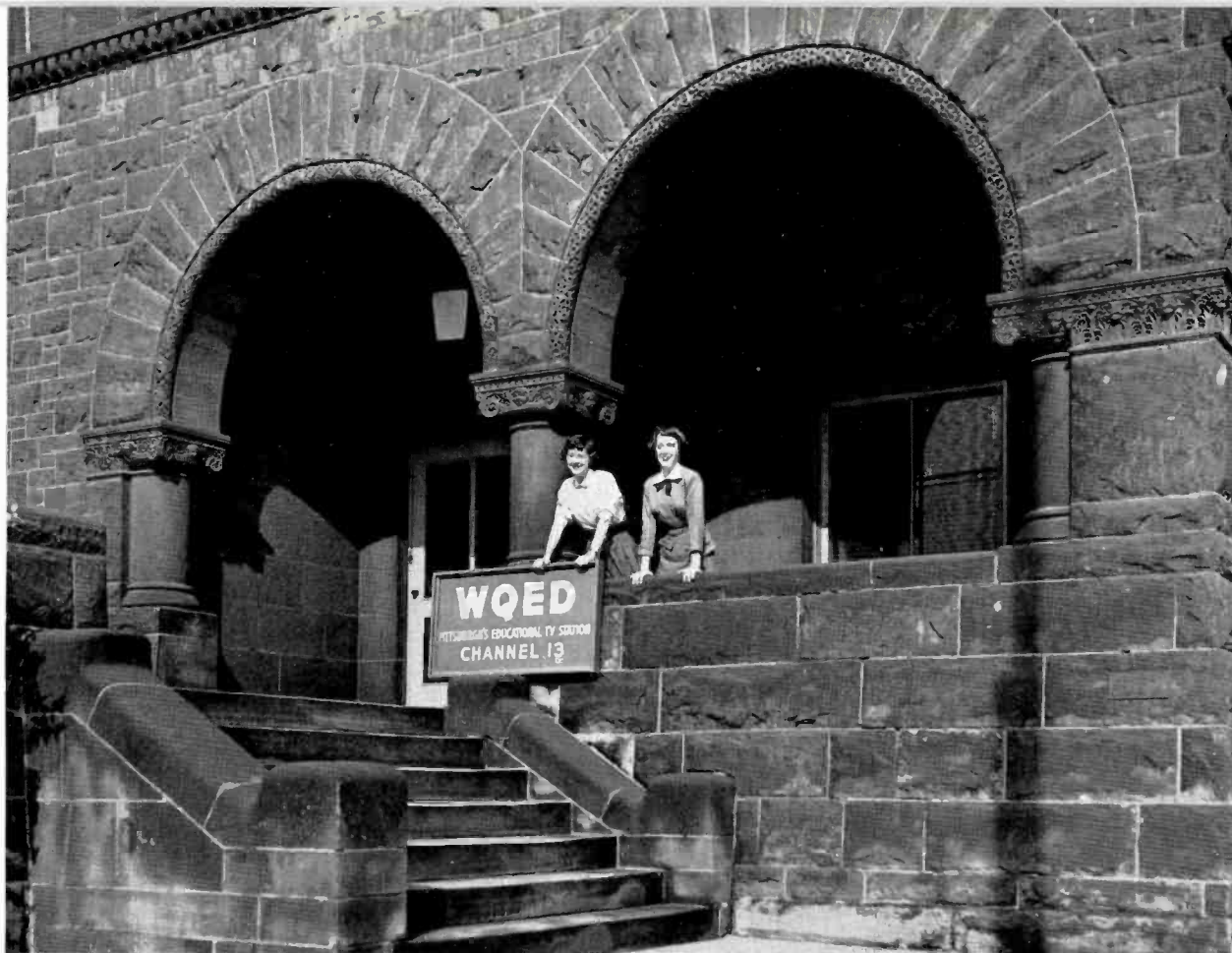

Offices and studios of WQED, Pittsburgh's educational TV station, are housed here. The Pittsburgh Plate Glass Co. conveyed a deed to the University of Pittsburgh for the building and grounds which were made available to WQED.

WQED FIRST COMMUNITY SPONSORED EDUCATIONAL TV STATION

In its 21 months on the air WQED, Pittsburgh's educational TV station, has attracted nationwide attention among commercial TV stations, educators and other educational TV enthusiasts.

Program plans call for a 67-hour-a-week schedule on channel 13 starting this fall. This is believed to be one of the most ambitious undertakings of any of the eighteen educational television stations now operating in the country today. This is quite a jump from the modest four hours of telecasting per week when the station first went on the air on April 1, 1954.

The story behind this dynamic example of community effort and enthusiasm goes back to April of 1951. At that time Mayor David L. Lawrence called a meeting of the fourteen colleges and universities in the area, as well as representatives of various civic and cultural groups, to explore the feasibility of establishing an educational television station for the Pittsburgh area.

With the backing of such groups as the Allegheny Conference on Community Development, a privately financed citizens organization dedicated to the advancement of community interests, the Mayor's Com-

mittee on Educational Television approved the establishment of a non-profit corporation to administer an educational television station for the Pittsburgh district.

Financial Support

Three foundations have made grants totalling \$350,000 for the equipment necessary to begin operation of the station. They are the Ford Foundation, the Arbuckle-Jamison Foundation and A. W. Mellon Trust. The Westinghouse owned station KDKA gave the use of its FM tower above Pitt Stadium. Pittsburgh Plate Glass Company conveyed a deed to the University of



Funds for station operation are partially derived from subscriptions to WQED Program Previews.

Pittsburgh for the present studio and office building. The university then promptly made the building and grounds available to WQED.

As an educational television station, WQED receives no support from commercial on-the-air advertising, nor does it derive any funds from state or federal subsidy. It receives the major portion of its support from public subscription. Additional funds are forthcoming from school districts and gifts from individual donors.

The station is presently in the midst of a campaign to raise \$335,000 from 50,000

sponsors in its annual campaign for operating funds. More than 5,000 men and women have volunteered their time to help reach the quota. Families owning TV sets are asked to subscribe \$2 per year to WQED Program Previews, a schedule and description of future programs.

Volunteers Aid Regulars

Any community effort must depend on volunteers; WQED is no exception. Until this fall the station has had only 24 full-time personnel. Usually, more than half of the staff at the station is composed of volunteers. They do everything from aiming

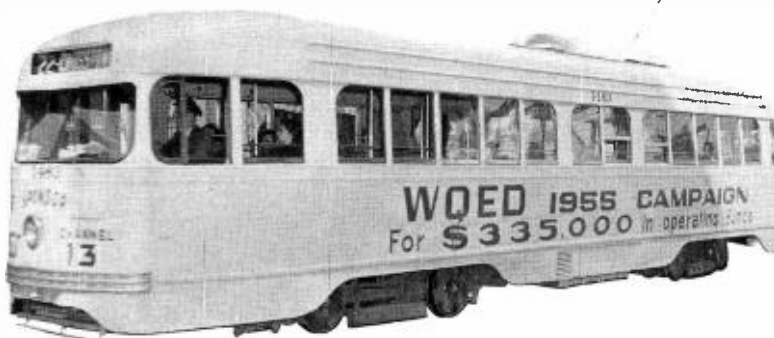

Local transit company cooperated in 1955 fund raising campaign.



More than 5000 volunteers aided in the fund raising campaign to raise \$335,000 from more than 50,000 sponsors. This annual appeal for operating funds is the station's primary support.



Volunteers greatly aid in both operation and upkeep of the station. Here a couple of volunteers pitch in to redecorate the offices.

the RCA field-type cameras and manipulating puppets to pulling cable and announcing. They work side by side with the regular staff.

Nowhere has the spirit of community cooperation been more apparent than in the relations between WQED and the commercial TV stations in town. Last March a big wind took down WENS's transmitting tower. Program schedules were bent to fit both stations as WQED came to the rescue and broadcast WENS material as well as its own. Sponsored programs on WENS have been cancelled in order to bring UHF channel-16 viewers a WQED program deemed to be of exceptional public interest.

Station KDKA, the other VHF station in town, and WENS made it possible to increase remote coverage at the Allegheny County Fair this year by providing equip-



More than half of the WQED staff is composed of volunteers. Here a group of student volunteers study lighting fundamentals and the operation of the station's lighting board.



Pat Hamilton, known to thousands of WQED Tame Tigers as "Miss Pat", is teaching Daniel S. Tiger and Josie Carey (left) how to make a salad in her new series of "Fireless Cooking" lessons each Wednesday on the 4:30 Children's Corner.

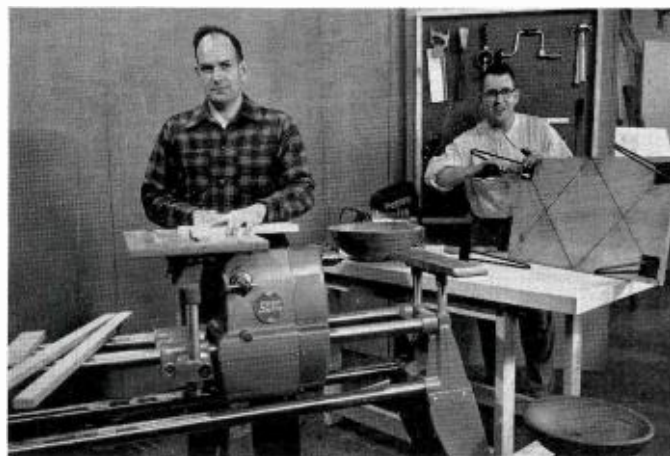

"Shop Talk", one of the popular adult programs. This is conducted by industrial vocational teachers for the benefit of Pittsburgh area "do-it-yourself" enthusiasts.



Children's Corner hostess, Josie Carey pins button on Dr. Frank Baxter of "Shakespeare on TV" series fame, as the children's favorite, Daniel S. Tiger, presides.

ment such as a mobile unit, Zoomar lens and two RCA field camera chains.

WQED Programming

Programs are planned for the interest and benefit of many specific groups of viewers ranging from the pre-school child to the mature adult. There are three major divisions in WQED's programming schedule, consisting of: in-school programs for classroom reception; out-of-school programs for children; and informative, cultural and educational program for adults.

The in-school programs are financed, planned and guided by the various elementary and secondary schools of the ten-county area surrounding Pittsburgh. Intended to enrich and supplement the school curriculum, the programs are listed in a quarterly *Schooltime Study Guide*. This allows the teacher to fit her daily schedule around *Schooltime TV*. Use of the television medium may prove to be one approach to solving the evergrowing problem of the nation's teacher shortage.

For the young viewers at home *Children's Corner* has become their favorite program. It has proved to be so popular that over 4,000 letters, mostly from youngsters, are received each week. Daniel S. Tiger is the puppet president of a Tame Tiger Torganization whose moppet membership, numbering over 13,000, receive merit awards for learning simple French and performing other creative tasks. The show, which also teaches arts and crafts as well as the care and feeding of pets, has been signed by NBC to do four sustaining half-hour shows.

Providing educational opportunities for the more than 70 per cent of people in Western Pennsylvania who do not possess

a high school diploma is *The Adult High School of the Air*. Accelerated courses lead to a high school diploma in two years. These telecourse students pay \$2 per course and, when their studies are completed, they can take final examinations through the State Department of Education or the Pittsburgh Board of Education. These educational courses extend to the college level as well, for WQED is now offering a telecourse in *Family Dynamics* for college credit.

Regular High School of the Air programs were received in the Allegheny County Workhouse and for the first time anywhere prisoners in a correctional institution had the same educational opportunities as persons on the outside.

During the summer, high school students who failed in their work in the previous semester had a chance to make up their studies by viewing regular high-school courses broadcast by WQED. A teaching load was thus removed from already overburdened classrooms. This representative outline of programs should give a fair picture of WQED's contribution to community life.

Another program which has been signed by the National Broadcasting Company for a series on that network is Dr. Benjamin Spock's baby and child-care program, *Parents and Dr. Spock*. This program is part of the 10 hours per week of recording done on the RCA TMP-20B Kinerecorder.

As a community television station WQED's programming policies are directed by a Program Committee composed of the Board of Directors of the station and other educational, civic, business and cultural leaders. President of the station and head of the Board of Directors is



Volunteers at the Allegheny County Fair. Other local stations made it possible to increase this coverage by providing extra camera chains and a mobile unit.



More than 600 local Children help celebrate Daniel S. Tiger's birthday. These are members of the Tame Tiger Torganization whose moppet membership is 13,000.



High School of the Air student who was unable to attend school. WQED engineers installed this TV receiver in boy's trailer home.

Mr. Leland Hazard, Vice-President and General Counsel of Pittsburgh Plate Glass Company. In the main, they are guided by the broad general principle of providing material that is cultural, educational and informative in nature. WQED is there to serve the people.

Even with the tremendous enthusiasm and support of its volunteer staff, things did not always go smoothly during the first year. Fortunately it has been possible for a small nucleus of experts to supervise and train the non-professionals. Center of this nucleus is Edward C. Horstman, chief engineer and administrative officer for WQED. He was formerly director of engineering and general service manager for the American Broadcasting Company in Chicago. He came to WQED in January 1954, intending to stay just long enough to get the station started. He has been there ever since.



"At Home with Your Child." Baby care, the subject of this program, is near and dear to the heart of every mother. Dr. Ann Wagner, Child Specialist, presides over this popular program series.



Local corps de ballet performs before WQED cameras. WQED programming is guided by the broad general principle of providing material that is cultural, educational and informative in nature.

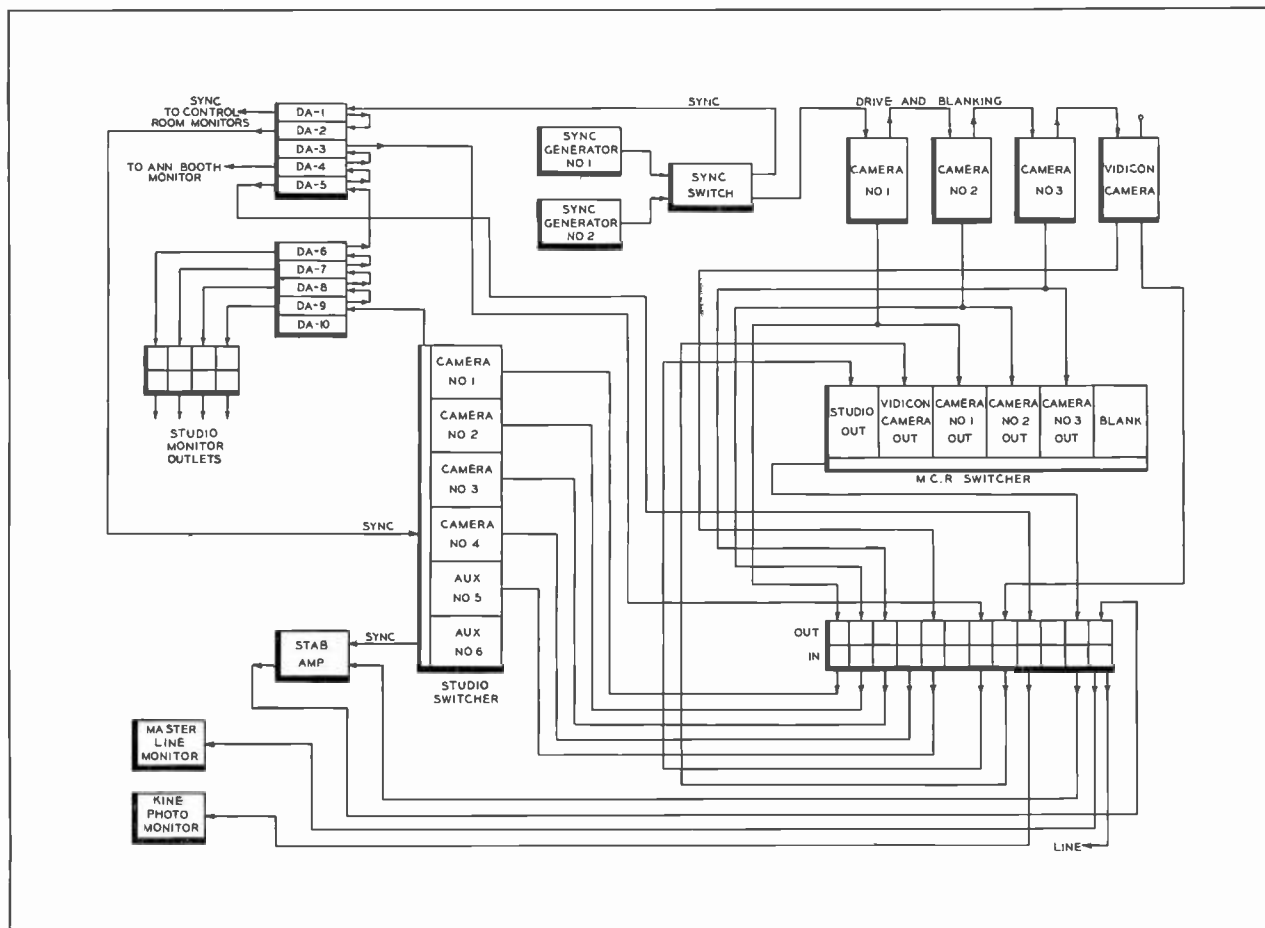

Video distribution diagram of WQED studios.

TELEVISION STUDIOS

WQED's building houses two studios, the main one measuring approximately 64 feet by 32 feet. Three RCA image orthicon cameras allow for adequate flexibility in programming. Since these are field-type camera chains, they are also available for remotes. That these cameras are easy to operate is demonstrated by the fact that volunteer operators with little technical knowledge, in a matter of months, have turned into good cameramen. Another smaller studio, just off the main studio, measuring about 20 by 28 feet has a permanent working kitchen set where programs designed for the homemaker originate.

Mr. Edward C. Horstman, WQED Chief Engineer and administrative officer.



The control room is located at studio floor level on the long dimension of the main studio. Five monitors mounted just below the control-room window allow an unobstructed view of both studios while being clearly visible to the control-room staff.

The audio operator sits in front of an RCA studio console with two turntables located immediately to his left and a tape recorder to his right. The director is seated to the right of the audio operator where he not only directs the show but does the switching on the field switcher. This field-



This studio measures approximately 20' x 28' and contains a permanent working kitchen set where programs designed for homemakers originate.



The main WQED studio measures about 64' x 32'. A dress rehearsal is in progress of an original production by a University of Pittsburgh student.

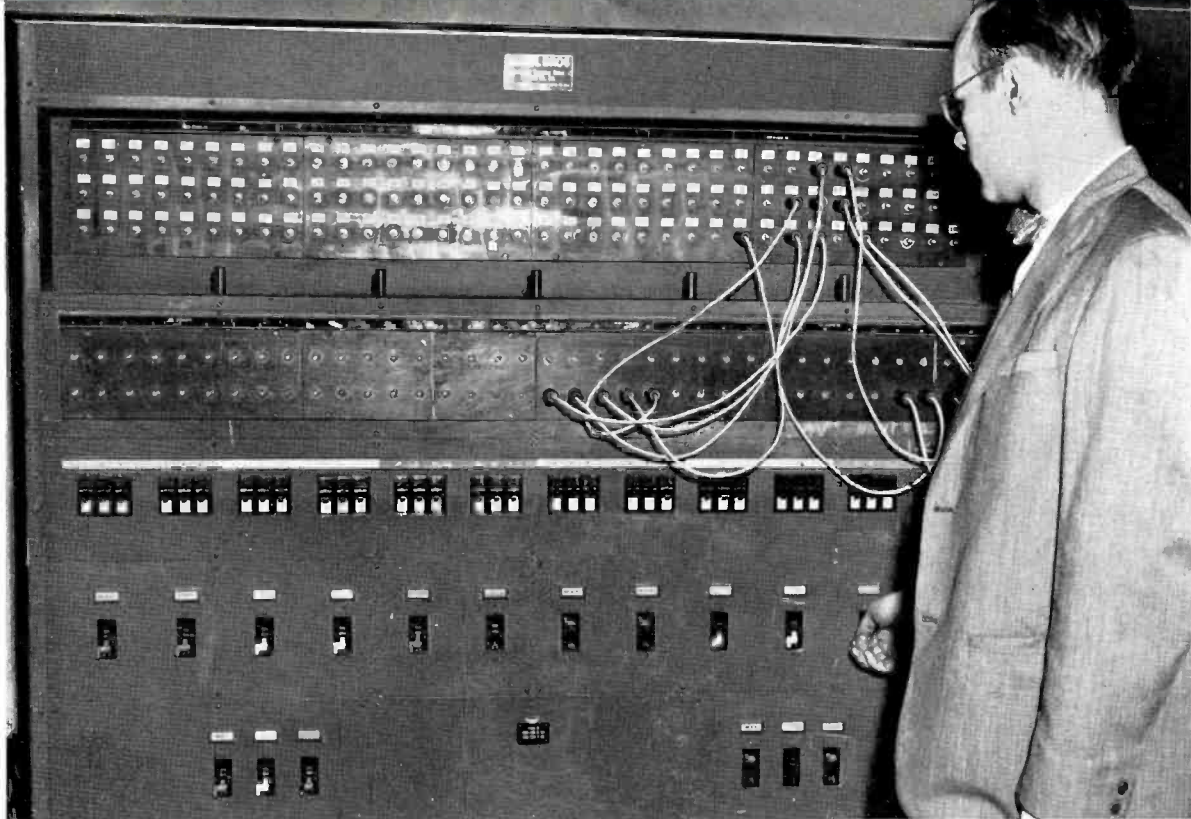

Childs Wolfe, Program Director, also helps out at lighting control board which controls both of the station's studios.

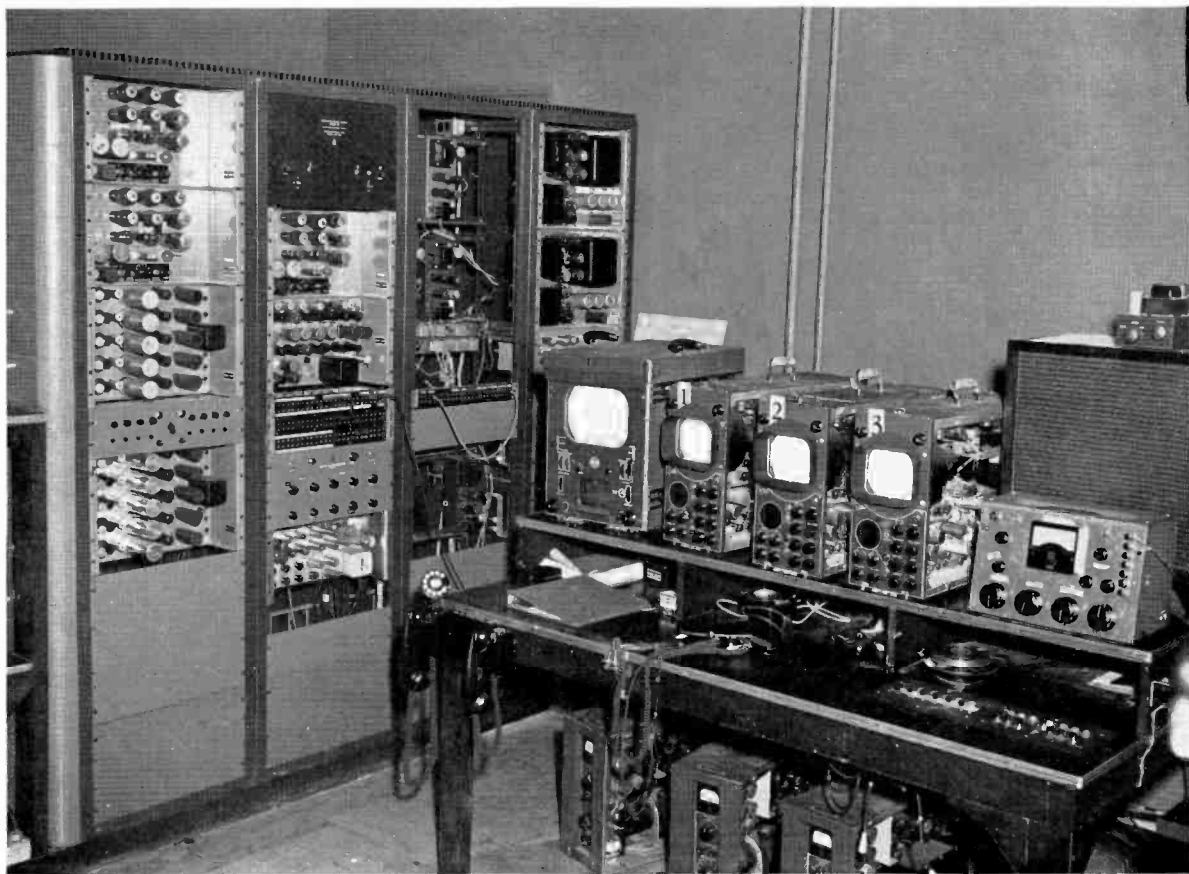

Master control room. Camera control units for the station's three field camera chains are located here with four racks of terminal equipment.

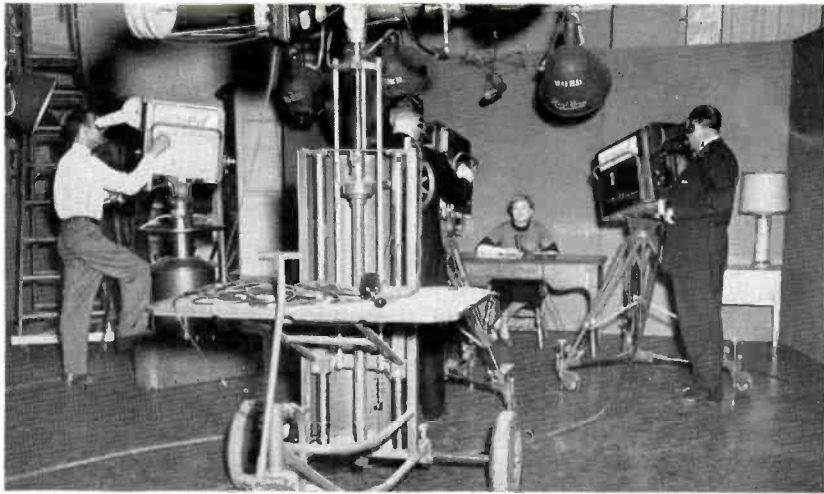

A single set in the station's main studio showing all three of the cameras in operation.



WQED control room. Switching, audio and production activities are centralized here.



Close up of the program director's switching console.

switching system serves not only as a means for transferring camera outputs, but permits fades, superimpositions, lap-dissolves and other effects.

An announce booth, containing a picture monitor and a microphone, is located to the left of the control room. A visitors' booth is situated directly above the control room, giving the citizens of Pittsburgh a chance to see what a television studio looks like when their station puts on a live show.

Film Facilities

The film-projection room is located next to the control room where film reproduction is handled by the Vidicon Film Cam-

era TK-21. Two RCA 16mm film projectors and a Gray slide projector are directed into the TP-11A Vidicon Multiplexer.

Two monitors are mounted on the wall behind the vidicon film camera. One monitor shows the projectionist the picture on the vidicon camera; the other is a line monitor. Approximately half of WQED's program material is on film.

Master Control Room

Situated directly behind the projection and control rooms is master control. Kinescope films of WQED's most successful programs are produced for national distribution on RCA TMP-20B kinephoto recording equipment located in one corner

of the room. These films are distributed by the Ford Foundation-sponsored Film Center at Ann Arbor. Magnetic sound-recording equipment next to the video recorder reproduces the audio portion of the programs.

The camera control units, three in number, are located on a long desk along with two master monitors and a video switcher. Two sync generators are provided which feed into a switch allowing a rapid change-over to the spare sync generator in case of momentary failure of the other.

Four cabinet racks containing power supplies and a grating and dot generator complete the equipment layout in master control.



Vidicon film facilities at WQED. Two RCA TP-16 16mm film projectors and a dual disc slide projector are used with the RCA TP-11 vidicon multiplexer and TK-21 vidicon film camera.



RCA TMP-20B kinephoto recording equipment. Kinescope films of WQED's most successful programs are produced here for national distribution through the Ford Foundation film center.

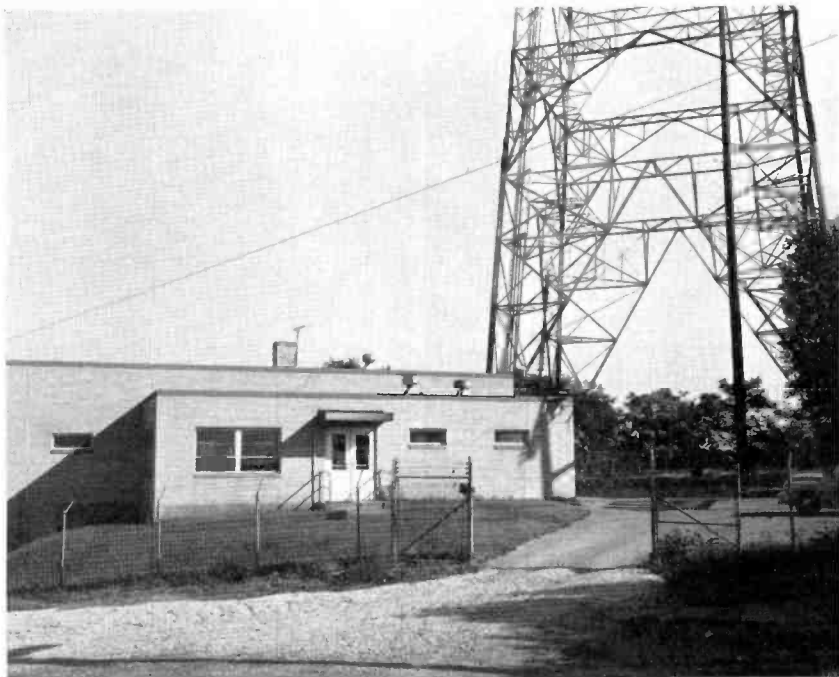

WQED transmitter house is located at the site of the KDKA-FM tower.

WQED'S TRANSMITTER INSTALLATION

One of Mr. Ed Horstman's first duties when joining the staff as chief engineer was supervising the installation of the 5-kw VHF transmitter. The antenna and transmitter are located at the site of the KDKA-FM tower. The FM antenna has been side-mounted, permitting the RCA TF-6AH six-bay Superturnstile antenna to be mounted on the top of the 527-foot tower. The transmitter building is a low, one-story affair located next to the tower.

The continued success of WQED should afford a healthy climate for the many educational TV channels still to be allocated.

Pittsburgh's commercial TV stations are planning to continue their active support of this first community-sponsored TV channel. They feel that there is nothing in community or educational television that is in competition with its commercial counterpart. An educational TV station can do with assignments of blocks of time devoted to specific projects what commercial television cannot do and should not be expected to do.

The story of WQED and its impact on life in the Pittsburgh area is not only an example which other communities may emulate, but a challenge as well.

The tower is shared by WQED and KDKA-FM. The FM antenna has been side mounted, permitting the RCA TF-6AH six-bay Superturnstile antenna to be mounted atop the 527-foot tower.

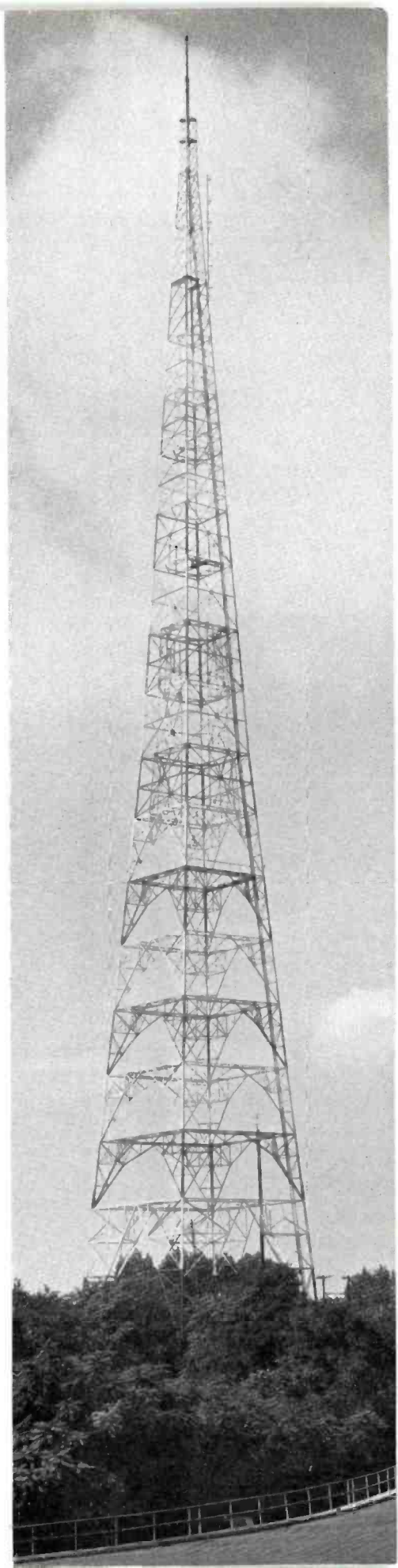

Fire-damaged equipment at WJPA.
Replacement was made quickly
with an RCA BTA-250M.

SIX STATIONS BACK ON AIR IN RECORD TIME AFTER FIRE AND FLOOD DAMAGE

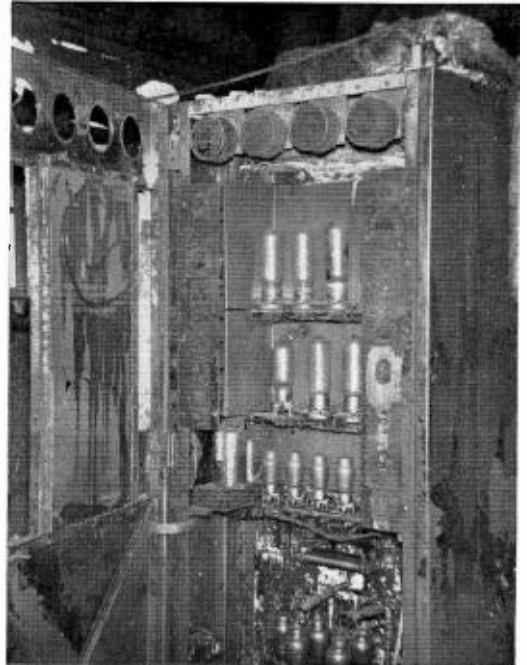

WCOV MAKES FAST RECOVERY AFTER DEVASTATING BLAZE



Fire damage in the WCOV-TV studio. One of many scenes of devastation throughout the building. Station back on air in twenty days with new RCA equipment.

Not once, but twice, WCOV-TV, the first television station to be established in Montgomery, Alabama, has built their station! And now for the second time, WCOV-TV, Channel 20, is operating full blast after amazingly fast recovery from one of the most treacherous fires in TV history.

It happened in the early morning of August 5, 1955, when Walt Spiro, radio announcer, was reporting to work. Apparently burning for over an hour, the inferno was unapproachable. Mr. Spiro immediately placed the alarm.

The photo at the lower right is only one of many scenes showing the devastating effects of this fire.

Twenty days later WCOV-TV was back on air operating with new RCA studio equipment and transmitter. A TTU-1B 1 kilowatt transmitter was placed in service on August 25. On August 26 a TTU-12A 12 kilowatt amplifier was shipped. Now operating on full power and a normal schedule, WCOV-TV with complete interior renovation, is serving Montgomery, Alabama's Capital City as before.

WCOV radio temporarily disrupted, was back on air within an hour after the fire.

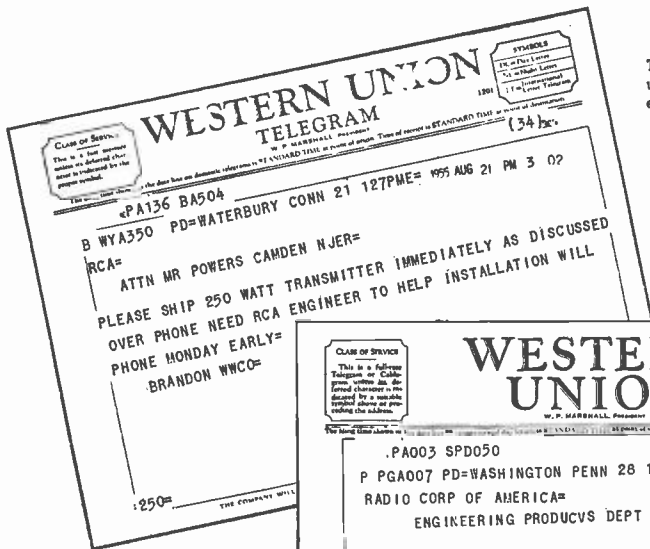

Typical telegrams point up the urgent need for equipment.

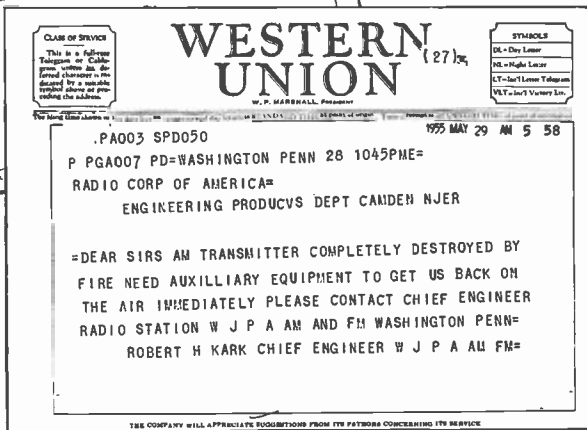

Raging New England floods leave WWCO a twisted mass of debris. In a matter of hours new RCA equipment was on its way.

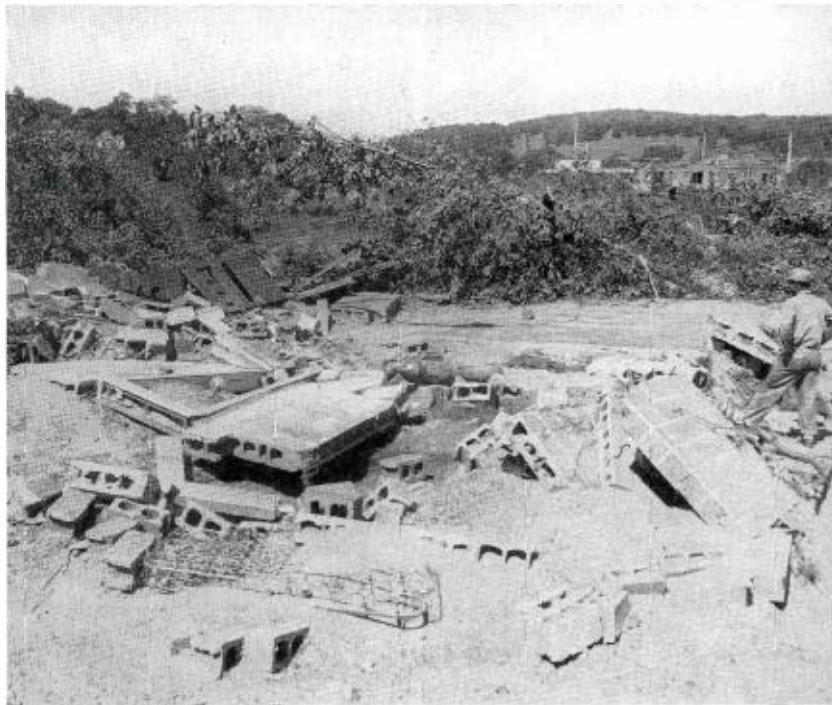

WJPA, Destroyed By Fire, On Air 5 Hours After Receiving New RCA Transmitter

On May 29, 1955, Chief Engineer Robert H. Kark of WJPA, Washington, Pennsylvania, wired RCA in Camden, New Jersey for a new transmitter to replace equipment which had been destroyed by fire on the day before.

Quoted from a letter to RCA after this station returned to air, Mr. Kark goes on to say, "I would like to add the additional comment, that five hours after the RCA BTA-250M transmitter arrived by special truck, we were on the air and operating on STA (special temporary authority) at full output from temporary quarters in the garage-basement of the burned out building—confirming the versatility of RCA equipment."

WWCO Makes Fast Comeback With RCA Equipment After Flood Destruction

Torrential floods crashing through New England in the latter part of August, left WWCO a shambles of twisted debris. Mr. Lawrence Brandon, General Manager of WWCO states . . . "The destruction was caused by the raging and overflowing Naugatuck River . . . it all happened in the space of a few hours." The photo at left gives evidence of the havoc caused by this raging flood.

Above is the emergency telegram which started new RCA 250 Watt Transmitting equipment (the RCA BTA-250M) on its way to put WWCO back on air in record time. In traditional broadcast spirit, WWCO, undaunted, is back on air!

RCA PUTS KSCO BACK "ON AIR" AT TEMPORARY SITE 54 HOURS AFTER COMPLETE TRANS- MITTER DAMAGE



On Tuesday, March 8, 1955, the KSCO 1 kilowatt radio transmitter, located at Santa Cruz, California, burned to the ground. So severe was the damage that complete technical facilities were destroyed. On that same date a new RCA BTA-1M radio transmitter, limiting amplifier and audio consolette were on their way to California via Flying Tiger Air Freight.

The equipment arrived in San Francisco at 10:04 p.m. Wednesday evening, March 9th and in less than an hour was on its way by truck to Santa Cruz. By noon the following day, KSCO was back "on-air" with a temporary installation set up in the manager's office.

Such a feat as setting up a transmitter in an office can be attributed to the space-saving design of the RCA BTA-1M 1 kilowatt transmitter.

Set-up time is reduced to a minimum, as evidenced by the short time required to put several of these transmitters on the air on an emergency basis. (See story on WINX and WHBL, opposite page.)

The total time involved from receipt of the emergency order at RCA in Camden, New Jersey until the temporary transmitting site was placed in operation was approximately 54 hours.

Once again the expanse of a continent did not hinder RCA in getting a distressed broadcaster back on air as quickly as possible.

Shipment of a 1 kilowatt radio transmitter is made ready for fast flight to KSCO near Los Angeles, California as replacement for burned out station. RCA order service and shipping personnel, Ray Fox and George McCole, look on as Ed Meehan, Sales Coordinator, labels shipment—"via air".

WINX Back "ON AIR" In Less Than 18 Hours After Transmitter Was Burned Out

On Friday, March 11, 1955 at 1:30 p.m. the WINX 1 kilowatt radio transmitter was burned out by fire. Within a few hours after this accident (approximately 4:30 p.m.), Mr. Richard Eaton, owner of WINX, called RCA in Camden to discuss replacement of the damaged equipment (another brand). Immediate shipment of a new RCA BTA-1M 1 kw transmitter was promised.

While paperwork was being drawn up the shipping department near the end of their work week was alerted to standby until all items—transmitter, crystals to op-

erate on 1600 kc and accessory items were packaged for shipment.

Complete new equipment arrived at WINX, Maryland at 3 a.m. the next morning, Saturday, and at 10 a.m., in less than 18 hours after the order was placed, WINX was back on the air with a brand new, top performance, RCA BTA-1M.

Photo at right typifies WINX transmitter. Actual scene, however, is at WHBL. (Story below.)

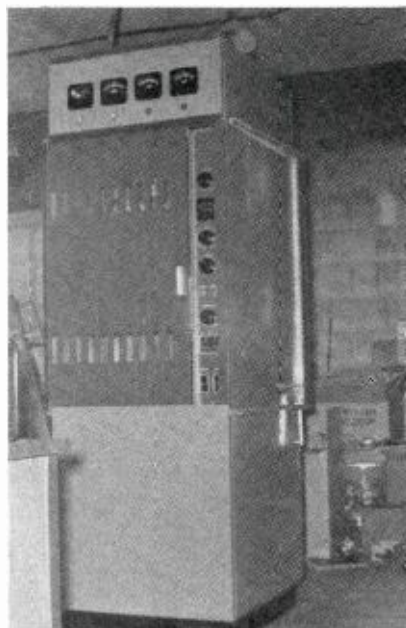

WHBL Returns To Air 33 Hours After "SOS" For New RCA Radio Transmitter

After a fire on September 26, 1955, which completely destroyed the WHBL radio transmitter, WHBL returned to the air in less than 33 hours with brand new RCA equipment. Following the emergency call to Camden for a new transmitter, paperwork was cleared rapidly and the new equipment was trucked to the Newark, N. J. airport and placed aboard a Slick Air Freight plane bound for Chicago. In Chicago it was met by a truck operated by the Scheffler Trucking Company, which quickly transported it to Sheboygan, Wisconsin, WHBL's location. In a matter of hours the new equipment was placed into operation.

To relate the scene: On Monday, September 26 about 10:15 a.m. the WHBL transmitter went off the air. Since the transmitter was a remote-control installation, station engineer Chris Markworth drove from the studio to the transmitter site to determine the trouble. When but a few blocks from the building he noted a heavy funnel of smoke pouring through the thermostatically-controlled building exhaust fan. Upon opening the door, flames

and smoke billowed out violently. Mr. Markworth closed the door, raced across the street and called the fire department. In a matter of minutes the fire department arrived and put out the fire.

An RCA BTF-10B FM transmitter operating adjacent to the damaged AM transmitter remained on air despite the terrific heat. It was shut off during the fire-fighting episode but was back on air in less than an hour.

Shortly after the station's return to the air, Charles E. Broughton, President of WHBL, broadcast an expression of appreciation to RCA and others who helped make possible the rapid delivery and installation of the new radio equipment.

This account as well as the others described on these pages points up the excellent cooperation and coordination between the stations and RCA in the event of an emergency. RCA's interest in the customer goes far beyond the purchase and RCA's unequalled replacement facilities are worthy of consideration when new equipment is contemplated.



WHBL fire damage in transmitter building. Adjacent RCA FM transmitter, shut off during fire-fighting, returned to air in less than one hour.

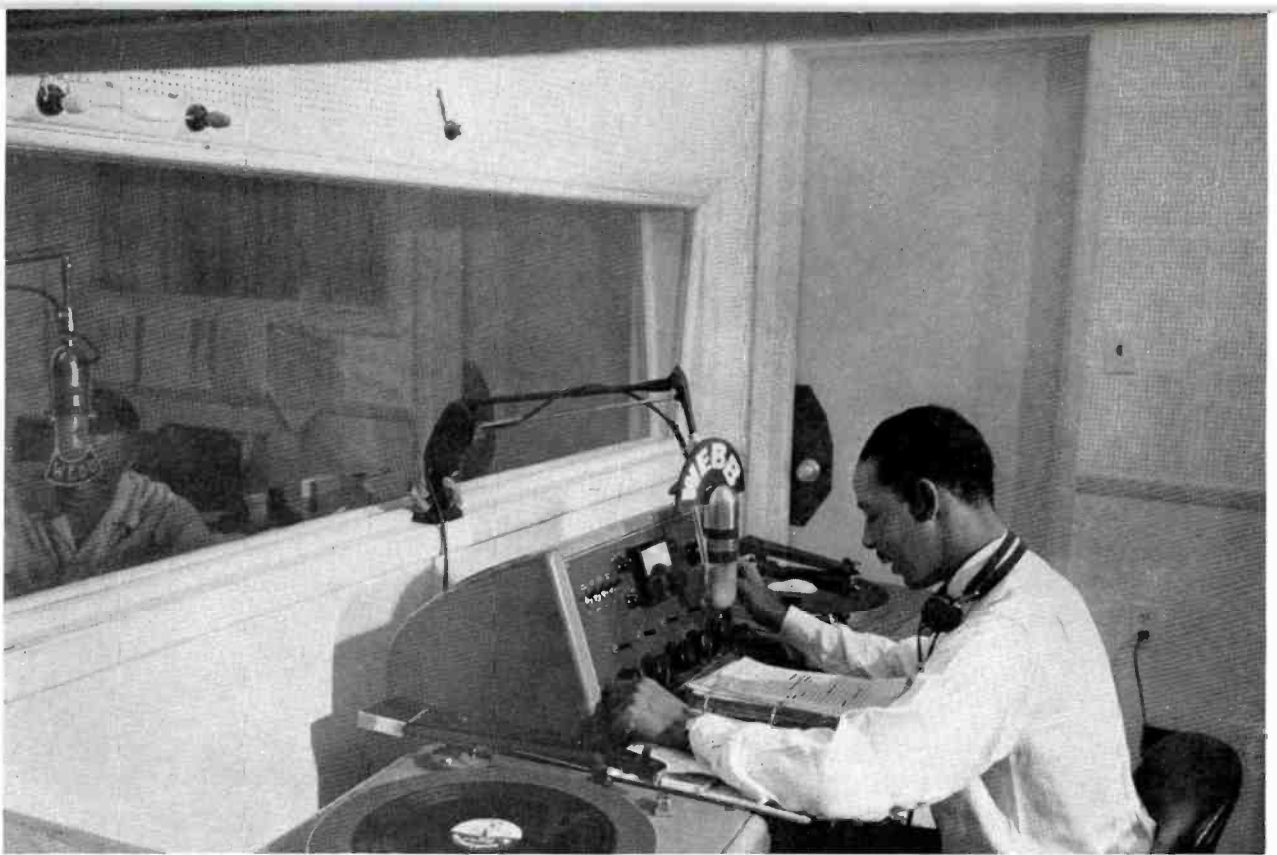

Control room, looking into large studio. The BC-4A audio central console contributes materially to smoothness of station operation.

WEBB MAKES RAPID STRIDES

WEBB radio has been serving the Baltimore, Maryland area since March, 1955 when the station owned and operated by the 1360 Broadcasting Company began operations. Located in Dundalk, Maryland, a near suburb of Baltimore, WEBB serves more than 90 per cent of the area's population of approximately 1,800,000 with a power of 1000 watts from a combined studio-transmitter building.

The Studios

The studios, which were planned by Mr. Ross Beville, a well-known Washington engineer, were laid out so as to combine efficient operation with a minimum of waste space. The single large studio is adequate for accommodating groups of ten to fifteen people, should such a need arise.

The Control Room

The center of operation is the control room which has also been planned for space saving, efficient operation. The control room faces the main studio, which also

serves as the record library. Despite the fact that WEBB has been in existence only a few months, a popular music library of more than 1500 individual discs and albums is available to the program personnel. Extensive use is made of 45-rpm records.

The two 16-inch, 3-speed turntables shown in Fig. 1 have since been augmented

by the addition of a third turntable, an RCA BQ-1A, which is used entirely for microgroove (45 or 33 $\frac{1}{3}$ -rpm) discs.

The station staff is quite enthusiastic concerning the regular use of the turntables, feeling that the added flexibility of programming made possible with the third unit increases the overall program quality.

Tape recording equipment is not installed permanently, but is kept in its portable case, permitting it to be moved to an out-of-the-way corner when it is not required. As the controls are operated by announcers most of the time, the Chief Engineer, Mr. Joseph Sporney, feels that the simplicity of operation of the RCA BC-4A Audio Central Console has contributed materially to the smoothness of operation of the station.

Considerable use is made of tape recording at WEBB. The station's leading disc personality is Buddy Young, star back for the Baltimore Colts professional football team. Buddy's shows are tape recorded in advance when the team's trips take him



Mr. Bentley Stecher, General Manager, signs order for new RCA equipment as Bill Valentine, RCA Broadcast Sales representative, looks on.

out of town. In addition, many of the station's spot announcements are taped, which gives greater variety of presentation.

Transmitter and Antenna Array

RCA equipment is used throughout the station. The transmitter, a type BTA-1M, is built into a wall effectively dividing the operating area from the workshop and maintenance area in the rear. As shown in the floor plan, the transmitter is so positioned that the operator on duty at the control console can keep the transmitter under continual observation. The phasing equipment is contained in a directly adja-

Joseph Sporney, Chief Engineer, takes meter readings on the RCA BTA-1M 1 KW transmitter and associated phasing equipment.

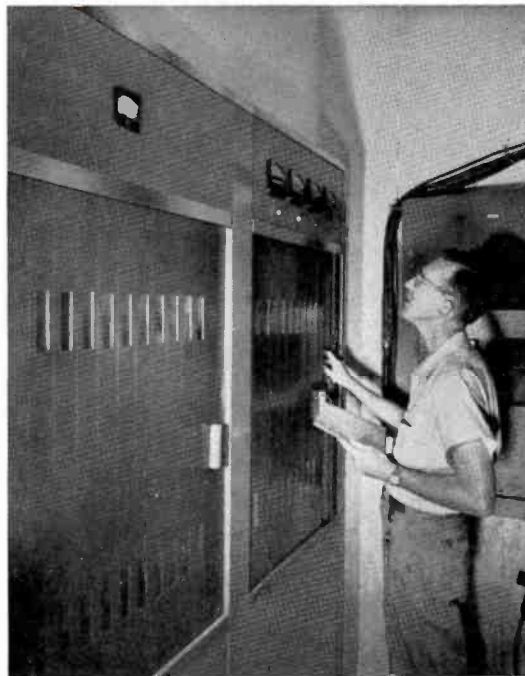

Two Stainless towers form directional array. Location is a semi-swamp where moisture in the soil provides an efficient ground system.

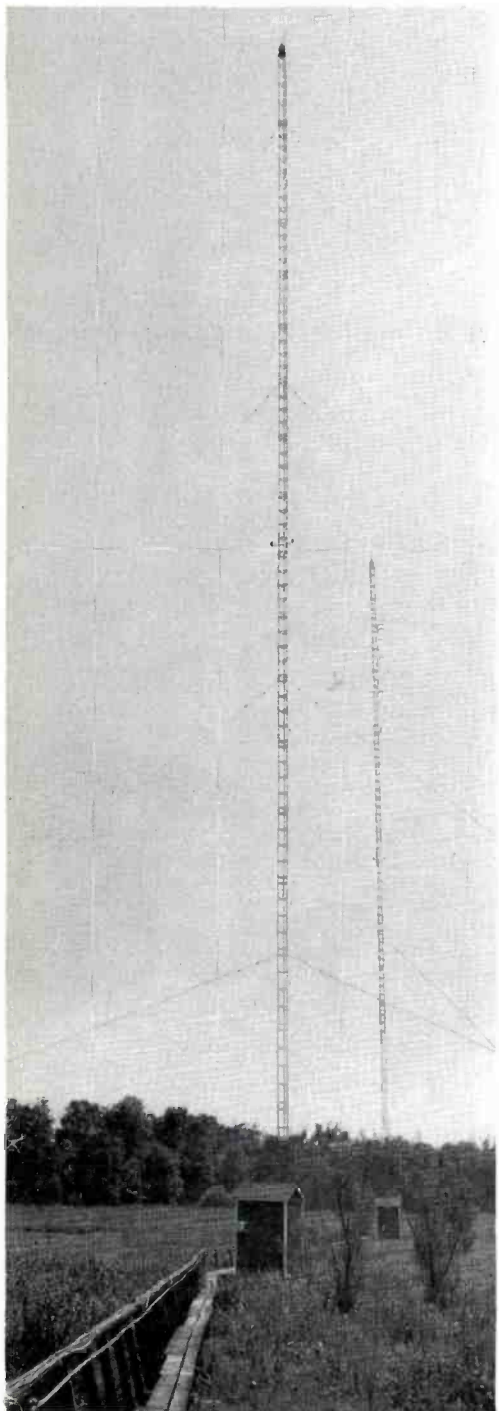

cent matching wing cabinet to the left of the transmitter. According to Mr. Joseph Sporney, Chief Engineer, the sliding door construction of the transmitter and phasing cabinets is of considerable assistance during routine maintenance. The equipment is adequately cooled by the built-in blower, but it is planned that a separate room-type exhaust fan will be installed to improve circulation in the rear room, which is not connected to the building air conditioning system.

A two-tower directional antenna system, which beams a powerful signal in the direction of downtown Baltimore, is located in a semi-swamp. This location is excellent for the antenna array, due to the moisture in the soil which increases the efficiency of the ground system.

In a matter of months WEBB has established itself as a well-accepted source of news, entertainment and public service by residents of the Baltimore area.

Floor plan of the WEBB combined studio-transmitter.

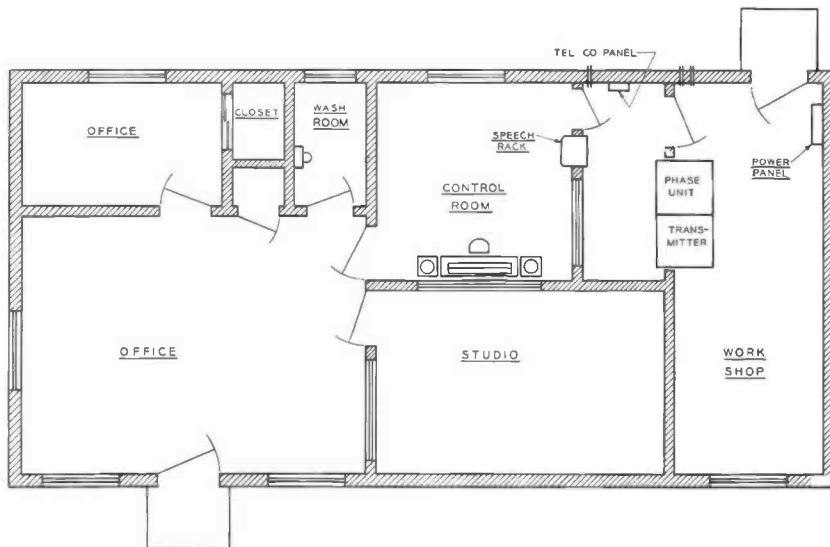

It's Here! RCA's Production

1 
**Performs
4 Functions**



MORE EFFICIENT

"All-in-one" Processing Amplifier combines the signal processing functions of previous channel amplifier, gamma corrector, shading generator, and monitor auxiliary.

Only 
1 1/3 Racks

COMPACT

The new equipment utilizes only 100 inches of rack space; can be mounted in only 1 1/3 racks for efficient, compact installation.

1/3 Less Tubes

LOW OPERATING COST

Requires half the ac power needs of conventional equipment and permits elimination of 50% of former dc power supplies. Uses 9 less rack-mounted units, and 134 fewer tubes—conservatively operated for extended life.



FAST SETUP

Centralized controls minimize setup time, require but a single operator for control functions. In addition, over-all stability, improvement in camera performance and picture quality are assured.

No need to wait any longer for *production* live color TV equipment! RCA has it now... a complete new TK-41 Color Camera chain with new all-in-one Processing Amplifier, which combines four major functions in one. It not only provides important savings in components, floor space and operating costs, but assures highest quality at lowest expense.

This is the complete color camera TV equipment that television stations are now using in their swing to color, or in expanding their color facilities. For complete technical information, call your RCA Broadcast Sales representative. In Canada, write RCA VICTOR Company Limited, Montreal.

RCA TK-41 TYPE COLOR CAMERA

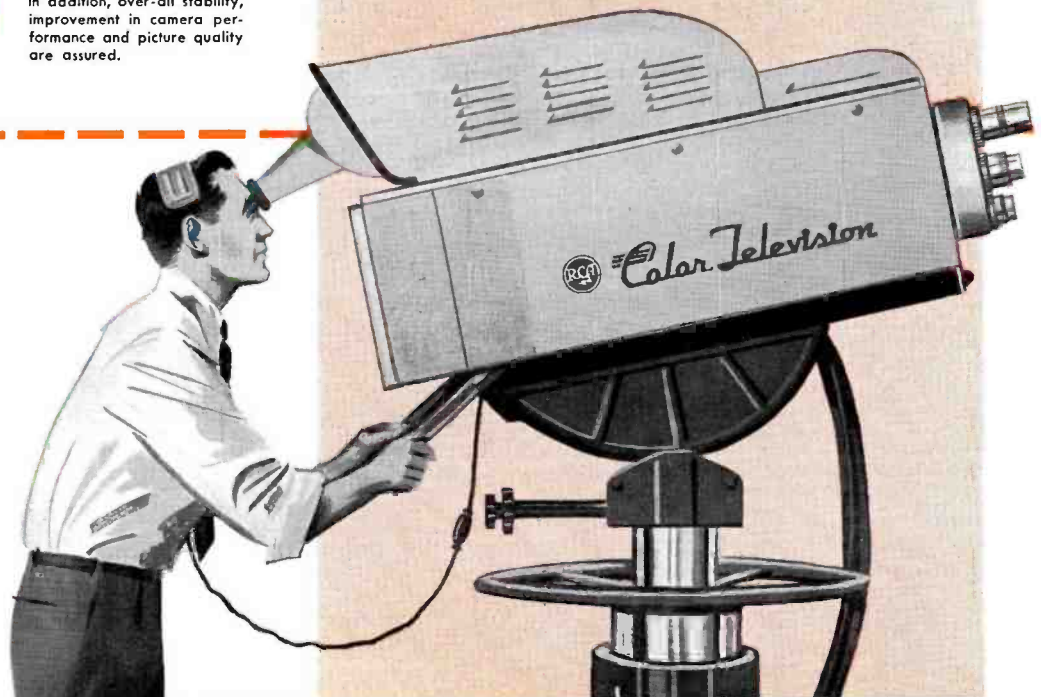

COLOR CAMERA TV EQUIPMENT

... with the revolutionary all-electronic
processing amplifier

which combines all
signal processing
functions in a
single chassis.

12-Page Descriptive Brochure
Available on Request.

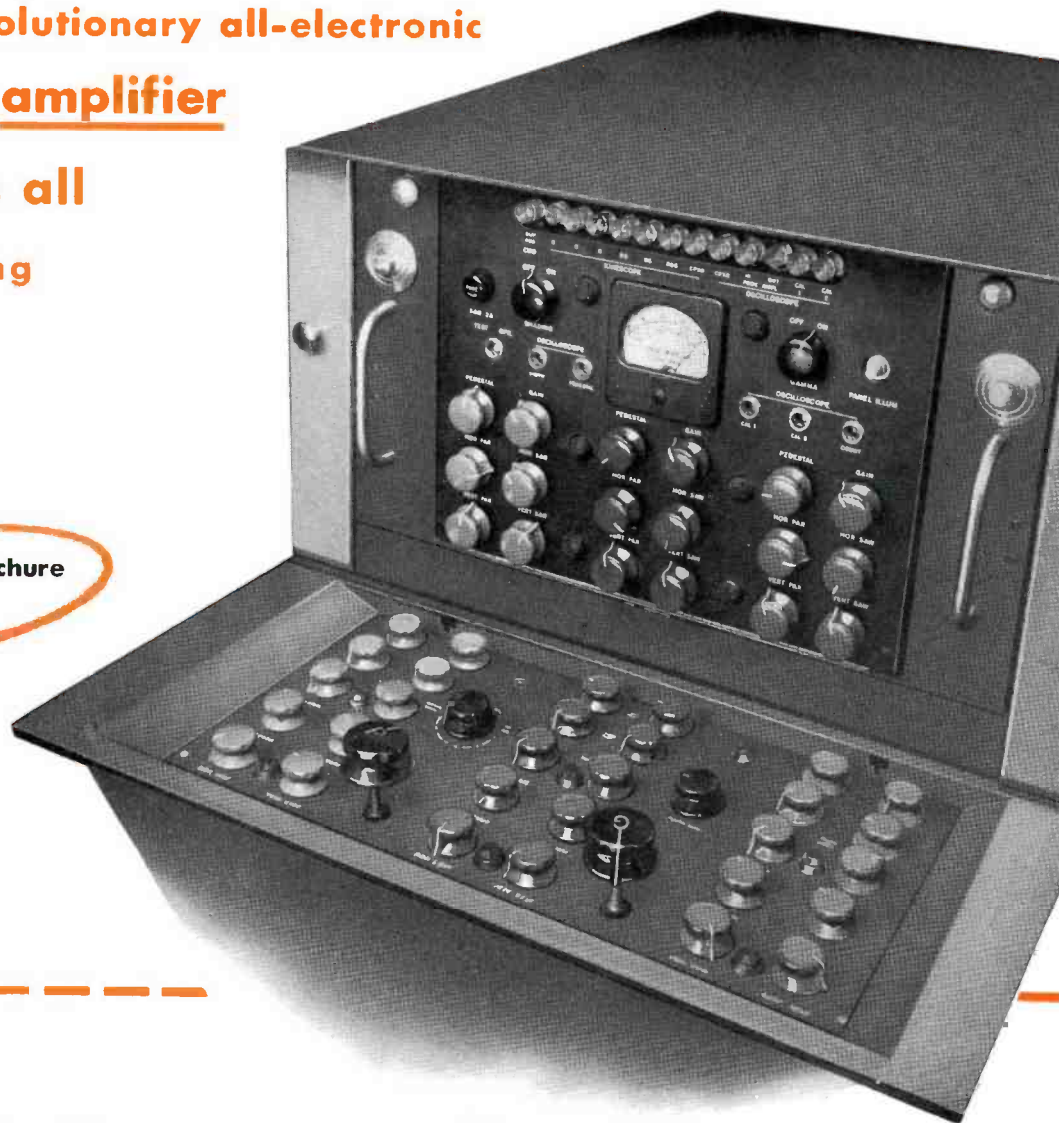

RCA Pioneered and Developed Compatible
Color Television

View of
Processing
Amplifier



RADIO CORPORATION of AMERICA
ENGINEERING PRODUCTS DIVISION
CAMDEN, N.J.



How to bring 1000 doctors into the operating room...with RCA's color TV

In Philadelphia's Convention Hall, a thousand surgeons watched an operation performed several blocks away. It was a demonstration of the RCA closed circuit color television for medical use. Not only did the visitors get a "surgeon's-eye" view of the procedure in full color; they also saw, greatly enlarged, a microscopic specimen removed from the patient, together with a diagnosis, charted and explained by means of X-ray.

For the exchange of medical information and for education in this field, RCA's new television system for medical use

represents today's most important single advance in teaching surgery. Among its many applications may well be its use in a "super-clinic," where widely separated hospitals are linked together by television.

The system includes complete video and audio equipment. It is typical of RCA's standard of construction and performance.

For information on RCA closed-circuit color TV or other RCA electronic products, write to RCA Engineering Products Division, Dept. YC-163, Bldg. 15-1, Camden, New Jersey.



The world's best name for quality in electronics

RADIO CORPORATION of AMERICA

Choose RCA Electronic Products for better business!



RCA Industrial TV lets you see where it's too hot, too dangerous or too impractical to go. The TV camera "eye" provides a high-definition, high-contrast picture that permits constant centralized control.



RCA Sound Systems are engineered to give the best in internal communications. Widely used by industrial plants, schools and large institutions for spoken messages or music... to any or every in-plant location.

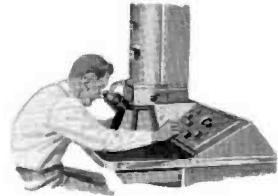

RCA Electron Microscopes are vital research tools of science and industry. They permit accurate photography of particles less than 1/5,000,000th of an inch in diameter.

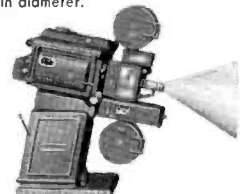

RCA Theatre Equipment is increasingly the choice of the nation's motion picture exhibitors. The complete line includes everything for the modern theatre... both indoor and outdoor... from projectors to carpeting.



RCA Mobile 2-Way Radio provides instant 2-way communication between the office and vehicles in the field. It cuts costs, speeds service, reduces mileage and telephone expense.

For Export . . .



NEW RCA SSB-1 TRANSCEIVER OPENS A NEW ERA IN LOW-COST HF COMMUNICATION

COMPACT NEW RCA SSB-1 is only 24 $\frac{1}{4}$ " high, 22 $\frac{3}{8}$ " wide, 16 $\frac{3}{8}$ " deep. Ideal for simplex and duplex radio-telephone and radiotelegraph services.



FOR THE FIRST TIME in HF Telecommunications, RCA is making available the proved advantages of single-sideband communications . . . at a cost everyone can afford. This technique of communications has been used in intercontinental telephony since 1926, but never before has it been offered at such a low price.

Another advantage that will be welcomed by users of high frequency telephony and telegraphy is the extremely simple operation of RCA's new SSB-1. And of course, the SSB-1 offers you the practicality and dependability that have made RCA communications equipment world-famous. For full details, see your RCA distributor or write for free booklet today!

THE 60-WATT SSB-1 GIVES YOU THESE 6 BIG FEATURES:

1. **SPECTRUM CONSERVATION**—Uses less than $\frac{1}{2}$ frequency bandwidth of conventional AM.
2. **HIGHER EFFECTIVENESS**—60-Watt SSB-1 is equal to 500-Watt conventional AM Transmitter.
3. **REDUCTION OF DISTORTION AND INTERFERENCE**—50% less interference than conventional AM.
4. **VERSATILITY**—Four channels, telegraphy and telephony.
5. **SIMPLICITY**—Does not require a technical operator.
6. **ECONOMY**—Low initial and operating costs.

FREE

Send for booklet giving full details of the new RCA SSB-1. Write:



TRADEMARK(S) © REGISTERED
MARCAS(S) REGISTRADAS



**RCA INTERNATIONAL DIVISION
RADIO CORPORATION of AMERICA
30 ROCKEFELLER PLAZA, NEW YORK, N. Y., U. S. A.**

BTA-5H!

Newest

with 6 Major

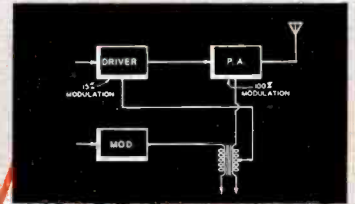

1. Bi-Level Modulation improves linearity and fidelity . . . saves power.

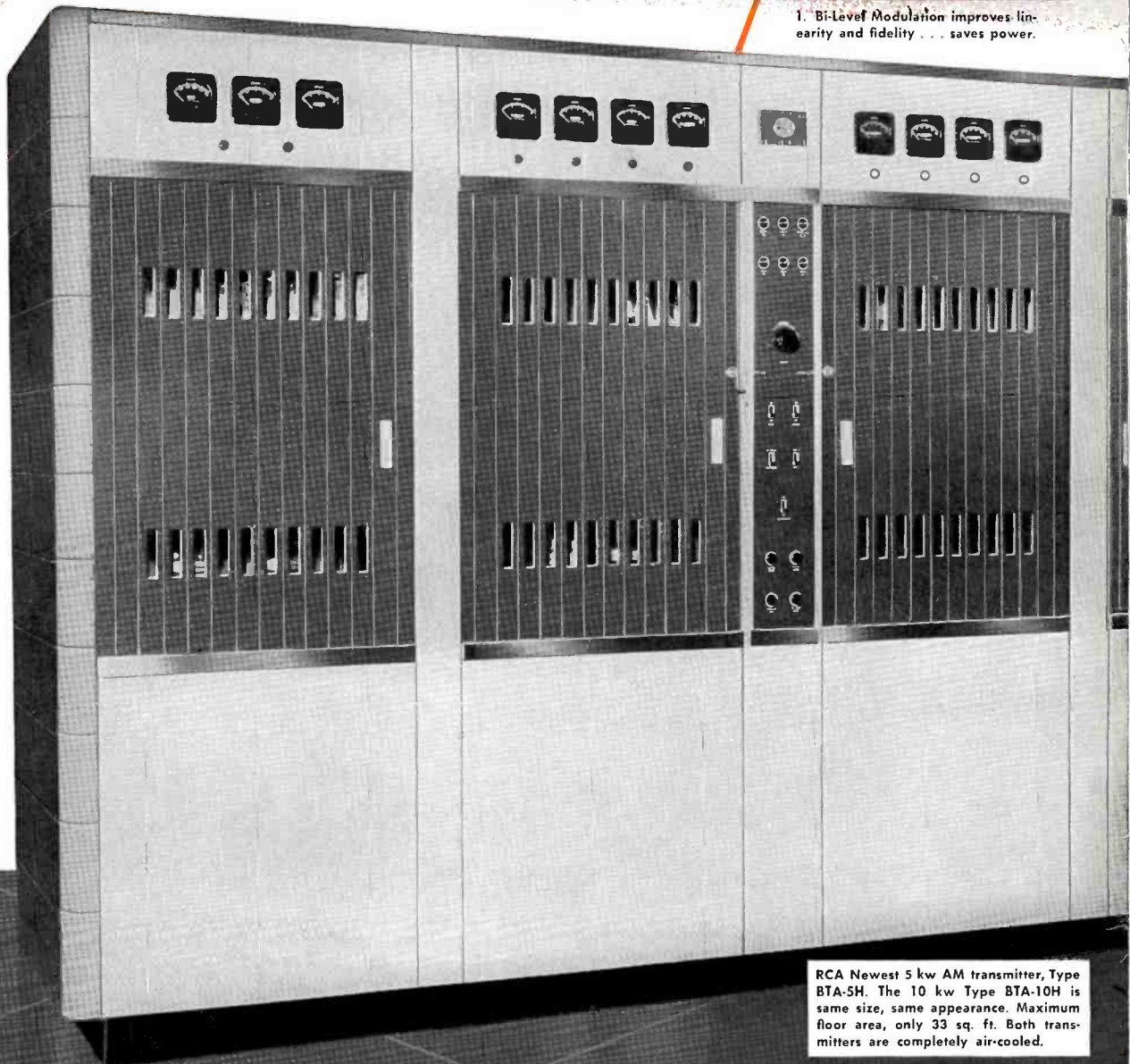

RCA Newest 5 kw AM transmitter, Type BTA-5H. The 10 kw Type BTA-10H is same size, same appearance. Maximum floor area, only 33 sq. ft. Both transmitters are completely air-cooled.

RCA 5-KW "AM"

Benefits, Including Bi-Level Modulation

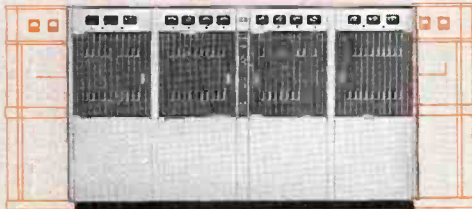

2. Up to 40% less floor area than previous "5 kw's"

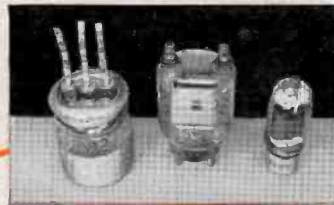

3. Power tube costs reduced

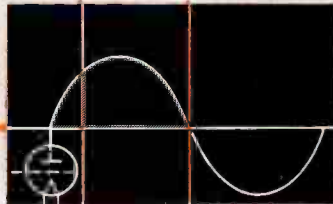
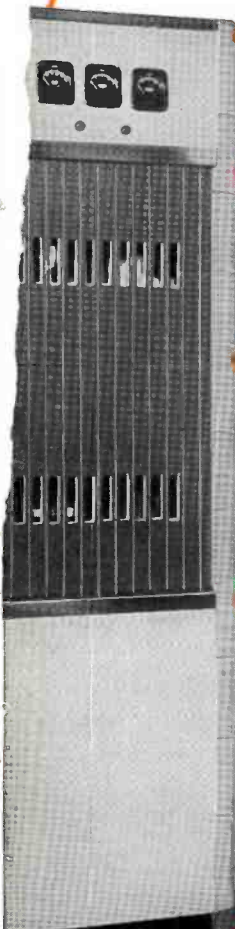

4. 1/60th second arc-back protection

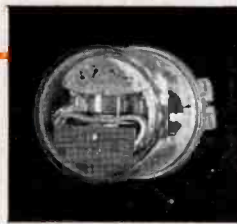

5. Lower power bills



6. Sliding doors—front and rear

Just read these exclusive features . . .

- 1 Bi-level modulation, accomplished by adding a controlled amount of audio to the r-f driver increases efficiency, reduces power consumption and reduces distortion. Linearity of the power amplifier is greatly improved by varying the drive in proportion to the modulation.
- 2 BTA-5H requires less "operating" floor space than other 5 kw's—saves up to 40% floor area. Entire transmitter is only 84" high, 130" wide, 32½" deep.
- 3 BTA-5H is the only "5 kw" with such low tube costs. Power and modulator stages use the new small size, lightweight RCA-5762—costing less than half that of power types in most "5 kw's."
- 4 It's the ONLY "5kw" with "split-cycle" overload and voltage protection—using thyatron-controlled rectifiers. Circuits work so fast audiences cannot detect "off-air" breaks.
- 5 BTA-5H holds power bills to the LOWEST in the "5-kw" field through smaller power tubes, fewer stages, fewer tubes (only 23 tubes and 7 different types).
- 6 BTA-5H is equipped with horizontally-sliding doors front and back. Benefits:
 - ✓ Saves over 60 square feet of floor area
 - ✓ Provides more elbow room for operator
 - ✓ Makes it easier to get at transmitter.

For all the facts about this new 5 kw transmitter . . . call your nearest RCA Sales Representative. Also ask for bulletin B.6535 shown at right.



RADIO CORPORATION of AMERICA
ENGINEERING PRODUCTS DEPARTMENT
CAMDEN, N.J.



**RCA
PRINTED
CIRCUIT**

PLUG-IN AMPLIFIERS FOR BROADCAST USE!

Provide These Outstanding Benefits...

SMALL SIZE . . . Considerably smaller than previous Broadcast Audio Amplifiers the RCA printed circuit series occupies about $\frac{1}{2}$ the rack and shelf space formerly needed. You free rack space for other AM and TV equipment, reduce rack and mounting shelf costs.

HANDLING EASE . . . Quick, safe and effortless installation or removal is assured by compact, light weight construction. Dependable 15-pin keyed connectors provide fool-proof positioning for rapid "in and out" handling. Connecting pins are gold plated to assure excellent electrical contact.

UNIFORM PERFORMANCE . . . The printed circuit assures uniformity and excellent frequency response. All units achieve extra dependability through use of hermetically sealed transformers. Each amplifier is provided with output terminals and a switch to facilitate current metering.

REDUCED-SIZE ACCESSORIES . . . Accessories such as BR-22A mounting shelf and BX-21A power supply used with the printed circuit amplifiers have also been "miniaturized." Example: shelf BR-22A, only $\frac{5}{4}$ " high can accommodate the following combinations of equipment: 10 BA-21A Preamplifiers, 3 BA-23A Program Amplifiers plus 1 BA-21A, 2 BX-21A Power Supplies plus 2 BA-21A, 2 BA-24A Monitor Amplifiers.

For complete details of the many further advantages of RCA's printed circuit amplifiers, call your nearest RCA Broadcast Representative. Ask for literature.



RADIO CORPORATION of AMERICA
ENGINEERING PRODUCTS DIVISION
CAMDEN, N.J.



BA-21A PREAMPLIFIER . . . Ideal as a microphone preamplifier, turntable preamplifier or booster amplifier. May be used as isolation amplifier by adding an MI-11278-E or F bridging volume control. Due to its small size, it may be placed in a control console, control desk or transcription turntable cabinet. One to ten of these units may be installed in a single BR-22A panel and shelf assembly.

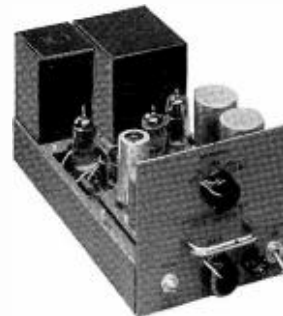

BA-23A PROGRAM AMPLIFIER . . . A versatile high-fidelity amplifier using special high-quality components and providing maximum accessibility. High gain and low distortion make it without equal as (1) program or line amplifier, (2) bridging amplifier, (3) isolation amplifier. Three BA-23A amplifiers can be mounted on BR-22A shelf with space for an additional amplifier.



BA-24A MONITORING AMPLIFIER . . . A high fidelity, high-gain, flexible 8-watt amplifier suitable for monitoring, audition, recording and talk-back uses. Also serves as a program or line amplifier. Excellent for transcription playback booths, since the 105 db gain will operate a speaker (LC-1A) directly from the output of a turntable (70-series). Also an excellent recording amplifier.



**"TELEVISION'S FINEST"
-for all visual-aural operations**

Regardless of the tubes you need—for your cameras, transmitter, film system, video and audio equipment, control equipment, power supplies—you can rely on RCA high-quality types for day-in, day-out dependability. When you need replacement tubes, call your RCA Tube Distributor. He'll give you prompt, efficient service on the entire line.



RADIO CORPORATION of AMERICA
ELECTRON TUBES

HARRISON, N.J.

NOW-11 KW

...with RCA's TT-10AL

for VHF

With recent design advances, RCA engineers have increased the power output of the TT-10AL VHF transmitter. This popular transmitter now delivers a full 11 KW of peak visual power (low band)—measured at the output of the sideband filter. If you need this extra KW, it's yours now.

Costs no more than the original 10-KW design—and of course it can handle color.

With power increased to 11 KW, RCA's exclusive TT-10AL—in combination with an RCA 12-section antenna—is the most

outstanding VHF system in the industry, delivering 100 KW ERP at the lowest operating cost of any VHF equipment package now available.

RCA 11 kilowatters are ready to ship. Order yours now for early delivery. For complete details, see your RCA Broadcast Sales Representative. In Canada, write RCA VICTOR Company Ltd., Montreal.

Ask your Broadcast Sales Representative for literature describing RCA's new 11-KW design for channels 2 to 6.

RCA Pioneered and Developed Compatible Color Television



RADIO CORPORATION of AMERICA
ENGINEERING PRODUCTS DEPARTMENT CAMDEN, N. J.