

AM · FM · TELEVISION

BROADCAST

NEWS

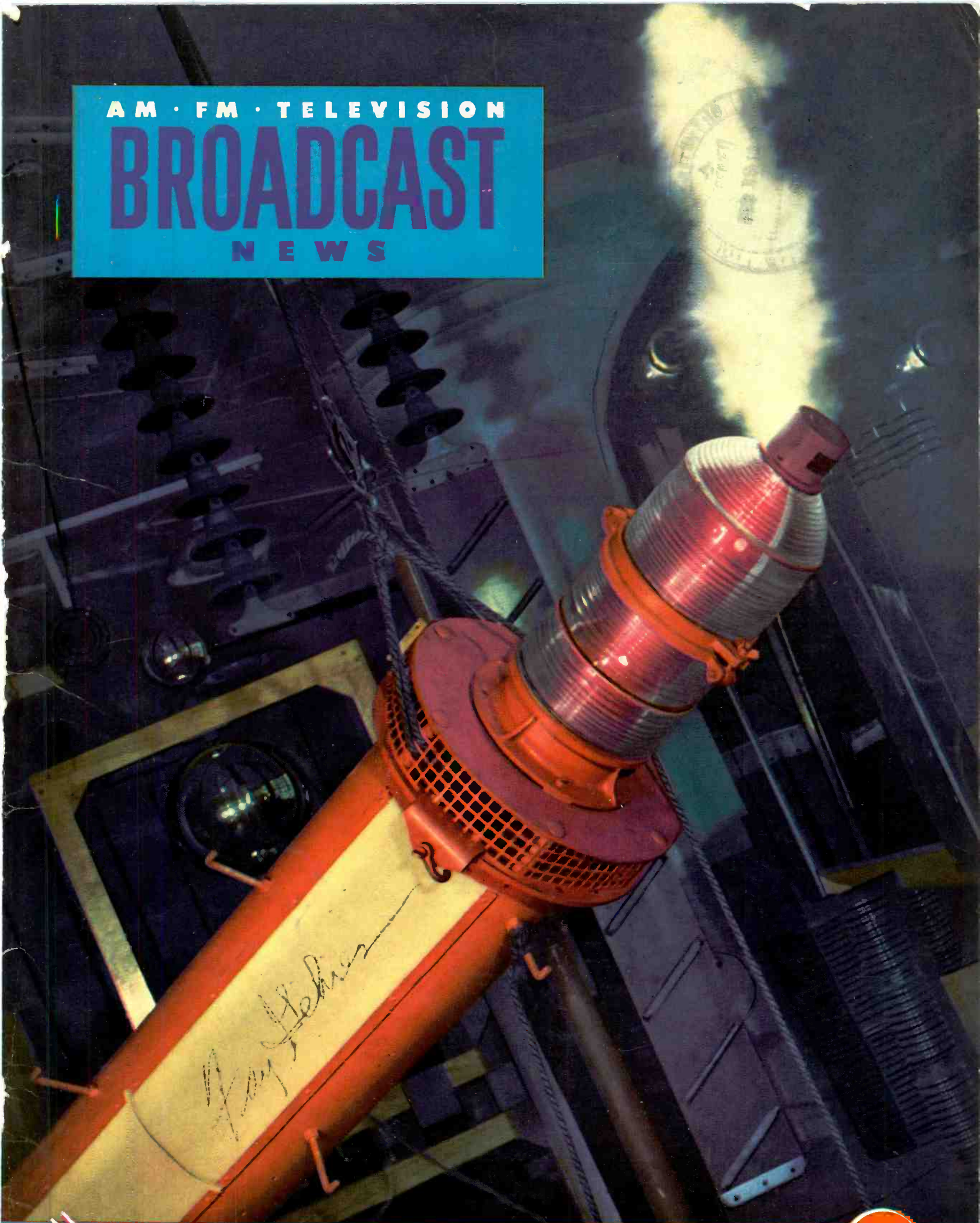

Frank B. Johnson

TESTING THE PYLON ANTENNA . . . SEE PAGE 8



HERE'S HELP

in making
HF, FM, and TV
measurements

THE TYPE WV-75A
VOLTOHMYST —
a new member of
the famous RCA line

RCA HIGH-FREQUENCY VOLTOHMYST

... flat up to 250 megacycles!

• With diode probe, measures peak-to-peak voltages up to 250 megacycles. The High-Frequency (Advanced) VoltOhmyst is ideal for television, FM, and routine, high-frequency measurements. The diode response is also flat down to 30 cycles.

The WV-75A is calibrated in rms voltages up to 100 volts in 4 ranges. An adaptor is supplied for low-frequency measurements up to 1000 volts.

The WV-75A also measures d-c voltages up to 1000 volts in six ranges and resistances to 1000 megohms in six ranges.

Available from your RCA Laboratory
Measuring Equipment Distributor.

RCA H-F VoltOhmyst reads peak to peak
for either simple or complex wave forms.

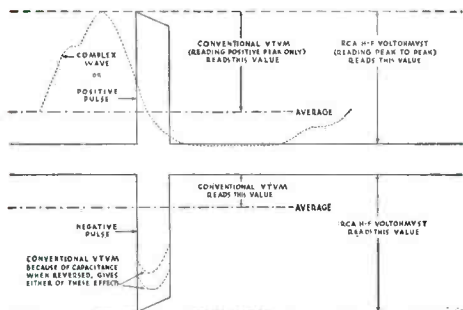

TEST AND MEASURING EQUIPMENT
RADIO CORPORATION of AMERICA
ENGINEERING PRODUCTS DEPARTMENT, CAMDEN, N.J.

In Canada: RCA VICTOR Company Limited, Montreal

Broadcast News

AM • FM • TELEVISION

Published by the

RADIO CORPORATION OF AMERICA

ENGINEERING PRODUCTS DEPARTMENT . . . CAMDEN, NEW JERSEY

NUMBER 47

DECEMBER, 1947

Subscription Rate \$1.50 per year.

Single copy 50c.

JOHN P. TAYLOR, Editor

JUDY J. ALES, Ass't Editor

Contents

LIGHTNING TESTS ON THE PYLON ANTENNA . . . by T. I. ELDRIDGE, JR.	8
WSAV's PYLON	13
MEASURED CHARACTERISTICS OF THE PYLON ANTENNA by O. O. FIET	14
300 KILOWATTS OF FM POWER	22
TELEVISION PROGRESS by DAVID SARNOFF	26
RCA AT THE NAB EXHIBIT	32
LARGE-SCREEN TELEVISION AT NAB	36
TELEVISION ENGINEERING CLINIC REPEATED by E. B. MAY	38
WWL CELEBRATES 25TH ANNIVERSARY	42
WMOX, MERIDIAN, MISSISSIPPI	46
WAAT READIES TELE	48
WBAL's "NEW WORLD OF TOMORROW" STUDIOS by HAROLD C. BURKE	52
TECHNICAL FACILITIES FOR WBAL's NEW STUDIOS by R. S. DUNCAN	58
WBRE-FM, WILKES-BARRE, PA. by DAVID BALTIMORE	62
WSBA AND WSBA-FM, YORK, PA. by W. G. EBERHART	64
AMERICAN TELEVISION SHOWN IN THE VATICAN . . . by E. K. PRICE	69

Copyright
Radio Corporation of America
RCA Victor Division
Camden, N. J.

PRINTED IN U. S. A.

OUR COVER for this issue is reproduced from a Kodachrome made in the laboratories of the Electric Service Manufacturing Company of Philadelphia. Occasion was a series of tests which were being made to determine the effect of direct lightning strikes on the RCA Pylon Antenna. This particular picture was snapped as the full output of a 500,000 volt "lightning generator" was discharged to the top point of the antenna beacon. A series of such tests indicated that the Pylon, properly installed, is practically immune to even direct strokes of lightning. Full story is contained in the article starting on page 8. Credit for this beautiful color picture goes to Rod Allen of our photographic staff.

INCIDENTALLY, we would be interested in looking at any color photos you have which you think might make a good cover illustration. Naturally, we prefer shots of our own equipment; however, we're also interested in photos of buildings, towers, studio interiors, and the like. Also closeups of installation details—particularly if they show unusual or particularly striking features of your layout. For best results we prefer transparencies not less than 3 1/4 x 4 1/4 in size. If you have some "beauties," send them to us. We'll take good care of them and return them promptly.

PYLONS, PYLONS, PYLONS. They come in for a lot of attention in this issue. And rightly so—for the Pylon, introduced just a little over a year ago (BROADCAST NEWS No. 44, Pg. 42), has become without question the favorite antenna for FM broadcasting. As of the first of December some 125 of these had been shipped. And that is only the beginning!

Early claims made for the performance of the Pylon have been completely substantiated by an extensive series of field measurements made by Owen Fiet of our Development Engineering Section with the assistance of Mr. H. H. Wescott of the same group. Results of careful measurements of impedance, radiation pattern and gain are given in the article starting on Page 14. Tests of the Pylon under full load conditions are described in another article on Page 22.

TELEVISION, IT'S HERE, was the theme of Mr. Sarnoff's talk to the NBC Affiliates' meeting in Atlantic City (just preceding the NAB Convention). We have reproduced this talk in full (Page 26) because we believe that the message it contains is of the greatest importance to present day broadcasters. In it Mr. Sarnoff reviews the present status of television, estimates its increase during the coming year and makes some carefully considered predictions on its future course. Pointing out the effects this may have on sound broadcasting he says, in summing up ". . . I would suggest that you (broadcasters) reflect carefully and thoughtfully upon the possible ultimate effects of television upon your established business, if you do nothing, and of the great opportunities for your present and future business, if you do the right thing."

As we said in our June issue—"T-day, everywhere, is closer than you think."

WAAT-TV article (Page 48) is, we hope, just an advance notice on a really good story which Frank Bremer has promised us when the station is complete. They expect to be on by February—"the first station on Channel 13"—and their transmitter installation obviously is going to be a knockout. There'll be more about it in another issue.

ALREADY ON THE AIR with new RCA television transmitters are WMAL-TV and WNBW, Washington; WBAL-TV, Baltimore; WTMJ-TV, Milwaukee; and WLWT, Cincinnati. These, of course, are in addition to KSD-TV, St. Louis and WFIL-TV, Philadelphia, which were previously reported. Together with two prewar models they add up to nine RCA television transmitters in operation—that's nine out of a total of sixteen on the air (as of December 1, 1947).

NEARLY READY are ten additional stations to whom RCA television transmitters have been shipped. The next three or four months should see all of these on the air, at least experimentally. And after that comes another group of twelve more stations who have ordered RCA television transmitters, but have not yet received them. These will all be shipped within the next few months. Television, it's wonderful!

The revolutionary new 10-KW

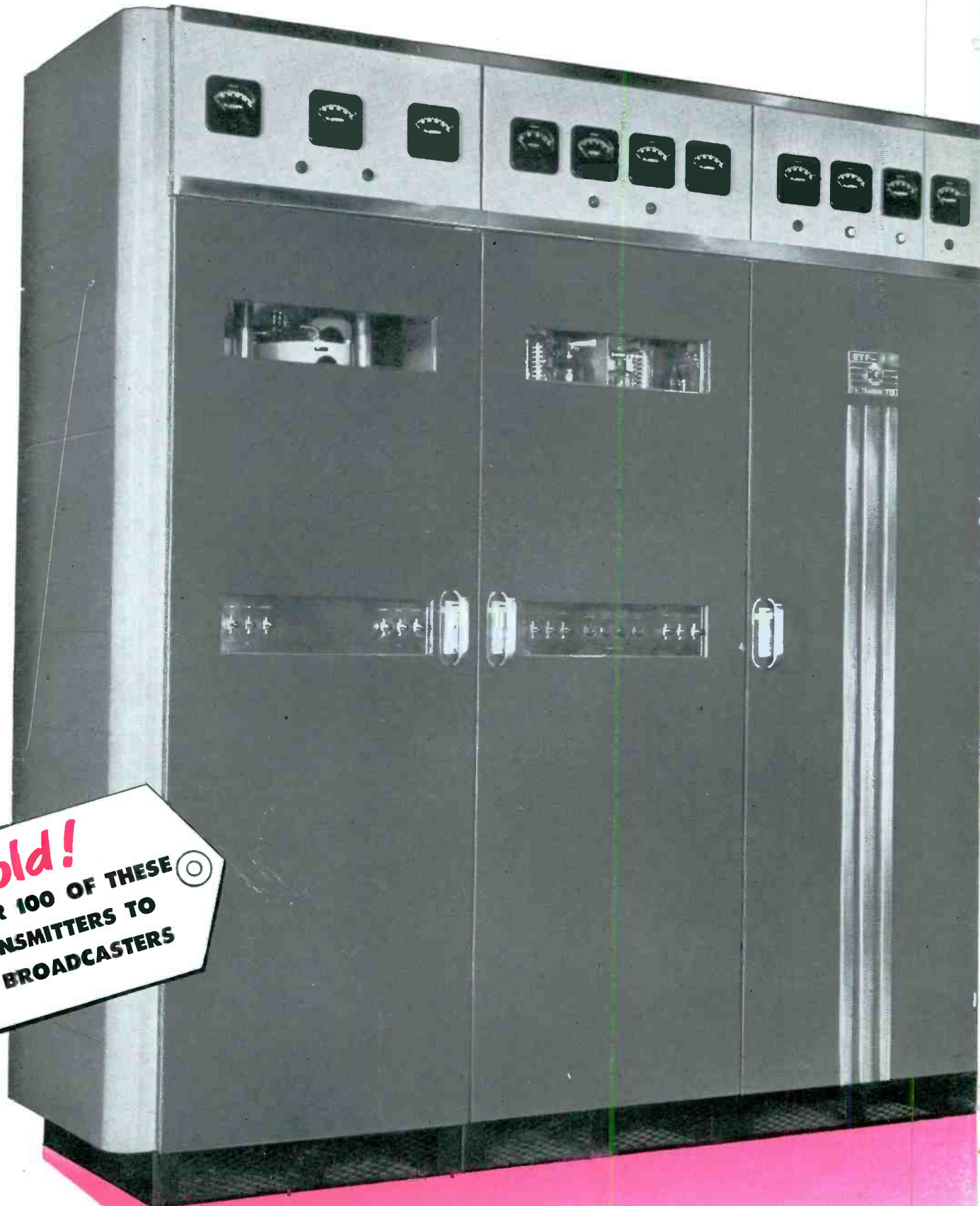

Sold!
...OVER 100 OF THESE
TRANSMITTERS TO
FM BROADCASTERS

FM transmitter — that saves you up to \$1500 a year

Four important reasons why the BTF-10B costs less to run

Reason No. 1... It Uses Smaller, Less-Expensive Tubes.

Because Grounded-Grid circuits are used throughout . . . in driver stages as well as final, the extra power of the driver stages (ordinarily wasted) automatically adds to the output of the power amplifier. Thus, the final power amplifier is not required to furnish as much power—and smaller, less-expensive tubes can be used in it.

Reason No. 2 . . . It Uses Fewer Tubes. Because "Direct-FM" circuits are used in the exciter . . . and because one main rectifier supplies all high voltages, the BTF-10B uses substantially fewer tubes than most 10-kw designs. There are only 39 tubes, total. And only 23 of these are required for emergency operation. (The other 16 are control tubes whose failure will not take the transmitter off the air).

Reason No. 3 . . . It Takes Less Power. Because it uses fewer tubes, because the final amplifier tubes are smaller (use less filament power), and because the amplifiers all operate at high efficiency, *the power consumption of the BTF-10B is only 22.5 kilowatts.*

Reason No. 4 . . . It Requires Fewer Spares. Because the last three stages of this transmitter use the same type tube, the RCA-7C24, and because the overall number of tubes used is relatively small, the total *number of tube types required is only 14.* This greatly reduces the number of spares you must keep on hand.

Ask the RCA office nearest you to give you
the figures which prove these claims

New York 20, New York
36 W. 49th Street,
Telephone: Columbus 5-3800

Cleveland 15, Ohio
718 Keith Building,
Telephone: Cherry 3450

Chicago 11, Illinois
666 N. Lake Shore Drive,
Telephone: Delaware 0700

Atlanta, Georgia
502 Citizens & Southern Bank Bldg.,
Telephone: Walnut 5946

Dallas 1, Texas
1907-11 McKinney Ave.,
Telephone: Riverside 1371, 72, 73

Los Angeles 14, California
621 S. Hope Street,
Telephone: Mutual 1103

San Francisco 3, California
1355 Market Street,
Telephone: Hemlock 8-300

Boston, Massachusetts
820 Metropolitan Bldg.,
260 Tremont Street,
Telephone: Hubbard 0123

Kansas City 8, Missouri
221 W. 18th Street,
Telephone: Harrison 6953

Washington 6, D. C.
1628 K Street, NW,
Telephone: District 1260



BROADCAST EQUIPMENT
RADIO CORPORATION of AMERICA
ENGINEERING PRODUCTS DEPARTMENT, CAMDEN, N.J.

In Canada: RCA VICTOR Company Limited, Montreal

Only ONE TYPE TUBE—from 250-watt driver through 10-kw final

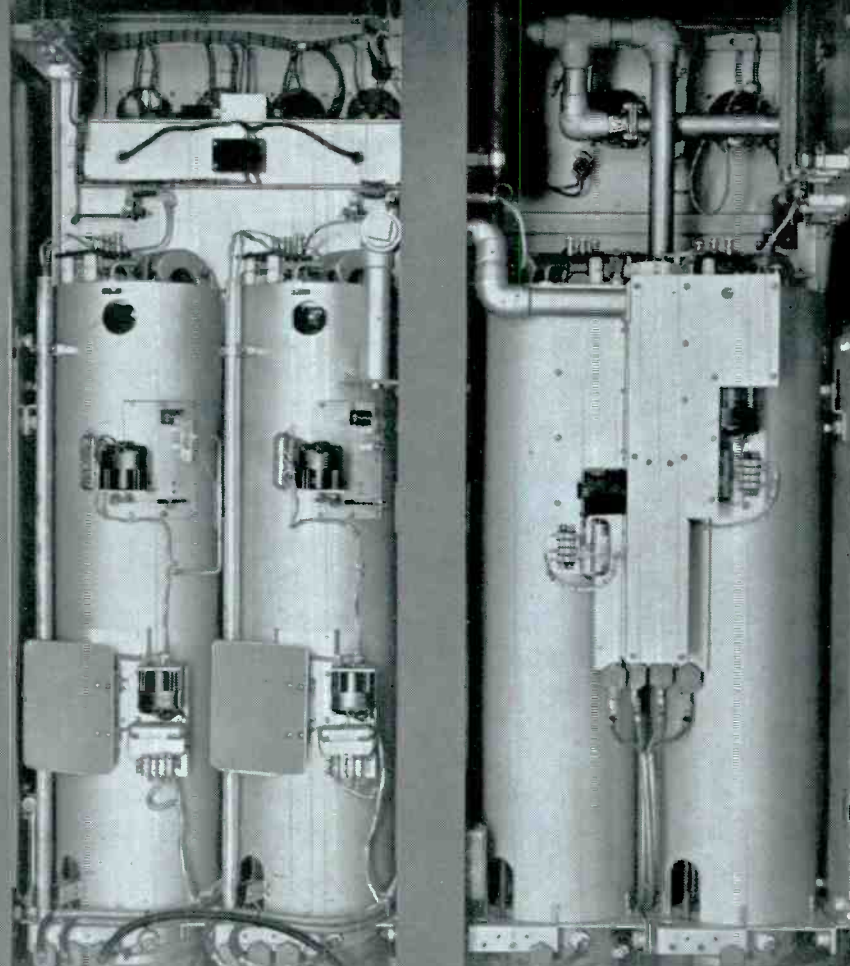

**Power Amplifier
and Drivers of the
RCA BTF-10B
FM Transmitter**

Each cylinder is a grounded external conductor for its respective stage. It houses one RCA-7C24 power triode in a grounded-grid circuit... provides perfect shielding for its inner conductor. No r-f radiation in transmitter room so no r-f pick-up in adjacent a-f circuits. Second, third, and final stages are motor-tuned. Circuit similarity makes it practical to use identical tubes, blowers, and components... saves you substantially in stocking spares.

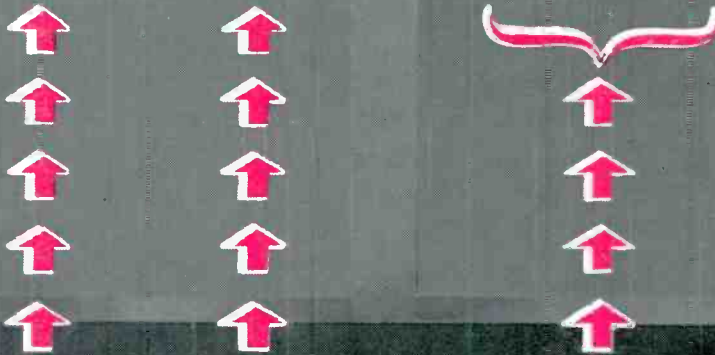

1st Driver
uses one RCA-7C24
power triode

2nd Driver
uses one RCA-7C24
power triode

Power Amplifier
(parallel-connected) uses two
RCA-7C24 power triodes



BROADCAST EQUIPMENT
RADIO CORPORATION of AMERICA
ENGINEERING PRODUCTS DEPARTMENT, CAMDEN, N.J.

In Canada: RCA VICTOR Company Limited, Montreal,

\$290.⁰⁰ buys the two tubes in this 10-KW FM Amplifier

... because it uses high-stability grounded-grid circuits with power feed-through

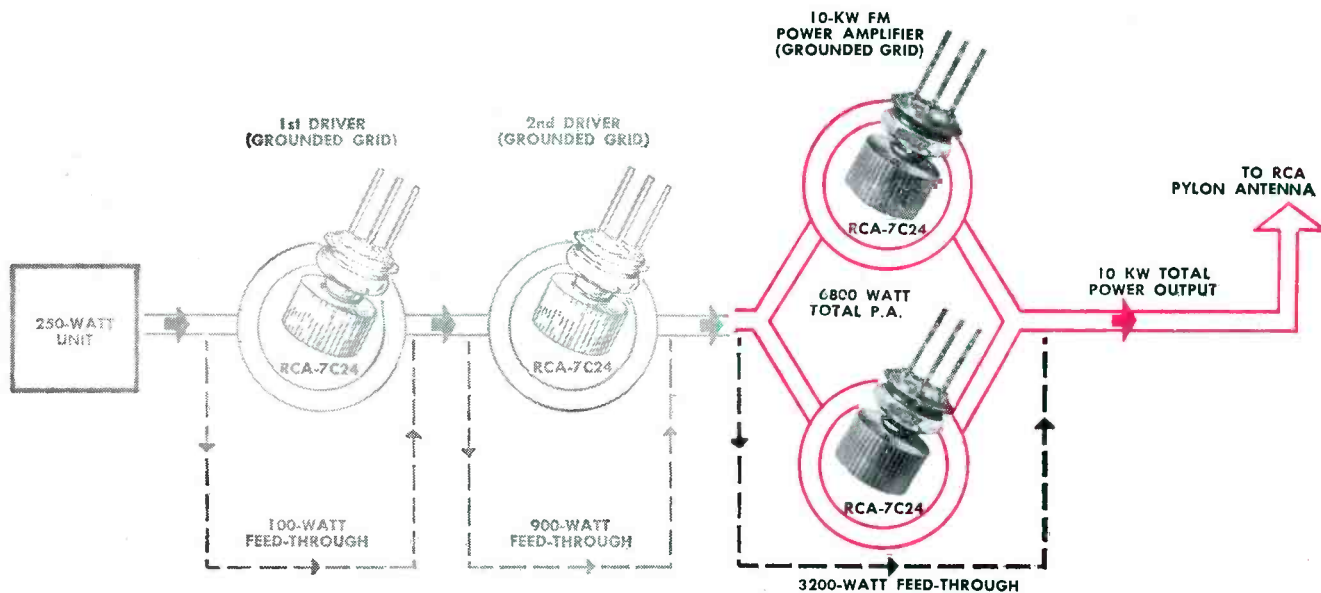

PLENTY OF REASON why RCA's revolutionary new 10-kw FM transmitter costs less to run . . . because this grounded-grid final power amplifier and 2-stage grounded-grid driver *share the load*.

Here, nearly 3200 watts of power from the drivers automatically add to the output of the final power amplifier—because the r-f input and output of each tube is in series . . . and in phase. Consequently, only four 7C24's are used in the entire transmitter.

In this 2-tube power amplifier and 2-stage driver, the tanks are concentric lines using RCA-7C24's in

grounded-grid circuits. All tanks are similar. Each plate circuit is isolated from its grid circuit by perfect shielding. Benefits: neutralizing is unnecessary. Tuning is easier. Fewer parts are needed. *The tubes and nearly all the components in all four tanks are directly interchangeable.*

For full data on the BTF-10B . . . the 10-kw FM transmitter that requires only 22.5 kw to operate and uses only 14 basic tube types, and just *one* high-voltage power supply, see your RCA Broadcast Sales Engineer, or write Dept. 19-L.

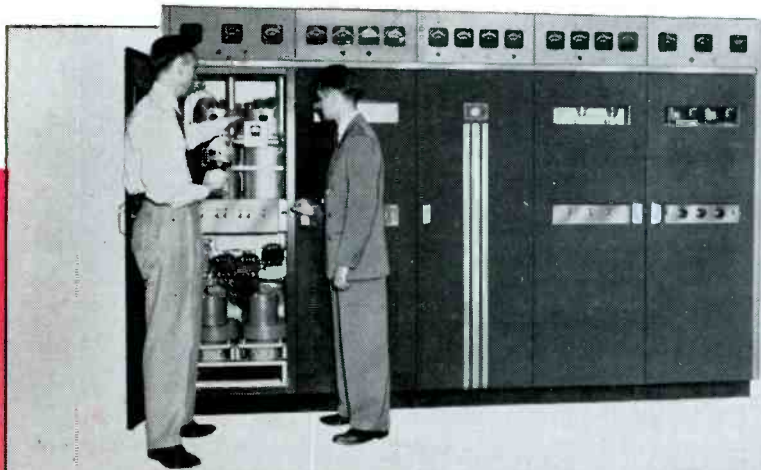

The BTF-10B 10-kw FM Transmitter

Handsome to look at. Sweet to listen to. A genuine satisfaction to supervise. Saves you up to \$1500 a year in running costs. The final amplifier is housed in the cubicle at the left. The drivers are housed in the cubicle next to it. Automatic cut-back is available as an accessory.

Broadcasting's favorite

Type 76-B4.
Type 76-C is
similar in
appearance



**OVER
1,000 RCA
CONSOLETTES
SOLD**

Features of both Type 76-B4 and Type 76-C

- Over-ride facilities for all remote lines. Permits engineer or announcer on remote broadcast to "call-in" by override on control room speaker.
- Six-channel mixer.
- Direct talk-back system to any studio and any remote line. Studio speakers and remote lines are interlocked to prevent feed-back.
- Cue feed to remote lines.
- Five spare monitor inputs for monitoring externally produced programs such as networks, other studios, outgoing channels, etc.
- Large VU meter connected to rotary selector switch permits accurate program monitoring. Plate current checking system for all tubes and program channel.
- No lost time due to possible failures of amplifiers or power supplies. Emergency operation may be obtained quickly by means of switches.
- Headphone monitoring across output line, monitor and external source, such as network.
- Recorder feed.
- Low-noise, low-microphonic type-1620 tubes.
- The 76-B4 has built-in isolation coils for remote lines and turntable booster amplifiers.
- The 76-C has two turntable cue-circuits normally connected for direct operation through monitoring amplifier. Terminal board connections permit routing turntable cue to external amplifier and speaker, if desired.
- The 76-C has all six pre-amplifier outputs and mixer inputs brought out on terminal boards for routing to external jack panels, echo and reverberation facilities, additional microphone inputs, remote lines, and relay switching.

In addition . . .

- The 76-B4 has built-in isolation coils

IMMEDIATE DELIVERY
TYPE 76B4 • PRICE—\$1375.00

Consolettes . . .

for AM, FM and TV

Nothing like the 76-B4 and 76-C Consolettes to keep studio programs and rehearsals in motion. Both are flexible and easy to operate. Both provide program quality that meets FM requirements. Both have full facilities for simultaneous auditioning and broadcasting . . . for practically any combination of studios, turntables, or remote lines—AM, FM or TV sound.

Choose the Consolette to Suit Your Station Needs

The Standard 76-B4. This model includes 4 pre-amplifiers. Similar to former RCA 76 series consolettes and known by broadcast engineers the country over, this flexible and versatile audio control system performs all the amplifying, monitoring and control functions of most large and small stations—AM, FM and TV sound.

The New De Luxe 76-C. Similar to the companion 76-B4 in appearance, this model incorporates two additional pre-amplifiers (six total). Designed for broadcasters by popular request, here is the complete audio control system to meet your special requirements.

WHERE IT IS USED

- For two-studio operation . . . with two microphones in each . . . one announce booth microphone, and one control-room microphone.
- For single-studio . . . using four microphones, one announce booth microphone, and one control-room microphone.
- For two transcription turntables using external booster amplifiers.
- For six remote lines . . . with independent control of each.

WHERE IT IS USED

- For two-studio operation . . . with four microphones in one studio and two in the other, one announce booth microphone, and one control room microphone.
- For single-studio operation . . . using seven microphones, one announce booth microphone, and one control-room microphone.
- For two transcription turntables, each using a booster pre-amplifier in the consolette.
- For four remote lines . . . with independent control of each.

For complete technical information and details on these consolettes . . . both backed by more than 20 years of broadcast engineering experience in this field . . . call your nearest RCA office or write Dept. 19-1.

NOW . . . Switching Systems for RCA Consolettes



Master Control

Sub-Control

Type BCS-1A—Handles the output of as many as five control consolettes. Feeds three outgoing lines. Enables you to monitor studio, network, recording room, remote inputs. Switches these inputs into transmitter or network lines.

Type BCS-2A—For the smaller station requiring only two RCA consolettes. Handles up to four studios and two announce booths. Routes your program to two outgoing lines (AM, FM, or either transmitter and a network line).



BROADCAST EQUIPMENT
RADIO CORPORATION of AMERICA
ENGINEERING PRODUCTS DEPARTMENT, CAMDEN, N.J.

In Canada: RCA VICTOR Company Limited, Montreal

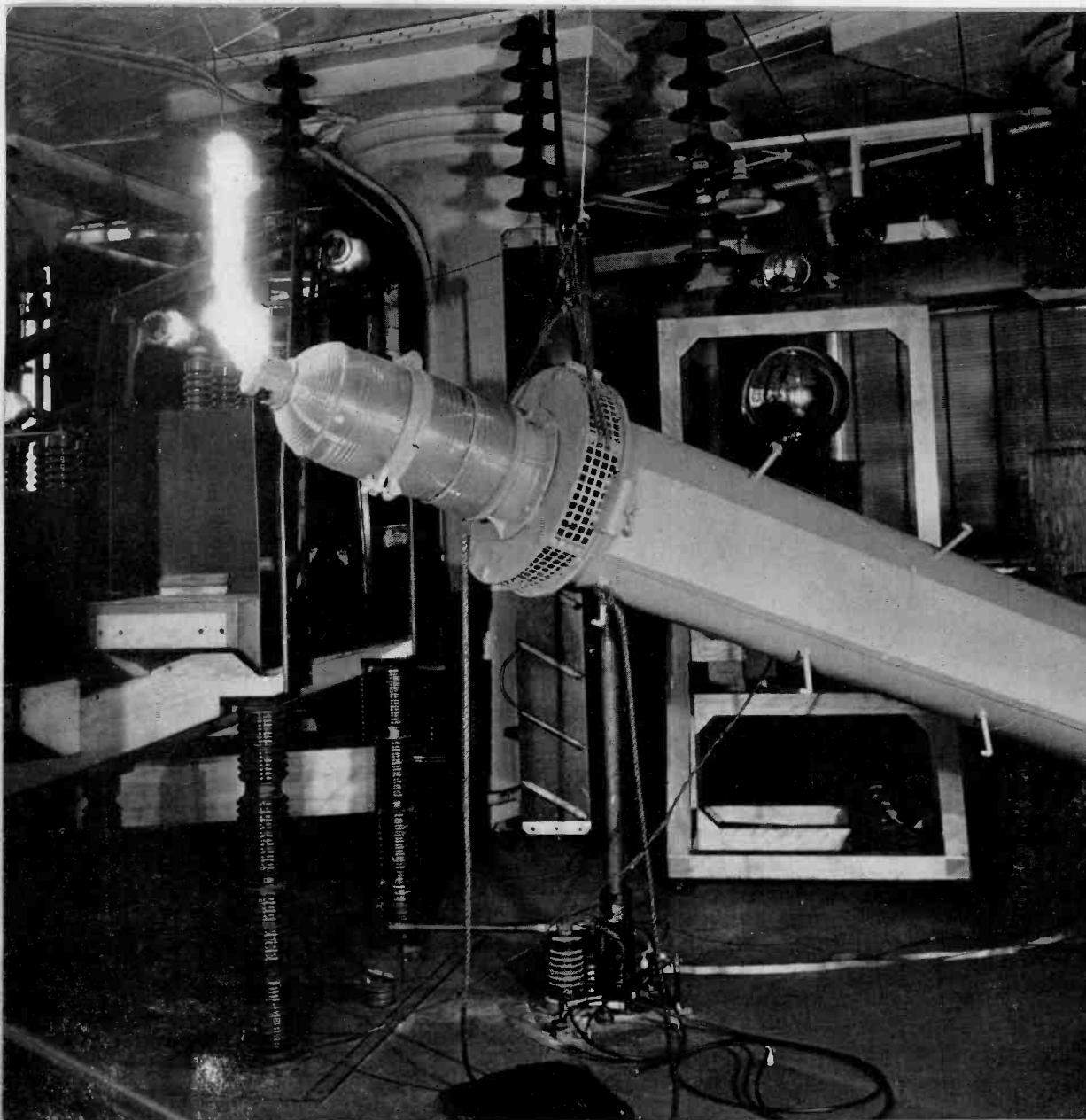

FIG. 1. (left) Pylon antenna being subjected to a 500,000 volt discharge in the high voltage testing laboratory.

FIG. 2. (right) In this view is shown the high-voltage generator which is capable of producing a $\frac{1}{2}$ million volt, 61,000 ampere lightning discharge. This simulates natural lightning phenomena.

LIGHTNING TESTS

on the

PYLON ANTENNA

by

T. I. ELDRIDGE, Jr.

Research Electrical Engineer

Electric Service Manufacturing Co.

Tests conducted in the High Voltage Research Laboratory of the Electric Service Manufacturing Company of Philadelphia on the RCA Pylon Antenna indicate that this antenna should generally be immune to lightning, even when subjected to direct or near direct strokes to the antenna itself. Since the Pylon transmission line feeder is housed within the Pylon cylinder, shielding of the line from lightning is effectively accomplished. To investigate this problem a Pylon was set up in the high voltage

laboratory in conjunction with an impulse or lightning generator and the other necessary equipment for recording the results (Figure 1).

The lightning generator is essentially a combination of inductance, resistance and capacitance, so proportioned that a single transient may be discharged into the test circuit. The waveform may be controlled so that the voltage or current can be discharged as an impulse of either positive or negative polarity reaching crest in a short period of time (in the order of one or more microseconds and decaying to zero very gradually or rapidly as the case may be). This is termed a logarithmic discharge because the calculation of this type wave employs logarithmic functions. It may also be controlled so that it is of an oscillatory form which gradually or rapidly damps out to zero depending upon the ratio of the circuit resistance to the critical resistance. This waveform is termed a trigonometric form because the calculation of this type employs trigonometric functions. When the circuit resistance is just equal to the critical resistance; i.e., when it is equal to the square root of four times the circuit inductance divided by the capacitance, the discharge is termed a critical discharge and may be of either positive or negative polarity. The discharge reaches crest value and then decays to zero without oscillation.

Although the lightning generator circuit is composed of a combination of L, R and C elements, the physical generator proper consists of one or more banks or racks of high-voltage capacitors, generally charged and discharged by means of Marx's

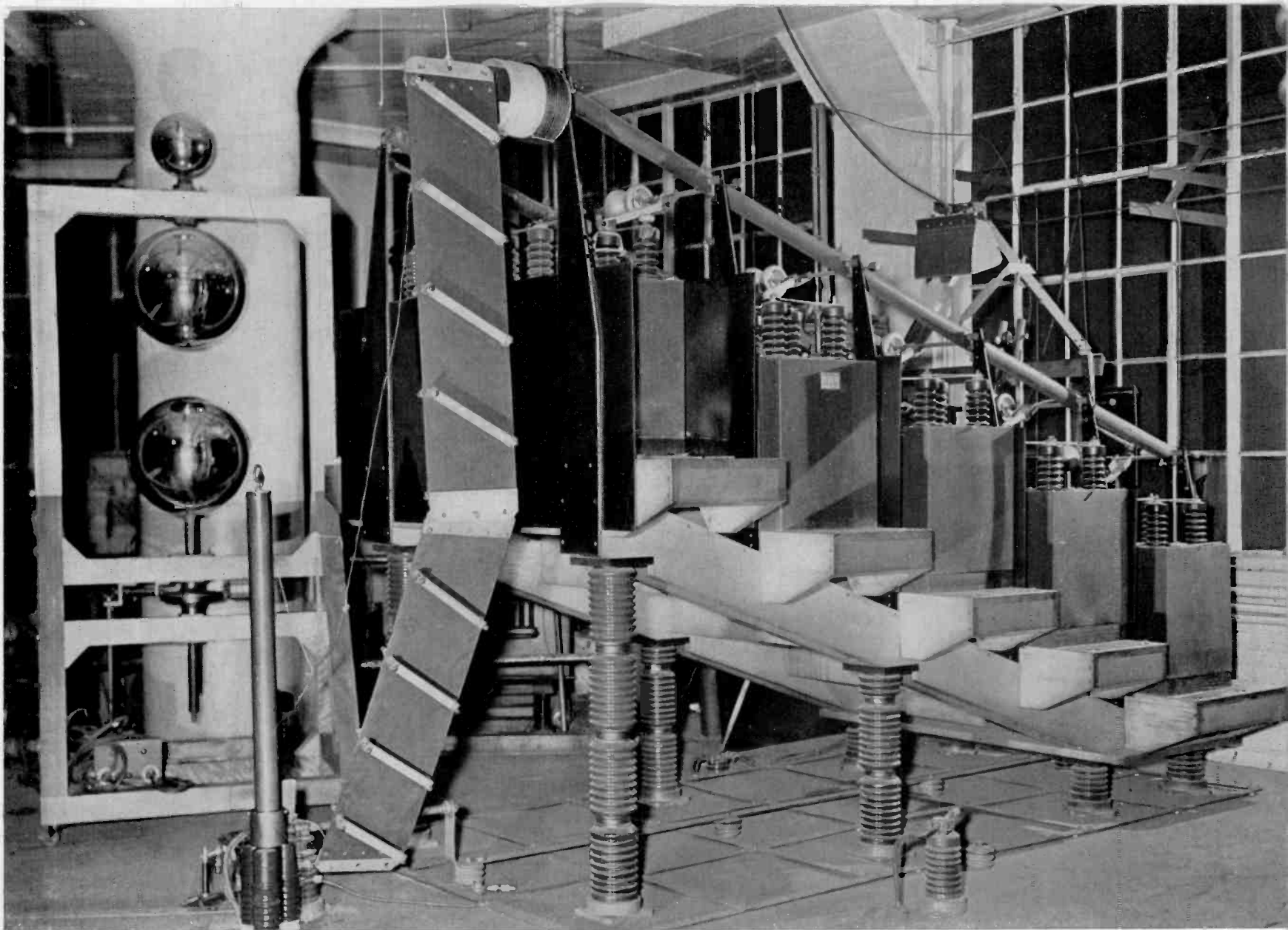

circuit in which the individual capacitors are charged in parallel, but discharged in series or series-parallel. Charging is generally accomplished by means of full-wave rectification using high-voltage rectifiers supplied by a 60-cycle high-voltage, high-impedance transformer. After the capacitors have reached full charge, a synchronous switch is used to initiate generator discharge into the test circuit. This usually consists of a combination of inductance "L", non-inductive resistance "R", the test piece and measuring devices such as sphere gaps, and/or a cathode-ray oscillograph similar to the cold cathode type which has been specifically designed for non-recurrent or single sweep transient recording. Figure 2 shows the physical construction of the generator and Figure 3 is a simplified schematic diagram of the lightning generator and its associated circuits used in these tests.

As can be seen in Figure 2, the lightning generator consists of five banks or racks of capacitors. Each bank has a rating of 100,000 volts, the total output being a half-million volts. The full generator capacity of slightly over $9/32$ microfarad was used and the resistance of the circuit was reduced to a minimum value. The frequency of discharge with the antenna as part of the circuit was found to be approximately 70,000 cycles per second.

Measurement of the voltages, including those induced on the transmission line feeder, was made with a cathode-ray oscillograph, radically different from the regular oscilloscope employed for radio work. Because of its unusual construction a description of it is in order. Figure 4 shows this instrument in operation.

With it, one is able to investigate phenomena that take place in a fraction of a millionth of a second; the time during which a point on the earth's equator has travelled less than two hundredths of an inch, although the surface of the earth has been moving at about 16 miles per minute. A fraction of a millionth of a second is a sufficient period of time for the voltage in a lightning stroke to rise from zero to millions of volts, a period sufficiently long to begin a whole series of disruptive events in distribution, transmission and other electrical circuits; in effect, the beginning of a chain reaction. This instrument, when operated by a highly-skilled engineer, enables analysis during these micro-time periods. It is possible to determine from such analyses what precautions must be taken to prevent or overcome the destructive effects of energy of enormous magnitude released in extremely short-time periods.

The writing agent of this instrument is a stream of electrons which are almost weightless and inertia-free and follow faithfully the fastest known changes. Electrons are produced in a system, similar to the RCA electron microscope, which requires continuous evacuation by means of a precision rotary or sliding vane pump in combination with either a diffusion or molecular pump. A continuous high voltage of 50,000 volts projects the electrons at high velocity from a cold cathode through a small orifice in the anode past a series of deflecting plates to either a fluorescent screen for viewing the trace made by the moving pencil of electrons, or directly on a film placed within the vacuum system for a future record of the trace. The electron beam may move across the film, which remains stationary, at



FIG. 4. In this view, an engineer is shown making observations and recording data, during tests, by means of the specially-designed cathode-ray oscillograph, or TIME MICROSCOPE, as it is sometimes called.

a speed of some 600 miles per second, yet it produces a sharp and distinct trace. Although a continually evacuated system is required to establish the beam, a low, but definite pressure must be held within restricted limits in order to obtain the proper intensity of the beam. This is accomplished in a rather unique manner, through a delicate leak valve which admits a tiny trickle of air near the anode. This air, however, is not taken directly from the outside, but from a bellows chamber, the volume and pressure of which can be controlled to within plus and minus one-fifth that of atmospheric pressure. It is interesting to note that the introduction of this tiny trickle of air permits the path of the electron stream to be visible between the electrodes, due to the ionization of the slight amount of gas which is admitted between the aluminum plug cathode and the anode.

In order to maintain a low water vapor pressure for proper establishment of the beam, a dehydrating agent, phosphorous pentoxide, is placed within the system; and, before a roll of ordinary orthochromatic film (which appears to be more sensitive to electrons than high-speed panchromatic) is used, it too must be thoroughly dehydrated in an auxiliary vacuum system. Time sweeps on the stationary film can be made from $\frac{1}{2}$ to 20,000 microseconds and spread out to about 3 inches; other means can be provided for extending the recording above the 0.02×10^{-6} seconds period.

Since it is claimed that the time consistency of this instrument is within one-hundredth microsecond (1×10^{-8} seconds), it is necessary to get the beam started on its trace ahead of the phenomenon being recorded. Obviously, a special technique is required for accurately measuring such extremes as millions of volts and hundreds of kiloamperes in millionths of seconds.

The foregoing will give the reader a description of the two major pieces of equipment used in making and recording the lightning tests on the RCA Pylon Antenna.

The lightning generator was connected to discharge to the beacon end of the antenna. No additional resistance or inductance was placed in the circuit as it was desired to secure a high magnitude of impulse current for the different voltages discharged. Voltages up to nearly the maximum output of 500,000 volts were released from the lightning generator. The waveform of these voltages is shown in Figure 5, rising to crest value in about $\frac{1}{4}$ of a microsecond, approximating a square front wave.

The impedance of the antenna was very low. This produced large currents, a maximum of about 50,000 amperes. The impedance of the generator circuit and the long lead required to reach the top of the beacon accounted for a great portion of the released voltage. Because of the low-impedance of the Pylon, slightly less than $\frac{1}{5}$ the released voltage actually existed on

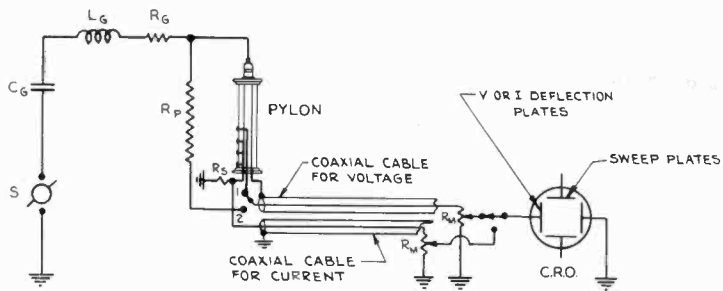

- C_G CAPACITY OF LIGHTNING GENERATOR
- L_G INDUCTANCE OF LIGHTNING GENERATOR CIRCUIT
- R_P RESISTANCE POTENTIAL DIVIDER
- R_S CURRENT SHUNT
- R_M MATCHING RESISTANCE FOR COAXIAL CABLE
- S SYNCHRONOUS SWITCH FOR STARTING CATHODE RAY OSCILLOGRAPH AND FIRING LIGHTNING GENERATOR
- R_G RESISTANCE OF LIGHTNING GENERATOR CIRCUIT
- 1 VOLTAGE ON TRANSMISSION LINE
- 2 VOLTAGE ON PYLON

FIG. 3. Circuit diagram of the lightning generator test circuit with the RCA Pylon shown under test.

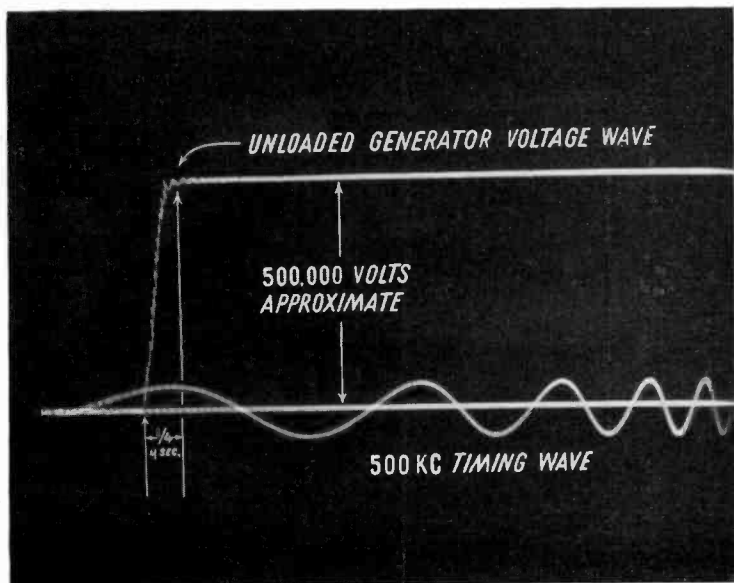

FIG. 5. This oscillogram shows the rapid buildup of the Lightning Generator voltage. This rapid rise is very essential to induce measurable voltages on the high-frequency, low-impedance Pylon antenna.

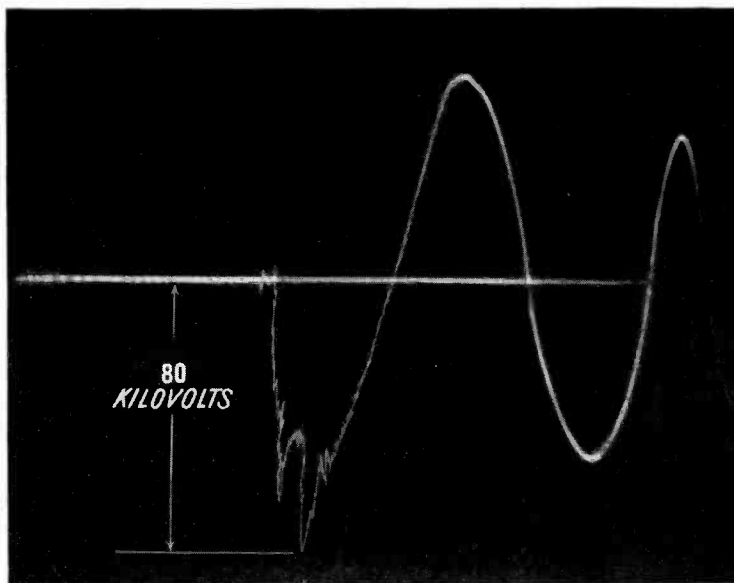

FIG. 6. The voltage wave shown here is equivalent to a peak voltage of 80,000 volts across the beacon and Pylon—caused by a 445 KV release from the lightning generator. The wave is oscillatory due to the L, C and R of the generator and Pylon.

the beacon. The waveform of the voltage across the antenna is shown in Figure 6, and that appearing across the coaxial feeder is similar and shown in Figure 7. The magnitude of the induced voltage on the transmission line feeder did not exceed 88 volts, which was recorded when the maximum voltage was released across the antenna. Figures 8 and 9 illustrate how the voltage on the Pylon feeder will vary with the charge released and the voltage of the lightning discharge.

Breakdown tests made upon the Pylon transmission line feeder indicate a sparkover in excess of 20,000 volts. It is apparent that a tremendous amount of energy must be released very rapidly to pass sufficient current through the antenna to even approach a sparkover in the coaxial feeder. Due to the low impedance of the shield, which is the Pylon proper, it is highly questionable whether natural lightning could cause damage to the coaxial feeder line.

In reviewing the subject tests upon the antenna one may ask what effect the lighted beacon, located at the top of the Pylon, has when the antenna is struck. This is an extremely interesting

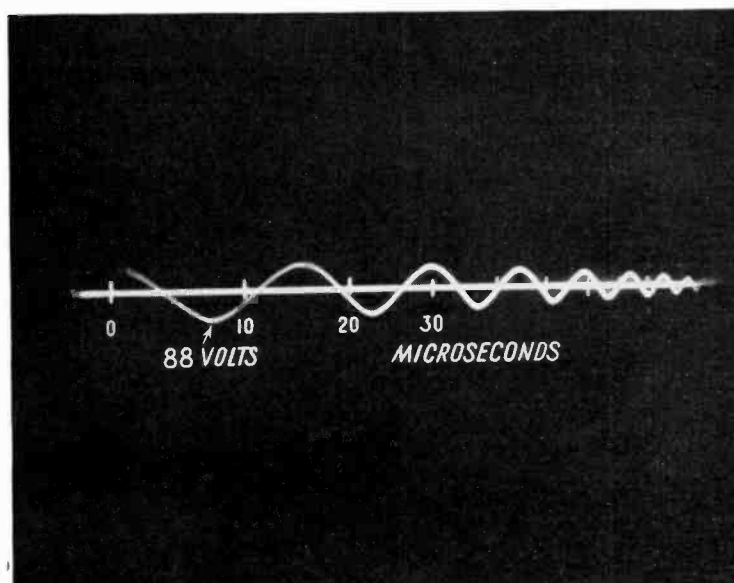

FIG. 7. This waveform illustrates that a voltage of only 88 volts appears across the terminated Pylon feeder line, when a 445 kilovolt discharge is released from the lightning generator.

part of the problem and it may be analyzed as follows. Prior to being struck the Pylon may be considered at ground potential and the beacon lamp circuit at 115 volts above ground. After the stroke hits the Pylon, the flow of impulse current through the Pylon, if of high magnitude, will result in a potential difference across the Pylon to the earthed base. The beacon lamp circuit being closely coupled to the Pylon will also have a potential difference to the Pylon, particularly at the top. The high voltage induced on the lighting circuit during the lightning discharge may cause breakdown of the lighting circuit insulation. This is overcome by use of lightning arresters located at the top and base of the Pylon. A double-gapped type arrester between both lamp leads, with the center point connected to the metal housing of the Pylon, satisfactorily solves this problem. It must be pointed out that the insulation of the wires, socket and terminal block must be high enough for the arresters to offer a sufficient factor of safety. Arresters were not used at these locations during the tests, and breakdown between the lamp leads did occur, as shown in Figure 10. Attention must be called to the fact that another important safety measure, which should be con-

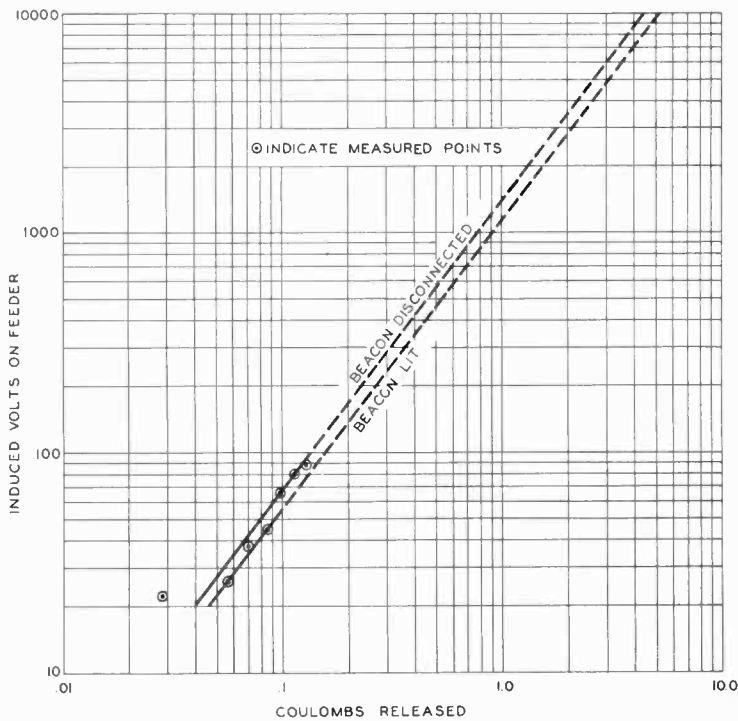

FIG. 8. Curves showing how the induced voltage on the Pylon feeder varies with changes in the charge released in coulombs.

sidered, is the protection by means of valve arresters properly connected on both primary and secondary sides of the power transformer supplying the beacon-lamp circuit. Figure 11 illustrates how the gapped-arrester will be scarred, if the Pylon is subjected to a stroke of the magnitude used in these tests, and a difference of potential between Pylon and lamp circuit operates the arrester. Occasional tower lighting failures caused by natural lightning strokes exhibit damage very similar to that resulting from the artificial tests on the Pylon.

In conclusion several facts stand out and bear brief review.

- (a) Under conditions of direct or near-direct strokes at the Pylon antenna location, very modest, in fact low values of



FIG. 10. The Pylon beacon as it appeared after test lightning strokes, WHEN LIGHTNING ARRESTERS WERE NOT USED. Note the wiring failure, just to the left, below the soot deposit on the left-hand lens. Also visible at the bottom of the photo is a soot deposit on the red filter.

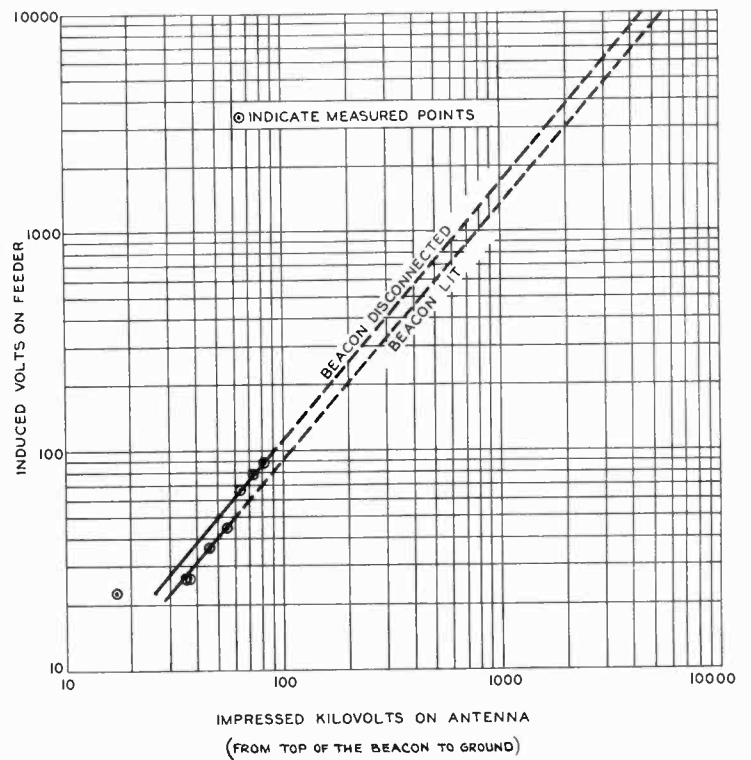

FIG. 9. Curves illustrating the variation of induced voltage on the Pylon feeder with changes in the impressed kilovoltage on the antenna.

voltages only, will appear on the transmission line feeder.

- (b) Proper precautions must be incorporated to prevent interruption of the tower lighting system because of flashover of the 115 volt circuit.
- (c) Good engineering practice dictates that properly rated valve-type lightning arresters be installed on the power-frequency transformer and circuit supplying the voltage to the beacon lamps.

The Engineers of the Electric Service Manufacturing Company, manufacturers of Lightning Protective Equipment for over fifty years, take this opportunity of expressing their appreciation to O. O. Fier and other Engineers of the Broadcast Equipment Section of the Radio Corporation of America for their assistance in making this study.

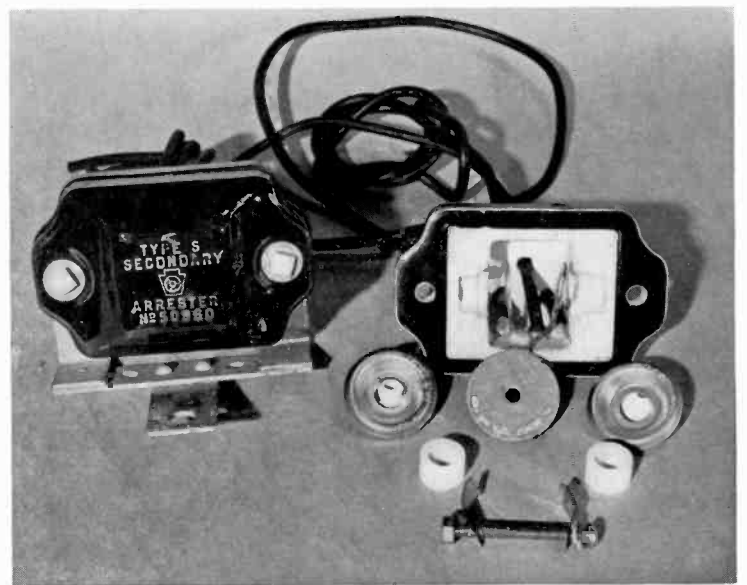

FIG. 11. This photo shows how the lightning discharge affected the arrester which was added to the beacon lighting circuit at the top of the Pylon. Note the scarring or pitting of the three lightning arrester plates. This did not impair the operation of the arrester.

WSAV's PYLON withstands full force of tropical hurricane

On October 15, a tropical hurricane struck with full force on Whitemarsh Island, location of WSAV's FM installation. Ripping in across the coast without warning it first struck Savannah Beach, then roared across Whitemarsh Island, which is about $4\frac{1}{2}$ miles from downtown Savannah. Winds were recorded at 95 miles per hour in Savannah and undoubtedly were much higher on the Island. Particularly hard hit was the airport at Saffold Field. The entire roof of a new concrete-block hanger was lifted off and piled over the side of the structure (see below).

WSAV's four-section Pylon is mounted on a 400-foot tower located about 2 miles from Saffold Field. During the blow it was buffeted by winds which were at least 95 miles an hour and probably much higher. Inspection immediately after the storm showed that there was no damage to the antenna or tower, although the transmission line between the building and tower was slightly damaged due to collapse of some of the supporting poles.

FM stations located in the hurricane and tornado areas of the country will no doubt be glad to have this extra proof of the Pylon's ability to withstand terrific wind velocities.

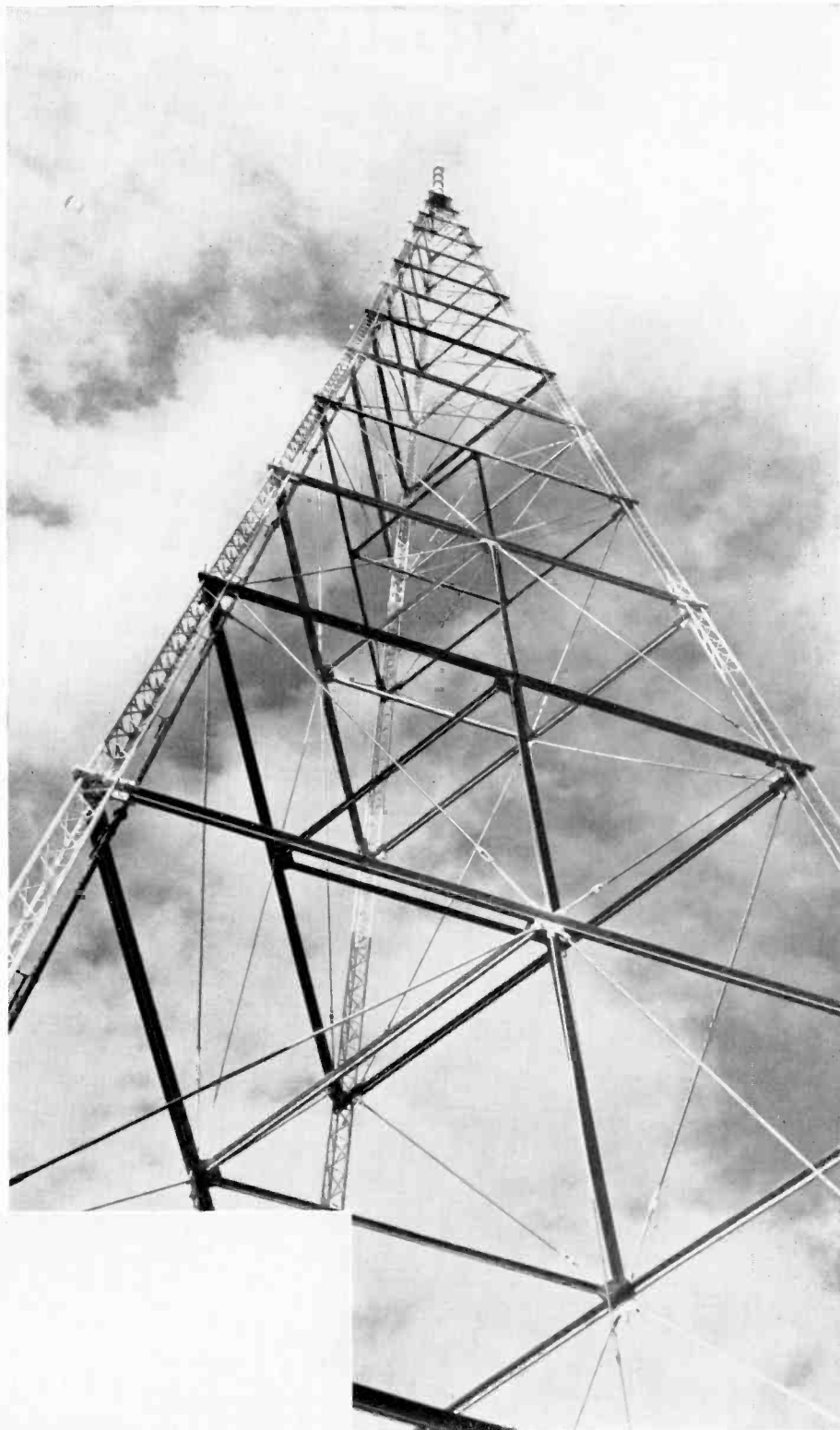

Above: WSAV's four-section Pylon is mounted on a 400-foot tower. Location is only two miles from wrecked airport shown in illustration at left.

Left: Wreckage at Saffold Airfield, two miles from WSAV. High winds did this damage but WSAV's Pylon was unharmed.

MEASURED CHARACTERISTICS of the PYLON ANTENNA

by

O. O. FIET*

Transmitter Engineering Section
Engineering Products Department

During the past few months the Development Group of the Transmitter Engineering Section has carried out an extensive series of tests to determine the exact impedance and performance characteristics of the Pylon Antenna. These tests, which are described in detail below, were made on production-type models of the one-, two-, and four-section Pylons which are now being shipped to FM stations all over the country.

* This paper is a part of a thesis submitted for a Master's degree in Electrical Engineering at the Moore School of Electrical Engineering, University of Pennsylvania, Philadelphia, Pa.

Measurements of impedance, standing-wave ratio, radiation pattern, and gain were carefully made according to accepted methods of engineering practice. In some cases measurements were "double-checked" by alternative methods. The results, which are shown in a series of graphs (Figure 4 to Figure 11) indicate that the actual performance of the Pylon, as installed in the field by FM stations, will closely approach the performance as predicted by theoretical considerations.

DESCRIPTION OF TEST SETUP

In order to make measurements which would be affected to a minimum degree by surrounding objects, a four-section Pylon was set up in a large field near our Engineering Laboratory. This Pylon (Figure 1) was bolted to a rotatable mounting so that the whole antenna could be rotated about its vertical axis. By this means it was possible to make horizontal radiation patterns without moving the field intensity meter—thereby eliminating discrepancies which might occur in making measurements at different points.

During a part of the test measurements the Pylon was connected to an FM transmitter through a standard slotted transmission line. Measurements of antenna reactance and resistance were made at this time (Figure 2) as well as measurements of the standing wave ratio on the line.

In order to measure vertical radiation patterns the several different antennas (one-, two-, and four-section) were mounted horizontally on a turntable (Figure 3). By rotating the antenna

FIG. 2. (below) *Antenna reactance and resistance measurements were made by use of the precision slotted-line test setup shown here.*

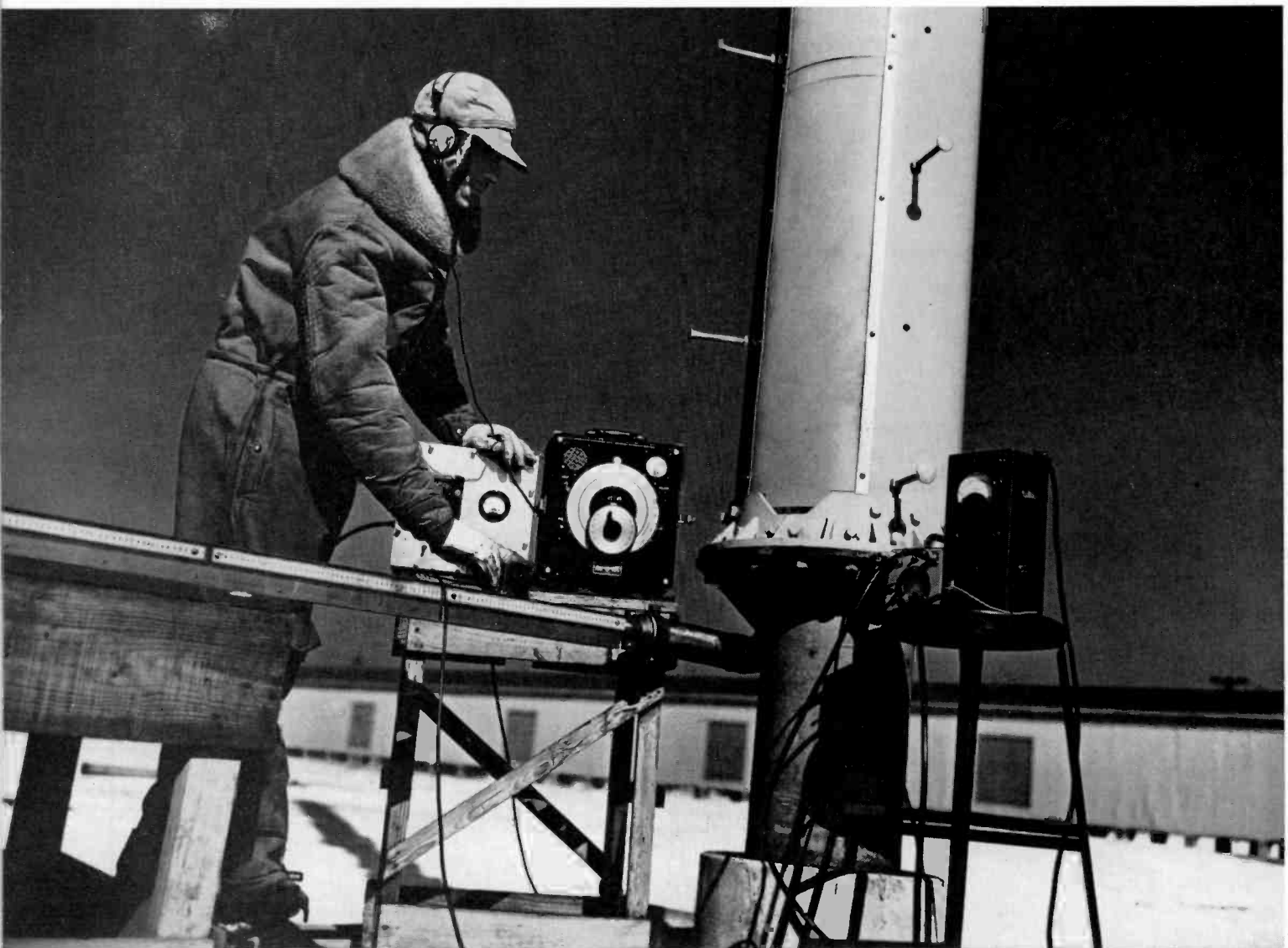

FIG. 1. (right) *Horizontal Radiation Patterns were obtained through measurements made on the RCA four-section Pylon shown here.*

in the horizontal plane radiation measurements could be made at a single point (note field intensity meter in background). In order to avoid errors due to spurious radiation the excitation for this test was supplied by a battery-operated oscillator mounted in one end of the cylinder and connected directly to the standard feed system.

TESTS OF THE FEEDER SYSTEM

A gas-filled concentric transmission line feeder system is installed inside the Pylon cylinders. Suitable transformers and broadbanding circuits are incorporated in the feeder system for the purpose of obtaining a voltage standing wave ratio less than 1.5 to 1, using a 51.5 ohm line at the input to the feeder system. Typical operating standing wave ratios of the one-, two-, and four-section Pylons, as measured at various frequencies in the FM band of 88 to 108 mc, are shown in the graphs of Figure 4. Two sets of transmission lines are available for use with each type of Pylon, one covers the lower portion of the 88 to 108 mc band, the other covers the upper portion. A substantial overlap is provided for both halves of the FM band. In addition a broadband feeder is utilized to match impedances at the lower half of the FM band. The standing wave ratio ob-

FIG. 3. (below) *Field pattern measuring setup. Note receiving antenna at the right in background.*

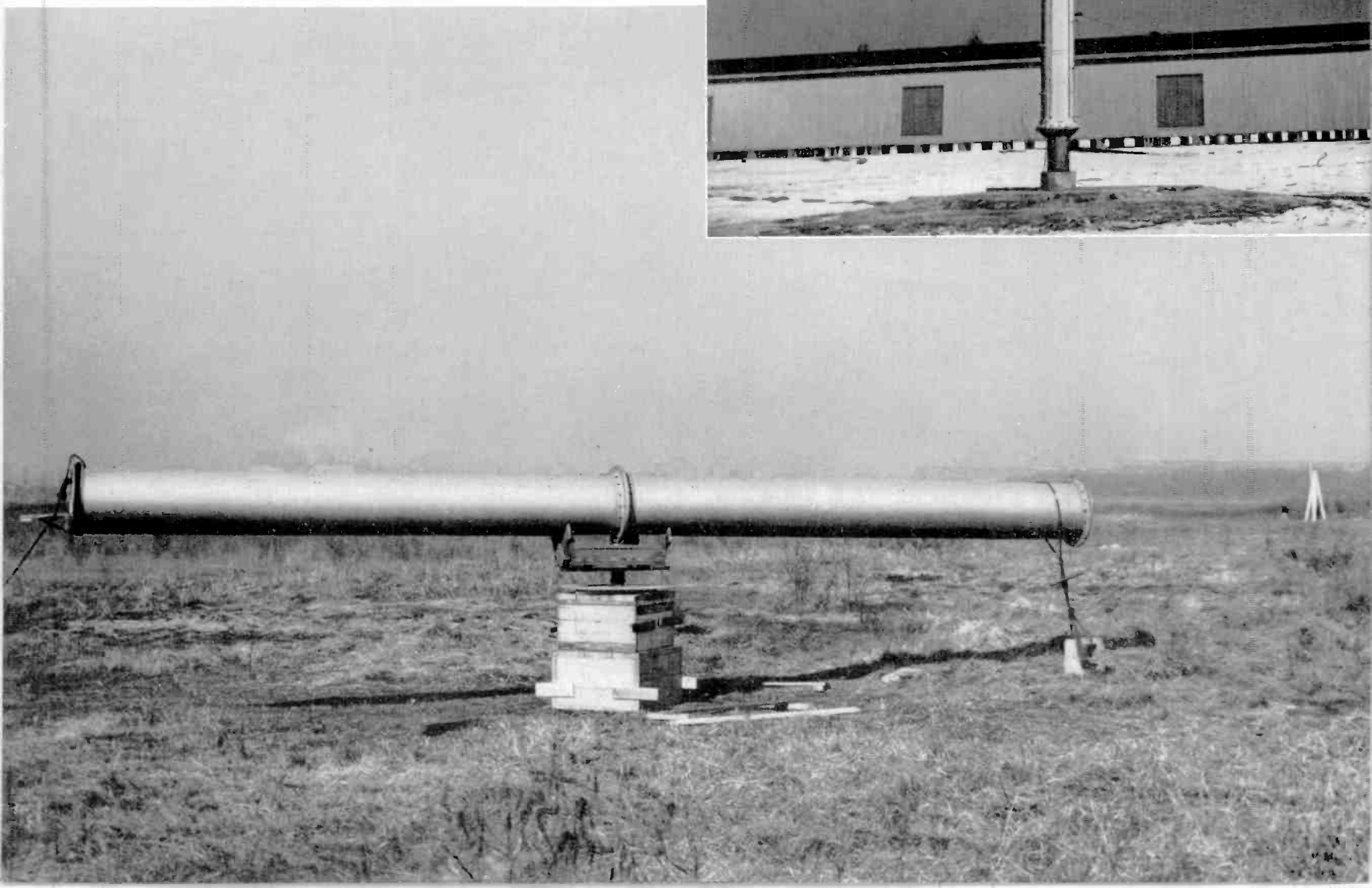
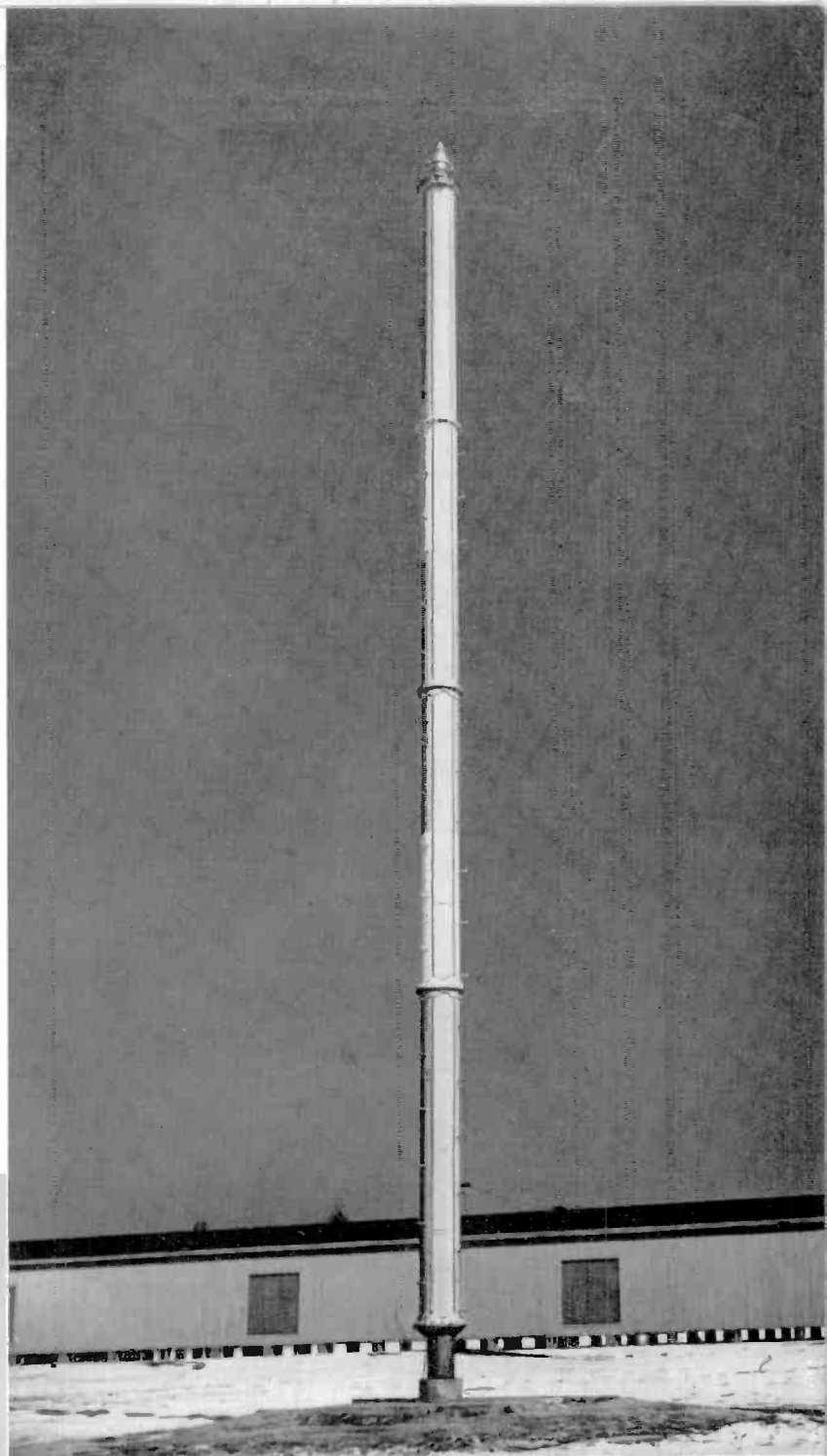

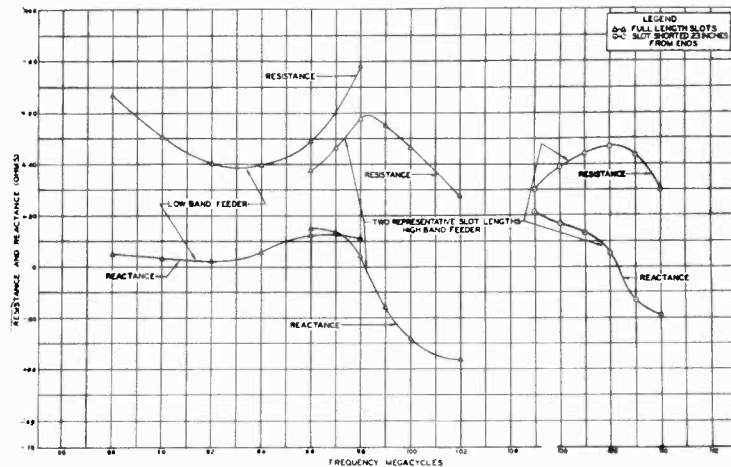
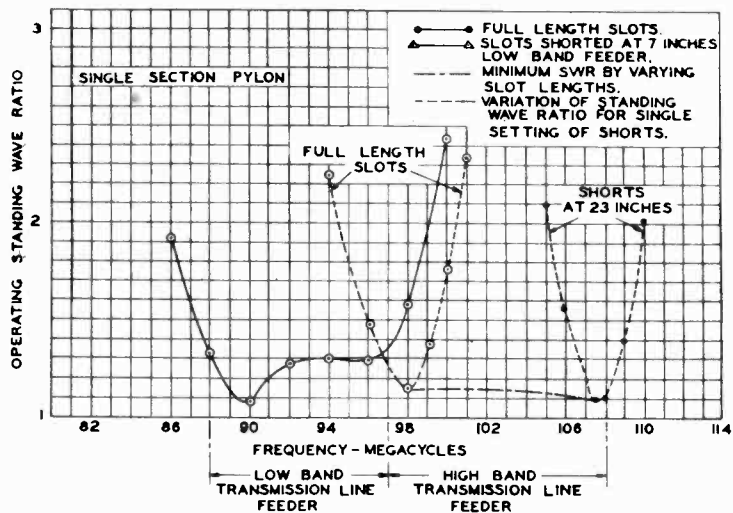

One Section Pylon.

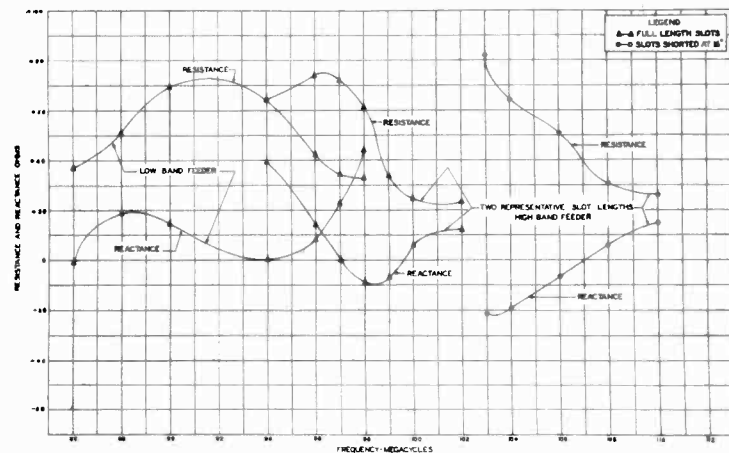
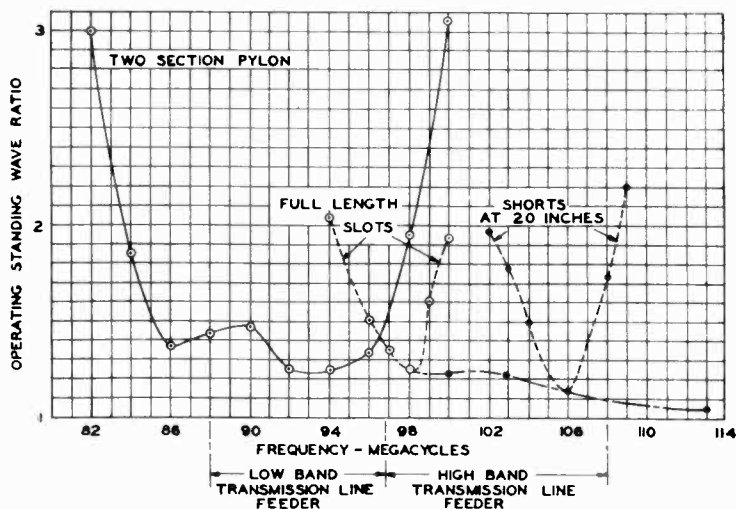

Two Section Pylon.

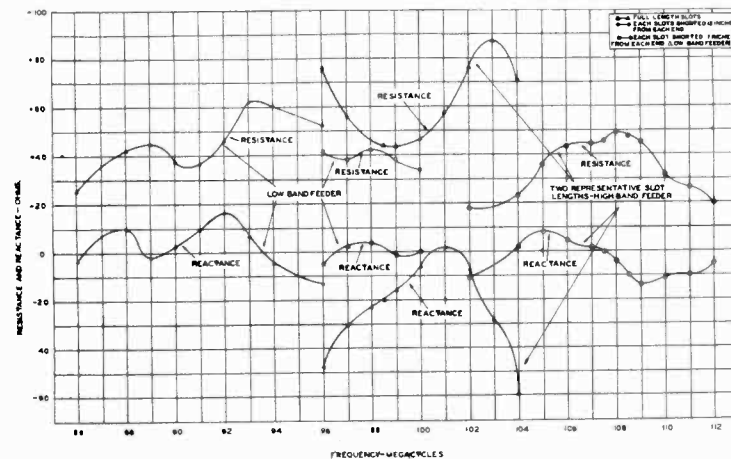
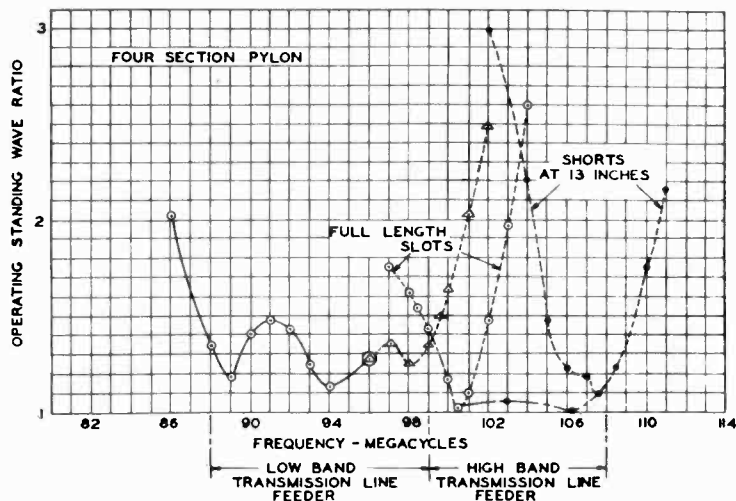

Four Section Pylon.

FIG. 4. The curves above show typical operating standing wave ratios for the one-, two-, and four-section Pylon.

FIG. 5. The three curves show how resistance and reactance vary with frequency. (Data was taken for the one-, two-, and four-section Pylon.)

tained for this portion of the FM band is less than 1.5 to 1 and no adjustment is necessary for a considerable portion of the lower half of the bandwidth.

Shorting bars placed near each end of the slot in the Pylon provide a proper impedance match of the antenna for any channel in the upper portion of the FM band. The exact positioning of the shorting bars is predetermined by using shorting distance versus frequency curves. A simple feeder is utilized to match the input impedance for the entire upper half of the

FM band. Since the antenna input impedance is approximately 50 ohms resistance, high-Q critical reactance adjustment systems are not necessary and the inherent broadband impedance characteristic of a self-resonant antenna is thereby maintained. Typical standing wave ratios obtained for various positions of the slot-shortening bar (used when tuning the high-band one-, two-, and four-section antennas near the center and upper-end of the FM band), are shown in Figure 4. The locus of the operating standing wave ratio (obtained with the proper setting of the slot-shortening bar for any desired frequency) is also shown in Figure 4.

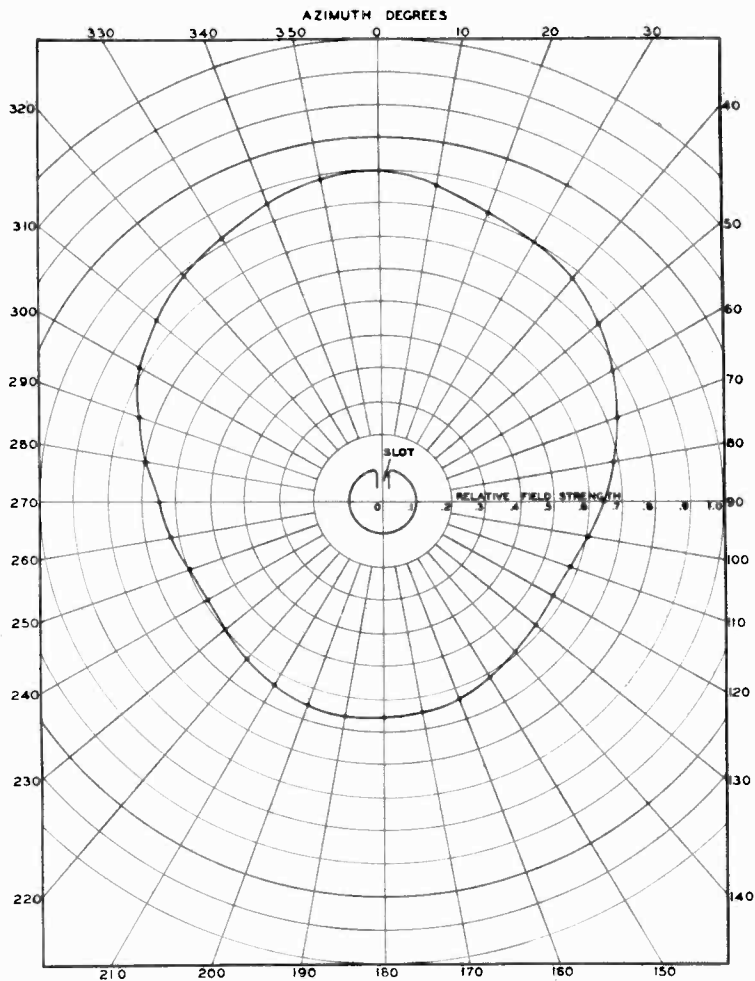

FIG. 6. The horizontal pattern for the one-, two-, and four-section Pylon is illustrated here. (Frequency 98 megacycles.)

FIG. 8. Typical 250 watt FM transmitter coverage with a single-section Pylon. (Frequency, 98 megacycles; antenna height, 100 feet; Receiving Antenna height, 30 feet.)

Typical resistance and reactance characteristics of the one-, two-, and four-section Pylon antennas at the input to the impedance matching system are illustrated in Figure 5.

Maximum horizontal power gain occurs in stacked Pylon antennas when the currents feeding each section are equal and in phase. This same current relationship is maintained, independent of frequency, by using the same lengths of feeder lines for each section of the Pylon antenna. No radiator spacing or adjustments are required to maintain the proper current relationship at any operating frequency.

Since the mutual impedance between adjacent Pylon sections is negligible, bolting the Pylon structure directly to a tower, building or pier will not adversely affect the input impedance. However, consideration should be given to the effect of the supporting structure on the vertical field pattern. A Pylon antenna fastened directly to a tall building, without any intervening structure to elevate its base above the large flat roof, may result in an undesirable vertical field pattern due to radio waves reflected from the roof. Since the transmission lines are inside the cylinder where it is impossible for ice to form, the vertical field pattern will not be disturbed by adverse weather conditions.

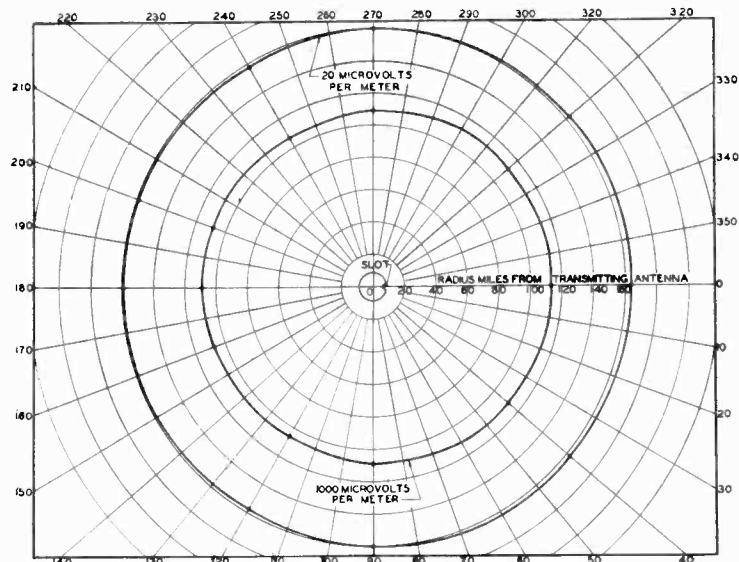
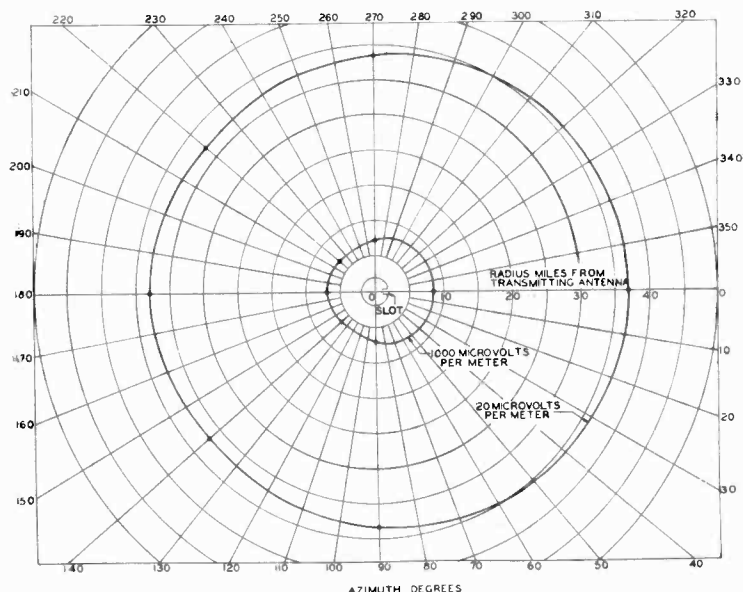

FIG. 7. Typical 50 kw FM transmitter coverage with an eight-section Pylon. (Frequency, 98 megacycles; antenna height, 5000 feet; Receiving Antenna height, 30 feet.) Note primary rural service radius of 160 miles.



PATTERNS AND COVERAGE

The typical horizontal field pattern measured for the one-, two-, and four-section Pylon antennas (shown in Figure 6) exhibits a tendency to become pear shaped. The horizontal gain varies about ± 2 db from the nominal power gain represented by a perfect circle. The pear shaped pattern does not, however, change the horizontal coverage from circular by more than a few per cent. Typical coverage information for the Pylon antenna was calculated on the basis of ground-wave signal range propagation curves set forth in the F.C.C. Standards of Good Engineering Practice Concerning FM Broadcast Stations. The coverage contours are plotted in Figure 7 and Figure 8 for typical extreme conditions of effective radiated power and transmitting antenna height. The coverage was calculated on the basis of a smooth, uniform terrain. Actual coverage contours are affected by irregular terrain and ground conditions and will not necessarily resemble exactly the horizontal pattern of the Pylon antenna or the calculated coverage shown in Figures 7 and 8. Inspection of the coverage contour of Figure 8 will show a slight departure from a circular pattern. The slight directional characteristic may be used to obtain better coverage of a service

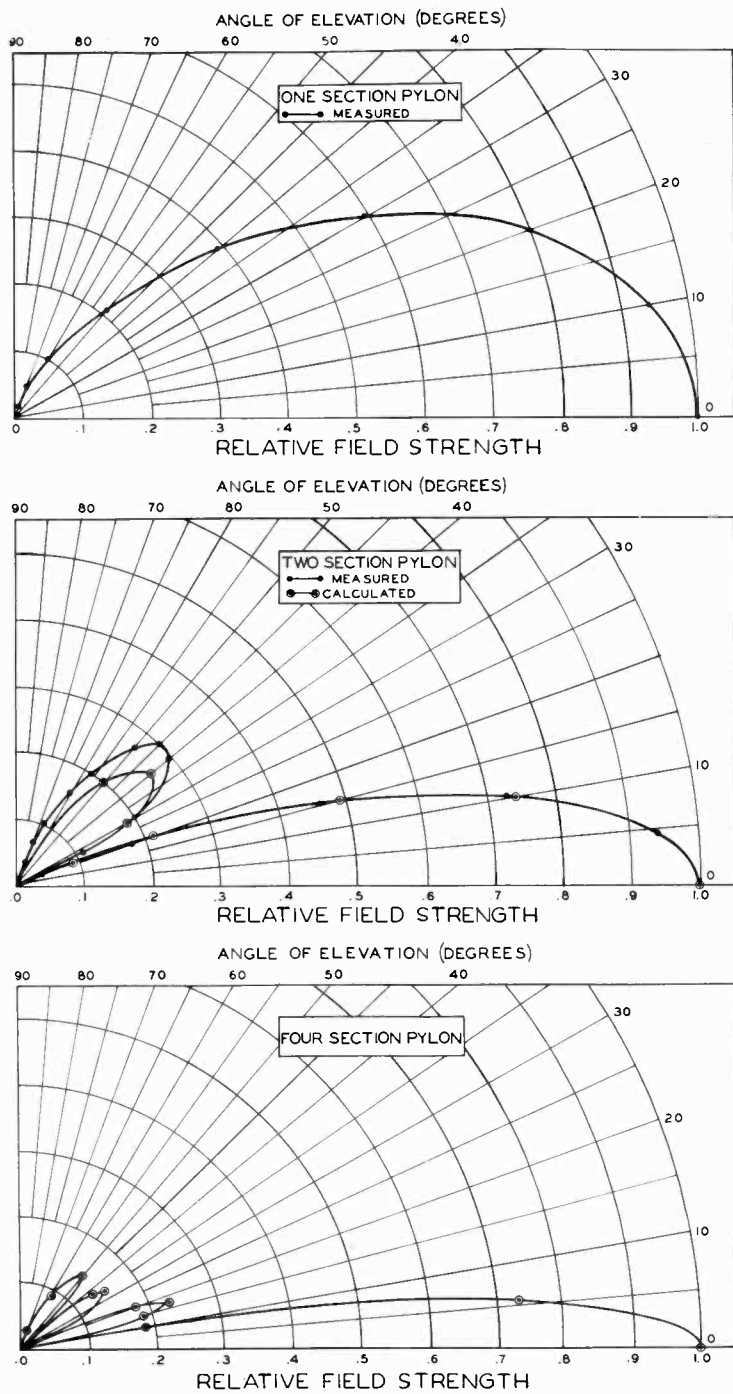

FIG. 9. Vertical field patterns in free space. (FULL length slots, frequency 88 megacycles.) Note how wasteful skywave radiation is reduced by stacking Pylons.

area which is not circular or one in which the transmitting antenna is located off-center. This same characteristic may also be used to compensate for irregular terrain or shadows caused by buildings.

It is possible to obtain a nearly circular horizontal pattern by using a staggered slot arrangement for stacked sections. However, the circular horizontal pattern is accompanied by a tilted or broadened vertical pattern and consequently the horizontal gain is reduced. Since there is no practical advantage to a perfect circular horizontal pattern, the in-line slot design was chosen to permit mechanical simplification of the feeder system and utilize multiple section Pylon antennas to their greatest advantage.

Vertical pattern, of the one-, two- and four-section Pylon antennas at 88 and 108 mc, shown in Figures 9 and 10, illus-

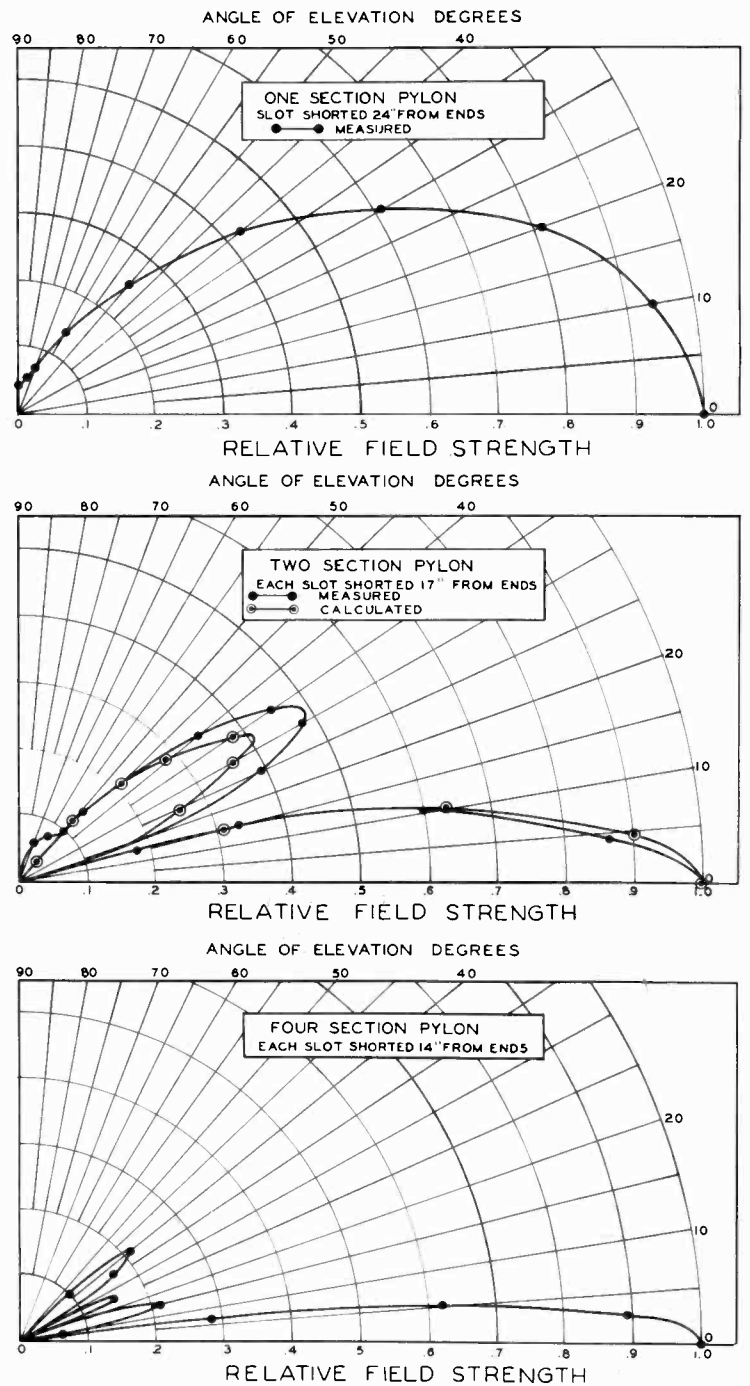

FIG. 10. Vertical Field Patterns in free space. (Slots shorted at optimum positions—frequency, 108 megacycles.)

trate how stacking Pylon sections reduces wasteful skywave radiation and increases the power radiated in the horizontal plane. The power gain or increase in horizontal radiated power is shown in Figure 11.

A Pylon antenna with a power gain of 12 will give the same horizontal coverage with 1/12 the transmitter power required as when an omnidirectional antenna with a power gain of one is used. The economic and operating advantages of using a high-gain antenna and a lower power transmitter in preference to a low-gain antenna and a high-power transmitter are apparent for most FM broadcasting installations designed to cover a given market area.

The power gain of the Pylon antenna can be measured by several methods. Two common methods are: (1) a comparison of the field strength produced by an unknown antenna with that

of a standard antenna of known power gain, and (2) an integration of the radiated power as determined from measured radiation patterns.

The *first method* (substitution method) is quite simple and basic. However, difficulties due to ground reflections are encountered when attempts are made to measure the gain in the presence of the earth's surface. The undesirable effects of ground reflections can be avoided when highly directional microwave antennas are measured. Since the Pylon is relatively large, and because precise field strength measurements are required, the substitution method proves to be inadequate for consistent gain measurements at 100 mc. Experience has shown that carefully made gain measurements by the substitution method at 100 megacycles cannot be duplicated with an accuracy of greater than $\pm 20\%$.

Gain may be measured approximately by comparing Pylon field strength measurements with those of a standard transmitting antenna of known gain, under identical conditions. In this method of measurement field strength readings are continuously* recorded along a single radial from the transmitting antenna. In taking data for both the Pylon and Standard antenna, the same location should be used for the center of radiation.

The ratio, between the *average field strength* produced (on the radial) by the Pylon, and that of the Standard antenna (as measured in the vicinity of a fixed distance from the transmitting antennas) may be used to estimate gain. See equation (1) below.

$$G_p = \left(\frac{E_p}{E_d} \right)^2 \frac{P_d}{P_p} \text{ eq. (1)}$$

Where:

- G_p Power gain of unknown antenna referred to that of a half-wave dipole.
- E_p Field strength produced by unknown antenna at a fixed distance and receiving antenna height.
- E_d Field strength produced by a half-wave dipole at a fixed distance and receiving antenna height.
- P_d Power input to half-wave dipole.
- P_p Power input to unknown antenna.

* See G. W. Klingaman's article, "How to Make a Field Survey of an FM Station", BROADCAST NEWS, No. 43, June 1946.

Equation (1) may also be used to measure the gain of antennas under free space conditions. Free space conditions are difficult to obtain, except for microwave antennas. Consequently, gain measurements by the dipole substitution method, for FM broadcast antennas, must depend upon propagation characteristics over the earth's surface. The field strength produced by a dipole, E_d , for a given power input, may be calculated or measured. It is helpful to remember that a half-wave dipole produces a free-space field strength of 137.6 millivolts per meter, at one mile, with one kilowatt input.

The *second method* of measuring gain, the integration of radiated power by using measured patterns, is quite tedious and usually requires many carefully measured patterns to obtain an accurate integration of the radiated power. The accuracy obtained by practical measurements is good. Careful measurements yield calculated gains which can be duplicated within one or two percent.

The gain determined from measured patterns can be compared with a theoretical gain obtained from calculated patterns. The agreement obtained in the case of the Pylon is quite good.

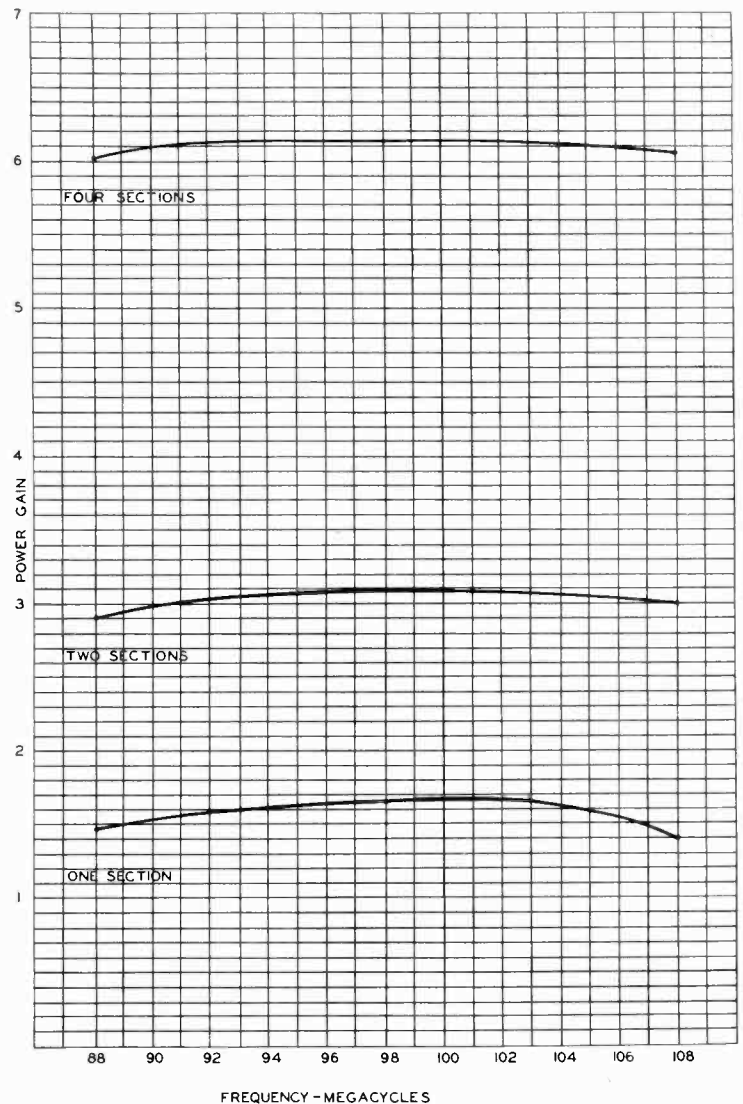

FIG. 11. Pylon Antenna measured power gain compared to that of a half-wave dipole. Gain is substantially independent of frequency.

The vertical patterns of the Pylon antenna can be measured readily by a set up similar to that illustrated in Figure 3. The Pylon antenna is installed on a turntable with the desired vertical patterns located in a horizontal plane. A battery operated oscillator is installed at one end of the Pylon and connected to the feeder system. The battery operated oscillator eliminates the possibility of undesirable r-f radiations from power leads. In a-c operated oscillators the r-f currents radiated are induced in the power leads thus affecting the measured field pattern of the Pylon antenna.

The receiving antenna and field intensity meter are installed at a sufficient distance from the Pylon antenna and turntable to obtain the lowest possible nulls on the vertical side lobes. The site used for pattern measurements should be a large flat area without reflecting obstructions in the vicinity. Patterns are obtained, after the field strength meter is adjusted, by rotating the Pylon antenna on the turntable and measuring the relative field strength as a function of angle of rotation. A simple pointer and dial, divided in degrees, can be installed on the turntable to indicate the angle of rotation of the Pylon.

The vertical pattern in all planes through the axis of the Pylon is nearly identical. The mean of four vertical patterns measured in various planes at right angles gives an average pattern suitable for accurate gain calculations. It is important

to calibrate the field strength meter scale for relative field strength if the patterns are to be used for accurate determination of gain.

The integration of radiated power, over the surface of a sphere, is greatly simplified; when the sphere encloses the radiating system; and when the center of the sphere is also the effective center of the radiating system. The Pylon field pattern has near rotational symmetry about the axis of the cylinder. A half-wave dipole has rotational symmetry about the axis of the dipole.

The power gain of an antenna may be defined as the ratio of the *maximum* to the *average* power-radiation intensity. The gain given by this method is relative to an isotropic radiator or to a source radiating uniformly in all directions. The gain of a half-wave dipole is 1.63 times the isotropic radiator. Therefore, the gain referred to a half-wave dipole is $\frac{1}{1.63}$ times the gain, as referred to an isotropic radiator.

The gain, G_1 , referred to an isotropic radiator is given by equation (2) for patterns with rotational symmetry.

$$G_1 = \frac{4\pi}{\int_0^\pi P(\theta) 2\pi \sin \theta d\theta} \quad \text{eq. (2)}$$

The gain relative to a half-wave dipole G_D is given by equation (3).

$$G_D = \frac{4\pi}{1.63 \int_0^\pi P(\theta) 2\pi \sin \theta d\theta}$$

$$G_D = \frac{\int_0^\pi \left[\frac{\cos \frac{\pi}{2} \cos \theta}{\sin \theta} \right]^2 d\theta}{\int_0^\pi P(\theta) \sin \theta d\theta} \quad \text{eq. (3)}$$

Where:

- θ = Angle from the axis of rotational symmetry.
- $P(\theta)$ = Relative power radiation intensity as a function of angle from axis of symmetry. (The maximum of $P(\theta)$ for any θ is 1).
- $P(\theta) = [F(\theta)]^2$.
- $F(\theta)$ = Field pattern about axis of rotational symmetry for the antenna of unknown gain. Maximum value of $F(\theta) = 1$.

The integral, $\int_0^\pi \left[\frac{\cos \left(\frac{\pi}{2} \cos \theta \right)}{\sin \theta} \right]^2 d\theta$,

is proportional to the power radiated by a half-wave dipole to sustain a standard maximum field strength at a known distance from the dipole.

The integral $\int_0^\pi P(\theta) \sin \theta d\theta$

is proportional to the power radiated by the antenna whose gain is desired to sustain a standard maximum field strength at a known distance from the antenna.

The integrals for radiated power are frequently difficult to evaluate analytically and in most practical cases the integration

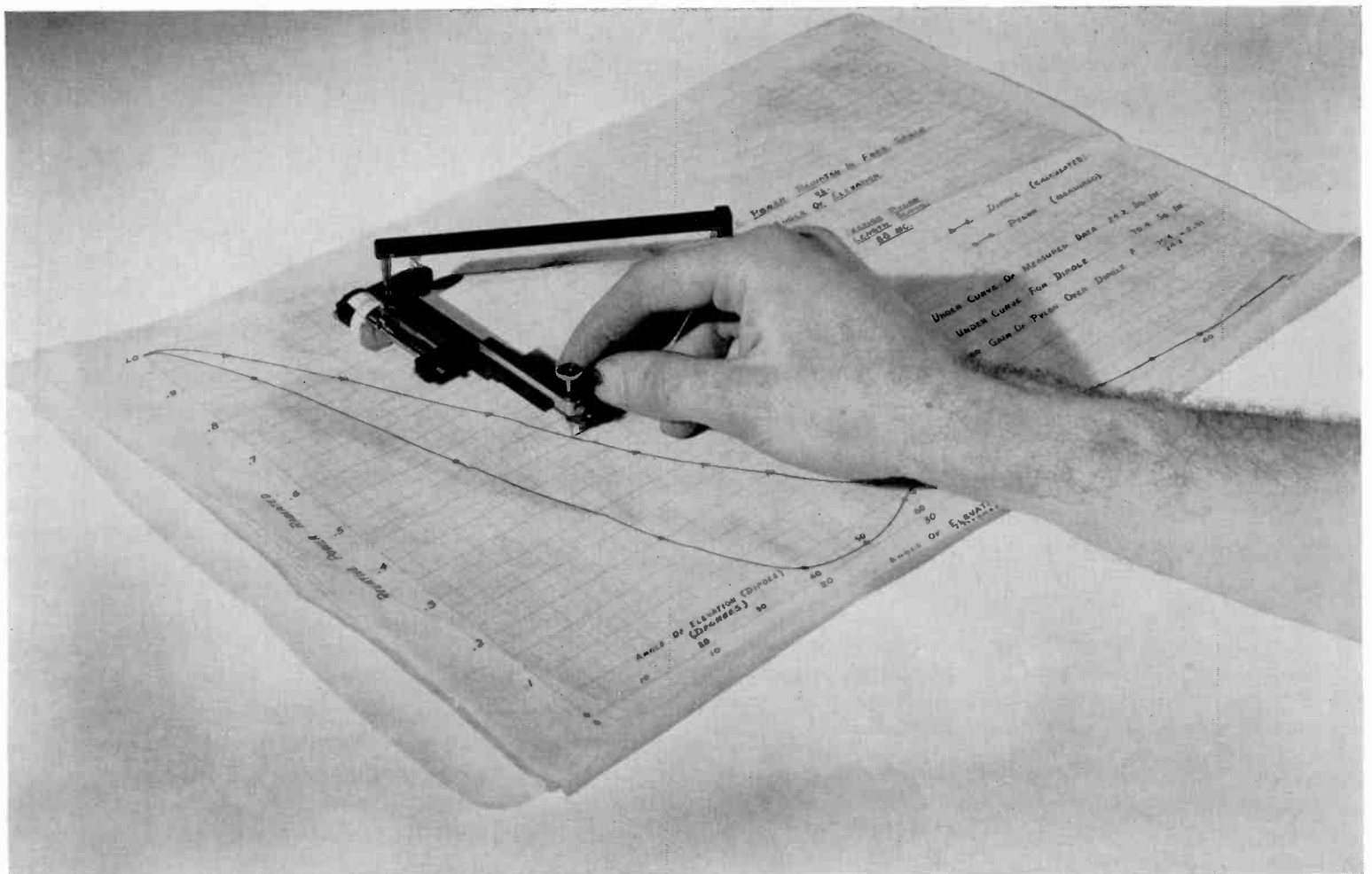
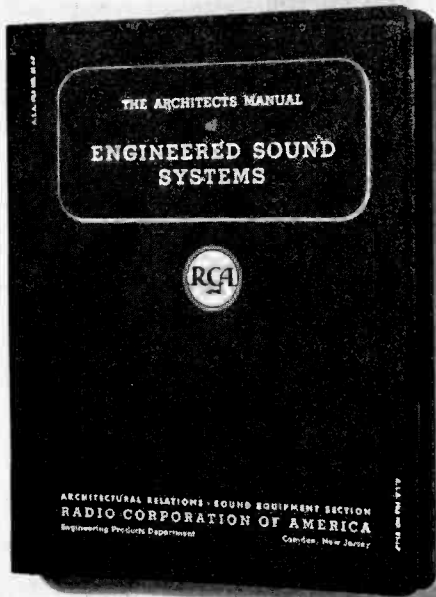

FIG. 12 Gain may be calculated by graphical means. In this view, the planimeter is being used to measure the area under the curve.



THIS BOOK WAS NOT WRITTEN FOR BROADCAST ENGINEERS

But some broadcast engineers may find a need for it, and almost any engineer will welcome it as an addition to his personal reference library.

Intended primarily as an aid to architects in planning sound installations for schools, churches, hospitals, and auditoriums, the ARCHITECTS MANUAL is a 288-page book which is filled to the brim with useful information of the type needed in preparing detailed building plans and specifications.

Most of the material included in this book has appeared previously in various publications, but until now it has never been available in a single volume. Recognizing the need for such a book, engineers of the RCA Sound Section have collected together, edited, and presented in easily used form most of the information ordinarily required by architects in their sound systems planning.

The first 32 pages of the ARCHITECTS MANUAL are devoted to definitions and symbols. The 25-page section on symbols is outstanding, containing as it does, not only the American Standard Graphical Symbols for Telephone, Telegraph and Radio Use, but also the American Standards for Graphical Electrical Symbols for Architectural Plans. The latter, which contains the proper symbols for outlets, panels, circuits, etc., should

be useful to broadcast engineers when they are required to draw or check building plans.

Following the section on symbols is a 20-page section on the components of sound systems, followed by a short section on studios and control rooms, a section on acoustics, and sections on film projector and antennaplex installations. The final 148 pages of the book consist entirely of typical layouts and specifications. These are arranged in sections, i.e., one on schools, another on churches, a third on hospitals, etc. They should be of invaluable aid to the architect or designer faced with the problem of drawing sound system specifications.

Only a small part of the information contained in the ARCHITECTS MANUAL is of direct usefulness to broadcast engineers in their every day job. However, those who are planning a new studio installation or who may now and then be called on for consulting advice on sound installations will find it a valuable aid.

The book is standard size, 8½" x 11", is handsomely bound in a post binder with gold-stamped imitation leather cover. The price is \$5.00 (\$5.50 foreign). Orders should be addressed to BROADCAST NEWS, Building 15-6, Radio Corporation of America, Camden, N. J.

(Continued from opposite page)

is performed graphically. The integral $\int_0^\pi P(\theta) \sin \theta d\theta = \int_0^\pi [F(\theta)]^2 \sin \theta d\theta$ and $\int_0^\pi \left[\frac{\cos\left(\frac{\pi}{2} \cos \theta\right)}{\sin \theta} \right]^2 d\theta$

may be evaluated by plotting the integrand of each as a function of θ on rectangular coordinates. The relative area may be measured by weighing the cutout pattern, counting squares under the curve, or by means of a planimeter as shown in Figure 12. The ratio, of the relative area obtained for the half-wave dipole to the relative area for the antenna of unknown gain, is the power gain relative to a half-wave dipole eq. (3).

Suitable scales may be selected, for θ in the case of the dipole and unknown gain patterns, to utilize the paper most effectively

for accurate gain calculations. Figure 12 illustrates the use of a scale factor of 2 for θ . In the case of the 2-section Pylon, the measured area for the Pylon is then multiplied by ½ to obtain an area relative to the dipole area.

Although the pattern method of measuring gain does seem somewhat involved with calculus, the actual procedure for calculating gain by graphical means, in the case of the Pylon antenna, can be performed readily without resorting to calculus. In the graphical method, accurately measured field patterns are necessary.

ACKNOWLEDGMENT

Credit is due to each of the members of the RCA organization who participated in the conception, development, and design of the Pylon Antenna described in this article.

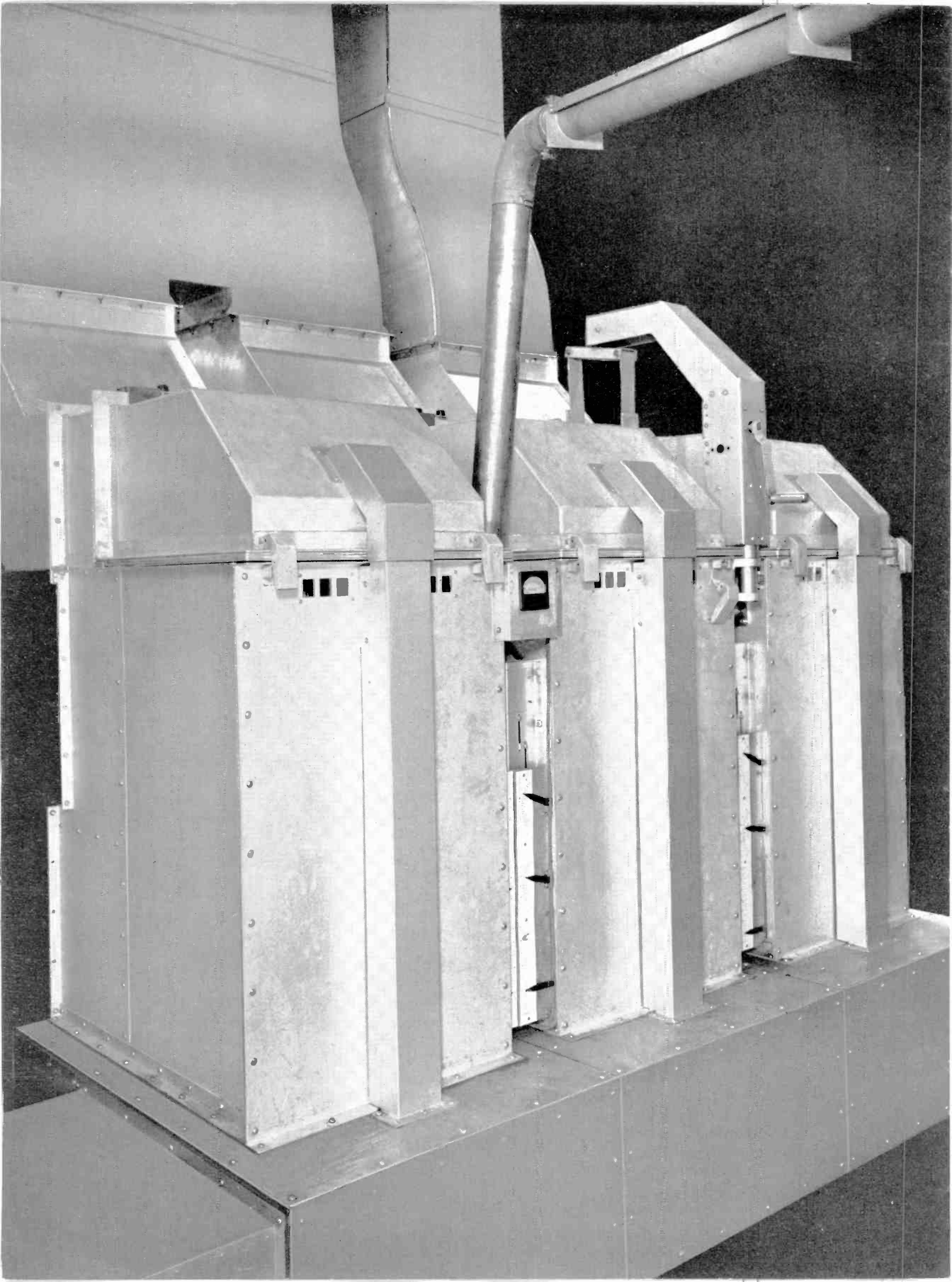

300 KILOWATTS OF FM POWER

TEST SETUP AT CAMDEN, ON THE
AIR SINCE JUNE, DEMONSTRATES PER-
FORMANCE OF RCA 50KW FM TRANS-
MITTER FEEDING FOUR-SECTION PYLON

During recent months RCA broadcast engineers have been conducting tests, with over 300 KW of radiated FM power (Figure 1), on the FM band of 88 to 108 megacycles. Up to 60 kilowatts of FM power has been fed to a 55-foot, four-section Pylon antenna (see Figure 2), which has a power gain of 6. Individual tests have been successfully conducted at each of the following frequencies: 88.1, 95.1, 99.3 and 107.9 mc. The combination of the 50 KW FM transmitter and the four-section Pylon provides an effective radiated power of 360 kilowatts. (Power gain of $6 \times 60 \text{ KW} = 360 \text{ KW}$.)

The four-section Pylon is installed on top of the Transmitter Engineering Building, Camden. As may be seen in Figure 2, the Pylon base is in close proximity to the roof of the wooden building in which conduit, wiring and piping was installed. No

FIG. 1. (left) *The fifty kilowatt FM power amplifier, which has been in operation at Camden since last June, and which has been exhaustively tested at several frequencies between 88 and 108 megacycles. This setup, which is an exact prototype of the driver-amplifier section in the BTF-50-A Transmitters now being manufactured, consists of three identical, completely enclosed, grounded-grid, concentric line tanks. One of these is the driver, and operates from excitation furnished by a standard RCA BTF-3-B Transmitter. The other two are the power amplifiers, the output tanks of which are connected in parallel.*

FIG. 2. (right) *Standard four-section Pylon erected on roof of the transmitter laboratory (the famous "53 Building") for the series of tests described here. This antenna has a gain of six, which together with the transmitter output power of 60 KW (at which the transmitter was operated during tests, although the rated capability is 50 KW), gave an effective radiated power of approximately 360 kilowatts.*

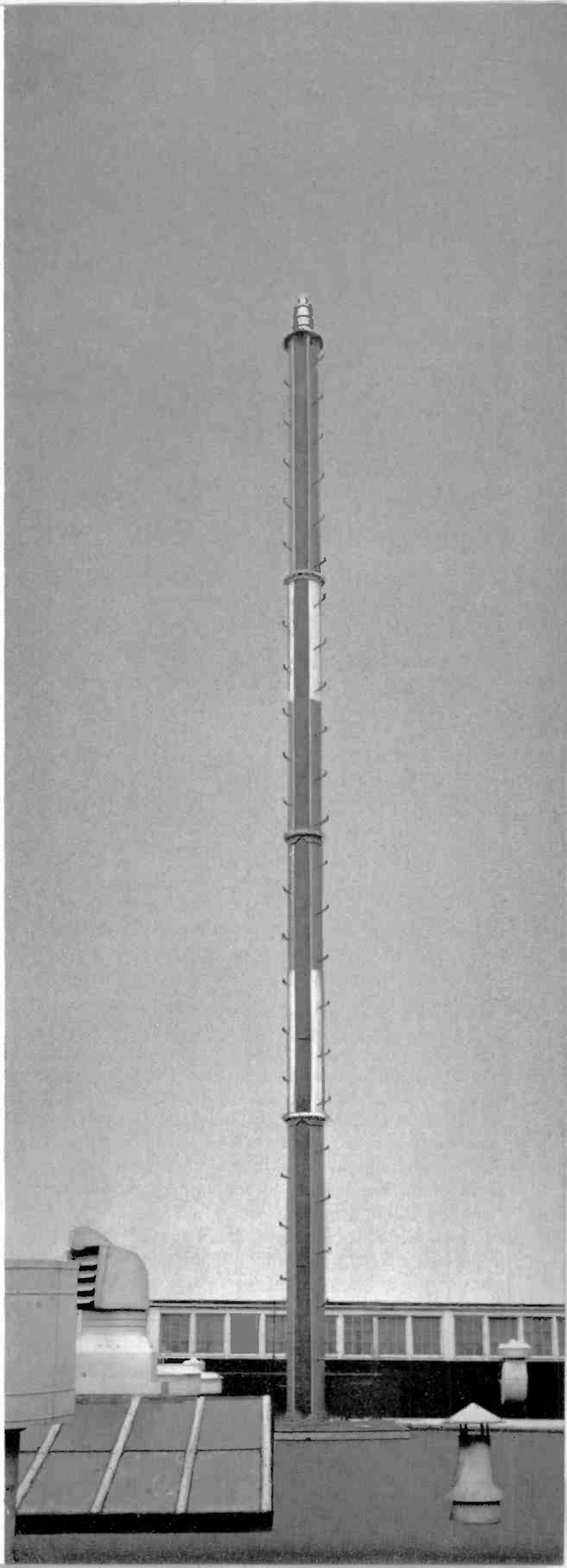

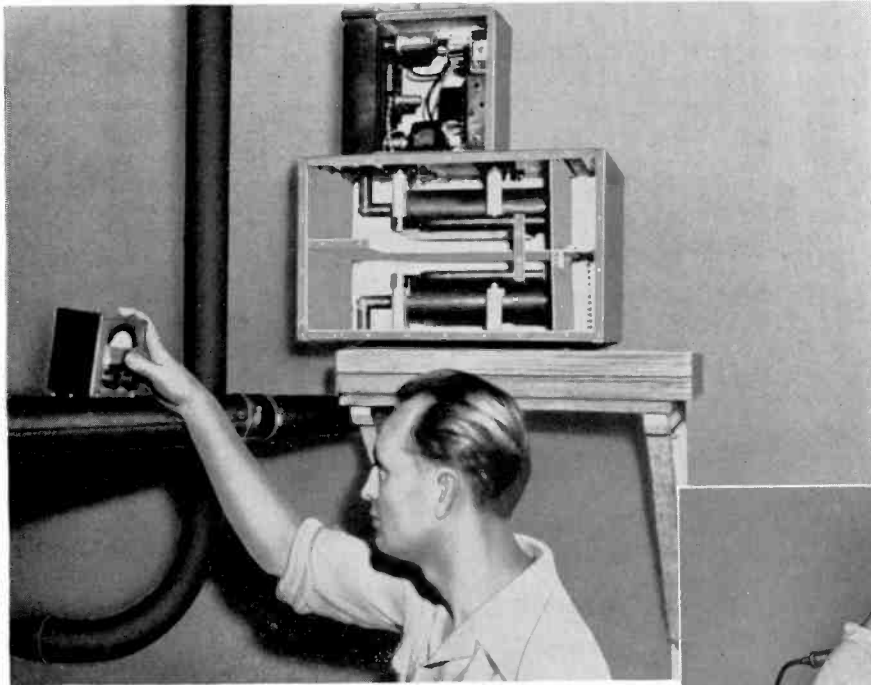

FIG. 3. (left) Power was fed from the power amplifier shown in Figure 1 to the antenna shown in Figure 2 by means of a $3\frac{1}{8}$ " concentric line. In this illustration Owen Fiet, transmitter development engineer, is using a slotted concentric-line measuring setup to determine standing wave ratios on the antenna line during operation at full power output.

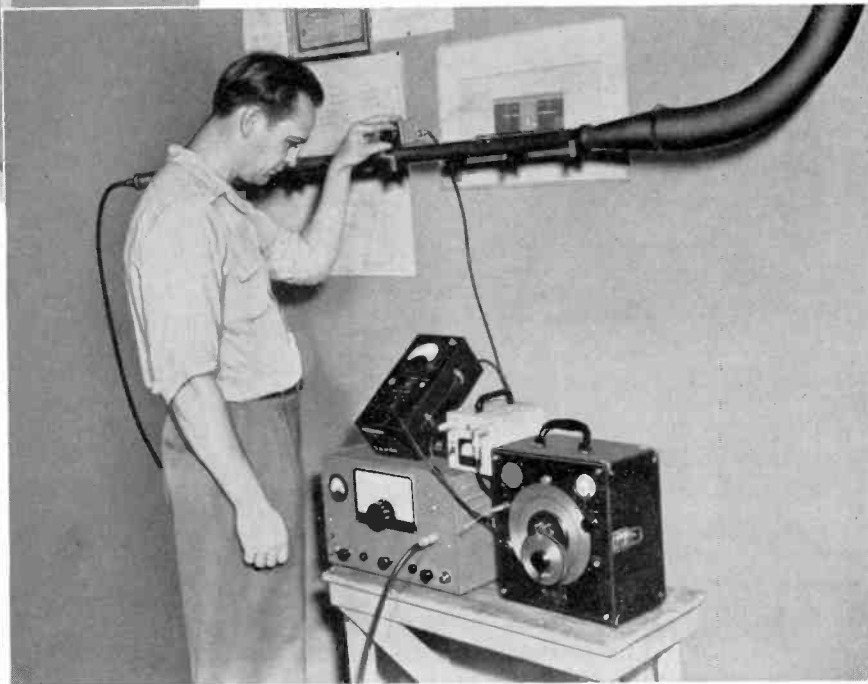

FIG. 4. (right) In this view Mr. Fiet is demonstrating a somewhat different setup used in making precise impedance measurements before and after high-power test. Equipment includes a signal generator used as a circuit driver and a vacuum tube voltmeter for voltage distribution measurements.

difficulties were encountered with overheating, sparking, or heavy currents in the wiring system. This illustrates the low radiation intensity directly below the Pylon antenna.

Representing the first commercial type 50 KW FM transmitter to be air-tested in the new FM band, high-power tests began on June 20 and were conducted between the hours of midnight and 6:00 A.M. Power was fed from the RCA 50 KW transmitter to the Pylon antenna through a $3\frac{1}{8}$ " transmission line (Figure 3). The entire test provided an opportunity, not only to check the power-handling capability of the Pylon, but also to check the operation of the power output monitor and the harmonic filter. The large $3\frac{1}{8}$ " slotted concentric-line measuring setup (Figure 3 shows $3\frac{1}{8}$ " measuring line connected to harmonic filter) was used to measure the impedance characteristics of the antenna and harmonic filter *during actual 50 KW operation*. Measurements were recorded at various points on the transmission line by varying the position of the probe along the slot.

In addition, precise impedance measurements were also obtained *before and after high-power tests* by means of the test arrangement shown in Figure 4. During these measurements the signal generator was used as the circuit driver and the vacuum tube voltmeter to record voltage measurements. Just above the test equipment of Figure 4 is shown a small precision measuring

line with a tuned voltmeter probe mounted on top. By varying the position of the probe along the slot, voltage distribution was checked along the transmission line. Characteristics of the antenna, transmission line and harmonic filter were not affected by the high-power operation.

Actual test broadcasts were conducted using standard audio facilities including turntable, microphone, amplifiers, monitoring and control equipment. No special shielding or screen cages were needed and satisfactory results were obtained, while operating in the immediate vicinity of the 50 KW FM transmitter and four-section Pylon.

The overall fidelity of the entire high-power FM system and the predicted system performance (coverage and field strength) were confirmed. All operating tests proved the practicability and usefulness of both the RCA high-gain Pylon and the 50 KW FM transmitter for high-power FM use. The excellent power-handling capabilities exhibited by the Pylon will contribute to its extensive use in the high-power FM field. Up to 600 kilowatts of effective radiated FM power may be obtained by means of an 8-section RCA Pylon and a 50 KW FM transmitter. This will enable high-power FM broadcasters to serve primary service areas, up to 200 miles in radius, when mountain elevations are used for the high-gain, high-power installation.



FIG. 5. (left) Another view of the 50 KW power amplifier. Dana Pratt, manager of broadcast transmitter sales, has opened two of the enclosures to show internal construction. The hood of the enclosure at the left has been raised, but the grid shield is still in place. The grid shield of the center enclosure has been lifted up to demonstrate easy access to tubes.

FIG. 6. (right) This is a closeup view of the grid shield in place. The RCA-5592, especially designed for use in grounded-grid circuits, has a grid construction which provides complete internal shielding. The external grid construction is of the disc-seal type. The grid shield shown here extends the internal shielding so that no neutralizing is required. Operation is extremely stable at all FM frequencies.

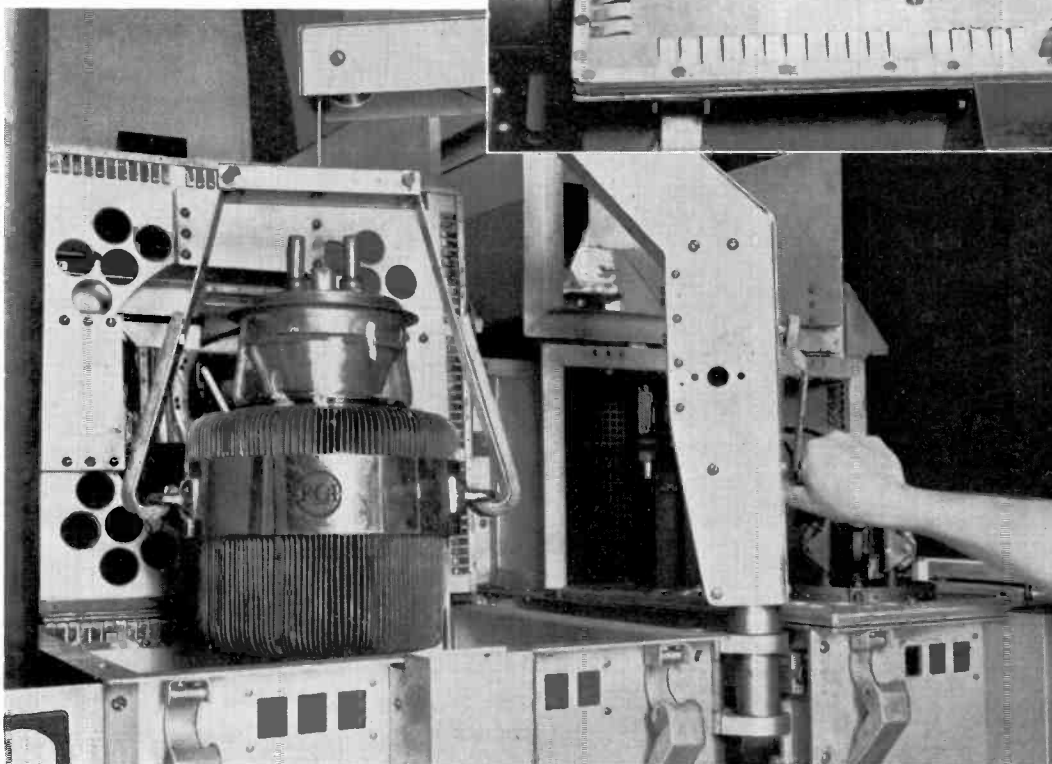
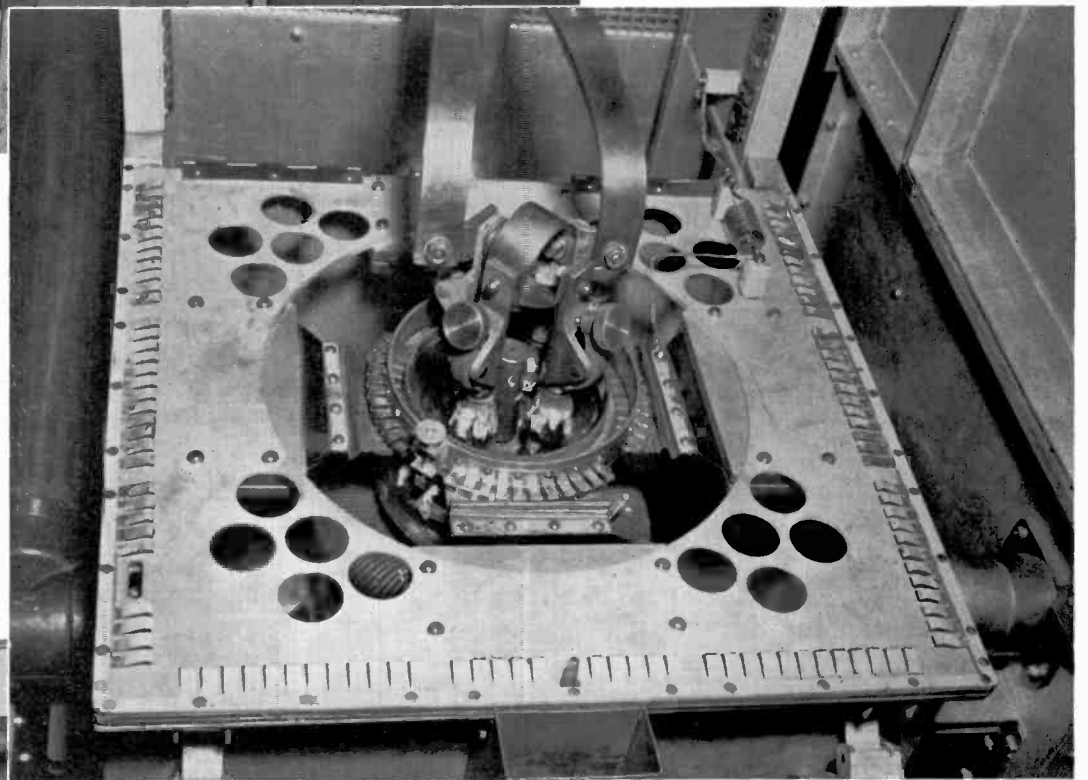
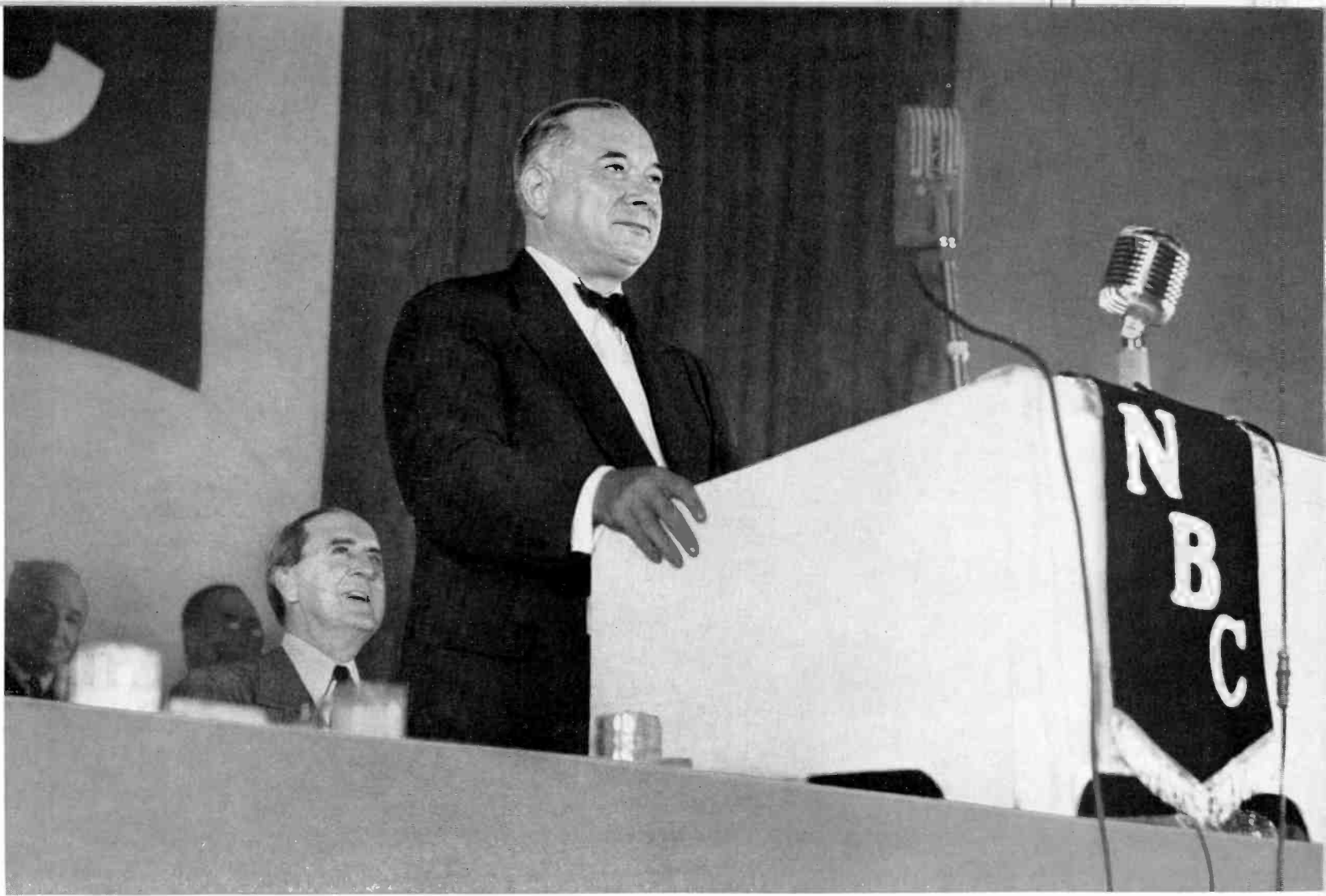

FIG. 7. (left) This shows the rig provided for easy tube changes. Handle at the right is turned to elevate tube from enclosure, after which the tube is swung forward and handle turned in opposite direction to lower the tube to waist height. From this position it may be lifted with ease by one man. Operation of removing tube and inserting new one can be carried out in less than a minute.



Brigadier General David Sarnoff addressing the NBC affiliates meeting at Atlantic City, September 13, 1947. Theme of his talk was the rapid spread of television service, the attendant growth of the television audience, and the implications therein for present-day broadcasters.

TELEVISION PROGRESS

by DAVID SARNOFF

Text of an address delivered by Brigadier General Sarnoff, Chairman of the Board and President of the Radio Corporation of America, at the NBC Affiliates' meeting held in connection with the NAB Convention at Atlantic City, September 1947. (Note: Figures for cp's, applications, stations-on-air, etc., are as of September 1, 1947).

In speaking of television for the past twenty-five years or so, we have been accustomed to say that "television is around the corner." In my observations today I should like to bury that phrase. Television is no longer around the corner. It is beyond the doorstep; it has pushed its way through the door into the home!

I would like to go into the subject directly and with a few timely and conservative figures. They will help to illustrate the general remarks I will make about the possibilities of television as a new industry and as an important new service to the public.

TELEVISION STATIONS

The Federal Communications Commission has authorized to date a total of 69 television stations, and 16 applications are

pending. This means that 85 television stations already have decided to lead the way. I believe that many more will follow. Today there are 13 stations on the air with regular television programs. By the end of 1947 this number may be doubled. In 1948, the list of stations will increase as transmitting equipment becomes available.

My estimate is that by the end of 1948 there will be approximately 50 television stations on the air in this country with regular programs. There may be more.

TELEVISION RECEIVERS

All kinds of figures have been mentioned about television receivers, and here is my estimate: between 150,000 and 175,000 receivers will be in use by the end of 1947. By the end of 1948, I foresee a total of 750,000. This means that for 1948 our estimates are approximately 600,000 above the number that will have been installed at the end of the present year.

TELEVISION AUDIENCE

Surveys have been made of the number of people within range of present television programs. Approximately 30,000,000 people live within the areas covered by current television broad-



RCA's booth at the NAB Exhibit as viewed from the balcony of Convention Hall. The exhibits of the various manufacturers comprised the largest display of transmitting equipment ever assembled. Operating television setups were featured by several manufacturers.

casts. By the end of 1947, this figure will be 40,000,000 and thereafter this audience will be augmented by many millions.

Surveys indicate that seven viewers constitute the average audience at each television receiver. Therefore, if you multiply 750,000 by seven you will see that by the end of 1948 there will be a large audience for television—somewhere near 5,000,000.

The broadcaster must build his own television circulation as does a new magazine or newspaper. That is the broadcaster's job. He cannot toss that responsibility to the television set manufacturer, any more than the magazine or newspaper publisher can transfer his problem to the printer.

A newspaper or magazine spends a substantial part of its initial investment in building circulation; the job of the broadcasting stations, likewise, must be to build circulation in television.

FUSION OF SOUND AND SIGHT BROADCASTING

I have previously advanced the idea that sound and sight broadcasting will in due course combine. I repeat that thought now. The fusion of sound broadcasting with television is destined to come in radio ultimately, just as the combination of sight and sound took place in motion pictures. Indeed, the time may come when an important broadcast program that we cannot see will seem as strange as a movie we cannot hear. This does not mean that such development is around the corner.

Programs limited to sound and prepared through the techniques of sound broadcasting alone will continue to serve millions of people through many hours of the broadcasting period

AN IMPORTANT MESSAGE

It is not our practice to print, in BROADCAST NEWS, the speeches of bigwigs—whether or not they be RCA officials. In fact, since BROADCAST NEWS was started, some seventeen years ago, we have printed speeches en toto on only two occasions.

We are well aware that our readers do not like speeches—and that ordinarily they will not read them. But, this speech is different—for it is more than a speech—it is an important message. And, although it was delivered before the NBC affiliates meeting, it is, in a larger sense, a message to the whole industry.

It is a message that comes from a man whose willingness to back his belief in the future has been responsible, in a large part, for the progress of television to date—and whose position is such that he is better situated than any other to know the exact status of television today.

It is a message which has an import no broadcaster can deny—and none should underestimate; a message which has the accurate and deadly timing of a delayed-action bomb.

Many of you have been reading BROADCAST NEWS for a long time, and through this medium, as well as through personal contact, have come to know us well. We feel, humbly but surely, that you have some faith in our judgment as to what is interesting and important in the business of broadcasting. Believe us, this address is.

—THE EDITOR.

when the eye cannot be concentrated on the television picture. We must expect that these services will continue to grow and to supplement each other. Therefore, during the years of transition, it seems to me, there will be ample opportunity for broadcasters operating AM and FM receivers to do a substantial volume of business and to render a vitally necessary public service.

LOCAL TELEVISION

I should like to say a few words about local television before entering into a discussion of national service. Television programming can be started by local stations in a small way with a minimum of facilities and expanded as receiving sets and com-

mercial sponsors increase. In the meantime, until nation-wide networks are available, films of live shows and newsreels can be flown to stations throughout the country to add to their program variety.

Like the many independent local broadcasting stations which are successful and profitable, television stations also can thrive upon local talent and community service. There is no end to local program possibilities, for the small town is a natural television stage. People like to see their friends and neighbors on the screen. I can foresee many uses for television in religious and educational activities. Television can be a great aid to good government in city, town and county by making citizens better acquainted with their local leaders and their work.

Local merchants will find television an effective means of advertising. Dramatic groups, county fairs and community sports events will enlarge their audiences. Often a local baseball or football game or a prizefight is as interesting to a community as a professional sports event in a distant city. Civic and fraternal organizations and women's clubs also are sources of programs for local television stations.

You can imagine the interest that would be shown in a local community if, for example, one or more department stores were the scene of a shopping hour in the morning or afternoon. The television camera would show the merchandise and the shopper at home could see what each store had to offer before she left home for her marketing. I should think that this would be an interesting experiment in advertising.

NETWORK TELEVISION

Automatic relay stations, either alone or in combination with the coaxial cable, show great promise for speeding extension of television program service throughout the nation. Radio relay stations are now in operation between a number of cities, and others are being erected. Eventually these microwave channels will reach out further to connect additional communities in television network service, especially cities not reached by coaxial cables.

Doubtless you have heard about the experiments being conducted from time to time with coaxial cables and radio relays which can carry not only television, but ordinary speech, telegraphy at high speeds, and of course FM and television programs. Because these new cables and relays can handle several services simultaneously, they will be completed, I believe, sooner than we expect. I should not be surprised, if it is possible to have a television coast-to-coast network within the next few years.

TELEVISION PROGRAMS

In considering home-television, we must recognize that good programs are the master key to public acceptance of the art. Television's popularity, as well as its speed of advance, will be governed by the caliber of the shows. That is the important responsibility of the broadcaster. The success of television and the popularity of the video station will depend upon it.

The telecaster will, of course, have the problem of talent. He cannot depend solely upon the radio, motion pictures, and other established sources of entertainment for his performers. Television is a new art form that calls for new techniques and for the development and encouragement of new talent to supplement present radio entertainers. Many well-known radio artists will adapt themselves to television as successfully as the artists of the silent screen adapted themselves to the talkies.

News and sports already have proved natural drawing features for television. Films also will play an important part in the flexibility of television programming. But timeliness is the great advantage which television has over all other forms of visual entertainment. Those who recently watched the American Legion Parade in New York, the Davis Cup tennis matches, and big league baseball games throughout this summer, can attest to this. News associations are studying methods of television news service to supplement the service they now perform for sound broadcasting. The presidential nominations and election in 1948, with political candidates competing for public attention, will stimulate public interest in television on a widening scale.

It is an interesting fact that broadcasting received its first real impetus in 1920, when the Harding-Cox election returns were broadcast and picked up by amateur stations. It was the presidential election that really put broadcasting in the news and stirred public interest. Then came the Dempsey-Carpentier fight in 1921, which gave tremendous impetus. And strangely enough, the same factors are asserting themselves in these early days of television.

RECENT TELEVISION DEMONSTRATIONS

Recently, there have been several extraordinary demonstrations, one this week, which you perhaps read about in the press: several surgical operations at the New York Hospital were televised by RCA, enabling those attending the American College of Surgeons Congress to view the operations on television screens in the Waldorf-Astoria. Television may prove to be the Medical Lecture Hall of the future. A prominent surgeon remarked, "This is a teaching medium that surpasses anything we have had in the past—I never imagined television could be so effective until I actually saw it!"

In still another field, the U. S. Navy recently announced success in underwater television experiments in which RCA equipment was used. This opens an entirely new field in deep-water investigations and novel television programs. Fishermen may use television to locate schools of fish and oyster beds. Explorers can scan marine life on the ocean floor as well as wrecks, by lowering television cameras into the sea. Submarines may yet be equipped with television eyes.

ULTRAFAX

You may have observed recent announcements of revolutionary progress in radio communications—only yesterday in Chicago I spoke before a meeting of the United States National Commission for UNESCO and reported that RCA within the next month will demonstrate in Washington, D. C., a new system of communications known as Ultrafax. It is a combination of television and facsimile. Ultrafax uses a television station for transmitting printed matter and messages, maps, books, documents, letters, drawings, balance sheets, etc. This new system can transmit and receive at the rate of one million words a minute. I used to think, in the days when I was a wireless operator, that if an operator could send 35 to 40 words a minute and keep it up for eight hours, it was quite an accomplishment.

Now by the Ultrafax system, a 500-page book can be sent from New York to San Francisco in half a minute, and a Sunday metropolitan newspaper, including the comics, in one minute. A single circuit could carry the equivalent of forty tons of air-mail, coast-to-coast, in a day. So we have something here that may dip into the mail bag. We may have a radio mail system!



Photos by Lydie Bloch of the ADVERTISER

Some of those attending the NBC "Convention" in the Claridge. Top: The Steinman Brothers—J. Hale and John F., of Lancaster, Pa., center their widely-popular Genl. Mgr. Clair McCollough. Former FCC Commissioner Charles Denny Jr., RCA's Pres. David Sarnoff with NAB's Pres. Judge Justin Miller. KDYL's Pres. Sid S. Fox with NBC's GM and Exec. V. P. Frank Mullen. 2nd row: NBC's I. E. Showerman; WRC's Genl. Mgr. Carleton D. Smülh and RCA Vice Pres. and Adv. Dir. Orrin Dunlap. NBC's Bill Brooks, KFI, Los Angeles' Genl. Mgr. Bill Ryan, Martin Campbell, Genl' Mgr. WFAA, Dallas, and Capt. Harry Butcher, KIST, Santa Barbara, Cal. NBC's Washington VP, Frank "Scoop" Russell and Mrs. and Mr. Rex Schepp, Genl. Mgr., WIRE, Indianapolis. WBEN, Buffalo's Bob Thompson and WSPD's Ed Flanagan. 3rd row: Col. Jack Harris, Genl. Mgr. KPRC, Houston, Texas, with KARK, Little Rock's Sales Mgr., Julian Haas. WNBC's Jim Gaines and WNBZ's Noran Kersta. Quintette: WLW, Cincinnati's Dwight Martin, WIRE's Rex Schepp, WLW's Genl. Mgr. Bob Dunville and Mr. and Mrs. James Shouse, WLW-WINS' Pres. Steinman Station's Bob Gulick. 4th row: NBC's Easton C. Wooley, WLW's Vice Pres. Eldon A. Park and NBC's VP Bill Hedges. Needham, Louis & Brorby's Melvin Brorby, Chicago, BMB's Prexy, Hugh Feltis, William Wyse, KWBW, Hutchinson, Kansas, and NBC's Bill Hedges. KTRI, Sioux City, Iowa's Dietrich Dirks. Young & Rubicam's Pres. Sigurd S. Larmon. WOW, Omaha's Pres. and NAB Board Member, John J. Gillin. Bottom row: WSM, Nashville's GM Harry Stone. KSD, St. Louis' GM George Burbach. Lorrin Thurston, KGU, Honolulu reminisces with Brig. Genl. Ken Dyke. NBC Spots' John S. DeRussy and his Chief James V. McConnell . . . and WBZ, Boston's Bill Swarley with WTIC's Sales Chief Walter Johnson.

All of this may give you an indication of the march of science and a picture of the important place which a television station in the future may occupy in the community.

INTERNATIONAL TELEVISION

Today, international television may seem far off. But let us recall that five years after sound broadcasting started as a nation-wide service, we had international broadcasting. While the technical problems of international television are more difficult to solve, nevertheless I believe we shall achieve international television in about the same period of time. The scientific knowl-

edge for doing the job exists. In fact, I know of no problem in international television that money cannot solve.

TELEVISION WILL CONTINUE FREE

Television will reach the home by radio as free to the audience as broadcasting is now. A proposed system of so-called wired "phone-vision" would introduce a monopoly feature into television by limiting its service to telephone subscribers only. Such a system, which would further limit its service only to those who would agree to pay for the programs as well as for the receivers, is an idle dream. The political implications, the legal

and regulatory aspects as well as the technical difficulties of preventing non-payers from receiving the same programs doom such an impractical system from the start. Moreover, the idea is not in keeping with the traditional American policy of "Freedom to Listen" and "Freedom to Look." These are the principles upon which our country's broadcasting is founded and under which it has developed and prospered.

RELATION OF MANUFACTURING TO BROADCASTING

I should like to digress a bit to make an observation regarding a statement I have heard from time to time which implied that it is sinful for a company to be interested in both broadcasting and manufacturing. The truth is that manufacturing interests have been largely responsible for the development of television and have provided broadcasters with new opportunities for service. If it were not for research, engineering and manufacturing, there would be no broadcasting, either sound or sight.

Therefore, I feel that while a broadcaster should not be criticized for confining his activities to broadcasting or a manufacturer for confining his operations to manufacturing, nevertheless, where both are conducted by the same organization, the art and industry are advanced rather than retarded. Years of experience have amply demonstrated this to be a fact.

The 25-year period of experimentation and development of television has been full of difficulties. It has been an extremely complex new science and art to establish in the laboratory, the factory and on the air. The scientists, research men and engineers have done heroic work, for which all of us will ever be indebted.

TELEVISION AS A NEW INDUSTRY

Television is moving forward rapidly and is destined to become one of the major industries of the United States. In addition to serving the home, television has application to the theatre, the motion picture studio and the entertainment film. In the manifold processes of industrial life, television also is destined to play an important role.

The possible size of the television industry is indicated by the following figures: in the first two years of sound broadcasting, that is, 1921 and 1922, the sales of receiving sets amounted to approximately \$100,000,000. In those two years, more than 500 broadcasting stations were on the air.

Now, for the first two full years of postwar television operation, namely, 1947 and 1948, with approximately only ten percent as many stations on the air, that is 50 instead of 500, it is estimated that the public, during this two year period of television, will spend approximately \$375,000,000 for receiving sets—\$375,000,000 in television, as compared to \$100,000,000 in sound broadcasting. This does not take into account the additional expenditures on television transmitters, the cost of erecting and operating them and the cost of programs. Therefore, in round figures, within a year and a half or so from the present time, we shall approach a \$500,000,000-a-year industry in television. And that will be only the beginning. As time goes on, I am confident the industry will grow substantially.

TELEVISION AS AN ADVERTISING MEDIUM

Television will be supported by advertising, both local and national, for it is an ideal advertising medium, unsurpassed in its simultaneous appeal to the eyes and ears of many millions of

people. Studies indicate that the pulling power of advertising on television is many times that obtainable by sound broadcasting alone.

Television is setting a much faster pace as an advertising medium than broadcasting did in its pioneering days of the early 20's. It is apparent that sound broadcasting soon will face keen competition from television. As television expands on a national scale, this competition is certain to increase.

SAFEGUARDING THE BROADCASTER'S FUTURE

It seems to me that broadcasters should not consider television solely from the standpoint of profits or losses during the pioneering period. We must look to the opportunities ahead and weigh the obligation which all of us share to render maximum service to the public.

There are other important economic considerations, which must not be overlooked. As the television audience increases and programs improve—and both results are sure to be achieved—many listeners are bound to switch from sound broadcast to television programs. I do not mean that they will switch permanently from sound broadcasting to television, but they will be switching back and forth between these two services. They cannot enjoy both at the same time unless sight and sound are combined in all programs. As the switching goes on, it will reduce the audience of sound broadcasting stations and increase the audience of television broadcasting stations. Those who are not in television will find their sound broadcasting revenue, which is based on circulation, diminished. That fact is self-evident.

To maintain their present position in their local communities, to render the greatest possible service and to safeguard the capital investments and earning capacities of established sound broadcasting stations, prudent owners will consider television as an added new service, vitally necessary to insure their existing business against reduction of audience, loss of profits and depreciation of investments.

A MESSAGE TO BROADCASTERS

Affiliates of the NBC: This is the message I should like to bring to you. I do not want to ask you to buy television stations, or to erect them, or to urge you to enter television beyond your own convictions, or to promise you immediate profits. But I feel that I should be less than frank if I did not on this occasion, particularly when you are all assembled, share with you the thoughts I hold, not only about the future possibilities of television—and my enthusiasm is unlimited as to that—but also about the possible effects that television may have upon the present broadcasting business.

I have lived through several periods of development in the fields of communications and entertainment. I remember the day when wireless as a service of transoceanic communication was regarded by some as a joke. In the days when I worked as a wireless operator, a cable company could have acquired the Marconi Wireless Telegraph Company of America for only a few million dollars. Those who owned the cables could not see wireless as a competitor of cables. Who, they asked, would send messages that were not secret through the air? Who would entrust important messages to a service that was filled with static?

Today, the law says to the Western Union: "You must divest yourself of the cables." But now it is difficult to find a buyer

for cables. Today, radio is the modern method of international communications, and can reach every country directly.

I lived through the day when the Victor Talking Machine Company—and those who founded it did a great job in their day—could not understand how people would sit at home and listen to music that someone else decided they should hear. And so they felt that the “radio music box” and radio broadcasting were a toy and would be a passing fancy. What was the result? Not many years after their fatal dream, RCA acquired the Victor Talking Machine Company, and the little dog changed its master.

I saw the same thing happen in the field of talking motion pictures. It was argued by many that people would not go to a movie that made a lot of noise and bellowed through an amplifier and disturbed the slumber of those who enjoyed the silent movie. That, they said, was a preposterous idea! The very virtue of the silent movie, they contended, was its silence! And then—in 1927—came Warner Brothers with “The Jazz Singer” and Al Jolson. Almost overnight a new industry was born. The silent actor became vocal, and the silent picture was given an electronic tongue. Today, who goes to a silent movie?

Now, I should like to impress upon those of you engaged in radio, that for the first time in its history, radio itself has a stake in the present. It must be careful not to act like the cable company, the phonograph company and the silent motion picture company, which looked upon the new children of science as ghosts of obsolescence that might adversely affect their established businesses. In their desire to perpetuate and to protect

their existing businesses, some of them stubbornly resisted change and progress. Finally, they suffered the penalty of extinction, or were acquired by the progressive newcomers.

Let me assure you, my friends, after more than forty years of experience in this field of communications and entertainment, I have never seen any protection in merely standing still. There is no protection except through progress. Nor have I seen these new scientific developments affect older businesses, except favorably, where those who were progressive, gave careful thought and study to the possibilities of new inventions and developments for use in their own business.

Despite the fact that the Victor Talking Machine Company passed into radio hands, more phonograph records are made and sold today than ever before. And so it is with the entertainment industry. Talking pictures saved that industry at a time when it needed saving and has kept it prosperous ever since. Television in the theatre may be as much of a stimulant to an industry which at the moment, at least, needs a new stimulant, as sound was to the silent movie.

Therefore, may I leave you with this final thought: I am not here to urge you to enter the field of television beyond the point where you yourselves think it is good business for you to do so; nor to propose that you plunge all at one time. Rather I would suggest that you reflect carefully and thoughtfully upon the possible ultimate effects of television upon your established business if you do nothing, and of the great opportunities for your present and future business if you do the right thing!

W. W. Watts, left, Vice President in Charge of the RCA Engineering Products Department, and E. M. Stoer, Vice President of Hearst Radio, Inc., which owns and operates station WBAL-TV, discussing television plans for the Baltimore station, which recently received an RCA 5-kilowatt television transmitter, Type TT-5A. In the background at the RCA display at the convention is WBAL-TV's Mobile Television Unit.





Prominent feature of the RCA booth was this line of transmitters. Left to right, the BTA-5F 5 KW AM Transmitter, the BTF-10B 10 KW FM Transmitter, and the TT-5A 5 KW TV Transmitter.



Biggest single item on the exhibit floor was this television mobile unit. Just out of the factory and completely equipped it was all ready for delivery to WBAL, Baltimore.



Newest equipment exhibited was this setup of studio-type video units. Under the canopy are new video control and program consoles. In foreground is the new studio camera.

RCA exhibit, as usual, was the center of attraction. Plenty of space and plenty of chairs made it a convenient place to pass a few spare minutes between meetings.



RCA at the NAB Exhibit

The equipment exhibit at this year's NAB Convention was outstanding, not only for size, but also for the number of new items displayed. Approximately 25,000 square feet on the main floor of the Convention Hall was reserved for exhibits. This space was in the front of the hall and so arranged that NAB members walked down a wide aisle between exhibits in going to and coming from the main meeting area at the far end of the hall.

Manufacturers were quick to take advantage of this unusually favorable opportunity to display their equipment. Represented by large booths were all of the eight manufacturers of heavy transmitting equipment, as well as several dozen smaller manufacturers, transcription companies, publications and others. The overall display of equipment was easily the largest and most comprehensive layout of AM, FM, and TV broadcasting equipment ever brought together in one place.

RCA had the largest space, the most equipment, and by far the best attendance in its booth. This "booth" consisted of a space which extended 60 feet along the main aisle and was 52 feet deep. Within

this area was assembled some 68,000 pounds of equipment—including a representative display of RCA's complete line of equipment for all types of broadcasting.

Across the back of the RCA booth were three transmitters; a 5 KW AM transmitter, a 10 KW FM transmitter, and a 5 KW television transmitter (illustration at top of opposite page). Flanking the transmitters was a new completely-equipped television mobile unit ready for delivery to WBAL (center picture, opposite page). At the front of the booth was a setup of new video units, including a brand new control desk, a program director's desk, auxiliary rack equipment, film equipment, and the new studio camera which was displayed for the first time (lower picture, opposite page). Also at the front of the booth were various audio units, test equipment, and the 72-foot Pylon-Turnstile Antenna which literally topped everything in the show.

As usual plenty of space and plenty of chairs were available so that our many friends among the broadcasters could sit and chat a bit with us.



(Above) This closeup view shows the video control and program director's consoles in actual operation, as they were during hours the exhibits were open. Seated at the controls, from left to right, are John Roe, L. E. Anderson, W. J. Poch and George Jacobs of the RCA Television Terminal Equipment Engineering Section.

(Below) This view shows the two consoles to better advantage. The video console, on the left, is made up of standard camera control units. Ordinarily there is one for each of the studio and film cameras plus one which is used as a master monitor. Additional units are easily added whenever it is desired to expand facilities. The program console, on the right, contains three video monitors, one for program, one for preview and one for cue. Pictures are observed on mirrors viewed through the long horizontal opening in the sloping panel.



(Right) View looking into the RCA booth from the balcony of the Convention Hall. The combined FM-TV antenna in the foreground consists of a 2-section Pylon for FM and a 6-bay Superturnstile for TV. This antenna was built for WBAL to whom it was shipped immediately following the convention.



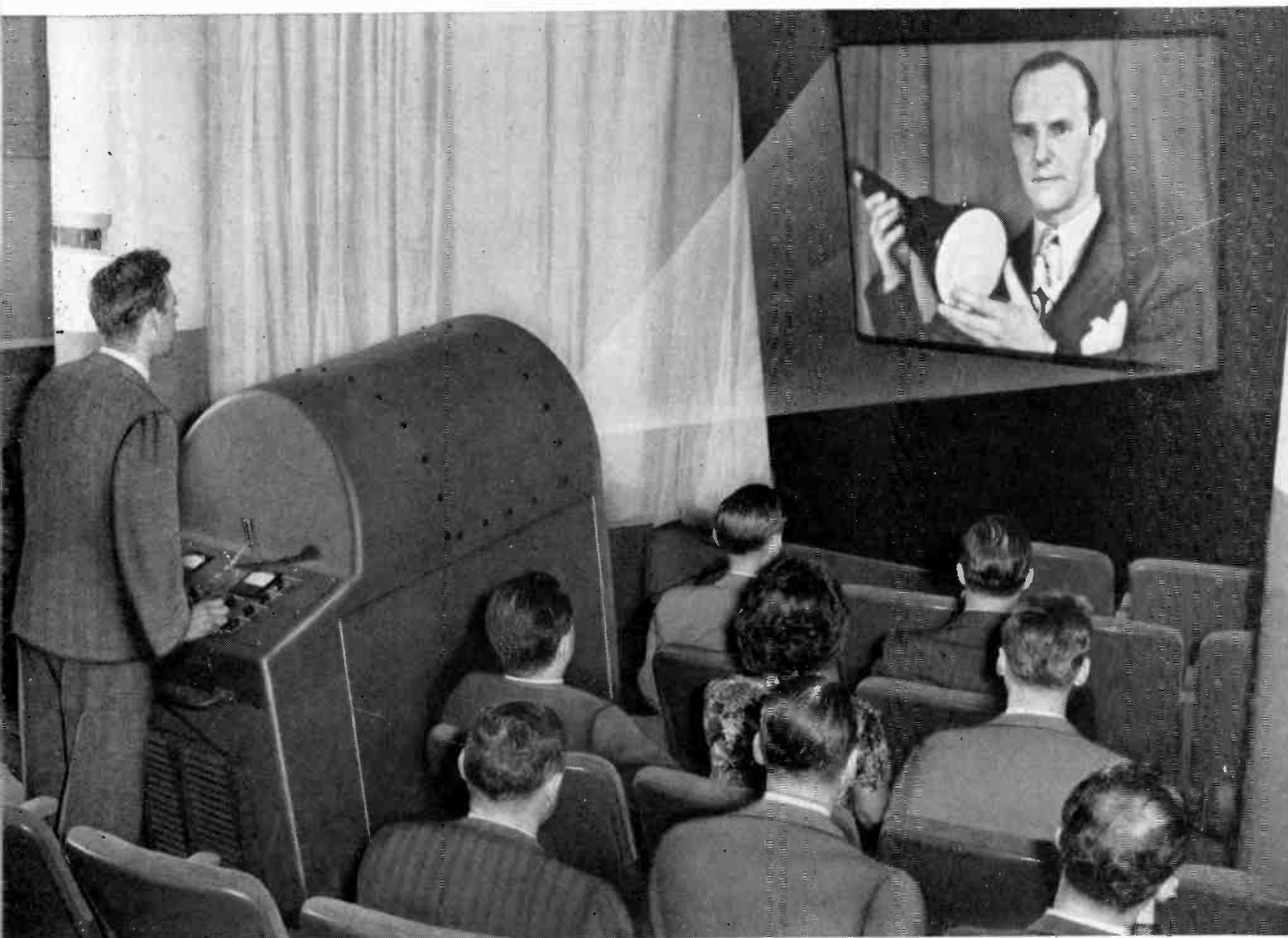

(Left) Large-Screen projector used to provide 6 feet by 8 feet television pictures for NAB Convention. Programs shown were relayed from Philadelphia and New York by relay system illustrated on opposite page.

LARGE-SCREEN TELE AT NAB

DAILY TELEVISION PROGRAMS BROUGHT TO CONVENTION BY SIX-HOP RELAY SYSTEM USING STANDARD RCA MICROWAVE EQUIPMENT

During the five days of the recent NAB Convention members of the NAB and their guests were able to enjoy daily television programs on a 6-foot by 8-foot screen located on the mezzanine floor of the Ambassador Hotel. Programs were supplied by ABC and NBC by microwave relay from Philadelphia and New York. The 200-mile (route miles) transmission of video programs was accomplished by means of a six-hop microwave relay system, the most ambitious attempted up to this time. The demonstration, designed to show the feasibility of inter-city television programming with standard equipment, was a joint endeavor of ABC, NBC, WFIL-TV, WPTZ, and the RCA Victor Division of RCA.

The equipment used to produce the 6-foot by 8-foot pictures at the Ambassador was RCA's standard large-screen projector (Figure 1) of the type being delivered to three large motion picture companies as a part of joint development work in this field (BROADCAST NEWS, No. 46, Page 21). The pictures produced by this equipment were of such clarity and brightness that they brought comments of amazement from most broadcasters seeing them for the first time. Typical reaction was that of Milton Sleeper, editor and publisher of FM AND TELEVISION magazine,

who says in the November issue of his magazine, "RCA's theater television on a screen 6 by 8 feet, demonstrated at the NAB Conference, was really startling, both as to the fine quality of the images and the possibilities opened up by this development."

Programs for the large-screen demonstration were supplied by ABC and NBC. First showing was to the special meeting of the NBC affiliates on Saturday afternoon (September 13). On Sunday a similar showing was arranged for ABC affiliates, and from then on the system was operated for several hours each afternoon and evening with invitations being issued to all NAB members and guests as well as all those attending the International Telecommunications Conference then in session.

In order to bring the best available television programs to Atlantic City a very ambitious relay hookup was arranged (Figure 2). New York programs from WNBT were relayed through Philco's relay station at Mt. Rose, N. J. to the WPTZ (Philco) transmitter site at Wyndmoor, Pa. The system to this point was the same as that regularly used by WPTZ in bringing NBC television programs to the Philadelphia area.

From Wyndmoor the video signals were fed by RCA micro-

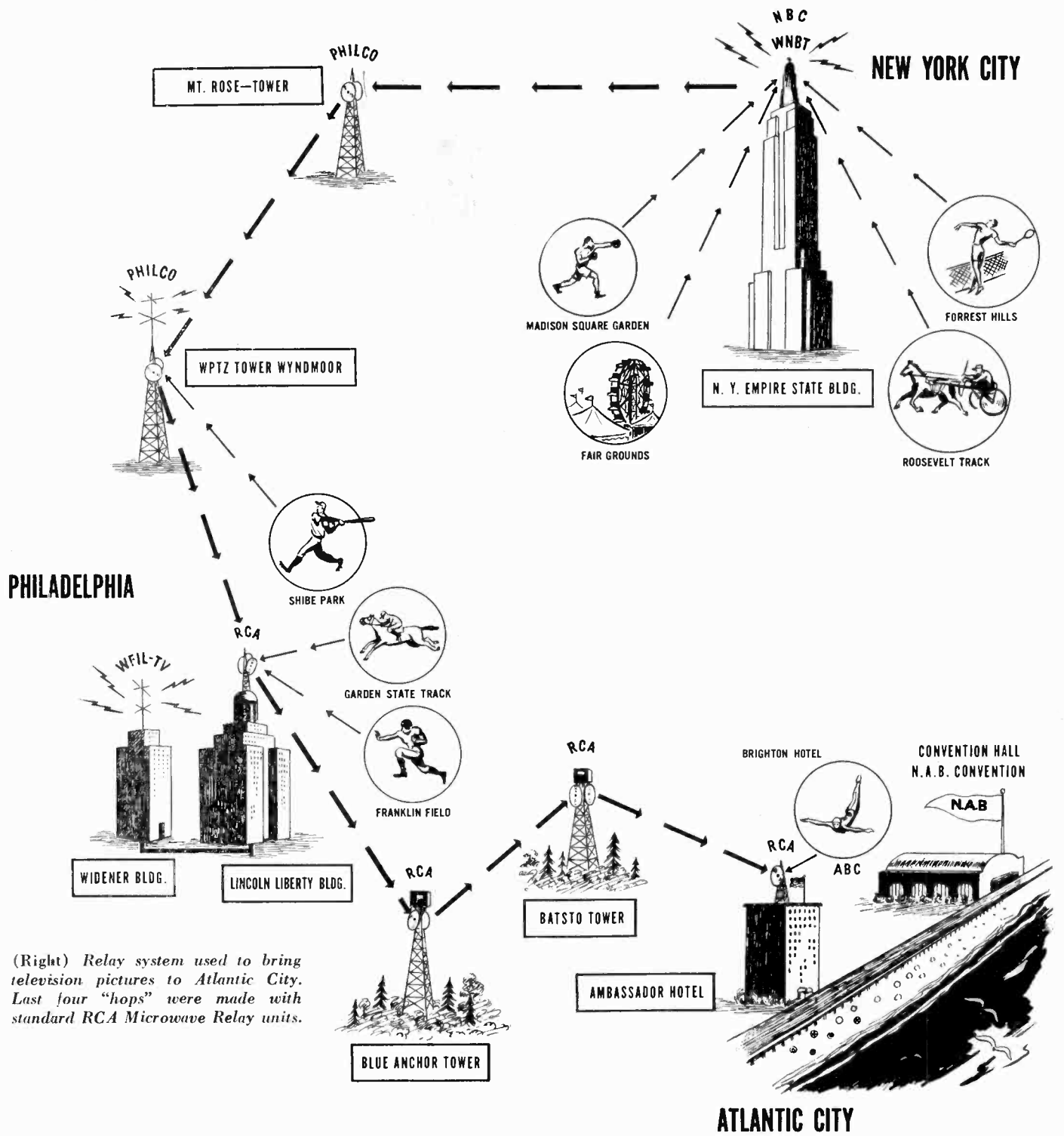

(Right) Relay system used to bring television pictures to Atlantic City. Last four "hops" were made with standard RCA Microwave Relay units.

wave link to the Lincoln-Liberty Building in downtown Philadelphia and from this reception point to the studio of WFIL-TV in the Widener Building, next door. The control room of WFIL-TV was used as an intermediate switching point so that programs originating in Philadelphia could be fed in here. From the output of the WFIL-TV switching system video signals were fed back to the top of the Lincoln-Liberty Building and from there, by a three-hop relay, to the roof of the Ambassador Hotel in Atlantic City. Intermediate points on this leg were fire towers at Blue Anchor and Batso, N. J. The equipment on this leg, as well as on that between the WPTZ transmitter and the Lincoln-Liberty Building, was made up entirely of standard RCA microwave units, i.e., Type TTR-1 Transmitters and TRR-1 Receivers (described in BROADCAST NEWS, No. 44, Page 20). This furnished a striking demonstration of the ability of this equipment to provide high quality picture signals through at least four hops. The overall circuit (New York to Atlantic City) involved six hops and during a considerable part of the time there was a

seventh hop (i.e., when NBC in New York was using a similar relay to bring programs to Radio City from Forest Hills, etc.).

The performance of this seemingly complicated system was excellent in every respect and in some ways exceeded expectations. NBC programs from New York included national tennis championship matches from Forest Hills; pro-football from Yankee Stadium; and special studio programs. WFIL-TV programs included football from Franklin Field and horse racing from Garden State Park. WPTZ programs included regular studio programs and baseball pickups from Shibe Park.

The equipment operated continuously with only very minor difficulties. Quality of pictures, as noted above, was good enough to surprise most viewers. When it is considered that this was a temporary installation, arranged almost on the spur of the moment, it becomes obvious that even more elaborate television networks are a near-future certainty.



Ted Smith, general sales manager of Engineering Products Department, welcomes visiting engineers to Camden.

TELEVISION ENGINEERING CLINIC REPEATED

by **E. B. MAY**
RCA Victor Division

Broadcast engineers from leading radio networks and independent stations participated in the second RCA television engineering clinic, which was held during the last week of September.

This second clinic was planned at the request of stations and networks represented at the first clinic who sought a repeat performance for the benefit of their staff engineers who had not attended the first clinic, and for additional stations which had indicated their interest in taking part in such a course.

The week-long television course, which was identical to the first program conducted last May by the RCA Engineering Products Department, included a comprehensive and practical training program which prepared the participants to face the problems which will confront them when their own stations install and operate television equipment.

To acquaint the visiting broadcasters with typical problems of installation and maintenance, RCA appointed as instructors their top television engineers—the men who have designed and worked with the equipment and who are thoroughly familiar with every phase of its operation. The technical sessions included discussions of all aspects of television, ranging from fundamental theory, to design of television studios, studio air-conditioning, and erection of the super-turnstile television antenna.

Members of the visiting group had an opportunity to gain practical experience in the operation of the newly-announced image orthicon studio television camera, performing such opera-

tions as alignment, focusing, and adjusting. RCA's 7000-mega cycle microwave television link equipment was also demonstrated by actual transmission and the technicians were able to check operational characteristics as they would in the field by the use of standard test equipment.

Other equipment operated by the broadcasters included the 16mm and 35mm television motion picture projectors and the new television switching unit for fading and lap-dissolving of video pictures fed to it from studio cameras, film cameras, or remote pickup points. They also received detailed instruction in the operation of the synchronizing generator, the monoscope camera, and the studio master monitor.

Host for the television clinic was Merrill A. Trainer, Manager of RCA Television Equipment Sales, who arranged several tours for the broadcasters, including trips through the RCA Victor plant in Camden and the RCA Laboratories in Princeton, N. J. In the Camden plant, the engineers toured the television receiver production line where a stream of receivers is produced, tested, and shipped every day. In another section of the Camden plant, they saw 5-kilowatt television transmitters (Type TT-5A) and other standard broadcast and FM transmitters in production.

In Princeton the visitors were welcomed by Dr. C. B. Jolliffe, Executive Vice President of the RCA Laboratories Division. Dr. P. T. Smith, who developed the 8D21 high-frequency power tube, used in the 5-kilowatt television transmitter, discussed the



The week-long television course given visiting engineers alternated "blackboard" lectures with actual demonstrations of operating equipment. Instructors were top RCA television engineers. Demonstrations allowed visitors to get the "feel" of the equipment they will soon be operating in their own stations. In the view above, W. A. Poch, supervisor of RCA's television terminal equipment section, is explaining method of bridging across a video program line.

Broadcasters hear a talk on the television switching unit and television master monitor operation from Norman Bean of RCA. Mr. Bean is shown pointing to one of the controls on the monitor. From left to right the group includes: Carl H. Menzer, WSUI-KSUI; Howard Lutgens, NBC, Chicago; K. A. West, Fort Monmouth, N. J.; R. H. Hammett, Hearst Radio; L. E. Anderson, RCA; A. E. Towne, KSFO.

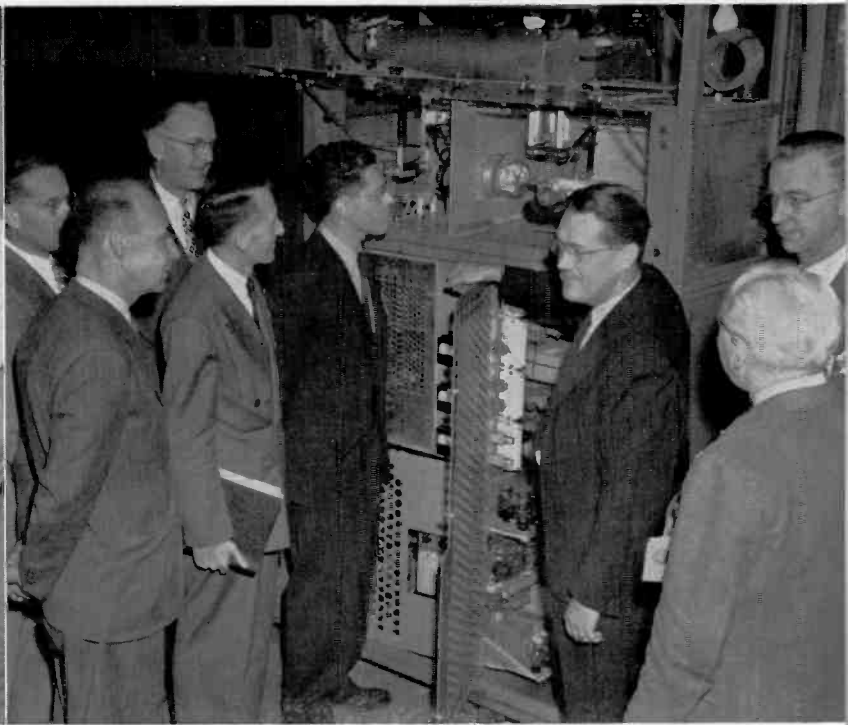

The hooked wave guide, parabolic reflector and control unit of an RCA Microwave relay transmitter are examined closely by the visiting engineers. From left to right they are: E. W. Lewis, WTVJ; H. E. Inslerman, Fort Monmouth, N. J.; C. Rosencrans, RCA Engineer,—behind him is F. V. Bremer, WAAT; R. Craig, WCAU; S. H. Barbour, RCA Engineer.

Broadcasters get an inside view of the TT-5A Television Transmitter. C. D. Kentner, RCA, directs the engineers' attention to the 8D21 dual tetrode transmitting tube. The men are, left to right: H. Lutgens, NBC, Chicago; A. C. Anderson, KTAR; A. H. Saxton, NBC, Hollywood; A. E. Towne, KSFO; L. L. Lewis, WOI; J. Leitch, WCAU; and F. V. Bremer, WAAT.



H. E. Gihring, supervisor of RCA's television Transmitter section, uses models to explain layout of television stations. Looking on, from left to right, are: Gilbert Rix; A. F. Rekart, KXOK; M. A. Trainer, Manager of RCA Television Equipment Sales, who was host to the broadcasters; A. E. Towne, KSFO; Harold Nebe, WSMB; F. V. Bremer, WAAT; and W. J. Poch, of RCA.



Operation of the new RCA studio image orthicon television camera is discussed by Norman Bean of RCA. Looking on with interest, left to right, are: J. Kyle, WMBG; H. M. Potter, RCA; A. F. Rekart, KXOK; R. E. Bailey, RCA; A. C. Anderson, KTAR; L. L. Lewis, WOI; A. H. Saxton, NBC, Hollywood; W. F. Coleman, WTIC; and F. J. Kelley, RCA.



Multiplexer, which permits use of two film projectors with a single film camera, is demonstrated by R. J. Smith, RCA engineer. Facing the camera at left are: L. E. Anderson, RCA; F. Catanzaro, RCA; C. H. Menzer, WSUI-KSUI; M. A. Trainer, Manager, RCA Television Equipment Sales; and at right is E. Frost, RCA. In foreground, with backs to camera are, left to right: A. E. Towne, KSFO; and E. Hill, RCA.



John H. Roe, of the RCA Television Terminal Equipment Section, shows the broadcasters a method of lining up the resonant cavity on the RCA Microwave Relay transmitter. With backs to camera at left are: E. W. Lewis, WTVJ; F. V. Bremer, WAAT; W. F. Coleman, WTIC. Looking on at right are: P. Stevens, WBEN; I. B. Robinson, The Yankee Network, Boston; and J. Nickels, RCA.

operation of the duotrode tube. Dr. R. R. Law outlined the 500 to 1000 megacycle band. Dr. H. F. Olson, famous for his research in acoustics and the development of the RCA Duo-Cone Speaker, demonstrated a wide-range sound reproduction system and a new electronic pickup for use with transcriptions. Dr. Albert Rose, co-inventor of the image orthicon television pickup tube, completed the Princeton sessions with a discussion of the history and development of this super-sensitive tube, now used by the entire television industry.

The list of broadcasters who attended the course included: James Kyle, WMBG, Richmond; Earl W. Lewis, WTVJ, Miami; K. A. West, Ft. Monmouth, N. J.; Hans E. Inslerman, Ft. Monmouth, N. J.; A. H. Saxton, NBC, Hollywood; Howard Luttgens, NBC, Chicago; S. E. Leonard, WTAM, Cleveland; A. C. Anderson, KTAR, Phoenix; Gilbert Rix, WWJ, Detroit; W. F. Coleman, WTIC, Hartford; A. E. Towne, KSFO, San Francisco; Frank V. Bremer, WAAT, Newark; Richard K. Blackburn, WTHH, Hartford; I. B. Robinson, The Yankee Network, Boston; Leo M. Feller, Signal Corps, Belmar, N. J.; George Lewis, WCAU, Philadelphia; R. Craig, WCAU, Philadelphia; Louis L. Lewis, WOI, Ames, Iowa; C. Richard Evans, KSL, Utah; Philo Stevens,

WBEN, Buffalo; Carl H. Menzer, WSUI-KSUI, Iowa City; A. F. Rekart, KXOK, St. Louis; Harold Nebe, WSMB, New Orleans; Jack Leitch, WCAU, Philadelphia; C. Robinson, WCAU, Philadelphia; David Martin, WMAR, Baltimore.

The course of instruction for the week was as follows:

Monday

General TV Theory
Complete RCA TV Studio System
TV Field Equipment

TV Relay Equipment
The Mobile TV Unit

Tuesday

TV Film Camera Chain
Tour of TV Receiver Production Line

TV Film Projectors
TV Studio Camera Chains and Equipment

Wednesday

TV Studio Camera Demonstration
TV Transmitter Equipment

R-F Circuits
Video Circuits

Thursday

Super Turnstile Antennas
Demonstration of TV Transmitter

Installation of Antennas
Tour of TV Production Area

Friday

TV System Detail Discussion
Period
Visit to RCA Laboratories.

TV Test and Measuring
Equipment



E. J. Meehan, of RCA Television Equipment Sales, discusses the operation of the television monitoring control console, which is used with the TT-5A Transmitter shown in background. The broadcasters are, from left to right: S. E. Leonard, WTAM; C. Robinson, WCAU; E. W. Lewis, WTVJ; James Kyle, WMBG; G. Rix, WWJ; C. W. Turner, RCA; I. B. Robinson, The Yankee Network, Boston; and W. F. Coleman, WTIC.



An RCA high frequency superturnstile television antenna. C. W. Armstrong, RCA engineer, is shown pointing to a broadband radiator of one of the antenna sections. Broadcasters looking on, from left to right, are: R. Craig, WCAU; Gilbert Rix, WWJ; S. E. Leonard, WTAM; F. J. Kelley, RCA; E. W. Lewis, WTVJ; J. Kyle, WMBG; W. F. Coleman, WTIC; and I. B. Robinson, The Yankee Network.



R. M. Harris, Production Superintendent of Receiver Department Group, also toured the television receiver production line with the group. In view above the visitors inspect a combination FM-AM phonograph and direct viewing television console (before insertion of the kinescope tube). This group includes: F. V. Bremer, WAAT; R. Craig, WCAU; H. E. Inslerman, Ft. Monmouth; C. H. Menzer, WSUI-KSUI; A. E. Towne, KSFO; E. J. Meehan, RCA; and Rex Rand, RCA.



At one of the test stations along the RCA Victor television receiver production line, visiting broadcasters watch a technician tuning one of the amplifier stages. From left to right they are: E. W. Lewis, WTVJ; W. F. Coleman, WTIC; George Lewis, WCAU; A. C. Anderson, KTAR; A. H. Saxton, NBC, Hollywood; H. Luttgens, NBC, Chicago; James Kyle, WMBG; H. Walter, RCA; and E. J. Meehan, RCA.



On the final afternoon of the week-long television clinic the visiting engineers toured the RCA Laboratories at Princeton. This view shows Dr. C. B. Jolliffe, Executive Vice President of the RCA Laboratories Division, outlining the organization and operation of the Laboratories to the visiting engineers.



C. N. Hoyle demonstrating the simultaneous equation solver in one of the laboratories at Princeton. This device solves up to 10 linear simultaneous equations with 10 unknowns by electronic means. It is particularly useful for carrying on analysis and synthesis of networks containing up to ten meshes.

WWL, New Orleans, celebrates 25th

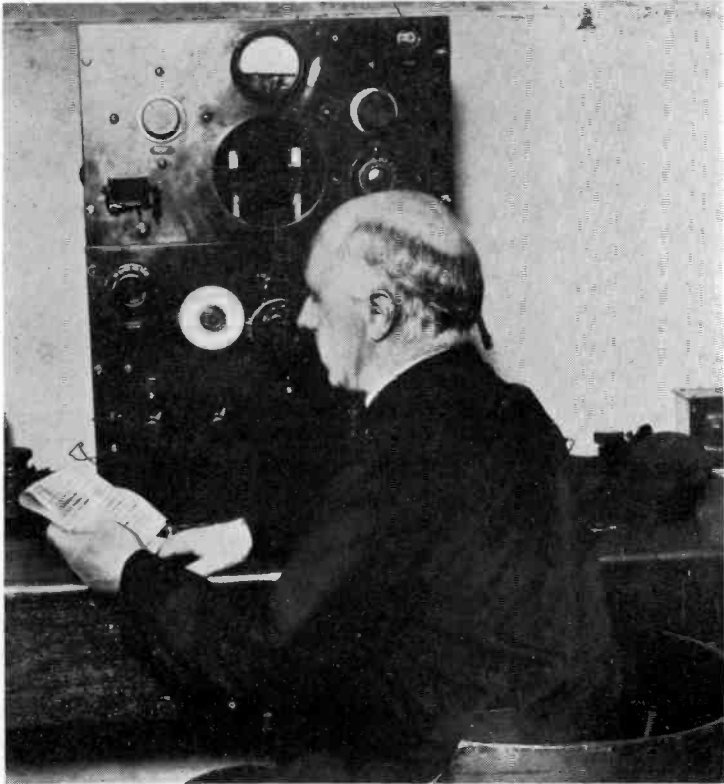

1922 The first broadcast in the deep South was made on WWL by Father S. J. Commings, the President of Loyola University, on March 31, 1922, using this 10-watt transmitter, which was salvaged from a surplus warship.

1928 The 5000-watt composite transmitter shown below was built by station engineers in 1928. It made WWL one of the high-power stations of that day.

Radio Station WWL, New Orleans, which celebrated its 25th anniversary during the week beginning September 21, was originally built of odds and ends from a surplus war ship after the first World War. With only 10 watts in power, the first WWL station started as a classroom physics project at the Loyola University of the South after the university had completed a training program for ship and land wireless operators for the Armed Forces in the first war. Today WWL is a 50,000-watt, clear channel station and has all facilities, technical equipment and its own talent for production of its own radio shows for nationwide listening audiences.

The station's first broadcast, on Friday, March 31, 1922, appealed for funds for Loyola University's building program. The station is still operated as a department of the university.

WWL's progress over the years has been steady, and today it is regarded as a community asset providing entertainment, news and cultural services for the great part of the Mississippi Valley. The station was granted 5,000 watts in 1928; 10,000 watts in 1931; joined the Columbia network in 1935; and received the maximum power of 50,000 watts in 1938.

Today WWL occupies the major portion of the second floor of the Roosevelt Hotel in downtown New Orleans and has just completed two additional studios for its Silver Anniversary celebration. These studios combine the latest RCA engineering developments in broadcasting with smart decor.

1932 This 10,000-watt RCA transmitter (below) was installed in 1932. It was WWL's first commercial transmitter. WWL has been an "RCA-equip" station ever since.

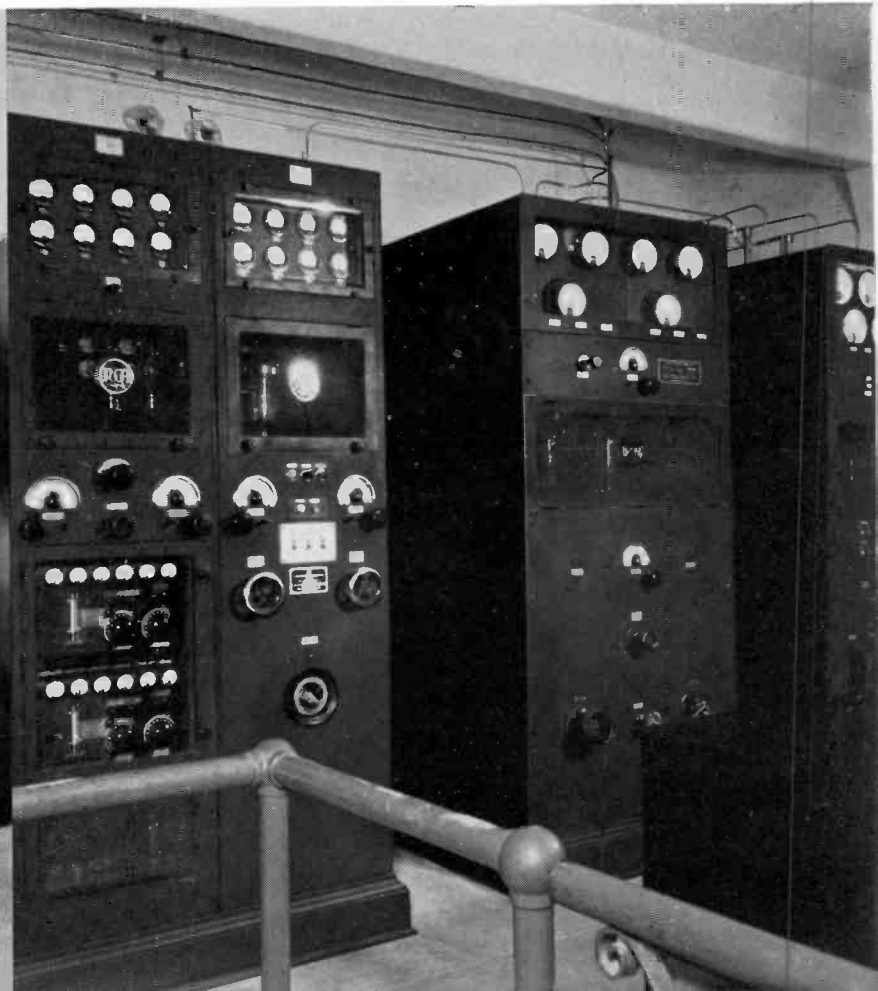
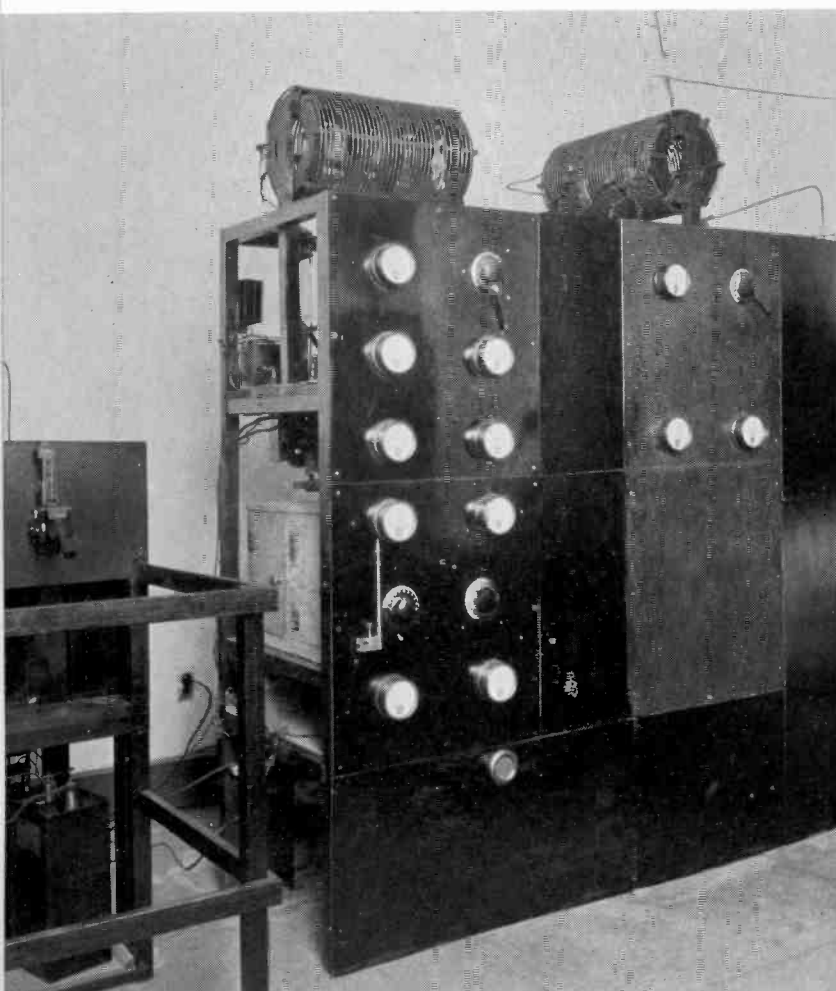

ANNIVERSARY

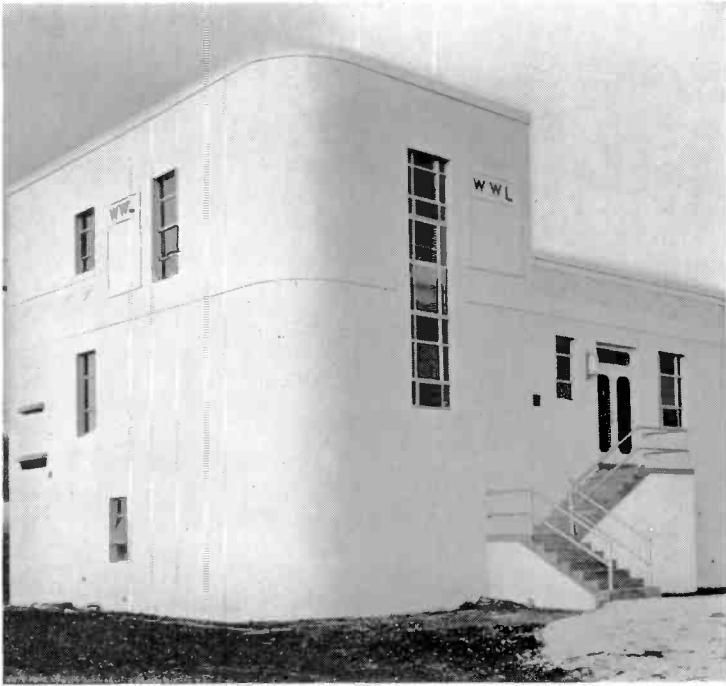

BUILDING which houses WWL's present transmitter (shown below) is a beautiful modern structure located on the shore of Lake Ponchartrain, about eight miles north of downtown New Orleans.

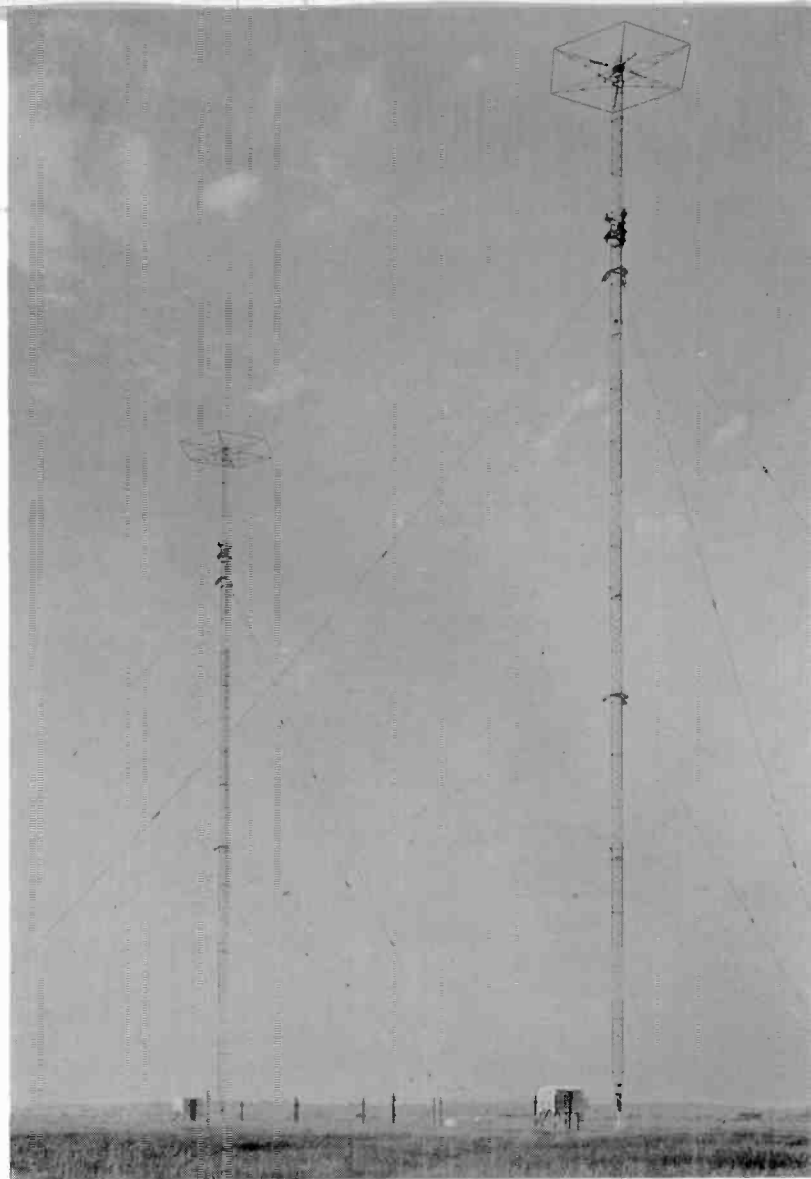

TOWERS of WWL have striking appearance. Sectionalized, and provided with "top hats", they make up a directive system with maximum radiation in northward direction (thereby saving power which would otherwise be wasted in the Gulf).

1938 WWL's fifty kilowatt RCA transmitter (shown below) was installed in a new building (see above) at a new site in 1938. It is one of the country's finest installations.



WWL'S ANNIVERSARY



Left: A corner of the control room in the new WWL studios. The control console (additional pictures on opposite page), was designed and built by the station staff, using standard RCA plug-in type amplifiers.

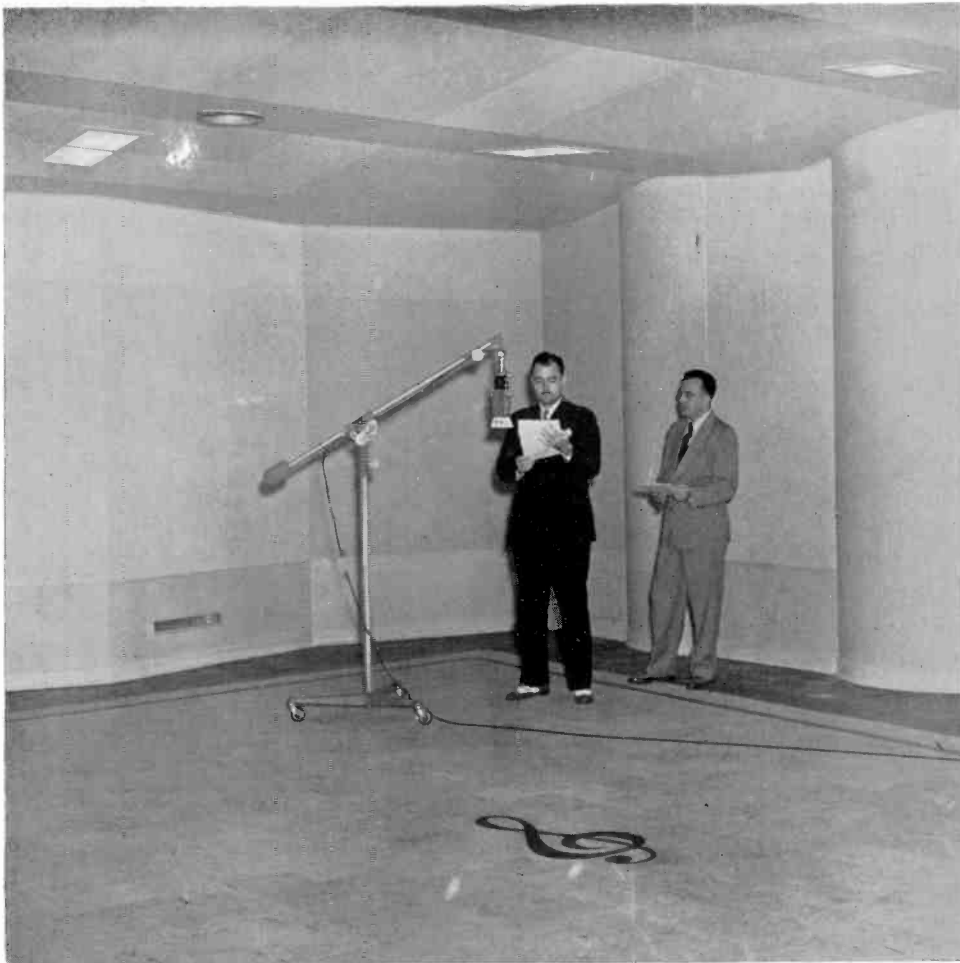

Above: The new Silver Anniversary studios of WWL combine the latest engineering developments in broadcasting with smart decor—including panelling in pink and two shades of yellow, insulation, and cantilever roof which permits the effect of a much higher ceiling.



Above, right: J. D. Bloom, Jr., Chief Engineer and designer of WWL's studios, is shown above with transmitter tubes of 1922 and 1947, which presents in vivid contrast the growth of WWL from 10 to 50,000 watts in 25 years. "J.D." is the ranking employee at WWL.

SILVER STUDIOS

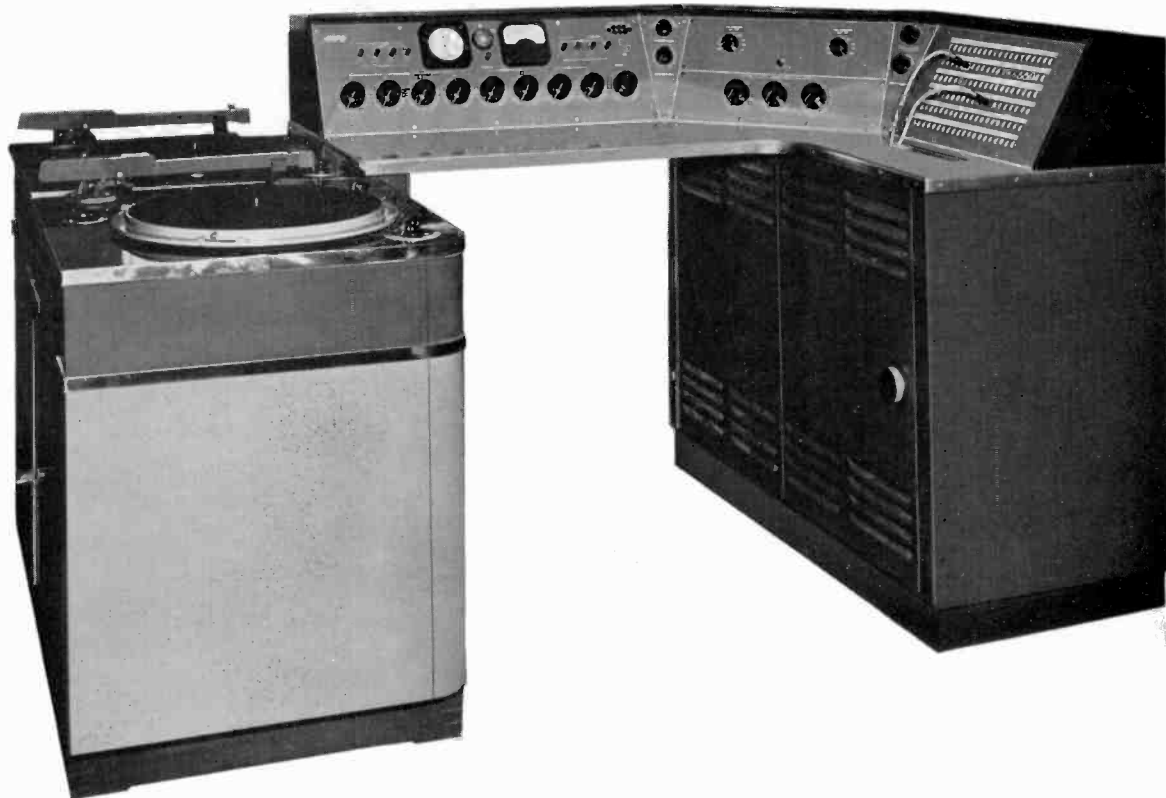

Above: This illustration shows the WWL master control console with two turntables as it is setup in the new studios. The main control board has mixers for four microphones, two turntables, two lines and a master. The meter to the left is a Thompson timer and the one to the right is a VU meter with talkback mike in between. The group of indicating lights in the right-hand corner show the termination in master control. When the lever keys are pressed down, the mixer is connected to the program circuit; when they are pressed up, they are connected to a sep-

arate check circuit, including BA4A and speaker. In the first gusset is a VU meter attenuator with the volume control for a reverberation chamber below it. In the off-set panel, which is a standard 19-inch panel, is mounted an RCA sound effects filter, with a three-channel mixer below it. In master control, these panels will be changed to the master control switching panel. The second gusset is a monitor bus selector switch and the monitor volume control is below it. The last panel to the right is, of course, a jack field.



Above: This view shows the interior of the equipment cabinet. The bottom shelf to the left takes one BA3A and one BA4A. The top shelf takes either one BA3A and one BA4A, or two BA4A's as required. The BA1A's are mounted horizontally as shown. Above these are an hour counter, the meter for reading tube current, the volume control for the studio head phones, the volume control for the check speaker, the volume control for the studio speaker and the volume control for the speaker in the announcer's booth. Below the meters are seen the Clare plug-in relays and the preamplifier power supply.

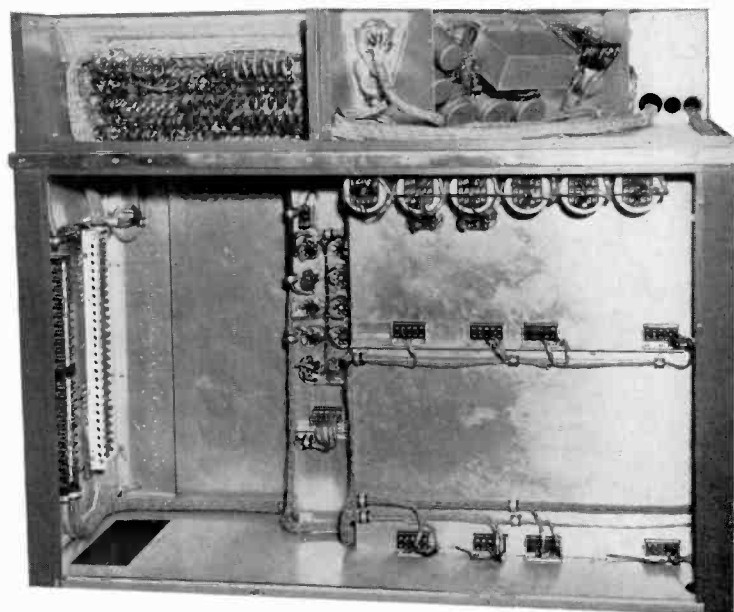

Above: This view shows the wiring in the back of the equipment cabinet. It will be noted how simplified this wiring becomes when used with plug-in amplifiers and relays and this manner of assembly. The row of transformers in the top are for various bridging and line termination purposes. All connector strips are in the front of the cabinet where they are readily accessible with the hole in the bottom for bringing the conduits in.



FIG. 1. (Above) Control room of WMOX. The streamlined control console, built by WMOX, has several ingenious features, including a guard wall, which protects the 70-C1 Turntables, an acoustic baffleboard behind the 76-B2 Console, and an 88-A Microphone mounted on a conveniently adjustable pipe-arm.

WMOX

MERIDIAN, MISSISSIPPI

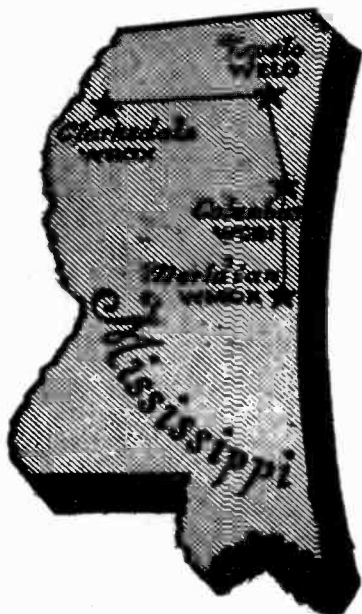

The Mid-South Network

In March WMOX, Meridian, Mississippi celebrated its first year on the air. WMOX is one of the chain of Mid-South Network stations owned and operated by Birney Imes, Jr. and under the general management of Bob McRaney.

One of the most modern and up-to-date stations in the south, WMOX is RCA-equipped throughout. An RCA 250-L Transmitter is built into the wall of the control room so that only the front of the transmitter is visible. Monitoring equipment, which includes an RCA Limiting Amplifier, an RCA Modulation Monitor, and an RCA Frequency Monitor, is mounted on a rack also built into the wall. Access to the back of these units is from the workshop adjoining the transmitter room.

The transmitter building is located just at the edge of the city limits and houses a work room and supply room, as well as the 250-L Transmitter. The ground system is laid in a marsh covering seven acres. The 300-foot tower is a vertical-guyed Wincharger with a concentric cable supplying the r-f to the tower via a catwalk six feet above the ground. The tower with its flashing beacon is visible for miles.

The installation was made by Holt Dyess, former Chief Engineer for the Mid-South Network and Raymond Bates, the Chief Engineer for WMOX. The staff includes two full-time operators and one part-time operator in addition to Mr. Bates. The station is locally managed by Jerry Kerns. Foy "Tiny" Vickery is the Sales Manager.

FIG. 2. (Right) A corner of WMOX's Studio A, looking toward the control room. Lobby and offices are to the right. Microphones include an 88-A and 44-BX on a boom stand. WMOX's Studio B, which is not shown, is 25 feet by 30 feet in size and has a skylight which provides an interesting daylight effect. Type 44-BX's are also used in this studio.



RAYMOND BATES
WMOX Chief Engineer

RAYMOND BATES is a Meridian, Mississippi resident, holder of a First Class Radio Telephone license. He was first employed by the station to install and operate the transmitting and studio equipment and was made Chief Engineer when the station went on the air. He is a rabid photographic fan and has taken many pictures of the station equipment.



JERRY KERNS
WMOX Manager

JERRY KERNS came to Radio Station WMOX from Akron, Ohio, where he had been engaged in radio work for a number of years. Mr. Kerns joined the staff of WMOX shortly after the station went on the air, as production manager; and just recently was elevated to the position of station manager.



FOY "TINY" VICKERY
WMOX Sales Manager

From ace automobile salesman, to radio announcing, to sales manager of Radio Station WMOX, is the thumb-nail biography of FOY "TINY" VICKERY, 390 pound sales manager of Radio Station WMOX, Meridian, Mississippi. "Tiny" does things in a big way, including his personal appearance as master of ceremonies, announcer, and salesman.

WAAT READIES TELE

BREMER BROADCASTING, NEWARK, PUTTING FINAL TOUCHES ON ELABORATE TELEVISION INSTALLATION

The Bremer Broadcasting Corporation (WAAT, Newark) is putting the final touches on its new TV transmitting plant located on West Orange Ridge, six-and-a-half miles from downtown Newark. By the time this article is published the transmitter building and main tower (shown here in partially-finished state) will have been completed and WAAT engineers will be moving in equipment. Soon after the first of the year WAAT-TV will take the air on channel 13—the first “high-band” station in the New York Metropolitan area.

Completion of WAAT's television station will mark another “first” for the Bremer Corporation in radio pioneering in the Garden State. WAAT, (5000 watts, 970 kc.) was the first sta-

tion in New Jersey to operate 24 hours a day. WAAW, the Bremer Corporation's FM station, took the air June 23rd as the first commercial FM station in New Jersey. WAAT-TV, the first television station in New Jersey, completes a trio of firsts which goes far towards substantiating WAAT's claim to being “New Jersey's First Station.” As if that were not sufficient, WAAT plans to provide, in the near future, still another service—facsimile. (Their experimental transmissions, received daily in WFIL's booth, were a feature of the NAB Convention.)

PROGRAMS

In commenting on the FCC's grant of a TV construction permit to WAAT, Mr. Irving R. Rosenhaus, president of the Bremer

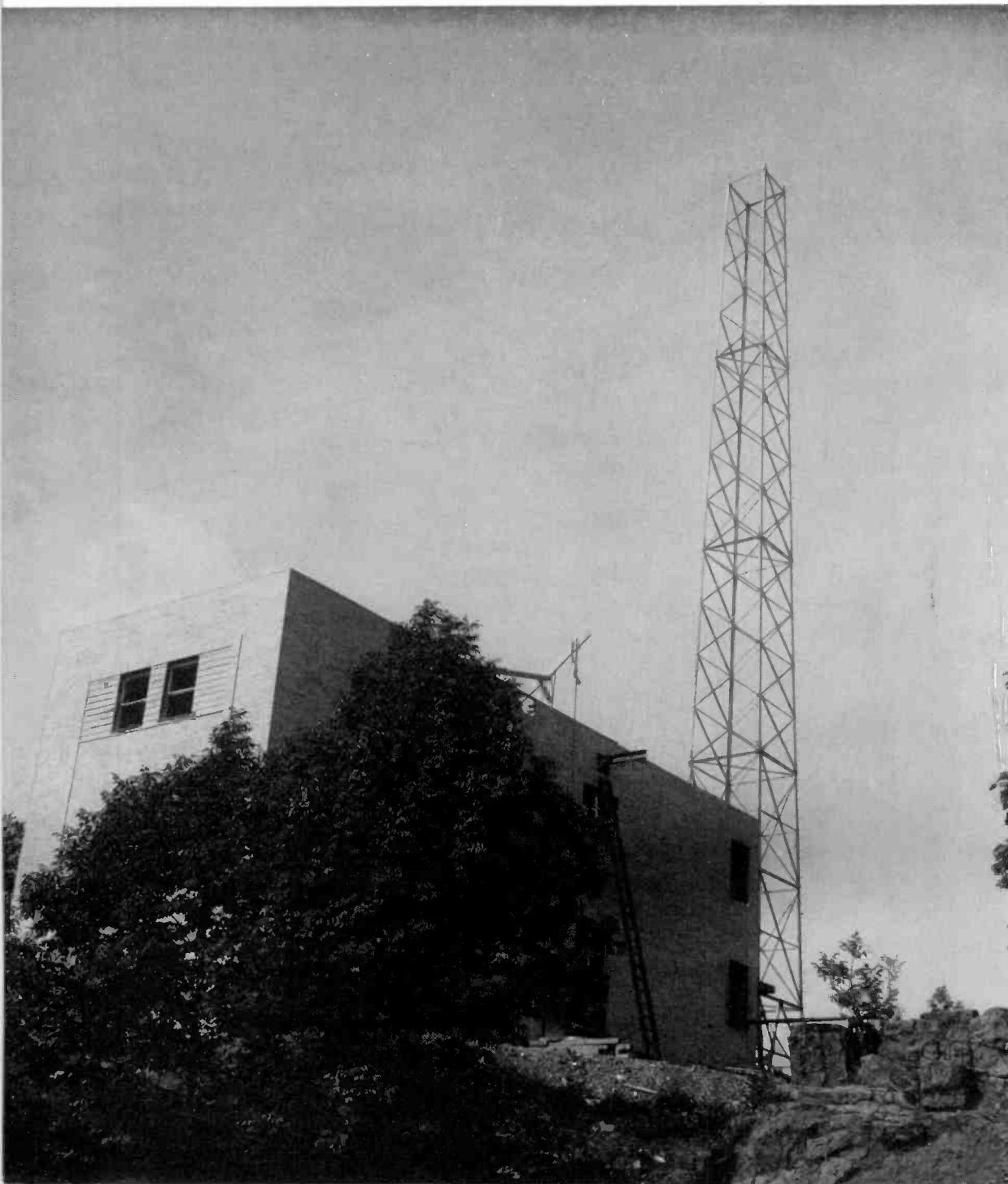

FIG. 1. (left) This three-story brick building on top of West Orange Ridge will house WAAT-TV and WAAT-FM. 130-foot tower at the right will support a 2-section Pylon for FM and a 6-bay superturnstile for TV.



FIG. 2. *WAAT-TV will be completely RCA-equipped, from cameras to antenna. Shown here looking at some of this equipment are (left to right) Edward Reeves, WAAT Technical Assistant; Frank V. Bremer, WAAT Vice President in charge of engineering; and Irving R. Rosenhaus, President of the Bremer Broadcasting Corporation. W. L. Lawrence, RCA Television Sales, is explaining the microwave relay equipment, while L. E. Anderson, RCA Television Engineer, is just emerging from the hatch in the roof of the RCA Telemobile Unit on which all are standing. (This photo was made at the NAB Convention).*

Broadcasting Corporation, pointed out that WAAT-TV will provide television coverage for the three-and-a-half million residents of northern New Jersey, as well as for residents of the New York Metropolitan area. According to Mr. Rosenhaus, WAAT-TV will provide entertainment for all ages. Sports events will play a prominent role in the television station's programs. Boxing bouts, basketball games, baseball and track events will be brought into television-equipped homes and meeting places.

In addition, he said, educational forums from New Jersey's leading colleges, universities and secondary schools, audience-participation shows and dramatic presentations by little theater groups will be televised. Latest local and world-wide news events will find their way to television screens via films, as will animated cartoons and other filmfare.

TRANSMITTER BUILDING

WAAT's transmitter building on West Orange Ridge (Figure 1) will eventually house, not only WAAT-TV, but also the Bremer FM station WAAW and WAAT's facsimile transmitting equipment.

The building, which is three stories high, is approximately 22 feet wide by 60 feet long. It is of poured-concrete, reinforced-with-steel construction with exterior of yellow smooth-faced brick. On the first (ground) floor will be a kitchenette, storage room, and other service facilities. Television transmitting, monitoring, and STL equipment will occupy the second floor. On the third floor will be located the 10 KW FM transmitter and associated equipment, together with the facsimile transmitting equipment.

EQUIPMENT LAYOUT

The arrangement of the television equipment on the second floor of WAAT's transmitter building is shown in Figure 5. The transmitter control room is unusually spacious and provides plenty of working space around the equipment units. The operator's position at the control console faces the transmitter with monitoring equipment racks in a convenient position at his left. Note that there are windows in the side of the building which is at the operator's back, but none on the transmitter side. Thus, outside lighting can be used during daylight hours without the operator facing window glare.

Studio-transmitter link equipment and other auxiliary equipment will be mounted on racks in a 12- by 15-foot room adjacent to the transmitter room. In the floor of this room, as well as that of the transmitter room, are 6-inch ducts (trenches) which provide for inter-connecting of equipment units, the position of these ducts is indicated by broken lines on the floor diagram (Figure 5). In addition there are, along the sides of the building, a number of 3-inch by 12-inch "sleeves" which run through all three floors and up to the roof. These provide for connections between floors and with equipment on the roof.

ANTENNA

The antenna system, which will be used jointly by WAAT-TV and WAAW (FM), is shown diagrammatically in Figure 3. The base is a 130-foot self-supporting tower of standard construction. This tower stands just behind the building (Figure 1). On top of this will be mounted a 2-section (heavy-duty type)

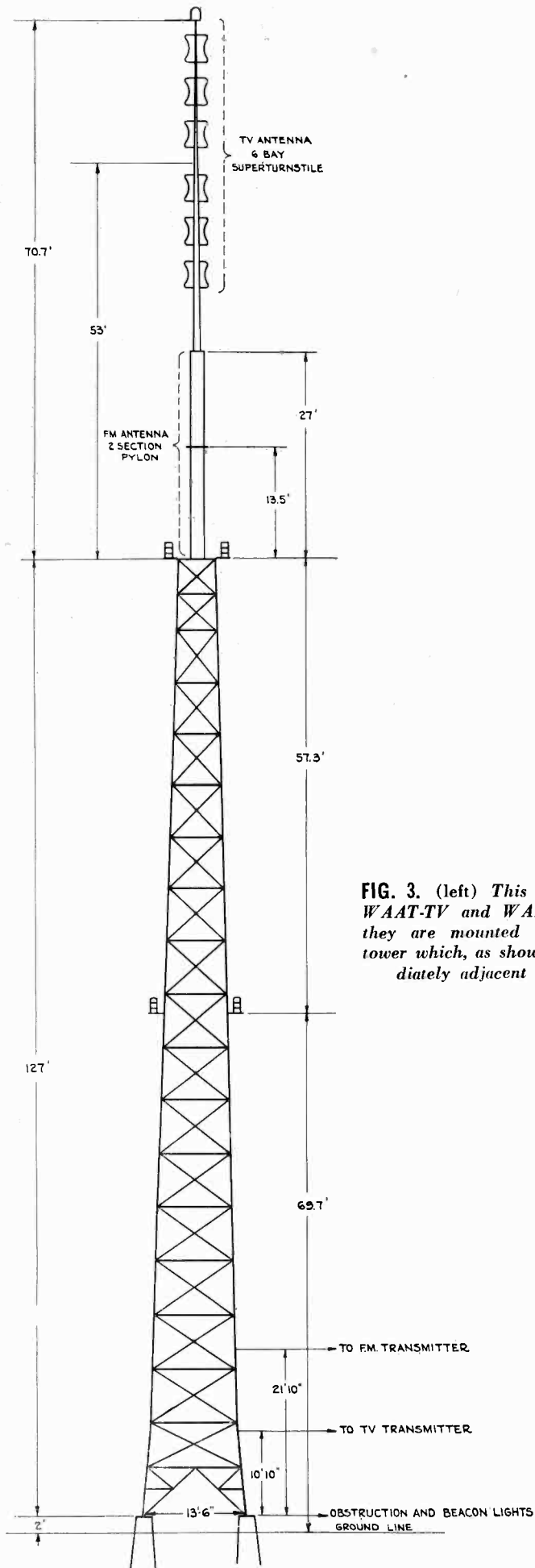

FIG. 3. (left) This is a simplified drawing of the WAAT-TV and WAAT-FM antennas, showing how they are mounted on the 130-foot self-supporting tower which, as shown in Figure 5, is located immediately adjacent to the transmitter building.

Pylon which will in turn support a 6-section superturnstile. Center point of the television antenna will be 180 feet above ground. As the ground level at this point on West Orange Ridge is 620 feet above sea level, the effective height of the television antenna will be 800 feet.

STL INSTALLATION

WAAT-TV's studios will be located in downtown Newark about six-and-a-half miles from the transmitter. Video signals will be sent from the studio to the transmitter by standard RCA Microwave Relay equipment (Type TTR-1 and TRR-1, described in BROADCAST NEWS NO. 44). The relay receiver will be mounted on a 50-foot tower which is being built on top of the main transmitter building. This tower will have a large square top so that it can easily accommodate additional equipment which may be added at a later date.

EQUIPMENT

WAAT-TV, like most of the television stations now being installed, will be completely RCA-equipped. At the transmitter will be a standard TT-5A (5 KW) Transmitter, a TF-6A six-section Superturnstile Antenna, complete monitoring equipment, and the receiver part of the STL equipment. For studio and remote use two complete sets of RCA Field Equipment have been ordered. For the immediate future one set of this equipment will be used regularly in the studio. Other studio equipment includes a complete setup of cameras and projectors so that slides, 16mm and 35mm film may be used interchangeably.

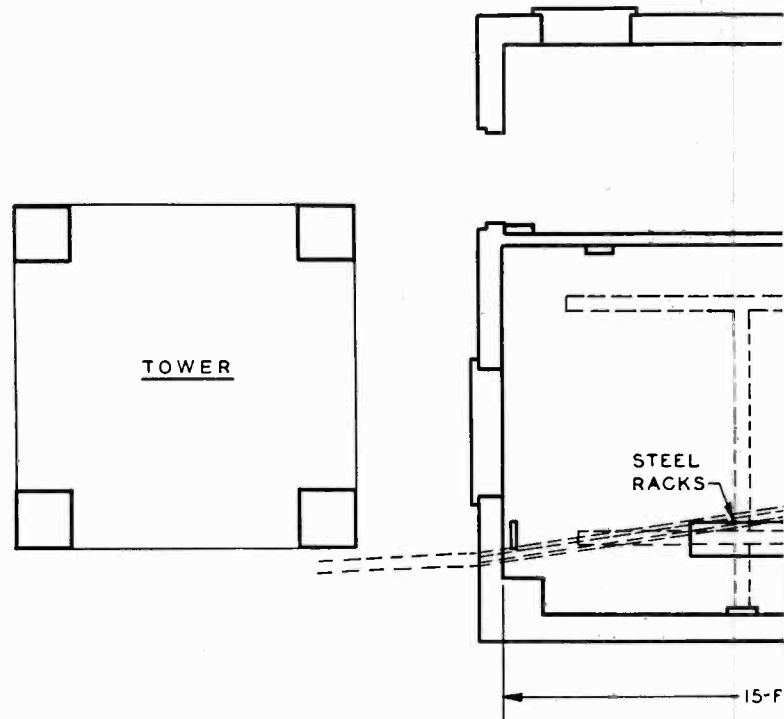

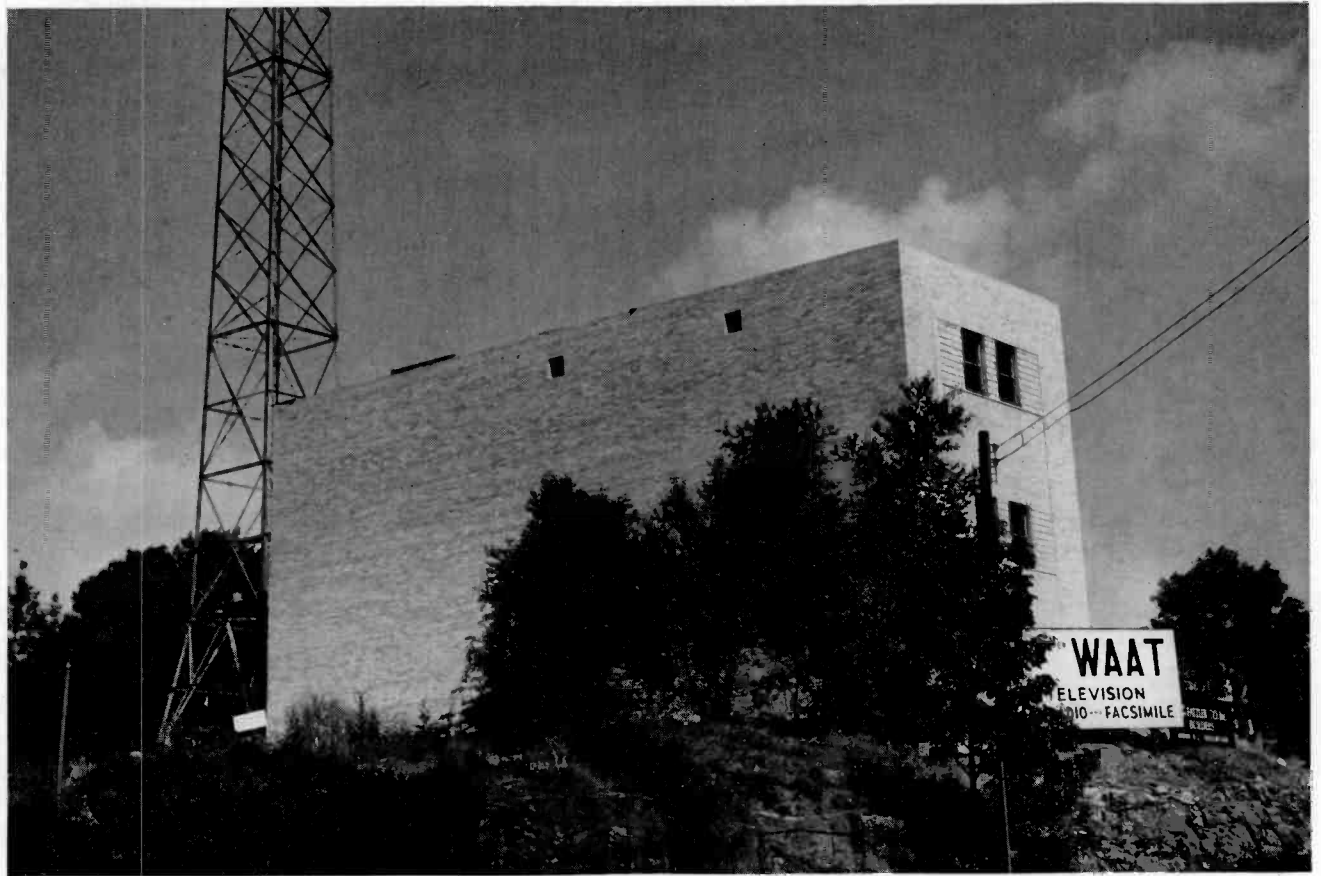

FIG. 4. This is another view of WAAT's new transmitter building on West Orange Ridge (6½ miles from downtown Newark). Space for storage and auxilliary services is provided on the first floor. Television equipment will be located on the second floor. FM and facsimile will occupy the third floor. The side of the building shown in this view has no windows, since it is planned to place the transmitters against this wall (see below). The opposite side of the building has four large windows on each floor, thus providing plenty of daylight illumination for the operating rooms.

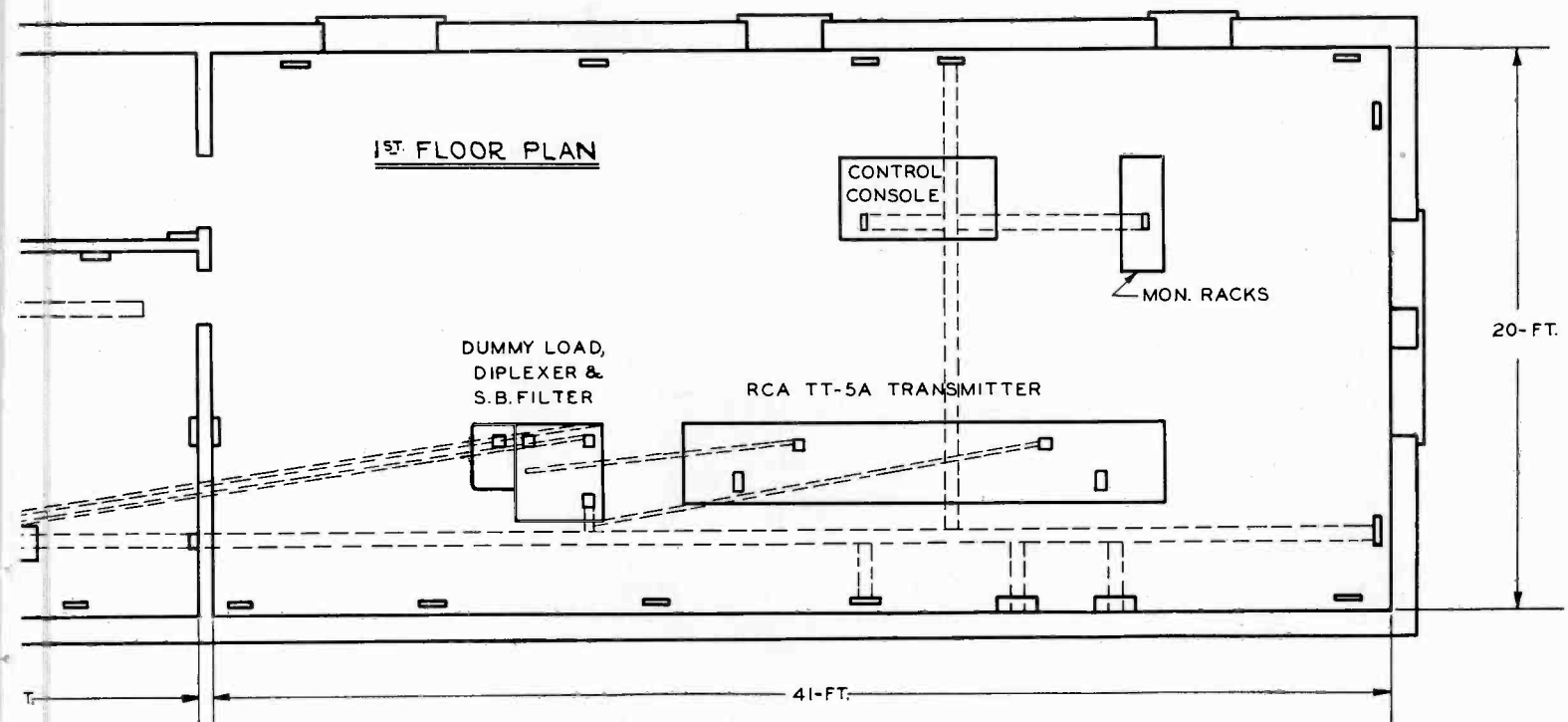

FIG. 5. This is a simplified floor layout plan of the second floor of the new WAAT transmitter building. Arrangement of the various television equipment units is shown (approximately to scale). Widespread broken lines, running horizontally and vertically, indicate floor trenches for inter-unit wiring. Close-spaced broken lines, running at diagonal angles show position of coaxial connecting lines. The racks in the small room at left will house the relay and terminal equipment.

WBAL'S *New-World-of-Tomorrow*

by

HAROLD C. BURKE

Manager, WBAL, Baltimore

WBAL'S ultra-modern "New World of Tomorrow" studios were officially opened on September 1. Situated at 2610 North Charles Street, the station's seven new broadcasting studios are a product of the most advanced engineering and architectural skill in the radio industry today.

James R. Edmunds, Jr., Baltimore architect, designed the studios, with the NBC Engineering Department acting as consultants. The entrance door from Charles Street opens on a wide corridor with a receptionist's desk at its front. To the left of the desk is a loudspeaker and cathode-ray tube so that the program currently on WBAL can be heard and the sound waves seen. Behind the desk is the WBAL newsroom, which is visible to the public in its entirety, since its walls are made of plexiglass.

TRANSPARENT WALLS

The transparent walls enable visitors to see and read the news coming in on the International News Service, Associated Press

and United Press wire service teletype machines. WBAL's newsmen prepare the news bulletins for broadcast in this room. Five separate clocks on the wall show the time of day in far-off capitals such as Tokyo, Moscow, London and Berlin and, of course, Baltimore. Giant illuminated maps decorate the walls of the main first-floor corridor, showing Baltimore city and the vast listening area reached by WBAL's 50,000 watts.

ARRANGEMENT OF STUDIOS

Seven studios, primarily designed for audio broadcasting, are included in the section of WBAL's new studio plant which is now in use. Two additional studios, especially designed for television, will be added in the near future. The seven broadcast studios are arranged on the first two floors of the building as shown in Figure 4 and Figure 7. The four on the first floor of the building include two medium-sized studios (A and B), a small Studio C and an announcer's booth which adjoins the newsroom. On the second floor are two large studios. One of



FIG. 1. (left) Major Thomas D'Alesandro of Baltimore "spins the platters" in the control room of WBAL's new studio installation. Looking on, like a proud father, is Harold C. Burke, manager of WBAL.

FIG. 2. (right) Largest of WBAL's new studios is the "Air Theater," which seats an audience of 180 in permanent theater-type push-back chairs. Two-level stage is 34 feet wide by 25 feet deep. Irregular wall surfaces, plaster-covered, are used in the auditorium section—polycylindrical diffusers at the sides and rear of the stage.

STUDIOS

FIG. 3. (right) *Modernistic front of WBAL's new studio installation at 2610 North Charles Street. Facilities now in use include an imposing entrance-lobby; seven studios, four of them with separate control rooms; a master control room; and offices for the entire WBAL staff.*

these (Studio F) is the large "Air Theatre"; the other, the medium-sized "Futuristic Studio". In addition, there is a beautifully appointed edition room which doubles as a speakers' studio. All seven of these studios are described at further length below.

STUDIO ACOUSTICS

WBAL's new studios represent the latest advances in acoustical design developed by the Johns-Manville Company. The acoustical treatment is composed of diverse surfaces, varying from polycylindrical panels, segmented spheres of "diffusispheres" and splay to classic planes and scroll contours. Absorptive and reflective material are blended to achieve the most desirable reverberation characteristics and the maximum diffusion of reflected sound obtained for the enhancement of the tonal qualities of performers and orchestras without disturbing echoes. The multiplicity of the dispersing surfaces and strategic location of the absorbing material not only minimize the problems of micro-





FIG. 4. (left) Arrangement of the second floor of WBAL's new installation. The "Air Theatre" and "Futuristic" studio are on this floor, as well as most of the station offices. Entry to this floor is by means of a wide circle stairway at the front of the building. The lobby is large and luxuriously furnished.

FIG. 5. (right, above) Cast of "Hi Jinks", a WBAL feature program, on the stage of the "Air Theatre." The stage is in two sections, a rear one-step-up part for the orchestra and a front section for soloists, announcers, etc. Rear wall of the stage has cylindrical panels which can be shut off by a traveling curtain to provide a more subdued sound effect.

FIG. 6. (right, below) WBAL's most striking studio, aptly dubbed the "Futuristic" studio. Breakup of sound waves is provided for by use of diffusispheres, which in this case are symmetrically arranged, but of varying sizes. In addition, the side walls of this studio have a "stepped" layout. Colors are equally striking, the diffusispheres on the far end being yellow, while those on the side walls are dark maroon. Background color on all walls is neutral grey.

phone placement, but result in a pleasing reinforcement of sound to the musicians and conductors.

Special precautions have been taken to isolate the studios from extraneous sounds of adjacent spaces by the use of a unique double-wall construction utilizing cinder block. The ceilings, walls and floors are supported on special springs and felt to reduce the transmission of vibration to the studios from the building and surrounding machinery.

THE "AIR THEATRE"

Most striking of WBAL's new studios is the 180-seat auditorium on the second floor (Figure 2), where the audience may watch and enter into the spirit of the program from the cinematic comfort of Kroehler theatre-type Push-back chairs. The stage, which is 25 by 34 feet, is on two levels (which can be separated by a plush traveler), with the orchestra place on the one-step-up rear portion and the individual artists doing their stuff on what might be termed an oversize apron. The side walls are finished in relatively smooth acoustic plaster, with various vertical segments placed at varying angles. The rear wall is

padded with rockwool over which is laid Transite. The rear wall of the stage has six cylindrical panels for acoustic effect. These panels can be shut off by a second traveler where a more subdued sound is required. (Figure 5).

A public address system brings the program to the audience and is set up so that an announcer can move among the audience and talk without producing any feedback noise and be heard throughout the theatre. The studio is attractively decorated in soft, blending shades of blue and the control room, constructed in angular form overlooking the stage, lends a modernistic appearance to the auditorium. The latest fluorescent lights illuminate the audience-half of the studio, while spotlights play on the stage and the actors and musicians.

THE "FUTURISTIC STUDIO"

Most dramatic of the WBAL studios is the modernistic one, also on the second floor. The so-called diffusispheres, devised a couple of years ago by NBC's acoustic engineers, have been used here. (Figure 6). Modern design, however, has affected these spheres, too; for, where equal-size spheres were originally



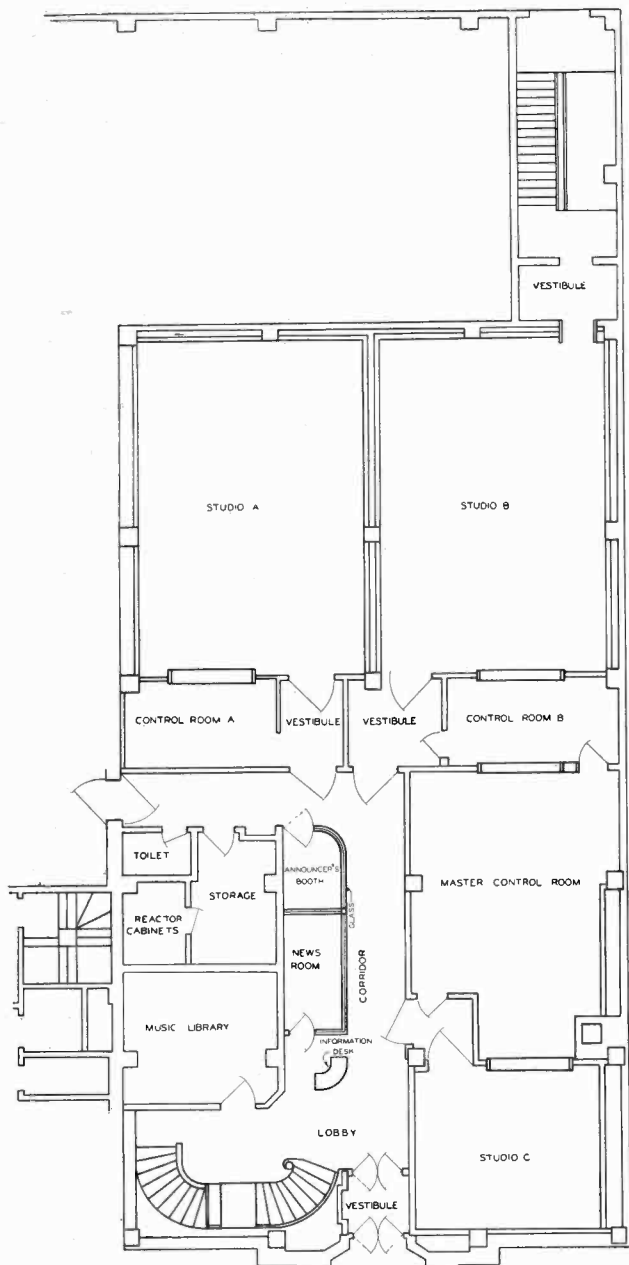

◆
FIG. 7. (left) Arrangement of first floor of the new WBAL installation. Four studios are on this floor; the twin studios, A and B, each with its own control room; a smaller studio C, controlled from a 76-B console in the master control room; and an announcer's booth or "studio" which is glassed-in just off the news room.

◆
FIG. 8. (right, above) View in studio A looking toward the control room. This studio and Studio B are identical. Each is 24 feet wide by 32 feet deep. Walls are transite covered except for far end on which there are two long cylindrical panels which are extended over the length of the ceiling as shown in this view. Studios A and B are used for dramatic shows, disk-jockey programs, and other small shows. Pianos, sound-effects machines and other props are part of permanent equipment.

◆
FIG. 9. (right, below) Studio C looking toward the master control room. This small studio is used by newscasters, speakers, and small groups. It is also used for station breaks, spot announcements, etc. The 76-B Console, which controls operations in this studio, is located in one end of the master control room so that a single operator can handle all operations during hours when only network programs are aired.

placed at random, the present studio achieves the same end by utilizing spheres of varying sizes arranged in a special design.

The "Futuristic Studio" is 25 by 40 feet in size and can comfortably seat an audience of fifty persons. It is brilliantly decorated in red, white, and yellow hues. Here again a curtain at one end of the studio can be adjusted for desired acoustic effects.

TWIN STUDIOS

The twin studios on the first floor of the building are identical in shape and size, both measuring 24 by 32 feet. (Figure 8). These studios are used for originating dramatic programs, disk-jockey programs and generally the smaller shows. They are also used for rehearsals for the programs which later originate from the larger studios.

The sound-proofing provided throughout the building is such that a full-piece orchestra can rehearse in one of the twin studios without interfering while a show goes over the air from the one immediately adjacent.

AUDITION ROOM AND SPEAKER STUDIO

This studio is attractively furnished like a living room with three couches, several easy chairs, a deep rug, large mirror and

lamps. It is used primarily for auditions, but is also employed as a broadcasting studio for programs having just one or two speakers.

SMALLER STUDIOS

Two smaller studios are used by announcers and newscasters. (Figure 9). One of them is at one end of WBAL's newsroom and is used for emergency breaks in the event of sensational news. When a story of major importance breaks, WBAL's news editors can go on the air right from the newsroom with the sound of the teletype machines in the background.

STUDIO EQUIPMENT

Each of WBAL's new studios is provided with its own control room so that any of them may be used individually for audition or rehearsal. Or they may be fed through the master control room to any one of four outgoing channels. The arrangement of equipment units which provides this flexibility is described by our chief engineer, Mr. Duncan, in the article starting on the second following page.

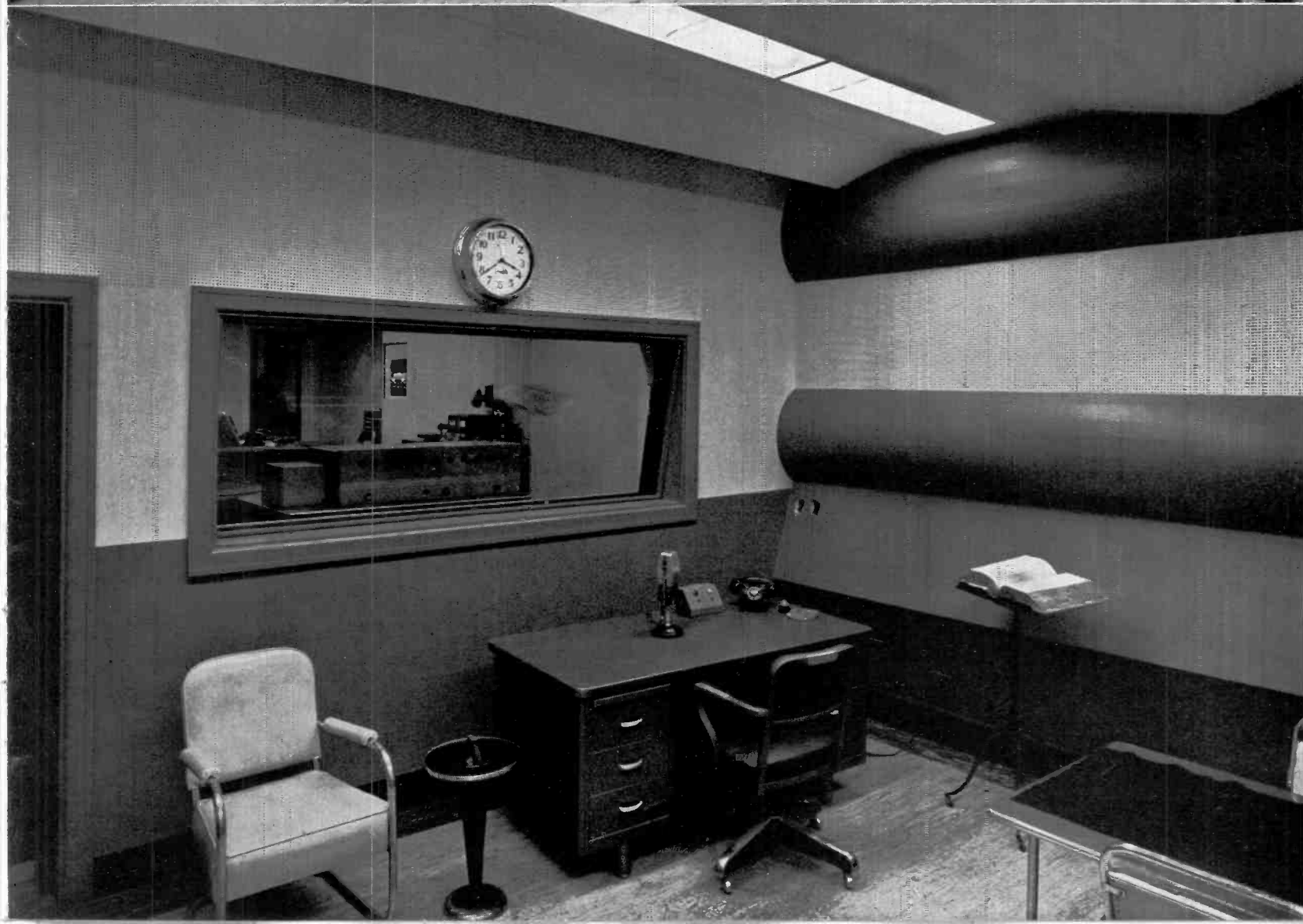



FIG. 1. Master control room of WBAL's new studio installation. R. S. Duncan, Chief Engineer of WBAL, at the control console.

Technical Facilities for WBAL's New Studios

by

R. S. DUNCAN, Chief Engineer, WBAL

In designing and choosing the technical equipment for WBAL's new "World of Tomorrow" studios, every effort was made to provide simplicity of operation plus flexibility, ease of maintenance, and reliability. With a rather large number of live shows being produced in our studios, it was imperative that no limitations be placed on production by the Engineering Department. We have, therefore, provided more than adequate facilities wherever needed, including such items as the number of microphone channels available, inputs for sound effects and associated equipment, talk-back and talk-in systems, auditioning circuits and the many items which, while not concerned with the actual broadcast of a program, are indispensable to its proper preparation, rehearsal and production.

The system is arranged to take care of seven program originating points, including studios, news booth, and master control

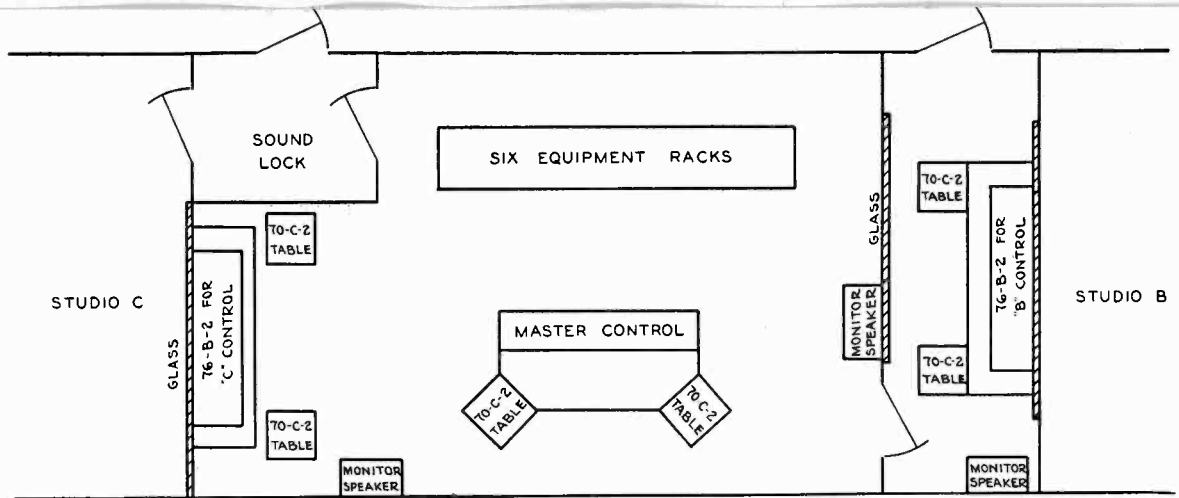
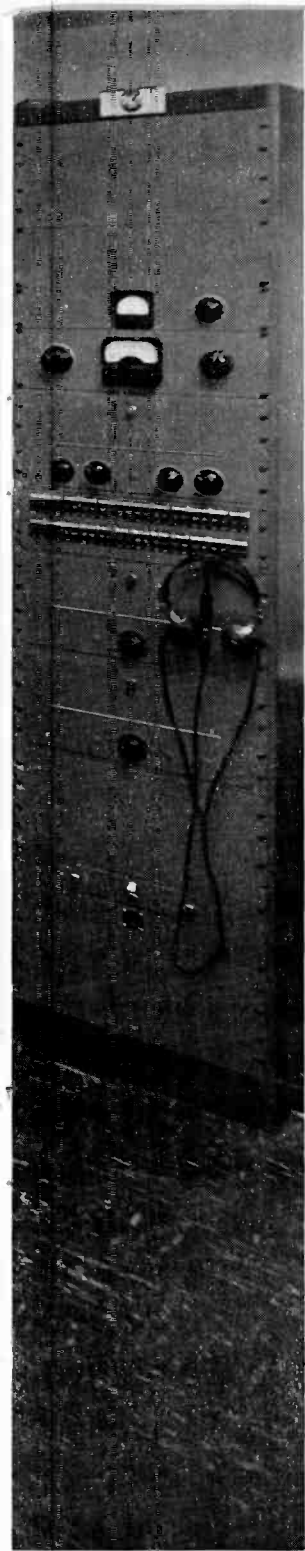

FIG. 2 Floor layout of the WBAL master control room and Studio B control room.

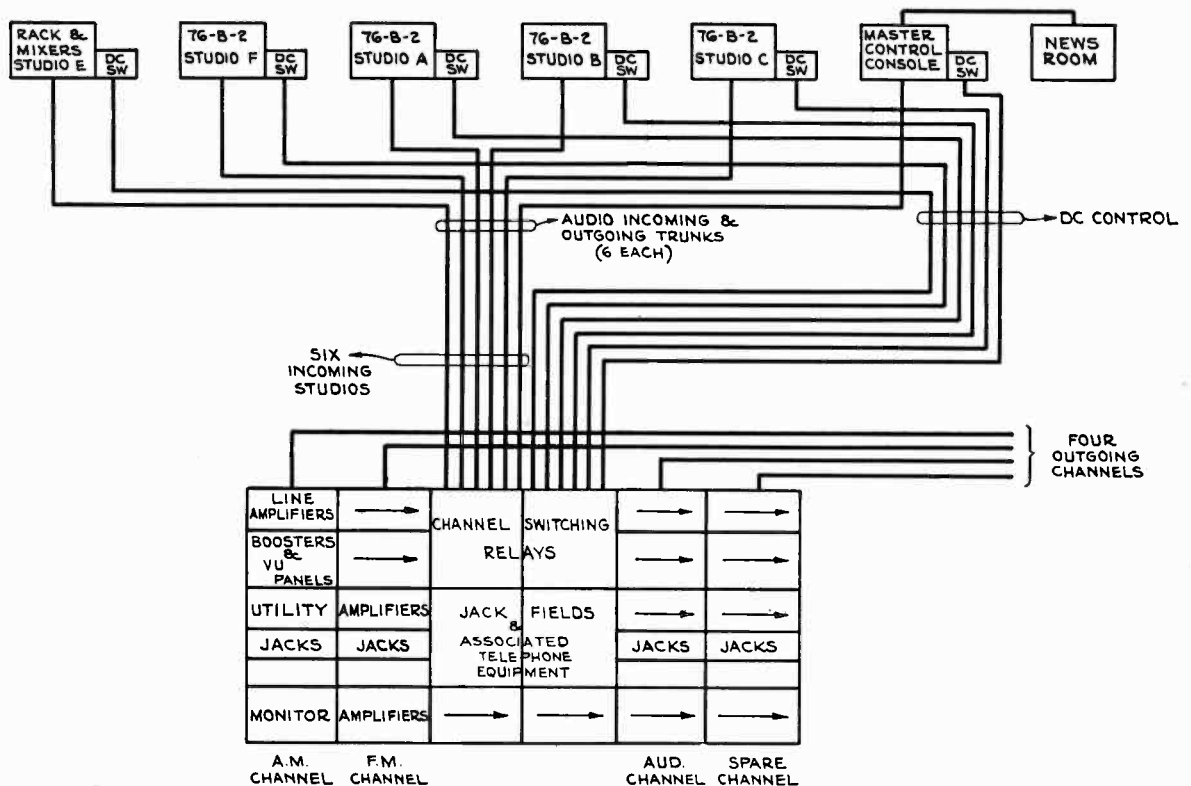

FIG. 3. Block diagram showing circuit arrangement of main equipment items at WBAL.

room. Any program originating from any one of these points may be switched to any of four outgoing channels, AM, FM, audition and utility. These four channels all operate identically insofar as levels are concerned, and all four are provided with the necessary repeat coils and line loading units in case they need to be used for separate outgoing feeds. The switching system, a 7 x 4 cross-over designed and built at WBAL, employs only thirty-two telephone type relays, all of which are located in the master control room. Each program originating point has its own switching position by means of which one or more outgoing channels are selected. On this switching position appear four lights which indicate the occupancy of the channels, four which indicate the use of the studio, and eight push buttons which pick up and drop any channel. Electrical interlocking prevents any program originating point from picking up a chan-

nel if it is already occupied. However, for purposes of program duplication to two outgoing points, any program originating point may occupy as many channels as desired, provided they have not already previously been occupied by another point. In the master control room, supervisory control of the switching positions in B and C studios is available since these two studios are located adjacent to the master control room. Thus, any program originating from studio B or studio C may be switched on and off any channel either from B or C control booth or from the master control room console. The occupancy of the four channels is shown by a signal light in the master control room visible to the master control operator at all times. A reliable source of signal voltage for these switching circuits is supplied by using 12 volts d-c from either of two banks of storage batteries or from a charging rectifier located in the battery room.



FIG. 4. *WBAL is also readying their television installation and has received most of a complete equipment layout ordered from RCA.*

Switching arrangements for the signal voltage are such that either set of batteries, with or without the charger, both sets of batteries with or without the charger, or the charger alone, may be used to supply a stable source of d-c signal voltage.

Audio facilities are standardized throughout the entire system, with the exception of the master control console and the mixing turret for the auditorium studio. With the exception of these two items, all amplifiers and associated equipment are RCA. Each of the studio control booths is equipped with an RCA 76B2 Consolette and two RCA 70-C2 Turntables. From the master control room, six utility trunks are run to each of the control booths in addition to six monitoring lines, four program circuits with spares, and other auxiliary pairs. In the case of the master control console, requirements of flexibility as well as uniqueness in design made it expedient that the unit be built in our own shops to our own specifications. The master control console is in itself a program originating point, since through it we are able to broadcast any remote program, NBC, and play transcriptions or records from the two turntables located at the master control desk. This desk also has level metering facilities for all outgoing channels, monitoring facilities for them, and a large jack field for emergency patching of circuits. A microphone is provided in studio C as well as one in studio B which the announcer can open by means of a push button operated relay for the purpose of taking station breaks, reading spots, and supplying any other program of short duration which does not require more than one microphone. These two microphones may be punched on only if the master control program originating point

is occupying a channel, and the corresponding "ready light" is on at the announcer's control position. Gain control for these microphones appears in the center position of the master control console. Also on this unit, provision is made for adjustments in level in any of the four outgoing channels. Complete communication facilities are at the operator's position to all control booths as well as to the office PBX, remote cue circuits, and to private outside telephone lines.

A total of six racks are required to house the booster and line amplifiers, monitoring amplifiers, bridging amplifiers, equalizers, jack field, channel selecting relays, and other utility equipment. Four of these racks are identical, one being associated with each of the four above-mentioned outgoing channels. These racks contain booster amplifiers, line amplifiers, monitoring amplifiers, and a jack field directly relating to the amplifiers for the channel. VU meters are provided both in the master control position and on the rack for each channel used. Each amplifier associated with the operation of any outgoing channel is provided with a duplicate spare amplifier which can be patched-in in case of equipment failure. Also located in these racks is an amplifier which is used to provide talk-in service from either B or C studios, adjacent to the master control room, enabling the announcer in either of these studios to pick up a small talk-back microphone for communication with the master control operator at any time.

Recording facilities consist of two sets of two each of the RCA 73B Professional Recorder. These recorders are complete with thread removal equipment and instantaneously switchable



FIG. 5. WBAL engineers have been "getting acquainted" with their television field equipment. This is a "see-yourself" setup at Huxler's Department Store.

to any of the four outgoing channels. In the case of studio A, however, it is not necessary to utilize a channel for recording purposes since the recording equipment is located in the control booth for this studio, and an additional position is provided whereby any program recorded from here may be placed directly on the recorders. Additional recording facilities will be provided at our transmitter at some future date in order to make "off the air" recordings without tying up additional equipment in our studios.

The equipment in the auditorium studio is of the rack and mixer type, employing two racks of standard RCA amplifiers and a specially-built mixing turret. Provision is made on the turret for eight microphone inputs and two remote inputs. Each of the latter is supplied with an eight-position push-button enabling the operator to select remote, turntables, sound effects equipment, or other utility program sources. The mixing turret is in reality divided into two parts, each part containing a mixing control for four microphones and one remote input and are grouped under one sub-master control. The two sub-masters then feed into a master control enabling a complete fade of all channels. It has been found that this system of grouping microphone inputs is extremely effective in providing a balance between an orchestra and vocalist, sound effects, dramatic cast microphones, and other microphones on the stage which are concerned with extremely low volume sound sources. It has also proven quite valuable in providing sound reinforcement in our auditorium studio. The sound system used therein may be instantaneously switched

to either sub-master control, to the complete output of the mixing turret, or to any one of four other positions, such as network, turntables, or remote lines. This mixing turret contains an adequate jack field for emergency patching of spare amplifiers and for terminating trunks to the master control room.

On the stage itself, outlets are provided for eight microphones, all microphone circuits being duplicated at opposite points on the stage. Terminating on the stage also are circuits which carry the output of the four-channel monitors, the network program, and several utility circuits which may be patched to any source desirable. A hanging microphone, capable of being raised or lowered to any desired height, is provided at center stage front for purposes of making pickups of large orchestras or choruses. Also on this stage are provided outlets for television camera controls, as well as facilities for at least 15 KW of additional lighting in case it is desired to televise shows produced on the stage. Facilities have been installed at the rear of the auditorium to make it possible for the sound track from a projector to be played directly into the auditorium sound reinforcing system by merely selecting the proper input on the amplifier controls at the mixing turret. Through the use of this very complete mixing system in our auditorium, it is possible to meet adequately most any problem of production normally encountered.

It may readily be seen that the technical equipment described above represents the utmost in flexibility as well as ease of operation, and will certainly enable the Engineering Department at WBAL to provide the best in facilities throughout its entire plant.

WBRE-FM WILKES-BARRE, PA.

by **DAVID BALTIMORE**

Asst. General Manager, WBRE, Wilkes-Barre

WBRE-FM began interim operation on May 1, 1947, after a year and a half's work in constructing building facilities and procuring equipment. However, all was not completed at this time since we were using a "stove pipe" antenna only 20 feet off the ground. As its name implies, this antenna was constructed from the pipe chimney of the pot belly stove which was used during the construction of the transmitter building. Putting out 700 watts with this rig, we were picked up over 60 miles away with a good clear signal. A few weeks later our RCA Pylon was installed and we went on the air with full radiated power of 2200 watts. Our Pylon is erected on top of a 380-foot tower which is located on a mountain 2100 feet in elevation. The tower and the transmitter building were built large enough and strong enough to handle television equipment, which we hope to install in the future. The tower is 36 feet wide at the base and weighs over 100,000 pounds.

WBRE-FM uses RCA equipment exclusively from the top of the tower to the bottom of the control room. Our equipment has all been designed for the full-frequency range of 30-15000 cycles. Off-the-air monitoring right at the studios, with the best receiving equipment we could put together, has given us reproduction of music with fidelity which has never been heard here before. The beauty and range of music that can be heard over FM is truly outstanding. The quiet signal that is heard in the primary coverage area, even during the most violent thunder storms during which time AM is impossible to listen to, really makes

FM stand out head and shoulders over any other form of audio broadcasting.

Our 400-foot tower, which stands out as a beacon high above Wyoming Valley and which can be seen for miles, also seems to attract all the lightning to it for miles around. Since it is located on solid rock, it has been exceptionally difficult to drain away the charge without damage to the equipment. Grounding to a 250-foot well has helped in part to solve the problem, and an elaborate system of ground wires buried from 6 inches to 2 feet is also helping to bring the trouble under control. Our telephone lines have been damaged severely several times because of lack of protection, but as our ground system has been increased, the damage has been lessening. Fortunately, no damage to the other equipment has been sustained up to this time.

One night, when lightning blew the fuses on the power transformer outside the building, our operator, not knowing what had happened, sat in the dark waiting for the power to be restored. Meanwhile, lightning continued to strike the tower. With each new bolt, according to engineer Dick Cybulski, the building lit up like a pin ball machine with all the fluorescent lamps glowing from the lightning charge, and the telephone bells jangling wildly.

WBRE-FM has gone into new places where radio reception has been impossibly poor heretofore. For example, at Fish's Eddy, New York, located in Read Valley and surrounded entirely



Left: *WBRE-FM* transmitter room. The RCA FM-1-C transmitter is built into the inset wall. Monitoring and test equipment is mounted on a rack just to the right of the transmitter. The convenient, streamlined control console was built by the *WBRE* staff. Shown in this view is Mr. David Baltimore, assistant manager of the station. He is the son of Louis G. Baltimore, owner and general manager of *WBRE*.

Right: *WBRE-FM antenna is a two-section pylon mounted on a 380-foot tower. Location is the top of a 2100-foot mountain overlooking the entire Wyoming Valley. WBRE also expects to use this location, in the very near future, for television operation.*

by the Catskill Mountains, radio reception has been extremely poor. A listener there, who was ready to give up radio in disgust, accidentally tuned in on radio station WBRE-FM, while switching to his phonograph. Having never heard FM before, he was quite surprised, and as he listened more and more, he became overwhelmingly pleased with the fine reception, quality of the music, and just the general good reception of a radio station for the first time in his life. He is now a constant listener of WBRE-FM.

Over all, we have reached out as far as the RCA Communications Lab at Riverhead, Long Island; the outskirts of Philadelphia. We also have several regular listeners in Binghamton, New York; Williamsport, Reading, Bethlehem, Allentown, and Lancaster, in Pennsylvania; and other points in between. As one listener from Allentown, Pennsylvania put it, "Your classical music programs are the best advertisement your city (Wilkes-Barre) has."

WBRE-FM operates a six hour daily schedule from 3:00 P. M. to 9:00 P. M. (3:00 P. M. to 10:00 P. M. on Saturday), during which time we have popular music, light concert and classical music, the Radio Playhouse, which a local college group presents, regular news features and sports programs. We are duplicating as much of our AM facility as we are able. Our program schedule will be extended as soon as the music situation is cleared up and we are able to present a wider variety of programs.

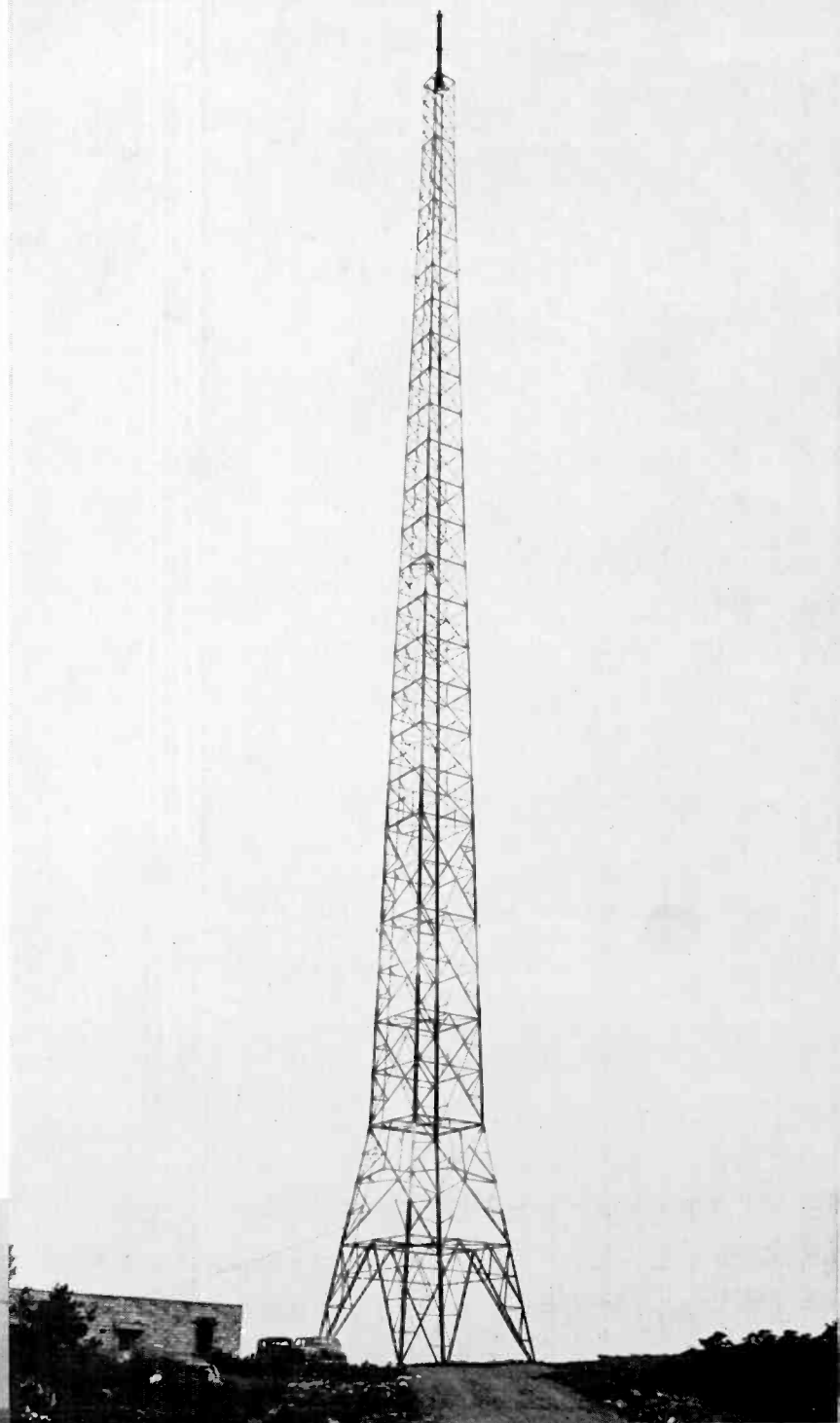

Left: *Studio control room of WBRE-FM, like the rest of the station, is 100% RCA-equipped. The standard 76-B console is flanked by a 70-C-2 turntable. Through the window may be seen the studio with its 44-BX microphones.*

WSBA and WSBA-FM YORK, PA.

by
W. G. EBERHART

Director of Engineering
Radio Station WSBA

Most listeners in the Pennsylvania Dutch community of York probably look upon WSBA as a veteran radio station that has been serving them for a long time. Actually, such is not the case! It was not until 1942, less than six years ago, that WSBA obtained authorization to begin construction of its 1 KW AM station for operation at 900 kilocycles. And construction of WSBA-FM was started less than a year ago.

Technical planning and actual installation of the 1 KW AM transmitter, as well as the 3 KW FM which followed later, were under the supervision of the writer. The descriptions given here, together with the photographs of the equipment used, will

perhaps be of interest to other broadcasters considering or planning AM-FM installations with somewhat similar operating conditions to satisfy.

WSBA'S 1 KW AM TRANSMITTER

As is usually the case, the size and location of the building, towers, antenna, and the overall layout of the station were determined largely by the transmitting equipment to be used, working space desired, and the area to be served. The one-kilowatt AM transmitter and studio control equipment are pictured in Figure 1 and Figure 2.

Between the transmitter and the 240-foot vertical Wincharger (AM) tower is a four-wire unbalanced transmission line approximately 375 feet long. Within a small tuning house, directly at the base of the tower, is located the RCA AZ4293 antenna tuning unit.

At WSBA, as the photographs of Figure 1 and Figure 2 illustrate, the 20- by 24-foot transmitter room contains the RCA 1-K

FIG. 1. (below) Complete control of studios and AM transmitter is provided by this flexible arrangement consisting of 76-B2 and 76-B4 Consolettes and 70-C2 Turntables complete with recording attachments. Messrs. Beaver and Lovett, operators, are shown at the master controls which face the AM transmitter.

FIG. 2. (below) Llewellyn Jones, Chief Engineer, at the controls of the WSBA 1-kilowatt AM transmitter, RCA Type 1-K.



FIG. 4. (right) The pleasing, clean-cut appearance of the WSBA-FM transmitter building is a result of the modern and practical styling employed. The FM building and tower base pictured here are situated five miles from the AM building.

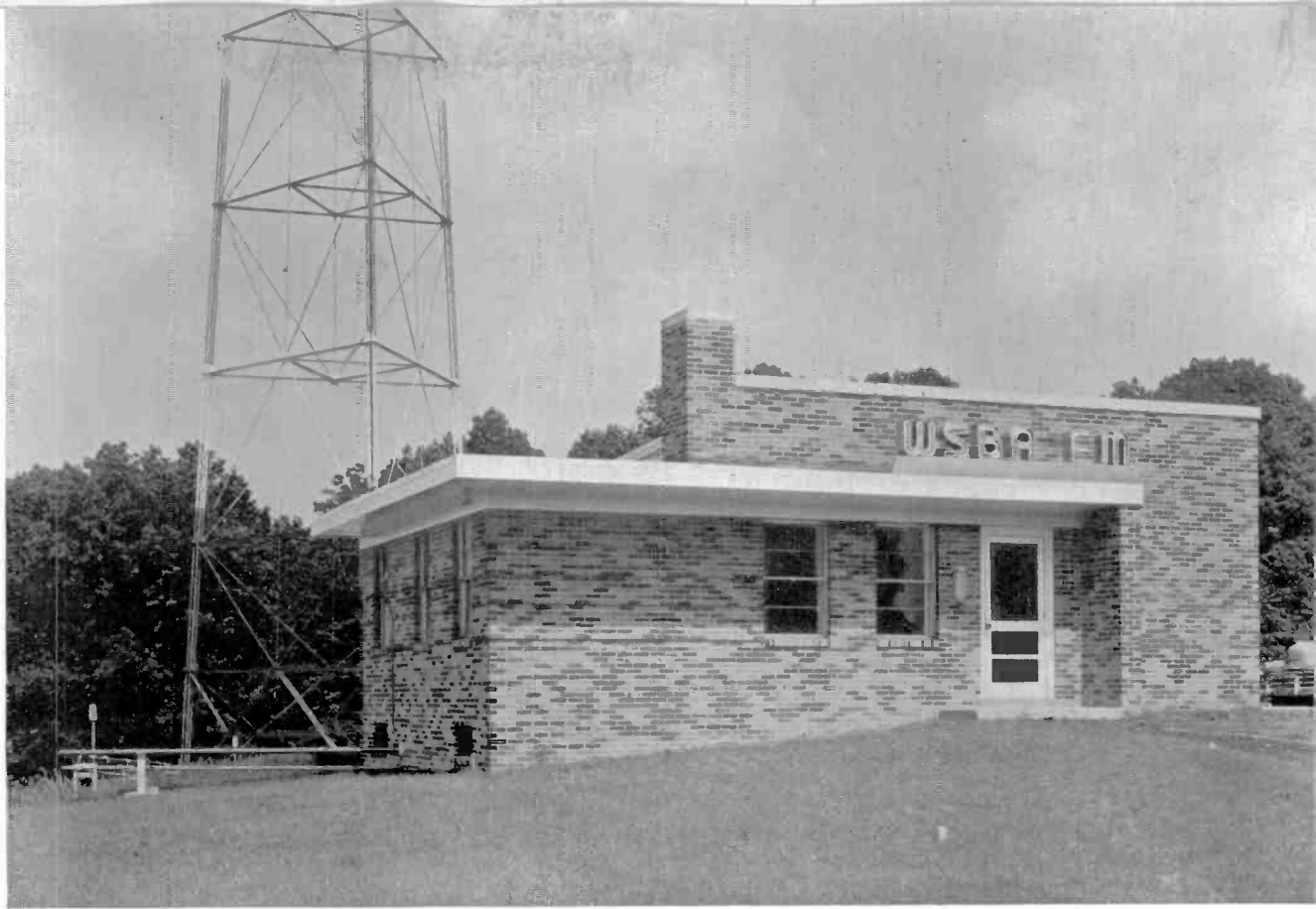
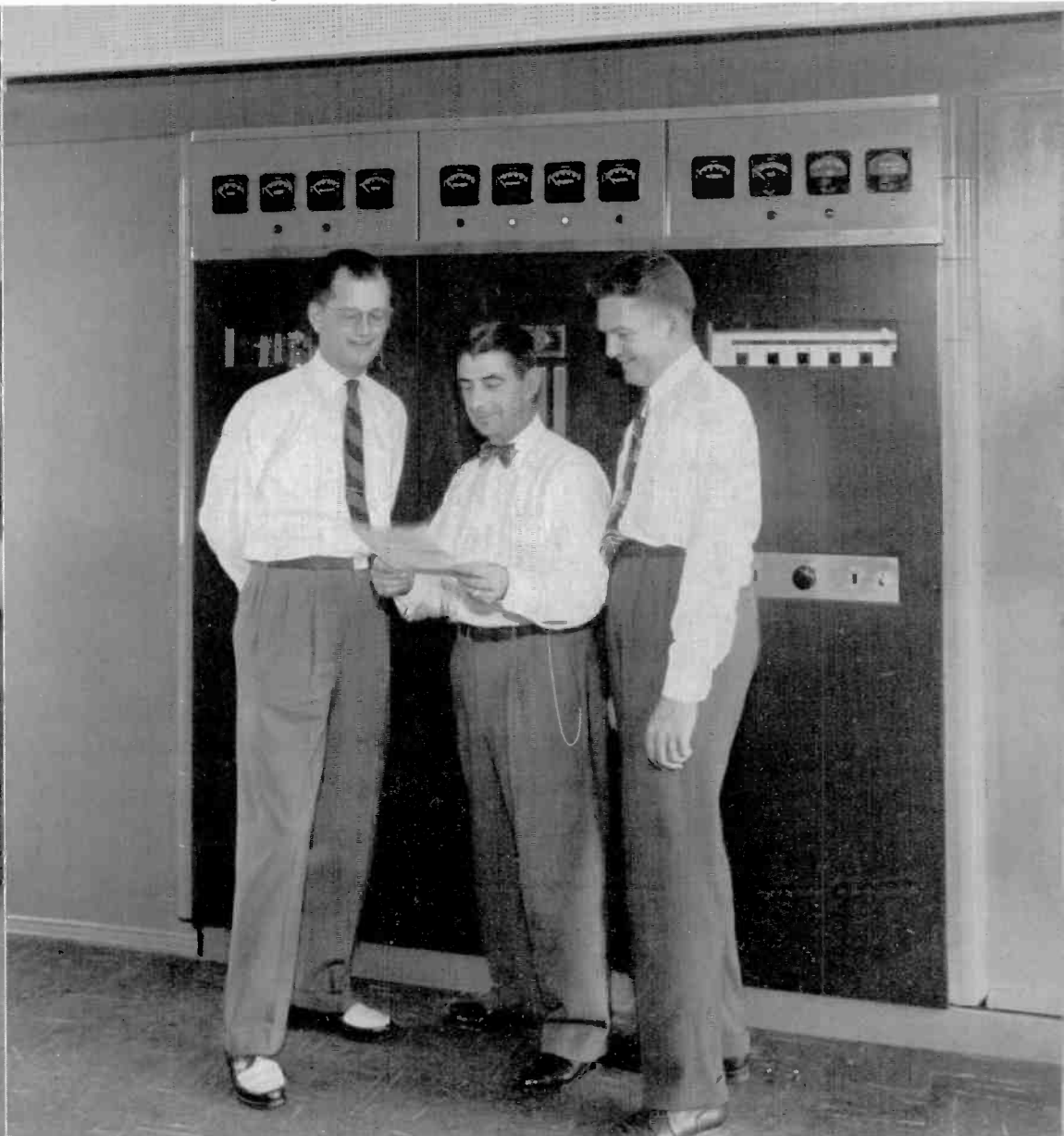

FIG. 3. (below) The flush-mounted 3 KW FM transmitter lends a streamlined appearance to the overall FM setup. Panels on each side of the 3 KW transmitter will be removed to make room for the 10 KW amplifier which is on order. Shown here, left to right, are: L. W. Haeseler, RCA; Walter Rothensies, General Manager, WSBA; and W. G. Eberhard, Technical Director, WSBA.



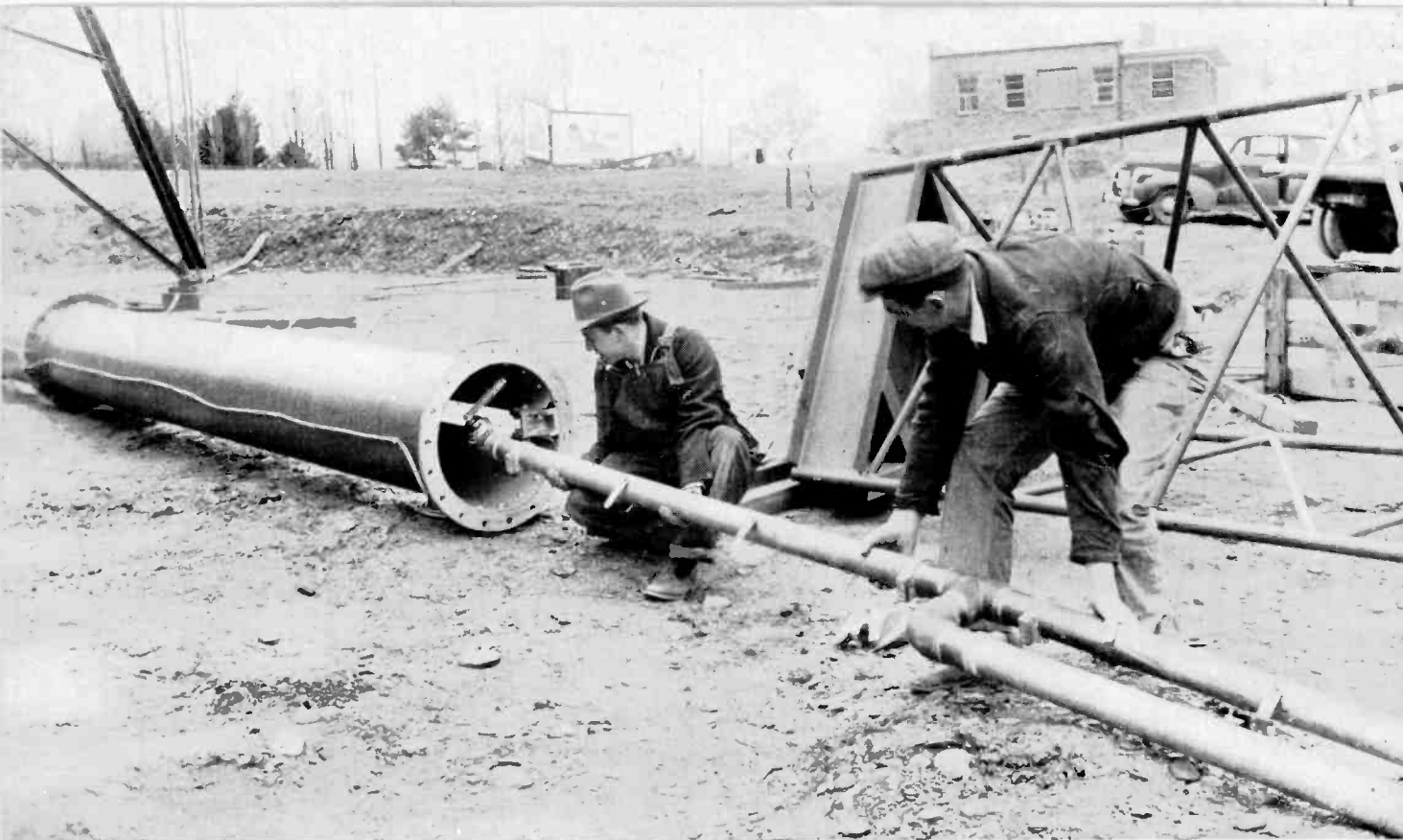

FIG. 5. *In this view the two workmen are installing the transmission line harness inside the metal pylon cylinders. With the pylon antenna only one transmission line connection must be made "in the air."*

(AM) transmitter and the 76-B2 and 76-B4 control consolettes which are set up on a metal desk finished to match the styling and appearance of companion equipment. One consolette carries the AM program while the other handles the FM program. Each consolette has four microphone inputs, two inputs for each of WSBA's studios. Two other inputs are used for turntables, network and remote circuits. Also provided are cueing and talk-back facilities for six remote lines. To the operator's left, facing small studio B, are two 70-C2 turntables equipped with vertical and lateral pickups and 72-C recording heads.

Originally two RCA 9AX Equipment Racks were installed to hold supplemental facilities. The number one rack was the base for the 33-A Jack Panel. All the control equipment was terminated in the jack panel which gave the whole setup a maximum of flexibility and facility. The number one rack contains, in addition to the jack panel, a variable equalizer and attenuator, the 82-C House Speaker Amplifier, the type 94-D Recording Amplifier and three 85-B Pre-Amplifiers. The number two rack holds an RCA 311-A Frequency Monitor, a 66-D Modulation Monitor, and a 96-AX Limiting Amplifier. In addition, a Halli-crafter SX-28 Receiving Set was installed to pick up portions of the British Broadcasting Company, North American Service and other incidental long and shortwave checking and rebroadcasting.

At the present time microphones employed by the station include: three 74-B's, four 41-BX's, and one 77-D. This completes the AM lineup for WSBA with the exception of an OR-1 Portable Turntable and Recorder which have been used extensively and heavily for the past five years, and four 64-B Speakers, two of which are mounted on the control room ceiling, a third in studio A, and the fourth one in the manager's office.

AND NOW . . . WSBA'S 3 KW FM TRANSMITTER

Plans for WSBA-FM began only a little over a year ago and it was then decided to locate the 3 KW FM transmitter approximately 2½ miles south of York, Pennsylvania, on the top of Queen Street hill. The completely new and modern transmitter building (Figure 4) is about five air-line miles from the studios. Dominating the whole hilltop, and indeed most of the beautiful surrounding country, is the two-section RCA 12-B Pylon Antenna, which is mounted atop the 380-foot Trucson, self-support-

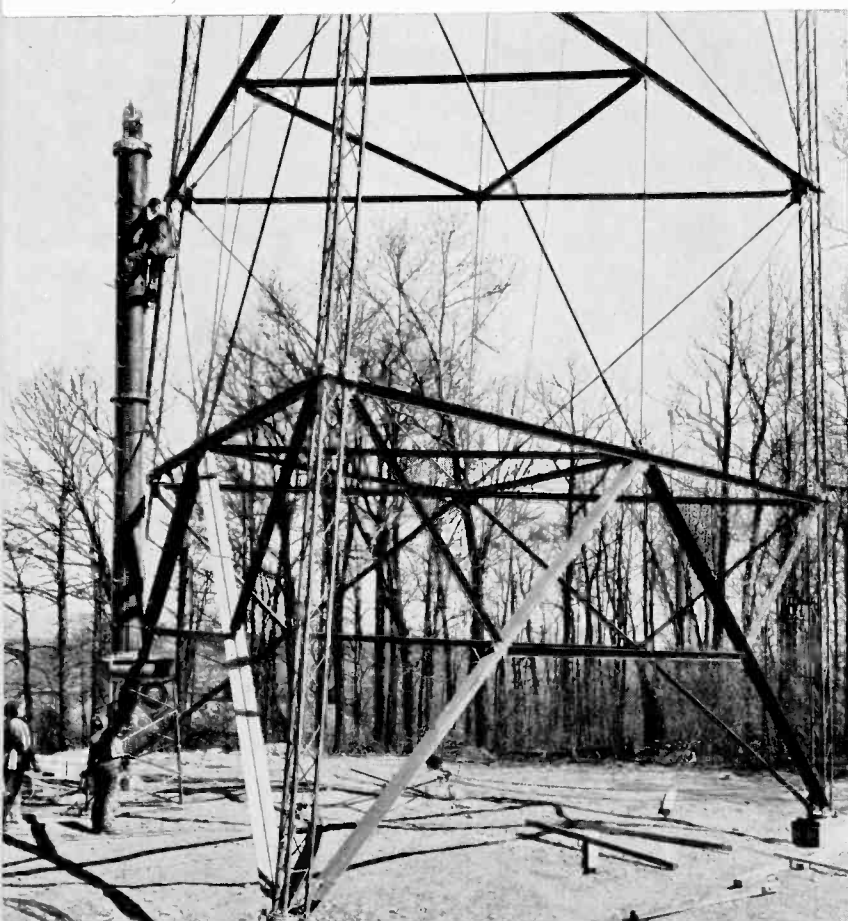

FIG 6. (left) *Here the two-section RCA pylon antenna completely assembled and mounted on the top tower section is ready to start its way up the tower.*

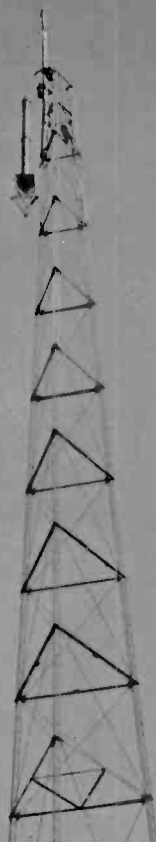

FIG. 7. *The WSBA two-section pylon antenna is hoisted into position prior to being mounted atop the tower.*

ing, steel tower. The photographs (Figures 5 through 8) illustrate how WSBA assembled and installed the RCA Pylon as a complete two-section unit. Completely installed, the Pylon is at an elevation of 1107 feet above sea level. Shown in Figure 7 is the $3\frac{1}{8}$ -inch coaxial cable installed between the FM transmitter and tower.

The RCA BTF-3B, 3 KW FM transmitter is flush-mounted in the south wall of the control room in order to provide a neat, streamlined arrangement in which all controls are easily accessible. The back of the transmitter is situated in an air-exhaust ventilated room (20 feet long and 8 feet deep) which provides an adequate working space around the transmitter. The overall dimensions of the building, which houses the FM transmitter and control console, are 36 feet-6 inches by 22 feet. Contained within is the 17- by 20-foot operating room and an auxiliary studio 9 by 11 feet. A lavatory is also located on the first floor. In the basement is a fully-equipped shop, an oil burner, and powerful exhaust fans.

In the control room are two RCA 9AX Equipment Racks,—one contains the r-f monitoring equipment, while the other rack holds the speech input equipment, three BA-1A pre-amplifiers and one BX-1A Power Supply for low-level circuits. In addition there is a BA-3A Program Amplifier and one 86-A1 Limiting Amplifier. A mixing panel and a BA-4A Amplifier feeding a Jensen speaker completes the FM transmitting plant.

Another 76-B4 Console and two matching 70-C2 Turntables were installed in the studios (5 miles distant) and to these were added the beautiful new 72-DX Recording Heads, complete with suction pump and equalizers. One additional equipment rack was

FIG. 8. (right) *This is how the WSBA tower appears with the two-section pylon mounted in place. Tower and pylon have a total height of 404 feet.*

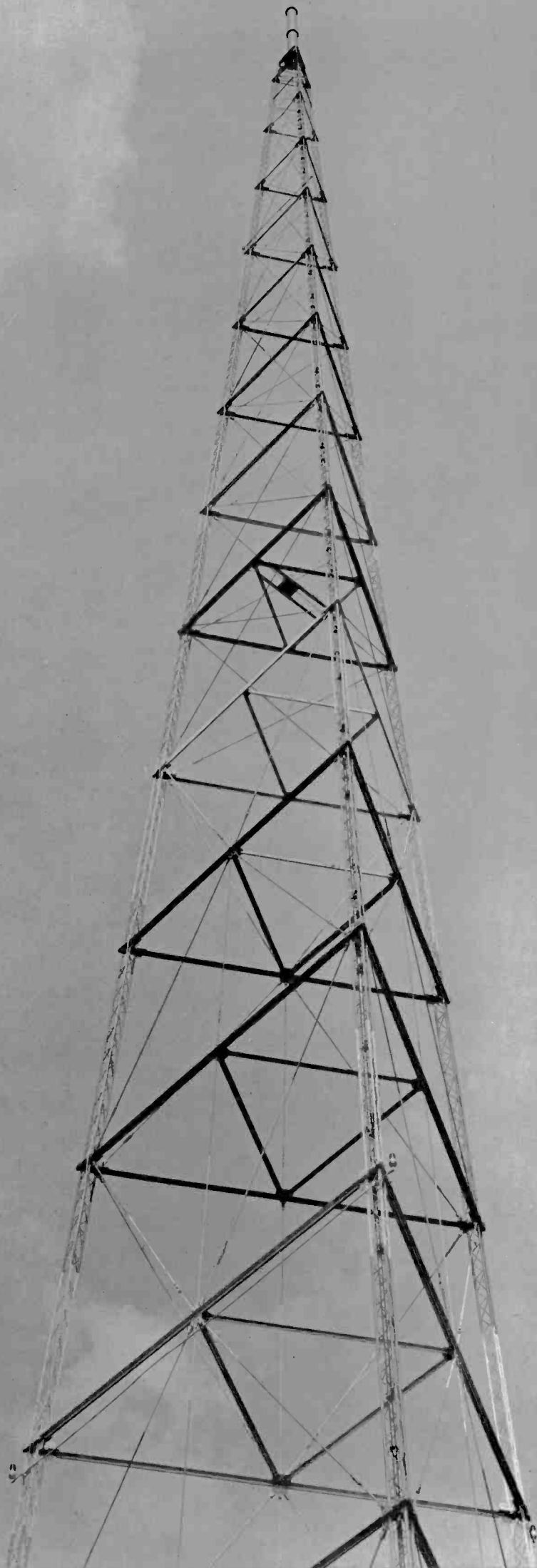



ROBERT A. ELLIOT
Manager, Broadcast Audio Sales

BOB ELLIOT APPOINTED MANAGER OF BROADCAST AUDIO SALES

Appointment of Robert A. Elliot as Manager of Broadcast Audio Sales has been announced by A. R. Hopkins, Sales Manager of the Broadcast and Industrial Section of the RCA Engineering Products Department. Prior to his present assignment, Mr. Elliot supervised export sales of Broadcast Audio Equipment for the RCA International Division. In his new position, Mr. Elliot will direct national sales of RCA's complete line of broadcast audio equipment.

Mr. Elliot joined the International Division of RCA in 1945 and acquired extensive sales engineering experience installing broadcast equipment in many parts of the world, including Europe, Asia, Cuba,

Mexico, and Central and South America. During the war, he was in charge of studio engineering for the Radio Section of the Office of War Information.

Mr. Elliot's wide experience in the radio broadcasting industry began in 1933 when he joined the National Broadcasting Company. After five years with NBC in different capacities, he went to Schenectady in 1937 and became first a time salesman and later assistant evening general manager of radio station WGY.

In 1938 he became studio engineer and night manager of WQXR, in New York City, and thoroughly familiarized himself with the equipment and problems encountered by the studio engineer.

purchased to hold three BA-1A Pre-amps, one BX-1A Power Supply, a BA-3A Auxiliary Line Amplifier and one BA-4A House Monitoring Amplifier. All of this equipment was matched to the AM console so that by means of the jack panel all would be as interchangeable and flexible as possible. The consoles, as shown in Figure 1, are side by side with the speakers overhead and the turntables to the left and right respectively. All wall-type monitoring speakers were converted into three-channel jobs with a selective switch that permits anybody in any office to listen to AM, FM, or Audition at will. The whole operation was fitted into WSBA's physical setup of one large and one small studio, by the addition of another small studio large enough to hold three broadcasters or for single-announcer shows, etc. The interchangeability desired necessitated the design of a signal light system to tell announcers at a glance when their particular microphone operation is open for use by either station. In addition, it informs the announcer whether AM, FM, or a combined station break is to be given.

Testing equipment includes the usual distortion meter, attenuator panel and audio oscillator. These three items are mounted in a cabinet to make them as easily portable as possible. In addition there is a vacuum tube voltmeter and a five-inch oscilloscope.

An STL Transmitter is located in the AM control transmitter room to feed the programs to the FM transmitter. FM test broadcasts were started from the 3 KW transmitter on the 24th of May 1947. Mail response indicates that our equipment is enabling the Susquehanna Broadcasting Company of York, Pennsylvania, to deliver a strong signal to all listeners within its area. So far, cards and letters to WSBA-FM, resulting from the FM broadcasts are full of praise and some humor. As one nearby listener wrote (of the Pylon antenna), "Darn red thing certainly looks like a firecracker, but it sure sounds pretty." And it does! WSBA-FM began broadcasting on a regular schedule to York and York County on 103.3 megacycles, channel 277, during July. Twice in five years WSBA has installed modern broadcast equipment to serve Central and Southern Pennsylvania with a diversified assortment of programs which deal with the

fields of entertainment, information, and education. Now with the RCA FM Pylon looking down over York and adjacent counties, another WSBA Voice of Service will be heard.



"please!"
Join the
MARCH
OF DIMES

JANUARY 15-30



THE NATIONAL FOUNDATION FOR INFANTILE PARALYSIS

FRANKLIN D. ROOSEVELT, FOUNDER

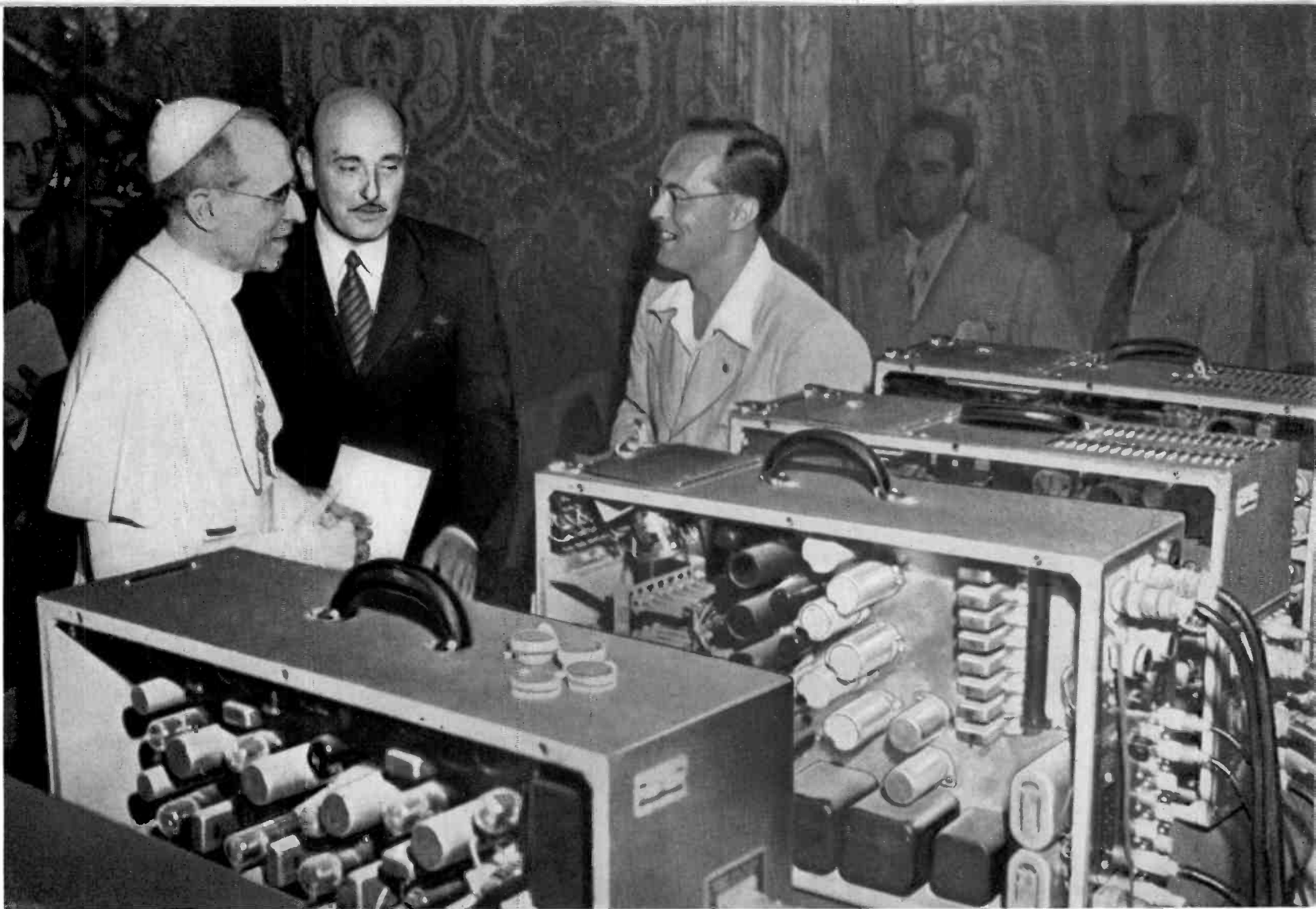

FIG. 1. (above) *His Holiness Pope Pius XII, inspects image orthicon equipment used in televising the Vatican Choir. Originating in the Hall of Consistory of the Vatican, the program was seen by the Pope on the screen of a television receiver installed in his private chamber. Joe Jenkins, RCA Promotion Department television director is explaining the equipment. To the immediate left of His Holiness is Count Enrico Galeazzi, General Director of Technical Services in the Vatican.*

American Television Shown in the Vatican

by **EDW. K. PRICE**

RCA International Division

A special television performance for His Holiness Pope Pius XII was the climax of a series of demonstrations of RCA television equipment and techniques in Italy during June 1947. These demonstrations, made during a two months' tour by a picked crew, included the televising of the Milan Sample Fair, radio shows, and the La Scala Opera. Equipment used throughout was the new image orthicon field pickup gear with its capable companion piece, the microwave relay link.

This "television tour" was arranged by the RCA International Division under the direction of Meade Brunet, Managing Director, and carried out with the cooperation of the RCA distributor in Italy, Telonda International Corporation.

Equipment and a technical staff were assembled in Camden and shipped overseas. RCA's "road show" crew was plumbed and jabbed with vaccine needles, rendered bilingual via U. S. Army language guides, duly passported, and loaded on a DC-4. The equipment, which in addition to television included an FM transmitter, studio consoles, test gear, and an electron microscope—all for exhibition—had been sent across earlier, and necessarily, on four different cargo ships. Inasmuch as the normal power frequency in Italy is 42 cycles, we carried our own power: a 20 KW Diesel-driven generator for studio and fixed installation work, and a 5 KW gasoline job for remote microwave work.

The Milan Fair, one of the outstanding industrial expositions held in Europe each year, was the scene of portable television's postwar European debut. At the Fair we used the theatre of and worked in cooperation with the Italian broadcasting organization, Radio Amministrazione Italia, known as RAI. In demonstrating operable television two correlated methods were used: (a) closed circuit or driven video operation and (b) microwave relay link operation for transmission and reception of remote programs. For example, radio shows in the fair grounds theatre were televised and the video "piped" around via coaxial cable to telesites there and in adjacent buildings. The receivers used were simply standard television receivers

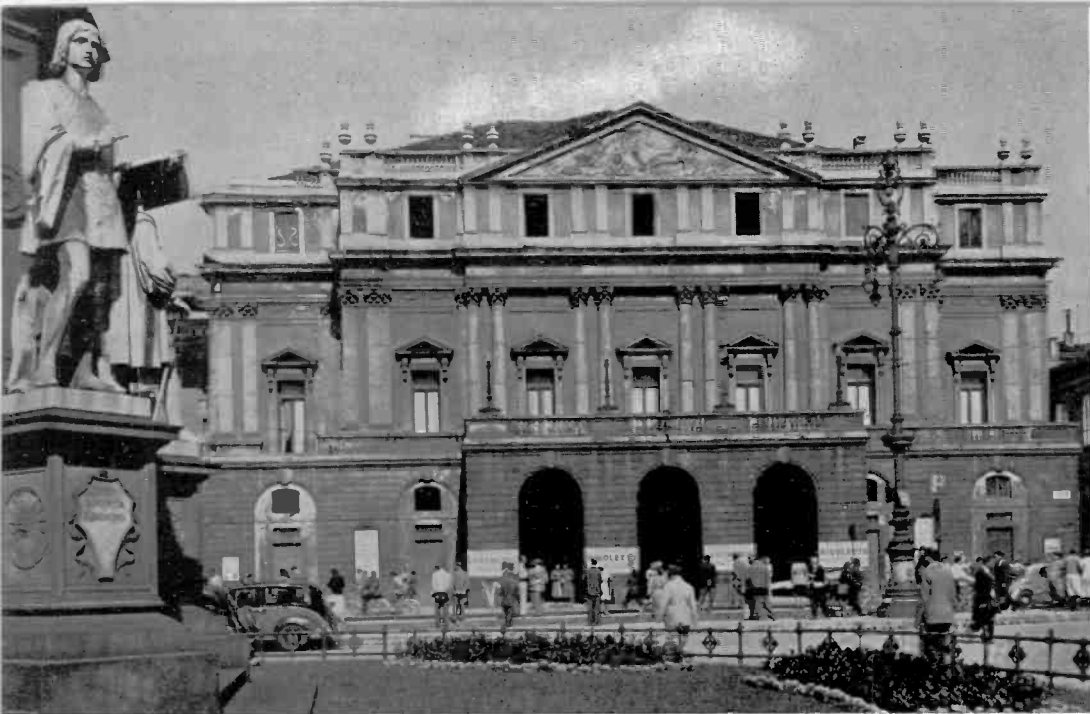
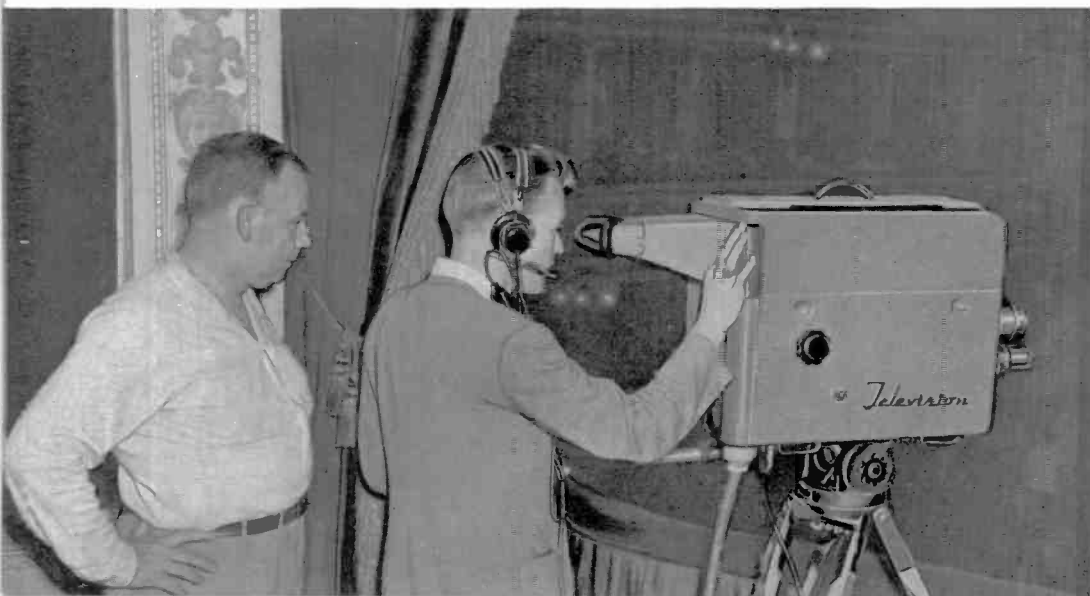

FIG. 2. (above) *La Scala opera house in Milan, wellspring of much of the world's musical culture. The micro-wave relay transmitter was set up on the roof at the rear of the building.*



FIG. 3. (above) *Classic ballet with its sweeping stage routines, made especially good television fare.*

FIG. 4. (below) *Televising from the Royal Box at La Scala where one camera was set up. At left, Dick Hooper, RCA Promotion Manager; at right, the author manning the camera. A second camera was mounted in a side box right off the stage.*



in which the RF sections are shorted out, the picture and sound signals being fed directly into the video and sound circuits. Programs were also picked up and transmitted via microwave relay to fixed points across the fair grounds or across the city of Milan. Equipment demonstrations took place both during the day and at night when special programs such as opera were televised.

Incidentally, we found that in Europe there seems to be a rather definitive distinction between the use of the word "demonstration" there and its use in the U. S. The proper word over there is "manifestation," a term having a positive and more friendly connotation when compared to "demonstration," a more radical term common to bomb-tossing circles.

Arriving in Milan after a 20 day sea trip and a rough trucking from the port of Genoa, the television equipment had undergone negligible damage; and once we had power from the auxiliary generators, pictures were on the receiver screen in short order.

In addition to telesites in the radio theatre, receivers were installed in the Marconi Pavillion, an impressive three-story structure built to commemorate the fiftieth anniversary of the "Father of Radio's" first successful experiment. Marconi Day was June 26, and we had the privilege of televising the building's dedication by the Marconi family. Along with modern electronic equipment displayed by RCA and other manufacturers, both European and American, this building contained a very interesting museum of Marconi's early inventions. For instance, Marconi's first crude receiving set was on display. It was housed in a rather familiar looking "period" cabinet, faintly labeled: "25 Sigari" (25 cigars).

One of the technical highlights of the Milan Fair was the televising of grand opera and ballet and its transmission via microwave relay link. On June 17, 18, and 19, for the first time in history, the world famed La Scala Opera was televised and this musical art form transmitted to a remote point. At receivers in the fairgrounds three miles away the video and music were beautifully blended in individual closeup shots, long orientation shots, and sweeping stage panoramas. Sound and music were transmitted on radio program lines and coordinated with the video received at the fair. In "surveying" the job we had spent several days and nights attending rehearsals to check lighting and camera angles, crawling

through backstage scenery (81 backdrops!), and climbing all over the 200 year old roof establishing line-of-sight positions.

The advantages of portability and flexibility in field pickup and relay equipment became evident in televising a job such as this. The image orthicon gear with its eight individual units presented no great logistics problem: the "suitcases" were simply picked off the truck and carried into the opera house. Any of the relay link components are light and small enough to be carried by one man; so the problem of over-the-stage cat-walks and spiral staircases up to the La Scala roof was simplified. The four foot parabolic "dish" was somewhat unwieldy for one man, but a stout piece of clothesline dropped from the roof to a convenient window took care of this. Interchangeability of the 24-conductor camera and relay-control cable was a helpful advantage, especially on a remote job where camera locations are subject to quick change, or where some building must be circumvented to gain line-of-sight location. Thus it was necessary only to carry one type of spare cable; and the 50, 100, or 200 foot lengths could be connected either to extend a roof-top relay mounting, or to change a camera location, say to an outside balcony or down to the marquee.

Two cameras were used for television's operatic premier: one in the former Royal Box and the other in a side box close to the stage. The control room was a small room adjacent to the Royal Box. Our power truck was parked in the street next to the opera house and lines were run into the control room and up to the transmitter and transmitter control on the roof. On the first evening the ballets "Coppelia," "Invitation to the Dance," and "Three Cornered Hat" were televised. On the succeeding two nights during which the operas "Madame Butterfly" and "La Traviata" were presented, acts sufficiently lighted for good picture quality were also televised and transmitted. The microwave receiver parabolic "dish" was installed on the roof of the Palace of Sports building at the fair, and the video fed to the receivers in the nearby radio theatre. Once "dish" alignment was established between the opera house and the fair and the link checked out, the relay equipment was operated unattended, power being switched on in the control room down below.

During the war the beautiful old La Scala opera house had been almost com-

FIG. 5. (right) The actual first evening televised program of the ballet which was transmitted from La Scala to the fairgrounds 3 miles across the city of Milan.

FIG. 6. (below) The auditorium at the Milan Sample Fair where transmitted La Scala programs were picked up and shown on television receivers. Radio shows of the Italian Broadcasting Company originated here and were televised as part of the program.





FIG. 7. Shown here (left to right) are Giuseppe Biando, President of Teoranda International Corporation, Carlos Villavazo of RCA Intern'l Division in Madrid, Spain, His Holiness, Pope Pius XII, and Michael Ramalli of RCA Intern'l Division, New York.

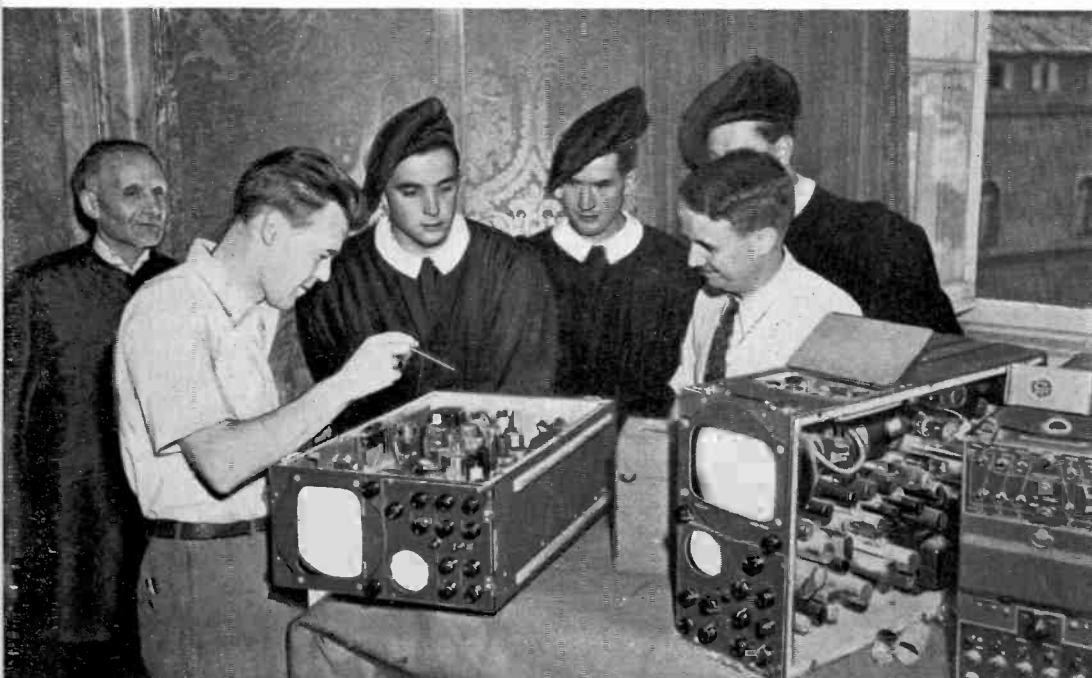
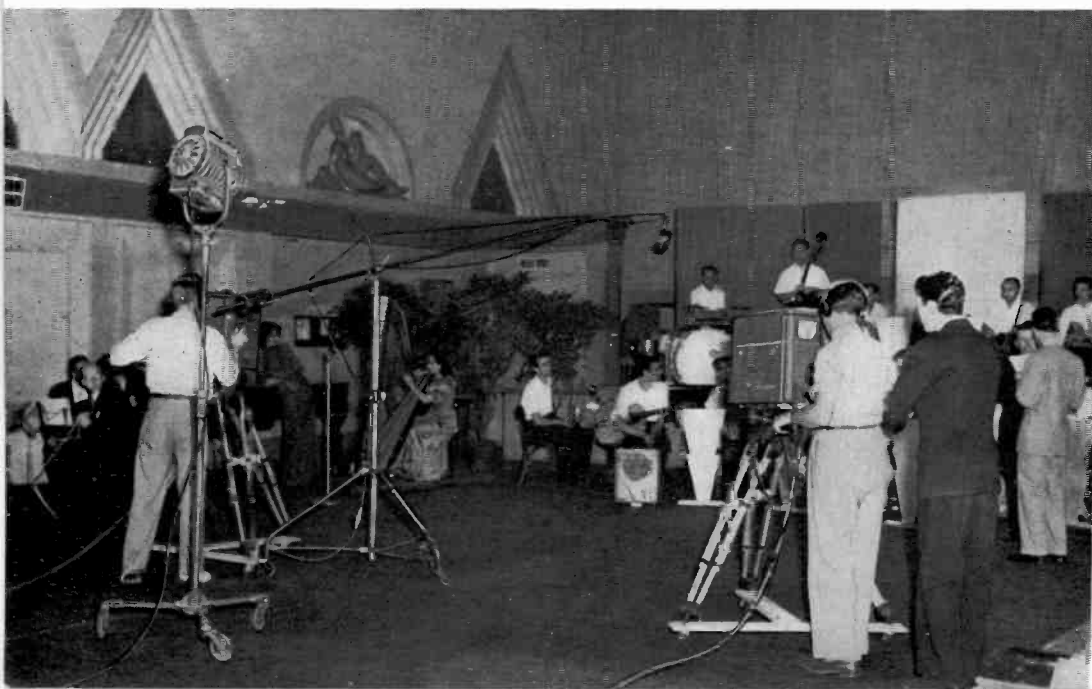

FIG. 8. (above) The Vatican's famous Swiss Guard put aside their 17th century spears, as RCA engineer John Roe, and the author explain modern television equipment.

FIG. 9. (below) The RCA crew televising a radio program in the modernistic studios of IIRO (Italian Broadcasting Company) headquarters station in Rome.



pletely demolished, but through monetary contributions from both home and abroad and a great deal of meticulously hard work, this fabulous structure was rebuilt in one year as closely to the original as possible—from the marble floors and brocaded walls right up to the 24 carat gold leaf ceiling.

Television engendered enthusiasm at La Scala. So that he could watch the program on the screen, we installed a monitor receiver in the office of the manager. On the first night just before the ballet's intermission, we went down to check the video and sound. The receiver had originally been mounted on a small table in the office but when we arrived, we found the table up-ended and standing in the doorway, with the receiver perched precariously on top of it. The corridor was filled with people—stage hands, ballerinas, and radio personalities, all watching the show. Some of them didn't leave the hallway for over two hours. The manager himself was delighted with the idea that he could remain in his office and watch his artists at work if he so desired.

In addition to the opera, programs originating at the fair radio theatre were picked up and transmitted about the grounds to receivers in three different locations, the relay link receiver supplying one building, and coaxial cable feeding the other two locations. Italian radio programming seems quite similar in format to that of the United States; symphonic, quiz programs, variety music (42 accordions on one stage) and operas de sapone (soap operas to us). For us Americans it certainly lent zest to the job to be able to televise live musical programs. Other features such as the visits of the American Ambassador, James Dunn, Italian Premier de Gasperi, and other notables, came before our cameras.

The language barrier presented some problems in operating in a foreign country; but as we found during our Mexico television tour last Fall, years of amateur radio have given common currency to many radio and electrical terms; and in speaking with strictly technical people we managed moderately well. However, your American ego undergoes a considerable deflation when you suddenly realize that, in Italy, even the cab horses can understand some Italian!

Upon the conclusion of the Milan Fair on June 29, our television equipment was packed up and trucked down to Rome

where it was to be demonstrated to His Holiness Pope Pius XII at the Vatican. The equipment arrived in Rome July 7 and was taken to Vatican City, set up and tested in a building adjoining the private chambers of the Pope. On the following day we moved into the Hall of Consistory where the televised program was to originate. Two cameras were used in the Hall, the corner of which was made into a temporary studio. One 10-inch table model receiver was installed in the private chamber and five others in adjoining reception rooms. Inasmuch as the operation was to be confined to a single building, use of the relay link was unnecessary; so the receivers were line-driven for video and sound. The short program consisted of the singing of madrigals by the Vatican Men's Choir. At 6 P.M. the Pope entered his private office where the television receiver was located and seated himself before the screen.

As the choir sang, the Pope held before him a large manuscript of the music, following the notes page by page. At the conclusion of the program His Holiness was escorted to the Hall of Consistory where he first received and congratulated the choir and next viewed the cameras and studio equipment. One of the cameras had been "dollied" across the floor into close vicinity to the monitor equipment so that it was possible for one to "see himself" being televised. The Pope's greatest enthusiasm was concerned with the picture clarity and definition; and it was with marked surprise that he turned to the camera control screen and viewed his own picture in "close-up".

The Vatican operation was one of the most pleasant and smoothly coordinated jobs of our television tour. This was largely due to the splendid cooperation of the Vatican radio station personnel and to the efforts of Count Enrico Galeazzi, General Director of Technical Services in the Vatican.

Our last "manifestation" in Italy was the television of a radio program originating at the headquarters station of the R.A.I. organization in Rome where Premier de Gasperi and high government officials were the guests. A typical orchestral program was presented along with a short fashion show. At its conclusion, the tour was officially "wrapped up" and the equipment packed for overseas shipment—to Toronto, Canada, where we made the deadline for the Canadian National Exhibition in September.

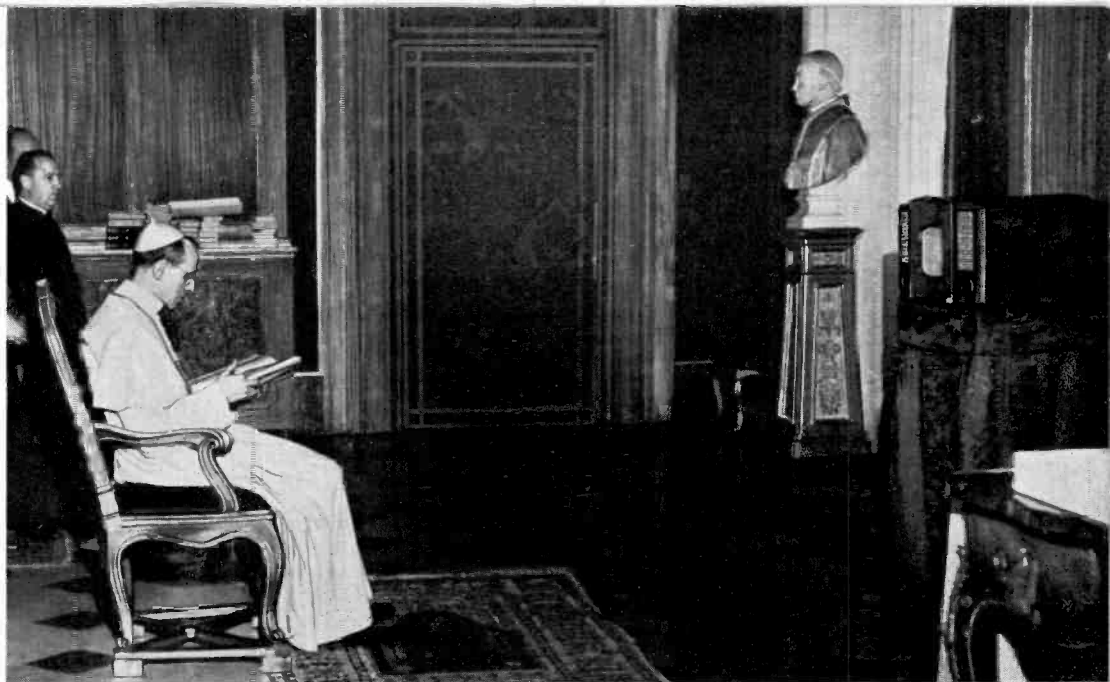
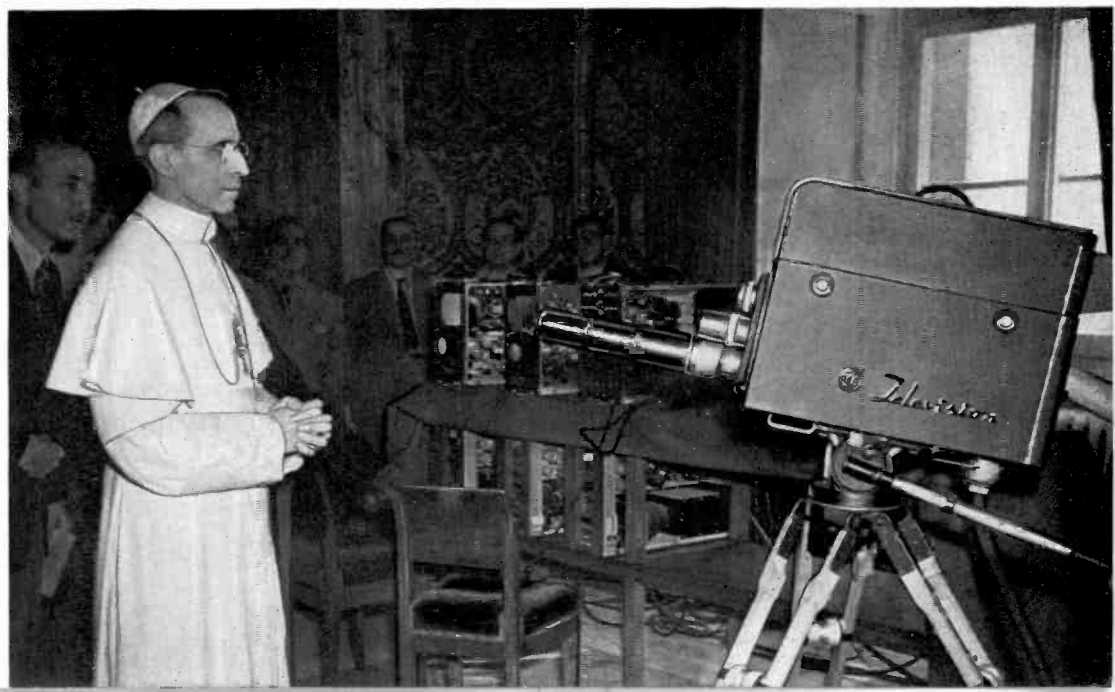

FIG. 10. (above) His Holiness Pope Pius XII seated in front of the television receiver in his private chamber. Here he both saw and heard the program of the Vatican Choir, meanwhile following the music of the manuscript.

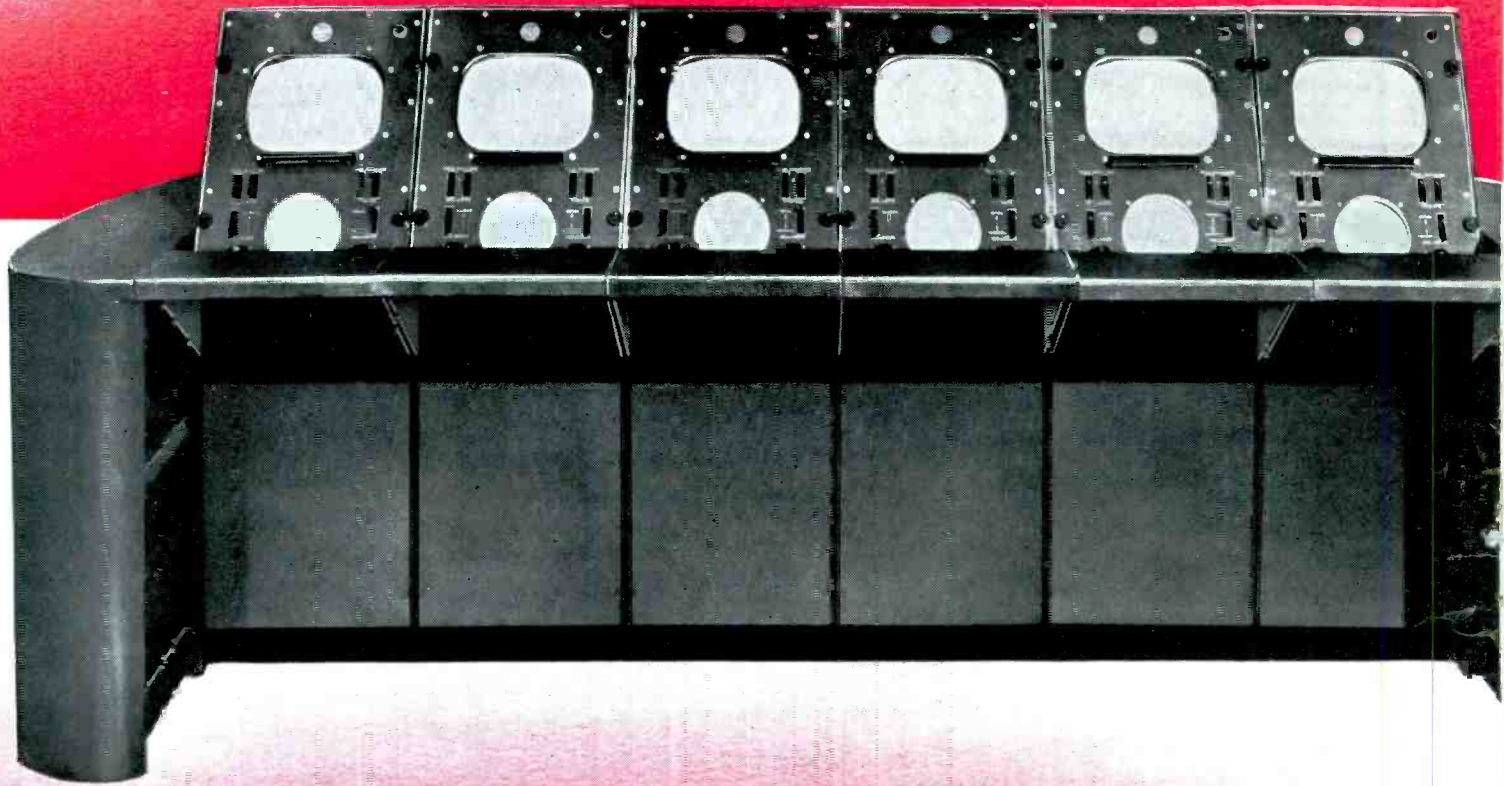

FIG. 11. (above) The Pope inspects the image orthicon camera equipment set up in the Hall of Consistory in the Vatican. Joe Jenkins describes the equipment.

FIG. 12. (below) His Holiness stands in front of the camera where he can be televised and watch himself on the monitor screen at the same time.



Now... a deluge



THE NUMBER OF UNITS DEPENDS UPON THE SIZE OF YOUR STATION

CAMERA MONITOR SECTION
(ONE FOR EACH STUDIO
AND FILM CAMERA)

PROGRAM MONITOR SECTION

PREVIEW MONITOR SECTION



HOUSING END SECTION
(LEFT END)

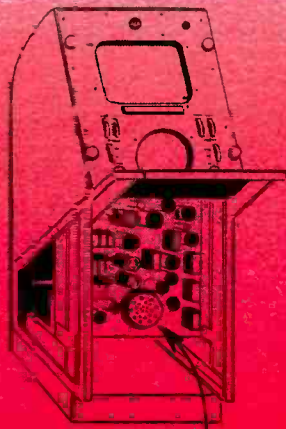

CAMERA CONTROL UNIT

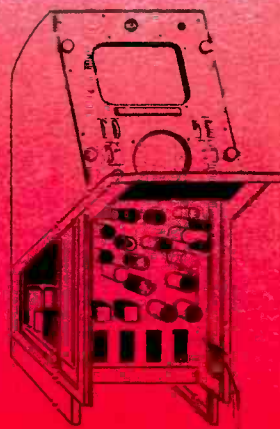

CAMERA SWITCHING UNIT

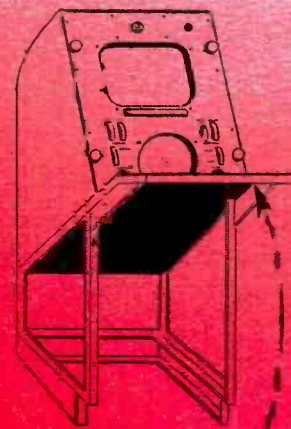

ON-THE-AIR
CAMERA SWITCH

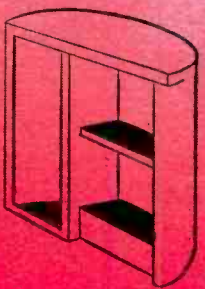

HOUSING END SECTION
(RIGHT END)

Studio Console

for smooth video programming

Includes every practical facility and refinement for monitoring, dissolving, fading, and switching.

HERE'S THE CONSOLE that puts all electronic aspects of television programming "under control." It is already in production at RCA.

It contains everything needed to monitor, control, and switch the outputs of several studio cameras, film cameras, and network lines. Ten-inch Kinescopes provide for direct picture monitoring; five-inch oscilloscopes for checking video signal components. It's easy to increase picture brilliance, adjust contrast and focus, and provide proper shading.

Complete switching facilities centralize the selection of all video program material . . . permit push-button control of closeups, long shots, film commercials, station breaks, fadeouts, dissolves, wipes, special effects, and network programs.

Engineered with an eye to the future:

The number of units in the video console depends upon the size of your station. RCA's "add-a-unit" design gives you a compact, unified console, whatever your requirements . . . permits easy and economical addition of extra units as your

station expands . . . without discard of any original equipment.

To co-ordinate all programming directions, provision has been made for telephone communication between key studio personnel and console operators.

This console, we believe, is a real contribution to convenient video control . . . another step by RCA to assure smoother studio programming . . . more interesting, more dramatic telecasting. We'll be glad to make specific recommendations for your station. Write Dept.

Normally, two operators handle a 5-monitor console . . . one selects the "on-the-air" signal at the request of the program director; the other has technical control of the individual cameras.



TELEVISION BROADCAST EQUIPMENT
RADIO CORPORATION of AMERICA
ENGINEERING PRODUCTS DEPARTMENT, CAMDEN, N.J.

In Canada: RCA VICTOR Company Limited, Montreal

Now...

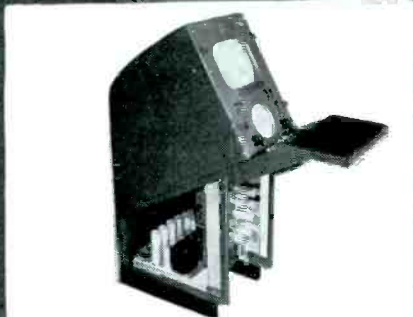

This RCA Switching System consists of a master "on-the-air" monitor and oscilloscope, a waist-high control panel (enlarged view, above) and mixing amplifier, below. This equipment becomes one of the standard-size sections of RCA's unit-built video console (top of page). Any combination of camera-controls and monitors is possible to fit your particular station.

split-second selection of all television program material

New RCA Camera Switching Unit provides convenient, push-button control at your video console

HERE, in one compact unit, is a control center for your television programs. Into it can be brought as many as six video inputs—from studio cameras, film cameras, relays, and network. One operator can handle the lot!

Twelve different types of switching are your assurance of a smooth, dramatic presentation, whatever the program. Look at the possibilities:

Your operator can *instantly* switch: (1) between two local camera signals; (2) between two remote signals; (3) from local to remote; (4) from remote to local; (5) from local to black screen (no signal); (6) from remote to black (screen); (7) from black to remote. With the special manual fader control he can, *at any desired speed*: (9) fade out local to black; (10) fade in local from black; (11) lap-dissolve between any two locals; (12) superimpose two locals and adjust the level of each. All sorts of trick effects are possible by moving the two levers that make up the fader control.

Tally lights provide an instant check on which input is being used and whether a remote signal is being received. If remote sync fails for any reason, local sync automatically takes over.

The monitor in the top of the console section allows the operator to either view the on-the-air signal or preview one of the two remote signals.

An unusually flexible intercom switching system (not shown) is included to permit private, special-group, or conference communication between practically all personnel. All have access to program sound through one earpiece of their headsets.

Here, we believe, is a switching system that represents the most advanced engineering in television station techniques. It will help you simplify television station routine—bring new possibilities to television programming. Be sure to get the complete story. Write Dept. 30-L, Radio Corporation of America, Engineering Products Department, Camden, N. J.

FADING CONTROL

MONITOR SWITCH

3-position: program line, either of two remotes

GAIN FOR REMOTE INPUT (#6)

REMOTE INPUTS

RELEASE BUTTONS

TALLY LIGHTS

and switches for remote sync

CAMERA SWITCHES

(2 rows) handle 4 inputs from studio and film cameras and 2 remotes to permit fading, instantaneous switching, special effects.

TALLY LIGHTS

for six inputs

GAIN FOR REMOTE INPUT (#5)

PROGRAM SOURCES

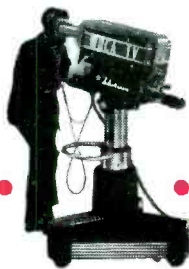

RCA Studio Camera (Switching Unit handles up to four)



RCA's Mobile Studio (Switching Unit can handle two remotes)



RCA Film Camera (Switching Unit handles two with 2 studio cameras)



TELEVISION BROADCAST EQUIPMENT
RADIO CORPORATION of AMERICA
ENGINEERING PRODUCTS DEPARTMENT, CAMDEN, N.J.

In Canada: RCA VICTOR Company Limited, Montreal

CONTACT YOUR NEAREST RCA FIELD ENGINEER

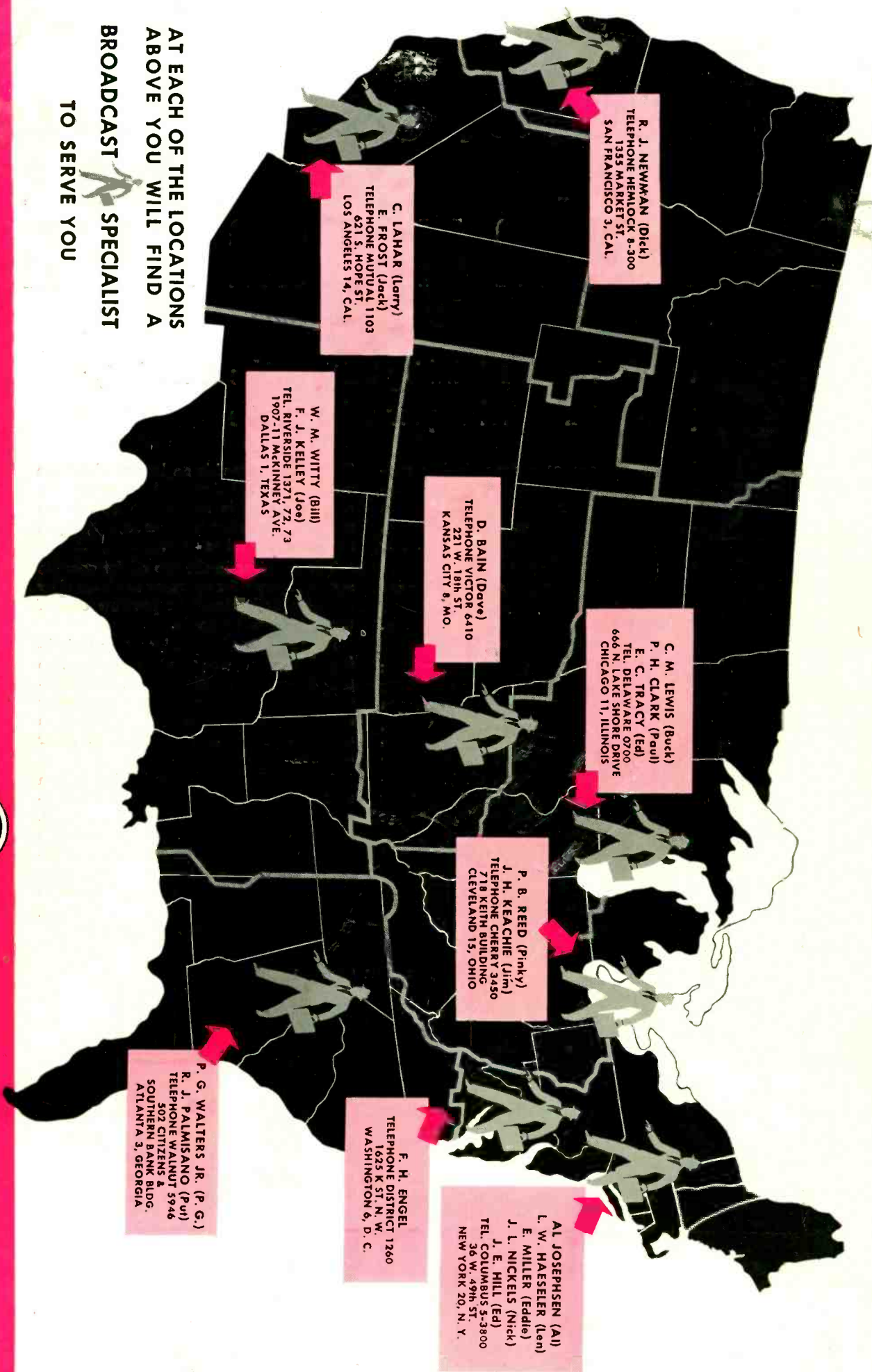

R. J. NEWMAN (Dick)
TELEPHONE HEMLOCK 8-300
1335 MARKET ST.
SAN FRANCISCO 3, CAL.

C. LAHAR (Larry)
E. FROST (Jack)
TELEPHONE MUTUAL 1103
621 S. HOPE ST.
LOS ANGELES 14, CAL.

W. M. WITTY (Bill)
F. J. KELLEY (Joe)
TEL. RIVERSIDE 1371, 72, 73
1907-11 MCKINNEY AVE.
DALLAS 1, TEXAS

D. BAIN (Dave)
TELEPHONE VICTOR 6410
221 W. 18th ST.
KANSAS CITY 8, MO.

C. M. LEWIS (Buck)
P. H. CLARK (Paul)
E. C. TRACY (Ed)
TEL. DELAWARE 0700
666 N. LAKE SHORE DRIVE
CHICAGO 11, ILLINOIS

P. B. REED (Pinky)
J. H. KEACHIE (Jim)
TELEPHONE CHERRY 3430
718 KEITH BUILDING
CLEVELAND 15, OHIO

F. H. ENGEL
TELEPHONE DISTRICT 1260
1623 K ST. N. W.
WASHINGTON 6, D. C.

AL JOSEPHSEN (Al)
L. W. HAESELER (Len)
E. MILLER (Eddie)
J. L. NICKELS (Nick)
J. E. HILL (Ed)
TEL. COLUMBUS 5-3800
36 W. 49th ST.
NEW YORK 20, N. Y.

P. G. WALTERS JR. (P. G.)
R. J. PALMISANO (Pui)
TELEPHONE WALNUT 5946
502 CITIZENS &
SOUTHERN BANK BLDG.
ATLANTA 3, GEORGIA

AT EACH OF THE LOCATIONS
ABOVE YOU WILL FIND A
BROADCAST SPECIALIST
TO SERVE YOU

WHERE EXPERIENCE COUNTS MOST



AM • FM • TELEVISION