

**TK-47 Cameras Handle Strong Competition  
On-Location for TPC Communications**

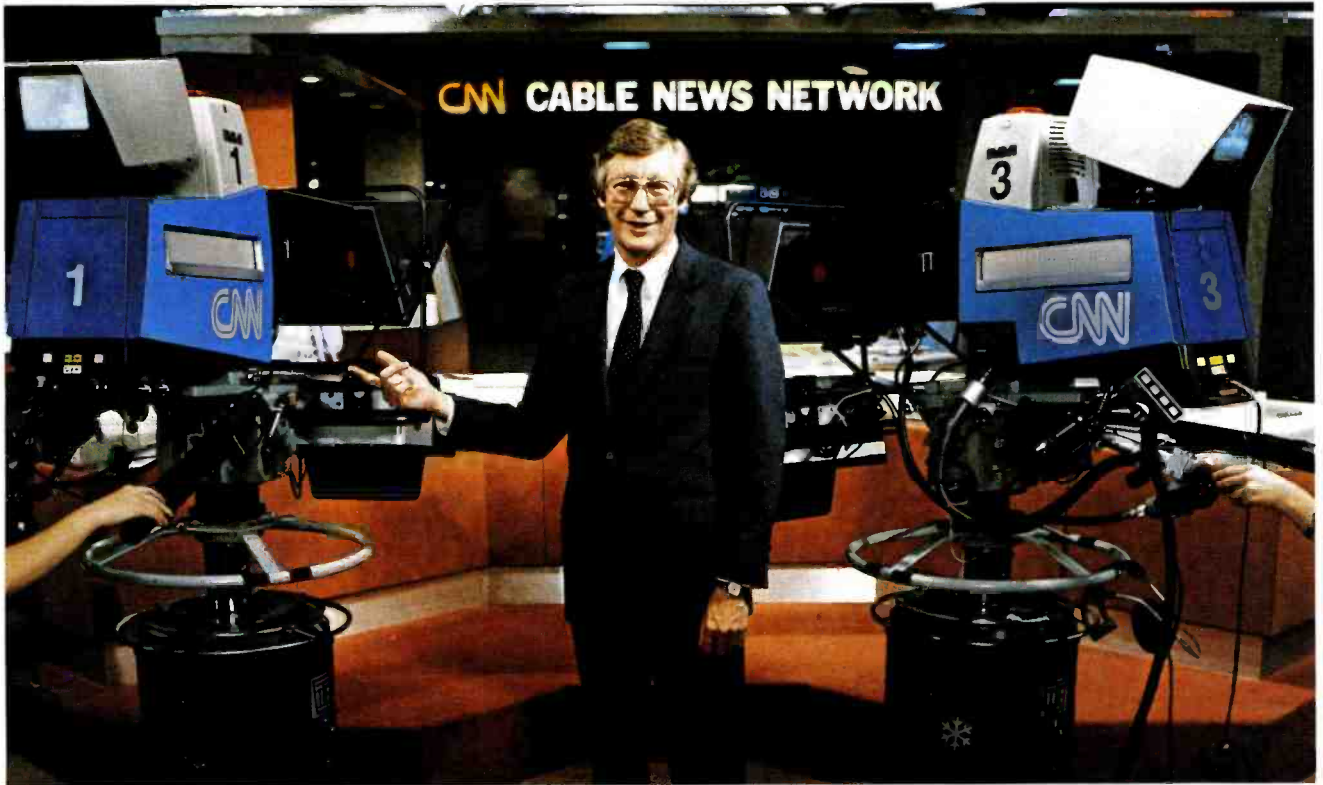

...Gene Wright, Vice President of Engineering, Turner Broadcast Systems

# 24 HOUR NEWS

## “Around-the-clock operation doesn't faze our TK-47 cameras”

Turner Broadcast Systems operate eight RCA TK-47 Automatic Color Cameras. Four of the cameras are live 24 hours a day at Cable News Network. They're never turned off. Four other TK-47's are used in the WTBS system.

How are the cameras performing? Let Gene Wright tell you:



“ Our TK-47 cameras are on all day long at CNN and they've performed outstandingly. They don't drift; they're extremely stable. But just as a confidence check, from time to time, we push the auto-check button. In a matter of seconds, over fifty camera functions are checked and stabilized. That's real operating confidence. With the kind of 'round-the-clock demands we make on equipment, we have to know that our cameras will deliver quality pictures with the best stability and reliability. Our TK-47 cameras are doing the job for us...helping us

” deliver all the news, all the time. Find out how the TK-47 can give you a new "look" in cost saving, time-saving, and picture quality. TK-47—it's automatic, versatile and now available in Triax. Call your RCA Representative and ask for a showing of a tape in which six top engineering professionals tell how they are using TK-47's in their broadcast and teleproduction operations. You'll see why the TK-47 is first choice for savings and performance. RCA Broadcast Systems, Bldg. 2-2, Camden, NJ 08102.



Page 6

### TPC's StarTruck Drives In the Fast Lane

With seven cameras, six VTR's, video switching and a comprehensive audio complement aboard, TPC Communications' StarTruck is a self-contained television production facility on wheels. A track record of quality road performances keeps StarTruck booked and travelling.



Page 10

### KTVU's Magnificent New Broadcast Center

The striking new facility built by Cox Broadcasting Corp. on the Oakland waterfront is the end product of careful planning, committed management and a \$20 million investment. KTVU's remarkable state-of-art technical center is featured in this article.



Page 20

### Cleveland's New UHF Operates Commercial and STV

WCLQ-TV operates commercial by day and STV at night from a combined technical center and transmitting plant. Master Control and production functions are centralized in one spacious area which permits efficient operation with a limited staff.



Page 26

### KCPQ-TV, Tacoma, Goes Commercial With CP Transmission System

When Kelly Broadcasting put TV-13 back on-air, the change was very noticeable. A new tower with a circularly polarized antenna and a 60 kW transmitter provide extended coverage of the market with a more powerful, consistent signal. Viewer response to the strong signal and new programming has been positive.



Page 32

### Milwaukee's Newest TV Tower and Transmitting Plant

Commercial Ch. 18 (Gaylord Broadcasting) and Public Ch. 10 and Ch. 36 cooperated to build a new tower and transmitting plant—with mutually beneficial results: added power, improved signal, and better coverage for all. Planning and installation of the tower, antennas and transmitting facilities are covered.

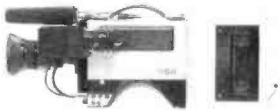

Page 38

### HAWKEYE: The Broadcast Quality Recording Camera System

First introduced at the 1981 NAB Convention, RCA's HAWKEYE Recording Camera System effectively demonstrated the potential of this exciting concept. An overview of the innovative technological achievements as well as the design philosophy from which this recording camera system evolved is presented here.



Page 44

### TK-47T: A NO-COMPROMISE TRIAX CAMERA SYSTEM

A design constraint in developing the TK-47T Triax Camera was that it had to be accomplished without compromising camera performance. Frank Davenport, Chief Engineer, RCA Jersey Ltd. tells how it was done.



**SATCOM III SATELLITE GETS ITS "TOP HAT"**  
 Engineers lower feed-horns and antennas to the RCA Satcom III-R commercial communications satellite. The C-band array will provide complete coverage of the contiguous states and Alaska, as well as a spot beam to Hawaii. The satellite is being assembled at RCA Astro-Electronics, Princeton, N. J., for RCA American Communications, also in Princeton.

### RCA's Third Communications Satellite Readied For Launching

The third in RCA's series of domestic communications satellites is being readied for launching from NASA's Kennedy Space Center in Florida.

The spacecraft will serve customers in the cable TV industry when it is placed in a geosynchronous orbit at an altitude of about 23,000 miles.

Developed and built by RCA Astro-Electronics in Princeton, N. J., for RCA American Communications, also of Princeton, the spacecraft has 24 channels, each capable of carrying an FM/color TV transmission.

The 2,385-pound satellite will go aloft on a Delta 3910/PAM-D launch vehicle and will be placed in a 132-degree west longitude orbital position over the equator. It will provide high-quality reception for millions of cable TV subscribers and give them a wider choice of cable and pay TV programming.

The first RCA Satcom was launched in 1975 and the second in 1976. They are providing a wide range of communications services for government and commercial customers in the U. S.

The spacecraft are controlled from tracking, telemetry and control earth stations at Vernon Valley, N. J. and South Mountain, Calif. An antenna at Astro-Electronics monitors spacecraft performance.

The RCA Satcoms are basically repeater stations, receiving signals from various earth locations and beaming the signals back down to about 1,400 receiver antennas.

Without the spacecraft, thousands of miles of ground cables and microwave links would be required to perform the same task. Satellite channels not used for TV can carry 1,000 voice circuits or 64 million bits-per-second of computer data.

The space vehicles are self-contained and have attitude control thrusters, thermal control, propulsion, ranging and telemetry equipment.

In addition to its commercial services, RCA American Communications provides earth stations for use by NASA, the Department of Defense, the National Oceanic and Atmospheric Administration (NOAA), the Voice of America and other governmental organizations.

### Dr. Robert Hopkins Elected Fellow of SMPTE

Dr. Robert Hopkins, manager of field camera engineering and product management for RCA Broadcast, has been elected a Fellow of the Society of Motion Picture and Television Engineers.

SMPTE Fellowships are conferred on members of the Society who, because of their proficiency and contributions, are considered to have attained a super-



rior rank among engineers or executives in the motion picture, television or related industries.

Dr. Hopkins serves as the chairman of the SMPTE Committee on New Technology, and his standards committee work has led to the development of worldwide digital video compatibility. Through his leadership the Society's international scope of activities has been expanded significantly.

Dr. Hopkins joined RCA in 1964 as a member of the technical staff of the RCA David Sarnoff Research Laboratories, Princeton, N. J., a position he held until 1976 when he joined RCA Broadcast Systems.

Dr. Hopkins was graduated from Purdue University with a bachelor of science degree in electrical engineering, and earned his master's degree and his Ph.D. from Rutgers University.

### Jerry E. Smith Appointed Director, Domestic Sales



Jerry E. Smith has been promoted to Director, Domestic Broadcast Sales.

Based in Camden, Mr. Smith is responsible for an organization selling RCA's line of radio and television studio and transmitting systems throughout the U. S. Previously, he was manager, Southern Broadcast Sales.

Before joining RCA in 1965 as a sales engineer, Mr. Smith was vice president—engineering, for KRIS-TV, Corpus Christi, Tex.

A native of Wichita Falls, he attended Midwestern University there.

### Venezuelan TV Network, Venevision, Expands With \$3 Million In RCA Broadcast Equipment

The Corporacion Venezolana de TV (Venevision) in Caracas, Venezuela is increasing the teleproduction, outside broadcast and newsgathering capabil-

ities of its TV station network with the installation of RCA broadcast equipment valued at approximately \$3 million.

The equipment order includes ten TR-800 one-inch video tape recorders, two TH-50A portable recorders, four TK-47 automatic studio cameras and six TK-86 hand-held cameras. The order also includes a mobile program production van equipped with four TK-780 triaxial cameras, designed for cable runs of up to 5,000 feet.

The TK-47 cameras will be used in a new teleproduction studio at Venevision's program production and origination center in Caracas. The TK-86 hand-held cameras will be used for electronic newsgathering and on-site program production by Venevision's television stations. The new mobile van will join two existing outside broadcast units designed and equipped by RCA for Venevision. The new RCA recorders mark Venevision's entry into one-inch tape operation and will augment the company's extensive RCA quadruplex video tape facilities.

### **KOKH-TV, Oklahoma City, Installs Three RCA TK-47 Cameras**

KOKH-TV, a commercial UHF station serving Oklahoma City, has installed three RCA TK-47 studio cameras to improve program production and origination.

The cameras give KOKH-TV top quality program origination capabilities, according to D. K. Hart, chief engineer at the station.

Studio 25, an Oklahoma City teleproduction firm owned by Blair Broadcasting, parent company of KOKH-TV, also will use the RCA cameras in its complete program production facilities.

### **KRBK-TV, Sacramento, Modernizing With RCA Studio Equipment Purchase**

Koplar Communications of California Inc., is modernizing the company's recently acquired television station in Sacramento, Calif. with RCA television equipment valued at \$1.6 million.

The equipment for independent KRBK-TV (formerly KMUV-TV), Channel 31 includes four TH-280 one-inch video tape machines, which feature three-hour recording capability, and associated time base correctors. A TH-50 portable recorder will be used for on-location production assignments, along with a TK-86 hand-held camera.

Also included in the purchase were two TCR-100A video tape cartridge machines, along with two complete TK-29 telecine systems, including three TP-66 16mm Projectors and an FR-35B 35mm Projector. One system is used for air operations. The second film island is

equipped with a TK-29C Teleproduction Telecine Camera and the servo-controlled FR-35B Projector. This system is extensively used for dubbing 35mm film master prints to 1-inch Type C tape masters.

### **WDSE-TV Duluth, Minn. To Begin CP Broadcasts**

WDSE-TV, a public broadcasting station in Duluth, Minn., will begin circularly polarized broadcasts following installation of a new RCA transmitter and antenna.

Valued at more than \$1.5 million, the equipment ordered from RCA includes two TTG-50H 50-kilowatt transmitters to be used in an alternate/main configuration and a TCL-16A8 Tetra Coil circularly polarized antenna.

The Duluth-Superior Area Educational TV Corp., non-profit owner of channel 8, is building a new transmitter facility and antenna tower near the present site to accommodate the new equipment.

The new transmitter and antenna will combine for an effective radiated power (ERP) of 316-kilowatts according to Rex Greenwell, the station's chief engineer. George Jauss, WDSE-TV's general manager, said the improvements will increase the station's coverage area and enhance its signal.

### **WBNS-TV, Columbus Adds Six TK-47 Cameras**

WBNS-TV, Columbus, Ohio (Ch. 10) is expanding and improving its program production capabilities with the purchase of six RCA TK-47 automatic studio cameras valued at approximately \$900,000.

According to Bill Orr, director of engineering for WBNS, three of the TK-47 cameras will replace RCA TK-46 cameras. The other three TK-47s will increase the station's program production capabilities.

### **WWLG-TV, Macon, Ga. On-Air With RCA UHF Transmitting System**

A new commercial UHF station in Macon, Ga., owned by Russell Rowe Communications Inc., is going on-air with an RCA transmitter and antenna valued at about \$1 million.

The equipment for station WWLG (Channel 24) includes an RCA TTU-60D, 60-kilowatt transmitter and an RCA TFU-36J omnidirectional pylon antenna.

The transmitter and antenna will combine to produce a maximum effective radiated power (ERP) of 1.35 megawatts, according to President Jane Grams of Russell Rowe Communications.

The station will be an ABC affiliate, the third network-affiliated station in Macon, Ms. Grams said.

### **WGGT-TV Debuts In Greensboro, N.C.**

A new commercial UHF television station, WGGT-TV in Greensboro, N.C. operated by Guilford Telecasters Inc., is on-air with RCA transmitting equipment valued at more than \$1.2 million.

The equipment for the new station includes a TTU-55C 55-kilowatt transmitter and a TFU-36J pylon antenna. Channel 48's new RCA transmitter and antenna combine to produce an ERP of 1.2 million watts, according to James Thrash, president of Guilford Telecasters.

### **KTRK-TV, Houston Begins Circularly Polarized Transmission**

KTRK-TV, Houston, Texas is beginning circularly polarized television broadcasts, following the installation of a \$1.5 million RCA antenna and transmitter.

The new Channel 13 system includes a TCL-16A13 Tetra Coil circularly polarized antenna and a TTG-30/30H 60 kW parallel transmitter.

The antenna will be installed at a new site atop a 2,000 foot tower, according to Robert Niles, vice president and director of engineering for Capital Cities Communications Inc., group owner of the station. The antenna and transmitter combine for a maximum effective radiated power of 316 kilowatts, Niles said.

Another Capital Cities Communications station, WTVD, Durham, N.C., was the first TV station to purchase an RCA TCL-16 Tetra Coil antenna, and began circularly polarized broadcasts in 1979.

### **RCA, Data Communications Corp., Announce Marketing Agreement For Master Control Automation System**

RCA Broadcast Video Systems, Camden, N. J., and Data Communications Corporation, Memphis, Tenn., have announced a non-exclusive marketing agreement under which RCA will sell Data Communications Corporation's Master Control Automation<sup>®</sup> system.

Carleton H. Musson, manager, studio products for the RCA activity, and Scott Pierce, president of DCC's Broadcast Division, said the agreement covers all segments of the television broadcast industry.

Master Control Automation is the television industry's first fully-integrated master control system, offering stations a data base common to both traffic and operations. The system allows operations personnel to automate on-air switching and machine assignments, verifies machine delegation, and provides stations with up to five alternate schedule logs to support the main program log.





Audio Console on StarTruck (above) can handle 44 inputs and has a 24-channel output.

Video switching and control (right) occupy a separate compartment in StarTruck.

TK-47 automatic cameras capture the action at the "Strongest Man" competition held at Great Gorge, New Jersey (left).

TPC's StarTruck (bottom left) unloads in Miami for a taping session on the beach.



# FOR TPC'S STARTRUCK "HOME" Is A Nice Place To Visit...

... but the payoff for mobile television production units is in road performances. Which is why StarTruck is a roamer and a rover—and why its owner, TPC Communications, Sewickley, Penna., makes every effort to keep it away from home.

StarTruck is a 55-foot trailer which houses a complete on-location television production facility with an equipment complement rivalling that of many full-scale studios—in quality and capability.

The idea behind a good remote unit is to make it capable of travel without sacrificing the video quality that comes from using studio equipment.

### Video, Audio, Switching

TPC has equipped StarTruck with that in mind. The truck's interior is divided into three units for video, audio and production.

The front section houses a Grass Valley 1600-7K production switcher with three mixing and special effects systems, each of which provides mix or wipe transitions between sources to a keyed insert, or to a pre-set pattern.

The middle section of the truck contains an audio console that can handle 44 inputs and has a 24-channel output. With eight submix buses, the Audiotronics unit handles all the sound, making a separate sound truck unnecessary.

"On some shoots, like tennis matches, we've got microphones all over the place. We use the board to capacity," says Fred Elliot, TPC's manager of production services.

One producer, according to senior sound man John Sutton, has hired the audio section of the truck as the sound unit for

an entire production.

### Seven Cameras Aboard

The video portion of the truck carries up to five one-inch Type C video tape recorders and numerous monitors to keep track of the feeds from as many as eight cameras that can be brought to a shoot.

In a move to improve camera performance on the StarTruck, TPC purchased five RCA TK-47 studio cameras and a TK-76 hand-held camera last year. Another TK-76 rounds out the truck's RCA camera complement, with a third TK-76 also available when needed.

The truck carries two setup terminals that automatically adjust 99 control functions on the TK-47 with the push of a button.

"It's more of a tool than a necessity,"

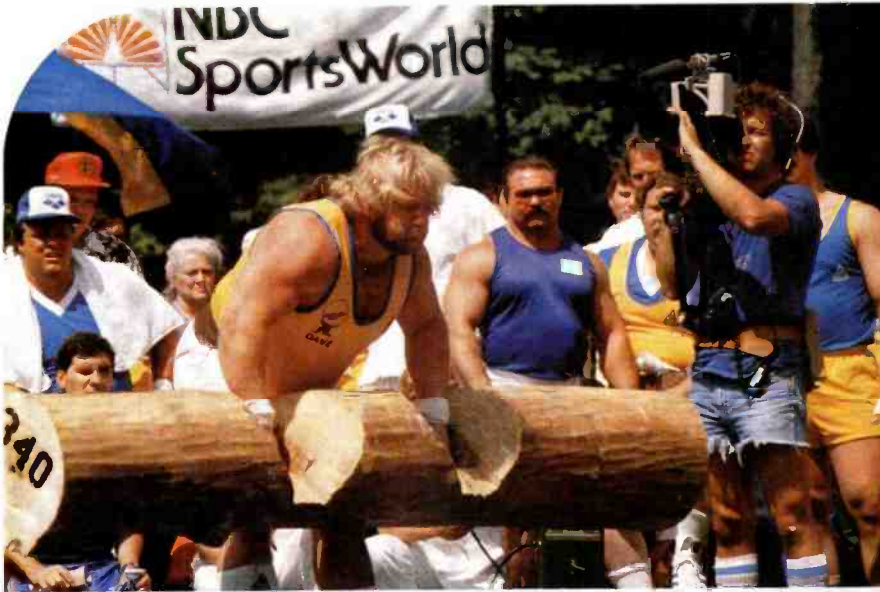

StarTruck's seven cameras cover "on-location" events from every angle. TPC's two multiple camera remote units are on the road 85% of the time.

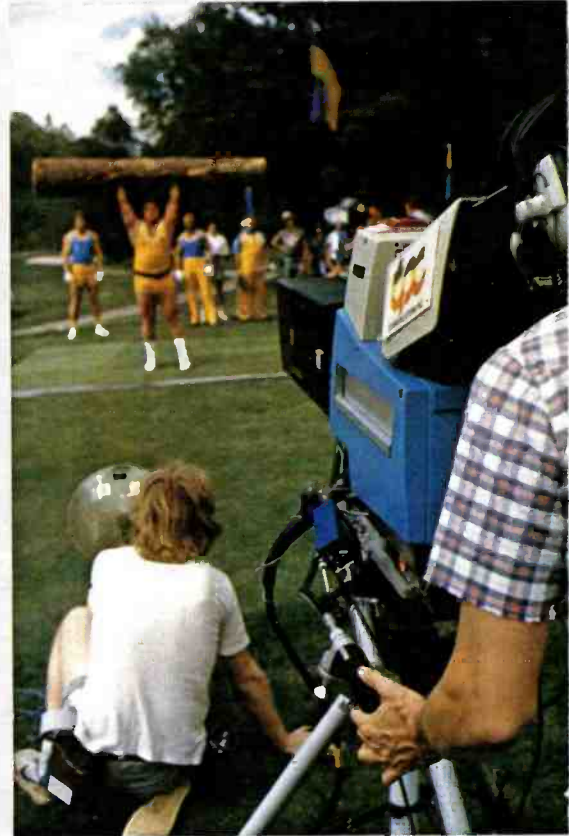



says John Luff, head of StarTruck engineering operations, commenting on the automatic setup option. "It gives the camera operator extra time to work on details and allows us to get the maximum use out of the camera every time."

#### **Quality Reputation Builds Business**

The crew's attention to detail and the truck's impressive array of equipment have earned TPC a good reputation. "Your reputation is your best sales tool," Luff claims. He says TPC wins some jobs despite lower bids by other companies. "Our clients feel we're worth the money we charge. Our reputation is built on everything we've done in concert over the years."

#### **An Impressive Client Roster**

In recent months, the list of events StarTruck has covered includes: Ronald Reagan's Inaugural gala, the Jerry Lewis Telethon, both national political conventions (for foreign broadcasters), the Junior Miss Pageant, several Phil Donahue shows, the Battle of the NCAA Cheerleaders (for network television) and the opening show of Kennedy Center Tonight.

In addition to many professional sporting events, such as football and baseball games, the StarTruck has been able to cash in on network use of unusual sports programming. Recent assignments: mud-wrestling, women's body building, the strongest man competition, karate matches and equestrian events.

#### **A Decade of Steady Growth**

Since starting as a small teleproduction firm in 1971, TPC has grown to become one of the biggest companies in the industry. Last year, TPC did more than \$9 million worth of business, ranking it among the top "four or five" companies in the East and the top eight in the nation, according to Luff. The remote truck operations were only one facet of that volume.

The company also produces commercials, network television shows and industrial films. And it is second in the country in providing dubbing services to program syndicators.

#### **New \$8 Million Facility**

Since March 1980 the video has been pouring from TPC's new \$8 million facility in Sewickley, Pa., about 15 minutes from the Pittsburgh airport.

Identified as "Production Plaza", the new 52,000 square foot video center houses two sound stages; two on-line edit suites; one off-line suite; a color correction suite and audio booth—plus extensive videotape and video cassette duplication facilities. Administrative offices for TPC are also located at Production Plaza.

The first production in the new building featured comedian Bill Cosby, who performed in a series of five-minute children's segment called Picture Pages®, a daily part of the Captain Kangaroo show.

The broadcast program production segment of TPC's operation also completed several episodes of Mr. Roger's Neighborhood for educational television, and a segment featuring Art Linkletter and Carol Lawrence for a children's telethon.

#### **Diversified Services**

Another aspect of TPC, called Channel One Ltd. duplicates tapes for producers and distributors. "M\*A\*S\*H.", "Dinah", "Battlestar Galactica" and "Let's Make A Deal" are copied at TPC for delivery to stations that have purchased the programs. Channel One also provides other services: film-to-tape transfer, color correction, audio changes, inserting commercials and editing to meet time specifications.

In yet another area of its operations, TPC shoots and edits video presentations for some of the nation's top corporations, including: Westinghouse, Xerox, Firestone, Gulf Oil, Sohio, Fisher Scientific and Mellon Bank.

Dow Jones hired TPC to write and produce a video presentation explaining its news retrieval service. The program, sent over cable television, introduced the experimental service to potential consumers.

In addition to these services, TPC personnel produced or completed 862 commercials last year. Major advertising agencies, including Ketchum, McLeod and Grove and McCann Erickson hired TPC to produce commercials for such clients as Goodyear tires, Nike shoes and Glidden paint.

#### **The Three Rivers Stadium Connection**

In the company's early years, before it established a reputation, the remote trucks were the staple that kept TPC alive. TPC bought two remote units and

acquired the rights to the TV cable system under Three Rivers Stadium, home of the Pittsburgh Steelers and Pirates.

This highly visible presence attached new meaning to the letters T-P-C and built a reputation that allowed the company to move into other areas of television production.

Because of the prominent events they cover, the trucks continue to serve as a means of calling attention to TPC and its various services.

In 1980, the two multiple camera remote units were on the road 85 per cent of the time. "We bid on just about every major job in the East," Luff says.

#### **TK-47 Triax Cameras**

To keep pace with a market that requires very long cable runs on some shoots, TPC will equip the StarTruck with the triax version of RCA's TK-47 camera, which can handle cable runs of up to 10,000 feet. TPC's multicore cable TK-47 cameras will be exchanged for TK-47T triaxial cable cameras.\*

TPC didn't hesitate to continue with TK-47's, because the company had selected the RCA camera after extensive comparisons to other studio cameras.

In addition to its fine technical specifications, the TK-47 also offered what Luff termed a "subjective edge" in picture quality. "Its picture quality is as pleasing or more pleasing than any camera on the market," says Luff.

#### **Reliability Plus Picture Quality**

But another factor may have been more important. "We decided on the TK-47 because its mechanical design and its engineering indicated it would be the most reliable in the long run," Luff says. Because it eliminates multiple settings from different camera operators, the automatic setup option will probably contribute to the camera's longevity, he pointed out.

And reliability is the most important quality for a camera in a remote unit.

"In this business, there's always somebody right behind you, waiting to pick up your business," Luff says. "We can't afford to stumble too many times." □

\*The new TK-47T cameras were installed and used first for taping the Women's World Championship of Golf tournament in August 1981.



# KTVU BUILDS ITS MAGNIFICENT BROADCAST CENTER ON THE WATERFRONT

KTVU Aerial Photo by Steve Proehl.



## OAKLAND

By 1976, it was apparent that KTVU was going to have to vacate its familiar, cramped facility at One Jack London Square, on the Oakland waterfront. It had been home for the independent KTVU since the station went on-air in 1958.

The aging building had been changed, re-arranged and upgraded periodically, but was physically incapable of meeting the projected operating needs of its owners, Cox Broadcasting. It could not be shaped into the dynamic full service broadcast center envisioned by William "Bill" Schwartz, then General Manager of KTVU and now President and Chief Operating Officer of Cox Broadcasting Corp.

Mr. Schwartz's concept of a new KTVU facility called for:

1. *A customer-oriented building.* As an independent, KTVU was (and is) particularly active in developing new

broadcast clients, especially in retailing. The new building had to provide space and services to accommodate the needs of current and new clients.

2. *A people-oriented building,* providing a pleasant, comfortable, desirable working environment.
3. *A state-of-art technical center* with ample equipment and space for providing the full range of services required.

The plan for an advanced broadcast facility as articulated by Mr. Schwartz was accepted by Cox Broadcasting management. Then for the next two years he, along with Chief Engineer Ray Swenson and Production Manager Brooke Spectorsky, toured the country checking out new stations and production facilities—talking, listening and gathering reams of information.

The benefits of this extensive and intensive planning effort are readily apparent

in KTVU's magnificent new three-story broadcast center. The new facility, representing a \$20 million investment, is located on five acres of ground along the Oakland estuary on San Francisco Bay, about 1,000 yards south of its old location.

The charm, waterfront view, and ready access for driving and public transportation are all retained at KTVU's new address of Two Jack London Square. The site offers a magnificent view of San Francisco's waterfront and skyline rising from the opposite shore of the Estuary, with the landmark Mt. Sutro Tower and its impressive antenna array standing tall above the city.

A California-style design, using earth tone colors and generous expanses of glass for the exterior, KTVU's new building is distinctively different, yet blends comfortably into its waterfront environment.

KTVU's new broadcast center presents an impressive profile. Main entrance to the lobby is at the center of the building. Photo by Paul Bielenberg for Walker Associates, Inc.



The building is a three-story structure, constructed on 13-foot modules. The main television production studio has a full-height 39-foot ceiling, while the other two studios have 26-foot ceilings.

The lobby mirrors the modern, functional look of the building. Its three-story ceiling makes the space seem larger than it is. Functionally, the lobby is the hub for directing the flow of building traffic and as a security control point.

As shown on the layout, the first floor houses the technical area, News, support functions and Retail Services. This group is responsible for developing clients and sales and is staffed to provide a full range of client services including creative and commercial production. According to Ray Swenson, KTVU is the number 1 station in the country for developing clients for TV. This emphasis results in a heavy production requirement which keeps the studios, editing and control rooms operating on a full schedule.

The Design Department, headed by Dick Weise, supports Retail Services with complete graphics capability, and also handles design and graphics for KTVU's on-air and station promotion needs. The station also operates a complete printing shop.

Administrative operations, Sales and executive offices occupy the second floor, accessed by an open staircase from the lobby. Here also the arrangement evidences careful planning, with functions grouped for efficient work flow. Sales Managers' offices are along outside walls, with staff members clustered in attractive "open office" areas. The layout is designed so that sensitive areas such as Personnel and Accounting can be easily secured during non-working hours. Another important facility on the Second Floor is the comfortable, handsomely appointed Employee Lounge and outdoor roof "garden."

The Third Floor is reserved as a major conference/entertainment area, with complete audio-visual facilities; a kitchen, and two spacious roof gardens for outdoor functions.

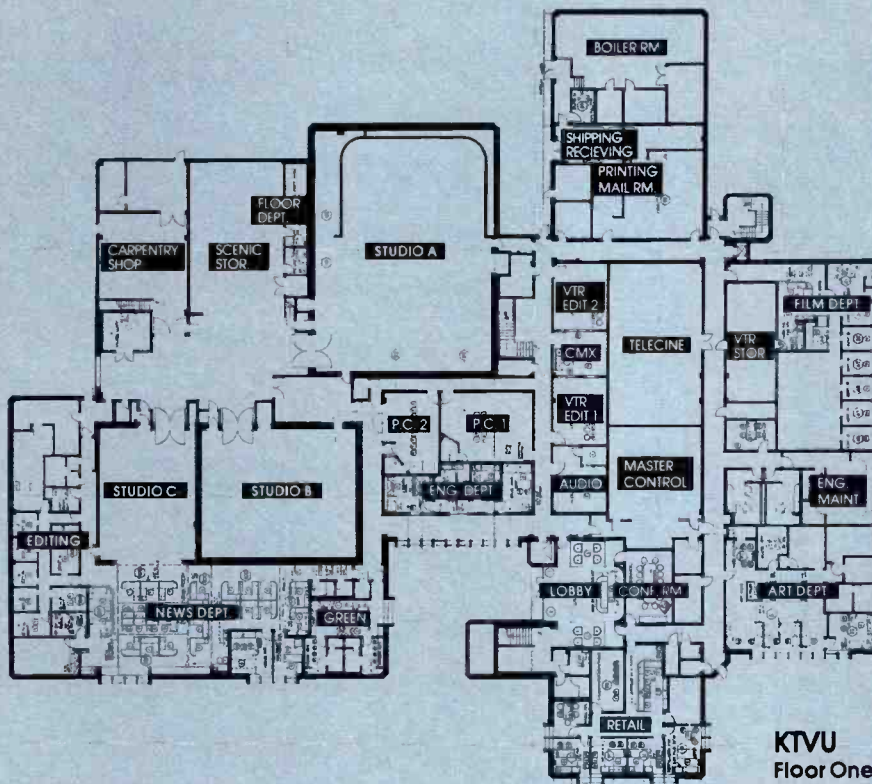

KTVU  
Floor One

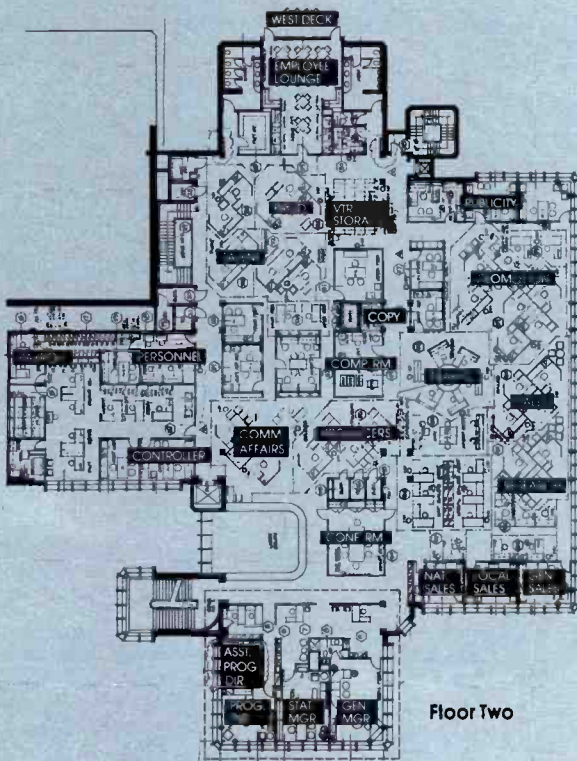

Floor Two

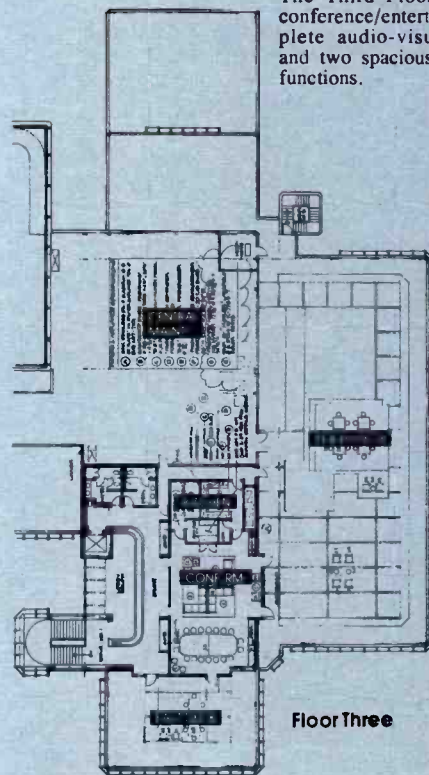

Floor Three



Photos (clockwise from left). The Lobby, with its three-story ceiling, gives the entire interior of the building a spacious, open look.

Handsomely appointed General Manager's office offers a "picture postcard" view of the area.

Traffic Department work area.

One of two roof garden patios on the Third Floor outside deck.

Main Conference Room. Third Floor.

General Office area, with "open offices" grouped in functional clusters.

All photos on this page are by Paul Bielenberg, for Walker Associates, Inc., interior designers for KTUV's new building.





Ray Swenson, Chief Engineer, at Master Control console.  
(KTVU photos by Charles Haacker)

### Flexible Technical Plant

"The basic design philosophy of KTVU's new technical plant is to have complete flexibility, so we can make changes, correct any shortcomings, or rearrange to suit our needs as they change," Swenson comments. "The technical area was conceived and programmed to provide adequate space and to handle the flow of product, people and functions efficiently."

In space alone, the technical area has grown from a tight 33,000 sq. ft. in the old location to a spacious 80,000 sq. ft.

"We wanted total flexibility to be able to change, expand or re-locate our technical operational facilities," explains Assistant Chief Engineer Ken Manley.

"At the same time, we wanted the flexibility to enable us to overcome any system or equipment outages without disrupting normal operations. And we wanted a versatile system capable of handling a number of related operations simultaneously—especially production functions."

Contributing to the overall flexibility of the system are:

- Computer flooring, with cable trays
- A data buss loop system for system control
- Accessible terminal blocks for audio and video system outputs

As an example of the versatility inherent in the new plant, Mr. Manley cites the fact that production work could be handled simultaneously on four video switchers at four separate locations:

- Production Control Room #1
- Production Control Room #2
- CMX Editing Suite

Master Control—utility switcher  
—all without disturbing the on-air operation. All five of the video switchers in

the plant are effectively wired in parallel.

### Planning—And Implementing The Plan

Planning the new technical plant, defining its required performance capabilities and establishing the required equipment complement were major responsibilities assigned to Ray Swenson, Ken Manley and Dan Cervelli.

With the system design concept defined, the next step was to determine the most efficient and cost effective means of completing the job—specifying, installing and documenting.

"When we evaluated the scope of the project and put a cost-and-time frame on our ability to accomplish it, we realized that it could not be done without expanding our own technical staff," Mr. Swenson acknowledges. "It should be impossible for a station's engineering staff to handle a job of this magnitude—otherwise it is overstaffed.

"At this point we decided that a qualified subcontractor could best translate our ideas into the finished system. However, we wanted to be sure that the selected contractor understood and carried out the basic design concepts that we wanted to be integral to our system. We didn't want somebody else's design.

### RCA TV Systems Engineering Selected

"To implement the plan, we looked for a supplier who had the capacity, the know-how and the ability to give us the two things we were looking for: an exceptionally good installation job plus complete documentation of what happened. We selected the TV Systems Engineering group from RCA Broadcast to handle the project."

Comprising the RCA engineering team assigned to the KTVU project were: Project Leader S. C. Starr, P. T. Jackson and C. R. Morris. Their responsibilities included maintaining liaison with each

supplier, developing complete system diagrams and documentation, identifying all system inputs and outputs. They also handled the in-plant wiring to interconnect the operating equipment components—audio boards, video, routing and assignment switchers, etc.—with pre-wired rack outputs.

"Getting the new technical plant detailed, installed and operational turned out to be a real team effort," Mr. Swenson adds. "Our ideas and concepts were transferred to the RCA people; then they contributed quite a bit to the detail design work. Their experience in handling similar type jobs helped out a great deal on this one."

### Major New Equipment Purchases

The investment in the new KTVU plant approximates \$18 million, with about \$12 million in land and building plus furnishings.

Ray Swenson served as the owner's representative for the entire building project, involving contracting, negotiating, acceptance and handling a multitude of detail.

In his 30-plus year career in broadcasting, Swenson has built several new television stations, none as sophisticated as this one. He came to KTVU in 1976 from WIIC-TV, Cox Broadcasting's Pittsburgh, Pennsylvania outlet, where he was Director of Engineering.

Building the state-of-art technical facility required major purchases of new equipment, including:

- 6—TK-47 Automatic Studio Cameras
- 5—VPR-2 VTR's
- 2—Complete TK-28 Telecine Systems
- 3—Video Switchers
- Assignment Switching System
- Routing System
- Machine Control System
- Audio Mixing, Distribution and Intercom Systems

McCurdy audio systems are used throughout the plant—mixing boards, distribution and intercom. Utah Scientific supplied the assignment switcher, and Telemation (Fernseh) the machine control system. In addition, three new switchers from Grass Valley were installed, along with two GV switchers moved from the old location.

#### Supplier Equipment Pre-Wired In Racks

To facilitate putting the new KTVU technical plant together, the suppliers of audio and video switching and distribution equipment were required to provide prewired system electronics in terminal racks, providing 25 ft. pigtailed outputs for everything in each rack. Custom 90-inch racks were shipped to each of three suppliers for the installation and wiring of components. An additional quantity of technical racks were assembled and wired at the RCA custom assembly plant in Pennsauken, N. J.

The racks are mounted in Master Control, easily accessible from the rear for maintenance. Some 300 feed-through video outputs and 36 Thomas & Betz audio blocks, wall-mounted, are used for terminations, providing full flexibility for rearrangements and with ample expansion capability. The computer flooring simplified the task of interfacing the rack terminations with the system wiring which was installed during construction.

#### Assignment Switching and Machine Control Systems

Assignment switching and machine control are two key systems which give KTVU's technical plant an unusual degree of operating flexibility. Ken Manley elaborates:

"We selected an assignment switcher that had a through-time that was only slightly greater than a distribution amplifier. This made it possible to take one output from a camera, for example—feed it straight to a switcher via its own distribution amplifier, and to take the second output from that camera and feed it into the assignment switcher. Then the output of that assignment switcher is still in time with the original signal because it has the same through time as the DA's.

"The timed sync system eliminates cross-points, and everything in the system is in time at all times," Mr. Manley adds.

"There are assignable inputs on our production switchers, as well as some dedicated inputs—like certain cameras are "homed" to a particular activity.

As long as a machine is in the remote control mode and has not been assigned to someone else, it can be delegated. If it has been assigned, a "lockout" condition prevents its use elsewhere. Some of the machines—Telecine and Tape—are fully dedicated to on-air operations and normally are not available for other use.

However, they are only a pushbutton away from use anywhere in the plant.

#### Machine Control Philosophy

"Because of the philosophy of this station," Mr. Manley continues, "we were very wary about having a central control unit or processor which could take our whole system down if someone pulled the plug or if the central processor crashed. The system we had at the old plant was of this type, so we hardwired to all of the machines for back-up.

"In the new plant, machine control functions are handled by a computer-bus-based system, using eight data busses. We split the eight busses and run four in one direction around the building and four in the opposite direction.

"Each control panel is assignable to each of the eight data busses, and each machine assignable to those eight data busses—so at any one time, all you can lose is either one machine or one control panel. If anyone cuts a cable or shorts something out, you don't destroy the whole system and all you do is switch over to another buss and keep on operating."

"Altogether there are some sixty micro-processors either in control panels or in machine interfaces. This is very much a distributed system which provides excellent flexibility for expanding or re-

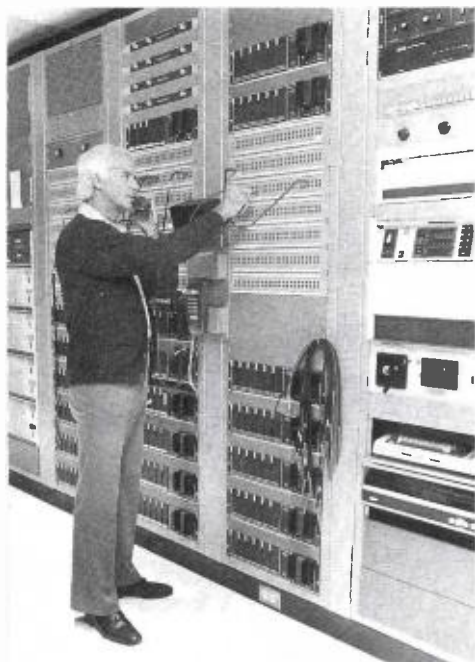

Terminal equipment racks were pre-wired, with system electronics installed, ready for interconnection on-site.

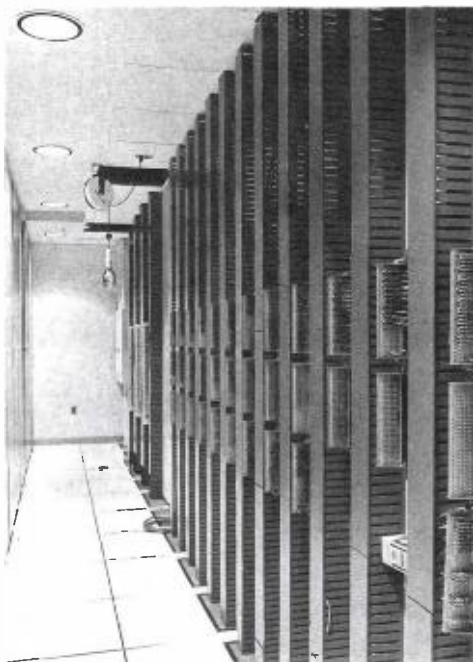

Audio and video terminations are on blocks for easy access for maintenance or re-arrangement.



TK-47 Camera Set-Up Terminals and Camera Processing Units are rack-mounted in the Master Control area.

arranging.

"In the case of Master Control—we wanted to have redundancy, but we accomplished this by putting in a second panel and using a different one of the data busses that were there. Everything is redundant; we just put two of the machine interfaces on each of the machines that are involved in that operation so that if one machine interface crashes, we're still on the air."

#### Master Control Console

Master Control is a spacious area, necessarily so, since it includes the rack and terminal equipment for the audio systems; video distribution, and for the video, routing and assignment switchers.

In addition, the electronics for the CMX system are rack-mounted in Master Control.

The Master Control console is an impressive hook-shaped arrangement equipped with two switchers, machine controls for tape and film systems, and a comprehensive complement of monitoring and control facilities for studio video facilities and for the transmitter.

RCA TV Systems Engineering was responsible for the fabrication of the MC console, which was also assembled at the company's facility in Pennsauken. The electronics for this console alone were the equivalent of 22 full equipment racks.

The on-air switcher is a Grass Valley M208/1600-4S, and the back-up is a GV-1600-7R which also serves as a utility production switcher.

The MC console includes the studio terminal for a new TFT remote control system for KTVU's 30 kW TT-30FL transmitter. "It is a state-of-art system that provides a graphic presentation of the remote controlled operation at all times," Mr. Swenson says. "In the event of a failure, the system takes you through to the point of failure and displays the location of switch positions, prompting you through the corrective action procedures." (The transmitter is operated remote controlled, with only the Transmitter Supervisor at Mt. Sutro handling maintenance during a normal shift.)

Also housed in the MC console is a Tektronix Answer II system which provides a computer reference for measuring and comparing parameters programmed in with the actual system performance. Mr. Swenson elaborates, "We can measure video parameters for the entire studio plant operation at any time. For example, we can measure and compare video parameters for each control room—including all switcher functions—from input to output."

#### Combined Telecine and Tape Operation

Telecine and video tape equipment are centralized in a large area next to Master Control.



The KTVU Master Control Console is an impressive, multi-functional facility. Photo, Bielenberg.

A new Transmitter Remote Control system and a computer-based control and monitoring system are a part of the Master Control Console.

Telecine and Videotape room. The Control/Monitoring station at right identifies delegated and assignable videotape and film sources to provide for effective machine utilization without disrupting on-air operations.

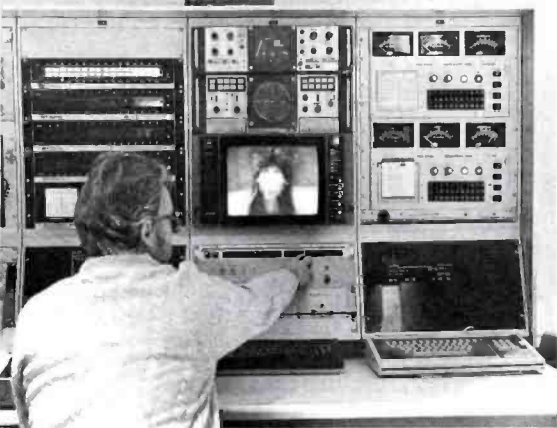



Since the Telecine/Tape area is so critical to maintaining a smooth operation as well as for providing machine facilities for production, it is equipped with a Control/Monitoring position and is manned by a supervisor.

Three RCA telecine systems are installed; two 'new islands with TK-28 cameras, and one with a TK-27 from the old facility. Two other film systems are installed in the VTR Edit Rooms. The TK-28's are well utilized for on-air operations, Mr. Swenson says, and are measuring up to performance expectations. Along with its slate of fringe and prime time syndicated programs, KTVU airs a regular schedule of films, drawing from its library of more than 1200 major movie titles. These and a like number of cartoons, shorts and special features owned by KTVU are stored in an air-conditioned, humidity-controlled environment in the Film Department. Videotapes of syndicated programs and commercial

masters are also stored there. Films still comprise about 80% of the station's programming, although this is changing rapidly to one-inch tape, especially for syndicated material.

Videotape program playback is handled by two quad and two one-inch VTR's, while commercial playback functions are handled by two ACR-25 cartridge tape machines, one of which has registered more than one million threads. An active file of 5,000 cartridges is maintained, and all commercials are dubbed to "carts".

#### Multi-Format Tape Facility

At the far end of the Telecine/Tape Room is the Utility Video Tape area, a compact grouping of VTR's in various formats which just seemed to evolve as the new plant became operational, Mr. Swenson recalls. It provides a complete range of tape machines for transferring, recording and playback on-air of just

about any tape format. Tape machines in this cluster include: Quad; 1-inch; ¾-inch; Beta-max, and VHS.

The ability to handle all types and formats of video tape provides excellent versatility. It is particularly useful to the News operation, where they no longer need be concerned about the tape format of any incoming story.

With complete tape capability in place, Mr. Swenson anticipates closing down the station's film processing operation within a year.

#### Production: A Station-Integrated Function

Production is a major function, involving news and program production; extensive in-house station promotion, and client commercial production, with special emphasis on retail service operations.

At KTVU, production is a station-integrated function, not a separate operation, Mr. Swenson explains. "Here personnel and equipment are not specifically dedicated to station operations or commercial production. The people are interchangeable in that they can work production, cameras, in-house promotion or Master Control, depending on the schedule."

#### Three Production Editing Rooms

There are three fully equipped Editing Rooms in the Technical area:

*VTR Edit 1* is equipped with three VPR-2 one-inch tape machines and a Telecine system.

*VTR Edit 2* is for quad editing, equipped with three VR-2000 VTR's.

Edit 1 and 2 are also equipped with a captioning camera and table for inserting graphics.

*The CMX Editing Suite* is a client-oriented facility which includes a Grass Valley Switcher, a McCurdy audio board and a compositor-character generator. The room is also equipped with ¾-inch VTR's for off-line editing sessions.

Quad, 1-inch and ¾-inch tape facilities are available in all of the editing rooms. A large audio sweetening room adjoins the bank of Edit suites.

#### Three Production Studios

KTVU operates three studios which are clustered so they can be conveniently served from the Carpenter and Paint Shops and the central prop storage area. Doorways to the studios are 14 feet tall, so sets built in the Carpenter Shop can be mounted upright on dollies and rolled into position without having to be re-assembled on the set.

Studio "A" ( 55 ft. x 80 ft.) has a 39-



Film and Tape storage area is air-conditioned and humidity-controlled.



One of the three production editing rooms is equipped with a CMX editing system. This suite also includes audio mixing and video switching facilities.

foot ceiling and built-in plaster cyc which is angled so that sound will not bounce directly back. Its epoxy floor is true to within 1/16-inch in any ten feet. The walls are acoustically treated to NC-20 criteria—equivalent to that of a sound recording studio.

(The new location for the plant included some environmental problems which had to be resolved. The building sits under the instrument landing pattern of nearby Alameda Naval Air Station, with planes flying directly overhead at an altitude of 600 feet. In addition, the Sante Fe Railroad runs by on Embarcadero Street. Extensive and expensive acoustic treatment was required to overcome these noise and vibration problems.)

A computerized 100-dimmer lighting system is installed, with cabling from all three studios coming in to the main board where it is re-patched. Portable lighting control CRT terminals can be used either in the studios or in the control rooms.

Six new TK-47 automatic cameras are used for production; three assigned primarily to Production Control Room #1 and three to PC #2. Remote joystick controls for any of the assigned cameras are located in each control room. Redundant Set-up Terminals and the Camera Processing Units for the TK-47's are rack-mounted in Master Control.

While all three studios are used for production, one is set up for the News operation. This studio has full width folding

Production Control Room #1. (Photo, C. Haacker)



wall at one end which opens on the News Room, which can then be used as the set for instant reports away from the anchor desk.

For ENG operations, KTVU uses two microwave-equipped vans to support a six-vehicle news gathering fleet. Since the station packages its news for presentation during the prime 10-11 P.M. time slot, most stories are taped and returned to the station for editing. The vans provide the added flexibility of going live or of feeding taped material directly back to the station for recording and editing. A just-completed four-wheel van is equipped as a mobile microwave repeater, greatly expanding news coverage capability.

The News operation now is equipped with four ENG editing suites, with plans to expand to seven in the near future. News Director Fred Zender notes.

#### Production Control Rooms

The Production Control Rooms are

nearly identical in layout. However, PC #1 is larger and is equipped with the new GV-300 Full Digital Production Switcher. It is most frequently used for commercials and program production, while PC #2 is used for News and program production. All monitors in both rooms are located in the same positions, so either control room can be used for any type of production.

Cameras and other inputs are lined up in the same positions on the video switchers. Cameras 1, 2, and 3—the TK-47 automatics—are normally dedicated to PC #1 and assignable to PC #2 via the inputs on the production switcher. Another set of TK-47's is dedicated to PC #2 but assignable elsewhere. Both control room console positions include delegated Remote Machine Controls and joystick video controls for the TK-47 Studio and TK-28 Telecine cameras.

For convenience, each control room also includes a small announce booth.

#### Efficient Air Handling

Computer flooring used in the technical area is of a heavy-duty aluminum waffle construction. All cabling is carried in trays under the flooring. The space under the flooring also serves as the fresh air plenum for the air conditioning system, with the above-ceiling space as the return air plenum. "To take further advantage of this arrangement," Mr. Swenson adds, "we have designed our racks with a four-inch space between them. This space carries equipment cables, but also serves as an air-conditioning duct, pulling cool air up and exhausting to the return air duct at the top of the rack. The temperature is maintained at 55 degrees for air flowing through the equipment, keeping it comfortably cool and very stable."

There are three air conditioning systems for the Technical Area, any two of which easily carry the total load.

To maintain the temperature, the air volume is varied rather than changing temperature, and humidity is maintained at 40% for Master Control, machine and

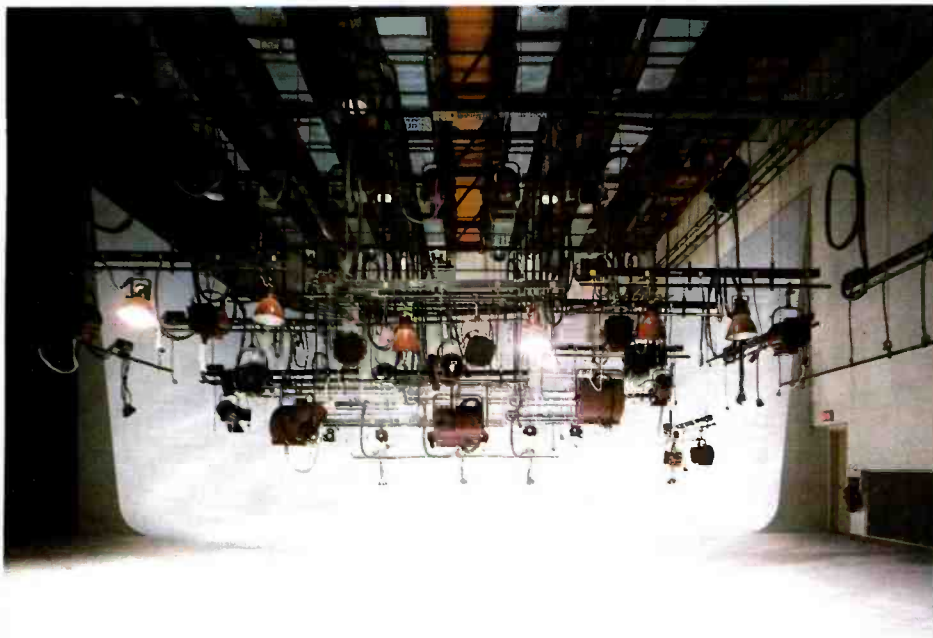

film and tape storage areas.

The grounding system for the technical area is an 8' x 8' grid of heavy welded copper cabling, measured at .23 ohms to earth. More than 1,000' of cable is buried beneath the technical area.

#### Separate Telco Facility

Adjoining the KTVU Master Control area is the Telco Room—the receiving and distribution center for incoming signals from all outside services—Telco, Western Union; satellite receiving and other signals. This arrangement, Ray Swenson observes, keeps the in-house facilities separated, resulting in more efficiency in maintenance and in managing the inside and outside operations.

Microwave receiving dishes are mounted on a 50' tower on the roof. All RF signals from the microwave receiving dishes terminate in a small room on the building roof, and are distributed from there via the assignment switcher. This set-up makes it easy to distribute these signals in-house, and also eliminates the need for running waveguides through the building to the Master Control area.

#### A Smooth, Unannounced Changeover

No fuss was made when the changeover was made to the new location. It was totally and deliberately low key, with no fanfare or on-air pre-announcements. In fact, the News set from One Jack London Square was dismantled and moved over

the weekend, and used on the first news broadcast from the new location—without a break in continuity.

As Ray Swenson puts it: "People watch KTVU because they prefer the quality of the on-air product. The fact that we moved is important only if the audience perceives an improvement in our performance."

The changeover was planned for minimum disruption—no small feat, since more than two-thirds of the equipment from the old plant was transferred to the new one. The initial move was made on March 8, 1981 when the first programs were aired. The move was completed on April 8 and was handled so smoothly that it went virtually un-noticed, which is just how the station wanted it to go.

#### Strong Programming—Fringe Thru Prime

KTVU is the only independent among the Cox Broadcasting stations, and has a large measure of autonomy in selecting and negotiating for syndicated material. Its first run, off-network shows, including "Barney Miller", "M\*A\*S\*H" and "Laverne & Shirley" have delivered excellent share of market numbers. The station also has been the most successful among independents in building audiences for "Operation Prime Time" productions.

#### Award-Winning News

The KTVU news operation is a strong

contender in the competitive Bay Area market, frequently garnering a #2 audience share. Indicative of its performance and impact on the market is the fact that KTVU News has won the "Best News" Emmy Award for the past two years, and for four of the past seven years. Among independents, it is the top-rated newscast in the country.

#### Quality Staff Delivers Quality Performance

The turn-around for KTVU started in 1975 when Mr. Schwartz was named General Manager. Since then there has been a steady climb to the point where now, under the direction of present management—Alan Bell, Vice President and General Manager and Jay Finkelman, Station Manager—KTVU is pushing hard on the network affiliate stations for ratings and share.

The difference, Ray Swenson points out, can be attributed to the quality of the people on staff. "KTVU operates with a leaner staff than its network competitors, expects more of its people, and they deliver—as reflected in the station's performance record."

For KTVU, the original concept of a customer-oriented, people-oriented broadcast center with state-of-the-art technical capability turned out as planned. □

Six TK-47 cameras are used for production and news at KTVU. (Photos, Ron Willis, KTVU).

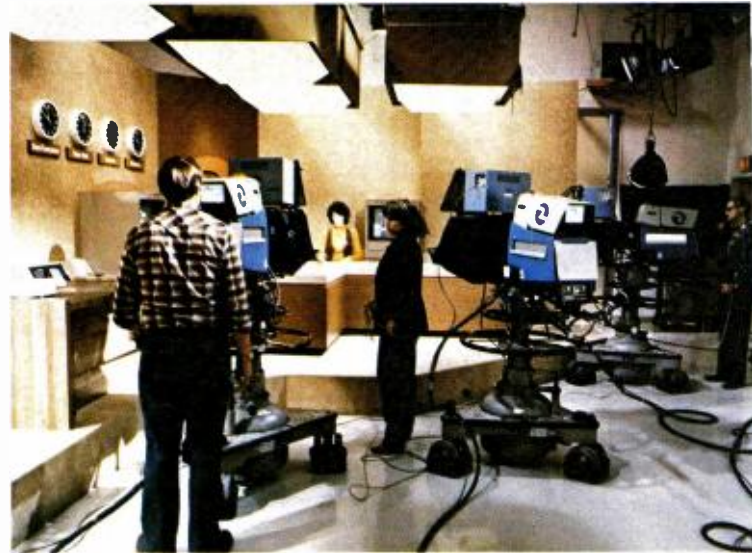

# WCLQ TV

## DESIGNS FOR EFFICIENCY

*Operates Commercial and STV*

Tech Center Layout, WCLQ-TV, Cleveland

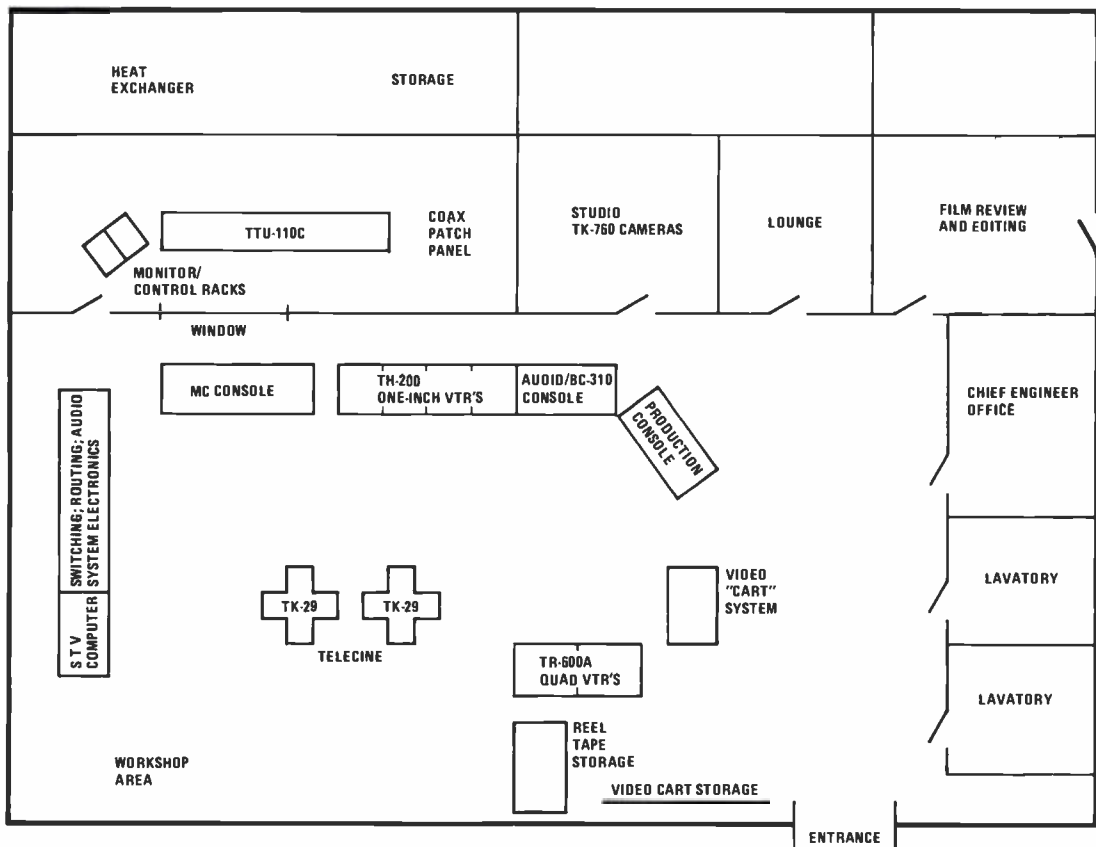

Cleveland's newest television station, WCLQ-TV, occupies the top of a hill in suburban Parma, Ohio—where most of the area's TV antennas are sited. The station operates commercial by day and STV at night. At 2,000,000 watts, ERP, it radiates the most powerful signal in the market.

In constructing this new television facility, the owners of TV-61 took a slightly different approach. Instead of building just a transmitting plant at the tower site, they chose to include a complete technical center. The business end of the operation—Sales, Traffic, Promotion and Administration—are located in a separate leased facility in Independence—about five miles from the transmitter site, and with easy freeway access to downtown Cleveland. This arrangement isolates and centralizes the technical operation and improves operating efficiency.

TV-61 is owned and operated by Cleveland Associates, a joint venture, with Harry and Elmer Balaban holding a majority interest. Much of the planning, particularly in site selection, layout and equipment specification was done by Al Petzke, Director of Engineering for WTVO-TV, Rockford, Ill., another Balaban station. Harold Froelich, Executive Vice President for WTVO, also serves in this capacity for WCLQ, and had a large responsibility for planning, staffing and programming the new station.

### An Impressive Beginning

WCLQ-TV went on-air from its new facility on March 4, 1981, starting with commercial broadcasts. Subscription television programming began on the evening of March 7.

The new station hit the market with a bang—opening with the blockbuster movie "Deer Hunter". The result was a smash—garnering a #1 viewing rating in prime time with the first program—much to the delight of Mr. Froelich.

"We presented 'Deer Hunter' on the first two nights of operation to introduce TV-61 and its programming to as large an audience as we could muster," Mr. Froelich explained. "It was a key part of our 'roll-out' and proved extremely effective."

Prior to going on-air, publicity and promotion signalled the coming of TV-61. For the opening shows, special two-minute informational commercials were

produced at the Technical Center, using the facility as the set. On-camera talent "toured" the Center, calling attention to the array of new video tape, film, production and transmitting equipment housed there. Other spots previewed the programs to be presented. The commercials offered dynamic evidence to potential clients and to viewers that WCLQ was, indeed, a first class broadcast operation, well endowed with latest technology equipment.

### Why Cleveland?

Why was Cleveland selected as the locale for the new station? According to Mr. Petzke, it was a matter of noticing that this "Top 10" market was covered by only four commercial stations—three network and an independent—so it seemed likely that the market had the potential to support another station. In addition, Channel 61 was available.

The initial survey of the Cleveland market was made in 1974 and the license application was filed in 1976, with another two-year lapse to obtain the Construction Permit.

In the Spring of 1979, the present tower site was located and the process of obtaining clearances started again. One of the reasons for the delay was the need to secure approval for the transmission system from the Canadian government through the U. S. State Department. This approval and that of the FCC was received in April 1980.

In anticipation of the approval, the tower was ordered in September 1979 and in December an order was placed with RCA for an equipment package valued in excess of \$2 million.

### Subscription TV: A Separate Operation

From the start, WCLQ was planned with a combined commercial/subscription TV operation in mind, Mr. Froelich asserts. The commercial program fills a market void, providing the basic fare of independent stations—popular syndicated sit-coms; dramas, religious programs and movies. Many of TV-61's movies are "classics", which are drawing well in this market.

The subscription television operation—PREVIEW—is totally separate from the TV-61 broadcast operation. An American Television Communications (Time-Life) unit, PREVIEW buys time on WCLQ from 8:00 P.M. until sign-off,

usually 2:00 A.M. The programs are usually supplied on one-inch tape.

A quality signal is essential for a successful over-the-air Pay-TV operation, Mr. Froelich notes, and TV-61 is delivering a strong signal throughout their ADI. The STV company is getting requests for hookups in Canton and Youngstown, near the Pennsylvania border, and some installations have been made near Toledo, some 65 miles distant.

### Combined Transmitter Plant and Technical Center

The TV-61 technical center is a sturdy, windowless brick building which squats on the top of a hill that was leveled off down to shale rock. The building is constructed with a steel decking for the roof, which is topped by a thick layer of concrete for protection against falling ice. Inside, it is climate-controlled and air conditioned, with several zones providing area control for comfort.

Behind the building, the Ch. 61 tower rises to a height of 1092 feet above ground, the tallest in Cleveland. It is topped by a custom RCA TFU-25G Pylon Antenna, the first of its type to be radomed for protection against the elements. Instead of using coax transmission line, TV-61 opted for waveguide for its efficiency and higher power handling capabilities at high frequencies. The transmitter is an RCA Type TTU-110C, 110 kW, the first of this power level to be equipped with high band (VA-955H) high efficiency five-cavity klystrons. The entire transmitting plant was designed to permit ready expansion to 220 kW operation as a future consideration.

WCLQ-TV's antenna, transmitter and Technical Center share a hilltop, surrounded by a cyclone fence security net.

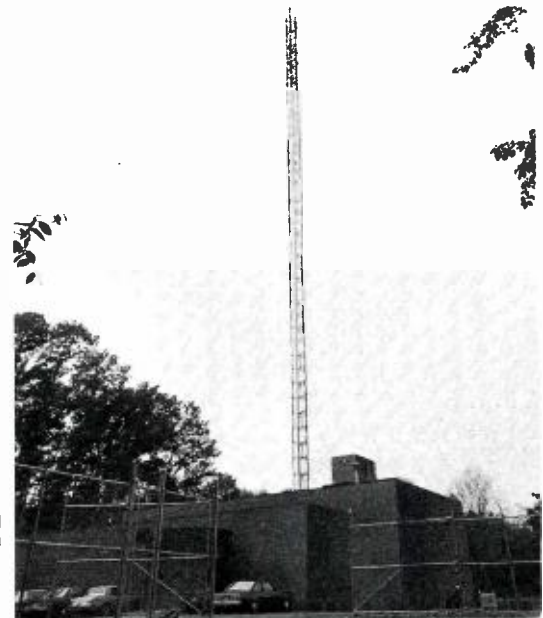



WCLQ-TV Technical Center is a spacious and amply equipped facility.

#### A "No Frills" Operation

Visitors entering the hilltop TV-61 Technical Center are immediately confronted by a large room, with subdued lighting, and amply stocked with complete facilities for on-air and production operations, both of which are conducted simultaneously. There is no lobby or receptionist in this efficient, "no frills" operation.

The technical and production center occupies a spacious 75' by 41' room, with computer flooring for easy access to cabling. The equipment complement includes:

- TH-200 Type "C" 1-inch VTR's
- TR-600A quad tape machines
- ACR-25 video "cart" machine
- TK-29B telecine systems
- Chyron Graphics System
- Grass Valley Master Control,  
Production and Routing Switchers
- TK-760 Color Cameras

**110 kW Transmitting System Installed First**  
Chief Engineer Al Evans signed on with Ch. 61 during the early construction stages of the new station, and had a key role in setting up the technical facility. Even before the building was totally completed, the TTU-110C Transmitter was moved into place and installed by Mr. Evans and his modest staff. Only after the transmitter, inside transmission line and heat exchanger were set up and ready for check-out was the balance of the equipment positioned and cabled. The computer flooring under the Technical Center simplified the task of cabling the system, Mr. Evans remarks.

His present small staff of ten includes three technicians who handle equipment maintenance.

TV-61 is on-air from 7:00 A.M. until 2:00 A.M., with commercial programming carried from sign-on until 8:00 P.M., when the STV operation begins. Production is a 12-to-20 hour a day operation and is handled by Al Evans and his staff.

Although a limited number of outside production assignments are handled, in-house production is given heavy emphasis. Station programs are extensively promoted throughout the broadcast schedule.

During the evening shift, two people handle on-air operations plus tape dubs, routine maintenance, equipment clean-up etc. One is the MC operator. The second is the transmitter operator, also known as the "Pit" man who has the additional responsibility of loading film and tape.

Everyone has an opportunity to operate all of the equipment Evans notes, rotating to different jobs to become familiar with all facets of the operation. Even the maintenance specialists work an on-air shift each week to maintain proficiency in equipment operation as well as its service requirements.

#### An Efficient, Spacious Layout

In planning the Transmitter/Technical Center layout, Al Petzke concluded that combining the Master Control and Production functions in a single area would enhance overall efficiency. Operational experience has confirmed the validity of this arrangement.

Along one wall of the room is a large combined Master Control and video control console. The MC Switcher is a GV-1600-1T, audio-follow-video. To the left of the switcher are two remote control

panels for the two TH-200 one-inch VTR's used for on-air playback. The machine function controls for the other two TH-200's will be remoted to the MC console for added flexibility, should it be necessary to use either or both production VTR's as on-air playback units. Similarly, the Play/Machine function controls for the two on-air VTR's will be remoted to the Production Console for added capability.

The remote controls for the film projectors and the two TR-600A quad VTR's are mounted in the desk to the left of the MC Switcher. Above the switcher are Preview and Line monitors and a monitor showing the demodulated off-air picture. In the same area, the waveform monitor, routing switcher panel and intercom are all within easy reach of the Master Control operator.

In addition, the operator can look through the window to check the operation of the TTU-110C transmitter in the next room.

Further along on the MC console is the video operator position, with the joystick remote controls for the TK-29 cameras, and for the two TK-760 studio cameras. At the end of the console is a keyboard for the graphics system.

#### Four TH-200 1-inch VTR's

To the right of Master Control is a bank of four TH-200 Type C one-inch tape machines, identically equipped. Each is mounted in a console housing, with a TBC-200 Time Base Corrector in the base, and monitor and vectorscope above the TH-200 tape deck. A separate routing switcher remote panel sits at the top of the console, providing easy access to all house video sources at the touch of a button.



Master Control Console (left and below) provides complete machine controls for operator, and a direct look-in at the 110 kW transmitter operation.

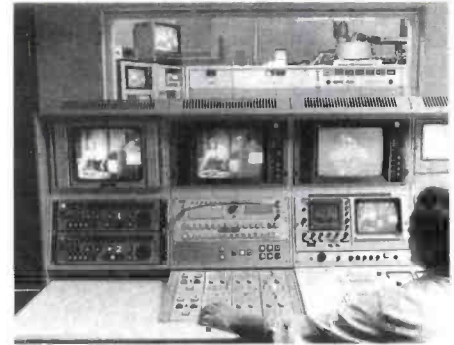

Two of the four VTR's are used for program playback and two are reserved for production. All four machines are equipped with Dynamic Tracking which is well utilized for slow motion and still framing in production.

The Production Console includes a GV-1600-1X Switcher, and Chyron Graphics system. As noted previously, the remote panels for the two TH-200 tape machines designated for production are located here.

Two TR-600A quad machines are used for dubbing and for playback of subscription television and broadcast program material that comes in on quad tape. All commercials, ID's, PSA's and promos are dubbed to the video "cart" machine for playback.



Production Control area, with a production console and audio mixer, are located in close proximity to both the studio and the 1-inch VTR's.



TR-600 quad VTR's are used for production and program playback; the video cartridge tape machine for airing commercials.

### Two TK-29 Telecine Systems

Two complete telecine systems are installed, each with two TP-66 16mm projectors; the ever-popular TP-7 slide projector, and TP-55 Multiplexer. TV-61's new TK-29B film cameras are equipped with Saticon tubes. One system is dedicated to production; the other for on-air operations. With the "automatics" in the TK-29, it is seldom necessary to use the joystick remote controls at the console. Al Evans remarks. Most of the syndicated programs are still coming in on film, keeping the telecine systems well utilized.

A row of racks along one wall provide a centralized location for most of the system electronics. The electronics for the MC switcher; Production switcher, and routing switcher are housed here, along with audio patch panels and the CCU's for the two TK-760 cameras.



TK-29 Telecine Systems are well utilized for film programming and production.



Two of the four TH-200 VTR's at WCLQ-TV are used for program playback and two are primarily production units. All are equipped with Dynamic Tracking.

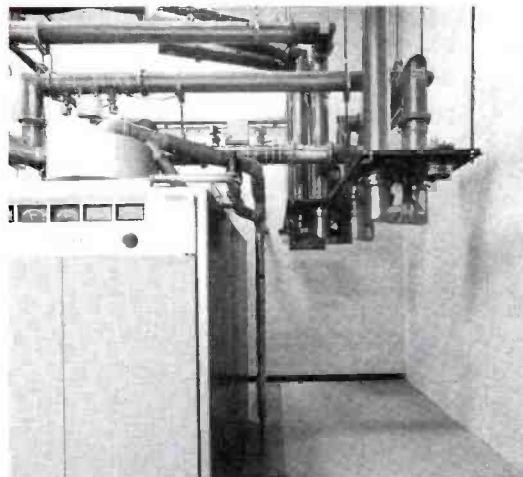

Photos (clockwise from top left).  
 Film Department occupies a separate room in the  
 Tech Center and is a key facility, since much  
 of TV-61's programming is on film.

System electronics are centralized in this row of  
 terminal racks along the end of the room nearest  
 Master Control.

Custom patch panel permits any klystron tube  
 to be switched to dummy load.

Aluminum waveguide transmission line provides  
 efficiency and higher power handling capability  
 at high frequencies.



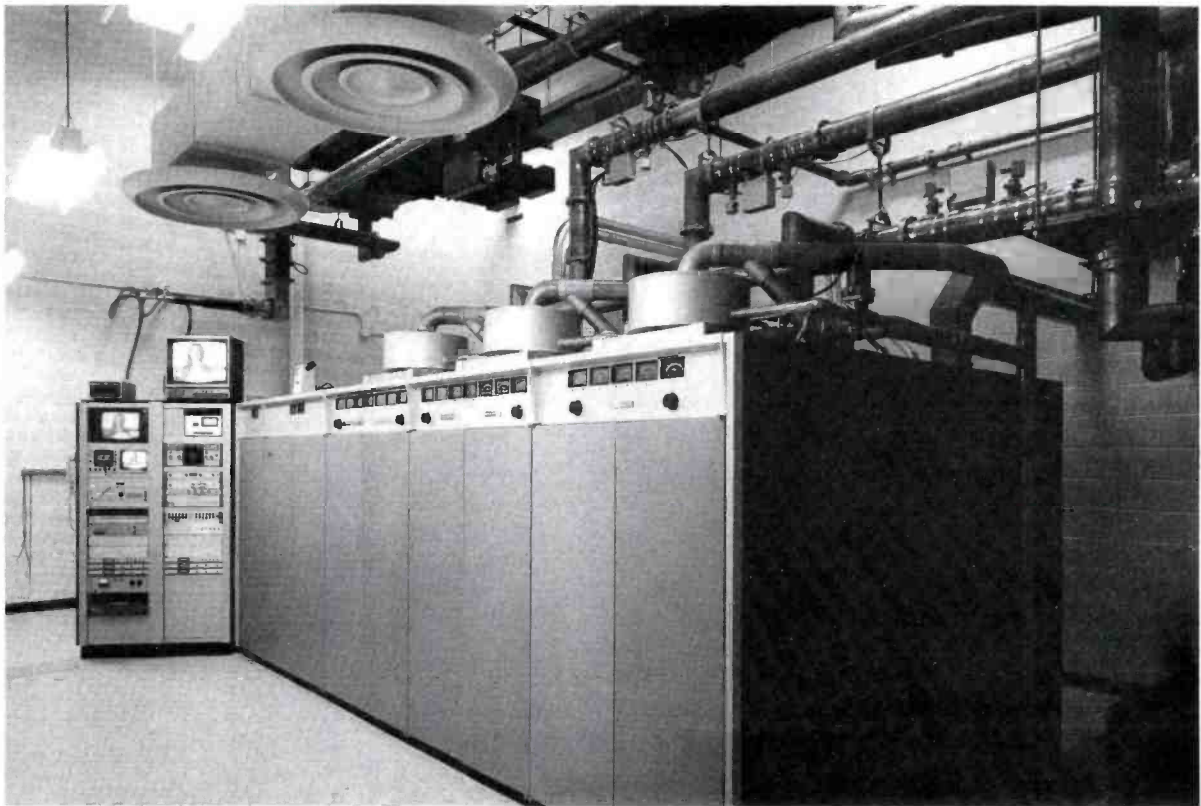

TV-61 operates with a 110 kW transmitter. The transmission system is designed for flexibility plus future expansion capability to 220 kW operation.

The studio is small, but suited to its purpose as a production support facility. Conveniently located near the Production Control console, it is equipped with two TK-760 cameras. TV-61 does not originate any live programming at this time.

#### **Transmitting Plant Adaptable For Future Needs**

The TTU-110C Transmitter is equipped with a Mod Anode Pulser for power-saving efficiency. The exciter for the transmitter was modified by Mr. Evans to work with the subscription television system. For additional redundancy, the spare TTUE-44 Exciter package was purchased.

The transmitter was delivered in November 1980, and the FCC proof of performance completed on January 13, 1981 when on-air program tests were started.

A custom patch panel designed by Mr. Petzke permits any klystron tube to be switched to dummy load. The transmission system is designed for flexibility plus expansion capability to 220 kW operation in the future. Ample floor space has been provided to accommodate a second 110 kW transmitter, its heat exchanger and ancillary equipment.

A Waveguide Hybrid is used to combine the two visual klystrons, with the output going to a Waveguide Notch Diplexer for adding aural, and the output of the

Notch Diplexer going to the Waveguide Switch. The system is set up so the diplexer can be by-passed in the event of a failure of the aural tube, in which case the aural output would be switched to a visual tube for combined aural-visual operation with minimum loss in output power.

The heat exchanger is in a separate room directly behind the transmitter, and the unitized power supplies are located in another room. By-pass check valves in the heat exchanger system permit switching pumps while on-air without shutting down. There is a separate test load pump which can be used as a replacement for either of the others.

#### **Waveguide Transmission Line**

Lightweight aluminum waveguide is employed for transmission line. The waveguide was tuned for minimum VSWR, aided by a computer program developed by Dean Sargeant Engineering. A sliding terminating load was used to check VSWR for all sections of waveguide on the tower.

The WCLQ-TV tower is a heavy-duty guyed structure designed to accommodate the waveguide transmission line; the TFU-25G Pylon Antenna, and a complement of radio and communications facilities. It can hold two 12-bay FM antennas; 25 two-way radio stations; microwave

systems and other services.

The omnidirectional Pylon Antenna for TV-61 has an 0.8° beam tilt, and is providing excellent coverage throughout the ADI area. As noted previously, this was the first TFU-25G to be equipped with a radome. Even during period of severe icing conditions last winter, the VSWR was negligible, according to Mr. Petzke.

#### **A Solid Beginning . . . With More To Come**

Already some new projects are under consideration to further improve TV-61's operational efficiency. One such is a microwave system between the administrative office and the Technical Center for transmitting programs and commercials for preview or client screening. A similar microwave set-up would permit connecting the STV company with the Technical Center, permitting them to screen upcoming programs without having to leave the office. Also in the planning stage is an earth station for daytime commercial programming and for the STV operation.

After only a few months of operation, WCLQ-TV is making inroads and has achieved recognition as a competitive factor in the Cleveland market. And the future looks even more encouraging. □

SEATTLE/TACOMA



New transmitter, tower and circularly polarized antenna for KCPQ-TV atop Gold Mountain, with a commanding view of the market area.



# KCPQ-TV INTRODUCES CP TO PUGET SOUND TELEVISION

In 1980 Kelly Television Company became the fourth family-owned station a market of five commercial broadcasters serving Seattle/Tacoma, Washington. "When you think about who now owns what television stations today, it's phenomenal that we have such a high concentration of locally owned properties in one market place," said Bob Kelly, Resident Partner and General Manager. "I think that's good—it's healthy for the industry."

Getting Channel 13 on the air was a challenge, one which Kelly relished. "It's like finishing a good book," he said. "You start out, work like hell, then finish it. It's a nice feeling."

Less than nine months after Kelly purchased the station, the re-born Q-13 commenced broadcasting a maximum power 316 kW ERP circularly polarized signal from its new tower site atop Gold Mountain, seven miles west of Bremerton.

#### First CP System in the Northwest

The new installation is the first CP television transmission system in the Northwest, and the 60 kW state-of-the-art TTG-30/30H parallel transmitter is the first of its type in the market.

KCPQ's 708 foot guyed tower is topped by a 68 foot RCA Type TBJ circularly polarized panel antenna which extends to 2,395 feet above mean sea level—making it the tallest in the Puget Sound area, and the maximum allowable height (2000 ft. above average terrain).

The new tower location with its added height and the CP transmitting system bring TV-13 clearly into the picture as a new viewing alternative for area set owners.

#### Favorable Viewer Response

Have the area viewers responded to the new Q-13? Bob Kelly, the Resident Partner and General Manager in charge of the Tacoma operation, is ready with the share of market figures that reflect the early and growing acceptance of KCPQ's programming.

"We went on air Nov. 4, 1980 and were covered for most of the November ARB Sweep. Our share for that rating period was 5%. In the January Sweep, share went up to 6%, then to 7% in February. Our May ARB share was 8% metro.

"The demographics for our audience is basically not different than that of the networks, since we are offering another choice. Currently our programming is heavy in movies, especially the 'classics' which seem to have universal appeal."

#### From Sacramento to Seattle

KCPQ-TV is Kelly Broadcasting Company's second television station; the other is KCRA-TV, Sacramento, a family property since it went on-air in 1955.

The company was founded by Ewing C. Kelly, starting with the construction of KCRA-AM, a 250 watt station which went on-air April 23, 1945, the date of President Franklin D. Roosevelt's death. In 1947 KCRA-FM, 96.1 MHz went on-air. A television station application was filed that same year, but was delayed for many years. KCRA-TV began telecasting on September 3, 1955, with the distinction of being the first station to go on-air broadcasting in color.

After Ewing Kelly died in 1960, his wife Nina and sons Bob and Jon formed a partnership to continue the business. The AM and FM stations were sold to the Chicago Tribune, and a search was started for other television properties for acquisition.

#### \$6.25 Million Purchase

One station that was researched and became available was KCPQ-TV, owned and operated by Clover Park School District (Tacoma). The study indicated that TV-13 offered a great opportunity for improvement in a market which is growing and has an excellent potential. Kelly Broadcasting's offer of \$6.25 million for the station was accepted by the school district in January 1979. Final FCC li-

cense approval was received in February 1980, and TV-13 went dark until November 4.

Julie Guy signed on as Station Manager for KCPQ within days after its purchase by Kelly Broadcasting. The original staff included two engineers, two secretaries and a market research specialist. When TV-13 went back on-air in November 1980, the staff had grown to sixty, and has been expanding gradually since then.

At the time of purchase, Ms. Guy notes, TV-13 had some major shortcomings: it was undercapitalized, had inadequate facilities, and its signal was poor. Kelly Broadcasting recognized the problems and was willing to make the required investment to overcome them. In addition to the purchase price, nearly \$4 million was invested in new equipment, new facilities and for complete rehabilitation of the office and studio area which was leased from the Clover Park School District.

#### New Tower, Antenna and Transmitter Plant

"We recognized the need for a change in transmitter site and transmitting plant even before the purchase was made," Bob Kelly adds.

"Our consultants, Jules Cohen and Associates, conducted studies and selected the site on Gold Mountain as the best available. This was done while the appli-

New CP transmission system provides excellent coverage of the Puget Sound market.

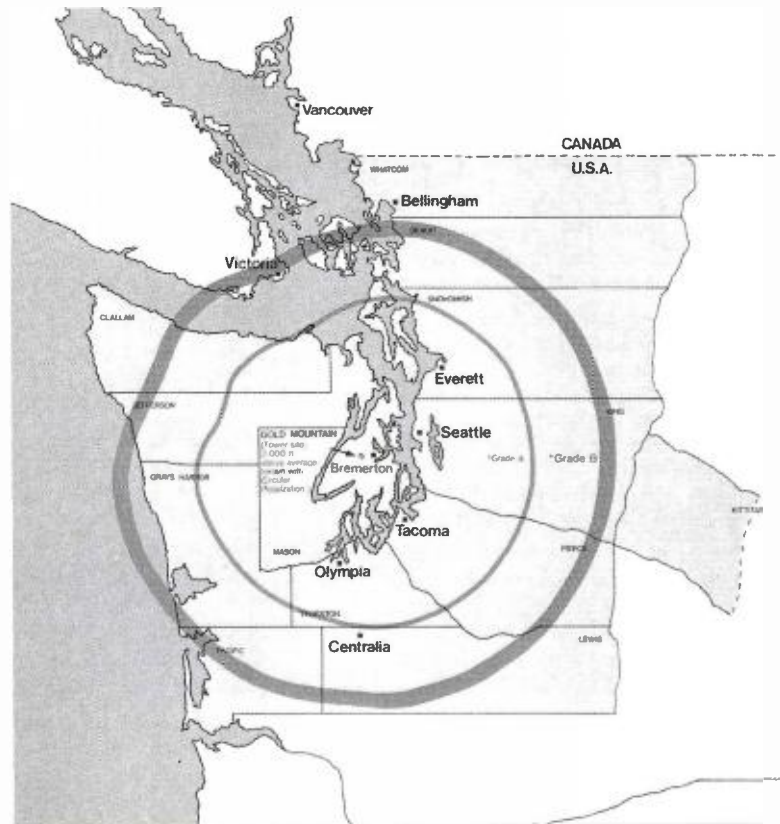

## KCPQ-TV Transmitter Building

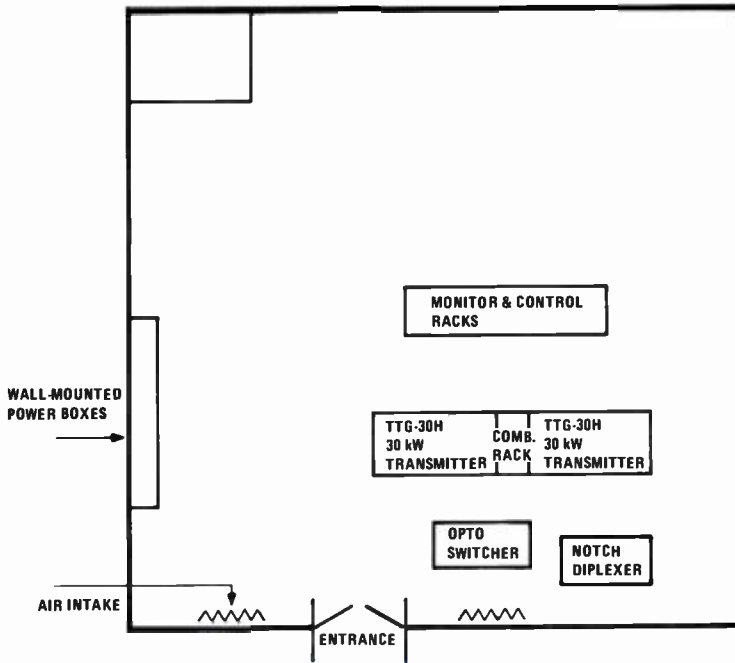

### WHAT VIEWERS SAY ABOUT THE NEW 13

When TV 13 resumed broadcasting on November 4, 1980, Bob Kelly made an on-camera appearance introducing the new operation and inviting viewers to comment on how they were receiving Q-13's new circularly polarized signal. Below is a sampling of responses compiled during the first week of operation.

#### SUMNER

... "my antenna is right in the ground, behind my trailer home. The reception and visual contrast is flawless . . ."

... "Your Ghost Free high resolution Picture is beautiful. I'm seeing colors I've never seen on my set before."

... "The very minute your station came on it was perfect. Sound, picture, everything."

... "I live in the Fremont area of Seattle, use rabbit ears, and get a super picture!"

... "My location is North Seattle. The reception is the best. Rabbit Ears—the reception is superb—no ghosts in the picture quality."

#### EDMONDS

... "We could not get 13 here before. Now is best channel with rabbit ears."

#### NORTH SEATTLE

... "Our reception of your channel is GREAT—rabbit ears only."

#### SEATTLE

... "I live in an area just south of Seattle where there are lots of hills in all directions. Your new antenna puts out a clear-ghost free picture, just as you said it would. All other channels have lines and ghosts in the picture. Channel 13 comes in clear as a bell."

#### BELLINGHAM

... "Audio perfect and picture about 95% perfect. Located seven miles north-northeast of Bellingham."

#### MOUNTLAKE TERRACE

... "Your new antenna is fabulous—I get an excellent picture now, way out here in Mountlake Terrace. I use rabbit ears."

#### SEATTLE

... "The reception is absolutely perfect."

#### FEDERAL WAY

... "Video: Very good. Color stability very good, Audio—very good."

#### BALLARD

... "We live on Sunset Hill in Ballard. You come in just great. We are just using our Rabbit Ears."

#### TACOMA

... "You certainly hit the jackpot with your new antenna. We have an outside antenna that is about 20 years old and would not bring in the old 13 at all but the new channel 13 is perfect."

#### TACOMA

... "It's good to see 13 on the air again. Our reception is great."

#### KENT

... "We have no outside antenna. The picture we get is just unbelievable. The color is perfect and clear as a bell. There are no ghosts, whatsoever!!"

cation was being reviewed by the FCC. The increased tower height and its new location, combined with the new state-of-the-art circularly polarized transmission system extends our coverage area by 7,000 square miles and provides a more powerful, consistent signal throughout the market.

"This is a difficult terrain for broadcasting, with hills, valleys, water and islands. Since going on-air, we have received hundreds of letters from viewers commenting on the signal, many of whom note that TV-13 is now giving them the clearest picture of any station in the market—and many from remote locations who note that they were unable to receive TV-13 at all before and now receive it clean and sharp, even on 'rabbit ear' antennas. (See Box.)"

"From the beginning we wanted a state-of-art facility, starting with a top quality signal. The equipment package put together by Director of Engineering, Bill Karpisek, including the new transmitting plant, achieves this goal. Our on-air picture is equal to or better than any of the stations in the market."

### Gold Mountain Tower Power

The KCPQ-TV Transmitter/Antenna site occupies 10.8 acres at the top of Gold Mountain (1687 feet AMSL), accessible from a narrow logging road which slithers up the heavily wooded slope.

Clearing the top of the mountain for the transmitter building and for anchoring the tower sections, the CP antenna and transmitter up required both care and ingenuity.

The TBJ antenna came in a single 70 foot tower section mounted on a flat-bed trailer. Navigating the sharp twists in the road would have been impossible without using a "skyhook". The rigger's solution was close to that. He hired a truck with a crane to follow the antenna trailer. The crane was attached to the antenna trailer, and hoisted the rear end to move it clear of obstructions and to straighten out the tight turns.

The top-mounted TBJ panel type CP antenna was specified because of special pattern shaping requirements. The antenna is radomed and functioned without a problem throughout the first winter of operation, unaffected by icing conditions, some severe.

### Transmitter Building Designed With Room To Share

Construction of the tower and transmitter building began in July 1980. The trans-

mitter building is a 50' x 50' cinderblock construction, with no windows, with locked and alarmed front doors for access. The building easily accommodates the TTG-30/30H Transmitter with ample room for adding a second transmitter as well as two FM transmitters. The tower is capable of handling a second TV antenna and two FM antennas.

The transmitter layout is standard, with the paralleling cabinet in the center, flanked by the two 30 kW transmitter sides. Opposite the front line cabinets of the transmitter are the racks of monitoring, STL and remote control equipment. Ample room is provided at the rear of the transmitter for access.

An Opto Switcher (Optimized RF Output Switching unit) is included in the system, providing motorized switching of aural and visual transmitter outputs.

The Opto Switcher and Notch Diplexer for the system are floor-mounted behind the transmitter. Each side of the transmitter delivers 24 kW power output. Separate power inputs and circuit breakers are used for each transmitter side, with emergency power provided by a 179 kW diesel auxiliary.

#### **Transmitter "Worked Right-Out-Of-The-Box"**

Lee Pinski, Chief Engineer, feels good about the TTG-30/30H Transmitter. And well he should. Before joining Kelly Broadcasting as Chief Engineer for TV-13, he was the RCA Sales Representative who sold the KCPQ system. According to Pinski the TTG transmitter is simple to operate, and is reliable, with excellent signal-to-noise and Incidental Phase.

It virtually worked "right out of the box" he notes, although on-site fine tuning was necessary. The installation was handled by RCA Service Company and the RF system was optimized, including the combining equipment.

The transmitter is easy to maintain and to work on when necessary, Pinski adds. It is going on remote, unattended operation three months ahead of schedule, using the STL subcarrier for remote control. The transmitter/antenna site is some 30 miles North and West of the Tacoma studio.

"Q-13's signal and coverage with the new system is excellent," Pinski affirms. "The CP antenna provides Ch. 13 with a very good signal in all areas of Puget Sound, and the antenna height provides for extended coverage."

#### **Q-13's CP Antenna Promotion**

As the "new kid in the neighborhood", KCPQ backed its investment in circularly polarized transmission with a \$50,000 summer spot TV promotion aimed at encouraging viewers to check their outdoor receiving antennas for damage or wear, and to consider purchasing new circularly polarized models available from local distributors. Another element in this campaign was directed to "rabbit ear" antenna users, suggesting that TV-13 can deliver a clear, clean signal with a minor adjustment in orientation.

The CP antenna promotion was successful, explains Paul Fava who handles viewer reception problems among other duties at TV-13. One good result is far fewer calls about signal problems. Before the summer campaign, 8 to 10 calls were received daily regarding reception—more than 80% of which were corrected by having viewers fine-tune their TV set, adjust indoor antennas, or replace defective, corroded outdoor antennas.

#### **CP Transmission Provides Signal Consistency**

The new tower location and CP operation have had a favorable effect, especially in difficult reception areas such as Mag-

nolia Hill and View Ridge in metropolitan Seattle, Fava says. These areas went from no signal from TV-13 to an excellent one, even on rabbit ear antennas.

Signal consistency is a significant advantage of CP transmission which is confirmed by TV-13's operation, Bob Kelly states. Even with the hilly terrain, the KCPQ signal covers the entire market area, reaching all population areas.

#### **Program Development**

To capitalize on the picture quality, it was necessary to schedule a program mix that attracts and keeps viewers tuned in.

"In developing the program matrix for the market to compare competitive offerings, movies seemed to provide a major opportunity for effective alternative programming," Ms. Guy remarks. "They have been quite successful for us—especially the 'classics' which we run on a regular basis."

As a practice, TV-13 airs fewer minutes of commercials than are permitted by NAB code. The "8 O'Clock Movie" is presented as "minimally interrupted" program, with two commercial breaks for a two-hour show. In addition to the two "commercial clusters", a News and Weather brief is inserted in one program break.



TTG-30/30H Transmitter is a parallel 60 kW system.

# Technical Center KCPQ-TV, Tacoma, Wash.

HALLWAY

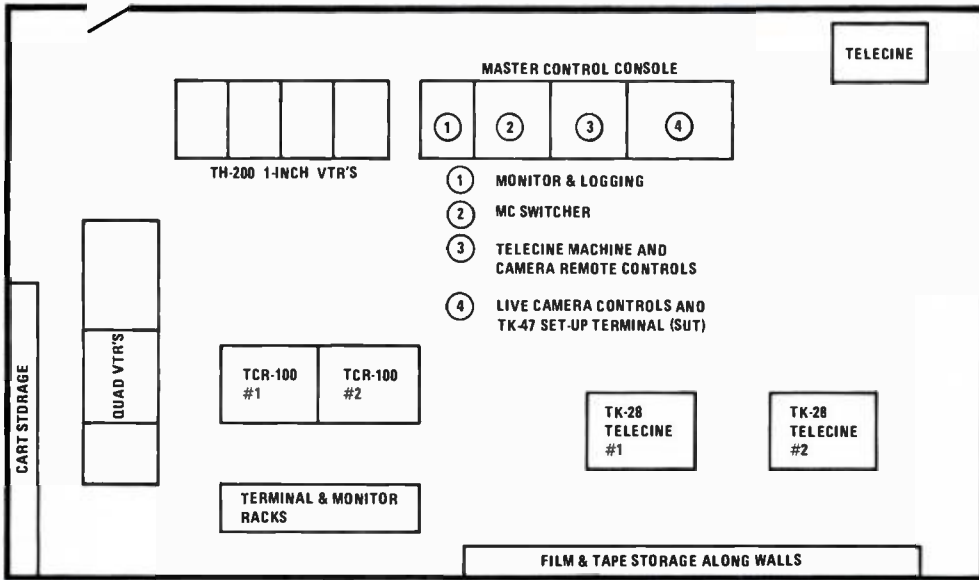

TH-200 VTR's with Dynamic Tracking are used for both program playback and production.



Two TCR-100 video "cart" machines handle a heavy volume of commercial playbacks for KCPQ.



Master Control is an integral part of KCPQ's Technical Center. Machine controls and live and film camera video controls are built into the MC console.

### Extensive New Studio Equipment Package

In addition to the major investment in the new transmitting plant and the refurbishing of studio and administrative areas, a full complement of studio equipment had to be acquired by Kelly before going on-air as a commercial operation. Included in the new studio equipment package were:

- 2—TK-47 Automatic Color Cameras
- 2—TK-28 Telecine Systems
- 2—TCR-100 Video "Cart" Machines
- 4—TH-200 Type C format VTR's
- TH-50 Portable VTR
- 2—TK-76C Portable Cameras
- 2—Grass Valley video switchers for Production Control and Master Control
- Vidifont Character Generator System
- ADM-1600 Production Audio Console
- BC-13 Audio Console

Only a bare minimum of equipment was salvaged from the old TV-13 operation: two IVC-7000 cameras; a Cohu Telecine System, and two VR-1200 VTR's.

### TK-47's: Easy To Set-Up; Easy To Operate

In the studio, the TK-47 cameras have just about taken over completely, according to Lee Pinski. They're used now for local programming, commercial production and for news.

The TK-47's at KCPQ-TV are the first in the Northwest area, Pinski notes. "These cameras have worked out fine for us," he says. "The camera is easy to set up and so stable that we seldom have a need

to use the "Auto-Check" facility. Picture quality is excellent. "The camera, with its microprocessor control, takes the burden off the video operator. It also makes the camera operator's job easier, so much so that even less skilled operators can produce desired results with little training."

At KCPQ, the engineering staff of 25 handles maintenance for Studio and transmitting equipment, as well as technical operations, including camera and video tape operators as well as Production Control and Master Control operators.

### Master Control and Technical Center

The Technical Center and Master Control operations are functionally grouped in one large room.

The Master Control console includes the customary switching, monitoring and machine control facilities as well as video controls for the film and studio cameras. Joystick remote control panels are used for the TK-28 telecine cameras and for the TK-47's. On one end of the console is the Master Control Switcher; on the other is the TK-47 Set-Up Terminal (SUT).

The four TH-200 VTR's are rack-mounted side-by-side and are equipped with built-in Dynamic Tracking which provides broadcast quality pictures in slow motion, fast motion and freeze frame. The TH-200's are used for program playback and for production work, including editing, using the built-in editing facilities of the machines.

With a heavy schedule of movie programming, most of the material aired by

TV-13 is on film, providing a steady workload for the TK-28 telecine systems.

As an independent, TV-13 finds the TCR-100's an indispensable part of the operation. Just about everything is dubbed onto the "cart" machines for on-air play-back, Lee Pinski remarks—including film and video taped commercial spots, PSA's, ID's, trailers and bumpers. A heavy volume of the station's production output is devoted to program promotion, which is also "carted".

### Expanding The News Capability

The next area of program development for KCPQ is a news operation. News has been and is a strong programming feature of Kelly's flagship station, KCRA—Sacramento, and is a logical move for Q-13 in serving the Puget Sound market. "As an independent, we have access to two sources of national and international news, both coming in via satellite," Mr. Kelly explains. "These services—CNN and INN—are both relatively new. In addition, we are moving ahead with plans for an expanded local news operation."

### High Expectations . . . Encouraging Results

Bob Kelly summarizes KCPQ's progress in less than a year of on-air operation: "We had high expectations for this market—and the results so far are very encouraging, in terms of ratings and in progress toward our goals. Our initial 5-year plan called for turning a profit by the end of the second year of operation. We're running ahead of that projection, and are expected to reach break-even by the end of the first year." □

Two TK-47 automatic cameras effectively handle local programming, commercial production and news.





Three-antenna array atop Milwaukee's "T-Bar" tower includes a UHF Type TFU-36JDAS Pylon on left; VHF TW-12A Traveling Wave on right, and Pylon TFU-28DAS side-mounted on tower below the "T".



## PUBLIC and COMMERCIAL STATIONS COOPERATE To Build NEW TOWER and TRANSMITTING PLANT

**T**he newest tower and transmitter building on Milwaukee's TV antenna "farm" is shared by a commercial and two public television stations. For the three stations involved, getting on-air from a new site was an extended, tortuous route—but the results have made it a worthwhile effort.

The two public stations—Ch. 10 (WMVS-TV) and Ch. 36 (WMVT-TV) are operated by Milwaukee Area Technical College—and the commercial station, Ch. 18 (WVTV) is a Gaylord Broadcast-

ing Company property.

A unique aspect of this situation is that all three of the stations involved are both landlords and tenants to each other, with the public stations owning the land and Ch. 18 owning the tower and transmitter building.

In making the move to the new site, the stations have installed new RCA antennas, transmission line and transmitters valued at \$2.5 million.

### "Tee"-Bar Antenna Mount

The new tower rises 1013 feet above ground and is topped by a "Tee"-Bar on which are mounted the Ch. 18 (TFU-36JDAS) and the Ch. 10 (TW-12A) antennas. The Ch. 36 antenna (TFU-28 DAS) is side-mounted on the West tower leg 90 feet below the "Tee"-Bar.

In addition to the three TV antennas, one circularly polarized FM antenna is installed on the tower, with provision to accommodate two more.

### Cooperative Planning For New Site

Planning for the new transmitting facility has been an on-going project for several years. Bill Witt, Director of Engineering for WVTV and Harold Wagner, Chief Engineer for both WMVS and WMVT, have been mutually involved in seeking a new site for their stations since 1973.

In 1978, the Milwaukee Area Technical College (MATC) acquired a 32 acre property at the northwest end of the antenna farm—the last usable site in the area. Known locally as "Blue Hole", it



Breaking ground for the new tower on March 31, 1980 are (left to right) Harold Wagner, Chief Engineer for WMVS/WMTV; Joseph Loughlin (then General Manager of WVTV), and Bill Witt, Director of Engineering for WVTV.

**MILWAUKEE**



had been a limestone quarry and a landfill.

The acquisition of the desirable "Blue Hole" site, expedited action on the project. Gaylord Broadcasting leased the property from MATC and provided space for them on the tower and in the transmitter building which were to be sited there. The "antenna farm" location for the new tower solved a number of problems, Mr. Witt notes. In particular, it is in an FAA approved area, which simplified clearances. And, since the other local stations operate from this area, home viewer antennas are oriented toward that direction for best reception.

**Increased Power And Coverage For Ch. 18**  
With its new TTU-55C 55 kW Transmitter and custom TFU-36JDAS Pylon Antenna, WVTV increased its coverage area, with a substantial improvement in signal quality throughout, according to Mr. Witt. The ERP was increased from 1,892 kW to 2,500 kW. Along with its additional advantage of being located on the antenna "farm", the new antenna is 482 feet taller than the old one—reaching a height of 1,008 feet Above Average Terrain (AAT). The replaced tower and antenna (still maintained as a standby)

are located on the top of the Marc Plaza Hotel in downtown Milwaukee.

WVTV's Pylon Antenna is modified for a 30.5 vertical gain instead of the standard 36 gain. Horizontal gain is 1.9, with null fill and 0.5° beam tilt.

**For Ch. 10 and 36—Added Power; Improved Signal**

The move to the new tower was a short one for Ch. 10 and Ch. 36—only a shift of about a half-mile to the Northwest. Previously operating from the WITI-TV (Storer Broadcasting) tower, the two public stations had long wanted to relocate to gain antenna height.

For Ch. 10, moving to the new tower, even with increased height, did not result in a substantial increase in coverage area, Mr. Wagner says, since the station had been operating at the maximum ERP of 316 kW visual. The predicted signal radius was extended from about 52 to 60 miles from the transmitting site.

A major difference was in the picture quality. Previously there had been areas where the Ch. 10 picture was difficult to receive: some "dead" spots and some areas where there were "ghosting" problems. Since changing to the radomed

TW-12 Traveling Wave Antenna on the "T" Bar, reception has been excellent throughout the coverage area, Mr. Wagner reports. The shaped vertical pattern of the TW-12 eliminated dead spots and ghosting.

The changeover to the new system was made on April 1, 1981 during a WMVS-produced program, with a brief ceremony where the board chairman pressed the button signalling the changeover.

For Ch. 36, the change was even more dramatic. The coverage area is extended from 30 miles to a predicted 48 miles. The increase in tower height (from 440 feet to 890 feet) was accompanied by a major increase in power output—from 316 kW to 2,340 kW ERP. A part of the increase in coverage is credited to the added efficiency of the new TFU-28DAS Pylon Antenna and new 60 kW TTU-60D Transmitter.

Channel 36's TFU-28DAS Pylon Antenna radiates a skull pattern, and is null-oriented to the middle of the tower. A study was made by the RCA Antenna Engineering group at Gibbsboro to determine the best spacing for minimum pattern disturbance.



Standing on catwalk at the tower base are Bill Witt; Director of Engineering and Dennis Brechin, Transmitter Supervisor for WVTV; Gino Monaco, Transmitter Supervisor, and Harold Wagner, Chief Engineer for WMVS/WMVT.



First section of tower is moved into position on the base.

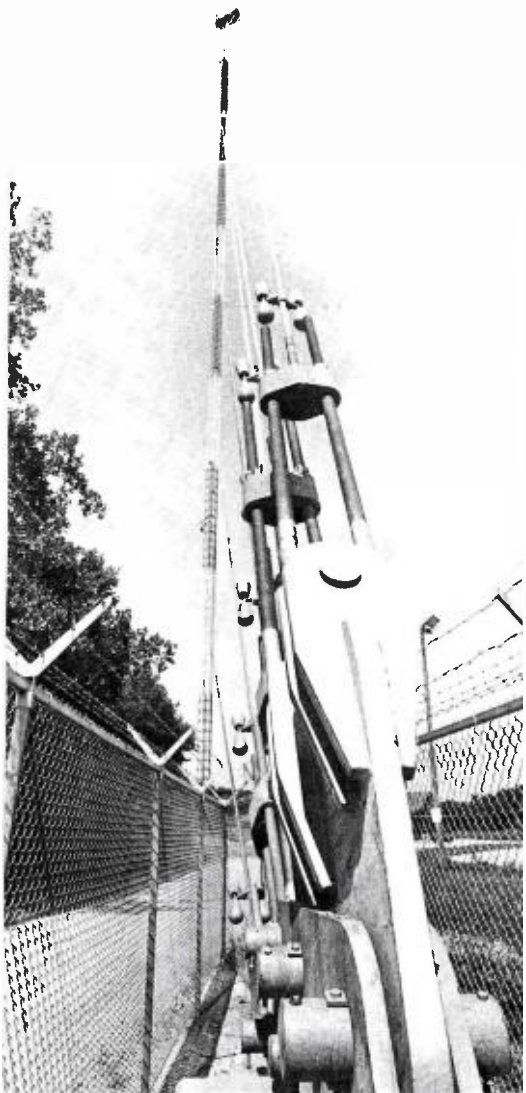

### A Heavy-Duty Tower Structure

The heavy-duty guyed tower was designed and constructed by Kline Tower Company, Columbia, South Carolina, and is the fifth tower which that company has built for Gaylord Broadcasting.

The tower has a 60-43 windloading with a half-inch of radial ice and Mr. Witt specified that it be designed with a 25 percent extra windload provision for future CP operation. A computerized dynamic study was performed by Kline to project the tower reaction to a full range of wind loadings and severe environmental conditions. This is the second such dynamic study conducted by Kline, the first being for the multiple antenna structure on Mt. Sutro, serving the San Francisco-Bay area.

The tower rests on ten "I" beam steel pilings driven down to bedrock—44 feet underground. Copper grounding wires are cad-welded to the "I" beam pilings, and grounding radials are laid out to 120

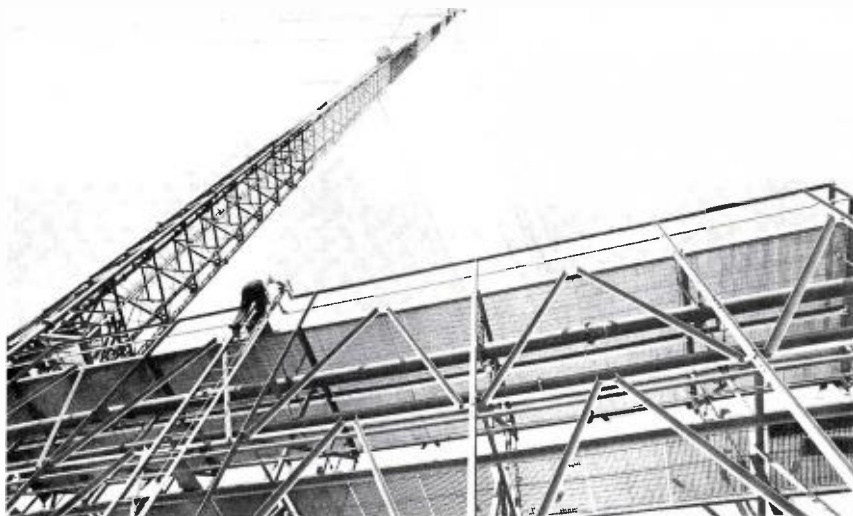

Heavy-duty catwalk from transmitter building to tower protects transmission line from ice damage.

feet from the tower base at 20 degree spacings for further grounding protection.

The tower facing is ten feet at the base. Six layers of guy wires were used, in three directions, a total of eighteen guys. One of the guys had to be stretched across the Milwaukee River and anchored in Lincoln Park, requiring a special easement. This guy was a particular problem, requiring extensive excavation and taking 102 cubic yards of concrete for anchoring.

Bell type dampers are used for high frequency damping, Mr. Witt says, and new sand dampers are being installed for low frequency damping. These consist of sand-filled pulleys on each guy which are connected to concrete-embedded pad eyes under each set of guys. The concrete imbedments are located 70 feet from the base of the tower. The sand-filled pulley system is designed to prevent guys from "galloping" under severe stress conditions.

The "Tee"-bar at the top of the tower (1,013 feet above ground) is a substantial structure—ten feet wide and ten feet deep, with a steel plate at the top and a metal grid at the bottom. The Ch. 18 TFU-36JDAS Pylon and Ch. 10 TW-12 Traveling Wave antennas are mounted on either end of the "Tee", separated by thirty feet from center-to-center. The "Tee"-bar was assembled on the ground and installed in two pieces. The Ch. 36

Pylon antenna is side-mounted on the West tower leg below that of Ch. 18. The three FM antennas will also be located on the West tower leg.

### Circularly Polarized FM Antennas

WEZW-FM, the first radio station on-air from the tower operates with an RCA Type BFM-4B, four-bay circularly polarized antenna which is equipped with de-icers, and was optimized by RCA.

Terry Baun, Chief Engineer for WEZW-FM selected the BFM because he wanted a high-power, heavy-duty antenna which is capable of being expanded at a later date if desired. He also wanted a low Q antenna, since icing is a problem in the Milwaukee area. The new system went on-air in June, and Mr. Baun confirms that he is well-satisfied with the results. The station moved from the nearby Ch. 6 tower to obtain increased antenna height and improved coverage.

### Spacious, Sturdy Transmitter Building

Constructing the transmitter building on the "Blue Hole" landfill site was not without its problems, Mr. Witt remarks. The building is 5,400 square feet, compartmented with separate spaces and entrances for WTV; WMVS/WMVT, and for the three FM transmitter rooms.

The 129 foot by 42 foot building is a solid structure, with a peaked roof resting on concrete-block walls faced with dark brown bricks. The roof is con-



Transmitter building is currently shared by three TV transmitters and an FM transmitter, with additional space available for another FM transmitter operation.

structed of 2½ inch tongue and groove planking, topped by a rubber roofing material and is capable of withstanding 500 pounds of falling ice, Mr. Witt says. The building is separated from the tower by sixty feet to provide for transmission line expansion.

The building itself sits on 32 steel "I"-beam pilings going down to bedrock—37 to 42 feet below ground level. As with the tower, the building is grounded with copper wires cad-welded to the piling at bedrock.

Constructing the building over a landfill added an extra consideration—the need to install a system to monitor and pump the methane gas out on a regular basis to prevent a potentially hazardous pressure build-up.

The main power transformer for the transmitter building carries 26,000 volts, which is stepped down to 480 V. Each of the three television operations has 480 V, 500 Amp electric service, while each FM station has two lines of 280 V, 200 Amp Service. Power comes in to a common source and splits off to each occupant.

#### WTVU Builds With CP Operation In Mind

In planning the tower and transmitting system, WTVU provided for the future option of going to circularly polarized operation. As previously noted, the tower structure is designed with reserve capacity to handle a CP antenna.

In the transmitter room, the planning for expanding to CP is even more obvious. The present transmitter installed is a 55 kW, Type TTU-55C, but the entire plant is laid out with easy conversion to a 110 kW system in mind. The second transmitter could be installed in two days, Mr. Witt says.

For example, the aural cabinet of the TTU-55C is separated from the visual cabinets, with space provided in between for moving in the new system components. Water lines and plumbing are already installed behind the front cabinets for ease in adding the second TTU-55.

The front line cabinets are walled in for appearance and sound isolation, and space is provided for adding a spare ex-



Monitor and control facilities for Ch. 18 and front line cabinets for TTU-55 transmitter are built-in for aesthetics and sound deadening.

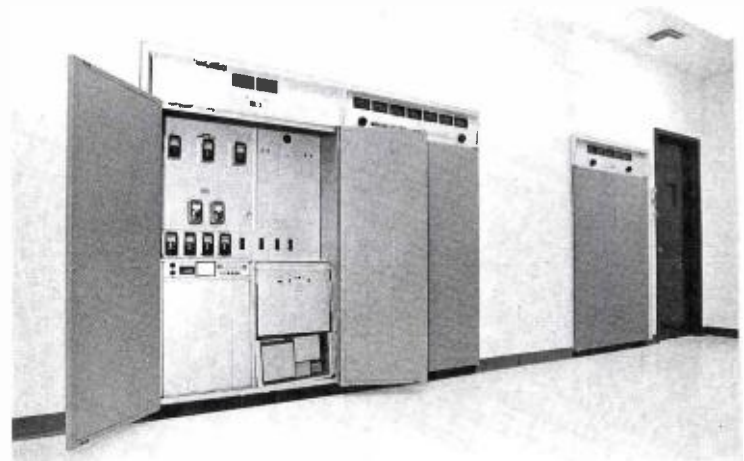

Front line cabinets for TTU-55C. Note cabinet spacing, with room provided for easy installation of a second TTU-55C.

citer with the new system. And, for immediate and future power savings, the Mod Anode Pulser unit is installed.

The diplexer (ceiling mounted) and heat exchanger are both designed for 110 kW operation. Two complete, switchable water systems are installed, with three pumps: one for on-air operation; one for the dummy load, and a spare. A voltage regulator controls system power within ±1 V. Wherever feasible, redundancy has been built into the system, Mr. Witt remarks.

A separate air room was built by Ch. 18 instead of the usual ducting system for delivering air to the condenser. And, instead of an electric pump, a compressor is used to open the air louvres. The flow

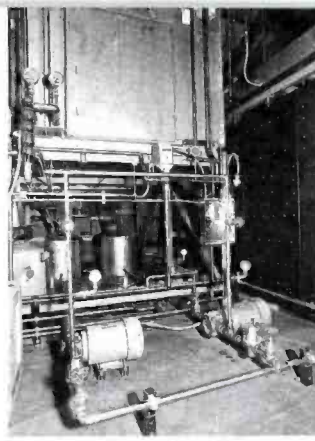
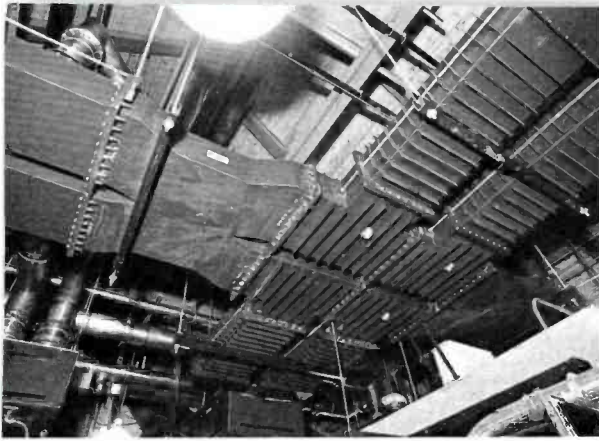

Ceiling-mounted diplexer (left) and heat exchanger (right) are designed for 110 kW operation.

## MATC Transmitters Share Space and Facilities



WMVS/WMVT share transmitting space, with their TT-35FH, 35 kW VHF transmitter and TTU-60D, 60 kW UHF transmitters also sharing monitoring and control facilities.



of incoming air is controlled by two "blenders" at the intake. For economy, provision is made for re-circulating warm air from the heat exchanger to heat the transmitter room in the winter.

Channel 18's TTU-55C transmitter is operating at 52 kW output to achieve the ERP of 2.5 megawatts.

MATC ordered their antennas, transmission line and transmitters well in advance of construction, placing the order with RCA in 1978.

Channel 10's TT-35FH 35 kW Transmitter and Ch. 36's TTU-60D, 60 kW Transmitter were delivered by RCA just one day apart, in December 1980. Although this created a temporary log-jam in the MATC transmitter area, it was a relatively smooth move-in, Mr. Wagner recalls. Installation of both transmitters was handled by the WMVS/WMVT technical staff.

The transmitting area is shared by the two transmitters, with additional space available for expansion, should this be desirable in the future.

The transmitters are laid out in an "L" configuration with the front cabinets built-in for sound isolation. The monitor and control racks for the two transmitters are also set up in an "L" arrangement, which makes it easier and more convenient for the operator to check and calibrate the equipment.

Common remote control facilities are used for the TT-35FH and the TTU-60D, and both transmitters are remote controlled from the MATC studio, located in the Milwaukee Area Technical College complex in the downtown area of the city.

In planning the move-in, floor markings were used to show the location of all transmitter cabinets and other equipment for easy spotting and positioning.

### 35 kW VHF Transmitter

Channel 10's TT-35FH transmitter is a parallel system comprised of two 17.5 kW units. The system is operated at 32.9 kW output to maintain the 309 kW ERP. The system includes the Opto-Switcher—an optimized RF output switching unit that provides for motorized switching of aural and visual transmitter outputs. The redundancy of the TT-35FH is an excellent feature, and insures reliable, uninterrupted service to the public, Mr. Wagner comments.

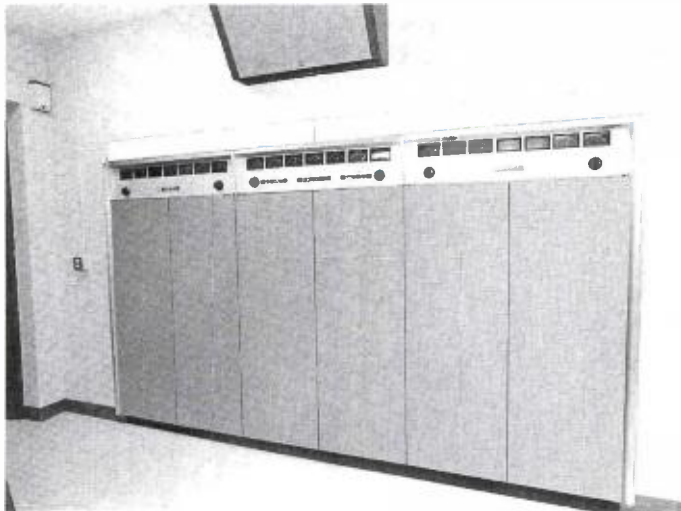

TT-35FH (above) and TTU-60D (below) are installed in a "U" configuration for operational convenience. Front cabinets are built-in for sound isolation.

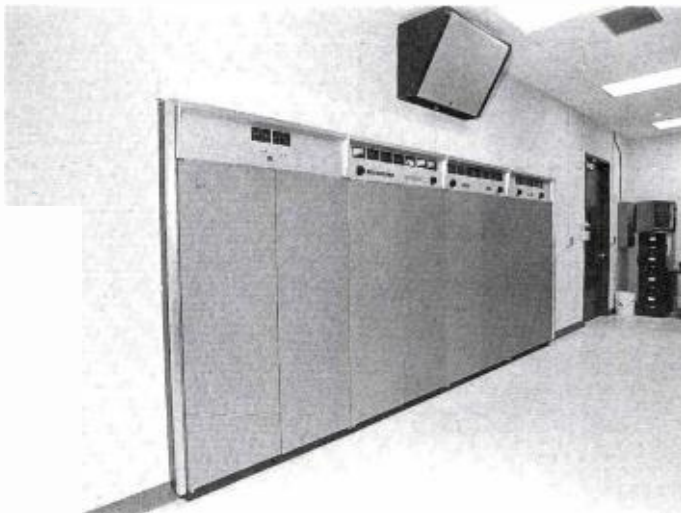

The previous Ch. 10 transmitter and antenna were installed in 1957, while Channel 36 installed their previous antenna in 1963, and the transmitter in 1965. In each case, it was not cost-effective to move the transmitters to the new location.

#### An Efficient 60 kW UHF System

Channel 36's new 60 kW transmitter is equipped with a Mod Anode Pulser and is operated at full power. "We are looking for all the efficiency we can get," Mr. Wagner avers. He is pleased with the efficiency achieved with the new transmitters, particularly in the case of Ch. 36. The new system attains 2,340 kW ERP, a substantial increase over the 316 kW ERP, of the replaced transmitting system.

With the large increase in power output,

the electric bill was projected to be 1.7 times that of the previous system. It is turning out to be even less than that, Mr. Wagner notes. For added efficiency, the station is planning to install an aural coupler in the TTU-60D.

#### "Nothing But Good Comments From Viewers"

Although field strength measurements will be made later, Mr. Wagner is confident that they will bear out predicted results. To date, he says, we have had nothing but good comments from viewers on the picture quality of both Ch. 10 and Ch. 36.

With its new transmitting system, Ch. 36's extended signal radius is providing service to a significant number of new

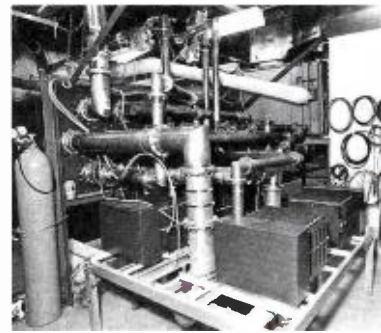

Patch panel for TTU-60D Transmitter.

potential viewers, while those closer in are receiving a noticeably more stable TV picture and a cleared audio signal.

An unexpected response to Ch. 10's new on-air signal came during the change-over program on April 1, from a cable company in Muskegon, Michigan, on the other side of Lake Michigan. The cable operator recorded the program and showed the signal going from "snow" to a clear picture as the switch was made. A Fond du Lac, Wisconsin, master antenna distributor reported that there was a 9 dB increase in signal strength for Ch. 10 at his location. He also reported Ch. 36 as going from an unusable picture to a good one with the new system.

#### Cooperative Venture Mutually Beneficial

In announcing the cooperative effort which resulted in the new tower and transmitting facility, Ralph Bowes, then Chairman of the Milwaukee District Board of Vocational, Technical and Adult Education, said, "The cooperative venture with the Gaylord Company offers several attractive benefits. With Gaylord financing the cost of the tower and transmitter building in exchange for the use of our property, we're saving the District's taxpayers about \$900,000."

Joseph Loughlin, the former General Manager of WVTM commented: "Since the early days when Channel 18 was owned by the Columbia Broadcasting System, the station has operated at a disadvantage because of FAA limits on antenna heights in downtown Milwaukee. The new tower eliminates that disadvantage. We've had a fine relationship with WMVS and WMVT over the years, and we are happy to be able to be of help in making this joint venture a reality."

"The new design antennas and the replacement transmitters, along with the substantial increase in height, will dramatically improve both stations' audio and picture quality, radiated signal and area coverage," Dr. Otto Schlaak, General Manager of WMVS/WMTV noted.

For these three Milwaukee broadcasters, the results of their cooperative venture have more than measured up to expectations. □

## NEW PRODUCT OVERVIEW

The many faces of HAWKEYE: HCR-1, one-piece Recording Camera System; HC-1 Portable Camera; HR-1 Portable VTR; HR-2 Studio VTR, and HE-1 Edit Controller.

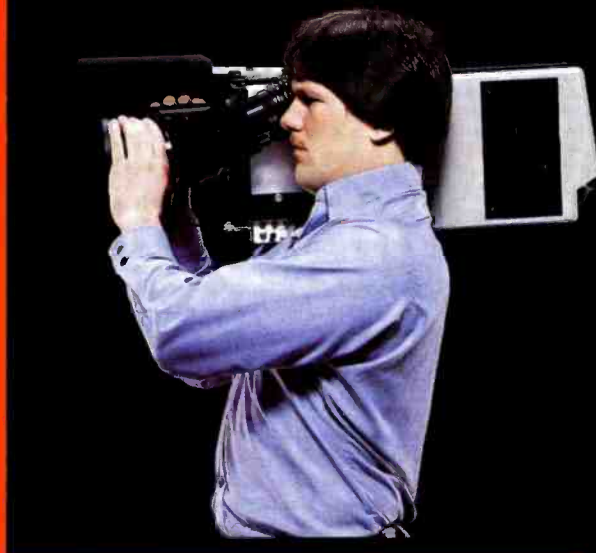

# HAWKEYE

## THE BROADCAST-QUALITY RECORDING CAMERA SYSTEM

From the earliest days of ENG and EFP, when the two-piece portable camera/VTR system began replacing film in the field, the industry set its sights on the day when video, with its appealing advantage of instantaneous pick-up and playback could also offer the maneuverability and reliability inherent to self-contained film systems such as the CP-16. RCA's goal of producing an integrated camera/VTR system dates back to a time before the development of the TK-76. However, practical implementation of the concept was continually frustrated by the limitations of available technology—until only recently. This article offers an overview of the innovative technological achievements as well as the design philosophy from which the HAWKEYE recording camera system evolved.

#### The User As Specifier

It has always been the RCA philosophy (as well as a sound business practice) that advancement in the state-of-the-art would not fulfill the practical requirements of the market without close collaboration with market users during product development stages. Therefore, final design parameters of the HAWKEYE recording camera system were not set until after an indepth study of user preferences was conducted in 1978. Hundreds of camera operators, news and production directors, chief engineers, and facility

managers were surveyed. Asked to rate relative importance of key design features, respondents agreed that low weight and high camera sensitivity were essential to a practical and useful system. The primary concern of these professionals, however, was recording performance. On this, the majority agreed—improvement over ¾-inch picture quality was not only desirable, it was sorely needed.

#### Designing the HAWKEYE System

With its user study results as a basis, RCA formulated its five major design objectives.

1. The miniaturization of camera and recorder to allow the development of an integrated, single-piece system small enough and light enough to be easily handled by one person.
2. Camera performance that would meet top-rate video standards. A new generation of broadcast quality recording performance that would succeed in maintaining the integrity of the camera's high quality signal in the video recording.
3. A total system design, including complete studio editing facilities, to assure uncompromised broadcast quality performance from signal pickup, and recording, to final edited output.
4. The refinement of design techniques

affecting durability and reliability to eliminate the major contributors to field and studio downtime.

5. A highly flexible system with the appropriate options to accommodate a variety of application requirements and to protect users' unamortized investments in cameras and VTRs.

With the achievement of these design goals, the era of "electronic cinematography" emerges. The HAWKEYE recording camera system, with its advanced technology allowing broadcast quality system performance and reliability, promises substantial reward for the user.

#### One-Unit, One-Person Field Production

With HAWKEYE, field production is brought full circle. The freedom of mobility once possible only in film is now obtainable in video due to an integrated design that combines camera, video cassette recorder, microphone and batteries into one shoulder-mounted unit. Including lens and viewfinder, the unit is only two-thirds the weight of the lightest comparable two-piece broadcast field production system. Low weight and the total elimination of the troublesome camera/recorder umbilical cord, provides the one-person crew with an easy handling, highly dependable field system.

Careful attention has been given to



HCR-1—a one-unit, one-person field production system.

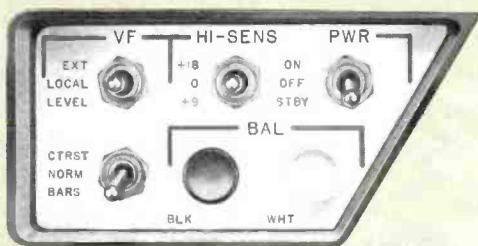

Camera controls are clustered for operational convenience.

Camera viewfinder displays an array of useful information.



VTR is activated from the camera lens.

Snap-in battery.



operator comfort, convenience and control. The HAWKEYE HCR-1 Recording Camera System sits easily on the shoulder. It's low profile, low center of gravity and excellent balance combine to reduce operator fatigue on lengthy shoots. Operating controls are within fingertip reach, and include switchable +9 and +18 dB gain modes, contrast compression and pushbutton automatic white and black balance. Other automatic features include flare, iris and comet tail suppression. A six position filter wheel accommodates special effects or light correction needs.

The viewfinder for the HAWKEYE HC-1 camera is self-contained, and has a high resolution 1.5" image display area plus an array of LED's that indicate useful information such as low battery, video record confidence for the VTR, tape end, amount of tape remaining, VTR malfunction warning and audio channel peaks.

Video recording is initiated by depressing a button on the camera lens. Each video cassette provides twenty minutes of recording time, and slips in and out for quick loadig and unloading. Two audio tracks and a dedicated SMPTE/EBU Time Code Track are standard. The built-in Time Code Generator adds time code in the field to save editing and production time in the studio.

There are an array of lenses and batteries available which were especially developed for the HCR-1. The Angenieux lens has a 15 x 7 (7 to 105mm) focal length with an aperture of f/1.4. The lens has a minimum focusing distance of 32 inches and built-in 2X extenders. Fujinon Optical offers two lightweight lenses—the 14X and 12X lens. Both provide f/1.4 apertures. The longer of the two, 14X7, has a built-in 2X extender for a basic range of 14mm to 196mm. The 12X7 servo zoom lens offers a 7 to 84mm zoom range. Both lenses will focus down to a minimum of 0.8mm. Servo/manual zoom control is standard on each; focus is manual, but a compact servo is offered.

Both Nicad (1.5 amp hours, 30 minutes running time) and silver-zinc (4.5 amp hours, 90 minutes running time) batteries are available. The batteries are small, lightweight and triangular-shaped for easy mounting in a dove-tail position within the camera's shoulder mount. In addition, larger battery belts may be used to power the system via cable connectors.

In achieving the operational goal of a totally integrated system, HAWKEYE performance goals are realized—in fact, the major technological advances employed to reduce the size and weight of the HAWKEYE camera and recorder are the

very innovations contributing to the system's outstanding video quality.

#### Closing the Performance Gap

Current ¾-inch video recording system performance falls below that of portable three-tube cameras, causing a performance gap between cameras and recorders. HAWKEYE closes this performance gap with a design-matched camera and recorder, each achieving a high level of broadcast standard video quality.

The HAWKEYE HC-1 camera is a totally new design. The three-tube unit uses a new generation of ½-inch Saticon® or diode gun Plumbicon® tubes. These tubes not only lower the weight and power consumption of the camera, their excellent performance helps the HC-1 meet professionals' demand for high sensitivity and resolution. The Amperex Plumbicon® tube features a diode electron gun for low lag and excellent resolution; low output capacitance for a high signal to noise ratio; isolated front end mesh contact and evaporated wall electrode for reduced line pick-up, and electrostatic focus for both low weight and excellent resolution. The RCA Saticon offers the best resolution in this format, and lag performance which is actually lower than most ¾-inch tubes.

New preamplifier circuits in the HC-1 contribute to the camera's high S/N ratio



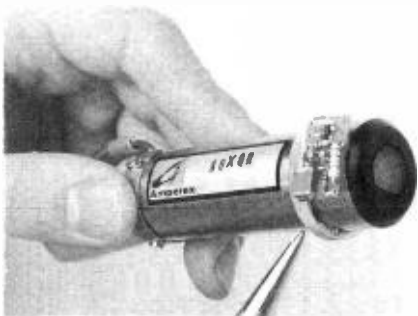

New 1/2-inch Saticon\* or Plumbicon\* tubes are available for the HC-1 Camera.



and sensitivity, while precision alignment of tube and yoke assemblies provides unprecedented registration accuracy for the tube size utilized. The total result of these improvements is a camera that in some areas exceeds the performance of cameras utilizing three 3/8-inch tubes.

Camera resolution is 53% at 400 lines (5 MHz)\*. Registration error is a low 0.1% in Zone 1, 0.2% in Zone 2, and 0.3% in Zone 3. There's no compromise in picture clarity, sharpness—or in low light capability. At f/1.4 HAWKEYE achieves 46 footcandle sensitivity with a S/N ratio of 52 dB.

Additional innovations which contribute to picture quality and color matching are an extremely precise dichroic prism and new color encoder. The encoder is self-adjusting, with no manual adjustments at all.

\*Standard burst chart, center of raster, excluding error in lens. Resolution ("Modulation Transfer Function") of all lenses varies with zoom position. For complete accuracy, multiply RCA resolution number by lens manufacturer's MTF.

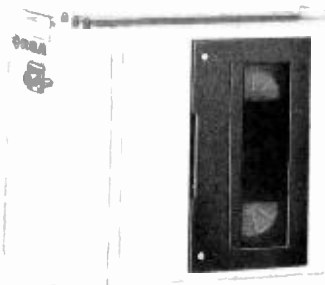

The HR-1 VTR uses a standard six-hour (250m) videocassette which provides 20-minutes of recording time.

### Unique ChromaTrack Recording System

To maintain the dynamic range, resolution and color fidelity of the camera pickup in the recording, the HAWKEYE HR-1 VTR employs a unique recording technique called ChromaTrack, which separately records the Y, I and Q video components. Utilizing standard six-hour

(250 m) VHS cassettes, the ChromaTrack format moves the tape at a linear speed of 8 ips (six times faster than normal VHS record speed) to yield 20 minutes of recording time per cassette. ChromaTrack does not use the heterodyne color (or amplitude modulated color under) system; rather luminance and chrominance are recorded on the tape through new methods of processing. The resulting improvement in color resolution and signal-to-noise response provide broadcasters with a new generation of broadcast quality field recording performance that surpasses 3/4-inch recorders, offering 10 dB better signal-to-noise and a 3:1 improvement in chrominance resolution, picture distortion, and multi-generation chrominance to luminance delay. (The accompanying chart shows performance comparisons based on RCA tests of three top-rated 3/4-inch VTRs).

PERFORMANCE COMPARISON CHART		
	HAWKEYE	3/4" VTRs
Chrominance Signal/Noise	48 dB	38 dB
Resolution (Chrominance) (Bandwidth)	1 MHz	0.33 MHz
Geometric Fidelity (C-L Distortion)	2%	6%
Third Generation (C-L Registration Error)	90 nsec	300 nsec

The high levels of performance achieved in the HC-1 camera and HR-1 VTR result a performance-matched system which meets broadcast standards for the first time. The advantages that total performance compatibility offers the user will do much to advance ENG/EFP images.

### Studio Performance Matching

RCA carries HAWKEYE performance compatibility down the production line with recording equipment for the studio. Along with the HC-1 Camera, the HR-1 In-Camera VTR and the integrated one-piece HCR-1 Recording Camera, the HAWKEYE product line includes the HR-2 Studio VTR and the HE-1 studio edit controller.

Offering performance that matches the high levels attained in the HAWKEYE recording camera, the HR-2 studio VTR utilizes the ChromaTrack format to deliver exceptional video quality, consistently. Complementing that performance is the microprocessor-based HE-1 edit controller, providing full editing capability for HR-2 recorders.

Compatibility of all HAWKEYE system components assures uncompromised broadcast quality from original through multiple generation dubs. Whether the HR-2 is used with the HE-1 in the editing suite, operated as a free standing studio VTR for origination or production applications, or integrated into a multi-format post-production system, its system compatible design achieves a substantial performance advantage.

### Extra Performance Value

Further advantage is found in the operational capability and extra performance features built into HAWKEYE's studio edit controller and video tape recorders.

For precise operation, HR-2 studio VTRs feature full direct drive of the video head drum, capstan and reel motors; head switching in the vertical interval; as well as electronic record interlock. Fast response to machine mode commands is a result of a microprocessor-based design that allows mode changes without going to stop. The advantage is smoother tape handling which saves wear and tear, and



The HR-2 is a versatile, full-function VTR which can be used in the studio or in a mobile unit.

speeds editing.

Precision electronic editing on the HR-2 is enhanced by the built-in SEARCH and JOG functions. A single large Search/Jog control dial is used for both functions, providing bi-directional search capability over a full range of speeds ( $\pm 8 X$ ). Jog and Search functions can be handled from either the HR-2 control panel or from the HE-1 edit controller.

The bold new upright configuration of the HR-2 VTR allows convenient front access to cassette carriage and controls during operation. And because tape transport and controls are vertically configured and the cabinet more compact, the HR-2 can be mounted in virtually any space. Rack, table-top, or under desk mounting are examples of HR-2 flexibility.

The HR-2 easily fits into mobile units. It can operate with the HAWKEYE camera, the RCA TK-86, TK-76, TK-47, or other cameras with standard video outputs for on-location or in-studio production. With the optional built-in HT-1 Digital Time Base Corrector, the HR-2 recorder can be used for direct on-air broadcast. Additional flexibility permits the cost effective insertion of titling and special effects during recording, instead of in real time. The HR-2 may also be used with any time base corrector which feeds a subcarrier out.

Providing microprocessor control of two HR-2 VTRs, HAWKEYE's HE-1 control track edit controller is ideally suited to news or production operations. Precise edit points can be located quickly using two Search/Jog control dials with

The microprocessor-based HE-1 Edit Controller provides full editing capability for the HR-2.

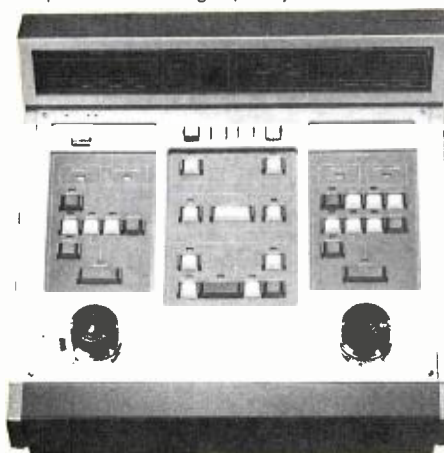

HR-1 with cover removed. Compact design with fewer moving parts improves reliability and performance.



Optical system for HC-1 Camera is totally sealed.



HR-2 Studio VTR, with lower panel dropped, showing front access to plug-in modules.

ten selectable speeds for moviola-type editing from 1/16 to 8X play speed forward and reverse, with still capabilities and viewable picture at all editing speeds. The Jog feature allows frame-by-frame movement and control of the tape in both forward and reverse via the control dials. LED indicators, above the dials, display tape speed. Editing decision points can be located "on-the-fly" with either the playback or record VTR serving as the reference.

The HE-1 performs split audio/video edits as well as automated insert and add-on edits and provides full preview functions.

In the studio, HAWKEYE features, capability, and system compatible performance combine to expand creative control and post-production efficiency. This no-compromise video production system enables the user to respond to market needs better, faster and more economically.

#### **Challenging Reliability Standards**

Certainly the other factor affecting operational economy is the length of time equipment can be relied upon to keep operating. The benefits durability and reliability offer are key to equipment cost effectiveness. The design approaches taken in HAWKEYE advance reliability to challenge standards set by conventional equipment.

The integration of camera and recorder completely eliminates reliability problems caused by cables to recorders. Cable problems were reported as common to 88% of broadcasters polled in a survey on equipment reliability conducted by Dr. Vernon Stone for the RTNDA (Radio and Television News Directors Association). Some broadcast stations surmise that by eliminating the cable problem, downtime could be cut in half.

Getting the recorder off the ground and on the shoulder prevents mechanical damage caused by the rugged use often demanded of field VTRs. Mechanical damage rates as the leading contributor to breakdowns in field recorders, according to broadcasters polled by Dr. Stone.

Further reliability is ensured in the simple mechanical operation of HAWKEYE's in-camera recorder. The HR-1 utilizes fewer moving parts and an all new transport design that reduces wear to the threading mechanism. Another HR-1 feature is a self-diagnostic routine to verify that the field recorder's microprocessor is working correctly.

The HC-1 camera features a new, totally sealed optical system with an f/1.4 prism. The design of this system allows precise collimation of each channel at the fac-

tory for unprecedented registration accuracy in a small tube size. The optical system is closed by a dust proof one-quarter wave quartz window, which reduces polarized glare.

The camera mainframe and recorder transport are made of a rugged die-cast aluminum, while the recording camera exterior is enclosed in a cover of graphite epoxy. Graphite epoxy, a space age material which is extensively used in satellites and new aircraft, is lightweight, extremely durable, and flexes but does not break. Operational switches are also sealed and recessed to protect against breakage under heavy use.

Simplicity is also the keynote of mechanical operation in HAWKEYE HR-2 studio recorders. Here, as in the field recorder, the number of working parts have been reduced. Simplified threading and microprocessor control, allowing continuous operation during mode changes, reduces wear to the threading mechanism and produces a machine that is extremely quiet in operation. No belts are used. All major recording and playback functions are driven directly.

Transport and one-piece chassis are constructed of rugged die-cast aluminum. Critical components and mechanical parts are mounted onto the chassis which helps ensure the stability of their alignment and the overall durability of the unit. The use of ultra-stable circuits throughout helps to lengthen the life of components.

Easy accessibility to plug-in circuitry is facilitated by the upright configuration of the cabinet. The entire top section of the HR-2 swings up and the lower section panel drops down to reveal the module nest. Front access to all modules means that most maintenance can be done while the machine is in use, even when it is mounted in a rack. Maintenance convenience is a key to reduced downtime in the HR-2.

#### **The System Build Concept**

HAWKEYE is a total system concept designed with the flexibility and versatility to handle a wide range of application requirements. The system offers a number of configuration alternatives providing an opportunity for users with substantial unamortized investments in ENG and EFP equipment to build their HAWKEYE system capability in easy steps.

All HAWKEYE components have a standard video output, accommodating use with virtually all field and studio broadcast and production facilities.

The adaptability of the HCR-1 recording camera provides for a variety of operational modes. By attaching a feed cable, live output can be aired while recording.

Simple adaptors permit the separation of the HC-1 camera and HR-1 VTR, so the recorder can be slung over the shoulder, carried on a cart or by another individual. In this configuration, maintenance may be done to one module without interrupting the operation of the other.

The availability of HC-1 camera, HR-1 recorder and HR-2 studio VTR as separate products permits optimum utilization of existing equipment, protecting investments in equipment that has not reached the end of its life span. Professionals who require new camera may choose to start with the HAWKEYE HC-1 camera. It can be used live, with a microwave system, or any VTR operating within the facility. Another alternative is to begin with the miniaturized HR-1 recorder. It can be operated with the TK-76, TK-86 or any other camera with a composite output. In either case, the recording camera option is always available with the addition of the other half of the system.

Completely compatible with the NTSC standard equipment, the HR-2 studio recorder offers similar application flexibility. It may be used with the HC-1 camera, TK-86, or any other camera for studio or on-location production. As the companion to HAWKEYE recording cameras and field recorders, the HR-2 allows playback of HAWKEYE recorded cassettes for viewing of program material or, when equipped with a TBC, on-air broadcast capability.

The ENG editing suite may be operated in the dual format by replacing one 3/4-inch VTR with the HR-2, and later converting to the ChromaTrack format with the addition of a second HR-2.

A post production system equipped with HAWKEYE studio VTR's with TBC's, may be linked to a switcher/effects system and sophisticated editing system for expanded ChromaTrack editing capability or for use in a multi-format post-production system.

#### **One Step Ahead**

While the building block concept employed in HAWKEYE accommodates many preferences and economies, the prime operational benefits derived are the new levels of convenience, performance and reliability the HAWKEYE system affords.

By basing design objectives on the market's needs, and employing highly progressive technology to meet those objectives, RCA brings forth a system which removes many of the barriers that have long frustrated production activities. HAWKEYE represents one more step forward in electronic news gathering and field production technology. □

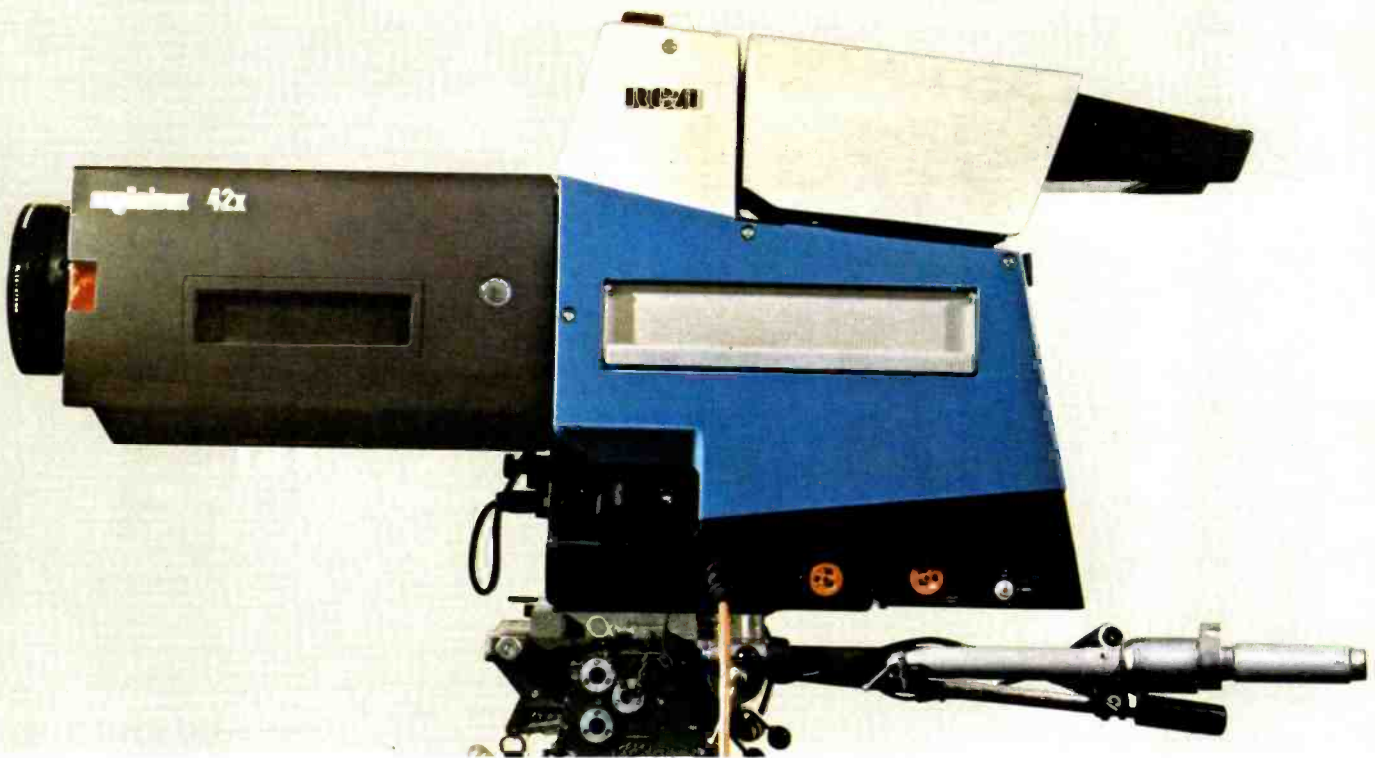

# TK-47T A "NO COMPROMISE" TRIAX CAMERA SYSTEM

**Frank Davenport**  
**Chief Engineer, RCA Jersey Limited**  
**Jersey, Channel Islands, U.K.**

Broadcasters and teleproducers have always been well aware of the limitations imposed by long camera cable runs. To overcome this operational handicap, camera systems were developed which utilize a triaxial cable to replace the heavy and costly multiconductor cable.

Triaxial operation permits the camera head to be operated at far greater distances from the Camera Control Unit, and significantly reduces the costs of rigging, cable and maintenance. Unfortunately, most of the currently available Triax systems also result in compromises in camera operational features or technical performance.

RCA was reluctant to accept compromises, particularly for its top-of-the-line TK-47 Automatic Camera. However, recent advances in communications technology have allowed a Triax camera system to be developed that offers no compromises, only advantages.

#### **Design Objectives For The TK-47 Triax Camera System**

In its basic design, the TK-47 automatic

color camera employs latest technology in circuit integration and design; in solid state memories, and in microprocessor-controlled functions. Since its introduction, the camera has been extremely well received, achieving superior performance and new levels of stability, reliability and operational simplicity.

In adding Triax capability to expand the versatility of the TK-47, design decisions were based on meeting these objectives:

1. No compromise in operational features or facilities.
2. No compromise in technical setup either manually or automatically.
3. No compromise in technical specifications.
4. When installed, the camera system should be easily convertible.
5. Should provide additional features not found in other triax cameras.

#### **Triax Function Requirements**

To satisfy these product design objectives, the signals and facilities required in triax systems must first be considered.

1. Wideband RGB video signals between the camera head and the

Camera Processing Unit (CPU). Bandwidth determined by 5.5 MHz low pass linear phase filter.

2. Viewfinder video from CPU to camera head nominally 5 MHz bandwidth.
3. Camera setup and control data from CPU to camera head.
4. Return data from camera head to CPU.
5. Advanced camera sync from CPU to camera head.
6. Two program quality microphone channels from the camera head to CPU.
7. Talkback to and from the camera head.
8. AC to the camera head for camera power and utility outlet (100VA).

These signals have to be combined and transmitted over the triax cable. The system requires the simultaneous transmission and reception of signals at both ends of the cable. Separation of the signals is complicated by the bandwidth involved, and differences in transmit and receive signal levels.

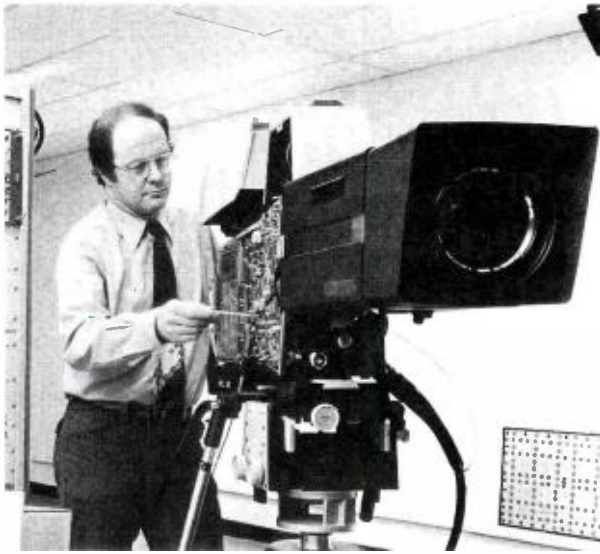

**Frank Davenport** received his technical education at Norwood Technical College, South London, gaining in 1965 a Diploma in Telecommunications and Graduate Membership of the Institution of Electronic and Radio Engineers (I.E.R.E.). In 1972 he became a member of the I.E.R.E. and registered as a Chartered Engineer.

1965—Joined BBC as direct entry engineer engaged in VTR, operations and maintenance.

1967—Joined RCA Sunbury as VTR Field Service Engineer.

1969—Joined newly formed Yorkshire Television Limited as Supervisory Engineer, in charge of Engineering, Planning and Installation.

1975—Joined RCA (Jersey) Ltd. as Chief Engineer responsible for technical support and product development.

#### Triax System Considerations

In establishing performance parameters for a Triax camera system, an obviously important consideration is the limitations inherent in the triax cable itself.

Power has to be provided to the camera head for both operation of the camera and to provide a utility power outlet. In the TK-47T it is possible to power the camera head directly, but when operated normally, the power is fed via the triaxial cable. This power feed will suffer an  $I^2R$  power loss caused by the loop resistance of the cable inner and screen (Fig. 1). In the TK-47 multicore camera, 280V AC is fed to the camera head Switched Mode Power Supply (SMPS). One of the advantages of the SMPS is its ability to tolerate wide input voltage variations, and this feature is utilized in the triax mode of operation.

**Fig. 1. Power Loss From Cable Loop Resistance**

AC into Cable at CPU	280v
Min. spec. S.M.P.S. Operate Voltage	<u>210v</u>
Thus, Max. volt. drop due to cable	70v
Camera Head power nominally	200w
Utility AC Outlet max. power	<u>100w</u>
Max. Power required via triax cable	<u>300w</u>
Current cable at max. voltage drop	$\frac{300}{210} = 1.43$ Amps
Cable loop resistance required, to drop 70v at 1.43 Amps	$\frac{70}{1.43} = 49$ Ohms



Typical Triaxial Cable.

By extrapolating from the tabulated cable data, (Fig. 2) a length of approximately 1.36 km of 8.5 mm triax will drop the AC to the minimum power supply voltage.

Investigation of maximum cable lengths due to RF attenuation of the cable (Fig. 3) shows that at 50 MHz there is an attenuation of approximately 6.5 dB on 100 m of 1mm/8.5 mm triax cable. A 1 km length will reduce a 50 MHz signal by 65 dB. When received, this signal requires amplification of at least 65 dB and this cannot be achieved without the addition of some noise. Currently available amplifiers are capable of gains in excess of 70 dB before amplifier noise becomes a system limitation. For example, with a gain of exactly 70 dB, operation of 1mm/8.5mm triax would be possible to a distance of approximately 1.1 km ( 3600 ft.).

These two examples show that in the TK-47 system, maximum cable length is limited by the RF attenuation of the cable rather than the resistive voltage drop. Of course greater distances are possible with larger cables having less RF loss. This is shown in Fig. 4 for the TK-47T.

#### The TK-47 System

Having determined the basic system parameters let's look at the techniques adopted to achieve the required facilities and technical performance.

Fig. 2. Triaxial Cable Data

Type (Inner Conductor, mm)	1.0	1.4	2.1	2.5
O.D. (mm)	8.5	11.0	14.4	16.2
DC Loop Resistance (Ohms/km)	36.0	17.5	9.0	7.0
Attenuation (dB/100 m @ 50 MHz)	6.5	4.0	2.8	2.3
Net Weight (kg/km)	100.0	180.0	300.0	359.0

Fig. 3. Triax Cable Attenuation

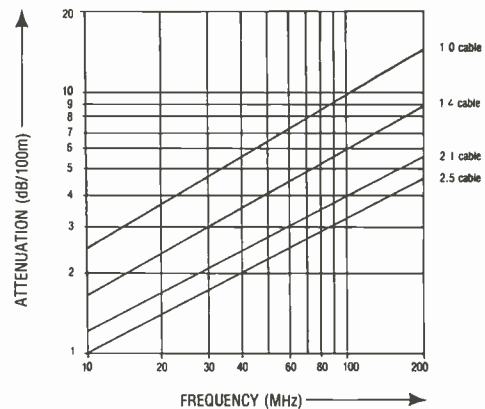

Fig. 4. Maximum Cable Length, Triax Operation\*

Cable Size	Distance
1.0 mm ( 8.5mm/1/3" OD)	1.2 km/4000 ft.
1.4 mm (11.0mm/7/16" OD)	2.0 km/6500 ft.
2.1 mm (14.4mm/9/16" OD)	2.8 km/9000 ft.
2.5 mm (16.2mm/5/8" OD)	3.4 km/11000 ft.

\*Data listed refers to Felten & Guillaume cable. Similar performance can be expected with equivalent cable from other manufacturers.

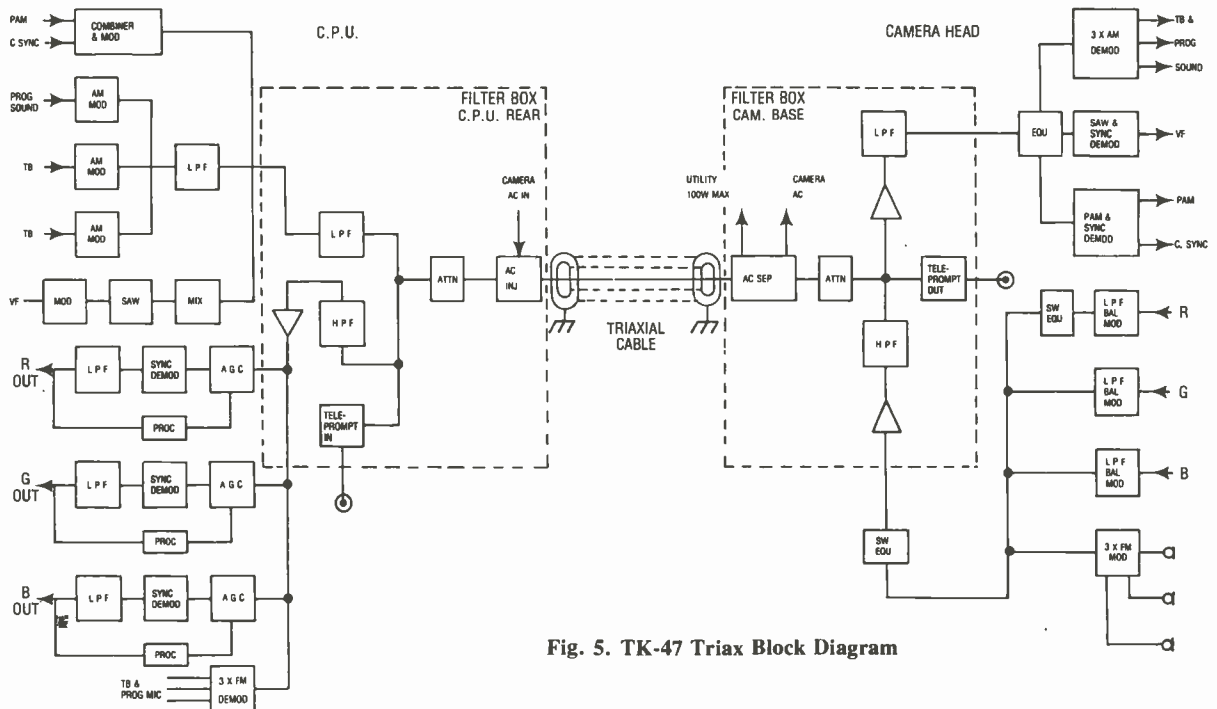
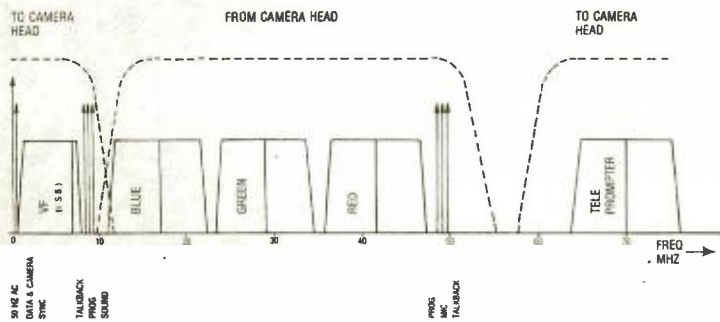

Fig. 5. TK-47 Triax Block Diagram

Fig. 6. TK-47 Triax Frequency Spectrum



The TK-47T block diagram (Fig. 5) shows in some detail the component parts of the system. The most important system requirement is the undistorted transmission of the three wide band video signals (RGB).

The technique adopted to accomplish this was double side band suppressed carrier amplitude modulation for all three signals (RGB). This method although costly in terms of bandwidth, offers both performance and simplicity. By using currently available technology, more than adequate performance has been achieved. Encapsulated mixers and phase splitters are used in the modulation process with wideband hybrid RF amplifiers driving the triax cable. These amplifiers must have low intermodulation distortion and a good return loss. Return loss (the ability to correctly terminate the cable at all frequencies of interest) is most important if good transient response and zero ghosting is to be achieved.

The RGB signals are received at the Camera Processing Unit, and amplified using similar hybrid RF amplifier and band split. The signals are synchronously demodulated and filtered using similar low pass linear phase filters.

Full operational and technical setup capability is achieved by transmitting the complete CPU data bus to the head as serial 8 bit words. Advanced camera sync is added to the data and this composite signal modulates a horizontally locked 750 KHz carrier.

The Viewfinder video is transmitted to the camera head as a vestigial sideband (VSB) AM signal. This signal is another application of current techniques in that the VSB is produced by Surface Acoustic Wave (SAW) filtering. The SAW filter offers an accurately defined passband, precisely controlled waveform parameters and zero setup adjustment. In this application the Viewfinder AM signal is offset towards the high frequency end of the SAW filter passband which results in a full lower sideband but vestigial VSB.

At the camera head a similar SAW filter

is used to separate and band limit the RF amplifier to the synchronous demodulator. The system produces a nominal five MHz video bandwidth.

The TK-47 Triax Frequency Spectrum (Fig. 6) shows the various signals present on the cable and their direction of transmission.

There are three AM audio channels from the CPU to the camera head. These provide program (Cue) audio and two talkback channels and have bandwidths of 7.5 kHz. From the camera head there are three wideband FM audio channels which are used for the cameraman's mic and two high quality microphone inputs.

Provision has been made to inject and extract a 70 MHz carrier onto the cable. This passive 'RF window' can be used to send teleprompt or cueing video to the camera head.

Finally let's look at the lower end of the cable spectrum. A nominal 280V 50/60 Hz signal is launched into the cable from an isolated transformer winding. The AC is fed, via a safety circuit, to the cable center and inner screen. The outer screen of the cable is not used by the system except to provide a safety ground which ties the camera head metal work to the CPU.

In the camera head the AC is sensed and feeds the camera head power supply and a toroidal transformer. This transformer provides an isolated, fused, 100VA utility AC feed of nominally 220/110V which is suitable for a small monitor or soldering iron. The utility feed is available even when the camera head power is switched off. Incidentally, full talkback is also available under these conditions, facilitating rigging or trouble shooting.

The triax cable is protected by a comprehensive safety circuit which has the following characteristics:

1. Will not apply AC to the CPU triax socket if the cable is missing or if the cable is not uniquely terminated by the camera head. This unique termination forms part of the camera head switch on sensing circuit.

2. The AC connection will be broken if the cable current drops below a certain lower limit, i.e. an open circuit cable.
3. Over current failure is handled by a fuse.

The camera head may be powered directly and connection to the CPU provided by a coaxial cable such as RG-59. In this mode of operation the CPU maintains control of the camera head power on/off. This type of operation could be suited to fixed installations within buildings or stadiums.

#### The TK-47T Triax Package

Four modules and two sub-assemblies comprise the TK-47T Triax package. In the CPU, the Equalizer is removed and replaced by a double module called the RGB Demod. A triax only module called the Sync/Audio/Data (SAD) module is added in an adjacent spare slot in the CPU. At the rear of the CPU is the AC safety circuitry and the RF Processor.

In the camera head, the RF Processor, toroidal transformer and the Triax Power Supply are housed in a new camera base unit which is designed to replace the original camera mounting. Access to the RF Processor and Triax Power Supply is provided by means of a slide-out module drawer which also contains heat sinks and the triax cable socket.

The camera head contains two new modules—the Transmitter and Receiver—which are added to a slightly widened right side panel.

#### Simple Conversion

Conversion between Triax and Multi-conductor operation can be achieved in under five minutes. In the CPU the two Triax modules are removed and the Equalizer module is replaced. At the Camera Head it is only necessary to change over a plug assembly and operate the AC rocker switch. When operating in multicore the camera head triax circuitry remains installed but depowered.

The simple conversion offers the TK-47 Triax owner complete flexibility to shoot wherever he chooses. By utilizing modern developments and established technology the product design objectives have been achieved. Whether on multicore or Triax the technical performance and operational facilities are uncompromised, producing one camera for all uses.

The TK-47 Triax system was designed and developed in Europe by F. Aschwanden and J. Lusch of RCA Laboratories, Zurich, Switzerland. It is in production, and numerous TK-47T triax-equipped cameras are in use. □

**HAWKEYE IS A CAMERA**

**HAWKEYE IS A RECORDING CAMERA**

**HAWKEYE IS A RECORDER**

**HAWKEYE IS AN EDITING SYSTEM**

**A system you can build at your own pace.**

**See your RCA Representative today for all the HAWKEYE facts. Deliveries are sooner than you think. RCA Broadcast, Bldg. 2-2, Camden, N.J. 08102**



## USE IT...

as a live camera. With HAWKEYE field and studio recorders. Or any format VTR, including your own. The HC-1 is a tough lightweight...easy to handle...built to take abuse. With its new 1/2-inch pick-up tubes and advanced design prism optics, you can depend on the HC-1 to deliver consistently superior broadcast quality pictures under a wide range of operating conditions.



## USE IT...

for the ultimate in operations economy and mobility...reliability and picture quality. RCA's HCR-1 is the field system you asked for. And the one you specified. A single-person, single-piece production unit that, with its new ChromaTrack recording format, closes the performance gap between small, portable recorders and broadcast cameras by delivering far superior VTR picture quality. The kind of quality that is required for demanding production assignments as well as highly professional news and sports coverage. And, because the HCR-1 and its companion HR-2 studio VTR have a standard NTSC color output, you can use them with your present broadcast equipment for excellent results.

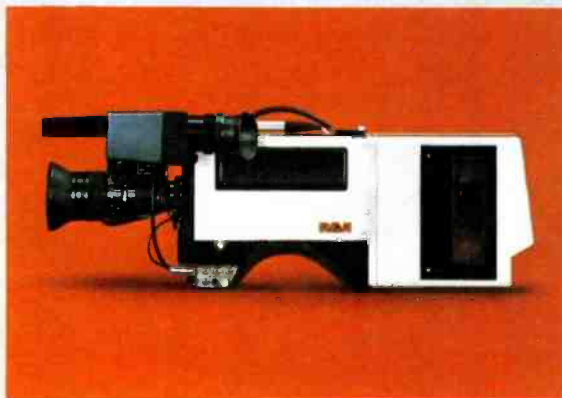

## USE IT...

in the field with any camera. When you choose the HR-1, you're getting a VTR that outclasses portable 3/4-inch recorders. It's smaller...lighter...built to last. The HR-1 delivers exceedingly better picture quality, too, with RCA's new ChromaTrack recording format. That means your edited tape will be of higher quality. Whatever format you use: ChromaTrack, 3/4-inch, one-inch or quad. You can edit in your own format by adding the fully compatible HR-2 studio VTR to your system.



## USE IT...

alone for simple cut editing or integrate it into your sophisticated effects or multi-format system. The HE-1 edit controller and HR-2 studio video tape recorders provide complete editing capabilities. Including 8X play speed forward and reverse searching, and full preview/review, assemble/insert editing. Providing a standard NTSC color output, HR-2 ChromaTrack format recorders may be added to your post-production system with full operating advantage.



# YOUR EMMY

We are proud to be the recipient of an Emmy for the development of an automatic color television camera — our TK-47. We are grateful to The National Academy of Television Arts and Sciences for this prestigious Engineering Award for "...the development of digital computer techniques for the automatic alignment of color television studio cameras."

But it is you, our TK-47 customers, who are the real Emmy Award Winners. With over 300 TK-47 cameras in use today around the world, it is you who are producing news, documentaries, variety shows, dramas, commercials and public service programming with award-winning camera performance. You know that you have to start with the best camera in order to deliver the best programs.

TK-47 cameras and TK-47 customers are a winning combination! We, at RCA, are proud of the part our TK-47 has played in advancing the technology of the television industry and in helping our customers produce picture-perfect programming. RCA Broadcast, Building 2-2, Camden, New Jersey 08102.

The RCA logo is displayed in its classic multi-colored font, with each letter in a different color: R (orange), C (yellow), A (green), and A (blue).