

# BROADCAST NEWS

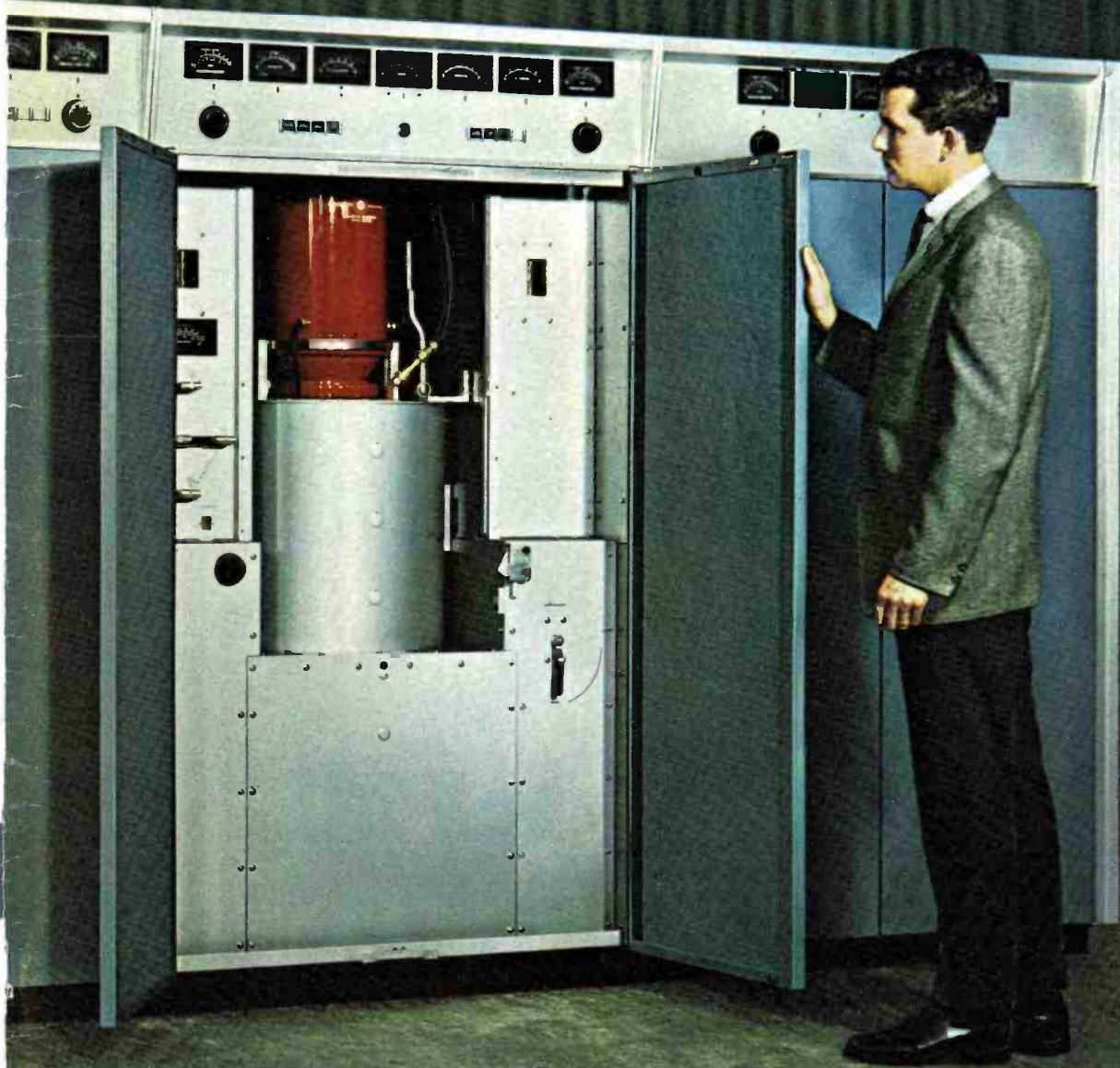

110-KW TRANSMITTER FOR MAXIMUM POWER UHF



Vol. No. 136  
OCT. 1967

# HOW THE "BIG TUBE" IMPROVES COLOR TV PICTURES

It's like using a larger negative in photography to increase resolving power and produce pictures with more punch. The TK-42's big 4½-inch tube operates over a broad contrast range, adding snap and sparkle. Result: You get pictures that please both advertisers and audience.



The Most Trusted Name in Electronics

Vol. No. 136

October, 1967

# BROADCAST NEWS

*published by*

**RADIO CORPORATION OF AMERICA**  
BROADCAST & COMMUNICATIONS PRODUCTS DIVISION, CAMDEN, N. J.

*issued bi-monthly*

**PRICE** *in U.S.A. - - - - - \$6.00 for 6 issues*  
*outside U.S.A. - - - \$7.00 for 6 issues*

## C O N T E N T S

	Page No.
New UHF TV Transmitter for 5 Megawatts ERP . . . . .	6
New Look 25-KW VHF Television Transmitter . . . . .	11
WKTR Brings UHF Color to Greater Dayton . . . . .	17
KDKA Eyewitness News Clicks in Color . . . . .	30
ETV — The Sleeping Giant . . . . .	35
New UHF TV Pylon Antennas . . . . .	38

---

Copyright 1967 Radio Corporation of America All Rights Reserved Trademark(s) Registered. Marca(s) Registrada(s)

PRINTED  
IN  
U.S.A.

## KENTUCKY ETV NETWORK ORDERS 12 TRANSMITTER PLANTS

In September RCA was awarded more than \$4 million in contracts by the State of Kentucky to supply TV transmitting equipment for the 12 broadcasting locations in the state's new educational television network. The contracts represent the largest single purchase of RCA broadcast equipment in company history.

Largest of the two RCA equipment packages calls for 12 complete UHF transmitting plants, to include at each location a TV transmitter and antenna, antenna tower, transmission lines and other items. RCA also will supply approximately \$100,000 in film projection equipment for television under a separate agreement.

Contracts for the equipment, which will be produced at RCA plants in Camden, N. J. and Meadow Lands, Pa., were signed for the RCA division by E. C. Tracy, Division Vice President. Broadcast Sales Department, in Lexington, Ky.

O. Leonard Press, Executive Director, Kentucky Authority for Educational Television, said most of the system — the nation's largest state ETV network — is scheduled for operation by September, 1968. Programs will be originated in color and black-and-white at the outset, with color broadcast provided from film and video tape. Current plans call for adding "live" color in 1969.

The Kentucky network's educational programs will concentrate for the most part on the elementary and secondary school levels. When the 12 transmitting sites are in full operation, programs will



Contract signing scene shows J. M. McClain (seated), Kentucky Purchases Director, checking document with E. C. Tracy, RCA Broadcast Equipment Sales VP. Others from left are Carl Raasch, RCA Sales; O. Leonard Press, Kentucky ETV Authority Executive Director, and Ronald B. Stewart, ETV Authority Chief Engineer.

reach nearly all of the state's 750,000 pupils at these levels. The transmitting sites were chosen to assure coverage of all households represented by the state's three million population. Equipment provided by RCA will include two translators to assure fill-in coverage in areas remote from the 12 principal television transmitter sites.

Main studios of the state network in Lexington will contain approximately 35,000 square feet of floor area and will be capable of producing full-scale professional programs. Plans also call for studios at the seven state universities and for interconnection by microwave of the system's four major arms.

## BURBANK PLANT STRIKES AN EXPANSIVE NOTE

Burbank, California, facilities of the RCA Broadcast and Communications Products Division have been expanded for the second time in 18 months to keep pace with the increasing demand for the "Professional Television" systems and equipment produced there.

The most recent expansion provided an additional 11,000 square feet of floor area in a one-story modern building near the Lockheed Airport. It is being used for the assembly and test of Professional TV cameras and components.

Headquarters for West Coast Operations at 2700 W. Olive St., Burbank, is responsible for systems assembly and test as well as for production of film recording equipment. The plant building was enlarged in the spring of 1966 with the addition of approximately 8,000 square feet to the work area.

The Professional TV line includes the PK-330 and PK-315 viewfinder cameras, the PK-310 TV film camera and the PK-301/302 nonviewfinder cameras as well as monitors, switches and other items for full "turnkey" installations.



PK-330 vidicon camera is popular Burbank product.



TK-42 camera (above) catches dance group in morning show routine on floating stage.

## WTVT FLOATS ITS TALENT, CAMERAS IN TAMPA BAY

In Tampa where all is sun, sea and sand, WTVT floats two of its five TK-42 color cameras on a barge in Tampa Bay to capture tropical backgrounds of palms and glistening water for fashion shows and other remote program originations.

The 40-by-80-foot barge is moored behind the station's Color Communications Center, a small studio on the bayshore in nearby St. Petersburg. The other three TK-42's operate at Channel 13's main studio and business office in Tampa.

Principal use for the floating studio has been for taping "AM," a variety show of news, weather, sports and special features, which is aired mornings as its name suggests. Thus far the Tampa Bay waters have remained calm and camera crews and performers haven't had to call upon their "sea legs" during program sequences.

As part of its local promotion, WTVT held separate demonstrations of the new color cameras in Tampa and St. Petersburg shortly after they were received. Members of Chambers of Commerce of the two cities were special guests and station officials heard such tributes as "excellent" and "amazing" as the TK-42s went through their paces.

Ever-popular swimsuit shot finds barge cameraman and program MC on full alert.



## MOST POWERFUL ELECTRON MICROSCOPE PROBES MICRO-WORLD

A million-volt electron microscope delivered by RCA to U. S. Steel in late summer promises the scientist a view of particles in atomic dimension, as small as 8 billionths of an inch. This capability makes it the most powerful instrument of its kind ever built in this country and one that is expected to wrest new secrets from the unseen world of matter.

To attain this vast power, the microscope uses a million-volt accelerator to produce a stream of electrons that moves through the instrument's magnetic lenses at 94 per cent of the speed of light. Made by a Swiss firm, the accelerator stands 17 feet high and weighs 15 tons yet its precision stabilization system maintains the DC voltage constant to within .0004%.

The beam velocity gives the electrons a penetrating power of up to 10 times that of beams used in standard electron microscopes, making possible the examination of thicker specimens for the first time.

Increasing the accelerating voltage also has the effect of reducing the wave length of the electrons which, in turn, improves the instrument's resolving power. Thus the scientist can "see" features only 2 Angstroms (8 millionths of an inch) apart, which is essentially the theoretical limit of the microscope system.

While the super scope will be used primarily in metallurgy, its high velocity beam, together with image intensification techniques, could make possible the examination of living material. Normally, the beam of an electron microscope destroys such specimens.

With image intensification, specimen damage is averted by reducing the strength of the electron beam by up to 50 times. A beam of this strength produces a dim and barely visible image which is brightened electronically and displayed on a TV screen. One-shot images or "transient phenomena," as they are called, also can be video recorded for replay and restudy.

Later this year RCA expects to deliver a 500,000-Volt electron microscope to the University of Virginia where it will be used also for metallurgical research. RCA has delivered approximately 1,300 standard (50 to 100 KV) electron microscopes since it entered the field in 1940.

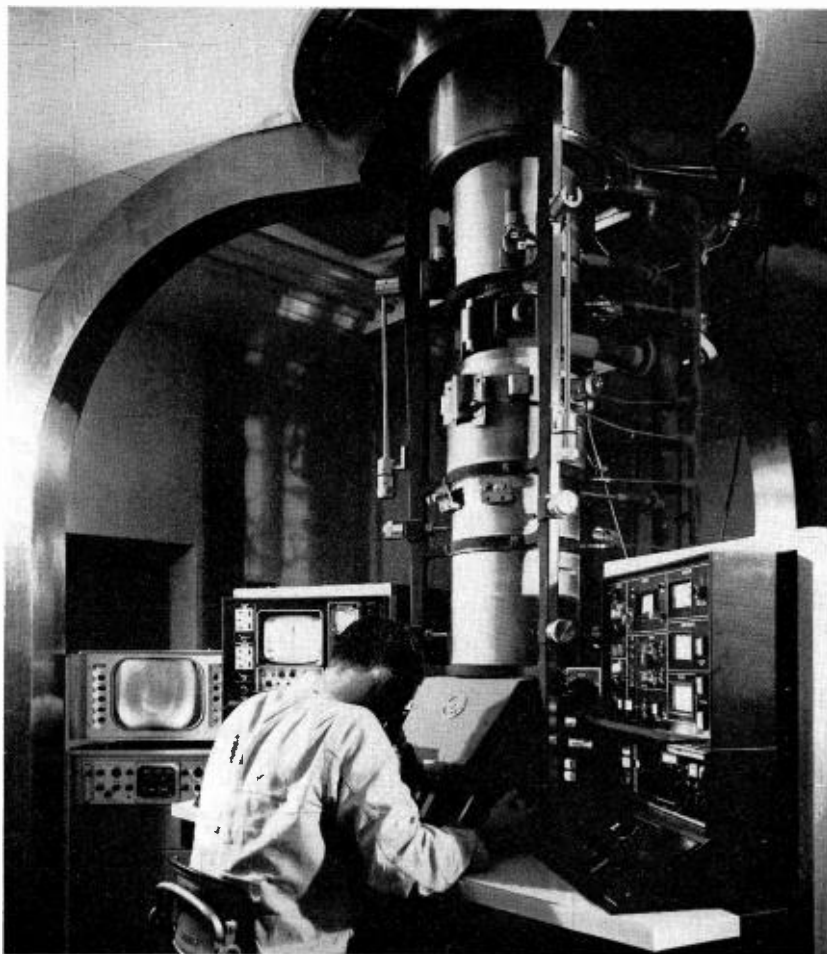

Million-volt instrument set to unlock metallurgical secrets for U.S. Steel researchers.

## *RCA SURVEY SHOWS FM STEREO STATIONS NUMBER 588 AFTER SIX YEARS OF MEDIUM'S GROWTH*

The number of FM stations authorized to broadcast in stereo has grown to 588—nearly one-third of all commercial FM stations on the air—in the six years since such programming was first permitted, an RCA study of Federal Communications Commission records indicates.

One or more stereo stations are located in 397 cities and towns. The count by states showed California in the lead with a total of 66 stereo stations covering 35 major markets within the state.

FCC authorization of stereo broadcasting, to begin June 1, 1961, stirred a rush among broadcasters to be first on the air with the new medium and among listeners to acquire the first stereo receivers.

A month later RCA began shipping FM outlets its BTS-1 stereo subcarrier generator needed to produce the stereo signal. The unit can be used with all RCA FM transmitters built since 1948. The RCA generators delivered in the six-year period represent a substantial part of the total number now in FM broadcast use.

**BIG 'HAUL AWAY' ON AS  
RCA ANTENNA MAKERS  
ENJOY BANNER YEAR**

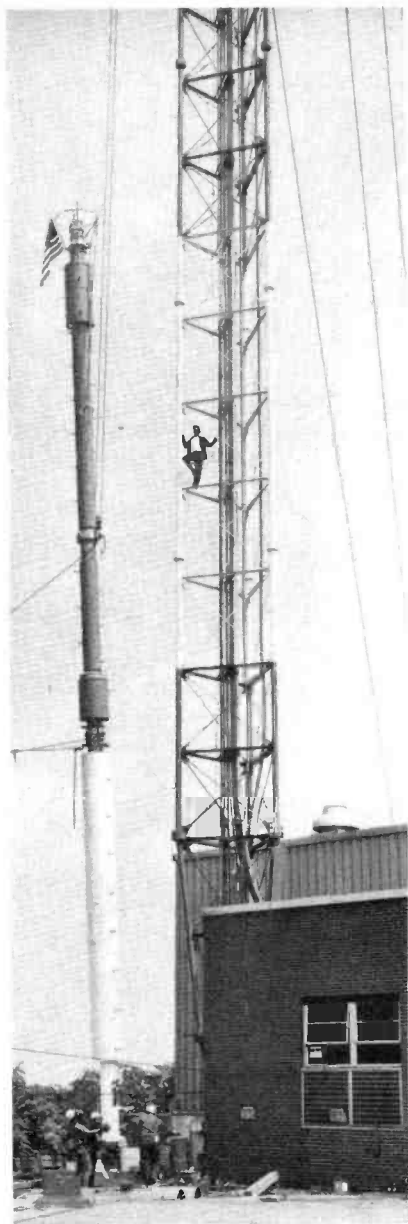

Six-ton antenna begins journey to WIIC-TV's tower top (above). Pittsburgh station typifies new installations that are making loading scenes at RCA's Gibbsboro site more frequent. New UHF outlets are major contributors to antenna boom.

**LEARNING ELECTRONICALLY LOOKS LIKE FUN**



Penny Kaspar commands new study center to reproduce audio-visual lessons.

More and more students these days are enjoying the experience of studying electronically. In the privacy of individual booths they select pre-recorded TV lessons as easily as their parents picked reference volumes from the library stacks.

An RCA innovation in this fast-growing offshoot of educational TV is a table-top study center, demonstrated for educators at a recent equipment exposition. Suitcase-sized, the unit can be used on almost any desk or table.

Upon opening the unit's doors, the student faces a built-in 8-inch TV set, dons a headset and checks his control panel. He chooses a lesson from the directory and dials the stipulated number to start up

film or tape playback equipment located at a remote point.

Program playback may be full audio-video or, in the case of language studies, music appreciation and like courses, audio only. The study center's equipment also includes an audio tape recorder and film slide projector that the student may operate on his own.

Thus the modern student can tap a wide range of learning resources without ever leaving his chair. Equally important, the design of the RCA study unit has been streamlined and its controls simplified so that the student concentrates on his work without the distraction of gadgetry.



exciter all offer a measure of backup that almost equals a second transmitter. Such dependability is required in today's operation, especially where remote control is contemplated and no standby transmitter is planned.

Since both IPA stages are broadband tuned, should the need arise, a single change of small coaxial connectors at the front of the transmitter will permit the visual signal to be fed through either IPA stage while the aural signal may be fed directly to the aural klystron. Further, the identical aural and visual PA stages are equipped with front panel (input) patch facilities to provide a redundancy that permits up to 50 percent normal transmitter power to be maintained in the event that any of three klystrons should fail. If necessary, one visual PA can be substituted for a disabled aural PA, or one of the visual PA's can supply up to 50 percent visual power and thus stay on the air. Although not standard with the transmitter, patching facilities might be provided at the

output to further utilize this redundancy. There are several manual or semi-automatic switching system possibilities available as optional equipment for patching around the diplexer directly into the filterplexer.

#### Low-Cost Vapor Cooling

Increased operating economy is provided in the TTU-110A through use of a vapor cooling system rather than water cooling. Volume for volume, vapor cooling is almost one thousand times more efficient than water cooling. In practical operation, vapor cooling requires only about one-tenth the coolant flow of a comparable liquid cooled system. Also, the water-to-steam system, by reducing the size of pump motors, etc. saves as much as 10 kilowatts of power.

#### Only Four Standard Cubicles

The transmitter is housed in four new low profile 77-inch cabinets. The three

cubicles at the right contain the aural and visual klystron power amplifiers. The left-hand cubicle contains the aural and visual exciters, IPA's and control circuits. Shown in dotted lines is the matching smaller cabinet, about half the width of the standard cubicle, housing "hot" spare aural and visual exciters and provisions for switching to these spares. This is available as optional equipment.

#### New Power Components

The TTU-110 incorporates solid state high voltage rectifier modules that consist of matched unit assemblies. These modules simplify identification, reduce maintenance time, improve rectifier cooling and efficiency. All other power supplies are also solid state.

Two separate overload systems are employed in the transmitter: An electro-mechanical overload using relays to protect the transmitter against power supply overloads and an electronic antenna overload. The antenna overload system is a

FIG. 5. Aural and visual exciter and modulator assemblies are located in left-hand cubicle. Adjacent cubicle contains aural klystron PA. Two right-hand cubicles house diplexed visual klystron PA's.

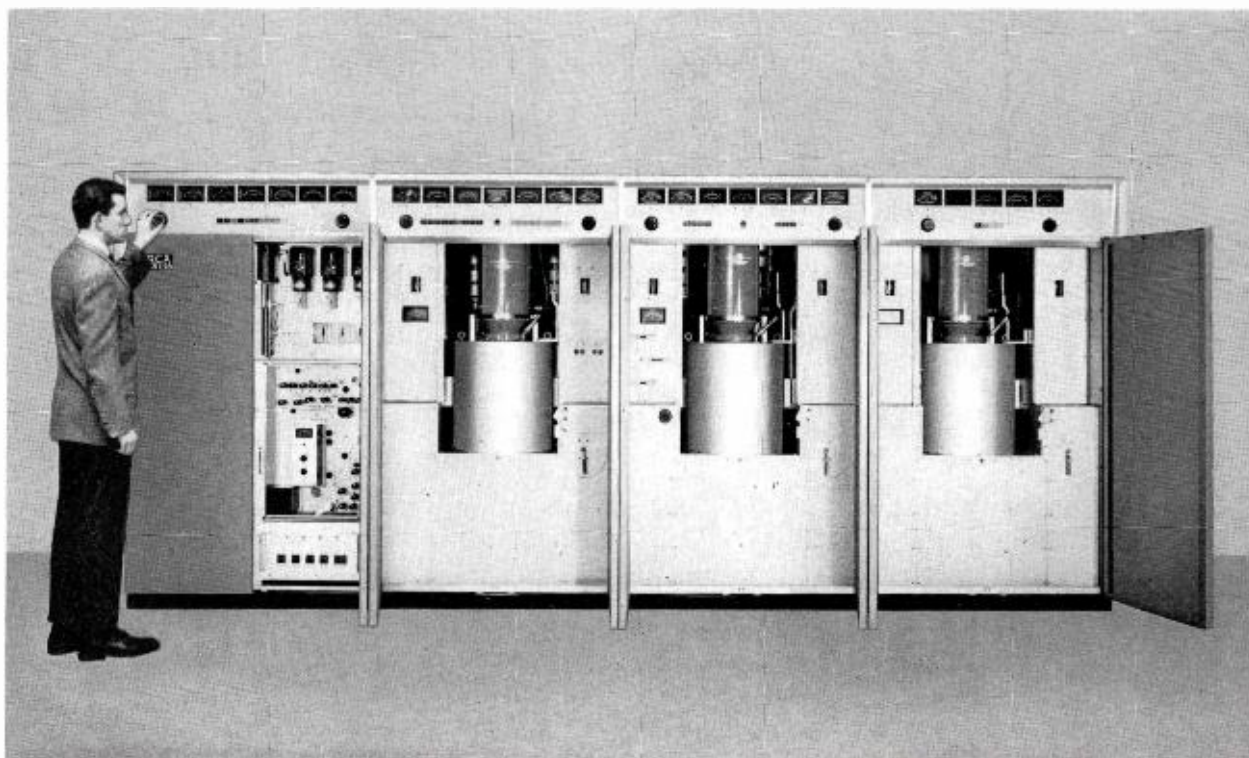



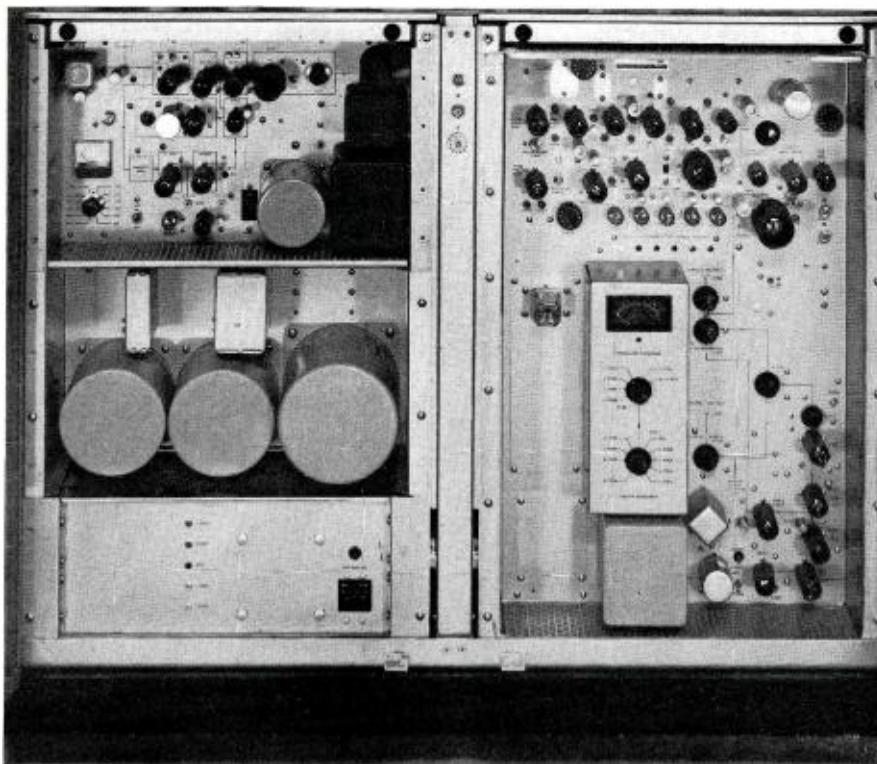

**FIG. 6.** Aural and visual exciter/modulator employs proven, high reliability circuits and 10,000 hour premium tubes.

## TTU-110 INCORPORATES PROVEN FEATURES COMMON TO RCA UHF-TV LINE

cycling type of protection that cuts off the visual and aural output within six microseconds should an overload occur in the antenna system, filterplexer or transmission line.

### **Direct FM Aural Exciter**

The frequency modulated aural exciter in all RCA UHF transmitters is the same unit used in the new line of high fidelity RCA FM broadcast transmitters. It has only nine different stages, or half as many as previous exciters. The aural carrier is generated, modulated and amplified in only four stages. The AFC system employs four more, making eight, and the ninth stage is a voltage regulator. This simplicity results in exceptional stability and dependability. Maintaining precision control of carrier frequency through use of a counter detector, magnetic amplifier and vari-cap diode, the new AFC system overcomes the

drift problems inherent in many multi-tube systems.

### **Low Level Visual Modulation**

Visual carrier frequency is developed in a temperature controlled crystal oscillator operating between 7 and 11 MHz depending on the frequency of the assigned channel. This precision signal is heterodyned with both the modulated video and aural signals, resulting in a complete television signal at low power level and with aural and visual output carriers separated by 4.5 MHz.

Visual modulation occurs at the grid of a type 4055 pencil triode that operates in a tuned cavity designed for ease of tuning and drift-free operation. The picture signal is applied to the visual carrier at the two-watt power level, with the advantages of reduced modulator complexity and markedly improved color picture quality.

### **Built-in Remote Control**

As are all RCA UHF transmitters, the TTU-110A is essentially self-operating, requiring little more than turning the transmitter "on" in the morning and "off" at the end of the broadcast day. The transmitter is fully ready for operation by remote control, including metering points for remote monitoring. All wiring, relays, motor driven controls are built in.

### **New Look Cabinets**

All these transmitters are housed in smart, low profile cabinets with eye-level meters and convenient finger tip controls. Although physically small so that the equipment occupies the least amount of valuable floor space, there is no sacrifice of the accessibility necessary to inexpensive maintenance and servicing. Double front doors, hinged meter panels and tilt-out chassis are features of all models.

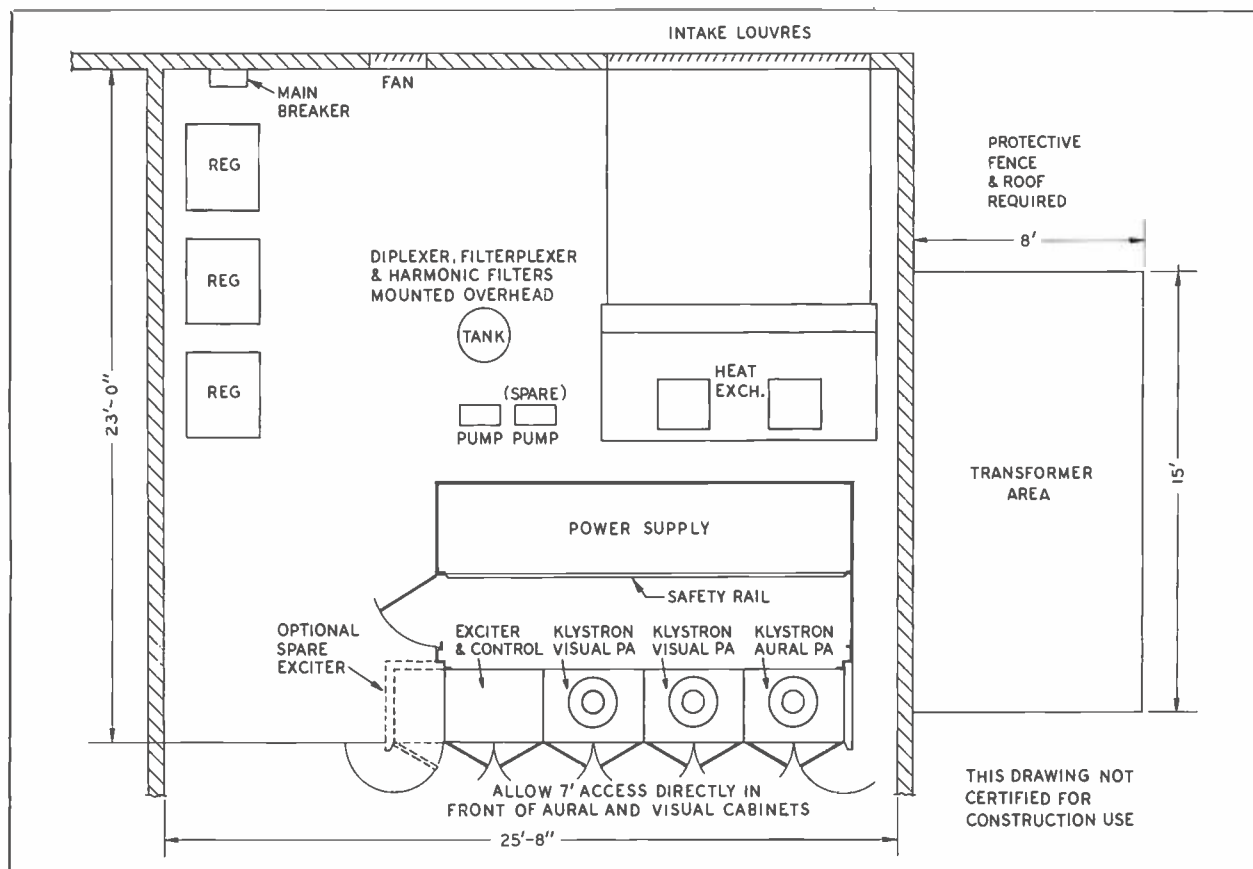

FIG. 7. Floor plan layout of TTU-110A transmitter offers considerable flexibility. Power supply may be located remotely, if desired.

### Conclusion

The TTU-110A extends the upper limit of the RCA UHF TV transmitter line to an unprecedented power level of 110 kilowatts, making 5 megawatt ERP's practical. This power level is achieved through use of a tried and proven transmitter design—by developing a super power version of the high power transmitters that are providing day in and day out reliability in the field. This design will certainly fill an important need for a dependable, high quality maximum power transmitter for UHF broadcasting.

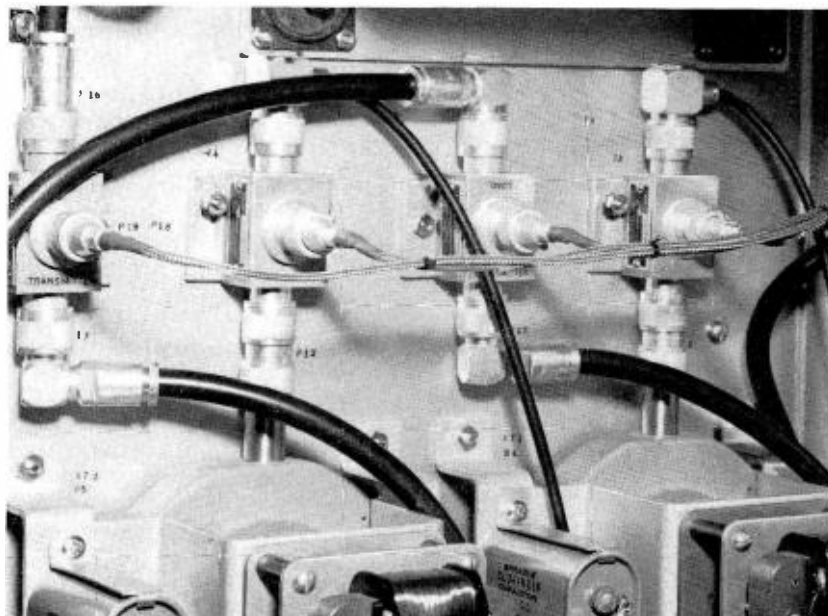

FIG. 8. Motor driven controls, relays and metering points are built in for remote control of the transmitter.

# NEW LOOK 25-KW VHF TELEVISION TRANSMITTER TT-25EL

New Transmitter Features Reliable Operation, Modern Circuitry,  
Economy of Operation, is Designed for Color and  
Ready for Remote Control

by D. L. WRIGHT, *Product Analyst,*  
*VHF Broadcast Transmitter Equipment Merchandising*

FIG. 1. The "New Look" TT-25EL VHF Transmitter, a new addition to the RCA Matched Line with its attractive blue-gray and chrome finish.

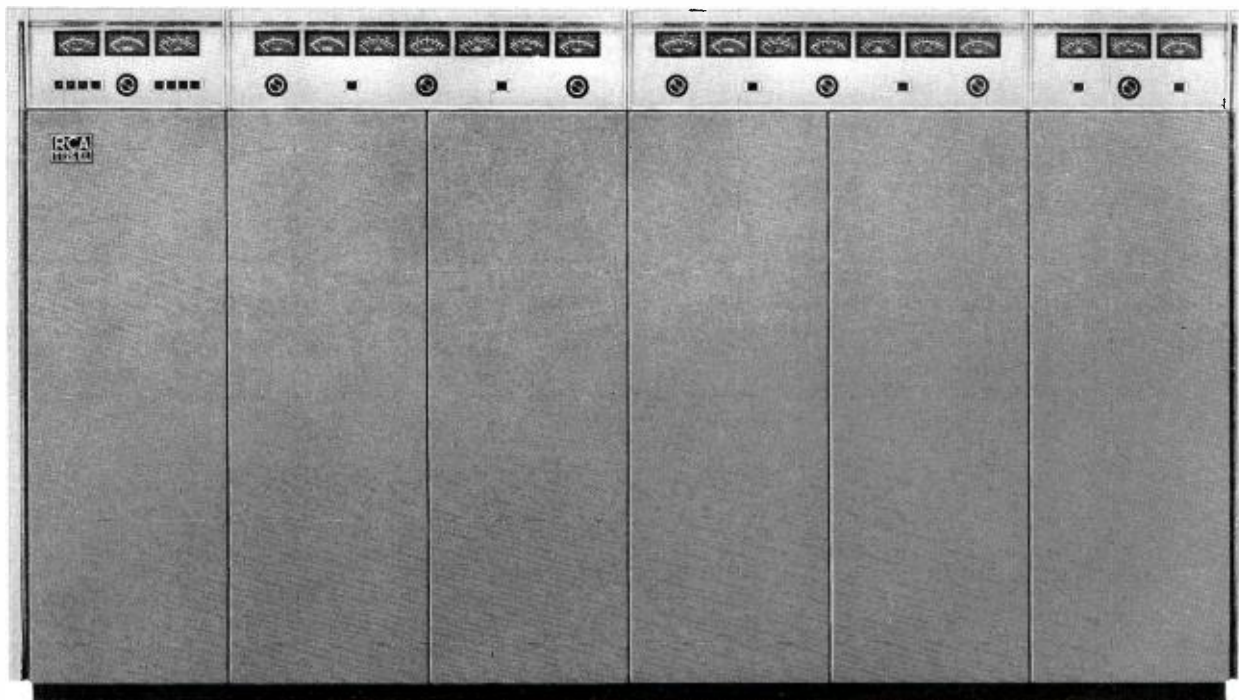

The "New-Look" TT-25EL is designed for color and for new ease of operation, manual or remote. This low band Channel 2-6 (47-88 MHz) VHF transmitter, when used with one of the current RCA VHF antennas, provides maximum allowable effective radiated power. Peak visual power output is a full 25 kW (22.5 kW CCIR); aural power capability 7 kW.

For high band, Channel 7-13 (174-216 MHz) an RCA "New-Look" 25 kW VHF transmitter is also available, the type TT-25EH.

Improved color picture quality is achieved largely through simple, straightforward circuits, reliable long-life PA tubes, solid-state rectifiers, and stable air-cooling system. Color performance has also been enhanced by linearity correction circuits built into the modulator, and other high efficiency circuits, described in this article. The paralleled PA system assures reliability through its diplexed circuitry.

#### Exciter

The TT-25EL Transmitter is driven by a common RF exciter, containing both visual and aural chains. Accurate control of the separation of visual and aural carrier frequencies is the result of precise engineering circuit design. The visual chain is driven by either one of the two crystal controlled 6AK5 oscillator circuits as a primary source of frequency control. Oscillators may be switched by means of a DC relay, thus making this circuit adaptable for remote control.

The aural oscillator is a free running master oscillator employing the "direct modulation" process for simple trouble free high performance audio modulation and is locked by an automatic frequency control circuit to maintain the 4.5 MHz separation between carriers. This technique provides precise separation that is always referenced to the visual carrier frequency and assures the optimum performance of inter-carrier TV receivers. The "direct modulation" process uses fewer tubes and eliminates numerous multipliers and converter stages resulting in low noise and minimum distortion.

#### Visual Modulator

The visual modulator applies grid modulation to the 4CX5000A visual modulated amplifier which drives the linear 25 kW amplifier. This technique results in only one linear amplifier to achieve the high power output and thus contributes to the simplicity of tuning and the overall stable performance with respect to video response performance. A modulator output signal

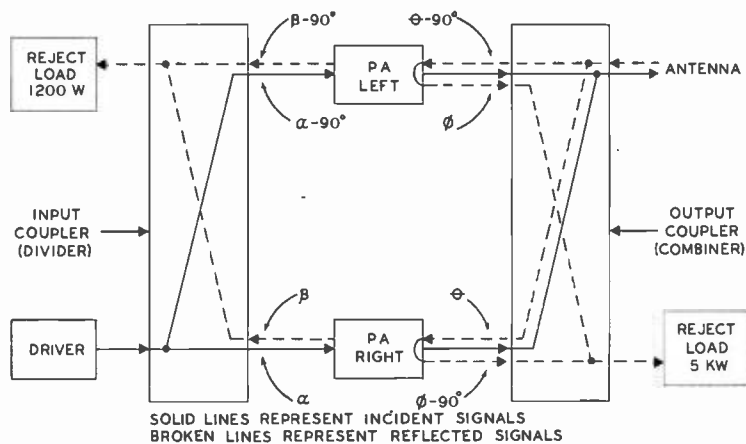

FIG. 2. The coaxial coupler used with the TT-25EL to combine the outputs of the diplexed power amplifiers.

of approximately 150 Volts peak-to-peak is required for full modulation of the visual transmitter. The modulator amplifies a standard 1 Volt video signal to the required level. Motor-driven operating controls for the video gain and pedestal level are included for operation and are available when remote control is incorporated.

#### Built-In Linearity Correction

The first amplifier stage in the video modulator is a conventional shunt-series peaked video amplifier. This is followed by an inverter stage and a linearity corrector stage, each of which has a gain of approximately unity. The linearity corrector is designed to predistort the signal to compensate for the non-linearity which always occurs in a grid modulated stage. Linearity correction is accomplished by the use of four biased diodes connected in the linearity corrector cathode circuit. The bias voltage on each diode is separately adjustable. Any one of the diodes can be made to start conducting at any brightness level. The grid of the linearity corrector is clamped in order to insure the same correction to the linearity characteristics regardless of the average brightness of the picture signal.

#### High Efficiency Circuits

The linearity corrector is followed by a second video amplifier using a 6CL6 tube and then by a third video amplifier consisting of two 5933 tubes. The grids of the third video amplifier are also clamped and from this point on the circuit is DC coupled. The output (modulator) stage is a shunt regulated cathode follower. It consists of three 6146 tubes connected in a circuit very similar to a conventional cathode follower, except that the cathode resistor

is replaced by four 6146 tubes operating in parallel. The grids of these four tubes are fed with a signal from the plate load of the three cathode follower tubes. This makes the circuit essentially a feedback amplifier of high efficiency capable of delivering modulation at a high level to a large capacitive load. A carefully designed clamp circuit assures reliable clamping even with greatly degraded input signal. Back porch clamping is employed.

#### Regulated Power Supplies

Two regulated power supplies are used in the modulator. One supplies 250 Volts to the low level stages while the other supplies 575 Volts to the third video and modulator stages. The use of a negative 575 Volt supply makes the use of a bucking bias supply unnecessary. The outputs of both supplies are electronically regulated by regulators mounted on the modulator chassis. This greatly reduces the possibility of unwanted video resonances in power supply leads. The modulator rectifiers are located on the rear wall of the transmitter enclosure.

A monitor amplifier is provided for monitoring the modulator output signal. Numerous test jacks are also provided to simplify trouble-shooting and modulator alignment.

#### RF Circuits

Exciter circuits employ a chain of multipliers and amplifiers. In the visual chain a 7034 tube operates as the first visual amplifier, driving a 4CX300A amplifier which in turn drives a type 4CX5000A grid modulated power amplifier. The output of the modulated amplifier is equally divided by a power-splitting coaxial

coupler to drive two 6166A 12.5-kW linear amplifiers. The outputs of these two amplifiers are then combined in a coaxial coupler to provide 25-kilowatts (22.5 kW CCIR) of peak visual power. Excitation control for the visual transmitter is accomplished by varying the screen voltage on the 4CX300A stage. The aural chain consists of a 4CX300A amplifier followed by a type 4CX5000A class "C" power amplifier. Power output of the aural transmitter is adjusted by varying the screen voltage on the 4CX5000A stage. Both these controls are operated by motors and therefore can be adjusted from a remote position.

The visual linear amplifiers following the modulated stage each employ a 6166-A tetrode in a grounded-grid, grounded-screen circuit which allows the grid and screen to be by-passed to a common ground plane. Input and output circuits are then constructed on opposite sides of the ground plane to obtain the maximum stability of operation. DC is used on the filaments of the 6166A to achieve the maximum possible noise reduction. In ad-

dition to improving the noise reduction the use of DC on the high power filaments aids in the maintenance of performance standards where non-synchronous standby power facilities have to be used during emergencies.

### Coaxial Couplers

The coaxial coupler, used with the TT-25EL, is a symmetrical four-terminal network of the "crossover" type. See Figure 2. A signal fed into any port will divide equally between the two ports on the opposite side of the coupler. The signal at the diagonally opposite port will lag the other output signal by 90 degrees. To combine two signals at a single port, the two signals must be 90 degrees out of phase. The combined signal will appear at the port directly opposite the port at which the lagging input signal appears.

These features are used to good advantage at both input and output of the two visual amplifiers. Equal line lengths are used for the two amplifiers at both the input and the output; thus the 90 degree phase difference is maintained from the

time the driver power is split until the amplifier outputs are combined. The power reflected from the PA input circuits will also have a 90 degree phase difference, and if the amplitudes are equal, all of the reflected power will go into the reject load. If the reflections are unequal, only half of the difference will go back to the driver. Thus, the VSWR seen by the driver will always be much better than that of either input circuit.

Any reflections coming back from the antenna system will be split equally between the two PA output circuits, and as these reflected signals bounce back toward the antenna, they combine in the output coupler and are absorbed by the reject load. The result is a ghost-free picture even when the antenna VSWR is unusually high.

### Power and Control Equipment

Wherever possible in this transmitter, the same DC power supplies are used for both the visual and aural amplifiers. This greatly reduces the number of components in the transmitter. An exciter supply is built into the common exciter unit using

FIG. 3. Simplified block diagram of the TT-25EL VHF Transmitter.

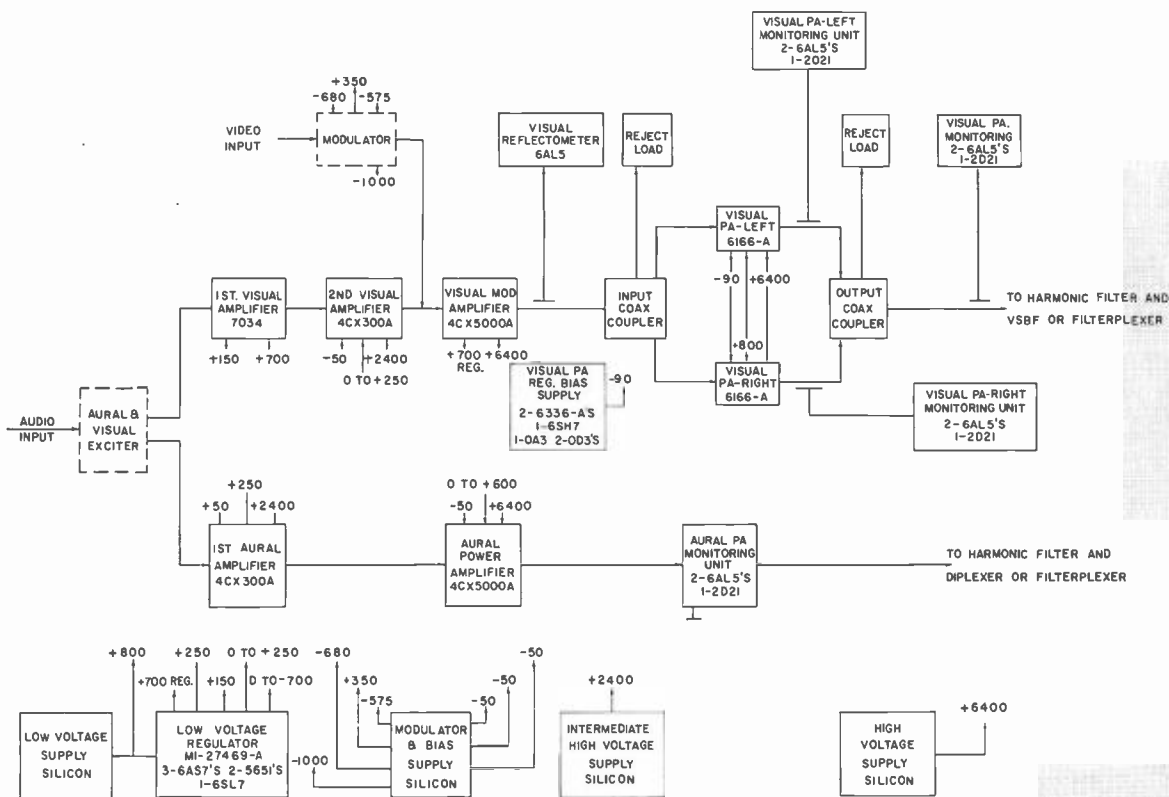

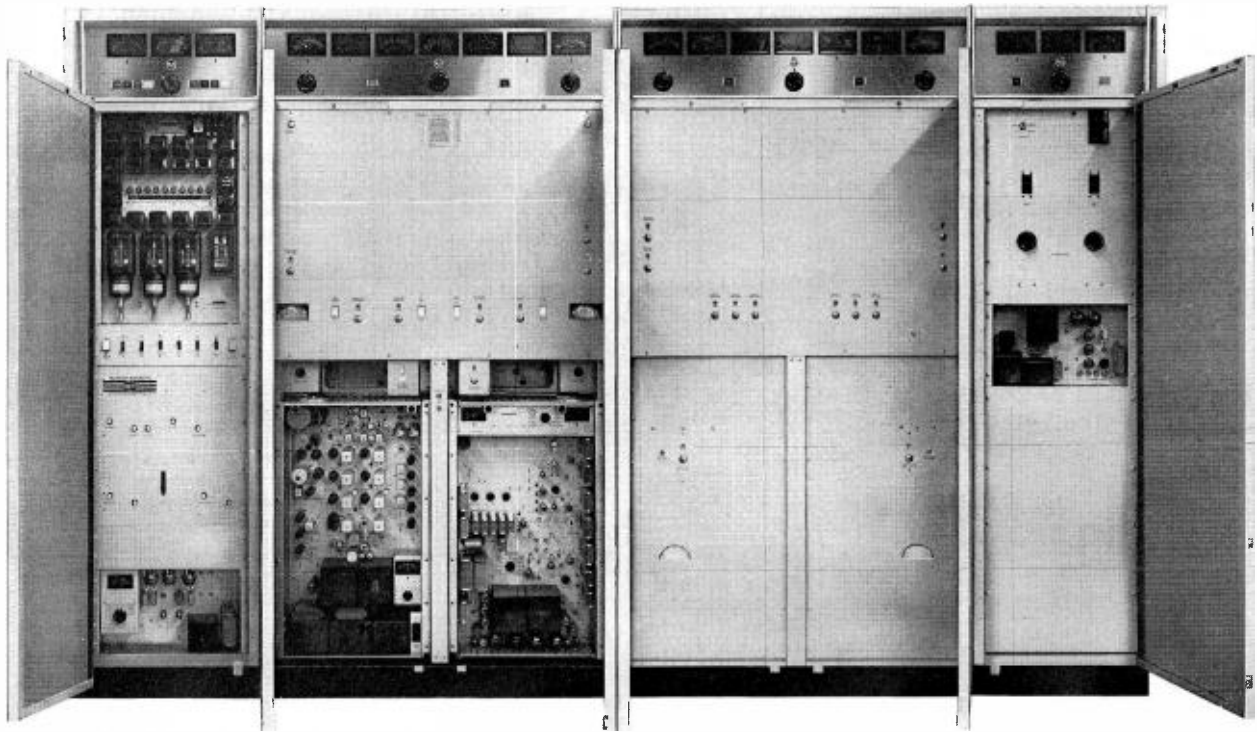

FIG. 4. Front view of the TT-25EL VHF Transmitter showing, from left to right, the transmitter control cabinet, the 6 KW driver cabinet, the diplexed 25 KW power amplifiers and the last cabinet is the auxiliary control.

stacked germanium diodes. The other supplies, all using silicon diodes, are located on the rectifier panels at the rear of the enclosure. An 800-Volt supply furnishes all screen voltages as well as the 7034 plate voltage. The intermediate voltage supply has a 2400-Volt output for the 4CX300A plates. The high voltage supply uses silicon diodes, providing 6400 Volts for the plates of the two type 6166-A power tubes and the two 4CX5000A tubes. High voltage switching allows independent operation of visual and aural final amplifiers. In addition, this feature permits removal of plate voltage from either visual amplifier in the event of tube failure which results in a minimum of lost air time. All voltages for the visual modulator are furnished by the remaining supplies. One has an output of +350 Volts, and the other has several outputs, all negative with respect to ground, which supply the high-level video stages as well as bias for the modulator and RF stages.

The transmitter includes an automatic line voltage regulator which provides a stable line voltage to the filament primaries, the exciter, the modulator, and the low voltage power supply.

#### Overload Protection

A single integrated control circuit is provided for both the visual and aural transmitters. The blower, filaments, and each rectifier is protected by thermal overloads which can be adjusted to reset automatically. In addition, a main line breaker and an auxiliary breaker are provided. Each incorporates magnetic trips. All rectifiers and RF stages following the exciter are protected by instantaneous overload relays which automatically recycle twice. If the fault continues on the third try the overload circuit will remain tripped until reset. Overload indicator lights are provided for each circuit. These lights have a separate reset and will remain on after the first overload thus providing a record of the circuit giving trouble even though it may be intermittent.

Shown in the block diagram, (Fig. 3), are visual PA monitoring and aural PA monitoring blocks. These items are included as a part of all RCA TV transmitters to provide for constant monitoring of the transmitter power output as well as the standing wave ratio on the output coaxial line. These monitoring units contain relay and thyatron circuitry that can be

adjusted to remove plate power from the transmitter when the VSWR exceeds a predetermined level, providing for automatic protection against possible transmission line and transmitter damage due to a loss of proper load.

Each power amplifier also has its own monitoring unit that functions in the same manner to protect the diplexing equipment as well as providing tuning indication for tuning of the power amplifier stage.

#### Construction

The transmitter is housed in compact in-line cabinets that are broken down for shipping into racks and panels of varying size for easy handling. The cabinets from left to right as seen in Figure 4 are as follows:

Contained in the left hand narrow cabinet are all the control circuit equipment and protective relays as well as the low voltage power supply and primary low power AC distribution. Protective breakers are provided to protect all operating circuits of the transmitter along with indicating lights to aid in the quick location of a malfunction.

The second cabinet contains the RF exciter, the video modulator, and the as-

sociate aural RF amplifiers, and visual RF amplifiers and provisions for monitoring the aural and visual output power level and standing wave ratio.

Cabinet No. 3 contains the high power linear visual amplifiers. This amplifier uses two RCA type 6166A ceramic power tubes in a duplexed arrangement. These tubes have a record of proven long life resulting in minimum tube operating costs.

Cabinet No. 4 on the extreme right contains the bias power supply for the 25 kW visual power amplifier, filament voltage control for the 6166A tubes and the high voltage switching facilities that allows independent operation of the visual and aural final amplifiers. This feature permits removal of plate voltage from either visual amplifier to permit continued operation at  $\frac{1}{4}$  power output in the event of tube failure.

A single access door on the left end of the transmitter provides access to the rear of the control and RF racks as well as the rectifiers and components mounted on the rear wall of the enclosure as seen in Fig. 5. All heavy units such as the plate transformers and large reactors are mounted on

a base on the floor. Since all operating controls and important adjustments are brought out to the front of the transmitter, it is not necessary to enter the enclosure while power is on.

Figure 6 is a back view of the transmitter as seen from inside the walk-in enclosure. On the right-hand side is cabinet No. 1 which is the control cabinet. As can be seen from this view, vertical chassis type construction is employed to provide the greatest degree of accessibility possible to facilitate easy maintenance.

Next to this cabinet is the No. 2 driver cabinet containing the exciter, modulator, and modulated driver and aural output stage. In the lower half of this cabinet are the tilt-out exciter and the tilt-out modulator. Once again vertical type chassis construction has been employed for ease of maintenance. In the top half of the cabinet the RF amplifiers are contained in their complete enclosed shielded enclosures. Access to tubes and component parts is through the four separate doors seen on the back of the enclosure. At the extreme top of the shielded enclosures are located the two ducts which carry the exhaust cooling air out through the top of

the transmitter. The inlet cooling air is obtained from an integral plenum chamber located in the bottom foreground of this picture. Air is provided to this plenum chamber from the blower located in the walk-in enclosure.

Again looking at the top half of cabinet No. 3 note the complete RF shielded enclosure for the visual power amplifier tubes and circuitry. Easy access to the 6166A power amplifier tubes and associated components is through the two full length doors on the back of the shield enclosure. At the top of the shield enclosure are the exhaust air ducts for each of the PA tubes which carry the exhaust cooling air out through the top of the transmitter. As one may imagine, many of the customers have taken advantage of this supply of warm air to supplement their plant facilities heating system to help reduce the heating facilities requirements.

Cabinet No. 4 on the extreme left shows the placement of the high voltage transfer switch and the PA bias supply and filament voltage control rheostats. Also note the space available in the lower half of this cabinet. This space may be used to mount auxiliary equipment.

FIG. 5. View looking toward the rear of the enclosure showing arrangement of power equipment.

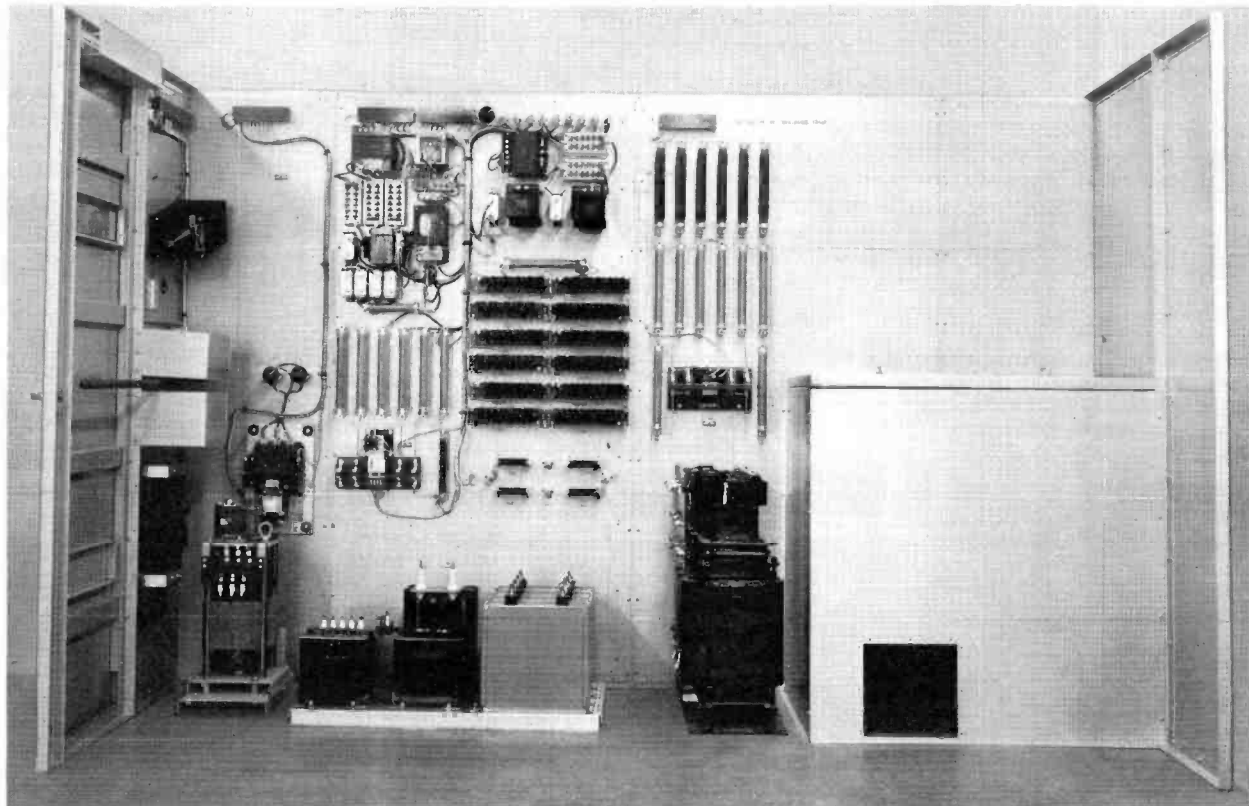

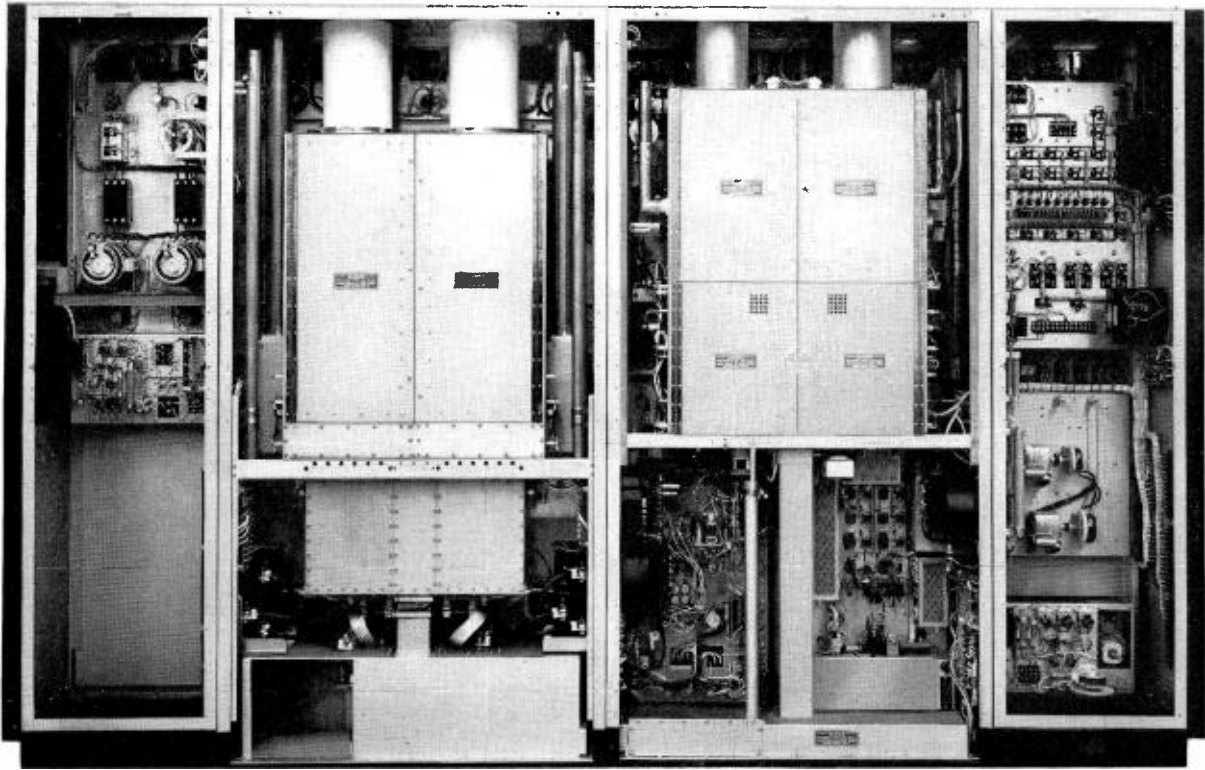

FIG. 6. Rear view of the TT-25EL VHF Transmitter showing from left to right the auxiliary control, duplexed 25 kW power amplifiers, 6 kW driver and transmitter control cabinets. Note the compact vertical construction which is completely accessible from the walk-in transmitter enclosure.

In addition to the normal electrical interlock at the entrance door to the enclosure there is a bar at waist height across the entrance. This bar is connected to a knife switch which completely disconnects the power line from the high voltage power supplies to protect personnel against accidental turn-on of high voltage while doing maintenance in the enclosure. On the back wall of the enclosure are located the solid-state rectifiers and associated power supply components. The top of the enclosure is open to allow for necessary access to the RF plumbing associated with the transmitter installation.

#### Minimum Floor Space

Reduction of required floor space is effected by the walk-in enclosure design of the TT-25EL. This type of construction eliminates the need for external access space at the rear of the enclosure. The enclosure may be placed directly against a wall or even in a corner of the room if an air intake opening is provided.

#### Economical

The TT-25EL circuits employ the latest design features that spell economy in operation, such as the air-cooled 6166-A

tubes which have long life and reliability. Single ended RF circuits reduce the number of necessary tubes and circuit components. Low power consumption is the result of all solid-state power supplies. Extensive overload protection with indicating lights aids in quick location of faulty circuits.

#### Easy Servicing

The "New-Look" design affords complete accessibility from the front and the rear. Access to all components of the transmitter is possible from within the enclosure. The easy-to-read meters are angled and are on lift-up panels for easy viewing and servicing. In the driver cabinet the common visual and aural exciter unit and modulator unit may be serviced by tilting the chassis forward, without removal from the cabinet. In the driver and amplifier cabinet the front panels remove easily for ease of access and maintenance. Air pressure is read directly in inches on a meter scale. Illuminated pushbutton switches show transmitter status at a glance. Under-bias relay status is indicated by a light on the front panel. All critical controls are motorized.

#### Ready for Remote Control

The TT-25EL VHF Transmitter includes all of the necessary provisions for remote control operation and is ready as soon as the FCC approves remote control for VHF television. The relays, motorized controls, and other devices required for remote control are built into the TT-25EL as standard equipment. The functions that are ready for remote control are: Transmitter Start and Stop, Plate Power On and Off, Visual and Aural Excitation Increase and Decrease, Overload Indication and Reset, metering for Driver and PA Plate Voltage, plus remote controls for crystal switchover, pedestal level, and video gain.

#### Conclusion

The new TT-25EL Transmitter offers the broadcaster dependability, accessibility, with ease and economy of operation, which represents great savings over a period of time. The improved picture quality is an added bonus at no extra cost. When remote control of VHF television transmitters is approved, another great saving can be realized.



# WKTR-TV BRINGS UHF COLOR TO GREATER DAYTON

Employs New Look Equipment, 760 KW ERP,  
Unduplicated Programming

FIG. 1. TK-42 cameras zoom in for new car interior and exterior shots during dealer-sponsored studio show.

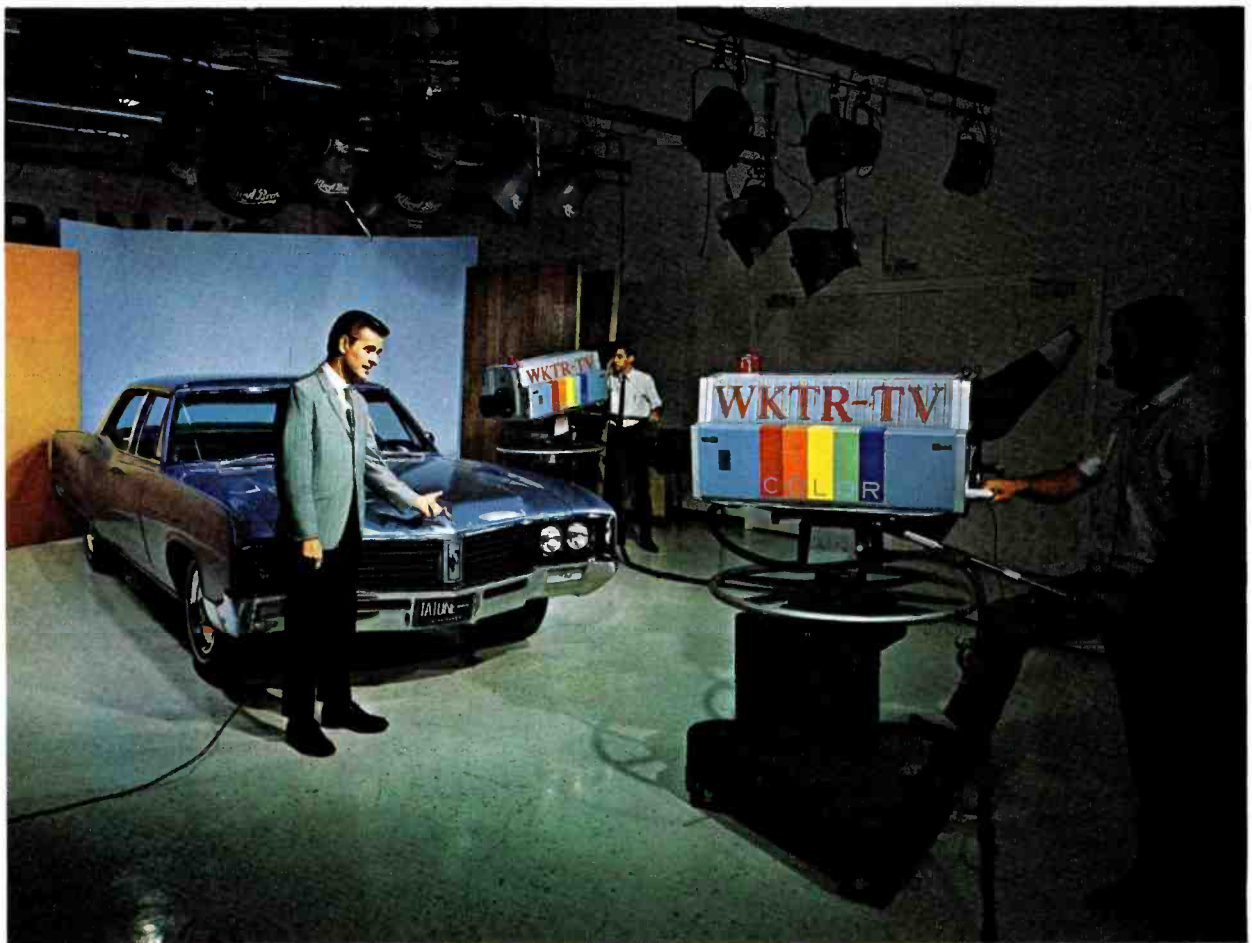



Kenneth D. Caywood, president and general manager of Kittyhawk Television Corporation, is a native Daytonian. He formerly worked for WAVI in Dayton. Mr. Caywood is also president of Kittyhawk Broadcasting Corporation, Dayton, which has an AM application pending.

A long time dream came true for 34-year-old Kenneth D. Caywood on March 20, 1967, when he pushed the button and personally "signed on" WKTR-TV for the start of programming. A native of Dayton,

Ohio, Ken Caywood is president and general manager of Kittyhawk Television Corporation, the owner of the Channel 16 independent station at Kettering, Ohio, in the Greater Dayton area.

"We started from scratch when our CP was granted," said Caywood, "but only 14 months later we had a new building ready, the latest color equipment installed, a staff hired, and we were on the air with planned programming. We might have made our original target date of February 1, except for weather problems and material shortages, and we had to wait for FAA clearance on the height of our tower."

#### All "New Look"

TV equipment units are the most modern RCA designs and are all finished in matching New Look blue. The transmitter is a TTU-30A with an output of 30 kW feeding a high gain omnidirectional TFU-30J Pylon Antenna. Two TK-42 color cameras are assigned to the main studio A, and two TK-60 4½-inch I O. black and white cameras to studio B. Studio control is operated "blind" from a large master control room which houses not only camera controls but two TP-66 film projectors, a TK-27 color film camera, TK-22 monochrome film camera, TP-7 slide projector, TR-22 TV tape recorder, TR-5 TV tape

recorder and TS-40 custom switcher with special effects.

Audio equipment in the control room includes a BC-7 Console, BQ-51 turntable, RT-21 Reel Tape Recorder, and three RT-17 Cartridge Tape machines.

#### Color Matched Building

The New Look blue color of the equipment has been carried beautifully throughout the building in a pre-coordinated color scheme involving hallway and office decorations and furnishings.

The first floor of the studio building is devoted primarily to the two studios, a control room and talent dressing rooms. Administrative offices are on the second floor, together with an employees' lounge and a large conference room where live studio programs in progress on the main floor can be viewed.

#### Carpeted Control Room

WKTR-TV has what is believed to be the first carpeted control room. The carpeting, which, of course, matches the blue motif of the walls and equipment, and incidentally covers the floor trenches, was installed to further restrict reverberation in the acoustically planned control room that has an announce booth at one corner looking in. Ceiling speakers are mounted to provide a "cone of sound" to restrict coverage to proper personnel.

#### All-Color Schedule

WKTR-TV programs daily from 8.45 a.m. to 12:15 p.m., a schedule that has been recently expanded. All live programs, including sign on and sign off are in color, as are all commercials and most film and tape shows. No extra charge is made for color.

#### Dayton's "Movie Station"

WKTR-TV is called the "movie station" in Dayton, where movies rank high in total program preference. WKTR-TV runs 27 films a week, with double-feature movies weekdays 6:30 p.m. to 10 p.m., Saturdays at 7:30 p.m., and Sundays at 6 p.m. Being the only independent, the station has prime time available during the movie blocks.

#### Studio and Tape Shows

Live programs include four weekly shows: "Meet the Manager," during which



FIG. 2. Kim Christy chats with her puppet friend on "Kim's Kartoon Kapers."



FIG. 3. Talented youth perform on "Rising Generation."

Mr. Caywood talks with visitors and explains TV station operation; "The City Manager Reports," a civic affairs program moderated by Kettering City Manager Ervin Welch; a showcase for young talent on "Rising Generation"; and arena wrestling, a 60-minute live audience show. A daily half-hour "pre-teen" program, "Kim's Kartoan Kapers," is hosted by 12-year-old Kim Christy, popular local girl who performs entirely ad lib. WKTR-TV taped programs include the "Bonnie Prudden Show" and "Merv Griffin Show."

#### Veteran Staff

There are presently 53 people on the WKTR-TV staff. Most of these who are in production, programming, talent, engineering and administration are professionals with several years' major market experience in their chosen fields before joining the station.

#### Programmed for Television

"Our Channel 16 is not just UHF—it's television," said Mr. Caywood, in discussing his program philosophy. "We program more like a 'V' than a 'U', and our people have had extensive V experience. We offer the area a unique, unduplicated schedule.

FIG. 4. Special ring and audience seats are set up in studio for live colorcasts of wrestling.

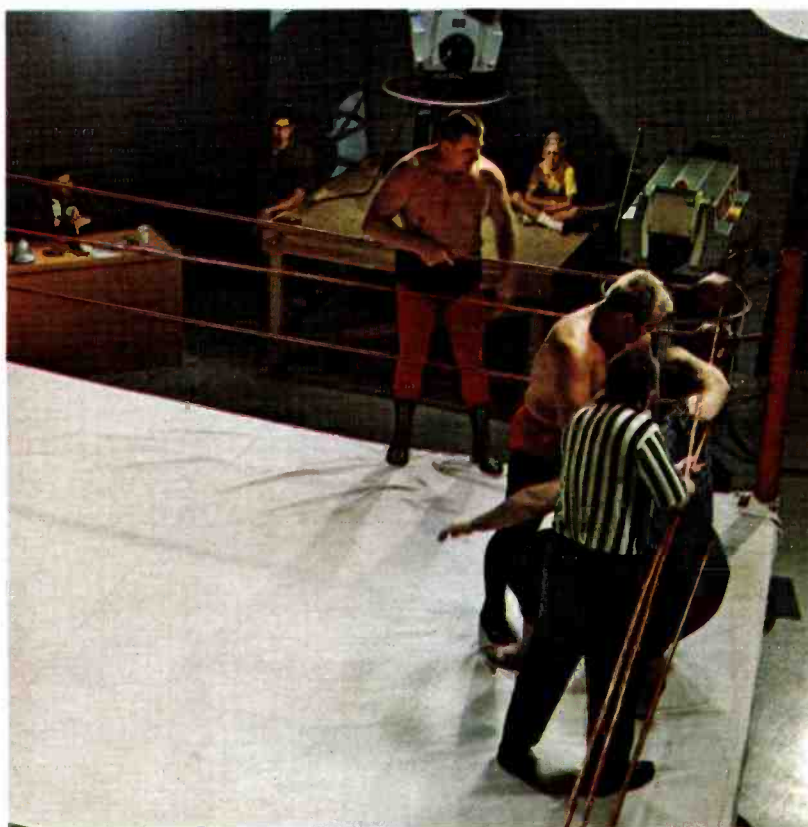

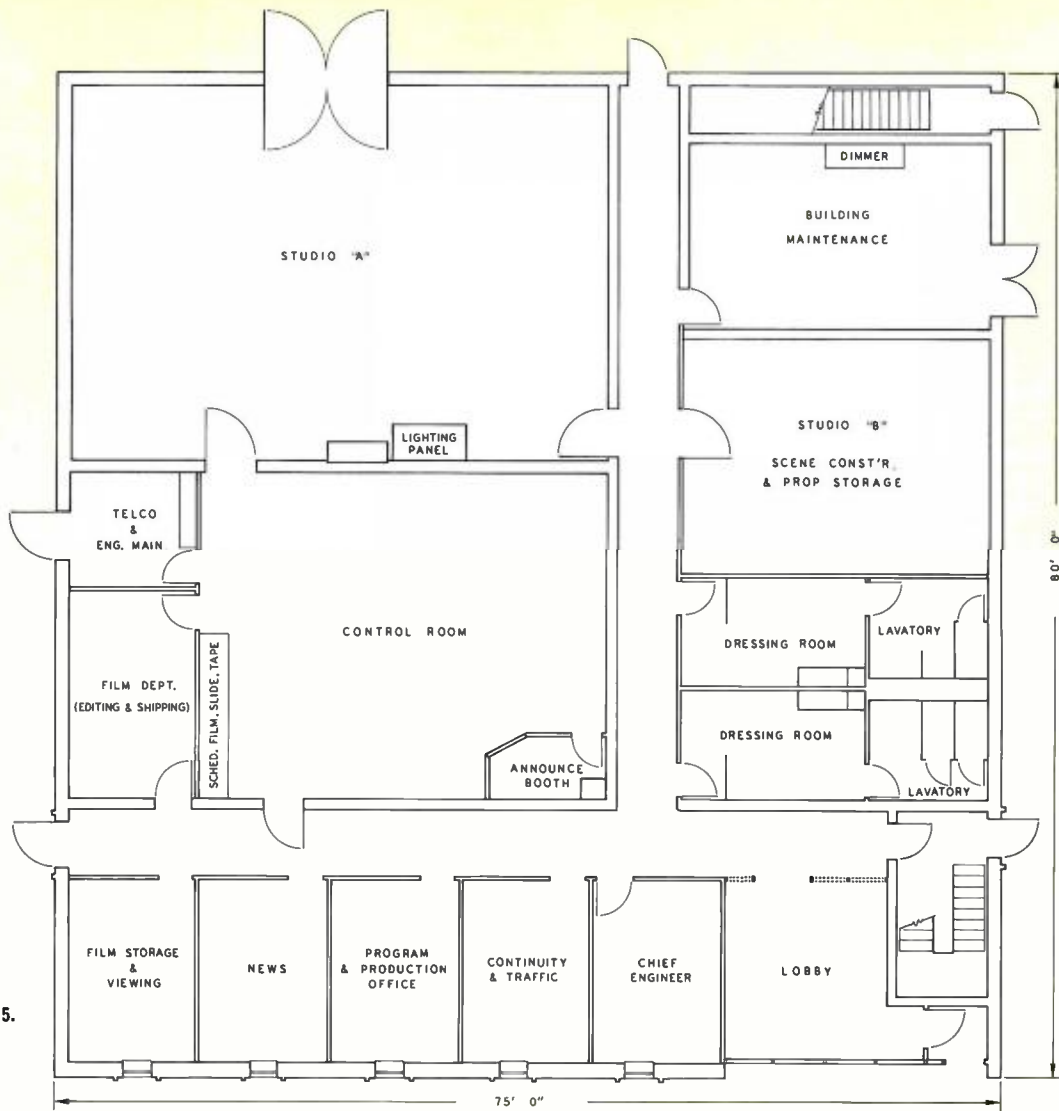

FIG. 5.

FIG. 5. Station first floor plan showing studios, control room, film handling areas, production facilities and offices.

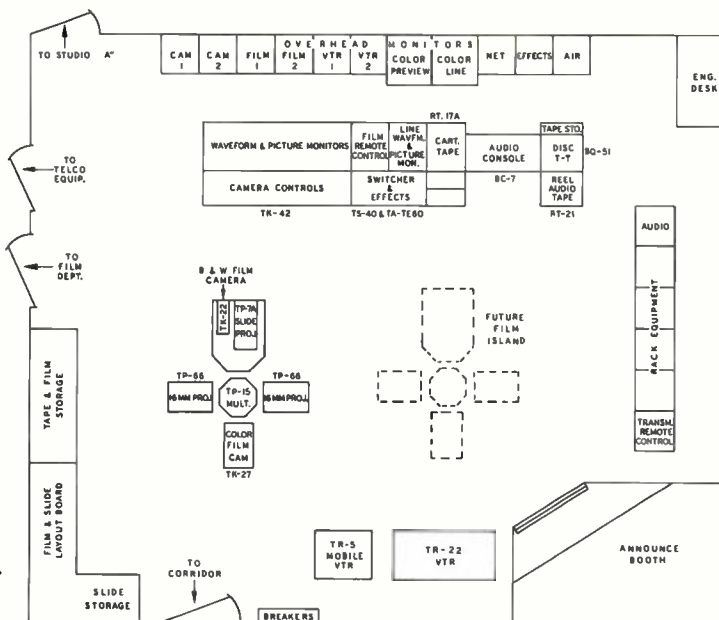

FIG. 6.

FIG. 6. Plan showing equipment layout in the single control room where studio and master control operations are combined.

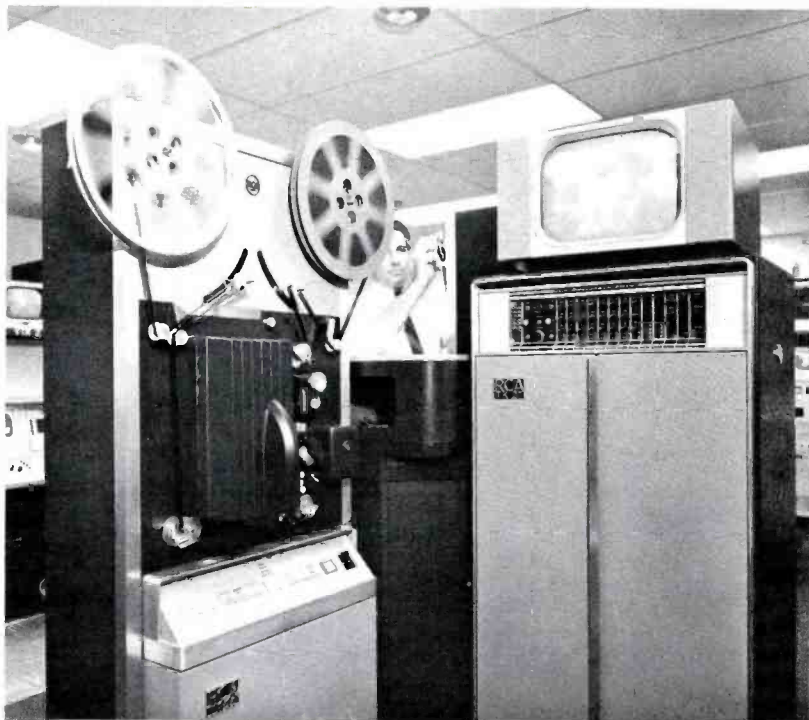

**FIG. 7.** Unified, New Look monitoring and control position comprising color studio and film camera controls, TS-40 switcher and special effects system, film remote controls, audio console and tape recorders.

“Our programming is designed to reach a “good mix” in tastes and age groups including drama, comedy, musicals, detective stories, educational and informational material.

**Highest ERP**

WKTR-TV operates with an ERP of 760,000 Watts visual and 76,000 Watts aural power. The leased studio building is a modern two-story structure with 12,000 square feet housing studios and equipment rooms on the first floor and offices on the second floor. The transmitting facility, which is remotely controlled, is located about eight miles from the studio. The transmitting site was a 40-acre corn field



**FIG. 8.** Color and monochrome film and slide “island” consists of two TP-66 16mm projectors, TP-7 slide projector, TK-27 color film camera and TK-22 vidicon film camera.



FIG. 9. Closeup view of custom TS-40 switcher and special effects panel. Above are tape and film remote controls.

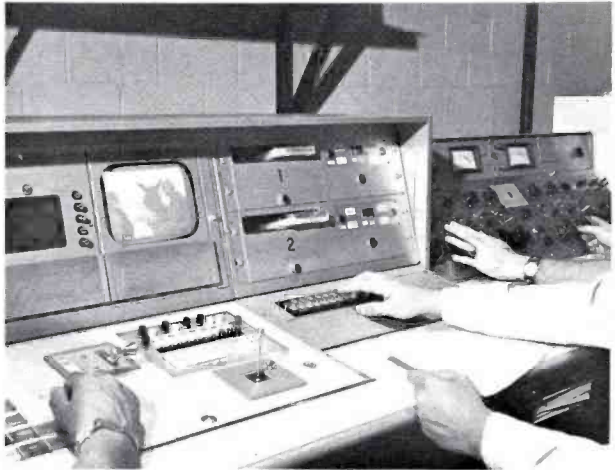

FIG. 10. Independent TS-2 delegate switcher enables technical director to select picture for previewing.

and was acquired because of its proximity to the existing Dayton stations.

Since the WKTR-TV transmitting antenna is located close to existing Dayton TV stations—a site toward which Dayton and Kettering receiving antennas are presumably pointed—proper orientation of consumer TV antennas for best reception of the new Channel 16 is assured. This, the WKTR-TV staff calls “automatic consumer antenna orientation.” Good reception of the WKTR-TV signal has been reported in Toledo, 170 miles to the north, and in Jackson, Kentucky, 230 miles south of Kettering.

#### Remote Control

The 30 kW transmitter located about eight miles from the studio will soon be completely remote controlled. The system, which is installed and awaiting FCC approval, will provide metering, alarms and 20 control functions from a panel located in the control room.

#### Set Up Simplicity

Engineering Department reports from chief engineer Robert Dye and engineering supervisor Ervin Warnick reveal a great deal of satisfaction with operation of the big tube color cameras. Major alignment procedure is gone through approximately every thirty days and requires about one hour when done by an experienced operator. (This means a man who has attended

the course of instruction given at the RCA Color Training Center in Camden, N. J.) Minor set up is done daily at the beginning of the broadcast day, consists essentially of making registration adjustments from the console with charts before the cameras, and requires 15 to 20 minutes. In addition, the log grey scale chart is usually employed before each show.

#### Good Color Quality

“Our live color quality, we think, is very good and this judgment is also confirmed by outside reports. Clients say it’s better than anything they have seen, when viewing our production of their commercials—as they see them on the playback monitors.

“More important is the consistent color quality that we get. Although we had a

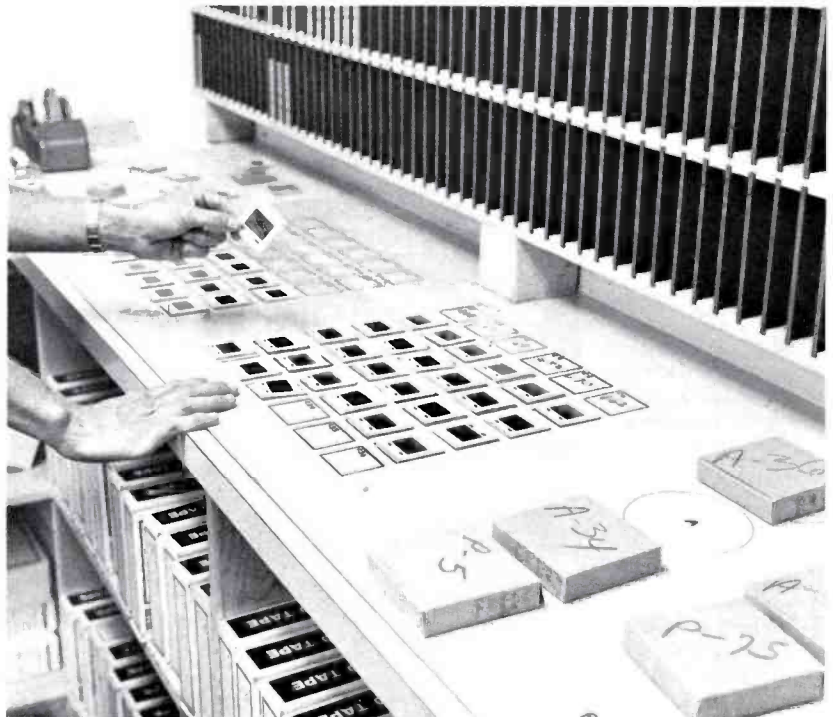

FIG. 11. This “layout board” in control room designates sequence of slides and films for each two hour period of programming.

FIG. 12. Coaxial patch system at transmitter location. The 3/8-inch patch at top center of photo is used to bypass the filterplexer. The 6/8-inch patch in foreground is for connection of dummy load.

bit of convergence drift, this is being eliminated by installing the Mu metal shields supplied by RCA. The 4-tube concept, we think, is a boon to broadcasters because it does not show the little misregistrations the way that the 3-tube camera does."

#### Color Operation

"Those of us who handle the lighting have had considerable experience. We employ both flat and modeling—depending on the situation—using fill and key lighting as needed. We use all quartz, which is better than incandescent (or a mixture) because there is not so much drop-off with age. It is important with color to keep the color temperature uniform.

"Our production people are getting excellent results from their efforts using our New Look equipments. Since many of them were trained on the new 4-tube cameras, they do not realize how difficult it once was to get good color. For example, the new built-in zoom lenses and stabilized controls make it easy.

"Scenery design, wardrobe and make-up for color are all done internally by WKTR-TV staff people. The director responsible for developing a show works with the artist and the agency in design of backgrounds and the construction is done on the premises. We usually make scale models first and look at these on camera. The director and the talent work together on make-up and wardrobe, testing on camera to obtain the desired effect."

#### Improved Color Cameras

"We once worked with the old 3-tube cameras and as a result are much happier with the TK-42. The new 4-tube color camera is easier to set up and to align. The stability is much better on the TK-42. Furthermore, the 3-tube requires more than one person, whereas the TK-42 can be set up and aligned by one man."

FIG. 13. Type TTU-30A 30-kW transmitter being checked by Robert K. Dye, WKTR-TV chief engineer. Transmitter employs high efficiency, vapor cooled, integral-cavity, klystron power amplifiers.

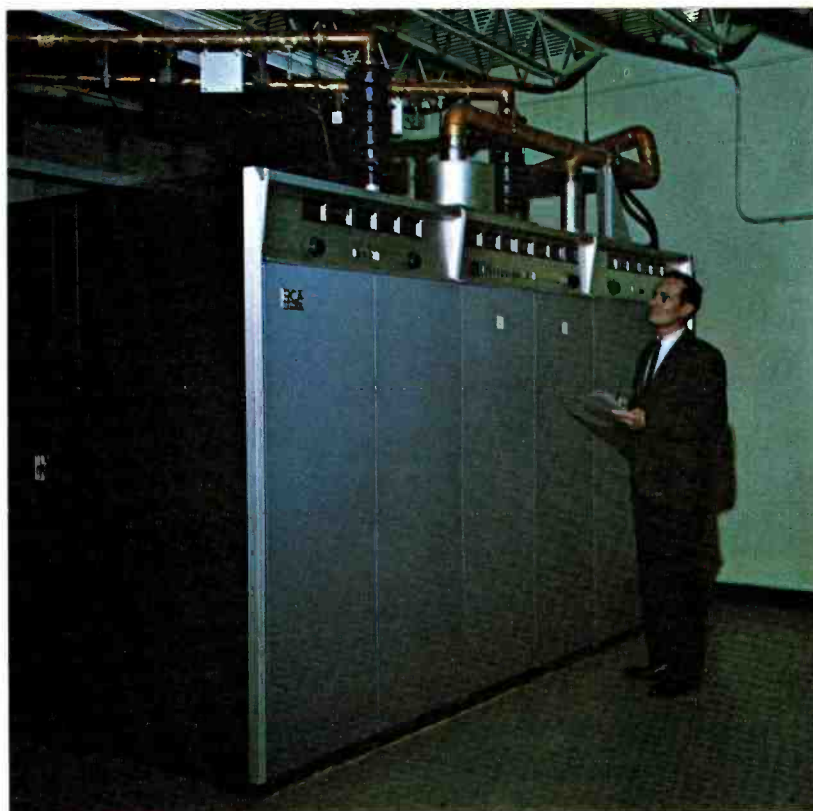
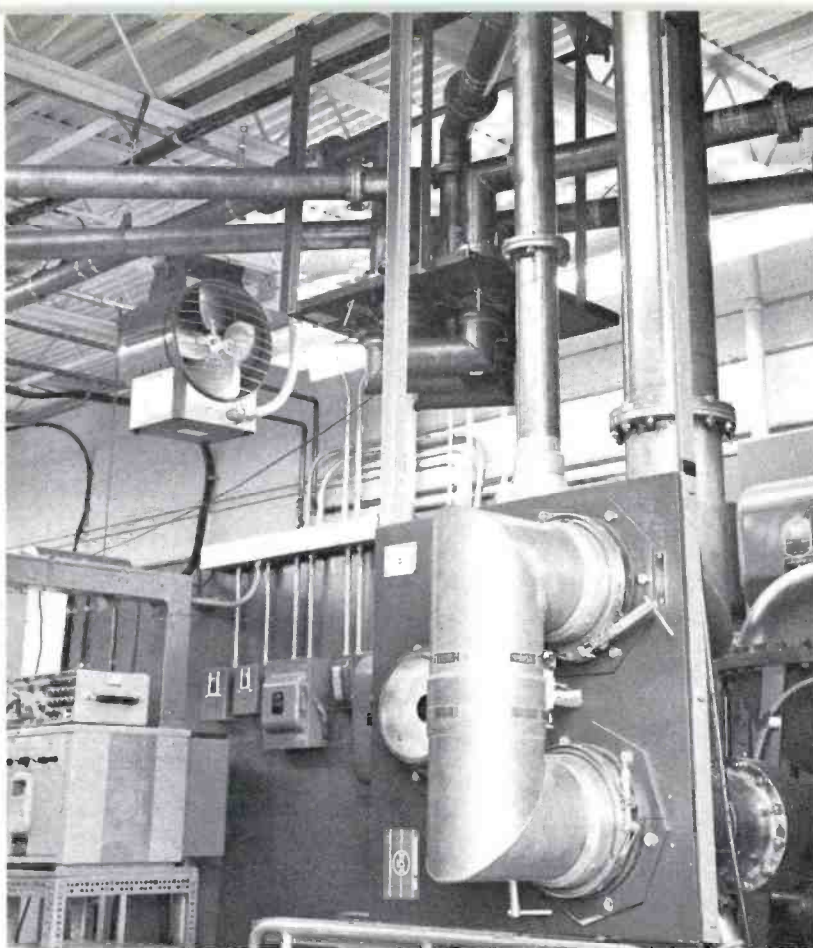

# TV Stations Are Getting Great Color On Outdoor Remotes With RCA TK-42 Cameras

KHQ-TV Tapes Spokane Fair With Single Camera and Mobile Recorder



Scene at KHQ-TV loading dock as TK-42 and TR-5 are loaded into panel truck that serves as mobile unit.



At the Fair Grounds power requirements were so small that KHQ could move about at will to cover the various attractions.

## KTAR-TV Acid-Tests Color on Rodeo Parade in Phoenix

Although the day was overcast and color ranged from one end of the spectrum to the other, it was a beautiful show on viewers screens.







Because the parade passed close by KTAR-TV studios, it was only necessary to use some 300 feet of cable, a raised 18-ft. platform, and a forklift to capture the entire rodeo.

## KHVH-TV Brings Colorful Hawaii to Mainland, U.S.A.



It was the biggest day in Hawaii's TV history when KHVH-TV, with TK-42 cameras, gave the mainland its first look at Hawaii in live color TV.



A KHVH-TV production crew on Waikiki beach presented a 90-second color remote via satellite during half-time of Michigan State-Notre Dame football game.

This is the kind of color versatility you get with RCA TK-42 live color cameras. They're just as great outdoors as they are in the studio. The big tube performance shines through wherever the requirements are exacting . . . For more information and latest brochure see your RCA representative or write: RCA Broadcast and Television Equipment, Bldg. 15-5, Camden, N. J. 08102.



# CBC "big tube" cameras put sharp TV coverage where the action is!

Three color TV mobile units similar to this one near the 18th hole were used by CBC to cover the event.

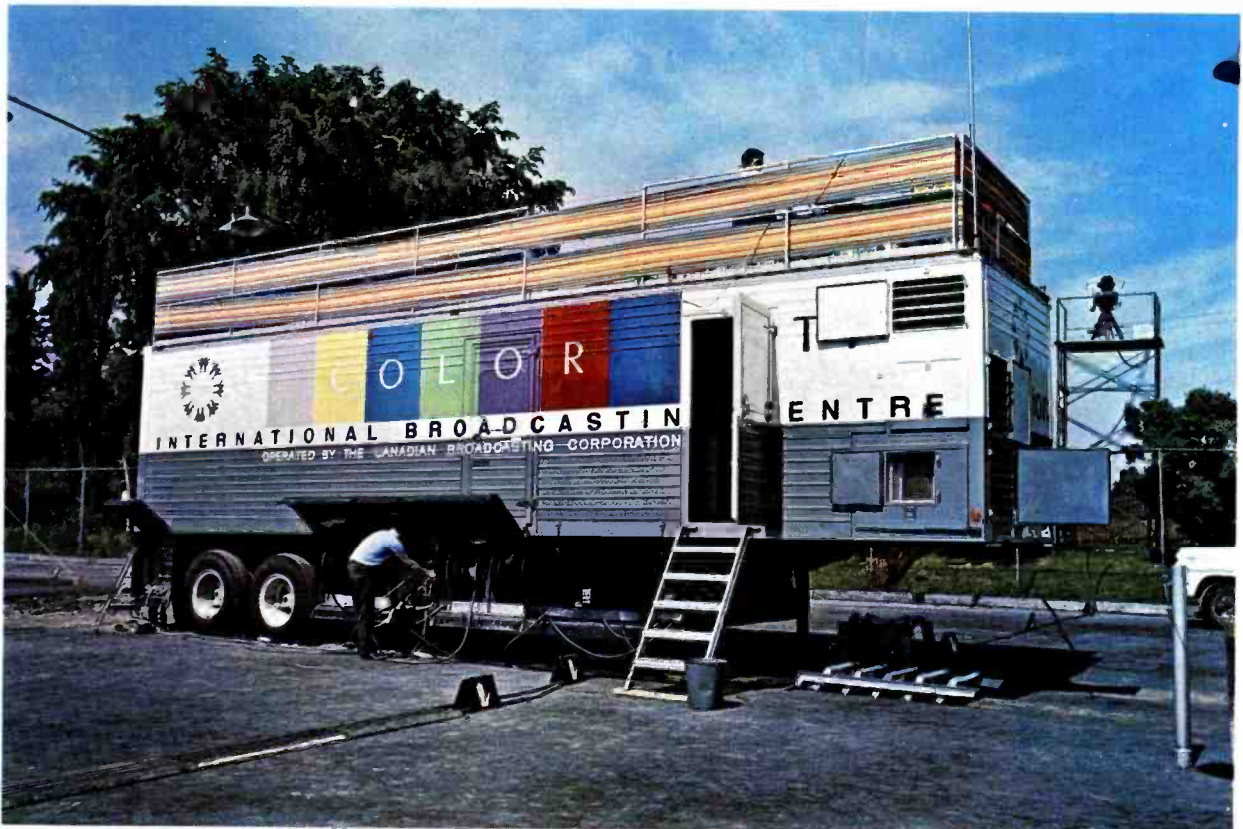



One of a total of eleven TK-42 cameras in use—located at several strategic points to pick up all the action.

During the Canadian Open Golf Championship at Montreal—an Expo 67 feature which attracted “name” golfers from all over the world—11 TK-42 “big tube” color cameras were deployed, 3 of them around the 18th green and fairway where much of the action took place.

These cameras were operated throughout several days of changeable weather and with widely varying light levels, constantly producing pictures of brilliance and sharp detail. Long shots depicting the milling crowds of spectators watching a long drive, or close-ups showing the details of tense putting sequences were equally effective.

A total of three RCA Victor-built vans, equipped with eleven TK-42 color cameras, was used to give the very finest coverage from any vantage point. Narrative was simultaneously done in English and French—the usual procedure in Canada. The English program was fed simultaneously to an American network.

Whether you are interested in large-scale remote pickups, such as this out-size one for the Canadian Open Golf Championship, or for local remotes around town, you will get the best results with RCA’s “big tube” color cameras.

# TK-42s capture fast action under blazing sun... give CTV superb color pictures!

To get the big view of the game one TK-42 was stationed  
on roof of press box. Three TK-42s were used in all.





Soccer matches for CTV, Canada's privately owned color network, were among the programs broadcast in breathtaking living color from the grounds of Expo 67. The remote pickup, shown above, was made with TK-42 cameras during a "round-robin" series of games between England—the present world professional title holder—and Russia, Mexico, West Germany, Belgium and Austria, at the 25,000-seat stadium, "Autostade."

Two things are especially noteworthy in these pictures: The soccer field is ablaze with the light of the mid-afternoon sun; play is fast and furious. Yet what kind of pictures were received on the home screens? Superb!

Whether the sun was high in the sky, causing short shadows, or late in the day when shadows became elongated, pictures were always brilliant—colors true to life. Details in close-ups or long shots came through consistently well. This was picture performance that put the viewer right on the field, with sharpest pictures possible.

CBC made extensive use of the TK-42 cameras throughout Expo, with results that proved there is nothing like a TK-42 for location shooting. If you want the very finest color pictures under widely varying conditions, get the best—RCA's "big tube" color cameras.

# EYEWITNESS NEWS CLICKS IN COLOR

KDKA-TV, Group W Pittsburgh Station  
Projects New Image With BIG TUBE Cameras  
in Showcase Newsroom

by RAYMOND J. HOFFMAN

Only the seed of an idea in late January, the concept, which is used by the other Group W television stations (KYW-TV, Phila.; WBZ-TV, Boston; WJZ-TV, Baltimore, and KPIX-TV, San Francisco) became an on-the-air reality in full color on March 1. In the intervening weeks, more than 2400 man-hours of labor went into the reconstruction of a formerly drab studio, making it an operational news showcase.

Referred to by some of the news wags as "Pittsburgh's Parthenon," the "Eyewitness News" studio is home base of all the daily color news shows on KDKA-TV. This includes four, half-hour reports Monday-through-Friday, and two half-hour reports and two 15-minute reports, as well as several five-minute reports every Saturday and Sunday.

The entire news staff, on-the-air personalities, producers, writers, editors, film editors and administrative directors—are officed in the "Eyewitness News" studio; and viewers often see the men-behind-the-

FIG. 1. KDKA-TV Eyewitness News Studio, showing desks for writers, reporters, and photographers.



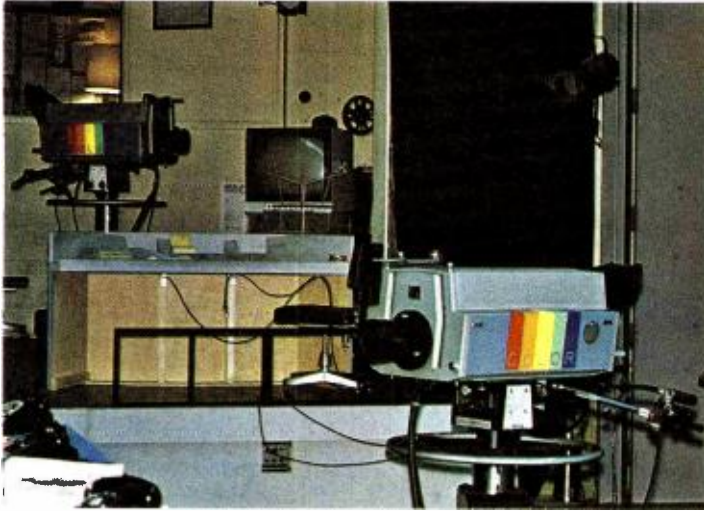

FIG. 2. Looking into the two color cameras from the talent side of the camera. Note 2-levels.



FIG. 3. New Big Tube TK-42 Cameras are used for color newscasting.

#### ANATOMY OF A NEWSROOM

In essence, this is the formula blended by KDKA-TV in launching the innovative "Eyewitness News" approach:

*Basic materials needed:* A top news gathering facility, complete with personnel; a crowded, combined radio-television newsroom; a large, all-purpose television studio overburdened with activity of a major market; an auxiliary television studio partially used for news to help alleviate the combined newsroom space problem, and the imagination and leadership to mix the ingredients into a successful formula.

*Methods and procedures:* Decide that something dramatic must be done if the station is to maintain its high quality level of news reporting to its market. Design a functional newsroom-studio and completely remodel the auxiliary area now partially used for news by moving in carpenters, electricians, painters and artists to implement the design. Move all television news personnel and equipment into the new setting, and blend in a quantity of new equipment, including two, RCA, TK-42 "Big Tube" color cameras. Give the project an exciting new dimension by sending newsmen on multiple "on-the-scene" stories every day while still maintaining responsible news broadcasts in the old format. Cap off with a total name concept which attracts attention and delivers its promise.

*Result:* The creation of "Eyewitness News," which has captured the eyes and ears of the Pittsburgh television market.

scenes on phones or at typewriters while a news show is being aired.

Teletypes, photo facsimile machines and telephones operate during the shows, but noise is absent to the home viewer. The teletypes, police radio, the two-way radio system for seven mobile units and photo fax machine are located in a secreted sound proof area, and the phones are equipped with a quiet ring system.

In building the new studio, seven carpenters worked 12-hour days for 21 days, and four of those carpenters worked an additional seven, eight-hour days. Electricians installed 30, new, 3200-degrees Kelvin quartz lighting fixtures as well as two, 40-foot rows of fluorescent lights. In addition, they removed all the old incandescent fixtures. Five newswire machines and 20 telephones were installed, and four rows of work desks were built.

The studio, which features a two-seat anchor desk elevated three feet above the floor in the front of the room, is completely walled in by panels on which "Eyewitness News" symbols and letters are embossed, some strategically painted in different colors from the basic light blue-grey background.

A rear, three-seat news desk on the floor, as well as two-tiered desk areas on opposite sides of the studio, arc within camera range at the director's discretion.

One of the color cameras is on the main floor, and is used principally for shots at the rear news desks, and side work areas. The second color camera is on the platform directly in front of the anchor desk. A special scissors lift was constructed to elevate

the camera to this anchor position. The lift also makes it possible to lower the camera for use on the floor, if desired, or in the adjacent larger studio for other programming purposes.

The front of the set and the rear are lit by the quartz fixtures during the telecasts. At other times, the room is brightly illuminated by the twin banks of new, super high-intensity fluorescent fixtures.

Assisting with the art work were Sandy Shutak and Bernard Blazier, of the station's art department. The electrical work was done by the station's technical staff.

During the construction period, all news

shows originated in the adjacent studio, and the entire TV news staff worked out of the combined radio-television newsroom.

Along with this "new look" in news, the station is emphasizing on-the-spot reports from all members of its news team. In fact, although there are anchor men for each show, it is not unusual to see any news personality in action on any given show.

The news staff has responded favorably to the change which moved it from a crowded combined newsroom a floor above the television studios to the new unit on the street floor of the Downtown Pittsburgh, Group W station.

KDKA-Radio continues in the former second floor newsroom, gaining much-needed space in the move.

Many veterans of the station say the "Eyewitness News" studio reconstruction was one of the fastest rebuilding projects they had ever seen. In fact, there were about 10-days of dry-runs and color testing in the new facility before the first "Eyewitness News" telecast.

General Manager Paul G. O'Friel sums up the feeling of station personnel by saying that "once more the teamwork and leadership we have at the station has proved it can face extreme deadlines in an outstanding professional manner."

FIG. 4. Note the multi-level construction of Eyewitness Newsroom.

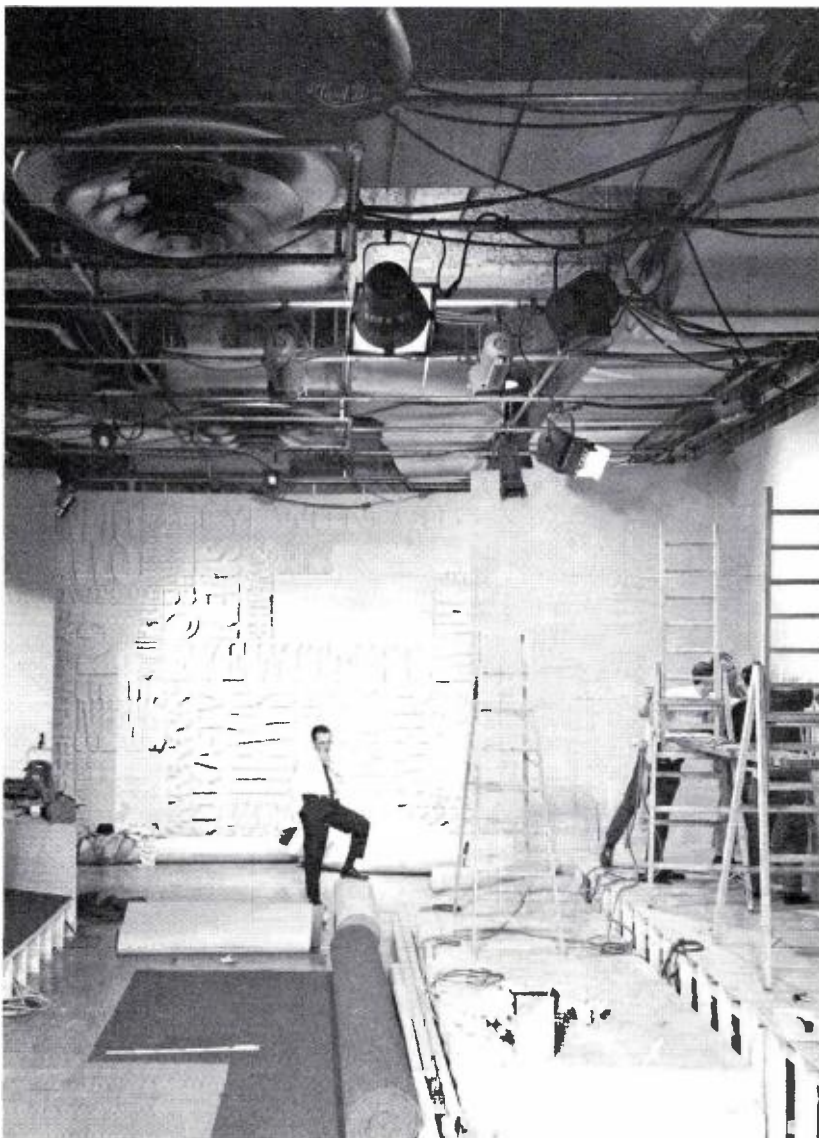

## How KDKA-TV Created A Combined News Office and Color Studio

by

W. H. ARTZBERGER, JR.

*KDKA-TV Engineering Department*

The days of monochrome were rapidly coming to an end for station KDKA-TV, Pittsburgh, Pa. As many other progressive broadcasters, they were looking forward to color. Although they had been telecasting color movies (using the RCA TK-26 and TK-27) and color video tapes, (using the RCA TR-4) they had not yet begun live color programming.

Two newly-arrived TK-42 Cameras were to start the transition from B & W. But, the station management was searching for some new approach to begin their change-over.

### An Idea Is Born

Studio "B" had been used very little. Mostly, it was a catch-all serving for everything from storage space to a repair shop. It was reasonably large, measuring 44 by 30 ft. and complete with control room, lighting and air-conditioning. Drawing boards were activated and after a few weeks of intensive planning, Studio "B" was to be converted into a completely new and fully-equipped color studio. The mode of operation was an "on-the-air, working newsroom." Through careful design, working space was allotted for 17 newswriters, re-



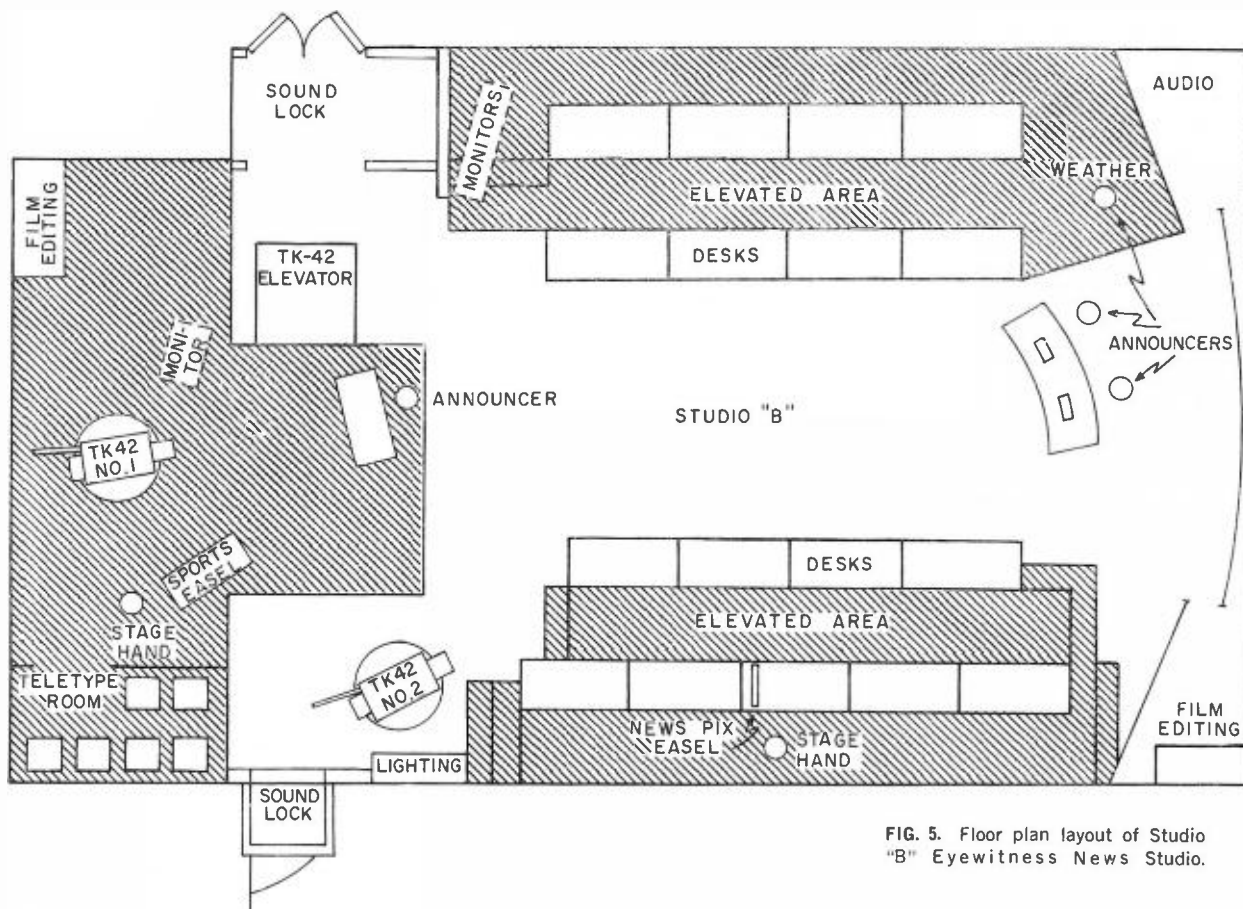

FIG. 5. Floor plan layout of Studio "B" Eyewitness News Studio.

porters and photographers. The studio was their full-time office. At this central location, the news would be gathered, written, edited and prepared for the air. It was a natural setting for an instantaneous news show.

#### A Studio Is Re-Born

The control room was abandoned. The wall separating it and the studio was removed. This gained an additional 9 by 17 ft. area. The problem here was the control room floor was 3 ft. higher than the studio floor. This height was used to an advantage by adding on and projecting an 8 by 10 ft. stage into the main studio. It was perfect for the location of one of the TK-42s. Adequate space was provided on the stage for a newscaster at his desk. The writer's desks were then arranged in tiers along the studio walls so the cameras would see no heads behind heads. Every person on either camera would be fully in view. One more interesting facet is the entire newscast could be done with two cameras and without dollying either TK-42 to another position.

#### The Full-Treatment

The fact was: station personnel would be spending more time in productive work

in the new studio than they would on the air. A studio could be very drab with its usual black lighting fixtures randomly hanging and its walls lined with ropes, pulleys and wiring. The art department furnished a cleverly designed permanent backdrop that covered the walls. The station call letters and the new program title "EYEWITNESS NEWS," were used in perspective both vertically and horizontally for background effect. Bright reds, yellows, greens and blues were used on No. 1 gray. Though colorful, care was used not to detract from personalities on camera. Since people would be working during "on-the-air" periods, heavy rugs were used to cover all floors, except on camera runways. This was done to prevent background distractions, such as shuffling of feet or accidentally dropped items.

The lighting used during office hours would necessarily differ from camera lighting. This was overcome by installing twelve 100 Watt fluorescent tubes on the studio ceiling above the desks. These are turned off during air time.

The lighting director and technicians made a study of the new techniques needed

to light a studio for color. The older incandescent fixtures were removed and quartz-iodine luminaires (3200 Kelvin, color light temperature) were installed. This decision was made because of the advantages of quartz-iodine lamps and their wide acceptance in the industry. The ultimate goal was to have the lighting level at 250 foot candles over the entire studio. This is the optimum light requirement for the TK-42 color camera.

After a few trial and error measurements, it was discovered that a complement of 40 fixtures produced the desired light. With the combined efforts of the production staff, set designers, lighting personnel and technicians, old studio "B" had been transformed into a modern color television studio.

During the construction period, the station's engineers and cameramen were schooled in theory and techniques of color telecasting. One technician was spared from the re-building program and sent to the RCA TK-42 seminar in Camden, New Jersey. In turn, the technician was very beneficial in the instructing of other Engineering Department personnel.

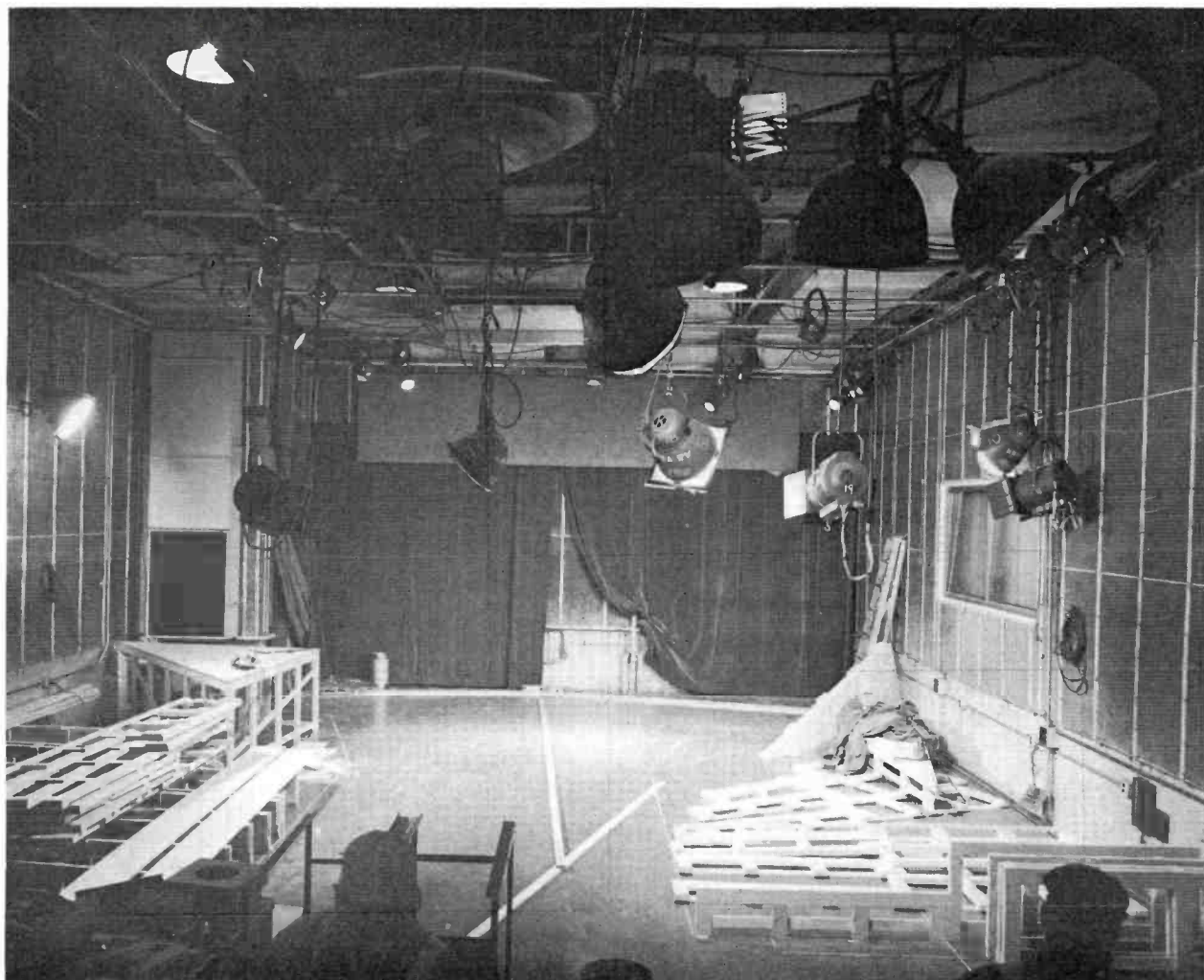

FIG. 6. Progress shot as former Studio "B" was being converted to Eyewitness newsroom.

#### **Eyewitness News Has Impact**

March 1, 1967 was the target date for KDKA-TV's first live color program. The format was to be as simple as possible, yet impressive. The studio floor plan lent itself to simplicity. Each TK-42 was focused alternately on a newscaster or an easel. Camera No. 1 was on the elevated stage. (A hydraulic platform elevator was installed for removal of the camera, when necessary.) Camera No. 1 panned the principal newscaster and sports score easel. Camera No. 2 panned another newscaster, sports announcer, the weatherman and the news picture easel.

While the newscasters commented on the news, writers could be seen in the background busily at work. The built-in props: desks, typewriters and telephones added excitement. This dramatic display added a freshness for the viewers. It evoked immediacy and was the approach the station was searching for.

EYEWITNESS NEWS has been programming quite successfully for more than six months. All the departments involved in the operation, although unnerved for the first show, have been rewarded. The new concept of a studio has proved its versatility and the new TK-42s added the color.

# ETV

## THE SLEEPING GIANT

### How TV Teaching Is Effectively Used For Large Groups and Has Become An Integral Part of Military Training

by MAJOR FRANK J. PETERSON

With growth almost unobserved, educational television has reached sufficient stature to obtain national recognition as a valid tool of learning. Currently there is widespread interest in ETV because of its tremendous capacity for coping with the twin problems of how to assimilate the exploding fund of knowledge, and how to educate the exploding population. It augurs well for the future development of any nation to bespeak a serious interest in instruction via television.

Naturally enough, ETV has captured the attention of not only educators, but also national leaders in the legislative and executive branches of state and federal governments. Many are the proposed plans to establish, and to nurture the employment of television as an educational tool. Not forgotten is its importance as a medium for mass dissemination of information and the contact of culture.

All this activity may, however, generate more heat than light, more dialogue than achievement, unless there is an accurate focus on objectives and a clear understanding of what the wedding of television and education cannot do, as well as, what it can do.

In an effort to shed some little light on the subject, we offer here a review of our experiences in the utilization of ETV for training by the military.

The USASCS\* has long since recognized that education for large masses of troops could be a difficult and time consuming

process, especially, when shortages of trained instructors compound the problem.

Much thought was given to the vast numbers that had to be educated either through repetitious absorption—or subliminal methods.

The School felt that television was the answer to the mass instruction problem, using key instructors as one would use TV talent. The results have proved this reasoning to be correct.

The U.S. Army Signal Center and School has approached the problem with the premise that educational television need be neither dull nor uninteresting. To be completely informative, it had to be dynamic, visually exciting. Showmanship, we reasoned, is conducive to good learning.

And this theory has motivated the programs produced by the Signal Center.

Producing educational television programs is not accomplished by pushing a button. It's hard, detailed and sometimes exasperating work. And without the intelligence, experience and creativity of personnel on which to draw to do the job, the task would be impossible.

The entire staff at the Signal School's Education TV System represents over 301 years of experience in all aspects of the field of television.

Among both military and civilian personnel, there is a wealth of former technicians and talent from the major television and radio stations.

A college degree is far from an uncommon fact among civilians. There are also holders of master's degrees in television

production and the fine arts, and many who are working towards this end.

Many of the military have had extensive civilian experience in television with the major stations in the nation.

Some of the Signal School's TV staff were no strangers to educational television when they joined the U.S. Army Signal Center and School. They were producers and directors, and some even instructors, at universities and educational television stations.

And what have we at the School accomplished with Educational Television? Perhaps we can best answer that question in this fashion:

Today in the services, thousands of young soldiers are doing an outstanding job for their country in the totally vital fight against aggression. Some of the credit for this fine showing by the trainee replacements arriving in critical areas today is due to the improved training techniques made possible through our educational television system.

Many youthful Army Signal Corps communicators are among those who have received much of their specialized training through educational television.

Today, throughout the U.S. Continental Army Command, educational television systems are playing a major role in training communicators, pilots, artillerymen, infantrymen, and other personnel in the vital skills necessary to field a fighting Army.

Needless to say, we are not alone in our realization of this facility. The other services are well aware of the benefits of educational television training.

\* USASCS: U.S. Army Signal Center and School.



Major Frank J. Peterson, Chief, TV Division, USASCS, retires October, 1967, after 20 years military service, 17 of which have been in radio and television broadcasting. Before joining the U.S. Army in March, 1957, Major Peterson was a "mud" Marine stationed on Guam. Later, as a combat radio-TV correspondent, he had the opportunity to produce and "emcee" a 15-minute telecast on KSD, St. Louis, which since has been credited as the first "Marine TV show." He later produced many TV shows, stage shows, performances and narrations for an east coast motion picture unit.

The majority of 26 U.S. CONARC service schools use some form of an operating closed circuit Educational Television System that provides supplemental support, and, in some cases, provides total instruction to students in the various service schools and training centers.

Giant strides have been made in the development and application of Army television since its modest beginning in 1949 when the Department of the Army officially assigned the responsibility for developing educational television to the then Office of the Chief Signal Officer.

At that early date, a number of activities and facilities were designated to explore the use of television as an educational device. The first of these was a mobile television unit which was assembled and stationed at Fort Monmouth.

Within a short time, the Signal School was producing live educational television presentations, which included lectures and demonstrations.

It is interesting to note that over 15 years ago USASCS was pioneering the use of educational television.

And the Signal School of today is continuing to maintain its pioneer position in the forefront. It is now one of the largest and most active of Army Television Systems in the nation.

The number of hours the U.S. Army Signal School TV System was in operation last year jumped about 150 percent over 1965. The same percentage increase was recorded in the total number of programs produced.

And these percentages will probably go even higher for this year as the Signal Center and School continues to fulfill its role of preparing trainee communicators and helping to alleviate the shortage of trained instructors.

Over 10,000 Signal School students received training through television in 1966. This number will soar to more than 19,000 in 1967.

The Signal School presently uses 21 channels for closed-circuit transmissions. From two professionally-equipped studios, live, taped and filmed lessons are broadcast to almost 500 classrooms and conference rooms, three theatres with large-screen projectors and to 35 receivers in the post hospital. In November, 1966, the system expanded its broadcast time to 24-hours-a-day, five days a week.

Television provides a convenient and effective means of reaching large audiences and makes possible the presentation of the following programs to post-wide viewers: Command Addresses, Staff and Faculty Briefings, Educational Films, Programs on Safety, Character Guidance, Dental Health and Command Information.

And on the theory that a well-informed soldier is a better soldier, we televise current news programs 10 times daily into the classrooms.

All of the School's TV operations are in support of the three academic divisions and the Signal School Brigade. In addition to training newly-assigned enlisted personnel to fulfill our own needs, the station supports other Army Television facilities, by providing TV productions on military subjects.

And what had been the motivation behind this extensive use of a fairly-young medium? It is simply this: Our goal in the USASCS has always been to produce the best trained soldier-communicator in the world. Thanks largely to educational television we are meeting this goal.



FIG. 1. Patterns of Army Educational Television.



FIG. 2. Typical studio scene at the USASCS.

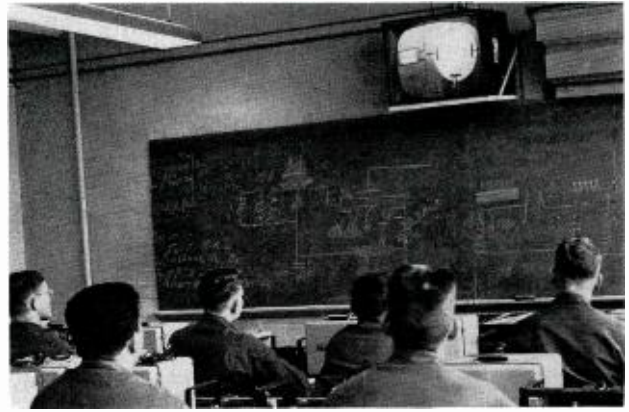

FIG. 3. Typical classroom scene at USASCS.

But no goal is ever reached without its obstacles. And we had ours at the Signal School. The first major hurdle occurred in March, 1966, when the Signal Center and School was faced with a large input of student trainees and a corresponding shortage of qualified teachers.

This crisis was met by the existing teaching staff with the aid of Educational Television. Without any special preparation, the Department of Specialist Training at the Signal School converted platform teaching methods to television presentations.

Although there were initial problems, the instructors adjusted to this new type of presentation rather quickly.

These men were seasoned instructors and some were hardened combat veterans who had faced bayonet attacks. But when they were preparing to step in front of the TV camera, the one-eyed monster, many of them froze and became momentarily ineffective.

But after the initial shock, this increased pressure had a stimulating effect as these same instructors, who, working with TV personnel, began to devise methods of improving their presentations.

The instructors and TV staff were soon creating methods to shorten and concentrate the lesson periods as the student buildup necessitated three shifts of classes and shorter sessions. Math formulas and circuit schematics were prepared on visual aids for instant display, thus saving instructor time before the cameras.

And we did not neglect the educational needs of those who required additional instruction due to unavoidable absences, hospitalization or simple failure to grasp the work. For these special few, a condensed one-hour version of the week's in-

struction was presented as a summary of important points.

This one-hour version features a technique of narration-over-visualization, featuring a Huntley-Brinkley format with graphic dominated instruction to hold student interest.

There are two fears which we must put aside—permanently.

The first is that TV instruction replaces the classroom teacher. The second is that concentrated accelerated instruction through TV becomes stereotyped and mechanical, destroying personalized contributions on the part of the instructor.

The answer to both is a vehement "not at all."

Television supports the work of the instructor. It can never replace him.

Secondly, instructors still show individualism and signs of showmanship. In fact, most of them come across much better on TV than when they are standing in the classroom. And this skill on the part of instructors-turned-showmen was not something that just happened by accident. It was the result of studied planning of the problem of instructor training.

Television proved to be an invaluable instructional aid in providing guidance and advice to instructors. Proper TV instructional techniques, including classes in script writing and the preparation of visual aids, were covered along with approved instructional methods. Video taped classes helped the instructor to refine his teaching ability by seeing himself as his students saw him.

One can see that the many challenges of instructing large numbers of students in complicated subjects were not easy obsta-

cles for the School to overcome. And these hurdles are still being met daily—and conquered. But there is still a constant effort of self-improvement.

The School continues to be one of the world's largest users of educational television. In addition to our new mobile TV van, three have been placed at the Armor School, Fort Knox, Kentucky; the Special Warfare School, Fort Bragg, North Carolina; and the Aviation School, Fort Rucker, Alabama.

We know that future developments will be at least as spectacular as they have been in the past. Equipment evolution will probably lean toward more personalized, compact methods of replaying recorded course material which students may study at will.

Signal School personnel in educational television are beginning to think seriously about the application of color television and its relationship to courses of instruction.

As we consider the use of color in educational TV, it is not surprising to discover that certain types of military instruction lend themselves to color, such as electronics circuitry with its color coding, map reading, training in camouflage techniques, and many other fields.

Earlier questions about television's effectiveness have given way to full confidence in the use of the medium. Television is an integral part of the future of Signal School training and more commands will utilize it as facilities are acquired.

The medium can be effectively used to support training or as the primary method. But whatever its use, the previous years has proved conclusively that educational television has grown until it is now accepted as a full partner in the training of personnel.

# NEW UHF-TV PYLON ANTENNAS

## Eight New Models Enhance An Ever-Growing Family of UHF-TV Pylon Antennas

by A. J. GALINUS

*UHF-Antenna Product Analyst*

The RCA Pylon has become one of the most popular of UHF-TV antennas. Since it was first introduced in 1952, approximately 200 UHF Pylons have been shipped. One reason for this acceptance, aside from the inherent electrical and mechanical superiority of the antenna, has been the ever-expanding breadth of the Pylon product line. Literally, there is a Pylon for every application. It has been said that UHF Pylon customers—with their varied requirements—stimulated the design of many models of the extensive line which,

with these new additions, now includes 21 types.

### **New Medium-Power Pylons**

Three of the eight new Pylons, designated TFU-36J, TFU-42J and TFU-45J, provide power gains of 36, 42 and 45 at zero-degree beam tilt. These antennas, which are an extension of the very successful TFU-30J null-filled vertical pattern design, now permit a wider selection of antenna-transmitter combinations for a given ERP. Of these three antennas, the TFU-36J is also avail-

able as a high power TFU-36JDAS directional, the characteristics of which will be described later.

The TFU-36J is a medium gain, medium power omnidirectional Pylon that can be supplied for Channels 14 through 70, and for higher channels if required. The power gain for a zero-degree beam tilt is 36. Gains for other values of beam tilt are shown in Table 1, and the power handling capability is indicated by Curve C in Fig. 5. The null filled vertical pattern for a beam tilt of 0.75 degrees is shown in Fig. 6.

FIG. 1. The TFU-45J is a high gain, medium power Pylon that can provide an ERP of one megawatt with a 30 kW transmitter.

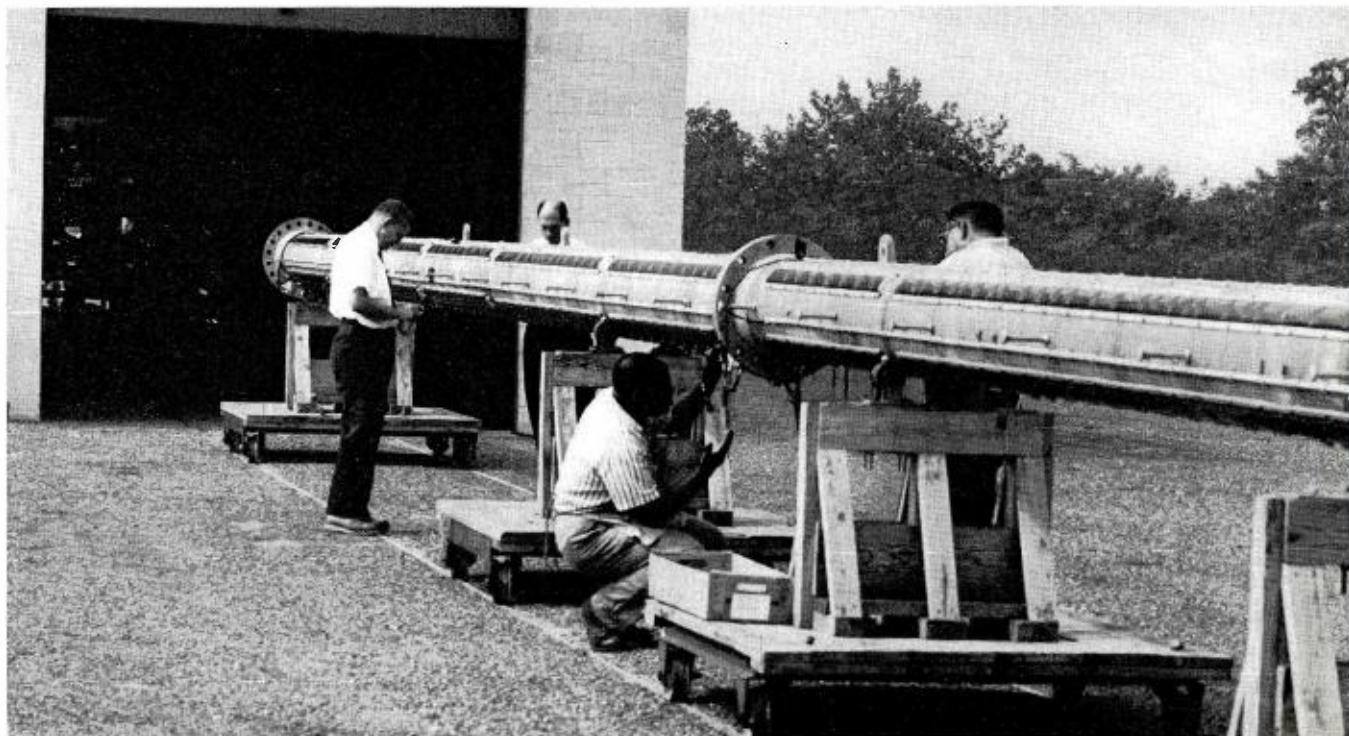

The TFU-42J is another medium gain, medium power omnidirectional Pylon for Channels 14 through 70. Power gain for a zero-degree beam tilt is 42, decreasing as additional beam tilt is incorporated. The power capability of the antenna is illustrated by Curve C in Fig. 5. The null filled vertical pattern for an 0.75 degree beam tilt is illustrated in Fig. 7.

The TFU-45J is a third medium gain, medium power omnidirectional Pylon for Channels 14 through 70. The TFU-45J, when used with a 30 kW transmitter, is

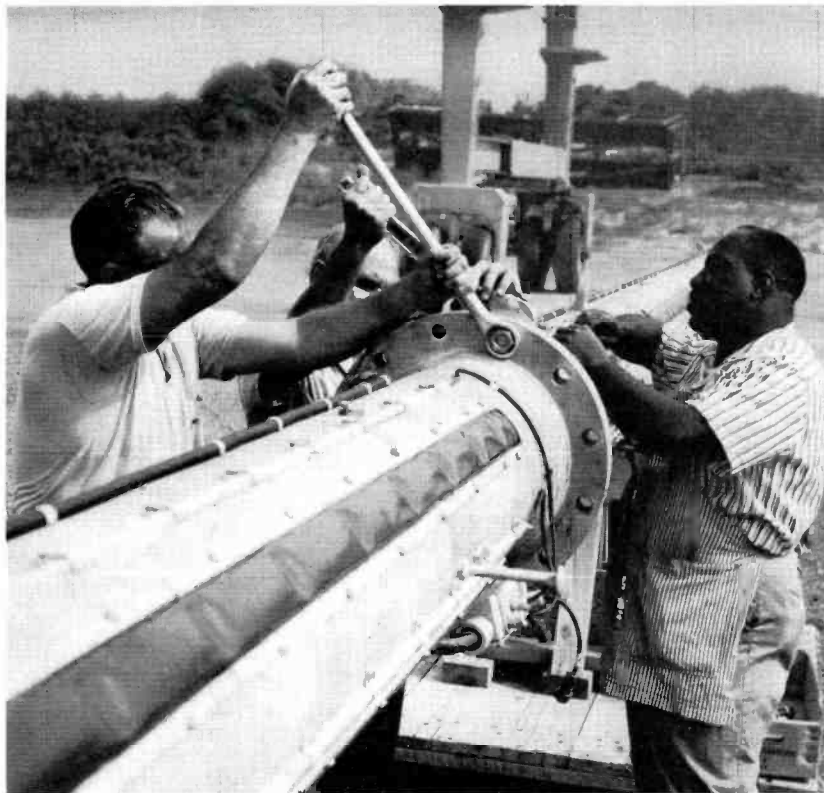

FIG. 2. New TFU-45J Pylon being made ready for shipment at RCA Antenna Engineering Center, near Camden, N. J.

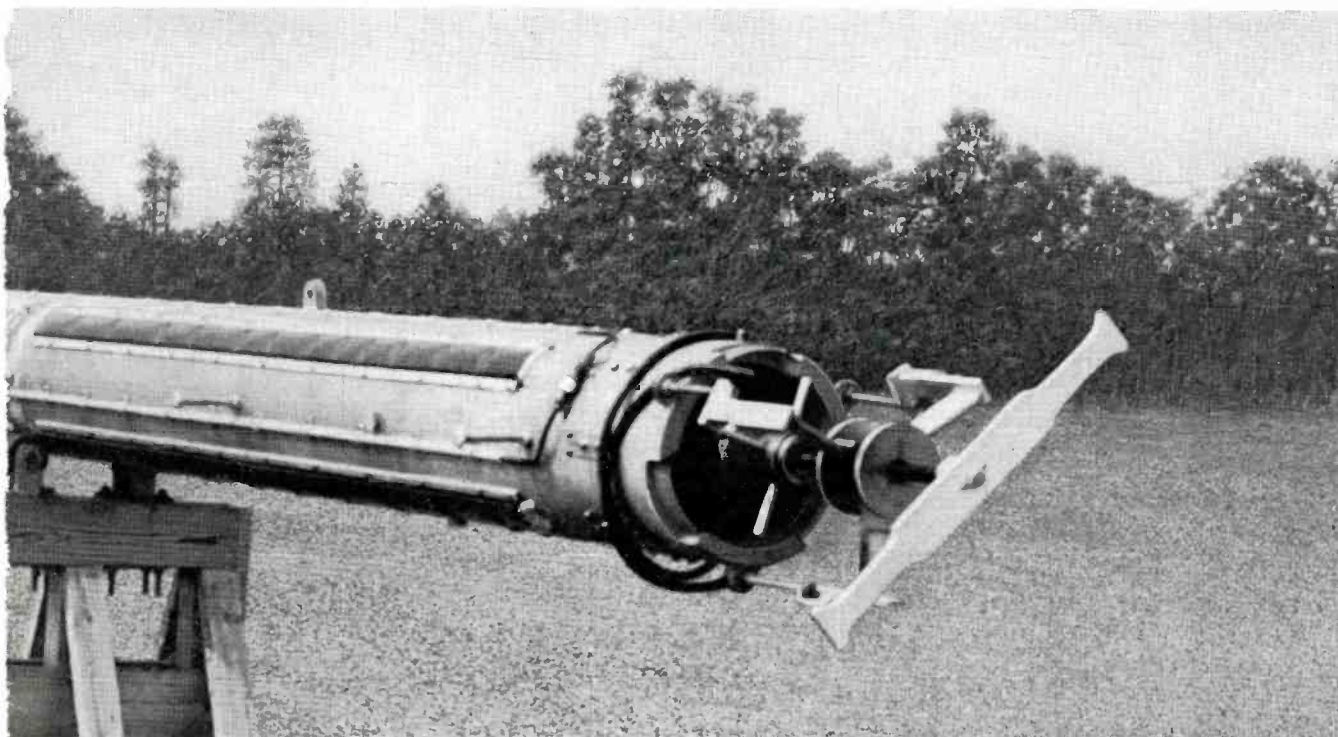



FIG. 3. "30J" Pylons of stations WKBD-TV and WTVS, Detroit.

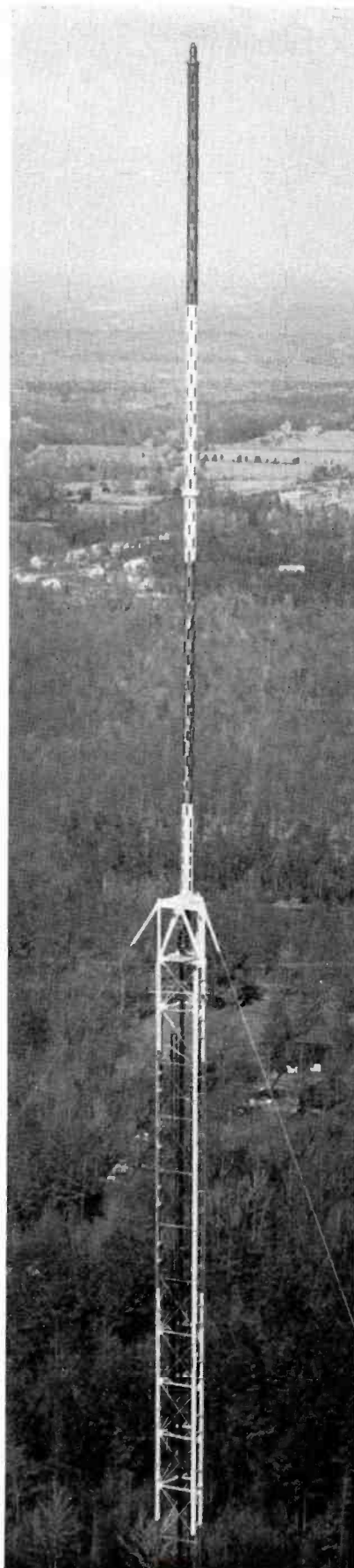

FIG. 4. (Right) WCVE-TV, Richmond Va., uses Type TFU-46K Pylon.

capable of providing an ERP of a megawatt or more, depending upon line length and efficiency. Power gain for a zero-degree beam tilt is 45, but decreasing with beam tilt. The power rating is shown by Curve C in Fig. 5, and the null filled vertical pattern is shown by Fig. 8.

#### Four New Directional Pylons

Based on the inherent null filled pattern advantages of the TFU-30JDA antenna introduced in 1966, come four new directional antennas in two types: TFU-30JDAS and TFU-36JDAS. Each of the two types is available in high power and medium power versions, and all are capable of producing "peanut," "skull" or "tri-lobe" radiation. Typical patterns are shown in Figs. 10, 11, and 12. These are moderately priced antennas utilizing "T-Feed" with  $9\frac{3}{16}$ -inch input for the high power models (Channels 14 through 30) and T-Feed  $6\frac{1}{8}$ -inch input for the medium power models (Channels 14 through 70). Power ratings for the higher power models are shown by Curve A in Fig. 5, and for the medium power models by Curve C in Fig. 5.

#### New Shaped-Pattern Pylon

A new medium gain, medium power TFU-25GA Pylon is now available for those urban installations requiring the characteristic "shaped pattern" of the TFU-25G, but with lower input power capability for added economy. The new Pylon is an omnidirectional antenna for Channels 14 through 70. Power gain, which for this antenna does not decrease with beam tilt, is 25, and the power rating is given by Curve C in Fig. 5. The shaped pattern and vertical radiation characteristics can be seen in Fig. 9.

#### The UHF Pylon Family

General specifications for the RCA family of UHF Pylon antennas are shown in Table 2. Types range from the 6-gain, 18 kilowatt TFU-6D, to antennas with gains as high as 46 and power ratings up to 158 kW. At least one of the many types is ideally suited to a particular coverage or terrain problem. Choices can be made from a variety of omnidirectional or directional patterns with either null filled or shaped vertical patterns.

#### Pylon Simplicity

The Pylon is the simplest of all UHF-TV antennas, which accounts for the many unique electrical and mechanical design advantages it offers as well as an outstanding record of reliability.

The antenna consists of a slotted, steel cylinder with a concentric copper coaxial feed line. Energy is coupled from the field



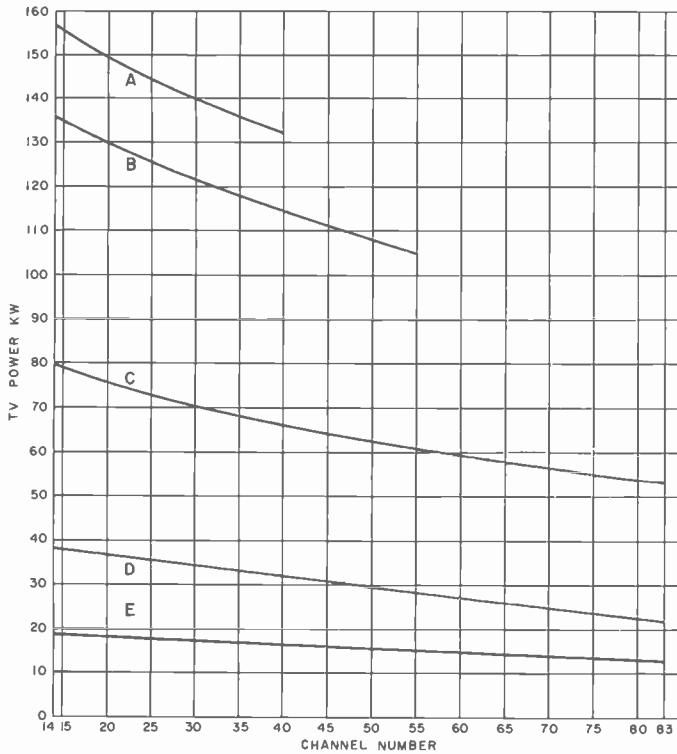

FIG. 5.

FIG. 5. Peak TV power rating curves for Pylon antennas, based on 0.6 black level visual power and 0.2 aural power.

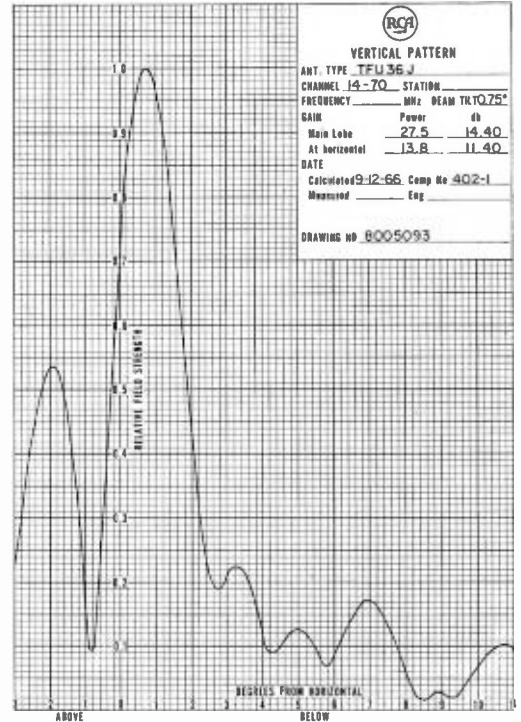

FIG. 6.

FIG. 6. Null filled vertical radiation pattern of TFU-36J Pylon for 0.75-degree beam tilt.

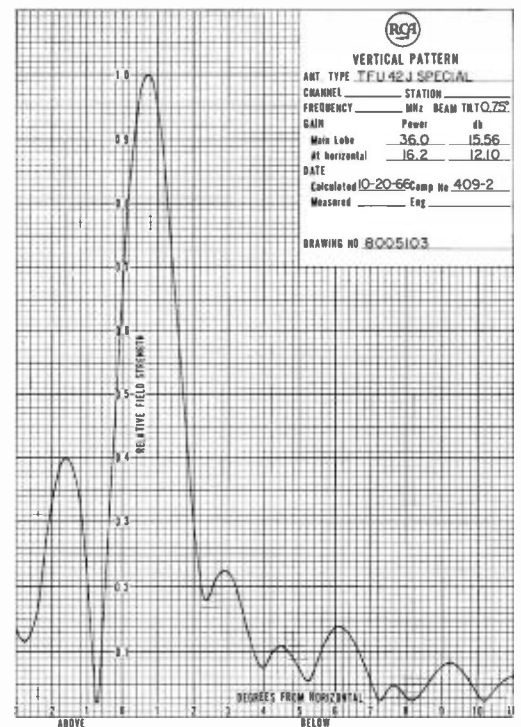

FIG. 7.

FIG. 7. Null filled vertical radiation pattern of TFU-42J Pylon for 0.75-degree beam tilt.

TABLE 1. POWER GAINS OF TFU-36J

Beam Tilt	Power Gain	
	Major Lobe	Horizontal
0.0°	36.0	36.0
0.25°	34.7	32.5
0.5°	31.6	24.0
0.75°	27.5	13.8
1.0°	24.5	5.7

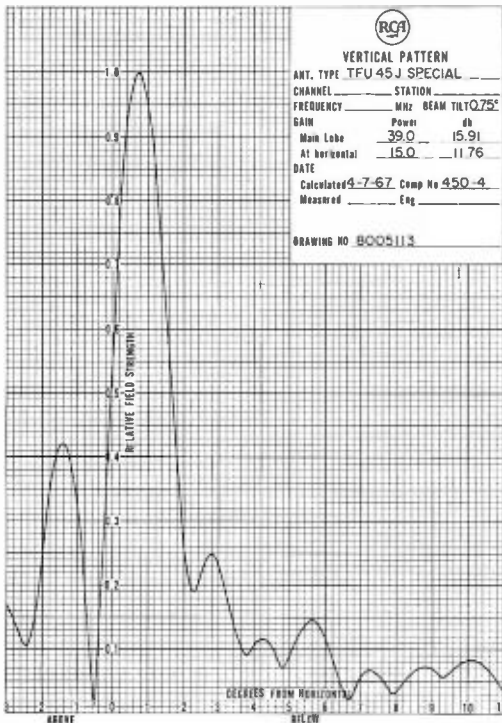

FIG. 8. Null filled vertical radiation pattern of TFU-45J Pylon for 0.75-degree beam tilt.

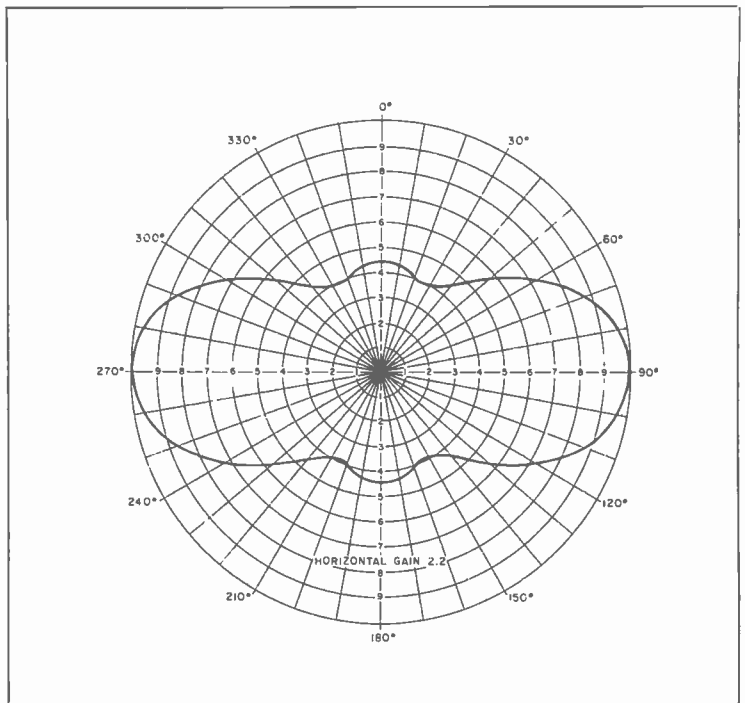

FIG. 10. Typical horizontal "peanut" pattern of UHF-TV Pylon.

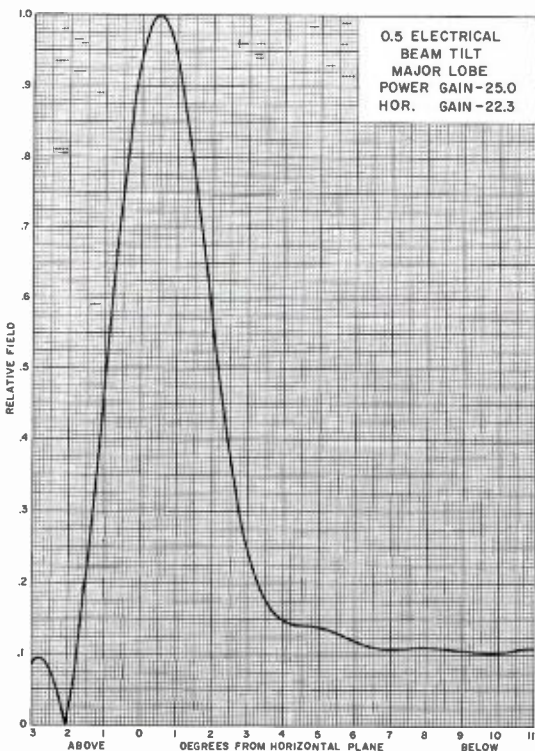

FIG. 9. Shaped vertical radiation pattern of TFU-25GA Pylon.

inside the antenna to the radiating slots by means of an aluminum bar coupler. The horizontal pattern is independently controlled by the number of slots and their disposition around the circumference of the Pylon; while the power rating is determined mainly by the size of the inner conductor. The heavy duty outer cylinder serves the dual function of radiator and supporting structure, eliminating the field distortion often caused by a separate support, and thus improving the circularity of the radiated pattern.

#### Minimum Tower Loading

Since the entire electrical system of the Pylon antenna is enclosed within the outer cylinder, there are no exposed radiators or transmission line elements. This reduces the wind load requirement of the tower to a minimum, and appreciably retards the formation of ice on the antenna.

#### Designed for Self Protection

The steel outer cylinder with its high conductivity and "earth" ground to the tower, offers the enclosed electrical system great protection from lightning damage. It also provides a sturdy shield for the protection of the antenna elements from the

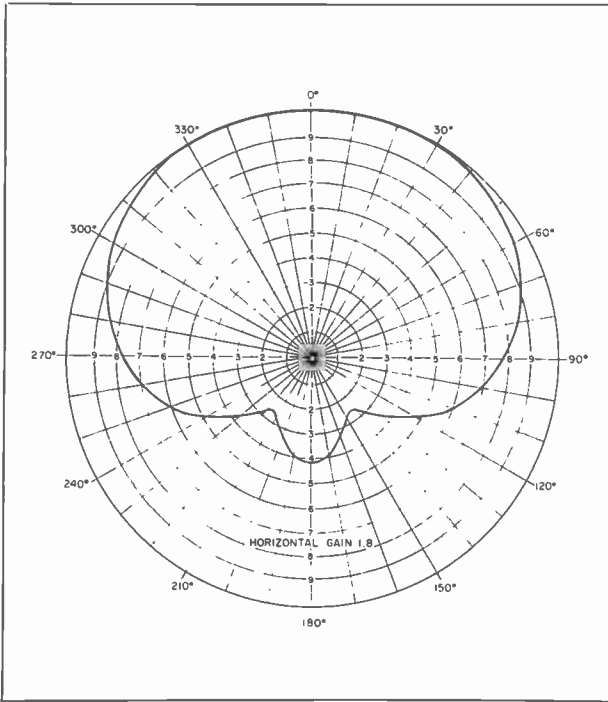

FIG. 11. Typical horizontal "skull" pattern of UHF-TV Pylon.

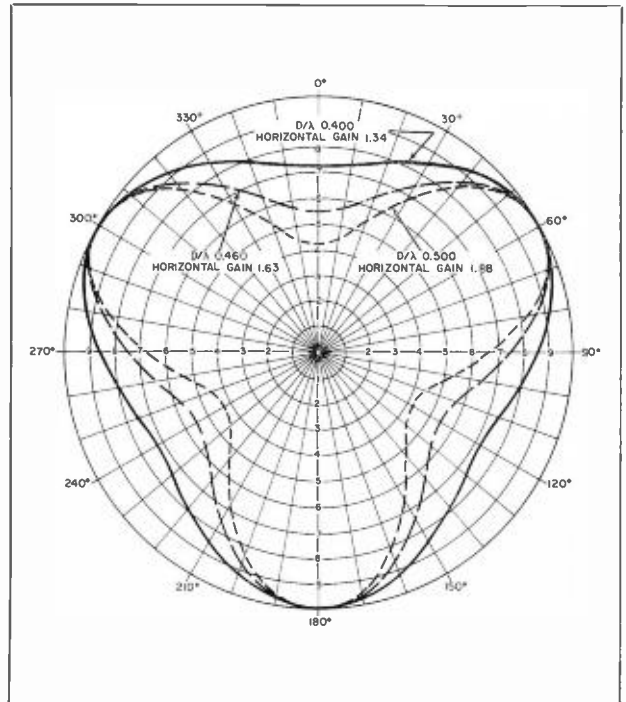

FIG. 12. Typical horizontal "tri-lobe" pattern of UHF-TV Pylon.

TABLE 2. UHF PYLON TYPES AND CHARACTERISTICS

Type Number	Channel Range	Gain		TV Power Rating kW <sup>1</sup>	Input Terminal MI. No.	Deicer Requirements			Vertical Pattern Type	Horizontal Pattern Type
		Power	dB			AC Supply, Volts				
						kW per ft. of height	Standard	Special <sup>10</sup>		
TFU-6D	14-57	6	7.78	E	19089 <sup>5</sup>	—	Radome	—	Broad beam	Omni.
TFU-6J	14-83	6	7.78	D	19089 <sup>5</sup>	.30	230-1ϕ	230-3ϕ	Broad beam	Omni.
TFU-24DL	14-30	24 <sup>2</sup>	13.80	E	19089 <sup>5</sup>	.45	460-3ϕ	230-3ϕ	Filled	Omni.
TFU-24DM	31-50	24 <sup>2</sup>	13.80	E	19089 <sup>5</sup>	.30	460-3ϕ	230-3ϕ	Filled	Omni.
TFU-27DJ	31-70 <sup>1</sup>	27 <sup>2</sup>	14.31	D	19089 <sup>5</sup>	.60	460-3ϕ	230-3ϕ	Filled	Omni.
TFU-30J	14-70 <sup>1</sup>	30 <sup>2</sup>	14.77	C	27792 <sup>6</sup>	.60	460-3ϕ	230-3ϕ	Filled	Omni.
TFU-36J	14-70	36 <sup>2</sup>	15.56	C	27792 <sup>6</sup>	.60	460-3ϕ	230-3ϕ	Filled	Omni.
TFU-42J	14-70	42 <sup>2</sup>	16.23	C	27792 <sup>6</sup>	.60	460-3ϕ	See Note 9	Filled	Omni.
TFU-45J	14-70	45 <sup>2</sup>	16.53	C	27792 <sup>6</sup>	.60	460-3ϕ	See Note 9	Filled	Omni.
TFU-25G	14-55	25	13.98	B	27792 <sup>6</sup>	.60	460-3ϕ	230-3ϕ	Shaped	Omni.
TFU-25G	56-70 <sup>1</sup>	25	13.98	C	27792 <sup>6</sup>	.60	460-3ϕ	230-3ϕ	Shaped	Omni.
TFU-25GA	14-70	25	13.98	C	27792 <sup>6</sup>	.60	460-3ϕ	230-3ϕ	Shaped	Omni.
TFU-46K	14-40	46	16.63	A	27793 <sup>7</sup>	.60	460-3ϕ	See Note 9	Shaped	Omni.
TFU-46K	41-55	46	16.63	B	27792 <sup>6</sup>	.60	460-3ϕ	See Note 9	Shaped	Omni.
TFU-46K	56-70 <sup>1</sup>	46	16.63	C	27792 <sup>6</sup>	.60	460-3ϕ	See Note 9	Shaped	Omni.
TFU-30JDA	14-30	30 <sup>2</sup>	14.77	D	27792 <sup>6</sup>	.45	460-3ϕ	230-3ϕ	Filled	Dir.
TFU-30JDA	31-50	30 <sup>2</sup>	14.77	E	19089 <sup>5</sup>	.30	460-3ϕ	230-3ϕ	Filled	Dir.
TFU-30JDAS	14-30	30 <sup>2</sup>	14.77	A	27793 <sup>7</sup>	.60	460-3ϕ	230-3ϕ	Filled	Dir.
TFU-30JDAS	14-70	30 <sup>2</sup>	14.77	C	27792 <sup>6</sup>	.60 <sup>1</sup>	460-3ϕ	230-3ϕ	Filled	Dir.
TFU-36JDAS	14-30	36 <sup>2</sup>	15.56	A	27793 <sup>7</sup>	.60	460-3ϕ	230-3ϕ	Filled	Dir.
TFU-36JDAS	14-70	36 <sup>2</sup>	15.56	C	27792 <sup>6</sup>	.60 <sup>1</sup>	460-3ϕ	230-3ϕ	Filled	Dir.
TFU-24DAS	14-30	24	13.80	A	27793 <sup>7</sup>	.60	460-3ϕ	230-3ϕ	Shaped	Dir.
TFU-24DAS	14-70 <sup>1</sup>	24	13.80	C	27792 <sup>6</sup>	.60 <sup>1</sup>	460-3ϕ	230-3ϕ	Shaped	Dir.

- The upper channel shown is 70 since Channels 70-83 have been tentatively indicated as community channels with a maximum ERP of 10 kW. Any of the antennas marked 1 can be supplied for Channels 71-83 upon application.
- Gain stated is for 0° beam tilt. To determine gains for other tilts, vertical patterns should be consulted. (For Types 36J, 42J and 45J see Figs. 6, 7 and 8 of this article.)
- See appropriate "Peak TV Power Rating Curve" listed by channel (Fig. 5).
- 600 W/ft. for Channels 14-30; 450 W/ft. for Channels 31-50; 300 W/ft. for Channels 51-70.
- MI-19089 is 3/8" EIA flanged 50 Ohm line.
- MI-27792 is RCA Universal 6/8", 75 Ohm line—MI-19387 6/8" EIA flanged, 75 Ohm input may be specified.
- For Channels 14-40, MI-27793 9/8" Universal, flanged, 75 Ohm line may be specified.
- 9/8" Universal, flanged, 75 Ohm line.
- Not available.
- Supplied at extra cost.

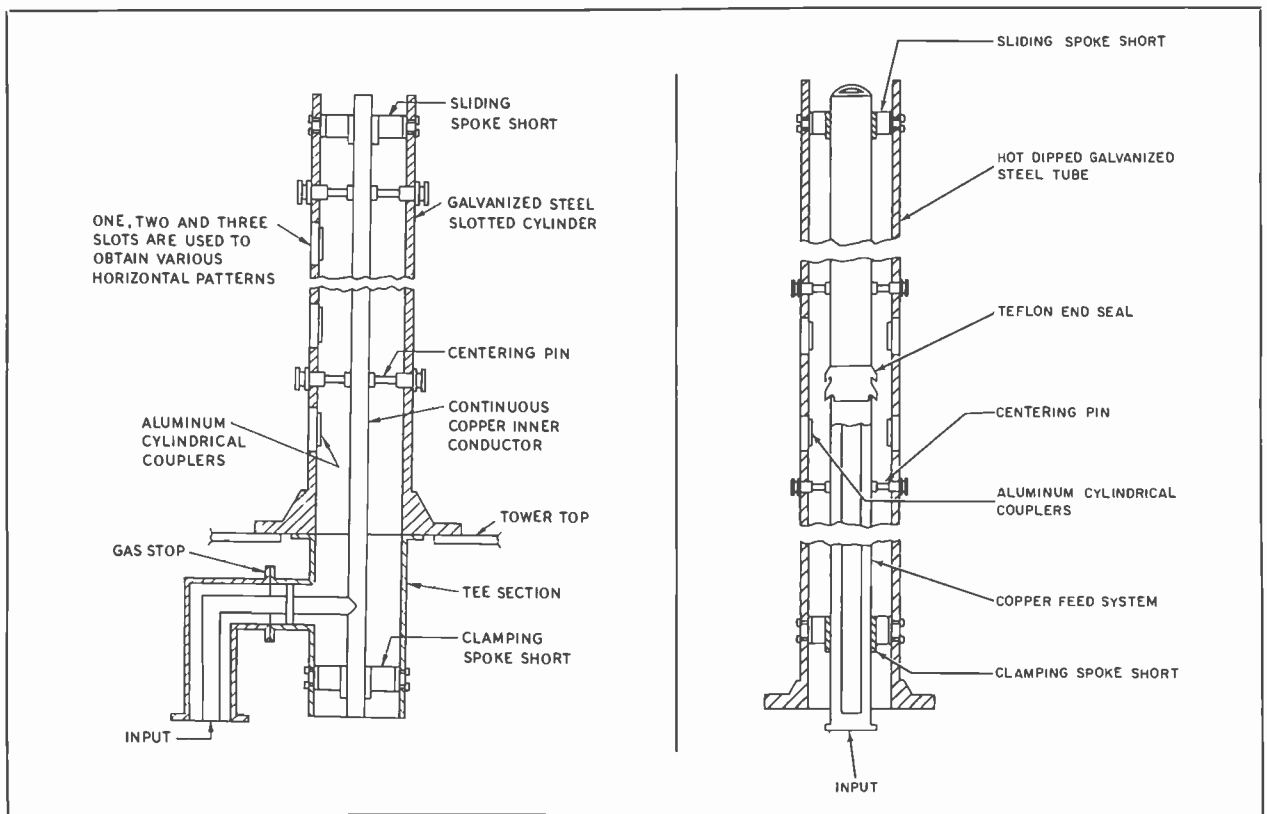

FIG. 13. Schematic diagrams showing end-fed Pylon, left, and center-fed Pylon, right. End-fed or "T-feed" is used to achieve high input power capabilities for directional antennas.

weather or from possible climbing damage. Heavy duty galvanize on all steel parts, stainless steel hardware and cast aluminum fittings contribute further to the anti-corrosion qualities of the Pylon. Usually, the only maintenance required is occasional painting to comply with FAA requirements.

#### Vertical Patterns

The vertical radiation pattern which, for Pylons is substantially the same in all horizontal directions, is a plot of the relative field-strength vs. vertical angle transmitted in a given vertical plane. Such a pattern shows how the radiated energy is distributed, and therefore, choice of proper pattern is an important factor in good coverage. Except for the TFU-6D and TFU-6J types, a measured, vertical midband pattern of the plane which most closely represents the average of all the measured planes is furnished by RCA with the Pylon antenna.

As seen in Table 2, there are various types of vertical patterns available, such as null "filled," "shaped" and "broad beam" patterns. A null filled pattern is one in

which the locations of the nulls are still discernible, but positive means—such as varying the amplitude of the radiated signal—have been used to fill the nulls.

In those types with shaped patterns, both the amplitude and the phase of the energy radiated from each layer is varied to produce a smooth pattern below the horizontal. Above the horizontal the energy is partially canceled.

#### Beam Tilt

Beam tilt, which is the angle of the maximum lobe in the vertical pattern below the horizontal, can be obtained both electrically and mechanically. Electrical beam tilt is built into each antenna. Mechanical beam tilting may be achieved by using stainless-steel shims which are supplied with the antenna. Some beam tilting is usually desirable to improve local coverage while only slightly reducing the signal at the horizon. Beam tilt may often be employed advantageously to improve signal level in a particular direction when the antenna is located on a plateau or mountain range overlooking a valley. With the proper combination of

electrical and mechanical tilting, the main beam of the antenna can be directed downward toward the service area, while a horizontal beam is directed backwards across the plateau.

#### Choosing the Right Pylon

A thorough study is advisable in planning any UHF antenna installation and this can be accomplished by the broadcast engineering consultant. However, the following paragraphs give some general considerations that should be observed in regard to antenna gain, height, and directivity.

#### High Gain Antenna

Most UHF antennas have high gains of the order of 46, or medium gains around 25. The higher gain results from narrowing the main beam. For a given transmitter input, the high gain antenna may sacrifice local coverage for more distant coverage. Hence if a higher gain antenna is contemplated, local field strengths should be calculated. It is generally advisable to maintain a 100 dBu level over the local coverage area, particularly if dense with multi-story structures. In hilly terrain it

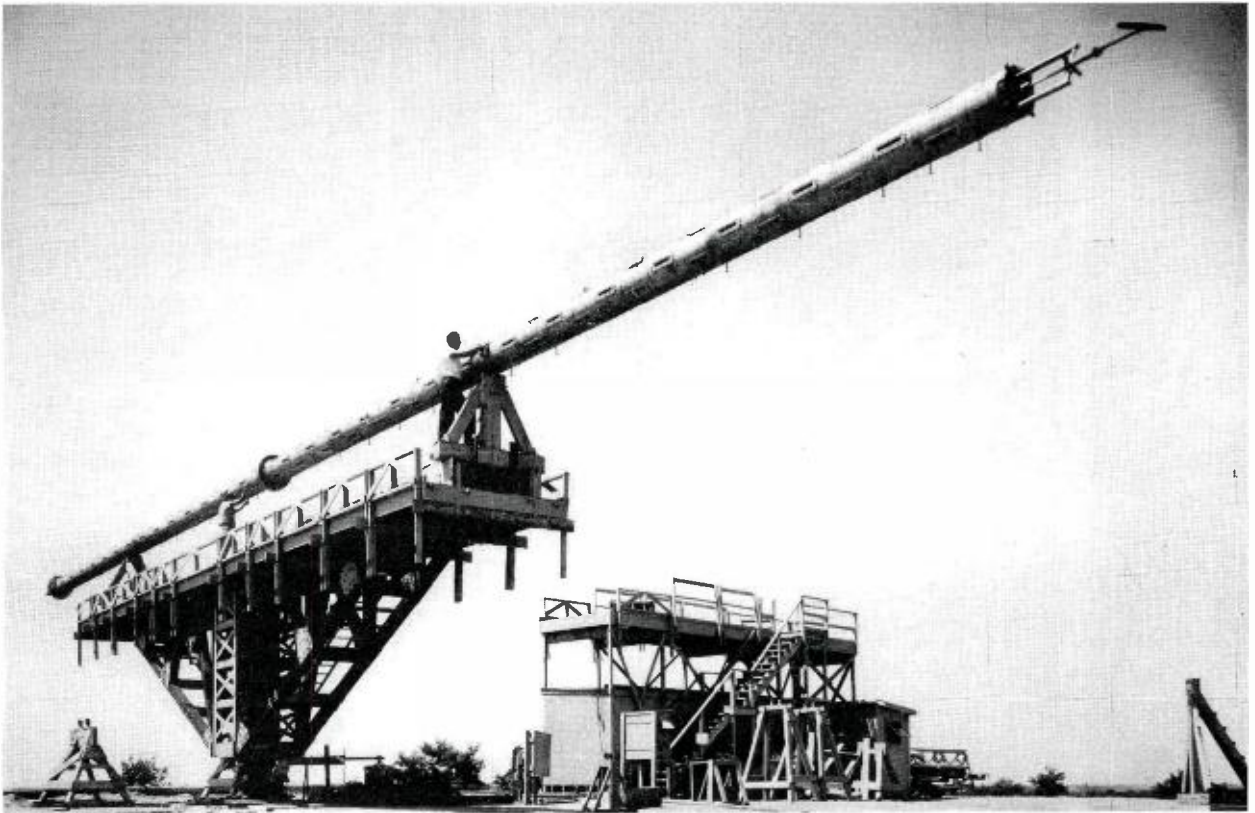

FIG. 14. Pylon antenna being pattern tested on turntable at the RCA Antenna Engineering Center.

may be desirable to increase this figure by 10 dB or more. If fields of this order cannot be achieved with a high gain antenna, the transmitter power should be increased to achieve it or a lower gain antenna used.

#### Antenna Height

An increase in height over terrain has the same general effect as increasing the gain of an antenna. For distant areas within line of sight covered by the main beam of the antenna the field strength in millivolts per meter for a given ERP increases approximately as the height over smooth terrain. However, the nearby areas generally receive less field strength since the vertical angle looking up towards the antenna is steeper to a point where the vertical pattern usually radiates less energy. Hence, an increase in height should be studied in the same manner as an increase in gain.

#### Directional Antennas

With a given ERP, the maximum area is covered from the center of the area to be served. If the antenna is located on the perimeter instead of in the center of the

same area using a directional antenna, the area covered drops to approximately one-half or less. This results from the fact that the service radius varies approximately as the fourth root of the ERP. If a natural low cost height is available at the perimeter which is approximately three times as high as that which would be used in the valley, the full area can be recovered. The economics of each situation should be studied. Because of the fourth root relationship between the service radius and the ERP, a voltage plot of a directional antenna can be misleading. The area to be covered should be calculated using propagation formulas to obtain a true evaluation. Often the benefits may be found marginal and possibly detrimental.

#### Antenna Engineering Center

These most recent Pylon designs were developed and pattern tested at the RCA Antenna Engineering Center near Camden, N. J. A new turntable recently installed at the center brings to three the number of sophisticated antenna supports now used for dynamic tests of all types and sizes of television antennas.

The Antenna Engineering Center is the birthplace of computerized designs. The vast calculations and extreme accuracy required for today's high power and high gain antennas would be prohibitive, were it not for advanced, high-speed computers that are producing superior designs at reasonable cost.

#### Conclusion

Addition of these new types of directional and omnidirectional antennas to the family of UHF Pylons enhances the selection, availability and performance of TV antennas for just about every new or modified UHF installation, regardless of power, terrain or location in the coverage area.

To date, the TFU-36J, -42J, and -45J type antennas have been shipped and reports indicate they are operating successfully. Although formal distribution of complete filing information on all these types of antennas has not been made, this information can be supplied on a per-channel basis through any RCA Broadcast Representative or by direct contact with the RCA Television Equipment Department in Camden, N. J.



# RCA color TV training center

## Another service for RCA customers

To help customers get the very best television pictures, RCA maintains this permanent training center for station engineers. Here users of RCA color studio equipment receive a program of instruction in operation and maintenance. This service is available to all customers, at no charge, to assist in getting the *full capability* of live color cameras, color film equipment, and TV tape recorders.

Instruction is given in seminars devoted to the various equipments. Each course runs from two to five days, depending on

the complexity of the system. Regular classes are devoted to the TK-42 and TK-43 color cameras, the TK-27 color film camera, the TR-70 and TR-3-4 television tape recorders. Groups are small so that each engineer receives as much individual attention as possible. They learn how to obtain peak performance from this sophisticated equipment and how to save money in its operation.

Courses begin with a description of the equipment, circuitry, and nomenclature. This is followed by a detailed study of operation, with practical exercises in line-up, maintenance and trouble-shooting. Courses are conducted by RCA engi-



## for station engineers

neers with experience in both practical and theoretical aspects. These seminars give visiting engineers the reasoning behind the complex new designs, their capabilities, and show how broadcasters can best achieve operating efficiency and finest pictures.

The technical and artistic demands of color television have resulted in broadcast equipment far more complicated than a few years ago. This new training center expresses in part RCA's responsibility to help broadcasters produce TV pictures that reflect optimum performance of their equipment. The Center occupies approximately 7000 square feet in RCA's

main office building in Camden, and includes a color TV studio for "live" camera demonstrations, a color TV film area, a color TV tape area, and a master control center.

For further information about this RCA TV Training Center, call your RCA Broadcast Representative. Or write RCA Broadcast and TV Equipment, Building 15-5, Camden, N.J.



The Most Trusted Name In Electronics

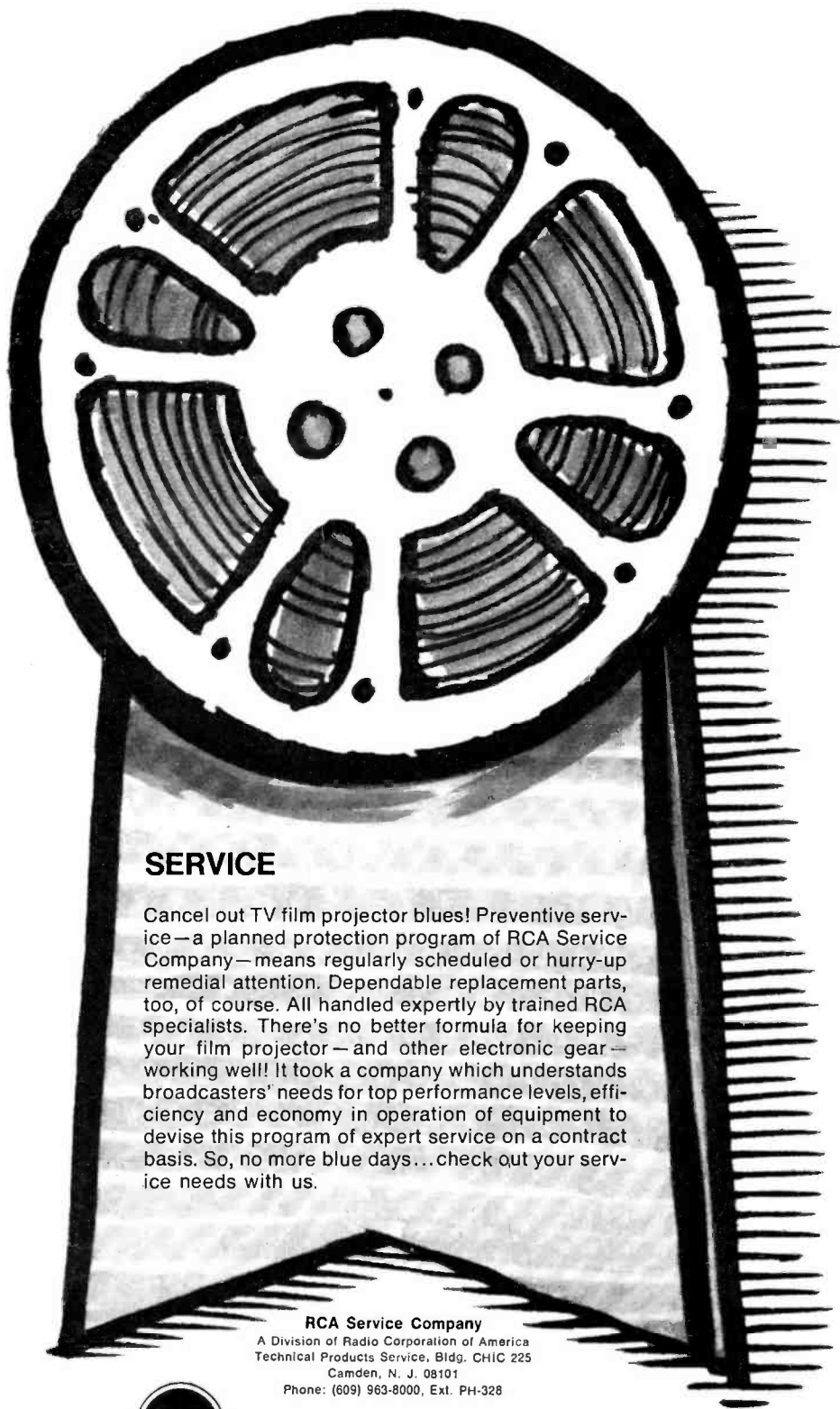

## SERVICE

Cancel out TV film projector blues! Preventive service—a planned protection program of RCA Service Company—means regularly scheduled or hurry-up remedial attention. Dependable replacement parts, too, of course. All handled expertly by trained RCA specialists. There's no better formula for keeping your film projector—and other electronic gear—working well! It took a company which understands broadcasters' needs for top performance levels, efficiency and economy in operation of equipment to devise this program of expert service on a contract basis. So, no more blue days...check out your service needs with us.

### RCA Service Company

A Division of Radio Corporation of America  
Technical Products Service, Bldg. CHIC 225  
Camden, N. J. 08101  
Phone: (609) 963-8000, Ext. PH-328



The Most Trusted Name in Electronics



# HOW THE "BIG TUBE" ENHANCES COLOR FILM PICTURES

The 50 per cent larger tube in the luminance channel of the TK-27 camera improves signal-to-noise ratio, increases resolution. It eliminates more of the disturbing grainy elements. Thus the picture is more pleasing and has more "snap" and sparkle.



The Most Trusted Name  
in Electronics

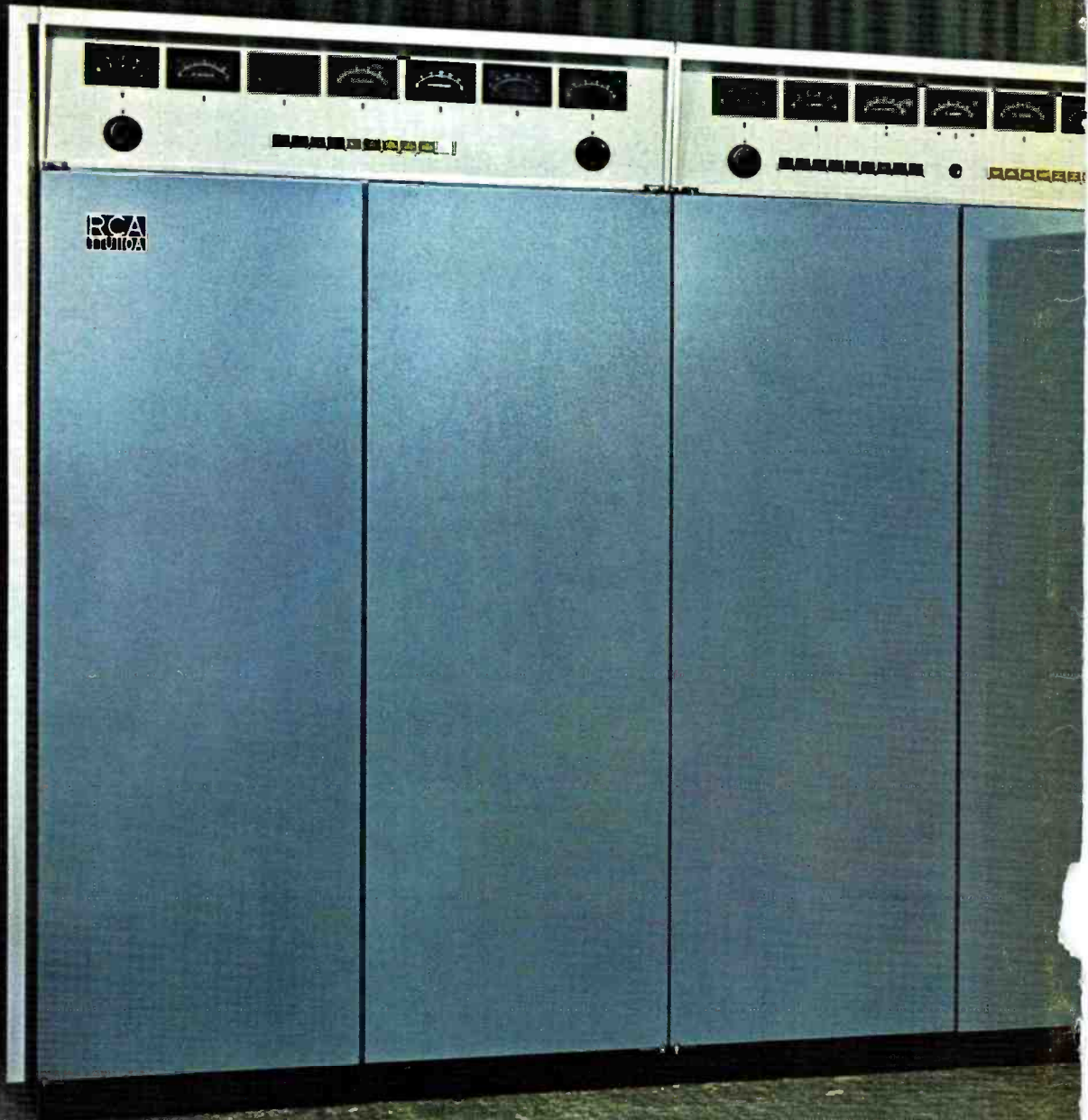

RCA  
RADIO