

BROADCAST NEWS

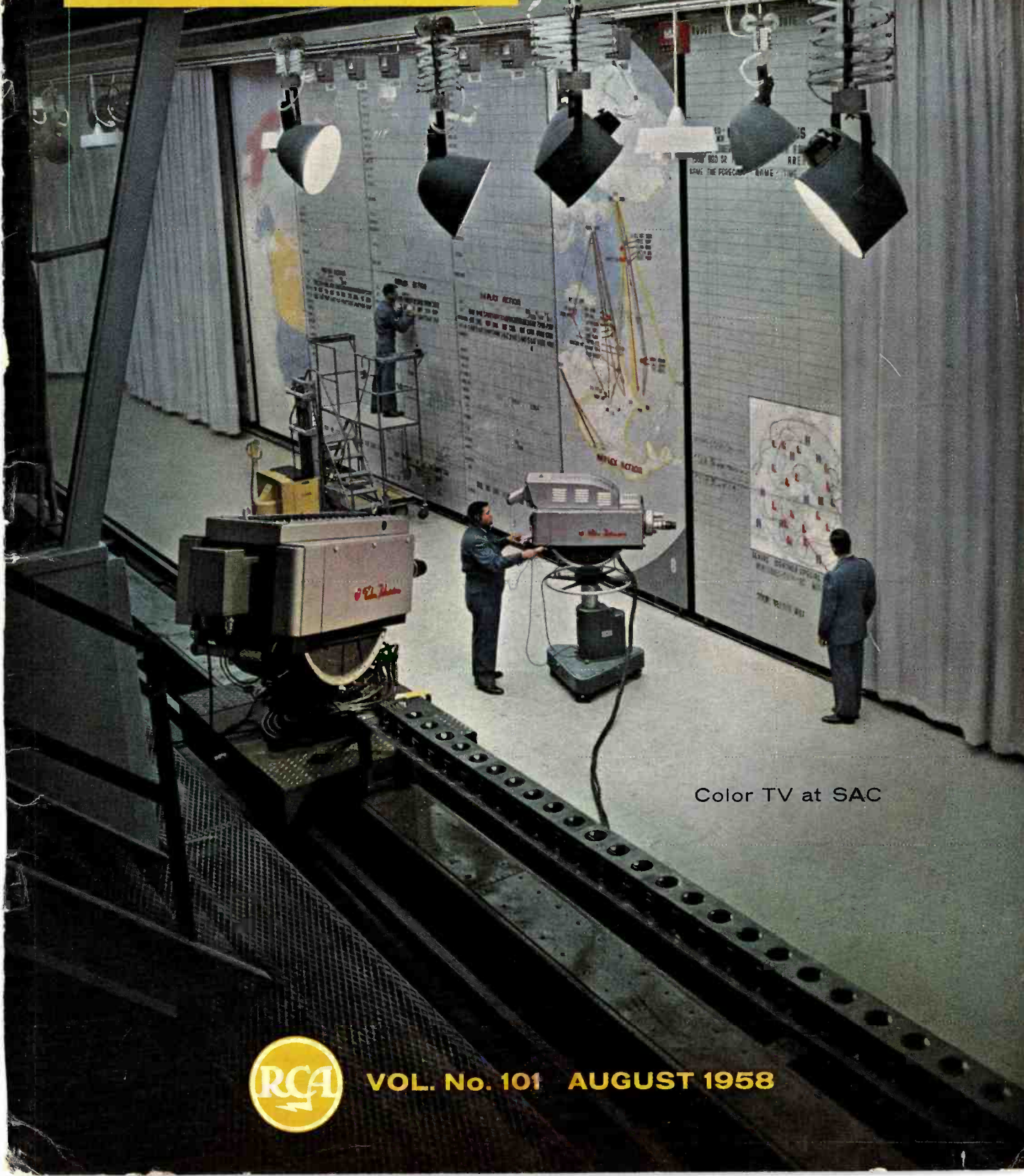

Color TV at SAC



VOL. No. 101 AUGUST 1958

Transistorized



Portable Remote Amplifier

COMPACT!



LIGHTWEIGHT!

CONVENIENT!

Take the BN-6A with you to the ball park, the boxing bouts, and enjoy new convenience and performance! Also ideal for use in department store promotions, parades and other remotes. Designed and functionally styled especially for remote radio and television use, this amplifier is fully transistorized and the lightest equipment of its type, weighing only 15 pounds. Completely self-contained for either battery or AC power operation, it assures amplification and control facilities needed for high quality transmission to studio via telephone lines.

The BN-6A provides four separate input channels that can be operated either single ended or balanced. It is capable of greater output level with less distortion. This provides for normal level with ample reserve. Cueing and monitoring facilities are included, and plug-in transformers are used for balanced operation. Comes complete with portable carrying case, equipped with carrying handle adjustable for stacking.

Ask your Broadcast Representative for complete information about this advanced Amplifier. In Canada: write RCA VICTOR Company Limited, Montreal

These wanted Features!

- All controls located on front panel, including illuminated VU meter, mixer controls, master control, phone jack, cue switch and power switch.
- Long-life Mercury batteries.
- Alternate germanium rectifier power supply.
- High-level mixing—four separate channels.
- New RCA Type 2N175 low-noise transistors which serve as input amplifiers.
- Amplified cue signal from studio.
- Functionally styled package.



Trnk(s) ®

RADIO CORPORATION of AMERICA

BROADCAST AND TELEVISION EQUIPMENT • CAMDEN, N. J.

Vol. No. 101

August, 1958

BROADCAST NEWS

published by

RADIO CORPORATION OF AMERICA
BROADCAST & TELEVISION EQUIPMENT DEPARTMENT
CAMDEN, NEW JERSEY

In U.S.A. - - - \$4.00 for 12 issues

PRICE

In Canada - - - \$5.00 for 12 issues

CONTENTS

	Page
RCA VIDEO TAPE RECORDERS IN OPERATION AT NBC TAPE CENTRAL, BURBANK, CALIFORNIA	8
STRATEGIC AIR COMMAND USES RCA COLOR TELEVISION TO EXPEDITE VITAL BRIEFINGS	12
WINS PROVES RELIABILITY AND ECONOMY OF 50-KW AMPLIPHASE AM TRANSMITTER	24
THE RCA MAGNETIC DISC RECORDER	30
DESIGN METHODS TO IMPROVE THE STABILITY OF AM DIRECTIONAL ANTENNA SYSTEMS	36
A GOOD WORD ABOUT THE RCA 5-KW AM TRANSMITTER, TYPE BTA-5H	41
NEW BROADBAND FM ANTENNAS	42
HOW TO GET BEST PERFORMANCE OUT OF THE TK-41 COLOR CAMERA	44
THE APPLICATION OF VERY PRECISE FREQUENCY CONTROL TO MINIMIZE TELEVISION COCHANNEL INTERFERENCE—PART II	56
AUTOMATIC CUING OF TP-6 SERIES FILM PROJECTORS	58
MOUNTING THE RCA ORBITER GENERATOR ON THE TK-31 FIELD CAMERA	62
HOW TO GET GOOD PICTURE QUALITY FROM THE TK-15 VIDICON STUDIO CAMERA	64
KETV PLANS FOR THE FUTURE WHILE PROGRAMMING TO TODAY'S TASTES	74

Copyright 1958, Radio Corporation of America, Broadcast & Television Equipment Department, Camden, N. J.

PRINTED
IN
U.S.A.



"FILM CENTRAL" for network operations. From this control room all the ABC film shows are fed to affiliates.

How ABC-TV gets top picture quality for all its network film shows

—Converts 100% to RCA Vidicon Film Camera Chains!

"For the top quality we require in our network film shows we chose RCA Vidicon film equipment," says Frank Marx, Vice-President, Engineering. They were so satisfied with their quality network film purchase that they converted *all* their film equipment to RCA Vidicon! Now they're piping the highest picture quality down their entire network line. Popular film shows like "Maverick" get the very best treatment, which pays off in viewers.

ABC first made careful tests of competing equipment. RCA Vidicon film camera chains showed up in first

place. Frank Marx summed it up like this, "In all our tests RCA Vidicon equipment proved best. We feel we moved miles ahead in film programming quality when we installed these modern Vidicon chains at all our stations."

Their first two chains were delivered in October, 1954, for the Disneyland opening in New York. Other chains soon followed. Then, in December, 1957, they decided to go "all the way" at all their stations. Today, ABC-TV is 100% RCA Vidicon. The results speak for themselves.



NERVE CENTER of ABC-TV operations—the master control room—is largely RCA equipped.



PROTECTION SYSTEM. RCA TP-6 16 mm professional projectors are used to double-up with 35 mm network projectors to insure on-air continuity in event of mishap. TP-6's are used throughout ABC local film rooms.

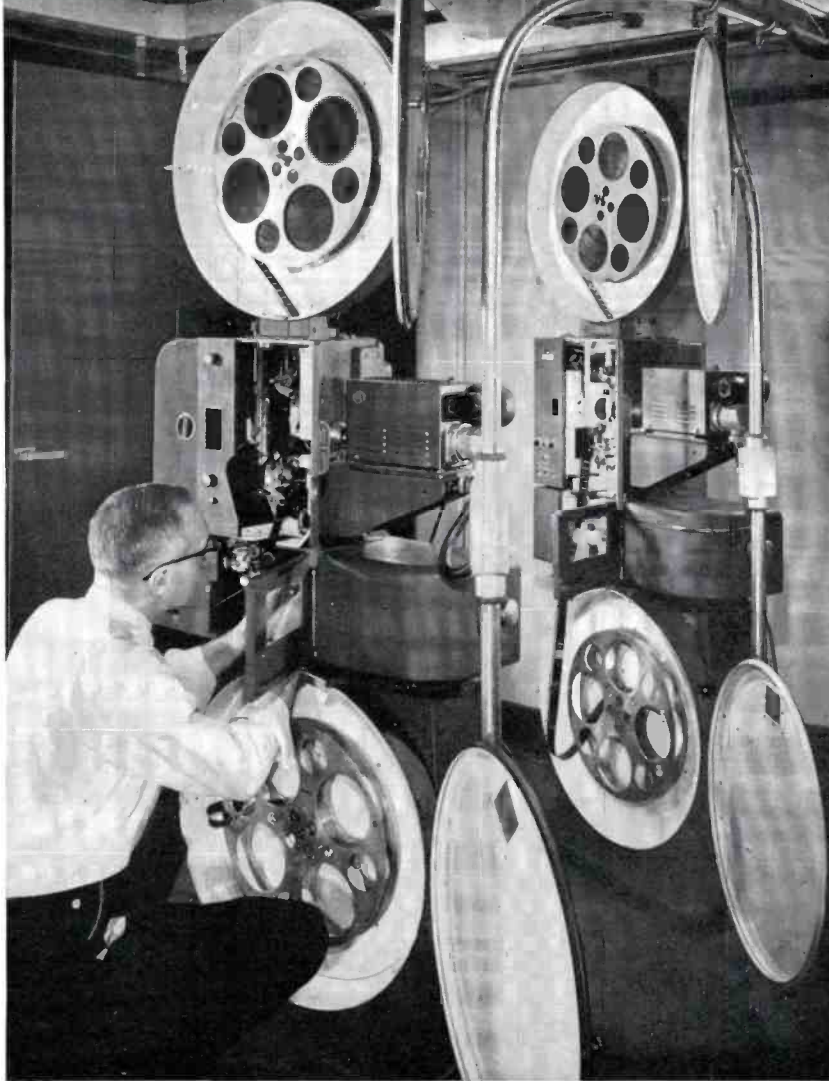

"KEY TO QUALITY" of their network film programs . . . these two RCA TP-35 projectors, monoplexed to Vidicon film camera chains.

EXHAUSTIVE TESTS of equipment, preceding decision to buy RCA, pointed out important fact: "RCA has the quality!" And here, Al Malang, a video facilities engineer, demonstrates camera features to group of ABC executives headed by Frank Marx, Vice-President, Engineering; including Wm. H. Trevarthan, Director, Network Operations; John G. Preston, Director, Engineering Facilities; and Verne Pointer, Chief Video Facilities Engineer. Al Josephsen, RCA, looks on.



Your RCA Broadcast Representative will be glad to explain how RCA Vidicon film equipment can make a success of your film room! In Canada: RCA VICTOR Company Limited, Montreal.



Trmk(s) ®

RADIO CORPORATION of AMERICA

BROADCAST AND TELEVISION EQUIPMENT

CAMDEN, N. J.



Type BK-1A Pressure Microphone—High-fidelity "Commentator" pressure microphone, non-directional in character. An ideal announce mike for speakers. It assures clear, crisp speech and is well suited for remote pickup.



Type BK-5A Uniaxial Microphone with Desk Stand—Standard of the television industry, highly directional, with high front to back ratio. Unidirectional characteristic simplifies microphone and camera placement. (See boom-type below.)

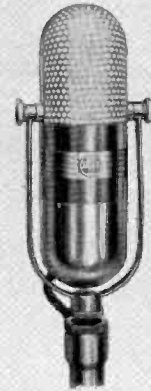

Type 77-DX Polydirectional Microphone—Excellent for both voice and music. The standard of the broadcast industry. Variety of directional characteristics, with high sensitivity over entire frequency range, assures high quality reproduction.

A Microphone

**Immediately Available
from RCA!**

Whatever your special microphone requirements, RCA can meet them exactly.

Look at the variety of models now offered. You can get pressure-type microphones—such as the BK-1A, SK-45, or BK-6B—and velocity-types—the BK-5A, 77-DX or SK-46. There are microphones for radio or TV station use; for intercom, paging, or PA use. Also mikes for announce, music, or both; for desk, boom, personal use—unidirectional, bidirectional, polydirectional.



Type BK-5A Uniaxial Microphone with Boom Mount. Specially engineered for the television industry to reduce camera noise and interference. Newly designed boom mount combines superior mechanical isolation with rugged durability. Also available with wind screen for outdoor use.

Also A Complete Line of Microphone Accessories...

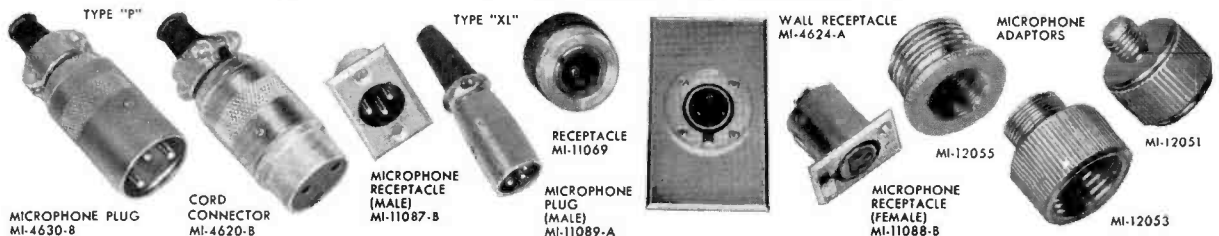

TYPE "P"
MICROPHONE PLUG
MI-4630-B

CORD CONNECTOR
MI-4620-B

MICROPHONE RECEPTACLE (MALE)
MI-11087-B

TYPE "XI"
MICROPHONE PLUG (MALE)
MI-11089-A

RECEPTACLE
MI-11069

WALL RECEPTACLE
MI-4624-A

MICROPHONE RECEPTACLE (FEMALE)
MI-11088-B

MICROPHONE ADAPTORS
MI-12055

MI-12051
MI-12053

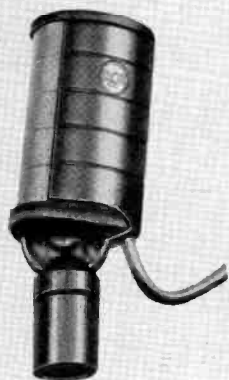

Type SK-45 Pressure Microphone—Rugged, announce microphone of the dynamic type, suitable for talk-back or cue-in purposes. Economical, light in weight, small in size. Designed for high or low impedance use.



Type BK-6B Miniature Microphone—Small but tough, this new personal microphone is easily concealed in hand or clothing. Only half the size and weight of previous models. Offers excellent speech balance when talking "off mike." Wide range frequency response.



Type SK-46 Velocity Microphone—Good low-cost studio velocity microphone for speech or music. Provides bidirectional characteristic over wide frequency range. Designed for high or low impedance use.

for Every Need...

For the finest microphones that money can buy, or for quality, low-cost, utility microphones... when you come to RCA, you know the microphone will be right—whatever the type. It has to reflect the standards for which the RCA symbol has long been famous.

... available for immediate delivery. All represent today's greatest microphone values. For information concerning any of the microphones illustrated, write today for descriptive literature. Bulletins describing desk stands, floor stands, and booms, also available.

Ask your RCA Broadcast Sales Representative



RADIO CORPORATION of AMERICA

BROADCAST AND TELEVISION EQUIPMENT

CAMDEN, N. J.

Tmk(s) ®

In Canada: RCA VICTOR Company Limited, Montreal

New "Traveling

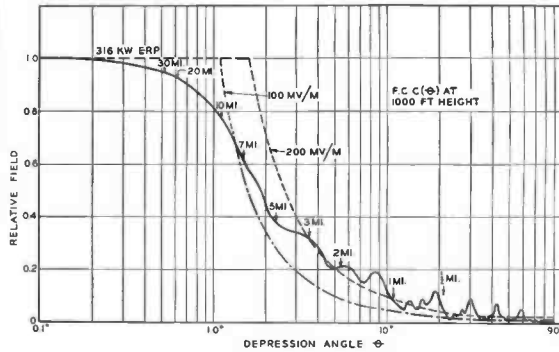

CHANNEL 10

GAIN OF 18 ANTENNA PATTERN
(CALCULATED)

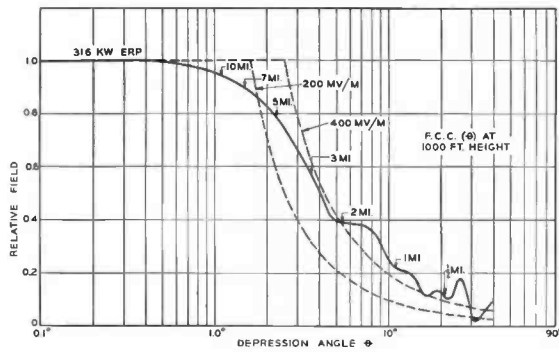

CHANNEL 7

GAIN OF 8 ANTENNA PATTERN
(MEASURED)

**FOR HIGH-BAND
VHF OMNIDIRECTIONAL
SERVICE**

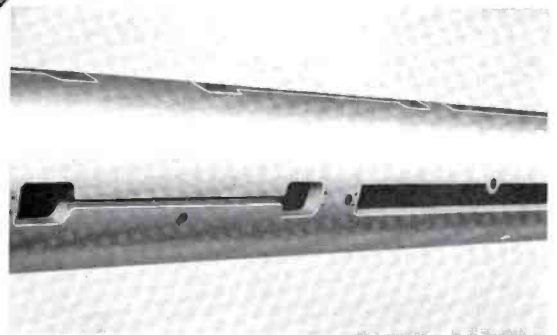

CLOSE-UP OF ANTENNA SHOWING
UNIQUE SLOT RADIATOR DESIGN



RADIO

Tmk(s) ®



Wave" Antenna

**Combines Improved Electrical Characteristics
with Mechanical Simplicity and Economy . . .
for High Power TV Applications**

Here is a VHF high-band antenna that has an inherently low VSWR and produces better patterns. A new design, based on slot radiators, results in improved circularity. This new antenna also features low wind resistance and better weather protection.

INHERENTLY LOW VSWR

The traveling-wave nature of the feed results in a low VSWR along the antenna. This characteristic inherently gives the antenna a good input VSWR without any compensating or matching devices. The input tee has been broad-banded to provide a smooth transition from the transmission line to the antenna.

ALMOST IDEAL VERTICAL PATTERN

A vertical pattern is obtained which is an extremely smooth null-less pattern—see accompanying patterns. This provides the service area at most locations with a uniformly high field strength. Gains from approx. 6 to 20 at VHF high band can be obtained.

IMPROVED CIRCULARITY

The individual patterns produced by slot radiators when added in phase quadrature result in an over-all pattern with improved circularity. In addition, there are no external elements in the field. This design combines radiating elements, feed system and antenna structure in one unit, giving excellent horizontal circularity.

LOW WIND RESISTANCE

AND WEATHER PROTECTION

The smooth cylindrical shape of the antenna is ideal for reducing wind load and has high structural strength. It is designed to withstand a wind pressure of 50 psf on flats, or $33\frac{1}{2}$ on cylindrical surfaces. In addition, the absence of protruding elements minimizes the danger of ice damage. The steel outer conductor is hot-dip galvanized for better conductivity and protection. The inner conductor of the antenna is rigidly supported at the bottom end without having to rely on any insulator type of support to carry the dead weight. The pole is designed for tower mounting with a buried section extending into the tower. The pole socket carries the dead weight of the antenna. Polyethylene slot covers are fastened to the pole over every slot.

SIMPLIFIED FEED SYSTEM

The feed system is completely inside the antenna, hence any effects on the pattern have been eliminated. The feed system is a simplified one consisting of a large coax line and coupling probes.

The RCA "Traveling Wave" Antenna can provide you with the answer to your need for a VHF High Band Antenna which combines mechanical simplicity and economy, especially in high-gain, high-power applications. Your RCA Broadcast Representative will gladly help with TV antenna planning. See him for details on this new antenna. In Canada: RCA VICTOR Company Limited, Montreal.

C O R P O R A T I O N o f A M E R I C A

BROADCAST AND TELEVISION EQUIPMENT • Camden, N. J.

RCA Video Tape Recorders in Operation at NBC Tape Central, Burbank, California

With the arrival of Daylight Saving Time—April 30, 1958—the new Tape Central of NBC in Burbank went into daily operation. At the present writing four RCA Video Tape Recorders are in use for delayed broadcasts. Both color and monochrome shows are being recorded and played back by these RCA equipments. The illustrations on these pages show how the RCA Video Tape Recorders are installed. Details of the equipment are pointed out and the manner of operation is explained.

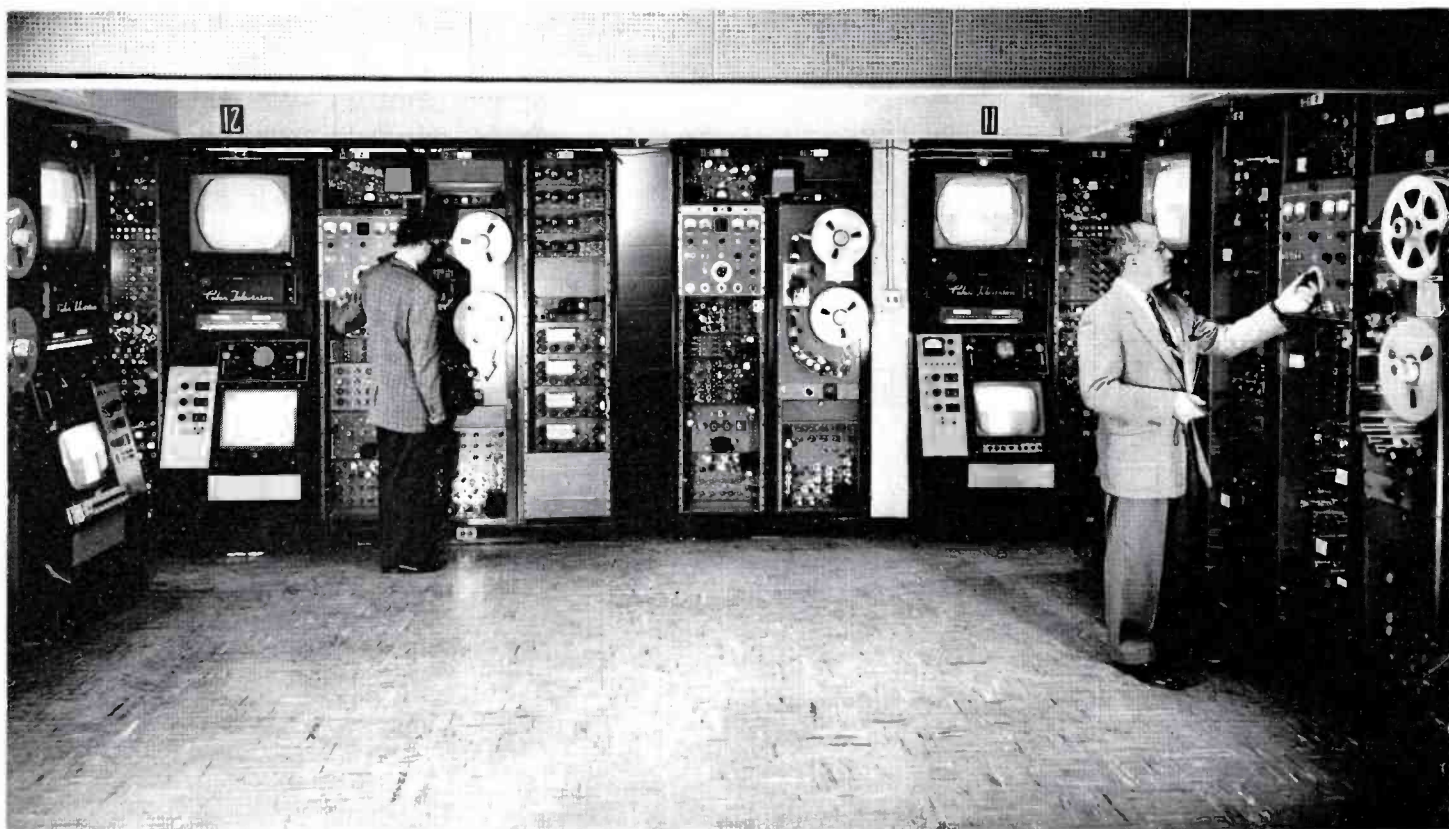
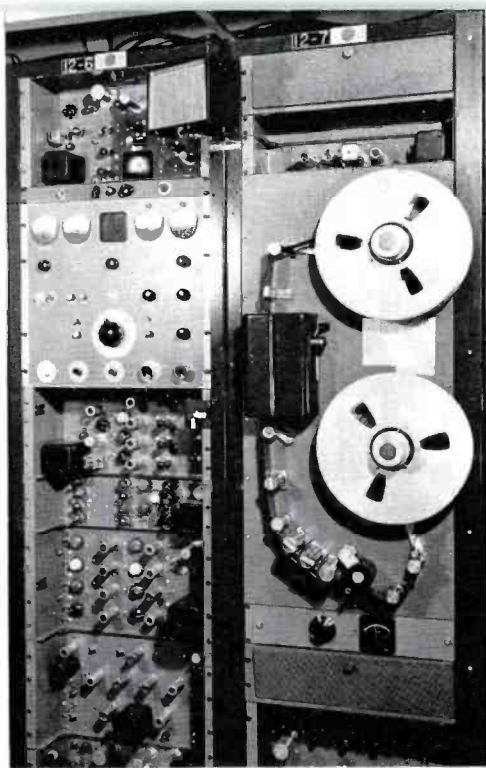

FIG. 1. Installation of four RCA Video Tape Recorders at NBC Color Studios in Burbank, California. Each complete Video Tape Recorder is housed in six standard cabinet racks in order to provide operating convenience and easy maintenance. The three operating racks of each Video Tape Recorder are located in this area, while the remaining three racks of each Video Tape Recorder are located in the rear.



LOCAL OPERATIONS CENTER

FIG. 2. This is a close-up of the two main operating racks. Rack at left contains (from top to bottom): FM Modulator, Control Panel, Recording Amplifier, Playback Amplifier, 4-Channel Equalizer and FM Switcher.

Rack at the right contains the Tape Transport Panel. Above this is the Audio Line Amplifier, and the Master Erase Oscillator (an exclusive feature of the RCA equipment). Beneath the Tape Transport Panel are: the Audio Metering Panel, Recording and Playback Amplifier and FM Switcher.

The Tape Transport Panel contains the mechanism of moving the tape past the various heads. At the top is the supply reel, tension arm and air-lubricated guide. Next, note Master Erase Head (exclusive feature) directly above rectangular cover. The Head Wheel Assembly is housed under the cover. Directly beneath cover is rewind tape lifter. Next is the Control Track Head followed by the air-lubricated guide. After this comes three Program Audio Heads: (1) Erase, (2) Record-Play, and (3) Simultaneous Playback. Then comes the Capstan and pressure roller. This is followed by two air-lubricated guides, a tension arm and, finally, the take-up reel.

MASTER CONTROL PANEL

FIG. 3. This is a close-up view of the Master Control Panel. The controls normally used for operation are the push-button switches located across the lower edge of the panel. They are: Stop, Play, Wind, Record, and Audio Only Record. The Wind push-button switch is used in conjunction with the control knob directly above it. When the machine is in the Wind mode of operation the direction and speed of tape wind is continuously adjustable through a range of fast forward to fast rewind. This control provides a very convenient means of cueing since the tape can be inched in either direction while listening to the program sound channel to find an exact cue point. The upper portion of the panel contains setup controls and meters for convenience in checking operating points such as audio levels, recording head currents, master erase current, control track current and control track phase. Also included are elapsed time indicators to permit logging running time on head wheels and on slip rings and brushes. A small continuity monitoring loudspeaker is mounted on the panel through which is reproduced the simultaneous playback program sound during recording or the normal program sound during tape playback.

TEST AND ADJUSTMENT

FIG. 4. Close-up of TO-1 Waveform Monitor and (beneath it) a switching panel. This switcher permits convenient display of a number of important signals on the CRO or the Monitors. (In the NBC operation two monitors are used for each VTR: one TM-21 Color TV 21-inch Monitor and one TM-7 Monochrome TV 17-inch Monitor. These monitors are looped through to give the effect of being wired in parallel.)

The following signals may be punched up on the CRO:

1. In coming line
2. Monochrome output
3. Color output
4. Switcher output
5. Tracking Head input
6. Tracking Head output
- 7, 8, 9 Spares

The following signals may be viewed on the color and monochrome monitors:

1. Incoming line
2. Monochrome output
3. Color output
4. Reference generator (240-cycle pulse)
5. Tone Wheel Presentation (tells when Head wheel is in sync)
- 6, 7, 8, 9 Spares

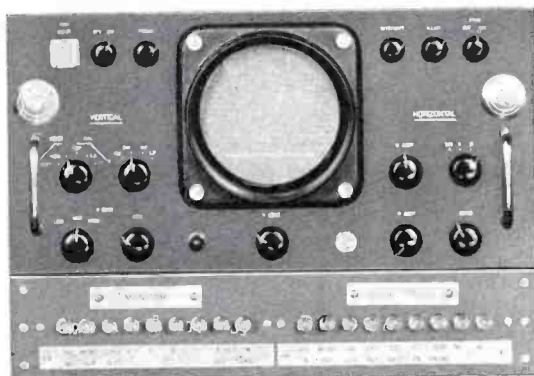
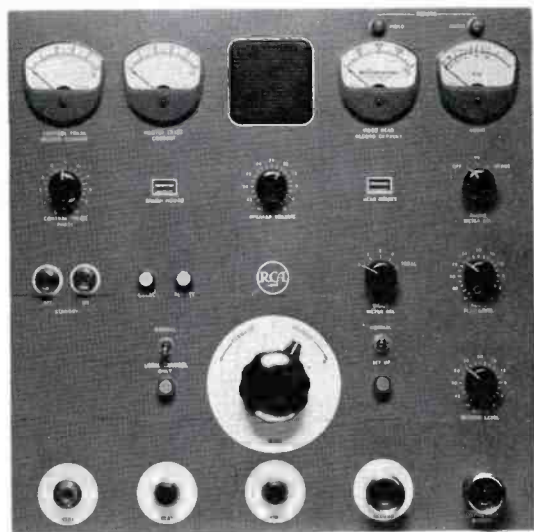



THE RECORDING OPERATION

FIG. 5. Setting up Video Tape Machine for recording operation. Operator is shown adjusting continuously variable speed control to bring tape into position. Note that the control is used only for forward and reverse speed control either prior to or after the record/playback operation. Speed is automatically controlled during the record/playback operation.

REWINDING

FIG. 6. Rewinding video tape after record/playback operation. Operator pushes "Wind" button at bottom of control panel. Then he turns "Wind" control to reverse position. A one-hour reel of tape can be rewound in three minutes.

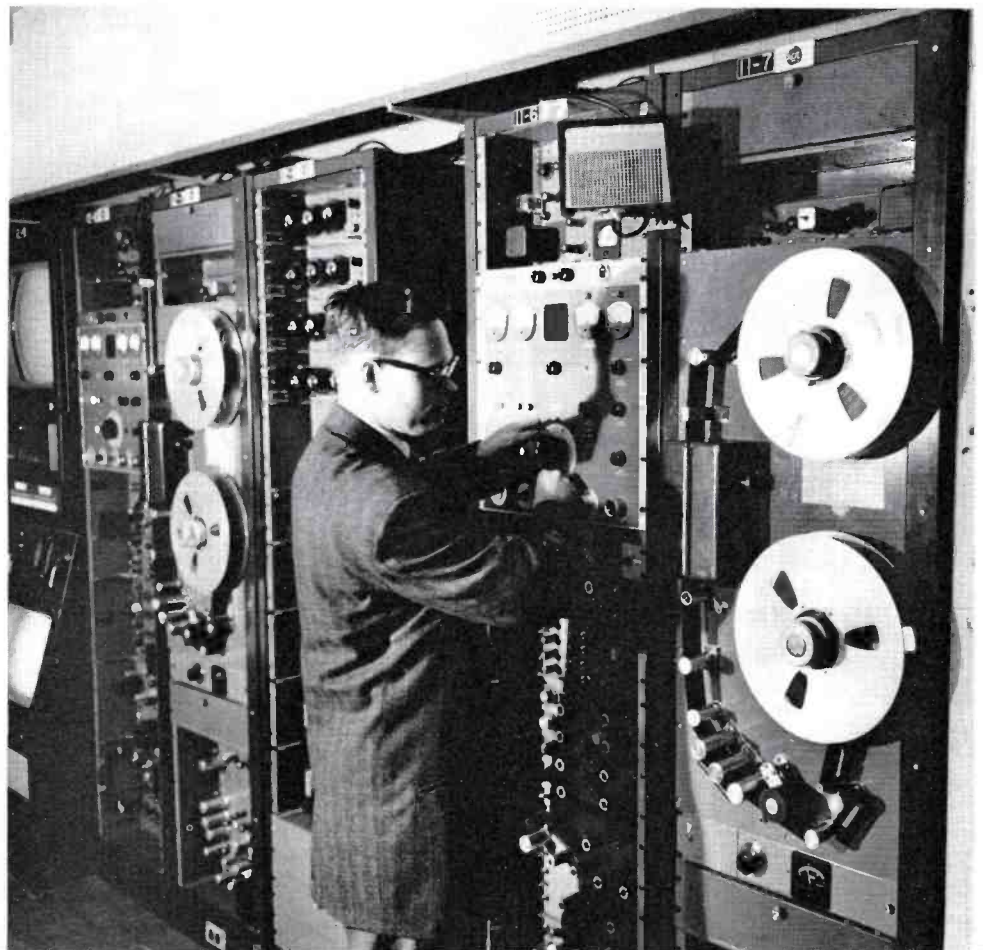

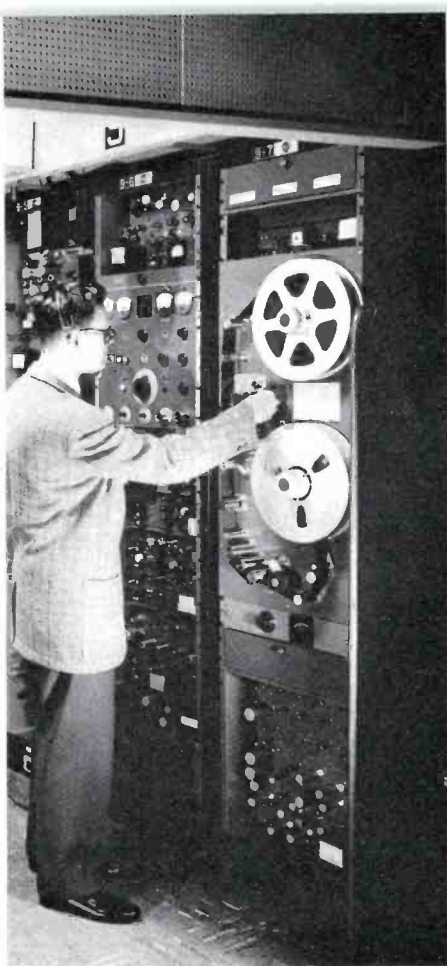

PREPARING FOR PLAYBACK

FIG. 7. Operator is shown adjusting head shoe pressure prior to playback. Then the "Wind" control on the control panel (left) will be turned to the left (forward speed) running the tape forward until the cueing signal is heard. Then the machine is ready for the playback signal from either the local panel or a remote source.

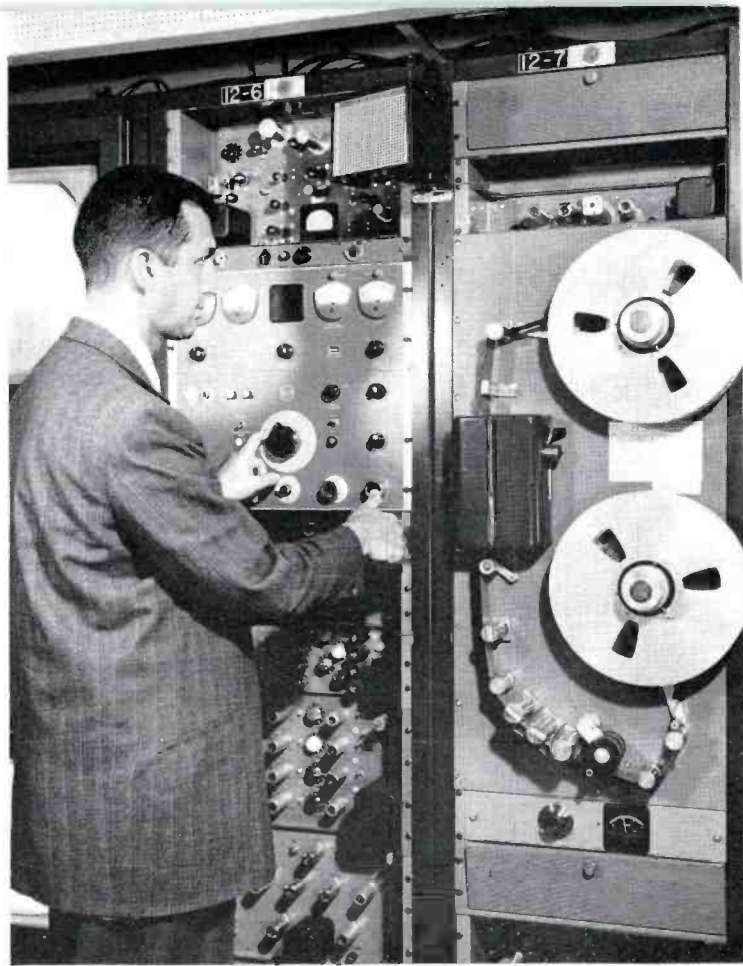

RECORDING AUDIO ONLY

FIG. 8. Operator is shown pushing "Audio-Only Record" button (with right hand) which means that program audio will be erased and a new program audio track recorded. This is used, for example, when it is desirable to substitute a local audio message on a TV commercial prepared for national distribution.

facilities of the RCA video tape recorder

The RCA machines provide facilities for maximum utility. Remote and local control are provided. Air-lubricated tape guides provide precise lateral control without distortion of tape edge. A sound monitoring head is included in the RCA machine for simultaneous playback during recording. A separate sound erase head for dubbing or re-recording of sound without disturbing picture information is also included.

For operating convenience an independent audio cue channel is provided for recording operating instructions. Tape wind and rewind speeds are continuously adjustable. The fast speed permits rewinding of a one-hour reel in three minutes. A tape footage indicator gives an accurate cueing reference. A built-in master erase head completely erases tape prior to recording.

The RCA Video Tape Recorder is designed for color and

monochrome operation. If desired, the color processing rack can be omitted for a monochrome-only operation. Provisions for tape splicing have been included. A 30-cycle framing pulse is recorded at one-half inch intervals on the control track. These framing pulses become visible by spraying the edge of the tape with a carbonyl iron suspension.

These Video Tape Recorders are used for broadcasts that are delayed several hours because of time-zone differences and also for shows that are pre-recorded several days before air time. Sometimes several shows are recorded in one day for play-back on different days. Furthermore, TV commercials can have new sound tracks dubbed in for local distribution. Use of these Video Tape Recorders provides NBC with a high resolution TV reproduction system for program delay.



STRATEGIC AIR COMMAND USES RCA COLOR TELEVISION TO EXPEDITE VITAL BRIEFINGS

Six Color TV Cameras Used in a 6-Channel Closed-Circuit System, with
12 Program Sources, to Extend Weather Information and World-Wide
Intelligence Data to 16 Key Locations at SAC Headquarters

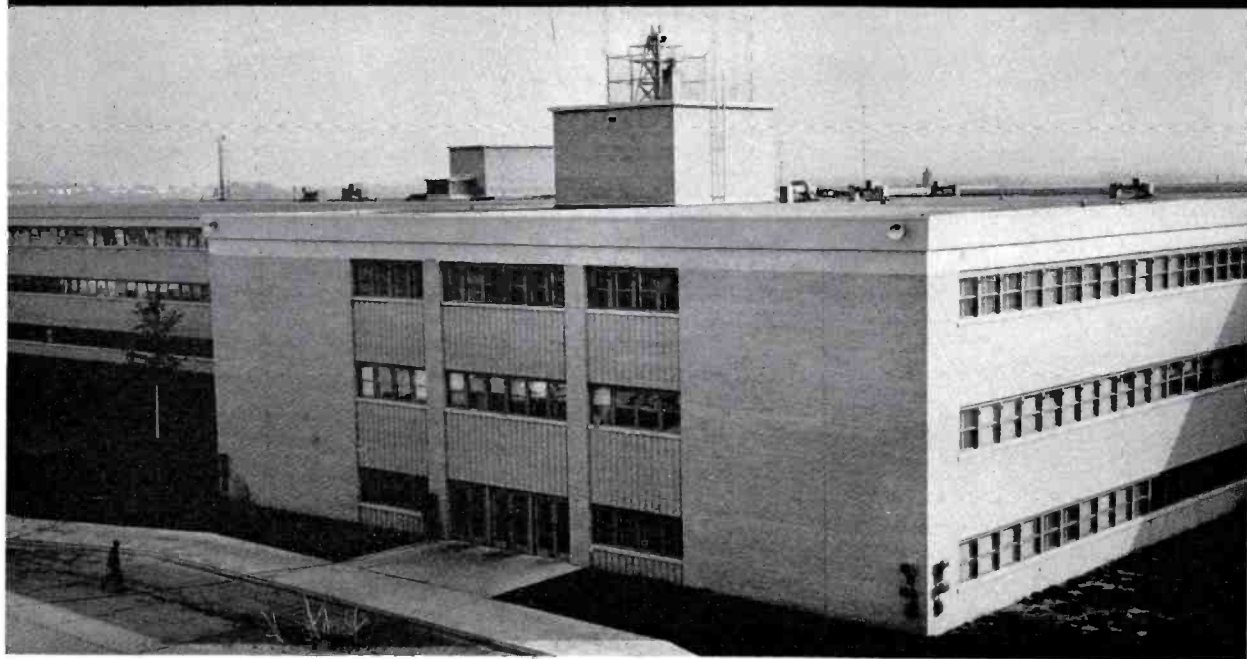

Offutt Air Force Base—ten miles south of Omaha, Nebraska—is the headquarters of the Strategic Air Command. The SAC mission—to preserve peace by maintaining a combat-ready force of poised strategic air power. Helping SAC in this mission is RCA color television.

Installed three stories below the earth in SAC's bombproof operations center are five live color TV cameras and a complete color film system. Six separate program channels are available to send information to various receiving locations. TV is used to brief the staff on weather conditions, deployment of aircraft and other information vital to making necessary decisions. From these decisions one day could come the order—only after hostile enemy intent is known—which would send strike forces from bases all over the globe toward the destruction of enemy military targets.

Headquarters—SAC

Strategic Air Command headquarters is housed in a sprawling building rising three stories up into Nebraska sky—and three stories down into Nebraska earth. Above ground is a typical modern military headquarters—a land of activity—of efficient offices, bright hallways, sprightly WAFS. Underneath are three stories of closed-door offices in which the plans for global peace are made. Here in this modern-day catacomb—enveloped by 3-foot thick concrete walls—is the SAC Combat Control Center.

Heart of this control center is the vast Operations Map Room—two stories high, 140 feet long and 39 feet wide. Giant panels, each eight feet wide and 20 feet high, line the entire wall the length of the room. These panels are constantly being changed to reflect information needed to direct the global force in peace or war—world maps, weather maps, charts showing deployment of force, operational status of aircraft and missiles, and training exercises. Here, color television picks up the latest information for transmission to the offices of key commanders, conference rooms and briefing areas.

Map Room Television

Four TK-41 Color TV Cameras are located in the Operations Map Room.

Two cameras are installed on a 106-foot-long track, located opposite the map panels. These cameras are remotely controlled and

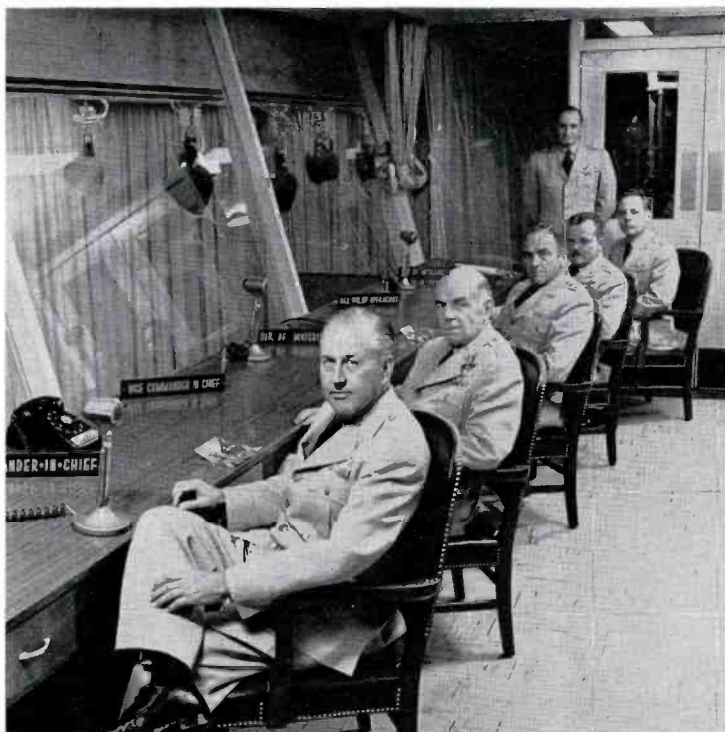

FIG. 2. General Thomas S. Power, SAC Commander in Chief, and his staff, are seated in the glassed-in balcony area overlooking the Operations Map Room. Each member of the staff is charged with a specific phase of SAC responsibility.

FIG. 3. The 140 by 39-foot expanse of the SAC Operations Map Room is shown here. Note, at left, the giant map panels each 20 feet high and 8 feet wide. Shown also is the map room lighting with its scoops and fluorescents. Note color TV cameras on floor and on elevated track at right.

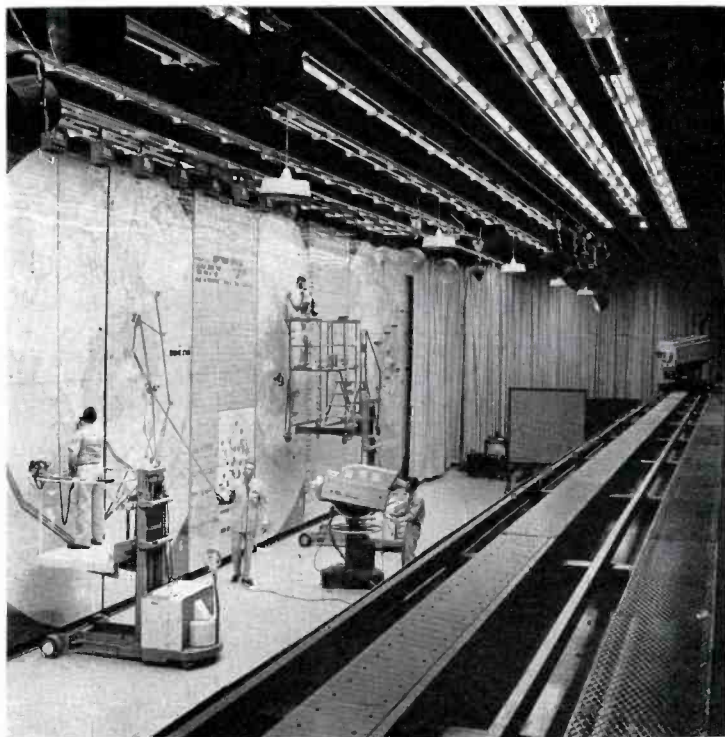

FIG. 1. View of SAC headquarters building, Offutt Air Force Base, Omaha, Nebraska. Below this, for three stories beneath the earth, is the heart of SAC command—an underground city which could seal itself from the world in case of enemy attack.

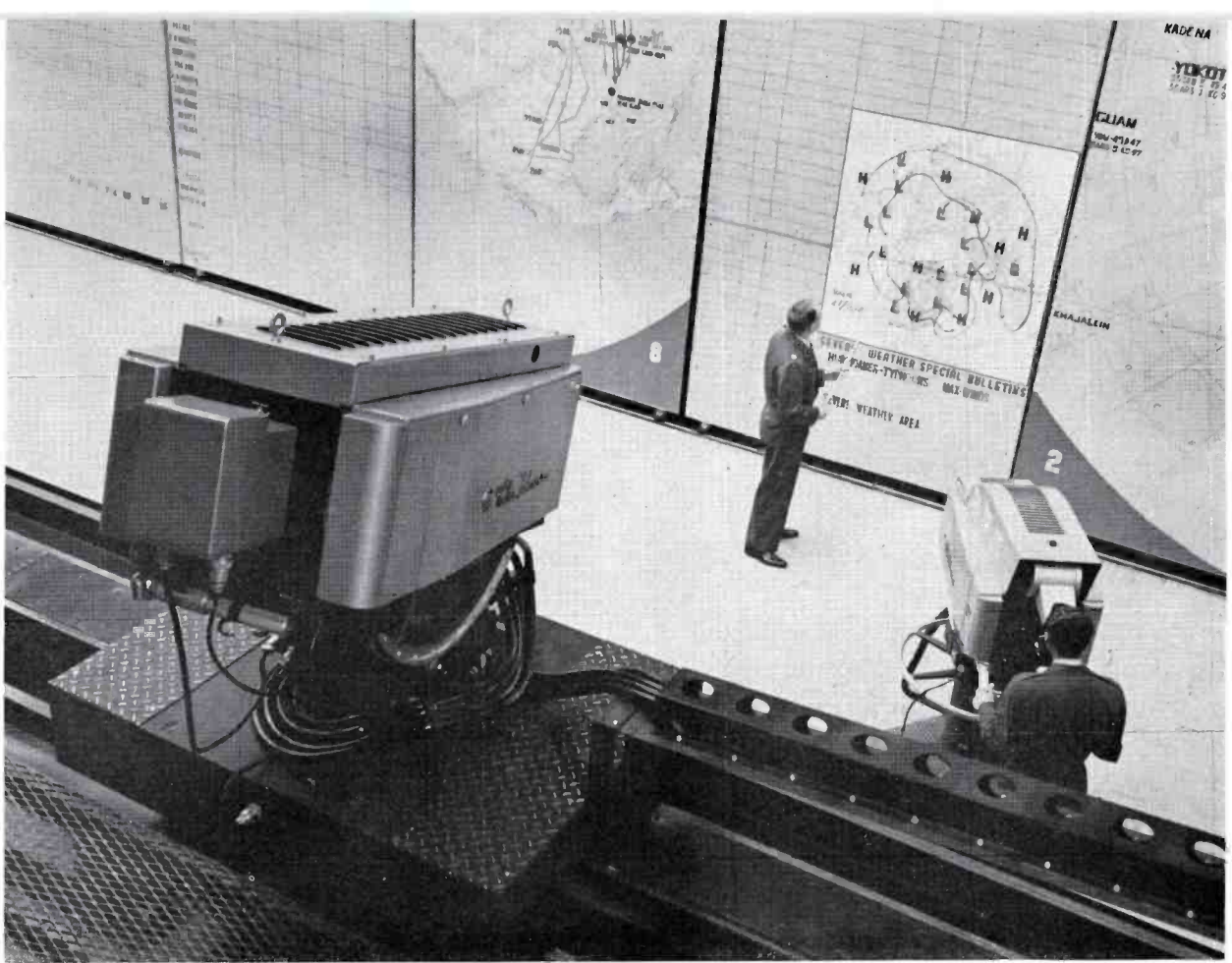

FIG. 4. Weather officer briefs SAC command and staff personnel via closed-circuit color television. Manually operated TK-41 Color Camera views the scene on the map room floor, while TK-41 Camera on track in foreground is operated remotely from control room.

can be moved up and down the track to scan the maps and charts on the panels. A catwalk along the track facilitates equipment maintenance. Remote pan-and-tilt operation of these two cameras enables viewers to see any part of the panel information desired, or to see officers making the briefings from the floor of the map room.

The cradle-type remote pan-and tilt head allows for 30-degree tilt up and down. It is driven by two constant-speed motors. Azimuth and tilt motions are provided with limit switches. The cradle and base are of cast aluminum with bronze worm gears, and shafts revolve on ball bearings. The head revolves and tilts at a speed of approximately 1 rpm.

Both cameras have remote control focus. The control motor is housed within the camera enclosure. Remote lens change is built into the cameras. Major components (motor to rotate lens turret, solenoid to release the turret-positioning detent and

switches to select lens position) are located at the rear of the camera.

A separate remote control unit is provided for each camera at the control position. This unit provides: (1) a "joystick" switch to control pan-and-tilt head motion, (2) a switch to control the lateral motion of the camera on the track. (3) remote focus control, (4) remote lens switches for selection of any one of four lenses on the turret, (5) main switch for disconnecting entire control system and (6) pilot lamp indicating system is on.

The other two TK-41 Cameras, with electronic viewfinders, are mounted on regular studio pedestals which can be moved to any position in the map room. They are used in picking up the briefing officers as they are presenting information on panels or charts. They are also used in daily intelligence summaries and newscasts which present world-wide and national news of vital import to SAC Commander in Chief, General Thomas S. Power, and his staff.

Each camera is equipped with a full complement of four lenses. (One camera is equipped with a Zoomar lens.) These cameras are each controlled by an operator, who focuses, pans, tilts, etc., while electronic control is performed in the control room.

Air Intelligence Room

Next to the Operations Map Room is the 39-by-60-foot Air Intelligence Room, restricted territory to all but the air intelligence staff and other key SAC officers. In this secret room current intelligence information on the status of possible enemy forces is kept. In the event of a national emergency or under actual wartime conditions, a TK-41 Camera from the Operations Map Room would be moved into this room for use in presenting Intelligence Briefings to General Power and his staff. A 17-inch monitor would also be moved into the Air Intelligence Room with the camera. Cable connections and lighting are permanently installed in the room ready for immediate use.

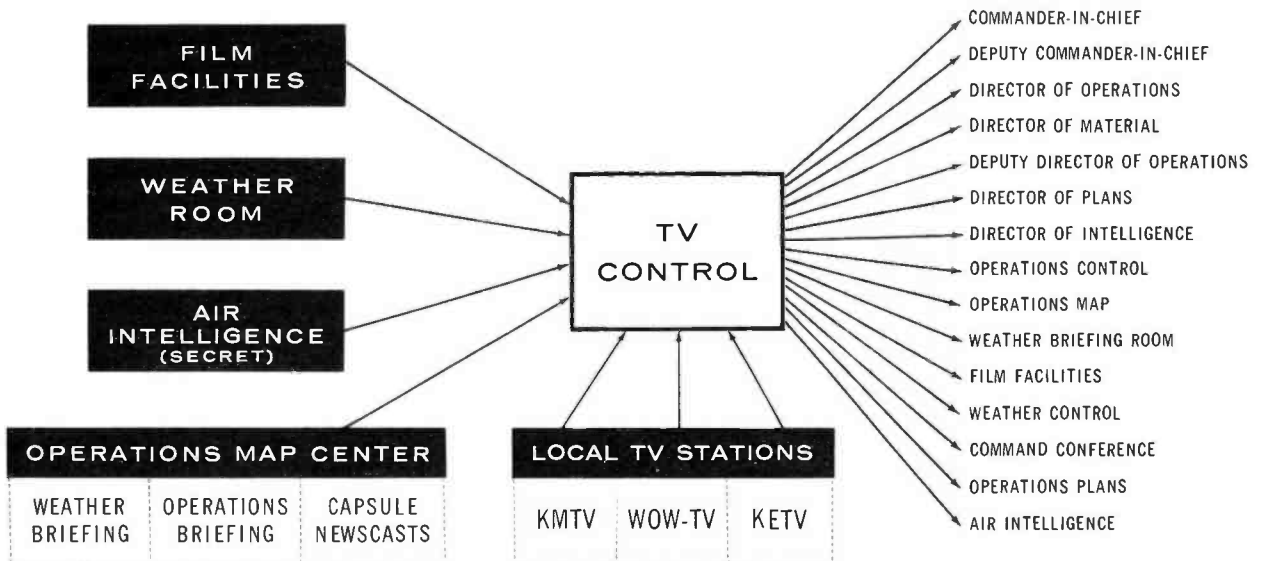

FIG. 5. Here's the battery of cameras the briefing officer faces each day as he presents operations intelligence to top SAC personnel. At top, two TK-41 Color TV Cameras can be remotely panned and tilted, moved along the 106-foot track. Third color TV camera is operated in normal manner. A fourth camera is available, and it can also be wheeled into adjacent Intelligence Room.

HOW THE SAC COLOR TV SYSTEM WORKS

PROGRAM SOURCES

SUBSCRIBER LOCATIONS



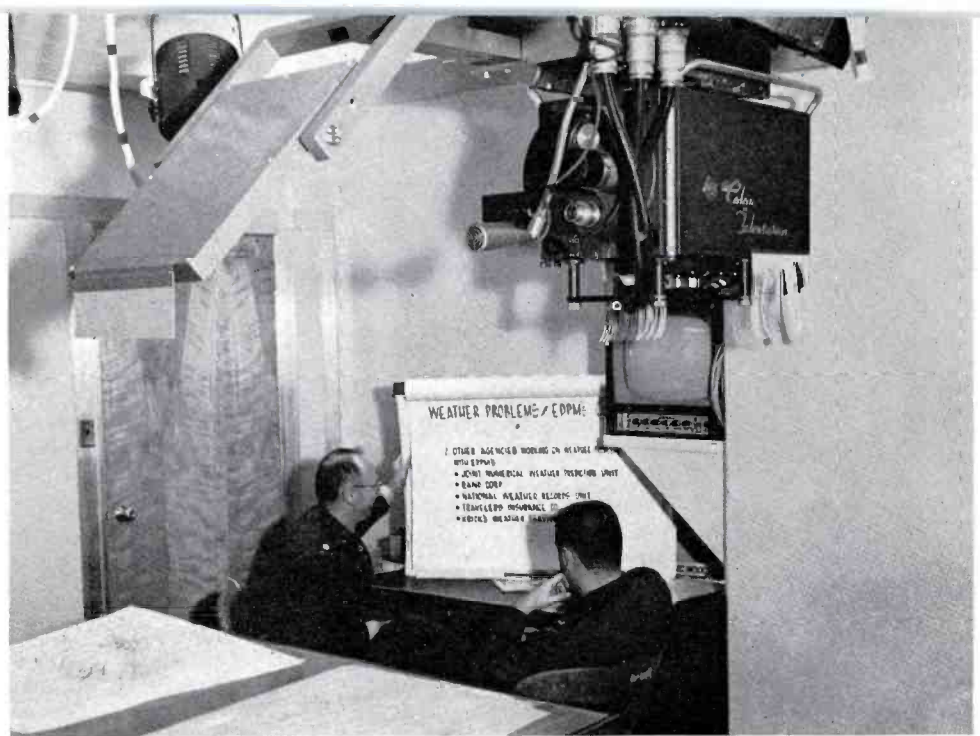

FIG. 6. This 3-vidicon TK-45 Color Camera is located in the Weather Briefing Room on the second floor of the control center. It views weather charts and other data for programming in the SAC color system when needed.

Weather Room

A single TK-45 3-Vidicon Color TV Camera is located in the Weather Briefing Room of the Control Center. This camera is mounted on a fixed frame suspended from the ceiling. It can be focused on the charts and maps used by the weather officers. From this room, weather data can be fed into the SAC TV system for integration with operations briefings. The 3-vidicon color camera which was designed primarily for closed-circuit applications such as this is used to view weather charts and other data. An officer standing next to the charts can make highly effective weather presentations from this point. Sound facilities

are also available here. The officer and the charts are lighted by scoops.

Film Room

Films and slides are an important adjunct of the constant briefing of top command personnel. A fully equipped film room located in the glassed-in balcony above the map room meets these needs. Provision has been made for showing 16mm film and 35mm slides for information supplemental to the briefing messages.

For this purpose a TP-6 Film Projector, TP-7 Slide Projector, together with a TP-15 Multiplexer and TK-26 Color Film Camera have been installed.

The output of the film camera feeds into the relay switching system where it can be switched to remote viewing locations as required. (This switching is done in the control room.) Control equipment for the TK-26 Film Camera is located in the film room. The control console houses a master monitor and processing amplifier. Film and slide projectors are started and stopped by the operator from this position. The operator, who also changes films, receives his directions from the TV control room where the programming director is located.

Also located in the film room is a 17-inch cue monitor and a 17-inch film preview monitor. A modified 21-inch RCA color

FIG. 7. Film-room operator controls film and slide output from this control console. Atop console are a 17-inch program monitor and a 21-inch on-air color monitor. Film room is in glassed-in balcony area above map room.



FIG. 8. The film room at SAC includes an RCA color film chain, 16mm film projector, 35mm slide projector and multiplexer. Films and slides, interspersed in briefing program schedule, educate SAC command in various fields of military knowledge.





TV receiver is used to observe output of film chain in color.

TV Control Room

Controls for cameras, switching, programming and subscriber selection are housed in an area alongside the Operations Map Room.

Along the far wall of the control room are six 17-inch monitors each showing one of the six channels on which briefings may take place. Although present peacetime briefings number only three a day, the system is set up so that five briefings can be made simultaneously. Switching the briefing channels to the command personnel is done in the control room. Channel

one is a preview channel. Channels two, three, four, five and six actually present the program material.

A TM-21 Color TV Monitor is used for line monitoring in the control room. Three modified 21-inch color TV receivers, used as monitors, are also located here to pick up the output of cameras.

Electronic (and in some cases remote) controls for each camera are located here. Number one and five positions control the TK-41 Cameras on the map room floor; numbers two and three are for the remote-track cameras, number four controls the TK-45 Camera located two floors above in the Weather Briefing Room.

FIG. 9. Here is the well-equipped SAC TV control room. Personnel operating controls are of the Presentation Branch, Control Division, Directorate of Operations. They control cameras, and do the switching.

FIG. 10. The SAC TV control room showing controls for three color TV cameras. Controls for remotely operated cameras are also located here.

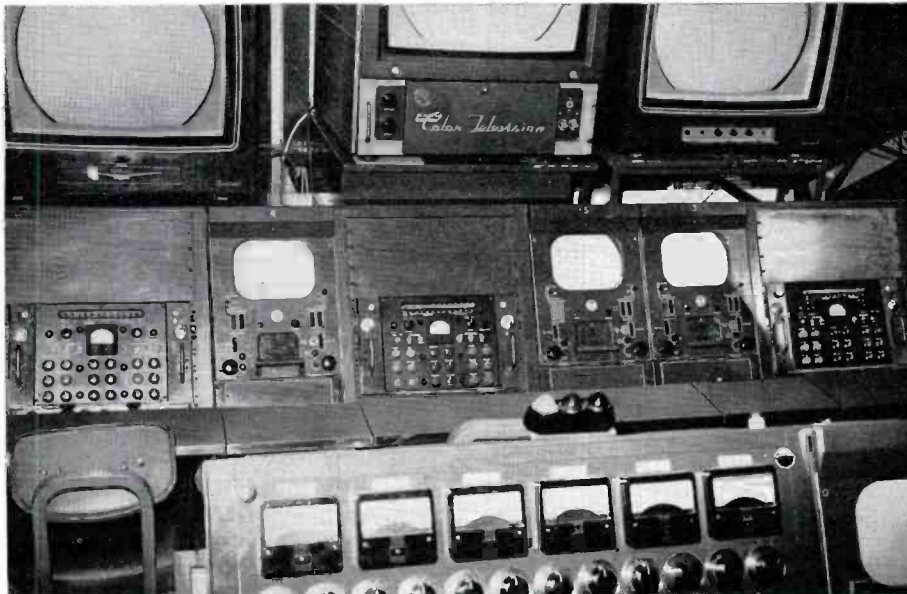

FIG. 11. Controls for Color TV Camera No. 1 are located in a separate corner of the control room. The operator can see the image in black and white on the master monitor as well as view the color presentation on the 21-inch modified color TV receiver positioned on top of the console.



TABLE 1

12 INPUTS AVAILABLE FOR SWITCHING INTO 6 CHANNELS

Input	Video	Audio
1.	Control Room—Camera No. 1	Audio Input
2.	Control Room—Camera No. 2	Audio Input
3.	Control Room—Camera No. 3	Audio Input
4.	Spare	No Audio Input
5.	Air Intelligence Room	Audio Input
6.	Weather Briefing Room	Audio Input
7.	Film Room	Audio Input
8.	Test Signal (Bar Dot Generator)	No Audio Input
9.	NORAD	Audio Input
10.	Channel 3—KMTV	Audio Input
11.	Channel 6—WOW-TV	Audio Input
12.	Channel 7—KETV	Audio Input

Program Selection Switching

Switching is done in the TV control room. Simultaneous switching of video, program audio, talk-back audio and tally information is permitted by the co-ordinated relay switching system.

For program selection switching a multi-button panel provides for switching of twelve inputs to the preview channel and five briefing channels. Five separate briefing sessions, weather forecasts, lectures, films, or training exercises might be carried on simultaneously over these channels.

One input is connected to a closed-circuit TV hookup with North American Air Defense Command Headquarters (NORAD) in Colorado Springs, Colorado. One spare input is provided for future expansion in the operations room. (See Table 1.)

Separate or combined operation of audio and video signals is available. By a push of a button, audio and video information from the same source can go over the lines or, if desired, voice from one channel and video from another may be switched into the system.

FIG. 12. The SAC closed-circuit color TV network consists of 6 channels which are fed by 12 program sources to be seen at the various subscriber locations (note that a total of 24 outputs are available for use). Below is the selection switching panel which provides for programming the channels, selecting the sources and switching desired programs to key SAC locations.

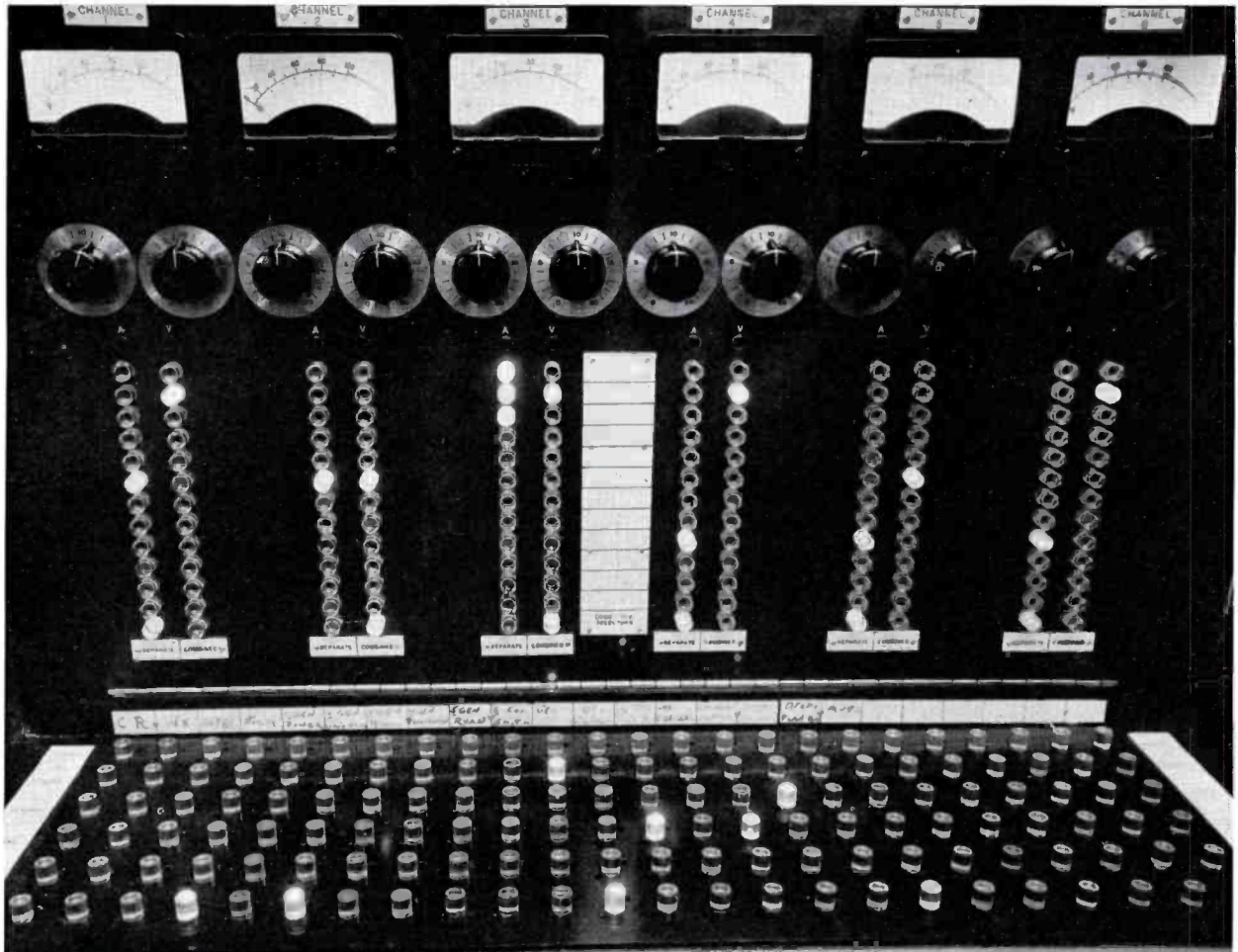



FIG. 13. View of the Operations Control Room, one of the locations receiving briefings via color television. Note RCA color TV monitor. Controller, foreground, can be put into immediate touch with SAC bases all over the world to sound the alert in case of enemy approach.

Output Selection Switching

A "subscriber" panel enables the control-room operator to select any program from the twelve inputs for switching to each subscriber location. Six push buttons are provided for each subscriber, representing the six channels available to each.

Presently, there are 17 subscribers but the panel is designed for future expansion up to a total of 24 as required.

Following are the 17 subscriber locations now receiving information via the SAC TV system:

1. Control Room
2. Weather Briefing Room
3. Film Room
4. General Power,
Commander in Chief
5. General Griswold,
Deputy Commander in Chief
6. Maj. Gen. Edmundson,
Director of Operations
7. Maj. Gen. Ryan,
Director of Material

8. Maj. Gen. Westover,
Director of Plans
9. Brig. Gen. Compton,
Deputy Director of Operations
10. Brig. Gen. Wade,
Director of Personnel
11. Col. Smith, Director of Intelligence
12. Operations Control Room
13. Operations Map Room
14. Weather Control
15. Command Conference
16. Operations Plans Room
17. Air Intelligence Room

Subscribers cannot make their own choice of channels simply by selection at their sets. All programming control is established at the TV control room so that no one can tap into the system to see a secret briefing or other material he is not supposed to see. Each subscriber must make a request for a channel choice by means of the talk-back facilities located at his receiver location.

Each subscriber location is furnished with one modified 21-inch color receiver

(Type 21-CD-7895) one BK-6B Microphone with push-to-talk button, and a tally light box atop the receiver, which is actuated when any one of the top six officers are talking back to control. Also, a program amplifier to provide line level audio from the talk-back microphone and a monitor amplifier furnish program information through the loudspeaker system. By this means each subscriber has complete two-way communication and facilities for CC-TV briefings.

Interphone System

The TV director and other personnel communicate with each other throughout equipment locations by means of an interphone system. By this means, duplex communications are maintained from (1) camera controls to camera operator, (2) camera controls to equipment controller (man at switching location), (3) camera operators to equipment controller, (4) equipment controller to lighting personnel and (5) equipment controller to racks.

FIG. 14. A briefing emanates from the Operations Map Room. The floor camera (TK-41) is focused on the briefer. One track camera (right) is trained on a small chart supplementing the main briefing. Banks of fluorescents provide much of the lighting required for televised briefings.

Map Room Lighting

Lighting for the Operations Map Room consists of eight scoops of 1500 watts each, three 1000-watt Fresnels, four 2000-watt Fresnels, one 2000 watt Leko, three 750-watt reflector spots and eight 1500-watt scoops. Fluorescent lighting covers the entire ceiling area of the map room. There are six banks of lights, 18 units deep, and containing two, three and five lights in each bank, furnishing approximately 350-foot candles of lighting.

Fluorescents are used since the plastic covering over most of the map panels in the room make use of scoops and spot lighting nearly impossible because of high reflectance. Scoops are now used only in briefings and in the newscast where the briefer sits at a desk, behind which a drape is hung or nonreflecting charts and maps are used.

Briefings

One operational briefing is scheduled early each morning giving deployment of aircraft, weather information, training mission details and other information. Air

FIG. 15. Daily newscast is presented by non-commissioned officer. This newscast features world and national news each afternoon to keep SAC personnel up to date on important events.



intelligence briefing on enemy aircraft movement and other classified material is given once daily. A member of the Presentation Branch staff, a former radio announcer, gives a 2:30 newscast featuring world and national news daily during the week. Films (security motivation) are shown on a nonscheduled basis.

Personnel

The TV personnel are assigned as a part of the Presentation Branch, Control Division, Directorate of Operations. The Presentation Branch is responsible for the

production of all graphic, visual, photographic, and television aids required in the support of the mission of the underground Control Center. Projects accomplished by this branch include preparation of all map panels, display area, art and illustrative briefing aids, flip-cards used in TV programming, and special effects for TV production.

The Presentation Branch is divided into an art section, photo section, TV maintenance section, TV production section and administrative section. Those we will

FIG. 16. A typical subscriber location at SAC. Here, Maj. Gen. Edmundson, SAC Director of Operations, watches a briefing in his office. Note microphone in his right hand, provided for conversing with control personnel.



mainly concern ourselves with are the TV maintenance and TV production sections.

The Chief of the Presentation Branch is assisted in the TV maintenance area by a Warrant Officer. This officer and the personnel that he supervises are assigned to the 30th Communications Squadron-Command for administration, and are assigned to the Directorate of Operations for duty under the supervision of the Chief of the Presentation Branch. There are twenty-three airmen in the TV maintenance section: one Master Sergeant, who is the noncommissioned officer in charge; five Technical Sergeants; two Staff Sergeants; six Airmen First Class; seven Airmen Second Class; and two Airmen Third Class. These airmen are charged with the operation and maintenance of the cameras and associated equipment.

One of the major problems has been providing training for inexperienced personnel. The maintenance section is mainly manned with personnel who have come from Radar Groups, Radio Teletype Schools and Communications Schools. This inadequacy has been offset by setting up an on-base school using contract RCA Engineers to teach the operation and maintenance of the installed color equipment.

TV Operations

One cameraman is used to operate each camera located on the map room floor.

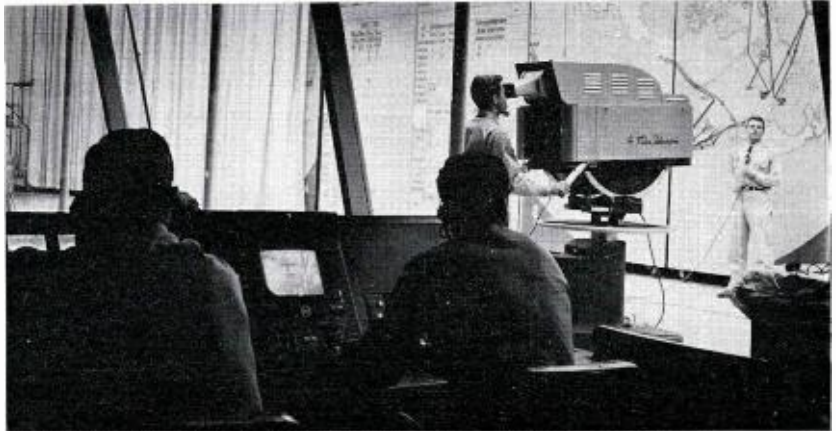

FIG. 17. SAC personnel operate and maintain the color TV cameras and associated equipment. Whether they work in the control room as cameramen or in the maintenance areas, their job is to keep SAC on the alert via TV briefings whenever needed.

The two cameras on the overhead track are remotely operated. The remote operator can: (1) focus, (2) change lens, (3) pan, (4) tilt, and (5) move the cameras on the 106-foot-long track. Electronic controls for five of the cameras are in the control room; for the sixth, in the film room. Six video operators are employed for handling the electronic controls.

A single operator acting as noncommissioned officer in charge is utilized at the program switcher. He (1) switches programs, (2) selects subscribers to receive

programs, and (3) rides audio gain. Although this man may not be the senior man present on duty, as program NCOIC he technically controls the briefing program from the standpoint of who gets the program and what program they receive.

The TV production section provides a daily program for the maintenance section to follow. Each day's program is different; however, is in line with the programming desired by the directorate and subscribers. A typical daily program for the SAC system appears in Table 2.

TABLE 2
TYPICAL DAILY MINIMUM PROGRAM

TIME		PROGRAM	Video	SOURCE	Audio
On	Off				
7:00 A.M.	7:25	Today, NBC	KMTV	KMTV	KMTV
7:25	7:30	Today in Omaha	KMTV	KMTV	KMTV
7:30	7:55	Today	KMTV	KMTV	KMTV
7:55	8:00	Today in Omaha	KMTV	KMTV	KMTV
8:00	8:25	Today	KMTV	KMTV	KMTV
8:25	8:29:30	Today in Omaha	KMTV	KMTV	KMTV
8:29:30	8:30	Station ID	SAC Shield		Silent
8:30	End	Operations Briefing	Studio		Studio
End for 30 sec.		Station ID	SAC Slide		Silent
10:55	11:00	Station ID	SAC Slide		Silent
11:00	End	Intelligence Briefing	Studio		Studio
End for 30 sec.		Station ID	SAC Slide		Silent
11:55	12:00	Station ID	SAC Slide		Silent
12:00 Noon	12:18:30	Noon Edition	KMTV		KMTV
12:18:30	12:19	Station ID	SAC Slide		Silent
2:25	2:30	Station ID	SAC Slide		Silent
2:30	2:44:30	AP News	Studio		Studio
2:44:30	2:45	Station ID	SAC Slide		Silent

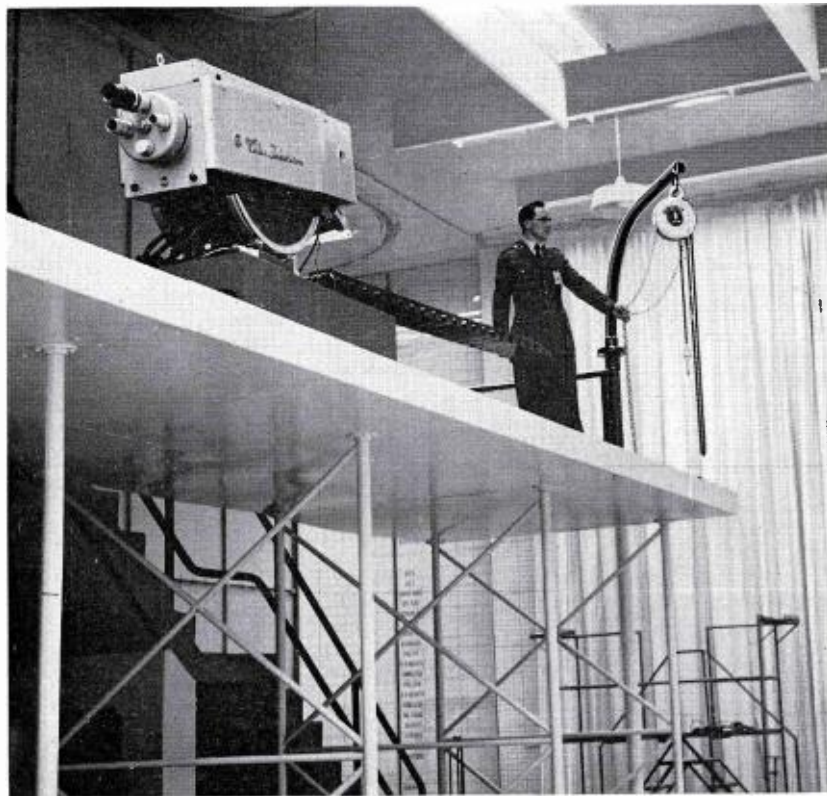

FIG. 18. Maintenance, performed on schedule, keeps SAC TV equipment in top-operating condition. Here Warrant Officer T. G. Ball inspects the hoist, used to convey heavy camera equipment to and from first floor level when major repairs are necessary.

TV Maintenance

Maintenance of equipment is also directed by the Warrant Officer in charge. Also, an engineer of the RCA Service Company, a division of RCA, is on duty along with the enlisted personnel. This engineer is, in fact, the only one of the group who had any working knowledge of the RCA color TV equipment before joining the group. His job is the supervision of all major maintenance problems.

Routine maintenance is performed on all equipment at least once a month on a certain date specified. Card files are kept on all equipment: parts, adjustments and other changes noted. Once a month a tube check is made on all equipment using the Type WT-110A Tube Tester. Maintenance schedules are carried out during regular duty hours, although major maintenance must oftentimes be performed on a nighttime schedule.

Colorplexers, sync generators, distribution amplifiers, frequency standards and

other critical equipment are adjusted on a day-to-day basis. This equipment along with control units, video patch panels, color signal analyzers, linearity checkers, relay chassis and power supplies are housed in three rows of racks—26 racks total—on the floor of the Operations Map Room.

If repairs must be made, tubes changed or other maintenance performed, work orders are made out with diagnosis of trouble and actual repairs being noted.

Rack Equipment

Located on the floor of the Operations Map Room and within easy access of the TV control room are three rows of racks containing equipment related to the operation and control of the color television systems at SAC. The system is a complex one. SAC personnel, although inexperienced with color TV, have thus far been up to the task of maintaining the system. The first row of ten racks contain colorplexers, utility control units for the TK-45 Camera

chain in the Weather Room, video jack panels, distribution amplifiers, stabilizing amplifiers, video patch panels for breaking in on subscribers, color signal analyzers, a color bar generator, linearity checker, pulse distribution amplifiers, sync generators, burst flag generators, sync generator switch and frequency standard.

The second row of ten racks contains video distribution amplifiers, a basic relay chassis, video distribution relays, 24-volt regulated power supplies, basic relay chassis, audio signal generator, distribution analyzer, audio amplifiers, program amplifiers, audio patch panels for checking trouble, six 6-way nets, two 3-way nets and one 4-way net. Here, too, are audio relays for subscribers, five 26-way nets for subscribers' talk-back to the control room, audio patch panel and audio programming relays.

A third row of six racks contains power-supply units providing d-c voltages for the system.

TV Guardian

In addition to the color TV equipment installed at SAC headquarters, RCA industrial-type TV equipment has been put to use as a guardian at the entrance to the map room and control area.

The equipment consists of an RCA Type ITV-6 Camera mounted on a pedestal near the door leading in this area. The camera can be panned and tilted remotely to obtain a full view of the visitor. The pan-and-tilt mechanism is operated from the nearby operations control room.

An ITV-6 Monitor is also located in the operations control room. When the controller identifies the visitor seen on the monitor screen, he pushes a button which automatically opens the door to the map room, allowing the visitor to enter the area.

The ITV-6 equipment at SAC headquarters has been giving excellent 24-hour-a-day, 7-day-a-week performance since its installation. This is necessary since no standby equipment is available at SAC. The equipment has eliminated the need for four or five guards formerly required to man this location. One guard is still on duty in the heavy-duty-traffic hours during the daytime.



FIG. 19. RCA industrial-type TV camera acts as watchdog for SAC operations area. When the guard is off-duty, the TV camera shows control personnel inside area those desiring admittance.

Future Plans

Sometime in the future, two TV studios will be built in or near the present operations map area. One will be like a TV broadcast studio with announce booth and control room. This will measure about 15 by 20 feet, the second studio about 20 by 20 feet. Here, it is planned, sets will be installed for special briefings and other presentations.

Two buildings near the SAC administration building may be acquired in the future for use as production workshops, TV maintenance area and storage facilities.

The TV system has been expanded to connect SAC with the North American Air Defense Command in Colorado Springs, and in the not-too-distant future will be connected with USAF Headquarters at Washington, D.C. After that is envisioned a closed-circuit television ring to permit immediate TV contact with all SAC bases the world over. The immediate transmission of combat information by television will permit complete and instant co-ordination of the nation's aerial offensive and defensive forces.



FIG. 20. SAC operations control room personnel identify visitors outside area via this TV control monitor. When positive identification is made, the operator allows the visitor to enter by pushing a button, automatically opening the door to the area.

WINS PROVES RELIABILITY AND ECONOMY OF 50-KW AMPLIPHASE AM TRANSMITTER

Operating Continuously, 24 Hours a Day, WINS Saves an Average of \$1,200 Per Month and Approximately 600 Square Feet of Floor Space

Station WINS, New York, is revamping its transmitter building in Lyndhurst, New Jersey, to take advantage of more than 600 square feet of reclaimed floor space. WINS installed the first RCA Type BTA-50G Ampliphase Transmitter, and now some of the many advantages accruing to this type transmitter are coming to light. Paul Von Kunits, Chief Engineer, estimates, for example, that the Ampliphase Transmitter has saved WINS over \$1,000 per month on power alone. Further, he estimates another \$200 per month saving on tube costs. Finally, the 50-kw ampliphase requires less than half the floor space occupied by the old 50-kw transmitter.

Transmitter Comparisons

The WINS transmitter building was designed to accommodate the old style 50-kw transmitters with high-power, class "B," amplifiers and water cooling. The old WINS transmitter was a composite; it was actually a section of the famous WLW superpower transmitter of the mid-thirties. It required about six times as much floor space as the RCA Type BTA-50G.

A new workshop, now being completed, occupies the area formerly required for the bias and filament power supplies of the old composite transmitter (see Fig. 2). The cabinets in the workshop will be used for the station's test equipment and will house the new 50-kw dummy load (see Fig. 2). Another small room just behind the BTA-50G has been converted into a tube storage room; it was used to house some of the old water-cooling equipment. The rear shed of the WINS building, now used for general station storage, was formerly the power transformer vault, and is approximately 30 by 10 feet in size.

An interesting comparison can be made between the space required for the BTA-50G and that required for the 10-kw standby transmitter. (This 10-kw standby was formerly used as driver for the old 50-kw composite transmitter.) Both transmitters

occupy almost the same floor space; however, the 10-kw unit also requires a room 18 by 10 for its power transformers, plus three more power transformers located outside the building. The 10-kw transmitter actually requires more building space than the 50-kw Ampliphase Transmitter.

Ampliphase Layout

Four cubicles contain all the components of the BTA-50G transmitter, and these

cubicles take up only 80 square feet of floor space (see Fig. 2). Switch gear and power distribution transformers are mounted on the wall at the rear of the Ampliphase Transmitter. The switch gear consists of a main plate circuit breaker, a delta-Wye switch, a distribution circuit breaker, a 460-to-230-volt bank of distribution transformers, and two single phase open delta connected regulators with control panels.

FIG. 1. Paul Von Kunits, WINS Chief Engineer, is shown making the one daily adjustment, the carrier level control, on the BTA-50G exciter modulator unit.



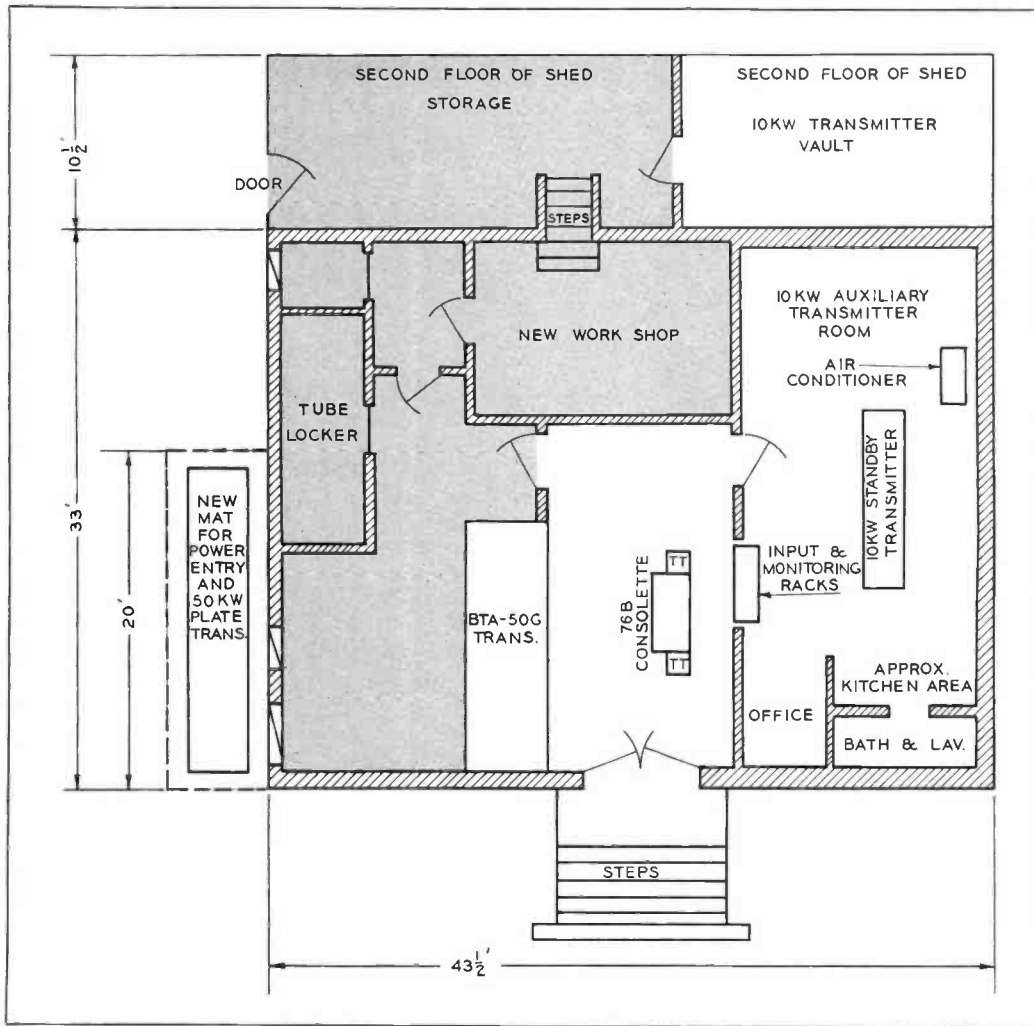

FIG. 2. The space-saving feature of the BTA-50G is vividly shown here. The gray areas on the floor plan show space that was formerly occupied by the composite equipment, and that has now been reclaimed for other use.

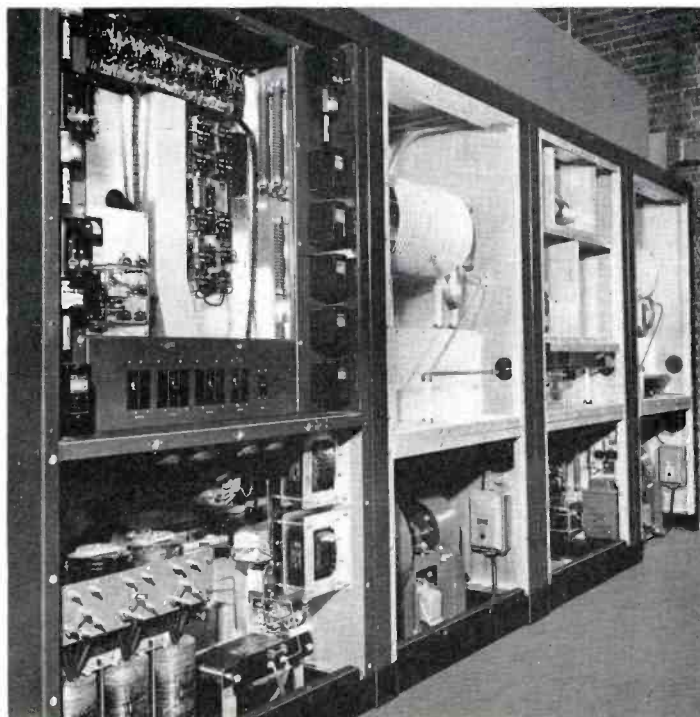

FIG. 3. WINS Ampliphase Transmitter with rear panels removed. Rectifier cubicle is in foreground, followed by PA cubicle, exciter cubicle and the other PA cubicle.

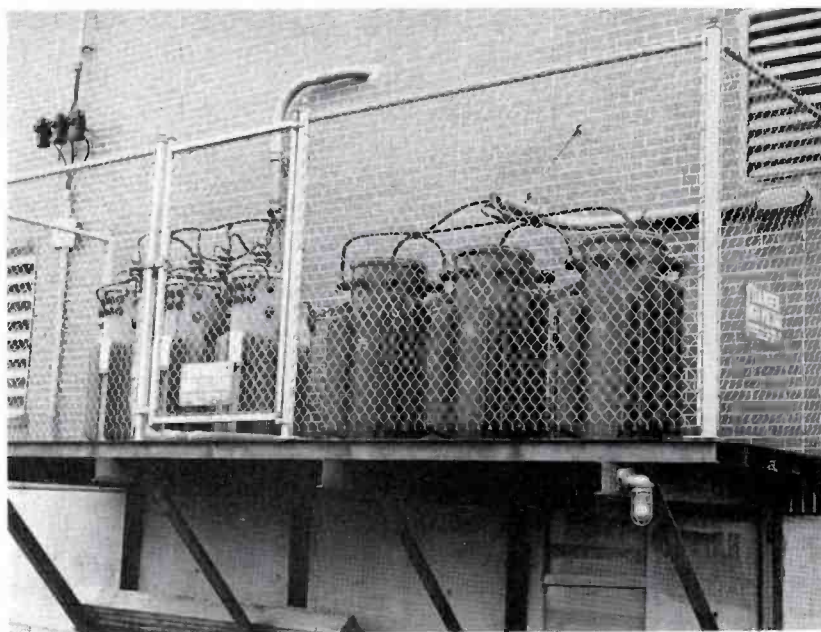

FIG. 4. All power transformers at WINS are on this raised platform at the side of the building. The three transformers at the left are for the BTA-50G while the three at the right, are used to step down the 4100-volt line.

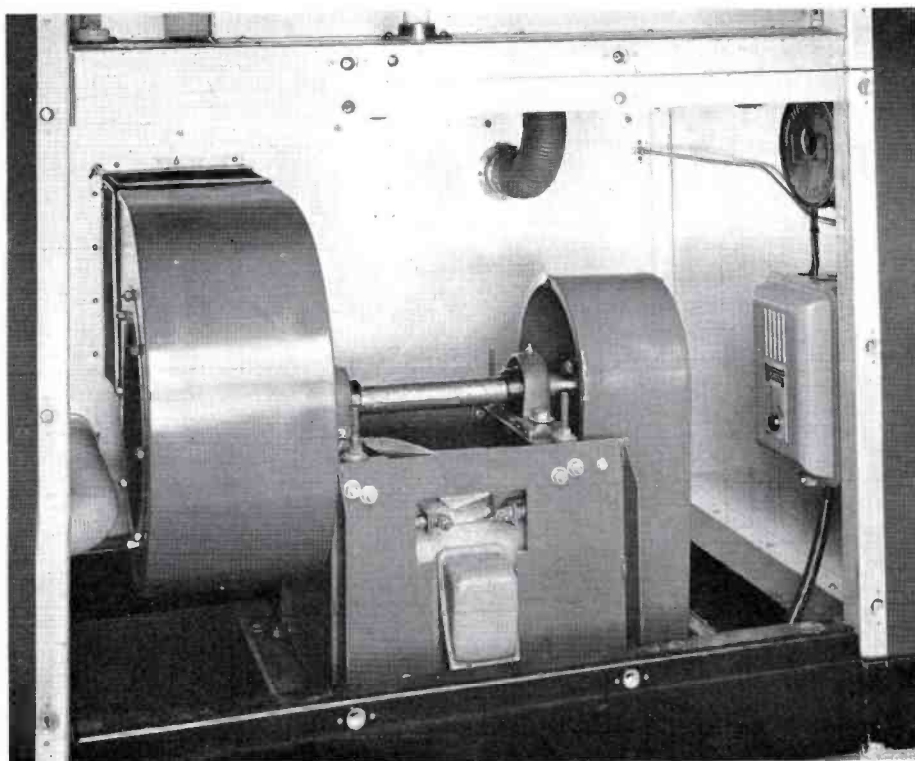

FIG. 5. This is one of the blower units used to cool the BTA-50G. Two of these units are used, one in each PA cubicle.

The BTA-50G operates on a 3-phase, 60-cycle, 460-volt line and this required a 225-kva substation to step down the line from 4,100 volts. Another 45-kva substation provides power for the 10-kw standby transmitter. Outdoor location of the power transformers improves cooling, and it also saves more floor space within the transmitter building (see Fig. 4).

Cooling

The BTA-50G is air cooled (see Fig. 5) by blowers set at bottom of each PA cubicle. WINS has installed a 20-by-40-inch, air-exhaust duct that runs along the top of the four cubicles. The two blower units are mounted directly on the concrete floor to reduce vibration. The old composite transmitter was water cooled, and the plumbing for this was removed just after the BTA-50G was put into operation. However, WINS is using the old cable trenches under the BTA-50G for air-intake ducts. Because of high industrial smog conditions, WINS uses electrostatic air cleaners to filter the intake air. The transmitter uses impingement-type air filters as standard equipment. Actually, the type of filter is largely a matter of station choice and local conditions may also affect the choice.

The two 5671 triodes in the power amplifiers have been in service for over 12,000 hours at WINS. These air-cooled tubes operate with minimum heat radiation. Since the amplitude system of modulation elimi-

nates the high level modulator stages, the heat radiated is less than that of conventional modulation systems.

Wiring

Built-in shielded wire ducts run along the top rear of the four cubicles of the BTA-50G. Terminal blocks mounted in these ducts simplify wiring and maintenance (see Fig. 6). WINS has eliminated external wiring trenches. The left PA cubicle of the WINS BTA-50G is placed directly against a wall, and the top plate was cut to bring the wiring out at this point. Normally, the wiring is brought out at the end of the rectifier cubicle to connect with the wall-mounted switch gear.

The aluminum cabinets of the BTA-50G not only reduce weight, but provide excellent shielding. Spurious radiation is well within the current FCC specifications, and the transmitter was designed with the thought that these regulations may be tightened in the future.

Automatic Standby

The unbalanced 50-ohm output of the Ampliphase Transmitter is fed through a 3 $\frac{1}{8}$ -inch coaxial line to an automatic switch. If the BTA-50G should go off the air, the 10-kw standby transmitter is automatically turned on, and the output of the 10-kw unit is switched into the antenna system. This automatic relay switching assures continuous operation, and lost air time is kept to the absolute minimum.

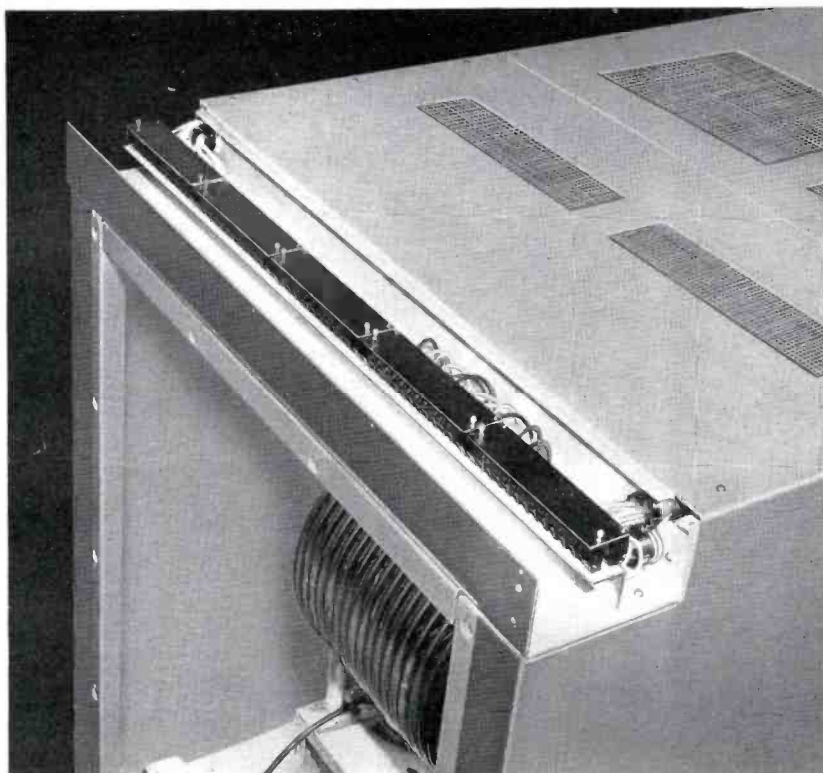

FIG. 6. Built-in shielded wire ducts run along the top of each cubicle. Wiring is normally brought out at the rectifier cubicle, but WINS brought the wiring out on the end PA cubicle for convenience to the wall-mounted switch gear.

FIG. 7. This is the WINS transmitter building in Lyndhurst, New Jersey. The antenna system is directly behind the building.



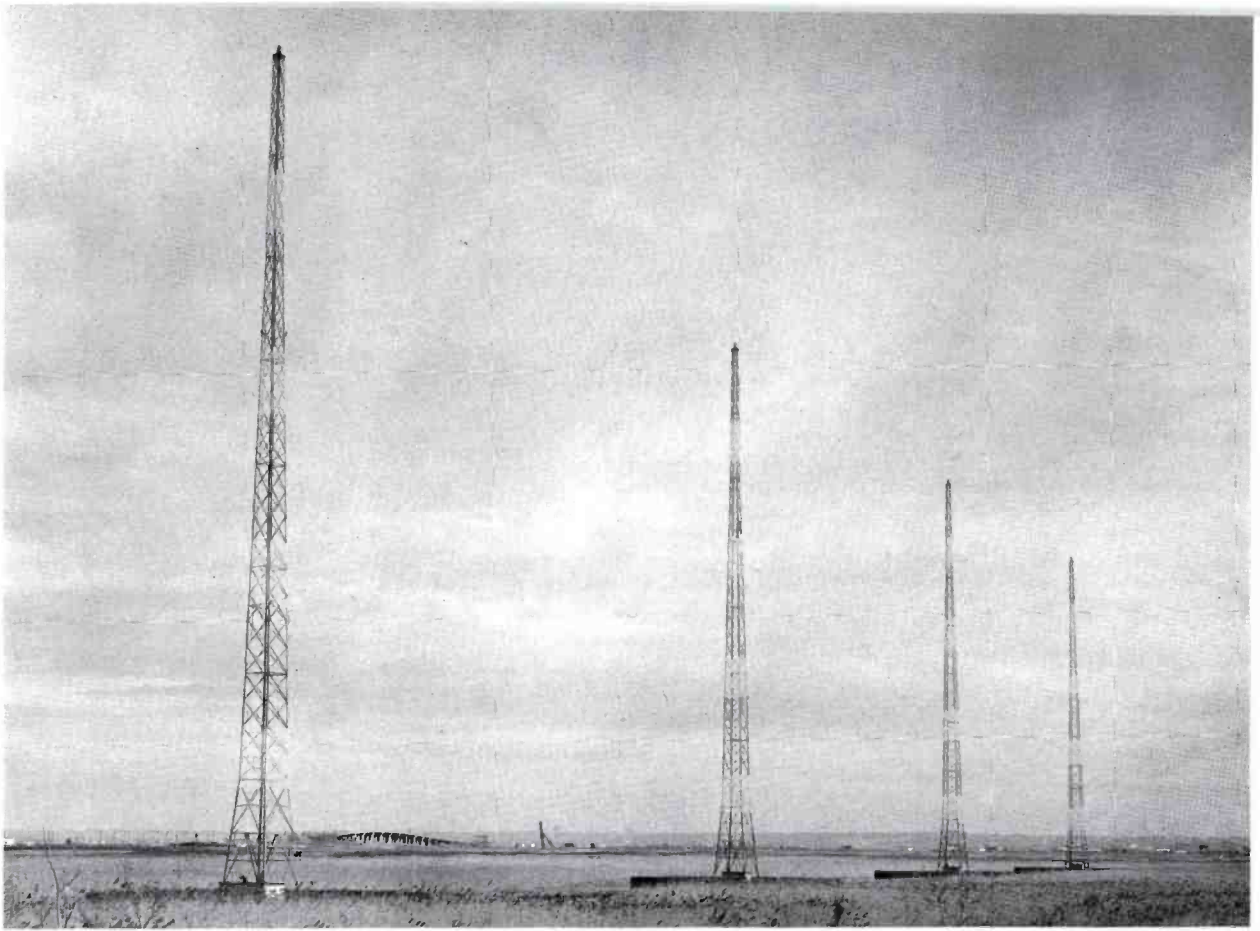

FIG. 8. A four-tower array is used by WINS to meet a tight directional pattern. The towers are surrounded by marsh which greatly improves conductivity.



FIG. 9. Paul Von Kunits, WINS Chief Engineer, holds the new RCA 50-kw dummy load. This unit requires only 15 gallons of ordinary tap water per minute to dissipate up to 75-kw (a 50-kw transmitter produces 75-kw of power at 100 per cent modulation).



FIG. 10. Alfred Jorgenson, WINS Transmitter Engineer, is shown at the 76B Console in the transmitter building. One of the 70C Turntables is on his right. The input and monitoring equipment is to the rear within arm's reach. This console and turntable can be used to originate programs at the transmitter site.

Antenna System

WINS has a very tight directional radiation pattern to maintain. Four self-supporting towers make up the array. The antenna system is located behind the transmitter building in a marsh. The ground has very high conductivity which greatly improves the radiated signal (see Fig. 8). The bases of the towers are surrounded by water most of the year.

Additional Equipment

WINS continues to use the input and monitoring equipment installed prior to World War II. A 76B Console is used as a transmitter control console, and it can be used to originate programs from the transmitter site along with two 70-C Turntables which can be used for air work at the transmitter (see Fig. 10). The new dummy load for the BTA-50G is shown in Fig. 9. The amazingly small size of this dummy load makes it a very practical item. A flow of fifteen gallons of ordinary tap water per minute is the only cooling needed, and the dummy load can

normally be mounted on a wall. At WINS the dummy load will be placed in a cabinet in the new workshop.

Reduced Operating Costs

Low power consumption of the BTA-50G has saved WINS approximately \$1,000 per month on power. At average modulation the BTA-50G consumes only 100 kw of power. Paul Von Kunits, WINS Chief Engineer, also estimates an additional \$200 per-month savings on tube costs. The only tubes that have been replaced have been small tubes and rectifiers.

Another saving that is inherent with the phase to amplitude system of modulation is the reduced tube inventory. Elimination of the high-power modulator eliminates these high-power tubes, and obviously no spares are needed. This saving is realized not only in dollars, but also in floor space.

Reduced Maintenance

WINS has been able to cut maintenance time with the smaller and easy to operate BTA-50G, since the entire transmitter is

contained in only four cabinets. Elimination of a high-level modulator reduces maintenance time, as well as reducing tube costs.

The dual exciter-modulator section is the heart of the transmitter. These dual units also provide extra protection; if one exciter should fail, the other can immediately be put into operation without lost air time.

Proven Performance

WINS was the first station to install a BTA-50G Transmitter; and after months of reliable 24-hour-a-day service, WINS has decided to equip its sister station KDAY, Los Angeles, with another Ampliphase Transmitter. KDAY will soon put a BTA-50G on the air, and the same economical service can be expected from this second transmitter. WINS is an example of a up-to-date 50-kw station which realizes the savings that can be obtained with the BTA-50G Ampliphase Transmitter, at the same time achieving reliable operation and increased coverage.

FIG. 1. The Type BQ-51A/BA-51A Magnetic Disc Recorder, shown here, is a completely self-contained unit. The only external equipment required for recording is a microphone which plugs in under the meter. This unit can also be used for playback.



THE RCA MAGNETIC DISC RECORDER

New Technique Makes Possible Fast Recording and Playback of Commercials and Announcements; Incorporates Automatic Cue; and Paves Way for Automatic Programming

by G. C. WEILENMANN
Broadcast and Television Sales

A new means of recording has been developed by RCA that combines the advantages of magnetic tape with those of phonograph discs. Using pregrooved magnetic discs, this method meets the broadcaster's requirements for fast recording and playback of spot announcements, commercials, station identification, etc. Not only does it improve present station performance—it also becomes an integral part of a future automatic programming system, since it is readily adaptable to record-changing mechanisms that are now enjoying increasing popularity in broadcast use.

This RCA magnetic recording system is extremely simple in operation, minimizing the skill required to produce a professional recording. Grooves for the recording are molded into the blank discs. Since cutting mechanisms, optical devices, and heated styli are no longer required, the recording operation is considerably simplified. In addition, the same equipment serves both for recording and for playback.

Typical Operation

In the recording operation the magnetic disc turntable (BQ-51A) is started, and the magnetic pickup is placed in the outer



FIG. 2. This is the Type BA-51A Recording Amplifier. Note the microphone connector under the meter. The red panel light glows when the amplifier is in the record position. Cue burst is inserted with the small "cue" push-button switch.

groove of the magnetic disc. The output level of the BA-51A Recording Amplifier is adjusted by a panel control and observed on the self-contained volume-indicating meter (see Fig. 2).

The amplifier also provides a cue signal that can be recorded at the beginning and again at the end of recorded information, to facilitate operation in an automatic playback mechanism. The cue signal is inserted by operation of a push button switch, located on the front panel. On manual playback the cue signal is not required and this function can be omitted.

When the recording operation is completed, immediate playback is accomplished by merely switching the BA-51A Amplifier to the playback position, and again engaging the magnetic pickup in the outer groove of the magnetic disc.

Information recorded on the magnetic disc may be erased by placing the disc in an eraser unit which is included in the system. Discs can therefore be re-recorded many times.

The following summary of the operation of this new system—including magnetic disc, magnetic tone arm and head, BA-51A Amplifier, BQ-51A Turntable, BQ-104 Automatic Turntable, and the disc eraser—will explain the functions provided by each equipment unit.

Magnetic Disc

The pregrooved magnetic disc has a physical appearance similar to the con-



FIG. 3. Pregrooved magnetic discs are same size and shape as conventional 45-rpm records.

ventional 7-inch 45-rpm phonograph record. Information may be recorded on both sides. Magnetic discs are extremely rugged, not easily scratched, and can be played innumerable times. Recorded information can easily be erased, permitting re-use of the disc (see Fig. 3).

The magnetic discs are molded from a uniform dispersion of iron oxide particles in a synthetic elastomer (rubber type) binder with various plasticisers, lubricants, and other additives mixed in to give the material the desired physical properties. An aluminum plate is imbedded between the two magnetic layers to provide rigidity. A distinctive label is provided on each side of the disc to allow identification of title,

date, file number, artist's name, sponsor and playing time.

A maximum recording time of sixty seconds is obtained from each side of the disc, plus an additional ten seconds for "cue-in" and "trip-out" cue tones. These cue signals are used when automatic operation is planned. The frequency response extends over the range of 100 to 10,000 cps. The grooves are maintained to specific dimensions that provide good tracking of the magnetic head and optimum performance with regard to cross talk. Cross talk decreases rapidly as the wavelength becomes shorter; therefore, wide-groove spacing and 33 $\frac{1}{3}$ -rpm speed were determined to be the best combination.

Magnetic Head and Tone Arm

The magnetic head used in the system consists of two C-shaped laminations made of material that is extremely hard physically, but very soft magnetically. The head assembly is mounted in a mu-metal shield with the pole tip protruding through a narrow slot. An epoxy resin is used to provide protection against moisture (see Fig. 4).

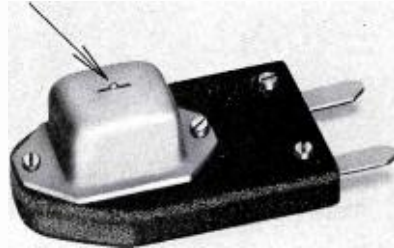

FIG. 4. This is the magnetic recording head. The pole pieces, which do the recording, protrude through the narrow slot (note arrow). Operation of head is very similar to a tape recording head.

A newly designed tone arm is a companion unit for the magnetic head (see Fig. 5). It will also conveniently handle the standard MI-11874-4 and 11874-5 pickups by means of a plug-in socket arrangement. Thus, it is obvious that the turntable can also be used for reproducing transcriptions and phonograph records up to 12 inches in diameter.

BA-51A Amplifier

A new amplifier was designed to perform both the recording and the reproducing functions. With its self-contained power supply, the amplifier may be installed in either a BQ-51A Manual Turntable or a BQ-104 Automatic Turntable. Provisions

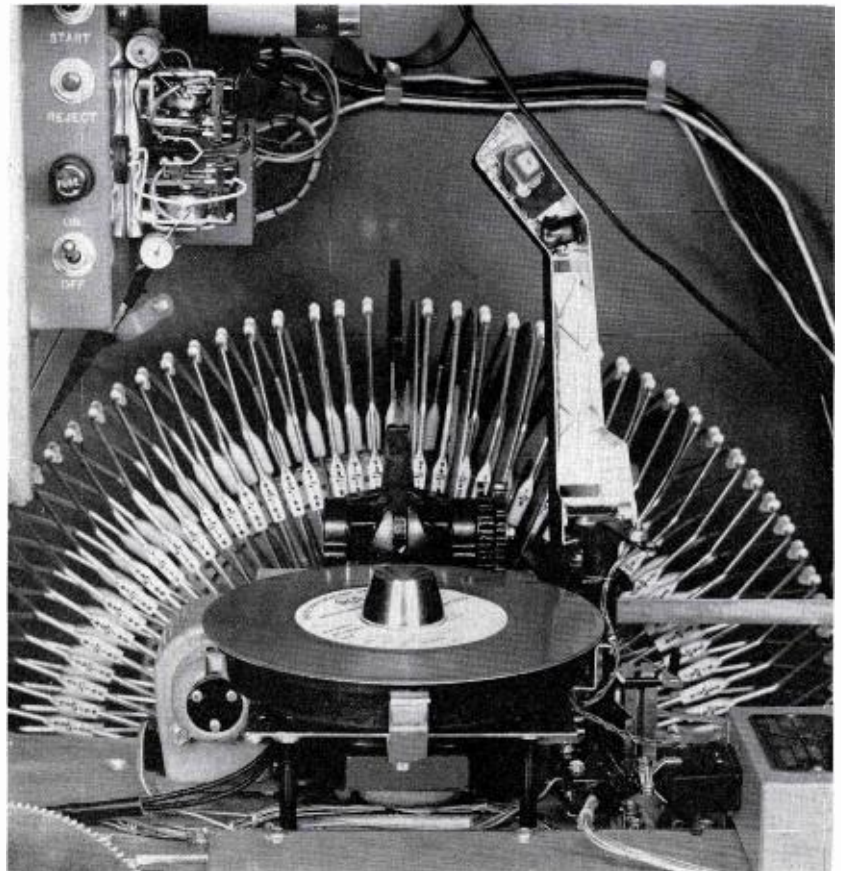

FIG. 5. A new tone arm is shown mounted in a Type BQ-104 Automatic Turntable. Standard pickup heads can be used interchangeably with the magnetic head in the BQ-51A.

have been included in the design to guard against accidental erasure.

Selection of the operational function is achieved by means of a record/play switch. A red warning light glows when switched to the record position. Recordings may be made directly from a microphone plugged into the connector provided for this purpose on the front panel, or from a program line connected to bridging input terminals located at the rear of the amplifier chassis. An illuminated volume indicator and independent gain controls are available for obtaining proper signal levels for both the record and the reproduce functions.

During recording, the amplifier provides pre-emphasis of high frequencies. In playback the amplifier frequency compensation is changed to provide a boost of low frequencies. Thus, the over-all frequency response is equalized from 100 to 10,000 cycles per second. A push-pull oscillator provides the a-c bias current for recording.

A special feature of the amplifier is the push-button controlled 10-kc oscillator which provides a cue signal for recording at the beginning and end of the message. These signals are utilized in the BQ-104 Automatic Turntables to "cue in" the disc to the start of the message and to "trip out" the change mechanism at the end of the message. To prevent a 10-kc signal, which may be present in the audio signal, from being recorded a twin-T notch filter is incorporated in the amplifier. The same circuit is used during playback to prevent a cue signal from reaching the program output terminals. The cue signal is amplified by a separate amplifier circuit, which is peaked to select the 10-kc signal, rectified and, in turn, used to control a plate circuit relay.

In the design of the amplifier extensive care was taken to minimize hum and noise. The input transformer is extremely well shielded and the heater power of the input tube is obtained from the self-contained d-c supply.

BQ-51A Manual Turntable

The BQ-51A is a two-speed turntable that will accommodate 45 and 33 $\frac{1}{3}$ -rpm records up to 12 inches in diameter. The cabinet is designed so that the BA-51A Amplifier can be easily installed, and the tilted front panel provides a maximum of operating convenience. The BQ-51A Turntable may, of course, be used to play standard records when equipped with a proper pickup cartridge and equalizing pre-amplifier such as the BA-26A. The turntable mechanism is of the rim-drive type with a hysteresis synchronous motor.

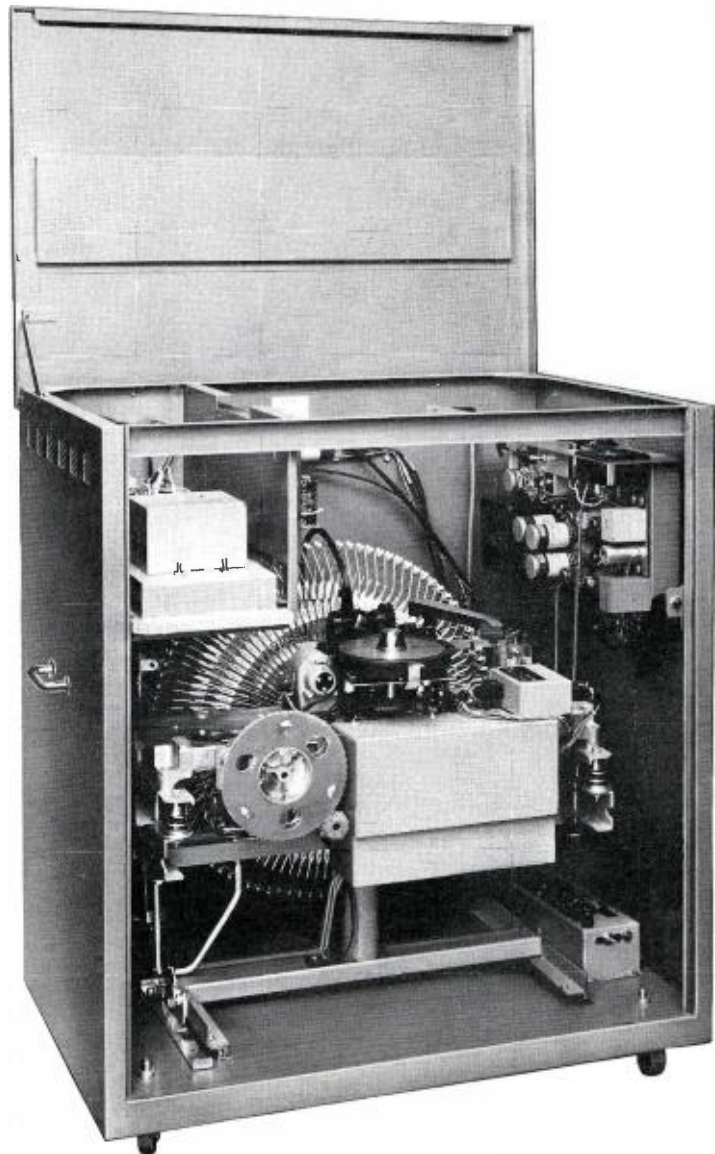

FIG. 6. Here is a Type BQ-104 Automatic Magnetic Disc Turntable. The BA-51A Amplifier is placed in upper right corner. Magnetic discs are placed in basket, at the rear of cabinet, where it is possible to store 100 discs.

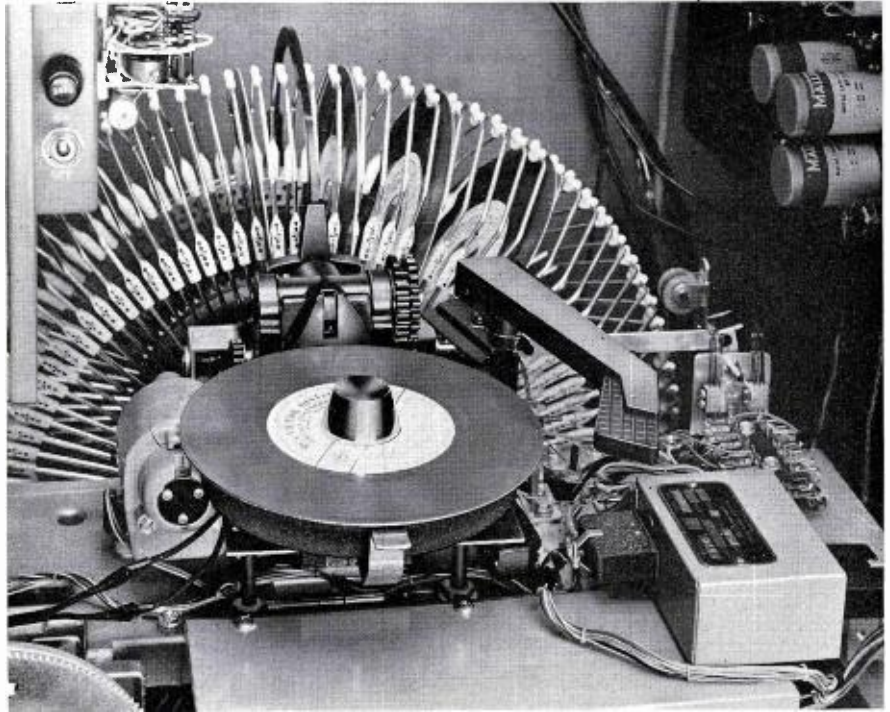
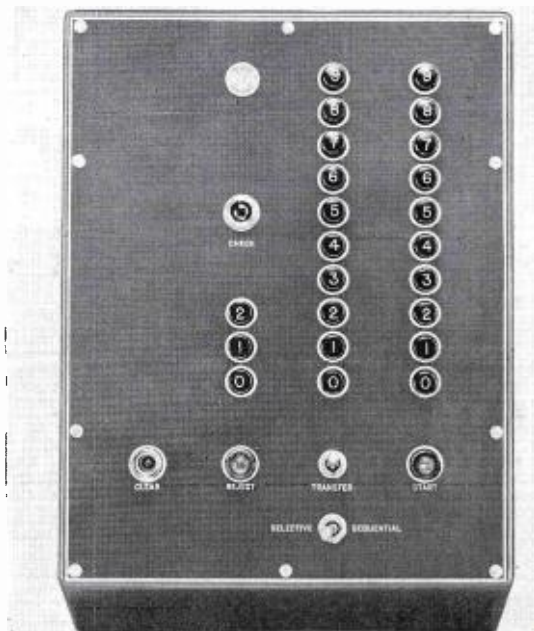

FIG. 7. The BQ-104 Turntable, shown here, is similar to a conventional 45-rpm unit. Discs are removed from the basket by the curved arm mounted over the basket and placed on the turntable automatically.

FIG. 8. Random and sequential selection of magnetic discs in a BQ-104 can be made on this control box; however, when the BQ-104 is operated in the automatic programming system, this control unit is replaced by automatic equipment.



The BQ-104 Automatic Turntable

The BQ-104 Automatic Magnetic Disc Turntable has storage capabilities for 100 magnetic discs (200 selections). (See Figs. 6 and 7.) A manual control box makes it possible to play selections in any sequence (see Fig. 8). The turntable mechanism operates at $33\frac{1}{3}$ -rpm speed and is similar to the BQ-103 Automatic Turntable that handles conventional 45-rpm records.

The BQ-104 design provides improved magnetic shielding. It includes a BA-51A Amplifier, mounted in the cabinet, and positioned for convenient access to controls.

Disc Eraser

A bulk eraser has been included in the magnetic recording system to provide convenient and speedy erasure of the material stored on the magnetic disc. (It may also be used for removing recorded ma-

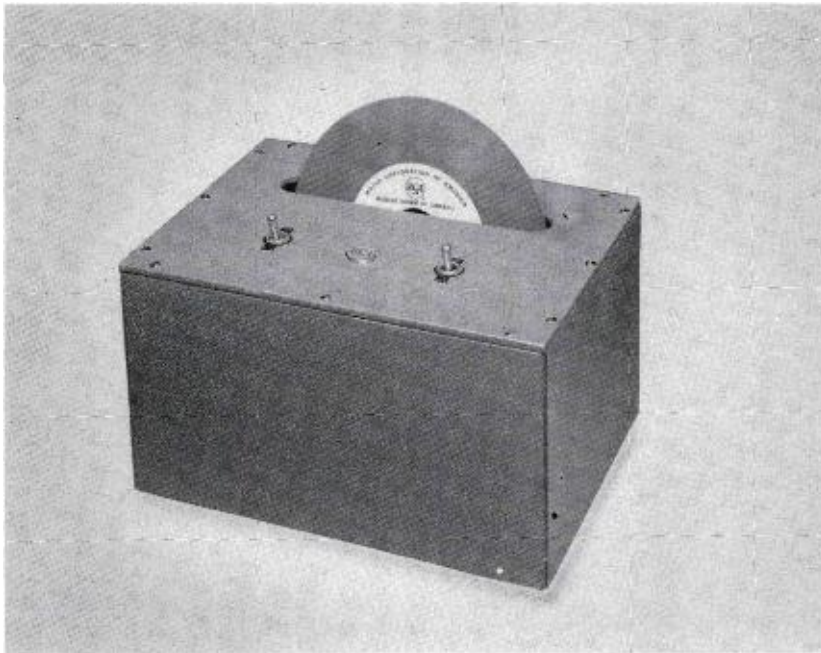

FIG. 9. Magnetic discs are erased in this bulk eraser unit. Two complete revolutions of the disc are sufficient for complete erasure.

terial from standard magnetic tapes.) In operation a magnetic field is produced by an elongated coil that is energized directly from the a-c line. Disc is inserted through slot in top of eraser case (see Fig. 9). It is held by two V-groove rubber rollers so as to be centered in the coil. One of the rollers is driven by a small electric motor which causes the disc to rotate slowly. After two or more revolutions the disc may be slowly withdrawn from the eraser. The disc is then ready to be re-recorded. Both sides of the disc are erased at the same time.

System Advantages

The RCA magnetic disc recording equipment provides an easy-to-operate means for producing broadcast commercials. The ability to erase and re-use the discs means lower cost, since announcements may be rehearsed until the desired results are obtained. The extremely durable construc-

tion of the disc greatly reduces the problem of breakage, providing long recording life. The magnetic disc, therefore, makes it possible to have the advantages of magnetic tape recording in addition to the operating convenience afforded by the conventional recording disc.

This magnetic disc system can be the first of the building blocks acquired by a broadcast station in preparing for automatic programming.* It paves the way for acquisition of companion units, such as automatic turntables for handling conventional recordings, and for handling magnetic disc commercials and announcements. Furthermore, the addition of the magnetic disc recorder not only prepares for the future, it also improves present-day operation.

* "Automatic Programming Equipment for Radio Broadcast Stations," *Broadcast News*, Vol. No. 101, August, 1958.

DESIGN METHODS TO IMPROVE THE STABILITY OF AM DIRECTIONAL ANTENNA SYSTEMS

by GEORGE H. BROWN, Chief Engineer, Industrial Electronic Products

On September 15, 1957, the Federal Communications Commission amended its remote-control rules to include stations operating with powers greater than 10 kilowatts and/or a directional antenna. To comply with the new requirements, a directional station applying for remote-control privileges must have an extremely stable antenna system and must also attest to its stability. This paper deals with a number of design factors which are important in achieving stability in AM directional arrays. A method of inversion is displayed. This method enables the designer to obtain an alternate configuration when undesirable impedance values occur in a design. Extensive examples and illustrations are used.

Introduction

The stability of directional AM antenna systems is important to successful remote control operation. In addition to the provision of an adequate ground system,¹ attention should be given to bonding of the connecting elements, positioning of guy insulators, base insulators with sufficient leakage paths, and low-loss capacitors and inductors in the phasing and power-dividing networks.²

As a further aid to achieving stability, some steps may be taken in the initial design. In some arrays, where the currents are not all equal, the designer may examine the design to learn if inversion is likely to offer an alternative configuration which will possess a greater inherent stability. In cases where inversion fails to give a new solution, circuitry may be employed which offers an advantage. The method of inversion will be illustrated by a number of examples.

¹"Ground Systems as a Factor in Antenna Efficiency," *Proc. I.R.E.*, Vol. 25, No. 6, June, 1937.

²"Installing Antenna Systems for AM Operations," *Broadcast News*, Vol. No. 95, June, 1957.

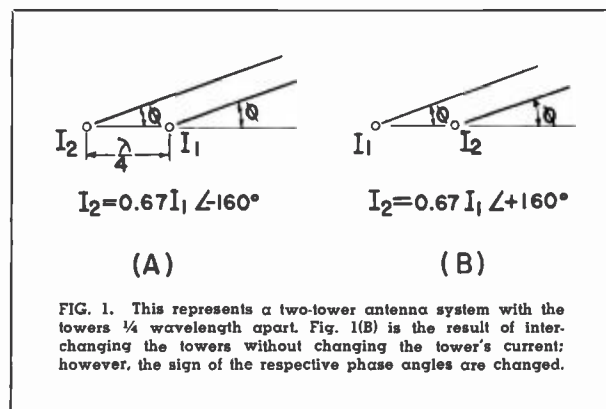

The Inversion Method

As a first example of the method of inversion, let us examine the arrays shown in Fig. 1. In both cases, Figs. 1(A) and 1(B), the towers are spaced apart one quarter of a wavelength. Figure 1(B) is obtained from Fig. 1(A) by interchanging the two towers, keeping the currents unchanged in the two towers as we move them but changing the sign of the respective phase angles. The field intensity pattern of the array shown in Fig. 1(A) may be written:

$$\begin{aligned}
 F &= K [I_1 + I_2 \angle -90^\circ \cos \phi] \\
 &= K I_1 [1 + 0.67 \angle -160^\circ - 90^\circ \cos \phi] \\
 &= K I_1 [1 + 0.67 \cos (160^\circ + 90^\circ \cos \phi) \\
 &\quad - j 0.67 \sin (160^\circ + 90^\circ \cos \phi)]
 \end{aligned} \tag{1}$$

The field intensity pattern of the array in Fig. 1(B) is:

$$\begin{aligned}
 F &= K [I_1 + I_2 \angle +90^\circ \cos \phi] \\
 &= K I_1 [1 + 0.67 \angle +160^\circ + 90^\circ \cos \phi] \\
 &= K I_1 [1 + 0.67 \cos (160^\circ + 90^\circ \cos \phi) \\
 &\quad + j 0.67 \sin (160^\circ + 90^\circ \cos \phi)]
 \end{aligned} \tag{2}$$

Thus we see that the absolute values of equations (1) and (2) as functions of ϕ are identical, if the values of I_1 in the two equations are equal. An examination of the circuit relations of these two arrays, with due consideration for the effect of mutual impedances,³ reveals that this equality exists in addition to the other results displayed in Table 1. This table shows that in Fig. 1(B) we have a condition where most of the power flows into antenna 1. In fact, the power into antenna 2 is so small that it may be neglected and antenna 2 may be operated as a parasitic reflector. This is not a desirable state, since one has very little control over the magnitude of the current and the phase angle with parasitic operation. The arrangement of Fig. 1(A) would provide an array of greater inherent stability.

³"Directional Antennas," *Proc. I.R.E.*, Vol. 25, No. 1, January, 1937.

TABLE 1
Operating Conditions of Two-Tower Array
Shown in Fig. 1.

	Current, in Amperes		Resistance, in Ohms		Power, in Watts	
	I_1	I_2	R_1	R_2	P_1	P_2
Before Inversion (see Fig. 1a)	6.04	4.05	20.5	15.5	746	254
After Inversion (see Fig. 1b)	6.04	4.05	27.18	0.61	990	10

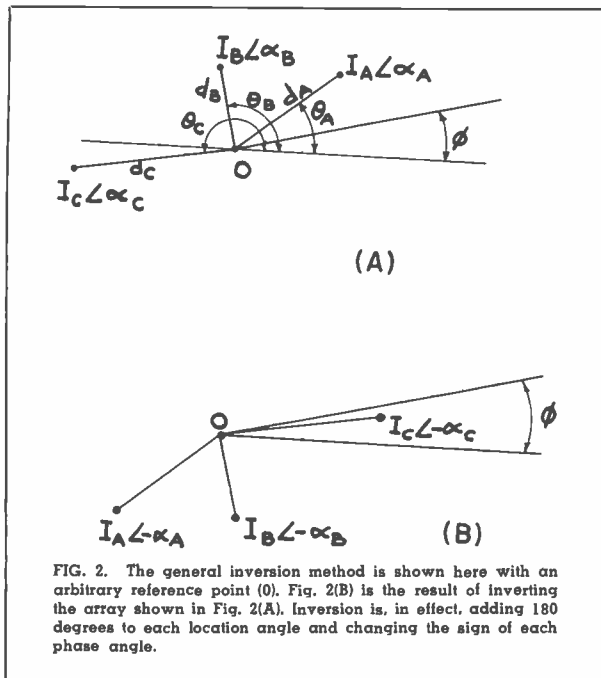

FIG. 2. The general inversion method is shown here with an arbitrary reference point (O). Fig. 2(B) is the result of inverting the array shown in Fig. 2(A). Inversion is, in effect, adding 180 degrees to each location angle and changing the sign of each phase angle.

The general method of inversion is illustrated by Fig. 2. Figure 2(A) shows a general configuration of three antennas. The location of the reference point, O, is purely arbitrary. To invert, each antenna element of the array is moved on a straight line through the reference point to a new location which places the element at the same distance from the reference point as before. This is equivalent to adding 180 degrees to each location angle. At the same time, the phase angle of the current in the element is reversed in sign. Thus, Fig. 2(B) is an inversion of the array shown in Fig. 2(A).

The field intensity pattern of the array of Fig. 2(A) is:

$$F = K \left[I_A \angle \alpha_A + \frac{360^\circ d_A}{\lambda} \cos(\phi - \theta_A) \right. \\ \left. + I_B \angle \alpha_B + \frac{360^\circ d_B}{\lambda} \cos(\phi - \theta_B) \right. \\ \left. + I_C \angle \alpha_C + \frac{360^\circ d_C}{\lambda} \cos(\phi - \theta_C) \right] \quad (3)$$

TABLE 2
Operating Conditions of Three-Tower Array
Shown in Fig. 3.

	Current, in Amperes			Resistance, in Ohms			Power, in Watts		
	I ₁	I ₂	I ₃	R ₁	R ₂	R ₃	P ₁	P ₂	P ₃
Before Inversion (see Fig. 3a)	4.21	4.21	2.105	20.89	21.61	56.20	370.00	383.00	247.00
After Inversion (see Fig. 3b)	4.21	4.21	2.105	26.52	25.75	16.92	471.00	456.00	73.00

or:

$$F = K \left[I_A \cos \left(\alpha_A + \frac{360^\circ d_A}{\lambda} \cos[\phi - \theta_A] \right) \right. \\ \left. + I_B \cos \left(\alpha_B + \frac{360^\circ d_B}{\lambda} \cos[\phi - \theta_B] \right) \right. \\ \left. + I_C \cos \left(\alpha_C + \frac{360^\circ d_C}{\lambda} \cos[\phi - \theta_C] \right) \right. \\ \left. + j \left\{ I_A \sin \left(\alpha_A + \frac{360^\circ d_A}{\lambda} \cos[\phi - \theta_A] \right) \right. \right. \\ \left. + I_B \sin \left(\alpha_B + \frac{360^\circ d_B}{\lambda} \cos[\phi - \theta_B] \right) \right. \\ \left. + I_C \sin \left(\alpha_C + \frac{360^\circ d_C}{\lambda} \cos[\phi - \theta_C] \right) \right\} \right] \quad (4)$$

The field intensity pattern of the inversion in Fig. 2(B) is obtained by writing $-a$ for α and $-d$ for d in equation (4). It is readily seen that the absolute values of equation (4) remain unchanged.

Another example of the method of inversion applied to a three-element array is shown in Fig. 3. The arrangement of Fig. 3(A) affords a reasonable distribution of power into the three elements¹ while the inversion requires a less desirable distribution. Table 2 displays the operating conditions relating to the two configurations.

¹ *Ibid.*, p. 101.

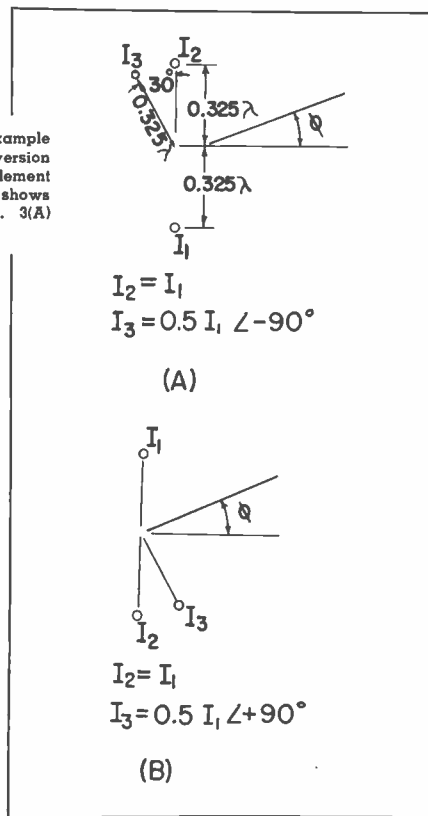

FIG. 3. Another example of the method of inversion applied to a three-element array. Figure 3(B) shows the system in Fig. 3(A) after inversion.

TABLE 3

Operating Conditions of Four-Tower Array Shown in Fig. 4.

	Current, in Amperes				Resistance, in Ohms				Power, in Watts			
	I ₁	I ₂	I ₃	I ₄	R ₁	R ₂	R ₃	R ₄	P ₁	P ₂	P ₃	P ₄
Before Inversion (see Fig. 4a)	5.23 ^{100 P₁2}	1.61	1.61	4.86	36.45	0	0	0	1000.00	0	0	0
After Inversion (see Fig. 4b)	5.23	1.61	1.61	4.86	6.19	42.75	42.75	25.73	169.00	110.50	110.50	610.00

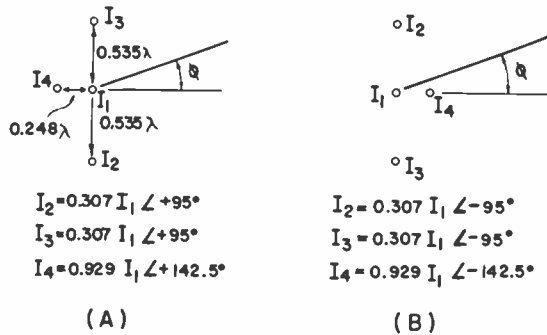

FIG. 4. Inversion produces great changes in resistance and power distribution for this four-element array. Figure 4(A) shows the configuration when all of the transmitter power is fed into antenna number 1 and the other antennas act as parasitic elements. Figure 4(B) displays the same system after inversion with power distributed among all four elements.

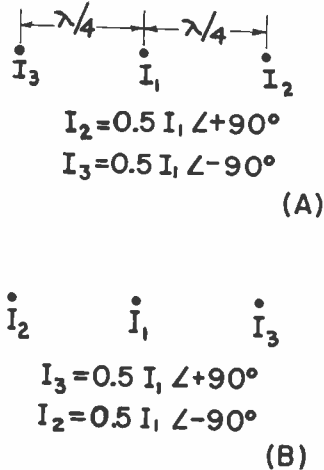

FIG. 5. Under certain conditions of current symmetry and geometrical symmetry, inversion fails to produce a new result. However, with special circuitry, stable and practical feed-point impedances may be obtained.

A striking example of the large changes in effective resistance and relative power distribution is displayed by the four-element array depicted in Fig. 4. In the arrangement of Fig. 4(A), the total power of the transmitter is fed to antenna 1 and the other antennas operate as parasitic elements. The inversion of Fig. 4(B) completely rearranges the power distribution, as shown in Table 3.

While the method of inversion offers a powerful means of obtaining a desirable redistribution of antenna parameters, it fails when a symmetrical array is encountered. This condition is illustrated by the array depicted in Fig. 5, where it may be seen that the inverted condition is identical with the original condition of Fig. 5(A). However, for an array of this type, we may resort to some rather special circuitry to obtain stability and to help in the problem of remote control.

Phase and Amplitude Control Under Stable Conditions

Before attacking the details of circuitry which is applicable to the array shown in Fig. 5, we shall examine some circuit elements that are useful. In Fig. 6, for example, we have a load R fed through a transmission line of characteristic impedance Z_c with a matching section at the end to convert the resistance R to match the transmission line. We choose the reactance elements X₁, X₂, and X₃ so that this match is effected and at the same time obtain a phase shift of ρ degrees.⁵ This phase shift is chosen so that ρ plus β is 90 degrees, or an odd multiple of 90 degrees. When the total phase shift designed into the over-all feed system is 90 degrees, the output lags the input

⁵ *Ibid.*, p. 130.

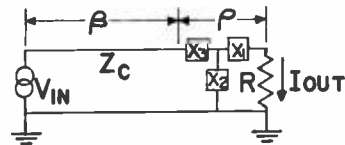

FIG. 6. A load (R) is fed through a line with a characteristic impedance of Z_c, and the matching section is needed to match R to the transmission line. X₁, X₂, and X₃ are selected to effect a phase shift of ρ degrees. The end object is to keep current in the same phase and magnitude when R changes in magnitude or becomes reactive.

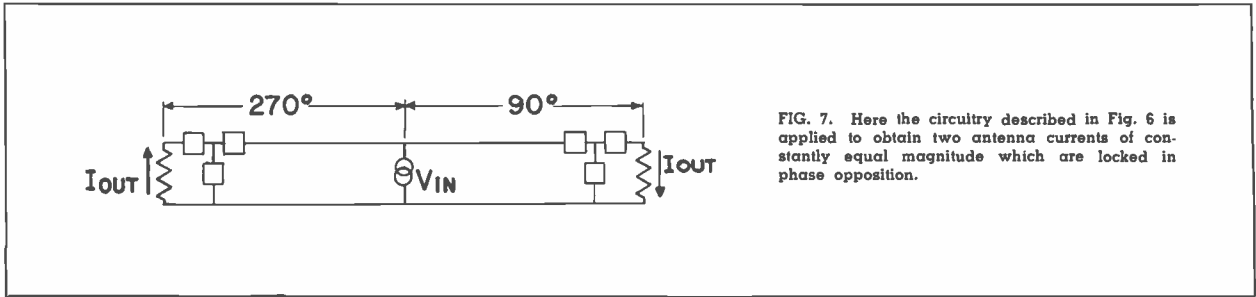

FIG. 7. Here the circuitry described in Fig. 6 is applied to obtain two antenna currents of constantly equal magnitude which are locked in phase opposition.

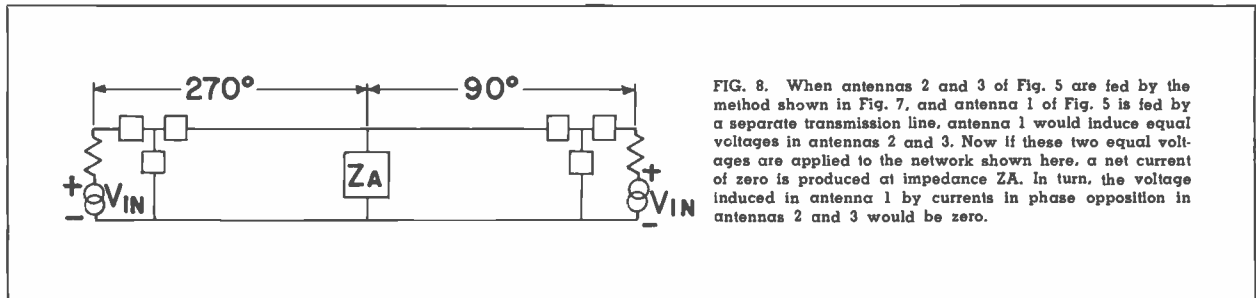

FIG. 8. When antennas 2 and 3 of Fig. 5 are fed by the method shown in Fig. 7, and antenna 1 of Fig. 5 is fed by a separate transmission line, antenna 1 would induce equal voltages in antennas 2 and 3. Now if these two equal voltages are applied to the network shown here, a net current of zero is produced at impedance Z_A . In turn, the voltage induced in antenna 1 by currents in phase opposition in antennas 2 and 3 would be zero.

voltage by 90 degrees, and a total phase shift in the feed system of 270 degrees results in an output current which leads the input voltage by 90 degrees. In either case, the output current remains constant in phase and magnitude when R changes in magnitude or becomes reactive. This condition may be used to insure stability.⁶

The circuitry of Fig. 7 shows a method of applying this principle to obtain two antenna currents which are locked in phase opposition, and locked in magnitude equality. This arrangement could be used to feed antennas 2 and 3 of Fig. 5. Then if the current in antenna 1 were obtained by a separate

transmission-line feed, this latter antenna would induce equal voltages in antennas 2 and 3. These voltages would be applied to the network of Fig. 7 as shown in Fig. 8. The two voltages when applied to this circuit would deliver a net current of zero to the impedance Z_A , when Z_A is located at the feed point of the network of Fig. 7. In turn, the net voltage induced in antenna 1 by the two currents in phase opposition in antennas 2 and 3 would be zero. These circuits may then be applied as shown in Fig. 9 to obtain the array conditions of Fig. 5. If the power divider of Fig. 9 permitted control of power division with a fixed phase shift and if the phase shifter permitted continuous phase shift without a change of input impedance, we could feed an array of the type of Fig. 5 with great inherent stability and a simple means of obtaining remote control.

⁶"Maintaining the Directivity of Antenna Arrays," *Proc. I.R.E.*, Vol. 22, No. 7, July, 1934.

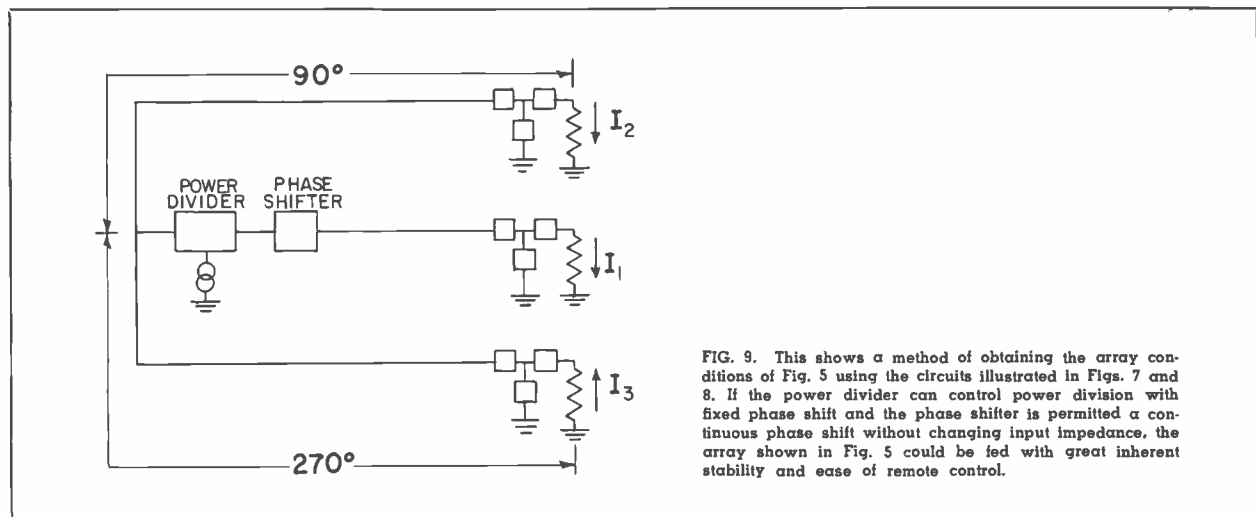
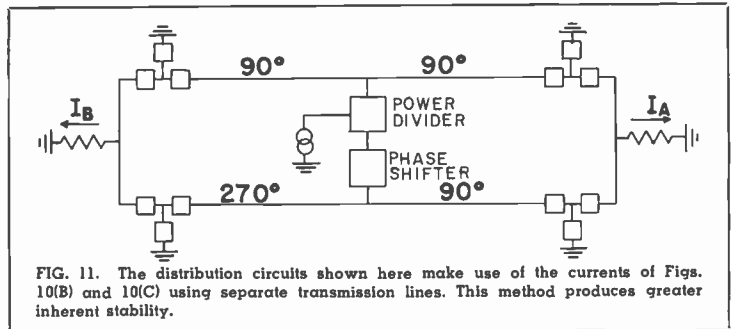
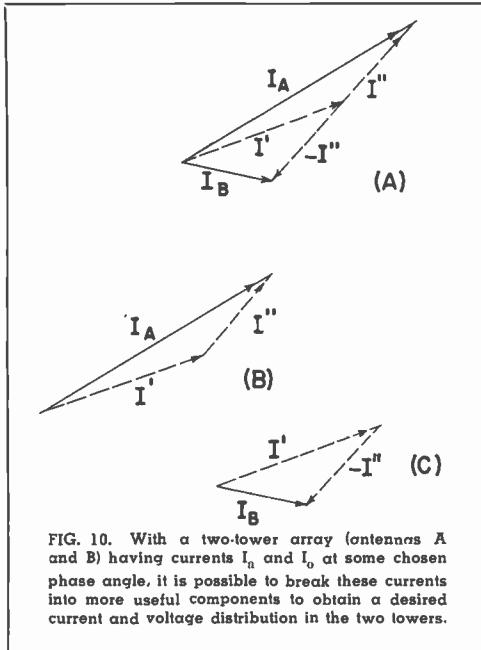
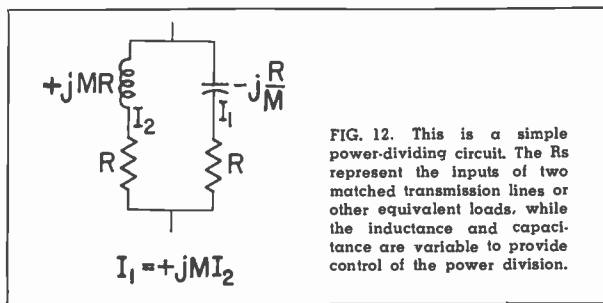

FIG. 9. This shows a method of obtaining the array conditions of Fig. 5 using the circuits illustrated in Figs. 7 and 8. If the power divider can control power division with fixed phase shift and the phase shifter is permitted a continuous phase shift without changing input impedance, the array shown in Fig. 5 could be fed with great inherent stability and ease of remote control.



The same principles may easily be applied to a two-element array with unequal currents in the two towers (or with equal currents). Let us suppose that we wish to feed two antennas, A and B, with currents I_A and I_B at some chosen phase angle. The construction of Fig. 10 shows how these currents may be broken into a useful set of components. Figures 10(B) and 10(C) show that I_A equals $I' + I''$ and I_B equals $I' - I''$. The circuit arrangement of Fig. 11 induces a current I' in each of the loads through the upper set of transmission lines and matching networks, while the lower set produces I'' in the right-hand load and $-I''$ in the left-hand load. The power divider and phase shifter provide complete control of relative phase and amplitudes of the two total currents while the phase lengths of the transmission lines and building-out sections provide inherent stability.



A simple power-dividing method is shown in Fig. 12. Here the two resistances R may be the inputs of two matched transmission lines or other equivalent loads. The inductance and capacitance are the variable elements which provide the control of power division. The current in the capacitive leg leads the current in the inductive leg by 90 degrees and is M times the current in the inductive leg. The input impedance of the network is a pure resistance of R ohms.⁷

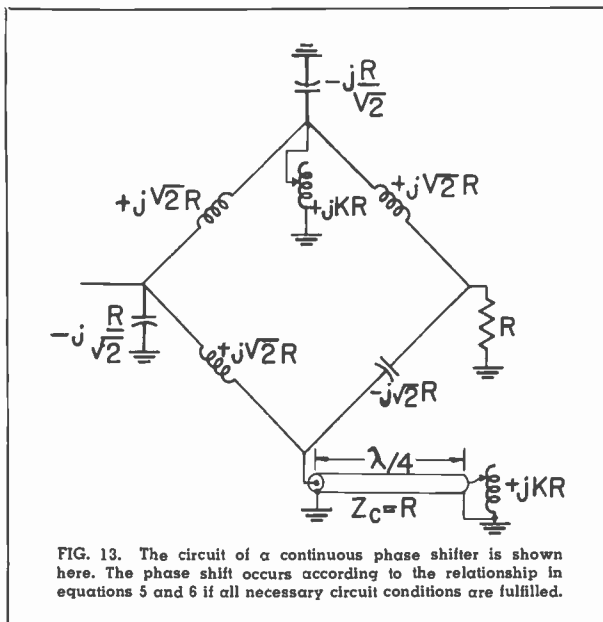

The circuit shown in Fig. 13 has useful properties as a continuous phase shifter. The quarter-wavelength of transmission line has a characteristic impedance equal to the load impedance R . The input impedance is a pure resistance of R ohms. The two variable elements are the identical inductances, each with a reactance of KR ohms. The output voltage remains equal to the input voltage and shifts in phase according to the relation:

$$E_{out}/E_{in} = 1.0 \angle \theta \tag{5}$$

where:

$$\tan \theta = \frac{-2K}{1-K^2} \tag{6}$$

As K varies from zero to infinity, θ progresses in a lagging fashion from zero to 180 degrees.

If the two variable inductors are replaced by variable capacitors of $-KR$ ohms, the phase shift is given by:

$$\tan \theta = \frac{2K}{1-K^2} \tag{7}$$

Conclusion

A method of inversion which is applicable to some directional arrays is explained and examples show how, in some cases, undesirable impedances may be avoided. Circuit arrangements which achieve inherent stability, as well as useful power-dividing and phase-shifting networks, have been developed.

⁷ "Adjusting Unequal Tower Broadcast Arrays," *Electronics*, December, 1943.

A good word about the RCA 5-KW AM Transmitter Type BTA-5H

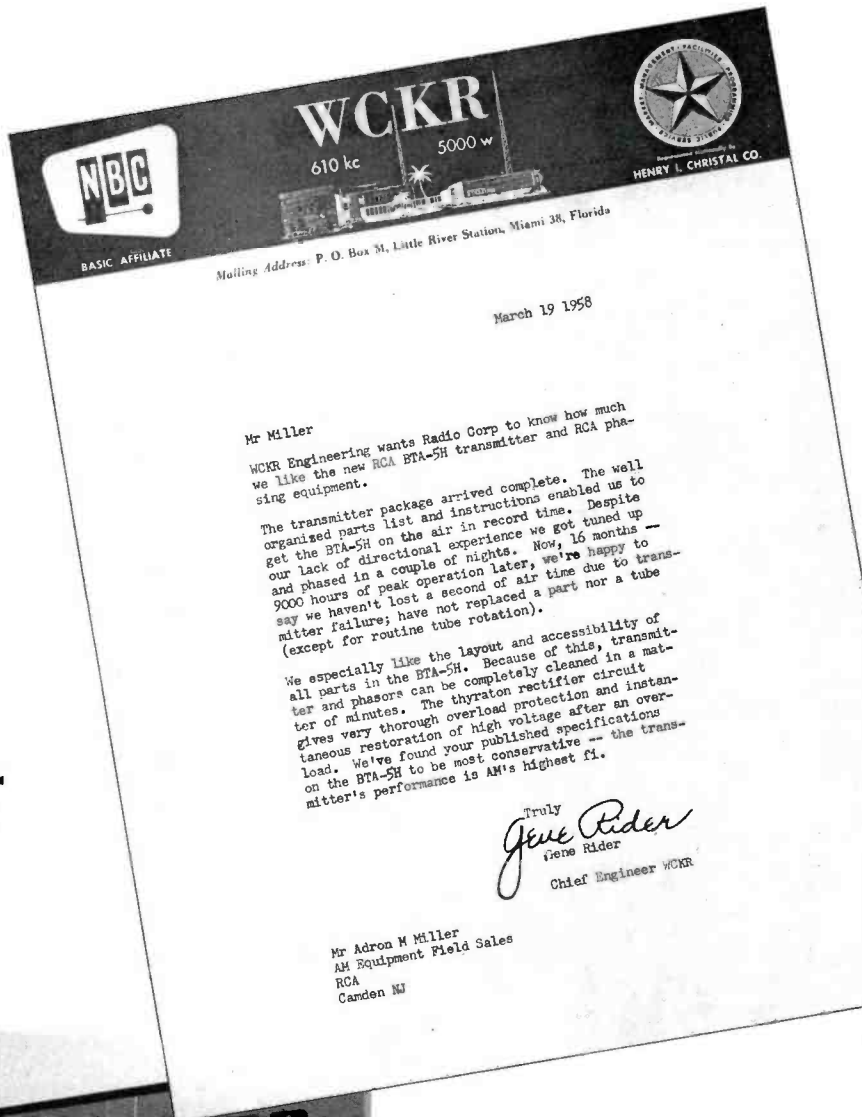
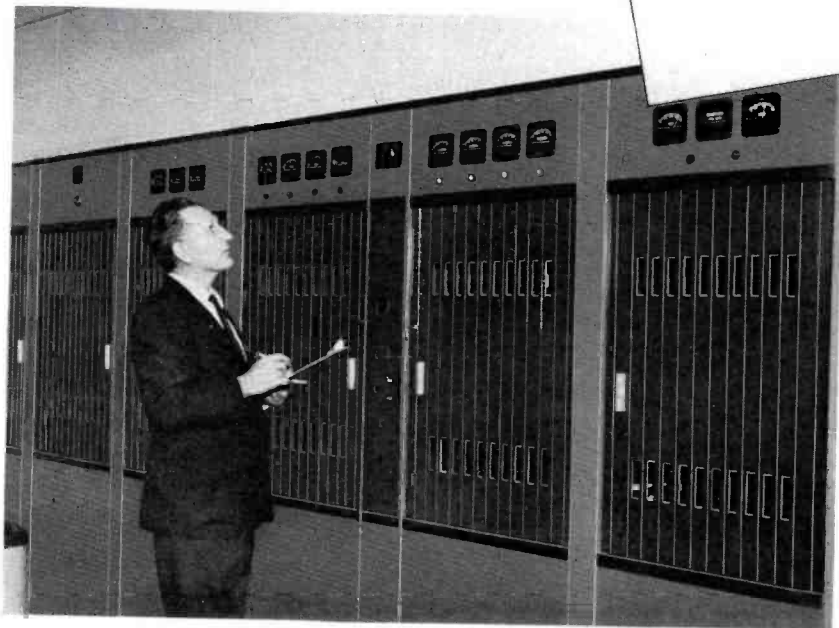

Mr Miller

WCKR Engineering wants Radio Corp to know how much we like the new RCA BTA-5H transmitter and RCA phasing equipment.

The transmitter package arrived complete. The well organized parts list and instructions enabled us to get the BTA-5H on the air in record time. Despite our lack of directional experience we got tuned up and phased in a couple of nights. Now, 16 months -- 9000 hours of peak operation later, we're happy to say we haven't lost a second of air time due to transmitter failure; have not replaced a part nor a tube (except for routine tube rotation).

We especially like the layout and accessibility of all parts in the BTA-5H. Because of this, transmitter and phasers can be completely cleaned in a matter of minutes. The thyatron rectifier circuit gives very thorough overload protection and instantaneous restoration of high voltage after an overload. We've found your published specifications on the BTA-5H to be most conservative -- the transmitter's performance is AM's highest fi.

Truly
Gene Rider
Gene Rider
Chief Engineer WCKR

Mr Adron M Miller
AM Equipment Field Sales
RCA
Camden NJ

NEW BROADBAND FM ANTENNAS

*High Gain and Low "Q" Make These Antennas Ideal for
Multiplex Operations*

by W. FIRST, Product Analyst, Antenna Equipment Sales

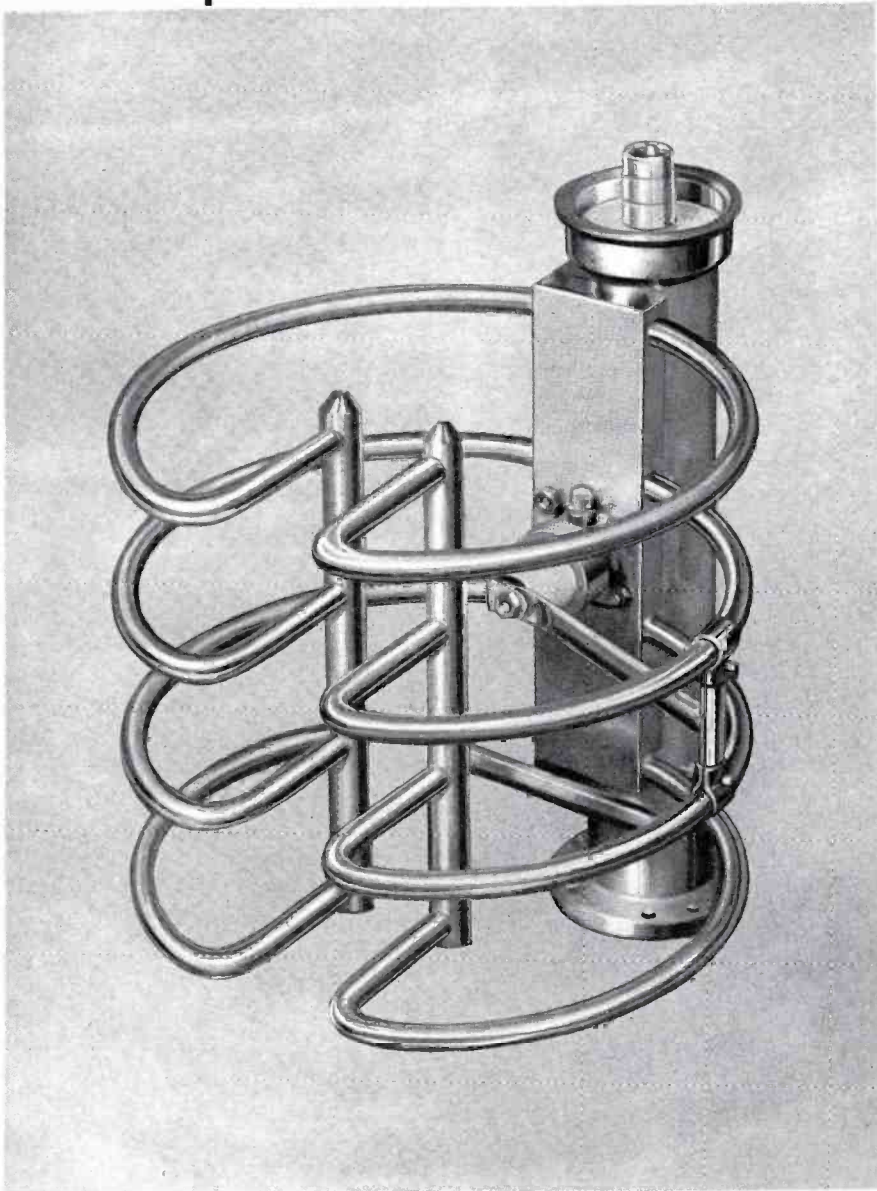

FIG. 1. Single section of BFA Broadband FM antenna; note support connector for 3/8-inch coaxial transmission line.

Broadcasters recognize the need for maintaining the high-quality sound normally associated in the public's mind with FM, hence, the new BFA series of FM Transmitting Antennas is another step in that direction. Today, there is more than usual interest in FM because of the Hi-Fi boom, the upsurge of stereophonic programming, and portending FM auto radios. In addition, background music service for stores, restaurants, and industrial plants can provide the station with extra revenue. This new antenna is especially designed to meet the demands of multiplex broadcasting.

Description

The RCA Type BFA Broadband FM Antenna consists of four tubular, stainless steel, radiating rings attached to a supporting frame (see Fig. 1). The shunt-fed antenna sections are supported by the new 3/8-inch RCA Universal Transmission Line, thus any number of sections can be stacked as shown in Fig. 2.

Internally mounted heaters provide adequate deicing for even the most severe conditions. All BFA series antennas are pretuned at the factory for any channel from 88 to 108 mc. to provide a low VSWR over an entire 200 kc channel. Sectionalized construction, low weight, and mechanical simplicity of the BFA antennas make installation quick and easy.

Low "Q" Increases Band Width

The RCA Broadband FM Antennas, Type BFA, have been designed to meet the stringent requirements of FM multiplex broadcasting. The necessary broadbanding is accomplished by stacking the four rings of a single section to reduce the "Q," and a "Q" in the order of 30 is easily achieved. Higher gains are obtained by discreet spacing of the sections of these BFA antennas. A power-handling capability of 3-kw per section has proved to be a very conservative value for the entire BFA series of FM antennas.

Low VSWR

Without field adjustment the new BFA series of FM antennas will meet a VSWR specification of 1.2/1.0 or better when the antenna is top-mounted, and a VSWR of 1.5/1.0 or better is achieved when the antennas are side-mounted. A built-in input transformer permits field trimming, and it can be used to obtain a VSWR of 1.1/1.0 or better.

Mounting

The BFA series can be mounted in many ways, and mounting hardware, brackets, etc., are supplied for both pole and side-mounting. This antenna can be easily mounted on self-supporting or tapered towers with the addition of a steel cross-arm support to keep the FM antenna perpendicular. The new RCA Universal Transmission Line ($3\frac{1}{8}$ -inch size) is used to perform a dual function: (1) shunt feed for the antenna, and (2) physical support for the radiators.

Circularity

A circularity of ± 1 db in free space is specified for these new FM antennas. While it is recognized that the mass of the tower, location of cross members, and length of cross members with respect to wavelength has some effect on the circularity of side-mounted installations, no significant deterioration of far-out coverage has been recorded.

Built-in Deicers

All but tropical installations will require some form of deicer, and the new BFA series will dissipate a normal 250 watts when supplied with 110 volts AC. For severe icing conditions the antenna can dissipate 1000 watts if supplied with 220 volts. An automatic control unit that operates deicers when temperatures fall below safe limits and turns them off when temperatures rise again is available for use with this new antenna.

Designed for Multiplexing

The BFA series of FM antennas represent a new approach for a broadband antenna that will meet the requirements of modern multiplex operation. Low VSWR and ease of installation contribute desirable advantages. All-weather operation has been made possible with the built-in deicers.

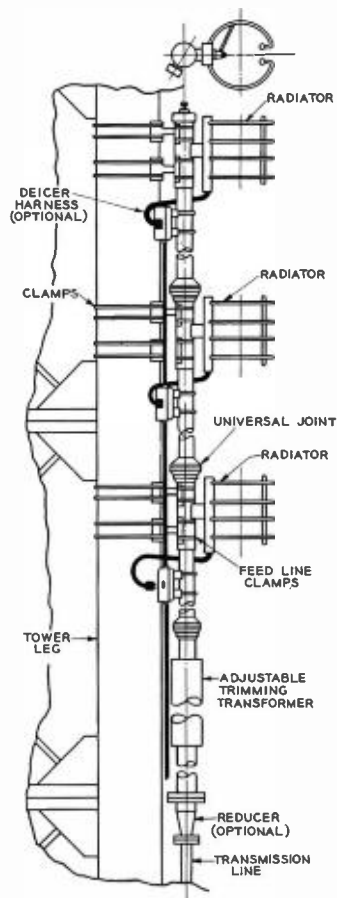

FIG. 2. Type BFA FM Antenna shown side-mounted on a typical uniform cross-section tower. Note optional deicer harness and adjustable trimming transformer location.

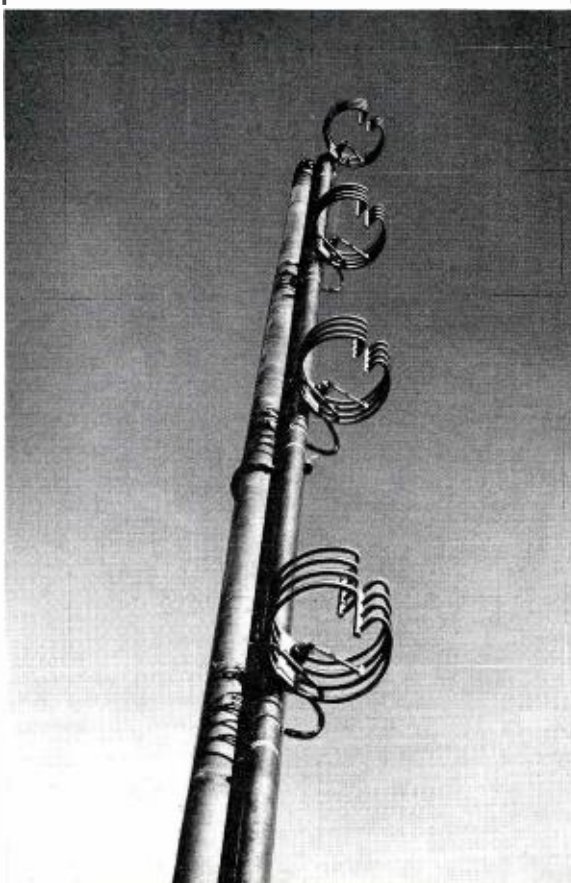

FIG. 3. Four sections of BFA FM antenna, pole-mounted and supported by new $3\frac{1}{8}$ -inch coaxial transmission line.

HOW TO GET BEST PERFORMANCE FROM THE TK-41 COLOR TV CAMERA



**New methods, based on simple monochrome procedures,
assure high quality pictures and good camera matching.***

*by S. L. BENDELL, H. N. KOZANOWSKI, and T. J. SHIPFERLING,
Broadcast and Television Engineering*

Simplifying Color Camera Control . . .

With color television equipment one can reduce operations to a series of simple step-by-step procedures which are easy to carry through consistently and logically, or one can take the opposite view that the system is overwhelmingly complex and can be manipulated only by a highly skilled artist. It is our belief, fortified by actual operating experience, that the "simplicity" point of view is the one which produces best and most consistent results, and that the concept of requiring "artists" to produce color pictures is rapidly becoming obsolete.

In color broadcasting the individual cameras must operate interchangeably, even at widely separated locations, to produce pictures with correct color balance. This accurate color balance is required under a considerable range of lighting conditions. Methods for initial adjustment of cameras based entirely on objective settings have been developed. An operating technique based on this set-up procedure assures stable tracking of color balance with changes in illumination.

With the proposed technique it is possible to obtain a high standard of camera matching not by subjective judgments or decisions based on color displays, but by straightforward monochrome methods.

We first have the purely physical requirement of producing three high-quality registered image orthicon camera picture signals. These three signals are, of course, the red, green, and blue simultaneous camera outputs which serve as the basis for the production of the colorplexed signal used for final transmission. In this discussion we are not directly concerned with this colorplexed signal, but will devote all of our attention to the factors which must be controlled to produce the three monochrome signals with the quality which is required in color operation.

* The intent of this article is to present over-all concepts which will be useful to the operator without giving him a mass of detailed information which is already available in instruction books, technical bulletins and field letters.



FOUR KEYS TO TOP COLOR PERFORMANCE

The objective of good color camera technical operations can be quite simply stated. This is to produce consistently good pictures with a minimum of set-up time, freedom from drift, ease of operation and minimum demands upon the operator for subjective judgments and decisions on quality. This goal can be divided logically into four areas:

1. Mechanics of setting up three image orthicon channels;
2. Standardized operating conditions for image orthicons;
3. Colorimetric conditions which can be fulfilled by a straightforward set-up procedure; and
4. A practical operating philosophy for lighting and staging.

1. MECHANICS OF SETTING UP THREE IMAGE ORTHICON CHANNELS

Use of Monochrome Procedures

We shall assume that the operator is fully acquainted with the production of a high-quality image orthicon picture such as that used for monochrome. The procedure from this point consists in straightforward adjustments of size, centering and linearity in deflection so as to register the three red, green, and blue signal components within a prescribed degree of precision. The techniques of this procedure have already been covered both in instruction books and in a previous article[†] on TK-26 Color Vidicon Film Cameras. Practically all of the information is directly applicable to the TK-41 Camera. A key to simplified operation is observation and recognition of the optimum in adjustments without "nursing" the controls.

Correct Registration

The procedure for correct registration consists of the following two steps:

1. *Mechanical Registry*—This is done with the camera focused on the test

[†] "How to Get High Quality Performance from the TK-26 3-Vidicon Film Chain." *Broadcast News*, Vol. No. 96, August, 1957.

pattern, operating in the overscan position, and following the procedures given in the TK-41 Instruction Book. Each tube is optically centered so that the four corners of the test pattern just touch the target ring. This should be done as accurately as possible so that a minimum of electrical centering (step 2) will be required.

2. *Electrical Centering*—This is done with the camera in normal scan position, following the procedure given in the TK-41 Instruction Book. This corrects the position of the three images so that they are accurately superimposed one upon the other. Note that electrical centering should not be used as a substitute for optical or mechanical registry, because excess centering current in the yoke is a possible cause of instability.

Tests in the laboratory have indicated that by using only optical mechanical means there is no drift in centering and the camera can in principle be used immediately after the power is turned on. The

closer one comes to this ideal the less reason there will be for day-to-day manipulations in the centering procedure. It is suggested that in the adjustment of horizontal deflection the "Q" pots be set at minimum resistance in the circuit and only enough "Q" resistance inserted in the circuit to control differential linearity to its correct value.

Checking for Defective Components

Tests have shown that drifts which turn out to be abnormally large can usually be attributed to defective components or improper adjustment procedures. Field tests have shown occasional difficulties in registration "jump." These are generally traceable to poor wiping contacts in the Jones plugs or defective centering or size potentiometers. The first cause can be identified by registering the picture and then deliberately moving the plug in its socket, at the same time noting any jumps in the raster. Where experience indicates that with large camera movements on rough floors such misregistry does occur, make sure that the Jones plug wiping connectors are clean and tight.

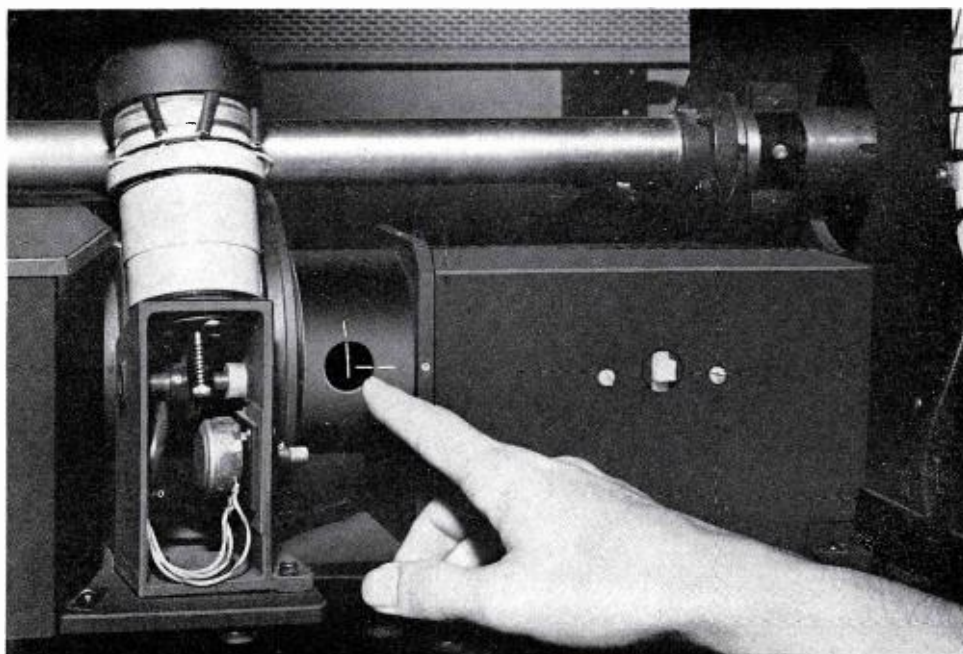

FIG. 1. Details of optic relay lens system showing adjustment of front element.

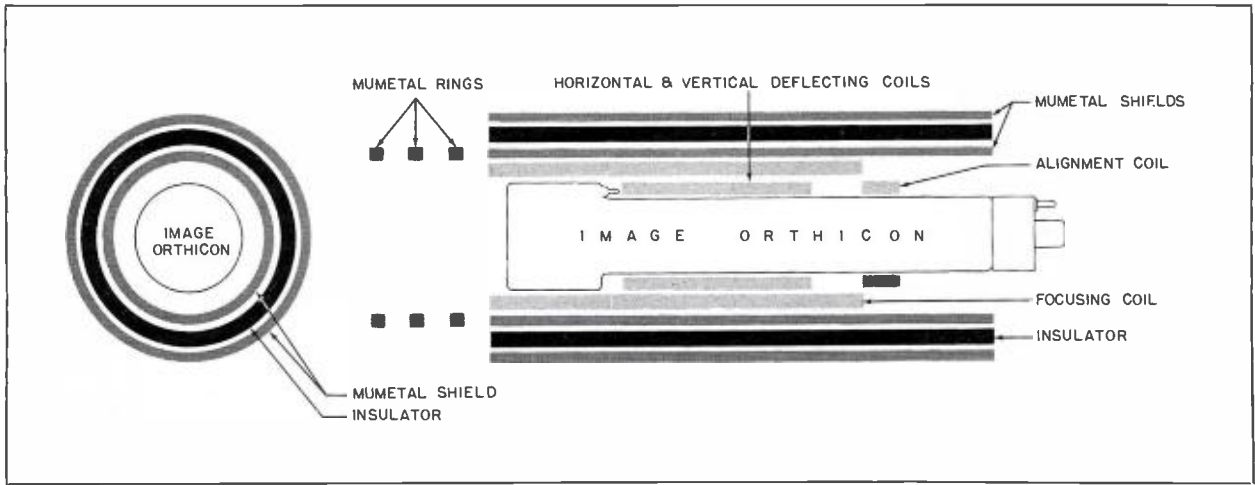

FIG. 2. Cross-sectional diagram of shielding modification for operation in areas of high stray magnetic fields. A double mumetal shield with an insulator is placed over the image orthicon yoke assembly to improve magnetic shielding. Three mumetal rings with spacers are placed at the photocathode end of the tube assembly for the same reason.

Operation in High Stray Magnetic Fields

In some cameras working in high ac and dc magnetic fields there may be evidence of misregistry with orientation of the camera. The existence of such a condition can be verified by using two test patterns located at right angles to each other and panning the camera from the first to the second. If the camera is registered on the first test pattern and misregisters as it is panned on the second, this is direct evidence that external fields are acting on the image orthicon camera. It is suggested that in such a case the image orthicon mumetal shields be exchanged for others which have been carefully annealed. Careful handling of such shields is necessary so that they do not magnetize due to shock or distortion strains. A simple modification (see Fig. 2) has been worked out which will allow cameras in high stray field locations to be provided with double mumetal shielding layers and with additional shielding from image section disturbances by the use of mumetal annular rings. Additional shielding can also be provided for the viewfinder to provide equal immunity to high magnetic fields.

Eliminating Horizontal Transient Ringing

In certain cases vertical bars at the left-hand side of the raster have been noticed, particularly on flat field scenes

and under conditions of high video gain. Turn multiplier gain to minimum and image orthicon beam to zero in each channel successively, observing the transient ringing in the raster. This shows only the pickup introduced into the video lead, whereas normal operation will also include disturbances introduced into the signal beam. These vertical bars are most often traceable to horizontal deflection transients getting into the video amplifier circuits. A simple modification involving the shielding of horizontal deflection centering return leads has been found to give excellent results in suppressing this type of video disturbance. See Fig. 3.

FIG. 3. Simplified schematic of modification to suppress deflection transient ringing. The deflection circuit return leads (A, B, and C) are shielded as shown below. For more details refer to RCA Technical Bulletin, HG-260.

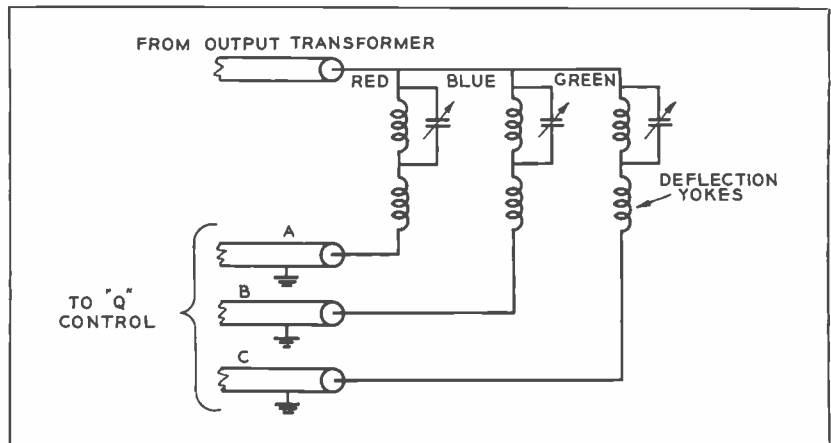

2. STANDARDIZED OPERATING CONDITIONS FOR IMAGE ORTHICONS

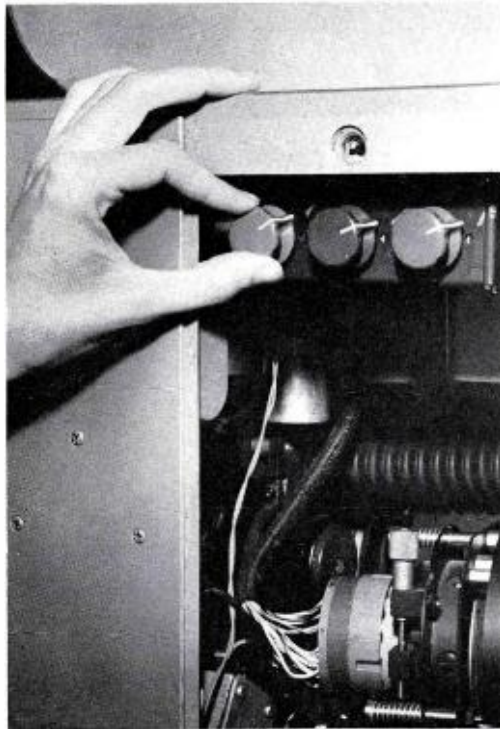

FIG. 4. Red, green, and blue dynode gain controls are used in setting multiplier gain to obtain a standard white signal level of 0.3 volt from the preamplifier.

In the color camera using the RCA 6474 image orthicon tube one can summarize the operating conditions as follows:

Setting Target Voltage

With the image orthicon tube set up according to normal operating procedures, which should also prevail in monochrome operation, the target voltage should be set at two volts above cutoff for all three tubes. Tests have indicated that this procedure will assure that the same transfer characteristic will exist for all three tubes when they are properly exposed according to the procedure discussed in "Locating the Knee."

Setting Multiplier Gain

With the image orthicon operating normally the multiplier gain (see Fig. 4) is set so as to obtain a standard white signal level of 0.3 volt out of the preamplifier, as displayed on the "input" to the "A" scope. One must, of course, be sure that the preamplifier gain is normal. This will assure freedom from preamplifier overload, streaking and compression effects. The processing amplifier gain control pots are used to obtain the same signal level amplitudes out of the processing amplifier. This is particularly important with respect to

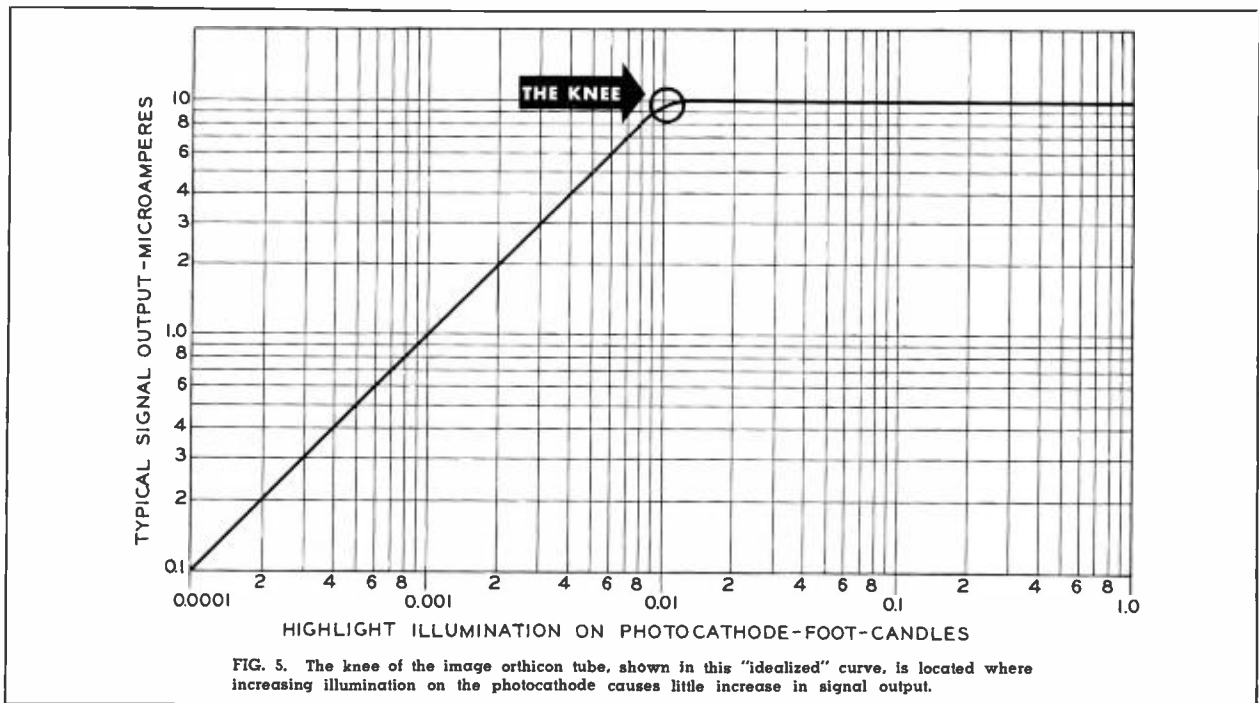

gamma correction. Since gamma correction circuits are constant voltage level devices to produce a definite transfer characteristic, it is important to maintain the input to the device within the limits previously quoted.

Locating the Knee

It is fundamental to all color camera operation that the same transfer characteristics exist for all three tubes so that the red, green, and blue components track in signal level with corresponding changes in illumination. This technique of adjusting exposure is carried out by arranging for the three image orthicons to hit the knee or saturation level at the same time. In practice this can be done by determining the behavior of each channel on the "A" scope display when the camera is looking at a gray-scale step-wedge chart. See Fig. 6. The point at which the whites just compress and at which the black information just starts to rise is defined as the knee of the curve. This technique requires padding the image orthicon tubes with neutral density filters so that in looking at the gray-scale step-wedge chart the white signal flattening occurs at the same iris opening for all three image orthicon displays on the "A" scope. It is important to check that sufficient image orthicon beam current is used to just discharge the highest white steps or highlights. An ideal situation would be one in which all three cameras are operating with no neutral density or "loss" filters.

A direct approach in determining operating position is that of removing all neutral density filters and then determining the knee points for the three tubes in terms of iris opening or f stop. This is indicated on the remotely controlled iris meter for red, green, and blue tubes. It is then very simple to select the correct neutral density filter on the basis of this single set of readings so that after the appropriate filter is inserted, all tubes will hit the knee at the same iris opening. The required filter value in terms of percent transmission is given directly by the square of the ratio of f stops. See the example calculation on this page.

Once the individual camera tubes have been adjusted so that the iris exposure will give the same point on the transfer characteristics for each image orthicon, we are ready to discuss the matter of standardizing adjustments so that true colors can be produced under all lighting and operating conditions.

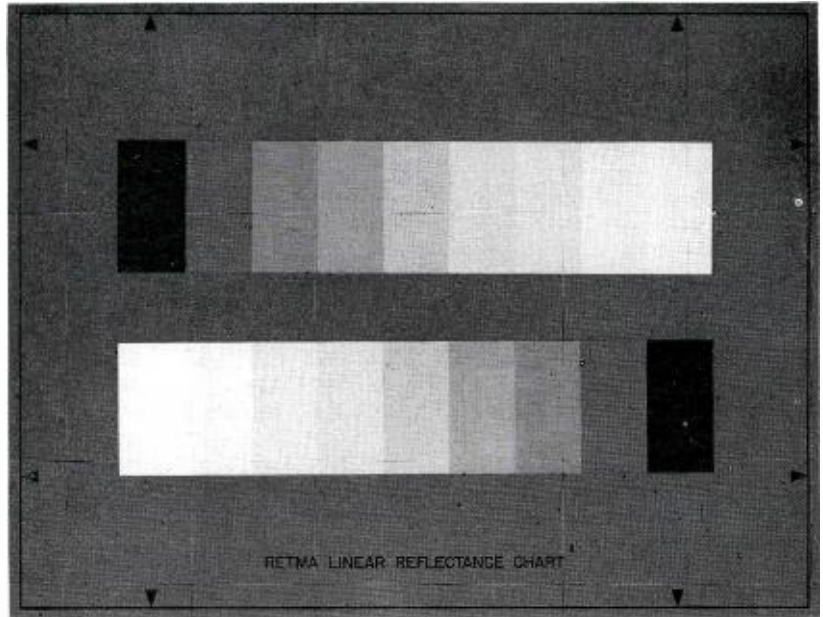

FIG. 6. RETMA linear monochrome step-wedge chart used in the zero subcarrier balance technique.

How to Calculate Neutral Density Filters Required to Pad Image Orthicon Tubes for Color Operation

1. Remove all neutral density filters in optical system and determine knee points of each image orthicon tube in terms of f stop. (This value is indicated on the remotely controlled iris meter.)
2. Calculate percent transmission using the formula:

$$\% \text{ Transmission} = \left(\frac{f_2}{f_1} \right)^2 \times 100$$
 where f_2 is the iris opening of the least sensitive channel.
3. Using the conversion table (below), select the density factor for the proper neutral density filter which corresponds to the percent transmission required.
4. Determine the filter value for each of the channels that require matching to the least sensitive channel.

Example

Remote iris meter reads:

$f/9.9$, $f/8$, and $f/5.6$

$$1. \left(\frac{5.6}{9.9} \right)^2 = .32 = 32\% \text{ transmission; } D = 0.5$$

$$2. \left(\frac{5.6}{8} \right)^2 = .50 = 50\% \text{ transmission; } D = 0.3$$

Hence:

The $f/9.9$ channel must be padded with a D 0.5 filter and the $f/8$ channel with a D 0.3 filter.

Conversion Table

Percent Transmission	to	Density
80		0.1
63		0.2
50		0.3
40		0.4
32		0.5
25		0.6
20		0.7
16		0.8
13		0.9
10		1.0

3. COLORIMETRIC CONDITIONS WHICH CAN BE FULFILLED BY A STRAIGHTFORWARD SET-UP PROCEDURE

The proposal recommended for the TK-41 Color Camera involves two main points:

- A. *Precise settings of black level (pedestal) for each color channel and elimination of pedestal riding as a system variable except under conditions where special effects are required.*
- B. *Precise setting of white balance by adjusting video gains at the output of the processing amplifier. This may be done by the use of calibrated attenuator pads (Daven) and observing subcarrier cancellation in the colorplexed signal. The gain potentiometers built into the processing amplifier are used for initial balance only since they may react with pedestal setting and shading adjust-*

ments, violating our first point, that of accurate black level set.

Although many of the points in setup are perfectly standard at the present time, they are repeated here to define the operating conditions completely: (See Figs. 7 and 8.)

1. Set targets on all tubes for two volts above cutoff.
2. Pad each *required* optical path in the usual manner so the "knees" occur at the same iris setting using the standard gamma chart techniques.
3. Set minimum beam current for discharge at knee. (Equalize dynode gains to get appropriate input level to processing amplifier.)

FIG. 7. Processing amplifier and camera control panel mounted in RCA console housing. In operation, set-up controls are hidden by a protective cover, exposing only pedestal and iris controls and "on-air" light.

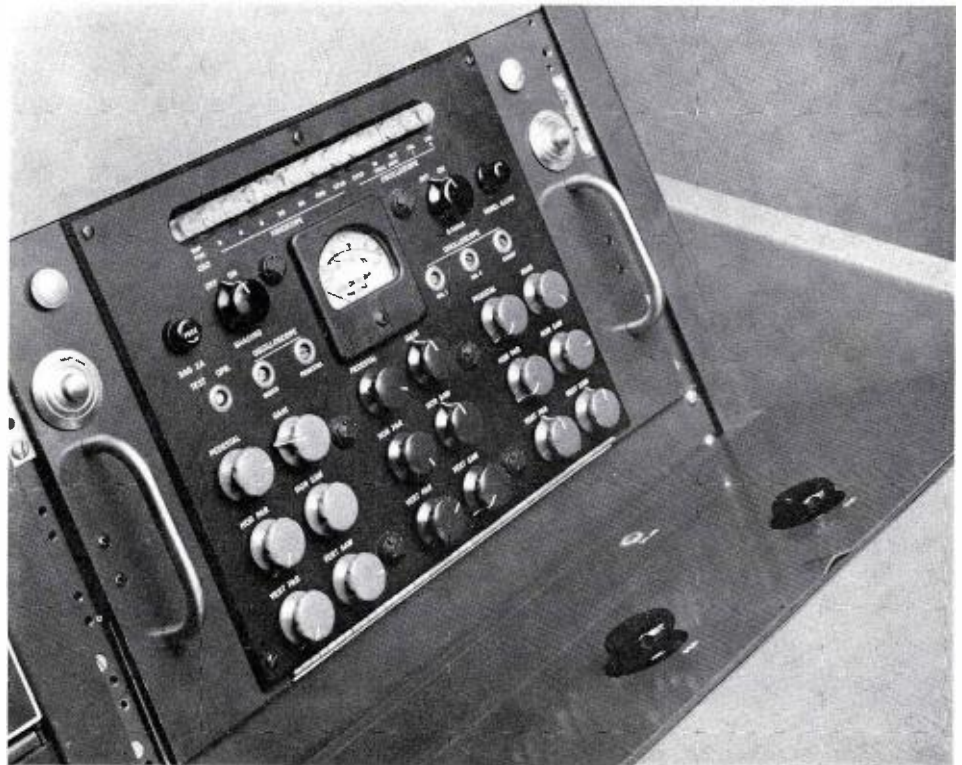

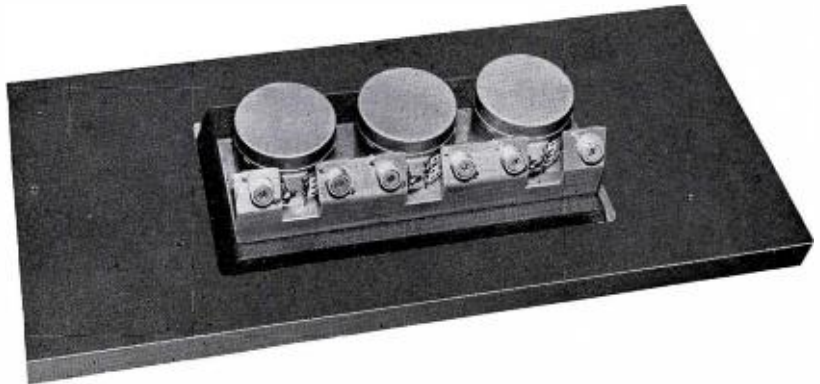

FIG. 10. Bottom view of panel showing Daven pads which are used as trimmers to correct minor color differences between cameras.

- balance. See Fig. 9. (Zero subcarrier with the iris set just below the knee.)
7. Recheck Step 5 to assure that gain adjustments made in Step 6 have not upset pedestal and shading. If readjustment is necessary, Step 6 may in turn have to be rechecked.
 8. The insertion of calibrated video attenuator pads between the processing amplifier and the colorplexer makes possible a final precise vernier adjustment of white balance without causing pedestal or shading shift. These pads are also useful for introducing deliberate predetermined color shifts of known amplitude to compensate for minor color differences between cameras or for special effects. The pads are thus used as true trimmers to get identical operation between cameras. Daven pads having 20 steps at 0.1 db per step are available for this service. See Fig. 10.
 9. When final balance is completed the following conditions must be met:
 - a. With lens capped, the resultant pedestal seen at the output of the colorplexer must contain zero subcarrier and be at black.

- b. With lens uncapped and iris just below knee, subcarrier amplitude on white must be zero.

Operational Test

A rigorous operational test of the accuracy of all these adjustments is that of focusing the camera on a white chip or gray-scale chart and observing the colorplexed signal. As the iris is varied from the normal operating stop (at or near the knee) to its minimum opening, the subcarrier should not appear in the display. *There will then be no perceptible shift in skin tones from minimum iris opening up to the knee. In fact, this test assures that all cameras will match each other under the varied lighting conditions which exist during a show.* A tacit assumption has been made that the colorplexer is always accurately white-balanced.

During normal program, pedestal riding should be avoided as this seriously upsets the effective system gamma or transfer characteristic. See Fig. 11. If low-key scenes must be handled during a program, it may be necessary to depress the master pedestal so that background or multiplier clutter is suppressed or clipped out. To enable the operator to come back to the original pedestal setting, a large pointer can be attached to the master pedestal control shaft. By means of a simple spring clutch the pointer can be oriented in a selected reference direction for normal pedestal setting.

RIGHT

WRONG

FIG. 11. Right and wrong black level setup and the resulting effect on skin tone as the iris opening decreases.

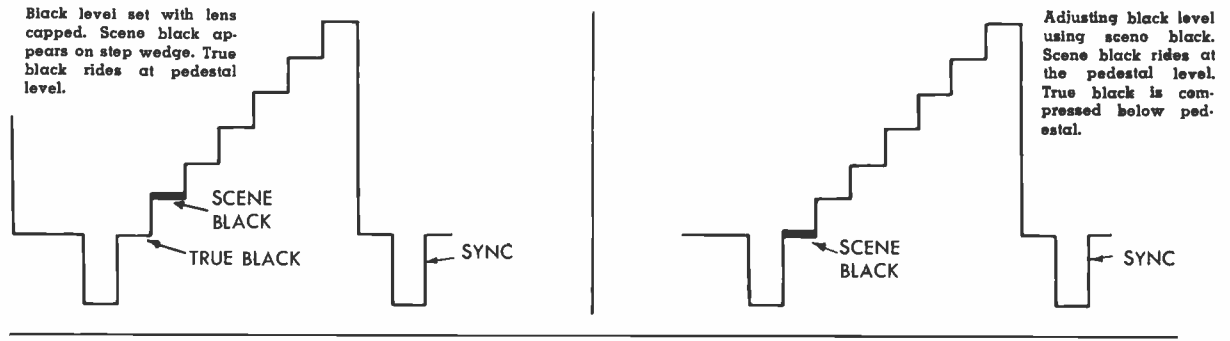

Iris Full Open

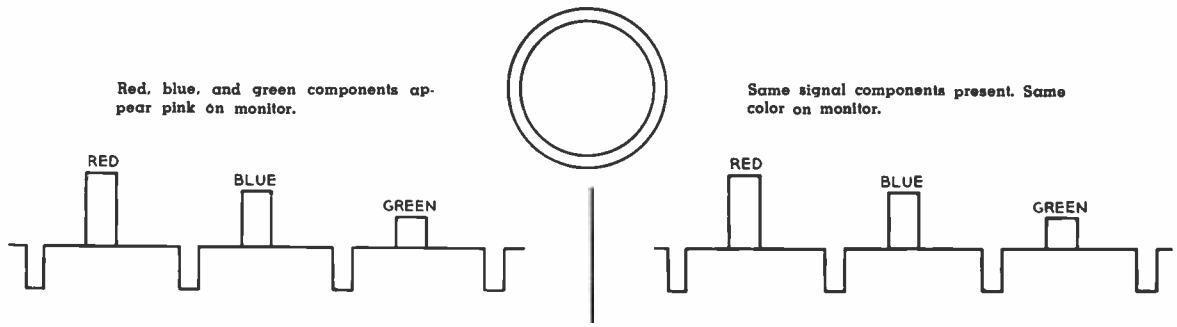

Iris Half Open

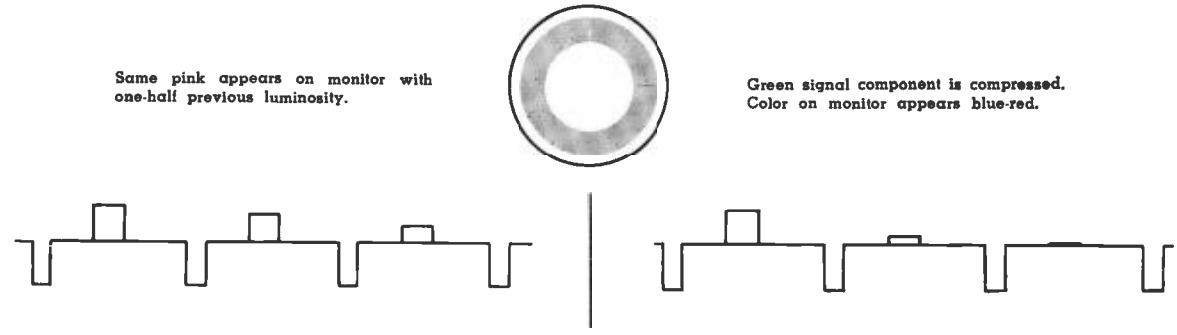

Iris Quarter Open

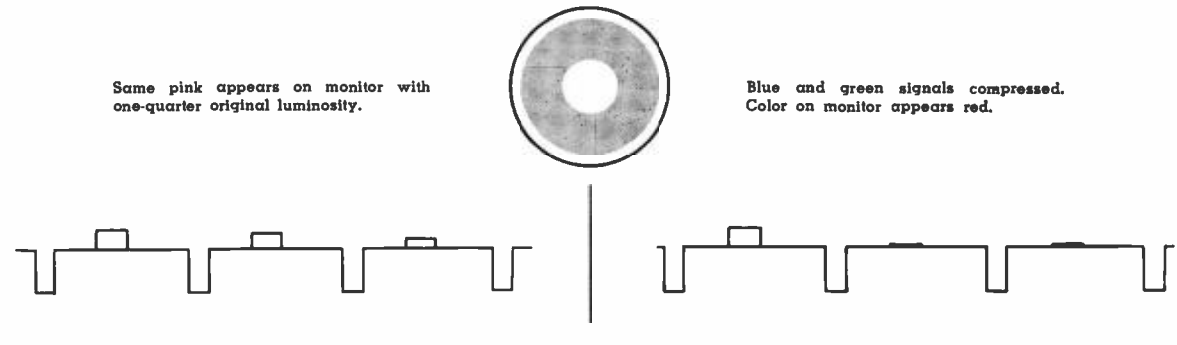

4. OPERATING PHILOSOPHY

Lighting

Experience has indicated that when the cameras have been adjusted in accordance with the foregoing requirements, the variables which deserve most attention are those of staging and lighting. In a sense one can simplify the problem by stating that scenes which are adequately lighted with uniform or flat lighting which is constant throughout the set are very easy to handle. In such a case the camera can be directed toward any portion of the scene, and the picture output level will stay constant, assuming that the scene contains subjects having a normal range of reflectance values. This corresponds rather closely to the practices used in filming color movies in which the lighting is fixed and no iris riding is attempted during a scene "take" except for special effects. The condition of flat and constant lighting is technically ideal for television since high quality can be assured for any subject position and lens shot. In this arrangement there will be no area in the scene where

excess light will cause the image orthicons to operate over the knee and no region in which the light level will be so low as to show multiplier and shading clutter.

In practice, however, the production (from an artistic point of view) would be severely cramped by such lighting restrictions. Therefore, it is more or less accepted that there will be variations in lighting level and mood, and that there will be some necessity for riding iris in order to avoid over and under exposure.

It has been the experience in production that spot lighting or "hot" lighting should be restricted to situations which are under careful control since it is very easy for a performer to wander in and out of the spot or hot-lit area in an unpredictable manner. There is then the possibility that highlights and even actors' skin tones will go over the knee, producing unflattering picture rendition and relatively unpredictable color quality. One should also be careful to use a minimum of specular or high-

light reflections in a scene since such objects can make the exposure go over the knee by many times producing secondary or colored ghosts which sometimes lead to embarrassing situations. In this case, specular reflections from jewelry, or other shiny objects, should be dimmed down by standard techniques or removed from the scene wherever possible.

Color Contrast and the Monochrome Picture

One of the problems which is extremely important in producing color programs is that of obtaining high quality monochrome rendition at the same time. It is quite apparent that by unfortunate choice of colors in scenery, costuming or stage sets one may choose colors which have high differential values or impact as seen on a color receiver but which may reproduce as the same shade of gray when seen on a monochrome receiver. Therefore, it is possible in principle to stage programs which can be very acceptable to color viewers and yet will

FIG. 12. While even over-all lighting will produce ideal camera operation without adjustment, production techniques will require some variation for changes in mood. Hence, there will be some necessity for riding iris to avoid over or under exposure.

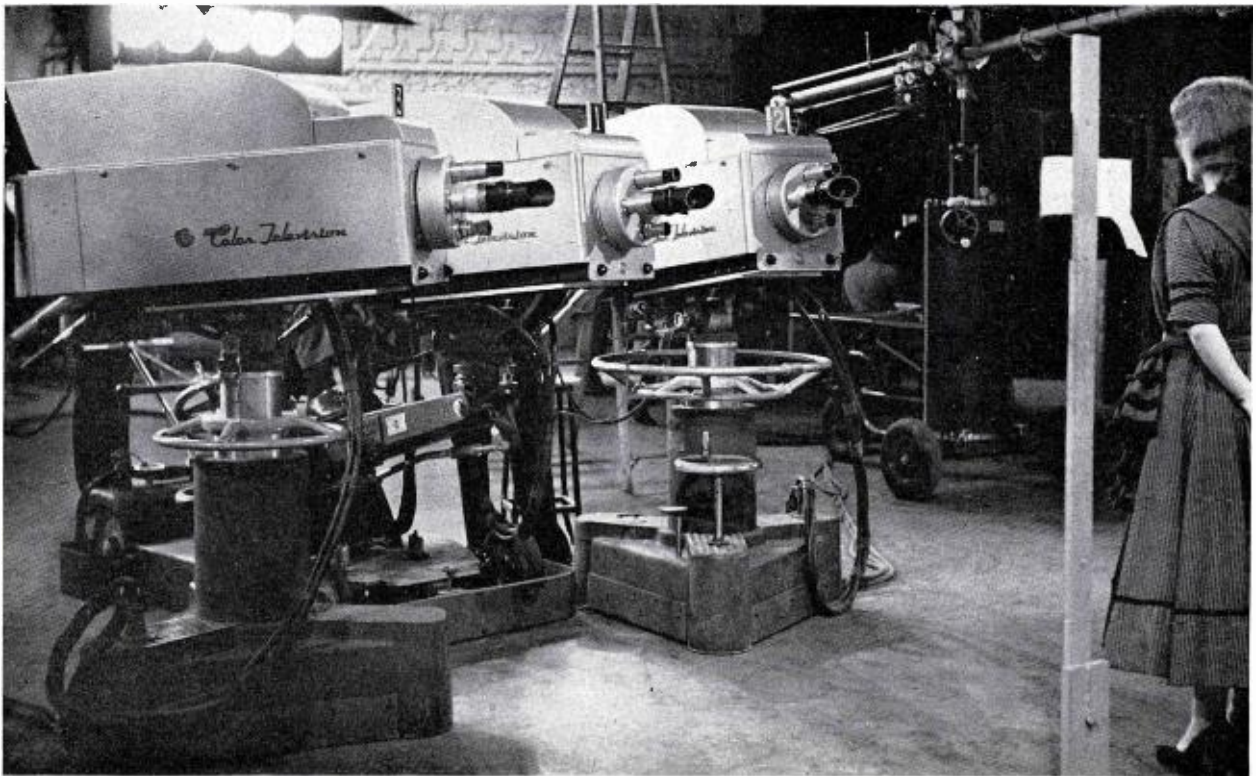

be completely lacking in subject contrast when viewed on a monochrome set. It is important to determine easily what the gray-scale value or luminance of every important portion of the scene will be since this luminance value will directly affect the appearance of a monochrome picture.

In an attempt to provide an easy means of determining this gray-scale rendition, a self-contained luminometer has been designed and constructed, and has been used experimentally with good acceptance (Fig. 13). Basically, the unit contains a 75-watt lamp which, by means of a suitable condenser lens assembly, illuminates the specimen whose luminance is to be determined. A photocell is arranged so that it receives reflected light from the specimen in the same red, green, and blue ratios as exist in the color television system. This is made possible by use of Wratten color filters on the face of the photo-resistive cell. A microammeter in the photocell circuit will then read the luminance or reflectance of the actual specimen.

The instrument is very easy to use. The technique provides self-calibration on a standard white card by adjusting the meter to read 85 (85 percent reflectance). The specimen whose luminance is to be measured is then put into the test position and its luminance, or gray-scale value is read from the dial. It has been found that the use of such a device gives assurance that the gray-scale separation in an actual television program will be sufficient to obtain good results and that no last-minute repainting or reshuffling of sets will be required.

Problems in Production

In the foregoing discussion we have assumed that the encoding or colorplexing of the three video signals into the single video wave used to modulate the TV transmitter is under complete control. It is important to realize that the colorplexer is a vital factor in over-all performance. However, at the present stage of development and with the techniques now available for colorplexer adjustment and balance, it is safe to assume that colorplexer difficulties can be kept to a minimum and the physical process of signal encoding can be kept under close control.

Final touch, comparison of skin tones between two cameras, is still generally accepted as the proof of system performance. The technique proposed in Section 3,



FIG. 13. A complete self-contained RCA luminometer provides excellent means of determining gray scale rendition. Direct readings can be taken as shown here after the luminometer has been calibrated on a white card for 85 percent reflectance.

using the adjustable attenuator pads between processing amplifier and colorplexer, has proved to be extremely useful in matching cameras to any degree of precision.

It has been noted that with the wide variety of lenses available to a studio there may be a shift in color balance on a given scene as the camera switches from one taking lens to another. These differences can be obtained by variations in the light transmission of the lenses themselves, particularly in their nonreflective coatings. In certain multi-element lenses the difference in color characteristics can be due to the light transmission characteristics of particular glasses used in the lenses themselves. Such differences can be compensated if desired by the use of the Daven attenuator pads which are suitably shifted with a shift of the camera lenses. The color-balance evaluation of lenses can be carried out easily by using the familiar

“balance on white” technique, reading the differences between lenses directly in db for red, green, and blue to restore white balance. Of course, a more desirable solution is to avoid using lenses of widely varying color characteristics. Incidentally, in network practice every new lens is checked against a “standard” lens, and if there is any substantial variation in color response, it is not used for color.

Systematic Method Yields Best Performance

It has been proved that this logical and systematic method for operating color image orthicon cameras will result in a high standard of performance. Moreover, it results in good control of camera match, colorimetry and tracking. It will reduce all of the setup and operating requirements into a routine which can be handled by straightforward means, not requiring subjective judgment on color quality.

THE APPLICATION OF VERY PRECISE FREQUENCY CONTROL TO MINIMIZE TELEVISION COCHANNEL INTERFERENCE

PART II — Equipment for Achieving Precise Frequency Control of Television Transmitters

by D. R. MASON
Broadcast and Television Sales

Cochannel interference may result in serious loss of coverage to all interfering stations in certain areas. It is caused by the simultaneous reception of signals from two stations offset by a nominal 10 or 20 kilocycles. It appears on the viewing screen as a visible beat pattern. When this interference is present, viewing is unsatisfactory for any of the interfering stations. Should the area of interference fall in a highly populated section, it may cause a serious loss of effective coverage. However, lost viewers can be recaptured, and cochannel interference can be reduced with the RCA Type TFC-1A Precise Frequency Control System.

Basic Theory

The minimum of visible cochannel interference occurs when the visual carrier frequency difference between the two interfering stations is an even multiple of the frame frequency. In addition to the necessity for precisely controlling the carrier frequency of each cochannel station, it is necessary to provide a stable source of frame frequency for maximum effectiveness of the system. FCC specifications for tolerance of the frame frequency for color broadcast, and the availability of equipment for this control make the use of 29.97 cps desirable as the frame frequency for the precise frequency control system.

With the 29.97 cps frame frequency a multiplier of 334 will yield 10,010 cps offset frequency for stations, and a nominal 10 kc offset and a 668 multiplier gives an offset of 20,020 cps. Both of these frequencies satisfy requirements for minimum interference.

It would thus be possible for three stations "A," "B," and "C" to realize identical reduction of interference with each other. Assuming "A" to be operating with zero offset, "B" with plus 10 kc and "C" minus 10 kc; thus the difference frequency between "A" and "B" and "A" and "C" would be a nominal 10 kc. The

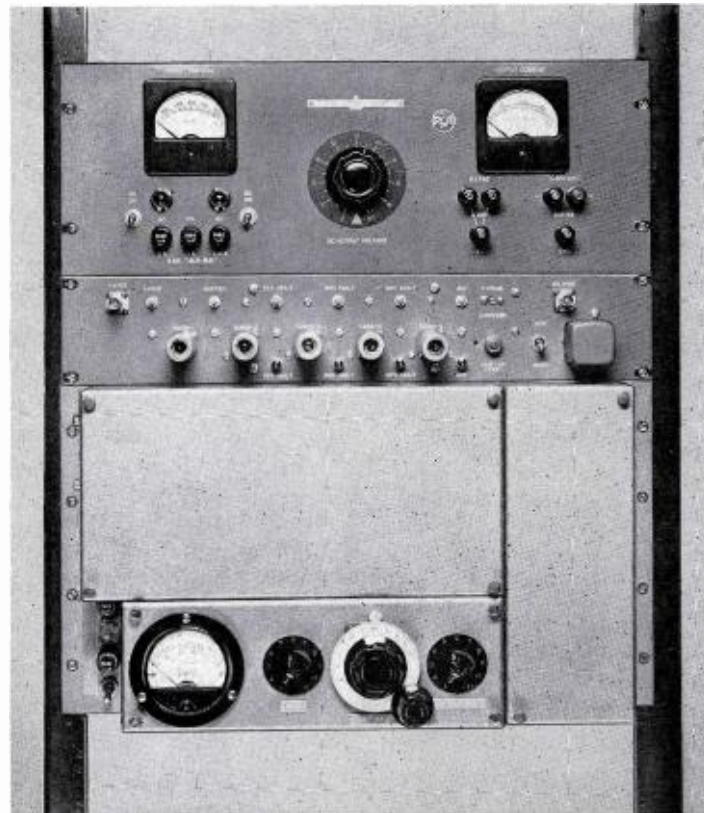

FIG. 1. Precise frequency control equipment is shown here from top to bottom: the regulated power supply, the frequency multiplier, and the crystal oscillator. All three units are mounted in a standard rack and they occupy approximately 21-inches of vertical space.

difference between "B" and "C" would be a nominal 20 kc. These separation frequencies would effect maximum reduction of cochannel interference between the three stations.

Operation of RCA System

The units furnished with the RCA Type TFC-1A Precise Frequency Control System are: a precise frequency oscillator (MI-34053), a frequency multiplier (MI-34054), a power supply (MI-34055), and a band-pass amplifier (MI-34056) (see Figs. 1 and 2). All units except the band-

pass amplifier, which is used only during tests, are designed for standard rack mounting, and they occupy a total of 21 inches of rack space.

A block diagram of the system is shown in Fig. 3. The oscillator output is fed to an RF frequency multiplier unit, and the multiplier output is in the frequency range of the crystal presently used in the visual transmitter. A coupling head furnished with the system adapts the output of the precise frequency source to the socket formerly occupied by the visual crystal. Thus, the installation is straightforward and simple.

Extreme stability of the oscillator circuit is achieved with a special bridge circuit*

Installation of the system requires only equipment that is normally found in a TV station, such as an oscilloscope and a vacuum tube voltmeter. Tests on prototype models of the TFC-1A indicate that frequency checks are only required at approximately sixty-day intervals.

Checking Offset Frequency

A setup for determining offset with another station is shown in Fig. 4. A field-intensity meter would be required in addition to a good oscilloscope. A frequency counter is desirable though not absolutely necessary.

The station making the measurement should be off the air, and the transmitting antenna may be used to receive the picture carrier of one of the other participating cochannel stations. This received signal is added to the proper harmonic of the local crystal frequency which is available at the "TEST" output of the multiplier unit. The two signals are then mixed in the field intensity meter. The resultant beat frequency which appears at the field intensity meter output is amplified in the band-pass amplifier, and it is then applied to the vertical plates of an oscilloscope. The sweep circuits of the scope are triggered by the drive signal obtained from a sync generator which is locked to the color subcarrier generator. Offset is then set for a stationary pattern.

With this system it is possible to adjust the offset frequency to an even multiple of frame frequency. To determine the exact even multiple, it is necessary to use a frequency counter, and this would complete the offsetting of frequency to obtain maximum reduction of cochannel interference with another station.

A Practical System

The RCA TFC-1A Precise Frequency Control System was developed after exhaustive field tests that proved its effectiveness in reducing cochannel interference. The equipment was designed with reliability, as well as simplicity in mind. The TFC-1A offers to the television broadcaster a relatively inexpensive system to reduce cochannel interference in areas now affected. Increased station coverage is made possible with this Precise Frequency Control System since interference areas can be eliminated.

* "The Application of Very Precise Frequency Control to Minimize Television Cochannel Interference" BROADCAST NEWS, Vol. No. 100, April, 1958.

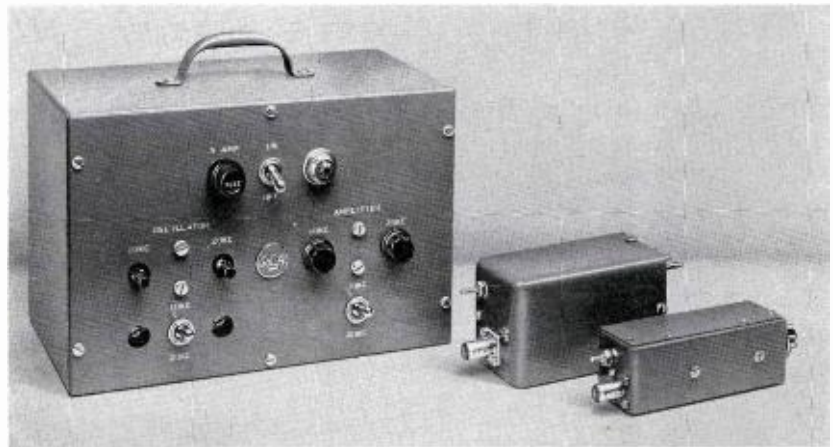

FIG. 2. These are the portable band-pass or selective amplifier and the coupling heads; they are connected into the system when making periodic frequency checks. The band-pass amplifier selects the proper low-frequency beat necessary for precise frequency measurement.

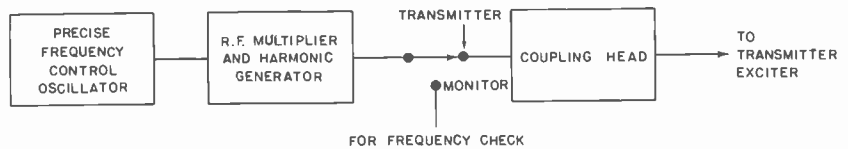

FIG. 3. The Type TFC-1A Precise Frequency Control System is shown here. The system has a frequency variation of less than one cycle per 100 mc over a seven-day period.

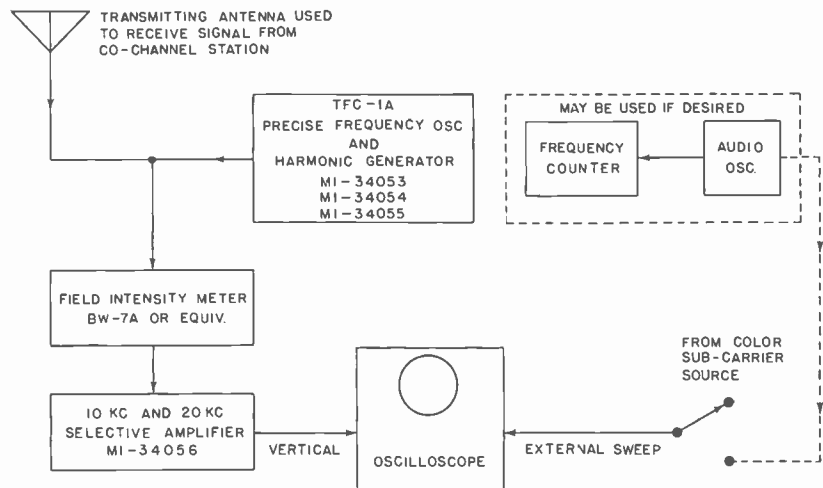

FIG. 4. This is a typical test setup for the TFC-1A Precise Frequency Control System. The oscilloscope, the 10-kc and 20-kc amplifier, and the field-intensity meter are the only test equipment used with the TFC-1A Precise Frequency Control System.

AUTOMATIC CUING OF TP-6 SERIES FILM PROJECTORS

New Technique Provides Cuing Accuracy Within One Frame, Eliminates Manual Errors and Lends Itself to Semi-automatic Operation of TV Film Rooms

by B. F. MELCHIONNI, Broadcast and Television Engineering



FIG. 1. Addition of a simple equipment kit allows the TP-6 series projector, shown, to be modified for automatic cuing.

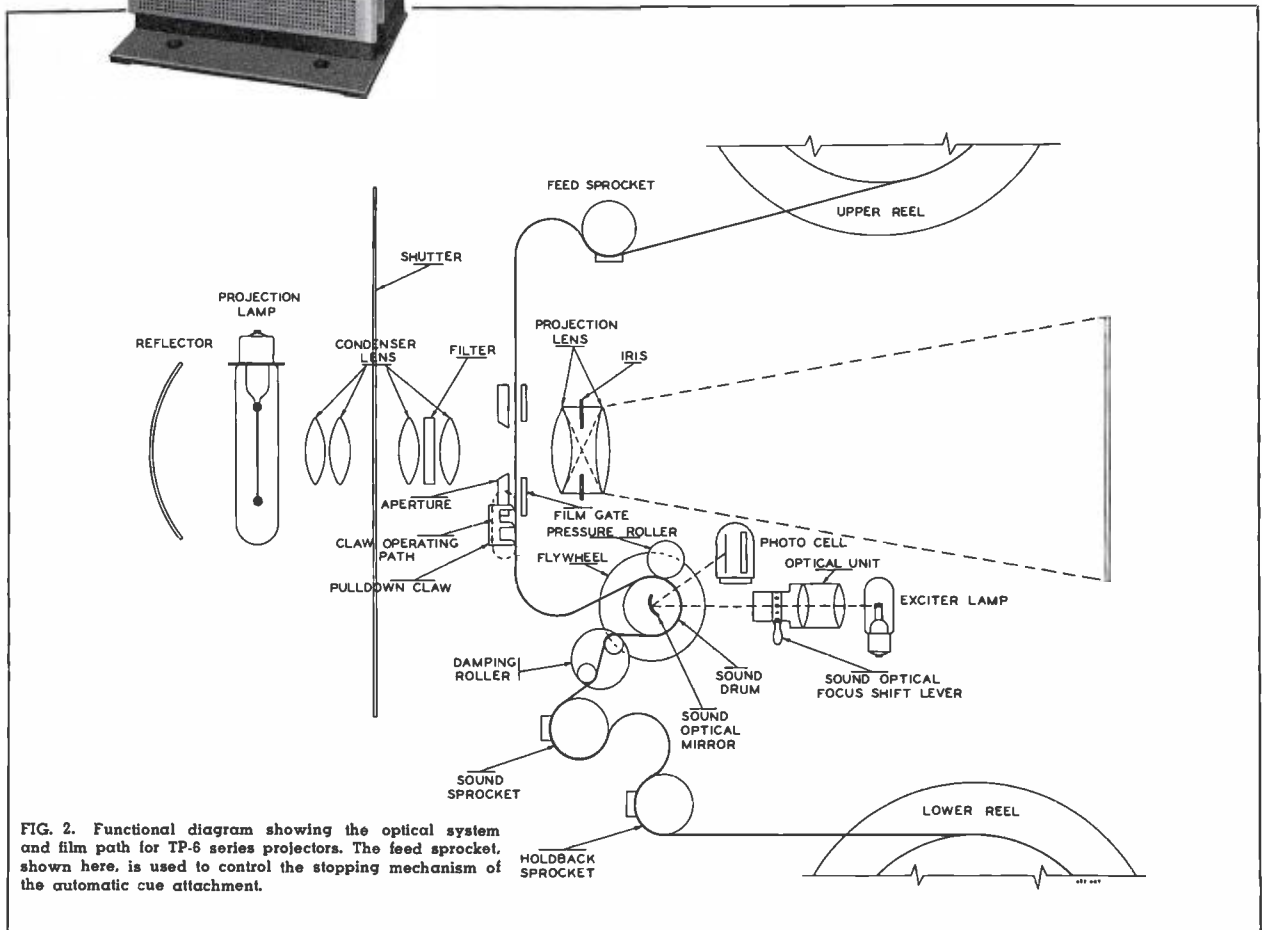

FIG. 2. Functional diagram showing the optical system and film path for TP-6 series projectors. The feed sprocket, shown here, is used to control the stopping mechanism of the automatic cue attachment.

Simple and accurate means of automatically cueing film are now available for TP-6 series projectors in the form of an automatic cue kit. By means of the kit, the TP-6 projector can be automatically stopped with any predetermined film frame positioned in the projector gate. This new technique offers new flexibility to film programming; greatly reducing rethreading and rewinding operations. It also helps the broadcaster make his film-room operation foolproof by eliminating manual error during film projection. Automatic cueing is accomplished by applying a small conductive patch with an adhesive backing over the film sound track. This sends a cueing signal to the projector mechanism causing it to stop at the predetermined frame. After five seconds, the projector is reset and ready for the next automatic cue signal. When the next start signal is received, the projector starts with the correct frame in the gate.

Any number of cueing patches may be applied to a reel of film in a matter of minutes. These may be removed at any time without damage to the film. A feature film, for example, may be quickly and easily "programmed" in advance by applying a series of conductive patches to automatically cue the beginning of the film as well as any desired stopping points to permit a station break or commercial insertions.

Automatic cueing also facilitates the showing of a reel of film containing several picture sequences which have been spliced together in accordance with a desired program schedule. By applying the conductive patches in the proper locations, the projector will automatically reset or cue itself for the next picture sequence as each preceding sequence is completed.

Measuring the Film Motion

By means of the automatic cue kit, the controlled stopping action is tied directly to film motion. In this way automatic stop is completely independent of variations in run-down time or rate. The projector mechanism actually counts the number of frames passing a given point while the projector is decelerating and then applies a mechanical brake to bring it to a stop very quickly.

In measuring film motion, the rotation of a film sprocket is conveniently utilized. Figure 2 shows the several sprockets in the film path. The most convenient of these for controlling the stopping mechanism is the upper feed sprocket. The shaft for this sprocket has been extended out

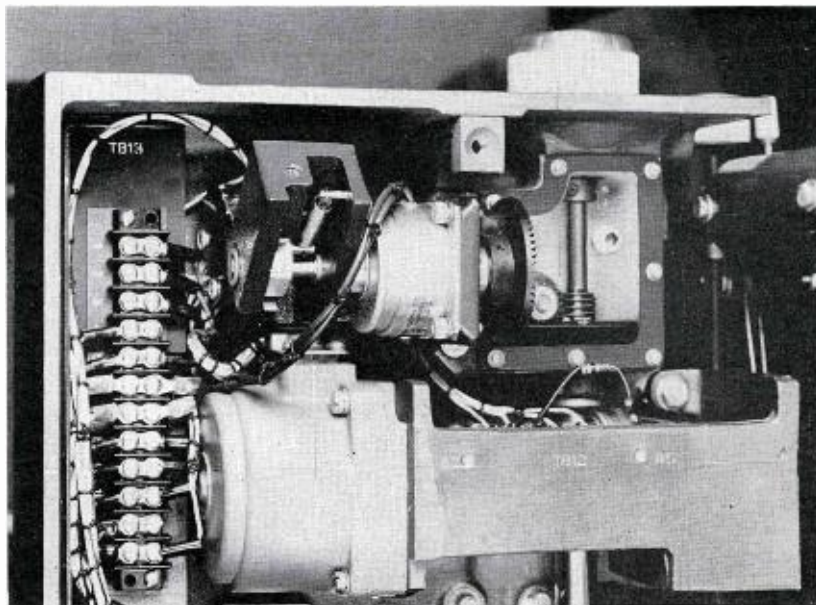

FIG. 3. View of upper gear box. Shaft from upper feed sprocket is geared to a magnetic clutch which controls film motion.

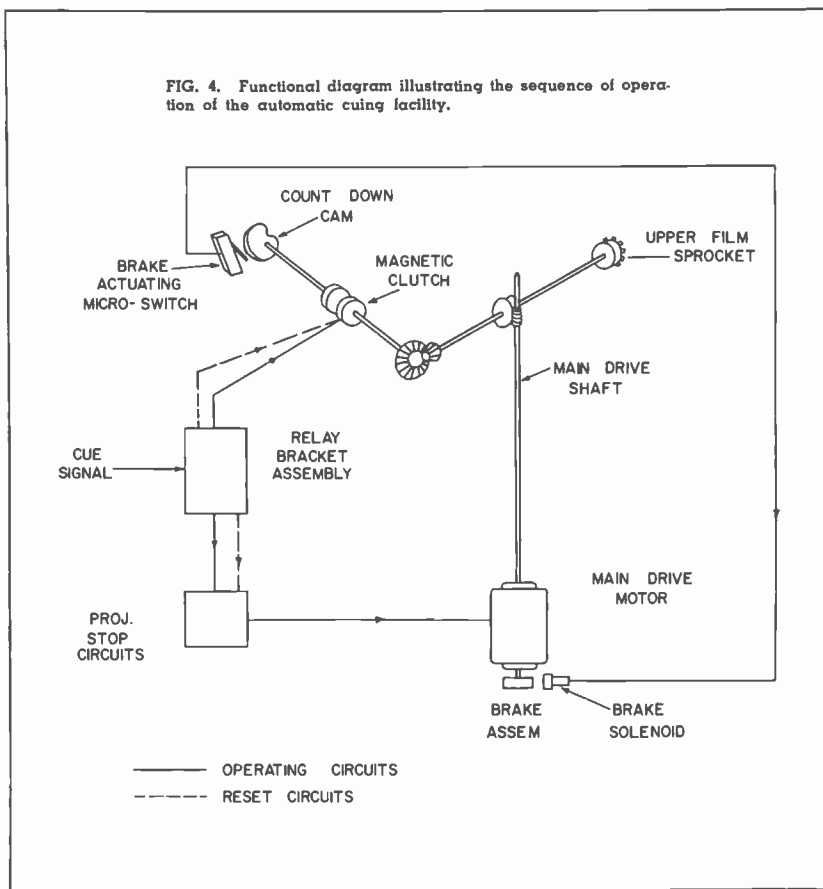

FIG. 4. Functional diagram illustrating the sequence of operation of the automatic cueing facility.

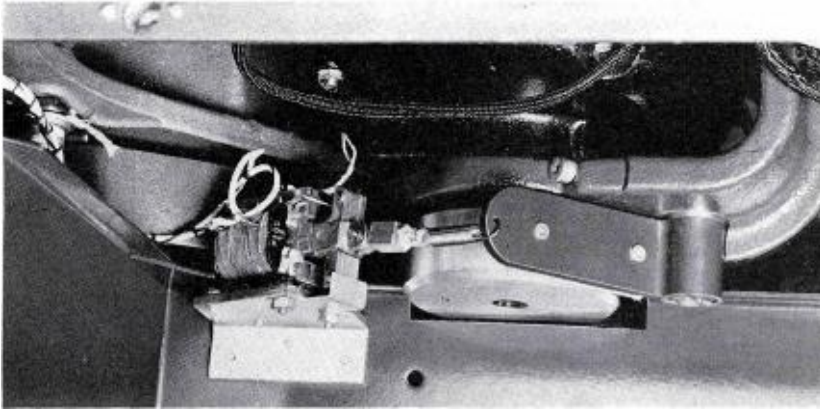

FIG. 5. The brake assembly is mounted directly on the casting which supports the main projector drive motor.

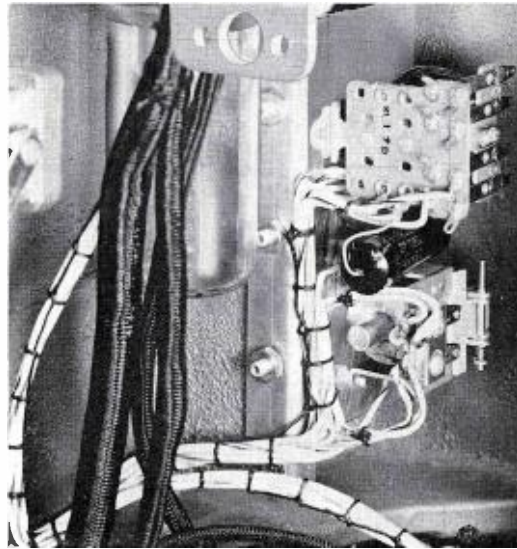

FIG. 6. Automatic cueing control circuits are mounted in the control box compartment of the TP-6 Projector. Addition of these circuits does not affect normal projector operation in any way.

through the protective plexiglas cover over the upper gear box on the back of the projector (see Fig. 3). The input shaft to a magnetic clutch is driven by a set of bevel gears from the sprocket shaft. The output of the clutch drives a special "count-down" cam. When the magnetic clutch is energized, this cam is coupled tightly to the film motion.

The action of the mechanism takes place in sequence. Initiation of the sequence depends upon the cue signal which activates the following processes (see Fig. 4):

1. The normal projector stopping circuits are actuated and at the same time the magnetic clutch on the count-down cam is energized;
2. The cam starts to measure the film as it passes through the projector during the first part of the deceleration;
3. After a predetermined number of frames (adjustable from 22 to 26 frames), the cam will close a micro-switch which energizes the solenoid on the brake;
4. By this time the main drive motor is rotating at a relatively slow rate, when the brake is applied it can be brought to a full stop in less than one revolution of the main drive motor;
5. After a short interval, the magnetic clutch and the brake are released to be ready for the next sequence.

The brake assembly, shown in Fig. 5, is mounted directly on the casting which supports the main drive motor. This motor has a shaft projecting from each end. On the lower shaft is mounted a large diameter brake drum. The shoe on this brake

drum is actuated by a solenoid. This brake assembly is more than adequate to stop the projector in less than one revolution of the drive motor, after the initial period of deceleration.

Control Circuit

When the cue signal is applied to the projector, it closes a relay which energizes the magnetic clutch and the normal stopping controls. In addition a five-second time-delay is released. At the end of the five-second period this relay releases the magnetic clutch. The cam mounted on the magnetic clutch is spring-loaded. When this cam returns to the zero position, the microswitch is released removing the power from the brake assembly. The time required between film sequences to stop and reset the projector automatically with the next cueing frame in the gate is five seconds.



FIG. 7. A split roller is installed just ahead of the power film sprocket in place of the reel guide roller. This split roller is shown here just to the left of the operator's right hand.

The method by which the control circuits are added to the TP-6 projector is shown in Fig. 6. Installation of these circuits in no way affects the normal operation of the projector.

Method of Cuing

Cuing of the projector is accomplished by a conductive patch which is applied over the sound track of the film. This device has been used successfully for control in automatic film printers. A split roller is installed just ahead of the upper film sprocket in place of the reel guide rollers (see Fig. 7). The split roller is mounted between two guide rollers to insure sufficient wrap of the film on the split roller for good contact. Brushes ride on the roller flanges and these in turn are wired directly to the relay circuits within the projector.

The conductive patch material employed in this system is aluminum foil with a silicone adhesive backing. This type of foil was found to be very durable and can be run through the machine many times without damage. In actual tests the same strip was run through more than fifty times without apparent deterioration.

The conductive patch system has a number of outstanding advantages. One of the most important is its complete separation from the audio system. An even more important advantage is the fact that the patches can be applied to the film without cutting or splicing and can be removed after use without any damage to the film.

The conductive patch need not be more than one inch in length. It is normally located after the cuing frame, but close

enough to it so that the patch passes through the gate position during the normal run-up of the projector. Therefore, there is no chance that it will show on the air or affect the sound.

Preparation for Automatic Operation

Use of the automatic cue kit with existing TP-6 projectors will contribute toward the conservation of manpower and time, lead to more uniform operation and tend to standardize station practices. The equipment is designed to stop repeatedly within ± 1 frame of any designated picture frame. This mode of operation becomes particularly necessary in a completely automatic system where the entire day's film requirements may be prepared in advance; and once the projector is threaded and initially cued, it need not be touched again until the reel of film runs out.

MOUNTING THE RCA ORBITER GENERATOR ON THE TK-31 FIELD CAMERA CONTROL

by ARTHUR R. O'NEIL, Chief Engineer, WSBT-TV
South Bend, Indiana



FIG. 1. Rear view of TK-31 camera control unit showing placement of the orbiter generator control box.

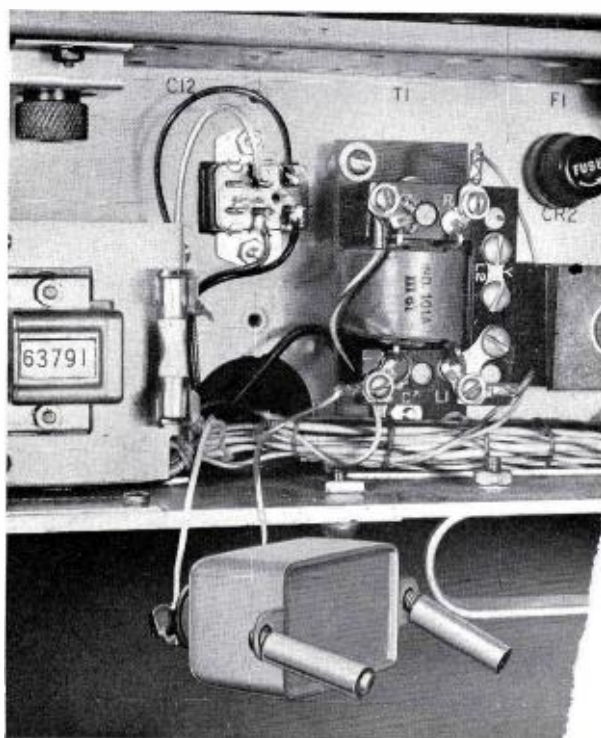

FIG. 2. Addition of a 300-series Jones socket behind C-12 on the camera chassis, facilitates removal of the entire yoke assembly.

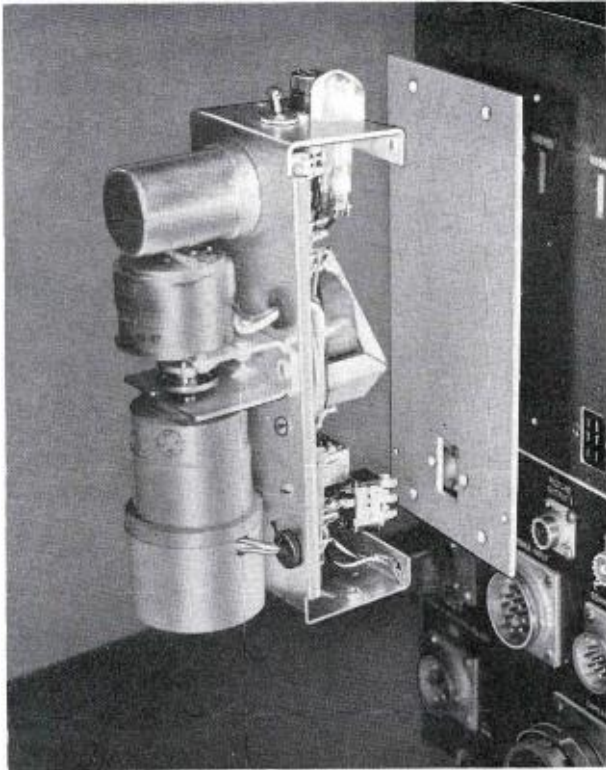

FIG. 3. Exploded view showing mounting provisions for the orbiter generator. For details, see text.

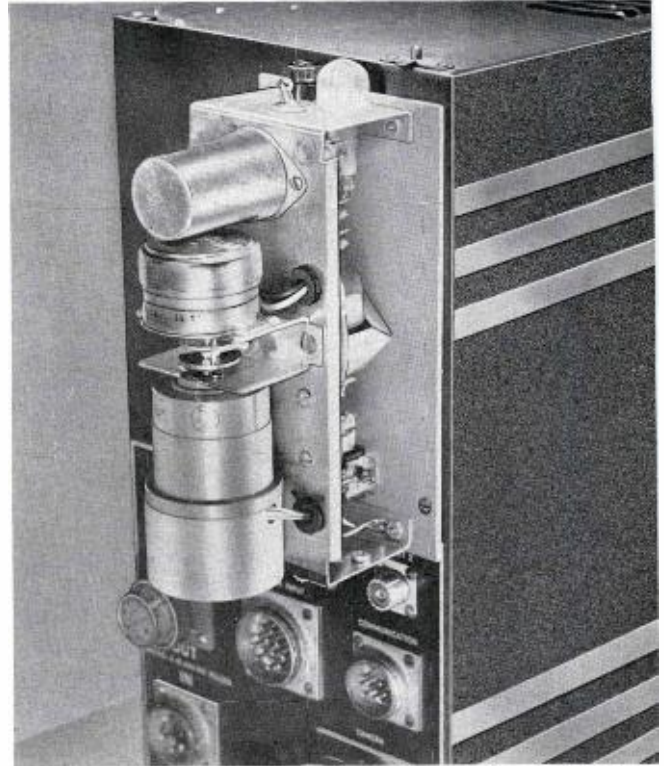

FIG. 4. View of orbiter generator in place with cover removed at rear of the camera control unit.

In installing four image orbiters for our TK-31 Field Camera Chains, we found it extremely convenient to mount the orbiter generator at the rear of our field camera controls (see Fig. 1). The idea and accomplishment of this form of mounting was devised by several members of our engineering staff and has provided ease of handling and convenient control, especially when using the cameras in the field.

Installation was accomplished by following the instructions accompanying the orbiter kits with simple modification. At the camera position we added a 300 series Jones socket and plug to enable easy removal of the entire yoke assembly for maintenance purposes. The socket, shown in Fig. 2, is positioned behind C 12, which is mounted on spacers to allow it to clear the socket.

At the field camera control a switch, fuse and neon pilot light were added to the orbiter chassis. The cover was turned over and these parts situated so that the cover would fit in place. The control switch supplied with the orbiter kit is designed to mount on the front panel of the camera control unit; however, it was installed

at the generator to avoid drilling into the escutcheon panel of the control unit.

A new back plate for the orbiter generator was constructed from aluminum stock and increased by $\frac{3}{4}$ of an inch in width to provide a $\frac{3}{8}$ -inch mounting lip. The original cannon connector was removed and a Jones 300 series connector mounted as shown in the exploded view, Fig. 3. The female mating connector was mounted on the camera control immediately above the picture output connectors. This resulted in very convenient wiring to the communication plug.

Figure 4 shows the orbiter generator, with cover removed, in place at the rear of the camera control unit. The chassis is held to the control unit by four screws and power is taken from the primary side of the transformer T-4.

Use of this mounting has provided us with a compact TK-31 camera modification especially convenient for use on remotes. Supplied for universal mounting on either field or studio camera, the RCA orbiter generator kit has been readily adaptable to our individual station requirements.



HOW TO GET GOOD PICTURE QUALITY FROM THE TK-15 VIDICON STUDIO CAMERA

*Recommended Operating Practices With Special Emphasis Upon Lighting
and Electrical Adjustments to Obtain High S/N and Produce Pictures
of Superior Quality*

by JOHN H. ROE, Manager, Camera Equipment Engineering

Obtaining Superior Pictures

Good television pictures don't just happen. They are made! Programming and technical personnel in a television studio are jointly responsible for picture quality. The programming people are mainly responsible for the artistic or aesthetic impact of the program on the viewer, but if the technical operators let them down with poor performance, the net result will be a "flop." Conversely, flawless technical performance will not save a poor program, but the program must be constructed and carried out in a manner which fits within the technical possibilities of the television equipment, or the operators will be put in an impossible position.

Mutual understanding of each other's desires, capabilities, and problems, and close co-operation are essential to a smoothly working operation.

Good Performance Requires Understanding of Equipment

The purpose of the text which follows is to assist the technical operators to a fundamentally sound understanding of the outstanding capabilities of vidicon cameras, especially the TK-15 Vidicon Live Pickup Camera, and of how to realize, not just average performance, but the best possible performance at all times. Careful study of the procedures and recommendations is strongly urged. This should be followed with practice and more practice to fix the ideas and to make them instinctive.

Those who have past experience with image orthicon cameras will find that some revision of their accepted practices is necessary, especially with respect to lighting. This requirement applies to both technical and programming people. When carefully studied, it will be found that the vidicon camera opens up new possibilities for realistic and artistic effects, not easily attainable before.

AUTHOR'S NOTE: The material in this paper and the method of presentation are not intended to replace the detailed information given in instruction books. The intent is rather to clarify the understanding of some of the basic characteristics of vidicons and vidicon cameras—to explain the philosophy of equipment design and operation for live pickup. No attempt is made to describe the details of circuits or packaging, nor to cover all the necessary steps in setup and operation. These can be obtained by a thorough study of instruction books. For those who wish to use the information in this paper to improve their operating knowledge and skill, the instruction books will provide invaluable background for understanding what is said. For those looking only for general information on what to expect from vidicon cameras, the story may be found complete in itself.

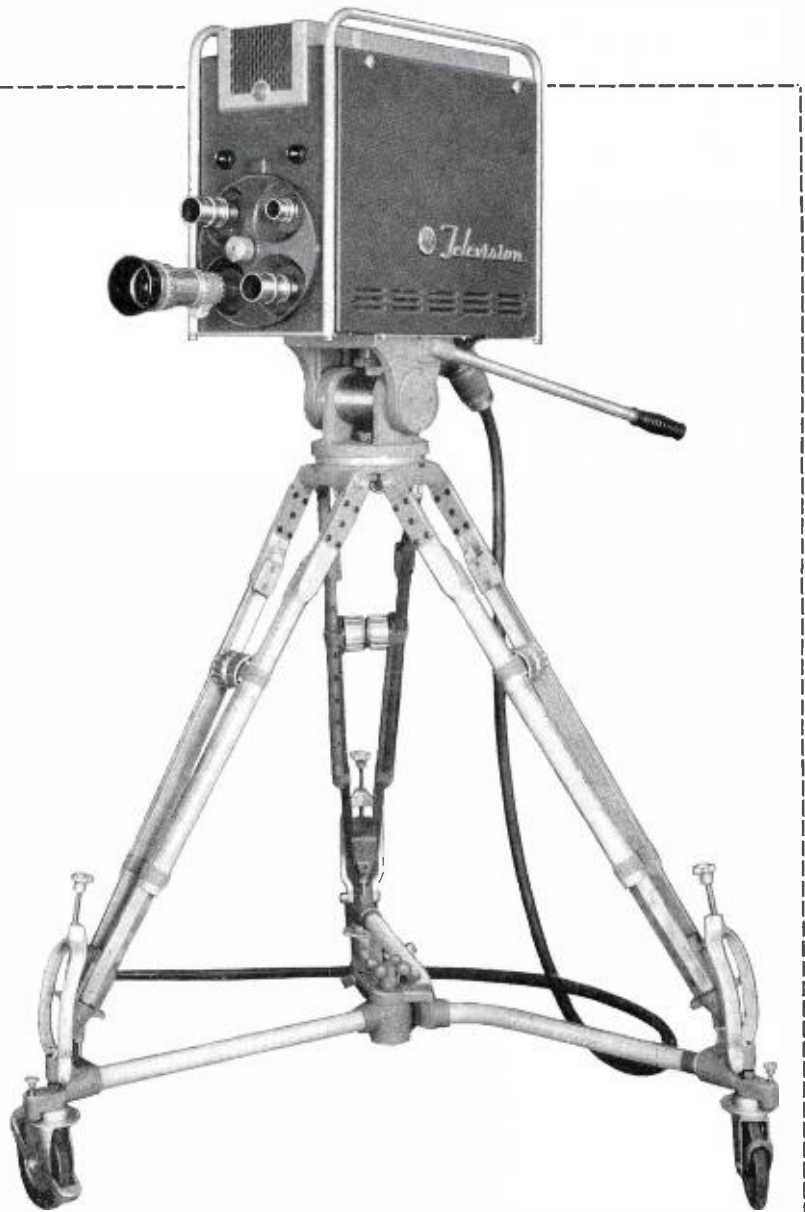

ADVANTAGES OF TK-15 VIDICON STUDIO CAMERA

- Low noise content (excellent signal-to-noise ratio)
- Unusually good gray scale response
- No spurious halo and edge effects
- Gamma correction for artistic purposes
- Aperture correction (sharpening of resolution)
- Freedom from sticking
- Pictures are of superior photographic quality
- Long-life, low-cost tube



FIG. 1. Standard broadcast 13-inch camera control console, housing TM-6 master monitor—may be used with the TK-15 vidicon camera.

FIG. 2. Special 22-inch camera control console, housing TM-4 monitor and TO-1 oscilloscope—may also be used with TK-15 vidicon camera.

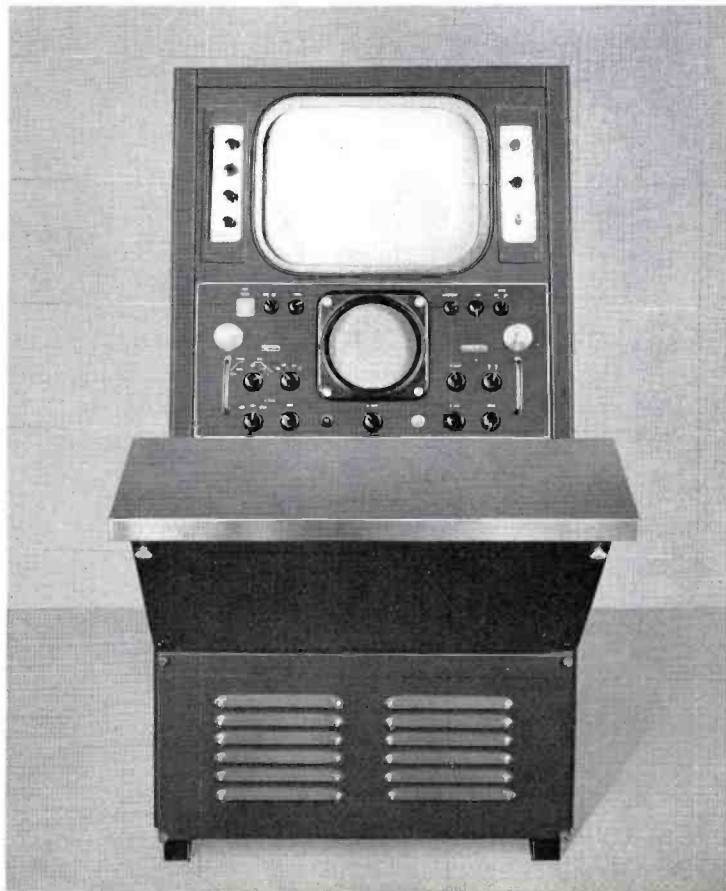

A New Vidicon Tube

The new RCA 7038 vidicon tube embodies some distinct advantages including greatly increased dimensional precision of the faceplate, and much more uniform deposit of the photoconductor on the faceplate. These result respectively in better optics and in improved uniformity of signal current and dark current. The uniformity of dark current provides almost complete elimination of edge-flare components in the output signal, and thus permits operating the vidicon at higher target* voltage, and consequently higher sensitivity.

These characteristics make the 7038 especially suitable for use in the TK-15 camera. Utilization of the 7038 forms the principal basis for the discussions in this paper.

What Can be Expected From Vidicon Cameras

Outstanding among properties of the vidicon cameras are excellent signal-to-noise ratio, good gray scale rendition, and freedom from spurious halo effects and sharp overshoots in the signal. Each of these deserves some discussion.

The low noise-content of a well setup vidicon picture is immediately obvious. The noise output of the vidicon itself is only about 1/300th of the useful signal output, and it is effectively zero in the picture blacks. This fact is in sharp contrast to the situation with the image orthicon where internally generated beam noise is highest in the picture blacks and tapers off to a lesser (but never zero) value in picture whites. Since the signal level produced by the vidicon is relatively low, a high-gain video amplifier is required. This amplifier, as mentioned in later paragraphs, therefore becomes the principle source of noise in the camera system, and it must be designed to avoid generating appreciable noise. Noise which may be observed in the picture blacks from a vidicon camera comes from the amplifier, not from the vidicon. To obtain optimum performance in the matter of low noise-content, it is essential to provide adequate lighting on the scene. This will be discussed in more detail later.

The gray scale response, or transfer characteristic, of the vidicon is a measure of its ability to respond to visible changes in shading in different areas of the scene.

* In some existing vidicon camera equipment, the term "signal electrode" is used. However, the term "target" has now been adopted and is used exclusively here.

The vidicon has unusually good response in this respect, permitting realistic portrayal of differences in gray scale over a wide range in contrast. In fact, it has this capability well beyond the reproducing ability of the rest of the television system. For this reason, it is important to limit the range of contrast in the scene to values which the system can accommodate. In other words, highly polished objects like sequins, jewelry, or brass wind instruments should be avoided whenever possible, or, if they are unavoidable, lighting should be arranged to minimize frequent direct reflections into the camera lens.

The image orthicon is self-limiting with respect to excessive lighting and tends to compress a wide range of contrast in the scene into a range which the system can accommodate, but in doing this it introduces spurious edge effects and black halos which may at times give unrealistic hardness to the picture. No comparable spurious effects are produced in the vidicon. If lighting for the vidicon is not controlled adequately, reflections from polished objects, or highlights from white clothing, can produce demands for signal currents greater than the available scanning beam current, and a flat saturated white area will appear in the picture. It is not possible to increase the beam current beyond the normal upper limit without danger of losing resolution or possibly without obtaining a double image (split-beam effect).

Some modification of the transfer characteristic, usually to enhance the contrast in the darker grays, is possible in the vidicon camera by introducing correction into the video amplifier circuit. This type of modification is usually called "gamma correction." It tends also to increase the appearance of noise in the dark grays, but *an outstanding advantage of the vidicon camera* is that its low noise-content permits considerable gamma correction for artistic purposes *without objectionable increase* in apparent noise.

Similarly, the low noise-content permits another type of electronic correction known as "aperture correction." This is simply an artificial sharpening of the apparent resolution in the reproduced picture to compensate for the fact that the vidicon (as do all other camera tubes) has limited inherent ability to reproduce very fine detail. Aperture correction also tends to increase the noise, but again, the low noise in the vidicon camera permits considerable correction without serious increase in apparent noise.

TABLE 1—Important Points to Remember to Obtain Maximum Picture Quality

1. Excellent signal-to-noise ratio may be achieved by maintaining signal current between 0.15 and 0.3 microampere.
2. Illumination on the scene and lens iris setting should be such as to provide the specified signal current at relatively low target voltage and low dark current (about 0.05 microampere). This will result in low lag.
3. Adjustment of illumination level should be used, whenever possible, to set video signal level.
4. Target voltage may be used to adjust video signal level when it is not possible to adjust illumination.
5. Adjustment of video gain should not be used to correct for changes in illumination level.

Importance of Lighting

Lighting a stage set properly is an important part of creating the desired atmosphere in a theater play. Lighting of sets for motion pictures is similarly important, and here the lighting director has achieved the stature of an artist in his own right. Lighting a set in a television studio requires equal skill and a new area of knowledge having to do with the characteristics of the television cameras.

Lighting for the Image Orthicon

In one way, the commonly used image orthicon camera has eased the problem of correct studio lighting because it has built-in ability to accept a wide range of light intensity and to compress it into the narrower limits which can be accommodated by the rest of the television system. In other words, the image orthicon is a self-limiting device with respect to light range when it is operated "one or two stops



FIG. 3. Remote control panel for TK-15 vidicon camera.

TABLE 2—Range of Performance, Using Target Voltage Adjustment as Sensitivity Control When Light Changes

Illumination Foot-Candles	Lens f No.		Depth Focus	* Target Volts	Signal μ amp.	Dark μ amp.	Video Gain	S/N	Lag	Remarks
	Vidicon	Equiv. I.O.								
200	2.8	8.0	Average	50	0.3	0.05	1.0	Excellent	Low	Recommended
100	2.8	8.0	Average	60	0.3	0.10	1.0	Excellent	Medium	
60	2.8	8.0	Average	75	0.3	0.20	1.0	Excellent	Excessive	

TABLE 3—Range of Performance When Dark Current is Held Constant But Lens Opening, Lighting, Video Amplifier Gain, and Video Signal Current are All Permitted to Vary

Illumination Foot-Candles	Lens f No.		Depth Focus	* Target Volts	Signal μ amp.	Dark μ amp.	Video Gain	S/N	Lag	Remarks
	Vidicon	Equiv. I.O.								
400	4.0	11.0	Large	50	0.3	0.05	1.0	Excellent	Low	
200	4.0	11.0	Large	50	0.20	0.05	1.5	Good	Medium	
200	2.8	8.0	Average	50	0.3	0.05	1.0	Excellent	Low	Recommended
100	2.8	8.0	Average	50	0.20	0.05	1.5	Good	Medium	
100	2.0	5.6	Lesser	50	0.3	0.05	1.0	Excellent	Low	
50	2.0	5.6	Lesser	50	0.20	0.05	1.5	Good	Medium	
16.7	2.0	5.6	Lesser	50	0.10	0.05	3.0	Marginal	Excessive	
16.7	1.1	2.8	Small	50	0.20	0.05	1.5	Good	Medium	

* Average values of target voltage are shown. In any one vidicon the actual voltages required for the currents shown may differ from these by as much as 25 per cent.

Note: All numerical values are approximate. All terms are relative. The purpose is to indicate trends rather than exact values.

over the knee." This method of operating an image orthicon camera, which is almost universal in the United States, has permitted a great deal of latitude in lighting of stage sets.

Lighting for the Vidicon

The vidicon is an entirely different device, and television cameras employing the vidicon will require a new approach to proper lighting. Briefly, the vidicon has nearly constant gamma. This means that its output will continue to increase according to a definite law as the light increases, limited only by availability of sufficient beam current. The relatively constant gamma characteristic of the vidicon permits it to produce a picture with contrast more pleasing and realistic than that obtained from the image orthicon, with more nearly the tonal character of a good photograph.

How Much Light?

So, the question is, "What constitutes good lighting for a vidicon camera?" First, it should be understood that the vidicon can produce pictures under a variety of lighting conditions, which can be accommodated by adjustments of target voltage and lens iris. There is, however, a relatively narrow range of lighting conditions where results are optimum in all respects—where the picture quality is highly acceptable. Correct lighting is such an important factor in this achievement that special emphasis is placed on it in this paper together with a discussion of how the electrical adjustments of the camera relate to it.

To obtain these optimum results the incident illumination on the scene should be about 200 foot-candles with an iris setting of f:2.8. The reasons for choosing these

values will become apparent in the following discussions. They are not the only possible values, but they fall into the previously mentioned range where the best pictures are produced.

Depth of Focus

The laws of optics may be translated directly from experience with image orthicons. The lens iris must be opened enough to admit adequate light, but not so much that there is too little depth of focus. With image orthicon cameras, adequate depth of focus for average use is obtained with the iris set at about f:8.0. Because of the smaller image size in a vidicon camera, the same effective depth of focus is obtained with the iris set at f:3.1. Most lenses do not include this value on the iris scale markings, but reasonable equivalence can be obtained at either f:2.8 or f:3.5 which



FIG. 4. Note large 7-inch viewfinder; convenient location of controls, and easy-to-grasp turret handle.



FIG. 5. Large 9-inch, 4-lens, broadcast-type turret is used on TK-15.

are common values. The value of $f:2.8$ is preferable because it increases the light reaching the vidicon, and permits some reduction in incident light on the scene.

What Other Factors Are Involved?

Among the other most important variables affecting the performance of the vidicon camera are signal current, dark current, target voltage, signal-to-noise ratio (S/N), and lag. These are all somewhat inter-related, and their significance individually and collectively are important in understanding how to obtain consistently good results.

Signal Current and Dark Current

The vidicon, in simplified terms, may be considered as a variable resistor in a closed loop of four parts, consisting of the photoconductor (or target), a fixed load resistor, the scanning beam, and the target voltage supply. Actually the photoconductor is the variable resistor, the resistance of which decreases with increasing light and vice versa. This is illustrated in Fig. 7. As indicated in the diagram, the target may be thought of as a large group of parallel variable resistors, since the conductivity at any point in the target depends on the

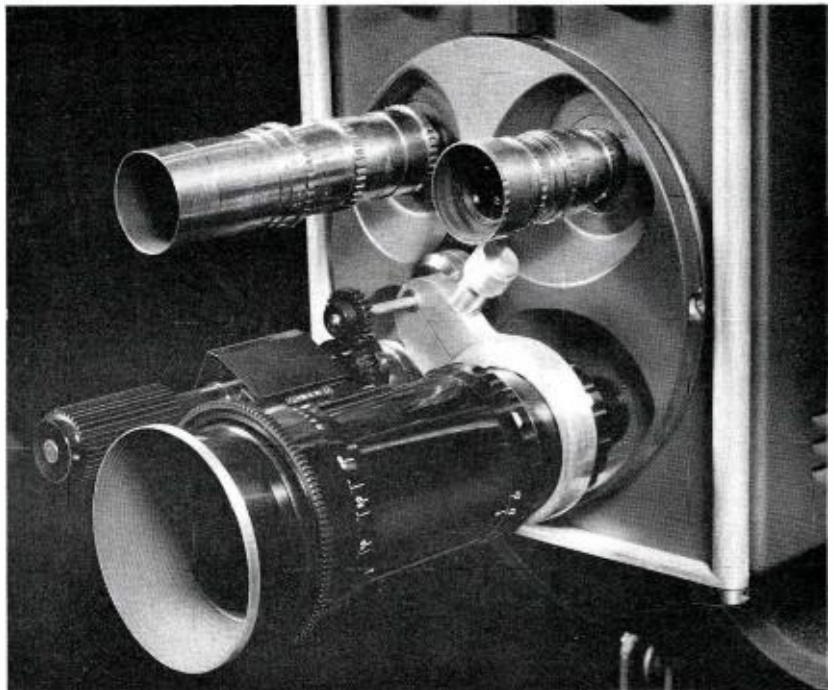

FIG. 6. The TK-15 turret accommodates zoom lens in addition to three other lenses.

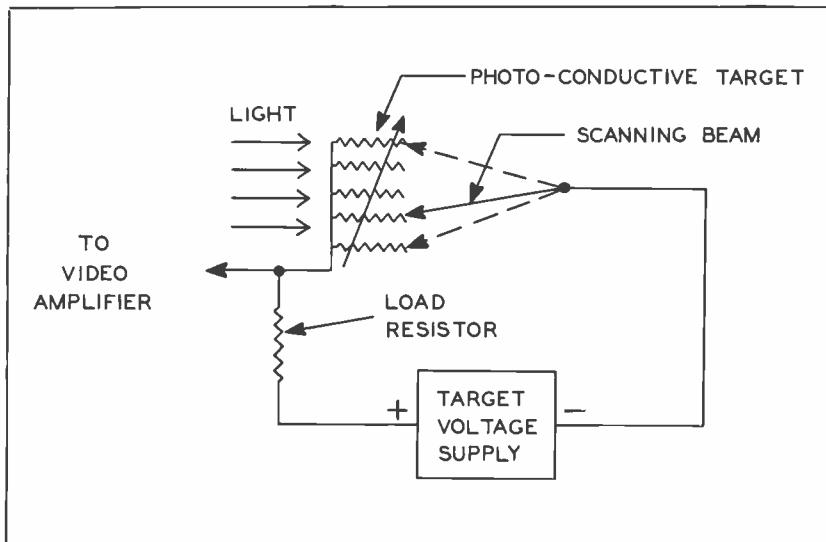

FIG. 7. Simplified diagram, comparing action of the vidicon tube to a variable resistor in a closed loop.

amount of light falling on that point. All are connected together at one end to the external target terminal, and the scanning beam acts as a commutator, completing the circuit through each one in sequence.

The total current flow in this loop may be defined as *target current*. When the target is dark, its resistance is not infinite, and there will be residual target current flow (normally quite uniform over the whole target area, especially in the new 7038 vidicon) known as *dark current*. By permitting light to fall on the target, the current increases. The *difference* between *total target current* and residual *dark current* may be defined as useful *signal current*. Since dark current is reasonably uniform, it may be considered as a d-c component of the total video signal. This is illustrated in Figure 8 where (A) and (B) show typical conditions for two different values of dark current.

What causes dark current to change? First, an increase in target voltage will increase *both* dark current and signal current. Second, dark current increases with temperature.

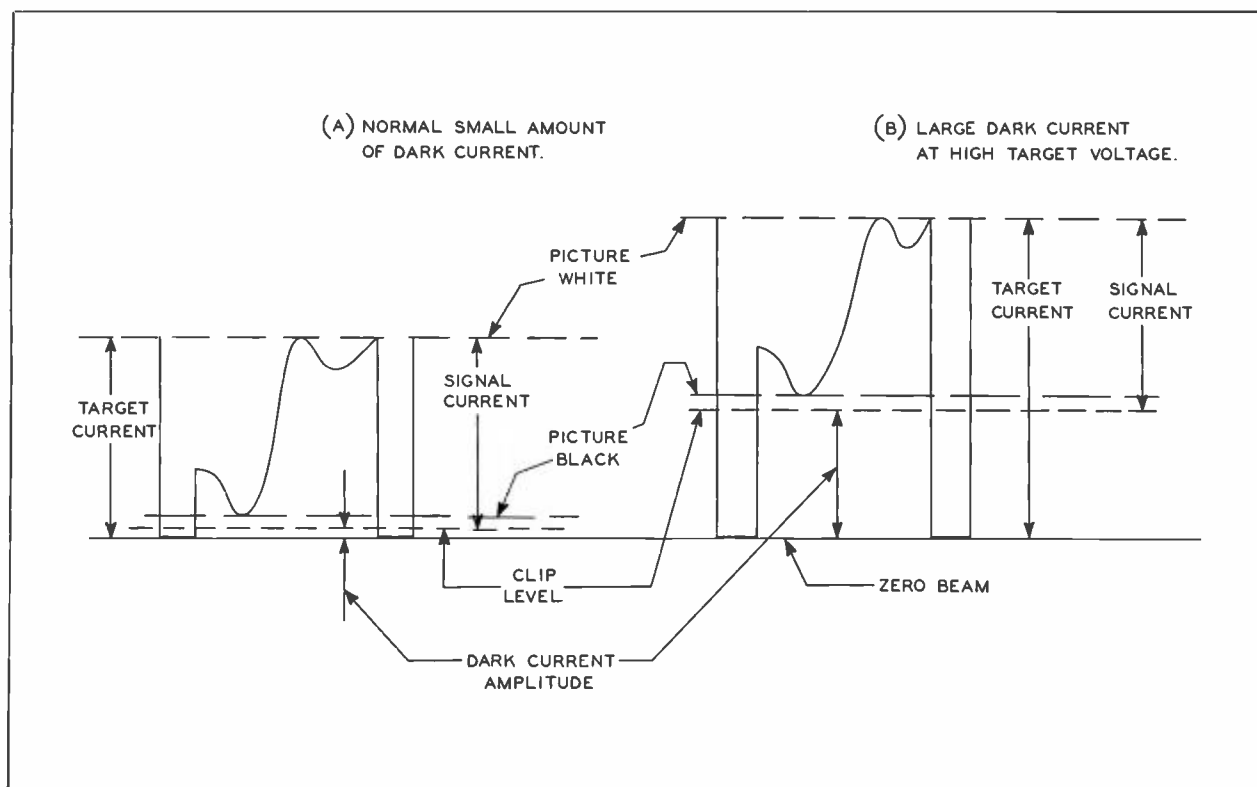

FIG. 8. Diagram showing effect of change in dark current.

Because dark current is not useful signal current, it is desirable to keep it at a minimum, and if possible, to keep it small compared to signal current, see Fig. 8(A). Under such conditions, temperature changes, even though they cause a 2-to-1 increase in dark current, make little difference in the relation of dark current to signal current. However, when the dark current is relatively large, as in Fig. 8(B), a 2-to-1 change in dark current causes a noticeable change in pedestal setting in the video signal, and may require readjustment of the pedestal control. Furthermore, a large increase in dark current may require an increase in beam current.

Limitations Affecting Signal Current and Dark Current

Total *target current* has been defined as the sum of dark current and signal current. When the vidicon camera is ideally adjusted the useful *beam current* (that portion of the steady d-c emitted from the gun which reaches the target) is just equal to the *maximum or peak target current*. When normal signal variations cause the target current to decrease, the excess electrons in the beam turn around and go back to the gun. The value of required beam current is, therefore, determined by peak or maximum values of total target current. If the demand on beam current becomes excessive, it is no longer possible to keep the dimensions of the beam small enough to provide adequate resolution. A practical upper limit of target current to avoid beam-spreading and loss in resolution is 0.5 microampere. Useful peak signal current for the typical lighting conditions given (f:2.8 lens opening, and 200 foot-candles incident lighting) is about 0.3 microampere. This leaves a value of 0.2 microampere for *maximum permissible* dark current. Actually, under the recommended typical lighting conditions, dark current will be much less, about 0.05 microampere. Conditions where dark current may be as large as 0.2 microampere are described in connection with target voltage adjustments.

Signal Current and Signal-to-Noise Ratio (S/N)

A most important aspect of vidicon camera operation is maintenance of the signal level at a value which will keep noise, or picture "snow," at a minimum. Good performance in this respect is measured in terms of signal-to-noise ratio (S/N). High S/N means good performance, a clean picture.

In an image orthicon camera, the main source of noise is the image orthicon tube

itself, and the video amplifier contributes no significant portion of the total noise. In a vidicon camera, on the other hand, almost no noise is generated in the vidicon itself, and the only significant source of noise is the video amplifier. Therefore, good vidicon cameras contain so-called "low-noise" input stages in the video amplifier. In modern techniques, the input stage is a cascode amplifier utilizing high-transconductance triode tubes.

How to Obtain High S/N

Once the minimum noise level is established by the amplifier design, the only approach to obtaining high S/N is to generate in the vidicon a useful signal at a level well above the noise level. This result can be achieved by proper adjustment of lighting and target voltage. An important factor influencing the adjustment of target voltage is dark current as described later. Aside from this, lighting therefore becomes the most important factor affecting S/N. Use of a video gain control to adjust for normal video signal level when lighting is inadequate, will result in a noisy picture. It is for this reason that a *video gain control should not be used as an operating control* of video signal level in a vidicon camera. The video gain control in the output amplifier of the TK-15 chain is intended for use as a preset control only.

The value of 0.3 microampere for peak signal currents will give excellent S/N when a cascode input stage of the type used in the TK-15 camera is provided. *This value for peak signal currents may be taken as a benchmark for maximum performance.*

Some variation from the suggested values may be acceptable if the factors involved are clearly understood. For example, with the lens iris set at f:4.0, the light reaching the vidicon will be halved, but the depth of focus will be increased by more than 40 per cent. A more important result, however, will be the 1.5 to 1 reduction of peak signal current out of the vidicon. Unless the target voltage is raised to restore the loss in signal current (see next paragraph), it becomes necessary to increase the gain of the video amplifier by 1.5 to 1 in order to obtain normal output signal level. Increasing video gain causes a loss of S/N. Practical experience has shown that peak signal current of 0.15 microampere provides a reasonably satisfactory signal from the standpoint of S/N, at the same time permitting economy in lighting, or greater depth of focus, without any increase in target voltage and dark current.

Target Voltage and Sensitivity

Sensitivity of the vidicon can be increased effectively by increasing the polarizing voltage on the target, thereby increasing signal currents. This will permit the vidicon camera to produce pictures under less favorable lighting conditions. However, as previously stated, an increase in target voltage also causes dark current to increase. *The upper limit beyond which the target voltage should never be raised is that voltage which gives a dark current of 0.2 microampere* for the 7038 vidicon (0.1 microampere for other types). Therefore, increased sensitivity obtained in this way is definitely limited by the amount of dark current which can be accommodated.

The limitation stated in the foregoing assumes that peak signal current of 0.3 microampere will be generated and used. If a lesser value of peak signal current is used, it should be possible theoretically to permit dark current to increase beyond 0.2 microampere, but limited to a value such that total peak target current does not exceed 0.5 microampere. It is *not recommended*, however, that dark current be permitted beyond the 0.2 microampere limit because lag will increase, resolution may be impaired, and temperature changes become more significant.

The target voltage control is provided, and may be used, as an operating sensitivity control, *but* within the limitations just described. Target voltages which keep the dark current to values *less than 0.1 microampere* (preferably as low as 0.02 to 0.05 microampere) will provide optimum results. *These can be obtained only by providing sufficient light on the scene to avoid the need for maximum sensitivity.*

Lag

So far this discussion has dealt with operating practices as they affect resolution, S/N, video level, etc. The vidicon has another characteristic called *lag*, which is also affected by light level and signal level, and therefore indirectly by target voltage adjustment. Lag is a name for the characteristic which produces an after-image following a moving object in the scene. Such after-images are especially noticeable with moving white objects against a dark background or vice versa. They disappear in a second or two, but have the effect of smearing detail in motion. No technique is known which will completely eliminate lag, but by proper control of operating conditions, it can be minimized to a point where it is relatively unimportant.

The phenomenon of lag is not completely understood, but it is known that it de-

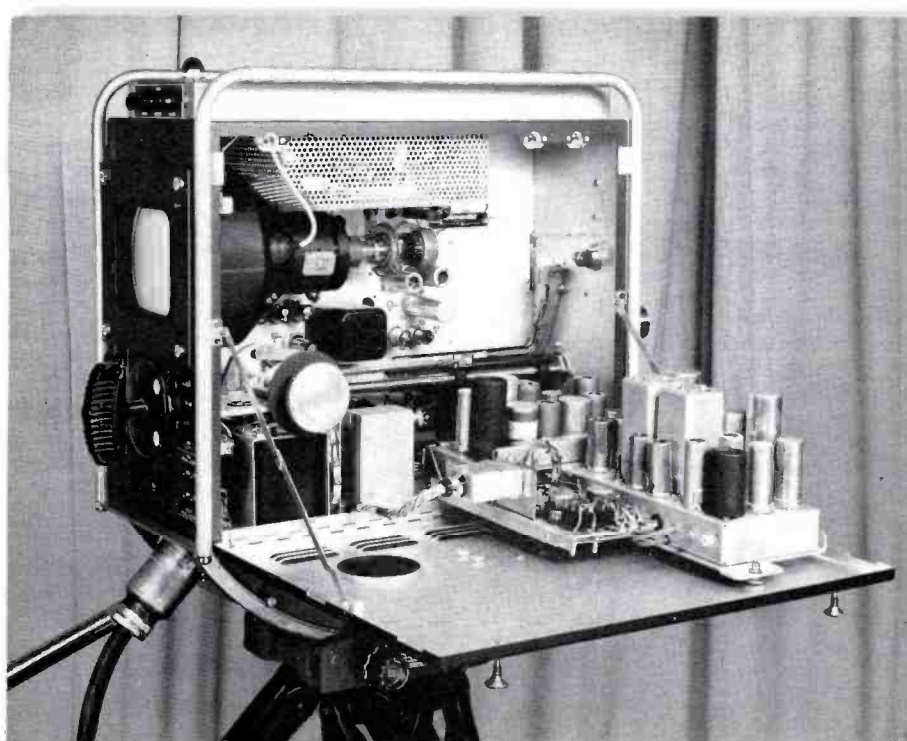

FIG. 9. Side panels of the TK-15 camera open to form a table for ease of servicing. Swing-out chassis provide for complete accessibility.

creases as light is increased on the vidicon. There is some evidence that it is also beneficial to maintain the signal current at a fairly high level. These conditions for minimizing lag therefore give further support to the recommendations for proper lighting and proper adjustment of target voltage, signal current, and dark current. Conversely, if light is reduced, and target voltage raised to restore signal output, dark current and lag will both increase beyond desirable proportions.

Practical Techniques in Operation

From the preceding discussion it is apparent that *minimum dark current is a key to good performance*. It is important therefore to be able to recognize it easily and to know how to compensate for undesirable effects produced by it. The effect of a large increase in dark current (caused by an increase in target voltage and possibly aggravated by increasing temperature) has been illustrated in Fig. 8. The result is a shift in pedestal which can be

compensated by readjustment of the pedestal control. Normally such a condition would arise only when there is an intentional change in target voltage to accommodate a reduction in light. Therefore, the need for resetting of the pedestal control can be anticipated and accomplished simultaneously. A waveform monitor is a convenient indicator in this case and should be used if available. A picture monitor is a less accurate indicator, but can be used if a waveform monitor is not available by simply readjusting the camera target and pedestal controls until the contrast and average brightness of the picture are restored to normal.

When the target voltage is raised to increase sensitivity, and the pedestal control is readjusted correspondingly, it may be found that highlights in the scene become saturated. This is an indication that the beam current is insufficient to provide the required peak target current. To correct this situation, the beam current must be increased. This is a direct indication that dark current has increased and it is a warning that the limit of beam current, consistent with maximum resolution, is being approached.

To avoid deterioration of picture quality from the presence of excessive dark current, it is highly desirable to know how to measure it and thus to be assured that it is within prescribed limits.

How to Measure Signal Current and Dark Current

In all RCA broadcast vidicon camera equipments there are built-in devices for measuring target current.

In the RCA TK-21 black-and-white vidicon film chain and the TK-26 3-V color film chain, direct measurement of average signal current is provided by a VT microammeter in the target circuit. With the lens capped and the meter properly zeroed, the meter indicates dark current only. With flat lighting (from a white card or from a clear slide in the projector), the meter indicates the sum of dark current and useful signal current. It must be remembered that the meter reads average current, not peak current. Therefore, the meter reading is significant *only* when the vidicon is uniformly illuminated over the whole area and properly scanned to a raster diagonal of 0.625 inch. Even then the reading will not indicate true peak current because of the blanking pulses. It will read about 0.9 of the true peak value. Thus, if the meter reads 0.27 microampere, the actual peak value will be 0.3 microampere.

In the RCA TK-15 black-and-white live camera chain and in the TK-45 color live

FIG. 10. Direct-drive focus control provides precision focusing. A 300-degree turn carries through complete focus range.

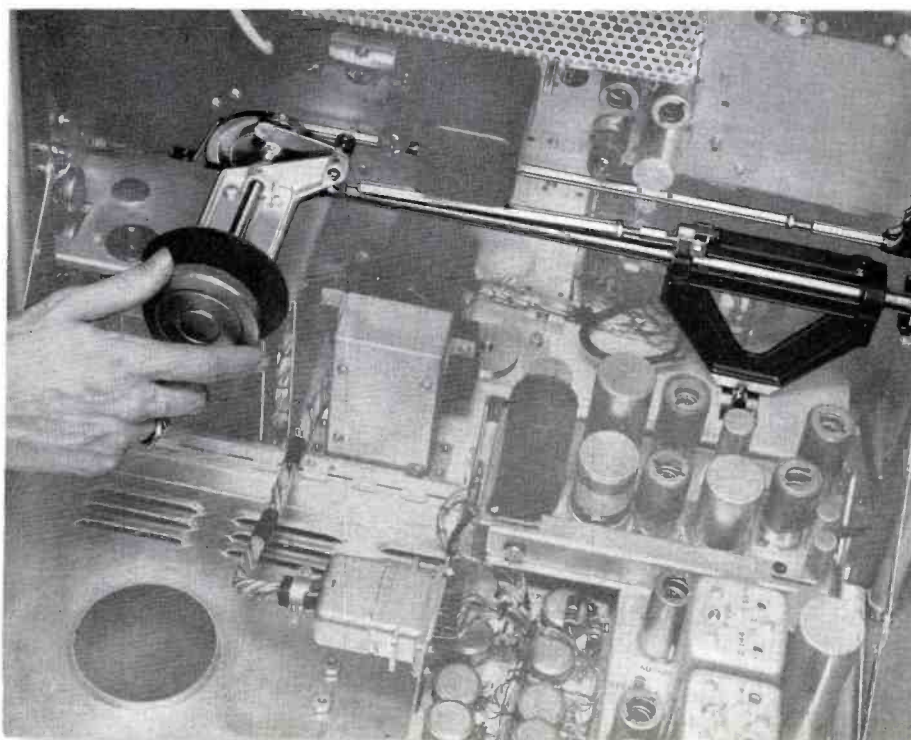

camera chain, measurement of signal current in the vidicon is made by comparison with a fixed calibration signal by the substitution method. In other words, a pulse signal of known amplitude is switched into the input of the video amplifier in place of the vidicon signal. In practice, the calibration signal is used to establish a scale of vertical deflection on the waveform monitor (CRO). Once the scale is known, it may be used to measure either signal current or dark current. To measure dark current at a given value of target voltage, the following steps may be taken (assuming that the target voltage control is already at the desired setting):

1. Cap the lens,
2. Bias off the beam completely,
3. Reduce pedestal adjustment to zero setup, and
4. Readjust beam until signal has reached a maximum.

The signal on the CRO will be from the dark current only, as long as the lens remains capped. In the TK-15, for example, the calibration signal corresponds to 0.3 microampere of target current. Thus, if the dark current signal produces one-third as much deflection as the calibrating signal, the magnitude of dark current is 0.1 microampere.

To measure the useful signal current, uncapped the lens, and readjust beam just to discharge maximum white in the scene. The *added* deflection on the CRO is then the useful signal current amplitude. For normal operation, readjust the pedestal control so that picture blacks coincide with the normal 5-10 per cent setup. An alternative method is to cap the lens again and adjust pedestal for the normal setup, after which the lens may be uncapped. Periodic capping of the lens will permit observing any drift in setup amplitude as a result of temperature effects on dark current.

Summary

The most important points in vidicon camera operation may be summarized as given in Table I. Using these important points as a basis for operation will assure consistent pictures of maximum quality. Table II summarizes the range of performance which can be expected by using target voltage adjustment as a sensitivity control when the light changes. In this table, the lens opening is kept constant.

A vidicon camera can produce pictures of usable quality under less favorable conditions, and it is recognized that such conditions are sometimes encountered. When they are, there are various ways of adjusting the camera. The results which may be expected are summarized in Table III

TABLE 4—Camera Setup Procedure

1. Adjust video amplifier gain to provide normal output signal level for an input of 0.3 microampere of useful signal current from the vidicon. (As explained previously, 0.3 microampere will provide the maximum S/N. If it is desired, a normal signal current as low as 0.15 microampere may be used with some economy in lighting and without serious degradation in S/N.) The calibrating signal provides a direct method for doing this. Do not use the video gain control as an operating control for subsequent adjustment of output level.
2. Adjust base lighting to about 200 foot-candles, incident.
3. Adjust the lens iris to f:2.8.
4. Adjust pedestal or "black level" control to provide approximately standard setup with lens capped and with beam biased off.
5. Uncap the lens and adjust the target voltage to yield normal signal level at the output. (This step assumes that beam current has also been raised at least to a point where highlights are fully discharged.)
6. Cap the lens again, momentarily, and reset the pedestal control for standard setup. Note that if substantial readjustment is required, it may be an indication of excessive dark current although this should not be expected under recommended conditions, see Table III. Also, note that successive repetitions of steps 5 and 6 may be necessary to obtain the correct combination of signal level and setup.
7. Readjust beam current to a value just sufficient to discharge highlights.
8. For subsequent operation, the preferred method for maintenance of output signal level is maintenance of proper lighting. Depending on the type of equipment available, there are several ways of controlling the light reaching the vidicon:
 - (a) Addition or subtraction of lights.
 - (b) Adjustment of electrical dimmers in lighting circuits (not recommended for color cameras).
 - (c) Insertion of neutral density filters.
 - (d) Adjustment of variable neutral density filters.
 - (e) Adjustment of the iris diaphragm in the lens.

The target voltage control provides an alternative method of adjusting output signal level, and it may be used effectively if dark current is not permitted to become excessive, but it should be re-emphasized that adjustment of lighting is the preferred method. Published data on vidicons permits maximum dark currents of 0.2 microampere for the 7038 and 0.1 microampere for other types. In either case, values in excess of 0.1 microampere may lead to marginal performance because of excessive beam current requirements and because of excessive lag.

where dark current is held constant but where lens opening, lighting, video amplifier gain and vidicon signal current are all permitted to vary.

A tabulation of recommended steps in setting up a vidicon studio camera is given in Table IV as an aid in achieving optimum performance. It is assumed that other adjustments such as scanning size, centering, linearity, alignment, etc., have already been made according to the Instruction Book.

How Vidicon Cameras Can be Used

An important key to the usefulness of the vidicon camera is its freedom from "sticking" or long-time image retention which is so common in the image orthicon camera when there is no motion in the scene. In fact, the vidicon can produce pic-

tures of excellent quality, if the light is sufficient to avoid noticeable lag.

Typical usage in broadcast service might include newscasts, pickup of inanimate advertising subject matter, and title cards. It can also be used for general studio work where rapid motion is not required. In the closed-circuit field, the relative simplicity of operation, the stability, and the low operating cost are substantial factors in the favor of wide usage.

The TK-15 vidicon camera is a precision camera designed for quality performance, stability, long life, and easy servicing. It is compatible in operating features, cabling, etc., with other RCA broadcast camera equipment, and yet is simple and flexible for easy application to closed-circuit work where quality and reliability are important.



KETV PLANS FOR THE FUTURE WHILE PROGRAMMING TO TODAY'S TASTES

*Omaha, Nebraska, TV Station Achieves Step-Saving Layout;
Incorporates Latest Engineering Advances, and Is Fully
Prepared for Future Expansion*



FIG. 1. The top-management team of KETV is headed by Ben H. Cowdery (left), President, and Eugene S. Thomas (right), Vice-President and General Manager.

A basic ABC-TV network outlet, Station KETV operates at a maximum 316,000 watts video, 158,000 audio, on Channel 7. It signed on the air September 17, 1957, with a flourish of bright new facilities and the resolve to be a truly local station. Behind the expert leadership of two veteran communications men, KETV has proved to be just that. Mr. Ben Cowdery, with over twenty years of newspaper experience, is president of the Herald Corporation, owner of KETV, and Mr. Eugene S. Thomas, vice-president of the corporation and general manager, has over twenty-five years of experience in the broadcast field.

The KETV building shows careful planning and long preparation. "We studied plans of many stations before we decided just what we wanted," Mr. Thomas said. He completely planned the building and the equipment needed. Mr. Thomas is no stranger to the procedure of putting a station on the air, as he planned and managed WOR-TV in New York and WTOP-TV in Washington, D.C. (when it was named WOIC-TV), before coming to Omaha.

"We built our three-story building for ample immediate use, with an eye for expanding," Mr. Thomas declared. "We can easily double the size. Furthermore, we planned the station so as to have all of

the production people on one floor and handy to one another," Mr. Thomas added.

Nothing pleases Mr. Thomas more than showing visitors his second-floor layout. He likes to call it KETV's "assembly line." Since he has directly helped build three TV stations from the ground up and served as consultant on ten others, he should know what he is talking about.

Assembly Line Design

Here's how the station's second floor programming assembly line works day by day: The program department is at the extreme west end of the building. This general area, approximately 70 by 32 feet, contains the offices of the program manager, his secretary, those of producers and directors, the art department, announcers' ready room and space awaiting the eventual arrival of a farm and education director.

These various subdepartments co-operate in shaping shows. The first program idea, born here or elsewhere, is given at least outline substance in this area. Here program scheduling is worked out. The framework is ready. Now comes the detailed outfitting.

Like an automobile chassis moving along an assembly line conveyor, the new show is constructed part by part in a smooth flowing, regulated fashion, moving along the second floor assembly line.

Several feet outside the program department, is the station mail room. All incoming mail, especially the arrival of film, is handled here. As a matter of fact, a window pass is cut in one of the mail-room walls adjoining the film library. There is no lugging of film packages from place to place. Simply handing them through the window pass puts them in their proper department (see Fig. 3).

Should the show under discussion need film clips, it is in the film library that they are found. Storage racks flank three of the room's four walls. Two projectors and screens are used to preview all film: feature, commercial, filler, public service. Trimming and editing are also done here.

Film is important to TV. So there is still more to the KETV second floor film story.

Adjacent to the film library is the station's film processing rooms. Here is the Houston processor that develops motion-picture film in a continuous ribbon in a matter of seconds. To the rear of the processor is a camera-loading compartment and film-developing cubicle, measuring six by twelve feet. The two workrooms are entirely individual, separated by a wall. In the film-processing area it is possible to use the Houston processor, load cameras and

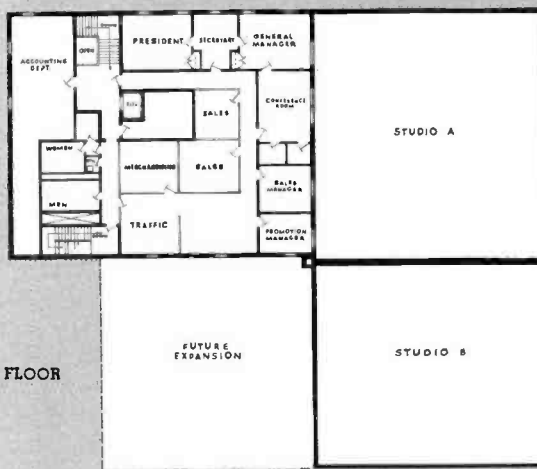
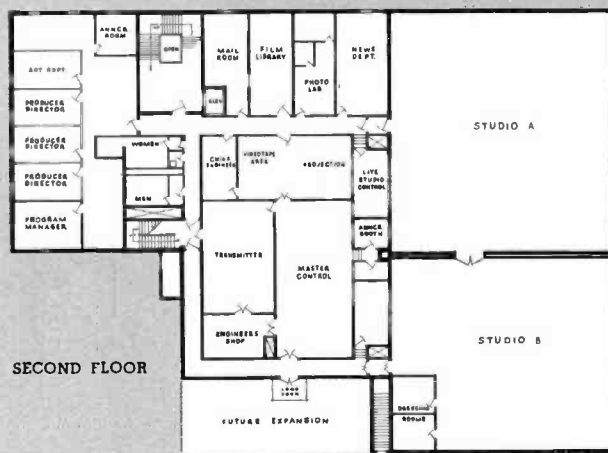
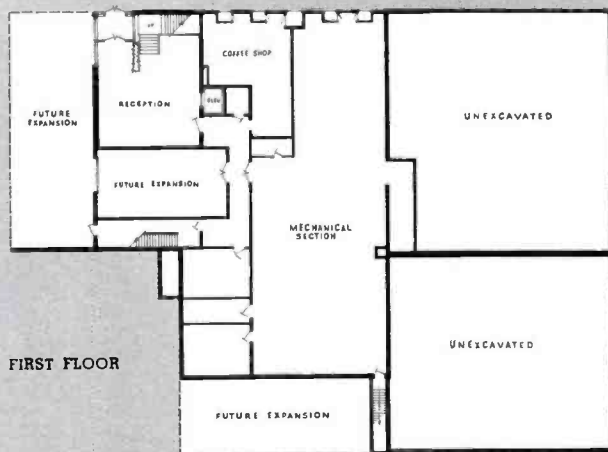

FIG. 2. Floor plans for three-story KETV building.

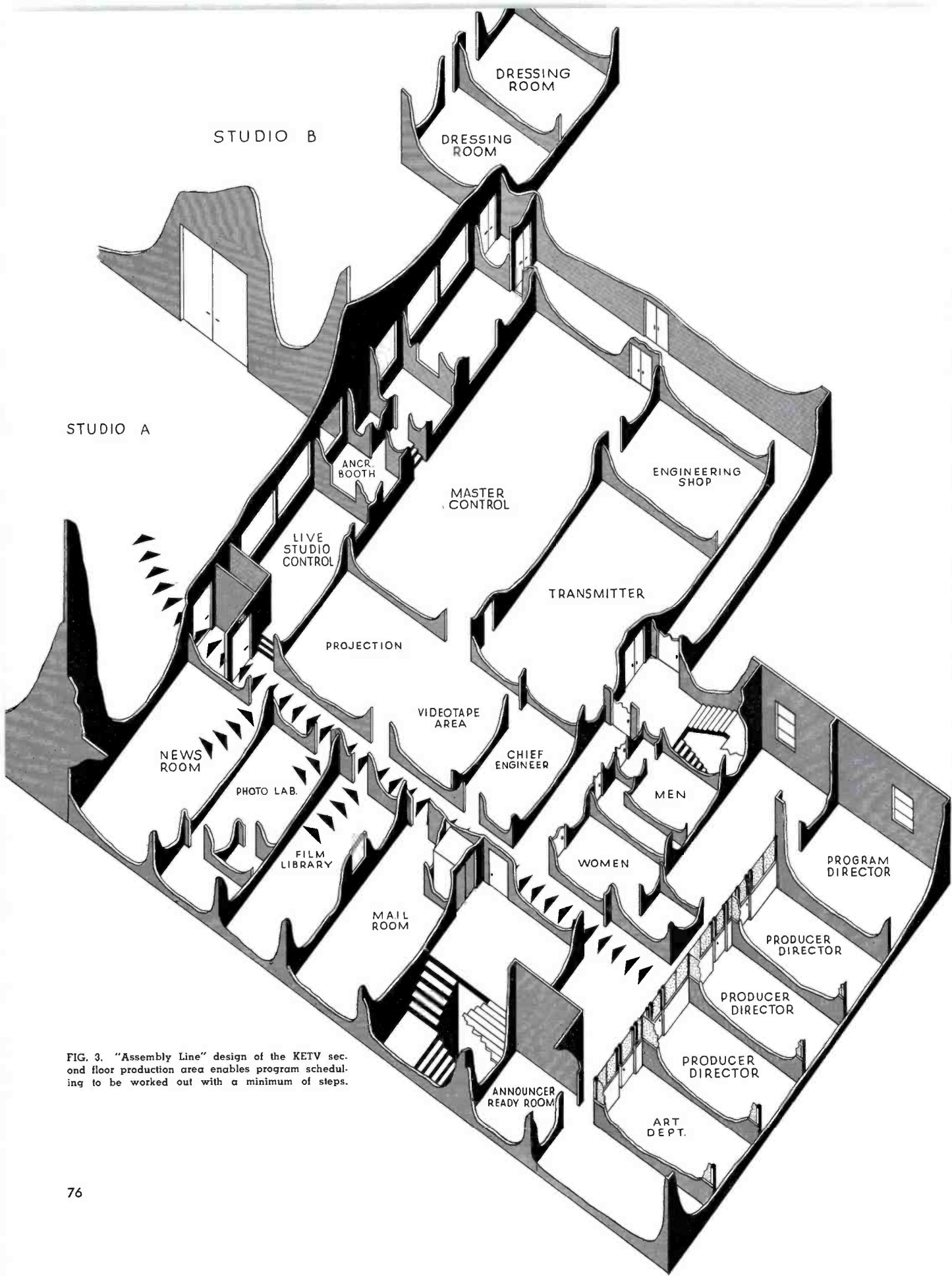

FIG. 3. "Assembly Line" design of the KETV second floor production area enables program scheduling to be worked out with a minimum of steps.

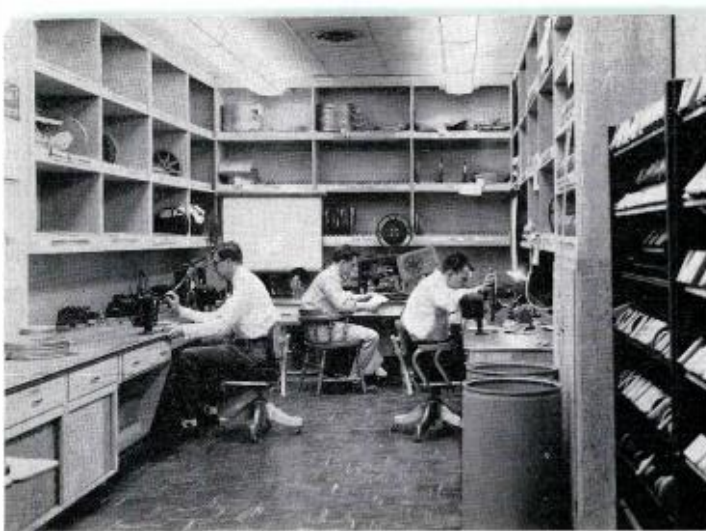

FIG. 4. KETV's film library and editing room is always a busy spot. All film is screened, trimmed, edited and cleaned before airing.



FIG. 5. Complete is the word for KETV's new room. Fully staffed, fully equipped, this room keeps KETV ahead with the news.

develop film "stills" at the same time without the slightest interference.

It was highly intentional that the door to the projection room was placed directly across the corridor at a midway point between the film library and the film-processing room. This saves many steps. When projection needs film, it's no more than the width of a hallway distant. When the film personnel want to put up the day's clips in the projection area, they enjoy the same convenience.

As a matter of fact, convenience was the master plan behind the layout of KETV's second floor. Convenience interpreted as function. When the station commences the use of video tape, these units will be in the same room directly opposite the film projector. This reserved space, in turn, is adjacent to the chief engineer's office. The master control room, engineering shop, and transmitter are all within a few short steps of each other. Large picture-windows permit engineers to see all parts of this section: from projection to master control; from the transmitter to live studio control and the announce booths.

Returning to the second floor "assembly line," the news, sports and weather rooms are all on this same level because: "We put the news as close as possible to the studio and the announce booths. When a hot story breaks, we can be ready in a matter of seconds to put it on."

Like newsrooms everywhere, KETV's is a clatter of teletypes, typewriters, telephones, sound-on-film editing, police short-wave monitoring and the clipped tones of men who interpret the news. Since a part of KETV's large main studio adjoins the newsroom, special efforts were made to soundproof it. The result: no newsroom noises enter the studio.

Across from the news section, three steps above the second floor level, stretches the live studio control rooms and announcers'

booths. These are the only steps on the entire second floor of the building. They were necessitated by a need to raise the control room somewhat above the studio, affording the producer and director with the fullest possible vision of activity on the floor.

Provision for Expansion

Expansion figures heavily in the KETV building plans. The east wall of the structure is not finished with face brick as is the rest of the building. Exposed concrete blocks look over a two-story apartment building now occupying a 50-by-150-foot land area owned by KETV. This is the space in which the station will probably make its first expansion. The apartment building will be removed and a property warehouse erected with access from both studios A and B.

Expansion possibilities also are available for the program and sales departments; engineering and even the accounting department can extend their facilities by relatively simple additions to the present building.

The tour of the second floor is terminated by a return through a rear corridor leading from Studio B. This enables entrance into and exit from this studio without the possibility of disturbing programming in Studio A.

Functional Building Reduces Overhead

Back on the main, second-floor corridor one is impressed by how compact and functional is this operations' floor. Assembling a program here is a series of organized steps, flowing from one development area to the next.

"Convenience and function mean a savings in time and personnel," says Thomas. Although KETV's building is the largest of the three television studios in Omaha, it operates adequately with the smallest staff. Its 32,495 square feet of space pres-

ently house only 50 full-time employees. Proof that a highly functional building can reduce overhead.

Form Follows Function

The over-all exterior appearance of the KETV building is uncluttered and dignified. It demonstrates that "form follows function," according to Architect Dell Boyer. The exterior is of pink Kasota stone and buff face brick.

The lobby is a first floor show place. It's spacious and modern, enhanced by a variegated slate floor, and walls covered by ledgestone and walnut paneling. Cinder concrete block construction is used throughout the building as well as in the studios, where it provides good low cost sound absorption.

Air Jets and Color TV

Among the added conveniences not found in many stations are the compressed air jets, located throughout the building. These jets help in cutting down maintenance time and cost in cleaning the electrical gear. The jets have outlets in both studios, projection and master control.

At present, the programs are produced in monochrome but the building has been completely planned for a near-future switch to color.

KETV's Technical Facilities

The technical operations and equipment are all located on the second floor of the three-story building. This includes two studios, control rooms, film-projection room as well as the 50-kw transmitter. The physical layout of this area is shown in Fig. 16.

In planning these facilities, many stations throughout the country were inspected before arriving at an efficient, well-co-ordinated design with particular attention given to anticipating future demands and expansion.

Studios

Live programs are produced in two of the midwest's largest studios. Studio A is 65 by 70 feet with a ceiling clearance of 27 feet. These large, nearly square studios, were preferred so that sets might be used on all four sides and still provide sufficient depth for special shows or commercials which demand a large area—automobile commercials, for example. This studio has easy accessibility for automobiles and props through a pair of huge 5-by-10-foot sound-proof doors.

The studio is completely soundproofed by its double concrete wall construction with air-space separation and by lining the interior surface with one-inch-thick acoustical panels by Tectum. This surface has excellent sound absorption properties as well as adequate rigidity.

A 4-foot plywood wainscot is provided for wall protection and for mounting wireways and outlet boxes. Two separate wireway channels with hinged covers circumscribe the studio—one for 110 and 220-volt power circuits and the other for microphone, intercom and video circuits. This allows easy installation of outlets anywhere in the room regardless of future expansion.

Custom-built grid and outlet strips were built to span the ceiling of the studio. Here again wireway channel with accessible hinged covers were used for constructing the overhead light outlets. These are mounted directly over 1½-inch round pipe (bottom). There are presently 144, twenty ampere, outlets in the grid structure. The number and capacity of the outlets can be readily expanded if greater foot-candle illumination is desired. Flexible multiple conductor cable is run from the light strips to a Century patch panel with three 5.5-kw dimmers. Each of the light strips can be independently adjusted to any desired height above the floor. Normal height is 14 feet; 18 feet is used for automobile commercials, etc.

Studio B is 55 by 65 feet and is used for special shows such as audience participation and wrestling programs. This easily accommodates over two hundred people each week for the live wrestling show on KETV. Figure 9 shows how TV camera platforms are built over the dressing rooms in this studio, to get the proper camera angle on the wrestling ring. The studio is also used for storage of active props. Additional property storage is provided in a temporary building adjoining the station.

FIG. 6. Studio A, 65 by 70 feet, is one of the midwest's largest studios.





FIG. 7. Studio A has accommodation for automobiles and trucks through a 5 by 10-foot pair of soundproof doors.



FIG. 8. Cables and wires can be terminated at any location in Studio A. Wireway with hinged covers circumscribe the studio; one is used for a-c power and the other for audio and video.

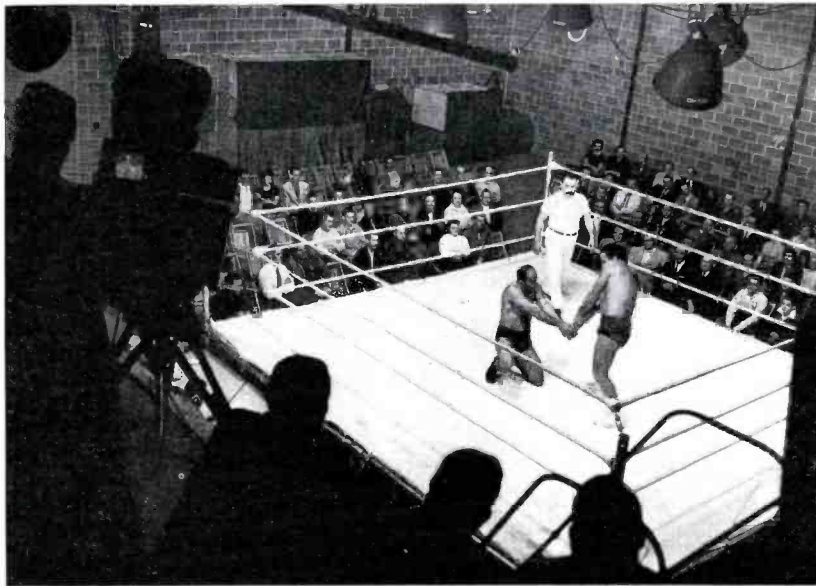

FIG. 9. Studio B is used for special shows and KETV's Monday night wrestling matches.



FIG. 10. Live studio control is nerve center of operations when KETV is producing a show from its studio. The producer-director has a bank of controls at hand, as well as the audio man. Window at rear looks into announcer booth.

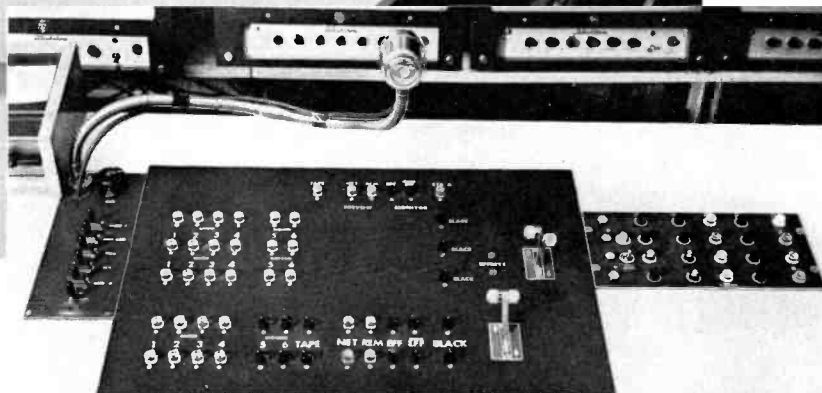

FIG. 11. Director's desk in Studio A control room consists of a custom-built video switching panel, audio intercom unit, and remote control panel for projectors and multiplexer.

Studio Control Rooms

Overlooking each studio is a control room which is elevated 30 inches for better perspective. Production of all live shows originates from this point, including audio and video switching. Monitors are located just below the eye level for easy viewing by the director in charge. Large glass windows permit easy visibility into the studios and adjoining announce booth. The director's switching panel, which was built by station engineers, controls the video relays in the TS-21 Switcher. Dual faders and lap dissolve amplifiers are used in this versatile arrangement.

The audio control console is a BC-6B with dual power supplies and amplifiers. An audio selector panel is used in conjunction with the console to provide selection of the twelve microphone outlets in the studio for the five pre-amplifiers in the console. Self-illuminating switches increase operating ease.

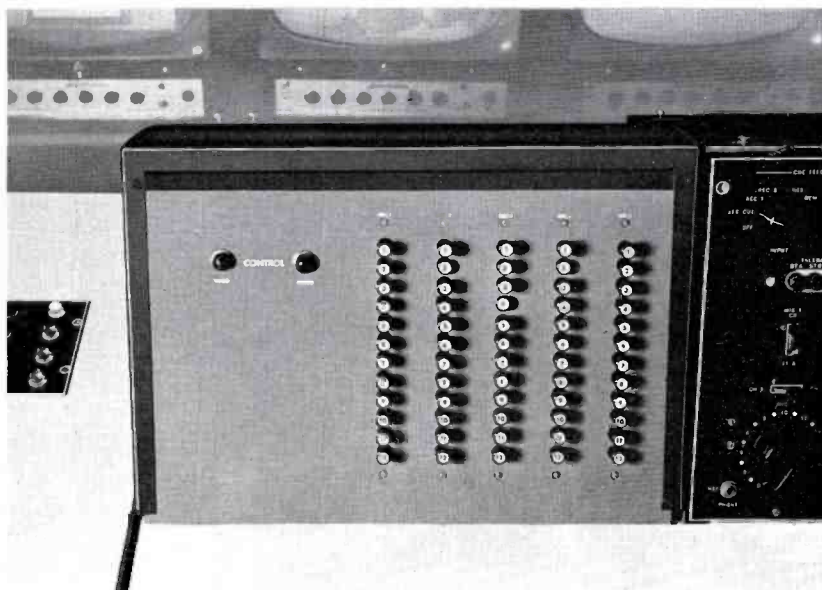

FIG. 12. Any of twelve microphone outlets can be selected for the five pre-amplifiers in the audio control console.



FIG. 13. Master control is located so that operator can see into both studio control rooms, both announce booths, and the projection room.

Master Control Room

The nerve center of the operation is the centrally located master control room. All programming sources including networks, remotes, film, studios flow through this control center before being transmitted on the air.

Normal program switching of film, slides and network are performed by the master control engineer, thus freeing the studio control room for rehearsal of live produc-

tions. The master control engineer performs this switching and other functions in the specially designed console layout shown in Fig. 13. Forty-five degree console sections were fabricated to provide the engineer with direct visibility into projection room, announce booths and studio control room.

An audio-video console built by station engineers is used to switch all programming signals. Relay control is used throughout

for the audio, video, projector start-stop and multiplexer functions. An automatic preset program switcher can be used for periods up to ten minutes in length. Two completely independent audio and video paths can be selected to feed the transmitter for maximum flexibility and reliability. Two TM-6 Monitors are used for monitoring each source. The monitor which is not being used for program line monitoring is available for preview.

FIG. 14. The transmitter control console for the TT-50 is mounted in a standard RCA console providing additional panel space for other controls.

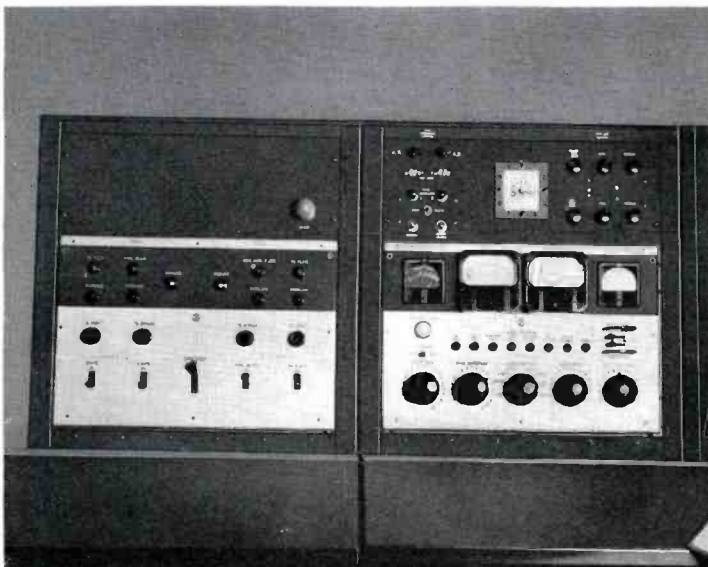
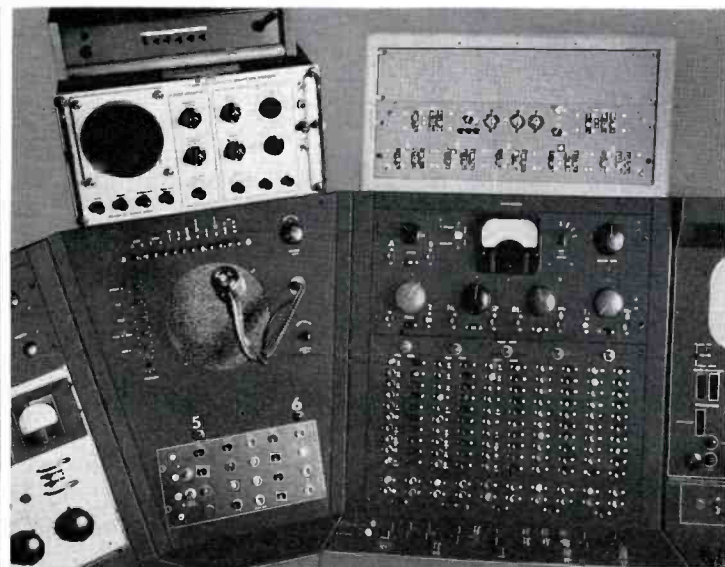

FIG. 15. Master control console consists of audio and video switching panels, and an automatic preset program switcher. Intercom and remote control of multiplexer and projectors are in 45-degree console at left.



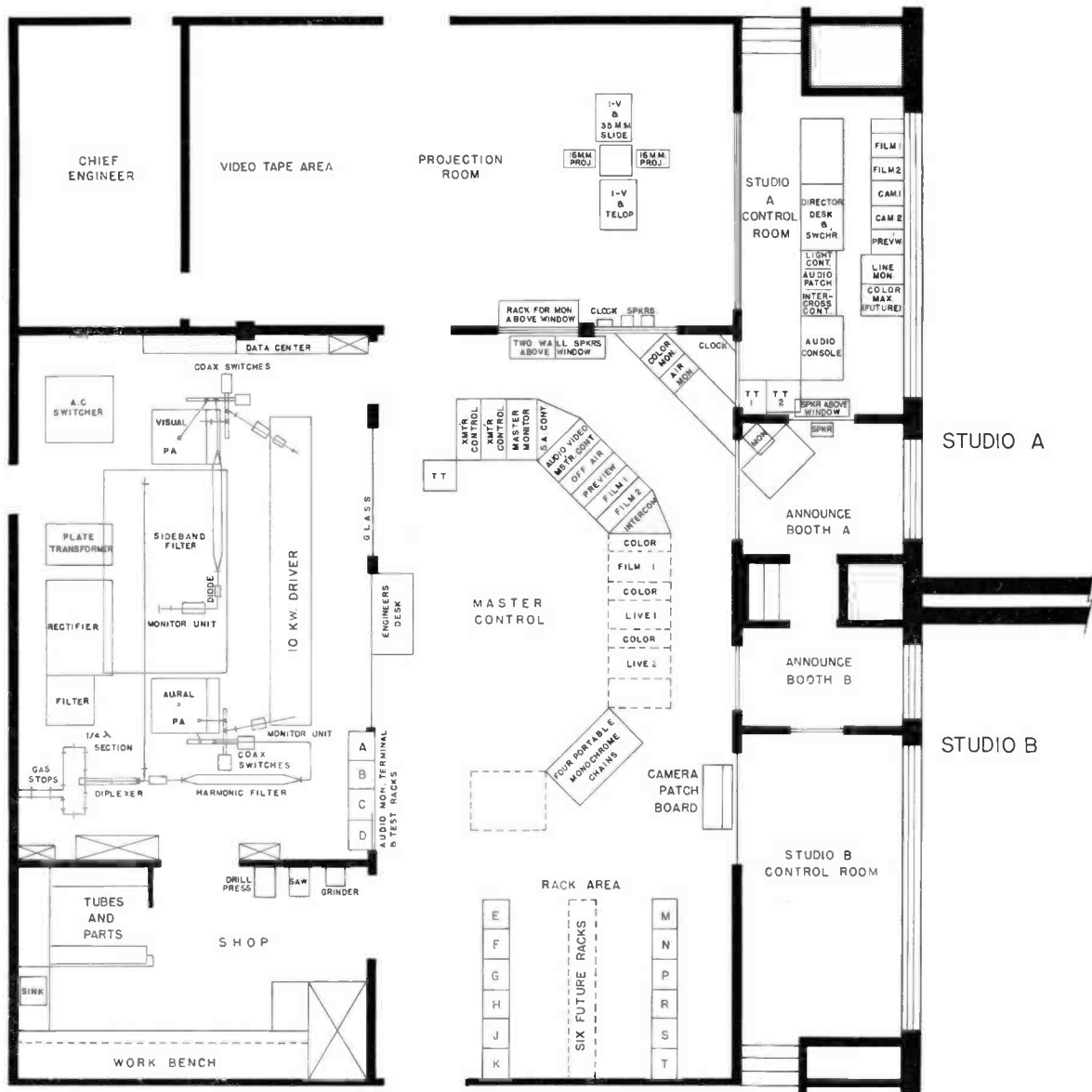

FIG. 16. Efficiency is the word to describe equipment layout on second floor of KETV; master control, transmitter, and engineer- ing shop are all within a few convenient steps of each other. Large picture windows permit engineers to see the operations.

A rather unique video switching system is employed by using three basic TS-21 Relay Switching Units. One is used for master control and two in tandem for Studio A control room. Two basic relay units are used for the studio switcher, so that the time-delay paths of the video signals can be equalized regardless of whether the video signal is switched direct or through effects amplifiers. Two effects or lap dissolve amplifiers (MI-40421) are used in the makeup of the studio switcher. The momentary self-illuminating push buttons controlling the relays feeding the

second amplifier are duplicated in master control console to provide dissolve switching when needed.

Also located in the master control position are the transmitter control consoles, remote control for sync generator switching and genlock, audio monitoring and intercom facilities and the control consoles for two TK-21 Vidicon Film Chains.

Layout permits either a single operator to perform the master control, plus video control, or provides ample space for one engineer to handle video shading for live

telecasts in Studio A, another engineer to handle video shading for rehearsal in Studio B and a third man to perform other master control functions.

The four studio camera control units are of the portable type. This allows complete interchangeability and use of all for remote telecasts. A camera patch panel permits use of cameras in either studio.

Two TA-9 Stabilizing Amplifiers are used for processing network and remote video signals. Remote controls are located in the master control consoles for gain and sync adjustments.

Rack Equipment

Most of the electronic equipment is housed in 12 equipment racks located at the one end of the control room, as shown in Fig. 18. Four additional racks house the audio, network, frequency monitoring and transmitter terminal equipment. Forced air ventilation, utilizing the building exhaust air, keeps the equipment operating at low temperatures. Thus, advantage is taken of the exhausted cooled conditioned air during the warm summer months. Electrostatic dust filters also keep maintenance at a minimum. Space has been allowed for an additional six racks to be installed in the future.

Less than two racks were required to house power supplies for the 280-volt, d-c power requirements. Eight WP-15 Power Supplies are used. A cross-switching system permits a spare power supply to be instantly substituted for any one in use (see Fig. 17). Other racks contain the vidicon control units, sync generator equipment, pulse and video distribution amplifiers, video switching and patch facilities.

Interconnecting wires between racks and other equipment are laid in trenches in the floor. In order to make this system practical for future expansion, a false floor was constructed by using 4-inch hollow tile blocks topped with a 2-inch layer of soft concrete, giving an over-all trench of 6 inches. Asphalt tile then covers the complete floor including the metal trench covers. If additional trenchways or modifications are needed, a conventional electric concrete saw can cut the desired paths with relative ease.



FIG. 17. Chief Engineer Jack Petrik at two racks which house power supplies for all 280-volt d-c requirements.

FIG. 18. Twelve racks with forced air ventilation are provided for the rack-type equipment. Space has been allowed for future expansion.



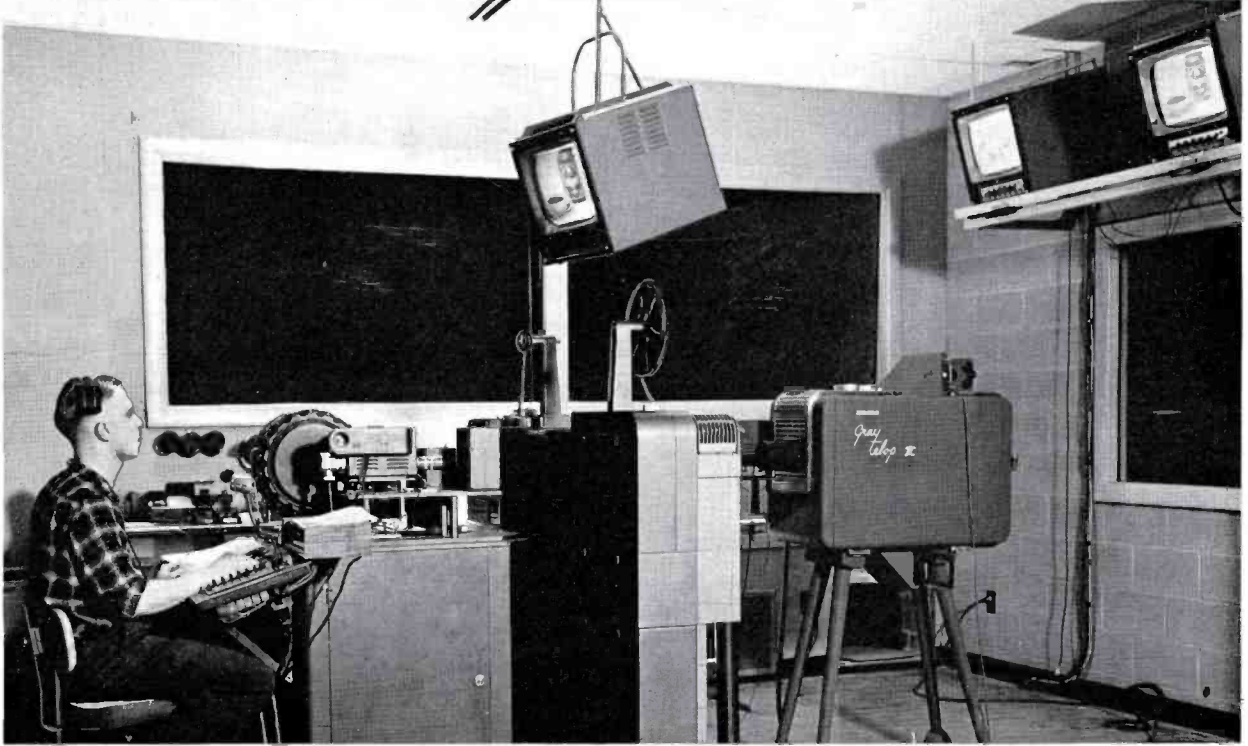

FIG. 19. In the film room the projectionist operates the proper control from a convenient desk panel designed and built by KETV engineers.

Film and Slide Operation

The film projection room has direct visibility with the master control center and the studio control room (see Fig. 19). It is also conveniently located to the film editing, shipping and developing rooms.

The operation is built around the TP-15 Multiplexer. Four inputs—two TP-6 Projectors for 16mm film, one telop, and one 35mm TP-7 Slide Projector—can be optically projected into either of the two monochrome TK-21 Vidicon Film Cameras. This provides complete preview facilities for all slides and film as well as protection for periods when maintenance is required.

The complete control of the multiplexer and all projectors, including starting, stopping, and slide changing, is made from a remote-control panel built into a console behind the slide projector. Remote-control panels are also wired into the master control and the studio control room.

The projectionist has easy view of three monitors mounted overhead—one for each vidicon and one for the on-air program. The air monitor is located directly above the multiplexer on a swivel hanger to facilitate focusing and alignment of the projectors.

Variable density light control units are used with the projectors even for the monochrome film cameras. Once the vidicons have been properly aligned, gain of the system is easily controlled for varying film and slide densities.

FIG. 20. Close-up view of projectionist's operating desk which contains a TP-15 Remote Control Panel, intercom unit and monitor controls.

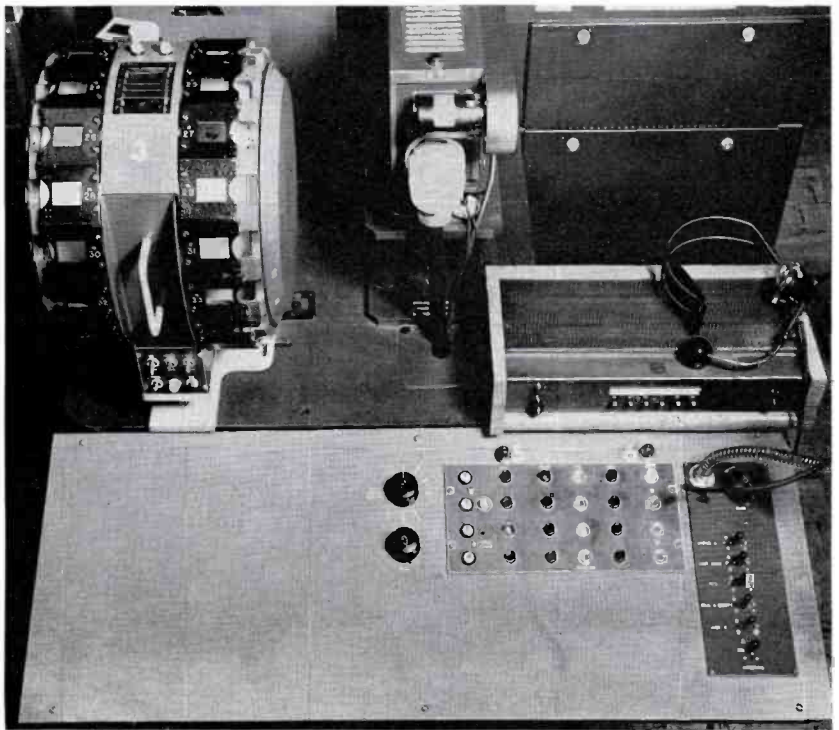

KETV FACILITIES FOR MAKING SLIDES AND FILM

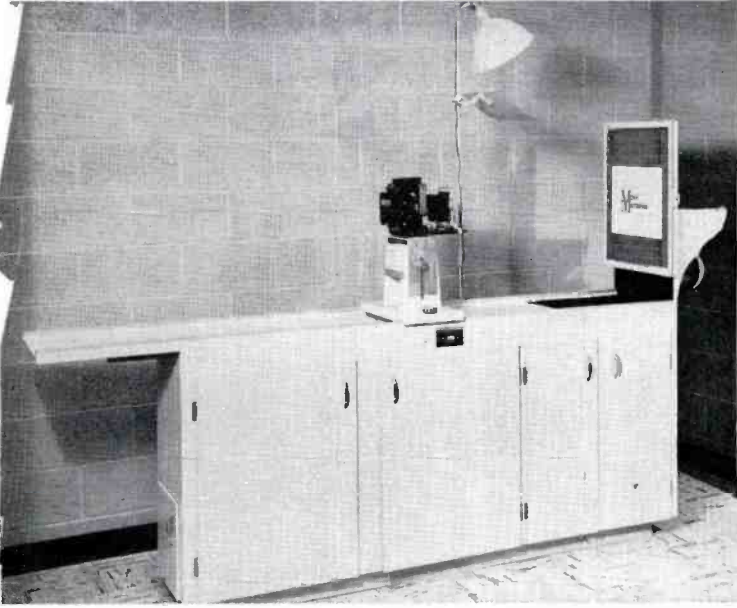

FIG. 21. The copy camera bench, illustrated here, was designed by Maurice Chicoine, in charge of KETV photo lab, and was built to do the specific jobs that come into a television photo lab. It is called a "copy camera bench" because it will accommodate various size cameras, from 8 by 10-inch view cameras to 16mm movie cameras. Some of the features of the camera bench are: lighting is from above and below, rather than the sides leaving the camera stand only 18 inches wide; a camera saddle that rolls toward and from the copy board, and adjusts in height to accommodate different size cameras; the copy board is covered by a special nonglare glass in a hinged aluminum frame. The 20 by 24-inch glass is called "Tru-site" and made by the Dearborn Glass Company. This special glass eliminates all reflections or glare from glossy prints or artwork. A soft 1/4-inch foam rubber mat on copy board gently presses copy against cover glass. A drop leaf at end of camera stand can be brought into position for extreme reductions, and the doors open up allowing ample storage space for cameras, etc. The camera saddle can be moved forward while shooting 16mm film, giving the same effect of a camera dolly or Zoomar lens in operation.

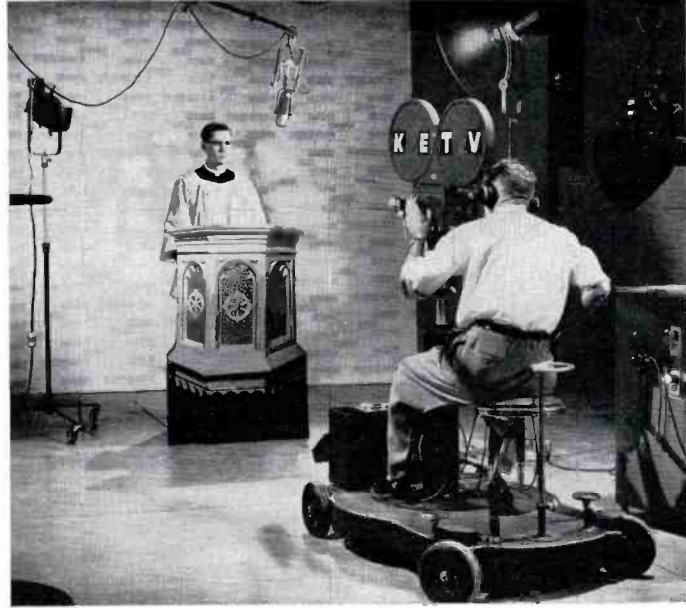

FIG. 22. KETV opens and closes its broadcast day with a filmed spiritual message from area clergymen of all denominations. The opening message is entitled "Thought for the Day"; the closing, "Meditations." Here we see KETV's sound-on-film Auricon camera filming one such message. The camera is equipped with a twelve-hundred-foot magazine, capable of recording a complete half-hour program without reloading.

FIG. 23. The "camera bench" lights are used to illuminate the gray telop crawl titles. In photo, below, the bottom door has been left open to show built-in bottom light in unique "above and below" lighting systems.

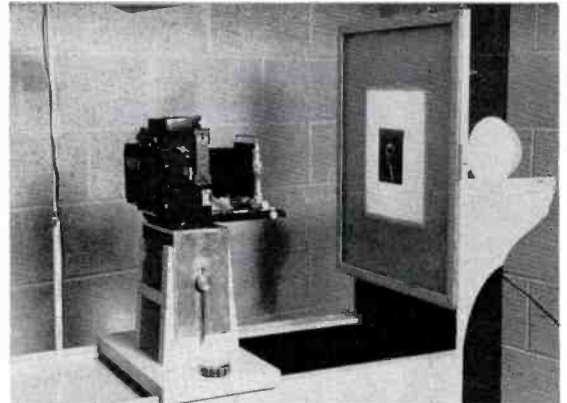
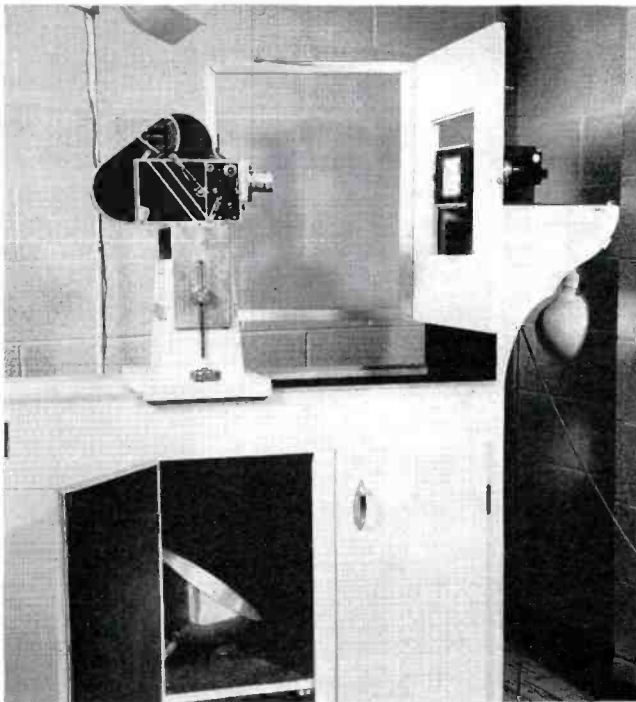
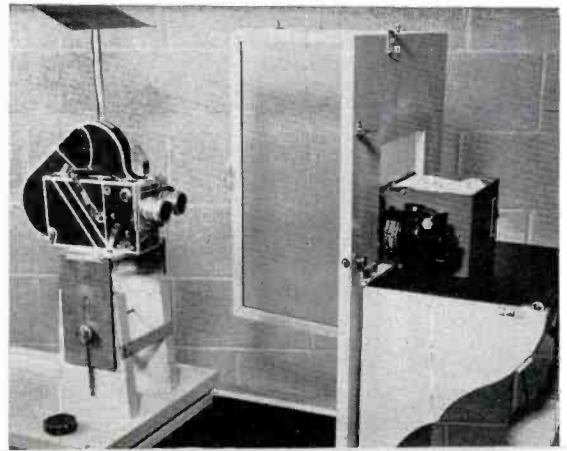

FIG. 24. A 9 by 11-inch opening in the center of the copy board covered by a recessed opal glass, and a light attached to the rear of the copy stand makes it possible to copy negatives or transparencies.

FIG. 25. With the opal glass removed, and the hinged copy glass swung out of position, a 16mm "super film" of moving credit titles can easily be made by placing a Gray telop crawl machine on brackets behind copy board.



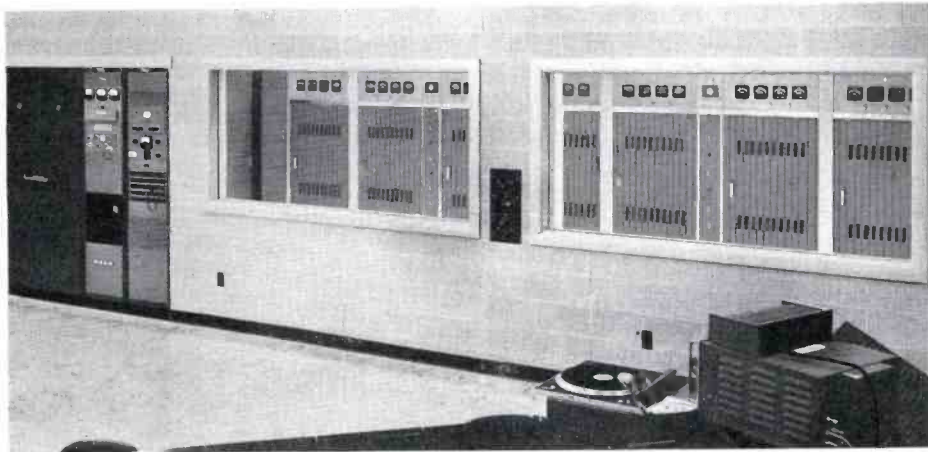

FIG. 27. The transmitter is located adjoining master control. A wall with large windows reduces noise in the master control room. Network terminating equipment, audio amplifiers and monitoring equipment are located in the recessed racks.

Transmitter Room

A 50-kw TT-50 Transmitter is installed in an area directly adjacent to the master control room. An additional wall with full-width, glass windows was constructed in front of the 10-kw driver unit in order to minimize the inherent transmitter, transformer and air noise entering the master control room (see Fig. 27). The glass permits easy visibility of meters and indicator lights. The transmitter control console is installed as part of the master control center.

All of the transmitter units with the exception of the blowers are located in the one room. The four air blowers are in a room directly beneath the transmitter. The outside air entering this blower room is filtered by an electrostatic cleaner before being circulated through the transmitter

tubes and components. This filter has reduced cleaning maintenance considerably.

Motor driven coax switches, Fig. 28, enable the antenna to be fed from either the 50-kw amplifier or the 10-kw driver unit. This power cutback arrangement takes only a few seconds to complete. The coax switches are also an aid in tuning and maintenance of the transmitter.

Antenna and Tower

The $3\frac{3}{8}$ -inch coax transmission lines carry the power to the 12-bay batwing antenna located on top of Omaha's tallest tower. Height of the antenna on the Idec tower is 585 feet above the ground and 626 feet above average terrain. A superturnstile TF-12BH with null fill-in radiates 316,000 watts ERP.

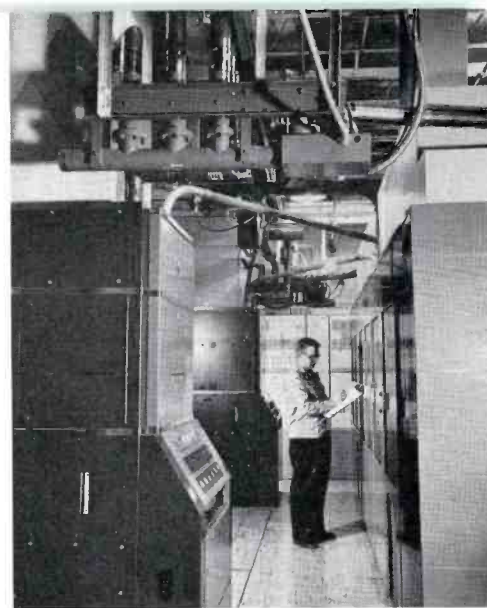

FIG. 28. Rear view of the 50-kw transmitter showing the PA's and motor-driven coaxial switches.

AC Power

One thousand kw of power is supplied to the building to handle the transmitter, building lighting, and air-conditioning load. Two parallel line transformers fed from underground circuits are used to provide uninterruptable service. In the event of power service failure on one circuit, power will be supplied without interruption from the second. Power feeding all the studio equipment is from a regulating transformer, thus insuring constant line voltage.

Convenience Interpreted as Function

Efficiency has been achieved in the step-saving KETV building layout, for both the engineering and the programming operations. This has not resulted accidentally, but is the end product of careful planning combined with years of practical experience. By this means KETV provides a pleasant as well as convenient atmosphere in which to produce programs. The net result is excellent morale, reduction of errors, and provision for the latest in programming. Finally, all these desirable features are combined in a broadcast plant that also incorporates full provisions for future expansion.

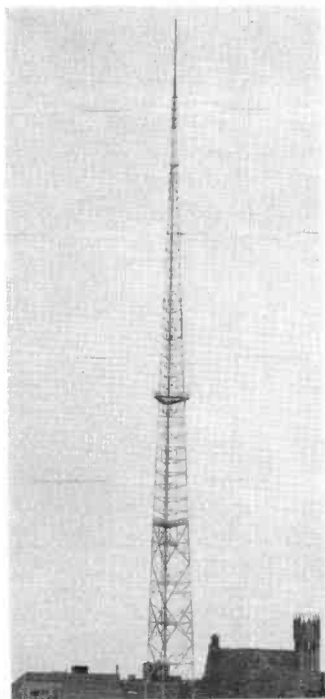

FIG. 29. KETV tower is the tallest in Omaha. It is located at site of KETV studio and transmitter. Station operates on Channel 7 at full maximum power of 316,000 watts.

FIG. 30. In this modern building, at the west edge of downtown Omaha, are located the studios and transmitter of KETV, Channel 7.



ASSURING THE MOST FOR YOUR EQUIPMENT DOLLAR



For Optimum Performance Despite High Noise...

The Superior New RCA Ultra-Directional Microphone

The BK-10A Microphone is designed to give superior performance in difficult noise situations where non-directional or cardioid type microphones are not effective. The BK-10A features a second order gradient directional characteristic which is used to increase the acoustical signal-to-noise pickup. It is ideal for controlling the level of the leading voice in a choral group. It also can be used to advantage when the solo voice is upstage and

the choral group downstage. For picking up weak voices without getting the microphone in camera range, it is excellent.

Shock mounting and a new cable provide superior isolation from stand noise. Low-gloss finish and a compact mounting arrangement assure minimum light reflection. Where premium performance in high noise areas is a must, choose the BK-10A.

Your RCA Broadcast representative will gladly explain the application of this superior acoustic tool in television and radio fields as well as in recording and public address systems. In Canada: Write to RCA VICTOR Company Limited, Montreal.



TMK(s) 12

RADIO CORPORATION of AMERICA

BROADCAST AND TELEVISION EQUIPMENT

CAMDEN, N. J.

ASSURING THE MOST FOR YOUR EQUIPMENT DOLLAR



TYPE BA-26A

TRANSISTORIZED

TURNTABLE EQUALIZING PREAMPLIFIER

The BA-26A is designed to mount in same position and space previously occupied by RCA Type MI-11877 passive equalizer.

Designed to provide both amplification and equalization of turntable output!

This compact equipment makes a modern replacement for bulkier combinations of separate amplifier and equalizing filters. Designed to provide both amplification and equalization of output of studio transcription turntables employing either the RCA Type MI-11874-4 or RCA Type MI-11874-5 Pickup Heads. The entire unit is completely self-contained including a-c power supply. Built-in equalization conforms to new industry standards of both NAB

and RIAA. A three position switch compensates for variations in transcriptions and records. Etched wiring circuits provide stable, trouble-free operation. Transistors are employed throughout to assure freedom from microphonics. Absence of inductances make the BA-26 insensitive to stray hum field pickup, greatly simplifying installation. Mounts easily in turntable, provides essentially noise-free operation and long equipment life.

For full particulars about the new BA-26A Transistorized Turntable Equalizing Preamplifier, see your RCA Broadcast Representative. In Canada: RCA Victor Company, Limited, Montreal.



RADIO CORPORATION of AMERICA

BROADCAST AND TELEVISION EQUIPMENT

CAMDEN, N. J.



New RCA 25 KW VHF

Assures flexible arrangement for economical floor plan

Combining all the newest design features of the recently announced RCA 6 KW TV transmitter and the enviable performance record of RCA's famous 25 KW power amplifiers, the new TT-25CL is today's best value! No other transmitter in this power class embraces so many advantages... advantages that engineers and station managers have asked to have incorporated in a single transmitter.

FLEXIBLE FLOOR PLAN—The "block build" design of the TT-25CL permits several combination arrangements. The layout may be as illustrated in the accompanying floor plan, or a modification of this general plan. The 6 KW Driver and P.A. Rectifier and Control Cabinets can be arranged in "U" fashion with the P.A. tanks moved forward and the driver power supply enclosure placed at a remote location to further conserve space.

PRECISE COLOR PERFORMANCE—Built-in linearity correction circuits and intercarrier frequency control, which accurately maintains frequency separation between aural and visual carriers, assure excellent color signal transmission.

EXCELLENT ACCESSIBILITY—Broadband tuning controls in the 6 KW Driver are accessible without opening any doors. All important driver circuits are adjusted from

the front of the unit. Exciter and modulator units have "tilt-out" construction for quick, complete accessibility.

THERMOSTATICALLY CONTROLLED HEATERS—for rectifier tubes are suited to ambient temperatures as low as 0° C. Designed for attended or remote-control operation.

ECONOMICAL OPERATION—A well-chosen tube complement affords lower power costs. Complete overload protection with "grouped" indicator lights makes troubleshooting quick and certain.

TIME-PROVED TUBES—Long life RCA 5762 tubes in both P.A.'s and Driver. Many broadcasters using other RCA transmitters which employ the 5762 tubes report "extra dividends" due to their long-life, economical operation. Over 100 RCA 25 KW amplifiers have been in continuous service to date—each employs the famous 5762.

PLUS . . . OTHER ADVANCED FEATURES—too numerous to mention here! Get the complete story from your RCA Broadcast Sales Representative or write for descriptive literature (Catalog Bulletin B-4011). In Canada, write RCA VICTOR Company Limited, Montreal.



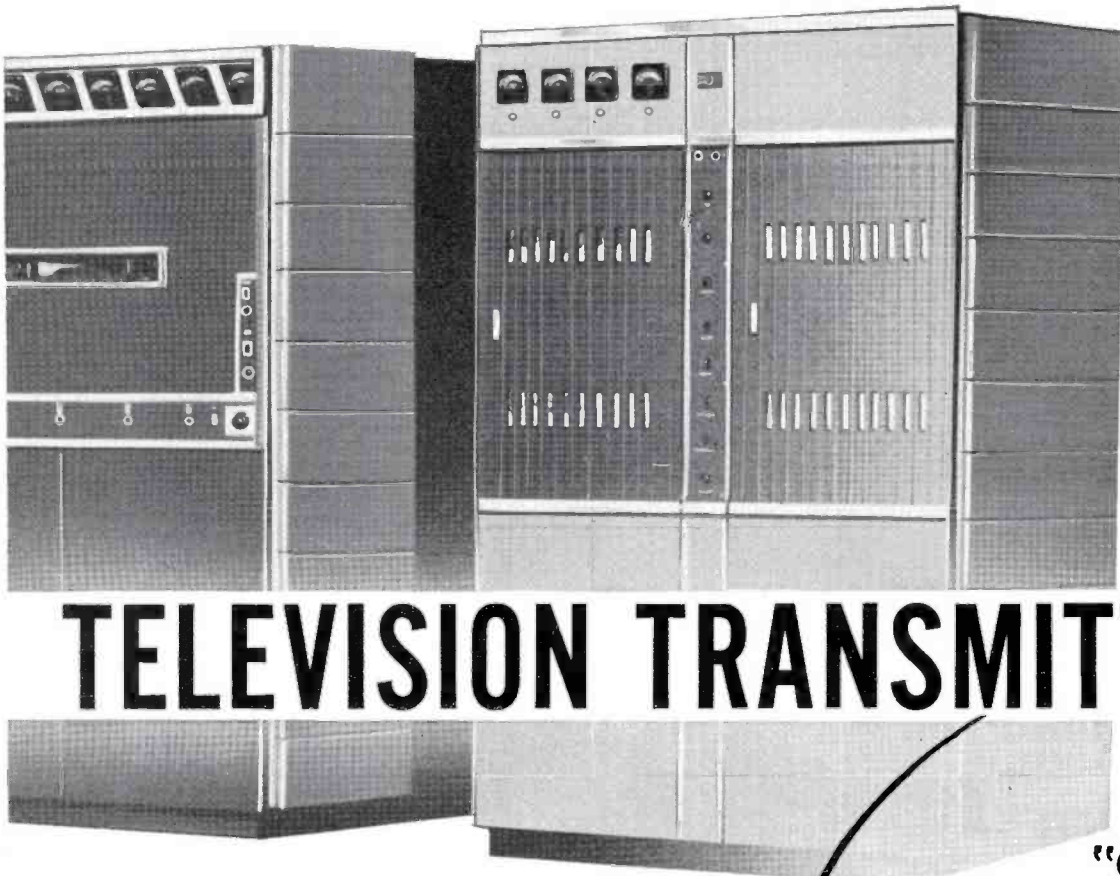

TELEVISION TRANSMITTER

(Type TT-25CL, Low Band)

**NOW
"ON-AIR"**

Reports from stations with TT-25CL's "on-air" tell of excellent results and audience response. Particularly gratifying comments come from color program viewers who are impressed with the fidelity of color transmission.

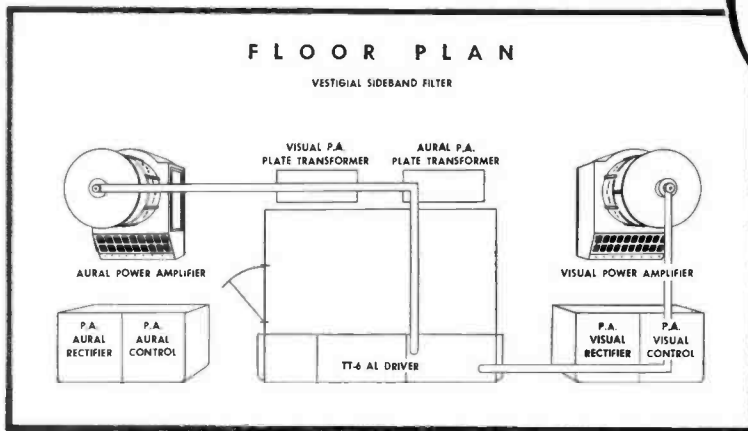

Where floor area is at a premium...

such as in "down-town" buildings, or where space must be yielded to other equipment, the TT-25CL is highly adaptable. When new transmitter buildings are contemplated, the space-saving TT-25CL helps to save building costs. The rectifier sections of both the 6 KW Driver and also the Aural and Visual Amplifier Rectifiers can be separated and placed in an adjacent room or basement. This is an added feature that saves valuable operating area.

DRIVER PORTION OF THE ABOVE 25 KW TRANSMITTER (LESS AMPLIFIERS) IS AVAILABLE AS A COMPLETE 6 KW TRANSMITTER



RADIO CORPORATION of AMERICA

BROADCAST AND TELEVISION EQUIPMENT • CAMDEN, NEW JERSEY

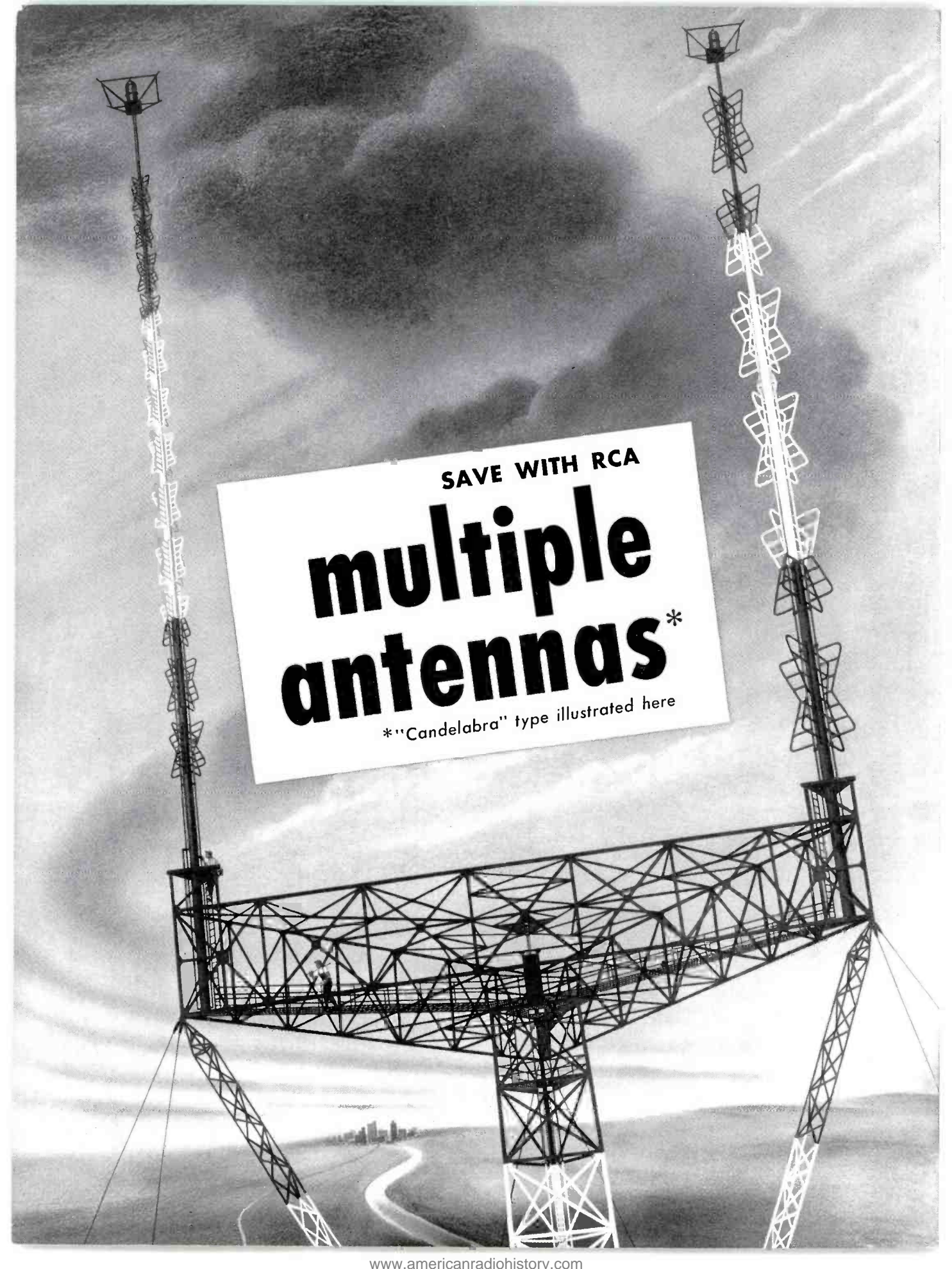

SAVE WITH RCA

multiple antennas*

*"Candelabra" type illustrated here

...save as much as \$250,000 per station!

MULTIPLE ANTENNAS...

MULTIPLE ADVANTAGES!

The RCA "Candelabra" represents a new approach to TV antenna design and gives broadcasters, who desire the same antenna location, many advantages. The tremendous savings of a common tower and single-site erection are combined with the benefits of equal height and a simplified transmission line installation. Through this design, maximum height attainable under aeronautical regulations may be achieved for both antennas.

\$250,000 SAVINGS PER STATION

In the first application of the "candelabra" design (left), the cost of the complete installation was considerably less than two separate installations. The saving to each station was estimated at \$250,000—a total of a half million for the two!

TWO-IN-ONE, THREE-IN-ONE DESIGNS

In the design illustrated at left, the RCA antennas occupy two of the corners of a single triangular platform, made to fit the tower's cross-sectional pattern. A counter-weight occupies the third corner. In other designs (see right), three antennas can occupy the one platform, or any arrangement that can serve efficiently will be provided.

OTHER ADVANTAGEOUS FEATURES

RCA antennas are designed for top performance. Elevators are provided for carrying personnel up the tower. Catwalks run out from elevator landing in center of platform to all three corners for necessary maintenance. Construction is carefully suited to geographical location and terrain.

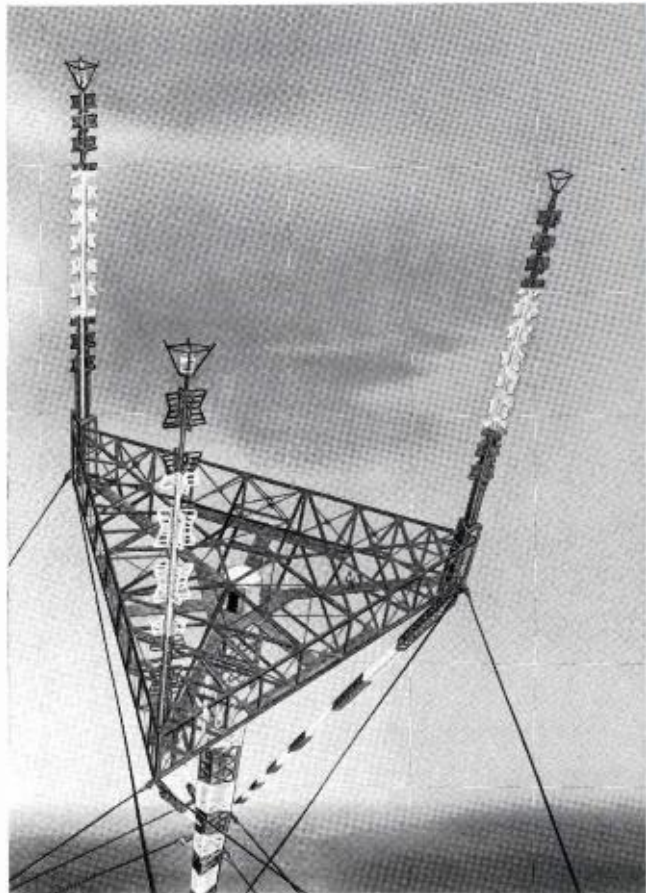

In the design above, three antennas occupy all of the corners, thus spreading the cost of the complete installation over three stations.

. . .

Why not look into the possibilities of a multiple antenna installation for the benefit of your station? Your RCA Broadcast Representative will be glad to answer questions about television antennas and show you how RCA can provide the kind you need. In Canada: RCA VICTOR Company Limited, Montreal.



RADIO CORPORATION of AMERICA

BROADCAST AND TELEVISION EQUIPMENT

CAMDEN, N. J.

Tmk(s) ©

RCA Vidicon



TYPE TK-15 VIDICON
CAMERA

7-INCH BUILT-IN VIEWFINDER



VERTICAL CHASSIS CONSTRUCTION



CAM OPERATED FOCUS MECHANISM



Studio Camera for Live Broadcast Use

Camera Design Combines Broadcast Equipment Standards with Operating Economy of the Vidicon Tube

For the first time the economy of vidicon operation is available in a live studio camera designed to Broadcast standards. RCA Broadcast engineers have incorporated the latest in techniques and circuitry into the TK-15 Vidicon Camera for TV studio use. The result is a camera which offers the same kind of operating convenience as other RCA Broadcast cameras. It provides high-quality pictures for flip card commercials, live news programs and other scenes on which the light level is adequate for vidicons.

*See your RCA Broadcast Sales Representative for additional information; or write for illustrated brochure containing complete particulars.
In Canada: write RCA VICTOR Company Limited, Montreal.*



Tmk(s) ®

RADIO CORPORATION of AMERICA

BROADCAST AND TELEVISION EQUIPMENT

Camden, N. J.

These Advanced Features:

- EXCELLENT PICTURE QUALITY WITH PROPER LIGHTING
- BUILT-IN 7" VIEWFINDER, 4 LENS TURRET FOR BROADCAST TYPE OPERATION
- QUICK AND PRECISE OPTICAL FOCUS ASSURED BY NON-LINEAR FOCUS MECHANISM
- SIMPLIFIED SET-UP AND OPERATION PROVIDED BY FEEDBACK STABILIZED CIRCUITRY
- 14-INCH RACK-MOUNTED OUTPUT AMPLIFIER MAY ALSO BE HOUSED IN FIELD CASE FOR REMOTES
- COMPLETE ACCESSIBILITY OFFERED BY VERTICAL CHASSIS CONSTRUCTION WITH HINGED SUB-CHASSIS



RCA Type BTA-50G transmitter at the WINS transmitter building in Lyndhurst, New Jersey, showing Al Jorgenson at Console.

“Our BTA-50G is a money-saver!”

Says Paul Von Kunits, WINS, New York



Paul Von Kunits, Chief Engineer, WINS, New York.

“We save \$1,000 per month on power alone with the RCA 50 KW Ampliphase Transmitter!”

The RCA BTA-50G replaced an old composite 50 KW transmitter at WINS which was spread out all over the transmitter building. Major benefits reported are: operating savings . . . space savings . . . labor savings.

The power savings amount to approximately \$1,000 a month to which can be added a substantial savings on tube costs estimated at \$200 per month.

The space savings total approximately 600 square feet. By replacing the bulky equipment they have gained space in the room behind the transmitter, and have provided a convenient workshop, a tube storage room (formerly occupied by blowers alone), and a utility shed (formerly the power vault for the old transmitter).

The labor savings are considerable, too. According to Al Jorgenson, transmitter engineer, the equipment needs very little attention.

For operating savings, added room . . . more program coverage . . . and high quality sound . . . the RCA BTA-50G is the answer. Now in daily operation at five stations, it has proved itself to be highly reliable. And KDAY, Los Angeles, affiliated with WINS, has ordered a BTA-50G . . . soon to go on-air.

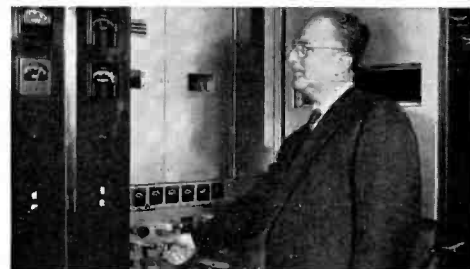

Paul Von Kunits making the only daily adjustment necessary—the carrier level control.

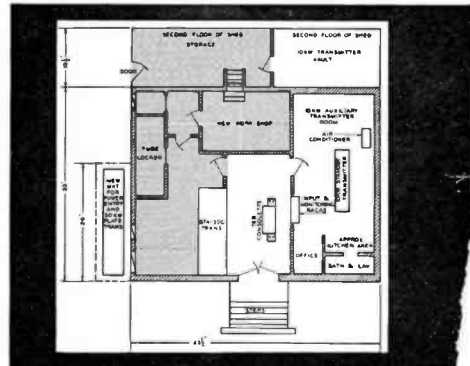

Gray areas on floor plan show space formerly occupied by composite equipment, now reclaimed for other use.

Your RCA Broadcast representative has the whole story. In Canada: Write to RCA VICTOR Company Limited, Montreal.



Tmk(s) ®

RADIO CORPORATION of AMERICA

BROADCAST AND TELEVISION EQUIPMENT

CAMDEN, N. J.

Planning a Radio Station ?

The image shows a hand holding a brochure titled "Transmitting Equipment and Building Requirements for a Radio Station" by RCA. The brochure cover includes the RCA logo, the text "Approved from BROADCAST NEWS, Volume No. 98", and "Radio Corporation of America". The background consists of several technical diagrams. On the left, a diagram labeled "TRANSMITTER BUILDING" shows a "TRANSMITTER" and "PHASING & BRANCHING EQUIPMENT" connected to a "PHASE MONITOR". A "COAXIAL TRANSMISSION LINE" and "COAXIAL SAMPLING LINE" are also shown. On the right, two diagrams show antenna systems with labels for "SAMPLING LOOP", "COAXIAL SAMPLING LINE", "LIGHTS", "FEEDING LINE", and "TO GROUND SYSTEM".

Before you choose that important item—your transmitter...

here's expert help—FREE!

The purchase of a transmitter is a long-term investment making its selection very important to the station and its operation. Thus, this new brochure deals with transmitter equipment, the building, remote control, towers and antenna systems. It combines the practical know-how of experienced station and equipment engineers and provides a check-list as a guide in transmitter selection.

Answers to many vital questions about building requirements and equipment details are included. Typical systems are considered and general principles of applications discussed.

Get your FREE copy now. Write to RCA, Department H-337, Building 15-1, Camden, N. J. In Canada: RCA VICTOR Company Limited, Montreal.

RCA . . . *your first source of help in station planning*



Tmk(s) ®

RADIO CORPORATION of AMERICA

BROADCAST AND TELEVISION EQUIPMENT

CAMDEN, N. J.



Photograph from The George Gobel Show, NBC-TV

If you haven't seen **Color TV** lately you can't possibly know what you're missing

The girls are prettier. The scenery sparkles as never before. Even the *music* seems brighter.

Today's "Living Color" brings new beauty, new excitement to TV—even to shows you've seen many times before. The colors are brilliant, full-toned, natural. As for dependability, RCA Victor Color TV has now been performance-proved in tens of thousands of homes.

You can tune in (and so easily!) on great color programs every day. There is 67% more color on NBC alone! Let your RCA Victor dealer show you what you've been missing. You'll

agree that Color TV is right and ready now and at prices as low as \$495.

Manufacturer's nationally advertised VHF list price shown, subject to change. UHF optional, extra. Slightly higher for West, South.



RCA VICTOR FACTORY SERVICE CONTRACT. Only RCA Victor TV owners can buy on RCA Victor Factory Service Contract for expert service and installation by RCA's own technicians. Branches in most TV areas.

RCA PIONEERED AND DEVELOPED COMPATIBLE COLOR TELEVISION



RCA VICTOR



THE PRIDE OF OWNERSHIP IS SECOND ONLY TO THE PLEASURE



ANDERSON
Striking Color TV console in
superb new Mark Series