

Wireless Weekly

Vol. 8. No. 12.

THE 100% VALVE PAPER

LOUD-SPEAKING ON SHORT WAVES

A SUPERHETERODYNE ADAPTER

By L.H. THOMAS





Published
1st of
every month.

Price
1/-
Monthly.

MODERN WIRELESS, the original 1/- monthly Wireless magazine, fully maintains its high standard. Every issue contains articles interesting and instructive to you. Take it regularly and keep pace with your hobby.

A SUPERHETERODYNE FOR THE OPEN AIR. By G. P. Kendall, B.Sc.

A portable receiver which will appeal to all who desire a set for use in the open air and which gives a wide choice of programmes on the loud-speaker from British and foreign stations.

A MASTER OSCILLATOR TRANSMITTER. By R. W. H. Bloxam (5 LS).

Transmitters will be particularly interested in this efficient 10-watt transmitter for working on 45 metres.

A SINGLE CONTROL FOUR-VALVE RECEIVER. By A. Johnson-Randall.

This set has been designed with a single control for the reception of the local station and Daventry. Music lovers will appreciate the pure reproduction given.

A COMBINED REACTION THREE-VALVE RECEIVER. By E. H. Berry.

The provision made for varying the inductive reaction and capacitive control enable the best proportion for smooth working to be secured.

AN INDISPENSABLE TESTING UNIT
By H. J. Barton-Chapple, Wh.Sch., B.Sc. (Hons.), A.C.G.I., D.I.C., A.M.I.E.E.

This simple unit enables accurate measurements of resistances and capacities to be made and will prove useful to all constructors and experimenters.

A MULTIPLE CIRCUIT SINGLE-VALVE RECEIVER. By E. J. Marriott.

Several types of aerial and reaction coupling arrangements can be tried with this set.

OTHER INTERESTING FEATURES.

CIRCUITS THAT WILL NOT HOWL.

By J. H. Reyner, B.Sc. (Hons.), A.C.G.I., D.I.C., A.M.I.E.E.

SINGLE OR MULTI-VALVE ?

By Percy W. Harris, M.I.R.E.

IMPROVISING AERIALS FOR THE COUNTRY OUTING. By A. V. D. Hort, B.A.

LOCAL RECEPTION ON FRAME AERIALS.

By D. J. S. Hartt, B.Sc.

Obtainable from all Newsagents, Booksellers and Bookstalls or direct from The Publishers. (Subscription Rates, 15/- per annum; 7/6, 6 months.)
Radio Press, Ltd., Bush House, Strand, London, W.C.2.

Modern Wireless

ARE YOU A PATIENT MAN ?

£200

IF YOU ARE



"Let's see—five separate units give five capacities, taken singly. Then I can have the first two in series or parallel—total seven. Then the first three all in series or all in parallel—two more. The first and third and second and third in series, total 9. Ditto, in parallel, 11. First and second in series, and in parallel with the third—12 And the total number of different capacities with the five units is ——— ?" What is it ?

**If you get it right,
you win £200!**

Whatever your skill in counting capacities, however, the purchase of a Dubilicon will bring you one sure reward. The Dubilicon gives any capacity up to 0.011 mfd. simply by varying the connections of the eight unit capacities of which it is composed; so that by using the Dubilicon you will be able to select with unfailing certainty the best value of fixed capacity for any desired part of your circuit.

The Dubilicon is a multiple condenser containing eight separate units, the terminals of each unit being brought out to sockets on the lid. By using Clix plugs (made by Messrs. Autoveyors, Ltd., 84, Victoria Street, S.W.1) of which two are given with every Dubilicon, the units can be connected in a variety of series, parallel and combined series parallel arrangements giving a very large number of different capacities.

The uses and advantages of the Dubilicon, which we have summarised above, make it more than worth its low price of 30/-.

In addition, the purchase of a Dubilicon entitles you to enter for the £200 prize competition. All you have to do is to estimate the number of different capacities you can get by connecting up the first five units in various ways.

Ask your dealer about one to-day—and mind you enter for the £200 competition! He will tell you all about it!

*The
Dubilicon*

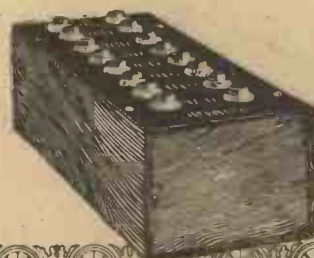

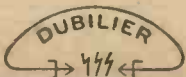
REGISTERED  TRADE MARK

DUBILIER

CONDENSER CO (1925) LTD

ADVERT. OF THE DUBILIER CONDENSER CO. (1925) LTD., DUCON WORKS, VICTORIA ROAD, N. ACTON, W.3. TELEPHONE: CHISWICK 2241-2-3. E.P.S. 193

BETTER RESULTS FROM THIS SIMPLE AND INEXPENSIVE AERIAL and EARTH LOTS MORE FUN!

Listening-in is the greatest fun in the world. There are programmes of every description which please both young and old.

For perfect reception a good aerial and earth system is more than half the battle. The most ingenious and expensive set will not give satisfactory results if the aerial and earth system is bad.

Use ELECTRON WIRE or SUPERIAL and make sure of perfect reception by completing the circuit with the ELECTRON EARTH MAT, the most amazing earth ever devised.

Many crystal users do not know the capabilities of their sets, and are generally satisfied with very ordinary reception. They hear something—a tinkle of music, a whispered talk—and that's all they expect.

Tell them to install the SUPERIAL and ELECTRON EARTH MAT and they will be amazed at the increased volume.



Reduced facsimile of Electron Earth Mat

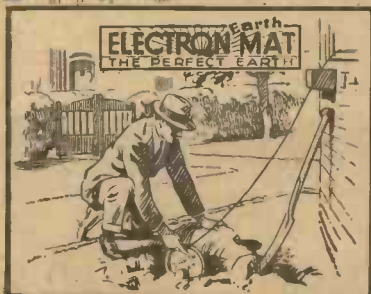
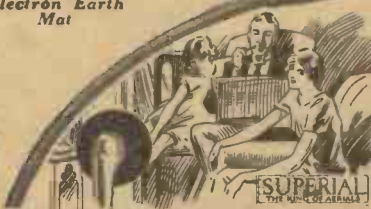

ELECTRON MAT
THE PERFECT EARTH

CHEAP, SIMPLE AND PERFECT
The ELECTRON EARTH MAT is supremely efficient. Its very simplicity compels it. The enormous surface offered by the innumerable strands of the fine mesh of which it is composed affords unusual freedom of release to the high-frequency currents. The ELECTRON EARTH MAT is made of the most expensive phosphor bronze fine-grained gauze, mounted on a strong metal rim, to which is fixed 25 feet of EARTH WIRE, complete. Remember the price also includes 25 feet of EARTH WIRE already fixed.

2/6
Postage 6d.

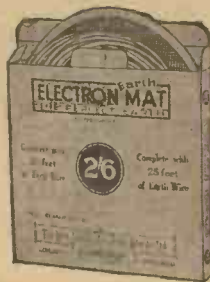

SUPERIAL
THE KING OF AERIALS

EXTRA - HEAVY INSULATION FOR LONG-DISTANCE RECEPTION
The mathematical combination of heavily tinned strands with a plated copper core in SUPERIAL—the King of Aerials—greatly improves the reception, both of voice and instrumental music. SUPERIAL, being insulated with extra-heavy vulcanised rubber, renders insulators an unnecessary extravagance, besides increasing the long-distance range of your set.



2/6
Postage 9d.
Including Wooden Spool.

How easy it is to run the Famous ELECTRON EXTENSION WIRE from the set in one room to the loud speaker in another, or even outdoors! Furthermore, you actually get improved reception because the EXTENSION WIRE considerably enhances the musical tone.

50 feet 100ft. (50ft. double) - 2/-
25ft. double) 300ft. (150ft. double) - 5/-
1/- 500ft. (250ft. double) - 8/-
Carriage Paid.
Postage 3d. Any length supplied.

If unobtainable from your Dealer send direct to us, together with HIS NAME AND ADDRESS, and we will deliver promptly by return. Do not be persuaded to buy anything else.

NEW LONDON ELECTRON WORKS, LTD.
Dept. No. 65. (Members of the B.B.C.)
EAST HAM, LONDON, E.6.

Telephones: Grange Wood 1408-1409.

Telegrams: "Stannum, London."

Wireless Weekly

Phone: City 9911

EDITED BY
JOHN SCOTT-TAGGART
F. INST. P., A.M.I.E.E.

Technical Editor:

J. H. REYNER, B.Sc. (Hons.), A.C.G.I., D.I.C., A.M.I.E.E.

CONTENTS

	Page		Page
Loud-Speaking on Short Waves. By L. H. Thomas (6QB) ...	359	Wireless News in Brief ...	372
Is Your H.F. Choke a Source of Loss? By W. S. Percival, B.Sc. (Hons.), A.R.C.S. ...	363	Non-Radiating Single-Valve Circuits. By the Staff of the Radio Press Laboratories ...	373
Short-wave Notes and News ...	365	The Week's Diary ...	375
A Model Radio House ...	366	Circuits for the Experimenter, No. 12 ...	377
Circuits that will not Neutralise. By J. H. Reyner, B.Sc. (Hons.), A.C.G.I., D.I.C., A.M.I.E.E. ...	368	Readers' Comments ...	379
Getting the Best from the "Neutroflex Two." By N. J. Gibson ...	371	Practical Topics. By G. P. Kendall, B.Sc. ...	381
		New Radio Press Envelopes ...	382
		Apparatus we have Tested ...	383
		Is Your Problem Here? ...	385

Nothing contained herein is to be regarded as permission

or encouragement to infringe any patent rights.

RADIO PRESS, LIMITED,



Bush House, Strand, London, W.C.2

TEMPRYTES

(REGD. TRADE MARK.)

The Perfect Control for all
Valve Filaments

Manufactured in values to suit all valves. From 3 to 50 ohms.

2/6
each.

Holder Mountings for Temprytes - 1/6 each.

Full particulars with valve chart on application.



Grounded Rotor Condensers

The absolute pinnacles of Condenser Perfection.

Square Law.

'001 Mfds.	21/-	each
'0005 "	17/6	"
'0003 "	16/6	"
'00025 "	16/-	"
'0002 "	15/6	"
'0005 Dual	27/6	"
'0003 "	25/-	"

Straight Line Frequency.

'0005 Mfds.	-	-	15/6	each
'00035 "	-	-	15/-	"
Large 4" Knob Dial, as supplied with Square Law Condensers	-	-	2/-	"

ALL POST FREE BY RETURN ON RECEIPT OF REMITTANCE.

From the Manufacturers: **SYDNEY S. BIRD & SONS,**
Cyldon Works, Sarnesfield Road, Enfield Town.
Phone: ENFIELD 672.

Anyone can build — and operate — the **Keystone Super-Het**

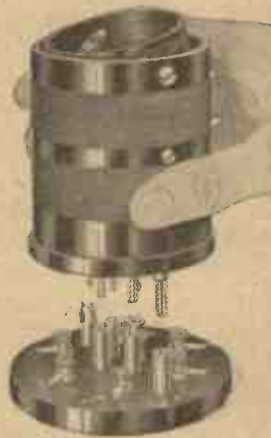

THE Super-Het has been regarded in the past as an instrument which is difficult and costly to build and complicated in operation. This idea has, however, now been dispelled; for, by the Keystone method, you can build a really trustworthy Super-Het, quickly and economically. In operation it is the essence of simplicity — the whole range of wavelengths is covered by means of plug-in interchangeable oscillator couplers, the principle of which will be seen in the illustration alongside. In the Keystone, in fact, all the advantages of a Super-Het are available for the first time without its costliness and complicated working.

You can listen to more than 30 Stations on the Loud Speaker if you build a

KEYSTONE SIMPLIFIED SUPER-HET

BUY THE KEYSTONE BOOK

Everything you want to know about Super-Het work will be found in the 40 pages of the Keystone Book. Its many simple diagrams and clear photographs will enable anyone to build a real Super-Het. Price, 1/6, post free, or complete with full size Blue Prints, 3/-, Write for it-to-day **3/-**

PETO - SCOTT
Co., Ltd.,
77, City Road, E.C.1

Branches at
62, High Holborn, W.C.1.
Walthamstow, Liverpool
and Plymouth.

BURNDEPT COMPONENTS

which ensure *perfect* filament control.



**Burndept
Fixed
Resistors**

From .75 ohms 2 amps
to 55 ohms .25 amps.

1/6 to 2/-



Burndept Screw Holders
ready for mounting either on
wood, ebonite, or behind a panel.

1/6 each.



Burndept Dual Rheostat
(5—30 ohms)

6/-

BURNDEPT FIXED RESISTORS

consist of fibre rods wound with resistance wire and adjusted accurately to definite resistances. They are intended for use either in place of a rheostat to control the filament current of valves or in series with an ordinary low-resistance rheostat when it is desired to modify an existing receiving set to operate with various low temperature valves.

On sets fitted with Shorting Plugs it only occupies a moment to replace the Shorting Plug with a fixed Resistor of a value suited to any valve it may be desired to use and without otherwise altering the set. Suitable screw holders for fixing Burndept Resistors may be obtained. By fitting the Burndept Dual Rheostat (5—30 ohms), a bright or dull emitter valve can be used as desired. This component is now made in a new form embodying improvements and suitable for one-hole fixing.

The Burndept range includes everything for efficient radio reception. Components, GUARANTEED SUPER-VALVES and complete installations. Ask any Burndept Dealer to demonstrate them.

BURNDEPT

WIRELESS LIMITED

Aldine House, Bedford Street, Strand,
London, W.C.2.

Telephone:
Gerrard 9072 (4 lines).

Telegrams:
"Burndept, Westrand, London."

BRANCHES AND AGENTS EVERYWHERE.



Wireless Weekly

Edited by
JOHN SCOTT-TAGGART,
F.Inst.P., A.M.I.E.E.

Technical Editor
J.H. REYNER
B.Sc.(Hons.), A.C.G.I., D.I.C., A.M.I.E.E.



Loud-Speaking on Short Waves

A SUPERHETERODYNE ADAPTER FOR EXISTING SETS

By **L. H. THOMAS (6QB).**

This simply-constructed superheterodyne unit is designed to operate in conjunction with an ordinary short-wave receiver, so that either C.W. or telephony signals may be heard at full loud-speaker strength.



HE average reception enthusiast's opinion of superheterodynes is, if the remarks of the writer's acquaintances are any criterion, that they are hard to construct, harder still to operate, and consume an enormous amount of current, in addition to their initial cost being very high. The superheterodyne "unit" described in this article was constructed with somewhat less trouble than is generally experienced with a "straight" receiver, is reasonably inexpensive, and consumes a total filament current of .38 ampere. It was, in fact, made for the purpose of showing that a superheterodyne need not be beyond the capabilities or the purse of the majority of users of the popular "detector and note-mag."

Autodyne Circuit

It is by now fairly well known that when it is desired to use a superheterodyne on the higher frequencies there is no need to

use a separate oscillator in conjunction with the first detector, or even to employ the well-known "Tropadyne" circuit, since the percentage detuning necessary to obtain a beat note with the incoming signal is small enough to be practically negligible. A

if it were a low-frequency amplifier.

A Separate Unit

The short-wave set might then be kept quite separate, and different circuits could be employed for the first detector, the "superhet" part of the apparatus remaining quite standard and untouched during these experiments, which would be rendered much more simple by this arrangement. The ends of the winding of the "filter" transformer are therefore simply brought out to two "input" terminals on the left-hand side of the front panel, and these are connected to the telephone terminals of any single-valve receiver (which must, of course, be made to oscillate) that it is desired to try out.

It should be mentioned here that, unless a separate oscillator or a "Tropadyne" circuit is employed, this arrangement will not be efficient on the broadcast frequencies; it is, however, eminently suitable for the recep-



Only the input and output terminals are mounted on the front panel.

straight autodyne circuit is perfectly efficient for the initial detection and heterodyning of the signals. For this reason the writer thought it advisable to construct, for short-wave work, a superheterodyne "unit" which may be added to any existing single-valve set just as simply as

LOUD-SPEAKING ON SHORT WAVES

(Continued)

tion of KDKA, WGY, and, in fact, all stations employing frequencies higher than about 3,000 kc. (i.e., wavelengths below 100 metres).

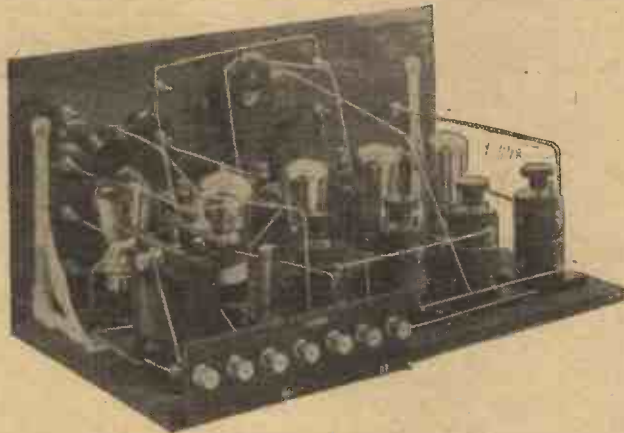

Valve Arrangement

As will be seen from the photographs and diagrams, the construction of this set is quite a simple matter. Actually, to assemble it and get it into thorough working order took much less time than is usually spent on a three- or four-valve receiver. Five valves are incorporated in this unit, three of these being amplifiers at the intermediate

should it be desired to listen on headphones, as it is usually distinctly uncomfortable to do so with the note-magnifier in circuit. A loud-speaker is generally left in the anode circuit of the last valve, and it is not often found necessary to tune in with the headphones in circuit, so great is the strength of signals. The writer, however,

interaction between these is capable of causing a great deal of trouble in operation. Fortunately the conventional superheterodyne circuit lends itself to a neat layout and short wiring. The simplicity of the latter will be apparent from the back of panel photographs.

Controls

The controls on the front panel, four in number, are simply a potentiometer controlling the grids of the three intermediate-frequency amplifiers, and three rheostats. One of these latter is wired in series with a 17-ohm fixed resistor, and controls the filaments of the I.F. valves; the second, in series with a similar resistor, the filament of the second detector, and the third is wired in the filament circuit of the note-magnifier, no resistor being used in this case.

Filament Supply

A six-volt accumulator is used to supply the filament current for all the valves, and provided that the variable resistances used have a resistance of not less than 30 ohms, valves of the .06 ampere type may be employed as the I.F. amplifiers. Actually the writer employs, in addition to these, a valve of the P.M.4 type as second detector, and either another of this type as the note-magnifier, or one of the B.T.H. B7 (6 volts, .06 ampere) type. In any case, if a six-volt



Compact layout is a feature of the set.



always prefers telephones when listening to C.W., and for this purpose the L.F. valve is very rarely employed.

The battery terminals are affixed, in the conventional manner, to a strip at the rear of the set. Three high-tension positive terminals are provided, one supplying the voltage necessary for the intermediate-frequency amplifier, and the others

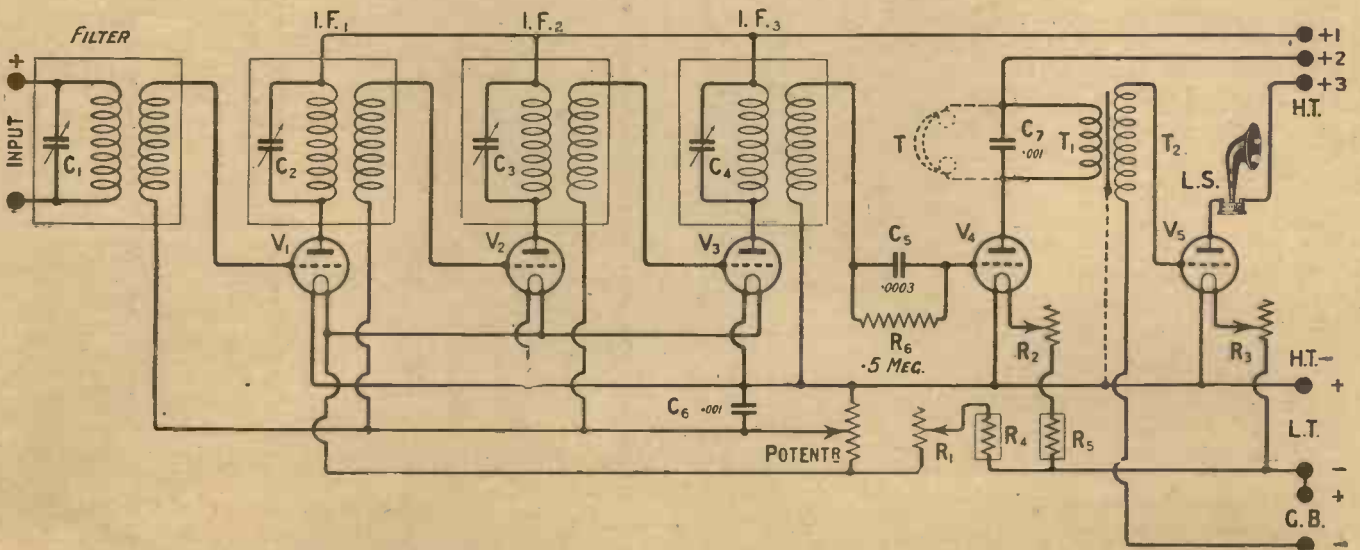

Fig. 1.—The terminals for the telephones place them in circuit in the position shown dotted in the diagram.

frequency, one the second detector, and the last an ordinary stage of note magnification.

Loud-Speaker or Telephones

Terminals are provided for connecting the telephones across the primary of the L.F. transformer,

the potentials for the second detector and the note magnifier.

Layout of Components

Probably the most important feature of the layout of the components on the baseboard is the spacing of the I.F. transformers, as

accumulators is used, the fixed resistors in the filament circuits of the I.F. valves and the second detector will be necessary.

Special Connections

The grid of the second detector, which employs the grid condenser

and leak method of rectification, is taken through the secondary winding of the last intermediate-frequency transformer, not to the centre point of the potentiometer, but straight to the positive low-tension terminal. It should be noted that all the rheostats and resistors are wired in the negative filament leads of the valves that they control. The capacity of the grid condenser need not be greater than .0003, but the grid-leak should have a fairly low value. The writer uses one of .5 megohm resistance, and finds that to be the most satisfactory value.

One of the most important components in the whole set is the fixed

LOUD-SPEAKING ON SHORT WAVES

(Continued)

condenser, of .001 capacity, shunted across the primary of the L.F. transformer. Without this the receiver becomes unstable and very difficult to operate. The condenser shunting the potentiometer winding should also not be overlooked. This is connected from the moving contact to the end of the winding which is connected to L.T. +.

Intermediate Frequency Transformers

With the particular make of I.F. transformers used in this set, another rather puzzling trouble is liable to occur unless the operator has been warned about it, for the following reason: the primary windings are capable of being tuned by small variable condensers connected across them (these, of course, being incorporated in the components themselves), and the filter transformer is similarly constructed. This means that no other capacity must be connected across the primary of this transformer, or the

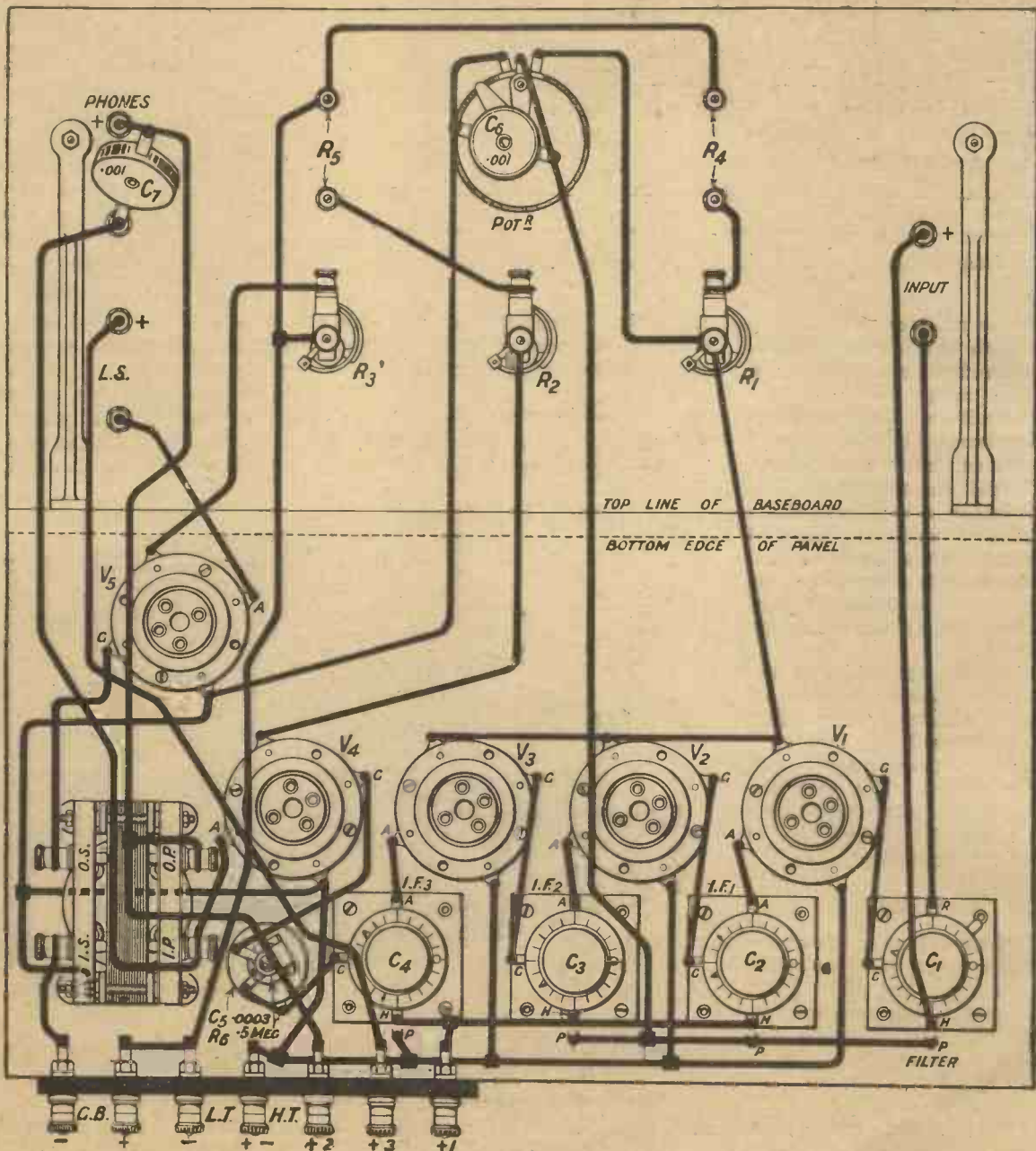

Fig. 2.—The core of the L.F. transformer is connected to L.T. positive.

LOUD-SPEAKING ON SHORT WAVES

(Continued)

matching of the set of transformers will be completely upset.

Oscillation Control

For this reason there must be no by-pass condenser across the ter-

smooth control can be obtained in this way, and one that is quite independent of the frequency. That is to say, for C.W. reception the potentiometer is simply turned towards the negative side until the slight "mushy" noise indicating self-oscillation of the I.F. valves is heard; and it may then be left alone. Should a station using telephony be picked up it is simply necessary to

lating. In addition to the thumps there is generally quite enough "mush" from Northolt and other long-wave stations (being received, of course, on the short-wave receiver) to make the average C.W. station sound rather like a spark signal when tuned in in this way.

Transformer Adjustment

The intermediate-frequency to which the writer's transformers are tuned seems to be approximately 100 kc. (3,000 metres), and is variable over a range of some 10 kc., enabling one to clear any interference from long-wave stations which may be received by direct pick-up on the part of the set. All four transformers must be carefully tuned, and this is best done simply by listening to a short-wave signal when in the oscillating condition and adjusting the four small knobs until the maximum signal-strength is obtained. This occurs at a fairly sharply defined point on each one, and rotating them does not vary the pitch of the signal appreciably, so that it will be seen that this initial adjustment is quite an easy matter.

Components

For the benefit of readers who wish to construct an exact facsimile of the set appearing in the photographs and diagrams, the manufacturers' names are given in the following list of components:—

One cabinet, 16 in. by 8 in. by

minals on the receiver to which the input terminals to this set are wired, and it is therefore preferable to use one of the many forms of the Reinartz circuit for the first detector. This always works excellently on short waves, and has, of course, the additional merit that no telephone condenser is required. There is no need to provide any form of fine reaction control for the first detector, as signals seem to be just as strong when it is oscillating hard as when it is just on the oscillation point.

It is, of course, advisable, for the benefit of neighbouring listeners on short waves, to arrange that the first detector is not oscillating too hard! The writer has found, however, that no reaction control other than the filament rheostat is necessary. Thus the whole superheterodyne is, in reality, a single-control receiver.

Telephony

For telephony reception the short-wave detector must be in an oscillating condition, but the intermediate-frequency stages must not. For C.W. reception, however, the intermediate valves are made to oscillate by adjustment of the potentiometer, which, by the way, is not connected direct across the accumulator, but across the filaments of the valves that it controls. A

take the potentiometer a shade towards the positive side, and the speech will be clearly received.

C.W. Reception

Actually, there does not appear to be the slightest necessity to make

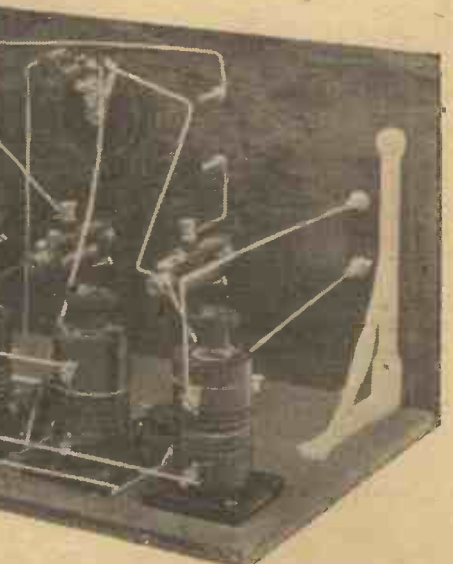

The leads to the I.F. transformers should be short and symmetrically arranged.

the intermediate stages oscillate to receive C.W., since this can be read quite clearly by the "key-thumps" heard when the receiver is not oscil-

9 in. deep, with baseboard and two panel brackets (Carrington Manufacturing Co.).

(Continued on page 382.)

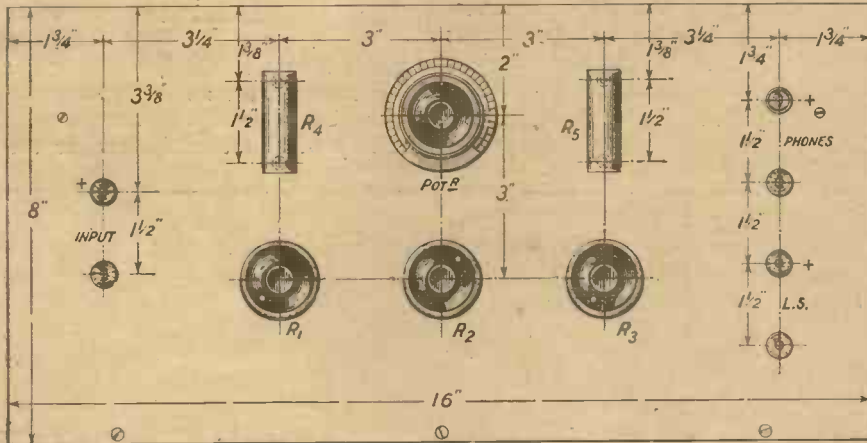
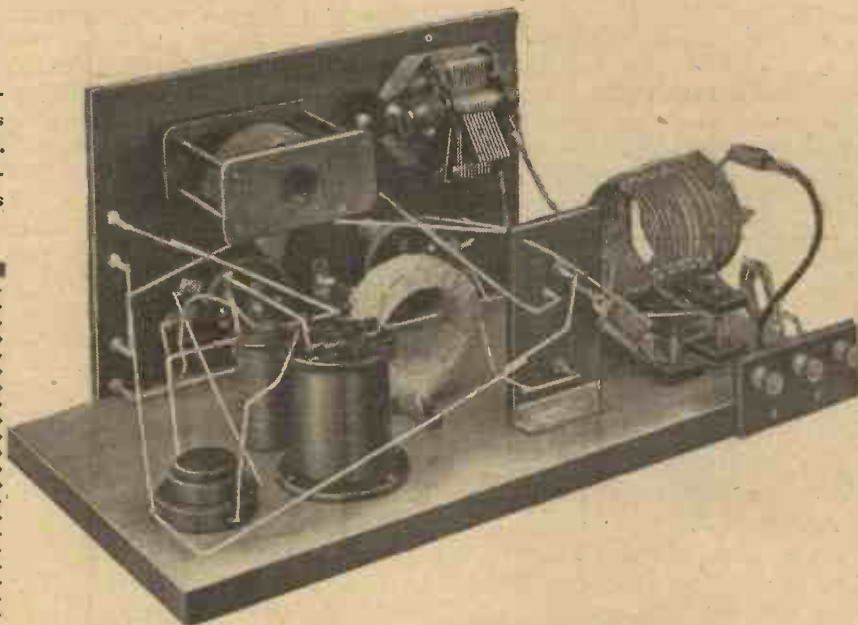

Fig. 3.—Interchangeable fixed filament resistors are conveniently mounted on the front panel.

IS YOUR H.F. CHOKE A SOURCE OF LOSS?

By **W. S. PERCIVAL**,
B.Sc. (Hons.), A.R.C.S.

How do dielectric losses affect the efficiency of H.F. chokes? Continuing his investigations into this subject, Mr. Percival gives the results of measurements on standard coils and draws some interesting conclusions.



The provision of efficient H.F. chokes is of particular importance in short-wave receivers.



THE function of a high-frequency choke in a wireless receiver is to provide a path of high impedance to radio-frequency oscillations.

According to the usual electrical definition of a choke it should do this by virtue of its inductance, its self-capacity being small, or, at any rate, insufficient, to tune it to the incoming radio frequency. In practice chokes frequently tune to a frequency lower than that at which they are required to operate.

An Example

In a previous article (*Wireless Weekly*, Vol. 8, No. 8) a choke of a well-known commercial make was mentioned which was found to have a natural wavelength of about 1,600 metres, although this instrument is employed quite successfully on the lower broadcast band. If we remember that certain stray capa-

latter being more than sufficient for tuning purposes. This capacity will not, however, possess an air dielectric, unless the choke is air spaced, but the dielectric will be composed of the insulation between the turns and layers of the choke. We must therefore be prepared to expect serious dielectric losses, unless the choke is thoroughly well designed.

Dielectric Losses and Self-Capacity

Now if the self-capacity of a choke is just sufficient to tune it to the frequency with which it is required to deal, then the current through the self-capacity will be equal to the current through the inductance. If the self-capacity is in excess then the current through this self-capacity will be greater than that through the inductance. Finally, if the self-capacity is sufficiently small, most of the H.F. current will pass through the inductance. Clearly in each case dielectric losses will play a different part, being greatest when most of the current passes through the self-capacity.

Some Experiments

In order to obtain a clear idea of what happens when a choke is used

it was decided to make a number of experiments. For this purpose the circuit shown in Fig. 1 was employed, where L is a coil of known inductance and H.F. resistance, C a tuning condenser, and M the choke to be tested. It was in practice necessary to place a vernier condenser in parallel with the main tuning condenser, in order to enable more accurate readings to be taken. For the sake of simplicity, however, this is not shown in the diagram.

The oscillator coil was loosely coupled to L and was necessary for

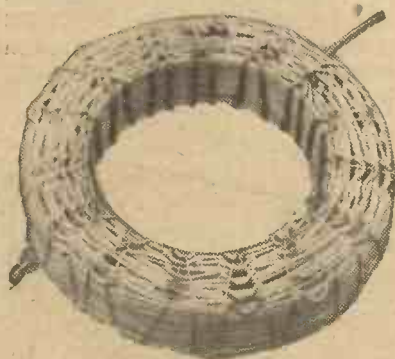

"Lattice" winding for choke coils has the advantage that no wax or similar supporting substance is needed.

cities between wiring, etc., will be in parallel with the choke when in use in an actual receiver, it is clear that the effective natural wavelength will be considerably higher.

Such a choke will function in a receiving set like a very large coil with a capacity in parallel, the

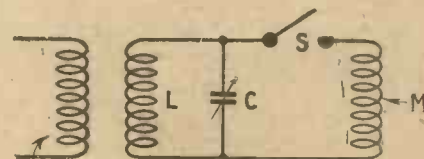

OSCILLATOR COIL

Fig. 1.—The circuit used by the author for testing H.F. choke coils, M being the coil under test.

measuring H.F. resistance, the details of this method having been described in a previous issue of *Wireless Weekly* (Vol. 8, No. 3).

To avoid the trouble of winding a large number of chokes, a series of commercial coils of a fairly well-known make were employed. All

Is Your H.F. Choke a Source of Loss?—continued

measurements were made at the frequency of the London station.

Measurements

The results are tabulated below. The third column shows the capacitative effect of the choke. Thus in the first line it is shown that a No.

75 coil somewhat above. It is curious to note, however, that the No. 250 coil is out of order, its capacitative effect being greater than that of a No. 300 coil of inductance 5,000 μ H, and even of a still larger coil of inductance 9,000 μ H.

negligible equivalent series resistance, as might be expected, owing to the absence of dielectric losses.

Effect of Size of Tuned Coil

Although this article is designed primarily to emphasise the importance of dielectric losses in chokes, yet it would not be complete without reference to the effect of the size of the tuned coil L on the equivalent series resistance introduced by a choke. Theory indicates that if the coil L is made smaller, and C correspondingly increased, then the damping due to the choke would be less owing to the relatively smaller current flowing therein.

Decreased Damping

For the purposes of examining this a No. 25 coil of inductance 25 μ H was substituted for the No. 40 coil previously employed for L. The markedly decreased effect of the damping introduced by even the worst choke coils is shown in the table. On the other hand it should be remembered that if the size of the coil L is increased then the damping introduced by the choke becomes much more pronounced.

L.	Choke M.	Effective Added Capacity in μ F.	Equivalent Series Resistance in ohms.
No. 40 coil of inductance 100 μ H and H.F. Resistance 6.5 ohms	No. 75 coil	- 85	0
	No. 100 "	- 20	4
	No. 150 "	- 10	6
	No. 175 "	- 2	6.5
	No. 250 "	+ 62	19
	No. 300 "	+ 16	9.5
	Coil of 9,000 μ H.	+ 25	16
No. 25 Coil of Inductance 25 μ H	No. 100 coil	—	Less than $\frac{1}{2}$
	No. 250 coil	—	About 1
	Coil of 9,000 μ H	—	About 1

75 coil had the apparent effect of subtracting .000085 microfarads from the circuit. This simply means that it was necessary to increase the capacity of C by that amount to retune the circuit after the choke was placed in parallel.

The fourth column shows the resistance which, placed in series with L, would exert the same damping effect as the choke.

Coupled with this fact we note that the equivalent series resistance of the coil is higher than that of any other.

A Deduction

If we now examine the other figures we see that the more positive is the capacitative effect of the choke the greater is its H.F. resistance. It will be admitted that this affords strong presumptive evidence in favour of regarding dielectric losses as of paramount importance. This is further supported by other evidence.

Thus coils of the particular make employed, while quite satisfactory when used in the ordinary way, are particularly inefficient as chokes when dielectric losses would be expected to become of greater importance.

Application to Circuits

In Fig. 2 is shown a circuit which, with minor alterations, is frequently employed for intervalve coupling. The effect of the damping of an inefficient choke M on the circuit LC will be immediately apparent from the foregoing discussion.

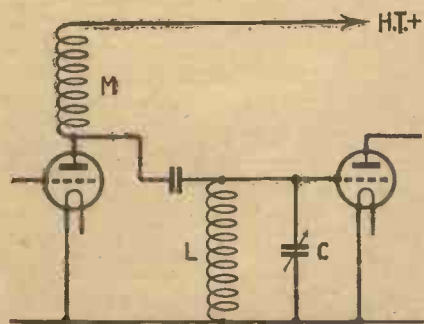

Fig. 2.—An inefficient choke in this circuit may have a damping effect on the tuned circuit LC.

A Curious Result

The results shown in the third column are of the order to be expected and indicate that the natural wavelengths of the coils gradually increase, that of a No. 175 coil being slightly below that of 2LO, and

Construction of Coils

Further, on examining the interior of the coil, which was of a common plug-in type, it was found to consist of a number of layers of impregnated cotton-covered wire, separated by thin brown paper. One would certainly expect a coil of this type to suffer from dielectric losses.

Lastly, one or two air-spaced coils of about Nos. 200 and 250 were tried. These were found to give a



There is wide scope for experiment in testing the merits of different types of windings.

The choke coil M is, in effect, in parallel with the tuned circuit, since the H.T. and L.T. batteries are at the same potential as far as high-frequency variations are concerned; consequently the full damping effect of the choke will be evident, as has just been described.

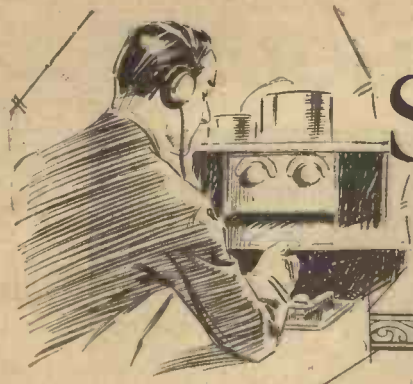

SHORT-WAVE

Notes & News



ALTHOUGH conditions have been by no means good on the reception side, the past fortnight has seen some excellent low-power transmitting feats, and the British stations still seem to be very active. No new countries have appeared "on the air," but the station SS-8LBT, mentioned in the last issue of these notes, has been found to be in Straits Settlements.

Low Power DX

G-6YD is apparently the star performer at present. He uses a maximum power of 10 watts and a master oscillator, and his signals have been heard in India, Uruguay, 10 times in Brazil and 22 times in the United States! The question now arises—"Why does anyone ever use more than 10 watts?" 5YG, of Glasgow, has also put up an excellent performance, having worked Brazilian 6QA with an input of 8.62 watts, his signals being reported a steady R4. This is real long-distance DX with low power, and to work Brazil with 8 watts is naturally much more creditable than to cover a distance of, say, 200 miles with .02 watt, although the "miles-per-watt" figure is not nearly so great.

We have a letter from Denmark bearing the glad tidings that the Danish Government are at last granting licences for amateur transmission. We hope to obtain a complete list of the addresses of the Danish transmitters very shortly.

QRA's in All Countries

We now have in our possession what is probably the most complete list of call-signs of amateurs all over the world, and feel that this will be useful to those who wish to send QSL cards to amateurs that they have worked or called. Such a list cannot be published without full permission of all the stations in-

cluded in it (many of whom are unlicensed), but we are always willing to communicate, in confidence, with anyone sending in a request for the QRA of a station. The list will be complete by the time this appears in print, and all letters relating to this service should be addressed "QRA Section," *Wireless Weekly*.

Irish Activity

The Irish stations are now bidding fair to outdo the ordinary plain "Gs" as far as DX is concerned. Whether this is due to the comparative absence of QRM in Ireland or to specially good "local conditions" it is not possible to say. The fact remains, however, that



Mr. T. Woodcock (G600) has done some good low-power work on the "Inexpensive Short-Wave Transmitter" recently described in "Wireless Weekly."

practically every active Irish station has some particularly good feat to his credit. 6MU has now worked Indian HBK on telephony with an input of less than 30 watts! He was reported at a fair strength with no distortion. He has now worked all Europe, Africa and Asia on telephony, and the other two continents on C.W.

The latest feat has been two-way working with PI-1AU (Philippine Islands) on C.W. with 18-20 watts. GI-6YW, it will be remembered, worked PR-4SA with an input of

2 watts. Belfast looks rather like being the "Hams' Paradise" so often mentioned in "QST"!

Why "Raw A.C."?

The interference problem is becoming really serious now, as more and more stations are using the 6,667-kc. band. The French stations, practically all of whom use "raw A.C.," are casting the blame on the Italians, who, it is believed, are attempting to blame the German stations. Why use "raw A.C." at all, when a rectified A.C. note with half the power will carry just as far, if not further? Fortunately the majority of British stations use D.C. notes, and those who have A.C. generally take the trouble to rectify it.

An Aerial Experiment

The horizontal experiments by 6QB mentioned in the last issue have yielded results that are not quite up to his original expectations. They consisted, briefly, of using an aerial divided in the centre by a series of insulators, with two separate down-leads, one half being used as aerial and the other as counterpoise. He had several interesting reports on his transmissions when this system was in use, but apparently the steadiness of the note, which was not affected by swinging on the part of the aerial, was the main advantage. Signal strength at a distance appeared to be the same as when the usual arrangement was in use.

Transmissions from Schenectady

We continue to receive reports of reception of the various "WGY" stations, and have ascertained that the call-signs used are 2XK, 2XAF, 2XAL and 2XAS. A summary of the reports will probably be published later. A letter will be found among the "Readers' Comments" in this issue, asking for further reports on this short-wave telephony.

A MODEL RADIO HOUSE

A few days ago a house in New York, completely equipped with wireless receiving apparatus, was opened by Captain P. P. Eckersley from Radio House, London. This article describes in detail the equipment of this model Radio House.

RADIO HOUSE exemplifies the ideal in radio broadcasting service in the home. It is designed to give the public a wholly new and broader conception of modern home installations, and represents radio engineering's most recent achievement in home radio installations, introducing such factors as remote control receivers, concealed wiring, "built-in" switches, automatic clock operation, and many other features.

Economy and Remote Control

The Radio House project is an example of what can be accomplished economically and effectively in greatly increasing the usefulness of a single receiving set, by the addition of a single distribution system with radio outlets or "feeders" in different parts of the house. Moreover, the principle of



A control panel for the second floor set is placed at the head of the bed in the "Master's" bedroom.

controlling the central receiver from distant points in the house, a decidedly necessary consideration where convenience is desired, is made use of to the fullest extent. Again, the possibilities of multiple receivers for a plurality of simultaneous programmes are fully demonstrated. In brief, the story of Radio House is the story of the radio-equipped home of the future.



The receiver takes its place as part of the ordinary furniture of the room.

Equipment in Radio House

On the first floor, the living-room, dining-room, kitchen and porch are equipped with receiving apparatus.

The master set for this floor, including the porches but excluding the kitchen, is an eight-valve super-heterodyne receiver, with a loop

The interesting description of a Model Radio House on these pages perhaps foreshadows a development which may become before long a regular and normal feature of domestic architecture.

aerial. This set supplies the input for a power loud-speaker in the living-room, opposite the set, and for another in the dining-room.

A three-way switch, conveniently located close to the set, enables the operator to transfer the set output to either loud-speaker, and to control the A.C. entering the power-speakers at the distant points. A two-way switch in the dining-room provides remote control of the living-room set, and A.C. to the dining-room loud-speaker. No batteries, outside aerial or earth are used.

The main porch, reached through doors in the living-room, is provided with suitable receptacles to accommodate the living-room loud-speaker, which may be moved only five feet from its living-room position to the porch. Control of the speaker, when in its porch location, can be effected at either of the two points in living-room or dining-room.

Time Clock

A timepiece of special design which automatically operates a switch, all mounted in a small mahogany case, takes its place on the cover of the receiver. A cord, connected to a terminal block inside the case, extends to the master control switch plate by the living-room set, where connection is made to the A.C. circuit. The clock may be set in advance, and when the hour corresponding with the setting arrives, the switch automatically closes, and the entire first-floor installation is set in operation.

The kitchen receiver is battery-operated and uses an aerial. This receiver is smaller than that used in the living-room, and because of the comparative size of the kitchen, a smaller loud-speaker is used, this being plugged into the receiver. The aerial and earth connections are made by a duplex cable, the terminal plug of which engages with a double receptacle mounted in the baseboard, the leads being arranged out of sight.



Another man who had never known really good Broadcasting

"NOW that's what I call a good Set" exclaimed Simpson enthusiastically, after he had heard Chopin's beautiful Mazurka in A Minor. "And yet"—here a note of doubt crept into his voice, "it seems very much like the Set you were using before Christmas." "It is the same Set," I conceded, "but with different valves. You'll remember Clarke who was with our crowd in Mesopotamia?" "Yes, rather, good old Nobby!" "Well, I dropped across him in the City the other day, and as he mentioned that he now had a job with a wireless firm, I asked him to come over and look at my Set. He said the Set was fine but that I was using the wrong valves."

"But I thought all valves were very much alike," cut in Simpson. "And so did I until Clarke enlightened me," I replied. "First of all he gave me an explanation as to how my Set worked. He showed me how the first valve had to act as a high frequency amplifier, the second as a detector, whilst the third valve, he explained, was responsible for obtaining good volume and pure tone from

the Loud Speaker. And then he proved to me why these three different jobs required three different types of valve. He had brought with him three Cossor Wuncell Dull Emitters. Taking out the first two valves from my Set and inserting in their places a Wuncell W₂ and a W₁, he asked me to compare the difference. It was startling. But the most amazing thing was still to come. He substituted a Cossor W₃ for the third valve, increased the H.T. voltage, and literally the Loud Speaker leapt into life. I remember a piece called "In a Monastery garden" was being broadcast at the time."

"Oh, Yes, I know it," interrupted Simpson, "it has lots of little trills among the high notes to imitate the birds in the garden." "That's the piece," said I, going on with my story, "the moment he put in that third valve I realised that I had never really known how good Broadcasting could be. All the time I had been blaming the makers of my Set when it was the valves which had been at fault."

"There certainly is a tremendous difference," admitted Simpson, "turn the Set round and let's have a look at these remarkable valves." I did so. "Why," he cried in amazement, "you can't see any glow from them!" "No," I answered, "that is another advantage. They consume so little current and work at so low a temperature that Clarke swears that they will last longer than any other valve on the market. He says that the filament which the Cossor people use is quite different—being made of wire having a very thick coating of some special substance which produces lots of electrons at a very low temperature."

"That must be an advantage," suggested Simpson, "for the extra coating must make the filament stronger and thicker." "Yes," I agreed, "even when one rolled off the table last night it came to no harm. Quite frankly I'm very much indebted to Nobby Clarke for the good advice he gave me." "You can include me in that," said Simpson with a smile, "for it is a long time since I spent such an enjoyable evening."

*W.1. For Detector and L.F. use - 14/-
Consumption : 3 amps.

*W.2. (With red top) for H.F. use 14/-
Consumption : 3 amps.

W.3. The Loud Speaker Valve - 18/6
Consumption : 5 amps.

*All the above valves operate at 1'8 volts, but those marked * are also supplied with special base with resistance to suit 2, 4-or 6-volt Accumulator. 16/-

Cossor Valves

Issued by A. C. Cossor, Ltd., Highbury Grove, London, N.5.

Gilbert Ad. 5090.

AN ADVERTISEMENT IN "WIRELESS WEEKLY" IS A GUARANTEE OF SATISFACTION TO BUYERS.

A PERFE^{CT} VALVE

C.T. 25.

Filament Volts 5-6
 Filament Amps25
 Anode Volts 30-300
 Voltage Amplification Factor 9
 Impedance 10,000
 Mutual Conductance .. 800
 Plate Current Saturation at 50
 Volts over 30 milliamps.

15/-

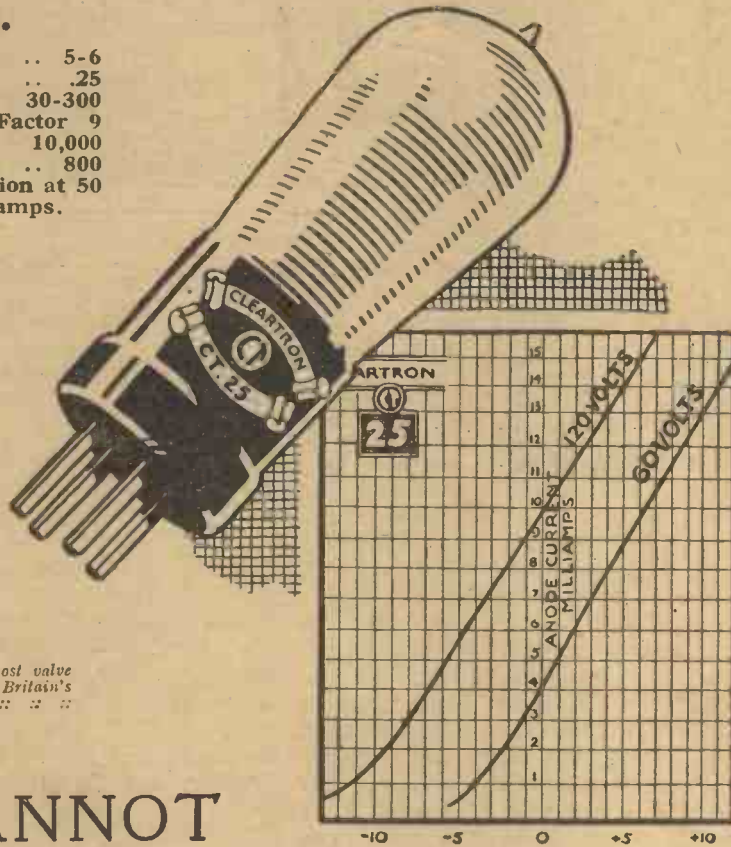

*America's foremost valve
 now made in Britain's
 newest factory. :: ::*

YOU CANNOT

be using the valve with qualifications for the supreme realities of wireless—generous volume, pure and sonorous tones or longer distances—unless you use CLEARTRON Valves, which are real y guaranteed under CLEARTRON'S IRONCLAD GUARANTEE.

12/6 STANDARD PRICES 15/-

They are ALL Dull Emitters, with lowest current consumption, and sold at Standard Prices. For 2, 3, and 5-6 v. Accumulators and Dry Cells, H.F. Detector and L.F.

Full technical data from your Dealer, or :

CLEARTRON RADIO LIMITED

1 CHARING CROSS, LONDON ; (Works : BIRMINGHAM).

Telephone: Regent 2231/2.

'Grams: Cleartron, Westrand, London.

British



Made.

46/595

AN ADVERTISEMENT IN " WIRELESS WEEKLY " IS A GUARANTEE OF SATISFACTION TO BUYERS.

A Model Radio House—continued

Bedroom Equipment

On the second floor there are three bedrooms.

The "Master's" bedroom contains a six-valve superheterodyne receiver. This set is located on a

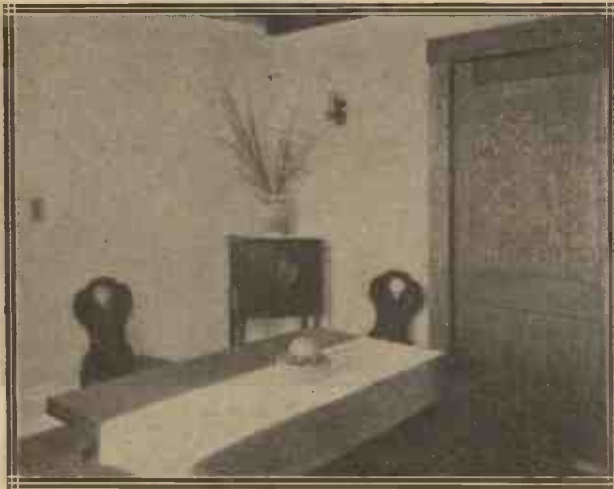

table at one side of the bed, while at the other side, at the head, is a control panel consisting of a number of "push" switches. The loud-speaker and H.T. battery eliminator is located on a small table at the foot of the bed, about fifteen feet from the set, the L.T. batteries being concealed in a small closet, where they may be reached conveniently.

The equipment in the "Guest" bedroom consists of a push-button switch, easily reached from the guest's bed, an H.T. battery eliminator and power loud-speaker. The loud-speaker, battery eliminator, and power amplifier are combined in two units, these units resting on a small table at the foot of the guest's bed.

Radio service for the Nursery is supplied by the loud-speaker in the "Master's" bedroom. A short extension cord permits the speaker to be moved slightly from its usual position, thus permitting the children to hear "Children's Hour" programmes in their own bedroom.

Operation of the Receivers

The living-room, dining-room and porch are served from a master receiver. Having selected the broadcasting station, the button at the master control panel is depressed for the living-room. Pressing another button sends the concert to

the dining-room, from whence the loud-speaker can be silenced by touching the dining-room control. The same plan of control applies when the loud-speaker is moved to its porch position.

Nursery. Another button controls the circuit to the "Guest" bedroom, while the loud-speaker there may be disconnected by touching a button beside the bed, without affecting reception in other rooms.

By pressing two buttons at the control plate, all of which are suitably marked, the receiver is ready for operation, as the A.C. and D.C. circuits to the eliminator and receiver have been closed. The receiver is then tuned, and radio service is available in the "Master's" bedroom. By closing another switch, the signal is also transferred to the "Guest" room, and, pressing still another, makes the radio service available in the "Guest" room only.

House Wiring

The radio wiring for the Model Radio House is entirely standard, the work having been handled by the same electrical contractor who did the electric light wiring, without complications or additional difficulties. The Model Radio House installation can thus be duplicated anywhere. It is interesting to note that the cost of Radio House wiring, in the final analysis, is considerably less than that of a good receiver, yet it serves to increase immeasurably the service rendered by the radio installation.



No external wiring is visible in the rooms, all the leads being run inside the walls.

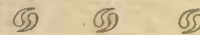

The kitchen battery-operated receiver has no external or remote control connections, this receiver operating in the usual manner. It is independent of all other receiving apparatus in the house, but may be operated simultaneously with any and all other receivers without causing any interference.

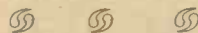

The master set on the first floor is a superheterodyne with a frame aerial, seen in the far corner of this room.



Control Upstairs

The bedrooms are served by one set. Having selected the broadcasting station, the button at the master control panel is depressed, and service is made available in the "Master's" bedroom and the

THIS WEEK'S INTERVIEW

The above feature is unavoidably held over from this week's issue, and will appear at an early date.

Circuits That Will Not Neutralise

By J. H. REYNER, B.Sc. (Hons.),
A.C.G.I., D.I.C., A.M.I.E.E.

Experimenters with neutralised H.F. circuits will probably have found that stable neutralisation is difficult or even unattainable with some arrangements. The causes of this trouble are discussed here by Mr. Reyner, and some of the possible solutions suggested.

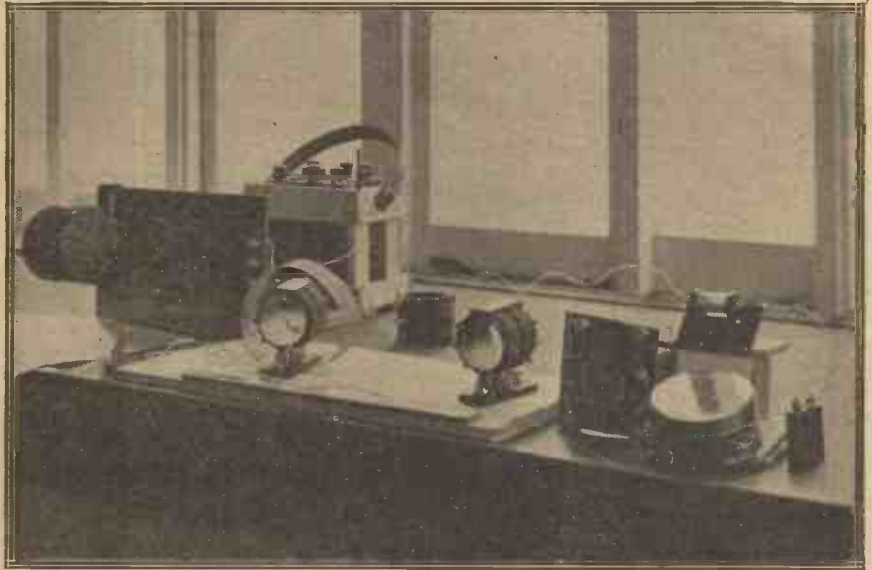

Some of the apparatus used by Mr. Reyner at Elstree in his experiments with neutralising methods.



THE problem of the neutralisation of the inter-electrode capacity of a high-frequency amplifying valve is one which has been receiving a good deal of attention recently. Many circuits have been tried and experimented on with the object of devising an arrangement which would remain stable over the whole of the particular tuning band employed.

Bridge Circuits

Many of the devices used employ a bridge arrangement, which is not, strictly speaking, a neutrodyne, since this word really only applies to the particular methods adopted by Professor Hazeltine, who has registered the name "Neutrodyne" to apply to his circuits. It

ingness of the part of the circuit to be stabilised. It may be found that the circuit behaves in a correct manner during the process of stabilising, but on switching on it is not really stable. For example, one of the methods of neutralising consists in tuning the set to the local station, turning out each valve

Parasitic Oscillations

I am not referring at all to the generation of parasitic oscillations, which have already been discussed in these columns, and the possibility of which is now fairly well known. The oscillations which are produced in such cases are at a very high frequency, and will not produce any heterodyning of the local station. They are chiefly evidenced by a sudden drop in signal strength, the set going completely dead. If the condensers of the set are touched with the moist finger the usual clicks will be obtained, showing that the set is oscillating.

A Circuit Which Gave Trouble

It is assumed, however, that with the particular neutralising methods adopted, precautions have been taken against the generation of these parasitic frequencies, so that any oscillations produced here are at or near to the frequency which is being received, and for that reason are perhaps even more puzzling. A particular circuit which gave trouble in this respect is that shown in Fig. 1. This circuit was a tuned high-frequency circuit, using a split-anode method of neutralising. The second anode coil was not split, in order to avoid the tendency towards the production of parasitic oscillations.

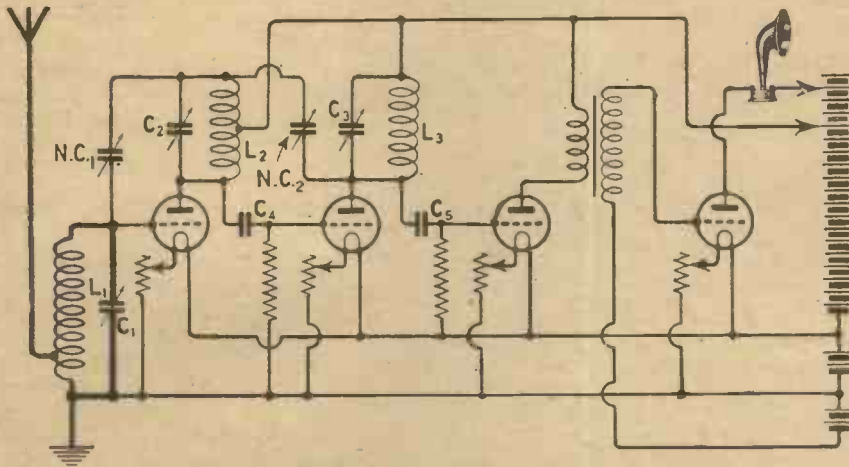

Fig. 1.— With this circuit failure to obtain complete neutralisation was found to be due to coupling between the coils L1 and L3.

is more correct, therefore, to refer to such circuits as neutralised rather than neutrodyne, because such a term covers any of the various methods which may be employed.

Now any experimenter who has carried out work on these circuits will have found himself puzzled at one time or another by an unwill-

ingness of the part of the circuit to be stabilised. It may be found that the circuit behaves in a correct manner during the process of stabilising, but on switching on it is not really stable. For example, one of the methods of neutralising consists in tuning the set to the local station, turning out each valve

Instability

Now this circuit, when first tried, neutralised perfectly according to

the ordinary methods, a crisp zero being obtained on the neutralising condensers when the respective valves were turned out. On switching on the valve again, however, the circuit was not found to be stable. While at times it would give satisfactory results, at other times it would burst into oscillation,

CIRCUITS THAT WILL NOT NEUTRALISE
(Continued)

Unwanted Couplings

The coils in the particular circuit had been placed at the critical angle

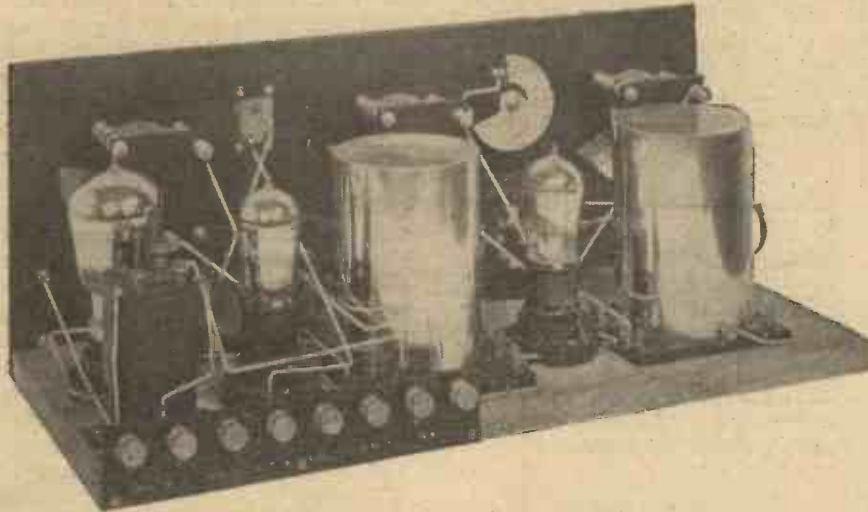

This receiver, the "Screened-Coil Long-Distance" Set, was the outcome of successful experiments with coil screens specially designed to eliminate stray couplings.

and behaved in a generally unsatisfactory manner. A slight variation of the neutralising condensers would usually check the oscillations at one particular setting, but it was immediately found that such an alteration introduced instability at other parts of the dial, so that it was impossible to find a setting of the neutralising condensers which would give stability throughout the entire range. In other words, the circuit persistently refused to neutralise.

The Cause of the Trouble

This was a matter which occasioned considerable thought. It is immediately obvious that since a symmetrical arrangement has been employed, there is no very clear reason for this lack of neutralisation. Moreover, the fact that the crisp zeros are obtained on the neutralising condensers when the valves are turned on indicates that each individual valve is being correctly neutralised. Strictly speaking, the circuit therefore is neutralised, and the oscillations are occurring from some other cause. This can only arise from stray magnetic or capacity coupling between the various portions of the circuit, and a little investigation showed that this was really the cause of the trouble.

of approximately 57 degrees, in order to obtain a zero coupling between the various coils. Now experiments showed that the coupling between the first and second, and the second and third coils was practically zero. The coupling between the first coil and the third was, however, by no

selectivity of the circuit must inevitably suffer if such direct transfer of energy from beginning to end of the set is possible, since the middle tuned circuit is completely useless. Secondly, if this coupling is in the correct direction, it will produce reaction from the back to front of the set, and the energy so regenerated will set up and maintain continuous oscillations throughout the amplifier.

It might be observed in passing that if the coupling is in the reverse direction, then exactly the opposite effect is obtained, and the amplifier is damped. If this is the case, then the sensitivity of the receiver as a whole will be very poor, because the amplification of each individual stage is immediately discounted by this reverse reaction coupling through the stray fields. Selectivity will be just as bad in such a case because this does not depend upon the direction of the coupling. From all points of view, therefore, it is desirable to reduce this stray coupling as far as possible.

Zero Coupling the Coils

It is well known that spacing the coils at the critical angle of approximately 57 degrees is alleged to produce zero coupling, irrespective of the distance of the coils apart. In this particular instance this was not found to be the case, and a little further investigation showed that, whatever position the coil was placed in, it was not possible to obtain a zero coupling arrangement. This has led to some definite research on the question of coupling

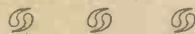
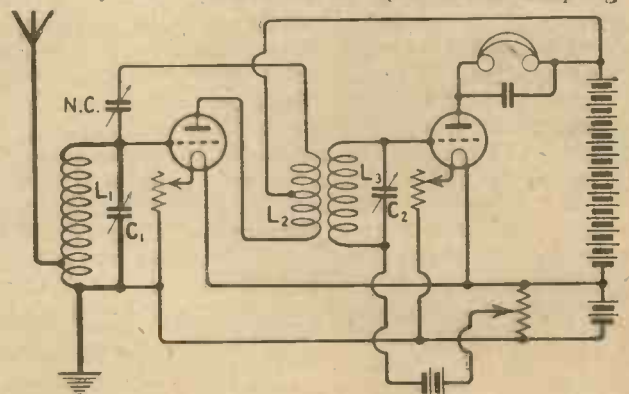

Fig. 2.—The design of the intervalve transformer is a vital factor in neutralisation in this type of circuit.



means zero. In fact, when the set was tuned to the local station, the middle coil of the receiver could be removed and the middle valve turned out, and excellent loud-speaker results were still obtained, the arrangement functioning simply as a loose-coupled circuit.

Reaction Effects

Obviously such an arrangement as this is totally undesirable. The

between coils, and I hope to publish some very interesting results shortly, showing that beyond a certain distance it is impossible to obtain a zero coupling position with the normal arrangement of coils as used in receivers.

A Remedy

In the particular case it was found that the coupling could be definitely reduced to a much smaller

CIRCUITS THAT WILL NOT NEUTRALISE

(Continued)

value by reversing the connections to the first coil. When this was done the transfer of energy from the first to third circuits with the second coil removed was very small, and, as was expected, the circuit then became perfectly stable. It should be observed that this was not equivalent to introducing damping into the circuit. If the reversal of the coil had simply reversed the direction of the reaction, then there would still have been a coupling from the first to the third circuit. It was found, however, that this was not the case, and, in fact, a lack of symmetry is introduced, due to the fact that both capacity and magnetic coupling are present. This point, however, will be dealt with at considerably greater length during a future article, the point being that it is particularly important to avoid stray couplings of any sort between the first and third circuits of a multi-valve amplifier.

Another Circuit

Another type of circuit which will often give trouble is that shown in Fig. 2. Here we have a transformer coupling after the high-frequency valve, the secondary of the transformer being tuned while the primary winding is centre-tapped. One half of the winding is included in the anode circuit of the first valve, and the other half is employed as a neutralising winding.

One would expect that this arrangement, being perfectly symmetrical, would give satisfactory results, but this is not always the case. The neutralising action in a case like this is not quite the same as that when the neutralising winding is definitely part of the tuned circuit. It is obvious that if the two sections of the primary winding were not coupled to each other no neutralising action would be obtained. In other words the action depends essentially upon the coupling existing between the two halves of the primary winding.

Importance of Tight Coupling

As a matter of fact it can be shown that, unless this coupling between the primary winding proper and the neutralising winding is very tight, then troubles are introduced. The ideal tight coupling is one in which all the possible magnetic

field from the one coil is interlinked with that from the second coil. If any portion of the flux does not affect the secondary winding, then it produces an effect similar to the introduction of a small inductance in series with the coil.

Fig. 3 shows a circuit in which a leaky transformer (that is to say, one in which the coupling is not perfectly tight) has been replaced by an ideal transformer and a small "leakage" inductance, as it is called, in series with the primary winding. It will immediately be obvious from an inspection of this circuit that we are here not obtain-

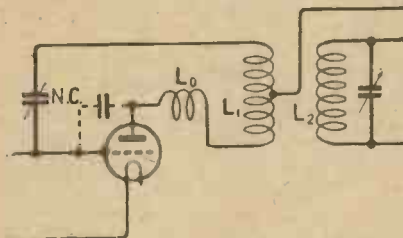

Fig. 3.—*Lo* is a "leakage" inductance in series with the transformer primary.

ing a correct balance, but we are balancing a pure capacity against a capacity and an inductance in series, and an adjustment which is correct in one part of the circuit will not be correct in another.

Effect of Small Primary

It is often found that if the primary winding of the split transformer (such as is shown in Fig. 2) is made small, possibly with the idea of improving the selectivity of the circuit, then the coupling between the two halves of the coil is too small, even if they are wound in one continuous length, and no satisfactory neutralisation can be obtained. The circuit will not even behave in a correct manner, it being impossible, if one of the valves is turned out, to balance out the signals by adjustment of the neutrodyne condenser. The trouble may be overcome by increasing the size of the primary, in which case the selectivity suffers.

A Curious Phenomenon

I have also come up against a peculiar phenomenon here which I have not yet explained to my own satisfaction. Some experiments were carried out with a transformer of this type employing two screened units for the grid coil of the first valve, and for the transformer between the first and second.

The secondary consisted of 90 turns on a 2-in. diameter former, while the primary consisted of 120

turns of No. 36 gauge wire, wound on a 1½-in. former inside the secondary. This primary winding was centre-tapped, one half being used in the anode circuit of the valve and the other half being employed for neutralising purposes.

Imperfect Neutralisation

I found that correct neutralisation could be obtained with this arrangement according to the usual tests with the valve out, and good and stable results could be obtained over part of the range. There was a portion in the middle, however, where a different oscillation took place, at about the same frequency as that being received, but not quite the same. It was not a parasitic oscillation, but showed quite clearly that there was some form of instability in the receiver. The trouble was overcome by reducing the size of the primary winding to 70 turns only, instead of the previous 120. This arrangement neutralised perfectly, but the energy transferred across the transformer was considerably reduced, and it was necessary to employ reaction on to the last valve, an adjustment that had not previously been necessary. A still further reduction of the primary winding resulted in the circuit becoming incapable of neutralisation, as has previously been described.

Further Research

If, however, as has been suggested, the trouble is really due to insufficient coupling between the

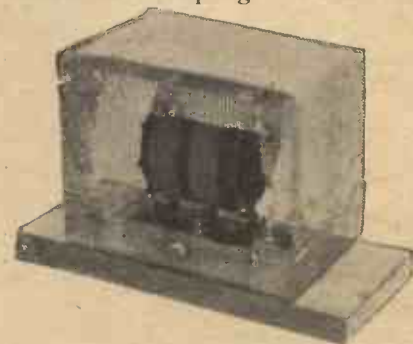

In some of his experiments Mr. Reyner tried enclosing the coils in perforated zinc screens.

two halves of the primary winding, then it would mean that better results might be obtained by winding these two halves one over the other. It would be possible to keep the capacity coupling between the two halves of the primary winding and the secondary quite small, and still retain the tight coupling between the two halves of the primary. Experiments on these lines are proceeding at the present time.

Getting the Best from the "Neutroflex Two"

By N. J. GIBSON.

Neutralising Adjustments—Valves—Tuning—Reception Results.



In last week's issue of *Wireless Weekly*, besides the theoretical and constructional details, a few notes on the operation of the "Neutroflex Two" receiver were published. It is thought, however, that a few further details on the operation of this receiver will be welcomed.

Neutralising the Receiver

The method of neutralising the receiver, by adjusting the neutralising condenser with the reaction condenser at its minimum position, until no oscillation occurred at any setting of the tuning condensers, was described last week. If, however, it should be found that with the neutralising condenser at its minimum no oscillation takes place, and that on increasing it reaction becomes evident, it does not necessarily mean that the set is not neutralising correctly, as, if the valve in use is of a sufficiently low capacity the minimum of the neutralising condenser, supplemented by stray capacities in the wiring, etc., of the set, may be sufficient to neutralise the H.F. valve.

In the same way this capacity may be sufficient to over-neutralise the valve in some cases, if very low capacity valves are employed, and thus cause oscillation. In this event it will be necessary to substitute a smaller neutralising condenser. If, however, the valves employed by the author are being used this will not be the case.

A Word of Warning

Owing to the design of the receiver giving great stability, it may be found that, if valves other and smaller than the .25-ampere small power type are used, reaction

may be difficult to obtain. In view of this, it is strongly advisable that the above type of valve should be employed, the detector valve in any case having a high impedance suitable for anode bend rectification.

Method of Searching

When the set is properly neutralised it is possible, without causing re-radiation, to search for stations

however, that once the set has been adjusted to a sensitive condition it will not be necessary to oscillate and heterodyne the carriers to tune in the majority of the stations, as by revolving the two tuning condensers simultaneously and at the same time keeping them in tune, the stations will come in without further adjustment of the reaction over practically the whole waveband.

It will probably be found advantageous with the above method of searching to use whilst searching larger coupling coils than are normally used, substituting smaller coils when the station is tuned in (and slightly readjusting the tuning condensers) if greater selectivity is required to cut out interference.

Results

Using the receiver on an aerial twelve miles north of 2LO it was possible practically to separate Cardiff and Manchester from London on the headphones, whilst Bournemouth, Newcastle, Birmingham, Aberdeen, and two or three foreign stations were audible on the loud-speaker. Nearly all the B.B.C. main stations, several of the relays, and numerous Continental stations could be received at good headphone strength.

ELSTREE TEST REPORT

The set was found easy to handle, complete stability being readily obtained. In operation the set behaved after the manner of a "straight" set, using H.F. detector and L.F. No sign of the howling common in some reflex receivers was present.

London, Bournemouth, Birmingham, and Nottingham were received on the loud-speaker, and also some Continental stations.

On the telephones all the B.B.C. main stations were picked up and numerous Continental stations.

with the detector valve oscillating, by obtaining the carrier on the detector grid tuning condenser, and bringing the high-frequency tuning condenser into tune until the carrier is heard at its loudest. The reaction can now be decreased until the detector valve ceases to oscillate and the actual signals become audible.

It may now be necessary to re-adjust the two tuning condensers to bring the signals up to their maximum strength. It will be found,

THE "MAGIC FIVE"

A New Set of Outstanding Merit

In the next issue of *Wireless Weekly* will be given a full description of a new 5-valve set, designed by Mr. J. H. Reyner. Features of this set are that it is compact, non-radiating, and highly selective; it has only three controls and no reaction adjustment, and it is comparatively inexpensive to construct.

Wireless News in Brief.



Hospital Broadcasting. In order that all the patients in St. George's Hospital, Hyde Park Corner, may take part in the religious services, a microphone has been installed in the chapel. This installation was used for the first time on St. George's Day, the patients in the wards listening by means of the ordinary receiver and headphones.

* * * *

Rugby Experiments. While staying at the Savoy Hotel, London, the wife of a distinguished American was enabled to converse with her children in New York, via the Rugby station. Conversation was carried on without any difficulty, perfectly clear speech being obtained.

* * *

Pictures by Wireles. Continuing the experiments in the transmission of pictures by wireless, as described in our last issue, Capt. R. H. Ranger recently transmitted to New York in twenty-five minutes a photograph of the captain of the *Mauretania*. This photograph, together with an explanation in Capt. Ranger's handwriting, also transmitted, was handed to the *Mauretania's* commander on her arrival in New York.

* * *

From the Programmes. Sunday, May 9.—London: Shakespeare's Heroines, by Mrs. Patrick Campbell; "Lady Macbeth."

Monday, May 10.—Glasgow: Beethoven's Piano-forte Sonatas.

Tuesday, May 11.—London: John Henry from an aeroplane. Birmingham: Musical Operetta, "Marriage by Lantern Light" (Offenbach).

Wednesday, May 12.—London: The Wireless Follies Concert Party. Edinburgh: The Embassy Orchestra. Nottingham: An evening of variety.

Thursday, May 13.—London: Wireless Symphony Orchestra. Bournemouth: A Sussex Evening. Belfast: Ascension Day music.

Saturday, May 15.—London: Brighton Competitive Musical Festival, relayed from Brighton. Newcastle: A brass band night. Aberdeen: The Aberdeen Radio Players in "Nettles," a rural Scots comedy.

Friday, May 14.—London: "The Valkyrie," relayed from Covent Garden. Jack Payne's Hotel Cecil dance band.

* * * *

Broadcast Opera. In addition to the operas already announced for broadcasting during the coming season, on June 1 Act 2 of "Othello" will be heard, and on June 4 Act 1 of "La Bohème."

* * *



A modern liner is very completely equipped for the transmission and reception of ordinary wireless telegrams, and often for the reception of broadcasting also.

International Broadcast. We hear that on the night of May 26/27, the broadcasting station (KOA) at Denver, Colorado, is to send out programmes intended for reception by the world. This transmission will be in connection with the Rotarian Convention, and we gather that the part of the programme specially arranged for this country and for Western Europe will take place between 4 and 5 a.m. The KOA station works on 322 metres with a power of 5 kw., and its transmissions have already been heard in England.

* * *

Bournemouth's Sussex Evening. Part of the special Sussex programme, which is to be given by the Bournemouth station on May 13 will be relayed from Worthing. The Bournemouth Wireless Orchestra, conducted by Capt. W. A. Featherstone, will also perform, and the evening's programme will be relayed to Daventry.

* * * *

John Henry to get a Rise. The broadcast which John Henry will give from an aeroplane between 10 and 10.30 p.m. on May 11 is in connection with the campaign in the London area for the Ground Defences and Auxiliary Air Force.

Non-Radiating Single-Valve Circuits

By the Staff of the Radio Press Laboratories.



Is it possible to design a single-valve circuit which will not radiate while retaining the full advantages of reaction? Some experiments in this direction carried out at our Laboratories throw light on this question, which is of universal interest.



HE Radio Press journals have for a considerable time been publishing details of multi-valve receivers in which the carriers from very weak transmissions can be heterodyned, thus enabling stations to be more easily picked up, and this without any trace of radiation from the aerial. These receivers have invariably involved the employment of one or more properly neutralised stages of high frequency before the detector valve. It is then possible to cause the detector or second stage of high-frequency to oscillate, without the oscillations produced being transferred to the aerial circuit.

A One-Way Coupling Device

This is owing to the fact that a properly neutralised valve will act as a one-way coupling device. In other words, high-frequency potentials impressed on the grid will produce amplified versions of these oscillations on the plate, whereas oscillations impressed on the plate will cause no corresponding variation of the grid potential. If it were not for the grid-to-plate capacity of the valve no neutralising would be required. As it is, however, this capacity couples the grid and plate circuit in the same way as any other capacity. It is therefore necessary to balance out the unwanted capacity, the process being known as neutralising.

This one-way action of the valve is entirely separate from its property of rectifying, and must not be confused therewith. A crystal will rectify, but cannot act as a one-

way coupler. In the same way a two-electrode valve, although it possesses the property of rectifying, cannot be used in the same way as a three-electrode valve to enable oscillations to pass in one direction and not in the other.

That non-radiating receivers using two or more valves can be successfully designed has been amply demonstrated by several Radio Press receivers.

The problem of incorporating this desirable feature in a single-valve set (with reaction) is more difficult, and this article indicates some possible lines for experiment.

At Least Two Valves Needed

It will thus be clear that, as far as present development is concerned, it is necessary to have two

aerial. One of these valves must be properly neutralised, thus acting as a one-way device, while the other must serve to introduce reaction, and if necessary to oscillate. A simple circuit of this nature is shown in Fig. 1, so that the action of the two valves may be clearly seen. In this circuit the oscillating current in the aerial coil L_1 will appear in an amplified form in the coil L_2 , whereas if the second valve oscillates the heavy oscillatory currents produced in L_2 will not be transferred back to L_1 .

The Single Valve

If we now transfer our attention to the single valve, it will be seen how difficult it is to make this valve oscillate without at the same time transferring energy to the aerial coil, which must in some way be coupled to the grid circuit. We are now called upon to combine the functions of the two valves V_1 and

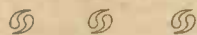
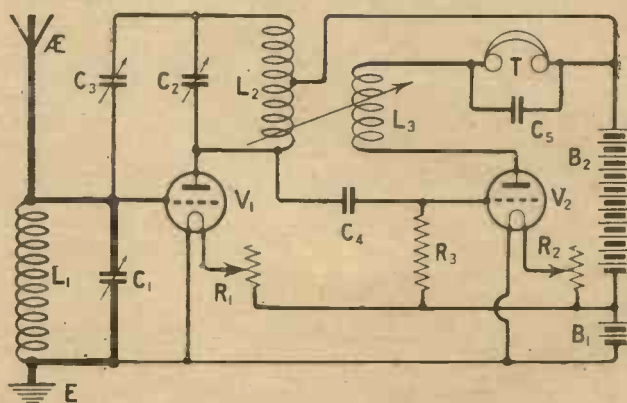

Fig. 1.—This type of neutralised two-valve circuit will not radiate when properly adjusted.



valves at least if it is to be possible to heterodyne a carrier without radiation being transferred to the

V_2 in the previous circuit. Clearly the valve is the only practicable non-return device to employ, so

Non-Radiating Single-Valve Circuits—continued

that we must in some way utilise this property of the valve.

Tropadyne and Super-autodyne

There are, it is true, circuits in which a detector valve can be made to oscillate and yet not radiate, but these are unsuitable for other reasons. The best known of these circuits are the Tropadyne and the Super-autodyne. In the first case

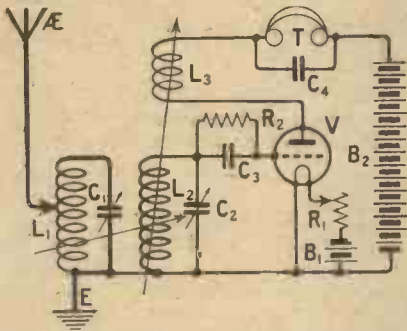

Fig. 2.—In spite of the fact that the reaction coil is not coupled direct to the aerial coil, radiation will be produced with this circuit.

a centre-tapped coil is employed, and if the exact electrical centre is obtained no appreciable energy is radiated when the circuit is oscillating. In the Super-autodyne circuit, which is really an improved form of the Tropadyne, two condensers are employed, so that the tapping point on the two neutralising condensers can be made to correspond with that of the coil. Thus as regards oscillations produced by the valve, these points are at the same potential, and no oscillating current gets into the aerial circuit.

Disadvantages

Both these circuits, however, suffer from a very serious disadvantage that, if the balance is properly obtained, no reaction effect can be produced. Their use is therefore limited to superheterodyne circuits, for which they were originally designed. For a non-radiating single-valver to be of any use, it is important that not only must it be always entirely non-radiating, but also that reaction must be almost if not quite as effective as in the usual detector.

The difficulty in the case of single-valve circuits really lies in the fact that in order to obtain reaction it is essential to have some

coupling, either magnetic or electrostatic, between the grid and anode circuits of the valve, and this must not be balanced out or neutralised as in the case of a high-frequency stage.

Use of a Loose-Coupled Aerial

Clearly, however, there is no need to make the grid circuit identical with the aerial circuit. Although it is essential to apply reaction to the grid coil, yet this reactive effect might conceivably be balanced out, so that no oscillating current produced by the valve could reach the aerial, and thus be radiated. The idea is thus suggested of employing a loose-coupled aerial circuit.

The importance of a separately-tuned, or at any rate semi-tuned, aerial circuit will be realised when it is remembered that in one tuned circuit of which the aerial forms part it is essential to reduce the resistance of the aerial by reaction in order to increase the signal strength. On the other hand, if we employ two tuned circuits before a detector, then it is quite sufficient to reduce the resistance of the second or grid circuit in order to obtain almost the full benefit from reaction.

Two Tuned Circuits

Fig. 2 shows a case in which two tuned circuits are employed before the detector, magnetic reaction being applied to the tuned grid circuit. It is not right, however, to suppose that this circuit does not radiate, for the coupling between the reaction and grid coils will cause a heavy oscillating current to pass in the grid coil, which will then be transferred by means of the magnetic coupling between the grid and aerial coil into the aerial circuit.

If we now introduce an extra reaction coil in series with that previously employed, and couple it in a negative sense to the aerial coil, then it is possible to arrange the coupling so that, although the grid circuit oscillates, yet none of this current should be transferred to the aerial, provided the second reaction coil is correctly adjusted. In practice it was not found possible to make this circuit entirely non-radiating, but at the same time a

considerable degree of success was obtained in this direction.

Interaction

A drawback in this circuit, which completely nullifies its use in practice, however, lies in the fact that the setting of the second reaction coil depends on that of the first, and also to some extent on that of the variable condenser.

The solution to the problem of the non-radiating single-valver does not therefore seem to lie along these lines, owing to the fact that not only is the adjustment, when found, extremely critical, but also it varies considerably as other constants of the circuit are changed.

Necessary Qualifications

The only really satisfactory method of making a single-valve detector non-radiating would take the form of a simple attachment, which, while not impairing the efficiency of the set for broadcast reception, would enable the receiver to oscillate violently without any of the oscillation reaching the aerial.



Test transmissions from the vessel conveying the Byrd Expedition to Spitzbergen via Norway may be heard on 40 metres. Other wavelengths are also used, the call-sign being KEGK.

An attachment which would not completely bar the passage of all radiation in the aerial circuit would be worse than useless, for it would encourage the amateur to oscillate violently with the expectation that no interference would be caused.

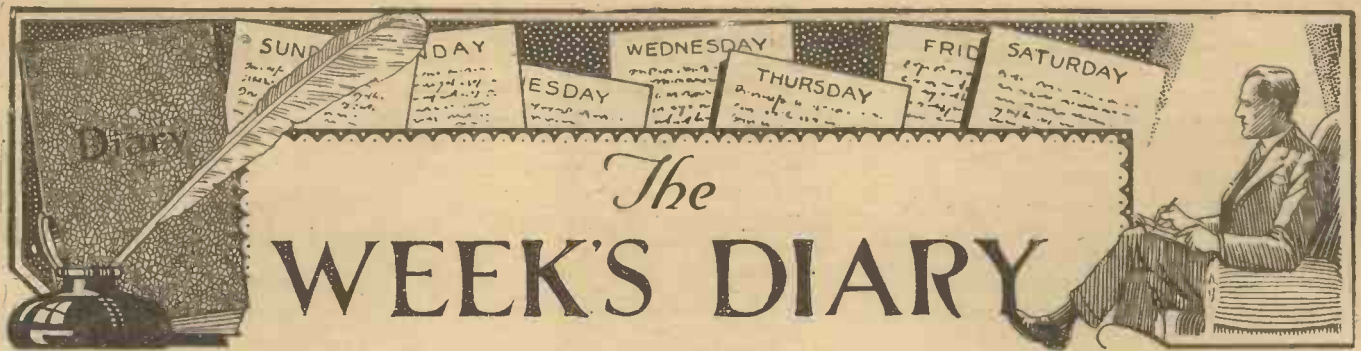

I AM sure warm welcome will be given to L. G. Mainland for his talks during what we may call the "Adults' Hour." Ordinarily Natural History talks of the conventional kind do not particularly interest me, but I could not help listening to every word of his talk last week on "Old Bill, the Walrus" and "The Strange Ways of Lobsters and Crabs." I do not wonder that the children are so fond of "Uncle Leslie," and he should not be any less popular with the grown-ups.

* * *

THE way of the wireless transgressor is steadily being made more and more hard. I see that proceedings have been taken out against 135 persons for installing wireless sets without a licence, and of this number 134 convictions were secured. These figures were given in answer to a question in the House of Commons recently. Many of the people prosecuted have been very surprised and have wondered how their activities could have been detected. The Post Office inspectors are becoming very clever in such work, and the special cars they have equipped as a result of over a year's experimenting have some remarkably ingenious pieces of apparatus in them.

* * *

THE Marconi Company is having considerable success with its latest equipment known as the "Orchestra Repeater," which can be fitted to any passenger steamer without in any way interfering with the ordinary wireless telegraph equipment used for communicating with other ships and with the land. The installation is the result of long experience with wireless microphones and other broadcasting equipment, and the detail design is largely the result of Capt. Round's experiments. The object of the "Orchestra Repeater" equipment is to enable a

band in, say, the first-class saloon to be distributed by loud-speakers to other parts of the ship. When the band is not playing, music can, if necessary, be provided by gramophone records. The New Zealand Steamship Company's *Remuera* is one of the latest vessels to be so fitted, and I am told that the equipment has met with an excellent reception among the passengers.

ECONOMY IN L.T. CONSUMPTION.

When valves of different filament ratings are employed together in a receiver, as for instance 2-volt and 6-volt valves, it is uneconomical to run the 2-volt valves in parallel with the 6-volt, with separate rheostats.

It is more satisfactory to connect the 2-volt valves in series, with a single rheostat to control them, leaving the 6-volt valves in parallel in the ordinary way.

The apparatus to which I have just referred is not, of course, really "wireless" equipment, but is simply the application to another purpose of the technique which has been developed in connection with broadcast transmission and reception. Similar apparatus was used last Saturday week for the *Daily Mail's* broadcast of the Cup Final teams. Microphones at the Stadium picked up the sounds of the cheers for the King and the singing of the National Anthem, and by means of the land telephone wires, the sounds were reproduced in Manchester to the immense crowd in Platt Field, Manchester, and the Wanderers' ground at Bolton. It is estimated that about 25,000 people at Manchester and a similar number at Bolton heard the enthusi-

astic cheers when Smith, carrying the cup, led his team out on to the field.

* * *

I SPOKE a few weeks ago of the thrills which would be given us by Transatlantic telephony, when at an early date the Post Office will be able to connect us by landlines to Rugby and thence by wireless to the United States. During some recent experiments between Riverhead (United States) and Rugby (England) the wife of a distinguished American staying at the Savoy Hotel, London, was permitted to speak by wireless telephony to her children in Park Avenue, New York. She had only to pick up the receiver of her telephone in the Savoy Hotel and chat to her children just as if they were speaking on the telephone from some other part of London. Even her small son, aged 7, was able to talk to her, and his first words were, "Hullo, Mummy; it is 11 o'clock here. What time is it with you?"

I am told by all who have been privileged to speak across the Atlantic in this way that the reproduction is exceedingly good; in fact, quite different from the results obtained when an American broadcasting station is reproduced through the B.B.C. stations here. It would be a good idea if the B.B.C. were to take an early opportunity of arranging with the Post Office to broadcast some interesting public function in the United States by means of the new system. At the present time experiments are being conducted every Sunday afternoon. Why could we not have a Sunday morning Church Service in America broadcast here during Sunday afternoon? The five hours' difference between the two countries would make this possible.

* * *

I HAVE just found that my old friend, Jack Binns, of CQD fame, is now Director of the Service Department of the

THE WEEK'S DIARY
(Continued)

Hazeltine Corporation, the owners of the Neutrodyne patents. Binns has had a varied career since the famous wreck of the "Republic," including a spell as war correspondent in South America and as a newspaper reporter in New York.

* * *

THE news comes that 2ZY has been heard in California. This does not surprise me, as the Editor of *Radio Broadcast* has just written to tell me that not only California but Colorado, North and South Dakota seem to be excellent receiving spots for English signals. This undoubtedly has some bearing on the theory put forward by Capt. Round and others that so long as the stations are far enough away, they will be heard quite well! I know this is not quite the theory, but it is a remarkable fact that sometimes when stations a few hundred miles away are inaudible, stations at

For example, I have heard a listener express the opinion that soprano songs "always come out badly." On many occasions it has been possible to prove that it was the apparatus and not the programmes that caused bad reproduction. Probably the only defect in the B.B.C. reproduction now noticeable on good apparatus is that of the drum and other percussion instruments. Incidentally, I am told that many hours of experiment have been devoted to finding some means of satisfactorily broadcasting the sound set up by the slamming of a door!

* * *

SPEAKING of sound effects, I do really wish the announcers would manage to avoid that irritating rustle of papers when they are reading their announcements and news bulletins. It is quite easy to do so if they will only try. One artist who manages to get a remarkably natural effect in his delivery, and who actually reads his contribution (although everyone imagines he delivers it without notes), has gone to a great deal of pains to

A FRIEND in New York has just sent me full particulars of the newly-opened Radio House, in New York, on which I commented in my last week's diary. The Editor tells me that he is publishing in another part of the Journal this week

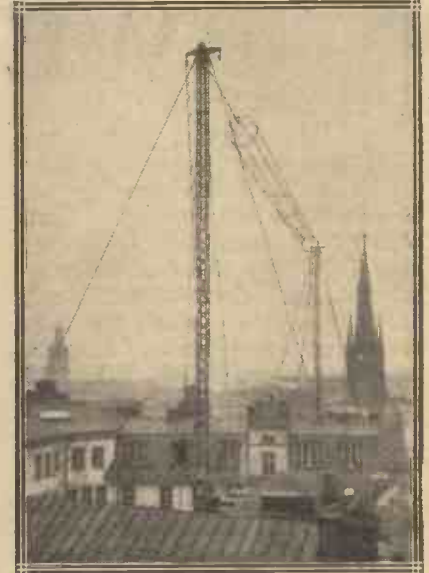

The broadcasting station at Stockholm, in Sweden, utilises a cage-type aerial. This station operates on a wavelength of 428 metres, usually between 7.30 and 11 p.m. or midnight.



☉ ☉ ☉

The leading-in point of the aerial and counterpoise at the new high-power Rosenhugel broadcasting station, near Vienna.

☉ ☉ ☉

a description of the House, so that I need not give you any descriptive details here. The Radio Corporation of America was responsible for the scheme, and my friend tells me that the Publishing Department had to work overtime and to spend no end of energy in getting the details perfected. Americans enter with extraordinary enthusiasm into stunts of this kind.

Dr. Alfred N. Goldsmith, Chief Broadcast Engineer of the Radio Corporation of America, welcomed the visitors to Radio House, and gave a most poetical talk to the assembly, bringing in references to Mark Twain's stories, *The Arabian Nights*, and so forth. Not knowing quite what to make of everything, the awestruck visitors were led into the kitchen, where a battery-operated receiver with aerial and earth connection connected to plugs in the wall provided entertainment in ample variety and volume for the workers in the kitchen. As the introductory speech was in such a poetical strain, I am surprised that nobody thought of suggesting that King Alfred's experiences with the cakes might be repeated by the cook in a slightly varied form.

double the distance come in excellently.

* * *

HAVE you noticed how many people blame the loud-speaker for faults which are really those of the set itself?

avoid broadcasting unnecessary sounds. His "story," instead of being typed on sheets of thin paper, is prepared on thick pieces of card, which are easy to handle and can be laid down silently page by page as they are finished with.

Why use Accumulators and Batteries?



The "Aero" Battery Eliminator

NO parts of a wireless receiver cause so much trouble and expense as do the accumulator and high tension dry battery.

Apart from the actual cost of recharging and constant renewals, who has not experienced the annoyance of finding that the batteries are exhausted, just when some specially interesting programme is due.

THE AERO BATTERY ELIMINATOR is connected to the nearest electric light (direct current), when it supplies the receiver with BOTH High and Low tension current and needs NO ATTENTION WHATSOEVER.

It is cheaper to run than other sources of supply; the cost being LESS than ONE PENNY for 3 hours.

DIRECT CURRENT MODEL
100-240 Volts.

No. R.B. 75/5 - £7 - 10 - 0

Brown Brothers Limited

— Allied Companies —
THOMSON AND BROWN BROTHERS LTD
BROWN BROTHERS (IRELAND) LTD
— WHOLESALE ONLY —
GREAT EASTERN STREET, LONDON, E.C.2
126, George St., EDINBURGH, and Branches.

Please order from your local Wireless Dealer:

Only the perfect Condenser passes the strenuous T.C.C. tests

YOUR fixed condenser is one of the most vital components in your set; yet you buy it on faith. For without an elaborate test you cannot tell whether it is functioning correctly.

Experts say that the majority of faults in home-built receivers are traceable to the use of inferior and badly insulated condensers. It is false economy to buy an unknown condenser, for although you save perhaps a few pence in the first place, it eventually becomes much more costly when breakdown occurs. Only by producing Condensers which give absolute satisfaction can T.C.C. hold their good name. When you buy a T.C.C. Condenser you know that you

have chosen a component that because of the strenuous and elaborate tests through which it has passed, can be indefinitely relied upon to be not only breakdown-proof but to have an almost negligible percentage of error. Look through the files of any of the technical Wireless papers and you'll find repeated testimony to the quality of the T.C.C.—its specification in circuit after circuit by experts who know.

Can you afford to overlook this Condenser—renowned for its accuracy and dependability—for one of doubtful origin and still more doubtful qualities? Do as the experts do—specify T.C.C.

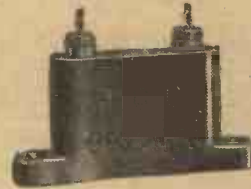

PRICES AND CAPACITIES

Mansbridge, 2 mfd. - 4/8	Mansbridge, '1 mfd. - 2/6
Mansbridge, 1 mfd. - 3/10	Mansbridge, '09 to '01 - 2/4
Mansbridge, '5 mfd. - 3/4	Mansbridge, '009 to '005 2/-
Mansbridge, '4 mfd. - 3/2	Mica, '004 to '001 - 2/4
Mansbridge, '25 mfd. - 3/-	Mica, '0009 to '0001 - 2/4



T.C.C. Condensers (Mica and Mansbridge)

Manufactured only by:
Telegraph Condenser Co., Ltd.,
Wales Farm Road, N. Acton, W.1

G.A. 5104.

ASTOUNDING REDUCTIONS IN

CLARKE'S "ATLAS"

TUNING COILS AND FIXED CONDENSERS

The House of "Atlas" beg to announce that owing to the enormous sales of Coils and Condensers and consequent reduction in Production costs, they are now able to offer these articles at the following prices:



ATLAS COILS
Patent
No. 215,053



FIXED CONDENSERS

Nos.	Retail Price ea.	Nos.	Retail Price ea.	Capacity.	Retail Price
25-50	2/6	500	7/6	.0001-.0005 Mfd.	1/6 each
65	3/-	600	9/6	.001-.002	1/9
75-150	3/6	750	10/6	.0125-.004	2/-
175-300	4/6	1000	12/6	.005-.007	2/6
400	5/6	1250	14/-	'01	3/6
		1500	15/6		

We are maintaining our Quality in every way, thus enabling us to still adopt our now World-wide Slogan:

"We make them good—good judges make them famous."

SOLE MANUFACTURERS—

H. CLARKE & CO. (MCR.) LTD.
Atlas Works, Old Trafford, Manchester.

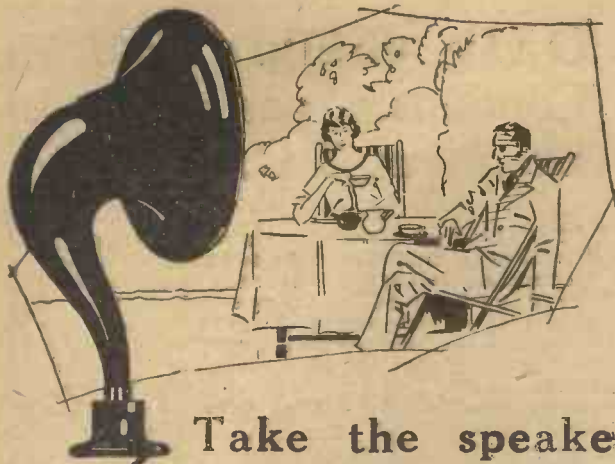

Take the speaker
into the garden
—leave the set
indoors

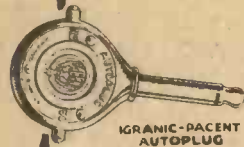

With the use of Igranic-Pacent Jacks and Plugs it is perfectly simple to have your loud-speaker and head-phones wherever you wish in the garden. No need to move the set about—thus securing maximum enjoyment with a minimum of trouble.

No need to worry about loss of signal strength through faulty connections—good contact is certain when Igranic-Pacent Jacks and Plugs are used.

Here we illustrate four of the range—write for the Booklet Y84, which describes them all, and see how easily they will solve your own particular problem.

All reputable dealers stock Igranic-Pacent Jacks and Plugs.



Exclusive Manufacturing Licensees
of Pacent Radio Essentials.

149, QUEEN VICTORIA ST.,
LONDON.

Works: BEDFORD.



Branches:

BIRMINGHAM BRISTOL CARDIFF GLASGOW
LEEDS MANCHESTER NEWCASTLE

Better Results —at less cost!

—by using
“MELLOWTONE”
COUPLERS



The “MELLOWTONE” Coupler replaces coils and holders at half the cost and gives far better results. It eliminates distortion, gives excellent selectivity and perfectly smooth reaction control. Is neat, finely finished, and takes up small panel space.

Obtainable from all reputable dealers. Write for Catalogue.

BUILT
TO
LAST.

PRICES
FROM
5/6



LONDON
DEPOT:
Triumph House,

BRETTELL LANE WORKS
STOURBRIDGE
Radio-Ads.

189, Regent St., W.1

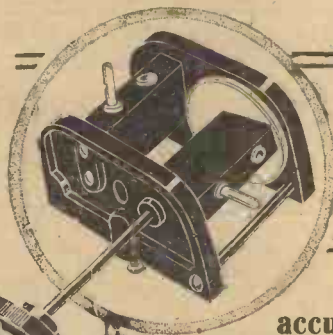

TWO TYPES:
For outside panel
mounting:
Two-way .. 7/-
Three-way .. 10/6
For inside baseboard
mounting, with 6 in.
handle:
Two-way .. 8/-
Three-way .. 12/6

Tuning is
accurate because the
moving block cannot fall.

Holds the heaviest coil securely in position and prevents the fading away of volume. The vernier movement consists of three sets of enclosed precision machine cut gears and reduces the speed of the moving coil block by eight times.

From all Radio Dealers:

LOTUS
VERNIER
COIL HOLDERS

Garnett, Whiteley & Co., Ltd.,
Lotus Works, Broadgreen Road,
LIVERPOOL.

Makers of the new Lotus Buoyancy
Valve Holder.

Bakelite
mouldings
for the side
plates, coil
blocks and
knobs;
also
heavy nickel
plating
for the
metal parts.

CIRCUITS FOR THE EXPERIMENTER

No. 12—A FRAME AERIAL CIRCUIT FOR THE LOCAL STATION

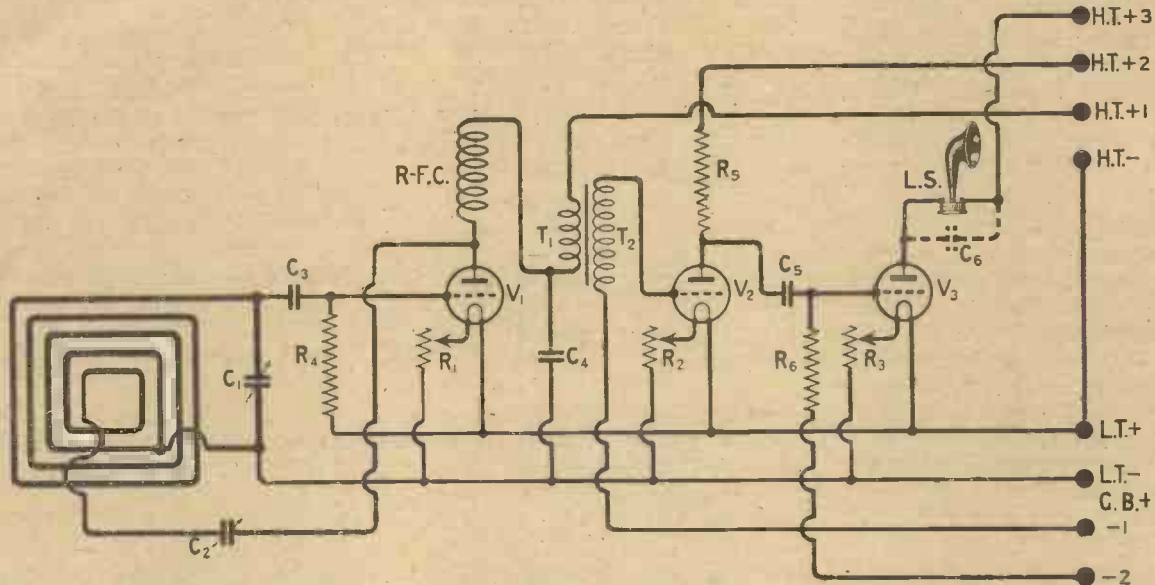

BY quite a number of experimenters the frame aerial is probably regarded as an instrument to be used only with sensitive circuits, such as superheterodynes or receivers with several stages of high-frequency amplification. It is quite true that this state of affairs is for long-distance work generally true, if we leave out of consideration special circuits, as, for instance, the "Armstrong" types or similar circuits, which make use of special reaction arrangements. As a matter of fact, it is quite possible to get good results on a frame aerial with a "straight" circuit, as long as the transmitting station to be received is within a reasonable short distance of the receiver. Experiments in this direction under various local conditions should prove of particular interest.

Advantages of a Frame

The frame aerial has certain undoubted advantages over the ordinary outdoor aerial, especially in crowded areas, where the erection of an outdoor aerial is difficult, if not impossible. Under such circumstances the frame may even be the only possible solution to the aerial problem. Again, the directional properties of a frame are too well known to need recapitulation here, but a further point which may appeal to a good many people is that such things as earthing

switches for the aerial can be dispensed with altogether. The fear of damage from lightning is a natural instinct with many people, and even with proper switching arrangements they often do not feel altogether happy when thunder-

CIRCUIT No. 12 SPECIAL FEATURES

1. No tuning coils required.
2. Reaction provided on the frame aerial.
3. Smooth reaction control.
4. Quality of reproduction.

storms are about. The frame does away with all this.

A Simple Circuit

The circuit of the type shown above should meet the needs of anyone residing within about ten miles of a main station, who requires loud-speaker results. With only two of the valves in use it should be possible at this range to obtain moderate loud-speaker signals, the addition of the second stage of amplification being available if required for greater volume. It should be understood, of course, that loud-speaker strength will not necessarily be attained with this cir-

cuit, even quite close to the transmitting station, if the immediate surroundings of the receiver offer bad screening. It is well known that in, for instance, buildings with a framework of steel girders it is not infrequently found that signals of only weak telephone strength can be picked up even on sensitive receivers at a distance of a mile or two from a main station. This is a matter which must be determined by experiment.

Reaction

Coming now to the details of the circuit given, it will be seen that the "Reinartz" type of reaction is provided. The use of the grid condenser and leak method of rectification by the detector valve V1 introduces a certain amount of damping into its grid circuit, and in order to compensate for this it is advisable to provide reaction. The customary method of providing reaction with a frame aerial, of using coils separate from the frame itself in order to secure the necessary coupling, has the disadvantage that a certain number of additional components are required. In this circuit the only coil needed, apart from the frame, is the radio-frequency choke coil in the anode circuit of the valve V1.

A Tapped Frame Aerial

In order to secure this advantage the frame aerial itself is tapped as indicated in the diagram, the larger

CIRCUITS FOR THE EXPERIMENTER

(Continued)

portion of the winding serving as the grid-tuning inductance and the remainder for reaction. The condenser C_1 tunes the grid circuit, while C_2 gives the necessary smooth control of reaction needed with a receiver in which the main tuning will be sharp.

Size of Frame

For the lower broadcast range of wavelengths the frame, which may have 2-ft. sides, should be wound with about twelve turns of wire, with half-inch spacing between the turns. The solenoid form of winding is indicated here, rather more turns being required if a flat spiral winding is employed. These twelve turns are included in the grid circuit of the detector valve, a further two turns being added for the reaction winding.

Variable Condensers

The two variable condensers, C_1 and C_2 , may be of .0003 capacity. Larger values than this are not to be recommended, since the reaction control will be rendered easier by

the use of a reasonably low-capacity value for C_2 , while the tuning of C_1 may be expected to be quite sharp. A vernier or slow-motion device may be of assistance in conjunction with this latter condenser. The aim should be to keep the parallel tuning capacity as small as possible, the number of turns on the frame being adjusted to suit the local station.

Hand-Capacity

One trouble that may be experienced with the circuit as shown is the presence of hand-capacity effects. If this offers a serious difficulty in operation, the following modification of the circuit will often set matters right.

The reaction winding of the frame aerial should be disconnected at the tapping point, the reaction condenser C_2 being placed in circuit between the tapping point on the frame and the inner end of the reaction winding. The tapping point, which is connected to L.T. negative, should then be earthed, the remaining connections being left as before. This will have the effect of placing the batteries at earth potential, and it will usually be found that hand-capacity effects

are much reduced, if not altogether eliminated. Some effect may be noticed when the hand approaches the frame itself, but this can be remedied by fitting an extension arm for the purpose of rotating the frame.

Low-Frequency Amplification

The two stages of low-frequency amplification call for no particular comment, these as shown consisting of the conventional methods of transformer and resistance-capacity coupling.

The inclusion of the by-pass condenser C_1 may be found to effect an improvement, this being a matter for experiment.

Valves

The detector valve V_1 should preferably be of the high-impedance type with a high-amplification ratio, such as the D.E.8 H.F., D.F.A.4 or D.E.5b. For V_2 a valve of the D.E.5b or D.F.A.4 type should be found suitable, while V_3 may be of the D.E.5, B4 or D.F.A.1 class.

Suitable values for the components in the last stage of amplification are 100,000 ohms for R_5 , 0.1 microfarad for C_5 , and .25 megohm for R_6 .



THE COLVERN SELECTOR. LOW LOSS
Reading to 1/3,600th capacity

Capacity—
•0005 mfd. - £1 1 0
•0003 mfd. - £1 0 0

TYPE F., without gear attachment.

Capacity—
•0005 mfd. - 15 0
•0003 mfd. - 14 0
One hole fixing.

Other capacities if required. Descriptive Folder upon request.

COLVERN INDEPENDENT VERNIER Price 2/6
Ask your dealer also for the Colvern Low Loss Coil Former Price 6/-

enables calibration and relocation to a high degree of accuracy!

COLLINSON PRECISION SCREW CO., LTD.,
Provost Works, Macdonald Road, Walthamstow, London, E.17
Telephone: Walthamstow 532

THE COLVERN LOW LOSS SELECTOR
(Geared 20-1.)

Calibration with certainty to the 1/3,600th part of the variable capacity. This is the tuning efficiency obtained with the Colvern Selector. The complete circle of the dial is divided to provide a value of 100 degrees for every rotation of the index. Pre-arranging your condenser and inductance to cover 300 metres, the degree interval represents 3 metres — obviously every station can be calibrated definitely.

The Colvern is logically the only condenser worthy of the attention of serious experimenters. An insulated spindle reduces the effect of hand capacity to a minimum, a point of paramount importance in the reception of distant signals.

See the Colvern at your dealer's!

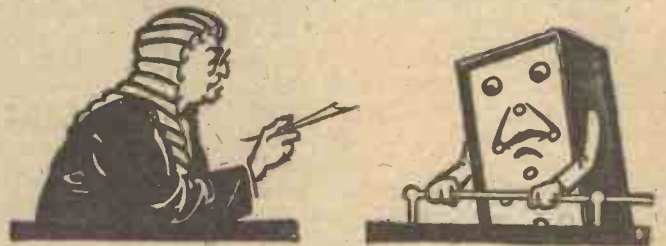

AN OLD OFFENDER

The Dry H.T. Battery is incorrigible. It is forever making itself a nuisance. That is why it must be sentenced to life banishment and its post given to the Westam H.T. Accumulator. The peace will then be kept: your concerts will not be disturbed by so much as a whisper of noise.

The Westam H.T. Accumulator is sold at the extraordinarily low price of 6d. a volt. It gives perfect reproduction with an absolutely silent background, can be recharged at any charging station and is so constructed that self discharge and creeping is impossible. The container (made of imitation crocodile leather) is acid proof and rot proof. Plates are interchangeable. Spare parts at proportionate prices. Obtainable in any voltage from Radio Stores or, in case of difficulty, direct from makers.

2 amperes model as illustrated 60 volts 30/-, also 90 volts £2 5s. 120 volts £3. Carriage 2/- extra.

WESTAM ACCUMULATOR COMPANY,
335, Katherine Road, London, E.7.

Telephone: Grangewood 1745.



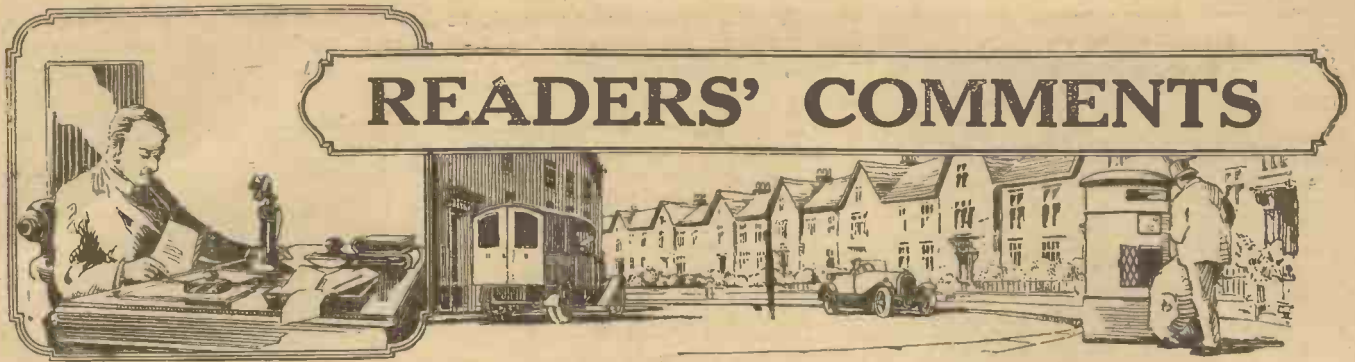

READERS' COMMENTS

Reception of WGY

SIR,—In the issue of *Wireless Weekly* for March 10, on page 136, there is a reference to reception of short-wave transmissions from WGY. It happens that last February I got the General Electric Company to carry out some tests on the short waves with a view to putting across a special programme intended for Germany. It was in the course of these tests that the wavelength was shifted from the 40-metre region to 35 metres. Also, transmissions were carried out in this

send in more extended form the information which you have at hand as to the signals from Schenectady. I am particularly anxious to have the exact dates and times of reception, with indications as to quality, fading, and "intelligibility." What is of particular value is to learn at what times the "intelligibility" was best, and about what percentage of words could be certainly understood. Quite a bit of German speech was put out in the course of the tests last February. Was any of this heard?

any reports which you may be able to communicate, I am,—Yours faithfully,
S. McCLATCHIE.
Cleveland, Ohio, U.S.A.

SIR,—I do not suppose very many of your readers realise how amazingly simple it is to receive WGY at good loud-speaker strength at this time of the year. Of his many simultaneous transmissions, that on 9,375 Kc. (32 metres) is probably the strongest, and has the additional merit of being almost entirely free of interference. I am surprised that the B.B.C. do not give us more of WGY, for the quality of his transmission is excellent, and on three valves he sounds very much like 2LO (eight miles distant) does on two!

I am also experimenting on WGY with a superheterodyne, and would like to compare my experiences with those of your readers.—Yours faithfully,

Sydenham. J. R. HALLIWELL.

L.F. Transformer Design

SIR,—We have observed on the back pages of one of your journals a statement by a transformer manufacturer which we believe to be incorrect. It certainly is incorrect when it says that "all radio experts agree," etc.

In our opinion the impedance of any particular valve is an almost constant factor, and since the impedance of the transformer necessarily varies over an enormous range as the notes vary over the musical scale, it is almost an absurdity to talk of transformer impedance suiting or matching the valve impedance.

We venture to suggest to you that statements of that character made in advertisements should be submitted to an independent expert before you allow the publication of them in a manner which we, for example, think is calculated to mislead your readers.—Yours faithfully,

FERRANTI, LTD.

Hollinwood, Lancs.

[Messrs. Ferranti raise an interesting point in their letter. The amplification of a transformer-coupled stage depends upon two factors. There is, first, the amplification of the valve itself, which is dependent to a large extent upon the impedance of the external anode circuit, in this case the primary winding of the transformer.

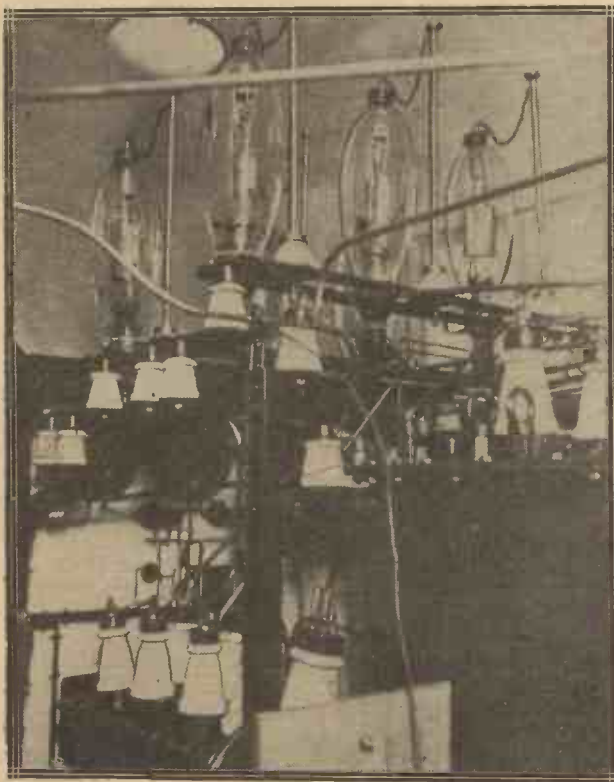

Six Telefunken rectifying valves are used at the new Rosenhugel broadcasting station, near Vienna. This station is transmitting at present on a wavelength of 582.5 metres, with an input of about 28 kw.



connection between 2 and 3 p.m. (Eastern standard time), which was quite out of the ordinary. I take it that some of these transmissions were heard by your staff or your readers. We had a number of reports from Germany, all of which were most unfavourable.

Now, it would be greatly appreciated if you would be so very kind as to

Any general information as to the quality of American short-wave signals during the past season would be much appreciated. All such information is of much value, and any which you can send will be passed on to other interested parties. I am in contact with KDKA and with Bellevue, Washington.

With many thanks in advance for

GRAVES

SUPREME VALUE WIRELESS OFFER.

A highly efficient 1-Valve Set, built up entirely of components of undoubted quality and unchallengeable merit, offered at a Keen cut Price, on Easy and straightforward Terms.

SPECIFICATION:

- Solid Oak Cabinet Polished Jacobean Finish.
- 'Utility' Low Loss Condenser (Square Law).
- Two-way 'Aermonic' Coil-holder, Low Loss.
- Igranite Rheostat and 2 Igranite Coils.
- 'Cosmos' Valve (Metro-Vic) S.P.18 D.E. 2-volt.
- General Radio Headphones.
- 60 volt. H.T. Battery.
- Exide 2-volt Accumulator.
- Ebonite Panel, Post Office Grade A.
- Solid Ebonite valve-holder. £6:0:0

With complete Aerial Outfit, & Accessories.

Each instrument incorporates the Marconi Patents in respect of which we pay a Royalty fee of 12/6 on every set that is produced

8!
NOW

TERMS: 8/- now & balance in 14 monthly payments of 8/- if you are entirely satisfied. Money refunded if disappointed.

CATALOGUE of Valve & Crystal Sets, &c., Post Free. Keenest Prices.

J. C. Graves Ltd. Sheffield.

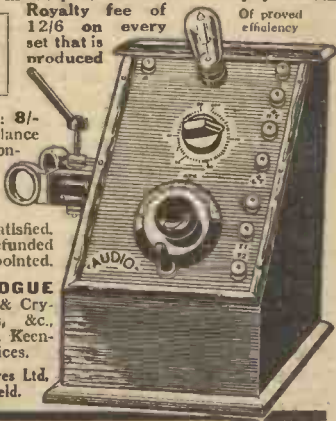

Secondly, there is the step-up ratio of the transformer.

Now, if the impedance of the primary winding is made equal to that of the valve, then the amplification obtained is 0.7 times the theoretical voltage amplification factor of the particular valve. As the impedance of the primary winding is increased, so the amplification of the valve gradually becomes nearer and nearer to the theoretical value. If the transformer impedance is made three times that of the valve, then the actual amplification is nearly 0.95 times the theoretical amplification factor. Obviously, therefore, very little is gained by making the primary impedance any more than about three times that of the valve.

Turning now to the consideration of the second factor, the step-up ratio, the secondary winding on a transformer is limited, not by considerations of ratio, but by the self-capacity of the windings. There is a limit where further increase in the number of turns ceases to increase the step-up ratio to any appreciable extent, owing to the counteraction of the self-capacity. Improved methods of winding enable the number of turns on the secondary to be increased, but, nevertheless, the limit is present.

Obviously, therefore, if the secondary turns are fixed and the primary turns are varied, the step-up ratio must vary. A transformer having a high primary impedance will of necessity have a low step-up ratio, while conversely a correctly designed transformer with a low primary impedance would have a high step-up ratio.

The application of these principles to a valve is as follows:—Following a high impedance valve, the transformer primary must be of high impedance, and consequently the step-up ratio is low. Following the next valve, however, which is usually made of low impedance, the primary impedance of the transformer need only be about three times that of the valve. The secondary, however, remains the same, so that the step-up ratio of the transformer is considerably increased. If a high impedance primary was used in the second stage, then the step-up ratio of the transformer would have to suffer.

While, therefore, Messrs. Ferranti are quite correct in stating that it is unnecessary to match the primary impedance with that of the valve, it is desirable to use different ratios for different stages, a low ratio for the first stage and higher ratios for succeeding stages. Messrs. Ferranti raise an important point in drawing attention to the fact that impedance depends essentially upon frequency, and for perfect quality the impedance of the transformer should be high at very low frequencies. With such an arrangement, however, there is grave danger of producing resonance points in the transformer, occurring actually in the audible range, so that the design of a transformer is very largely a matter of compromise.—Ed.]

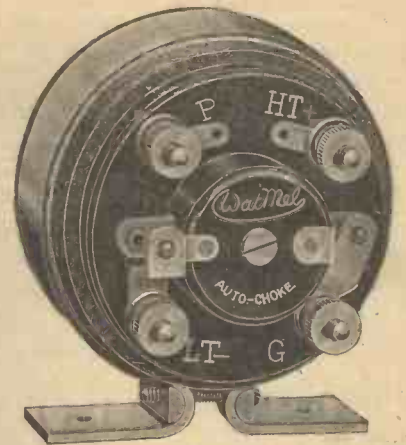

"...we might be in the studio—"

will be no uncommon remark now the Watmel Auto-Choke has come into being. Never before has there been such an amplifying instrument. Though building up whispers into voluminous sound, never does it sacrifice tone for volume. The secret lies in the patent core and specially balanced windings. Ask your Dealer for a demonstration and send to us for descriptive booklet—'Straight as a die.'

Complete with Condenser and fixed resistance. Bright parts heavily nickelled. Price **18/6**



THE WATMEL WIRELESS CO., LTD.
332a, Goswell Road - London, E.C.1
Telephone: 7900 CLERKENWELL.
Lancashire & Cheshire Representative:
Mr. J. B. LEVÉE, 23, Bartley St., Levenshulme, Manchester
Telephone: 475 Heaton Moor

All Post Free At Callers Prices

S.O.S. BATTERY TESTER



3-Bead Type Only tells immediately 3/6 if full or empty.



The Reliability Mark.

COIL FORMER.



46 Spoke Type with instructions Only 1/3

Square Law Var. Condenser.	British Wires.	Ebonite Panels.
With Knob and Dial	swg. dec. dec.	Matt. 1" 3/16"
.001 Panel type 6/8	18 1/11 3/5	8" x 6" 2/2 1/10
.005 .. 5/2	20 2/2 4/2	12" x 5" 4/6 3/8
.003 .. 4/6	24 2/6 4/7	12" x 12" 5/9 8/1
Vernier Blade extra 1/4	26 2/11 5/1	12" x 8" 5/6 4/9
Dublier, McMichael, 2/4	30 3/4 5/9	15" x 12" 7/8 5/8
Edison-Bell, Lissen, 30	3/9 6/8	4" x 4" 6d. 6d.
Mullard (usual prices), 32	4/10 7/8	7" x 5" 1/8 1/2
New Mansbridge, 36	5/5 3/9	8" x 8" 1/4 10d.
2 mid. 3/6. 1 mid. 2/6	8/- 12/-	Any size cut.
	40 17/- 20/-	So. in. 1", 1 1/4", 1 1/2"

Coil Holders.

- Reliability Vernier 3/6
- "Lotus" 2-way 7/-
- "Newey" 2-way 6/-
- "L. & P." 2-way 8/6
- "Polar" 2-way
- Cam vernier. 6/-
- "Goldtone" Vernier 7/-
- Back of Panel 8/-
- Aerial Wire 7/22"
- Enam. Bright 4 strd. 100ft., 3/3, 2/3. 1/1
- do. Electron. 1/8
- Shell Insulators, 3d.
- Lead-in Tube 9in. 1/-

Transformers L.F.

- Radio Int. 25/- 27/6
- Igranite 21/- and 20/-
- Eureka, No. 2 21/-
- "C'neert Gr'nd 25/-
- "Baby Grand 15/-
- Ferranti A.F.4 17/6
- A.F.3 25/-
- H.T.C. (Empire) 7/6
- "Formo" Sh'ded 10/-
- McMichael H.F. 10/-
- "Dimic" Coil 10/-

Valve Holders.

- Type A 7d. Polar 1/3
- Screwed 8 nuts 6d
- Ebonite .. 10d.
- Antiphonic .. 1/6
- Security Type 1/-
- Sullivan's 120-ohm
- Phones, ex-Govt. 4/6

Special Values.

- Wates Microstata 2/9
- R. I. Detector .. 6/-
- Liberty Detector 3/6
- Lissenolt Ualt 13/6
- Antiphon Valve-holder .. 1/8
- H.T. Batteries.
- With Wander Plugs 60v. 11/-, 60v. 7/6
- 36v. 4/8, 15v. 1/10
- 41v. P.L.B't't'ry, 4d.
- 60v. Ev'r-r'dy 12/6
- 36v. 7/-, 16v., 3/6
- Siemen's same price.
- Lissen 67v., 11/6

RELIABILITY WIRELESS GUIDE, No. 2.

Free on request.

J. H. TAYLOR & Co.
5 RADIO HOUSE,
MACAULAY ST., HUDDERSFIELD
7th 541 Grams THOROUGH HUDDERSFIELD

Subscription Rates

MODERN WIRELESS

- 15/- per annum United Kingdom.
- 13/6 per annum Canada and Newfoundland.
- 15/- per annum Other Countries.

THE WIRELESS CONSTRUCTOR

- 8/6 per annum United Kingdom.
- 7/6 per annum Canada and Newfoundland.
- 8/6 per annum Other Countries.

WIRELESS WEEKLY

- 17/4 per annum United Kingdom.
- 17/4 per annum Canada and Newfoundland.
- 19/6 per annum Other Countries.

WIRELESS

- 13/- per annum United Kingdom.
- 13/- per annum Canada and Newfoundland.
- 13/- per annum Other Countries.

Lesser periods than 12 months pro rata.

RADIO PRESS LIMITED,
Bush House, Strand, London, W.C.2

PRACTICAL TOPICS

By G. P. KENDALL, B.Sc.

H.T. Accumulator Troubles—Sludge Deposit—Stiff or Free-running Condenser Bearings?



WEEK or so ago I met a man who proceeded to grumble bitterly about his accumulator, saying what a rotten bad battery it was-- wouldn't hold its charge a fortnight, and always ran down before it should.

An Unusual Type

Now, the battery in question was a somewhat unusual one, the containers being glass boxes sealed across the top with pitch, while the plates also were out of the ordinary. As it happened, I had used one of these batteries myself with every satisfaction for over two years, and I knew that whatever its drawbacks failure to hold its charge was *not* one of them. As a matter of fact, it was particularly good in that respect, so that I told him I thought there must be something wrong in his treatment of it.

Not Inside

I was eventually shown the battery, and certainly the plates looked in perfect health, there was little or no sludge, the acid was up to the correct level and gave a satisfactory hydrometer reading. All the same, the cause of the trouble was quite obvious, because the same thing had happened to me and I knew what to look for.

Where it Was

The pitch tops of the cells were slightly sunk so that any moisture and dirt which might collect thereon remained in a layer which constantly thickened. Each time the accumulator was charged a trace of acid was emitted from the vents in the form of spray, so keeping the deposit moist, and the net result was a leakage path of comparatively low resistance between the terminals.

A Good Rule

The trouble is one which it is well to be on one's guard against, and it is a very safe rule to keep the inside of an accumulator well

charged and the outside thoroughly clean, especially round the terminals.

An H.T. Grumble

Troubles with accumulators remind me of a very sore point of mine: why on earth do some manufacturers of H.T. accumulators provide only a most microscopic space at the bottom of each cell to allow for the deposition of sludge?

It may be argued that an accumulator does not throw down a deposit when properly looked after, but it

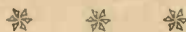

While well-designed bearings are important in variable condensers, skill in manipulation counts for a great deal.

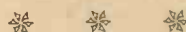

must be admitted that it usually *does* under everyday, as distinct from ideal, conditions. And just imagine what a job it will be when it becomes necessary to wash the sludge out of sixty separate cells!

A Point in Condenser Design

Do you like your variable condensers to run freely or stiffly? A matter of taste, no doubt, but it has always seemed to me that the ideal is a condenser running freely and smoothly as though fitted with ball-bearings; of course, without sloppiness or backlash.

A Personal View

I expect the condenser makers would like us to prefer the stiffly-moving type, which is probably easier and cheaper to produce, but my personal feeling about it is that

the extra few shillings would not be grudged if I knew that by paying them I could be sure of the motion wanted.

A Free-Running Point

Apart from the necessity of a high standard of workmanship in the bearings, a very free-running condenser presents special problems of its own. The obvious one concerns its method and position of mounting, involved herein being another of the factors which put up its cost.

If the condenser is mounted on a vertical panel the moving vanes will obviously tend to fall from certain settings, and a counter-weight must therefore be fitted. Now, a counter-weight involves an arm to carry it, and space for that arm to turn, and so up goes the bulk of the condenser.

Is it Worth It?

Almost inevitably, then, a very free-running condenser is one of greater cost, weight and bulk, and



some of my readers may doubt whether it is worth while to incur all this; much depends, I think, on the degree of manual dexterity possessed by the operator.

If he is capable of the delicate manipulation of fine controls (and most people can become so with practice) he will appreciate and reap the benefit of such a condenser as I have described.

When it is Felt

Given such capabilities on the part of the operator, a condenser responding to a light touch may make all the difference when it comes to tuning-in a really weak station. If the operator is heavy-handed, however, he will probably be actually worse off with a free condenser than with a stiff one.

New Radio Press Envelopes

WE have much pleasure in announcing the issue of two new Radio Press Envelopes, each dealing with the construction and operation of a set of outstanding merit.

The "Super Seven"

Superheterodyne receivers are becoming increasingly popular, so that the home constructor will welcome the appearance of the "Super Seven," which is fully described in Envelope No. 12. This receiver has been designed and the comprehensive instructions for building it are written by Mr. Percy W. Harris, M.I.R.E.

The "Super Seven" is highly selective, works on a frame aerial, and it possesses the great advantage of extreme simplicity of tuning. Included in the Envelope, the price of which is 5s., are full-size blue-prints of the layout of the wiring and of the panel, while eleven photographs, reproduced on special art paper, give a clear impression of the appearance of the finished receiver, as well as being of considerable assistance in the constructional work.

The "Three-Valve Dual"

The "Three-Valve Dual" Receiver, which is described in Envelope No. 13, was designed by Mr. John Scott-Taggart, F.Inst.P., A.M.I.E.E. The economy in valves effected by the use of the reflex system makes an appeal to a large number of constructors. The "Three-Valve Dual" is an econo-

LOUD-SPEAKING ON SHORT WAVES

(Continued from page 362)

One mahoganite panel, 16 in. by 8 in. by 3/16 in. (American Hard Rubber Co.).

One supersonic filter transformer

Two fixed resistors, type "DE," with sockets (A. J. Stevens, Ltd.).

One .001 fixed condenser (A. J. Stevens, Ltd.).

One 3 : 1 L.F. transformer (U.S. Radio Co.).

Five Lotus non-microphonic valve-holders (Garnett, Whiteley & Co.).

One 7-terminal strip (Burne-Jones & Co.).

One .001 fixed condenser (Watmel Wireless Co.).

One .5 megohm grid-leak (Dubilier Condenser Co.).

Six lacquered brass terminals.

Bolts, wood screws, etc., and a quantity of square tinned copper wire or "Glazite" for wiring up.

Radio Press panel transfers.

Construction

Very little need be said regarding the actual construction of the set, since the lay-out of the components is very clearly visible in the photographs, and the wiring is perfectly straightforward. It should be mentioned, however, that the first components to be wired should be the grid-leak and condenser, the valve-holder connections coming next.

Further notes on the best H.T. values, etc., and the method of operating the set will appear in next week's issue of *Wireless Weekly*.

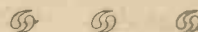
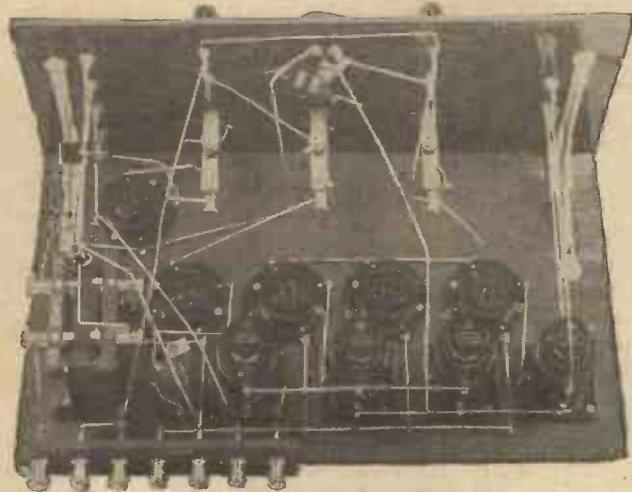

The arrangement of the wiring will be clear from this photograph.



and three supersonic intermediate transformers (L. McMichael, Ltd.).

One 300-ohm potentiometer (L. McMichael, Ltd.).

Three 30-ohm rheostats (C.A.V.).

One .0003 fixed condenser, with clips for grid-leak (H. Bowyer & Co.).

mical receiver, which employs a reflex circuit of proven utility, and the home constructor can embark on the construction of this receiver with complete confidence in his ultimate success.

Results Obtainable

Loud-speaker reception is possible with this receiver from the B.B.C. stations and from many Continental stations. Every possible constructional detail is fully explained, and the Envelope, of which the price is 2s. 6d., includes two full-size blue-prints and four sheets of clearly reproduced photographs. The instructions and illustrations combine to render perfectly straightforward the building of a receiver which should give the constructor every satisfaction.

Readers are asked to note that the prices of these Envelopes post free are 5s. 4½d. for Envelope No. 12, and 2s. 9d. for Envelope No. 13.

Amateur Transmitting Notes

QRA's Wanted

G-2BOW, PI-CD8, GI-5GH, R-DE2, D-7WA, IAXX, DCN, EAC9, E4, 2JD, KWS, LFG, PE-6XC, WBR, K-4ZM.

QSL Cards Held

We have cards for the following:—

From India to: G-2CC, G-6CM, G-2QM, G-6EP, D-7PK, U-1AI, SMUV, Y-1AF, F-8FU, F-8RST.

From Austria to: B-08, PCLL, N-oRP, OCNG, GBM.

"MODERN WIRELESS"

MAY ISSUE.

NOW ON SALE. PRICE 1/-

APPARATUS WE HAVE TESTED



Conducted by the Radio Press Laboratories, Elstree.

Plug-In Coils

Messrs. The Penton Engineering Co. have sent us a number of their plug-in coils for test and report.

The coils, which are fitted with plug and socket mounting, employ a special form of winding which is built up on an insulated former. The whole coil is covered by a strip of celluloid, and is fixed to the socket by a strong thread binding.

The three coils were numbered 35, 50 and 75, and their values are approximately the same as those of other makes of coils with the same numbers, although the value of the No. 35 coil appears to be somewhat on the low side. Their high-frequency resistances were found to be satisfactorily low and the coils gave a satisfactory performance in a set, both for aerial and H.F. purposes. They were not, however, found to be a particu-

A Gridleak

Messrs. Metro-Vick Supplies, Ltd., have sent us one of their 2-megohm gridleaks for test and report.

This is of the conventional pattern with a metal cap at each end to enable the component to be mounted between spring clips. Its resistance is clearly marked, the rated value being 2 megohms. When placed on test the actual resistance was found to be 1.8 megohms, which is near enough to the rated value for all practical purposes.

When used in a set it was found to be satisfactorily silent in operation, and we can recommend this gridleak for use.

A Multi-Ratio L.F. Transformer

We have received from Messrs. Radio Instruments, Ltd., one of their multi-ratio L.F. transformers for test and report.



The coils submitted for test by Messrs. The Penton Engineering Co. are of the standard plug-in type.



larly good fit in various sockets in which they were tried, being somewhat on the tight side.

A number of diamond weave coils without mountings were also submitted for test, and these were found to have satisfactory high-frequency resistances, while their inductances were of suitable values to enable them to be used on the broadcast wavelengths.

This instrument is of the shrouded type, and is finished in an attractive blue colour. A strip of insulating material carries six terminals at the top of the instrument, each of which is plainly marked. Instructions are given for the connections to be followed in order to obtain given ratios, of which there are seven. The lowest ratio obtainable is 1 to 1 and highest

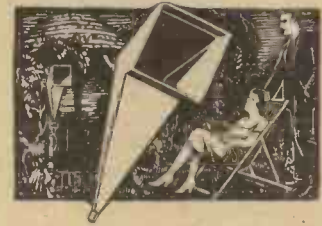

Build your own loud speaker for the summer.

Summer Time! To be spent in the garden basking in the sun—your diversion the invisible entertainer, radio. It is a thing to look forward to, this restfulness and to the full power and melow music of the "Lissenola." And the cost?—negligible; for your finished loud speaker works out at less than 15/- (the "Lissenola" is 13/6, and with it we give you full-size diagrams and clear instructions how to build a proved horn for a few pence! You could not have a better loud speaker whatever price you paid.

If you prefer it you can easily convert the "Lissenola" to carry a cone or any other diaphragm working on the reed principle by attaching the Lissen Reed (1/- extra). In addition, if you possess a gramophone you have only to substitute the Lissenola for the sound-box to convert it at once into a radio loud speaker.



Ask your dealer to show you the

LISSENOLA
LISSEN LIMITED,
30-32, Friars Lane,
Richmond, Surrey.

Managing Director: Thomas N. Cole

Everyone recommends

Trelleborgs
GUARANTEED
GENUINE EBONITE

"120,000 Volts per m.m.
No surface leakage."

—N.P.L. Test Report.

Stocked by
High Class Dealers

All Trade Enquiries to:—

TRELLEBORGS EBONITE WORKS,
LIMITED,
AUDREY HOUSE, ELY PLACE,
E.C.1.

"The Allwoodorn"



No metal strips
or dust collecting
ribs. Improvement
in tone, detail
and volume guar-
anteed.

Send for list of other
models.

Manufacturer and
Patentee—

H. MADDISON
2a, RONALD'S RD.,
Holloway Road, Near
Highbury Station, N.5

Hours : 9 till 6.30. Sat.
2 o'clock.

**APPARATUS WE HAVE
TESTED**

(Continued)

9 to 1. The transformer is guar-
anteed for one year by the makers. This
transformer was placed on our stan-
dard test panel and was tried out as a
first stage inter-valve transformer.
The ratios recommended for first stage
were tried out, and with a D.E.5b
valve as the detector. The best results
were obtained with the connections
which are recommended for first stage
only. The actual ratio is 3 to 1, and
the amplification obtained was in every
way up to standard, while the quality
of both speech and music was very
good indeed. With a ratio of 4½ to 1
the amplification obtained was some-
what above normal, but the quality,
although very good, was somewhat
higher in pitch.



The Multi-Ratio R.I. Transformer is
fitted with six terminals on an insu-
lating mount.

When tested in the second stage with
a D.E.5 type of valve the best results
were obtained with the 4½ to 1 ratio,
and not only did this give an increased
amplification as compared with the
standard, but the quality was in every
way highly satisfactory, giving natural
tones of both music and voice. With
the 6 to 1 ratio the amplification was
somewhat less, whilst the tone of
music was inclined to be somewhat
thin; the 9 to 1 ratio was found to be
somewhat better as regards quality,
although a slight drop in amplification
was still observed.

The insulation between primary and
secondary windings was found to be
infinity, and although slight variations
in quality of reproduction were
observed with the different connections,
it was in all cases of a very satisfac-
tory order. The instrument is well
finished and robustly constructed, and
can be thoroughly recommended for all
purposes, since the most suitable ratio
can be chosen for use in the particular
circuit being employed.

Wireless Weekly Small Advertisements.

BARGAIN—Fada latest model long-short five
B valve neutrodyne receiver—complete with
valves—conditions as new—perfect reproduc-
tion—gets almost anything—£30, no offers.
Edwards, 111, Leaside Crescent, Golders
Green. Speedwell 3395.

PATENTS, Trade Marks, Inventions,
Advice, Handbook and Consultations
free. B. T. King, Regd., Patent Agent,
146a, Queen Victoria St., London, E.C.4.

TELEPHONE RECEIVERS and Loud
Speakers Rewound, 2,000 ohms, 3/6.
—A. Roberts & Co., 42, Bedford Hill,
Balham, S.W.12.

•06 DE'S 10/6

Our Valves are admitted to be the best
British made valves on the market. 3 Volt
•06 L.P. or H.F. only 10/6. 2 Volt •34 only
10/6. Power Valves from 12/6. Write at once for
our FREE BOOK and get full particulars. If
your dealer is "tied" we supply
direct. **RADIONS LTD.** Radion
Works, BOLLINGTON,
Macclesfield, England.

TRITRON VALVES. Why pay 14/- for Dull
Emitter Valves when
you can obtain the famous **Tritron Dull Emitter**
Valve, 2 volt, 2 amp., 5/6, 3-4 volt. •06 amp., 6/6.
Power Valve, 10/6 post free.

WHAT OUR CUSTOMERS THINK.—R. S. E., East-
bourne, writes: "The best Dull Emitter I have
tried. I enclose P.O. for another."

SATISFACTION guaranteed or money refunded. By post
from H. E. NICHOLLS, 29-30, Trinity Sq., Tower Hill, E.C.3.

LUSTROLOX

ECONOMY VALVES FOR PORTABLE SETS.
2v. •06 H.F. L.P. and 234 P.V.
LOUD SPEAKER RESULTS FOR •46 AMP.
THE BETTER BRITISH VALVE
Obtainable from Lewis's Ltd., Liverpool and
Manchester, and
Lustrolux Ltd., West Bollington,
Nr. Macclesfield.

LITTLE WIRELESS GADGETS

MAP

Small Parts to the Trade.

MAP Co. 248, Great Western St. Birmingham.

C.O.D.

Any Wireless Goods advertised
in the "Wireless Weekly" can
be obtained by return of post
on C.O.D. from—
YOUNG'S (GLASGOW), LTD.
40, STOCKWELL ST., GLASGOW.

All communications regarding
advertising in "Wireless Weekly,"
should be addressed to:—

Advertisement Manager,
"WIRELESS WEEKLY,"
Bush House,
Strand, London, W.C.2.

The POLYTECHNIC
309, REGENT STREET, W.1.
ELECTRICAL ENGINEERING
DEPARTMENT.

(Wireless and High Frequency Section.)

A special course of Six Lectures on

The Thermionic Valve

and its

Uses in Wireless Circuits

by

W. H. DATE, B.Sc., A.M.I.E.E.

on Wednesdays, commencing

May 12th, 1926, from 6.30 to 8.30 p.m.

The lectures will be fully illustrated by
demonstrations (including transmission)
and lantern slides.

FEE FOR THE COURSE 7/6

Particulars and syllabus from the
Director of Education.

EASY PAYMENTS.

We supply by
easy
payments

Any make of accessories
Any make of sets
Any make of components

10% down.

Balance spread over one year.

Carriage Free.

No References.

Send list of requirements.

London Radio Supply Co., 11, Oat Lane,
London, E.C.2. 'Phone: City 1917.



Is Your . . .
Problem Here?

Neutralising with an H.F. Transformer

"I am contemplating constructing an H.F. and detector set, the H.F. stage being neutralised by the Cowper method. I have a number of H.F. transformers to hand and should esteem your opinion as to whether these would be suitable for the set?"

Certain types of H.F. transformers function satisfactorily as neutralising units in Cowper-type circuits, whilst others prove practically useless. Barrel-type H.F. transformers are to be preferred in which the coupling between primary and secondary windings is somewhat looser than is usual in mushroom types. It is generally found best to employ the larger winding, that is, the secondary winding, as the anode coil, whilst the primary

forms the neutralising winding. The correct connections for this latter may easily be determined by experiment, since if the set fails to neutralise properly with one set of connections, the leads to the "primary" or neutralising coil can be reversed.

Trouble with a Reinartz Receiver

"I have a 3-valve loose-coupled Reinartz type receiver, somewhat on the lines of that described by Mr. Underdown in the April, 1926, issue of MODERN WIRELESS, the only difference being that I have not arranged to load the grid and plate coils with ordinary plug-in coils, but merely to use the home-made coil described. The set worked excellently until returned from a friend's house, where it was tried. Now, however, I can hear no signals, but

only a humming noise, which, when the reaction condenser is adjusted to a setting which would normally make the receiver oscillate, results in a howl. If I touch either of the grid condenser clips, when the set is thus adjusted, shrieks are obtained. Can you tell me where the fault is likely to be located?"

From the symptoms given it is almost certain that the trouble is due to a break in the aerial coil which should therefore be tested with telephones and a dry cell for continuity. A humming noise such as you mention usually denotes that there is a break in the aerial or a grid coil, and the search for the faults should always be directed to these quarters. The fault can often be found by inspection, the most likely point for it being where a tapping is brought out from the coil. Therefore, examine these points carefully, moving each tapping with a pair of tweezers, when any break should be easily detected.

Long Loud-Speaker Leads

"I have a Transatlantic 5-valve receiver and wish to wire my house so that the set will run three loud-speakers simultaneously in different rooms, if required. The house is large and rambling, and this will mean that leads up to 70 feet in length will be required. I should like your opinion as to the best method of wiring to adopt, and whether twin flex or separate leads should be employed. There

THE CHOICE OF RADIO EXPERTS

AMERICA'S BEST SUPERHETERODYNE KIT.



331



271

Complete Kit of 4 Transformers — ONE Tuned, Type 331; THREE interstage, Type 271. Price £4 10s. Original — Shielded — Noiseless — Guaranteed Laboratory matched, in sealed carton. Sold separately at 22/6d. each. Recommended Blue Print 1/6d.

All GR Parts are guaranteed and may be seen at our London Stockists.

HAMLEYS LTD.
200, Regent St., W.1.

Remit direct if your dealer cannot supply, and ask for Complete Catalogue, free and post free: obtainable from:—

Sole Concessionaires for Great Britain:—
CLAUDE LYONS Est. 1918.
Radio Specialist. 76, Old Hall St., LIVERPOOL
Phone: Central 4641. 'Grams: "Minmetken, L'pool."

GENERAL RADIO CO.
OF AMERICA

"Money saved is Money earned—
So when your 'VALVES' get old or burned
Send them to us—and we, to you,
Will send them back 'MADE GOOD AS NEW.'"



Restored to function with original characteristics.
EFFICIENCY MAINTAINED, RESULTS GUARANTEED!
B.E. 4/6, D.E. 2V. 3 7/6,
D.E. '06 9/6.

Price List for Power Valves on application.
We return the actual Valve you send us, post free, within 7 days.

THE NORTH LONDON VALVE CO., LTD.,
22½, CAZENOVE ROAD - STOKE NEWINGTON, N.16.
Liberal Discount to Wireless Agents.



Two in One!

Ask your Dealer or send direct

**3/9 PEERLESS 3/9
DUAL RHEOSTAT**

The new Dual Rheostat—a "Peerless" product in every way. Specially designed to meet the demand for a resistance equally applicable to bright or dull emitters. It has two windings—one offering a resistance of 6 ohms, whilst a continuation of this is of 30 ohms resistance. The resistance element is wound on a hard fibre strip under great tension. One-hole fixing is provided and the terminals are placed in convenient positions. The contact arm has a smooth, silky action, and all metal parts are nickel-plated.

THE BEDFORD ELECTRICAL & RADIO CO., LTD.,
22, Campbell Road, Bedford.

Is Your Problem Here?—Continued

is A.C. lighting and power supply in the house. The three loud-speakers will not always be in use at any one time?"

The problem of employing three loud-speakers, in separate rooms, separated by appreciable distances, is not such an easy one as appears at first sight, and special precautions have to be taken if satisfactory results are to be obtained. The use of long leads sometimes tends to make the set unstable, giving rise to howling, whilst reproduction may be slightly muffled. It is advisable that some system be adopted so that the plate current for the last valve of the set does not have to traverse the long leads to the loud-speakers, and here we have the alternative choice of employing either a filter circuit arrangement or an output transformer. In your case we think a filter circuit, such as that indicated in Fig. 1, is to be preferred. The choke coil Z may be of the types such as are normally employed for choke-coupled note magnifiers, whilst the two condensers C may be of 2 microfarads each. By using two condensers instead of the usual one, the likelihood of H.T. leakage is minimised.

Where very long leads have to be employed, as in your case, it is usually preferable to use separate leads and not twirl flex to the loud-speakers, since the capacity between leads may be sufficiently large to introduce slight muffling. The presence, however, in your house of alternating current lighting and power mains precludes separate leads to the loud-speakers, since there is a tendency for such leads to pick up, by induction, the hum from the alternating current, which may completely drown signals, or at the best make the background far from pleasant. This difficulty can be overcome by employing twin lead-covered

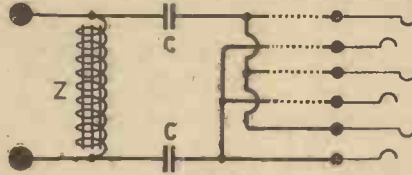

Fig. 1.—This filter circuit is specially useful when long leads to loud-speakers are needed.

cable, of which the outer metallic sheathing should be earthed at convenient points. Care should be taken in choosing the "runs" for the various leads, and some experiment may be necessary before the best way of taking them is found. If, through the employment of the wire mentioned above, muffling is introduced, this may be corrected by experimenting with

the values of one or both of the condensers C, these being decreased in capacity, as found necessary. For convenience we would suggest that open circuit jacks be employed, so that any loud-speaker can be inserted or withdrawn from circuit as desired.

Single-Valve Selectivity

"What is the simplest and cheapest way of increasing the selectivity of my single-valve reaction receiver? I use series tuning at present?"

The cheapest method, yet one which is thoroughly effective, of increasing the selectivity of your single-valve receiver is to adopt the so-called "semi-periodic" aerial coupling arrangement. You should wind, to the diameter of your present aerial coil, a coil of No. 24 gauge or similar size wire, of 15 to 20 turns. This coil should be tied to the present aerial coil and the aerial should be taken to one of its ends, whilst the other end should be joined to the earth terminal of the set and to earth. The connections to your aerial tuning condenser will have to be altered so that this is connected in parallel instead of in series with your original aerial coil. No alteration in coil size will have to be made here, since series tuning was originally used.

The coil indicated is suitable only for the higher broadcasting frequencies, and for Daventry and Radio-Paris a coil of 60 to 70 turns should be wound.

GOOD NEWS FOR CRYSTAL AND VALVE USERS!

Complete Amplifier
Price
38/-
Post free.



3 to 10 fold AMPLIFICATION WITHOUT VALVES. DIRECT FROM THE PHONE TERMINALS OF ANY CRYSTAL OR VALVE SET

BY THE NEW NON-VALVE MAGNETIC MICROPHONE BAR AMPLIFIER

(Patent No. 248581/25).

REALLY GOOD LOUD-SPEAKER RESULTS from CRYSTAL RECEPTION of average strength. WEAK CRYSTAL or VALVE RECEPTION made STRONG AND CLEAR.

Enables even very deaf persons to hear from crystal sets. Not a Microphone Button. Entirely free from distortion and microphonic noises. No valves, accumulators or H.T. batteries. No fragile parts. Nothing to get out of order. A child can adjust it. Operates on one or two Dry Cells lasting over 3 months.

EQUALLY EFFICIENT ON VALVE SETS.

MICROPHONE BAR and other PARTS of Amplifier also supplied separately. Fully Illustrated Lists Free.

Order from your dealer or from Sole Manufacturers and Patentees:

NEW WILSON ELECTRICAL MANUFACTURING CO., LTD.,
Phone: Museum 2703. 18, Fitzroy Street, Euston Road, London, W.1.

Radio Press Information Dept.

2/6 QUERY COUPON 2/6

WIRELESS WEEKLY, Vol. 8, No. 12, May 5, 1926.

This coupon must be accompanied by a postal order of 2/6 for each question, and a stamped addressed envelope.

Special Features:

- The N.A.R.M.A.T. and the S.R.M.
- Should the B.B.C. Interfere in Trade Matters? In Last Column The B.B.C. is Investigated.
- Do We Need Large Coils? By J. A. WILSON, F.R.S.M.I.E.E., and G. G. WILSON, F.R.S.M.I.E.E.
- The Glasgow Wireless Exhibition
- The Silent Salesman
- Radio Trade in Sweden
- By G. G. WILSON, F.R.S.M.I.E.E., and J. A. WILSON, F.R.S.M.I.E.E.

The Wireless Industry's Directory

Subscription Rates - - 7/6 per annum (10/- Abroad)

Available to the Trade only.

Business Card or Letter Heading must accompany remittance.
THE WIRELESS DEALER, Bush House, Strand, London, W.C.2

Now build for Power!

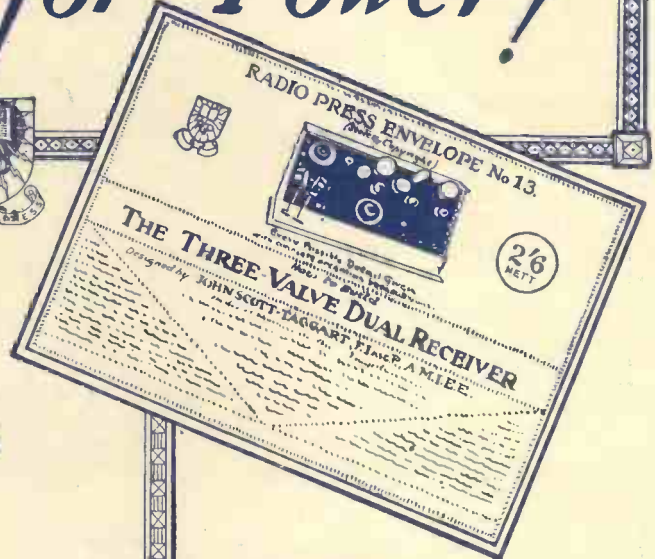

"The Super Seven"

By
PERCY W. HARRIS, M.I.R.F.

This set has to its credit the reception of 28 British and Continental Stations at full Loud-speaker Strength in one evening. With it you are able to completely eliminate the local station even at close range.

Having only two tuning dials, once preliminary adjustments have been made, manipulation of these two knobs and the occasional rotation of the frame aerial is all that is necessary to tune in station after station.

Price **5/-** Nett

Complete constructional details and full instructions for operation are included in this envelope, together with full-size Blue Prints of wiring and panel layout, etc.

Many thousands of home constructors take their initial step into wireless with the aid of an R.P. Envelope. The information given is found by them to be precise, complete and concise. Little wonder that they now define Radio Press Envelopes the easiest method of building a more comprehensive receiver.

The two new R.P. Envelopes illustrated here contain every detail and every piece of helpful advice which may be necessary for the successful construction of the powerful receivers described.

The Three-Valve Dual Receiver

Designed by
JOHN SCOTT-TAGGART, F.Inst.P., A.M.I.E.E.

This handsome and economical Three-Valve Receiver will give Loud-speaker results from B.B.C. and Continental Stations, and is sufficiently sensitive to receive American Broadcasting when conditions are favourable. It employs what is known as the reflex principle, in which one of the valves performs two functions, and in this way three valves are made to do the work of four.

Easily constructed, the only tools required are a hand-drill, a few twist drills, a screwdriver, a scribe, a 12 in. rule, a soldering iron, a steel centre punch and a pair of pliers.

Price **2/6** Nett

Complete constructional details and full instructions for operation are included in this envelope, together with two full-sized Blue Prints and four sheets of photographs.

RADIO PRESS LTD., Bush House, Strand, London, W.C.2

Too economical even to glow



THE wonderful "N" filament valves are so economical that no sign of glow can be discerned. They require only ONE-TENTH AMPERE from a 4-volt accumulator (or 3 dry cells). This means SEVEN TIMES THE LIFE of each accumulator charge; a distinct saving of your time and money.

ASK FOR THE P.M.3 . . . 16/6

The general purpose Valve, suitable for every circuit. Gives clear strong signals free from microphonic disturbance.

ASK FOR THE P.M.4 . . . 22/6

A power valve for majestic Loud Speaker volume. The finest Loud Speaker Valve ever produced.

GET THEM FROM YOUR RADIO DEALER



For a 2 volt accumulator ask for the P.M.2. Price - 18/6

Mullard
THE · MASTER · VALVE

ADVT., THE MULLARD WIRELESS SERVICE CO., LTD., BALHAM, LONDON, S.W.12

Published by RADIO PRESS, LTD., Bush House, Strand, London, W.C.2, on Wednesday of each week, and printed for them by THE AVENUE PRESS (L. Upcott Gill & Son, Ltd.), 55-57, Drury Lane, W.C.2. Address for Subscriptions and Editorial Communications:—Bush House, Strand, London, W.C.2. Address for Advertisements:—ADVERTISING MANAGER, "Wireless Weekly," Bush House, Strand, London, W.C.2. Registered as a newspaper and for transmission by Canadian Magazine Post. Subscription rates:—U.K., Canada and Newfoundland, 17/4 per annum; other countries, 19/6 per annum. Sole Agents for Australasia:—GORDON & GOTCH (Australasia), LTD. For Canada:—IMPERIAL NEWS, LTD. For South Africa:—CENTRAL NEWS AGENCY, LTD.