

Wireless Weekly

Vol. 4, No. 18
Sept. 3, 1924

CONTENTS

	Page
Editorial	566
Loose Coupled Circuits and Their Uses	567
Jottings By the Way	570
The High-Tension Battery	572
The Telephone Transformer	574
Random Technicalities	575
How Every Crystal User May Become a Valve Expert	576
Valve Notes	579
Filament Control	580
The "All-Britain" Circuit on the Omni Receiver	581
Handy Fixed Condensers	583
A Resistance Coupled Three-Valve Receiver	584
Practical Back-of-Panel Wiring Chart	590
Correspondence	591
Apparatus We Have Tested	595
Information Department	597

Editor: JOHN SCOTT-TAGGART, F.Inst.P., A.M.I.E.E.
Assistant Editors: P. W. HARRIS.
E. KEDPATH.

Radio Press, Ltd.

Publishers of Authoritative Wireless Literature.
DEVEREUX COURT, STRAND, W.C.2.

Tel.—Central 3763.

Advertisement Managers: BARCLAYS ADVERTISING LTD.,
Sentinel House, Southampton Row,
W.C.1. Tel.—Museum 7560.

Staff Editors:
E. H. CHAPMAN, M.A., D.Sc.
A. D. COWPER, M.Sc.
G. P. KENDALL, B.Sc.
R. W. HALLOWS, M.A.
S. G. RABTEE, Member I.R.E.

Scientific Advisor:
Prof. G. W. O. HOWE,
D.Sc., M.I.E.E.

Advisory Editors:
Prof. R. WHIDDINGTON,
M.A., D.Sc.

Prof. C. L. FORTESCUE,
M.A., M.I.E.E.

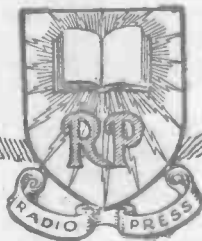

All correspondence relating to contributions is to be addressed to the Editor of "Wireless Weekly."

Nothing contained herein is to be regarded as permission or encouragement to infringe any patent rights.

Editorial

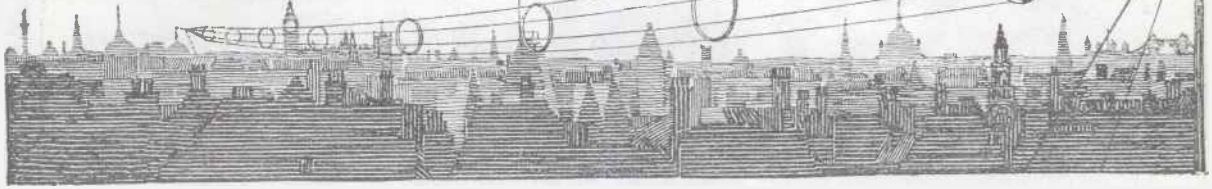

The N.A.R.M. Wireless Exhibition

Preliminary notices have been issued regarding a Wireless Exhibition which will be held by the National Association of Radio Manufacturers in the Royal Albert Hall, London. Readers will naturally wonder why this Exhibition is being organised by a section of the trade, and not in such a way as to benefit the industry as a whole. A few remarks, therefore, on this important subject would seem to be appropriate.

The National Association of Radio Manufacturers is an association which contains a very appreciable number of the leading manufacturers of wireless apparatus in this country, but the Association has not attained such a membership as to be able to claim to represent the whole wireless industry. There are a number of large firms still outside this Association, and there are a very large number of small component firms producing excellent products which have not thought fit, or have not been permitted, to join this Manufacturers' Association. A prominent trade journal has 10 per cent. of its advertisements occupied by members of this Association, and 90 per cent. of the pages represent the announcements of firms outside the organisation.

It will be remembered that the first principal wireless exhibition in this country was organised by independent enterprise, and, while limited to all-British wireless manufacturers, permission was not withheld from any manufacturer from showing his goods. Last year's Exhibition was also an all-British one, but this time there were two equal sections, one section being devoted to members of the National Association of Radio Manufacturers, and the other, equally large, which represented firms outside the trade organisation mentioned. This arrangement proved very satisfactory, and a very large number of British manufacturers were represented. This year, however, the N.A.R.M. have taken complete control of the matter themselves and are organising the Exhibition exclusively for themselves, not permitting any other manufacturers

of similar goods to show their products. At the same time, the N.A.R.M. forbids its members to take part in any other central exhibition. The position that exists, therefore, is that the N.A.R.M., while not possessing a sufficiently large membership to produce a truly representative exhibition, nevertheless, is sufficiently powerful to prevent anyone from organising an exhibition which could be said to represent the whole British wireless industry.

The motive for this action, of course, is not very far to seek; the effect of the N.A.R.M. attitude is to force members of the industry to join the Association for the sake of being able to exhibit their products at a big London Exhibition.

This subtle pressure is, of course, perfectly justifiable from the point of view of the N.A.R.M. They desire to increase their membership, and wish to make manufacturers feel that they are missing something by not joining. Whether measures which *directly* affect the public will be sympathetically received by them is very doubtful.

If we felt that joining the N.A.R.M. meant a serious overthrow of principles and set up a position which would adversely affect the wireless public, we would hold extremely strong views on these coercive measures.

It is for the N.A.R.M. to adopt a policy which in no wise could be compared to that of a trust, and which would lead to confidence rather than anxiety in the industry. In the past the N.A.R.M. has unquestionably followed a policy which has caused no small anxiety in various sections of the industry—an anxiety which has often been accompanied by a defensively hostile attitude. The N.A.R.M. have attempted to interfere where it is both injudicious and gratuitous to interfere. Attempts have been made to use a powerful combination of manufacturers for purposes which no association of its kind can successfully, or actually does, pursue. Perhaps this aggressive attitude on the part of the N.A.R.M. in its earlier days was the result of a not unnatural enthusiasm at having "all got to-

gether." Wiser counsels, however, seem to have prevailed, and there are indications that a fair, straightforward and limited policy is being adopted for the improvement and organisation of the industry as a whole. A really genuine attempt at a sympathetic organisation of the industry will not only avoid criticism but ensure support in practically all quarters, and the policy of the N.A.R.M. should be to dispel anxiety and encourage support.

The disadvantages under which this coming Exhibition will be held have, no doubt, been realised by the N.A.R.M. They know perfectly well that many visitors will be frankly disappointed at not seeing the products of perfectly sound and reliable British firms which, because they do not happen to be members of a particular trade association, are not permitted to exhibit. We feel it a duty to point out to our readers that the expression "All-British" used in connection with this Exhibition means simply that the apparatus will be British, and not that the Exhibition is truly representative of the British wireless industry. There will probably be only half the number of exhibitors that there would have been had the Exhibition been a free and open one to British manufacturers. The N.A.R.M. have, no doubt, weighed in the balance the advantages of a truly representative exhibition against the advantages to their own particular trade association of limiting the number of exhibitors.

If the N.A.R.M. truly represented the whole of the industry, or the great bulk of it, then their attitude would, in our opinion, be justifiable; but until such a state of affairs exists—and it may do so in a few years if a moderate and wise policy is followed—the Exhibition will suffer under a serious disability, but obviously the N.A.R.M. are prepared to wait—and meanwhile to use the Exhibition as a lever.

We cannot get away, however, from the fact that the wireless public, generally, will be disappointed at a state of affairs which prevents a really large national wireless exhibition being held in this country.

Loose-Coupled Circuits and Their Uses

By G. P. KENDALL, B.Sc., Staff Editor.

The subject of interference elimination is one of ever-increasing interest.

THE constant increase in the number of stations, broadcasting and other, in continuous operation, makes it almost inevitable that we should turn our attention more and more to means of increasing the selectivity of receiving circuits, more particularly upon the broadcast band of wavelengths. When one remembers the great volume of signals constantly filling the ether upon wavelengths between 300 and 500 metres, it seems indeed surprising that we are still content in the majority of cases to employ the really very broad tuning given by the average receiving set with its single tuned aerial circuit. Not merely is there the question of eliminating a high-power local station, with which trouble all who live in one of the broadcasting centres will be only too familiar, but the whole band is more or less filled with stray spark interference and "mush" from high-power arc stations which nominally work on long wavelengths but radiate a certain amount of energy upon shorter waves, known as harmonics.

The Transmitter

A great part of this interference can no doubt be eliminated by improvements in the high-power transmitting stations and with the sorting out of spark traffic upon more clearly defined wave bands; but unfortunately a residuum of jamming will always be with us, and there is undoubtedly a certain amount of justice in the allegation of the authorities that part of the trouble is due to the lack of selectivity on the part of the receiving apparatus.

Although attention is devoted to securing sensitivity in a receiving set, it is not often

that one finds that the designer has given very much thought to the question of selectivity. It is generally felt, apparently, that any attempt to improve selectivity usually involves complication of the operation of the set, and therefore is to be shunned. No

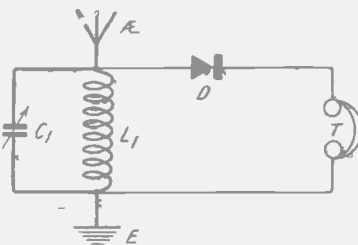

Fig. 1.—A typical flatly-tuned circuit.

doubt selective circuits are, in general, more complicated to operate than the single type with which we are all familiar, which consists of a single aerial circuit composed of an inductance in series or in parallel; but my experience shows that when once an experimenter has passed the novice stage and some chance leads him to try one of the more sharply tuned circuits, he is usually so delighted with the power to select the desired station and eliminate others which it confers that he is quite

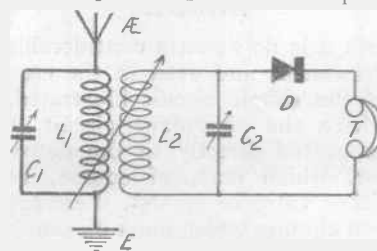

Fig. 2.—The standard loose-coupled arrangement.

reconciled to any extra trouble in tuning which it involves.

When confronted with any particular interference problem, one

has always to make the choice between the use of a selective circuit or a wave-trap, and naturally the choice must depend upon the nature of the interference it is desired to eliminate. In the case of a single interfering station, such as a local broadcasting station, probably the use of a wave trap is to be preferred, since it only complicates very slightly the handling of the circuit; but where the question is one of general improvement in selectivity of the receiver to enable any given station to be selected, to the exclusion of the others, it is usually worth while to consider seriously the question of adopting one of the various forms of inductively coupled tuning arrangements.

How Selectivity may be Increased

Let us consider first the main causes of flat tuning in the conventional type of circuit. Fig. 1 shows a very simple tuning arrangement with a crystal detector and phones connected in the ordinary manner across the tuned circuit. The aerial circuit consists of the aerial, the coil L_1 , and condenser C_1 in parallel and the earth. The sharpness or otherwise of the tuning of this circuit will, of course, depend upon the amount of damping, as the deciding factor, and apart from matters of aerial and earth efficiency, the principal factors within the control of the experimenter are the high-frequency resistance of the coil L_1 , the losses in the condenser C_1 , and the damping produced by the abstraction of energy from a circuit by the detector arrangement. In the case of a crystal detector this last is no doubt a very serious factor, but it is of less importance in the case of the majority of valve sets. Under the

ordinary conditions obtaining in the average experimenter's receiver, the high-frequency resistance of the coil L_1 is usually fairly high unless a specially wound inductance is employed, and improvements in selectivity can usually be obtained by turning attention to this coil. The damping applied by the detector circuit which is placed across the coil, however, cannot very well be reduced to a useful extent without very much weakening the signals obtained, and thereby defeating one's own ends. Some improvement can be obtained by tapping the crystal and phones across only part of the inductance, but this cannot be carried very far without a considerable reduction in the volume of sound obtained.

To increase the sharpness of tuning on the aerial circuit it would therefore seem desirable to remove the detector arrangement from this circuit altogether, and this is commonly done by means of the arrangement known as a loose-coupled tuner. This is shown in its simplest form in Fig. 2, and it will be seen that the aerial circuit now consists of the coil and condenser in parallel as before, and that magnetically coupled to the coil L_1 is a second coil L_2 tuned by a parallel condenser C_2 . The magnetic coupling between these coils is not at all strong, and energy is transferred from one to the other by the familiar phenomenon of electro-magnetic induction. We have here two powerful aids to selectivity. In the first place, the damping in the aerial circuit now consists only of that which is produced by the energy losses which are present in the coil, condenser, etc., and of course the re-radiation which takes place from the aerial. The only additional damping is that introduced by the passing of energy from the aerial to the secondary circuit $L_2 C_2$, and this is not now quite so great as was the case when energy was being directly abstracted from this circuit by the detector. It will thus be seen that the tuning of the aerial circuit has been considerably sharpened, while, secondly, there is the improvement in selectivity obtained by the fact that when

both aerial and secondary circuit are exactly tuned to the received wavelength, signals which may be impressed upon the aerial, and which possess a slightly different wavelength, will not be transferred from the one circuit to the other nearly so strongly as those of the resonant frequency.

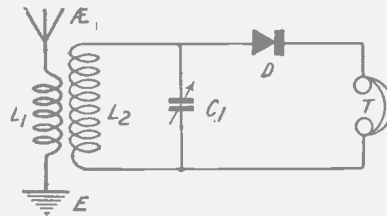

Fig. 3.—In this circuit tuning is sharp and handling is simple.

It is, of course, understood in the case of this, and all the other circuits dealt with in these notes, that the crystal circuit may be taken to represent any sort of detector or amplifier which is connected to the tuned circuit.

Simplifying the Tuning Arrangements

The conventional loose-coupled arrangement illustrated in Fig. 2 has, it cannot be denied, the drawback of introducing an additional tuning adjustment, namely, the variable condenser C_2 . In moderately complicated receiving

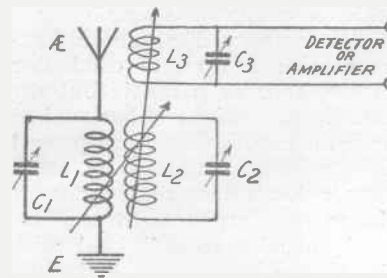

Fig. 4.—An ultra-selective circuit used in certain commercial receivers.

sets it is no doubt a considerable drawback, and even in the case of the simple circuit illustrated, where the secondary circuit is connected directly to the detector, which may, of course, be either valve or crystal, there are two circuits which must be simultaneously operated. The matter becomes more difficult still when one or more high-frequency stages are added to these tuning circuits, with attendant tuning operations. There are a variety of methods of simplifying the

operation of the set, one of the most useful being that which is known as the aperiodic aerial method of tuning. This, perhaps, should not be regarded as a loose coupled circuit in the strict sense of the term, but since it employs an inductively coupled pair of windings to achieve the desired end, and since it improves the selectivity in a manner somewhat similar to that of the conventional arrangement, I propose to give a few notes upon its use.

Fig. 3 illustrates the simplest form of the aperiodic aerial arrangement, and it will be seen that the aerial circuit comprises merely a winding L_1 , which is coupled as tightly as possible to the secondary coil L_2 , tuned by the variable condenser C_1 . The detector or amplifier is joined across this secondary circuit in the ordinary manner.

The aerial is believed to function in a more or less aperiodic manner, transforming sufficient energy to the circuit $L_2 C_1$ to throw it into oscillation at the resonant frequency.

This circuit gives a considerable improvement in selectivity when compared with the simple type illustrated in Fig. 1, and it will be noted that it retains the advantage of possessing only one tuning adjustment. It is particularly beneficial upon the shorter wavelengths, such as those employed for the main broadcasting service, and those who care to try it will find that the following data will be successful when winding the necessary coils. The coil L_2 may consist of 70 turns of No. 22 d.c.c. wire wound upon a 3 in. diameter ebonite tube, the condenser C_1 being of 0003 μF capacity. The aerial winding can consist of either 10 or 12 turns of No. 20 d.c.c. wire wound directly on the top of the previous winding, and secured in one of the usual ways. It is best not to impregnate either winding with wax or varnish. When using this circuit, it will be found that selectivity is considerably improved, and if the coil is wound in an efficient manner such as that described, or in one of the methods of interweaving primary and secondary in, say, a basket coil winding, signal strength does not appear to be lost.

The Use of Intermediate Circuits

In the majority of cases the ordinary loose-coupled arrangement or the aperiodic aerial arrangement adequately meets the need of the experimenter desiring greater selectivity than the normal, but in some special cases, such as that which arises when the receiving station is situated at an extremely short distance from some powerful source of interference, something better still may be needed.

A circuit of still higher selectivity, but also of greater difficulty in operation, is illustrated in Fig. 4, and may be recognised by some readers as being that embodied in certain commercial apparatus. The aerial circuit consists as before of a coil and condenser in parallel, and coupled to this is what is known as an intermediate circuit $L_2 C_2$, tuned to the received wavelength exactly as was the secondary circuit in the previous cases. Coupled to this again is a third circuit, also tuned to the desired wavelength, and across this last circuit the detector or amplifier is connected.

By employing fairly loose coupling between the various coils L_1 , L_2 and L_3 , a very high degree of selectivity can be achieved, but the operation is so difficult that it is practically essential that a wavemeter be employed when searching for any given station. From the experimenter's point of view, this is not a really practical arrangement, but I have recently been using a modification thereon which I have found eminently valuable, and which is practically as easy to operate as the standard loose-coupled arrangement with separately-tuned primary and secondary. This is illustrated in Fig. 5, and it will be seen that it employs the principle of aperiodic aerial tuning which we have already been considering.

We have in this circuit the usual 10 or 12 turn winding in the aerial, coupled as tightly as possible to the tuned secondary winding L_2 , while variably coupled to this circuit is a second closed circuit $L_3 C_2$, which feeds the detector or amplifier. There are here only two circuits to be tuned by means of variable condensers, and the coupling be-

tween two coils to be adjusted, and this will be found a relatively simple matter when a little practice has been gained and the peculiarities of the circuit have been noted. The same coil may be used for the windings L_1 , L_2 , as was described in connection with the circuit illustrated in Fig. 3, while the coil L_3 can be one of the ordinary No. 50 or 75 plug-in coils commonly used for secondary and tuned anode circuits, arranged so as to be variably coupled to the winding L_2 .

In this circuit I have found it most convenient to use some form of multi-layer coil for the windings L_1 and L_2 , a lattice coil being quite suitable. An

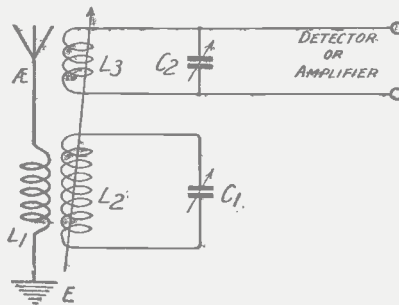

Fig. 5.—The selectivity of this circuit is almost as high as that of the Fig. 4 type, while its operation is very much easier.

easier coil to wind is the basket coil, which may consist of primary and secondary wound on simultaneously side by side for 10 turns, the primary being then cut off and the secondary continued for another 60 turns. If this coil is wound upon a spider having a central hub about 1 in. in diameter the resulting coil will tune comfortably over the broadcast band with a variable condenser of 0.0003 μ F. This coil can then be mounted upon one of the standard coil plugs by means of one of the adapters sold by the majority of dealers for gripping basket coils, and this coil and the coil L_3 can then be mounted upon a two-coil-holder. The ends of the primary winding L_1 should be furnished with short extension leads about 6 in. in length of flex, which can be taken out to a couple of terminals upon the panel.

The Effect of Variations in Coupling

It will soon be found in operating any of these circuits where

there is a means of varying the coupling between two coils, such as that possible in the Fig. 2 circuit, where the coils L_1 and L_2 will presumably be mounted upon a two-coil-holder, there is commonly a best position for the two coils in respect to each other when receiving any given station, and alterations in the coupling may produce very marked effects. In the first place, it can be laid down as a definite rule that the wider apart the coils—that is, the looser the coupling between them—the sharper will be the tuning of both circuits, but when the coupling is reduced beyond a certain point signal strength begins to fall off, and improvement in selectivity is only obtained at the expense of volume of sound. In some special cases it is, of course, worth while to sacrifice signal strength to eliminate some persistent interference, but in the majority of cases one is content with a moderate weakening of the coupling.

It will usually be found that the signal strength increases as the coils are approached towards each other only up to a certain position, usually when the coils reach an angle of perhaps 30 degrees to each other, and that increases beyond this point produce very little improvement in signals, and merely serve to bring in the interference which one is striving to eliminate. Since this article is intended to provide a practical guide to the use of these circuits, I will not attempt to deal here with the theory of the matter, and would merely advise the reader to experiment and acquire stability in handling these circuits, which he will find of extreme interest.

(To be concluded.)

EIGHT NEW SETS

The autumn double number of "Modern Wireless," now on sale, contains full particulars of how to build eight efficient wireless sets of proved efficiency; an article entitled "Tri-Coil Circuits," in which the Editor describes a highly interesting method of using three-coil tuning; a special article on "How Broadcasting Helps the Experimenter," by A. R. Burrows (Uncle Arthur of the E.B.C.) and many other fine features.

BUY IT TO-DAY.



JOTTINGS
BY
THE WAY

THIS week I beg leave to present you with a simplified diagram of the wonderful Goop-Wayfarer Circuit No. 761, to which a note magnifier has been added with the help of the various components and pieces already discussed. I have always been very much in favour of simple straightforward wireless diagrams, and you will, I think, agree that in that now published Professor Goop and I have produced something that anyone can follow. I would like to give you a pictorial representation of the same circuit, but as Gubbsworthy has in my absence stolen from me the entire outfit of components which I borrowed from Poddleby, I am quite unable to do so. However, you being no doubt a person of commonsense and endowed with no small skill in wireless matters, will be able to wire up this circuit without any further help from me. I may say that the Professor and I have lately received several tempting offers from large manufacturers of wireless sets who are trying to induce us to join their staffs as designing experts. I am pleased to be able to tell you that both the Professor and I are so wedded to our art that no monetary consideration will tempt us to debase it into mere commercialism. In coming to this decision the horrid fact also occurred to me that in most offices they expect you to work from about nine o'clock until six o'clock with only two or three hours off for lunch. I am quite sure that my genius could never flourish in such circumstances, and I can hardly see the Professor arriving to time in the morning, for he is never quite sure whether any appointment is for to-morrow or for last Tuesday week.

How it is Done

I am emboldened by an article in which Mr. Percy Harris has given to the world the method by which he designs his sets (which, I may say, are in every way inferior to the Goop-Wayfarer Circuits) to tell you how the Professor and I go to work. The whole secret of successful wireless designing is method, method and again method. I want you to picture

pencil minus a point comes from the box labelled tintacks, whilst from a drawer marked dividend warrants I take my writing pad. Having found one of my boys and borrowed his penknife to sharpen the pencil, I am ready to begin. I take up the slide rule and push it about in an airy kind of way, then lay it down with a sigh and do a few simple calculations on a piece of paper. The compasses are

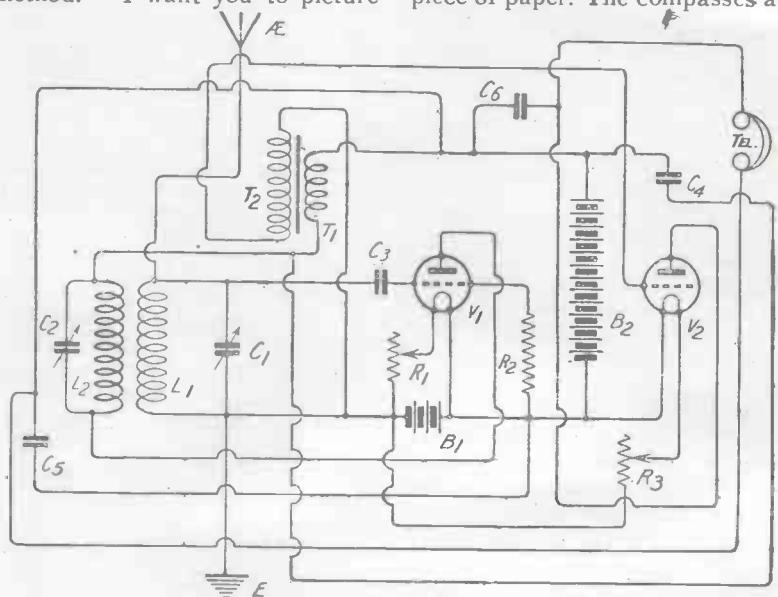

The simplified circuit of the G.-W. Circuit No. 761, with note magnifier added.

me as I sit after a conversation with the Professor at my study table putting into concrete form the result of our experiments and deliberations. In front of me as I sit is a row of neat boxes labelled protractors, slide rules, T-squares, pencils, indiarubber, centre punches, drills and so on. This is an example of method. Just to show you how I work we will imagine that I desire to start drawing a circuit. I open the box marked compasses and extract from it a footrule. A

not where they ought to be in the box labelled gridleaks, but I make light of this and withdraw from my pocket a penny with which I describe a circle intended to represent a valve.

Progress

The sight of this blank circle reminds me irresistibly of Poddleby's face, and I proceed to fill in his features with deft touches. After all, why should not one be cheerful even when drawing wireless circuits? It is

these artistic touches which help the weary worker to get on with his task. Just as I have got so far the maid enters to announce that the chimney sweep has come to do his worst, or that the gas man wants to clean the burners, or something of that kind. Heaving a sigh of relief I proceed to the garden, where I transfer myself to a deck chair and absorb myself in brain work rather than manual labour. About two hours later my better half digs me in the ribs and says that if I want my lunch I had better come along, for all the rest of the family had finished half-an-hour since. It is curious to notice how closely a man who is absorbed in deep thought may resemble one who is merely asleep. I have pointed this out to my wife on several occasions.

The Afternoon Spell

Having lunched lightly and smoked three or four pipes, I am, of course, burning to get back to work again. Once more I go to my table and find to my horror that in my absence some one has tidied up all my drawing instruments. When you really know where things ought to be, nothing is more disconcerting than to find after opening every other one of your boxes that your pencil is in that labelled pencils. To put it there shows just the complete lack of method that one expects to find in the gentle sex. There are, I am told, tidy people who always keep things in their proper compartments, which evinces a distressing lack of originality. It is for such people I imagine that those neat little drill canisters are made that you can buy at any big tool shop. The thing contains complete sets of Morse drills from No. 1 to No. 60, each lying in a little nest. It has a double lid in which are pierced ingenious holes. When you want, say, a No. 34 drill you merely twiddle the revolving lid round until the figure 34 is opposite the pointer. You then set a little stop in a nick labelled 20 to 40, invert the canister, give it a shake, and the drill arrives in your hand. In a moment of extravagance I once bought one of these things which still decorates my workshop and evokes the loudly expressed admiration of my friends. The only trouble is that you must always replace a drill in its nest before you take out another one.

Now I cannot possibly work on these cramped lines. If I am doing a wireless job I like to have all the drills that I am likely to want lying about on the bench. When I have finished I just bundle them back. Nobody, I think, can be expected to put each one of a dozen or more back into its own compartment. Certainly I don't; they just go in where there is room for them. Now this adds a spice of excitement to my drill canister. You can go through all the complicated evolutions for securing a No. 34 drill if you like, but the chances are that when you have finished a No. 1 or a No. 60 will trickle into your hand. You never quite know what is coming, so that there is no chance of your being dull.

On, and On, and On

And so the process of designing goes forward with steady, unremitting toil until I have produced a few of those noble circuits which decorate these pages from time to time. How do we, the Professor and I, think out these amazing novelties in the wireless line? Ah, this is indeed a question. Each of us has his own special method. Professor Goop tells me that one of the moments in which inspiration most frequently comes to him is when his valet has forced him into a chair and is engaged in shaving him. The Professor, I should explain, though theoretically clean-shaven, has in practice usually anything from four to seven days' stubble upon his bulldog chin. If it were not for his man's efforts he would, I fear, be a record beaver.

The Zurich Station

The Zurich station was officially opened on August 23, at 12.30 p.m. by a lunch, at which Councillor Herr Bundesrat Haal gave an address.

The proceedings were broadcast by the station and the transmission was followed by a concert which lasted until 3 p.m.

The wavelength of 650 metres adopted by this station is only provisionally and may be subject to alteration.

Zurich being in the part of Switzerland where German is

As for me, I have no special moments. Inspiration may come whilst I am singing in my bath, flying high above the clouds in an aeroplane, or fishing for tiddlers in the horse pond at Little Puddleton. It is a great strain to be called upon to do so much original work, but being one of your strong silent men I have never so far given way under it. A great deal of my work is done during the watches of the night, and, counting the time that I spend between the sheets, I can claim that I do a solid twelve-hour day. Naturally, to maintain the flow of ideas one must keep physically fit. This I do in a thousand ways. There are few more enthusiastic members than I of the Little Puddleton Sparrow Club, and almost any day you will see me with my catapult potting "spadgers" on the local chimneys. Shooting is as fine a recreation as I know. Motoring, again, is quite a hobby of mine, and I make frequent use of the 'bus service between the Town Hall and the station. It is only by living a strenuous life of this kind that one can keep really up to the mark.

Perhaps as you whizz along in your Rolls Royce over the road in the neighbourhood of Little Puddleton you may see a lonely figure with its back propped against a milestone and its hat over its eyes. To a casual eye it might appear to be nothing but a slumbering wayfarer. It is a Wayfarer certainly, but the great mind is at work, and next week's circuit is well under way.

WIRELESS WAYFARER.

□ □ □ -

mostly spoken, this language is used by the station announcer, Herr Redactor P. Albeer.

The musical director is Herr Kapellmeister H. Holman. Transmission is now taking place regularly every evening, including Sundays, at 8.30 p.m., ending at 10.15, the last 15 minutes being devoted to a late news bulletin.

Modulation is quite good and reception in London is quite easy on 1H.F., 1Det. and 1L.F.

Music begins at 8.30 p.m., or is sometimes preceded by a quarter of an hour's lecture from 8.30 to 8.45 p.m.

The High-Tension Battery

By R. W. HALLOWS.

There is, I suppose, no unit of a wireless receiving set which is so much taken for granted as the high-tension battery. It seems a perfectly straightforward piece of apparatus, neither requiring nor receiving any particular attention, which goes on functioning until old age and decrepitude cause it to be discarded in favour of a new one. There is an impression, too, that any battery will do provided that it contains a certain number of sockets and that it is marked 66 volts or 100 volts. All this is really rather curious, for the high-tension battery is actually one of the most important components of the set, and both its design and its manufacture demand a great deal of expert knowledge. Further, the battery which is well looked after will last far longer and give better service than one which is left simply to care for itself.

Main Function

The main function of the high-tension battery is, of course, to provide the high potential which is required by the anodes of the valves. It is not always realised that it must also supply the current which flows from filament to anode and round the plate circuit or that this current may in certain cases swell to comparatively large proportions. Hence it happens not infrequently that the high-tension battery is overloaded, with the result that its current supply becomes uneven and the set is rendered noisy.

I suppose that 99 per cent. of the high-tension batteries in use are made up of varying numbers of small dry cells. Now there is a very great deal in cell design and there is a great deal too in the way in which the cells are combined into batteries. Take, for instance, the case of the flashlamp refill. This is intended to supply about .25 ampere of current for a second or two at a time and then to have a fairly long rest before it is used again. The voltage delivered is only 4.5, so

that the insulation between cells need not be very good. But make up a dozen or two dozen flashlamp refills into a high-tension battery by connecting them in series, and you have a very different state of affairs. Each cell is now called upon to supply current continuously for perhaps several hours on end; the amount of current may be small actually, but even 5 milliamperes is a very large drain for these little cells

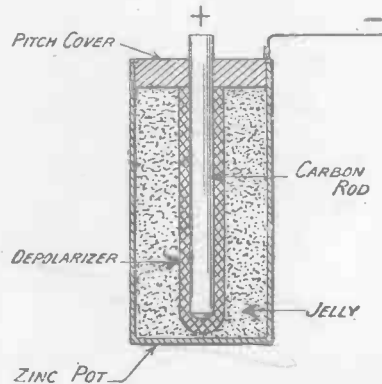

Fig. 1.—How the dry cell is made up.

to withstand. Again the voltage is now no longer a small one. When a dozen refills are placed in series the voltage becomes 54, and we shall find in some cases that the insulation is not good enough to ensure quiet working. There are, of course, refills and refills. Those of the best makes are well insulated and may do quite well even in high-voltage batteries; but cheap refills can produce as much noise in the receivers or loudspeaker as the combined atmospherics of a dozen different thunderstorms. This noisiness is due partially to bad insulation and partially to the process known as polarisation. Fig. 1, shows diagrammatically how a dry cell is constructed; the term dry is, of course, strictly speaking a misnomer, for no cell can work without a certain amount of moisture:

The cell is contained in a zinc pot which forms the negative element. The positive element is a brass-capped carbon rod

which is surrounded by a bag filled with the manganese dioxide depolariser. Between this and the case is a solution of sal ammoniac mixed with either gum arabic or isinglass, which sets into a jelly and forms the electrolyte. The top of the cell is covered with a layer of pitch.

Generation of Hydrogen

When it is placed in a closed circuit hydrogen bubbles are given off owing to the action of the electrolyte upon the zinc. These make their way towards the carbon rod, and if the discharge is heavy they will surround it with a kind of cloud, thus setting up a very high internal resistance and lowering its output. This is the process of polarisation. The depolariser absorbs these bubbles, one of its oxygen atoms combining with a double-atomed hydrogen molecule from a bubble and forming H_2O , or water, which helps to keep the cell moist. Up to a certain point the depolariser can act most efficiently, keeping the output of cell fairly steady; but when a comparatively large amount of current is drawn from it more hydrogen is formed than the depolariser can deal with effectively and the result is that since the internal resistance fluctuates both the voltage and the current are continually changing. Fluctuations then occur in the plate circuits of all the valves in the set and these are amplified and passed on to the telephones where they produce a varied assortment of noise.

Permanent polarisation

Gradual polarisation of a permanent type also occurs during the life of the cell. Thus a perfectly new cell may show a voltage reading of 1.5 volts, which will drop after a discharge of several hours to perhaps 1.25. If a long rest follows the cell will pick up again, but it will probably not quite reach its original E.M.F. The life history of a cell under normal conditions is somewhat as shown diagrammatically in Fig. 2, though the process of deterioration is, of course, not so rapid as is shown in the diagram.

This permanent polarisation or falling off in voltage is assisted by overwork, by dampness or by excessive heat. The less we run

a cell down during each period of work and the longer we give it to recuperate, the greater will be the life of the battery. Vast numbers of high-tension batteries peter out long before their time for the simple reason that those who are using them do not realise the strain to which they are being subjected. The average high-tension battery is made of cells of the same size as those used for flashlamp refills, the difference in its construction being that if it is of good make the insulation between cells is of high quality.

Small cells

Now these small cells, though they will give .25 ampere or more for a few seconds at a time

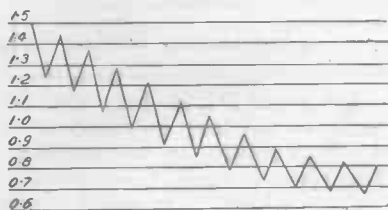

Fig. 2.—Discharge curve of inadequate cells used to make up an H.T. Battery.

cannot deliver more than the tiniest current for long periods on end. After a good many experiments with numbers of high-tension batteries good, bad and indifferent, I am convinced that the maximum total output for those of the best make should not exceed 5 or 6 milliamperes, whilst batteries of inferior quality can seldom deliver more than 2 or 3 milliamperes without becoming noisy in a very short time. Inferior batteries may work fairly well for a time upon a single valve set, or even upon a two-valver, but to use them upon anything larger is simply to ask for trouble. Good batteries of the same size will work a 3- or 4-valve set, provided that a power valve is not in use and that extra high-tension voltage is not used on the anode of the last valve. For bigger sets and in all cases where a power valve is used, a much heavier type of high-tension battery is desirable. These can be obtained from good makers, and they are an excellent investment, for they keep their voltage for very long periods and do not be-

come noisy until they are in the last stages of decrepitude. I had one recently which after many months of heavy use ran down from 120 volts to 45 without developing more than a slight trace of distortion.

Power Amplifiers

In all cases where a power amplifier is used or where a high potential is applied to the anodes of note magnifying valves suitable negative grid bias must be employed not only to avoid distortion by cutting down grid current, but also to ease the strain on the high-tension battery. Unless you wish to work several loudspeakers in parallel there is no point in passing a very heavy current through the last valve of the set, for it is not the steady current, but the degree to which it is modulated that gives loud signals. With a power amplifier on my own set I find that I can obtain reception that is quite free from distortion with a negative grid bias of only 3 volts. At this setting the current passing in the plate circuit of a small power valve is 9 milliamperes. By raising the grid bias to 9 volts negative the plate current is cut down to 4.75 milliamperes without any diminution in signal strength and without bringing the working point down to the lower bend in the characteristic curve. The economy thus effected is enormous, for by halving the output of the battery you treble or quadruple its useful working life.

The two other points mentioned, preserving the battery from damp and keeping it from the influence of excessive heat are also of great importance. If a film of moisture forms upon the surface of the battery—particularly if this is of pitch, which is strongly hygroscopic—insulation between cells may drop to a very low figure and the battery will quickly run itself down. Heat has the effect of drying up the jelly electrolyte of the cells and it may cause gassing which will make them burst their pitch coverings. The battery should therefore be kept in a dry place, and should never be left exposed to the full glare of sunlight or placed in the winter time close to a fire or a radiator.

If you notice a swelling of the pitch or a discolouration of the wax above any cell, you may be pretty sure that it is on its last legs. When this happens always test at once with a voltmeter and if the E.M.F. has dropped to less than two-thirds of what it was originally, cut the cell out altogether by short-circuiting it. A single dead or badly polarised cell in a high-tension battery may set up an enormous resistance, causing the total voltage to fluctuate, and giving rise to big variations in current.

SPIDER COIL CALCULATIONS

USERS of spider coils would find it useful to be able to make approximate calculations of the length of wire on the former. This is easily and quickly achieved by the following process, the result being very nearly correct.

The shaded portion in the diagram shows one segment of the former. Measure the longest wire across this section, which is, say, 1.125 in., then measure the shortest wire, which is, say, 0.5 in., add the two together, which gives you 1.625 in. Multiply the

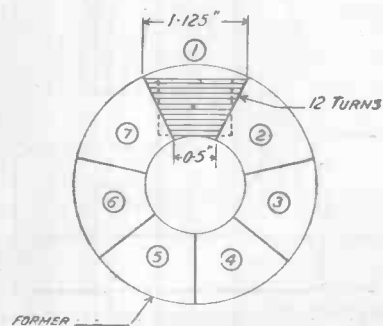

Illustrating the manner of calculation

answer by the number of turns on the top face of the segment (12), which gives 19.5 in., and multiply again by the number of segments on the former (7), which in this case gives 136.5 in., which, reduced to feet, becomes 11.375. Add a small percentage to the answer to allow for the bulging of the wire round the former, which results in the approximate answer 12.0 ft., which will be found to be approximately correct. H. B.

The Telephone Transformer

It is not always realised that building the telephone transformer into the receiving set may result in considerable noisiness or distortion in the loud-speaker or telephones. Everyone knows that two low-frequency intervalve transformers placed anywhere near each other will interact with very unpleasant effects. This undesirable feature can be minimised in various ways, amongst which are placing the cores at right angles to one another, earthing the cores and arranging the transformers so that they are as widely separated as possible. Mr. Harris has shown recently that no matter what precautions are taken a certain amount of interaction is likely to occur even with shrouded transformers placed a foot or more apart. Both the tendency to self-oscillation at audio-frequency and distortion can be reduced to negligible quantities by the precautions already mentioned.

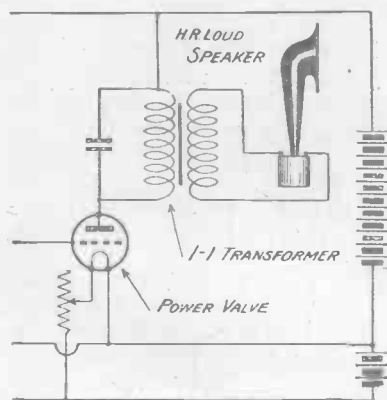

Method of connecting the telephone transformer.

It must, however, be remembered that the telephone transformer is also an audio-frequency iron-cored instrument, and that it is just as liable to the effects of interaction as is an intervalve transformer. If we build it into the set we increase the chances that reception will be noisy and not up to a high standard.

The writer's method, which gives excellent results, is to make this transformer part not of the receiving set itself but of the loud-speaker. The loud-speaker is

fastened to the top of a wooden box about 5 in. square and 3 in. deep. Within the box the telephone transformer is placed, the primary leads being taken to two

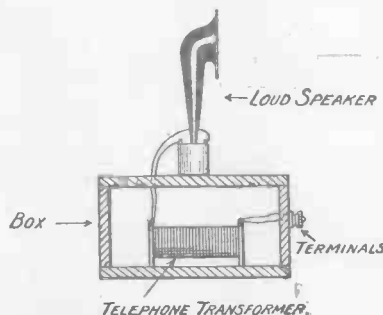

A suggested arrangement for mounting the transformer.

terminals mounted on one of the sides by means of panel bushes, whilst the secondary leads go to the loud-speaker. The loud-speaker with its transformer box stands eight or nine feet from the set, connections being made by flex leads. It is found that in this way reception is very much improved since there is no tendency for the telephone transformer to pick up noises through the effects of stray couplings with intervalve transformers.

The number of people who use telephone transformers is growing very rapidly, for to obtain the best loud-speaker results one must use a power valve, and this means that a transformer is advisable, for it is unfair to call upon the windings of high resistance instruments to carry the large steady current passed by the valve with a voltage of 100 or more. Those who already possess high resistance telephones or loud-speakers can use them quite well with a small power valve if they employ a 1 to 1 telephone transformer. An examination of the diagram will show that if this is done the normal steady current in the plate circuit of the power valve passes only through the primary of the transformer and does not reach the delicate windings of the loud-speaker. All that reaches them is the modulation of the steady current, which is what is required to work the

diaphragm. These 1 to 1 transformers can be purchased quite cheaply from reliable firms, or they can be made at home on the lines of telephone or intervalve transformers, the details of whose construction have already been given in *Wireless Weekly*. In making a 1 to 1 transformer care should be taken to put plenty of wire on the windings. The core should be fairly stout and the direct current resistance of both primary and secondary windings should be approximately that of the loud-speaker. If the 1 to 1 transformer is made up it should be mounted in a box to serve as a stand for the loud-speaker in the way which has already been described.

R. W. H.

A Switching Device

A SIMPLE but efficient switch may be constructed as shown in the diagram. The pivot is made from a valve socket, which is mounted upon the panel, as shown. The switch arm may be made of springy brass, bent to the shape shown, and having a piece of ebonite riveted at one end. The contact studs are mounted upon the panel in the usual manner, and the usual connections are made from

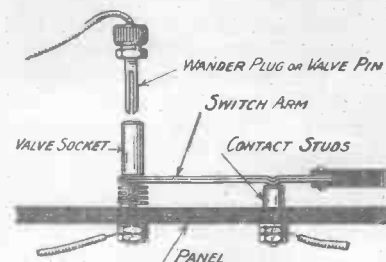

Details of the switch.

the valve socket pivot and the contact studs. The object of using a valve socket as a pivot is to enable the experimenter to rapidly make a further connection to this point from some part of the set, as is often necessary. To do this a wander plug or valve pin attached to a flexible lead will be required, the other end of the flexible lead being connected to the point desired. There are several ways of making practical use of this little gadget, which the experimenter will find for himself, as no method described would suit the individual concerned.

H. B.

Random Technicalities.

By *PERCY W. HARRIS*, Assistant Editor.

The new process adopted by most valve manufacturers by which a silvery deposit is formed upon the inner walls of the valve, thus giving the valve a mirrored appearance, is designed, not to conceal the inner structure of the valve, but to improve the vacuum. It is the endeavour of every valve manufacturer to make his valve as "hard" as possible, that is to say, with the highest possible vacuum, save, of course, in a few exceptional cases where a soft valve is required. Most elaborate and expensive pumping apparatus is first of all used to draw out the air, but the final traces cannot be removed in this way. During the process of manufacture the plate of the valve has affixed to it a small spot of metallic magnesium, this, of course, remaining in place during the exhausting of the valve. When all possible air has been removed in this way the valve is sealed off and laid inside a cylindrical chamber around which is wound a coil of very thick wire.

Eddy Currents Made Useful

Through this coil of wire is passed a high-frequency current of great intensity, with the result that in any metal work placed within its field powerful eddy currents will be set up. Eddy currents will heat the metal just as much as ordinary currents of sufficient intensity, and it is most fascinating to watch the plate grow hotter and hotter until it is glowing with a brilliant red heat. As soon as a certain temperature is reached the spot of metallic magnesium evaporates, the bulb is momentarily filled with a pale blue light, and in a much quicker time than it has taken me to tell you, the mirror-like deposit has formed on the inner walls of the glass.

When you inspect a valve you will find that in most cases the mirror effect is more pronounced

on one side of the glass than on the other; this is due to the fact that the magnesium is shot off from one side of the plate only.

Neglected Long Waves

Before broadcasting began most experimenters were apt to spend their time in investigating long-distance reception on the long wavelengths used by commercial high-power stations. Soon after the War, when valves were released for amateur use, it was found possible in favourable conditions to receive high-power stations several thousand miles away with a single valve, and in one or two well authenticated cases, the Dutch Station at Java, in the East Indies, was successfully received in England with a single-valve reaction set. There is certainly a great fascination in searching for these distant transmitters, and provided the experimenter has good knowledge of the morse code, he should have little difficulty in identifying them. From eight or nine thousand metres up to the 23,400 odd metres used by the Lafayette Station at Bordeaux, almost every available space is occupied, so that with an autodyne receiver the listener is regaled with a musical medley of heterodyne notes.

Separate Oscillations

A separate oscillator circuit to provide the beat note is of great value in searching the ether for long-wave stations, and far better signals are obtainable this way, the reason being that in order to get a beat note with an ordinary oscillating receiver, the receiver itself must be de-tuned considerably to give the necessary difference in frequency. This de-tuning on long wavelengths means considerable loss of signal strength. For example, on short waves, such as are used for broadcasting and ship work, the de-tuning necessary to give a

beat note of a thousand frequency is so slight as not to diminish appreciably the signal strength. On the long waves of which I am writing the de-tuning is considerable. If your transmitting station is sending on a wavelength of 18,000 metres, and you are using an autodyne receiver to obtain a beat note of a thousand frequency, you must de-tune a thousand metres to either 17 or 19 thousand, and thus when listening to one station your receiver may be tuned to the wavelength of another. With a separate heterodyne, of course, you can tune your receiver exactly to the wavelength required, and attain the beat frequency without loss of efficiency.

Indoor Aerial Reception

My new masts not having yet arrived, I am still using an indoor aerial for most of my experiments. The other morning (at 11-20 a.m. to be exact) I tried to see what could be done in receiving American stations on an indoor aerial. With a two-coil holder and a variable condenser as tuner, a single-valve panel, with 60-volt H.T., and a separate oscillator I had no difficulty in reading WQL (Long Island, U.S.A.) for over half an hour. WQL uses about 200 kilowatts, which should certainly give carrying power to his signals.

CALL-SIGNS OF FRENCH EXPERIMENTAL TRANSMITTING STATIONS

In next week's issue will be given the call-signs of 146 French Experimental Transmitting Stations. This list has been especially checked for "Wireless Weekly" by the French Postal Authorities and is corrected up to August 25.

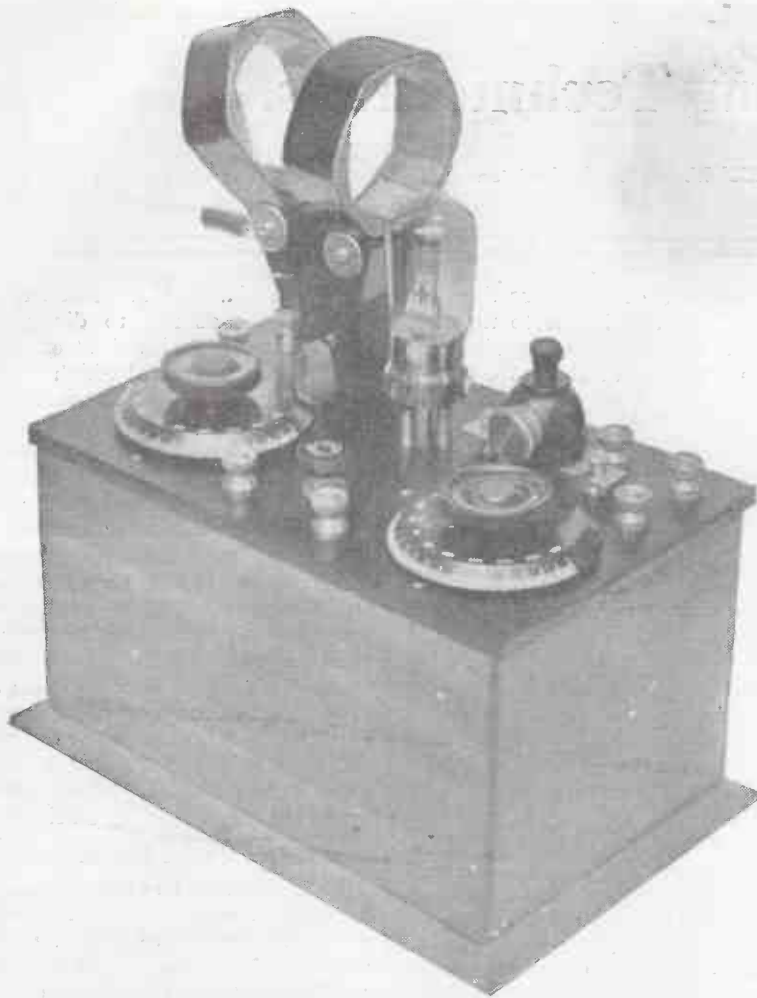

Fig. 1.—A single-valve dual amplification receiver.

DURING the past twelve months, dual amplification or "reflex" circuits have become increasingly popular. Apart from the desire on the part of enthusiasts to try-out each new arrangement that comes along, the popularity of dual amplification circuits is no doubt due to the economy in valves which can be effected.

Several keen experimenters have put in a good deal of work in developing the application of the principle, particularly in reference to receiving sets incorporating two or more valves. The principle itself, however, is by no means new, the present writer having experimented with single-valve dual-amplification circuits as long ago as 1917.

In previous articles, the action of valves when employed as high-frequency and as low-frequency amplifiers has been dealt with. Dual amplification is obtained

when a single valve is made to function as a high-frequency and low-frequency amplifier simultaneously.

High-Frequency Amplification

Consider the input circuit of a high-frequency amplifying valve,

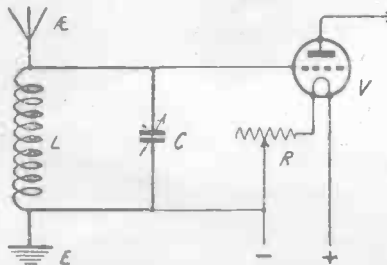

Fig. 2.—The input circuit of a valve connected as an H.F. amplifier.

as shown diagrammatically in Fig. 2. The aerial circuit, comprising the aerial itself, aerial tuning inductance *L*, variable condenser *C* and earth connection *E*, is tuned to resonance with

**How every
Crystal User
may become a
Valve Expert**

By E. REDPATH,
Assistant Editor.

the distant transmitting station by means of the variable condenser *C*, and high-frequency variations in potential between the ends of the inductance coil *L*

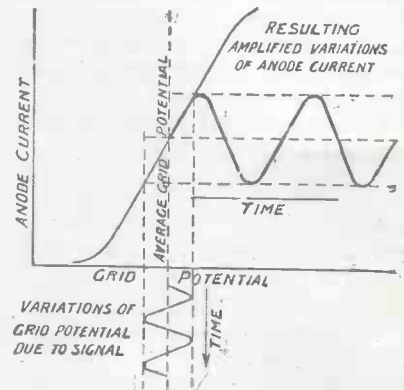

Fig. 2a.—Graph illustrating the H.F. variations in anode current produced by H.F. changes of grid potential.

are applied to the grid and filament of the valve.

The effect of these high-frequency variations in grid potential is illustrated graphically in Fig. 2a, the important point to note for the present purpose being that the changes in anode current are occurring at high-frequency. The actual frequency, of course, depends upon the wavelength being received. In the case of a 300-metre wave, for instance, the anode current variations will occur at the rate of one million per second. Note also that the anode current varies equally above and below a definite normal value, which in turn depends upon the normal grid potential.

In Fig. 3 is shown the input circuit of a low-frequency amplifying valve. This circuit, it will be observed, does not differ in essentials from the input circuit of Fig. 2. In each case, poten-

The present article explains the principle of dual amplification and shows how to construct a compact single-valve dual receiver.

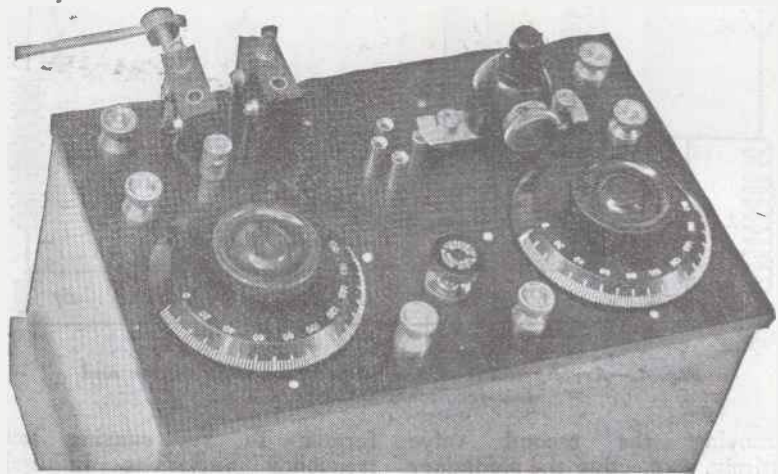

Fig. 1a.—The receiver with coils and valve removed to show panel.

tial differences set up between the ends of a coil are applied direct to grid and filament. The coil in Fig. 2 is suitably constructed to deal with high-frequency currents, whilst the coil in Fig. 3

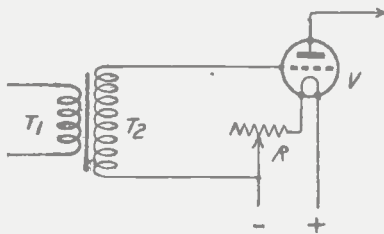

Fig. 3.—The input circuit of a L.F. amplifying valve.

(T2, the secondary of a step-up iron core transformer) is particularly adapted for dealing with low-frequency currents.

The rate of change of grid potential in the arrangement illustrated in Fig. 3 depends entirely upon the frequency of the currents traversing the primary winding T1 of the transformer, and, in actual practice, may range from the lower to upper limits of audibility, say, from 32 to about 10,000 per second. (The upper limit of audibility is actually higher than 10,000, but the figure given is about the limit for telephone diaphragms.)

Suppose, for example, the frequency of currents flowing through the transformer primary T1, and consequently the rate of change of grid potential, to be 100 per second. Provided that the normal grid potential was as indicated in Fig. 2a, the variations in anode current would be exactly similar but, instead of occurring at a rate of possibly one million per second, they would occur at the low-frequency of 100 per second.

Superimposed Grid Potentials

In order to make it quite clear how two independent variations may occur simultaneously in the anode current of a valve, suppose that whilst the action illustrated in Fig. 2a is actually occurring, the filament rheostat is adjusted so as to slowly increase and decrease the filament current, say, once per second.

The effect of this will be to increase and decrease the normal anode current at the same rate and, provided that the variation is not so great as to bring the normal anode current too near to either end of the anode current characteristic curve, the high-frequency anode currents will follow the slowly varying average

modern three-electrode valve is quite capable of amplifying two frequencies simultaneously, provided of course that these frequencies are substantially different. It remains therefore to illustrate the application of the theory.

Fig. 4 is a theoretical circuit diagram showing the ordinary arrangement of two amplifying valves. The first valve acts simply as a high-frequency amplifier, the high-frequency currents set up in the closed oscillatory circuit L1, C1 being rectified by the crystal detector D and passed through the primary winding T1 of a step-up iron-core transformer T1, T2. The output of this transformer is then applied to the

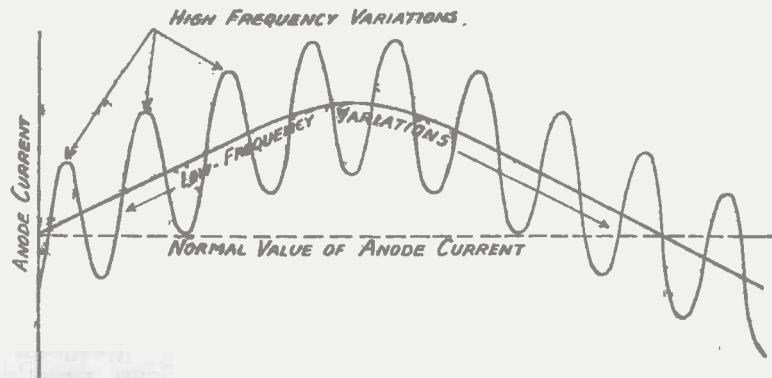

Fig. 3a.—The effect of H.F. variations superimposed on low-frequency variations.

or normal value without appreciable distortion, with the result illustrated in Fig. 3a.

Practical Application

From the foregoing it will no doubt be gathered that the

grid and filament of the second valve which functions as a low-frequency amplifier only.

The output of this second valve is made to traverse the windings of the telephone receivers connected in the anode circuit. By

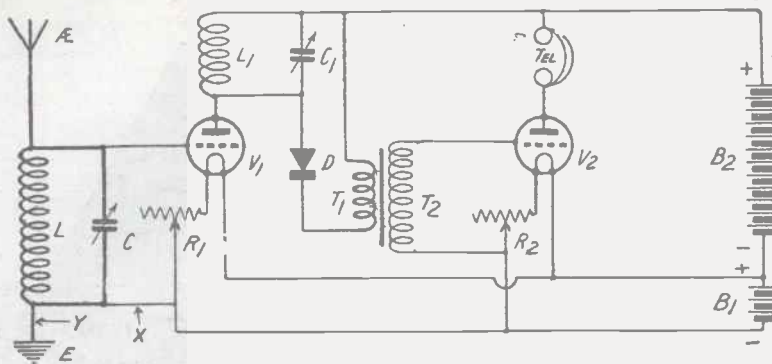

Fig. 4.—Arrangement of H.F. valve, crystal detector and low-frequency valve.

removing the second valve entirely, connecting the secondary T_2 of the iron-core transformer in the grid-filament circuit of the first valve at the point X, or in the aerial circuit at the point Y, and connecting the telephone receivers between the positive terminal of the high-tension battery B_2 and the anode of the remaining valve, the arrangement of Fig. 4 can be converted to a single valve dual-amplification circuit.

The modified arrangement is shown in Fig. 5, the "feedback" circuit (comprising the detector D and the primary T_1 of the step-up iron-core transformer) being indicated by heavy lines. Fig. 5 is the theoretical circuit diagram of the receiving set illustrated in the photograph, Fig. 1, and the action involved is as follows:—

Oscillatory currents set up in the aerial circuit (which now includes the aerial, aerial tuning inductance L, with parallel variable condenser C, a series condenser C_2 , capacity 0.001 μ F, and earth) cause high-frequency potential changes on the grid of the valve and consequent building up of amplified oscillatory currents in the anode circuit L_1 , C_1 .

High-frequency pulses of current from the high-tension battery B_2 , necessary to maintain the oscillations in the closed circuit L_1 , C_1 , are by-passed across the telephone receivers by the fixed condenser C_3 .

The currents in the tuned anode circuit are rectified by the detector D, and, as explained in detail in a previous article, a resultant low-frequency current will traverse the primary winding T_1 of the step-up iron-core trans-

former T_1 , T_2 , causing low-frequency variations in grid potential to be set up across the secondary winding T_2 , which is shown shunted by a fixed condenser and connected in the aerial circuit.

These low-frequency potentials are then applied to the grid of the valve, via the aerial tuning inductance L, and give rise to low-frequency changes in anode current which actuate the telephone receivers connected in the anode circuit.

As an alternative, the secondary winding of the iron-core transformer and the fixed condenser C_2 may be introduced into the grid circuit at the point marked X (Fig. 5). This modified arrangement works quite well, but there is a noticeable tendency for the complete receiver to become unstable, a state of affairs which gives rise to "howling."

(Further constructional details will be given next week.)

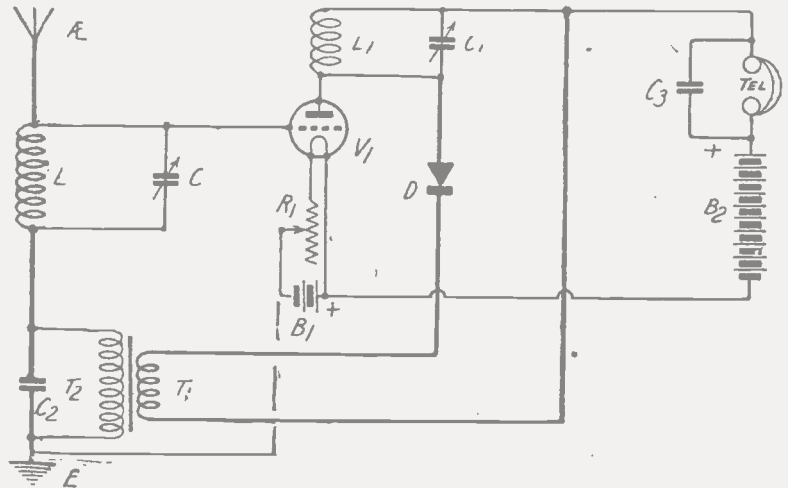

Fig. 5.—Dual amplification in a single valve. The theoretical circuit diagram of the receiver illustrated in the first photograph.

Post Office Prosecution.

DESCRIBED by the solicitor for the General Post Office as a case of some interest and importance, a prosecution for the alleged unlawful installation of a wireless telegraphic apparatus without a licence was heard at Hemel Hempstead Petty Sessional Court recently. The accused was Arthur Charles Hart, of 3, King's Hill Cottages, Berkhamsted, an electrician, and the prosecution was conducted at the instance of the General Post Office. There was a further summons for unlawfully working the apparatus without a licence. Accused

pleaded guilty, but without intention to defraud.

Mr. Gallaher, for the Post Office, said the intention was immaterial, having regard to the act.

Mr. Gallaher said that, although the accused stated that he dismantled the apparatus at the end of May, at the end of June he was found to be sending messages.

Accused was fined £2 for each offence, the chairman (Mr. Spencer Holland) expressing the hope that that would be a warning to him and to others that they must keep to the conditions of their licences, and not interfere with public rights and convenience.



Circuit for 1,600 Metres

THE increasing popularity of the 1,600-metre transmissions increases the number of practical circuits

The reply is in the affirmative. The use of the condenser enables a 200 plug-in coil to be used in the aerial circuit on any aerial, a .0005 μ F variable condenser

such a way that the current from the high-tension battery must pass through this lamp. The bulb will only allow a small current to pass—amply sufficient for the plates of the valve, but less than would be necessary to burn out a valve filament. Another device consists of a high resistance inserted in the high-tension lead, this also limiting the current to a figure below that necessary to burn out the valve. Both of these devices have disadvantages. The first kind, while excellent for many purposes, will burn out itself if the leads from the high-tension battery are short circuited, whilst the latter kind inserts high resistance in the circuit which may prove detrimental in some cases. A method not generally known which gets away from both of these disadvantages is to place in the high-tension lead a

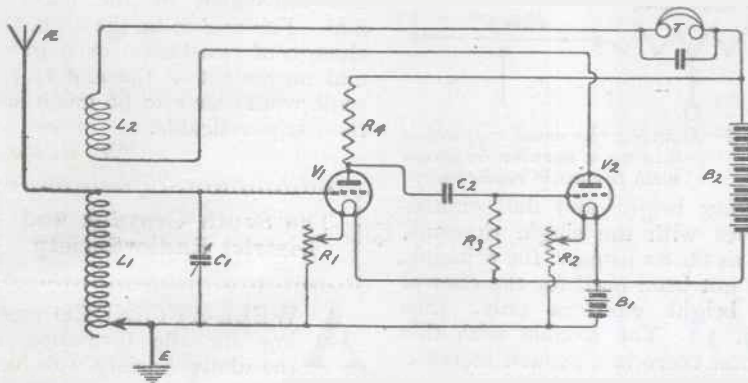

Fig. 1.—A resistance coupled H.F.-detector circuit for 5XX.

which may be employed for this wavelength.

Resistance amplification, which is of little use on the shorter wavelengths, such as 400 metres, now becomes a practical proposition, and circuits using resistance coupling may be tried with confidence.

It is not suggested that the results will be as good as when, say, a tuned anode method of coupling is employed, but on the other hand, it is possible to simplify the arrangements so that although a stage of high-frequency amplification is obtained, only one control can be employed.

Fig. 1 shows a suitable two-valve circuit which may be tried by those receiving on the 1,600-metre wavelength.

Fig. 2 shows a similar arrangement with a stage of low-frequency amplification added.

Constant Aerial Tuning

Inquiries are being made as to whether constant aerial tuning can be used on 1,600 metres.

being shunted across it. The usual .0001 μ F C.A.T. condenser is in series with the aerial lead. A slight reduction in

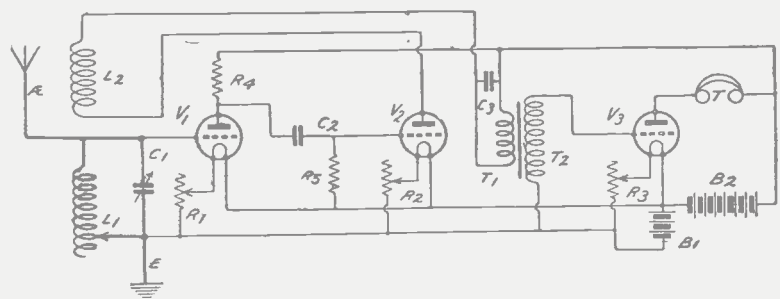

Fig. 2.—A similar circuit with an L.F. stage added.

signal strength may sometimes be noticed.

A Useful Valve Safeguard

When trying out new circuits on the experimental bench there is frequently a risk of burning out the valve by the current from the high-tension battery, and there are already on the market a number of devices devised as safeguards. One form consists of an ordinary flashlamp bulb fixed in the wander plug in

100-volt 30-watt lamp. The resistance of this lamp is not high, and will not in any circumstances pass sufficient current to burn out the average bright emitter filament. If, however, one can short circuit the lead from the high-tension battery so that 100 volts is applied across the lamp filament, then it will simply flow and not burn out. Incidentally, the bright flash of the lamp is quite sufficient to warn the experimenter in time.

Filament Control

MOST filament resistances are designed so that a given movement of the dial produces the same change of resistance in all positions of the dial. Now Richardson's formula for the thermionic emission from a heated filament for a given anode potential may be written

$$i = AT_e^2 - \frac{b}{T}$$

where i is the thermionic current, T is the absolute temperature of the filament, e is the usual exponential constant, and A and b are constants depending on the design and materials of the filament. If the curve representing this equation is plotted out, we get the result shown in Fig. 1. This agrees closely with the experimentally found curve. From this curve we see that the thermionic current, instead of increasing proportionally with the temperature, increases fairly slowly at first, but at higher temperatures increases very much more rapidly, a slight change in temperature making an enormous increase in thermionic current. The temperature where the large increase takes place is roughly that from yellow heat onwards, corresponding to the portion towards the end of the filament resistance. It is obvious that it is here that we require a very fine adjustment of resistance (and hence of filament temperature),

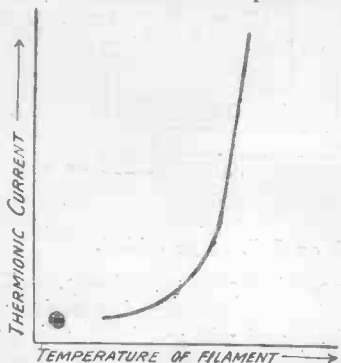

Fig. 1.—Illustrating relation of filament temperature to thermionic current for a given anode voltage.

yet most resistances offered for sale have no provision for finer adjustment towards the end of the scale.

Some get over the difficulty by putting a vernier in series with the main resistance. (See Fig. 2.)

Unfortunately, this involves the use of two knobs. Another disadvantage is that on a critical adjustment you might find yourself at the end of the vernier, and would then have to alter the main resistance so as to bring the vernier into use again.

Another way of partly overcoming the difficulty is to have the final part of the resistance wound with thicker wire than the beginning, so as to obtain a finer control at the end. This method has been used, I believe, for



Fig. 2.—Showing the usual method of adding a vernier in series with the main resistance.

trolling bright and dull emitter valves with the single rheostat, but as far as I know the principle has not been used for the control of bright emitters only. (See Fig. 3.) The trouble with this is that there is a sudden increase

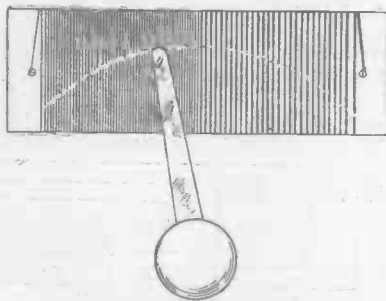

Fig. 3.—Illustrating the principle of a resistance which is wound with thick wire towards the end of the winding to give fine control.

in the sensitivity of the control which is not desirable.

A third method of winding rheostats to give increased sensitivity at the end of their scale is that shown in Fig. 4. The advantage of this method is that the sensitivity increases gradually. The wire can be wound on a shaped strip of fibre or mill-board and then bent into a circular form and fixed to a suitable former. Contact is made by a sliding arm on the edge of the coil, which, if of covered wire, should be bared. Since

succeeding turns are of decreasing size, and hence of decreasing resistance, there is a gradual increase in the sensitivity of control. Care should be taken to wire the rheostat up so that the



Fig. 4.—A suggested form of rheostat to give gradual control.

narrowest part of the resistance coil is being used when the filament is brightest.

Though this rheostat materially helps in fine control, it by no means makes the thermionic current directly proportional to the movement of the rheostat dial. For this to be the case, the change of resistance for a given dial movement at the end of the scale would have to be much less than is practicable.

W. E. M.

The South Croydon and District Radio Society

A WELL-ATTENDED meeting for the formation of the above Society was held on Tuesday, August 12, in the club room of the Society at "The Swan and Sugar Loaf Hotel," South Croydon. It was decided to hold the opening meeting of the Society during September; when it is hoped to arrange an attractive programme, details of which will be published in due course. Applications for membership will be welcomed by the Hon. Sec., George H. Tozer, 218, Brighton Road, South Croydon.

2-LO Heard 2,000 Miles

The Radio Communication Co., Ltd., received the following telegram from Captain Binney, Commander of the Oxford University Arctic Expedition, which is now near the North-East Land:—

"Oxford Expedition sends heartiest congratulations from North-East Land. Broadcast received perfectly over 2,000 miles from London. Polar transmitting set working admirably; is proving of utmost value and is safeguarding all our interests."

The "All-Britain"
Circuit on the . . .
Omni Receiver. . .

Another circuit which may
be tried upon this popular
experimental receiver.

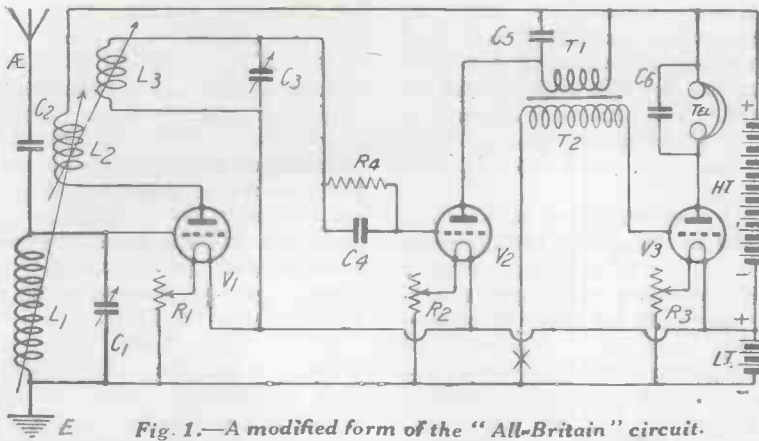

Fig. 1.—A modified form of the "All-Britain" circuit.

The All-Britain Receiver described in *Modern Wireless* for this month employs a three-valve "tri-coil" circuit, the first valve being a high-frequency amplifier, the second a rectifier, and the last, a note magnifier.

Fig. 1 shows a slightly modified form of the circuit of this receiver, the two vernier condensers in the original circuit being omitted. Constant aerial tuning is employed, the condenser C2 of 0.0001 μ F being included for this purpose. L1 is the aerial tuning coil, in parallel with which is the variable condenser C1 of 0.0005 μ F capacity. In the anode circuit of V1 is the coil L2, which is untuned. L3, tuned by C3 of 0.0005 μ F, is the secondary coil of the high-frequency transformer L2 L3, and is placed in the grid circuit of the second valve.

R4 and C4 are the grid-leak and condenser respectively, the value of R4 being about 2 megohms, and that of C4, the usual 0.0003 μ F.

The primary winding T1 of the intervalve transformer T1 T2 is in the plate circuit of the second valve, and is shunted by C5 of 0.002 μ F. The stepped-up voltages in the secondary winding T2 are applied to the grid of the note magnifying valve V3. In the anode circuit of this valve are the telephones shunted by the condenser C6 of 0.002 μ F.

At the point X, a small battery may be inserted to apply a negative voltage to the grid of the low-frequency amplifying valve.

Connections

The circuit lends itself to adaption on the Omni receiver,

and the following is a list of connections to be made between the various terminals on the set :—

51—11	43—27
3—1	42—40
9—52	10—48
2—1	22—46
1—12	21—6
9—10	22—24
4—25	30—16
17—24	29—48
33—34	8—31
41—42	23—24
34—35	32—40
35—19	31—47
14—27	23—39
21—45	

Coils

For wavelengths below 420 metres, a No. 50 plug-in coil should be inserted in the rear moving socket of the three-coil-holder. A No. 75 coil is suitable for the broadcast wavelengths above 420 metres. The centre socket of the three-coil-holder is that of the anode coil L2, for which a No. 75 or 100

coil is suitable. The coil L3, in the grid circuit of the second valve, may be a No. 75 coil, and is plugged into the front socket of the coil holder.

Owing to this arrangement of coils, it will be seen that variable reaction between the aerial coil L1 and the anode coil L2 is obtainable, and also, since the coupling between L2 and L3 is variable, selective reception is possible. The advantages of the foregoing do not need explaining.

Operating the Circuit

Having inserted the coils and valves, and connected the batteries to the set, tuning may be carried out, first of all keeping the coil in the rear socket well away from that in the centre, and the coil in the front socket closely coupled to the centre coil. The aerial is tuned by the condenser on the right of the panel, and the coil comprising the secondary of the transformer is tuned by the condenser on the

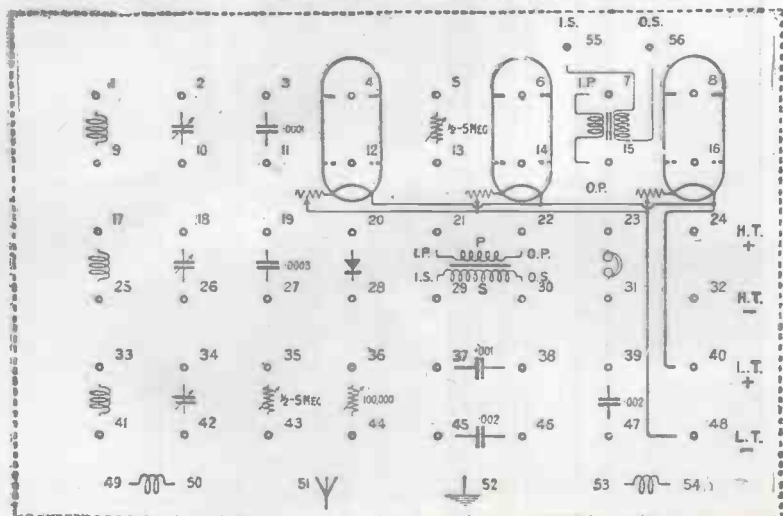

Fig. 2.—The terminal board.

left of the panel. The best value for the grid leak, which is on the left of the panel, must be found by experiment.

When best results are being obtained with the coils in the positions advised, the aerial coil may be brought up slowly towards the anode coil, retuning at the same time on the aerial tuning condenser until a point is reached where the set is just off oscillation point. Loudest signals are obtained with this adjustment, but the tone may be improved at the expense of a little strength, by reducing the coupling between aerial and anode coils and retuning again on the aerial condenser.

If the set will not oscillate with the aerial coil close to the anode coil, the connections to the former should be reversed. This may be carried out by disconnecting 1-3, 1-12, 1-2, 9-52 and 9-10, and joining 9-3, 9-12, 9-2, 1-52 and 1-10. There is also a correct and an

incorrect connection for the transformer secondary coil, and the effect of reversing the connections to this coil should be noted. The necessary alterations are:—Disconnect 34-35 and 42-40, and join 40-34 and 35-42.

Selective reception may be obtained by loosening the coupling between the transformer primary and secondary coils, and retuning carefully on the secondary tuning condenser. Variation of the reaction is also advantageous and often necessary after varying the coupling between the transformer coils, with a consequent retuning on the aerial condenser.

Experimenting with the Circuit.

When operating this circuit, it will be noticed that the tuning of the secondary coil is inclined to be rather critical, and this may be remedied by reducing the maximum capacity of the variable condenser which tunes this coil. This end may be achieved

by placing in series with the variable condenser, a fixed condenser of 0.001 μ F capacity, and incidentally this also reduces the minimum capacity of the variable condenser, which is another advantage. The necessary alterations on the terminal board are:—Disconnect 41-42 and 42-40, or, if the coil has been reversed, 41-42 and 42-35, and join 41-37, 38-42, and 40 or 35 as the case may be, to 41.

The connections to the secondary winding of the iron-core transformer may be reversed to see if better results are obtainable by this means. Disconnect 30-16 and 29-48; join 29-16 and 30-48.

The introduction of grid bias for the last valve will tend to improve the quality of speech and music. The addition of a small battery external to the set is necessary. Disconnect the lead 29-48, and join 29 to the negative terminal of the grid battery, and 48 to positive.

JOHN HENRY AT WORK

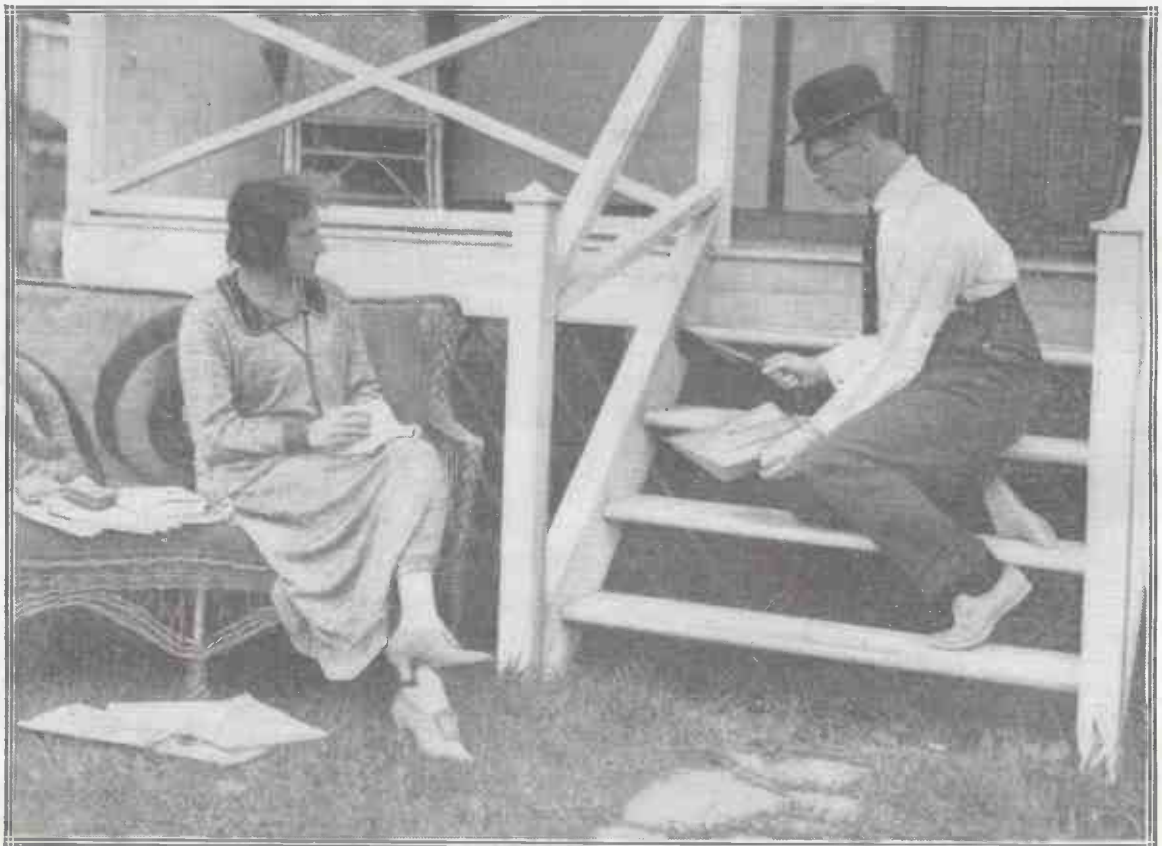

Our old friend is here seen sweeping the steps of his bungalow, while "Blossom," his wife, supervises the proceedings.

Handy Fixed Condensers

HERE is a very neat way of making up small fixed condensers to use on the wireless set. Besides being extremely simple to turn out in the workshop, these condensers are very compact, measuring only 1 in. by $\frac{3}{4}$ in. for any capacity from $.0001\mu\text{F}$ to $.005\mu\text{F}$. Moreover, if the best ruby mica $.002$ in. thick is used, the constructor may be sure that his condensers are of the desired capacity.

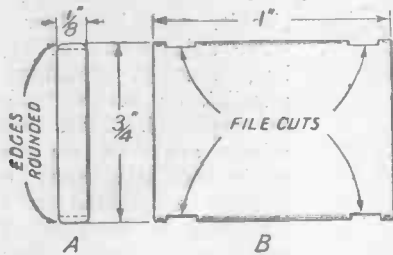

Fig. 1.—Details of the formers.

Obtain some good-quality $\frac{1}{8}$ -in. ebonite and remove the surface with emery paper. Now cut out as many formers as you require condensers, 1 in. in length and $\frac{3}{4}$ in. wide. Slightly round off the long edges of each with a fine file as shown in Fig. 1A, and make also shallow grooves at the ends of the former as shown in Fig. 1B. Now cut out some pieces of mica of the same size as the former and fix one of these to its face with shellac.

How is it possible to tell when a valve set is oscillating?

By listening carefully for a very distinctive "cluck" which occurs at a definite point as the reaction coupling is tightened and again, at approximately the same point, as the coupling is loosened. If the grid connection of the oscillating valve is touched with the finger, a somewhat different and a very much louder click is produced.

Will an increase in the size of a Tuning Coil result in reception from greater distances?

No. The distance over which signals can be received depends primarily upon the power of the transmitting station and the sensitiveness of the receiving apparatus. Increasing the size of the tuning coil

The plates are made of copper foil. They should be cut each 1 in. long and 1 centimetre wide. Shellac the first plate to the mica as shown in Fig. 2, allowing $\frac{1}{4}$ in. of it to project beyond the former. Cover with a sheet of mica and fix the second plate in the same way, making the overlap between the two exactly 1 centimetre. The two plates with this overlap will give a capacity of $.0001\mu\text{F}$. A condenser of any capacity can be made by simply adding one dielectric for each extra $.0001\mu\text{F}$ required. Thus a $.0003\mu\text{F}$ condenser such as is used for insulating the grid of the rectifier would require

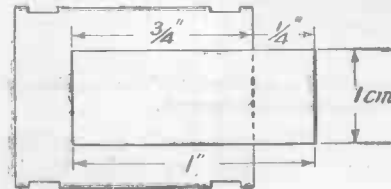

Fig. 2.—The mica sheets and copper strip.

three dielectrics and four plates with an overlap of 1 centimetre. Use thin shellac and do not put on more of it than is absolutely necessary.

When you have fixed as many plates as you require place a sheet of thicker mica over the last and then put the condenser

under a warm, heavy flat iron to dry. Press the iron well down on to it in order to make it as solid as possible. Care should be taken when fixing the plates and dielectrics to press them well down with the fingers so that there may be no air bubbles, for the presence of these will affect the capacity.

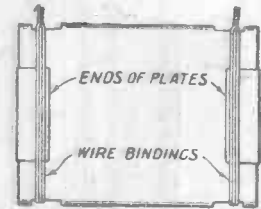

Fig. 3.—The final assembly of the condenser.

When the shellac has set, bind the ends of each set of plates together with a little solder and bend them round to the back of the former, as shown in Fig. 3. Now take some fine copper wire and bind as shown in the drawing. The ends of the binding wires should be twisted together and soldered. At the place where the bindings cross the ends of the plates a little solder should be applied to make all secure. The twisted ends now form handy points for the attachment of contact wires. If desired firmer contacts can be made by driving 4 B.A. screws right through from front to back at the ends of the plates and securing them with small nuts which should be soldered to the copper.

R. W. H.

Some Simple Questions

does not in any way affect either of these essential conditions, but merely increases the range of wavelength to which the receiving set can be adjusted. Incidentally, the high-power long-distance stations usually employ long wavelengths, so that for reception of their signals a large tuning coil will be required, and although reception of signals from this class of station may be obtained over great distances, it is entirely due to the high power employed.

Should the earth lead be insulated?

Not in the case of a receiving station, as the difference in efficiency would certainly not be

appreciable unless the lead was of very abnormal length. In the case of transmitting stations where the greatest possible efficiency is desired, the earth lead is generally insulated right up to the actual earth plate.

How much amplification can be obtained from each High-frequency Valve?

The addition of a single high-frequency valve to a receiver consisting of a rectifier only will appear to increase signals from perhaps 2 to 3 times, but the successive additions of further high-frequency stages do not maintain the same rate of improvement, so that little or no benefit may be perceptible on adding, say, a third high-frequency valve unless very special precautions have been taken.

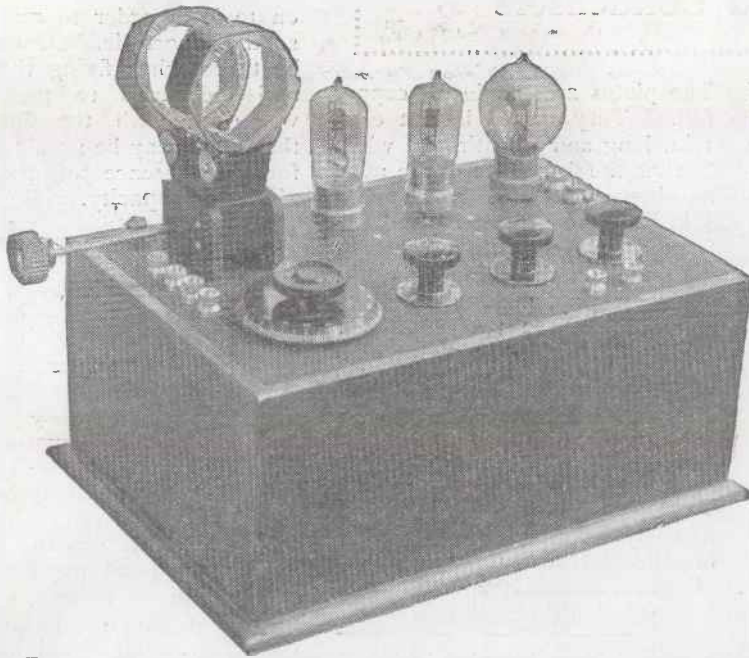

Fig. 1.—The compact appearance and neat layout of the receiver may be gathered from this photograph.

FOR distortionless reception of the local broadcasting station, a useful form of receiver is that comprising a rectifying valve followed by resistance coupled note magnifiers. Loud-speaker reception is in many cases much improved by this form of coupling, although it must be realised that the volume of sound obtained from two stages of resistance coupling is not so great as if low-frequency transformers were used, two stages of the former being roughly equal to one stage and a-half of the latter. The purity of tone obtainable is very noticeable when compared with cheap transformers, and will appeal to those who do not require merely loud signals, but who desire faithful reproduction above all. The receiver to be described takes the form indicated, and will be found very useful for loudspeaker reception up to about 15-20 miles from the nearest station.

The finished receiver is seen in the photograph Fig. 1. The two-way coil-holder carries the aerial tuning and reaction coils, the aerial tuning condenser being seen in front of the coil-holder.

The terminals on the left of the receiver are those in the aerial

A Resistor Three-Val

By HERBERT

Full constructional details of the receiver are given below. The fascination of the home constructor and

circuit, and by their aid the three chief forms of aerial tuning, namely, constant aerial, parallel, or series tuning may be employed. The battery terminals are seen on the right, while the telephones or loud-speaker are joined to the two terminals in front of the filament resistances. Fig 2 is a straight-on view of the panel, from which the layout may be gathered.

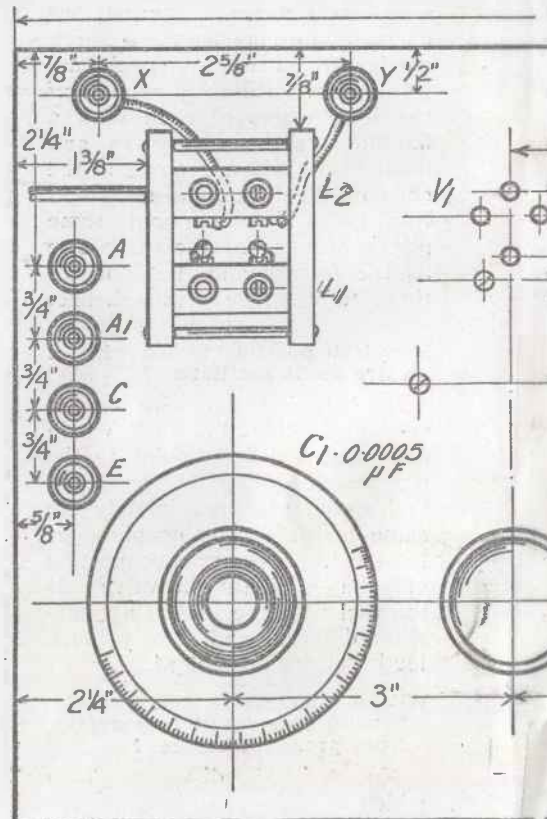

Fig. 3.—This drawing shows the layout of the panel for the home constructor to mark his panel correctly. The

Resistance Coupled Wave Receiver

By R. K. SIMPSON.

Who to build this very useful receiver are
resistance coupling will appeal to both
the experimenter with equal force.

The Circuit

The theoretical circuit diagram is given in Fig. 5, and it will be clear that the valve V_1 acts as a rectifier, reaction being obtained by coupling the coil L_2 to the aerial coil L_1 , while V_2 and V_3 are note magnifiers. The values of the various condensers, resistances, and so on are marked upon this diagram, which is thus rendered self-explanatory. The arrangement

of aerial terminals is as follows. By joining the aerial lead to A and connecting C and E together constant aerial tuning is applied, while if the aerial is joined to A_1 , leaving A free, and C joined to E, the constant tuning is omitted, the simpler form of parallel tuning being substituted. Series tuning is obtained

by joining aerial to C, earth to E, and leaving A and A_1 free. The earth connection is joined to E in all cases. Provision is made for reversing the connections to the reaction coil, the terminals X and Y being used for this purpose.

Parts Required

For the guidance of those readers whose intention it is to construct this receiver, a list of the necessary pieces of apparatus is given below. The names of the makers are in some cases added, but the constructor may use any equivalent makes should he so desire. All those parts used in *Wireless Weekly* sets have been fully tried, and may be used with confidence.

One cabinet with panel space 12 in. x 8 in.

Ebonite panel, 12 in. x 8 in. x $\frac{1}{4}$ in. (Paragon, Peter Curtis, Ltd.).

1 two-way coil-holder (Goswell Engineering Co., Ltd.).

1 0.0005 variable condenser (K. Raymond).

3 filament resistances (Burndept, Ltd., dual type).

3 valve holders (H.T.C. Electrical Co., type C).

2 100,000-ohm resistances (Dubilier Condenser Co.)

2 2-megohm resistances with clips (Dubilier Condenser Co.).

2 0.01 T.C.C. condensers.

2 0.0001 condensers (Dubilier).

1 0.0003 condenser with 2-megohm leak (Dubilier).

1 0.004 condenser (Dubilier).

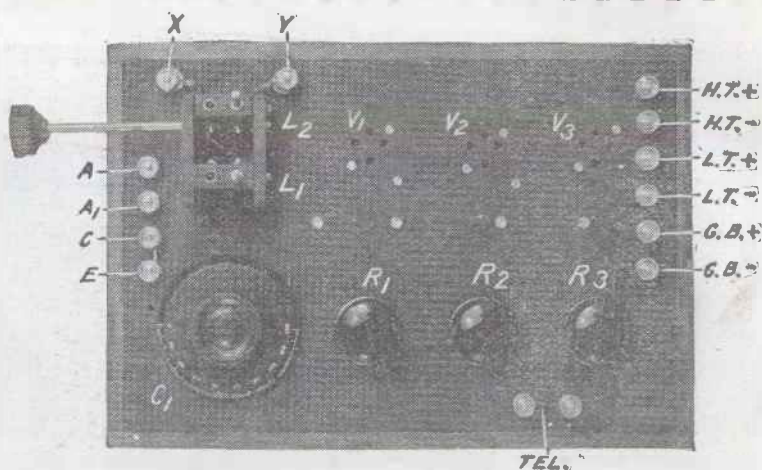
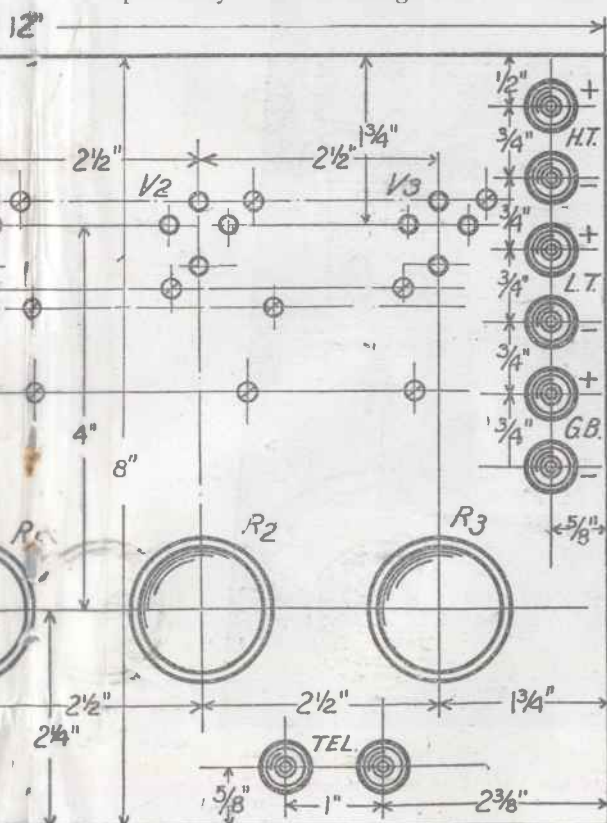

Fig. 2.—A plan view of the panel.



el, all the necessary dimensions being given to enable the
this drawing is exactly half-size. Blue print No. 63a.

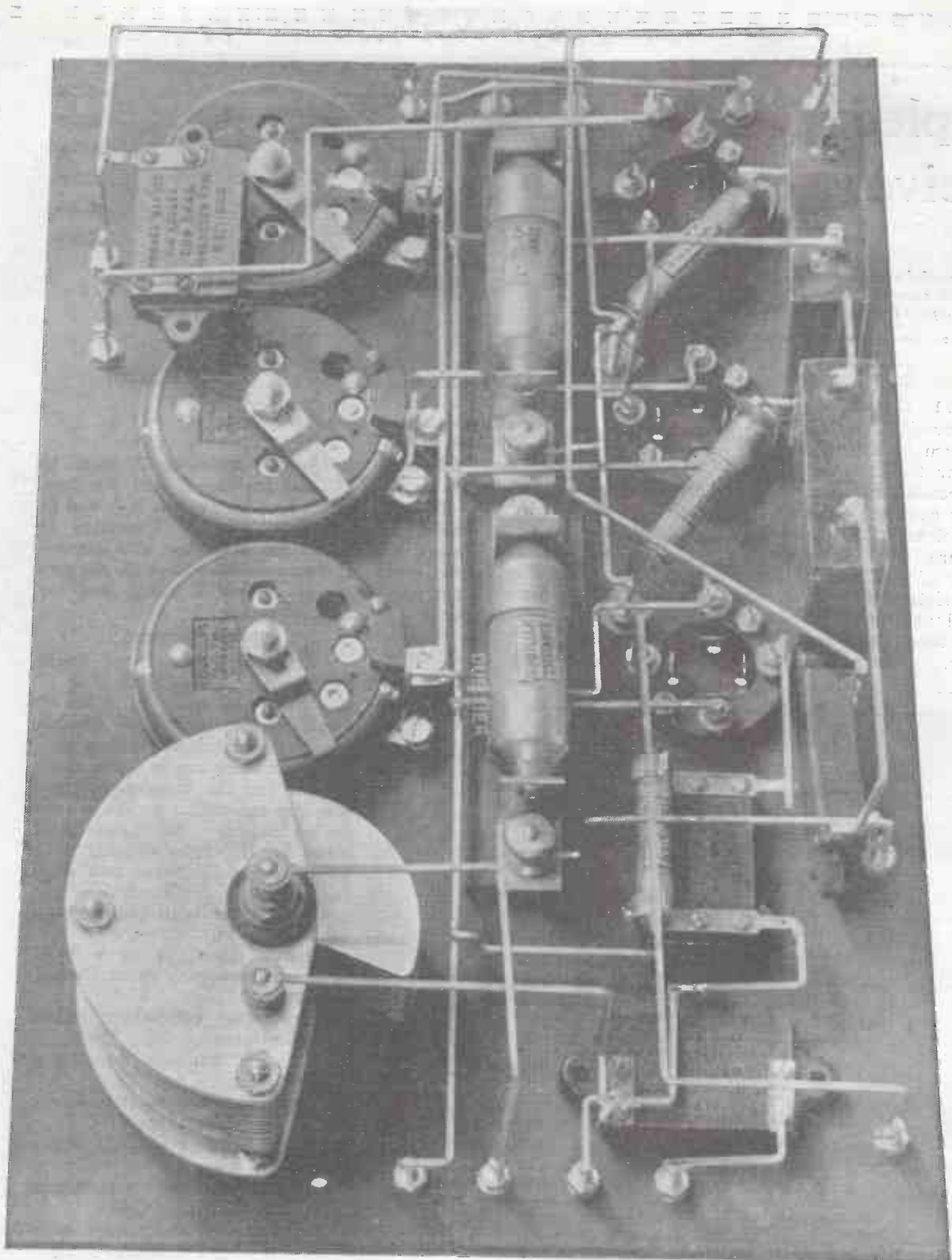

Fig. 4.—A photograph of the underside of the panel. The layout of the wiring is made clear. Note how the grid leaks are secured.

14 terminals, 4 B.A., W.O. type.

Square wire, flex leads, 2 spade terminals.

Drilling the Panel

Fig. 3 is a drawing of the top of the panel, showing the layout and all necessary dimen-

sions. The ebonite used should be of the best quality, free from surface leakage, but if unguaranteed ebonite is used, the surface

skin should be removed with emery cloth before commencing work on the panel.

Use a scriber for marking out

tioned are supplied with drilling templates, thus rendering the accurate drilling of the holes a much easier task.

condenser plates if this operation is left until a later stage. If, however, the constructor intends to make his own cabinet to fit the panel, no such trouble need be taken, and the parts may at once be secured in position on the panel. This operation is simple, and calls for no comment, with the possible exception of the large Dubilier resistances. These are sold already mounted on a strip of ebonite, and should be mounted directly on the panel as they stand. Do not attempt to remove the clips from the original ebonite strip, as much time and trouble will be spent which might be otherwise usefully employed.

Two flexible leads, ending in spade terminals, are taken from the screws on the moving coil holder to the terminals marked X and Y.

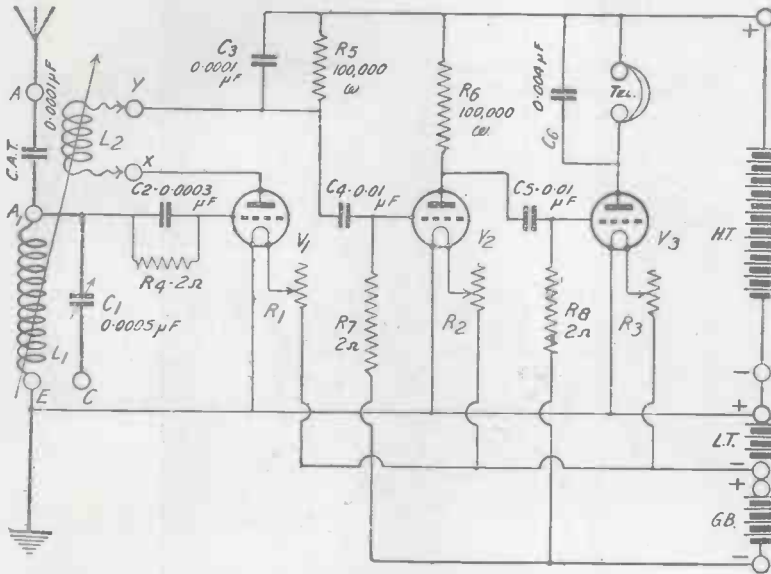

Fig. 5.—The theoretical circuit.

the panel, and lightly scratch the lines on the ebonite, the centres of the holes being afterwards marked with a centre-punch. The filament resistances and valve-holders of the type men-

If the panel is to be fitted into a cabinet, it will be found best to ascertain whether any fitting is necessary before the parts are mounted up, as the ebonite filings will get in between the

Wiring

Wiring is carried out with square section tinned copper wire, and should present no difficulty if the layout given in the wiring diagram Fig. 6 is followed. Carefully bend each piece of wire to fit between its

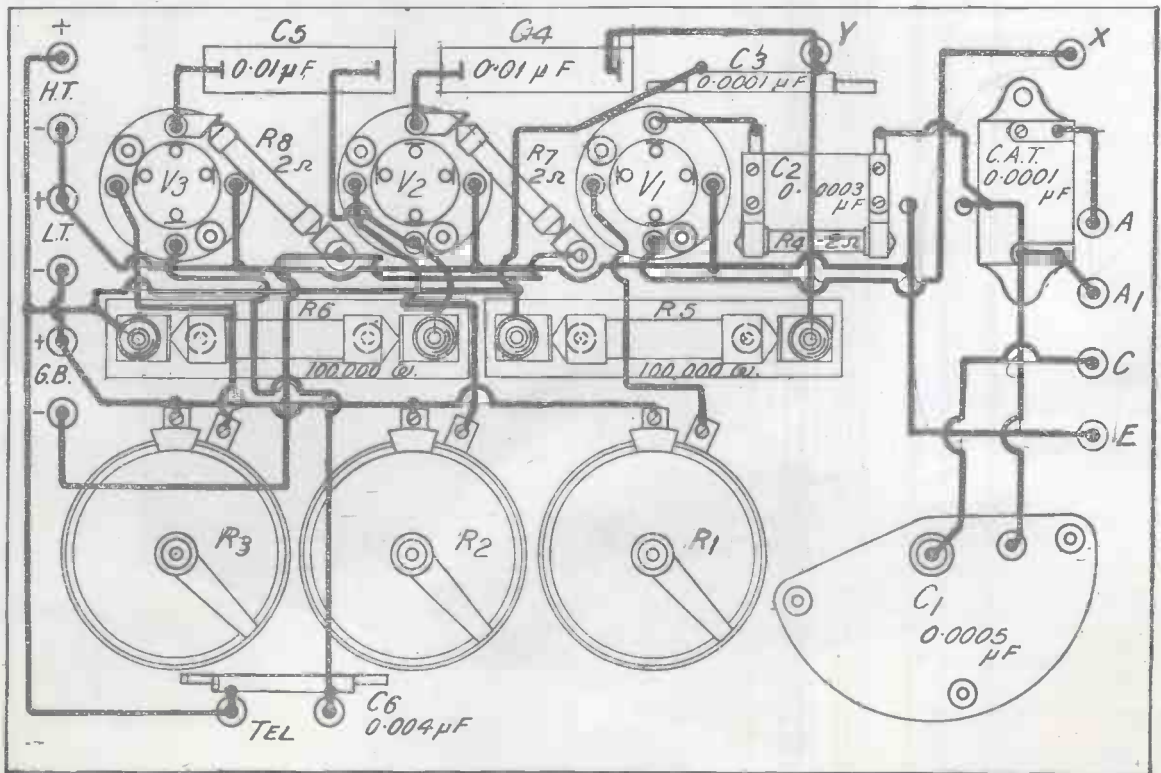

Fig. 6.—The wiring of the receiver. Blue print No. 63b.

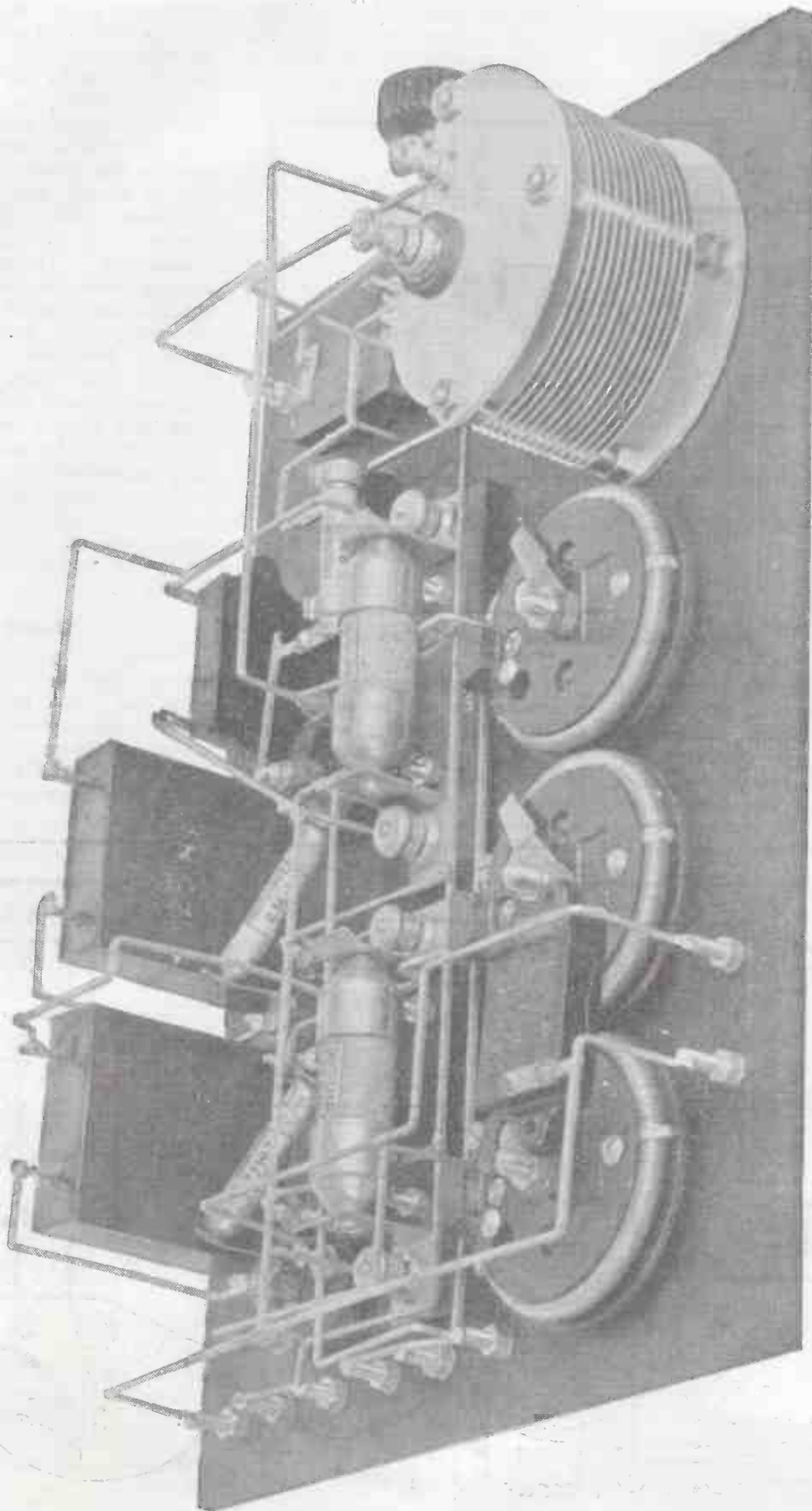

Fig. 7.—Another back-of-panel view, showing how the resistances and large condensers are mounted.

correct points before soldering up, as this is a great help. The large photographs of the back of the panel, Figs. 4 and 7, will help to make the wiring layout clear.

The Cabinet

When completed the panel may be mounted up in some form of cabinet, the actual type being left entirely to the reader's taste. In the case of the actual receiver described, a flat-top box-type of cabinet was employed. If desired, the cabinet may be purchased ready made from any of the firms specialising in this class of work.

Coils to Use

When using constant aerial tuning, the aerial coil L₁ may be a No. 50 plug-in coil for waves up to 420 metres, above which a No. 75 may be tried. The reaction coil L₂ may be a No. 75. For the longer wavelengths, such as that used by 5XX, the aerial coil L₁ may be a No. 200, while a No. 200 or No. 250 will be suitable for

reaction. Almost any good make of valve will be found satisfactory in this receiver, and the constructor may already possess some general-purpose receiving valves which will be suitable. Dull-emitting valves may be used, as suitable rheostats are incorporated in the receiver. For the reception of long waves, such as 5XX and Radio-Paris, without the incorporation of constant aerial tuning, the aerial should be connected to A₁, A being left free and coil No. 150 used for the aerial, and No. 200 or 250 for reaction, the remaining connections being the same.

Grid Bias

When using high anode voltages, some negative bias may be found necessary on the grids of the low-frequency amplifiers, and a pocket-lamp cell may be joined across the terminals provided, marked G.B., the best voltage being found by trial. If no extra grid bias is applied, the terminals GB+ and GB- must

be joined together by means of a piece of wire.

Operating the Set

Having joined up the batteries and telephones, and inserted the valves, join the aerial lead to A earth to E and join C and E together by a short external link. Insert a No. 50 coil in L₁ and a No. 75 in L₂ if short-wave broadcasting below 420 metres is to be listened for. Turn on the valves, keeping L₂ well away from L₁, and tune carefully on the variable condenser C₁ until signals are heard, when the coil L₂ may be gradually brought nearer to L₁. If this does not increase signal strength, the connections to the reaction coil should be reversed by changing over the leads from the coil holder to the terminals X and Y. Do not bring the two coils too close together, or the set will oscillate, causing interference to near-by listeners.

(A Test Report upon the working of this receiver will be given in our next issue.)

ARMY WIRELESS



The Army manoeuvres which took place this Summer included many interesting wireless experiments. Our photograph shows a section of the Royal Engineers with one of their portable stations in operation.

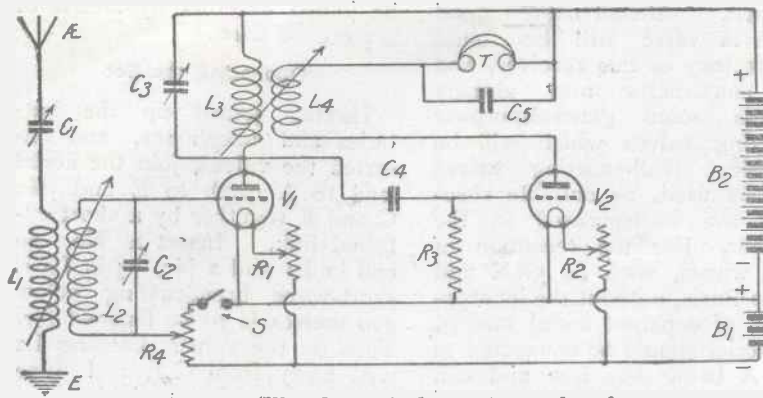

Fig. 1.—The theoretical circuit employed.

As will be seen from Fig. 1, this receiver consists of one stage of high-frequency amplification followed by a valve rectifier. The aerial tuning condenser C_1 has a capacity of $0.001 \mu F$, and is placed in series with the aerial coil L_1 , which is loosely coupled to the secondary coil L_2 . The latter coil is tuned by the available condenser C_2 , having the usual capacity of $0.0005 \mu F$.

In the plate circuit of V_1 is the anode coil L_3 , tuned by the condenser C_3 of $0.0003 \mu F$ capacity. C_4 and R_3 are the grid condenser and leak respectively, the former having a value of $0.0003 \mu F$, and the latter two megohms. Reaction is introduced by means of the coil L_4 , which is variably coupled to the anode coil L_3 . In series with L_4 are the telephones T , shunted by the fixed condenser C_5 , which may have the customary capacity of $0.002 \mu F$. The lower side of the secondary coil L_2 is connected

to the slider of a potentiometer R_4 , whose ends are connected to

with respect to the filament, simply by rotating the potentiometer knob.

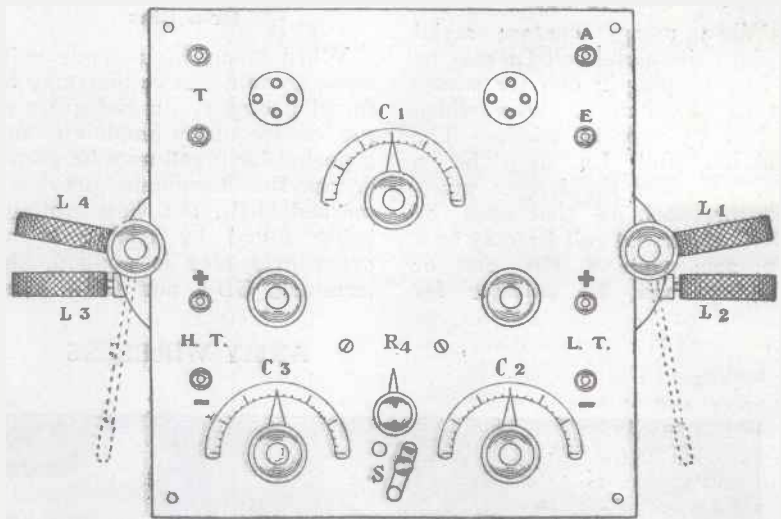

Fig. 3.—The lay-out of the panel.

the terminals of the filament accumulator B . Thus the grid of V_1 may be given a variable voltage

meter knob. Any tendency towards violent oscillation may be rectified by this means.

The small switch S is included to break the lead to the potentiometer when not using the receiver, in order to eliminate wastage of current from the accumulator.

The two coils L_1 and L_2 are placed in a two-coil holder on the right of the cabinet containing the ebonite panel; L_2 and L_3 plug into a similar holder on the left of the cabinet. The potentiometer, whose resistance should be about 400 ohms, is of the rotary type.

If difficulty is encountered in getting the receiver to oscillate, the leads to the coil L_4 should be reversed by connecting the wire from the top telephone terminal to the point Y , and the wire from the second valve plate socket to the point X , Fig. 2.

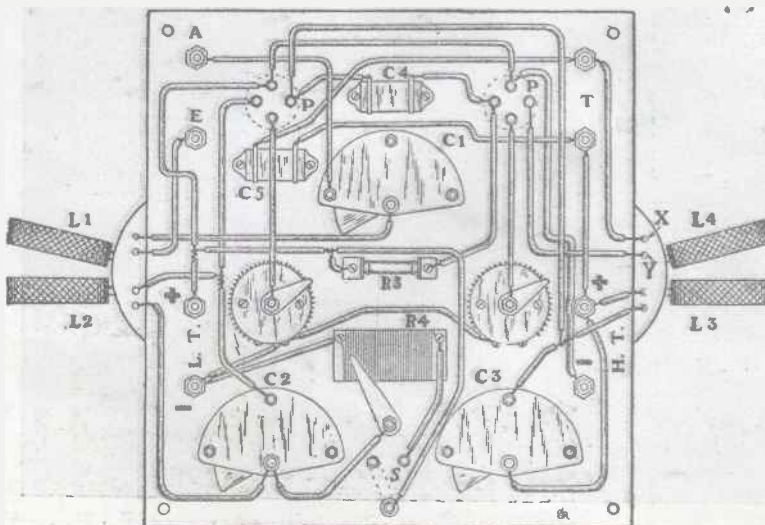
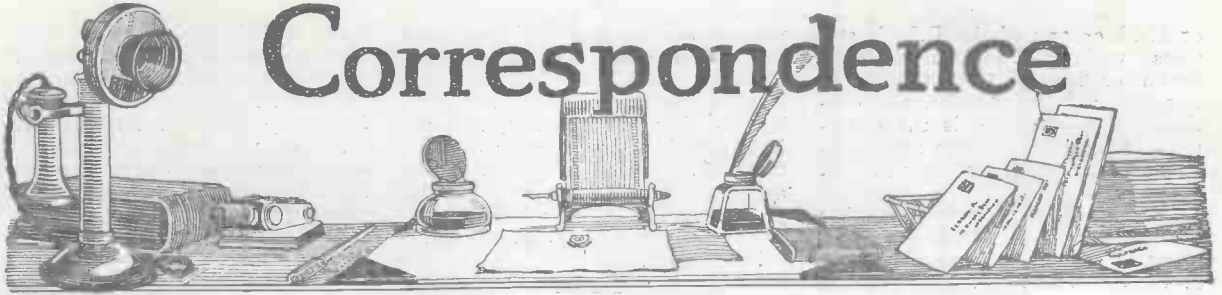

Fig. 2.—The practical wiring arrangements.

Correspondence



RECEIVING 5XX

SIR,—The way in which the majority of your correspondents criticise the transmissions of 5XX is really most amusing. In nine cases out of ten it seems to me that they are not genuine critics, for how can they justify their sweeping statements by carrying out simple tests in the *actual swamping area*? Most of the letters published have been written by experimenters residing in or around London. I myself have carried out tests with this station 15 miles from Chelmsford, and although reception on loaded broadcast sets was fairly good, it was none too pleasing; but I was in no way disappointed, probably because I expected nothing better.

The real test should be carried out

in an area as near to the prescribed 100 miles limit as possible, for the transmissions from this station are intended to reach the outlying districts.

I am at present situated at about 90 miles from 5XX, and using a very crude crystal set with single slide inductance; results are all that could possibly be desired. The volume is decidedly louder than that from 2LO—using a similar receiver 10 miles from London.

Aerial poles are cheap in the country; in fact, the whole outfit can be installed for less than £5, for one needs nothing elaborate in the way of a receiver. Everyone from the farmer to the cow-boy are now talking of wireless and of “that new station,” and instead of saving their

money for the annual “bust” at the village fair, they are now saving it for a crystal set. May the organisers of the new high-power station receive all the praise they deserve.—Yours faithfully,

OSWALD J. RANKIN.

Pluckley, Kent.

SIR,—With reference to the various reports of reception of 5XX, and its sometimes rather cool acknowledgment by London wireless people, it may interest them to know that 5XX is the only British station that coastal dwellers can hear without continual interference. The whole of the broadcast wavelengths are at the mercy of ship and shore spark stations, and for us in Brighton to be able to receive 2LO

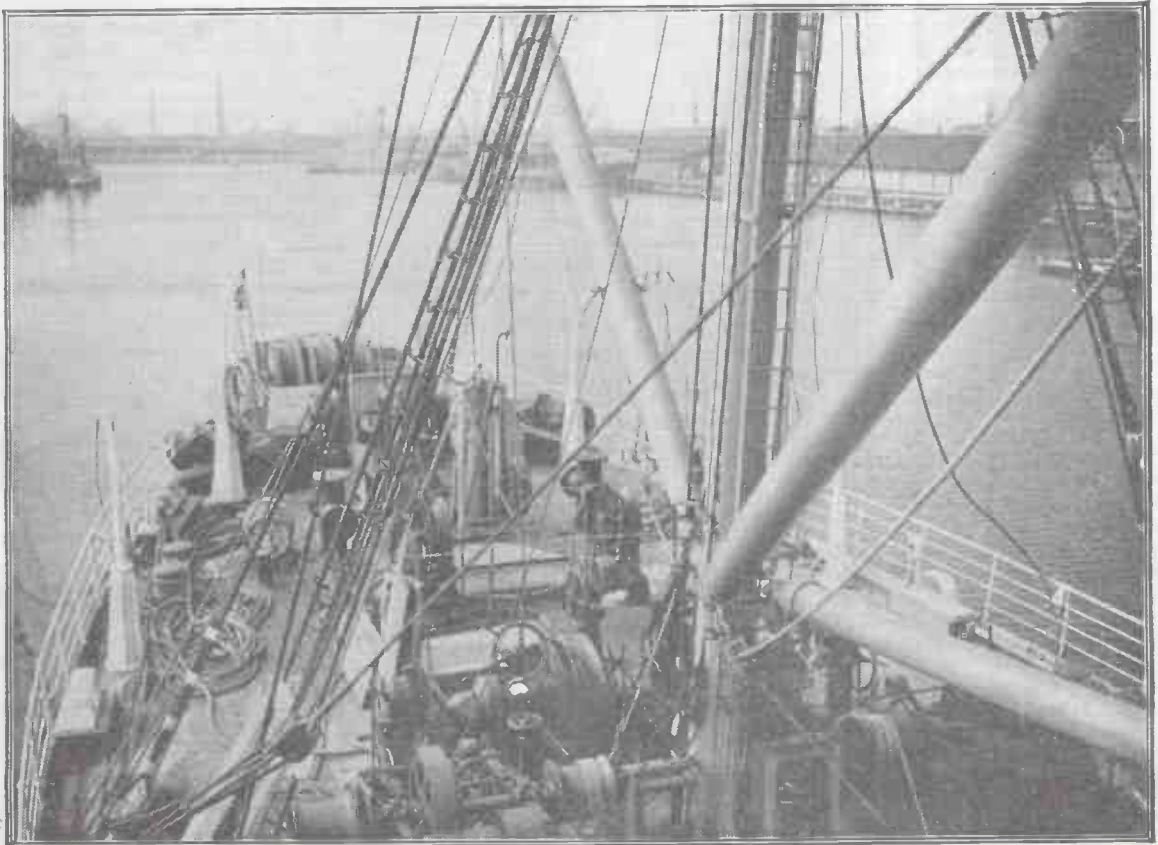

This photograph shows the “bow sheaths” on board the “Cyrus Field,” for raising and lowering cables. This vessel which left the Thames recently is carrying D.F. apparatus in addition to her general wireless equipment.

or 6BM or any of the B.B.C. stations without the bark of Newhaven or the spluttering duck of Dieppe, not to mention the continual ship jamming, is the exception. I have heard these spark signals over 100 yards from my B.T.H. speaker.

London listeners must remember that 5XX was not built for them alone. There are other radio people in these Islands.

So far as actual signal strength of 5XX is concerned, it appears to be received here on almost any sort of set, crystal up. This, anyway, is my experience. With four valves it is enormous, five I cannot use except in the open air. Its modulation seems good, but somewhat naturally, not quite up to 2LO or 6 BM. A power valve improves the tone immensely.

Brighton, by the way, is not by any means a "dead spot" as many people imagine. Many of the out-of-the-way Continental stations come in well, as well as all the B.B.C. stations. Quite a number of us here have received U.S. broadcasting.—Yours faithfully,

J. W. BURHOPE.

Brighton.

SIR,—My reception of 5XX is excellent and very economical, inasmuch as my valves only require sufficient current to light them. As a matter of fact, I do not need any reaction even when using an A.R.23 loud-speaker.

We are now able to take the benefit of the London programme, the reception of which previously was very indifferent, owing to fading and the screening from the Downs. Yours faithfully,

A. AISBITT-GIBSON.

Hove.

SIR,—I have nothing but praise for the station 5XX.

Being a travelling workman who frequently gets to some of the most out-of-way spots one can find in Britain, I have built a set with the ST100 circuit, but using a different lay-out to the published plans. For the containing box and panel I use a 3d. margarine box, stained and varnished a dark colour, fitted with handle, hinges, hasps and lock from a local bazaar. The components are mounted on a varnished three-ply panel bushed with ebonite where required.

A few weeks ago, when 5XX started, I could easily receive both 5XX and 2LO at Stratford E., on a short temporary aerial. Radiola could also be received with only the very slightest interference from either one or the other. So, London complainers, how is it I can do this on a poor man's set? Here at home, four miles N.W. of 2ZY, on a 24-ft. indoor aerial 5XX comes in

well on an Amplion Junior without any interference. On the 'phones, however, 2ZY is just audible. Radio-Paris is too weak for L.S., but is fair on 'phones, and the local station is silent as when on 5XX. I use A.R.D.E. valves and Nos. 6 and 7 Oojah coils for 5XX and FL.—Yours faithfully,

J. B. MASON.

Pendlebury.

MR. BROWN REPLIES

SIR,—With reference to the recent correspondence regarding the reception of 5XX, it is to be regretted that Mr. Cree, Colonel Dennis and "Experimenter" did not read my letter more carefully before giving their experiences. Had they done so, they would have noticed that I confined my remarks entirely to the reception of Chelmsford in the London area; reports on its reception in the provinces have not the slightest bearing on the point at issue.

It is particularly unfortunate that "Experimenter," with a complete lack of the caution one would expect from a Scottish correspondent, should, in his haste to deliver what he imagined was a crushing retort, miss this essential point and thus render his effort wholly abortive. "It is, to say the least, absurd!"

I have read the letters from London listeners with much interest; Mr. Dyer may care to learn that, as the crow flies, I am about 4½ miles from 2LO and 32 miles from 5XX.

Since writing my first letter I have met two listeners, both in the S.W. district, who are unable to get even a whisper from Chelmsford on a crystal set, and I adhere still to my opinion that the majority of Londoners are disappointed with the results from that station. I draw this conclusion from my own and my friends' experiences, and this conclusion has been further justified by letters and articles which have appeared in the Press.

In the *Radio Times* of August 15, Captain Eckersley himself, in an article on the results that are being obtained from 5XX, admits that "from London there is an undercurrent of growling dissatisfaction," and this of itself is sufficient to show that my contention is not the moonshine some apparently imagine it to be.—Yours faithfully,

CHAS. P. BROWN.

S.W.11.

ST100 ENVELOPE

SIR,—I wish to write and compliment you on the now well-known ST100 circuit, which I tried out for the first time recently with very satisfactory results.

All B.B.C. stations were received (except Aberdeen), and also two French stations.

Cardiff, Bournemouth and Chelmsford were good on loud-speaker.

My set was constructed from the details given in your ST100 Envelope, and you are entitled to very great praise for the patient and careful way in which every detail is explained and illustrated in the instructions. No alteration was made in the circuit, but D.E.R. Marconi valves were used with a two-volt Fuller block accumulator.

Bath is not supposed to be one of the easiest towns in England to get good results, and therefore a lot of the credit for my good fortune must be due to you and your circuit.—Yours faithfully,

G. BECKWITH.

Bath.

APPRECIATION

SIR,—About two months ago I became interested in wireless mainly because my sister brought home a very cheap and nasty crystal set that would not work. She was very disappointed because we could get no results, so I employed a man to make me a crystal set and erect an aerial. This he did at a cost of £3, and we obtained passable results. At this stage I found there was a book published called *Wireless Weekly*. This started my interest, and after reading several articles I purchased your envelope with instructions for the Four-valve Family Receiver.

Being a mere novice, I anticipated some difficulty, especially as I had no experience of soldering. I, however, followed the instructions to the letter, and the result is an exceedingly efficient set (although mounted on three-ply wood) with which I am very, very pleased. In fact, I will say this, that it gives better results both as to quality and quantity than a commercial receiver I thought of buying at a cost of £26, whereas mine cost about £8 10s., including valves. The details and diagrams are so clear that when in front of you it is as though the author himself were talking to you.

I have used first-class components throughout, and 1 Cossor H.F., 1 ditto L.F., Mullard Ora as detector, and Marconi as second L.F. Birmingham, 2LO, 5XX, Radiola, and Bournemouth all come in at L.S. strength, and a feature is the pureness of tone.

I think the switching arrangements excellent and a great convenience. I have made a wave-trap for use with Radiola and 5XX owing to the two stations coming in together, and find I can now separate them quite easily.

Congratulating you on your paper and your "envelope," and assuring you that I shall be a constant reader.—Yours faithfully,

G. BROWNE.

Kensington, W.14.

A NEW STATION

SIR,—I should be glad if you or one of your readers could inform me of the identity of a German broadcasting station which was testing at about 10 o'clock last Tuesday (August 12). An announcement was made in English to the effect that they were testing for long-distance reception, and the words "Hallo, England, Hallo, the British Isles" were frequently used.

The set I was using was the All-Concert three-valve, but the station was readable on two valves 0-V-1; the English, however, was very broken.

Hoping you will be able to publish the identity of this station, and thanking you for the numerous good things recently published in *Modern Wireless* and *Wireless Weekly*,—Yours faithfully,

S. TOWNSEND.

Gloucester.

THE PARADISE OF THE ETHER HUNTER

SIR,—I read with mingled feelings of amusement and pity the

article entitled "The Paradise of the Station Hunter," by your American contributor, Mr. George Barnard, in the issue of *Wireless Weekly* dated August 13, 1924. I say pity, for one cannot help feeling sorry for the fellow who thinks there is nothing so good in the world as that which is his. Of course, I know we Britishers cannot compete with the Americans for "swank," but I consider your contributor has drawn an exceptionally long bow in this instance.

As one who has had experience of the conditions prevailing in the American ether may I shed a little light on Mr. Barnard's "Paradise." It is certainly quite true that America has as many broadcasting stations in one city as we have in the whole country, but can this be called an advantage? The average broadcast listener in, say, New York, has the utmost difficulty in eliminating the stations not required, and more often than not this is not possible at all, with the result that he is forced to listen to the desired programme mixed up with that from another station. Imagine listening to, say, a Beethoven Sonata at the same time as a jazz band playing music lamenting the lack of bananas—it would be terrible whichever way your musical tastes lie. Yet this is what the American listener-in has to put up

with just because he lives in a "Radio Paradise." Compare this with the conditions existing in London. Apart from the few squealers and canaries, our interference is nil.

Mr. Barnard tells us that he entertains his friends nightly with selections from the programmes of twenty different stations in as many different States between the Atlantic and Pacific coasts, or, as he calls it, "a radio fishing pond of three thousand miles or so across," to include the U.S.A. only. It is significant, however, that he tells us nothing of the quality of the reception, especially the stations at the "three thousand miles or so" distance. We all know that telephony reception at distances exceeding 50 miles becomes somewhat poor from a musical point of view, and apart from the wireless interest, is not really worth listening to. I should imagine, therefore, that Mr. Barnard's friends, especially the musically-inclined and radio-disinterested ones, are not at all pleased with his nightly entertainment.

Then we have the question of programme quality. Those of us who have listened to WGY, KDKA, WHAZ, and others, have noticed the vast difference between the quality of the programme given by the American stations as compared with 2LO and other B.B.C. stations, the latter being very much more enter-

ENSURE THAT YOUR WIRELESS RECEIVING SET IS SIMILARLY EQUIPPED.

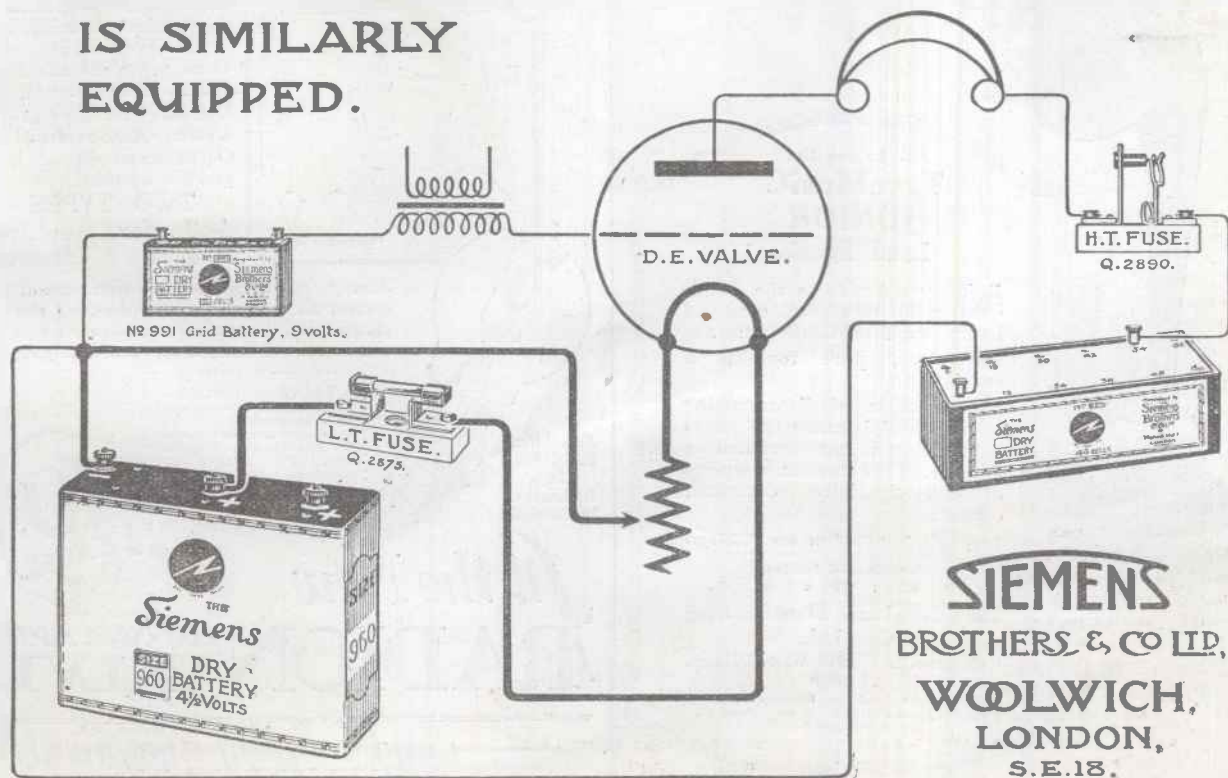

taining in every way. In fact, without prejudice, I consider that the B.B.C. programmes are very much better than those of any other station to which I have listened, and in this regard I may say I have logged practically every broadcasting station in Europe and also many from the "Paradise"; a "radio fishing pond," not quite so large perhaps as Mr. Barnard's but nevertheless containing a large number of "radio fish."

Then we are told by our American friend that the irony of the situation is that we have to pay to listen. We pay for our licence, I know, but then so does the good American, in other ways, so I fail to see the purport of this statement. Of course, the British Government pays a certain percentage of the licence money to the B.B.C., but then the tax is only 10s., so that it does not cost us anything prohibitive. If America did the same, perhaps there would be some better programmes and more order in the "Paradise" ether.

In conclusion, allow me to say that I bear Mr. Barnard no real ill-will, but I could not let his remarks against this country of ours go unchallenged.

Apologising for the amount of space I have taken.—I am, yours faithfully,

S. G. MATTHEWS.
(2 AUV.)

Seven Kings.

SIGNAL STRENGTH COMPARISON

SIR,—All the "R" tables which I have seen so far for conveniently comparing signal strength, seem to have been compiled purely for C.W. and spark signals. Might I suggest that the code given herewith be adopted when reporting the reception of broadcasting stations? Experimenters' reports on results from different sets and circuits would be of much greater value if this simple standard were used when giving comparative signal strength:—

- R1.—Carrier wave irresolvable.
- R2.—Music faint and unstable.
- R3.—Music faint but clear.
- R4.—Music quite clear but speech barely readable.
- R5.—Speech clear and readable.
- R6.—Music and speech fairly strong.
- R7.—Music and speech strong—faintly heard on loud-speaker.

R8.—Music and speech very strong—loud-speaker clear.

R9.—Loud-speaker strong. Intermediate strengths, if desired, would be denoted by decimal divisions.—Yours faithfully,
W. J. POTTER.

Leigh-on-Sea.

EASY SOLDERING

SIR,—The article appearing in the Radio Press publications are so excellent in every detail that it is with some trepidation that I write with regard to the article "Aids to Easy Soldering" appearing in *Wireless Weekly*, Vol. 4, No. 15. The suggestion I have to make is that a better tin is formed on the iron if, when cleaned and heated, it is rubbed on a tin lid or any piece of well-tinned iron, or sheet tin on which has been placed a drop or two of solder and a little flux. The reason is that there is rather a shortage of tin in the composition of the solder sold at the present time, and the tin on the sheet combines with the solder forming a surface on the iron which will be found to last longer than if the solder is run on with a match as explained in the article.—Yours faithfully,

JAS. H. SLATTER.

East Sheen.



Ask to see the
TrueMusic JUNIOR
Loud Speaker.

Before you decide on the Loud-speaker for your Set, see, and listen to a TrueMusic Junior.

Its clear, pure tone is a revelation.

Reproduction of Broadcasting is so faithful, because the metal in the Horn is not stretched or twisted. It is made in one piece of electrolytically deposited copper.

Drop us a Post Card for our Catalogue

TrueMusic Junior.
22 : 17 : 6

The Telephone Manufacturing Co., Ltd.,
Hollingsworth Works, West Dulwich,
London.

British Empire Exhibition, Wembley, Palace of Engineering, B.E.A.M.A. Section, Stand C1
Avenue 11, Bays 6 and 7.

They Magnify 8.5 Times.



Good magnification factor and low expense of running, if you fit RADION Valves.

These valves use only a third of usual filament current.

Use only 25 amps at 3.5 to 4 volts. Anode volts 30 to 90.

On all normal plate voltages no grid bias is needed.

TWO TYPES—
A 2 for amplifying.
D 4 for detecting.

Same price for each. Same filament and anode current also. If your dealer does not stock this efficient and economical valve write direct to us and we will see that you are immediately supplied.



Sole Mfrs.:
RADIONS
Ltd.,
Bollington,
Macclesfield

VALVE REPAIRS.
(Most Makes). Valves repaired by us are guaranteed: (1) Not to consume more current. (2) To have the same amplification. (3) To give the same radiation. Ordinary types. Price 6/6. Post extra. Trade enquiries invited.



Fit the New
RADION LOW CONSUMPTION
VALVES

— and amplify enjoyment! B&D



Apparatus we have tested

Conducted by A. D. COWPER, M.Sc., Staff Editor.

G.W.I. Plateless Valve

Messrs. G. W. I., Ltd., have sent for test a sample of their "plateless" valve, in which, in place of the ordinary plate of thin metal supported by wires, the anode is formed by a deposit of silver actually on the inner surface of the glass container; almost the whole inner surface of the latter accordingly acting as a "plate."

The valve is rather narrow and tubular, standing about 4 in. high on the ordinary four-pin base. The cap is fitted on to the glass in a novel way by means of rubber gasket-rings.

Whilst the grid is wholly

obscured by the silver deposit, sectional drawings supplied by the makers indicate that it is also

Four volts on the filament were required for satisfactory emission when the rather large filament-

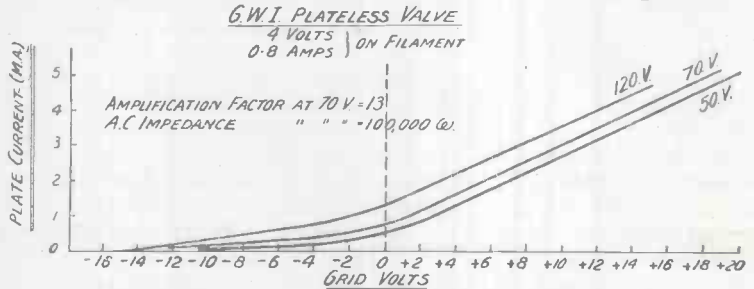

The characteristic curves of the G.W.I. Plateless valve.

of unusual design, consisting of two wires twisted together in a way that is claimed to be particularly rigid.

current of .8 amperes was recorded. The valve heats up considerably in operation, as the opaque mirror deposit on the

THE NEW
"DEXTRAUDION"
DULL
EMITTER

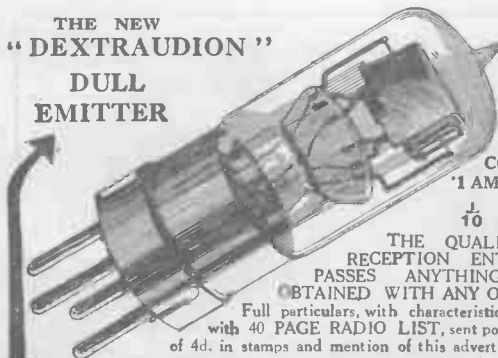

PRICE
21/-

MAXIMUM
CONSUMPTION
1 AMP. AT 1 VOLT.

to WATT!

THE QUALITY OF THE
RECEPTION ENTIRELY SUR-
PASSES ANYTHING HITHERTO
OBTAINED WITH ANY OTHER VALVE.

Full particulars, with characteristic curves, together with 40 PAGE RADIO LIST, sent post free on receipt of 4d. in stamps and mention of this advertisement.

ECONOMIC LTD. Head Office: 10, FITZROY SQUARE, LONDON, W.1. Showrooms: 303, EUSTON RD. N.W.1



"Why didn't someone think of it before?"

They say that there is only one good thing on earth that can't be sold by advertising—a spare collar-stud.

Is it a blessing this collar-stud?

Remember those grimy gropings beneath the bedroom furniture in its pursuit; but still you'll say "Yes—compared with the beastly buttons that our unhappy grandfathers had to put up with."

CLIX is as useful as the collar-stud—and CLIX is reliable. It supersedes all forms of switches, plugs and terminals, for it does all their work—and does it better.

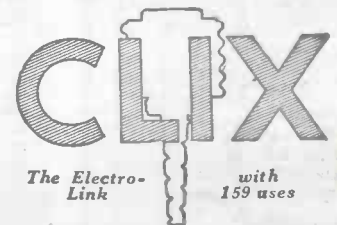

Retail Prices
CLIX
with Lock-nut
3d.

INSULATORS
(Six colours)
1d. each
BUSHES
(Six colours)
1d. pair

CLIX is patented
all over the world.

The introduction of this ingenious combination plugsocket marks the advent of a standardised system of instantaneous wiring.

Obtainable from all good Wireless Dealers or direct from the Patentees and Manufacturers:

AUTOVEYORS LTD
Radio Engineers and Contractors
84 Victoria Street, London, S.W.1

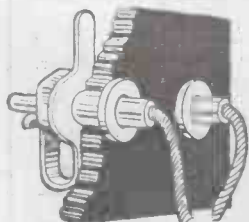

"FALLONS" PHONE TIP JACK

These new Tip Jacks are rapidly displacing the ordinary terminal.

POSITIVE CONTACT. QUICK OPERATION. No nuts to get lost. Adds 100% to panel appearance.

A HANDY LITTLE GADGET, takes any standard 'phone tip and several sizes of bare wire.

PRICE
9d.
PER PAIR

Manufactured only by

FALLON Condenser Co., Ltd.
White Ribbon Works, Broad Lane, London, N.15

glass decreases radiation; this does not appear to produce any evil results. At this rating the characteristics were determined for 50, 70 and 120 volts H.T., and indicated that ample H.T. is necessary in order to have an available straight portion of the characteristic to the left of the zero-grid-volts line for good distortionless amplification; and that for H.F. amplification and detection alike over 50 volts H.T. were desirable. These deductions were confirmed in actual trial in reception. With 120 to 170 volts H.T. good loud-speaking resulted without distortion, using a strictly moderate negative grid-bias. With 50-70 volts the valve operated well as a detector, being very free from microphonic effects. The tone was excellent. In H.F. amplification, on 70 volts, the valve operated well.

It was noticeable how the particular design of this valve had raised both the amplification-factor and the impedance; the A.C. impedance at 70 volts being no less than 100,000 ohms, as compared with the more ordinary

figure of some 30,000 ohms. The amplification factor was around 13 under these circumstances.

The valve is made in two types: Type G.I. (that tested here) for H.F. and detector work; and Type A.I., for L.F. amplification.

Valve Windows

In addition to the type of gauze - and - metal-frame valve-window or peep-hole, for use in the American type of receiver, with valves enclosed behind a vertical panel, which has already been noticed, Messrs. Grafton Electric Co. have submitted for our inspection a series of alternative patterns in different finishes. These all have the fine wire-gauze window, and are fixed by three small screws through the metal frame and a back ring, with nuts behind; but there is a choice of bright brass, bright nickel, black oxidised nickel, or mottled copper-and-black-nickel. The last should look extremely well on a mahoganite panel. We gather that the prices are moderate, and the fittings certainly add greatly

to the appearance of a set, whilst being easy to apply.

Small Box Spanners

A set of small box-spanners, fitting most of the sizes of B.A. nuts used in radio-construction work, has been sent for our inspection and trial by the Rockwood Company, Ltd. These bear the name "Spintite."

The hexagonal box-head of these spanners is mounted at the end of a hollow spindle about 2 in. long, which accommodates any projecting length of screw; this in turn is carried by a substantial fluted wood handle, giving a comfortable grip whilst at the same time enabling a nut to be spun on rapidly just as if one were using a screwdriver. Practical trial showed how convenient these tools were in practice, enabling one to reach nuts behind and close to the panel, etc., otherwise inaccessible.

DON'T FORGET TO BUY THE SPECIAL DOUBLE NUMBER OF MODERN WIRELESS NOW ON SALE

BUY BRITISH GOODS ONLY AND USE ONLY THOSE MARKED



Visit our Stand at WEMBLEY, Palace of Engineering Avenue 13, Bay 13.

Complete Catalogue, profusely illustrated, Post Free 1/-

MH L.F. TRANSFORMERS are most efficient



Most Intervalve Transformers are used with a fixed condenser in circuit. This model is provided with a pair of clips to take our standard fixed type condenser of suitable value.

PRICE 21/-

L.M. MICHAEL LTD IN CONJUNCTION WITH B. HESKETH LTD

Wireless Engineers, RADIO CORNER, 179, Strand, London, W.C.2.

A.J.S. TWO, THREE & FOUR-VALVE RECEIVING SETS

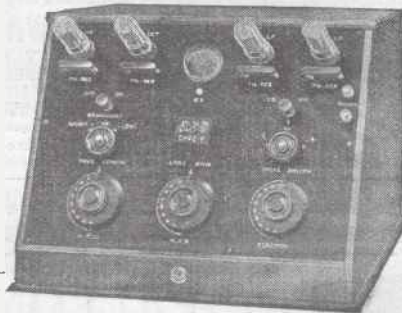

Are Simply Perfect and Perfectly Simple, and are unsurpassed for Selectivity, Clearness of Reception and Power.

REVISED PRICES:

COMPLETE SETS.	PANELS ONLY.
Two-Valve Set .. £17 : 10 : 0	Two-Valve Panel .. £12 : 0 : 0
Three-Valve Set .. £22 : 5 : 0	Three-Valve Panel .. £15 : 17 : 6
Four-Valve Set .. £27 : 5 : 0	Four-Valve Panel .. £20 : 5 : 0

Complete Sets consist of Panel, as illustrated, Valves, Head Phones, High and Low Tension Batteries, Aerial Wire, Insulators, Lead-in-Tube, etc. The LIST Price of the A.J.S. Sets is the LAST Price, as with them it is not necessary to purchase numerous extras, the Specification embodying everything ready for installation, and the prices include all Royalties.

Write for Illustrated Catalogue.

A. J. STEVENS & Co. (1914) Ltd., WIRELESS BRANCH, WOLVERHAMPTON.

Telephone: 1550 (3 lines). Wireless Call Sign: 5R.I. Telegrams: "Reception, Wolverhampton."

Information Department

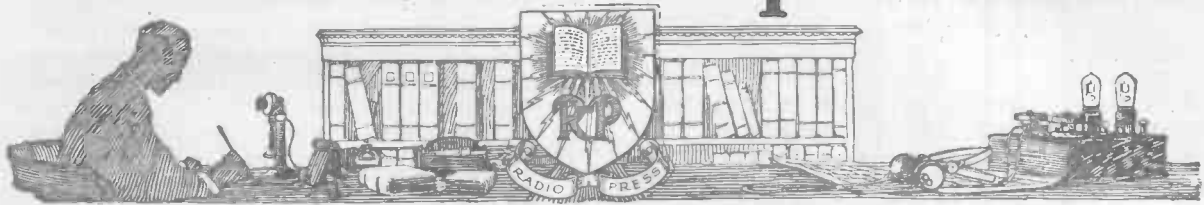

SUPPLIED BY RADIO PRESS SERVICE DEPT., LTD.

B. M. T. (BRADFORD) says that he is building a battery of small accumulators for high-tension supply, and inquires about a suitable wood to use for separators in the cells.

The following woods are used in commercial practice, after suitable treatment to remove various organic acids—

- Bass Wood.
- Poplar.
- Douglass Fir.
- California Red Wood.
- White Cedar.
- Cypress.

O. W. F. (CAMBRIDGE) wishes to build a short wave local oscillator, and asks for data for winding the tuning inductance to cover a wave range of 100 to 200 metres.

To cover so large a waveband with only one coil it will be necessary to use a fair-sized variable condenser, say one of $0.0003 \mu\text{F}$, and it will therefore be convenient to use one of the type which is provided with a vernier gear for the finer adjustment needed upon the shortest wavelength. The coil may consist of 25 turns of No. 22 d.c.c. wire upon a 3-in. diameter ebonite tube, the reaction winding consisting of 20 turns of the same wire wound upon the same tube, side by side with the tuned circuit winding.

J. G. (BOLTON) wishes to construct two slab coils, one for a wavelength of 14,000 metres, and the other for a wavelength of 25,000 metres. These are to be tuned by means of a $0.001 \mu\text{F}$ variable condenser in parallel.

For the construction of long wave coils such as those you specify, wire of about No. 36 s.w.g.

Quality RADIO COIL HOLDERS & COMPONENTS

"V" type COIL HOLDER

now made in 3-way with extension handles.

Price - - 21/-
Postage 4d.



2-way "V" COIL HOLDER

With cam-vernier fine tuning.

Price, 11/- Postage 3d.

If your dealer has not got them we send post free if you mention his name and address. LIST POST FREE.

GOSWELL ENGINEERING CO., LTD.,
12a, PENTONVILLE ROAD, LONDON, N.1.

LIBERAL TRADE TERMS.

Phone: North 3051.

Manufacture of Broadcasting Apparatus

USE OF PATENTS

The pioneer work of the Marconi Company in connection with wireless telegraphy and telephony is well known, and as the result of many years of research work and considerable expenditure, the Company controls numerous patents relating to the manufacture or use of wireless telegraph and telephone apparatus.

The Company is prepared to grant a licence for the use of its patents in connection with the manufacture of Broadcasting apparatus to any member of the British Broadcasting Company, Ltd.

A large number of firms (including the principal manufacturers) are already so licensed and pay royalty for the use of these patents, and all apparatus manufactured under licence is so marked.

Any persons or firms manufacturing or offering for sale valve apparatus embodying patents controlled by Marconi's Wireless Telegraph Company, Ltd., without its permission render themselves liable to legal proceedings for infringement.

Whilst hoping that it will not be forced to take legal proceedings the Marconi Company wishes to give notice of its intention to protect its own interests and those of its licensees, and in cases of infringement the Company will be reluctantly compelled to take such steps as may be necessary to defend its patent rights.

Marconi's Wireless Telegraph Co., Ltd.

Marconi House, Strand, LONDON, W.C.2.

may be used. If a 2 in. diameter former is employed, 1,200 turns of this wire will be required for the first coil and 2,000 turns for the second one. These coils may be wound in slab formation about $\frac{1}{4}$ in. thick, and impregnated with paraffin wax.

F. R. (CHISWICK) experiences considerable trouble from crackling noises in his set, which he is unable to trace. He has tried several different H.T. batteries, grid leaks, and even filament accumulators, but the noise still persists. He asks our advice.

As you appear to have examined all the most likely sources of this trouble, and as your connections are well soldered, it is very probable that the trouble is due to a defective intervalve transformer, or, alternatively, to the insulation of your telephones being defective. In both these cases the remedy is obvious, but we suggest that to determine from which source the noise arises you borrow a pair of telephones which you know to be in perfect condition and test them against your own.

T. W. (LIVERPOOL) has a valve receiver employing a detector valve and two low-frequency stages, which continually howls. He submits particulars of his tuning apparatus, and asks if we think that the values of the condensers are unsuitable, and if so, whether this would cause the howl.

We do not think that the trouble which you experience from howling is due to unsuitable con-

densers. It is more likely to be due to a pure reaction effect, which may be at high- or low-frequency. If the reaction is taking place at low-frequency it may be cured by reversing the connections to one or other of the intervalve transformer primary windings. You can ascertain whether the howling is in the high- or low-frequency part of the set by varying the tuning of the aerial circuit when the set howls. This should alter the note if it is occurring at high-frequency, and the remedy is to weaken the reaction and try another grid leak. Variation of the filament resistances of the low-frequency valves should alter the note if the howl is at low-frequency.

P. R. (BELFAST) asks the following questions with regard to a crystal set. (1) What kind of aerial wire should be used, and whether the length of aerial makes much difference. (2) If the same wire as used for the winding of the coil could be used to wire the remainder of the set, including the earth wire.

(1) When using a crystal receiver it is essential to obtain the maximum efficiency in the aerial circuit. For this reason stranded copper wire is generally used, which is best enamelled to protect it against atmospheric influences. The maximum length permissible under the regulations should be used to obtain the greatest efficiency from the set. (2) The wire which has been used for winding the coil will do for the wiring of the set, but wire similar to that used for the aerial should be used for the earth-lead. The wire used for winding the inductance is far too thin for use as an earth wire.

Send for 18 page leaflet "W" of Radio Fitments just off the press free.

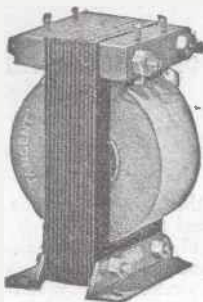

A standard article — if difficulty in obtaining, write us to name nearest stockist.

"TANGENT"

L. F. TRANSFORMERS

FITTED with soldering terminals
Tested on actual Broadcasting.
Guaranteed for silence, speech and music

ENORMOUS SALES ENABLE

ANOTHER PRICE REDUCTION to

12/6

GENT & CO. LTD.
FARADAY WORKS,
LEICESTER.

Est. 1872

No second-rate effects will satisfy the intelligent purchaser for whom "TANGENT" fitments are designed.

RADIAX Duplex Basket COILS

Far more efficient than honeycomb or any other type of coil. Exceedingly strong and rigid, mounted on standard ebonite plugs.

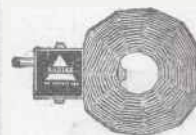

No.	Price.	Wave-length.	No.	Price.	Wave-length
25	2/-	350	100	2/6	1350
35	2/-	450	150	2/6	2000
50	2/-	650	200	3/3	2600
75	2/6	900	250	4/-	3200
			300	5/-	4000

Complete set of 9 for 25/-

YOUR DEALER CAN SUPPLY RADIAX COMPONENTS,

Get our Catalogue of all Components and Sets for Constructors. Stamps 3d.

RADIAX LIMITED

10, RADIO HOUSE, PERCY STREET, TOTTENHAM COURT ROAD, LONDON, W.1. Museum 490.
3 minutes from Tottenham Ct. Rd. or Goudge St. Tube Station.



HELLO !!!

EVERYBODY
Let me introduce
THE PERFECT COIL
HOLDER.

One hole fixing, large metal to metal bearings, swivel adjustable for wear and absolute micrometer adjustment of coils, can be set to zero instantly. Illustration shows moving holder turned to right with handle. Micrometer adjustment is obtained with knob which advances and retards moving holder in relation to stationary one.

(Trade Inquiries Invited.)

J. TELFORD, Electrical & Radio Engineer,
26, Margery St., CARLISLE.

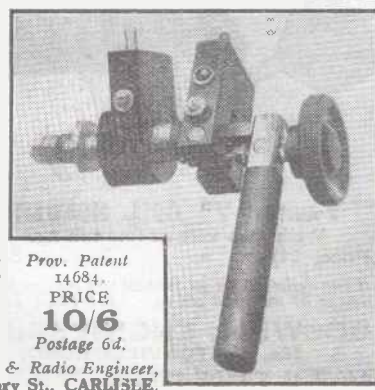

Prov. Patent
14684.
PRICE
10/6
Postage 6d.

Wireless Weekly

Vol. 4, No. 19
Sept. 10, 1924

CONTENTS

	Page
Editorial	600
The New Mullard Valves	601
Test Report Upon the Resistance Coupled Three-Valve Receiver	602
Jottings By the Way	603
Continental Broadcasting Intelligence	604
Valve Notes	605
An Easily Constructed Two-Valve Receiver	606
Loose-Coupled Circuits and Their Uses	610
A Useful Two-Coil Holder	613
The New Radio Press Offices	614
Call Signs of French Experimental Transmitting Stations	616
The Experimental Station—2KW	618
How Every Crystal User May Become a Valve Expert	623
Correspondence	625
Apparatus We Have Tested	629
Information Department	631

Editor: JOHN SCOTT-TAGGART, F.Inst.P., A.M.I.E.E.

Assistant Editors: { P. W. HARRIS.
E. REDPATH.

Radio Press, Ltd.

Publishers of Authoritative Wireless Literature.
DEVEREUX COURT, STRAND, W.C.2.
Tel.—Central 3763.

Advertisement Managers: { BARCLAYS ADVERTISING LTD.,
Sentinel House, Southampton Row,
W.C.1. Tel.—Museum 7560.

Staff Editors:

E. H. CHAPMAN, M.A., D.Sc.
A. D. COWPER, M.Sc.
G. P. KENDALL, B.Sc.
R. W. HALLOWS, M.A.
S. G. RATTEE, Member I.R.E.

Scientific Adviser:
Prof. G. W. O. HOWE,
D.Sc., M.I.E.E.

Advisory Editors:
Prof. R. WHIDDINGTON,
M.A., D.Sc.
Prof. C. L. FORTESCUE,
M.A., M.I.E.E.



All correspondence relating to contributions is to be addressed to the Editor of "Wireless Weekly."

Nothing contained herein is to be regarded as permission or encouragement to infringe any patent rights.

Editorial

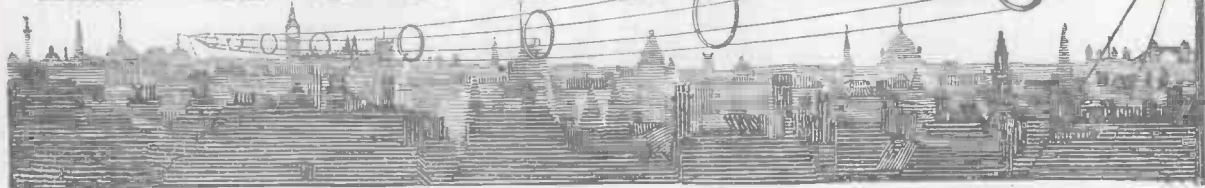

A Significant Move

IT will not come as a very great surprise to our readers and the wireless industry as a whole to hear that Radio Press, Limited, the proprietors of *Wireless Weekly*, *Modern Wireless*, and a complete series of non-periodical publications, have taken very large premises in Bush House. For many months the business of this company has been extending so rapidly that an extension of offices became essential, and the new ones will occupy more than 5,000 sq. ft. in this new building. It would, perhaps, be more expressive to state that the new offices will be more than four times the size of the existing ones.

The central position of Bush House is well known to every Londoner. It is the largest, highest, and

architecturally the finest, business building in London. What the Woolworth building is to New York, Bush House is to London, and it is not without a considerable amount of justifiable pride that we are able to announce that in a few days' time the address of our Head Office will be Bush House, Aldwych, W.C.2. Moving into Bush House is regarded by London business men as a synonym for prosperity, and it is a pleasure to say that this prosperity has been the result of the extremely wide sphere of influence of publications having a sane, sound, enterprising policy. In short, Radio Press publications have the public confidence, and this confidence is only gained by very patient attention to details. Every single set described in the pages of our publications may be inspected by our readers, and also demonstrated to approved representatives. The wireless public knows this, and also knows the technical staff responsible. The advantages of a highly qualified staff, of a Test Department, of a Service Department, can only be given by a firm carrying a multiplicity of radio publications. There is no secret in the fact that the Radio Press Service Department, though technically a great success, is, and was never really intended to be anything better than, a financial failure. It is a remarkable but highly expensive advertisement testifying to the efficacy of Radio Press designs. In other words, we guarantee our apparatus. If a reader makes up a set according to our designs, we guarantee the results, and if he does not get results, we undertake to point out his fault, and, if

desired to do so, we will *make* the set give the results. This new enterprise is an unequivocal expression of our absolute confidence in our own set designs, and the fact that we are carrying out this big service has made every reader of our publications have the utmost confidence in settling down to constructing the sets we describe.

The confidence of the wireless public in our papers and books is equalled by their confidence that, by ordering goods from advertisers in *Wireless Weekly* and *Modern Wireless* they will get a perfectly square deal. They appreciate that existing advertisers are known to us as sound, reliable firms, and that new advertisers have to submit their apparatus for test

before their advertisements will be accepted. Should in any exceptional case satisfaction not be obtained from the advertiser, and subject to the use of and conditions in our official order form, Radio Press will reimburse the reader. This matter, of course, brings us to the second large source of revenue, namely, that from advertisements.

The advertisement revenue from both *Wire-*

less Weekly and *Modern Wireless* is now higher than ever before, and the growing support which the wireless industry is giving to the Radio Press is the natural outcome of the increasing tendency of our readers to purchase from advertisers in our papers. Moreover, our periodicals do not appeal to the casual reader; they appeal to the man who constructs and who experiments. The very articles, by their originality and clearness, stimulate, and even compel, the average experimenter to construct the sets described. It is little wonder, then, that an increasing support is being given to publishers who are not only satisfying their readers, but also stimulating British trade. In a few days the Radio Press aerial will be literally "flying" over the roof of Bush House, and an even better service will be given from that address than from Devereux Court.

Radio engineers and technicians first, and then publishers, is a slogan of the Radio Press, which devotes itself *exclusively* to wireless publications. We are wireless people, and it is our intimate contact with the great wireless public that has given the Radio Press a position as outstanding as its new offices.



Bush House—The new headquarters of Radio Press, Ltd.



The Mullard Green Ring "Master" Valve.

The New Mullard Valves

In view of their special interest to readers, we have carefully tested these latest types of valves and give below the results of our test, together with some interesting characteristic curves.



The Mullard Red Ring "Master" Valve.

THE new types of Mullard bright-emitter valves, the Green Ring "Master" L.F. amplifying valve, and the Red Ring "Master" H.F. and detector valve, recently put on the market, differ considerably from the well-known Mullard "Ora" and R valves. In these new valves the plate takes the form of a trough inverted over an arched filament, and the grid is an open construction of wire bent in zig-zag manner, also trough-shaped. The mesh of the grid is fairly open, and it is in neither valve very close to

this proved to be the case on carrying out the usual routine tests on the two samples submitted.

The valves, very similar in appearance and construction, are $3\frac{1}{2}$ in. high by about $1\frac{1}{2}$ in. diameter, and are mounted in an insulating cap with a ridge around it for handling. The bulbs are partly obscured by a bright metallic deposit.

The rating for both valves was given, in a manner characterised by some elasticity, as 3.2 to 3.8 volts and 0.6 ampere for the filament and 30 to 90 volts on the anode. Both specimens tested showed small emission with a filament current of 0.6 ampere, but with 3.5 volts on the filament and 0.7

amperes for the H.F. detector valve and of 2 milliamperes for the L.F. valve resulting; accordingly the characteristic curves were taken at this rating. By raising the filament current to 0.75 ampere and the volts to 3.8, a saturation current of 2.7 milliamperes resulted with the H.F. valve, the filament being quite bright under these circumstances. It will be seen that these valves will operate satisfactorily with an ordinary 4-volt accumulator at its minimum safe discharge-voltage—a matter of some consideration to those who do not use a 6-volt accumulator for nominal 4-volt valves.

Characteristic Curves

The characteristic curves for the H.F. detector valve on 30, 50, and 90 volts H.T. showed an early attainment of saturation with a plate-voltage not much over 30 volts. At the latter value the characteristic showed a sufficient straight portion about the zero-grid-volts line for good amplification. On practical trial in comparison with our standard R valve the specimen submitted gave with 45 volts H.T. good H.F. amplification and detection. It was noticeably harder to make this valve oscillate with a critically-tuned H.F. coupling than with the standard valve of higher amplification-factor and more liberal emission.

No advantage resulted from the use of over 50 volts H.T. in practical reception, either as H.F. amplifier or detector.

The L.F. Valve

Curves for the L.F. valve at 30, 50, 70, and 90 volts plate-potential all showed

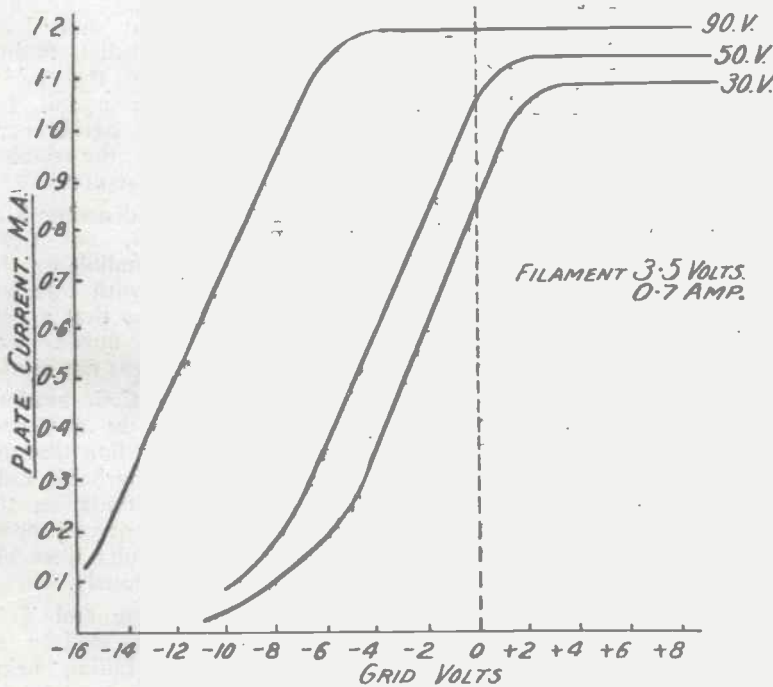

Characteristic curves of the new Mullard H.F. and detector valve (red ring).

the filament, so that it was to be expected that grid-control would not be conspicuously high;

ampere adequate emission for ordinary purposes was attained, a saturation current of 1.2 milli-

an excellent straight portion of a length corresponding to about 10 volts total grid-voltage swing, but except for the 30-volt curve these lay almost entirely to the left of the zero-grid-volts line. Accordingly a substantial negative grid-bias was indicated for good distortionless amplification. On actual trial with loud signals this was confirmed, no less than 5 volts negative grid-bias proving best for 50 volts H.T. and 9 volts for 90 volts H.T. With only 30 volts H.T., and but sufficient negative bias on the grid to avoid damping grid-current and unwanted grid-rectification (one dry-cell), good amplification resulted on any but quite loud signals. With the maximum plate-voltage (90 volts) the results on loud signals compared favourably with our standard R valve.

With H.T. up to 170 volts, proper grid-bias, and with the filament quite bright (over 4 volts on the filament), excellent power - amplification was obtained, at the cost, of course, of slightly over-running the valve.

Evidently this new Mullard L.F. valve will prove very con-

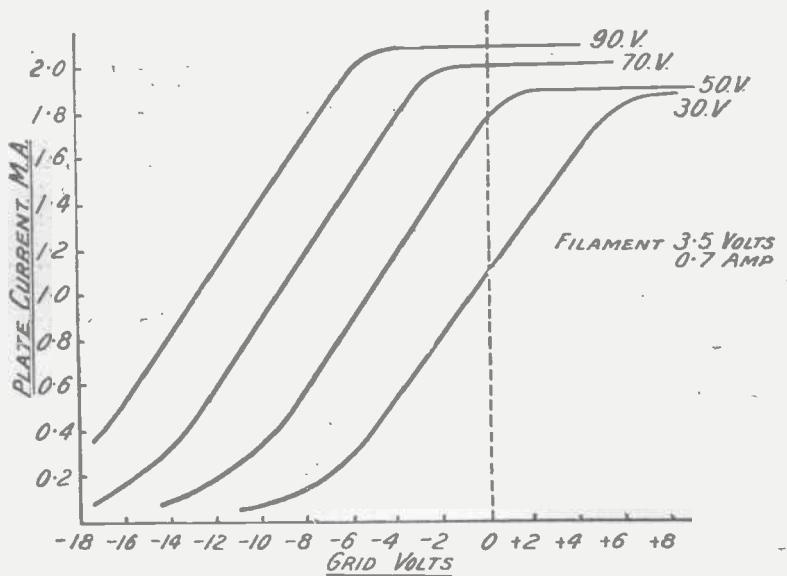

Characteristic curves of the Mullard (green ring) "Master" valve.

venient for the user of a 4-volt battery, and with proper value of H.T. and the grid-bias called for in proportion to the H.T. used, will give excellent distortionless amplification within its scope.

A practical point of some importance is noticed in the mode of packing these valves, which

should certainly minimise the risk of mechanical breakage before the valve reaches the purchaser. Each valve reposes in a felt nest in an inner cardboard carton, itself isolated by felt and cardboard buffers within the usual outer case.

A. D. COWPER.

Test Report Upon the Resistance Coupled Three-Valve Receiver

Constructional details of this receiver were given in our last issue.

LONDON at 9½ miles was received with constant aerial tuning, with a No. 50 coil in the aerial socket and a 75 for reaction. On 60 deg. on the aerial tuning condenser a No. 75 coil for reaction seemed to be the most suitable for all the stations received. When series condenser was used 125 deg. of the aerial condenser were required. With C.A.T. the reaction coil was very loosely coupled to the aerial coil, whilst with series condenser tuning, coupling was fairly tight. Very loud and clear signals were received on the loud-speaker, a large Claritone, on both systems, series tuning being best. No grid bias was used in the reception of any of the stations during these tests.

Bournemouth came in at mode-

rate phone strength and just audible on the loud-speaker at a few feet; C.A.T. was used, the aerial condenser being set at about 68 deg. Newcastle came in at rather weak phone strength, the same coils as above being used and the aerial condenser at 81 deg., the reaction coil being rather loosely coupled.

Birmingham, although much nearer than any of the other stations excepting Bournemouth, was hardly audible in the phones on speech, his call sign just being heard. A week previously atmospheric conditions were much better, and Birmingham was received on the loud-speaker.

Aberdeen was also very weak, and interference from commercial stations was experienced.

The high - powered station,

5XX, came in at full L.S. strength, with parallel tuning with a 150 coil in the aerial socket and a 200-turn coil for reaction, with the aerial condenser set at 80 deg., the reaction coil being loosely coupled.

The French Broadcasting Station, Radio Paris, on 1,780 metres was nicely audible on the loud-speaker, but with interferences from 5XX, so that a certain mixture of music was obtained. A trap was not used.

Although the B.C.C. stations were not greatly in evidence, stations south of a line through London came in remarkably well. The general conditions on the date of this test were very poor, as much better results were obtained a week previously.

The French Posts and Telegraphs came in very well on the phones, a slight fading being experienced. Much louder signals were obtained by tighter coupling, but owing to atmospheric conditions the reaction coupling was kept loose.

(Concluded on page 622)



JOTTINGS BY THE WAY

Professor Goop Takes a Hand

YOU will not, I think, be surprised when I tell you that Professor Goop was amongst the most indefatigable of the listeners for signals from Mars during that planet's approach to this funny old world of ours. For the purpose he constructed quite a number of sets embodying a variety of circuits designed with typical Goopian ingenuity. The one which he most favoured was named by him the Goopodyne, as a delicate compliment to our American friends who cannot string a couple of valves together without calling the combination a something or other dyne. I regret that I am unable to give you the Goopodyne circuit for two reasons. In the first place, it is so complicated that I am sure you would fall asleep whilst trying to trace it out, and, secondly, the pages of *Wireless Weekly* are not sufficiently large to do justice to a circuit containing twenty-seven stages of high frequency, a rectifier and half a dozen note magnifiers. Those readers who would like to have circuit diagrams measuring six feet by three should write direct to Professor Goop, The Microfarads, Little Puddleton, enclosing a £5 note and the address of their nearest asylum.

Anticipations

The Professor was full of hope during the weeks which brought the Red Planet and the date fixed for his experiments nearer and nearer. He was, of course, unable to test the set out on ordinary terrestrial stations, since even with the filaments turned very low, and with the high-tension battery eliminated in the best manner, signals were

so terrific that he was afraid of having the drums of his ears stove in. He has, however, designed a directional receiving aerial on an entirely new principle, and this he hoped to use in such a way that only signals coming from Mars would be received. He begged me to come and share his vigil with him so that I might be present at the great moment should communications be received. As his den is provided with a very comfortable armchair and a good supply of tobacco, I readily consented, for there are few sacrifices which I am not prepared to make in the interests of science.

The Receiver

Before I describe the events of that memorable evening, it will, perhaps, be better to give you a few details of the set itself. As ebonite was not considered suitable for the panels the Professor decided to use slate. He therefore purchased a secondhand billiard table, removed the cloth, and used the bed as the panel of the Goopodyne. The task of drilling and tapping about a thousand 4B.A. holes in slate an inch and a half thick was, I am sure, no small one, and the fact that he accomplished it in something under three months will show you what a sticker the Professor is when he gets down to it. To reduce resistance to a minimum the wiring, was done throughout with gas piping, all joints being neatly soldered. No less than 312 feet 4 inches of gas piping was used. This material, by the way, has not received sufficient attention from wireless enthusiasts, for, as the Professor pointed out, it enables one to dispense altogether with such expensive and finicky things as milliammeters for testing out

circuits. If, for example, you want to see whether the plate current of your seventeenth valve is in order, all that you have to do is to get your assistant to place his ear over the end of the gas pipe soldered to the anode leg whilst you blow sharply on the high-tension positive terminal. If he feels the draught all is well.

More Details

The way in which the valves were chosen and arranged is most interesting. The Professor explained that, as the incoming oscillations (if any) would be very small, and would be made heftier and heftier by each valve, it was obviously desirable to use bigger and bigger valves throughout the set. He therefore started with a "Peanut" as his first H.F. This was followed by a V24, after which came in turn a Cossor, an Ora, an "R," an LS5, a 5-watt transmitter, and so on. The final note magnifier was a 30-kilowatt transmitter with water-cooled anode specially imported from the States. As experiments showed that it was impossible to use dry cells for filament heating purposes, the talented designer of the Goopodyne removed all the furniture from his house, utilising the space thus gained for erecting a gigantic battery of the largest-sized secondary cells which produced a total capacity of 1,000-ampere hours. The high-tension battery, consisting of full-sized bell cells and delivering 1,500 volts, was housed in a shed specially built for it in the garden. As you may imagine, the whole of the Professor's demesne positively bristled with notices warning everyone of the danger of touching anything.

The Results

You would naturally imagine that with a set of this kind you were likely to obtain results if there was anything doing in the way of Martian signals. The Professor was quite certain that we should get something, and I confess that I was so excited when the great date came along that I hardly slept a wink all day. It was decided that we should begin our tuning in at nine o'clock in the evening, so, having dined frugally, I made my way round to the Microfarads a little before this hour.

Excitement

The Professor was in a state of considerable emotion, as I could see. He had been running his hands through his hair until it was all anyhow, and beads of perspiration glistened upon his high forehead. His hand was positively oscillating with emotion as he gripped mine, and said in a choking voice, "Wayfarer, my friend, this is going to be a wonderful evening, perhaps the most wonderful that there has ever been." He would have said a whole lot more if I had not then and there burst into tears and wept all down his neck. This cooled him a bit, and without further words he led me into what he had named his Martian room. There stood the Goopodyne as fit as a fiddle and ready to do its best. Without more ado the Professor crossed to the huge switchboard on the far side of the room, and pulled over both H.T. and L.T. He then trotted rapidly round the table, twiddling his thirty-four rheostats, and the Goopodyne leaped into life. He offered me a pair of headphones, but I motioned them aside, saying that it was only right the inventor should have the honour of hearing the first signal, and remembering also that I seemed to have noticed in the papers something about local thunderstorms. Perhaps the Professor had also seen that statement, for when I refused the phones he did not don them himself, but connected up a loud-speaker.

The Great Moment

In a trice he had attached the aerial and earth, and explained to me that he intended to search

thoroughly on all wavelengths beginning at 50 and working up gradually to about 100,000 metres. From the first I saw that things were going to be a little difficult. He had no sooner touched his tuning condensers when there issued from the spout of the loud-speaker a noise resembling the firing of a broadside by H.M.S. *Queen Elizabeth*. "Signals," cried the Professor. "Atmospherics, I think," said I. He gave another twiddle, and then everything seemed to happen all at once. About half a dozen of the biggest valves burst with loud reports, blue flames leaped all over the place, and the room was filled with dense smoke. I leapt for the battery switch whilst the Professor dashed for the aerial.

Recovery

When we had sorted ourselves out and recovered our senses a little we inspected the damage. The panels of the set were cracked and splintered, nearly every transformer was burnt out, and large portions of the gas pipe wiring were fused into unrecognisable masses. "Dear

me, dear me," said the Professor, as he stood inspecting the wreckage, "those Martians must be powerful fellows." Nothing would persuade the Professor that the damage was not done either by a Martian dot or the first portion of a Martian dash, but, personally, I am rather inclined to suspect that an atmospheric had something to do with it. As I said to him afterwards, if the oscillations coming in had a crest and trough value of only plus or minus 1 millivolt, it would have grown to something like 1,000 volts each way by the time that it reached the grid of the twentieth valve at the smallest estimate, and this is really quite enough, you know, to cause a bit of trouble. The Professor said that he had not thought of that, but that there was possibly something in it. Anyhow, it was a great evening, and if the Martians were responsible for what took place, I for one am quite content to wait another hundred years before making a further attempt to communicate with them.

WIRELESS WAYFARER.

Continental Broadcasting Intelligence

CONTRARY to the announcements made by both the B.B.C. and the Press, the Eiffel Tower is continuing its afternoon concerts, but these will only take place three afternoons a week. These days are Mondays, Wednesdays and Fridays. On the other days of the week—namely, Tuesdays, Thursdays, Saturdays and Sundays—a news bulletin will be given at 6.30 p.m., British Summer Time. On days on which concerts take place this news bulletin will be given, as in the past, at 7 p.m., B.S.T., after the concerts, which also take place at their usual time, as given in our list of Continental stations, e.g., 6.15 p.m., B.S.T.

The French station of L'Ecole Supérieure des Postes et Télégraphes, will no longer be transmitting on Mondays and Fridays until further notice. Transmis-

sion on the other days of the week will be as per usual, particulars of which may be found in our table of Continental transmissions.

Radio Iberica, Madrid, will shortly carry out some transatlantic tests in conjunction with WKAQ, of St. John, Porto-Rico.

These tests will be as follows:—Iberica will call WKAQ on September 23, 24, 25, from 2 a.m. to 2.15 a.m., from which time a concert will be given until 4 a.m.

Porto-Rico will reply on September 26, 27, and 28 in a similar manner. Spanish and English will be used. As given in our Continental table of transmissions, the wavelength used by Iberica is 392 metres; that used by Porto-Rico will be 360 metres. All times given are reduced to British Summer Time.



A New Valve Holder

I HAVE received from Messrs. Burndept a very distinctive and novel valve holder, which is intended for use particularly with dull-emitter valves, such as the .06 type. I pointed out in these columns the reason for the peculiar "booming" which is obtained when these valves are used in conjunction with stages of low-frequency amplification. I explained that frequently the air waves produced by a loud-speaker will vibrate the dull-emitter valves and so vary the anode currents. These variations are amplified and pass through the loud-speaker, thus producing a chain of low-frequency reaction of a very peculiar kind. The result is that a "booming" noise builds up and rapidly becomes a roar. This peculiar phenomenon, as was pointed out at the time, can be overcome by eliminating the vibration of the valves.

Messrs. Burndept, Ltd., have now produced the very thing for overcoming this trouble, and, incidentally, for increasing the life of the valves by eliminating the possibility of mechanical shock.

Shock-Absorbing Device

The valve holder is of really first-class workmanship, and, while not having an appearance much different from an ordinary valve holder, nevertheless has provided in it four springs which act as shock absorbers. Not only is this shock-absorbing system introduced, but also the connections to the legs are such as to avoid capacity effects and possible leakage.

Readers of my weekly notes know what strong views I have on the subject of the ordinary valve holder fitted with nuts for securing to the panel. These nuts come so close together that many sets fail to work, simply through

faulty insulation between them. A little moisture, a touch of flux, or even dust, will account for many faults in home-built sets, and the experience of our new Service Department amply bears this out.

I consider this new component as an example of enterprise which is curiously lacking in the industry to-day. As pointed out in a recent editorial, there is ample scope for ingenuity in new components.

When Accumulators are Run Down

There are many users of valve sets who, not possessing a voltmeter, are not quite sure when their accumulator is running down. This frequently happens when valves having mirror-like inner surfaces are used. In such cases it is not easy to estimate by the look of the filament whether it is too dull or not. In such cases there is always a very good rough-and-ready method of telling whether the accumulator is running down. When the accumulator is on its last legs, taking out one or more valves from the set will result in the other, or others, becoming very appreciably brighter, whereas, if the accumulator is fully charged, taking out or putting in a valve

will not appreciably affect the brightness of the others.

If signals gradually die down it is a sure sign that either the accumulator is running down or the high-tension battery. In most cases it will be the former. If the position is alleviated by increasing the brightness of the valves by means of adjusting the rheostats, the accumulator is obviously at fault, but if the rheostats are full in, or if the rheostats are full out, and signals seem unduly weak, then the test just described may be applied.

Another plan is to switch off the filament current and allow the accumulator to recuperate for about ten minutes; then switch on the valves, and good signal strength should be obtained, as the valves will light up much more brightly than before. This effect, however, will only be very temporary, and may only last for one or two minutes.

It is, of course, generally undesirable to run down an accumulator to such an extent, and a voltmeter is a really desirable adjunct to an experimental station. It is, of course, best to test the voltage across the filament terminals when the valves are actually taking current.

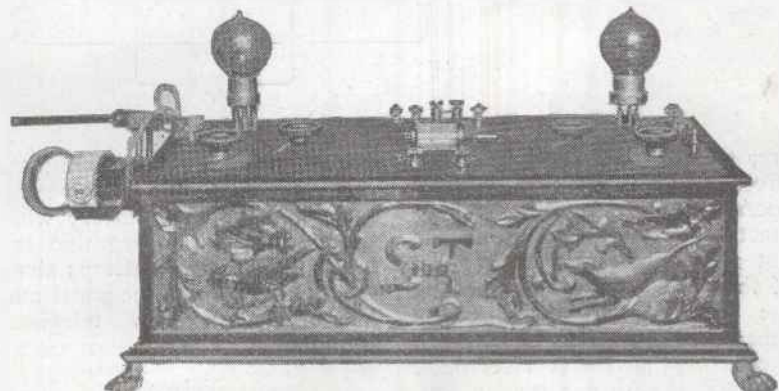

The possibilities of cabinet design for receivers is illustrated by this very handsome ST100 by a "Wireless Weekly" reader.

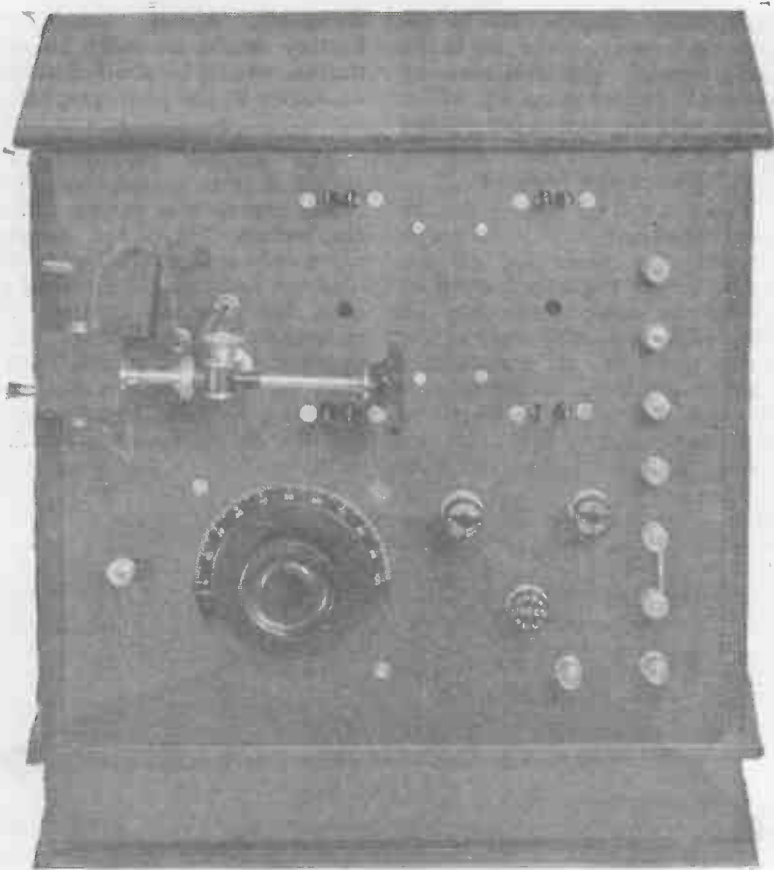

Fig. 3.—The receiver with valves and coils removed to show disposition of components.

Full constructional details are given of how to build an efficient two-valve receiver which permits tuning over a multiplicity of wave-lengths.

One H.T. battery up to about 70 volts.

One pair 2,000- or 4,000-ohm telephones.

Quantity of connecting wire.

Plug-in Coils

The coils required for this receiver are, in the case of the lower broadcast band, a No. 35 or 50 in the aerial socket, with a No. 50 or 75 for reaction. For the higher waveband, that is, wavelengths above 400 metres, a No. 50 or 75 will be required in the aerial, with a No. 75 or 100 for reaction. For the reception of wavelengths above these the following coils should be used:—

For aircraft telephony a No. 75 or 100 coil in the aerial, with No. 100 or 150 for reaction; for 5XX and Radio Paris a No. 150 in the aerial, with a No. 200 or

tion to the components incorporated in the set, and though there is actually no obligation in the choice of components, to obtain results similar to those possible with the receiver illustrated, the values given must be adhered to:—

One ebonite panel, measuring 10 in. by 9 in. by $\frac{1}{4}$ in.

One variable condenser of 0.0005 μ F capacity (Radio Instruments, Ltd.).

One two-coil holder (Radio Communication Co., Ltd.).

One Lissen "push - pull" switch (Lissen, Ltd.).

Two Lissenstat minors (Lissen, Ltd.).

One grid condenser of 0.0003 μ F capacity (Dubilier).

One grid leak, 2 megohms (Dubilier).

One fixed condenser of 0.001 μ F capacity (Dubilier).

One similar condenser of 0.002 μ F capacity (Dubilier).

One low-frequency transformer (H.T.C.).

Ten brass terminals.
Two Myers valves.

Set of plug-in coils for the wavelengths desired.

One accumulator (suitable for the valves chosen).

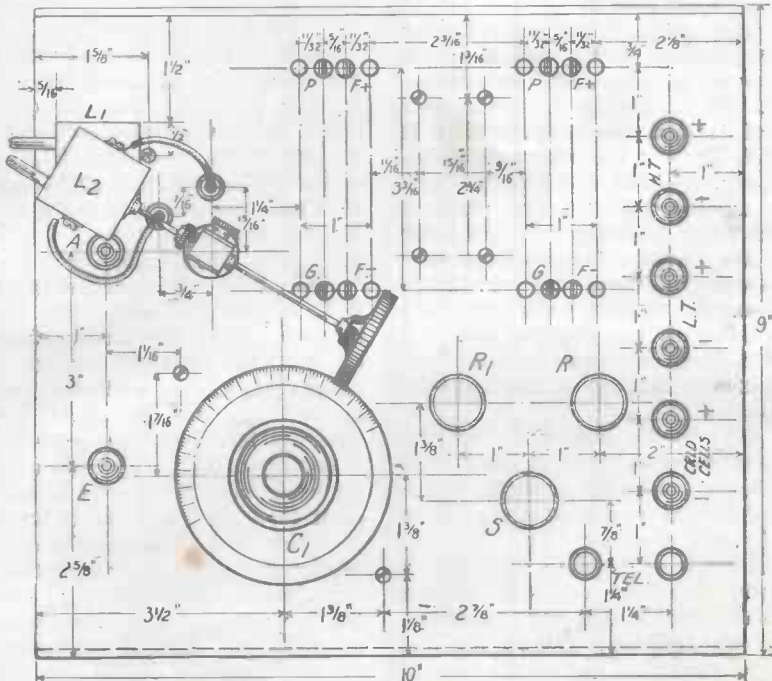

Fig. 4.—The panel layout and drilling dimensions. Blue print No. 64A.

250 for reaction; for the Eiffel Tower a No. 250 in the aerial, and a No. 300 or 400 for reaction.

The Panel

This is made from the ebonite sheet referred to in the list of components and drilled in accordance with the panel layout. With the panel drilled, the glossy finish on both sides should be removed by means of fine emery cloth, as it is often found that this glossy surface is a cause for poor insulation between components. If after this treatment the panel presents a somewhat poor appearance, the deep black finish may be retrieved by rubbing the panel with a soft rag and a drop of linseed oil.

In connection with ebonite there are certain manufacturers who are supplying highly-polished material guaranteed to be free from surface leakage, and in cases where purchasers are assured that in their case this material is supplied, the treatment usually given to ebonite may be omitted with advantage, as the highly-polished finish will give to the receiver a very distinguished and handsome appearance.

The Circuit

As stated earlier in the article the circuit employed constitutes a valve detector and one L.F. stage with reaction, and is shown in the illustration of the theoretical circuit.

The coil L_1 is the aerial tuning inductance, across which is the $0.0005 \mu\text{F}$ variable condenser. C_2 and R_2 are the grid condenser and leak respectively, whilst R and R_1 are the filament resistances. L_2 is the reaction coil connected between the plate of the valve V and the centre point of the switch. C_3 is a fixed condenser of $0.001 \mu\text{F}$ capacity, shunted across the primary winding of the transformer. C_4 is a fixed condenser of $0.002 \mu\text{F}$ capacity shunted across the telephones.

It may be observed that the telephone condenser is sometimes omitted when the detector valve is followed by one or more stages of note-magnification, but in cases where the detector valve is used alone the omission of the condenser C_4 will often be found to be sufficient reason for the receiver either not oscillating at all or not sufficiently to give

satisfactory results. B_1 is the filament battery, whilst B_2 is the H.T. supply. The grid biasing battery is indicated by B_3 , whilst S indicates the switch for cutting out the last valve when desired.

Wiring the Receiver

The method of wiring can be gathered from the photograph showing the underside of the panel, whilst the actual work of wiring the components may be followed by a careful study of the wiring diagram. All connections must be soldered; all leads must be kept as short as possible, particularly so in the grid circuits. It will be observed that

terminals, across which the battery would normally be connected, should be short-circuited, as shown in the photographs.

Switching

The purpose served by the switch S is to permit the use of either one or two valves. With the switch "in," the detector valve only is in circuit, when the filament resistance R_1 should be used for filament lighting, the resistance R being in the "off" position. With the switch "out" both valves are in circuit, when both the filament resistances R and R_1 should be used for filament lighting.

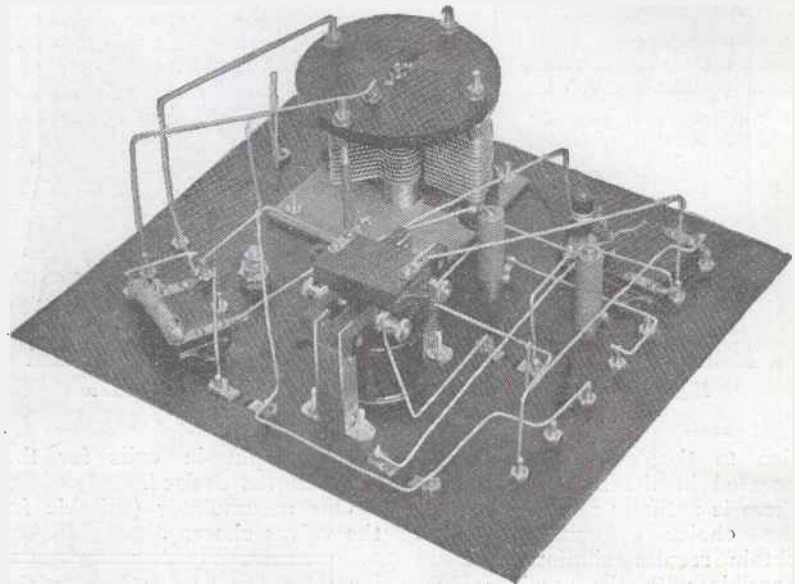

Fig. 5.—An underside of panel view of the receiver.

stiff bare wire is used for connecting purposes, but in cases where readers anticipate difficulty in employing this material, the easier method of using soft tinned wire and insulating sleeving may be reverted to.

Grid Cells

Should the reader decide to use dull emitter valves with this receiver, then the incorporation of a grid biasing battery is advocated, and in order that such an addition may be made, two separate terminals are provided. A battery of about $4\frac{1}{2}$ volts made up from flash lamp cells is sufficient for grid bias, the inclusion of which will eliminate the gruff woolly speech which is sometimes experienced when using dull-emitter valves for low-frequency amplification. Should the battery not be used, or should the cells become exhausted, then the two

It should be noted by readers that this switching in or out of the last valve does nothing more than change the position of the telephones in the circuit, but it may be found desirable when changing from one or two valves to effect slight re-adjustments of the reaction coil and tuning condenser C_1 .

Operating the Receiver

If it is intended to test the receiver during broadcasting hours, then reception should be attempted on wavelengths other than those used by the B.B.C., the 900-metre wave, for instance (coils No. 75 or 100 in the aerial socket with No. 100 or 150 for reaction). After inserting the coils the next operation is to move one coil at right angles to the other, connect the H.T. battery, and then light the valves to a suitable degree of brilliancy.

At this stage the variable condenser should be slowly turned, at the same time bringing the moving coil nearer to the fixed coil, taking care whilst so doing that the receiver is not permitted to oscillate too freely.

So long as the oscillating condition is approached with reasonable care, the point of oscillation will make itself known to the operator by a "cluck" in the telephones, at the indication of which the moving coil should be moved a little away from the fixed coil.

Should the set fail to show any tendency to oscillate, then the absence is indicative of the fact that the connections to the reaction coil should be reversed.

For the reception of the B.B.C. stations the same operations should be gone through, bearing in mind the same precautionary

remarks relative to oscillating, and using, of course, coils of suitable size for the wavelengths desired.

These operations are precisely the same when using either one or two valves.

Test Report

With receiver, as illustrated, and using 60 volts H.T. with bright- and dull-emitter valves of the type shown in the photographs, good reception was obtained from Radio-Paris upon an indoor aerial in S.E. London.

So far as the B.B.C. stations are concerned, Birmingham, Bournemouth, Cardiff, Newcastle and, of course, London were also received. In so far as strength of signals, Birmingham and Bournemouth were of good volume, even when roughly tuned, whilst Cardiff and New-

castle were quite up to the standard one would expect from such a simple circuit as that employed in this receiver.

Signals from 5XX, when received upon the same indoor aerial, are all that could be desired, whilst the tuning of this, as well as the other stations referred to, is extremely simple.

For the reader who is desirous of constructing a useful two-valve receiver which calls for neither skill in construction, nor operation, then the set illustrated is one that such a reader would find to best meet his requirements.

Blue Prints

Full size drawings of Figs. 4 and 6 may be obtained from the offices of this journal upon quoting the number given in the captions. The price of these blue prints is 1s. 6d.

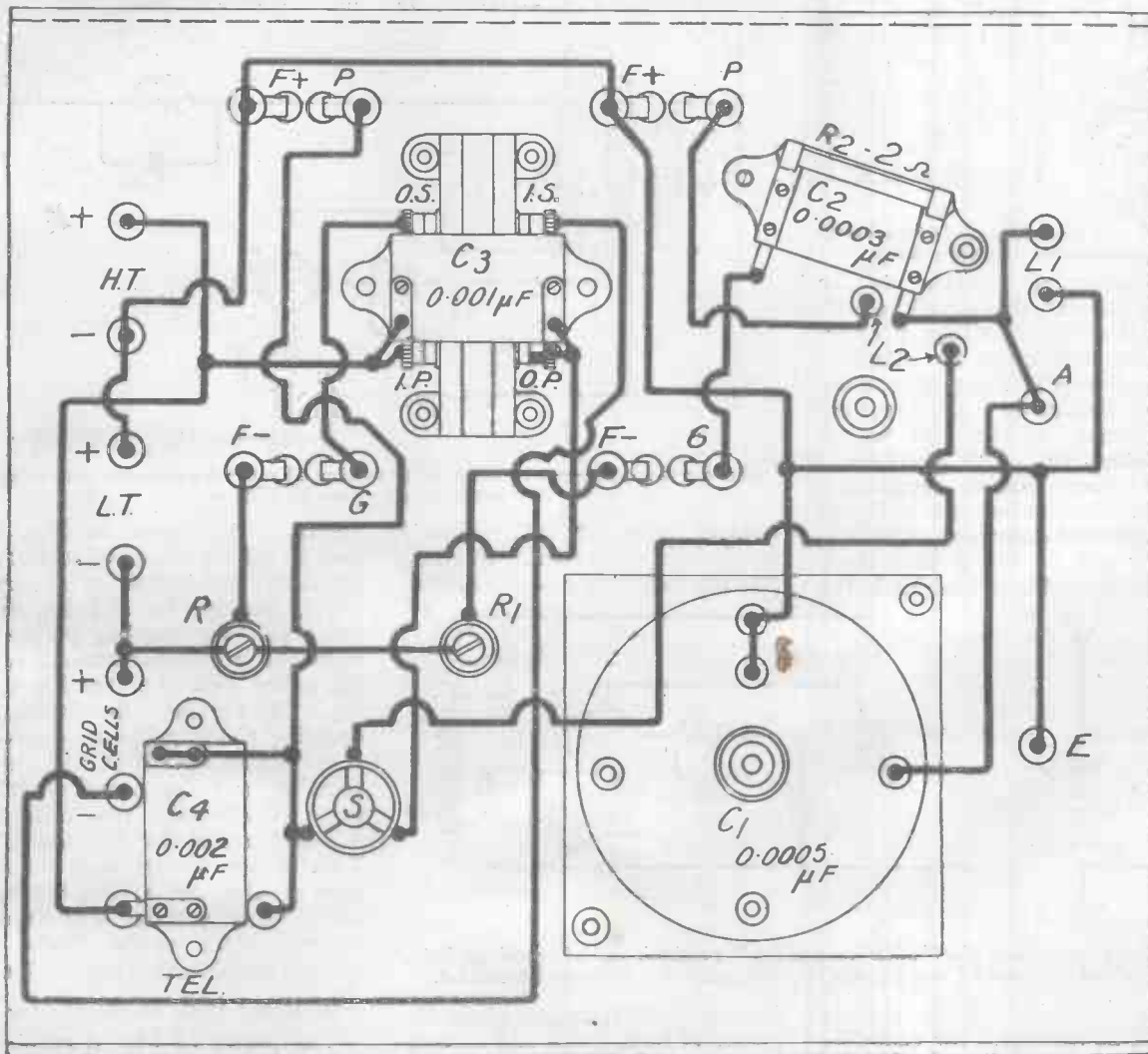

Fig. 6.—Practical back-of-panel wiring diagram. Blue print No. 64B.

Loose-Coupled Circuits and Their Uses

By G. P. KENDALL, B.Sc., Staff Editor.

The subject of interference elimination is one of ever-increasing interest

(Concluded from page 569).

Reaction Arrangements

Upon setting up a loose coupled tuning arrangement, one is at once confronted by a considerable difficulty regarding the

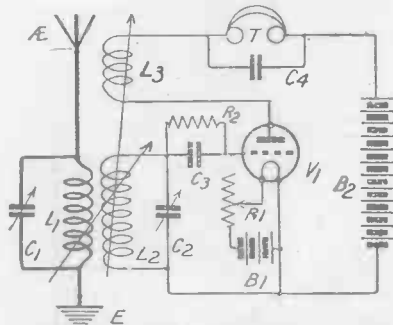

Fig. 6.—A loose-coupled circuit with reaction on the secondary.

application of reaction to the tuned circuits, and it will be seen that there are various possible methods which can be adopted. In the first place, one can use the circuit illustrated in Fig. 6, and couple the reaction coil to the secondary coil. This gives fairly satisfactory results, producing the well-known increase in signal strength and sharpness of tuning, but it will be found that there are considerable difficulties in the

between aerial and secondary coils is varied, that the reaction adjustment is completely upset. As the aerial coil is brought up towards the secondary coil, energy is transferred back into the aerial circuit, and the apparent reaction effects are reduced. On the other hand, as coupling

These difficulties are really rather ones of handling the circuit, and they can certainly be overcome with the aid of a little practice, but they must undoubtedly be reckoned as a defect of this particular arrangement, and the circuit known as the "split secondary" has been devised to overcome them. This

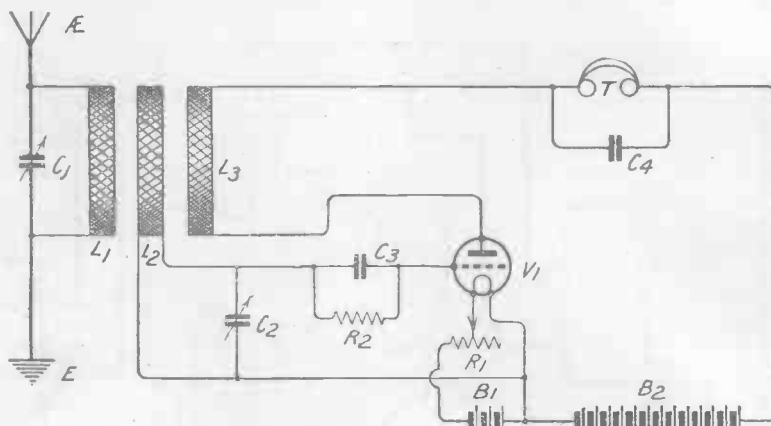

Fig. 8.—Showing one method of grouping the three coils for obtaining the coupling as given in Fig. 6.

reduced, the set will probably break into oscillation. Further, alterations on the reaction adjust-

circuit is illustrated in Fig. 7, and it will be observed that the secondary coil is divided into two parts, namely, L2 and L3, one being used for coupling purposes with the aerial inductance, and the other with the reaction coil L4. The various adjustments of coupling and reaction are thereby considerably simplified, and there remains only the practical difficulty of choosing two coils of a suitable size for L2 and L3. This is not always easy in the case of some coil series, but can usually be overcome. The circuit is one which seems likely to achieve considerable popularity.

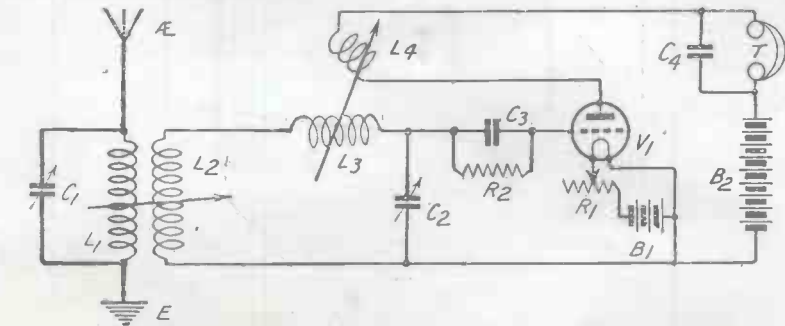

Fig. 7.—Illustrating the "split secondary" method, aerial coupling being obtained between L1 and L2 and reaction coupling between L3 and L4.

actual operation of the circuit. It will be observed, for example, that when the reaction has been critically set, and the coupling

ment may be found to upset the tuning of both aerial and secondary circuits to a considerable extent.

Grouping Coils in the Holder

The circuit of Fig. 6 requires that the aerial coil shall be one of the moving ones, that the

secondary coil be placed in the centre fixed socket, and that the reaction be the other moving one. This is illustrated in Fig. 8, and it has the defect which we have just noticed. With many circuits it will be found that more convenient operation is obtained by placing the aerial coil in the centre socket, and wiring the right hand moving socket as the secondary coil, and the left hand

ferred upon the score of convenience of handling, but if we consider alone the question of selectivity, the argument seems to point the other way. My own experience is that the Fig. 8 circuit gives greater selectivity when critically adjusted, but I believe that this may largely be a matter of individual conditions, aerial and earth resistance playing their part, and it is probable

arrangement to enable the circuits to be tuned one at a time. The solution requiring the use of a switch is, of course, the cheapest and simplest, and is most usually adopted. When this is done a double-pole change-over switch is provided to convert the circuit into the ordinary direct coupled type with only one tuning adjustment.

The usual arrangement is shown in Fig. 10, where it will be seen that the function of the switch is to connect the leads from the grid and filament of the first valve, whether rectifier or amplifier, across either the secondary inductance or the primary inductance. Thus, when the switch is in what is called the stand-by position, the valve is connected directly across the tuned circuit in the aerial, and the coil is removed from the secondary socket. The tuning arrangement is then just the ordinary one of aerial coil and condenser, either in series or parallel, and reaction directly upon the aerial. The station is then tuned in, and the switch is turned over to the "tune" position, the secondary coil is inserted in the middle holder, the coupling between aerial and secondary is set to a fairly strong value, and the secondary condenser is varied until the signals are picked up

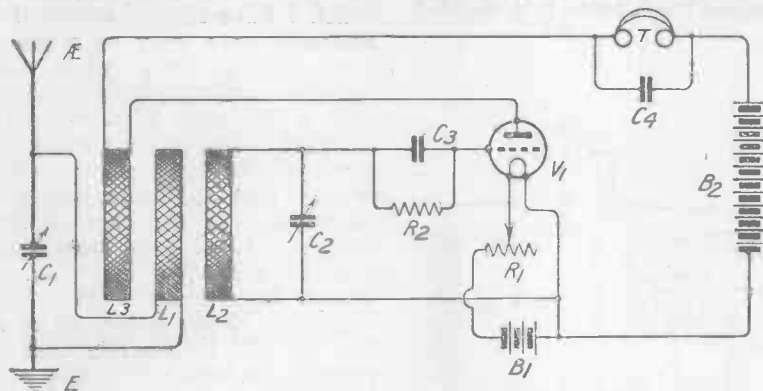

Fig. 9.—An alternative arrangement of coils in which the reaction coil is coupled to the aerial coil.

moving socket as the reaction coil, this arrangement being shown in Fig. 9. It will be observed that variations in reaction coupling no longer affect the tuning of the secondary circuit to so great an extent, but it will also be found that variations in coupling between primary and secondary will still vary the degree of reaction present, just as though the reaction coil itself had been moved. This defect, however, must be regarded as inherent in the majority of loose-coupled arrangements, and must be considered as a necessary evil. Another reaction effect which may seem somewhat puzzling at first is the rather peculiar effect of varying the tuning of either aerial or secondary circuit when the set is critically adjusted to the verge of self-oscillation, and both circuits are in tune with each other. It will be noticed that if either aerial or secondary circuit is detuned the set will quite likely break into oscillation, so that it can be noticed that when the secondary is properly in tune with the aerial, the set will cease oscillating, but will oscillate upon either side of this point, giving a clear indication of resonance in the two circuits.

It consequently seems that the Fig. 9 arrangement is to be pre-

ferred upon the score of convenience of handling, but if we consider alone the question of selectivity, the argument seems to point the other way. My own experience is that the Fig. 8 circuit gives greater selectivity when critically adjusted, but I believe that this may largely be a matter of individual conditions, aerial and earth resistance playing their part, and it is probable

Switching Arrangements

When one sets out to search for a distant station with a loose-coupled tuner possessing two

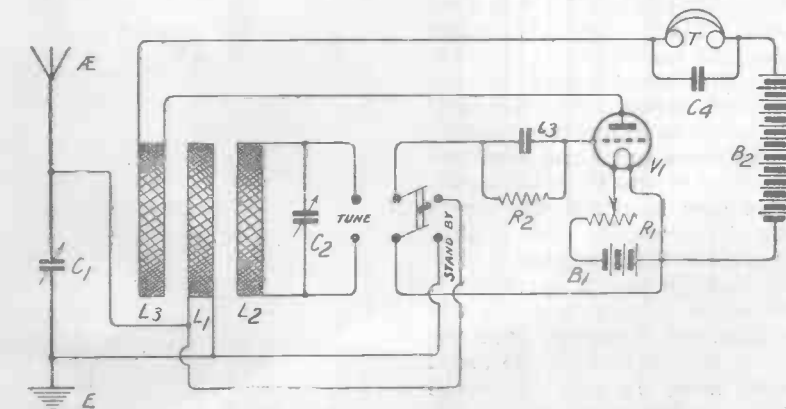

Fig. 10.—Switching connections for using either single or double circuit aerial tuning with the Fig. 9 arrangement.

variable condensers, and when quite likely the receiving set itself provides another tuning adjustment, considerable difficulty may be experienced in hitting upon the correct adjustment for the wavelength desired, and it is almost essential to use either a wavemeter or some switching

once more. Final adjustment of secondary and aerial tuning are then made, and the effect of varying the coupling between the circuits is noticed. Reaction is, of course, readjusted as necessary.

When this system of switching is used it is desirable to use the

arrangement of coils shown in Fig. 9, since if the Fig. 8 arrangement is adhered to, it will be observed that when the secondary coil is pulled from its socket, it may not be possible to bring the reaction coil sufficiently close to the aerial coil to produce the desired coupling. It will then be requisite to use so large a reaction coil that the reaction adjustment becomes floppy and difficult to handle.

connected across the middle socket, and under some conditions this may be regarded as a drawback. To overcome this a simple on and off switch, such as a two-stud rotary switch, should be inserted in the lead from one of the variable condensers, so that it can be cut out of circuit when not needed. Upon the longer wavelengths above 10,000 metres, however, this arrangement of condensers is a decided

size, say $0.0005 \mu\text{F}$, and yet be able to reach the longer waves by using them both in parallel with the coil.

Coil Sizes

For the benefit of those who are new to coupled tuning circuits, the following information regarding coil sizes may be of use. For broadcasting upon the ordinary wavelength, the aerial coil in all the arrangements which I have shown, except the aperiodic ones, may be a standard No. 35 coil, when the variable condenser is in parallel, with a condenser of $0.0005 \mu\text{F}$, although a No. 50 can usually be employed for the longer wave stations such as Birmingham and Aberdeen. In the case of the various sets of coils known as Concert coils, No. 2 or No. 3 would be correct. For the secondary circuit a No. 50 or a No. 75 will be suitable with a parallel condenser of $0.0003 \mu\text{F}$. Of the Concert coil series, No. 4 will serve. For reaction it will usually be found that a smaller size will serve than in the case of the direct coupled type of circuit.

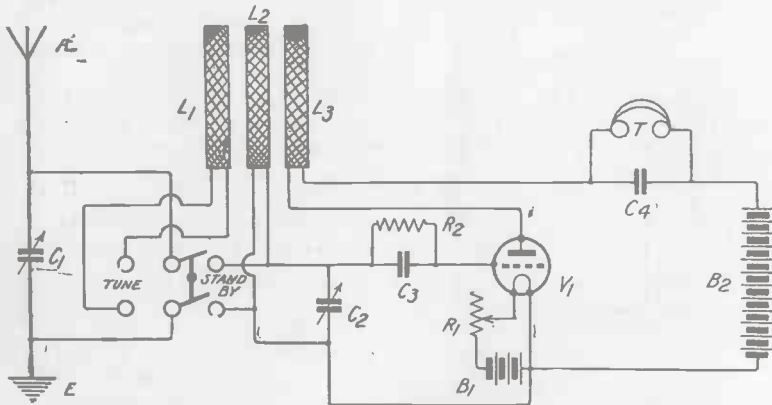
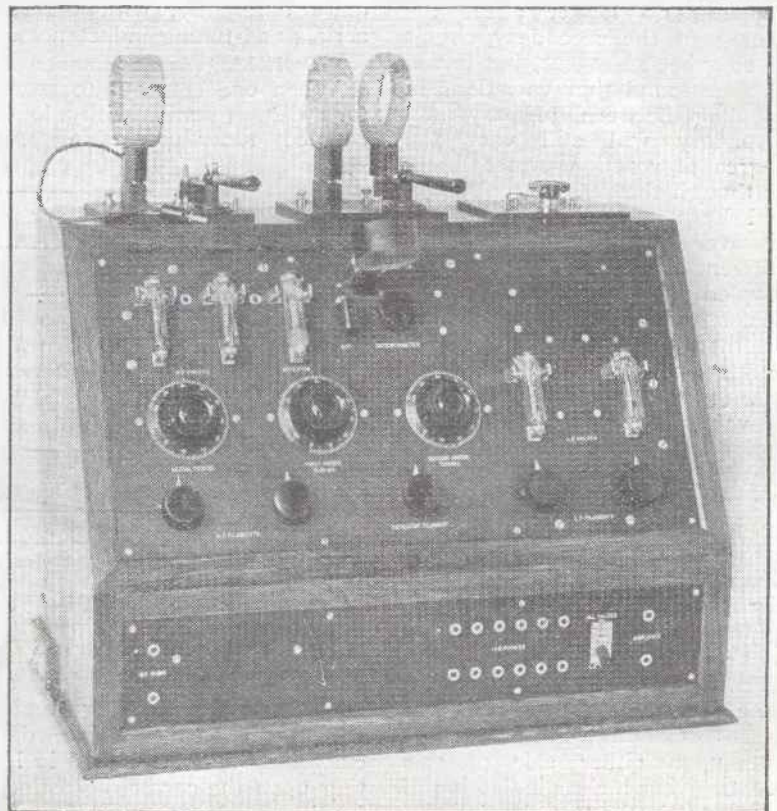

Fig. 11.—Connections for switch when using the arrangement of coils illustrated in Fig. 8.

To overcome this trouble, and permit the arrangement of coils illustrated in Fig. 8 to be used, I employ the system of switching shown in Fig. 11, where the desired change-over from single to double circuit tuning is produced by transferring the aerial and earth connection to whichever of the two coils it is desired to use. Thus, when it is desired to use the loose-coupled arrangement, the aerial and earth are switched across the left-hand coil, whereas to use the stand-by arrangement aerial and earth are connected across the middle coil, which now becomes the aerial coil. The reaction coil is thus always coupled to the middle coil, and the tuning operation is then made quite simple. It will be observed, however, that the correct size of coil for the aerial circuit must be inserted in the middle socket when the stand-by arrangement is being used. When changing over to the tune circuit this coil must then be taken out and placed in the left-hand moving socket, and a suitable coil for a secondary must be placed in the middle socket.

advantage, since one can employ two condensers of quite moderate

A further peculiarity of this arrangement is that when working on the stand-by side both the variable condensers are con-



Our photograph shows the compact five-valve receiver built by Mr. Tierney. A back of panel view of this receiver is given on page 622.

A Useful Two-Coil Holder

By R. W. Hallows.

THE two-coil holder is becoming a more and more useful piece of apparatus—in fact, it is one that the experimenter simply cannot do without. Amongst its many uses it may be employed for coupling the A.T.I. to the C.C.I., the reaction coil to a portion of the C.C.I., or the reaction coil to a tuned anode inductance. Again, it is excellent for making the loose-coupled high-frequency transformers which are now coming so much into favour with amateurs, and it can be used with advantage with super-heterodyne sets. One hardly ever sees the three-coil holder in use nowadays, for anyone who has tried the experiment of coupling primary to secondary and reaction to secondary in one of these coil stands will have found that it makes the set very difficult to handle owing to the mutual coupling which must exist between all three coils. For fine work the two-coil holder must be capable of movement in two senses. If we are able only to increase or decrease the distance between the two inductances, keeping their positions always

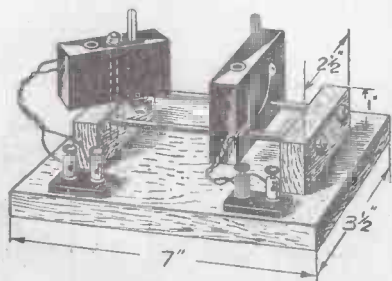

Fig. 1.—Showing the general construction of the two-coil holder.

parallel, or if one is fixed whilst the other has a radial movement, or, lastly, if one has only an axial movement so that starting from the parallel position it can be turned until it is at right angles to the other, the stand will give fairly good results, but it will not make it easy to accomplish the very fine adjustments of coupling which are necessary at times to obtain the best results.

A very satisfactory arrangement is shown in Fig. 1. Here one coil can be moved to and fro, since the mounting upon

which it is fixed slides upon parallel guide rods. The other coil has an axial movement, its mounting being pivoted upon one of the blocks which support the guide rods. With such an arrangement fine tuning at once becomes possible, and the selectivity of the apparatus is very much increased. The apparatus to be described is both simple and inexpensive to make.

Obtain a piece of hard wood $\frac{3}{4}$ inch thick and 7 inches in length by $3\frac{1}{2}$ inches in breadth. Prepare two pieces of the same wood $2\frac{1}{2}$ inches wide and 1 inch high. Quite close to the tops of these drill two $\frac{1}{4}$ -inch holes $1\frac{1}{2}$

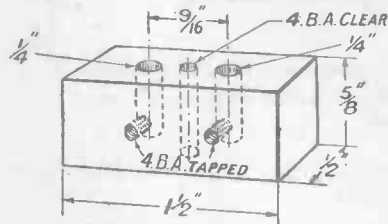

Fig. 2.—Illustrating the pivot block.

inches between centres. These holes are for the brass guide rods. Care must be taken to drill them so that when mounted the rods are quite parallel. Fix the plugs to the large piece of wood so that they stand with their inner faces 4 inches apart. Fixing is best done by driving wood screws up into them from below. Now cut out two 6-inch lengths of $\frac{1}{4}$ -inch brass rod and put a Whitworth thread on to the ends of each. Should you not possess a $\frac{1}{4}$ -inch Whitworth die, this is a job that you can get done for you at very small cost. Insert the rods, put nuts on to both ends of each, and make sure that they are straight and parallel. They can then be removed for the moment. The four terminals required for connections may be mounted upon strips of ebonite measuring $1\frac{1}{2}$ inches by $\frac{1}{2}$ inch, as shown in the drawing, $\frac{1}{2}$ -inch holes being bored through the wood to give their shanks a proper clearance, or the very useful little insulating panel bushes obtainable from advertisers in this journal may be used for the purpose. Fig. 2 shows the details of the pivot block,

which is cut from a piece of $\frac{1}{2}$ -inch ebonite $\frac{3}{8}$ inch high and $1\frac{1}{2}$ inches wide. A 4B.A. clearance hole is made through the middle of it for the pivot rod, and $9/16$ inch apart are two

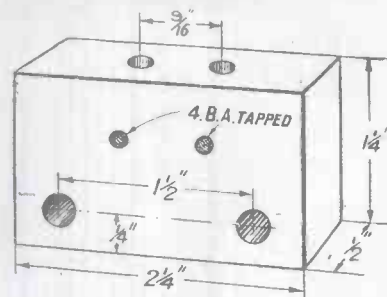

Fig. 3.—Dimensions of the slider block.

$\frac{1}{4}$ -inch holes to take a plug and a socket. These are an easy driving fit for $\frac{1}{4}$ -inch holes. When they have been forced home a 4B.A. tapped hole is made through the ebonite and the brass. Screws inserted into these holes serve the double purpose of keeping the plug and socket fixed and of providing contact points for the flexible leads. The pivot is a 2-inch length of 4B.A. studding, which may be screwed into the wood. To do this drill a hole with a No. 30 drill, enlarging it a little at the top so as to give the threads an easy start. Lock two nuts together on to the studding. It can then be turned down quite easily with a spanner, after which the nuts are removed.

Fig. 3 shows the way in which the sliding block is made. Half-inch ebonite is used here also, but the dimensions are larger. This block must be $1\frac{1}{4}$ inches high, so that the coil mounted upon it may be on a level with the one mounted upon the pivot block. The plug and socket are fixed as before, and two $\frac{1}{4}$ -inch holes $1\frac{1}{2}$ inches apart are made for the guide rods, the greatest care being taken to keep these holes quite parallel. The blocks are now mounted upon the stand, and flex leads of suitable length are taken from each of the terminals corresponding to it. For short wave work, where the effects of hand capacity make themselves particularly felt, it is as well to provide each block with a handle from 4 to 6 inches in length, so that the inductances can be moved without bringing one's hand close to the coils.



The imposing entrance to Bush House, when entering from the Strand.

READERS of this week's editorial will be interested to have some particulars of the new offices which the Radio Press, the publishers of *Wireless Weekly*, *Modern Wireless*, and other Radio Press publications, have taken in Bush House.

Situation

Bush House, a sketch of which appears on this page, is the largest business building in London. It occupies a commanding position at the foot of Kingsway, and is situated between Australia House and Marconi House. Its height is only second to the dome of St. Paul's Cathedral, and from the roof it is possible to obtain a magnificent view of London. The aerial which will be erected between masts on the top of the building will not be lonely. A short distance to the left is the sausage aerial of 2LO on the top of Marconi House, and a somewhat similar aerial is situated on the roof of the Air Ministry. Needless to say, signals from 2LO will not be used as a means of testing the efficiency of sets! We say this to short-circuit any humorist who might suggest that we were moving nearer 2LO on account of any difficulty in

hearing this station at Devereux Court.

Date of Change of Address

The actual date for the change-over from Devereux Court to Bush House will be announced in these pages, and members of the industry will be notified separately. The new offices are only

The New
Radio Press
Offices

a very short distance from Devereux Court, so that an ideal central position is maintained. On the other hand, since the offices will be at least four times as large, the company will be capable of handling the greatly increased amount of business which it expects this autumn. The final constructional details in the building will not be completed for two or three months, as everything is being designed expressly for the particular nature of our business. As the building is brand new, it is an easy matter for ideal arrangements to be carried out.

Editorial and General Offices

The editorial and general offices will, in the meanwhile, be established inside Bush House

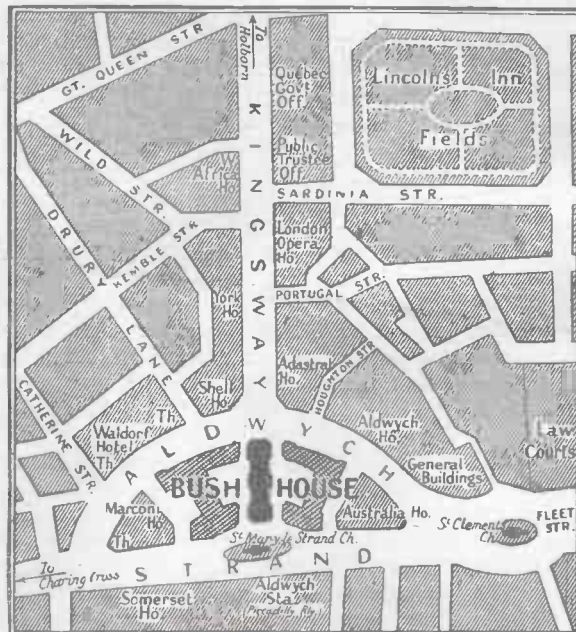

Guide to the approaches of Bush House.



We give below some particulars of the new offices we have taken in Bush House, together with a map for the benefit of visiting readers.



itself, but the Sales Department and the Radio Press Service Department will be accommodated in the wooden buildings belonging to Bush House situated between Bush House and Australia House. In the accompanying map these departments are in the position occupied by the letter S of "HOUSE."

Invalid sets should be taken to these offices from to-day's date (September 10), as the Radio Press Service Department is already installed there. The address for the Service Department is: Radio Press Service Department, Ltd., Melbourne Offices, Bush House, London, W.C.2.

Bush House is opposite the Aldwych tube station and within easy reach of the Holborn and Temple stations. The Museum tube station is also very close at hand, while numerous bus routes pass the Strand and the Kingsway entrances.

No visitor to London should



SIR,—It might interest you to know that we were successful in picking up an American station, the call sign being WBD (?) of Boston, Massachusetts. The reception was very good and audible on the loud-speaker in an ordinary room, but barely distinct enough. On the phones it came through very well.

The first part of the programme consisted of singing, both solo and choral, while the second part was instrumental played by "The Minerva Trio." At the close of the programme we held him nearly an hour. The announcer asked if we (not personally) had enjoyed the singing of—and here followed a list of names of the singers. He also gave the names of the trio, but we were unable to distinguish them in our excitement. Atmospheric and

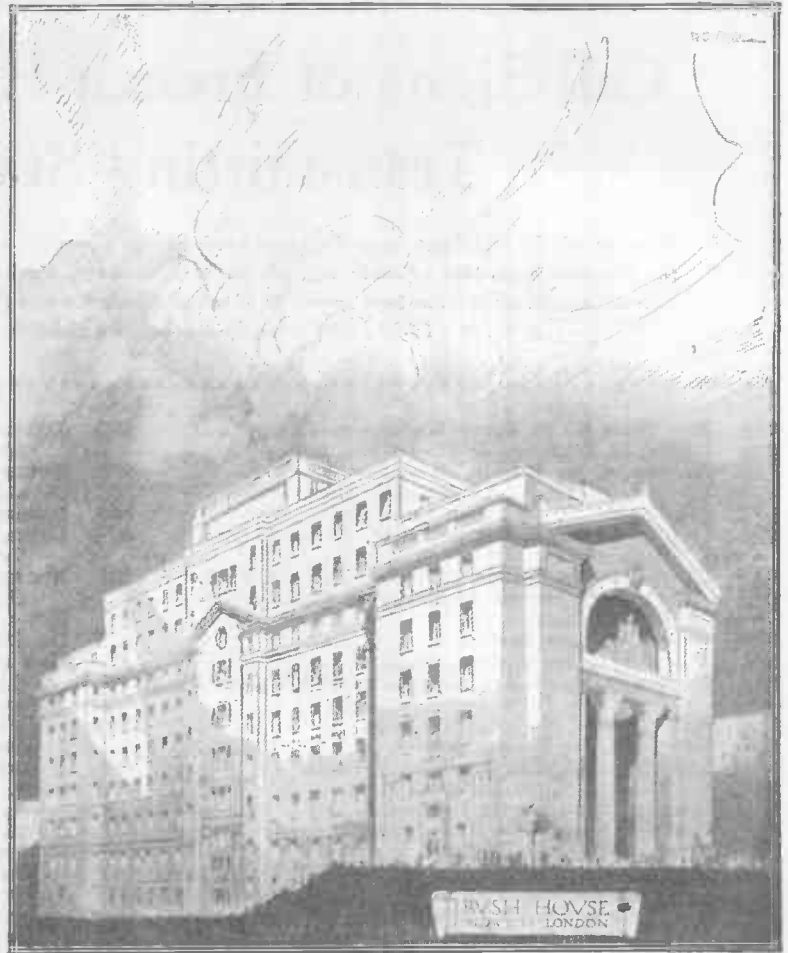

Some conception of the beauty of the building may be gathered from this etching.

fail to inspect this magnificent building, which is deservedly one of the sights of London. The architecture of the Kingsway and Strand porticos is magnificent,

and some idea of their beauty may be obtained from the sketches prepared by the architects, and appearing in this issue.

INFORMATION WANTED

Morse were a little troublesome, but nothing like last winter.

The announcer also stated on closing down that the station was at some hotel in Boston. Five minutes after this we tuned in another station on a much shorter wave, playing dance music, but sleep was claiming us, and we couldn't wait for the call sign.

The wavelength of the first station was approximately 310 metres.

We hope you or your readers may be enabled to enlighten us with

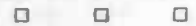

particulars of this station, as we would like to write for verification.

—Yours faithfully,
D. AND R. G. SMITH.
Edinburgh.

TECHNICAL STAFF REQUIRED

The rapid development of Radio Press, Limited, is accompanied by the need for further technical staff.

There are vacancies for young men between 16 and 30 who are keen and accurate, and also for those with a really sound experience of sets and how to put them right.

Applications by letter should be addressed, at once, to the Managing Director, Radio Press, Ltd., Devereux Court, Strand, W.C.2. All communications are treated as strictly confidential.

Call-Signs of French Experimental Transmitting Stations

In view of the excellent long distance work of the French amateur transmitting stations and the frequent reception of their signals in this country, we have obtained a complete list of French experimental stations specially checked for us by the French Postal Administration, up to August 15. Further additions will be published from time to time.

- 8AA** RISS, 38 bis, Bd. St. Beuve, Boulogne-sur-Mer.
8AB DELOY, 55, boulevard du Mont-Bron, Nice.
8AC ALAGIER, 4, rue Bel-Air, Marseille.
8AD ROUSSEL, 12, rue Hoche, Juvisy-sur-Orge.
8AE DR. CORRET, 97, rue Royale Versailles.
8Aé REVUE "LA T.S.F. MODERNE," 11, avenue de Saxe, Paris.
8AF RADIO-CLUB DE FRANCE, 95, rue de Monceau, Paris.
8AG COLMANT, 16, avenue de Robinson, Chatenay-par-Sceaux (Seine).
8AH COZE, 7, rue Lalo, Paris.
8AI GAUMONT, 12, rue Carducci, Paris.
8AJ SOCIETE FRANCAISE RADIO-ELECTRIQUE, 79, boulevard Hausmann, Paris.
8AK SCHREEDER, 28, rue Lauriston, Paris.
8AL GODY, quai des Marais, Amboise.
8AM LEMONNIER, 13, allée Gambetta, Marseille.
8AN MOUTAILLIER, 6, rue Ravignan, Paris.
8AO LARDRY, 71, Bd Négrier, Le Mans.
8AP PEUGEOT, Sous-Roche, Audincourt (Doubs).
8AQ SASSI, rue Marcellin Berthelot, Arpajon.
8AR DR. TRANIER, 81, boulevard Notre-Dame, Marseille.
8AS COISY, 76, bis, avenue du Chemin de Fer, à Rueil.
8AT PROVISEUR LYCEE DU PARC, à Lyon.
8AU BARRELLIER, 22, rue de la Paille, Le Mans.
8AV VOOS, 20 rue Werlé, à Reims.
8AX MARTIN, 17, rue du Maréchal Soult, Alger.
8AY THUILLIER, 13, rue d'Ormans, Alger.
8AZ VUIBERT, 7, rue de Vitry, Savigny-sur-Orge (S.-et O.).
8BA MICHELSENS, 35, passage Jouffroy, Paris (all wave lengths up to 200 m.)
8BB LABORIE, 69, avenue de la Grande-Armée, Paris.
8BC DRUELLE, 6, rue des Domeliers, Compiègne.
8BD DUBOIS, 211, Bd. St. Germain, Paris.
8Bé DESLIS, 24, rue d'Illiers, Orléans.
8BF LOUIS, 8, rue de la Moulliere, Orléans.
8BG HORGUELIN, Nuisement (Marne).
8BH COURTECUISSÉ, Société Tourcoing radio 10, rue de Gand, Tourcoing (Nord).
8BI LAPORTE, 61, rue Letellier, Paris.
8BJ VINCENT, 50, passage du Havre, Paris.
8BK VOISEMBERT, 27, rue Jean Binet, à Coombes (Seine).
8BL L'ECOLE POLYTECHNIQUE, 10, rue Lhomond, Paris.
8BM DUPONT, La Briquette par Valenciennes.
8BN BERCHE, 7, place Péreire, Paris. Poste à Garches (S.-et-O.)
8BO
8BP VEUCLIN, rue du Cauche, Rugles (Eure).
8BQ GAVAUDAN, 22, boulevard de la Liberté, Marseille.
8BR JARDIN, 2, traverse des Sœurs-Grises de St. Barnabé, Marseille.
8BS DELAUNAY, 1, rue d'Astorg, Paris.
8BT BROXHARD, 6, place Vieg d'Azir à Valognes (Manche).
8BU CAPITAINE BLONDEL, 18, avenue Victor-Emmanuel, Paris.
8BV PERROUX, 96, Bd. Montparnasse, Paris.
8BX VATINET, 5, avenue Gambetta, Vitry-sur-Seine.
8BY SEKSIK, 47, rue Reynard, Marseille.
8BZ MILOU, rue du Pêcher, Montélimar.
8CA AUDUREAU, 29, rue de Bretagne, Laval.
8CB DUSSAUGEY, 29, place du Marché, St. Honoré.
8CC SUQUET, 18, avenue Kléber, Paris.
8CD DUSSERT, Chateau de Pellepoix, par Beaumont sur-Sèze, près Toulouse (Hte-Gar.)
8Cé MOTTE M., 10, rue du Bloc, Amiens.
8CF GUINAND, Bramafan par Ste-Foy-les-Lyon.
8CG DUFOUR, 9, rue François Bonvin, Paris.
8CH BUTEZ, 77, rue Claude Bernard, Paris. Poste à Vaucresson (S.-et-O.).
8CI HUBERT et THIRRIOT, 6, Bd. des Deux-Villes, à Charleville.
8CJ BARBÁ, 18 bis, rue Demours, Paris.
8CK DR. ROUSSIN, 25, rue Roserie, Montélimar.
8CL MME LEBAUDY, Moisson par la Roche-Guyon (S. et O.).
8CM POIZAT, à Cou's (Rhône).
8CN LAFOND, 70, rue des Carmes, Rouen.
8CO J. GABLOT, à Dierre (I.-et-L.).
8CP DAUDOIS, à la Queue-en-Brie (S. et O.)
8CQ GOUY, 93, rue Armand Carrel, Sotteville-les-Rouen (S.-Inf.)
8CR ANDRÉ LE BLANC, 87, rue St. Jacques, Marseille.
8CS BURLET, 4, rue Tarbé, Reims.
8CT AUSCHITZKY, villa Cyclamen, Arcachon.
8CU HOURY, 20, rue des Anguignis, Orléans.
8CV MAURICE LESPAGNOL, 69, avenue du Chemin de Fer, Le Raincy (S.-et-O.).
8CX WADDINGTON, Vert-en-Drouais (Eure-et-Loire).
8CY BURLET, 22, rue de Sillery, Reims.
8CZ CREPIN RAVEROT, allée des Grandes-Fermes, à Vaucresson.
8DA SAUMONT, 37, rue Gondard Marseille.
8DB COLIN, 12, rue Dumont d'Urville, Alger.
8DC GALY, 143, avenue de Saxe, Rouen. Poste à Lyon (Faculté des Sciences), (Rhône).
8DD GALLIARD, Radio-Club Dauphinois, Ecole Vaucanson, Grenoble.
8Dé LE BLANC, 87, rue Reynard, Marseille.
8DF BALLANDREAU, 68, boulevard Pasteur, Paris.
8DG GILLE, 108, rue Bicoquet, Caen.
8DH WACHÉ DE ROO, villa La Baume, route de Morgion, Marseille.
8DI MARTIN, 63-65, Bd. de la République, Nimes.
8DJ ETABLISSEMENTS RADIO-LL. 66, rue de l'Université.
8DK ECOLE CENTRALE DES ARTS ET MANUFACTURES, 1, rue Morgolfier, Paris.
8DL LEBLOND, 65, quai Bérigny, Fécamp.
8DM DR. BAUDOIN, 120, avenue de Flandre, Charleville.
8DN CHENEY ET MARTIN, 44, rue de Sèze, à Lyon.
8DO BOURGEOIS, 5, rue des Futaies, Epernay.
8DP HUEBER, 40, boulevard du Roi, Versailles.
8DQ SCHLUMBERGER, 2, rue des Francs, Guebwiller.
8DR SOCIETE D'ENTREPRISES ELECTROTECHNIQUES, 35, rue du Général Foy, Paris.
8DS HENRI LEMOINE, Président du Radio-Club Châlonnais, 35, rue de Marne, Châlons-sur-Marne (Marne).
8DT CAVILLE, 22, rue de la Providence, Toulouse.
8DU GALOPIN, 28, rue du Pontifroy, Metz.
8DV BARTHELET, Port St. Louis du Rhône.
8DX AMAURY, 27, rue de Paradis, Paris. Poste 107, Bd Voltaire.
8DY RESTOUT, 8, rue de la Haie, Boisguillaume (Seine-Inf.)
8DZ HERVE, Radio-Union, 3, rue de Chaillot, Paris. (100 watts.)

- 8eA VILLEMIN, 9, avenue Hoche, Paris.
 8eB CLAYEUX, 54, rue des Potiers, Moulins.
 8eC COUPLEUX, 24, rue Esquermoise, Lille.
 8eD GRIMOD, 20, rue du Bel-Air, Laval.
 8eE VALENTIN, boulevard St. Roch, Avignon.
 8eF CONTANT, 46, rue du Pré, Pantin.
 8eG RADIO-UNION, 4, boulevard de Strasbourg, Toulouse.
 8eH ROSES, 2, place du Chateau, Romorantin.
 8eI SOCIETE, anciens Etablissements Ancel, 36, rue de Liège, Paris.
 8eJ MARCEL ROYER, villa Suzanne, rue des Canagues-Bompard, Marseille.
 8eK LEMOUZY, 42, avenue Philippe Auguste, Paris.
 8eL CHAUDRE, 50, avenue du Chemin de fer, Le Raincy.
 8eM DESMASURES, 25, rue de l'Hôtel-de-Ville, Neuilly-sur-Seine.
 8eN SICARD, 26, boulevard Pagès, Marseille.
 8eO JAOLU, 230, rue de la Convention, Paris.
 8eP DR. GUILLET, 28, rue des Carmélites, Caen.
 8eQ SANTOU, 212, avenue Victor Hugo, Clamart.
 8eR STAEFFEN, 9, rue J. Jacques Rousseau, Montmorency.
 8eS RADIO UNION, 3, rue de Chaillot, Paris (1kw).
 8eT PIERRE THIRION, 160, rue de Vaugirard, Paris-15.
 8eU LOUIS COTTRELL, 53, rue des Frères Herbert, Levallois-Perret (Seine).
- 8eV ALPHONSE BOUTIE, à Ain-Tédèles (Oran).
 8eX M. JACQUES PERRY, 16, rue Emile Deschamps, à Versailles, 100 watts wavelength : 180 to 200 m.
 8eY M. ALBERT CAPON, 22, rue Jean Bart, à Lille, 100 w. wavelength : 200 to 350 m., also 275 to 325 m.
 8eZ M. LUCIEN DUDITLIEU ALLAIS, 42, rue du Parc, à Fontenay-sous-Bois, 100 w. wavelength: 180 to 200 m.
- 8FA SOCIETE D' ETUDES ET D'ENTREPRISES RADIOTELEGRAPHIQUES ET RADIOTELEPHONIQUES (S.E.R.), 91, Bd. Malesherbes, Paris, 100 w. waves up to 300 m.
 8FB SOCIETE D'ETUDES ET D'ENTERPRISES RADIOTELEGRAPHIQUES ET RADIOTELEPHONIQUES (S.E.R.), 17, rue Pelleport, Paris, 100 w. waves up to 300 m.
 8FC M. PIERRE TERNYNCK, 45, avenue de Selaine, à Chauny (Aisne), 100 w. wavelength : 200 m.
 8FD M. KIERZKOWSKI, 25, rue de Metz, à Toulouse, 45 watts wavelength 250 to 400 m.
 8Fe ROBERT HELLEU, 51, rue de Prony, Paris-17e.
 8FF M. FERNAND BERJOAN, 2, rue des Convalescents, à Marseille, 100 w. wavelength : 200 m.
 8FG M. JACQUES GAUTIER, 25, rue Singer, à Paris-XVIe, 100 w. wavelength : 180 to 200m.
- 8FH M. MARCEL BORNOT, 111, rue de Paris, à Compiègne, 100 w. wavelength : 200 to 500 m.
 8FI M. GEORGES ACHER, 12, rue Gérando, Paris-IXe, 100 w. wavelength : 180 to 200 m.
 8FJ M. PAUL LEVY (pour M. Ménard), Le Blancat, à Gand (Basses-Pyrénées), 100 w. wavelength : 180 to 200 m.
 8FK M. GEORGES LOGEROT, 21, rue Morand, Paris-XIe, 100 w. wavelength : 180 to 200 m.
 8FL M. ANDRE BLANCHARD, Lieutenant de Vaisseau, chez M. Fabre, marchand de bois, route, du Cap Brun, à Toulon, 100 w. wavelength : 180 to 200 m.
 8FM M. FERNIDNAND MERCKEL, 9, rue Félix Faure à Neuilly-Plaisance, 50 w. : waves up to 380 m.
 8FN M. BEAUVAIS, 1, rue Léopold Robert, Paris-XIVe, 50 w.
 8FO
 8FP PAUL MOLES, 36, rue Léon Say, à Bordeaux-Talence, 100 w.wavelengths : 180 to 350 m. ; also 210 to 230 ; 275 to 325 ; 340 to 350 m.
 8FQ M. PAUL GERMAIN, Caporal au 8e Génie, Poste radiogoniométrique de Meudon (S.-et-O.), 10 w. wavelength : 185 m.
 8FR M. ROBERT DUBS, 16, rue Richenstein, à Mulhouse, 100 w. wavelength : 180 to 200m.
 8FS
 8FT M. GILLES DE LA TOCNAYE, 18, rue Choron, Paris-IXe, 100 w. wavelength : 180 to 200 m.
 8FU M. GEORGES DARDEL, 2, rue Lafayette, à Mulhouse, 100 w. wavelength : 180 to 200 m.
 8FV
 8FX GEORGES LEVY, 148, faubourg Saint-Martin, Paris-10e wavelength: 46 to 350 m. ; also 109-115-125-210 to 230-275 to 325 m.
 8FY M. C. BOULET, 101, rue de RENNES, Paris-VIe, 100 w. wavelength : 180 to 200 m.
 8FZ M. JEAN LEFEVRE, 33 rue des Blancs-Mouchons à Douai.
- 8GA SFR. Poste de Clichy, maximum power : 15 kilowatts ; wavelength, 850 m. ; telegraphy only.
 8GB SFR. Poste de Ste-Assise, maximum power, 15 kilowatts ; wavelength, 85 and 205 m. ; telegraphy only.
 8GC ETABLISSEMENTS RADIO—L—L, 137, rue de Javel, Paris XVe, maximum power, 6 kilowatts ; wavelength, up to 700 m.
 8GD M. G. DUVIVIER, 1 Allée Victor-Hugo, Le Raincy (S.-et-O.), maximum power, 100 watts ; wavelength, 10 to 200 m. ; 390 to 400 m.



Our photograph shows John Henry and his wife "Blossom" all ready for their flight over London. The transmitter which permitted communication with ZLO may be seen in the cockpit.

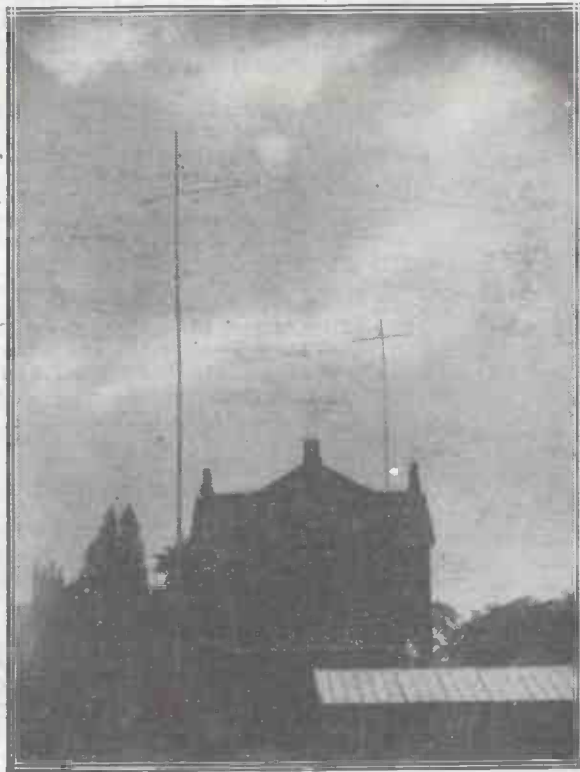

A photograph showing the masts and aerial at 2KW.

TREMENDOUS strides have been made in amateur radio during the last two years. From the time when the first American amateur was received on this side of the Atlantic progress has been exceedingly rapid. Even then some of us thought of the probability of conversing regularly with our American cousins. Despite vague criticisms we were last winter almost in nightly touch with the amateurs of the United States and Canada. It was for Mr. Deloy (F8AB) and Mr. Partridge (G2KF) to first effect two-way touch with 1MO. These successes were quickly followed by others, and it was soon quite a common thing for several stations to be in touch with the other side at the same time.

Romance

All this makes us think, and think hard. That a station using only a few watts and comparatively little apparatus should be capable of working over such a

range is truly marvellous. One cannot fully appreciate the thrill in carrying on communication over these distances unless one has actually done it. With what a hope we await the call, and with what feverish excitement it is answered. A few times the call signs are repeated, and we have changed over again. Then faint perhaps—but withal, steady—comes the reply. We have been heard and are perchance in direct touch with a station maybe several thousand miles away. There is something so romantic in it all, and yet something that is so wholly marvellous. When we become used to a thing its interest wanes, and we oft-times fail to consider it in any other than an everyday light. Be this as it may, I shall never forget that first thrill when I heard the code word of U2FP on the morning of December 8, 1921. Nor shall I forget the first time 2KW established two-way communication across the Atlantic with U1KC. But these things are

The Experiment 2KW

By W. R. BUKER

This station, which many readers will have received across the Atlantic. In the following phenomena experienced in short-wave description of the 2KW S

becoming an everyday occurrence so that one is apt to make light of them and say that anybody can do them. Like everything else they can be repeated when once the way has been shown.

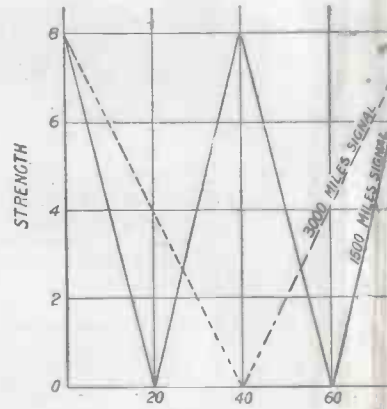

Fig 1.—Illustrating how signals away respectively miles

Early Tests

It is the purpose of this article to chronicle some of the mysteries connected with short-wave communication over long distances, and to give some indication of the type of apparatus used in this work. When amateurs first tried to span the Atlantic with their short-wave signals their efforts met with little or no success. The first series of tests were a failure, though in the second series a few months later several British and foreign amateurs logged signals transmitted by American amateurs. It is enough to say here that the first schedule transmission was heard by a Britisher.

ntal Station

NE.

heard, was one of the first to be
 following article many interesting
 transmission, together with a
 details are given.

Apparatus was improved and facilities granted to various individuals and societies in this country for the use of higher power. The next winter British and French amateur signals were

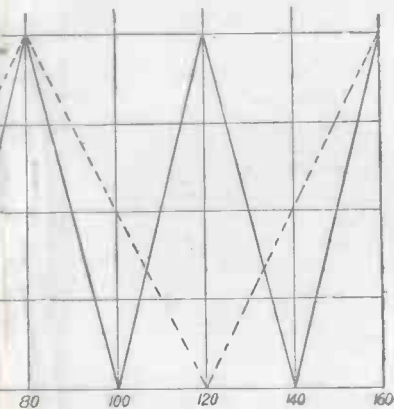

from stations 1,500 and 3,000 miles
 that be expected to swing.

heard in the States while American signals flocked in; every district in the U.S. being copied. But while most of the men were engaged in merely listening for signals, the transmissions of the American stations were being very carefully observed by the present writer and by Mr. Cash (2GW).

Fading

It was noticed that the fading of these short-wave signals was not always irregular. As far as could be determined the signals of U2ZL, which station made a series of special tests throughout the winter for the writer, very often faded quite regularly. Gradually increasing in strength until a maximum point was

reached, the signal would then decrease until a minimum point would be reached. Then slowly the strength would increase until the maximum point was again reached; thus a definite cycle of events took place. In the case of U2ZL the time taken for the signal to pass through all stages of intensity took about 80 seconds. All stations situated in the vicinity of New York took about the same time to swing.

Swinging

Now it was particularly noticed that a signal emanating from a station further away took a longer time to swing, likewise a signal from a nearer station did not take as long to swing. Thus it was possible to obtain a rough idea of the distance away from the transmitting station, and it was a fact that we could frequently tell whether a station was of the 4th, 5th, 6th, 7th, or 9th district, or the 1st, 2nd, 3rd, or 8th district. In Fig. 1 will be found a diagram showing how a signal emanating from a station 1,500 miles away and 3,000 miles away might be expected to swing. Whilst this type of fading was very marked it was noticed that on some nights there was hardly any fading. Yet frequently plenty of the irregular or spasmodic type troubled us; this

we did not consider, for it was pretty evident that there must be some satisfactory explanation for the regular kind, while there are probably a multiplicity of causes of the irregular type. The effects of the kind under discussion were so marked, and observations made on many different nights throughout the winter with different sets and at different stations, that there is bound to be some cause for such phenomena outside of the apparatus used.

200-Metre Reception

All this work was done on around 200 metres. Some nights were good whilst on other occasions no signals were audible. The fading of the signal rendered distant communication exceedingly unreliable. It was often said that the shorter band of waves were still better for this work, but everyone preferred to see his aerial ammeter read off the scale on, say, 200 metres rather than an ampere on a wave below 200. The average experimenter did not care very much for the purity of the note he emitted, and it is a fact that even now one hears attempts of telephony with a carrier wave that is all A.C. hum! Some time ago we were certain that it was the higher waves that carried best. Then 8AB and 1MO commenced using



An interior view of the station showing both receiving and transmitting apparatus.

short waves, and everyone changed their opinions. Now the loudest signals crossing the Atlantic are those sent on the shortest wavelengths. Furthermore, fading is almost non-existent on the shorter wavelengths; and it is truly awe-inspiring to hear a faint signal keep a constant strength over a long period.

Short Waves and Daylight

But the trouble with our short waves is daylight. It is perfectly easy to work over two or three hundred miles, and we hear that two-way communication has been established across America on 200 metres between 6XAD and 2ADM. This feat was abnormal. American and Canadian signals are at their best about an hour before dawn to half an hour after. Then they gradually die away, until about 1½ hours after dawn nothing is to be heard. Sometimes signals are heard well into daylight, but not often. Why we should be able to work over 300-500 miles in daylight and not over 3,000 miles is not very clear to me.

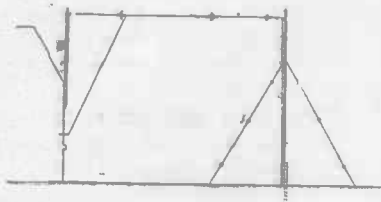

Fig. 2.—The aerial and leading-in arrangements.

The greatest problem at present is that of atmospherics. It cannot be doubted for a moment that given an efficient X-stopper DX work could go on all the year round.

Conflicting Reports

Very conflicting reports are met with where short-wave signal strength is concerned. Having made due allowance for the enthusiasm of the reporter, it is hard to credit some of the very peculiar differences in strength at distances of, say, 150 miles and 3,000 miles from the transmitting station. Some little time ago I heard 6RY working with an American station quite easily though his strength to me on two valves was about R3. I have often heard London stations who were getting across the Atlantic in fine style, and who have been

quite weak at 2KW. My signals have been reported by stations in the London district as weak, while 1,000 miles away over land they have been received quite well. 5AW (Southport), 40 miles away, is about R3-4 on one valve, and one would not credit his signals being heard very far away. In London, using the same type of receiver, I have heard him about

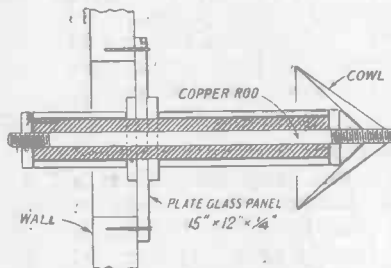

Fig. 3.—Details of the leading-in tube at 2KW.

the same strength, and he has been heard in Milan whilst employing an aerial current of .12 of an ampere. Short-wave work is the most interesting study, and we are finding out that only the outside edge of it has been touched. To guarantee reception of a particular station in a certain district without first trying is foolish when dealing with these short wavelengths. People are finding out—to their cost—that wireless is not quite such a simple proposition as they at first thought it was.

2KW

Many readers of *Wireless Weekly* have probably heard transmissions from 2KW. It is therefore felt that a brief description of some of the apparatus used will be of interest. It should be borne in mind that 2KW is strictly an experimental station, and consequently the gear is frequently being changed.

The aerial used up to a few months ago was of the 4-wire inverted L type. A span of 50 ft. served as the "flat top," whilst the down lead measured approximately 35-40 ft. The masts were 70 ft. high, a 45 ft. pole being fixed to the side of the house. Now the free end is supported by a 45 ft. mast. The distance between the masts is 90 ft. as the actual aerial is suspended clear of the roof and guy wires, as shown in Fig. 2.

The insulators in use at 2KW are made by Messrs. Buller &

Co., of London. Whilst the leakage surface is large, these insulators are also well glazed so that moisture will not be absorbed by the porcelain.

Insulators

A deal of controversy goes on as to the merits of a multi-wire aerial over a single wire. For transmission purposes a double, four, or even six-wire aerial may be desirable, though for reception it is debatable if any advantage is to be gained by the use of these forms of aerial. With the addition of extra wires, it is not as easy to tune out a nearby station, and all that seems to happen is that selectivity is reduced. The essential feature

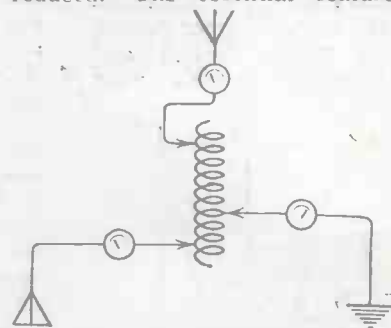

Fig. 4.—General arrangement of the radiating system at 2KW.

with an aerial is that it should be high. It is very important that the radiation resistance of your aerial circuit be made as high as possible.

Let us consider the following formula:—

$$\text{Rad.} = (39.7 \frac{h}{\lambda})^2 F \dots \dots (i).$$

Where

h = Effective height.

λ = Working wave in metres.

F = A "form factor" that depends on the distribution of current in the aerial.

Rad = Radiation Resistance

It will now be seen that if we want to increase our radiation resistance we may do three things to accomplish this end:—

1. The effective height may be increased.
2. The form factor may be given a higher value by carefully designing the aerial.
3. The wavelength may be decreased.

Assuming that the wavelength is fixed by the terms of our permit, and it is impracticable for us to juggle with the design

of our radiating system, there is nothing left but to increase the height of our masts. Thus height and freedom from screening are two very important points that should be carefully considered by the DX man.

Aerial Current

Now, a great many experimenters have an idea that, as the wave is decreased and the aerial current drops, the range of the set is automatically reduced. If the aerial current drops on a particular wavelength, it is pretty safe to assume that the range at the same time is reduced, because the power in the aerial has been reduced. If, on the other hand, we reduce our wavelength, and our aerial current falls, the important point to grasp is that the power in the aerial remains the same to all intents and purposes. Aerial current does not matter very much; if the power in the aerial is kept constant it is noticed from the formula (ii) that the lower the aerial current the better, for the desirable radiation resistance is thereby increased.

$$\text{Radiation resistance} = \frac{\text{Watts Radiated}}{\text{(Aerial Current)}^2} \quad \text{(ii)}$$

If we double the input power to the set, the aerial current will be increased by a half and not doubled; if it were so we should

have put four times the power into our set. It is also well to remember that aerial current does not mean radiation. One often hears of the amateur "radiating" an ampère; this, of course, he could not possibly do, unless perchance he had accidentally stumbled upon a somewhat useful death-ray!

In every case I have found that the shorter the wavelength the louder have been my signals

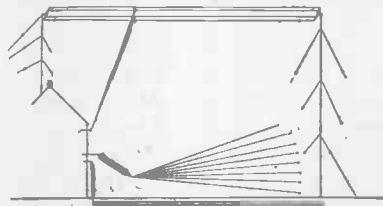

Fig. 5.—Showing how the counterpoise is sometimes used as an earth screen.

at a given point. It does not follow that, because our aerial meter is reading five amps., the signals are carrying as they ought. The mere fact that we have unlimited ampères at our command guarantees us nothing; it is the intelligent use of the amp. that counts. It may quite conceivably happen that an iron roof is situated near our radiating system, or the guy wires are tuned to the wavelength on which we happen to be working at the time. Consequently the most terrific absorption is taking

place. The very obvious remedy is to split the guy wires into even lengths, so that in the case of any absorption effects, they will evince themselves, as far as possible, on one particular wavelength. The "tin roof malady" is somewhat hard to overcome, yet it may be necessary to connect up all interfering masses of metal and connect them through a helix to the A.T.I. In this connection it is of very great assistance if a resistance curve of the radiating system be plotted covering the amateur band of waves of from 150-200 metres. By this means it is possible to see just at which particular wavelength absorption is taking place. The operation is, however, not very easy to perform, and no more than passing mention need be made of it here.

The Earth

The earth and "earth-screen" or counterpoise arrangements are also very important if the experimenters wish to attain their goal. Only too often a good aerial is erected whilst the lower end of the circuit is left to take care of itself. This should not be so. Most amateurs make use of the water pipe (earth) for reception, but it is found that this connection is of little use for low-wave transmission. At 2KW there is a net-

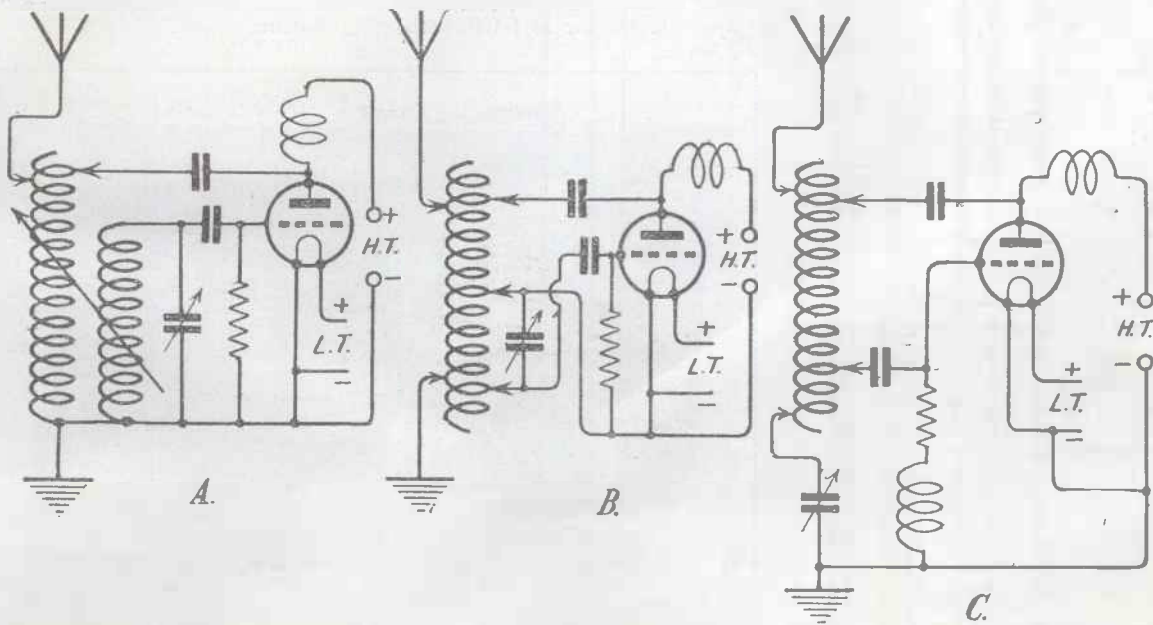

Fig. 6.—Three well-known types of transmitting circuits. A.—The 1DH circuit. B.—The "Hartley" circuit. C.—The Colpitts circuit.

work of buried wires 3 ft. down underneath the aerial and running parallel with it. The lead from this system is an eight-wire cage insulated from earth. The counterpoise or earth-screen is used for transmission and consists of eight wires 60 ft. long and arranged fan-wise underneath the aerial. Careful attention is again paid to insulation, Buller insulators being used. The wire is No. 16 hard drawn copper and enamelled. The lead-in is again caged so as to provide an easy path for high-frequency currents. The counterpoise lead-in should be well insulated and kept well clear of the house wall and by no means parallel with it. It is also of importance that all the wires in the counterpoise be of exactly the same length. Fig. 4 shows a general arrangement of the

radiating system at 2 KW, while Fig. 5 shows how the counterpoise is sometimes used as an earth-screen.

The best-known types of circuit will be found in Figs. 6A, 6B, and 6C. Fig. 6A is the "reversed feedback" or "1DH" circuit; Fig. 6B the "Hartley," whilst the "Colpitts" arrangement is shown in Fig. 6C. The parallel method of feeding the high voltage to the anode of the valve is shown in all cases, as the risk of burning out the filament transformer (if A.C. is used) will be reduced to a minimum by so doing. The "reversed-feedback" circuit is perhaps the best known in this country, though the other two arrangements have many staunch supporters.

(To be concluded.)

Test Report on 3-Valve Resistance Coupled Receiver

(Concluded from page 602)

Another foreign station, Petit Parisien (name announced), was received on the phones.

Two more stations below this wavelength, one with the condenser set at minimum and the other at 12 deg., were received at weak phone strength, these stations being German.

The purity of reproduction was remarkable, and for local work and 5XX a better set could not be produced.

NOTE.—With reference to the second and third grid condensers in this set, the values when the set was photographed were .25 μ F, but subsequent tests showed that any value above .002 μ F could be used, and the valves .01 μ F mentioned in the article were finally adopted.

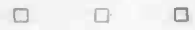

remarks, I cannot but write on my own experiences on a straight, direct-coupled one-valve set, as described in June *Modern Wireless*.

I can regularly bring in 5XX on the L.S. audible across the room, and also SFR on 'phones.

In fact, 5XX is almost at the same strength as 2ZY, seven miles away; as for critical tuning, 15 deg. of the condenser will not cut 5XX out even at this distance (about 150 miles).

Yours faithfully,
"EXPERIMENTER."

Oldham.

Letters from Readers

RECEIVING 5XX

SIR,—The appreciation of 5XX seems to be somewhat mixed, due, I should think, to faulty tuning in all cases.

It is a great boon to me on my Four-valve Family Receiver, as I can listen in comfortably to 5XX on the detector only, while for 2LO I require an extra valve on 100 ft. aerial, 30-40 ft. high. I get him beautifully off the bed-spring, although it is rusty; off the electric light wire; the wainscot; the fire grate, and, I daresay if I coaxed him, off my watch chain. What more could the grumblers desire?

I am 40 miles from 5XX, although we are well up on the Chilterns, about 500 ft.—Yours faithfully,

F. G. S. ANDERSON.
Amersham.

AMATEUR RADIO SOCIETIES

SIR,—Are radio societies closed corporations?

Last February I wrote to the secretary of one inquiring for particulars and conditions of membership. After waiting a month during which I received no answer, I wrote again, and in due course received a form of application with a letter saying that owing to illness my letter had been overlooked. I filled up the form and posted it promptly, and though this was six months ago, I have heard nothing further.

I understood that radio societies existed to foster interest in the science of wireless, but have come to the conclusion that this is a delusion.—Yours faithfully,
Cardiff.

AERIAL.

EFFICIENCY ON 1,600 METRES

SIR,—In your issue of July 23 an article on "Efficiency on 1,600 Metres" from the pen of Mr. Cowper appears. As far as I follow the

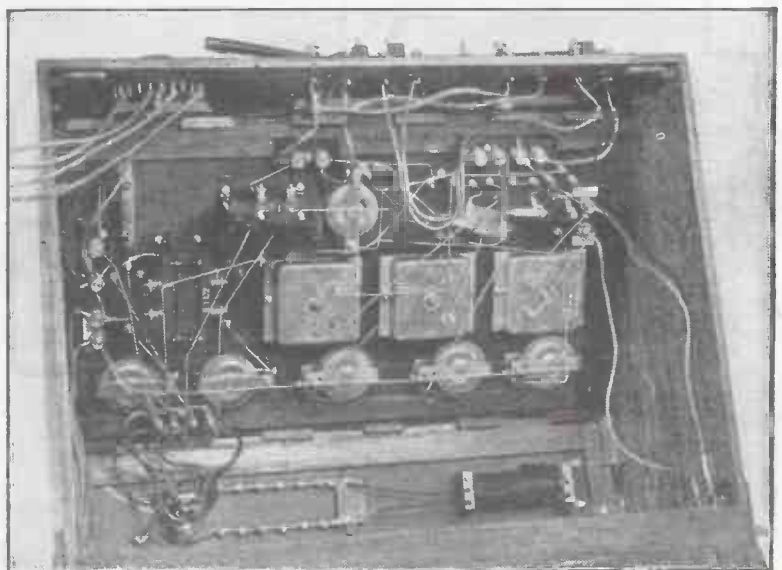

The workmanlike appearance of the receiver illustrated on page 612 is also maintained beneath the panel, as the above photograph shows.

How every Crystal User may become a Valve Expert

By E. REDPATH, Assistant Editor.

Further constructional details are given for building a single valve reflex receiver. (Concluded from page 578.)

General Description of the Set

The photograph, Fig. 1, in last week's issue, shows the receiver complete with coils, etc., all components being mounted either upon or beneath the ebonite

In the centre of the panel will be seen the standard four-pin valve socket, with filament rheostat of the carbon compression type, and two telephone terminals.

Constructional Details

Full details as to the method of drilling the ebonite panel and mounting the components thereon are given in Fig. 6, whilst the general disposition of components behind the panel will be seen on reference to the photograph, Fig. 7.

It should be noted particularly that in order to provide a really compact set the utmost use has been made of the space available, and readers who do not use components similar to those specified will be well advised to defer the marking off, drilling, etc., of the panel until they have obtained the components required and tried them in place upon a sheet of paper or cardboard marked or cut to the dimensions of the panel, namely, 9 in. x 5 3/4 in.

The containing box is of a standard type, measuring 9 in. x 5 3/4 in. x 5 in. deep, and in this case a dimensioned drawing is considered unnecessary.

Components Required

- One ebonite panel, 9 in. x 5 3/4 in. x 1/4 in. thick.
- Seven terminals.

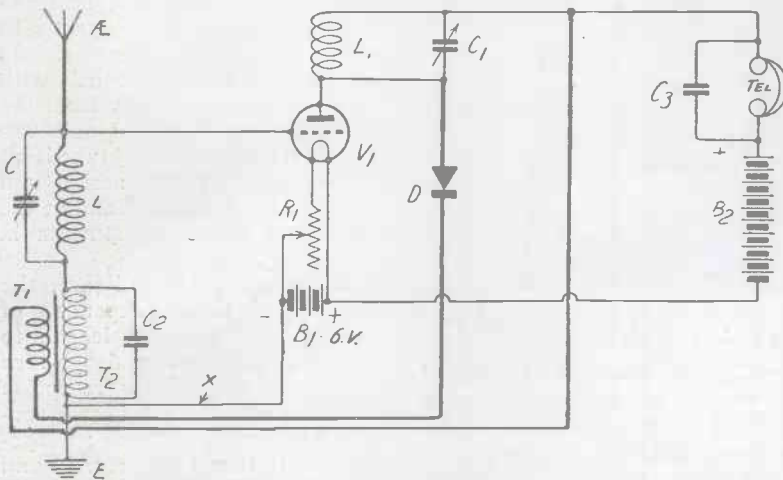

Fig. 5a.—Theoretical circuit diagram indicating alternative position of condenser C2 and transformer secondary T2. In last week's issue the point x was not marked.

panel, a further view of which was given in Fig. 1a, the coils, etc., being removed to show more clearly the disposition of the various components upon the panel.

The aerial circuit is tuned by means of a plug-in inductance coil placed in the left-hand (movable) coil holder, and the variable condenser (0.0005 μF) immediately beneath it. The two terminals upon the left-hand side of the panel are the aerial and earth terminals respectively, the former being the upper one in Fig. 1a.

The right-hand variable condenser, in conjunction with a second plug-in coil to be fitted to the fixed coil-holder, affords the means of tuning the anode circuit, whilst the variable coupling between the inductance coils permits reaction to be employed, with consequent increase in all-round efficiency.

In the right-hand upper corner of the panel are the three battery terminals, and the "Excentro" crystal detector.

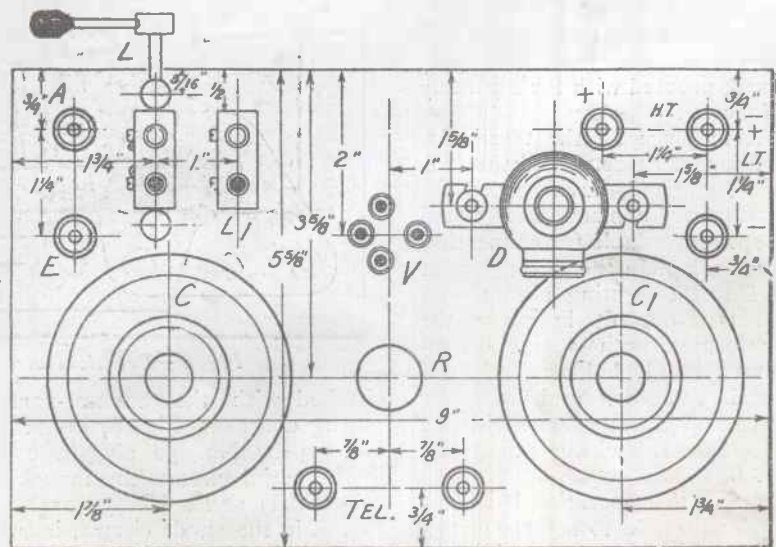

Fig. 6.—The layout of the panel.

- One 2-coil holder.
- One filament rheostat (Lissen).
- One crystal detector (Excentro).
- One iron-core intervalve transformer (Radio Instruments).
- Two fixed condensers, each 0.001 μ F (Dubilier).
- Two variable condensers, 0.0005 μ F (Jackson Bros. and Formo Co.).

space required by the moving vanes will be clearly indicated, and they will not subsequently foul any of the bare connecting wires.

The two fixed condensers may be fitted last, the telephone condenser being soldered direct to the shanks of the telephone terminals, whilst the condenser across the secondary of the

rheostat and observe that the valve lights up correctly before connecting the high-tension battery to appropriate terminals.

Connect aerial and earth leads, telephone receivers and high-tension battery. Probably as soon as the last-named is connected, a loud "howl" will be heard in the telephone receivers. If so, move the aerial coil further away from the anode coil and, should the howl not cease, re-adjust the crystal detector.

The actual tuning of the set involves two adjustments, namely, the aerial and the anode tuning condensers, and, for best results, it is important that the two circuits should be exactly in tune. These adjustments should be experimented with a little with the aerial coil well away from the anode coil. When signals are received and carefully tuned in, gradually bring the aerial coil closer to the anode coil and at the same time make adjustments in the tuning.

The size of this coil (*i.e.*, the number of turns) depends, of course, upon the wavelength to be received. 35- and 50-turn coils are required for reception of British broadcasting; a 100-turn coil for the Hague; a 150-turn coil for Chelmsford and Radiola, and a 250-turn coil for Eiffel Tower, Paris.

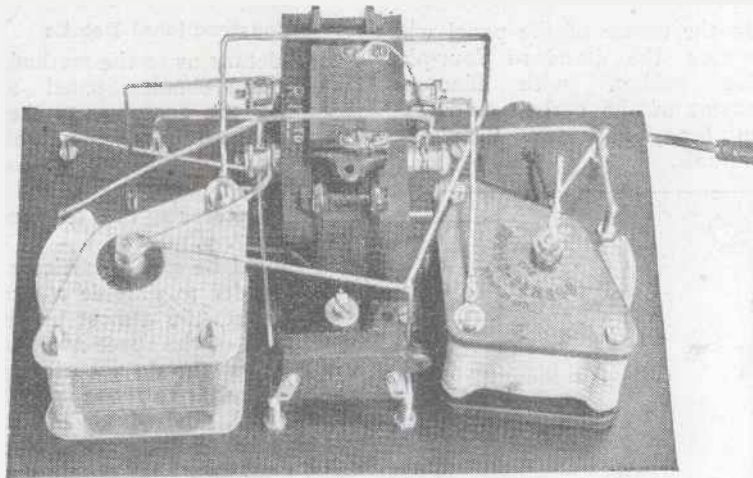

Fig. 7.—Photograph showing underside of panel.

Supply of tinned copper wire, round or square section.

Note.—The aerial tuning condenser should have a single plate vernier for fine tuning.

Mounting the Components

There are one or two points in connection with the fitting of the components and the subsequent wiring up, which call for special attention. Having prepared the ebonite panel in the well-known manner and drilled it in accordance with Fig. 6, or to suit whatever components have been purchased, proceed with the assembly as follows:—

Fit in place all the terminals, the filament rheostat and the four valve legs, and, having tried the transformer in place and noted the space available for connecting wires, complete the wiring up of the filament lighting circuit.

This done, fit in place the transformer, both variable condensers, coil holder and the crystal detector, and carefully connect up in accordance with the back-of-panel wiring diagram, Fig. 8.

During this operation it will be found advisable to set each variable condenser to its minimum capacity, so that the amount of

transformer may be connected by means of two short wires soldered to the condenser clips.

Testing and Operating the Set

When all connections are completed, carefully examined and

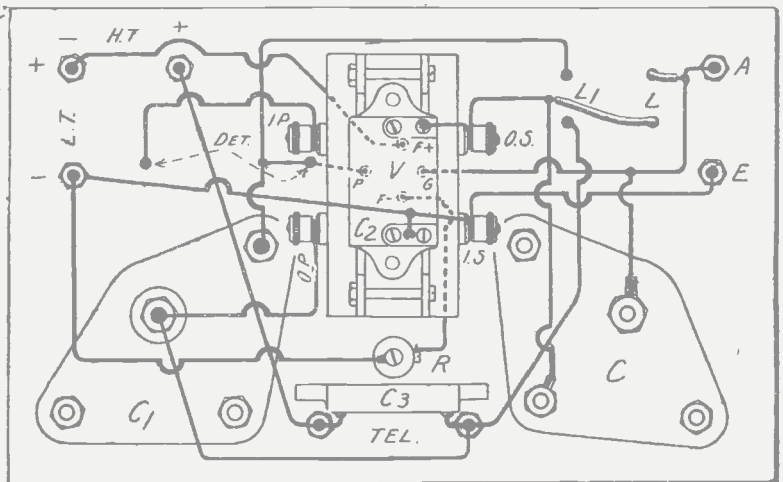
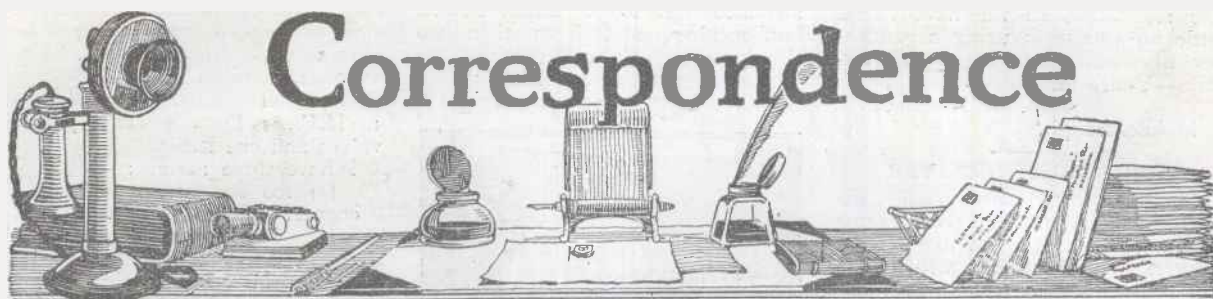

Fig. 8.—Practical wiring diagram of the receiver.

checked with the back-of-panel wiring diagram, Fig. 8, insert a No. 35 or No. 50 plug-in coil in the aerial circuit (the movable coil-holder) and a No. 50 or No. 75 coil in the anode circuit, insert the valve and connect the L.T. battery. Adjust the filament

With the set as described, in proper working order and carefully adjusted, very satisfactory results are obtainable, and it probably represents the most efficient and economical method of using a single valve.



THE POST OFFICE AND THE AMATEUR TRANSMITTER.

SIR,—It was with great interest that I read your editorial in the August 27 issue. I am certain that your challenge to the Postmaster-General will meet with the full support (and gratitude) of all amateur transmitters, as well as many amateur receivers, such as myself. The British Post Office, I believe, is noted for its "absurdities."

As an experimental receiver, I find the transmissions of amateurs of great value—of far more value than broadcasting—for judging the efficiency of sets and apparatus in general.

I trust that the authorities will see the direction in which their duty lies and take the necessary steps to rectify matters at once.—Yours faithfully,

EXPERIMENTAL RECEIVER.

S.E.20.

B.B.C. ANNOUNCERS

SIR,—About three weeks ago I was asked by a friend to come and hear his two-valve set, which I did. Falling into a comfortable chair and having a pair of headphones placed over my cranium, I started to listen-in. Was it good? Yes, very! Clear? Yes, and loud as well! And I was enjoying it immensely till I asked where it was coming from. "Don't know! Wait a little and you will hear."

I did wait a little, and still the programme continued. Some male voice sang a song, some female voice did the same; then four joined in. Great cheering and clapping! "Where is it coming from?" "Don't know! Wait till you hear!"

I continued still to wait, and as one song succeeded another and encores like a procession, I waited till I would hear "someone calling." Time went on, and still the merry programme continued. I got quite impatient. The programme was still good, but it was lost now to me, the burning question being, where is it coming from? Having sat more or less still for one hour and twenty minutes, explored the *Radio Times* in a vain endeavour to find out who was who and where who was. I at last cast my eye on the clock. Almost 10

o'clock. Trusting that a standard time having been reached, someone, somewhere, might condescend to say where they were. Then five minutes past ten, not a minute longer! Thoroughly exasperated and fed up with a never-ending programme which seemed to come from nowhere; I took the headphones off, and feeling quite disgusted with what was a good programme spoilt by the failure of the announcer to broadcast his station. He may however, have been overcome with the charm of the singing, but if this meets the eye of the offender, I trust he will take my remarks to heart and announce more often where his station is, unless he is ashamed to do so, in which case he would do better to buy a gramophone or start a fish and chip business.—Yours faithfully,

GEORGE MACKIE.

Perth.

ENVELOPE NO. 2

SIR,—I have much pleasure in informing you that I have now completed the set described in Envelope No. 2, "The Four-Valve Family Set," and I am more than satisfied with the results obtained.

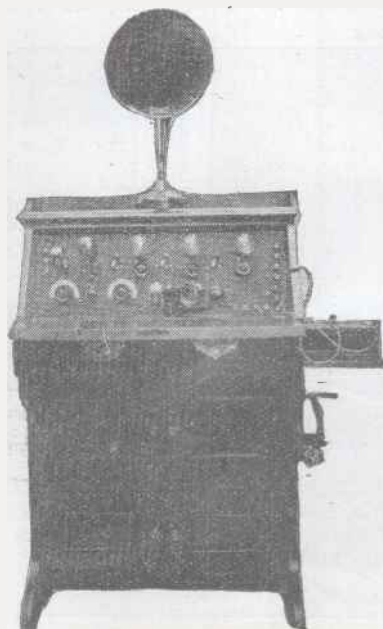

The Four-valve Family Receiver as made by Mr. Langley King.

I have been successful in tuning-in all the B.B.C. stations with the exception of Manchester, and also one of the French stations, all coming through very clearly on an indoor aerial on three valves; the fourth valve is not quite satisfactory, and I am at a loss to understand the reason, no increased amplification being noticeable.

The set is fitted with two Igranix transformers and, with the only other exception, viz., the two condensers are without Vernier attachments, every part is according to plan.

I enclose herewith a photograph of the completed set, and I think you will agree with me that it makes a very handsome piece of apparatus.

Please accept my best thanks for being the means of furnishing me with a set from which so much enjoyment is obtained, and in conclusion wishing your journals continued success.—Yours faithfully,
A. E. LANGLEY KING.

Woodford Wells.

MORSE RECORDING

SIR,—I would like to thank you for your recent article on the above subject, as I have at intervals experimented, in a small way, in this branch of wireless reception.

The use of a crystal rectifier and a secondary circuit was quite novel to me, and, on roughly making up the circuit, I was very surprised at the number of transmissions, and also of the apparently weak (distant) ones, which would operate my relay (Weston). I find C.W., if reasonably strong, much more satisfactory than spark for this purpose.

I have considered various methods of obtaining the desired record, including phonograph, gramophone motor, but am inclined to think that an instrument built for the particular purpose would be the best investment.

Up to the present I have used my Morse buzzer as an indicator that my relay circuits have functioned correctly, having personally tried most of the cable companies unsuccessfully for a discarded inker.

I find that the value of the condenser used across the output of my set has considerable effect on the number of stations which will work

the relay, but so far have found little advantage in using a condenser in the secondary (crystal) circuit.—Yours faithfully,

W. G. HARRISON.

Middlesbrough.

THE OMNI RECEIVER

SIR,—Having constructed the "Omni Circuit" receiver some months ago, I wish to express my appreciation of the ease with which one is enabled to test various circuits with this instrument. Previously one was obliged to have wires trailing all over the set, but now no untidiness is observable whatever the circuit in use.

As an example of the flexibility of the set, I might mention that out of 42 circuits shown in a number of *Modern Wireless* chosen at random (actually that for March), 17 may be tried without any alteration, 20 more may be tried by simply plugging in a special external inductance (such as a variometer, tapped coil, etc.), one requires an external condenser, two an external potentiometer, whilst of the two remaining circuits, one is a 10-valve super-heterodyne and the other is the "Millionaire's Own," which very few amateurs will wish to try! A single instrument which will do all this is obviously invaluable to the experimenter.

My own set is somewhat different from the original design, the chief alterations being the addition of Burndept fixed resistors in series with the rheostats and the provision of an extra variable resistance.

In conclusion, I would like to congratulate you on the production of *Wireless Weekly* and *Modern Wireless*, undoubtedly the best wireless periodicals.—Yours faithfully,

CHARLES DAVIS, M.Sc.

Manchester.

5XX IN CONSTANTINOPLE

SIR,—Being a staunch supporter of your topping little *Wireless Weekly*, I would like to inform you of some rather remarkable results I obtained with a Turkish friend of mine last night (Tuesday). We were working with an indoor frame 10 in. x 7 in.—18 turns—three H.F., detector and one L.F., and were taking Radiola, whose modulation seemed awful, on the 'phones—Brown's 4,000 ohms. There being an automatic station jamming we became more or less exasperated, and as I had read of 5XX in last week's *Wireless Weekly* I suggested that we try the experiment on 1,600. On switching over we were startled by getting 5XX not only much clearer than Radiola, but much stronger. We then switched off the 1 L.F. and replaced it by an additional H.F., making 4 H.F. only, and no L.F. The orchestra being so strong in the 'phones, we

switched over to our small Brown loud-speaker, and from then we simply sat back and received the whole programme, including "God Save the King" and "Goodnight."

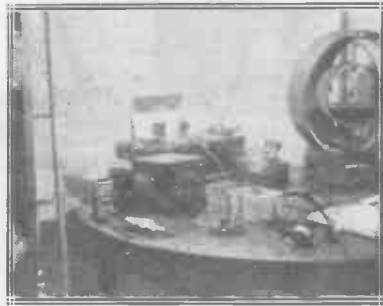

A corner of Mr. Lee's station at Constantinople.

I would like to add that I have heard Radiola for several months, but have never had such perfect reception as I received from 5XX.

I am enclosing a snap of one corner of my station; the whole thing is hand-made, and you must excuse the apparent disorder, as it is impossible to obtain wireless goods in this country, and my set is composed of all sorts of odds and ends.

You can imagine that I am now elated to be able to get a real English concert while being so far away—thanks to 5XX. Wishing W.W., R.P. and 5XX the best of luck.—Yours faithfully,

DONALD T. LEE.

Constantinople.

A READER'S RESULTS

SIR,—Perhaps the enclosed results obtained on different aerials and



The receiver upon which Mr. Symmons White made his tests.

earths may be of interest and possibly of help to some of my fellow readers of *Wireless Weekly*. I am situated 60 miles from the nearest B.B.C.; I use a four-valve set 1 H.F., 1 Det., 2 L.F., 3 D.E. valves and one L.S.5.

I have three aerials:—

(1) 100 ft. outside aerial, 7/22 copper. Height, 36 ft.

(2) Indoor aerial in roof, 100 ft. Electron wire, secured to rafters in roof, coming out of side of roof down side of wall to set.

(3) 60 ft. of bell wire round picture rail, on ground floor.

Earths:—

(1) Iron spike driven into ground 4 ft.

(2) Biscuit tin filled with ashes buried 3 ft.

(3) Counterpoise consisting of 100 ft. of Electron wire.

As regards aerials, there is little difference between 1 and 2 up to 100 miles; No. 3 is good on Cardiff 60 miles, Bournemouth 70 miles, and when there are atmospheric conditions there is a vast improvement on either Nos. 1 and 2.

Over 100 miles No. 1 is the best.

Earths: Of Nos. 1 and 2 the latter gives the best results. I use both 1 and 2 connected, when not using No. 3. As regards 3: This not only increases signal strength by 10 per cent., but adds considerably to the selectivity of the set, in so much that London and Manchester can be tuned in when Bournemouth and Cardiff are working (which is the bug-bear in this district). I do not use loose coupling for tuning purposes. All these tests have been carried out on loud-speaker, which can always be heard all over the house.

I am sure that if the counterpoise earth were only used amateurs would obtain much better results.—Yours faithfully,

G. SYMMONS WHITE.

Chippenham.

H.T. NEGATIVE AND L.T. NEGATIVE CONNECTIONS

SIR,—Re Mr. Kilman's letter in your issue dated August 13 concerning H.T. and L.T. battery connections. When H.T. and L.T. batteries are in series the danger of burning out a valve would be minimised if L.T. + was earthed instead of L.T. —. Had L.T. + been earthed in the set referred to in his letter, the worst danger would have been the shorting of the H.T. battery, which would be quickly noticed by the usual spark. Another danger is the possibility of accidental contact between an unusually long 'phone lead and the bare brass pointer on a filament resistance. This may be obviated by covering the filament resistance

pointer with some insulating material.

Wishing your paper every success.—Yours faithfully,
Glasgow. D. M. CAMPBELL.

SBR

SIR,—I thought you might be interested to hear that I have received the programme from SBR, Radio "Belgique, Brussels, every night for the past week on a one-valve reflex circuit, which has been adapted from the "sharp tuning crystal set for use in seaboard towns," explained in Vol. 3, No. 11.

I don't know whether there is anything very exceptional in getting the above station on a one-valve set, but in view of the loud signals obtained (after sundown, which is the time the programme comes through to best advantage), it certainly appears to me to be a performance which calls for special notice. The power used must be large, as the strength at times is much greater than that obtained from the local station at Liverpool. This is the only explanation I can put forward to account for this.—Yours faithfully,
Southport. A. G. BERRY.

RECEPTION OF AMERICAN STATIONS

SIR,—I thought it would interest

you to know that in the small hours of the morning of the 25th I was successful in picking up American broadcasting. I only used a two-valve receiver, with A.R.D.E. valves and 60 volts H.T. The set was entirely home-made from information obtained from *Modern Wireless*. I started listening at 2 a.m. and got WHAZ almost at once; it was rather faint, however, and I tried for something else, getting WGY quite easily, and at fair strength. I also got one other station, but do not know what it was.

I am sending you this as I believe it is very unusual to get anything at this time of the year with simple apparatus. I am only a boy of 13, and have only been at the wireless game about four months. This is the first time I have tried for America.—Yours faithfully,

Milnthorpe.

BRIAN SEWELL.

A NEW SINGLE VALVE CIRCUIT

SIR,—Now that we have a broadcasting station in South Africa, I am in a position to give you my experience with the "New Single Valve Circuit" as described in Vol. II, No. 19.

At the time I constructed this set

we had to rely on two Johannesburg amateurs for concerts. It is only fair to state that these gentlemen gave us excellent fare, and their activities were appreciated by listeners-in all over the country. I am situated twenty miles from Johannesburg, yet with a medium aerial and the set mentioned I had no difficulty in tuning-in the amateurs and getting splendid reception on three pairs of telephones. I also found the unit very selective. Both stations use little power, one 50 watts and the other 30 watts.

With the big station results are, to my mind, remarkably good. I tried the set on a frame aerial 18 in. square, and on two pairs of 'phones the reception was perfect in every way. In this case I "earthed" L.T. negative, and with the addition of one stage L.F. signals came in at sufficient strength to work a loud-speaker in a small room. I think these results cannot be improved upon, and they are well worth mention.

Another set which works perfectly is the crystal set described in Vol. III, No. 11. Using crystal detectors, I always have a lot of interference from our lighting mains, the working of our generator (220 volts D.C.) being perfectly audible. The crystal set referred to has done away with all this inter-

VALVE RENEWALS

THE ECLAT ELECTRIC MANUFACTURING CO., LTD. repair by their patent process (for which they have NATIONAL PHYSICAL LABORATORY'S Report of efficiency)

ALL STANDARD TYPES OF VALVES AT **6/6**

AND CARRIAGE PAID.

GUARANTEE (At least equal efficiency to new valves. To return in three days or return your money without quibble.)

THE ECLAT MANUFACTURING CO., LTD.
Spencer Works, Wimbledon, London, S.W.

Your Difficulties!

Whatever it is you want to know, so long as it concerns wireless, we can help you.

Just write us fully, giving details of your trouble, and we will send you expert advice, and the information you desire. We specialise in answering queries by post, and each one receives individual attention.

With each question please send P.O. for 2/6 to cover expense, and if you require complicated diagrams or calculations, send 4/6.

We answer all letters by return of post.

RADIO INQUIRIES,
Imperial Buildings, Oxford Road, Manchester.

Keep this for reference.

THE NEW R.I.



Low Frequency Transformer has the low self capacity of 18 micro-microfarads—a remarkable achievement in transformer design and construction. The original R.I. was good—but this is better.

We have secured the first consignments, and can deliver the new type ex-stock.
List No. 17190. Each 25/-

TAPPED INDUCTANCES

Providing coarse and fine tuning. For use with standard P.M.C. aerial, in conjunction with '0005 microfarads variable condenser. Strawboard former wound with double cotton covered wire. Fitted for mounting at back of panel.

List No. 15242a 250-700m. each 2/-
List No. 15242b 250-1650m. ,, 3/-

Please order from your Wireless Dealer. We cannot supply direct.

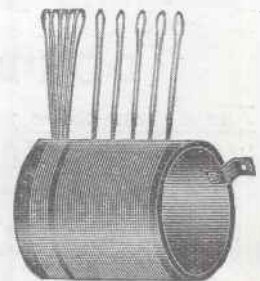

Brown Brothers Limited

— Allied Companies —
THOMSON AND BROWN BROTHERS LTD
BROWN BROTHERS (IRELAND) LTD

Wholesale only. Head Offices and Warehouses:
GREAT EASTERN STREET, LONDON, E.C.2.
118, George Street, EDINBURGH, and Branches.

ference, and reception is perfect on the three pairs of 'phones, every word and note being clear and distinct. It works equally well day or night.

I have also had splendid results with a roughly constructed "Transatlantic," and am now building a permanent "Transatlantic V" with the intention of trying to pick up some of the home stations and, if possible, America. I understand this last country has been picked up on several occasions on a three-valve set in Johannesburg.

Should I have any luck you will again hear from me, and meantime I wish to thank you for the world's two best wireless periodicals, *Wireless Weekly* and *Modern Wireless*.

Kindest regards to "Wayfarer."
Yours faithfully,
J. MACKENZIE MELVILLE.
Klip River, Transvaal.

100-METRE RECEPTION

SIR,—I thought some of your readers would be interested with the results I have obtained on the 100-metre receiver for KDKA by Mr. Cowper which appeared in your issue of March 19, 1924.

I have tuned-in KDKA and WGY, also CW from the Argentine station LPZ and several French amateurs.

The set is delightful to handle,

but I found it much better with the grid leak running to the negative of the low tension. I also found it necessary to alter the coils, the best results being obtained with the following:—Grid coil 17 turns No. 14 d.c.c., aerial coil four double turns No. 12 d.c.c., reaction coil 19 turns No. 26 d.c.c.

I also tried several different size choke coils and found a 200-turn coil of No. 35 d.s.c. on 2½-in. former in the plate circuit of the H.F. valve and a 500-turn dualateral No. 32 d.c.c. in the detector valve gave best signal strength.

The valves used were H.F. French .06 and a DE₃ for detector and a H.T. of 60 volts.

I would be very interested to hear from any readers who have made up this set and the results obtained.—Yours faithfully,

C. G. ALLEN,
Late Radio Officer, R.N.T.
Belvedere.

TYPE W4

SIR,—With reference to the type W4 three-valve set described in *Wireless Weekly* on April 9, I have just wired up this receiver and am highly delighted with it. Supposed to give all stations on a loud-speaker, I can say that I have received them all. Also, I am very pleased to find that I can get Paris

and Brussels with ease on the 'phones, and advise anyone who wants a very powerful three-valve set to wire this one up—the type W4. The two transformers I am using are Lissen T.1 and Eureka No. 2, which work very well together. If a switch is included to cut out the last valve very good loud-speaker strength can still be obtained up to at least 25 miles.—Yours faithfully,

Co. Durham.
R. GLASS.

A CIRCUIT TO TRY

SIR,—The circuit published under the above heading in your issue of August 20 is the best one-valve circuit I have yet tried.

Using "Polar Bloks" and an Edison A.R.D.E. valve, I was able to receive Radio Iberica (780 miles) from 11 p.m. to 1 a.m., when the station closed down. The strength was excellent, at times rising to comfortable loudspeaker strength.

All B.B.C. main stations have also been received at good strength in the 'phones.

Our thanks are due to Mr. Stickings for drawing attention to this excellent and selective circuit.—Yours faithfully,

J. S. YOUNG.
Caterham.

"Perfect Reception"
GUARANTEED
WITH OUR
REPAIRED VALVES

Whenever your valves burn out or filaments are damaged in any way
Send them to us
We repair them equal to new.

DON'T DELAY

The actual valve you send us is repaired
and returned to you within 7 days.

PRICE	POSTAGE	PRICE
6/6	3d.	6/6
(Bright Emitter Valves).		

WE ARE ALWAYS AT YOUR SERVICE.

Price list for D.E. and Power Valves
on Application.

The North London Valve Repairing Co.,
22½, Cazenove Road, Stoke Newington, N.16.

ALL POST FREE AT CALLERS' PRICES

EBONITE PANELS.	COMPLETE	TRADE	Var. Components.
Matt 3/10	F	E	.002 panel type 7/-
9" x 6" 2/2 1/10	E	N	.0027 (Vernier) 6/-
12" x 9" 4/0 3/0	I	G	.0003 (Blado) 5/-
12" x 12" 5/0 5/-	C	U	.0003 1/6 4/8
15" x 9" 5/0 4/4	E	I	.0002 Barba 3/0
15" x 12" 7/0 5/8	L	E	Knobbed dial 1. ex.
4" x 4" 9d. 5d.	T	E	Stock "Fallon &
7" x 5" 1/8 1/2	S	S	"J. B." usual prices.
6" x 6" 1/4 1/4	T	S	Vernier, no dial 2/6
Any size cut.			5 vane 1/3, 7 3/8
Sq. in. 1d. 1 1/2			Polar types .. 10/6
CONDENSERS			
Mill-Pol. Brass 2d.	Doblier	Variable Leaks.	New Lines.
B.A. Standard 2d.	Mullard (Usual)	Pilttron 0.7 meg. 3/-	Eureka Transformers
Lacquered 2d.	Edison-Bell (prices)	Watmel 0.5 meg. 2/6	No. 2 .. 22/6
Spade type, doz. 3d.	Mansbridge 1 mat. 1/6	Lissen type .. 2/6	Concert Grand 30/-
Telephone type 2d.	2mf. 1/8, 1/3 5mf. 3d	Resistances 2/6	E.E. Chokes .. 10/-
Multiphase 4v. 2d.			Shaw's Berkeley 1/-
" 6-way 1/-			
Rectifying spring 2d.	Headphones.	Engraved 3" .. 8d.	Jacks 4-Contact ..
2 B.A. Small 2d.	B.B.C. 4,000 ohms	Knobbed type 1/-	Bank of 2 .. 1/6
Contact Studs 2d.	Brown's "F" B.T.H.	2" Fil. Type 6d.	Single Jacks .. 1/6
Spring Washers 2d.	Siemens, Brandes,	Transformers L.F.	Standard Plugs 1/3
	Sterling, all 28/-	Radio Inst. .. 25/-	Potentiometer 300
	General Radio 30/-	Silvertown .. 21/-	ohms ex-Govt. 4/6
	Peloues .. 18/6	Igranic 31/- & 20/-	Buzzers .. 2/6
	120 ohms ex-Govt.	Burndett 25/- & 27/6	Microphones 3/-
	Sullivan's 5/6	Reliability 10/- & 12/6	Tapping Keys 3/-
	H. T. Batteries.	Perranti .. 17/6	H'phone Cords 1/-
	With Wander 22/-	Xtraordinary .. 8/-	Alum. H'bands. 2/6
	60v. 8/- 36v. 4/10	Tangent 12/6 & 14/0	All "Igranic" "Is-
	30v. 4/- 18v. 2/-	Royal .. 20/-	terdependent."
	4v. F.L. Biry 9d.	E.A.P. Modulation.	"Edison-Inst" and
	60v. Ever-Roy 12/6	Telephone & 10/12	"Sterling" Goods.
	30v. 8/- 16v. 3/6	"Unidyne" all 8/-	Coll Holders.
	Siemens same price.	H.F. Tangent .. 5/6	Ashley fixed .. 2/6
		McMichael's .. 7/-	" moving .. 3/6
		Oefah 900 .. 5/6	Igranic 3 Set .. 4/6
		" 300 m. 4/6	Ebonite 3 Coll 3/6
		Formers only .. 1/3	" 2 Coll 2/6
		Phil Resistances.	Single moving 1/6
		Good quality .. 1/6	" Fixed type 5d.
		Recessed do .. 4/6	Recessed do .. 4/6
		Vernier type .. 7/-	Switches, Ebonite
		Ormond 3/- Ajax 4/-	" Tumbler 1 1/3
		Burndett .. 5/-	B.C.O. .. 2/6
		T.C.B. 4/- & 5/-	R.C.O. .. 1/6
		Microstat .. 2/6	Dewar D.C.O. 3/6
		Fluostat .. 2/0	H.P.S.T. 2/6
		Mic-Met-Detector 6/-	Utility 2-way .. 4/-
		Amplion Jr. .. 27/6	3w 5/- 4w 6/- 5w 6/-
		Orders 5/6 value, carriage paid.	Lever Type Stocked
		Under 5/6, 2d. per 1/- packing, etc.	Miniature Turn 9d.
			Lissen 2-way .. 2/6
			" Series par. 3/6
			Double-arm do. 2/-
			H.P. Switch Set.
			D.C.O., 1/- 800, 9d.

J. H. TAYLOR & CO.
5, Radio House, Telephone 341
Macaulay St., Huddersfield. Huddersfield.
P. Grams: "Thorough."



Apparatus we have tested

Conducted by A. D. COWPER, M.Sc., Staff Editor.

Battery Connecting Cable

Messrs. Ward & Goldstone have sent for examination a sample of their "Easifix" 4-way multiple connecting cable, which combines in one neat cable the L.T. and H.T. battery leads. The black-covered main cable is just over a yard long, so will reach to an accumulator placed on the floor below the set; two distinctively coloured side leads, fitted with black and red wander-plugs, come out at about a foot from one end, and are for connecting up the H.T. battery on the table by the set, etc., while the leads which pass to the end

of the cable are coloured to indicate plus and minus L.T. The other end of the cable divides out into the four connections for H.T. and L.T. plus and minus, with the same distinctive colour-scheme, each end conductor being fitted with a neat and substantial spade-terminal.

The appearance of this fitting is decidedly attractive, and it is substantially made. Such an arrangement does away with a good deal of the unsightly appearance of loose wires in a domestic receiving set, and the colour-scheme may save a great many accidental short circuits and wrong connections.

A Refill H.T. Battery

Messrs. Grafton Electric Co. have submitted for trial samples of a new type of high-tension battery which they are handling: for use with the popular and economical flash-lamp refill battery.

Two types are provided: the nominal 63-volt type, which takes 14 refills, and the small nominal 36-volt type with 8 refills. The case of the first is 1ft. long by 2½ in. by 3 in., the other 7 in. long. The cases are neatly made of black-japanned tin, with a wood panel in the top which carries the wander-plug tapping sockets, tappings being made every 4½

No swathings—open to air and ether.
"Strong as iron bands."

Tangent Tuning Coils

Standard Plugs—will fit any set. Crystal or Valve. Strong cylindrical frames with air-spaced coils you can handle with impunity.

Low distributed capacity.

Highest electrical efficiency.

STOCKED SIZES.				
Coil No.	Min. W/L	Max W/L	Price	
25	250	390	4/3	
35	330	520	4/3	
50	430	840	4/3	
75	660	1070	4/6	
100	840	1430	5/-	
150	1100	2030	6/-	
200	1610	2720	7/-	
250	2009	3520	7/6	
300	2400	4250	8/-	
400	3300	6450	9/-	
500	4500	8750	10/-	



Send for Leaflet—
just off the Press.

GENT & Co., Ltd.

Est. 1872.

Manufacturing Electrical Engineers,
**FARADAY WORKS,
LEICESTER.**

We are showing at the N.A.R.M. Exhibition—Albert Hall, Sept. 27th—Oct. 8th. STAND 81.

London: 25, Victoria St., S.W.1.
Newcastle-on-Tyne: Tangent House, Blackett St.

FALLON'S VARIOMETER

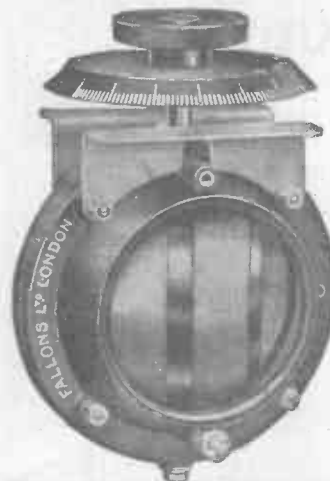

as used in the Single Valve Receiver for all Wavelengths, described and illustrated in MODERN WIRELESS July issue, pages 151 and 152.

The finest variometer on the market at any price. Inside winding. Suitable for broadcast reception on any P.M.C. Aerial, extraordinary close coupling, ensuring large tuning range. On a 30 ft. indoor aerial the maximum wavelength exceeds 120 metres, and the minimum on a 100 ft. aerial is below 350 metres. The maximum on a full size outdoor aerial is 700 metres, and the minimum on a 30 ft. is 200 metres. Inductance, the highest possible—9.5 to 1. Metal feet can be adjusted to four different positions.

PRICE 10/- Postage 6d.

FALLON FIXED CONDENSERS are made of highest quality mica and copper foil, each one tested and guaranteed. Fitted with soldering tags and nuts for making clean connections. Fix FALLON Condensers and improve your set.

Capacities up to .001 1/3 each. Capacities .0015 and .002 2/0 each.

WRITE DIRECT FOR TRADE TERMS:

FALLON CONDENSER CO., LTD.
The Condenser People. Tottenham 1932

WHITE RIBBON WORKS, BROAD LANE, TOTTENHAM, N.15

All Correspondence and Post Orders to above address.

City Depot: 143, Farringdon Road, E.C.1. Manchester Depot: 3, King Street West, Deansgate. Glasgow Depot: 120, Wellington Street.

volts. Spring contact pieces inside the lid make contact with the usual brass strips on the refill batteries by simply closing down the lid; at the same time, any cell can be removed and replaced at a moment's notice without undoing any connections, and it was found that considerable mechanical vibration did not vitiate the electrical contact. It would be an easy matter, therefore, periodically to check over the H.T. units and replace them piecemeal as required—which is the most economical and certain way of ensuring a silent and reliable H.T. supply.

The cases are lined, and the battery units separated by thick insulating paper. It was found that some type of foreign refills did not go comfortably into the box, as they are slightly taper in shape; but the cheap English refills fitted correctly. A minor point of criticism is that the labels on alternate tapping-points are made to read up from the positive end; when using different values of H.T. for detector and note-mag., e.g., it would in general be more convenient if they were numbered up from the

negative end. Otherwise we can confidently recommend this type of handy H.T. unit for general use, except where power amplification, or many valves, are used continuously—always in conjunction with a 2 μ F blocking condenser across each H.T. supply unit. The prices asked are remarkably moderate, considering the good finish and mechanical excellence of the units.

A Moderate-Priced Loud-Speaker

A loud-speaker of medium-large size and very reasonable price, marketed by Messrs. Grafton Electric Co., has been submitted to extensive tests. This is an instrument of the usual pattern, with large flaring horn, and with high-resistance windings. The relative position of magnets and diaphragm is controlled by a small knob on the base.

On trial it was found to be sensitive, and of considerable power when fed by a power-amplifier. Thus, on an efficient two-valve set and high aerial eight broadcast stations were tuned in directly on the loud-speaker under favourable circumstances,

the local one, at 35 miles, at a strength which approached an uncomfortable intensity in a large room. The tone of the instrument was a matter of favourable comment; it was a little "low-pitched" (using the phraseology of the Chief Engineer of the B.B.C.), i.e., rather greater prominence was given to the lower tones, producing a "mellow" tone which some listeners, however, claim to prefer. Speech was very natural, even on distant stations—the announcers at Madrid and Frankfurt being intelligible across the room in the test mentioned above. The impression received was that even musically-trained persons with sensitive ears could tolerate the reproduction of speech and music by this instrument night after night in regular broadcast reception, which is more than can be said for the majority of large, expensive loud-speakers.

These loud-speakers are finished either in plain black with a nickel band on the base, or in Chinese lacquer with a chaste willow-pattern design in gold on horn and base, giving a handsome appearance.

Same Receiver Greater Range

Bowyer-Lowe Square Law Condensers cost an odd shilling or so more than the ordinary kind, but they make all the difference to your reception.

Your set becomes more selective, your signals improve in quality, tuning is simplified, and the efficiency of your reception is increased by at least 33%.

Bowyer-Lowe Square Law Condensers are NO larger than the ordinary type. Substitution is easy, and users never go back to the other kind. Prices from 16/-.



Bowyer-Lowe Tested Square Law Condensers

represent the highest standard yet attained in condenser construction. All particulars and prices free for a postcard. - - Write now.

Bowyer-Lowe Co., Ltd. - - Letchworth

ALL BRITISH WIRELESS EXHIBITION
STAND 26 ROYAL ALBERT HALL
 September 27th to October 8th



*Terminate
 Those Terminal Trials.
 Put in a Refty
 And be all Smiles.*



G.W.I. VALVE RENEWALS

BURNT-OUT VALVES

renewed by the G.W.I. process are improved beyond recognition, and are **guaranteed** to give reception at least equal to **NEW** valves of the highest quality.

STANDARD TYPES 6/6 each
DULL EMITTERS, any type, 10/6 each

Let us send you particulars of the G.W.I. Plateless Valve, which gives Crystal tone with full Valve Strength!

G.W.I., Ltd., 43, Grafton St., Tottenham Ct. Rd., W.1.
(1 minute from Warren Street Tube Station.)

THE ORIGINAL AND LARGEST REPAIRERS OF VALVES.

EBONITE

Sheet rod and tubing in all sizes kept in stock and cut to any required size while you wait, or sent by post on receipt of cash.

WE CAN TURN ANYTHING IN EBONITE.

BURGE, WARREN & RIDGLEY, LTD.,
 91/92, GREAT SAFFRON HILL, LONDON, E.C.1. 'Phone: Holborn 5)

Information Department

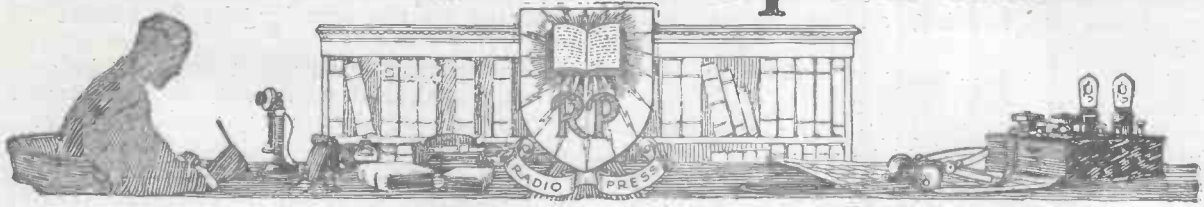

SUPPLIED BY RADIO PRESS SERVICE DEPT., LTD.

R. A. (WATERFORD) refers to his previous query (August 27th issue), and explains that as he does not already possess a Megger, he was considering the purchase of one of the special low voltage type, and repeats his enquiry as to its suitability.

You will find, on application to the makers, that a complete range of instruments for the measurement of high resistances is available, some being specially suitable for this particular purpose. The Megger most commonly met with, of course, is the 500 volt type, but many others are made.

W. B. M. (ST. LEONARDS) asks questions about interference likely to be caused by neighbouring tramcars.

At distances up to about 100 yards interference is possible, but not certain. At greater distances it is unlikely.

H. A. (LINCOLNSHIRE) proposes to build a 2-valve receiver employing variometers.

The wavelength range of this instrument he states to be between 350 and 500 metres, but he wishes to extend this. He asks whether loading coils might be employed, or what alternative arrangements we can suggest.

If the range you desire to cover is not more than double the original range, the addition of small fixed or variable condensers of equal capacity across the variometers will produce the desired increase. If the range is greater, say, up to 1,600 metres, loading coils should be placed in series with each variometer.

E. M. L. (WANDSWORTH) asks (1) whether a high-frequency transformer, wound on a 1½ inch inner diameter ebonite former with 250 turns tapped at every slot, would be suitable to cover a range from 300 to 3,000 metres. (2) He has found the basket coils to be the most efficient form of in-

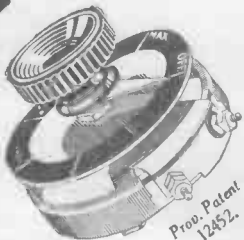

Handsome nickel dial.
One hole fixing.
Phosphor Bronze contact arm.

2/6
6 ohms
15 ohms
30 ohms

Winding cannot be damaged by ordinary use.

Size. 1½ ins. diameter, ½ in. high.

From all Wireless Stores or direct from:

The Bedford Electrical & Radio Co., Ltd.,

Electrical Engineers & Manufacturers,

22, Campbell Road, Bedford.

Buy PEERLESS JUNIOR When you want a better Rheostat

CONSTRUCT your OWN SET

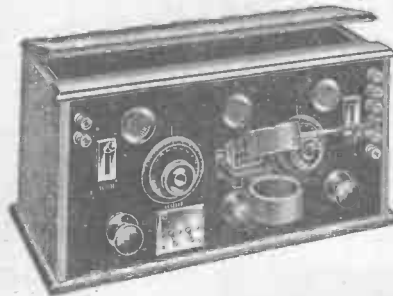

MAGNUM TAPPED COIL.

No. 1. 150-1050. No. 1 replaces Nos. 25, 35, 50, 75 Plug-in Coils, 12/6

No. 2. 450-3560. No. 2 replaces Nos. 100, 150, 200, 250 Plug-in Coils, 15/-

Construct the All-Concert-de-Luxe as illustrated (Envelope No. 4.), for £9 0s. 5d. All components exactly as described by Mr. Percy W. Harris. Everything of the best. Send stamp for Set of Leaflets dealing with S.T. 100, Family 4 valve, Simplicity 3, All-Concert-de-Luxe, Transatlantic 5, 3 Valve Dual, Omni, Puriflex, etc.

We specialise in components for each of above.

Carriage and packing free on Retail Orders value £2 and over.

Please Note NEW ADDRESS:-

BURNE-JONES & Co. Ltd.

Manufacturing Radio Engineers,

"Magnum House," 288, Borough High Street, London, S.E.1.

Experimental Stations:- 2 F.P. New Cross. 2 P.B. Kennington.

2 C.T. Lambeth. 6 C.W. Streatham.

Telephone: HOP 6257.

THE NEW "DEXTRAUDION"

DULL EMITTER

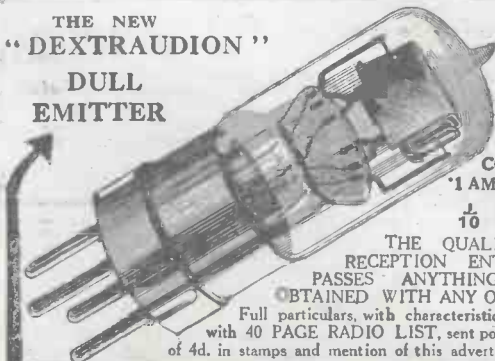

PRICE 21/-

MAXIMUM CONSUMPTION '1 AMP. AT 1 VOLT.

10 WATT!

THE QUALITY OF THE RECEPTION ENTIRELY SURPASSES ANYTHING HITHERTO OBTAINED WITH ANY OTHER VALVE.

Full particulars, with characteristic curves, together with 40 PAGE RADIO LIST, sent post free on receipt of 4d. in stamps and mention of this advertisement.

ECONOMIC LTD.

Head Office: 10, FITZROY SQUARE, LONDON, W.1.

Showrooms: 303, EUSTON RD. N.W.1

ductance for tuning purposes. He asks if this should be so. (3) Whether the thickness of the spokes on which the baskets are wound has any bearing on the inductance value.

(1) If your transformer has eight slots you should wind 100 turns into the first two slots and 200 turns in the others, using No. 40 d.s.c. resistance wire. The primary should be wound in every alternate slot and the secondary in the other ones. Tappings may then be taken from both primary and secondary, when you will find this transformer will cover the range required with fair efficiency.

(2) Properly-made basket coils are very efficient as inductances in oscillatory circuits. (3) The thickness has only a slight effect on the inductance value.

W. H. G. (CLAPHAM ROAD) has a 4-valve receiver in which the rectifier is a very soft valve, and finds that he is unable to raise the anode voltage to the necessary value for satisfactory working of the low-frequency valves, which are hard. He asks our advice.

The particular make of valve you mention is satisfied with about 24 to 30 volts on the plate, and therefore becomes readily saturated. You should use a separate high-tension tapping for your detector valve, otherwise your low-frequency valves are working too far down their characteristics. Your circuit diagram is correct.

“LOUD-SPEAKER” (TAUNTON) asks whether it would be a practicable proposition

to have an aerial consisting of three parallel wires, with some device so that he could put into circuit either one, two or three wires, according to the wavelengths he wishes to receive.

The arrangement you suggest could not be conveniently used, and would not, as a matter of fact, vary the wavelength very much.

J. G. L. (EVESHAM) has obtained exceedingly satisfactory results from the crystal broadcast receiver described in “HOW TO MAKE YOUR OWN BROADCAST RECEIVER,” Radio Press, Limited. He now wishes to know (1) how to make the results louder. (2) What causes injurious noises at about 1,000 metres wavelength. (3) How many pairs of telephones he can conveniently use, and whether a loud speaker might be used.

The addition of a two-valve low-frequency valve amplifier will increase the signal strength by a very considerable amount. A suitable instrument for this purpose is described in “Wireless Sets for Home Constructors.” The sound you hear on your crystal receiver at 1,000 metres wavelength is probably due to some “back-wash” from an arc station. (3) Two pairs of telephones could probably be used with this receiver, but if the note magnifier referred to is attached to it, it will then be possible to operate a large number of telephones or a loud speaker with fair volume.

The Wonderful ST100 —still the most popular Set.

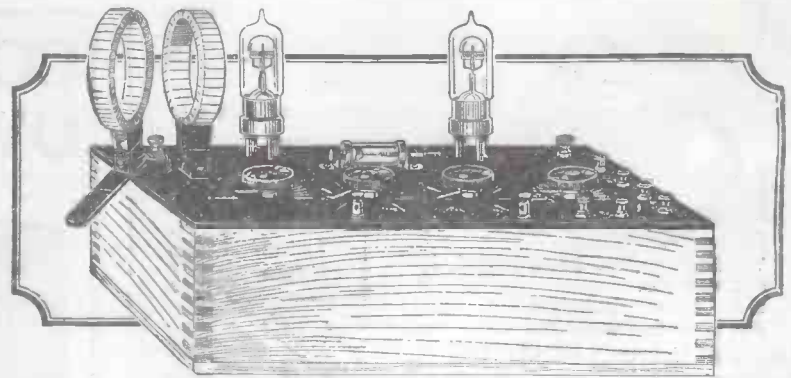

IN spite of all the new “dynes” and “supers” that have been produced during the last 18 months the ST100 still remains the most popular Set for Broadcast reception. To the sceptic its volume is amazing—in fact it is often necessary to de-tune it within 3 or 4 miles from a Broadcast Station, because so few Loud Speakers can cope with the volume. For long distance work it is unique—from any position in the country all the B.B.C. Stations can be received at good headphone strength. Is any more required from a Set?

Build your own ST100 and we will guarantee you successful results.

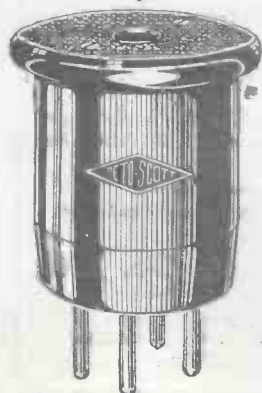

NEW H.F. TRANSFORMER

A high grade H.F. Transformer made throughout by us. Guaranteed wavelength range. Supplied matched in pairs without extra charge.

300-600 metres	6/6
500-900	7/-
900-1500	7/-
1200-2300	7/-
2200-4800	7/-

Because the ST100 is a Reflex Set it is imperative that the lay-out of the Set—the disposition of its components and the wiring should be correct. The safest way of ensuring this is to build up a Peto-Scott ST100. If the instructions we give are followed exactly you are ensured of success from the commencement. Further, we will back this statement with the following guarantee: If after building the Set from our kit of components it does not work satisfactorily, return it to us for testing. It will be put into thorough working order and should the defect be due to a mistake on the part of the constructor

only a nominal charge will be made. If it is due to some defective component, the part will be replaced entirely free of charge. Thus, the Peto-Scott way will enable you to obtain the finest 2-Valve Reflex at the cost of the materials alone. Complete kit of all components, including drilled and engraved panel, and all transformers, variable condensers, etc. (but without coils and valves) and including full instructions for assembly. Marconi Royalties paid £4 17 6
Polished Cabinet extra ... 7 6
Finished Instrument, aerial tested and Royalty paid ... £8 5 0

PETO-SCOTT Co. Ltd. Head Offices, Mail Order Department and Showrooms—**77, CITY ROAD, LONDON, E.C.1.**
Branches:—LONDON—62, High Holborn, W.C.1 PLYMOUTH—4, Bank of England Place. LIVERPOOL—4, Manchester Street, CARDIFF—94, Queen Street. WALTHAMSTOW—230, Wood Street. Gilbert Ad. 1364.

73 Chertsey Rd

Wireless Weekly

and the Wireless Constructor

Vol. 4.
No. 20

CONTENTS

A Long Range Two-Valve Receiver.

British and American Practice Compared.

A 1,600 Metre Circuit on the Omni Receiver.

Practical Wiring of the ST101 Circuit.

Experimental Station 2KW.

Jottings by the Way, Valve Notes, Box Spanners for B.A. Nuts, A Cheap Coil Stand, Correspondence, Apparatus We Have Tested, Information Department, etc., etc.

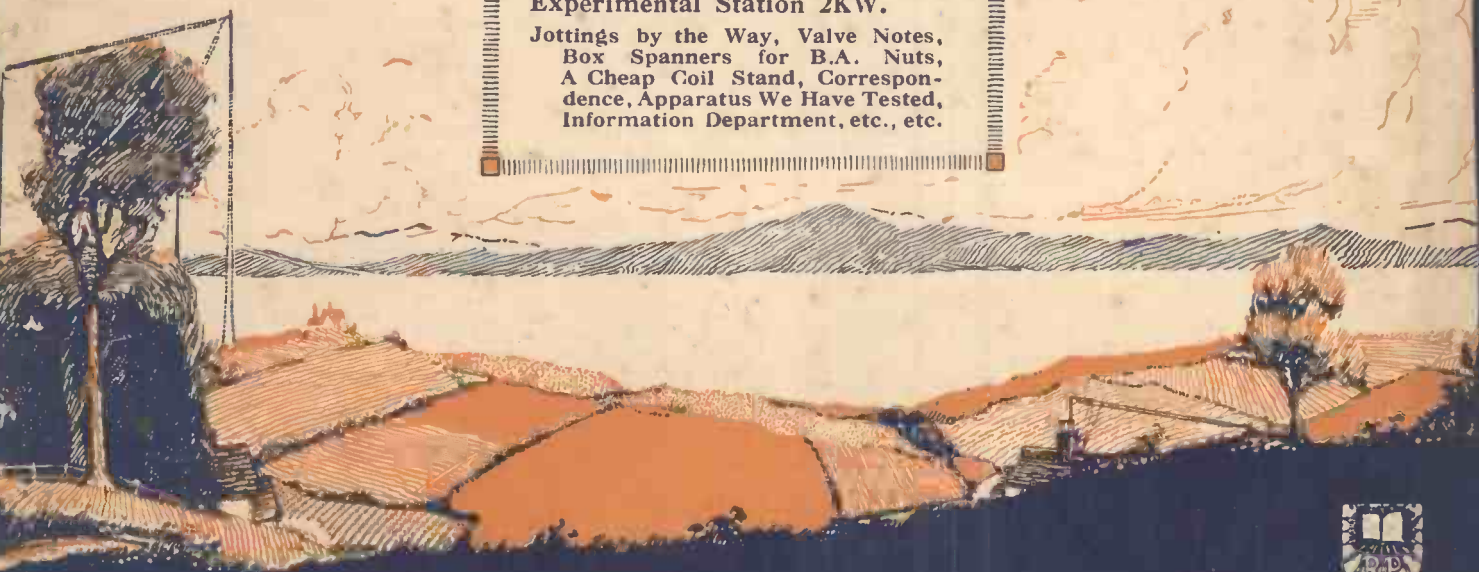

Circuits for the New Short Wavelengths

What you will see on the Burndept Stand at the All-British Wireless Exhibition

STANDS 72 and 74, BOXES 134 and 135.



Ethophone Duplex.



Ethophone Junior.



Ethophone No. I.



Ethophone V (Mark IV).



Ethophone Grand.



Ethophone Tuner (Mark X).



Ethophone H. F. 2 Receiver.



Ethophone Power Amplifier (Mark IV).



Ethophone III.

HERE are brief details of new Burndept Apparatus which you will see at the All-British Wireless Exhibition. At the same time exhibits of this apparatus will be held at our London Showrooms, Provincial Branches and Principal Agents.

RECEIVING SETS.

Ethophone Junior and Ethophone No. 1. High-grade crystal sets. Wave-length range 250-2,000 metres.

Ethophone Duplex. A five-guinea loud-speaker receiver. This entirely new two-valve set has a range of 250-5,000 metres.

Ethophone III. A powerful three-valve set for reception of home and foreign broadcast. Tunes selectively and amplifies without distortion.

Ethophone V (Mark IV). A four-valve receiver, retaining all the best characteristics of the Mark III Model, with important new features (including a self-contained selective device). Supplied to the Archbishop of Canterbury, His Holiness the Pope, Earl Haig, Signor Mussolini, the Lord Mayor of London, and the General Post Office and hundreds of satisfied users.

Ethophone Tuner, Ethophone H.F.2 Receiver, and Ethophone Power Amplifier. A series of instruments for the more advanced worker. Wave-length range 80 to 25,000 metres.

Ethophone Grand. "Receives broadcast anywhere on any wave." The three instruments mentioned in the previous paragraph are built into a cabinet specially designed by Broadwood, and together make up what is probably the finest wireless receiver ever made. Operates on wave-lengths from 80 metres upwards, gives perfect power amplification and has absolutely selective tuning.

ACCESSORIES.

Anti-Phonic Valve Holder. A patent valve holder eliminating microphonic noises and prolonging the life of dull or bright valves.

Transformers. Steel-clad transformers, designed to give perfect results with modern valves. Three types—high ratio, low ratio, and loud-speaker output.

"Low Loss" Variable Condensers. All-metal condensers embodying entirely new features. Laboratory condensers at popular prices.

Auto-Broadcast System. A unique system by means of which broadcast music and speech can be switched on as easily as turning on the light.

Burndept Super Radio Battery. A 45-50-volt high-tension battery of very long life, completely free from noise.

We have a complete line of every possible radio accessory.



BURNDEPT Ltd., Aldine House, Bedford St., Strand, W.C.2
 LEEDS: Basinghall St. (near City Square). CARDIFF: 67, Queen St.
 NORTHAMPTON: 8, The Drapery.



Wireless Weekly

Radio Press, Ltd.
DEVEREUX COURT, STRAND, W.C.2.
Tel.—Central 3763.

Assistant Editor:
PERCY W. HARRIS.
Scientific Adviser:
Prof. G. W. O. HOWE,
D.Sc., M.I.E.E.
Advisory Editors:
Prof. R. WHIDDINGTON,
M.A., D.Sc.
Prof. C. L. FORTESCUE,
M.A., M.I.E.E.

Staff Editors:
E. H. CHAPMAN,
M.A., D.Sc.
A. D. COWPER,
M.Sc.
R. W. HALLOWS,
M.A.
G. P. KENDALL,
B.Sc.
S. C. RATTEE,
Member I.R.E.

EDITED BY JOHN SCOTT-TAGGART, F.Inst.P.,
A.M.I.E.E.

Vol. 4, No. 20

SEPTEMBER 17, 1924.

Price 6d. net.

Technical Education in Wireless

One of the most surprising aspects of radio science at the present time is the almost complete lack of adequate and up-to-date technical education on the subject. During the last few weeks we have had an excellent opportunity of investigating this matter while studying applications and interviewing applicants for technical positions on the staff of Radio Press. Furthermore, we have been informed on many occasions by the larger wireless manufacturers and dealers that they, too, have great difficulty in obtaining the services of technically trained assistants. We are well aware of the existence of technical classes at various Polytechnics and Universities, but investigation goes to show that the instruction given is largely concerned with advanced theory and obsolete practice. In many cases the course wends its weary way through spark, arc, and high-frequency alternator methods, a final lecture or two being given on the valve method of transmission, to round off, so to speak, what is often called "a complete course."

We do not deny that in one or two cases very full and excellent theoretical courses are given, but these are of little practical value to the man who has to earn his living in wireless. It is too readily assumed that if a man is given a sound theoretical basis of knowledge he will be able to pick up the practical side with ease, but this is only true when the theory of the subject is developed to a far greater extent than is at present the case in radio. A theory which has been deduced from a limited number of facts may or may

not require complete revision when practical examination of the problem has led to the assembly of further facts, and we are afraid that theory is limping a long way behind practice at the present time.

Let us consider for a moment just one or two matters which the man who desires to enter the commercial side of wireless should know.

use of the wrong type of valve or transformer, unsuitable plate potentials, or other contributory causes. Without sound grounding in the principles of reflex work he will be hopelessly behind the times. It can only be the difficulty in obtaining adequately trained staff which gives rise to the pitiful displays of inefficiency so frequently found when well known commercial sets are publicly demonstrated.

There is no lack of keenness on the part of the staff concerned, and there are already enough assistants and demonstrators in the larger cities to make it worth while providing practical courses in combined theoretical and practical work for those who so badly need this type of instruction. The larger commercial firms should support such classes in every way by financial and technical assistance, and the provision of expensive apparatus, without which the work cannot be carried on.

An absolutely intimate knowledge of up-to-date circuits and practice is essential nowadays; and, generally speaking, academic institutions ignore what is going on in the outer world, with the result that many of their graduates are practically useless to commercial organisations.

In brief, there are an insufficient number of technically-trained men who are doing modern practical work.

Can nothing be done to improve this state of affairs? Have we, first of all, the necessary teachers? Wireless is a growing industry, and it should be worth while for students to regard radio as a serious and progressive profession.

CONTENTS

	Page
Some Practical Single Valve Circuits for Short Wave Reception	634
Jottings By The Way	639
Random Technicalities	641
Another Circuit on the Omni Receiver	642
American and British Radio	644
The Experimental Station 2KW	647
Valve Notes	649
Fixing Small Screws into Ebonite	651
A Long Range Two-Valve Receiver	652
Box Spanners for B.A. Nuts	656
A Cheap Coil Stand	657
Practical Back of Panel Wiring Chart	658
Correspondence	659
Apparatus We Have Tested	664
Information Department	665

First of all, he should be well acquainted with the characteristics of all the better known types of valves; he should be able to tell why distortion arises when combining a particular type of valve with a particular type of transformer. He should, for example, be able to know by a rapid examination of the set whether distortion, known to exist, is dependent upon bad lay-out, incorrect connections,

Some Practical Single-Valve Circuits for Short Wave Reception

By W. J. TARRING.

The fascination of short wave reception is too well known to comment upon, and in the following article is given many useful and interesting notes based upon practical experiment.

THE remarkable results achieved by some of our amateurs during the last few months by the use of transmissions on wavelengths in the neighbourhood of 100 metres, and the fact that the two well-known American broadcasting stations KDKA and WGY are also transmitting on these short waves, have attracted considerable attention, and it was thought that an account of some experiments in the reception of these signals with single-valve circuits might be of interest. Originality is not claimed for any of the circuits used; ideas, and in some cases the complete circuit having been culled from varying sources. The results achieved are not given as a criterion of what can be done, as the experiments were conducted during the months of April and May, by no means the best of times for DX (long dis-

signals on short wavelengths, by which is meant wavelengths of between 80 and 150 metres, certain points stand out, and, before

and where this cannot be arranged terminal nuts should be screwed down very tightly. Vibration of the set, particularly

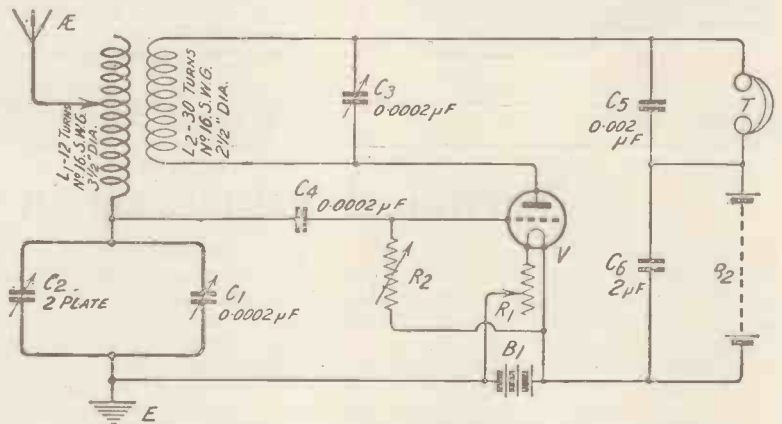

Fig. 2.—This circuit gave fair results, but would not oscillate over the full range of C3.

describing the experiments, it is proposed to touch briefly on a few of these.

of the tuning coils and valve, may give rise to crackling in the telephones, and precautions should be taken to prevent this.

It should be borne in mind that oscillatory currents flow on the surface of a wire, and that the high-frequency resistance of a conductor increases as the frequency of the oscillations flowing through it increases. In my opinion, it is therefore advisable that wire with a high conductivity and an ample surface area should be used in all circuits in which high-frequency currents are present.

Short Wiring

All wiring should be kept short and well spaced. This is much more important on these short wavelengths than on the wavelengths more commonly used for broadcasting, for two reasons—(1) since the facility with which oscillatory currents pass through a capacity varies directly as the frequency of the oscillations, the transfer of energy through stray capacities will be three or four

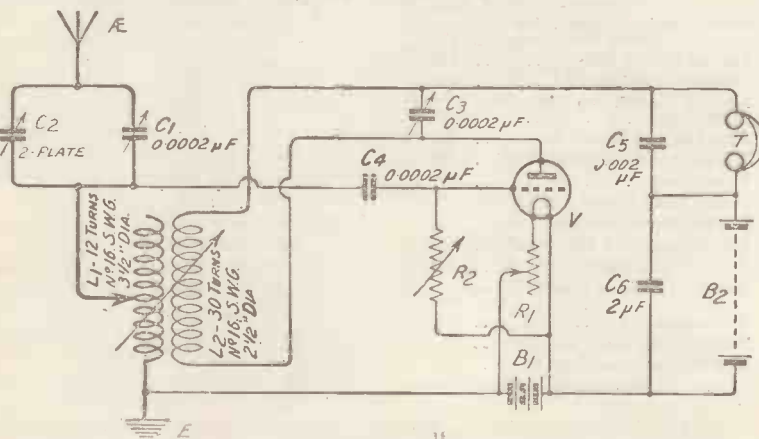

Fig. 1.—A circuit which gave difficult tuning with poor selectivity.

tance) work, and conditions at the writer's station are by no means all that could be desired.

Conditions to be Observed

From a general consideration of the conditions necessary for successful reception of radio

All component parts must be of good quality and in good order, as at the enormous frequencies with which they are called upon to deal, any slight defect becomes unpleasantly noticeable. Connections should be soldered wherever possible,

times as great as on the normal broadcast wavelengths, and (2) the higher frequency of the oscillations greatly facilitates an inductive transfer of energy.

Provision should be made for very accurate tuning owing to the extremely small waveband occupied by any transmission.

Body Capacity

Body capacity effects will be very marked unless the set is very efficiently screened or long extension handles are fitted. Removing the hand from a control knob may be sufficient to completely lose a transmission. If the aerial used is loose, or for

Aerial and Earth

The aerial used throughout these experiments was a twin wire 60 feet long, spaced 4 feet with the free ends connected. The average height of the aerial above the ground was 28 feet, but the effective height was considerably reduced by outbuildings and fairly tall bushes.

The earth connection consisted of a metal plate 5 feet by 2 feet buried in moist earth, at a depth of 2 feet 6 inches immediately under the aerial. The aerial system had a capacity of about 0.00034 μ F, and a natural wavelength in the neighbourhood of 120 metres.

Special Coils

For the purpose of these experiments two special coils of the single-layer solenoid type were constructed and mounted so that one could slide inside the other. The wire used was No. 16 S.W.G. bare copper. This was first wound tightly on a cardboard former, which was then removed, and strips of 3/16 in. ebonite, with 5/64 in. holes drilled at intervals of 5/32 in., were threaded on. This gave coils in which the turns were well spaced and separated almost entirely by air, thereby reducing

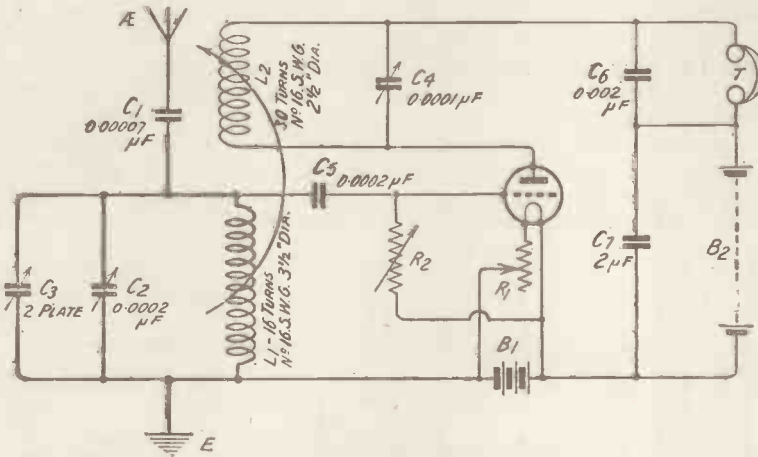

Fig. 3.—Very good results were obtained with this arrangement in the reception of European amateurs.

Perhaps the following example will emphasise the degree of accuracy necessary. The Westinghouse Company's station, KDKA, at Pittsburg works on a wavelength of 102 metres, which corresponds to a frequency of 2,941,176. Music frequencies vary this by, say, 10,000 on either side, giving resultant frequencies of 2,931,176 and 2,951,176, which represent wavelengths of 102.34 and 101.65 metres respectively, so that the transmission occupies a waveband of only .7 metres.

Fine Tuning

The variation in capacity in a tuned circuit to effect a change in wavelength of .7 metres is of the order of 0.0000015 μ F (1.5 microfarads), or well under 2 deg. on a 0.0002 μ F variable condenser connected in parallel with an inductance of 30 micro-henries. (On the same basis, assuming an inductance of 360 micro-henries, a transmission from 2LO would occupy a waveband of nearly 9 metres or 6 deg. on the same size of condenser.) An ordinary three-plate condenser connected in parallel with the main tuning condenser did not give sufficiently fine adjustment, so one plate was removed and the spacing between the remaining two increased.

any other reason it sways in the wind, its capacity is constantly changing, and, as a slight change in capacity has such a large effect on tuning, some means should be adopted to keep it rigid.

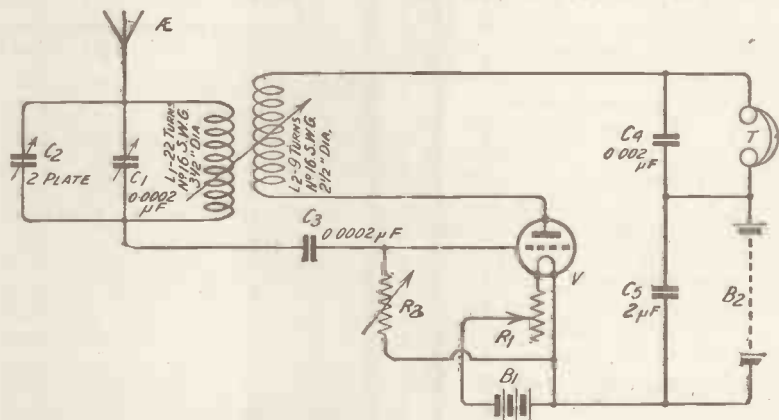

Fig. 4.—Many American and Canadian amateurs were received upon this circuit.

As no valve of the tubular type such as the V24 or Myers Universal was available, a valve of the ordinary 4-pin type, with its attendant comparatively high inter-electrode capacity, had to be used. This capacity was kept as low as possible by the use of air spacing between the pins and an anti-capacity valve-holder.

both capacity between turns and dielectric losses. For greater rigidity and freedom from vibration the wire was anchored, where it passed through the ebonite strips by means of celluloid cement. The outside coil consisted of 22 turns, and had a diameter of 3 1/2 in., while the inside coil contained 30 turns of 2 1/2 in. diameter.

In receiving C.W. signals without the use of a separate heterodyne oscillator, best results are obtained when the set is only just oscillating. It is therefore advisable to provide a fine control over regeneration, and a rheostat with a vernier adjustment will be found very useful for this purpose. A good variable grid leak will also be found to be a slight advantage.

Owing to the fineness of tuning and the fact that a considerable amount of reception would be of amateur stations whose transmissions are of comparatively short duration, thus giving little time for tuning, it was decided to reduce tuning controls to as few as possible, and the circuits described here were chosen with this in view.

First Tests

The first circuit tested is shown in Fig. 1, and is familiar to everyone, differing from a circuit widely used for reception of broadcasting only in the values of the components and the addition of a variable condenser across the reaction coil.

The condenser C₃ was necessary to make the circuit oscillate, and L₁ and L₂ had to be coupled quite tightly together. Owing to the tight coupling between the two coils, a variation in the tuning of the oscillatory circuit L₂ C₃ had a very considerable effect on the tuning of the aerial circuit. This made tuning of any particular transmission, especially weak C.W., difficult, as it was necessary to vary C₃ and C₁ simultaneously in opposite directions, and by widely different amounts, e.g., if C₃ was decreased by 4 deg., C₁ had to be increased by about 25 deg. On strong C.W. stations it was possible to tune entirely by means of C₃. The circuit, as might be expected, was not very selective, and A.C. hum was noticeable, but not objectionably so.

Results

Very fair results were obtained with this arrangement. Towards the end of May both KDKA and WGY were received one morning between 4 and 5 o'clock, speech being practically indistinguishable, but music could be recognised by the tune. The same morning at 4:35 the Argen-

tine amateur station CB8, using I.C.W., was heard very well, every letter being easily audible.

The next circuit is one recommended for short-wave reception by Mr. J. Scott-Taggart in his book, "Elementary Text Book on Wireless Vacuum Tubes," and is shown in Fig. 2.

The values of inductances and condensers were the same as for the circuit shown in Fig. 1, with which it is very similar in operation. The potentials applied to the grid of the valve are, in this case, derived from the condenser C₁ instead of from the ends of the inductance L₁, as is more usual. This arrangement was

larised in this country by publication in this journal and its companion paper, *Modern Wireless*. Owing to the ease with which radio signals on these short wavelengths pass through a capacity, the condenser C₁ in the aerial lead can be reduced below the usual value of 0.0001 μF, thereby enabling a greater number of turns to be included in L₁, and, in consequence, a greater difference of potential to be set up across the inductance. Although in the diagram C₁ is shown as a fixed condenser, in actual practice a 0.0001 μF maximum variable condenser was used.

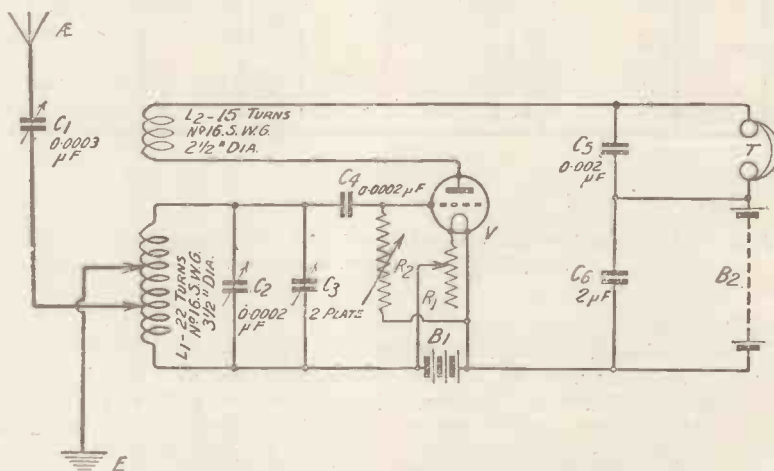

Fig. 5.—A very selective circuit upon which very good reception of KDKA and WGY was made.

difficult to push into oscillation, and with the values of L₂ and C₃ shown would not oscillate with more than about 100 deg. of C₁ included. As this setting tuned a wavelength of about 130 metres it was not considered worth experimenting to obtain oscillations over the whole range of C₁. A.C. hum was more apparent than with the Fig. 1 circuit, and parasitic noises, apparently picked up from the earth, were audible in the phones. The tight coupling of L₁ and L₂ again made tuning somewhat of a delicate operation on weak signals. The results obtained were almost identical with those given by Fig. 1, namely, weak signals from across the Atlantic, but good reception of European amateurs.

Constant Aerial Tuning

It will be seen that the circuit of Fig. 3 embodies the constant aerial tuning arrangement popu-

Another effect of the presence of the condenser C₁ is that the damping in the grid circuit is considerably reduced, with the natural result that the production of oscillations is much easier than with the two preceding circuits. This means that the coupling between L₁ and L₂ can be considerably loosened, and a lower value of C₄ used. In consequence of this weaker coupling the mutual interaction of the tuned circuits L₁ C₂ C₃ and L₂ C₄ is much less marked, with a corresponding simplification of tuning.

Further Results

This circuit gave very good results on European amateur transmissions, but on the only occasion that transatlantic reception was attempted the results were somewhat disappointing, both KDKA and WGY being conspicuously absent, and a few amateur stations being

just readable. As the circuit was not tested until the first days of June this may account for the comparatively weak signals from the United States. The selectivity exceeded that of either circuits 1 or 2.

No Earth Connection

Fig. 4 shows a somewhat unusual arrangement in which no earth connection whatever is used; a closed oscillatory circuit being included in the aerial lead. This circuit is based on one used by Captain Ainslie and referred to by him at an informal meeting of the Radio Society of Great Britain on March 12 (*Wireless Weekly*, Vol. 3, No. 15).

Reaction

The number of turns in the reaction coil L2 for satisfactory

by the first 20° of C1 and the minimum capacity of C2.

A.G. Hum

A.C. hum was noticeable at all times, but was less obtrusive when the circuit was oscillating, at no time being sufficiently bad to interfere with the reading of signals. When oscillating, the set was moderately selective, but when in a non-oscillating condition 2LO, at a distance of 7 miles, was just audible all the way round the condenser.

Like the majority of amateurs, the writer is engaged during the day on matters other than radio, and opportunities of spending the "wee sma' hours" on the set only arise occasionally. As a result this circuit was subjected to the critical test of reception of transatlantic stations for but one short hour. During this

the untuned type, the condenser C1 of which only about 25° was used, being made variable for the sake of convenience. Various experiments with coils wound over L1 between the turns of L1 and tappings taken at various points on L1 were tried, but loudest signals were obtained with the aerial and earth tappings in the position shown, i.e., the earth tapping on the grid side of the aerial tap, and with the 7 turns about the middle of the coil. The optimum value of L2 was found to be about 15 turns.

As C2 was increased from 0° to 140° the coupling between L1 and L2 had to be weakened, but beyond 140° the coupling had to be slightly tightened again. This peculiarity is apparently a variation of the effect referred to in connection with Fig. 4, the optimum ratio of inductance to capacity occurring when 140° was included. Oscillation over the whole range of C2 was easily produced.

The circuit was very selective and gave very good results, KDKA and WGY both being received well on one valve, speech from KDKA being exceptionally clear and free from distortion. Several American amateurs were easily read on one valve, and, with the addition of one L.F. valve, 31 transatlantic stations were received in the space of 2½ hours.

The Weagant Circuit

The last circuit used in these experiments is based on the American Weagant circuit. An untuned, or perhaps one should say a roughly tuned, aerial circuit was again employed, but in this case it was found preferable to wind a separate coil of 7 turns over the closed circuit, several layers of thick brown paper being between the two. From the theoretical diagram shown in Fig. 6 it will be noticed that reaction is applied on the Reinartz principle. By carefully adjusting the magnetic coupling between L1 and L2 it was possible to make the set oscillate over the whole range of C2, using a condenser with a maximum capacity of under 0.0001 μF, as the feed back condenser, C4. This gave a very delicate control over reaction, so much

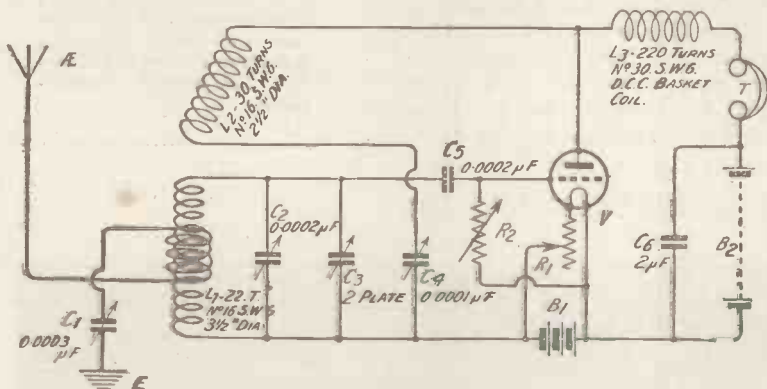

Fig. 6.—A very selective arrangement which gives that fine control of reaction usually associated with the Reinartz circuit.

operation was confined to comparatively narrow limits, either 9 or 10 turns giving the best results. Oscillation could not be produced with 7 turns, and 13 turns was rather too large. If the reaction coil was too large, it seemed to paralyse the set and prevent it from oscillating. All values of L2 were tried without avail in an attempt to make the circuit oscillate when less than 20° of C1 was included. A similar effect was noticed in the two circuits still to be described, and appears to be accounted for as follows:—Before oscillations can be produced in a circuit there must be present both inductance and capacity in some form or another. As the distributed capacity of L1 was so low, due to the wide air spacing of the turns, further capacity had to be supplied, and this was provided

time no sign of WGY nor KDKA, not even their carrier waves, was heard, but American and Canadian amateurs were received, Canadian 1AR being received particularly well.

Closed Circuits

In describing these experiments, the circuits used have been split up into two groups, the four already described deriving the potentials necessary to operate the valve directly from the aerial circuit and the remaining two working on a closed circuit. This does not represent the order in which they were tested, as the arrangement of Fig. 5 was the first one tried, it being thoroughly tested early.

Aerial Circuit

The aerial circuit included 7 turns of the coil L1 and was of

so that it was possible to adjust the circuit so close to the oscillation point that incoming signals would make the set oscillate, and with their cessation oscillation also ceased.

H.F. Choke

Various coils were tried as the high-frequency choke, L₃, from 100 turns up to 320 turns. Results gradually improved up to 220, beyond which no improvement was noticeable. Accordingly a basket coil of 220 turns of 30 S.W.G. d.c.c. on a cardboard former was used, and with this coil in circuit it was immaterial whether the 'phones were shunted or not, indicating that the high-frequency component of the plate current was being effectively choked back through L₂ C₄. (The condenser C₆ was integral with the H.T. battery, so no trouble was taken to remove it.)

The circuit was very selective, and towards the end of April good reception of American broadcasting was obtained up till

6 a.m., that is 1½ hours after dawn. Transatlantic amateurs were also received at very fair strength.

A Field for Experiment

The circuits described are only a few of the enormous number available, and were selected as each embodies some distinct feature. Under favourable conditions each one is capable of receiving America direct, and many interesting transmissions from our own and other European amateurs may be heard. Experimenters will find a most interesting field for the exercise of their ingenuity in this branch of radio, about which so little is at present known, and any time spent in this direction will be well repaid by the information gained. Close attention should be paid to reaction if it is desired to receive signals over long distances with only one valve, as that valve must be brought to its most sensitive condition by the care-

ful application of regeneration. It will probably be found that oscillation is more difficult to produce and control effectively on these short wavelengths, but once this has been done the resulting amplification appears to be greater than that obtained on higher wavelengths.

The Radio Society of Great Britain.

The Autumn Presidential Address to members of the Radio Society of Great Britain will be delivered by Professor W. H. Eccles, D.Sc., F.R.S., at the Institution of Electrical Engineers, Savoy Place, W.C.2, at 6 p.m. on Wednesday, September 24, 1924, on which occasion the President will deal with the latest developments of the position of the Scientific Amateur under the Wireless Telegraphy Regulations.

THE EDINBURGH STATION



Our photograph shows Mr. J. A. Beveridge, the engineer in charge, sitting by the transmitting apparatus.



JOTTINGS
BY
THE WAY

I THINK that I have remarked before that the Little Puddleton Wireless Club is nothing if not right up to date. Ours may be a small town, in fact, I rather doubt if you can find it marked on any map, and the club may have few members; but there is no doubt about it that there are not many places in the world where you can find a finer collection of brains or a more thoroughly go-ahead spirit. Bilgewater Magna, though only a few miles away, is quite a different proposition; I am told on the best authority that there are still people there who swear by coherers and magnetic detectors. To show you how really up to date we are I may mention that our parish pump is now worked by a useful, if rather unsightly, windmill. These things being so it is not I think surprising for Gubbworthy to have mooted at a meeting of the club not long ago that it would be a good thing if we were to start an inquiry section. The idea was that members should take it in turn to go on duty for a week, during which time they should be ready to supply information on wireless subjects, not only to their fellow members but to anyone in the neighbourhood who might be in need of it. After some discussion, in the course of which General Blood Thunderby and Admiral Whiskerton Cuttle fought their customary verbal duel and almost came to their not unusual blows, a motion to the effect that the Helping Hand Department should be inaugurated was put to the meeting and carried by acclamation.

A Noble Idea

The scheme we worked out was that the member who for the week was enacting the part of the Delphic Oracle should be

at the Clubhouse from six to seven on Mondays, Wednesdays and Fridays, and that he should open sympathetic arms to all who brought their woes to him. As it was decreed that a list should be drawn up in alphabetical order, and as Wayfarer begins with a W, I felt that things would have time to settle down nicely before my turn came along. The correct thing, so far as I could see, would be to barricade oneself on the far side of a table behind a rampart of voltmeters, ammeters, milliammeters, gal-

- Breadsnapp.
- Dipplesworth.
- Professor Goop.
- Gubbworthy.
- Poddleby.
- Snaggsby.
- Wayfarer.
- Admiral Whiskerton Cuttle.

The General Begins

I strolled round in the direction of the Clubhouse on the following Monday just to see how the General was getting on. I cannot say that I actually reached it, for the entire street in which it

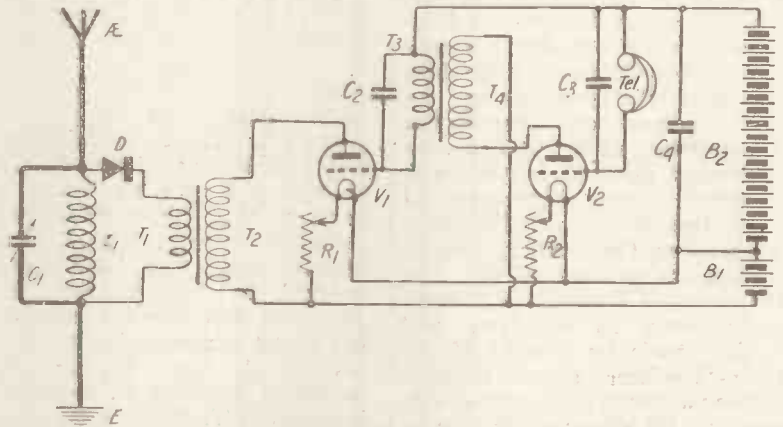

A circuit which is causing Wireless Wayfarer many sleepless nights. Why?

vanometers, meggers and things of that kind, and should an unanswerable question turn up to draw upon that supply of long words which is such a present help to wireless men when they are cornered. There was rather a hot debate as to whether General Blood Thunderby, owing to his double-barrelled name, should be classed among the B's or with the T's. Admiral Whiskerton Cuttle was very much in favour of the first half of double names counting, and the majority of the meeting was with him. The secretary therefore drew up a list consisting of General Blood Thunderby. Bumbleby Brown.

stands was blocked by a seething mass of people, whom P.C. Bottlesworth was frantically endeavouring to sort out into a queue. So far as I could make out every inhabitant of the place, old or young, male or female, married or single, had turned up with a query. It was a most engaging sight, especially as I was not on duty. I patted myself on the back on that account and registered the cheering thought that by the time that my turn came every possible querist would have offered every possible query for solution. When I met the General on the following morning and asked him brightly how things had gone,

he was, I thought, a little huffy in his response. I gathered, however, from the flow of words which proceeded from him (a) that the inhabitants of Little Puddleton were a pack of flat-footed idiots; (b) that it was beneath the dignity of the club senior member to answer such questions as: Should the cat-whisker touch the crystal? or, Why does a condenser condense? (c) that he believed that half the people asked questions just for the sake of asking them; (d) that the country was going to the dogs; and (e) that he would be jolly glad when his week was over. It struck me that if he was merely being asked only silly questions of the type mentioned the General's brain was not having sufficient exercise. I decided therefore to do what I could to provide a little real employment for him on the last day of his all-important duty. I should explain that I have a gardener. I like to say this, because it sounds important. As a matter of fact, an ancient man who rejoices in the name of Bugsnip comes in one day a month to attend to the vegetation which decorates the grounds of my desirable residence. Bugsnip has a boy who, as he told me, he christened Edward, in honour of a certain Royal Personage. I trust that his Royal Highness appreciates the honour, though he has not so far said so. The lad, Edward Bugsnip, is exceedingly keen on wireless, and having made up several of the Goop-Wayfarer super circuits, obtains at times quite remarkable results. He shows every sign of becoming a first-rate wireless man, for he has already developed a distinct handiness with the long bow.

Edward Bugsnip's Night Out

This lad, thought I to myself, is just the fellow to make the General sit up and do a bit of thinking. I will provide him with a question and he shall in due course convey himself to the wireless clubhouse and shiver the General's timbers with it. I will not tell you what the question was, because, though I do not know him, I have the greatest respect in the abstract for the chairman of your own wireless club, and I am quite sure that

if I were to give the secret away there would be horrible tales in the papers of chairmen of wireless clubs all over the country taking to drink or drugs or hurling themselves from high bridges into deep and swift rivers. This, as you will agree, would never do, and you will understand why I refrain from giving it away. It will suffice to say that when Edward Bugsnip propounded his poser the General's mulberry complexion turned first of all a rich purple and then a sickly greenish white, and his jaw waggled feebly, whilst no words issued from his throat, and with his fingers he beat the tattoo of a defeated man upon the table before him. The General had been getting a little above himself for some time; I therefore have no hesitation in working this off on him; there is, I fear, no hope of his thinking of suicide.

Unkind Fate

When your name begins with a W and the duty list goes in alphabetical order, you naturally think that you are fairly safe for some weeks to come. You will hardly believe me when I say that on the Monday of the following week we learned that Bumbleby Brown was away on holiday, that Breadsnapp was suffering from influenza, that Dipplesworth had been called suddenly to the Continent, that Professor Goop had broken his leg whilst endeavouring to climb his aerial, that Gubbworthy would be detained on important business in Town on every night of the week, that Poddleby was sitting at the bedside of a moribund great aunt-in-law, and Snaggsby was so bad with laryngitis that he could not use his voice at all. Now there is something very much wrong with the order of things when in alphabetical order W follows next after B. Still, so it seemed to be, and nothing that I could do would persuade the Admiral to take precedence of me by virtue of his exalted rank.

My Week

Now I was distinctly pleased with myself after the first night, for I felt that I had been a distinct success, and it added no

small measure to my already considerable reputation. On the Wednesday all was going well until on glancing up I observed about three places down in the queue no other person than Edward Bugsnip. Something told me that I was about to meet my Waterloo with this child, especially as I saw under his right arm he was carrying what appeared to be a wireless receiving set. I spent as long as I possibly could over those who came before him in the faint hope that as his bedtime was long passed the child might go home. But it was not to be. He stuck there drinking in at long range my replies to others, and obviously prepared to wait until midnight if need be for his turn. It came at last, and he placed before me his ghastly set. "Oi cawnt git nuffin wiv this 'ere, guv'nor," he said, with a smile which I suspected, and I prepared for the worst. The wiring was the worst tangle that I have ever seen in my life, leads meandering in all directions without apparent rhyme or reason. I could not answer there and then. I had to take it home with me, and the diagram published herewith shows the circuit as I eventually resolved it. Little Puddleton, I think, is not the place for Edward Bugsnip.

WIRELESS WAYFARER.

Personal.

With the large increase in the number of technical books published by this firm and in order that our readers' needs and interests be adequately catered for, the position of sales manager to the organisation has become one requiring not only business ability, but an extensive knowledge of wireless theory and practice.

Mr. E. Redpath, formerly Assistant Editor of *Wireless Weekly* and *Modern Wireless*, has now been appointed Sales Manager of Radio Press, Ltd., and our readers will therefore have the satisfaction of knowing that to whatever branch of the organisation they write, a fully competent member of the technical staff will deal with their communications.

Random Technicalities.

By PERCY W. HARRIS, Assistant Editor.

Some Notes of interest to the Experimenter and Home Constructor.

A FRIEND of mine, whose business connections bring him into contact with a large number of wireless manufacturers and dealers, tells me that recently there have been many reports of "burn-outs" in intervalve transformers and loud-speakers. These have not been confined to any one make, but seem to have been distributed among the well-known types fairly equally.

* * *

The wireless experimenter does not always realise the pent-up energy stored in the magnetic field of an intervalve transformer. When the current in the plate circuit starts to flow (by this I mean the steady anode current, not the pulsating current set up by the signals), the core becomes magnetised and a considerable magnetic field surrounds the windings. Variations of intensity in this field occur when signal currents arrive, but when there are no signals coming in we still have a steady plate current which, with low impedance valves and fairly high plate voltages, may reach a figure of 10 milliamps if no grid bias is used. Incidentally it is one of the great advantages of having suitable grid bias on note-magnifying valves that it reduces the steady plate current considerably, thus avoiding early exhaustion of the high-tension battery.

* * *

Now if for some reason or other we suddenly break the circuit, the magnetic field will collapse, the pent-up energy will be released, and will either break down the small air gap if the opening of the circuit is not wide—thus forming a spark (you can see this when you pull the plug out of a wander battery)—and will exert a tremendous strain upon all insulation, including that of the transformer. In fact, whether it sparks or not, this

strain will occur. Quite a bright little spark usually occurs when the wander plug is withdrawn, and the voltage required to produce a spark of this size is very much higher than that of the high-tension battery.

* * *

I think it will be found that in those cases where transformers and loud-speakers have been burnt out, not once, but two or three times, in the same set, that the user is too prone to play about with his high-tension voltage by pulling out the wander plugs and changing their positions at every conceivable opportunity. You will notice I have been writing about what are generally termed "burn-outs." Actually, however, a transformer rarely "burns" out in the sense of the wire fusing, as the wire used will carry considerably greater current without fusing than is ever put through it. The "burn-out" is really a break due to the stresses and strains set up in the winding.

* * *

It is very interesting these days to tune down to the very short wavelengths.

Nauen (POZ) and Paris (UFT₂) can be heard almost any evening calling the new station in South America (LPZ). Poldhu (call sign 2YM) is seldom quiet in the evening and during the night, and is generally calling ICMM. Paris usually works on about 75 metres, and Poldhu on about the same wavelength, while Nauen uses a slightly longer wavelength.

* * *

May I ask the valve manufacturers to see whether it is possible to make a good soft detector valve in this country? Such a valve is badly needed, and once it becomes generally available, those of us who write con-

structional articles will soon show the public how admirable results can be obtained with them. Every valve will rectify, of course, when used in the proper circuit, but it is only those who have actually become experienced in the handling of the soft detector valve who fully realise the great capabilities of detecting which may be obtained with these. Please give us a good soft detector valve which will at least equal any of those the Americans use.

The Latest Idea for the Constructor.

The latest Radio Press production, which has just been placed upon the market, is already meeting with a very big demand on the part of those constructors who like to give their set a good finish. The Radio Press panel transfers are unequalled, from the point of view of cheapness, high quality, and also of variety, and they have been specially designed to suit the receivers described in the various Radio Press publications.

With the aid of these transfers one can readily impart a really professional appearance to the home-built receiver with very little trouble, and at the very modest expenditure of 6d. The transfers operate on the hot pad method, and no particular experience is needed to obtain perfect results. They will be found to include every necessary letter for any type of receiving set, while a large number of special labels are included to suit the Radio Press sets.

The transfers are enclosed in a large stout envelope with a handsome design, and protected by a sheet of thick cardboard, and can be obtained through any bookseller or direct from the offices of the Radio Press, price 9d. post free.

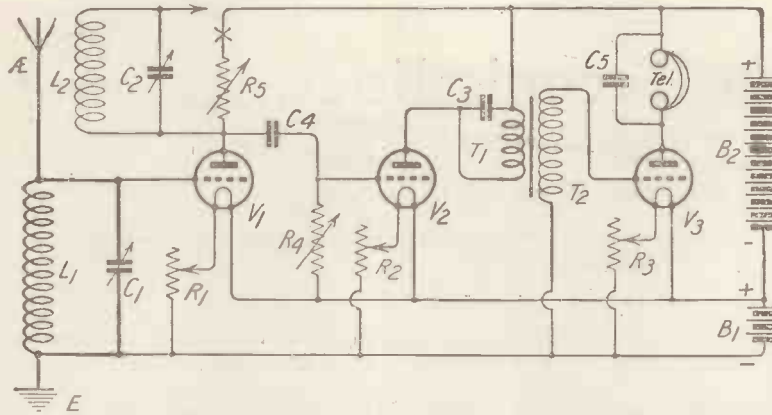

Fig. 1.—A three valve circuit which may be tried upon the Omni Receiver.

CIRCUITS with which it is possible to receive the high-power station at Chelmsford or the other British broadcasting stations at will are much in vogue just now. Such a circuit is shown in Fig. 1, from which it will be seen that either tuned anode or resistance capacity coupling between the first two valves may be employed by making only a small alteration to the circuit.

The resistance capacity method of coupling is, of course, used only when it is desired to receive Chelmsford; on the usual broadcast wavelengths this method cannot be compared with tuned-anode coupling. On the higher wavelengths, however, very good results are obtainable, whilst the tuning arrangements are very considerably simplified.

The aerial is tuned by the coil L_1 and variable condenser C_1 , the latter having a capacity of $0.0005 \mu\text{F}$. In the anode circuit of V_1 we have the resistance R_5 , for which a suitable value is 80,000 ohms. The inductance L_2 , tuned by C_2 of $0.0005 \mu\text{F}$ capacity, is shown connected to the plate of the valve on one side, and terminated by an arrow head on the other side. When conditions are as illustrated, resistance coupling is in use, and the anode tuning coil is substituted by breaking the lead to the high-tension battery at the point indicated by X, and joining the free end of L_2 to a point above X.

C_4 and R_4 are the grid condenser and leak, having the usual values of $0.0003 \mu\text{F}$ and about 2 megohms respectively. The primary winding T_1 T_2 is in-

cluded in the anode circuit of V_2 , and shunted by the fixed condenser C_3 of $0.001 \mu\text{F}$. The secondary T_2 is connected across the grid and negative filament lead of the low-frequency amplifying valve V_3 . The telephones are connected in the anode circuit of this valve and shunted by C_5 of $0.002 \mu\text{F}$.

Connections

To wire up the Fig. 1 circuit on the Omni receiver, the following terminals should be connected together:—

- | | |
|-------|-------|
| 51—17 | 13—40 |
| 25—52 | 6—21 |
| 17—18 | 21—37 |
| 18—12 | 38—22 |
| 25—26 | 22—24 |
| 4—36 | 30—16 |
| 36—41 | 29—48 |
| 41—42 | 8—31 |
| 34—33 | 23—24 |
| 44—24 | 32—40 |
| 36—27 | 52—48 |
| 19—14 | 23—39 |
| 14—5 | 31—47 |

Another Circuit on the Omni Receiver

A further experiment for the benefit of those readers who use this popular receiver.

Operating the Set

The set is now wired, so that the resistance R_5 is in circuit, its value being controlled by the centre knob of the three variable resistance knobs to the left of the panel. A No. 150 coil will be required for the reception of Chelmsford, plugged into the aerial socket in the middle of the three-coil holder. The only adjustment necessary for tuning is that of the aerial condenser in the centre of the panel. When results are obtained the values of the anode resistance R_5 , and the grid leak R_4 to the right of it, may be varied to obtain maximum signal strength.

If it is desired to receive the usual broadcasting stations, the circuit L_2 C_2 may be easily substituted for R_5 by disconnecting 44—24, and joining 33—24. The coil in the aerial socket should now be a No. 35 or 50 coil, with a No. 50 or 75 coil plugged into the front socket of the three-coil holder. Tuning is now car-

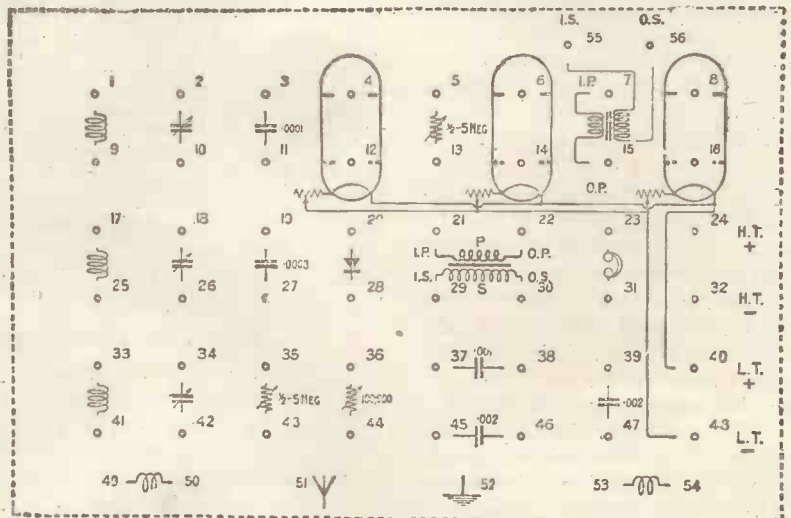

Fig. 2.—The terminal board.

ried out by variation of the centre and left-hand condensers simultaneously. A size larger coil may be tried in the aerial and anode sockets. Having tuned in a station to its maximum strength by this means, the coil in the moving socket may be brought slowly towards the fixed coil, retuning after every small movement on the two variable condensers. If the coils may be brought close together in this manner without the set oscillating, the leads to the anode coil should be reversed. This is effected by disconnecting 33—24 and 41—36, and joining 33—36 and 41—24. Best results will be obtained with the set just off oscillation point.

Experimenting with the Circuit

Assuming that we wish to listen to Chelmsford, a separate

□ □ □

I PROPOSE in this short talk to touch upon one or two of the more popular fallacies which are met with in discussion with radio enthusiasts, and the first and most common is perhaps "The Lightning Bogey."

To begin with, lightning is the result of a vast accumulation of electrical energy in the clouds. If this energy cannot leak away sufficiently fast a disruption discharge or flash takes place of somewhat terrifying aspect.

Now, any well earthed aerial of reasonable height must act as a definite leak or drain for this energy, and, in technical language, must lower the potential gradient in its immediate vicinity, thus tending to obviate the disruption discharge, which clearly makes an aerial a protection to life and property more than a danger.

On the other hand, one must look at the fatalistic side. No self-respecting lightning flash—should it occur—would condescend to travel down the usual 18 gauge earth wire without becoming disorderly, owing to the tremendous magnitude of the electrical energy. It is estimated that an amount of electricity equal to 20 coulombs will flow for 1/500th part of a second at a pressure of one million volts—or 10^{10} watts—which is four hundred thousand times the

anode voltage may be given to the detector valve with advantage. It is well known that a low-frequency amplifying valve may have a greater anode voltage than a valve working at high frequency, and in the case of the Fig. 1 circuit these conditions exist owing to the potential drop across R5. If we give the detector valve a lower voltage without altering the voltage applied to the other valves, better results may be obtained. The only alteration necessary on the terminal board is to disconnect the lead 22—24, and join 22 by means of a piece of flexible wire to a suitable point on the high-tension battery.

This arrangement may also be used with advantage when tuned-anode coupling is employed. However, as it will often be

The Radio Society of Great Britain

A talk broadcast from 2LO on 11th September by Mr. W. Kenneth Alford, a member of the Committee of the Transmitter and Relay Section.

power of the Chelmsford Station.

To produce such a flash the average electricity company would have to charge about £20.

II.—Self Oscillating Receivers

A matter which often causes consternation is the fact that a large number of home-made or bought valve receivers have a strong propensity for self-oscillation. The question is, whether the instrument is a good one or not. The answer is that it is either very well or very badly designed; in other words, the self-oscillation may be due to careful elimination of stray capacity, in which case the set "resonates" extremely easily, or else the wiring and arrangement is so bad that the anode grid capacities are producing an uncontrollable amount of "electrostatic" reaction.

In the case of the well designed instrument the "self-oscillation" can be overcome quite easily by a small positive grid bias applied to the H.F. valves by means of a potentio-

desirable to lower the voltage applied to the high-frequency amplifying valve when this type of coupling is reverted to, the difference will not be so noticeable.

Constant aerial tuning may be used on the lower wavelengths by disconnecting 51—17 and connecting 51—3 and 11—17. For the broadcast wavelengths below 420 metres, it is now possible to state definitely that a No. 50 coil will be suitable in the aerial socket, while for wavelengths above 420 metres a No. 75 coil should be used. The value of the anode coil, of course, is not affected.

Series aerial tuning may be tried by altering the original key as follows:—Disconnect 51—17 and 26—25, and join 26—51. A size larger aerial coil may be tried with this form of tuning.

□ □ □

meter, without affecting its reception properties—whereas, in the other case, extreme positive bias is necessary, which lowers the amplification very seriously and usually introduces premature rectification, which causes distortion.

The matter of avoiding oscillation and yet maintaining a receiver in its most sensitive condition for telephony reception is exemplified in the ingenious Neutrodyne principle invented by Professor Hazeltine.

III.—The Testing of H.T. Batteries

A great fallacy occurs in people buying a cheap voltmeter for testing their H.T. batteries. You can buy such a meter for about 7s. 6d., which reads 0—6 and 0—100 volts. Now, on the second range the meters pass a current of sometimes 100 milliamperes, which is roughly 10 times the current taken from the battery by an average 3-valve set. They cannot show even an approximately true reading, and frequent use will seriously deteriorate a battery. If you can't afford a good voltmeter leave the battery alone, and don't use the popular pea-lamp, which is a worse test than ever.

If the battery gets noisy, don't throw it away until you have tried placing a 2 μ F or more condenser in parallel with it.

(Concluded on page 657)

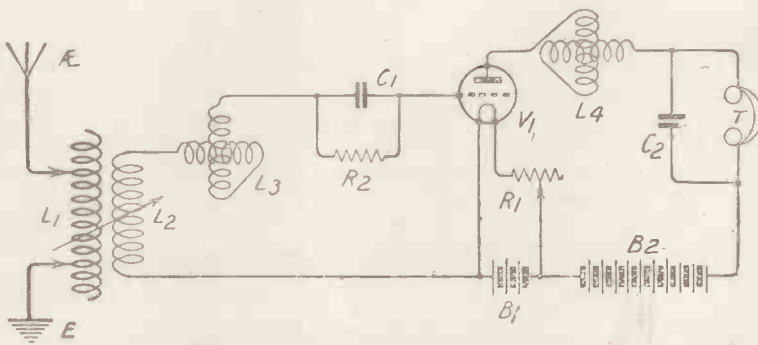

Fig. 1.—A highly popular American circuit, in which reaction is obtained by tuning the plate circuit.

American and British Radio

Interesting Points of Comparison.

By PERCY W. HARRIS, Assistant Editor.

IF, when you pick up an American radio publication, you find, as you are almost sure to do, that the claims made by constructional writers for their particular designs are far greater than you are led to expect from similar articles in this country, you are likely to jump to one of two conclusions. Firstly, you may think that American radio apparatus is greatly superior to ours, or, secondly, you may come to the conclusion that American wireless writers are—well, let us put it quite plainly—thumping liars. As a matter of fact neither conclusion would be correct.

Differences

The very considerable differences which exist between the apparatus and, what is more important, the working conditions on the two sides of the Atlantic, lead me to believe that a few notes upon the subject may be interesting to British readers. It so happens that within the last few weeks I have received two or three reports of the operation of sets made in America from designs of my own published here, thus enabling me to write with more certain knowledge than would otherwise be the case. Furthermore, I have been digging into technical literature published on the other side of the Atlantic, and have made a number of comparisons which throw a flood of light upon several points not previously made clear on this side of the Herring Pond.

Atmospheric Conditions

In the British Isles the broadcast listener is not greatly

troubled by atmospherics, save when he is using a very large aerial in some of the worst summer conditions. Please note, that by "Broadcast Listener" I mean the man who is content to receive the excellent programmes from the nearest one or two stations. I do not mean by broadcast listener the experimentalist who, with the desire to achieve the greatest possible distance, even at the sacrifice of quality and distinctness, is forcing the amplification of his



UV 201A, the American dull-emitter amplifying valve, showing base.

apparatus up to the limit, in order to cover long distances. On the other hand, the experimentalist here, who, perhaps owning a transmitting license, is anxious to receive amateur signals of low power over great distances—even from the other side of the Atlantic, may find a thoroughly bad night any time of the year. In the United States atmospheric noises or "static," to give it the American equivalent, are frequently so trouble-

some in summer months as to rule out any pleasurable participation in the radiated music, while many amateur transmitters give up work altogether in the summer months, owing to the difficulty of effecting satisfactory communication through the all-prevailing static. In winter months, on the other hand, the ether about the United States is singularly free from atmospheric troubles on short wavelengths, and almost incredible distances are covered with very low power during the hours of darkness. When the first transatlantic amateur signals were received on this side, I well remember Paul Godley, who came over from America with apparatus to receive the American amateurs here, expressing to me the greatest surprise at what he called the "impossible atmospheric conditions" over here.

Freak Ranges

When I first went to sea as a Wireless Operator some fourteen years ago, there were neither valve nor crystal receivers available, and all our receiving work was done on the very insensitive magnetic detector. Transmission, of course, took place on the spark system—not even a musical spark at that. Yet with such inefficient apparatus we were frequently able to cover enormous distances at night, and in certain parts of the globe we could generally rely upon long-distance transmission and reception after sundown. In these latitudes the difference between the day and night range was not very great, but south of the Equator the difference between

This article clears up many problems which have puzzled the British amateur when hearing of the experiments of his Transatlantic confreres.

the two ranges was considerable. In 1911, when sailing on a Union Castle liner, I was in charge of a set which had a daylight range of rarely more than a couple of hundred miles, yet almost any night after leaving the Bay of Biscay behind, I could send and receive over a thousand miles with it. In Australasian waters a similar set would frequently cover two thousand, when conditions were very favourable.

The American Ether

Now the United States seems blessed with conditions which resemble those we used to find south of the Equator in the days to which I refer. The American broadcasting stations are, on the whole, not so well equipped as ours, save in a few exceptions, such as in the case of broadcasting stations put up by one or two big corporations with the vast resources of the industry behind them. The more experienced British amateur transmitters would be ashamed to own many of the broadcasting stations listed in American publications. I have no doubt whatever, if you were to take 2LO, 5IT, or any of the other broadcasting stations known to us here, and operate it somewhere in the United States, for both quality and range covered, it would put nine-tenths of the American stations in the shade. Cynical people have said that the American broadcasting stations do not trouble greatly about their modulation, as a slight amount of distortion improves the American accent. Be that as it may, the British experimenter can take it as certain that the

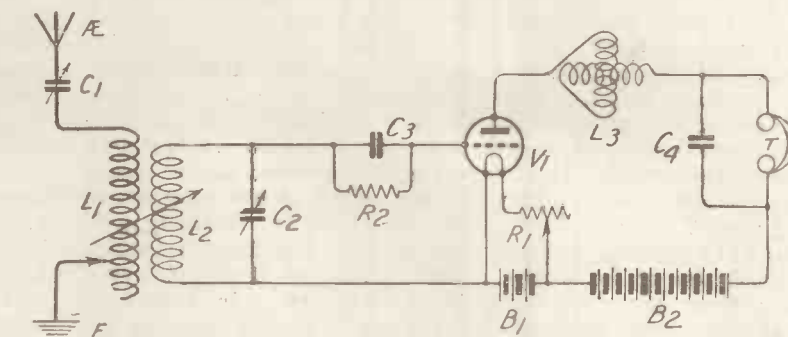

Fig. 2.—Another popular circuit on similar lines, but with aerial and secondary tuning condensers.

huge ranges common in America are due, not so much to the efficiency of the broadcasting stations as to the peculiarly favourable local conditions.

U.S. Amateur Transmitters

Speaking of power in relation to range, brings up the question of power rating common among amateur transmitters on the other side of the water. Now that amateur transatlantic communication is fairly frequent, quite a false impression of American



For comparison, the B4, a British valve closely resembling UV201A.

amateur efficiency has been given by the publication of reports in this country copied from American publications. We hear that, for example, Frank K. Brasspounder, of Dead Man's Gulch, Wis., has "got over" with a set having "only one 50-watt tube." Rather good you say, effecting transatlantic communication with only 50 watts! But wait a minute before you draw your conclusion. A 50-watt tube is not a valve of

which the input power is 50 watts as we should calculate here. Far from it. It is probable that this power on our rating would be about 200 watts. I have just been reading about the station of 6AWT in San Francisco, and as there are some actual figures given in the description, you can judge for yourself how far my argument about under-rating is true. 6AWT employs a single 250-watt valve. He was heard quite well in Australia. His plate voltage was 6,000 and his plate current 900 milliamps—5.4 kilowatts plate input power! No doubt this was grossly overloading the tube, but I have taken the trouble to turn up the maker's catalogue of this valve, and I find that their own rating, which is obviously conservative, gives the plate voltage as 2,000 volts normal, and the plate current 250 milliamps; this, of course, gives us a normal power of half a kilowatt, although it is called a 250-watt valve. I do not wonder that the makers say "several experimenters using one of these valves have obtained 5 or 6 amperes in the aerial."

Further Figures

Just to make sure I am not doing our American friends an injustice, I have turned up a tabulated report of the best American amateur transatlantic sending stations in the 1923 transatlantic tests, and I have picked out from the list the first twenty listed as using 50-watt valves. Several of these stations used two or three of these valves. I will not burden you with a lot of figures, but I think I shall be quite fair if I give you the

total number of valves used and the total plate watts. We can then see the average power used by an alleged 50-watt tube. These twenty stations used in all, forty-one 50-watt tubes. The total plate power utilised by these twenty stations was well over 7,000 watts, the average power of these 50-watt valves being about 175 watts!

It seems to be generally agreed that we are better off for receiving valves than our American cousins, at least, so far as amplifying valves are concerned, although for some reason or other which I cannot fathom, no British manufacturer has thought worth while to put on to our market a really good soft receiving valve, such as the Americans have available whenever they want. As a matter of interest, and as a guide to those who read American publications, and are somewhat mystified as to the actual valves used, here are a few particulars of the leading American receiving "tubes."

American Receiving Valves

The valves sold by The Radio Corporation of America are known as Radiotrons and have the letters UV and WD prefixing a number. The UV199 from which most of our British .06 ampere valves are copied, has a filament voltage of 3, current of .06 amperes, and a plate voltage of 20 to 40 as detector and 45 to 90 as an amplifier. In fact, these valves are almost identical with our popular .06 ampere valves. A practically identical valve sold as the C299 by T. C. Cunningham Company is made for this firm by The General Electric Company, the WD12 with a filament voltage of 1.1 and a filament current of .25 ampere with plate voltage of 20 to 40 as detector and 45 to 50 as amplifier, corresponding with our peanut valve. The UV201A, with a filament voltage of 5, filament current of .25 amp., and voltage of 45 to 90 as amplifier, is another valve copied in this country. A representative valve of this type is the B4, sold by the British Thomson-Houston Company over here; Marconi, Osram and Mullard also make a similar valve. In the United States the Cunningham equivalent is the C301A. American

valves, of course, have a slightly different mounting from ours, the four pins being much shorter. In general, too, their plate impedance is lower. I have before me as I write a specimen of the UV201A and a corresponding British valve; both are heavily silvered inside, owing to the effect of the magnesium process of finally "cleaning up" the vacuum, but there is enough clear glass to distinguish the inner structure. In each case there is a V-shaped filament, the plate being a flat open-ended box about the size of a postage stamp and about a quarter of an inch between sides. I notice the UV201A has a rib at the top and bottom of the plate, whereas the B.T.H. B4 is not so ribbed, although a close examination suggests that the general make-up of the B4 is a better mechanical job, as the plate is supported all the way up on each side, whereas the UV201A is only supported for about half of its length. The valve pins on the British tube project the ordinary distance of about three-quarters of an inch, whereas the American tube has pins which project the standard length of about 5/16ths of an inch. (See photographs.)

Where we Score

I have purposely given first of all a few examples of valves common to both sides of the Atlantic. Where the British experimenter scores heavily, however, is in our ordinary "R" type or general purpose valve, of which there seems to be no American equivalent.

American Detector Valves

The standard American detector valve is a Radiotron UV200 or a Cunningham C300. These have a filament voltage of 5 and a full ampere of filament current, while the plate voltage is 15 to 22 for detection. To get best results with this valve it is really necessary to have a vernier rheostat. Vernier rheostats are sold in this country, but I am not aware of a single valve (other than the soft Dutch tubes which are occasionally used here) in which the use of a vernier rheostat is at all helpful, save when cue is making very critical adjustments on some H.F. stages.

Receiver Design

The multiplicity of broadcasting stations has made high selectivity absolutely necessary in the American receiving set. On this side of the water we have relatively few broadcasting stations, and furthermore our broadcast listeners demand simplicity in operation. With Chelmsford on 1,600 metres, Radiola on a longer wave, Königswusterhausen and the Eiffel Tower on still longer wavelengths, aircraft telephony on 900, the Dutch concerts on 1,050, and so forth, a receiver to satisfy the British public must have a very wide wavelength range. In America a set which will tune from 300 to 600 metres covers all the broadcasting the average man wants, and, in fact, all that is available. The tuning arrangement almost universally adopted is to have what is known as a vario-coupler for coupling the aerial to a closed oscillatory circuit, reaction being obtained by tuning the plate circuit so that when it comes into resonance with the grid circuit the set will oscillate. By keeping the tuning just off the point of exact syntony it is possible to get a reaction effect without oscillation. A set of this kind (a circuit diagram is given in Fig. 1) used with a suitable soft detector valve gives exceedingly good results with very high selectivity. The aerial tuning, usually carried out by tappings and two switches, is not very critical. The secondary circuit, which can have its coupling with the aerial circuit varied by rotating the whole coil, is tuned either with a variable condenser or with a variometer in series with it, whilst plate tuning is effected almost universally with a variometer connected as shown. Such a set, whilst being very sensitive and highly selective, needs skilled handling to get even passable results from it; further, it is not suitable for a wide range of wavelengths, and cannot be satisfactorily loaded with plug-in coils. A few British experimenters have made tuners, utilising the above circuit; but few have obtained satisfactory results from them, mainly due to the fact that suitable valves for working the circuit are not obtainable in this country. A good soft detector valve, which we unfortunately lack, is absolutely essential.

The Experimental Station 2KW

By W. R. BURNE.

Some further particulars concerning short-wave work, together with details regarding the 2KW station.

(Concluded from page 622).

LET us now consider the Hartley arrangement in a little more detail— as arranged at 2KW (Fig. 7). The aerial ammeters are of the hot wire type reading 0-1.5 ampère and 0-10 ampères. Although such an instrument gives one an approximate idea of the current in the aerial, or, rather, at the particular point at which the instrument is situated, one cannot always rely 'on its reading accurately. Numerous errors are likely to occur, so that if a thermo-couple instrument can be purchased in the first instance the experimenter will be sure of obtaining accurate readings.* The condenser C_1 is tested to 20,000 volts D.C. Although the D.C. potential across this condenser be only a few hundred volts, we may have

*Editor's Note: This is open to question.

a potential difference of a few thousand volts across it. Generally speaking, C_1 should be tested to stand from five to ten times the working D.C. potential it is desired to use. Mica dielectric is used, sheets of this material being obtained from ex-army condensers now to be purchased fairly cheaply. C_2 is the grid condenser, and is a type 577 Dubilier fixed condenser of the order of .002 mfd, fitted to the small set, though a Dubilier type CD 158 is used on the high-power set, the capacity being the same. The radio frequency choke K_1 consists of from 300-500 turns of No. 26 S.W.G. double cotton covered copper wire wound on a 2-in. former. The grid leak is of the vitreous type: tapped every 1,000 ohms, it has a maximum resistance of 20,000 ohms. The condensers

C_3 are two (.01 μ F) type 577 Dubilier in parallel, and connected across the two halves of the filament transformer in order that any H.F. currents in the circuit may be safely by-passed instead of finding another path through the windings of the transformer. The filament and H.T. power transformers are home-made, and it is intended to describe their construction in a later article. The filament transformer gives an output of 10 ampères at 12 volts, whilst the H.T. transformer will give about .25 ampère at about 1,500 volts. Half this potential is obtained by using half the secondary.

Full-wave rectification is made use of, and the transformer is therefore wound with a split secondary. One of these sections is again tapped at the mid-point so that full-wave rectification

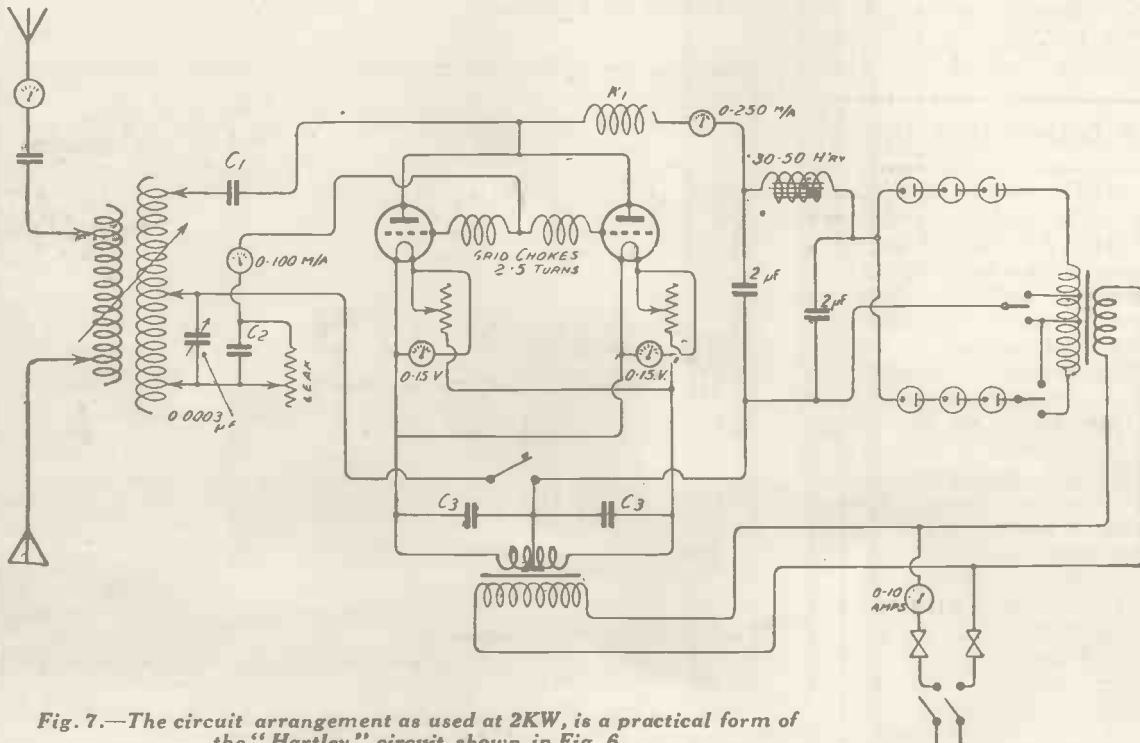

Fig. 7.—The circuit arrangement as used at 2KW, is a practical form of the "Hartley" circuit shown in Fig. 6.

may be obtained when only half the maximum voltage is used. A chemical rectifier is used to convert the 50-cycle A.C. into D.C. current. The electrodes used are aluminium and lead, while the electrolyte is neutral ammonium phosphate solution. The method of connecting up the rectifier with a centre tap transformer will be seen from Fig. 7 and 9. Many experimenters believe that when they have effected full-wave rectification all their troubles are over and a pure C.W. note without any A.C. hum will be the result. This is by no means the case, and we must turn our attention to the very necessary problem of filtering out the A.C. hum. We generally have, if our supply is

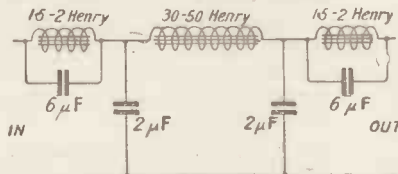

Fig. 8.—A suggested filter arrangement for a 50-cycle supply.

50 cycles, a hundred-cycle note predominating, with several harmonics of this frequency as well as a plain 50-cycle note. For telephony work it is, of course, absolutely necessary to remove this A.C. component before we can commence to speak. Happily for us, it is possible to design a filter that will remove most of the hum.

A Battery Lead Tip

WHEN double-flex leads with tagged ends are used for the connections of either high-tension battery or low-tension battery, there is always the danger of a short circuit through the two tags coming into contact when the leads are being unfastened or whilst they are lying on the table. Here is a simple little tip which removes the danger of such a short circuit occurring. Always cut one of the wires two inches shorter than the other, and bind them together quite close to the short end. When leads treated in this way swing loose there is no chance of the two tags coming together and a short circuit therefore cannot occur.

R. W. H.

Many experimenters that I have met merely kept putting condensers across the power terminals, and together with little silent prayers hoped for the best. The net result was that improvement was very slight indeed. Fig. 8 shows a suggested arrangement for a filter suitable for a 50-cycle supply. It would be as well to design the chokes so that the inductance may be varied. This may conveniently be accomplished by varying the width of the air gap in the core of the coil. If the choke control method of modulation is used, this method of filtering will be of little use, so a suggested arrangement is shown in Fig. 9. The choke is shunted by a condenser of the order of .001 μ F. By altering the value of this condenser a point will be found where there is practically no A.C. hum.

The photograph given last week shows a home-made tuner and Burndept Ultra III, while a Sullivan Standard Heterodyne Wavemeter is situated behind the tuner. The next panel is a two-valve low-loss receiver; next comes the low-power transmitter. A valve full-wave rectification unit is being constructed to work with this set. The set used to transmit across the Atlantic is on the right of the photograph.

Whilst using a power of 100 watts, 2KW has been heard in the 1st, 2nd, 3rd, 4th, 5th, 8th, 9th Districts of the United States. Heard also in Canada and by the MacMillan Expedition in the Arctic Regions, WNP, 2KW has worked on several occasions with five U.S. and three Canadian stations. Two-way communication was established with CrBQ when British 2NM was there, and I was able

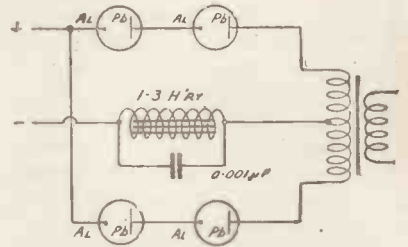
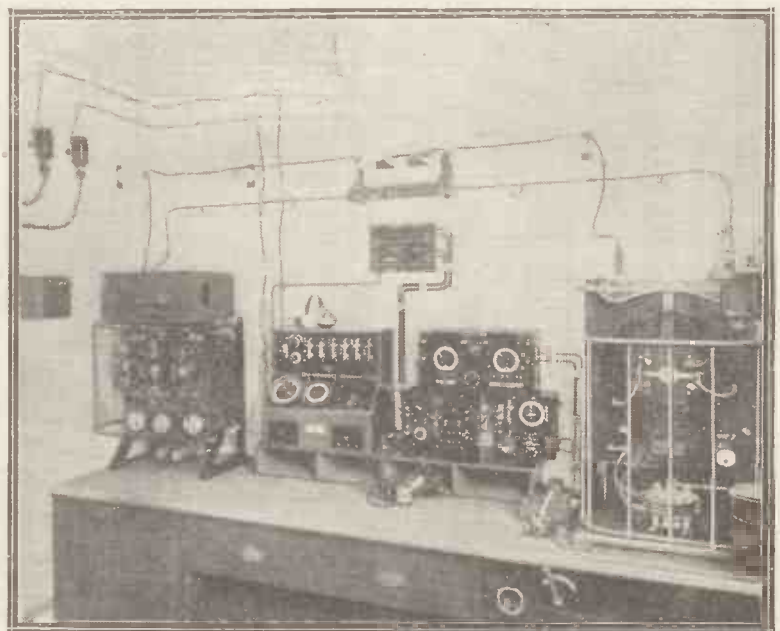

Fig. 9.—A filtering system for use with choke control.

to chat with my friend as easily as if he had been in his own station in London, instead of three thousand miles away. Over two hundred American and Canadian stations were heard last winter, using for the most part one valve and never more than two in a straight circuit! Duplex telegraphy has been effected on more than one occasion with U2XBB.



A standard 1½ KW Marconi ship set with D.F. spark, C.W. and "Emergency" equipment.



Low-Frequency Resistance Coupling

Considerable interest is being taken in resistance coupling for broadcast reception, and there are naturally varying opinions regarding its use. It is important to bring out very clearly the advantages of each method and not to come to conclusions too rapidly.

iron-core transformer is a consideration which governs many experimenters, and if, at the same time, a good make of transformer is purchased, and suitable grid bias, etc., employed, better results could not be wished for, but, on the other hand, where a large amount of low-frequency amplification is desired, resistance amplification appears to be

faithful result, but it has to be remembered that the aforesaid B.B.C. thinks nothing of using five or six stages of low-frequency amplification, and that transformers for this purpose would be out of the question. Where only one or two stages of low-frequency amplification are required, then the average man will vote for transformer coupling.

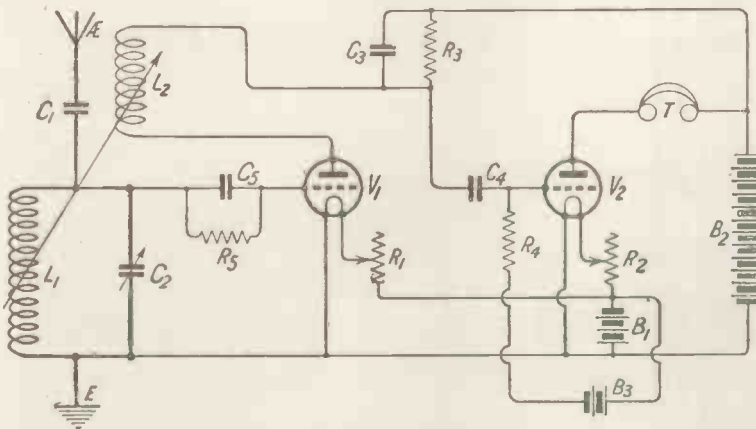

Fig. 1.—A two-valve circuit using one stage of low-frequency resistance coupling.

In the first place, resistance amplification is considerably less efficient than transformer coupling, as regards strength of signals obtained. On the other hand, it is probably correct to say that in the average hands a resistance amplifier gives purer results than a receiver using several stages of transformer coupling. To work two or more stages of low-frequency amplification without producing distortion necessitates a good make of transformer and proper operating conditions. Resistance coupling has acquired a reputation very largely because of the inferior and actually shoddy iron-core transformers on the market which, moreover, are frequently improperly used. The valve economy involved in the use of an

the only solution. Because the B.B.C. largely use resistance low-frequency amplification, it is assumed that this gives a more

Resistance Values

As regards circuits using resistance coupling, the accompanying Figures 1 and 2 will be found suitable. It will be seen in Fig. 1 that the first valve acts as a detector with reaction, and that low-frequency coupling is effected by means of the resistance R_3 , which may have a value of 50,000 or 100,000 ohms. Using an anode battery of about 70 or 80 volts it does not seem to make much difference if R_3 is 50,000 or 100,000 ohms. The condenser C_3 is merely a by-path condenser for the high-frequency anode currents of the first valve, and its capacity may be anything from .0001 μ F to .002 μ F. Larger capacities than the latter value will reduce the degree of low-

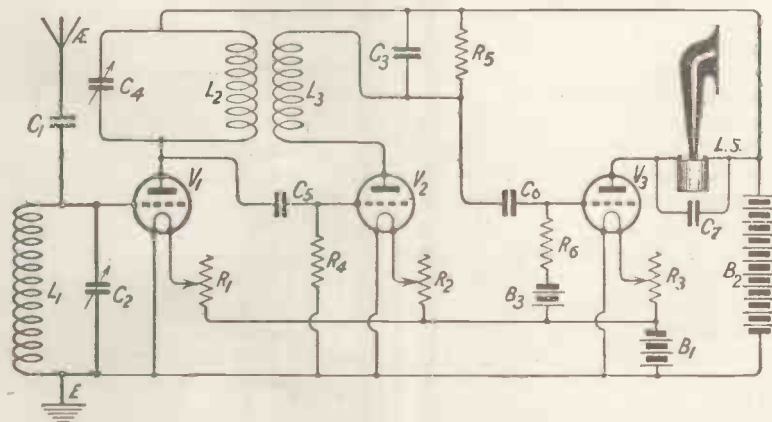

Fig. 2.—The ST34 circuit, followed by one resistance coupled low-frequency valve. Note that the L.T. positive is earthed to give stability.

frequency amplification obtained by the first valve. The condenser C_4 may have a value of from $.002 \mu F$ to $.25 \mu F$; the actual value does not seem to be at all critical. The larger sizes of grid condenser, of course, should be of the Mansbridge type, the cost working out at about 6s. each. A mica condenser would be too expensive for ordinary purposes, quite apart from the question of the size of the condenser. Grid bias may be applied to the grid of the second valve by means of a grid battery B_3 . In the case

of the Fig. 1 circuit the battery B_3 will not usually be necessary. As regards Fig. 2, this is an ST34 circuit followed by a stage of low-frequency amplification. Here the resistance R_5 is as before—50,000 or 100,000 ohms—while the condenser C_3 across it may have any value from $.0001 \mu F$ to $.002 \mu F$. A value of $.0001 \mu F$ will be probably cheaper, and will work just as well as the larger capacities. The grid condenser in the grid circuit of the third valve has the same value as C_4 in Fig. 1, and ordinary

grid leaks may be used in both cases. I would like to warn readers very solemnly about purchasing nondescript anode resistances. They may look very well outside, but the average kind sold in many shops is an extremely inferior article. Strangely enough, reputable manufacturers do not seem to have appreciated the growing demand for anode resistances. Fortunately, those who are appreciating the demand for fixed resistances are maintaining a high level of quality.

Drilling Panels Without Marking Them

IN marking out the drilling centres on ebonite panels in the ordinary way, lines are scratched on the underside of the panel. For general finish and accuracy it would often be preferable to drill from the top face of the panel, but this would necessitate laboriously removing the panel surface to eliminate the lines thus made. Another drawback in marking out centres on ebonite panels is the fact that it

folded edge rest against the corresponding edge of the panel itself. Fold the remaining piece of paper under the panel and clamp the two to the bench, as shown in the diagram. With an archimedean drill, bore through the paper and lightly into the panel.

PATENTS.
This is to give notice that a considerable number of wireless patents in the name of John Scott-Taggart will be disposed of almost immediately. Any firms or persons interested should make application at once to the above-named at Devereux Court, Strand, London, W.C.2.

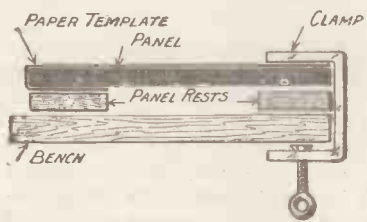

Illustrating the method of clamping the panel ready for drilling.

is very difficult to see clearly what one is doing on a jet black surface. It is as easy and as quick to accurately draft out the arrangement of the various holes on paper, as it is to do it on the panel. The writer suggests, therefore, that a drawing should first be made on paper of the drillings as they would appear from the top of the panel. If the constructor can draw his lines on ebonite, he can draw them on paper. The outside edge of the panel should also be drawn in. When this is done, cut out the paper template round three of the panel edges, leaving the fourth uncut. Fold the paper carefully along this line. Now lay the paper template, right side up, on the panel, letting the



Mr. H. M. Hill at the main oscillator at the Glasgow station.

Fixing Small Screws into Ebonite

THE tapping of ebonite to take a machine thread is very unsatisfactory, especially if a small diameter screw, such as 4, 6, or 8 B.A. be used. A good thread can be made for short distances, i.e., about a $\frac{1}{4}$ in., but very great care must be taken to use the correct size drill for the hole and very steady application of the tap to the material. The cause of taps stripping the material is due to heat generated by friction softening the ebonite. This latter then powders up, and still getting warmer expands so much that it binds the tap to the ebonite. A slight turn of the tap under these conditions will strip any thread that has been made. The tap should be totally withdrawn very frequently and cleaned with a stiff brush, and cooled by dipping into water for a second or two. A drop of water in the hole also helps matters.

In spite of very careful manipulation, the thread once formed has no great strength, and is liable to strip if too much tension is applied.

A very satisfactory method is to use wood screws, the picture showing the difference between a machine screw thread and a wood screw. It will be seen that whereas the machine screw has fairly thick, carefully designed and balanced threads, the wood screw threads are a little deeper and thinner in the walls. The top of the thread also has a fairly sharp point.

This allows the thread to easily pierce the ebonite and let itself in, instead of cutting the material away.

To use the wood screws in ebonite the following is the most satisfactory and simple method.

A hole is first drilled and cleared to allow of the first complete thread at the bottom of the screw to just enter it; the wood screws being tapered, act as a taper tap automatically.

The screw is carefully turned with a screw-driver backwards and forwards, going into the ebonite a little more each time, until the screw is in as far as required.

The best screws to use are "brassed iron" or plain "steel." The brass screws look much better, however, and their cost is a little more. Brass screws can be used, but the chance of them snapping off is very great.

The writer has found by experience that the size and length of screws usually required are as follows:— $\frac{3}{8}$ in., $\frac{1}{2}$ in. \times 4 in., $\frac{5}{8}$ in. \times 4 in., $\frac{3}{4}$ in. \times 4 in. countersunk. A $\frac{3}{32}$ in. Morse drill is the correct drill to use for these sizes. A smaller screw, $\frac{1}{4}$ in. \times 2 in., requires a $\frac{1}{16}$ in. or $\frac{5}{64}$ in. drill,

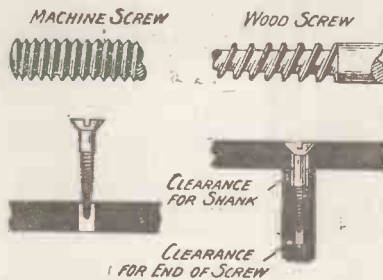

Illustrating the difference between machine and wood screws and the method of screwing the latter into ebonite.

and a few of these are very useful for fitting clips, etc. When drill-

ing into the edge of a panel, be sure to drill the hole deep enough to clear the end of the screw.

If the plain shank of the screw is liable to go into the hole, the top of the hole should be slightly enlarged, or the edge of the panel may split.

The larger hole should be drilled first and then the smaller after. An $\frac{3}{8}$ -in. drill will nicely clear the shank.

It is advisable to drill right through the panel and fill in the hole with heelball after the screw has been fixed. The reason for this is that should the screw meet the bottom of the hole in the solid, trouble may be experienced through the screw snapping close to the shank. If this should occur, the method of removing the screw is tedious, and requires a certain amount of care. A small centre punch mark is made in the top of the screw and a fine hole drilled right down the centre of the screw right through the panel. A slightly larger drill is then pushed hard into the back end of the hole sufficient to obtain a hold on the screw. Careful twisting will then bring the remnants of the metal out on top of the drill at the other side. If care is taken the original hole can still be kept at the original diameter.

W. H. F.

WIRELESS AND THE ARMY



Our photograph shows R.A.F. signallers listening to aircraft signals during the recent Army manoeuvres.

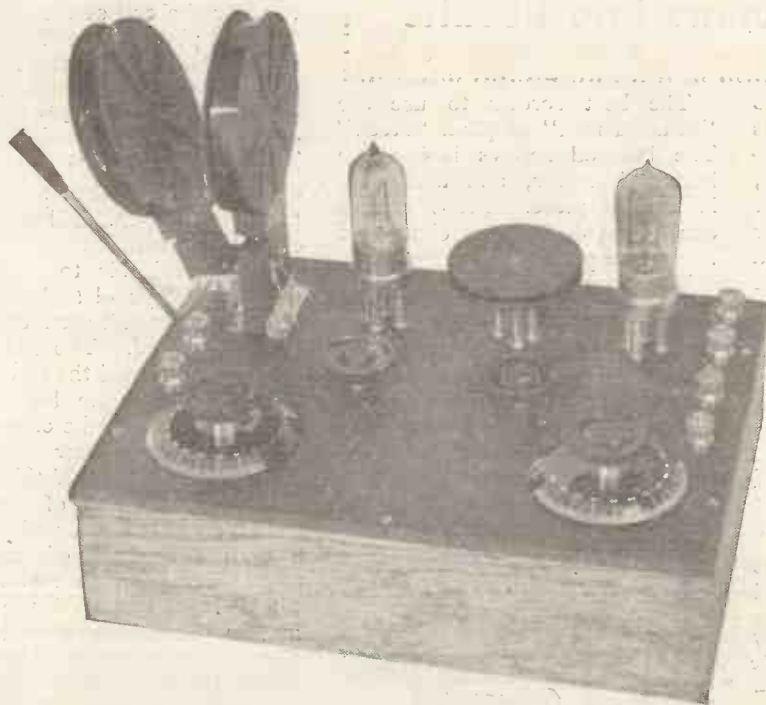

Fig. 1.—The neat layout and general appearance of the set may be seen in the photograph.

THE set to be described is particularly designed for range rather than volume on a nearby station, and although only two valves are used, on a good aerial, under favourable conditions, it should be possible to get all B.B.C. and a number of the Continental stations at good 'phone strength. With this object in view, the arrangement of one high-frequency valve, followed by a valve rectifier, has been adopted. This constitutes an ideal but quite simple arrangement for the purpose.

The Circuit

From the theoretical circuit diagram it will be seen that this is quite a simple and straightforward arrangement of a direct-coupled aerial circuit with a high-frequency valve, transformer-coupled to a detector, reaction being direct on to the aerial. This type of set is admirably adapted to adding note magnifying valves if desired for loud-speaker work.

The high-frequency side is devoid of switching, which is not to be recommended in circuits of

this type, and great care has been taken with the layout to avoid interaction. Readers are particularly advised not to modify the design in any way, as the particular layout has been found to give excellent results.

Aerial Tuning

Parallel tuning is used in the aerial circuit, and two terminals are incorporated, so that if desired a frame aerial may be tried if the particular properties of this type of aerial are required for directional work, or if space does not permit of the usual outdoor or indoor aerial being utilised. The aerial condenser in this case is across both the frame and what would, with the ordinary arrangement be the aerial coil, so that reaction may still be obtained if necessary. Of course, a much smaller coil would be necessary in this case, and possibly the reaction coil would have to be reversed for stabilising purposes.

These two terminals might also be used to insert a stabilising resistance in series with the aerial coil if necessary on a very short aerial.

A Long-Range Receiver

By J. UNL...

A receiver employing plug-in coils for all wave...

Referring again to the circuit diagram, it will be seen that the secondary of the high-frequency transformer is tuned rather than the primary, as this arrangement tends to give rather greater stability. The reaction coil is connected in the plate circuit of the detector valve in the conventional manner, and is coupled to that of the aerial by a two-coil holder. Only a small coil will be found necessary to give reaction over the whole broadcast range, and care must be taken not to use this so as to cause interference to other listeners.

Rectification is obtained by the leaky grid condenser method. Separate high-tension terminals are provided so that both valves may be worked under the best conditions and suitable types used

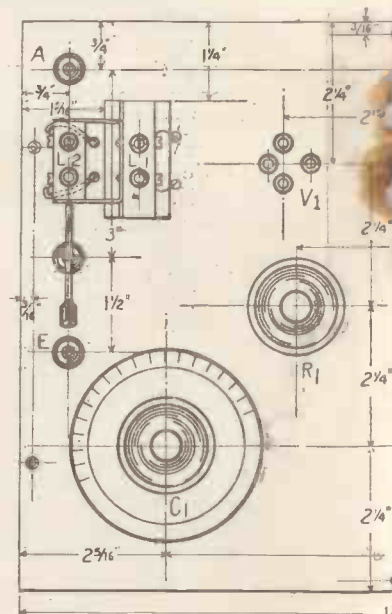

Fig. 2.—The layout of the panel

Large Two-Valve Receiver

ORDERDOWN.

and transformers, which may be used in lengths.

for high-frequency amplification and detection. A suitable by-pass condenser is placed across the telephones to ensure easy reaction control. The positive terminal of the low-tension battery is connected to earth, since greater stability is obtained in this way than when earthing the negative; any slight loss through this connection may be compensated for by the use of slightly tighter reaction coupling if required. On inefficient aerials with which difficulty is experienced in bringing the set into oscillation the negative may be earthed as shown dotted in the circuit diagram. In this case the lead marked \times is not required (joining the moving vanes of the $.0005 \mu F$ to the positive L.T. busbar).

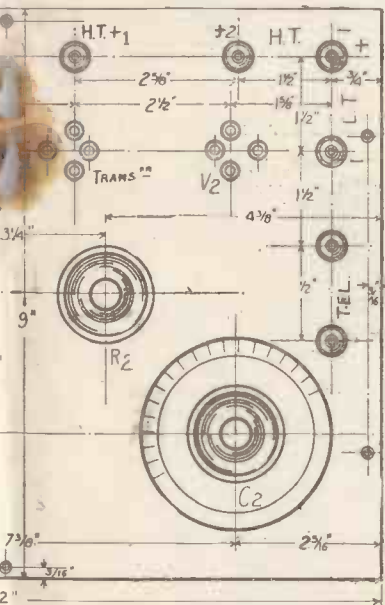

el. Ask for Blueprint No. 65A.

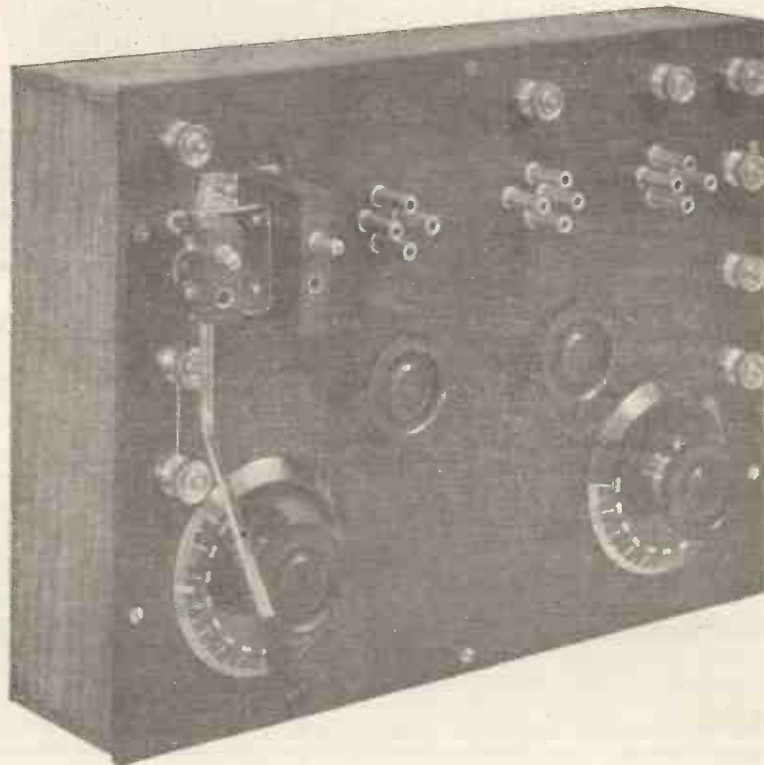

Fig. 3.—Photograph with coils and valves removed to show disposition of components on the panel.

General Layout

From the photographs the general layout may easily be seen. On the left-hand of the panel are three terminals; that at the back is for the aerial, whilst the other two are normally shorted and connected to earth. A two-coil holder is on the left-hand side of the panel, the moving holder taking the reaction coil whilst the fixed accommodates that of the aerial. Immediately in front of the coil-holder is the aerial condenser of $.0005 \mu F$. At the rear of the panel the terminals for positive H.T. are placed; that on the left is for the high-frequency valve, whilst the other is for the detector. The function of the other four terminals on the right-hand side is as follows: that in the corner of the panel is a common terminal for negative H.T. and positive L.T., whilst the next is for negative L.T. The other two are for the telephones.

The two valves are at the rear of the panel, and between them is the plug-in high-frequency trans-

former. Immediately in front are the two filament resistances. The variable condenser tuning the H.F. transformer is on the right-hand side and the front of the panel. Its value is $.0002 \mu F$.

Components

The components required are as given below:—

- 1 ebonite panel 12 in. \times 9 in. \times $\frac{1}{4}$ in. thick.
- 2 square-law variable condensers of $.0005$ and $.0002 \mu F$ (Bowyer-Lowe Co., Ltd.).
- 1 2-coilholder (Burne-Jones & Co.).
- 2 filament resistance (Gambrell Bros., Ltd.).
- 2 fixed condensers of $.002$ and $.0003 \mu F$ (Dubilier Co.).
- 1 2-megohm grid leak (Dubilier Co.).
- 12 valve sockets with nuts and washers.
- 9 W.D.-type terminals 4 B.A., complete with nuts and washers.
- Quantity of r6-gauge tinned copper wire and short length of rubber-covered flex.

As is usual, names of firms from whom the components were obtained are given for the benefit of readers who wish to exactly duplicate the receiver as illustrated. Any type of cabinet may be used to take the set. That shown was made by the author, and is particularly shallow to allow of being carried in an ordinary attaché case when required. The high-frequency transformer used was that known as the Discol, and is made by Gent & Co. If any other make is used it may be necessary to try the effect of reversing the connection to the primary and secondary to get the best effect. On first test with the set hardly any signals were obtained until the correct connections were found by experiment, but when correctly connected excellent signals resulted.

Constructional Notes

If the panel is not matted or guaranteed free from surface leakage the shiny surface should be thoroughly removed by the use of emery paper; use a little lubricating oil and rub with a circular motion, when a fine-looking surface will result. Having prepared the panel, mark out the position of the various holes by means of a scribe or some sharp instrument. Next mount the various components upon the panel and clean the points which are to be soldered by means of a smooth file. All is now ready for wiring.

Connecting Up

First carefully tin all the tops of the terminals and valve sockets, taking care to use the minimum amount of flux or soldering paste possible. If the panel becomes greasy with flux, this may be removed by carefully scraping or washing off with methylated spirits.

When soldering use an adequately hot iron so that it has not to be held on the point to be tinned more than a second or so. If the terminals become heated by too lengthy application of the iron they will probably be found to have loosened, and the nuts should be given a half-turn or so with the pliers before proceeding further. The wiring in the receiver illustrated has been carried out with No. 16 gauge

tinned copper wire which was obtained on a bobbin. To straighten this the best method to adopt is to securely twist one end round some firm object, such as the knob of the oven door or a table leg if a vice is not available, and after reeling off a few feet this should be stretched until it is felt to give slightly. If cut off in short lengths this will now be found to be perfectly straight, and will look much neater and be a source of pride to the user when the instrument is completed.

Careful Wiring

Carefully carry out the wiring as shown on the wiring diagram

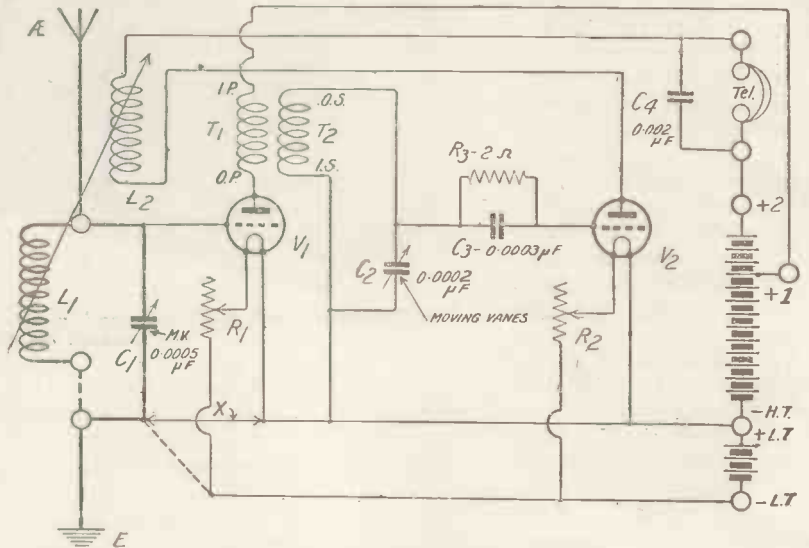

Fig. 4.—The circuit diagram showing alternative earth connection for greater freedom of oscillation.

and in the photographs, taking care to keep grid and plate leads well spaced. It will be noticed that the leads to the reaction coil are twisted together to prevent interaction. One consists of a piece of tinned copper wire almost to the holes through which the flex leads to the moving coil are taken and serves to keep the other, which consists entirely of rubber-covered flex, and is twined round it, rigid and away from the other leads. Little difficulty should be experienced with the wiring, as this is all quite straightforward and easily followed from the diagram and photograph. Readers may perhaps think too much stress has been laid on soldering hints, but our experience amply shows that it is here that great care

should be taken; as before stated, bad joints and too much flux have been found to be the cause of many failures.

Testing

The wiring being successfully completed, plug the aerial coil into the fixed block of the coil-holder and a smaller coil into the reaction or moving socket. For the broadcast band of wavelengths the writer used a Gambrell "A" coil for the aerial circuit and an "a" for reaction. For the higher wavelength stations, Aberdeen and Birmingham, a "B" coil was used in the aerial circuit. The "a"

was found suitable for reaction over the whole range and even above 600 metres. With other makes of coils a 35 or 50 will be found suitable for aerial and a 25 or 35 for reaction.

Plug in the valves and H.F. transformer and then connect the low-tension battery in circuit. Turn on the filaments and ascertain that the valves light correctly, after which the high-tension should be connected. For a start the two H.T. positives may be connected together and given about 60 volts or so with R-type bright emitter valves. Connect the aerial to the aerial terminal and join the other two left-hand terminals together and to earth.

The next step is to see that the reaction coil is connected

the right way round. To do this, first tune with the two condensers with the reaction coil as far from the fixed aerial coil as possible until a signal is heard. Then gradually bring the reaction coil towards the aerial coil, retuning at the same time on the aerial condenser. If the signal increases in strength until finally the set oscillates as evidenced by plocks in the phones on touching the aerial terminal, the coil is rightly connected. If, however, the signal gets weaker and it is impossible to make the set oscillate even by using a larger coil, the leads to it should be reversed at the moving coil block. This should be done in non-broadcasting hours to avoid interfering with other listeners.

The set being found to function correctly can now be tried on broadcast, and once the local station is obtained you have a basis on which to search for the others. Those of higher wavelength will be found to require higher condenser readings and tighter reaction coupling, and

vice versa for the lower wavelength stations. The tighter the

care should be taken to avoid oscillation.

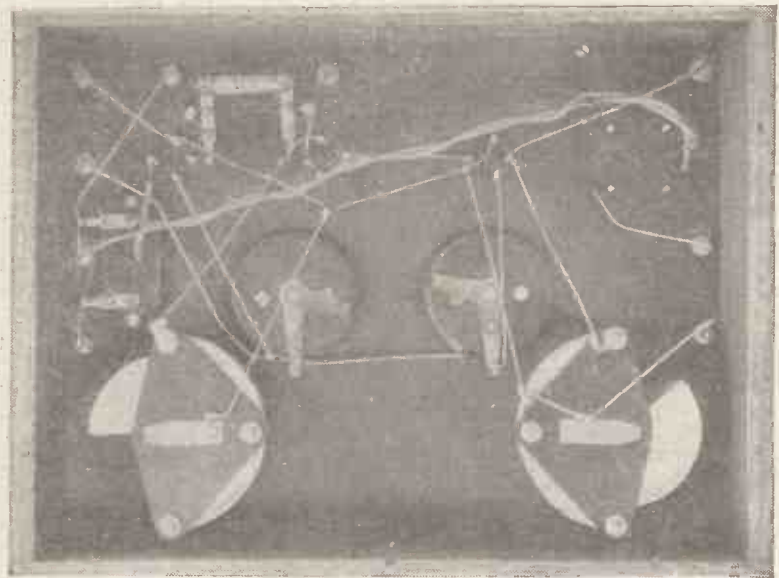

Fig. 5.—Photograph showing the wiring. Note particularly how the leads are spaced.

reaction coupling the greater will be the selectivity and the sharper the tuning, but great

A test report upon the working of this receiver will be given in our next issue.

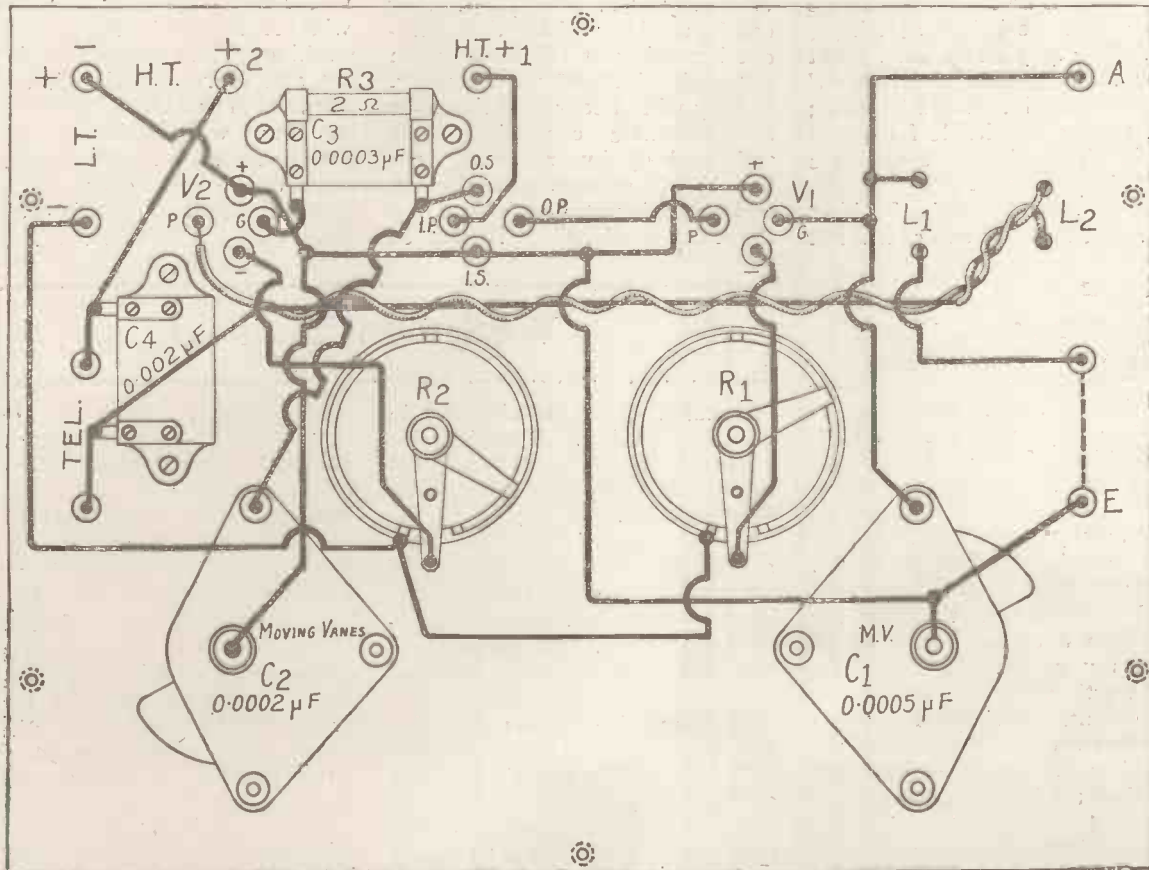
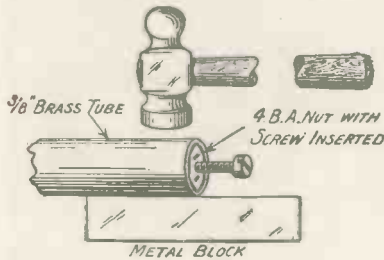

Fig. 6.—Practical back-of-panel wiring diagram. Blueprint No. 65B.

Box Spanners for B.A. Nuts

THE box spanner is one of the most useful tools, for it enables nuts to be tightened down in inaccessible corners where they could not possibly be reached by either pliers or flat spanner. It consists of a length of tubing, one end of which is made hexagonal to fit over a nut.



Method of shaping the tubing.

At the other end are drilled two holes through which a "tommy bar" can be passed so as to give one a good leverage on the spanner. A set of B.A. box spanners can be made by anyone in his own workshop at trifling cost. For 4, 5 and 6 B.A. stout brass tubing with an external diameter of $\frac{3}{8}$ in. should be used; $\frac{1}{2}$ -in. tubing is suitable for 2 and 3 B.A. To make these spanners proceed as follows.

Cut off a 6-in. length of tubing and insert into one end of it a nut

of the size which the spanner is to fit, with a screw in it. The screw is essential, for otherwise the nut itself will be flattened by the hammering which is necessary. Place the end of the tube upon a metal block and hammer all round so as to shape it to the nut. This process does not take long, but it must be done carefully in order to make the spanner a thoroughly good fit. When there is hardly any play at all between the nut and the tubing the former may be withdrawn and the end of the tubing finished up externally with a smooth file. At the other end of the tube drill a pair of $\frac{3}{16}$ -in. holes opposite to one another and cut off a 3-in. length of $\frac{3}{16}$ -in. rod to make a tommy bar. The same tommy bar will of course do for the whole set of spanners.

So long as good tubing is used the spanners will be found eminently serviceable, and they can be used for a long time without becoming at all loose upon nuts. If signs of wear appear, as they will in course of time, the box spanners can always be tightened up by repeating the hammering process with the nut and screw inserted as before into the hexagonal end. If desired

the spanners may be made double-ended. One end of the first tube, for example, might be made 6 B.A. and the other 5 B.A. Both ends of the second tube could be made 4 B.A. (since this is the most used size and this spanner will therefore get the hardest wear), and the third tube 2 B.A. at one end and 3 B.A. at the other. A set of three spanners will thus cover all the B.A. sizes that are used by the

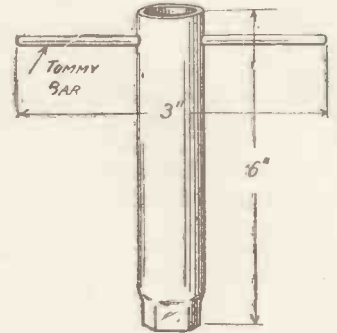

The spanner in its final form.

constructor of wireless apparatus. Rather more durable spanners can be made from medium-steel tubing by those who can undertake the process of working the metal whilst it is hot and of retempering it afterwards. The brass spanners, however, will be found good enough for all ordinary purposes, since one never exercises any great force in tightening up a B.A. nut. R. W. H.

MOST of us, I imagine, when we are engaged in some piece of constructional work, are apt to spend many valuable minutes in looking for a scribe, a centre punch, or some other small tool which has buried itself amongst a varied assortment on the workshop bench. I am not naturally a tidy person, but I have found that in the workshop a certain amount of tidiness pays so well that it is well worth while to reform to this extent. Perhaps the worst offenders are the drawers in the work bench. One is only too apt when tidying up to cast small tools and odds and ends into them indiscriminately, with the result that in time they become filled with such a medley that

Workshop Tidiness

one has the utmost difficulty in finding anything. Here is what I have found to be a useful and at the same time a not very irksome system.

At the back of the work bench against the wall, and quite out of the way, are twenty boxes of the kind used for containing a hundred cigarettes. Each of these has its special use. Six of them are devoted to B.A. screws and nuts from size No. 1 to size No. 6. The seventh, labelled "B.A. Miscellaneous," receives any nuts or screws that are found lying about, and these are sorted out whenever one has nothing else to do into their proper containers. Other boxes hold ter-

minals, tags, pieces of sheet metal, valve pins and legs, plugs and sockets, switch parts, knobs, condenser parts, bushes, and the various other small parts that one is continually using. Near these boxes are the drill stand and the taps and dies. At the back of the table there is also a larger box without a lid which holds pieces of used emery cloth. The two drawers of the bench are confined strictly to lengths of round, square and screwed rod, large pieces of sheet metal, scribers, centre punches, and unused emery cloth or glass paper.

Large tools, such as the breast drill, hammers, hacksaws, wood

saws, set squares, and the like hang on nails driven into one of the walls. For chisels and screwdrivers there is a rack in which are a couple of dozen $\frac{1}{2}$ -in. holes. Large files live in holders made by nailing strips of leather to the wall, and there are similar holders for small files. The drill plate hangs on a nail driven into the wall just above the drill stand, and from other nails close to it suspend folding footrules, dividers, compasses, calipers, and a B.A. gauge. Small measures and straight rulers have a box of their own. Pliers of various kinds repose in a rack similar to that which holds chisels and screwdrivers. Under the table are two large wooden boxes. The first contains pieces of ebonite of the size suitable for

panels, and in the second are all kinds of odd pieces of scrap ebonite. On a shelf fixed to the wall behind the bench are the oil can, the turpentine bottle, the shellac, Chatterton's compound, fluxite, and various paints and varnishes.

The golden rule in doing jobs quickly and without having to waste time in searching for tools or small parts is first of all to keep your things in an orderly way such as I have described, and secondly never to fail to put everything back into its place as soon as the job has been completed.

Two other useful accessories, which can hardly be called tools, hang from nails driven into the wall of the workshop. The first of these is a steel wire brush such

as is sold by ironmongers for cleaning stoves. Its use is to get rid of the clogging in files which have been used for trimming up ebonite. If one makes a point of using this brush on all files which have been used for working ebonite before they are put away one can always be sure that they will be keen when employed for the next job. Without some such means of getting rid of the clogging files used upon ebonite very soon become so dull that they are practically useless. The second accessory is a hearth brush, which is used for removing ebonite chips and brass filings from the table, the drilling machine, and the vice. I can strongly recommend these last two to any wireless constructor. R. W. H.

A Cheap Coil Stand

THE problem of how to keep one's spare coils is always rather a difficult one, and though one starts with the best intentions in the world, they are usually left knocking about

To make a stand for these coils cut out a piece of 1 in. or $1\frac{1}{2}$ in. oak or other hard wood $8\frac{1}{2}$ in. long by $3\frac{1}{2}$ in. wide and lay it out as shown in the drawing. Now drive in a row of screws,

three parallel rows, the distance between the screws of one row and the holes of the next being 3 in. It is thus easy to make up a compact stand for a couple of dozen coils. W. H. R.

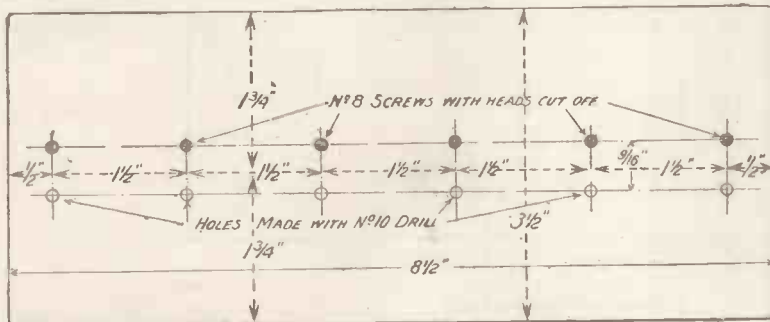

Dimensions and details of the coil stand.

either on the wireless table or loose in drawers, which is far from being good for their health. The insulation of the windings is almost bound to become injured in time at certain points, and then mysterious faults will occur in the set which may take a little tracing. The writer, who is not by any means a tidy person, has adopted a form of coil holder which is both easy to make and handy to use. The only materials required for its construction are a piece of hard wood of suitable size and some No. 8 woodscrews 1 in. in length.

cutting off their heads with a hacksaw and removing any roughness with a file. Opposite each of these drill a hole into which the coil plug is an easy fit. A No. 10 or 11 twist drill will answer for the purpose, though the exact size is not important, since there is no question of good contact. This completes the stand, though if desired certain refinements such as bevelling off the edges and glueing green baize on to the underside may be carried out. If a longer stand is required, then $1\frac{1}{2}$ in. should be added for each extra coil. Or coils can be placed in two or

THE R.S.G.B.

(Concluded from page 643.)

There are many little problems of all kinds which beset the experimenter, many of them due to the loose nomenclature which is so representative of the British Radio Science—for example, the unfortunate term "detector" for a "rectifying" valve is a good misnomer. All valves "detect," but only one does or should "rectify" on a receiver, although in multi-stage high-frequency amplifiers it is a matter of the greatest difficulty to obtain amplification without rectification. Rectification being, in the words of Professor L. B. Turner, "a symmetric" or lopsided amplification.

Similarly one sees low-frequency transformers which "amplify," whereas it is the valve which does the "magnifying," and the transformer is simply an "accessory after the fact." In passing, it should be noted that the accepted notation uses the term "amplifier" for H.F. valves and "magnifier" for L.F. valves, which obviated any possible ambiguity.

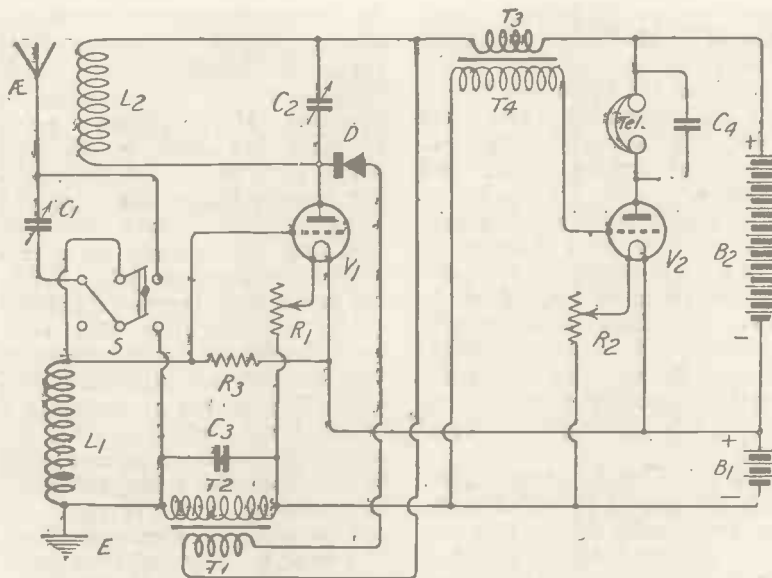

Fig. 1.—The ST101 Circuit.

Practical Back-of-Panel Wiring Chart

By OSWALD J. RANKIN

The ST101 Circuit

former T₃ T₄, the secondary winding T₄ being connected between grid and negative side of filament. The telephones, shunted by the fixed condenser C₄ of 0.002 μF, are placed in the anode circuit of V₂. The correct value of the condenser C₃

THE diagram in Fig. 1 shows the ST101 circuit.

L₁ is the aerial coil tuned by C₁, whose capacity is 0.0005 μF. It will be seen that this condenser may be placed either in series or parallel with L₁ by means of the double-pole double-throw switch S. In the plate circuit of V₁ is the tuned circuit L₂ C₂, the value of the condenser C₂ being 0.0005 μF. Across L₂ are placed the crystal detector D and the primary T₁ of the low-frequency transformer T₁ T₂. The secondary T₂ of this transformer is placed between the negative side of the filament battery and the earth. The coupling between the two valves is effected by the trans-

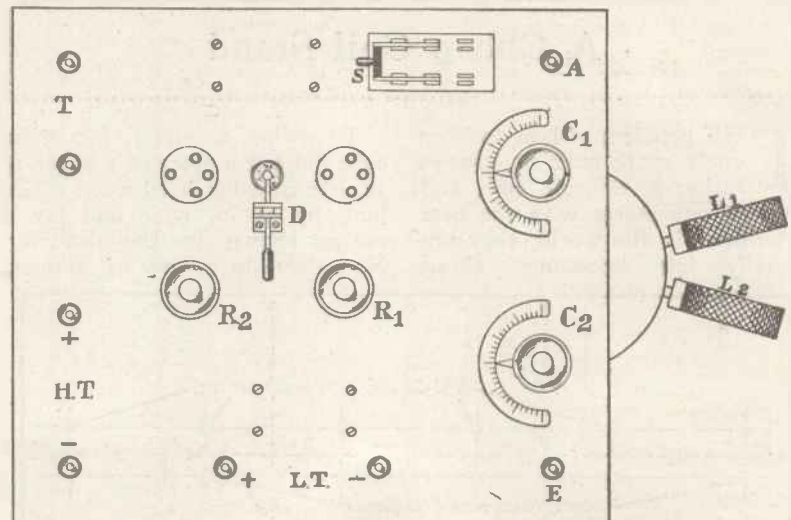

Fig. 2.—The Panel layout.

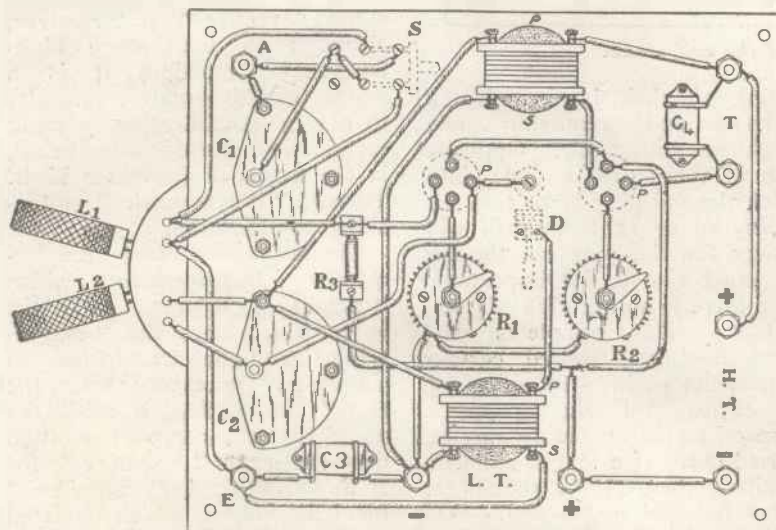

Fig. 3.—The Practical Wiring Diagram.

across the secondary of T₁ T₂, varies according to the make of transformer in use, 0.0003 μF generally being quite suitable. The value of the stabilising resistance R₃ is 100,000 ohms.

It is advisable before permanently wiring the set, to try changing over the connections to the primaries and secondaries of the two intervalve transformers, making permanent connections of those which give best results.

If the set will not oscillate even with the coils tightly coupled, the connections to L₂ should be reversed. Ample signal strength will generally be obtained with the coils well apart.

Correspondence



THE NATIONAL ASSOCIATION OF RADIO MANUFACTURERS WIRELESS EXHIBITION, ROYAL ALBERT HALL, 1924

SIR,—I have read with some interest the leading article in the issue of the *Wireless Weekly* of the 3rd inst., wherein you deal with the above-mentioned Exhibition. To my mind, the point of view as presented by you would tend to mislead your readers, although without such intention on your part.

As a signatory to the letter sent by the editors of the wireless papers to the N.A.R.M., objecting to its policy with regard to the Exhibition, you are aware that such communication, containing as it did a veiled threat, was resented. The N.A.R.M. offered to meet the editors concerned and give them the reasons on which its policy was based. Would it not have been

fairer to the N.A.R.M. and to your circle of readers for you to have had the N.A.R.M. point of view, so as to have enabled you to put the matter fairly and squarely before your readers, instead of issuing statements which are one-sided and partially incorrect?

For the benefit of your readers, I am sure you will permit me to tell them something about the N.A.R.M. and its objects. The N.A.R.M. has at present a membership of seventy, comprising both large and small manufacturers. Its membership is open to all reputable manufacturers (large and small) of British-made wireless apparatus. Nobody is refused membership if he can satisfy the Committee that he makes reliable apparatus, the performance of which he is prepared to guarantee to the public. The Committee naturally require to be satisfied that

he can fulfil his guarantees. Many self-styled manufacturers apply for membership, and on investigation prove to be one-room or spare-time men who are detrimental to so many trades. They are turned down.

The great policy of the N.A.R.M. is to encourage and support the all-British wireless trade, and every member has to sign an undertaking that the whole of his apparatus is made in Great Britain, wholly of British material and by British labour, and if an applicant for membership will not sign this clause he is refused membership.

The N.A.R.M. also take steps to stop trade abuses, to prevent price cutting, and to protect the public against fraudulent apparatus. The Association does not control or interfere in any way with the list prices at which its members' goods

WIRELESS CABINETS

IN VARIOUS DESIGNS, and WOODS

Mahogany. Satin Walnut. White Wood polished Mahogany.

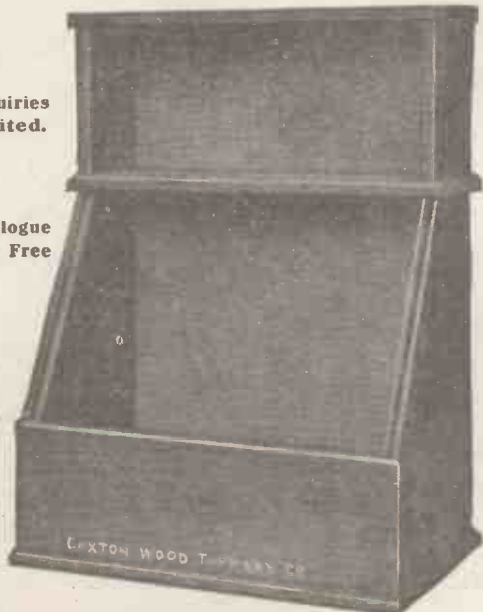

Enquiries Invited.

Delivery from Stock.

Catalogue Post Free

Specials to Order.

Makers: CAXTON CABINET & WOOD TURNERY MILLS MARKET HARBOROUGH.

Telegrams & Telephone: Haddon, 59, Market Harborough

VALVES repaired Quick!

THE advantage of sending your valve for repair to a valve manufacturer is that only a valve manufacturer can retain the valve characteristics when re-flamenting. Radions Ltd. are the pioneers of valve repairs, and still lead for good work, low price and QUICKNESS. Before sending your valve, consult this



PRICE LIST

No extra charge for New Glass or New Cap —or for both if needed.

Radion Mullard Dutch	R Type—4 volts.—.6 amps.	6/6
Marconi Cossor	Phillips	Postage on these valves POST is usually about 3d. EXTRA
Ediswan French	Moorhead	

Dull Emitters converted into Bright Emitters, with filaments as below :—

B.T.H. B.5.	..	4/5 volts.	..	.25 amps.	..	15/0
B.T.H. B.4.	..	6 volts.	..	.6 amps.	..	17/6
B.T.H. B.3.	..	4/5 volts.	..	.6 amps.	..	6/6
Mar. D.E.3.	..	4/5 volts.	..	.25 amps.	..	8/6
Mullard D.F.	..	4/5 volts.	..	.6 amps.	..	6/6

Power Amplifiers.

Mar. L.S.2.	..	6 volts	..	1.5 amps.	..	17/6
" L.S.3.	..	4/4.5 volts	..	.65 amps.	..	11/3
Mullard P.A.2.	..	5.5 volts	..	.85 amps.	..	13/0

Other Types—Prices and Particulars on Application.



RADIONS LTD.

Bollington, Nr. Macclesfield.

We make the new RADION Low consumption Valve. Price 10/-. Uses only a third of usual current.

are sold to the public, but it does seek to regulate the discounts allowed to the trade, making sure that the trade has a reasonable margin of profit, but not an excessive one. It must be obvious that the more discount which is allowed to the trade, the higher must be the price at which the article is sold to the public. In America, for example, a discount of 50 per cent. is allowed to the jobber and dealer, so that the American manufacturer has to increase his economic price by 100 per cent. to allow for this. The N.A.R.M. determined that the public who wish to purchase all-British apparatus made by its members should not be fleeced in this manner, hence their policy in regulating trade discounts. The knowledge that discounts are regulated in this manner encourages free competition amongst the N.A.R.M. members, and they all offer their goods to the public at the lowest possible prices, and no two firms' prices are the same.

In order to further encourage the British wireless trade, the N.A.R.M. have thrown open their doors to distributors and dealers, and these two self-governing sections, in process of formation, will be of immense assistance in furthering the cause of British industry.

I repeat, therefore, membership

of the N.A.R.M. is open to all reputable manufacturers or dealers who will whole-heartedly support British wireless trade.

I will now go on to deal with the various statements which you make in your leading article.

The Association have never claimed to be representative of the whole industry, and no firm has been refused membership without good reason. The public cannot be interested in a trade publication which they are not permitted to see, but why not tell them that the publication to which you refer carries advertisements of raw material, brass stampings and sundries, distributors' announcements, and last, but not least, advertisements of all sorts of foreign-made parts and telephones? Your own paper, I notice, carries eleven pages of N.A.R.M. advertising out of a total number of sixteen pages, not including those used for advertising your own publications.

With regard to the last two wireless Exhibitions in London, the first was very small and was held before the formation of the N.A.R.M. The N.A.R.M. were only more or less satisfied with the second Exhibition; they did not come into it early enough to have it conducted in accordance with their ideas. For this year the Association decided to

follow the lead given by other Associations (notably the Society of Motor Manufacturers and Traders), and run an Exhibition confined to its own members, and also that one or two exhibitions a year were quite enough, on account of the great expense and work involved; hence its decision not to support the numerous small exhibitions run all over the country by exhibition promoters for their own benefit.

I must absolutely deny your assertions that the Association is out to induce members of the industry to join them, either by "force or subtle pressure." I also deny your assertion that the N.A.R.M. have ever attempted to interfere "where it is both injudicious or gratuitous to interfere." I am also quite unaware that the Association has ever attempted to use their combination for purposes which no Association of its kind can successfully, or actually does, pursue.

I am glad to note that you have pointed out that the Exhibition will not be open to the whole trade. It was not our intention to suggest otherwise, and the Exhibition advertisements which we are inserting in various publications make this sufficiently clear; but the Exhibition will certainly be representative of the best class of all British wireless apparatus.

SIEMENS DRY BATTERIES

for L.T. & H.T. Purposes.

Large Output

Long Service

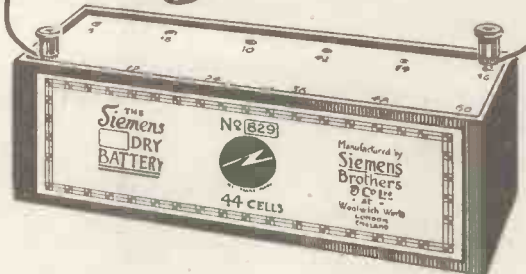

Obtainable from all Dealers.

SIEMENS BROTHERS & CO LTD, WOOLWICH, LONDON, S.E. 18.

You object to the term "All British," but you are probably unaware that this term is being used in conjunction with Exhibitions of Manchester, Plymouth and elsewhere, at which Exhibitions the N.A.R.M. will not be represented.

It may interest your readers to know that the more important wireless publications are supporting the Exhibition by taking space; that the Radio Society of Great Britain and the Radio Association will both have stands; that about £12,000 is being spent on the Exhibition; the lighting and decorative effects will inaugurate a new fashion in Exhibition lay-outs, and that all the latest productions of members will be shown.

In conclusion, I would like to say that the Association welcomes criticism, and wants the public to know all about it and its objects, and I hope in due course the work of the Association will merit the appreciation of the wireless community, trade, public and the Press alike.—Yours faithfully,

W. W. BURNHAM, F.I.R.E., etc.

Chairman, National Association of Radio Manufacturers.

[With reference to the above letter, our readers will appreciate that editorial opinion is invariably regarded as one-sided by those criticised. We have published, how-

ever, the above letter because we believe in being scrupulously fair in these matters.

The second paragraph of the letter deals with private correspondence between a committee of all the wireless editors and the N.A.R.M. All the wireless papers published in this country were unanimously of the opinion that an Exhibition on the lines planned was against the best interests of both the industry generally and the public. This unanimity resulted in a letter being sent to the N.A.R.M. pointing out our views. It was pointed out that if the present policy were carried out each paper would, in duty bound, have to indicate the narrow scope of the Exhibition. This presumably is the "veiled threat" mentioned in the N.A.R.M. letter given above.

The wireless papers, be it noted, are really unaffected by any other considerations than those which affect its readers. The N.A.R.M. assumed an air of outraged dignity and made the extraordinary suggestion that the considered letter of the editors should be withdrawn before the matter could be discussed. Several weeks afterwards the N.A.R.M. seemed to have arrived at the conclusion that a meeting could be arranged without the editors having to swallow their words. It

was, however, made perfectly plain by them that under no circumstances whatever could the policy be varied in any way, and that any meeting would be merely for the purpose of educating the editors. As we knew perfectly well what the N.A.R.M. policy was and their reasons for it, the editors felt that no useful purpose would be served by a belated meeting which could only involve the reiteration of facts which were perfectly well known to us when our letter was originally sent.

The letter from the N.A.R.M. published above does not contain one iota of information of which we were not aware when the original editors' letter was sent.

This matter, however, of the editors and the N.A.R.M. is purely a side issue, the only value of which, perhaps, is to show the unanimity of papers having no direct interest in the Exhibition whatever.

Our editorial meant to make it perfectly plain that the mere absence of a manufacturer from the N.A.R.M. Exhibition is in no way whatever any reflection on him; it may simply mean that the firm, in question prefers to carry on its business in its own way, rather than have its terms cut and dried by a trade organisation.

We wish to make no great point



B.T.H. Headphones

B.T.H. Headphones are supreme in all respects—in sensitiveness, tone, permanence, and comfort. Although fitting closely to the ears and thus excluding extraneous sounds, very little pressure is exerted and they can be worn for hours without discomfort.

Price per pair (4000 ohms) £1 5s. 0d.

A Proof of Superiority.

Ask your dealer to tune out his demonstration set until you can only just hear. Then substitute B.T.H. Headphones and you will be amazed at the clearness with which you can hear every word and note of music.

We also make Crystal Sets, Valve-Crystal Sets, Valve Sets, Loud Speakers, Amplifiers, Valves (including B5 type 0.06 amps) and Tungar Battery Chargers.

Obtainable from all Electricians and Wireless Dealers.

The British Thomson-Houston Co. Ltd.

Works: Coventry.

Offices: Crown House, Aldwych, London, W. C. 2.

Branches at: Belfast, Birmingham, Bristol, Cardiff, Dublin, Glasgow, Leeds, Liverpool, Middlesbrough, Manchester, Newcastle, Swansea, Sheffield.

ALL BRITISH WIRELESS EXHIBITION
Albert Hall, Sept. 27 - Oct. 8
Stand No. 41

out of the fact that a certain trade paper carried only 10 per cent. N.A.R.M. advertising. A careful investigation indicates that the figure should be 17 per cent., if manufacturers of raw materials and foreign manufacturers are excluded. This means that there are nearly five times as many manufacturers outside the N.A.R.M. as in it. We would not, however, regard this as a relative indication of the usefulness of N.A.R.M. and non-N.A.R.M. firms to the industry. We do not question for a moment the importance of the firms in the N.A.R.M. We simply repeat what we stated in our editorial, namely, that the Exhibition will not be representative of the industry, and that had it been free to the whole trade a very much larger and more interesting Exhibition would have been available to the wireless public.

With reference to the expression "All-British," this term, without a detailed explanation, is undoubtedly misleading, although, of course, there is no fear of our own readers being misled by it. As regards exhibitions elsewhere, there is no attempt to exclude the N.A.R.M. We simply implied that the words "All-British" should be reserved for exhibitions where all British manufacturers can, if they choose, exhibit.

The fact that wireless publications, including our own, will be represented at the Exhibition implies nothing at all, and the penultimate paragraph of the letter can only be regarded as an advertisement for it. The presence of wireless publications at an exhibition is certainly no guarantee of its representative character. We ourselves often show at small local exhibitions.

With reference to the statement of the objects and aims of the N.A.R.M., we are very happy indeed to publish the statement of its Chairman, above. We have no reason to make any comment on the statement, because, in the first place, we believe it to be a fair and accurate one, and in the second place, no criticism has been raised by us regarding the constitution and objects of this Association.

Our criticism was levelled against their Exhibition policy, and our readers will form their own judgment on this important matter.—
EDITOR.]

SPECIAL VALVES FOR RESISTANCE COUPLING

SIR,—We have read with interest the article appearing in your September 3 issue on the subject of a resistance coupled amplifier. This is a development in wireless receiver

manufacture which has for some time engaged the attention of our research laboratories and technical staff, and as a result the system has been adopted for our standard five-valve sets.

Perhaps it will be even more interesting to your readers to learn that we have now put on the market a valve designated the D.E.5B, which is specially designed for resistance-capacity work. The valve is intended to operate from a six-volt accumulator using the D.E.5 as a power amplifier in the last stage. It is a dull emitter consuming only .25 amp filament current at 5 volts. We recommend an anode resistance of about 150,000 ohms coupled with an anode voltage of about 120 in order to get the full amplification factor of 20 from the valve.

This valve should supply a long-felt need for amplifiers of this type, as, to get any volume with an ordinary general purposes valve, so many stages of amplification were required. With the D.E.5B the volume can now be obtained with a degree of clarity extremely difficult to obtain with transformer coupling.

—Yours faithfully,

For and on behalf of
THE GENERAL ELECTRIC CO., LTD.,
G. H. MARRIOTT,
Assistant Manager,
Valve Department.

THE NEW "DEXTRAUDION"

DULL EMITTER

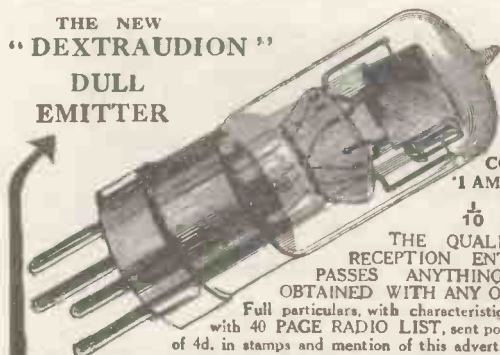

PRICE 21/-

MAXIMUM CONSUMPTION .1 AMP. AT 1 VOLT.

10 WATT!

THE QUALITY OF THE RECEPTION ENTIRELY SURPASSES ANYTHING HITHERTO OBTAINED WITH ANY OTHER VALVE.

Full particulars, with characteristic curves, together with 40 PAGE RADIO LIST, sent post free on receipt of 4d. in stamps and mention of this advertisement.

ECONOMIC ELECTRIC LTD. | Head Office: 10, FITZROY SQUARE, LONDON, W.1. | Showrooms: 303, EUSTON RD. N.W.1

VALVE RENEWALS

We repair by our patent process (for which we have NATIONAL PHYSICAL LABORATORY'S Report of efficiency)

ALL STANDARD TYPES OF VALVES AT **6/6**

AND

CARRIAGE PAID

GUARANTEE (At least EQUAL EFFICIENCY to new valves. To RETURN IN THREE DAYS

OR REFUND YOUR MONEY WITHOUT QUIBBLE.

THE ECLAT MANUFACTURING CO., LTD.

Spencer Works, Wimbledon, London, S.W.



Build a better set with



Experimental work is the life and soul of wireless advancement but—costly. In the matter of components there is no need now to experiment, for the name Igranitic on radio parts is your guarantee of first-class results from whichever circuit is used.

Igranitic Radio Devices include Honeycomb Coils, Variometers, Filament Rheostats, Inter-valve Transformers, Vario - Couplers, Battery Potentiometers, Bi-plug and Tri - plug Coilholders, Vernier Friction Pencils, Earthing Switches, etc.

The IGRANIC Low Frequency TRANSFORMER

is specially designed for the distortionless reproduction of speech and music. The metal shroud effectively shields from external interference. Recent improvements in design render it the finest amplifying transformer obtainable.

PRICE: Shrouded, 21/-; open, 20/-

Obtainable of all reputable dealers. Write us for List Y37. **IGRANIC ELECTRIC CO., Ltd., 149, Queen Victoria St., London**

Works: BEDFORD. Branches in Glasgow, Manchester, Birmingham, Bradford, Newcastle & Cardiff

RECEIVING 5XX

SIR,—Having read your readers' reports of reception of 5XX, I thought it might interest them to know how 5XX is received in the far North.

Using three valves, H.F.—D.—L.F., I can get 5XX just comfortably on 'phones, whereas 5NO, 6BM and 2LO on the same combination will work a loud-speaker, faintly but clearly.

These are quite normal receptions, and I have repeatedly compared them as quickly as I could change my coils. Congratulating you on your excellent papers, I am—Yours faithfully,

ERIC URQUHART.

Dingwall.

AIDS TO EASY SOLDERING

SIR,—With reference to Mr. Slater's remarks on the recent article, "Aids to Easy Soldering," where he suggests a certain method of tinning the iron which, I think, is an improvement on the method described in the article, my opinion is that the method which is most practical and more likely to appeal to the amateur is that of smearing a liberal quantity of "Fluxite" on a piece of medium glass-paper, sprinkling a few small chips of clean solder over this, and then rubbing the hot iron

briskly to and fro over the prepared glass-paper. It is most important that the abrasive action should be kept up throughout the process, and I have never yet known this method to fail, even in the hands of a raw beginner.

Regarding the shortage of tin in commercial solder, I have not yet experienced any trouble in this direction, and I think this matter can be ignored providing the best grades of solder are used.—Yours faithfully,
OSWALD J. RANKIN.

Pluckley.

TEST REPORTS

SIR,—May I respectfully draw your attention to a matter concerning the "test reports" quoted so frequently in your excellent papers, *Wireless Weekly* and *Modern Wireless*? These all appear to be carried out within approximate crystal reach of some such broadcasting station as 2LO or 5XX. If the official tester tried out a set or two on my aerial here in Cornwall his reports would be of a very different colour. Until 5XX commenced to prove such a godsend, clear reception on one or two low wavelengths was impossible, and even now with 5XX high power, Morse interference and the terrible atmospheric crashes turn what otherwise would

be a useful and delightful entertainment into a painful and sometimes earsplitting experience. Wave traps are useless on our special brand of Morse.

Can you not let us have a few test reports from this end? I can vouch for some very differently worded literature regarding new circuits and other gadgets. The reporter's difficulties experienced here might be the means of evolving something whereby we could obtain satisfaction from an article for which we pay anything from £25 upwards and a 10s. annual tax.

I have a three-valve set of well-known make working on a standard P.M.G. aerial, 75 ft. horizontal, 25 ft. at lead-in end and-unscreened, earth consisting of three 1½-in. diameter iron bars driven 5 ft. into wet ground and well connected electrically.

Wishing your excellent publications continued prosperity,—Yours faithfully,

ATMOSPHERICS.

Redruth, Cornwall.

EDITOR'S NOTE.—It is of course impossible for our staff to take each receiver to half-a-dozen places in the country, but the numerous readers' letters show what can be done with these sets in various parts.



TWO, THREE & FOUR-VALVE RECEIVING SETS



Are Simply Perfect and Perfectly Simple, and are unsurpassed for Selectivity, Clearness of Reception and Power.

REVISED PRICES:

COMPLETE SETS.	PANELS ONLY:
Two-Valve Set .. £17 : 10 : 0	Two-Valve Panel .. £12 : 0 : 0
Three-Valve Set .. £22 : 5 : 0	Three-Valve Panel .. £15 : 17 : 6
Four-Valve Set .. £27 : 5 : 0	Four-Valve Panel .. £20 : 5 : 0

Complete Sets consist of Panel, as illustrated, Valves, Head Phones, High and Low Tension Batteries, Aerial Wire, Insulators, Lead-in-Tube, etc.

The LIST Price of the A.J.S. Sets is the LAST Price, as with them it is not necessary to purchase numerous extras, the Specification embodying everything ready for installation, and the prices include all Royalties.

Write for Illustrated Catalogue.

A. J. STEVENS & Co. (1914) Ltd.,
WIRELESS BRANCH, WOLVERHAMPTON.

Telephone : 1550 (3 lines). Wireless Call Sign : 5 R. I. Telegrams : "Reception, Wolverhampton."



Ask to see the
TrueMusic JUNIOR
Loud Speaker.

Before you decide on the Loud-speaker for your Set, see, and listen to a TrueMusic Junior.

Its clear, pure tone is a revelation.

Reproduction of Broadcasting is so faithful, because the metal in the Horn is not stretched or twisted. It is made in one piece of electrolytically deposited copper.

Drop us a Post Card for our Catalogue.

TrueMusic Junior.
£2 : 17 : 6

The Telephone Manufacturing Co., Ltd.,
Hollingsworth Works, West Dulwich, London.

British Empire Exhibition, Wembley, Palace of Engineering, B.E.A.M.A. Section, Stand 61, Avenue 11, Bays 6 and 7.



Apparatus we have tested

Conducted by A. D. COWPER, M.Sc., Staff Editor.

Coil-Former for Plug Mounting

A former for basket- or spider-coils which is adapted for subsequent mounting on the conventional plug-in fitting has been submitted by H. C. Weston. This is a disc of 4 in. diameter, with 15 wide slots each $1\frac{1}{8}$ in. deep, but with a shaped projecting tag which is of the same size approximately as the usual ebonite plug-and-socket base of plug-in coils, and will facilitate greatly the mounting of the finished coil for use in ordinary plug-in coil-holders. The slots adjacent to this tag are arranged so as to render this

practicable. We anticipate that many home-constructors who make their own coils will find this former a great convenience, as well as stronger than the usual thin cardboard.

Coil-Formers

The Highbury Engineering Works have sent for our inspection samples of their basket-coil (or "spider-coil") formers. These are slotted discs, $4\frac{1}{2}$ in. diameter, of stiff prepared insulating material, with 11 slots neatly cut in them, giving a winding depth of $1\frac{3}{8}$ in. These are evidently of a convenient size and form, and the dielectric

losses should be negligibly small with this specially-prepared material, which is stronger than ordinary thin cardboard.

SPECIAL NOTICE.

Will readers please note that Radio Press Service Department Ltd. and its Staff cannot in any circumstances advise on the choice of components advertised in "Wireless Weekly" and "Modern Wireless." This is a matter in which readers must use their own judgment, as the components advertised are uniformly of good quality. Furthermore, tests cannot be carried out for commercial firms, the department exists solely for the benefit of readers of our Journals who have themselves built sets in question from our designs. Sets built from designs other than our own cannot be tested, nor can we deal with sets made with serious departures from our instructions.

Quality RADIO PHONE & LOUD SPEAKER EXTENSION BOARD.

Fills a much needed want for conveniently using both 'phones and loud speaker at a distance from the set, either in the garden or another room.

Polished teak base with N.P. terminals and switches and a centre pillar for four pairs of 'phones.

The double switch connects either the 'phones or the loud speaker in the circuit, the single switch controls the L.T. battery circuit and does away with that annoying walk to the set to switch off and save current when an unwanted item on the programme is announced. Finished in best possible style in polished nickel plate on polished teak base, with nickel-plated terminals for flex,

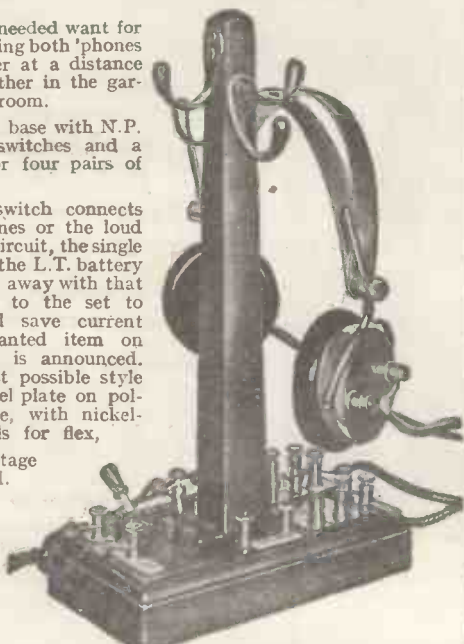

25/- Postage 6d.

Special 4-strand flexible cord, with 2 thick low-resistance strands for the battery, $1\frac{1}{3}$ yard.

GOSWELL ENGINEERING CO., LTD.
12a, PENTONVILLE ROAD, LONDON, N.1.
Liberal Trade Terms. LIST FREE. 'Phone: North 3051.

TRADE Grelco MARK

"THE TONE OF THE INSTRUMENT WAS A MATTER OF FAVOURABLE COMMENT."—Vide "WIRELESS WEEKLY," September 10th, for full detailed OFFICIAL TEST.



It will give you some idea as to the PERFECTION to which we have brought this LOUD-SPEAKER.

Specification—
Laminated Poles, Adjustable Air Gap, Height 22", Flare 14" dia., Base 6"
Price, £2 10 0.
Special Packing and Post, 2/- extra. Can also be supplied with Flare hand-painted in Chinese Art Lacquer, £1 extra.

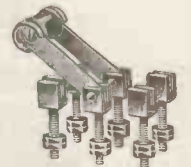

Our well-known PANEL MOUNTING SWITCHES. Also our own product. Supplied in Polished Brass or Nickel Plate.
SP.D.T. .. 1/-
DP.D.T. .. 1/6
Postage, 1½d.



OUR CLIP-IN CONDENSERS ARE OF GUARANTEED CAPACITY and are too well known to warrant further comment.
.001 to .001, 1/4 with clips, or 1/10 mounted.
.001 to .03, 2/- " " 2/6 " " " "
Postage 2d.



PANEL MOUNTING COIL SOCKETS and PLUGS. Complete as illustrated.
Brass, 3d., N.P. 5d. pr.
Postage, 1½d.

For our complete 124 page (1500 Illustrations) Catalogue full of Wireless, Electrical Goods and Tools send 3d. (Post free.)
Telephone: MUSGRAVE 564 Works: GLOUCESTER

ELECTRIC GRAFTON COMPANY

GRAFTON STREET, LONDON, W. TOTTENHAM COURT ROAD,

Information Department



SUPPLIED BY RADIO PRESS SERVICE DEPT., LTD.

J. R. W. (WALTHAMSTOW) has got a receiver employing two high-frequency valves, a rectifying valve and two transformer-coupled low-frequency stages. He finds that the set is inclined to howl, and that it is difficult to distinguish between the high and low-frequency howling, and asks whether it is possible for both to be occurring at the same time.

It seems somewhat unlikely that both high- and low-frequency self oscillation should take place at one and the same time, and the usual tests should be adopted to decide upon the nature of the howling. In the first place, notice whether the pitch of the howl is appreciably altered when the tuning condensers are revolved. If a noticeable alteration takes place, the trouble is in the high-frequency circuits. The usual remedies of applying a positive bias to the grid of the valves, the connection of variable high resistances across

the tuned circuits, the removal of any reaction coils, etc., may be tried. On the other hand, the alteration of the tuning controls may make no difference to the pitch of the whistle, and one then suspects the L.F. circuits, first making sure that the trouble is not due to some form of grid-leak howl, which is often only slightly affected by revolving the tuning condenser. Make sure that the grid leak is of the correct value, and then proceed to vary the filament current on the L.F. valves. This should produce an appreciable difference in the pitch of the howl. When confirmation of this has been obtained, reverse the leads to the IS and OS of one of the transformers, make sure that the H.T. battery has not developed a high internal resistance, try the effect of shunting a condenser of at least 2 mfd. across the H.T. battery, and also, as a last resource, connect a resistance of 100,000 ohms across the secondaries of the two L.F. transformers.



It is said wireless reception is better at night than during the day.

But with a Powquip L.F. Transformer in your set you can rest assured you will receive the best results that are possible day or night.

The Powquip knows no seasons, and will give lifelong satisfaction.

Each Transformer has to pass eight exhaustive tests, which include actual performance on a standard aerial for both speech and music, before it leaves our works. Fit a Powquip to your set to-day and be ready for the long evenings. Every Powquip is guaranteed for twelve months.

Open model 14/6 Shrouded model 18/-

The
POWER EQUIPMENT
COMPANY LIMITED

KINGSBURY WORKS, THE HYDE
HENDON, N.W. 9.

Manufacture of Broadcasting Apparatus

USE OF PATENTS

The pioneer work of the Marconi Company in connection with wireless telegraphy and telephony is well known, and as the result of many years of research work and considerable expenditure, the Company controls numerous patents relating to the manufacture or use of wireless telegraph and telephone apparatus.

The Company is prepared to grant a licence for the use of its patents in connection with the manufacture of Broadcasting apparatus to any member of the British Broadcasting Company, Ltd

A large number of firms (including the principal manufacturers) are already so licensed and pay royalty for the use of these patents, and all apparatus manufactured under licence is so marked.

Any persons or firms manufacturing or offering for sale valve apparatus embodying patents controlled by Marconi's Wireless Telegraph Company, Ltd., without its permission render themselves liable to legal proceedings for infringement

Whilst hoping that it will not be forced to take legal proceedings the Marconi Company wishes to give notice of its intention to protect its own interests and those of its licensees, and in cases of infringement the Company will be reluctantly compelled to take such steps as may be necessary to defend its patent rights.

Marconi's Wireless Telegraph Co., Ltd.

Marconi House, Strand, LONDON, W.C. 2.

Remarkable H.F. & L.F. VALVES

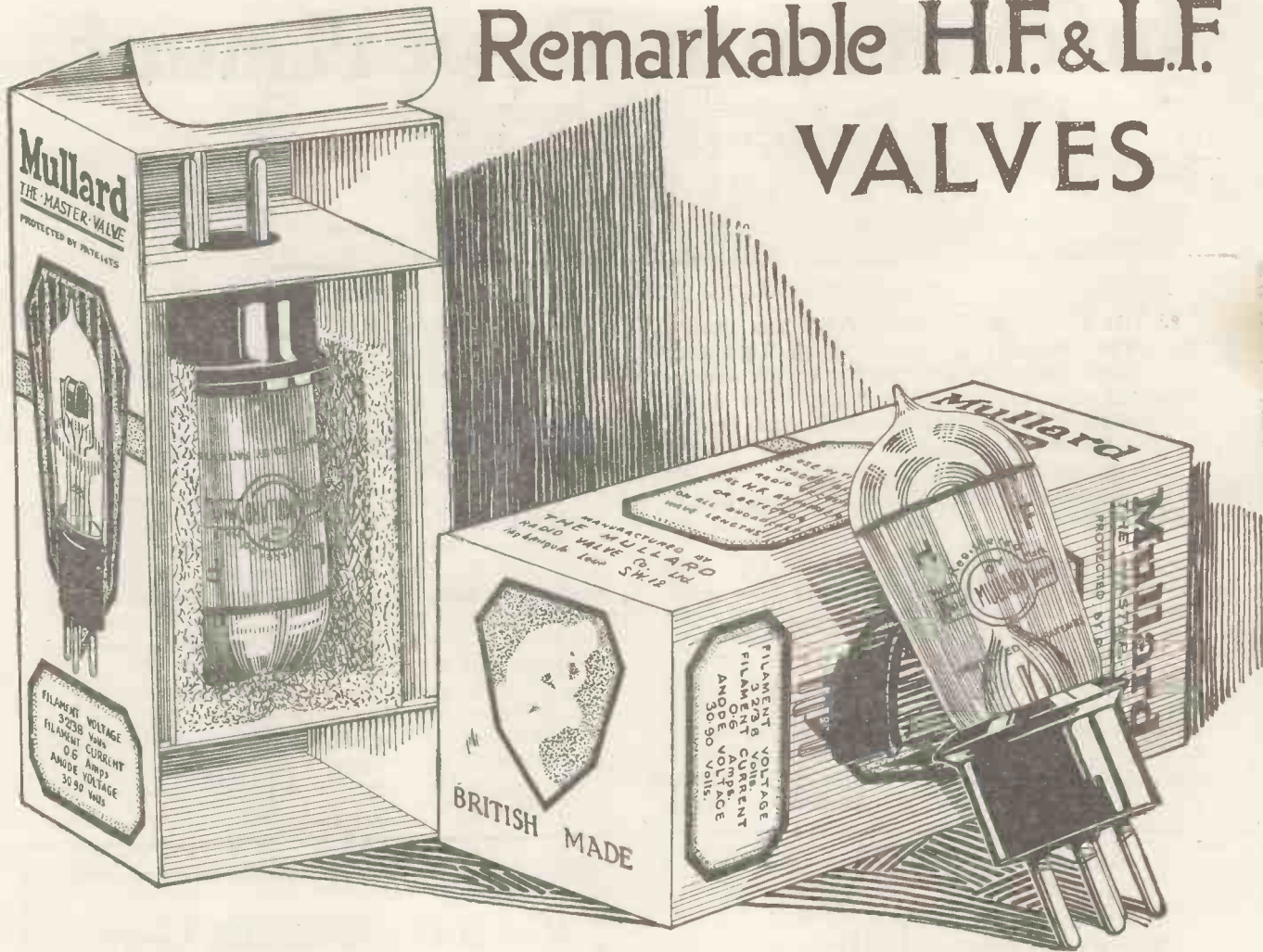

THE very finest reception your wireless set can give you is a pleasure you have yet to experience if you have not already purchased Mullard H.F. and L.F. valves. Every single feature in the construction of these Master Valves shows an advancement in superior design, producing, as a result, the finest bright filament valves ever offered to the radio public. Look for the unique and efficient Mullard Grid, the neat strong anti-capacity cap, and the colour distinguishing rings.

Mullard H.F. Red Ring Valves are designed for strong high frequency amplification and detection, 12/6 each.

Mullard L.F. Green Ring Valves are designed for pure low frequency amplification free from any distortion, 12/6 each.

You will be delighted with the splendid results these valves will give you.

Write for leaflet V.R. 18 for fuller information regarding these wonderful bright filament valves.

Mullard

THE MASTER VALVE

Advt.—The Mullard Radio Valve Co., Ltd. (W.W.), Nightingale Works, Nightingale Lane, Balham, S.W.12.
BRITISH EMPIRE EXHIBITION, PALACE OF ENGINEERING—Avenue 14—Bay 13.

It will pay you always to watch WIRELESS WEEKLY Advertisements.

MARCONI VALVES

MADE AT THE OSRAM LAMP WORKS

*For Resistance-Capacity
Amplification*

DE 5 B

MORE VOLUME—LESS DISTORTION

The DE 5B will give more volume in Resistance Coupled Amplifiers owing to its high Amplification factor of **20**.

Filament Volts	-	-	5-5.5
Filament Current	-	-	0.22 amps.
Impedance	-	-	30,000 ohms
Amplification Factor	-	-	20

Use a DE 5 Power Valve in the last stage with DE 5B Valves in the other stages and the results obtained will make the loud speaker a real pleasure to listen to.

PRICE 35/-

Obtainable from all Leading
Wireless Dealers, Electrical
Contractors, etc.

Manufacturers and Wholesale only—
The GENERAL ELECTRIC
Co., Ltd., Magnet House,
Kingsway, W.C.2.

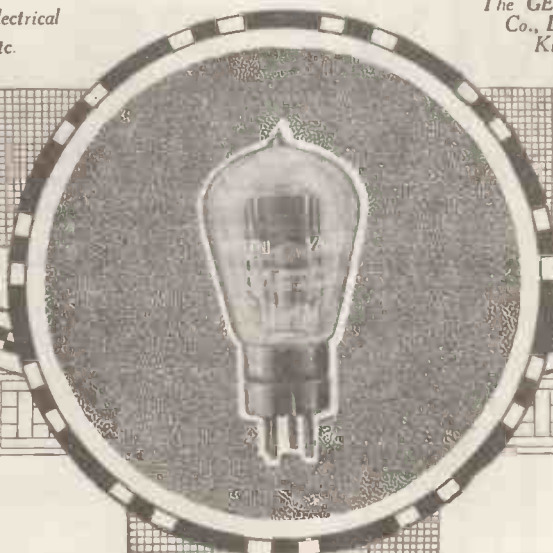

It will pay you always to watch WIRELESS WEEKLY Advertisements.



The lilt of a song or the re-introduction of an old-time melody conjures up long forgotten memories of happy moments in the fugitive past. The enjoyment of listening to the best entertainments the world produces can be yours, and your arm chair is as comfortable as a theatre stall. The Western Electric Loud Speaking Equipment, by reason of its wonderful reproduction and purity of tone, will prove a source of continual pleasure.



Loud Speaker £8
Amplifier - £24

Western Electric Company Limited.

Connaught House, Aldwych, London, W.C.2
Central 7345 (9 lines).

Branches: Birmingham, Leeds, Manchester, Newcastle, Glasgow, Cardiff, Southampton, Liverpool, Dublin.

The design of the MYERS is a proved definite advance over the construction of any ordinary valve. The bunching of electrode leads in the stem common to the four-pin method of design results in valve distortion and generally poor reception. That the MYERS brings the grid and anode leads out at opposite ends explains the striking results which users of MYERS continually experience. The high efficiency of the MYERS recommends its use for radio-frequency amplification.

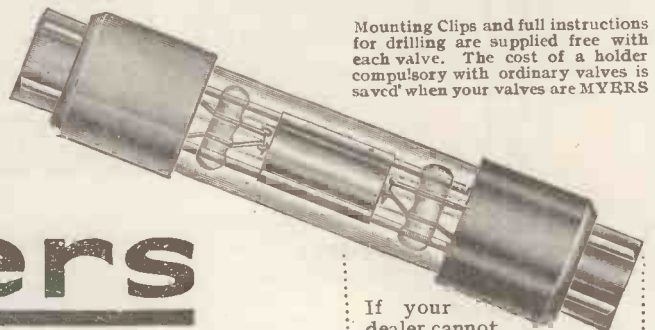

Mounting Clips and full instructions for drilling are supplied free with each valve. The cost of a holder compulsory with ordinary valves is saved when your valves are MYERS

—put the world on your dial

A New Zealand amateur picked up Alabama (10,000 miles) on one MYERS Valve. This is but one amazing performance in which MYERS are pre-eminent. Similar experience may be yours.

Myers Valves

PRACTICALLY UNBREAKABLE

Universal, 12/6 - - 4 volts '6 amp.
Dry Battery, 21/- - - 2½ volts '25 amp.
Plate Voltage, 2 volts—300 volts.

Get MYERS from your dealer. If he is out of stock—be advised—send direct to nearest selling agent and be supplied—post free.

If your dealer cannot supply MYERS, you need not hesitate to have them posted to you. Their rigid construction makes accidental breaking or damage almost impossible. Such rigidity also plays an important part in reception. In fact, MYERS, for this reason, are the only really non-microphonic. Remember, while MYERS are without compeer as amplifiers, they are to an equal measure perfect detectors.

AGENTS

- LONDON—The Dull Emitter Valve Co., 83, Pelham St., South Kensington, S.W.7 (Kensington 5331)
- MANCHESTER—R. Davis & Sons, Victoria Bolt and Nut Works, Bilberry St.
- LIVERPOOL—Apex Electrical Supply Co., 59, Old Hall Street, Liverpool.
- GLASGOW—Milligan's Wireless Co., 60, Sauchiehall Street, Glasgow.
- YORKSHIRE—H. Wadsworth Sellers, Standard Buildings, Leeds.
- SOUTHERN COUNTIES—D.E.D.A., 4, Tennis Road, Hove.

CUNNINGHAM & MORRISON,
Windsor House, VICTORIA ST., LONDON, S.W.1
Telephone: Victoria 827.

LISSENIUM.

Does it matter if a condenser leaks?

IT is usually asserted that condensers should be absolutely leak-proof—yet there is one position in which a fixed condenser may be used where it is immaterial whether it leaks or not. This is when the condenser is fitted in an ordinary one-valve receiver with the grid leak across the condenser. If the condenser itself were leaking when in this position, it would not make the slightest difference, **BUT IF THE SAME CONDENSER WERE USED TO CONNECT THE H.F. AND DETECTOR VALVE IN A TUNED ANODE RECEIVER, THE DEFECT WOULD RESULT IN THE COMPLETE PARALYSING OF THE SECOND GRID.**



CAPACITIES.

·0001 to ·0009	...	2/-
·001 to ·003	...	2½/6
·004 to ·006	...	3/-

Unless, therefore, your receiver is always going to be a one-valve one, it is better to use condensers which never leak. **LISSEN FIXED CONDENSERS ARE MADE WITH SCRUPULOUS CARE—THEY ARE ACCURATE TO 6%—THEY NEVER VARY—NEVER LEAK—THEY DELIVER ALL THEIR STORED UP ENERGY—ALL THE TIME.**

For sharp tuning,
for strong tuning,
————— use
LISSENAGON
Coils.

To equip your
receiver for the
finest detection
possible ——— use
LISSENSTAT
CONTROL ———
(7/6, 3/6, & 10/6)

For correct grid
potential ——— use
the **LISSEN**
VARIABLE GRID
LEAK, 2/6.

Use a **LISSEN PART**
WHEREVER YOU CAN
—Don't Mix Your Parts

Should a transformer miss the low notes?



Use the **LISSEN T1** for
the first stage **ALWAYS**—
for **POWER WORK**
ALSO—and throughout
when **SUPERLATIVE**
AMPLIFICATION IS
DESIRED. Price **30/-**

PARTS THAT PULL
TOGETHER ———
BUILD WITH THEM

Of musical instruments giving out notes of a complex sound construction, such as the violin or piano, the low notes are difficult to reproduce with amplification even with that of the higher notes. The higher notes are amplified much more easily than the lower ones. This accounts for the moderate reproduction which has all too generally and readily been accepted as good.

The **LISSEN T1** Transformer was introduced to go immediately behind the detector valve, because at this stage the impedance of the valve before the transformer is high. And results have justified the use of this expensive transformer at this stage, **FOR HERE IS LOST OR PRESERVED ALL THE BEAUTY OF PERFECT MUSIC.**

*If you contemplate buying an expensive transformer, you can be sure there is none to equal the **LISSEN T1.***

Parts with hidden power—

When you buy **LISSEN** Parts you have parts which you can put together knowing that even first of all your results will be better than if you had used other parts, **BUT THERE IS THIS DIFFERENCE, TOO—YOUR RECEIVER WILL YIELD CONTINUALLY IMPROVING RESULTS AS YOUR OWN SKILL IMPROVES—FOR THERE IS A RESERVE IN EACH ESSENTIAL LISSEN PART WHICH OUTWARD APPEARANCE GIVES NO INDICATION OF.**

LISSEN LIMITED

30-32, Woodger Road, Goldhawk Road, Shepherds Bush, London, W.12
Telephones—3380, 3381, 3382, 1072 Hammersmith. Telegrams—"Lissenium, London."

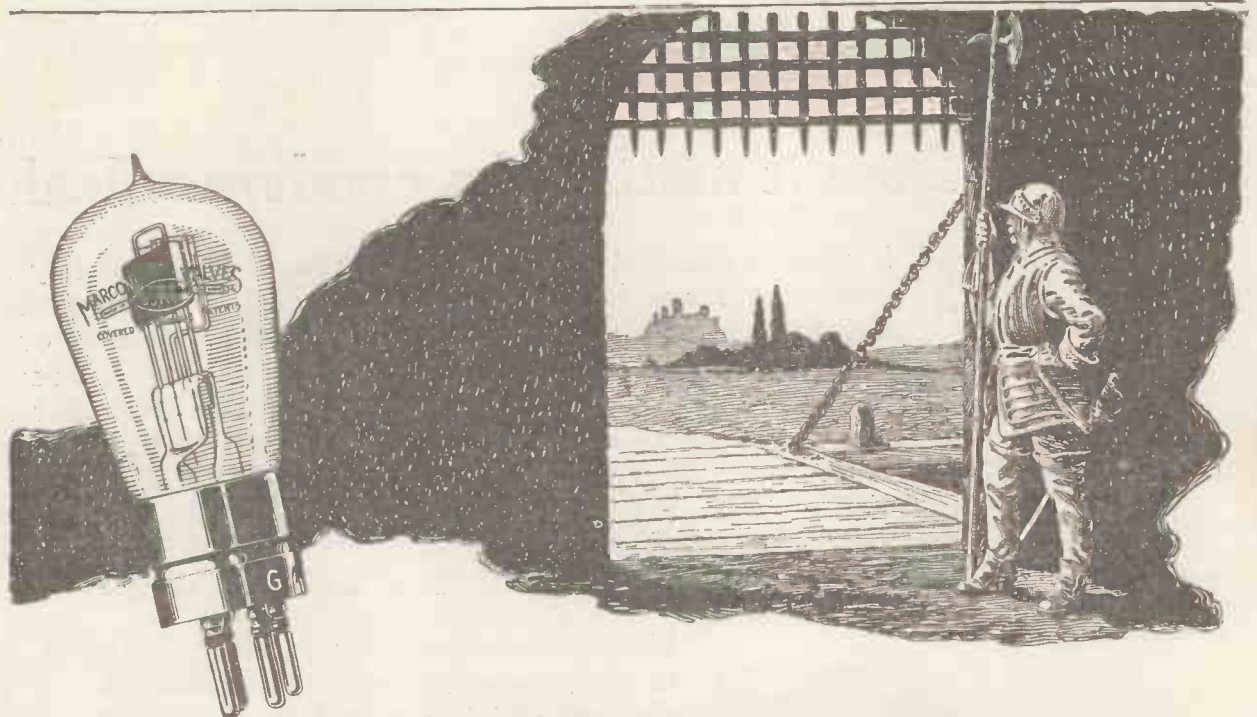

The Sentinel of Wireless

The sentinel of old stood guard at the drawbridge, with the welfare of the garrison in his keeping. Thus also to-day

MARCONI VALVES

MADE AT THE OSRAM LAMP WORKS

vigilantly safeguard the gates of wireless reception. Proudly on guard they stand, with the prestige that springs from a lifetime of unflinching devotion to the task in hand.

*Buy the Valve in the
Purple Box and—
“All’s well!”*

ALL-BRITISH
RADIO
EXHIBITION
(Promoted by the
National Association of
Radio Manufacturers)
ROYAL ALBERT
HALL
Sept. 27th to Oct. 8th.
THE
M.O. VALVE Co. Ltd.
STAND No. 21.

Sold by Wireless and Elec-
trical Dealers, Stores, etc.

Announcement of
the M. O. Valve
Company, Limited.



It will pay you always to watch WIRELESS WEEKLY Advertisements.

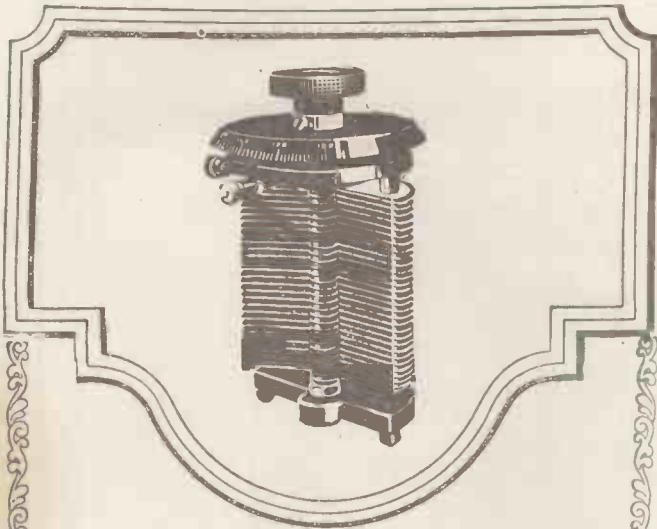

The Vanicon.

It is not until you come to examine a Vanicon closely that you appreciate the differences which can exist between condensers of similar outward appearance. But when you do, you will notice that the Vanicon is rigidly constructed, that the plates are evenly spaced; that there is no end-play in the spindle to give unexpected variations in capacity.

The moving vanes are connected to their terminal, not by means of a rubbing contact, uncertain in action, but positively by a strong phosphor-bronze strip. Sturdy safety stops are provided so that this strip cannot be damaged by overwinding, even when the dial is removed.

It is easy to be wise after the event; why not save yourself costly experience by fitting a Vanicon to your set in the first place?

Made in four standard capacities.

Capacity.	Price.	Extra for Ebonite Box.
.0003 mfd.	17 6	7 6
.0005 "	1 0 0	7 6
.0007 "	1 2 6	10 0
.001 "	1 5 0	12 6

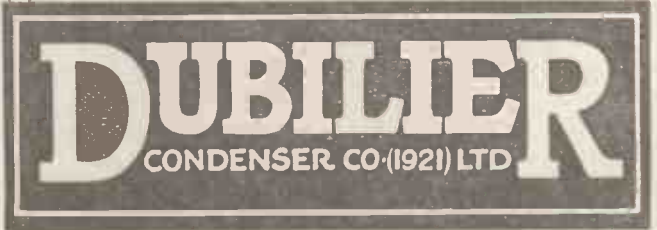

Advt. of the Dubilier Condenser Co. Ltd., Goldhawk Road, London, W.12. E.P.S. 64

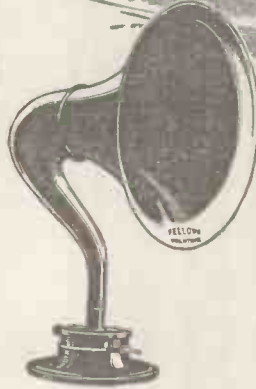

A Stolen Hour.

All the sweeter because it is stolen—and from my work, too. The so-called slack season has proved so successful that I simply don't get a minute to myself; it doesn't look as if I'll even get a holiday. I don't really mind, though; perhaps it's because of my record wireless Summer, but somehow a quiet hour or two in the garden after dinner—with my Volutone—seems to me easily enough recompense for just a holiday.

I'm really glad, however, we did produce the Volutone; the Junior is a fine little instrument, even better now we're fitting it with an adjustable diaphragm, but you do need something a little more powerful in the open air. You want to listen to a Volutone to appreciate how perfectly a modern Loud Speaker can give a large volume of sound without distortion. But more than anything I'm pleased about its price. It really is

Quality Apparatus at Low Cost.

Fellows Volutone. £4 : 10 : 0
Fellows Junior. £1 : 17 : 6



E.P.S.77.

Advt. of the FELLOWS MAGNETO CO., LTD., PARK ROYAL, LONDON, N.W.10.

AMPLION

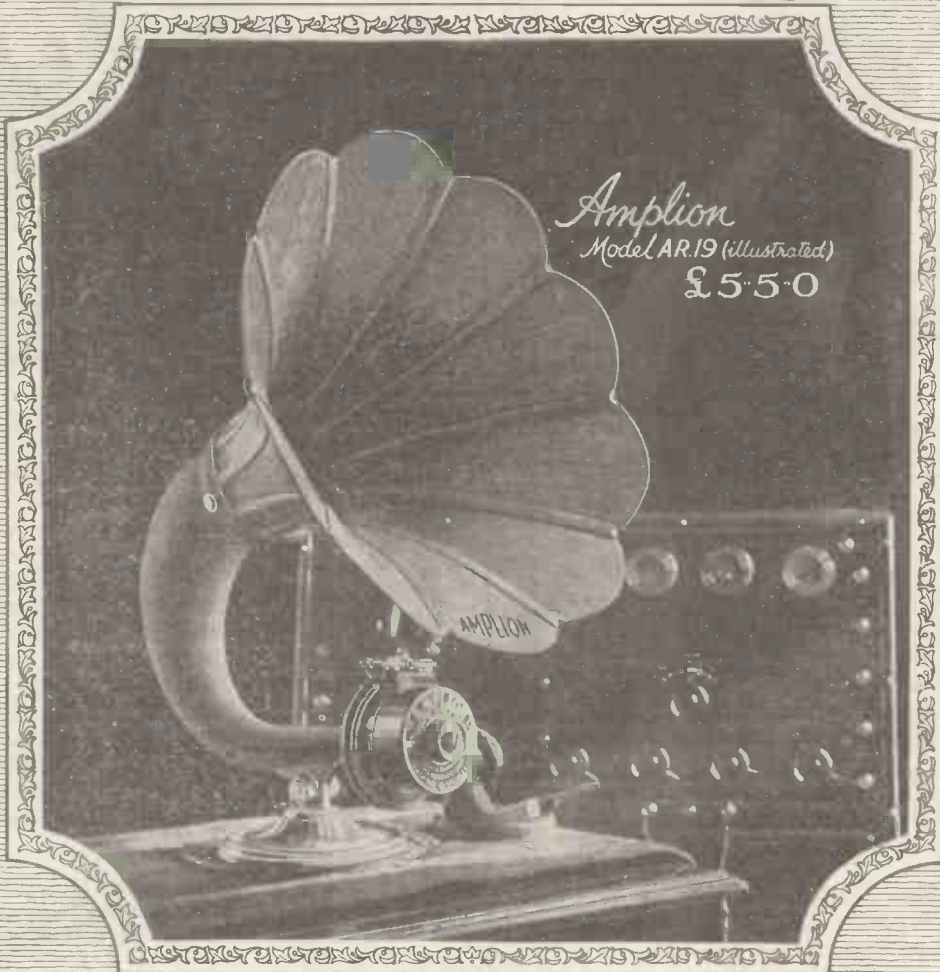

The World's Standard Wireless Loud Speaker

Amplion Loud Speakers are world-famous for sensitivity, full volume, clarity and wonderfully natural tone—qualities due to the incorporation of many exclusive features including a non-resonating sound conduit with wood horn and an improved unit embodying the "floating" diaphragm.

ALL BRITISH RADIO EXHIBITION STAND Nos. 45-46 ROYAL ALBERT HALL
Sept. 27th — Oct. 6th

ALFRED GRAHAM & COMPANY (E. A. GRAHAM)
St. Andrew Works, Crofton Park :: :: LONDON, S.E.4

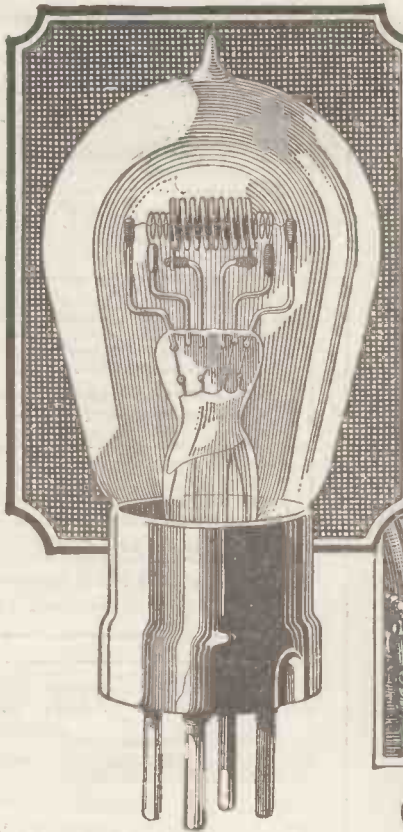

Louden



Columbus and the egg

Missing the obvious is a fault most of us are guilty of at some time or other and valve designers have proved no exception.

One of their chief aims has been to eliminate "mush"—that roaring or hissing sound which so often spoils what otherwise would be perfect reproduction.

It was found that "mush" was due to objectionable charges of electricity congregating near the anode and interfering with the electron stream.

All sorts of experiments were tried. Some increased the volume but at the expense of purity; others were free from distortion but still had "mush," and so on; and we seemed as far off as ever from our ideal valve, giving ample

volume, no distortion and no mush.

Then suddenly came the obvious solution. We simply made a way of escape for these objectionable charges—we made the anode like a spiral and immediately we got silver clear reproduction with plenty of volume.

It has been decided to put the Silver Clear Louden on the market at the extraordinarily low figure of 10/- This represents a certain faith on our part. To justify it the Loudens must sell in enormous quantities.

But we cannot pretend to be taking much risk.

Once you have tried the Silver Clear Louden you will be satisfied with no other.

Louden
VALVES



The Plain Louden for Detecting and Low Frequency Amplifying.

Filament Volts 4.8-5.
Filament Amps. 0.4.
Anode Volts 40-80.

10/-

The Blue Louden for H.F. Amplification.

All Loudens are silver clear and free from mush. The current consumption is low and the life long.

Louden Valves - Silver Clear

ADVT. OF THE FELLOWS MAGNETO CO., LTD., PARK ROYAL, LONDON, N.W. 10.

E.P.S.I.

It will pay you always to watch WIRELESS WEEKLY Advertisements.



No. 1 of a Series of Advertisements describing various processes in the manufacture of Brown Wireless Apparatus.



Grinding the Magnets

FROM the manufacture of the aluminium cases to the final assembly and testing, every process in BROWN Headphone and Loud Speaker manufacture is carried out under one roof and under the same supervision. Obviously during the many years S. G. Brown, Ltd., have devoted to the manufacture of Wireless Apparatus, their varied experience has enabled them to discover many improved methods of manufacture which combine to lift BROWN Headphones and Loud Speakers into a class by themselves. Even the magnets on the F. type Headphone—sold at the exceptionally low price of 25/- per pair—are ground to a limit of less than

1/1000th part of an inch. This ensures that every pair of Headphones functions at its most sensitive point, and that the distance between each pole-piece and the diaphragm is identical. Incidentally this process is a positive guarantee that every pair of F. type Headphones—no matter where or when purchased—attain the same degree of efficiency. Whichever type of BROWN Headphones or Loud Speaker you select it will have been made with the same scientific precision from material of the highest grade—there is only one standard of quality for BROWN Wireless Apparatus.

A-type.
PER PAIR
120 ohms - 53/-
2000 & 4000 ohms 62/-
8000 ohms - 65/-

D-type.
PER PAIR
120 ohms - 43/-
2000 & 4000 ohms 52/-

F-type.
PER PAIR
120 ohms - 22/6
4000 ohms - 25/-

S. G. BROWN, Ltd.
Head Office & Works:
Victoria Road, N. Acton, W.3.

From all Dealers.

Showrooms:
19, Mortimer Street, W.1.
15, Moorfields, Liverpool.



Gilbert Ad. 1404

It will pay you always to watch WIRELESS WEEKLY Advertisements.

THAT NEW SET

Before buying any components, get our quotation for parts and cabinets for any of the receivers described in "Wireless Weekly" or "Modern Wireless."

OUR SPECIAL LINES

"FYNETUNE." Admitted by all to be the best vernier adjuster, 2/6, post free.

"RADIOHM" BUS BAR 1/8th tinned, square copper wiring rod, as used on many "Wireless Weekly" sets, 2/- per dozen, 2 ft. lengths with tags, postage 3d.

"RADIOHM" COPPER STRIP makes a most efficient aerial, 3/- per 100 ft., postage 5d.

FLUSH PANEL MOUNTING COIL SOCKETS and plugs, also valve sockets 8d. per set, post free.

SPARKS RADIO SUPPLIES,
43, Gt. Portland Street, London, W.1.

Telephone: Langham 2463.

IT'S all in THE LEAK



The "BRETWOOD" GRID LEAK is the only one used by serious experimenters, who always want the very best results possible.

PRICE
3/-

Manufactured by
RADIO IMPROVEMENTS LTD.
Trade 95, Gt. Portland St.
Supplied. LONDON, W.1.

WIRELESS WEEKLY

SMALL ADVERTISEMENTS.

STUDENTS, successfully completing our 12 months' course on Wireless, are definitely guaranteed a position within one month of completion. Salary £150 to £500 per annum. (No Postal Tuition.) Prospectus free.—Wireless College, Bournemouth.

HEADPHONE REPAIRS.—Rewound, re-magnetised, readjusted. Lowest prices quoted on receipt of telephones. Delivery three days. Est. 26 years.—Varley Magnet Co., London, S.E.18.

TELEPHONE RECEIVERS and Loud Speakers Rewound, 2,000 ohms, 3/6.—A. Roberts & Co., 42, Bedford Hill, Balham, S.W.12.

FOR SALE, hack numbers "Modern Wireless," from first number to current issue inclusive. Apply, making offer to M. Brown, 9, Dora Road, S.W.19.

BATY Condenser. High Max., Low Min., High insulation, Min. weight, 5/3 post free. Coil to match, 230/4,000 metres, 6/9 post free. Combined space 4" x 1", weight 2 oz. Suitable for all circuits. Technical reprints giving circuits, 1/3 post free. Ernest L. Baty, Luton.

WIRELESS DEPT. (Wholesale) Assistant wanted for orders and sales. Capable and trustworthy. Apply letter only stating salary and experience. Simons, 100, Houndsditch, E.1.

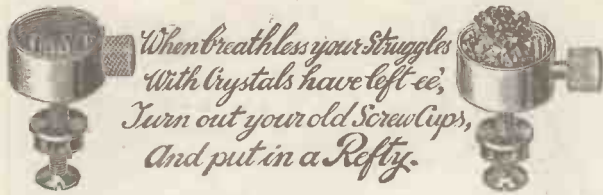

*When breathless your struggles
With crystals have left-ee,
Turn out your old ScrewCups,
And put in a Refty.*

IMPORTANT NOTICE

re

**WATMEL
VARIABLE GRID LEAK**

(Patent No. 206098).

The Watmel Wireless Co. wish to notify the trade and public that their Variable Grid Leak Patent Application No. 206098 was contested in the Comptroller's Court, and on Appeal; in both instances the Patent Grant was upheld and costs awarded.

It is only fair to bring these facts to the notice of persons and firms purchasing or dealing in Variable Grid Leaks, otherwise the successful issue achieved might not be known, and the public and trade might be persuaded that no Patent is involved in the Watmel Variable Grid Leak.

It is the aim of this Company to protect traders', customers' and also its own interests by securing Patent protection for the novelties in its specialities, as it is these novelties, invented by experts and exhaustively tested, which are the Hall Mark of all Watmel Products.

All goods of our manufacture bear our **WatMel** Reg. Trade Mark



Watmel Grid Leaks & Resistances are the best for the following reasons.

- Constantly variable.
- Silent in operation.
- Constant in any temperature.
- Dust and damp proof.
- Each tested and guaranteed.
- Neat and well made.



5 to .5 Megohms **2/6** 50,000 to 100,000 Ohms **3/6**

Other Resistances to suit any circuit.

Send P.C. for Descriptive Folder.

SEE THE TRADE MARK ON EVERY GRID LEAK. **WatMel**

BEWARE OF IMITATIONS.

Coil Former for Winding Inductance Coils 4/6
For full details see "Apparatus Tested," June 1924, "Wireless Weekly."

Insist upon "WATMEL" at your Dealers.

NOTE OUR NEW ADDRESS:

WATMEL WIRELESS CO.

332a, Goswell Road, London, E.C.1.

'Phone: CLERKENWELL 7990.

AT LAST

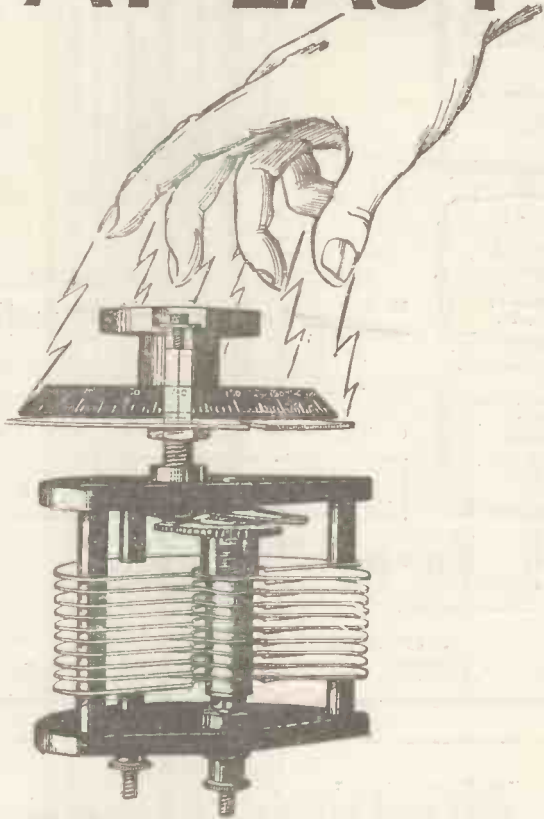

HAND CAPACITY ENTIRELY ABOLISHED.

The absolute elimination of all hand capacity effects is the outstanding feature of the Naylor Fulstop Condenser.

Beautiful clarity of tone and smoother operation is the result. Adjusted by means of a patent gear which allows for extremely fine tuning and removes all necessity for having a separate vernier condenser. An instrument possessing many refinements and conveniences which are over and above the actual requirements of the Condenser and make it absolutely complete and a luxury to use.

PRICES

.001.....	13/6	.0003.....	10/3
.0005.....	11/3	.0002.....	9/6

Stocked by most Wireless Dealers, but if you have any difficulty send direct to

J. H. NAYLOR, Ltd., Central Brass Works, WIGAN



BUY BRITISH
GOODS ONLY
AND
USE ONLY
THOSE MARKED



Visit our Stand
at
WEMBLEY,
Palace of
Engineering
Avenue 13,
Bay 13.

Complete
Catalogue,
profusely
illustrated,
Post Free 1/-



TRANSFORMERS

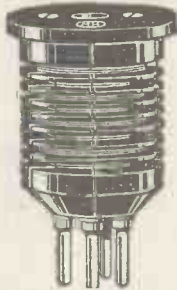

H.F. PLUG-IN TRANSFORMERS.

No. 0	80 to 150	Metres	8/-
1	150 to 300	"	7/-
2	300 to 600	"	7/-
3	550 to 1,200	"	7/-
4	1,100 to 3,000	"	7/-
5	2,500 to 7,000	"	7/-

Complete set of 6, £2.

Can be supplied in matched pairs at NO EXTRA CHARGE

VISIT STAND No. 75,
All-British Exhibition, Sept. 27th to Oct. 8th

L.M. MICHAEL LTD

IN CONJUNCTION WITH **B. HESKETH LTD**

Wireless Engineers,

RADIO CORNER, 179, Strand, London, W.C.2.



"Why didn't someone think of it before?"

How on earth did people manage without bootlaces?

No one will ever know. No hint of the small tragedies that were eternally springing from the absence of the prosaic bootlace can ever penetrate to twentieth century ears.

It's not merely a matter of doing up your boots. Every bootlace in the course of its brief and self-sacrificing existence fulfils a dozen other functions:

A world without CLIX is as unthinkable to-day as a world without bootlaces. CLIX supercedes all forms of switches, plugs and terminals, for it does all their work—and does it better.

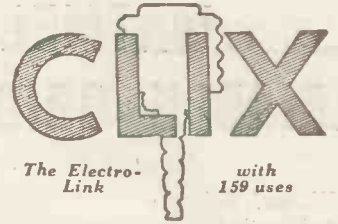

Retail Prices
CLIX
with Lock-nut
3d.

INSULATORS
(Six colours)
1d. each

BUSHES
(Six colours)
1d. pair

CLIX is patented
all over the world.

The introduction of this ingenious combination plugsocket marks the advent of a standardised system of instantaneous wiring.

Obtainable from all good Wireless Dealers or direct from the Patentees and Manufacturers:

AUTOVEYORS LTD

Radio Engineers and Contractors
84 Victoria Street, London, S.W.1

**No Bigger
Much Better**

Amateurs everywhere are installing Bowyer-Lowe Square Law Condensers in sets they have made. They can do this without dismantling and re-arranging their receivers because these new condensers are no larger than the ordinary type.

But the difference they make is astonishing even to those who bought them with full expectations of obtaining improved reception.

They simplify tuning, they increase wavelength range, they yield louder and purer signals, they increase selectivity.

Insist on having them.

**Bowyer-Lowe Tested
Square Law Condensers**

represent the highest standard yet attained in condenser construction. All particulars and prices free for a postcard. - - Write now.

Bowyer-Lowe Co., Ltd., Radio Works, Letchworth

**ALL BRITISH WIRELESS EXHIBITION
STAND 26** ROYAL ALBERT HALL
September 27th to October 8th



Prov.
Pat.
7213/24



**Rigid as a Motor Wheel.
Unshrouded—open to air.**

"Tangent" Tuning Coils

Electrically efficient.
Damping reduced to minimum.
Low distributed capacity.
Will stand unkind treatment.
Standard Plugs—will fit your set.

STOCKED SIZES.			
Coll No.	Min. W/L	Max W/L	Price
25	250	390	4/3
35	330	520	4/3
50	430	840	4/3
75	660	1070	4/6
100	840	1430	5/-
150	1100	2030	6/-
200	1610	2720	7/-
250	2009	3520	7/6
300	2400	4250	8/-
400	3300	6450	9/-
500	4500	8750	10/-



Send for Leaflet—it will please you
GENT & Co., Ltd.,

Est. 1872.
Manufacturing Electrical
Engineers,
**FARADAY WORKS,
LEICESTER.**

We are showing at the
N.A.R.M. Exhibition—
Albert Hall, Sept. 27th-
Oct. 8th. STAND 64.

London: 25, Victoria St., S.W.1.
Newcastle-on-Tyne: Tangent House, Blackett St.

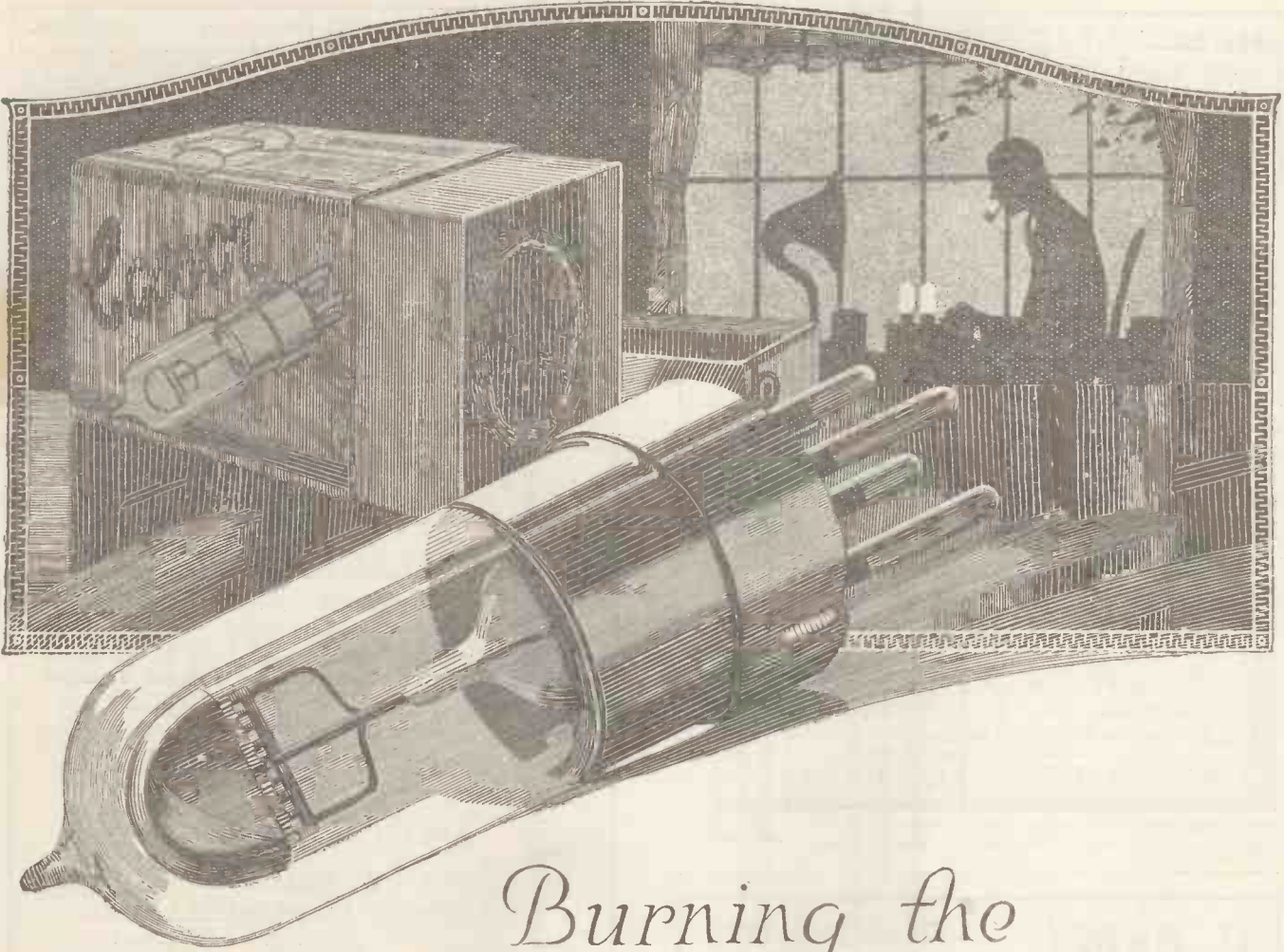

Burning the midnight oil

C Experimenters should note that due to its design and the stringent care lavished upon it during every detail of manufacture, that the Cossor Valve is particularly suitable for reflex and other circuits where a high efficiency Valve is required. Owing to the construction of the Grid—in which each wire is securely anchored in three positions—microphonic and other noises are totally eliminated, and the Cossor Valve enjoys an exceptional reputation for quiet working.

THAT'S just the trouble with Cossor Valves! It is so easy to pick up long-distance stations and the "10-Watters" who shake the ether after the B.B.C. stations have closed down, that one is sorely tempted to sit up late and see how many can be logged.

And the reason for this marked superiority in long-distance reception lies in the unique construction of the Cossor Valve. Its curved filament, inside the hood-shaped Grid and Anode, gives off an immense stream of electrons, and, because it is thoroughly shielded against leakage, practically the whole of the electron stream is used.

But this special design of the Cossor is productive of other advantages. In the ordinary Valve, for

instance, the straight filament is stretched between two supporters, and because metal when heated expands, and when cool contracts, so the filament is constantly undergoing a stretching and shrinking process as current is passed through it. Obviously, this is not good for it, and sooner or later (generally sooner!) it fractures, and the Valve is rendered useless.

The curved filament of the Cossor is not kept under tension, but is held in such a position that it supports its own weight—like the arch of a bridge—and the result is exceptionally long life.

Next time you buy a Valve see that it is a Cossor—no other Valve in the world can be an effective substitute, no matter what price you are prepared to pay.

A. C. Cossor, Ltd.

P.1. For Detector and
Low Frequency use **12/6**

P.2. (With red top)
for H.F. use only **12/6**
From all Dealers.

Highbury Grove, N.5

It will pay you always to watch WIRELESS WEEKLY Advertisements.

HELLO!!!

EVERYBODY
Let me introduce
THE PERFECT COIL
HOLDER.

One hole fixing, large metal to metal bearings, swivel adjustable for wear and absolute micrometer adjustment of coils, can be set to zero instantly. Illustration shows moving holder turned to right with handle. Micrometer adjustment is obtained with knob which advances and retards moving holder in relation to stationary one.

(Trade Inquiries Invited.)

J. TELFORD, Electrical & Radio Engineer,
26, Margery St., **CARLISLE.**



Prov. Patent
14684.
PRICE
10/6
Postage 6d.

Radiax Universal Sets for Home Construction.

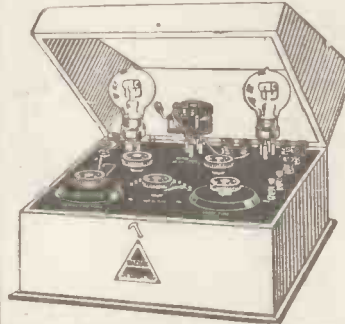

Complete with plan-diagram, instructions, all components ready assembled, panel fully drilled and engraved, and every item required to successfully build with ease. The set you want. The following prices include all Royalties:

- No. 81. 1 Valve Crystal Receiver .. 25 7 6
- No. P.24. 2 Valve Set .. 26 5 0
- No. P.26. 3 Valve Set .. 29 2 6
- No. P.28. 4 Valve Set .. 32 5 0

RADIAX LIMITED
10, RADIO HOUSE, PERCY STREET, TOTTENHAM COURT ROAD, LONDON, W.1.

Museum 490.



The above is only a small selection; send for Complete Free List of the full range of Radiax Crystal, Valve and Unit Receivers, or 3d. stamps to include Accessories Catalogue.

3 minutes from Tottenham Ct. Rd. or Goodge St. Tube Stat'n.

An Invitation.



You are cordially invited to attend an Exhibition of Radio equipment, including Television apparatus in its present state of advancement, to be held by the General Radio Company, Ltd. at 235, Regent Street, W.1, from Wednesday September 24th, to Wednesday, October 8th. (10 a.m. to 10 p.m. daily.)

You will be made most welcome.

GENERAL RADIO COMPANY



Radio House, 235, Regent St., London, W.1.
Telephone: Mayfair 7152. Telegrams: "Algenrad, London."

P. CAPEL, 3/4, Queen St. Arcade, CARDIFF.

All Wireless Accessories stocked. Immediate deliveries

	Retail Price.
Two-way Coil Holders	2/9, 4/6, 5/6
10 Tapped Coil 200/3,000 Metres	4/6
Vernier Pencils	2/-
"Grip" Detectors set of parts, boxed	1/-
Detectors, Universal movement on base	2/-, 2/3
"IDEAL" Slider Crystal Set	15/-
Interchangeable Filament Resistance for 5 and 30 ohms.	4/6
Miniature Switches, unmounted DPDT	1/6
Do. do. do. SPDT	1/-

A FEW SPECIALITIES:

Dull Emitter Valves, '06	20/-
French R5 Valves	10/6
Metal	8/6
Four Electrode Valves, five pin type, nickel base	17/6
"Monopole" Transformer, two transformers in one, latest invention unequalled for purity, volume, and no interaction effect	24/-

CRYSTALS:

My Crystals are noted for their marvellous sensitivity.
Write for sample "Vocalite" in glass tubes .. 1/-

Send your enquiries for anything "Wireless."
Liberal Trade Discount. Illustrated Wholesale List on receipt of Trade Card.

Telephone: 3298, Cardiff. Telegrams: "Waves," Cardiff.

"Perfect Reception"

GUARANTEED

WITH OUR

REPAIRED VALVES

Whenever your valves burn out or filaments are damaged in any way

Send them to us

We repair them equal to new.

DON'T DELAY

**The actual valve you send us is repaired
and returned to you within 7 days.**

PRICE	POSTAGE	PRICE
6/6	3d.	6/6

(Bright Emitter Valves).

WE ARE ALWAYS AT YOUR SERVICE.

Price list for D.E. and Power Valves
on Application.

**The North London Valve Repairing Co.,
22½, Cazenove Road, Stoke Newington, N.16.**

YOURS FOR 20/-

Send 20/- to-day, together with your order for the "Tonyphone," and this wonderful set, which receives all B.B.C. stations, will be delivered complete, including all accessories. You pay a further £1 each month afterwards. The total cost is only £15 9s., or if you prefer, £14 5s. cash.

"Tonyphone" Super Two-Valves Complete with Accumulator, H.T. Battery, Aerial, 1 pair 4,000 ohms Headphones, and two Valves—one High Frequency and one Detector. All Royalties paid. Send to-day and enjoy broadcasting NOW.



BRITISH ENGINEERING PRODUCTS CO.,
(Wireless Dept.), WINDSOR HOUSE, VICTORIA ST., LONDON, S.W.1

B.S.A.

EL-BE UTILITIES
 The "MIKROTUNE" MAKES TUNING SIMPLE & CERTAIN

Reversible Coil-holder.
 Adds 50% value to any set.
12/6



Coils under minutest control. A Perfect VARIOMETER
 Send us the name of your Dealer and we will arrange a demonstration for you.

LEIGH BROS., 37, St. James St., Gray's Inn Rd., LONDON, W.C.1
 Telephone: MUSEUM 4192.

REPAIRS
 TO HEADPHONES
 TO LOUD SPEAKERS
 TO COILS

Est. 26 years
 Rewound to any Resistance and made equal to new. Price quoted on receipt of instruments.

Prompt Delivery.
The VARLEY MAGNET Company
 WOOLWICH, S.E.18.
 Phone: Woolwich 888.

Cabinets for Constructors.



PICKETT'S Cabinets—they're good value, from 1/6 each, highly polished.

Cabinet Works, Albion Road, Bexley Heath, S.E.
 Write for Lists W.L.

SPENCER'S STORES
 4-5, Mason's Avenue,
 Basinghall Street, London, E.C.2.
 Telephone: LONDON WALL 2292.

KENITE
 Highest Dielectric Strength,
 6" x 6" 1/-, post free. Any size pro rata.

VALVES REPAIRED
 WITH NEW BULBS AND FILAMENT. **6/6** POST FREE.

The Master One-Valve Set
 Receives all B.B.C. and CONTINENTAL STATIONS
 Operates Loud Speaker under favourable conditions. Simple to operate.

37/6 plus Royalties. Marvellous Range and Power,
 Genuinely worth £4.

World's Wireless Stores
 WALLINGTON.

RADIO PRESS INFORMATION DEPT
2/6 QUERY COUPON

WIRELESS WEEKLY.
 Vol. 4, No. 20. Sept. 17, 1924.
 (This coupon must be accompanied by a postal order of 2/6 for each question, and a stamped addressed envelope.)

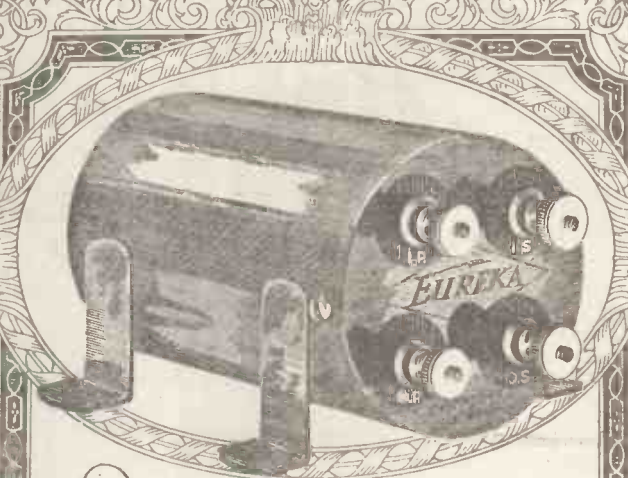

The economy of good Quality

AT last—probably as the result of much editorial space being devoted to the subject—the L.F. Transformer is being selected on quality and performance. Not as so much iron and copper wire, but as a definite part of a Receiving Set which can make or mar a reputation for clear and truthful reception.

The design of the Eureka is such that its production costs must necessarily be higher. For instance, its coils contain more than 2½ miles of fine drawn copper wire of the highest grade. Its steel casing—the principal factor in eliminating interaction—is covered with a deposit of copper. Its expensive core—the process of hermetically sealing the contents against atmospherical influences—the ruggedness of its construction, all these processes could be simplified and reduced in cost, but only at the cost of efficiency. This we cannot do. Every Eureka owner knows that he owns the finest possible L.F. Transformer money can buy and appreciates that the exceptional results he obtains have more than justified the extra expense.

Concert Grand, 30/- Eureka No. 2, 22/6
 (For 2nd stage.)

Sold by all Dealers and Manufactured only by—
PORTABLE UTILITIES CO., LTD.,
 7 & 8, FISHER STREET, LONDON, W.C.1
 Scottish Agents: FULLER, BLACKIE & RUSSELL, LTD.,
 30, Gordon Street, Glasgow.

EUREKA
 —the Quality Transformer

"Pilot" Panel Service—

An entirely new development for the benefit of the Home Constructor by Peto-Scott Co., Ltd.

WHEN a man decides to build a good Receiving Set he immediately comes up against the difficulty of a suitable cabinet and the drilling and engraving of the Panel. Cabinet making is a skilled man's job and many a perfectly good piece of ebonite has been spoilt by a hole in the wrong position or because it has been incorrectly cut to size.

To eliminate most of the difficulties in Set-building we have instituted the "Pilot" Panel Service. In future all Sets described in *Modern Wireless* or *Wireless Weekly* will be available in sets of parts for the Home Constructor with panels ready drilled, tapped and engraved. Two types will be placed on the market—Type A following the author's literal specification and using his actual components and Type B, an adaptation using Peto-Scott guaranteed components. Naturally, through standardisation of components and our lower manufacturing costs due to large output, Type B will often show a large saving over Type A.

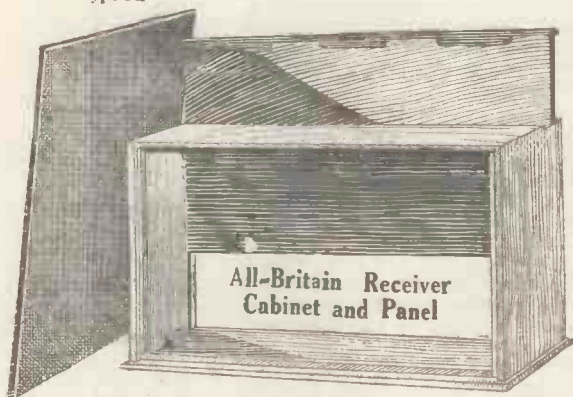

Other Receivers available under the "Pilot" Panel Service

In addition to the two Sets described in this Advertisement, we also supply the following Modern Wireless Receivers in Type A and Type B for home construction. Finished instruments in either type are also available.

- The Puriflex Receiver.
- The All Concert-de-Luxe Receiver.
- The 3-Valve Dual Receiver.
- The Transatlantic V (and others).

Remember that if our instructions are followed we positively guarantee that all Type B Receivers are the equal in every respect to the more expensive Type A Sets. Our Service Dept. is available for all our customers and will test and rectify errors of construction at a nominal charge. We want all our customers to have the utmost confidence in every Set produced under the "Pilot" Panel Service.

PETO-SCOTT Co., Ltd.

Registered Office & Mail Orders: 77, CITY ROAD, E.C.

Branches: LONDON—62, High Holborn, W.C.1. PLYMOUTH—4, Bank of England Place. LIVERPOOL—4, Manchester Street. CARDIFF—94, Queen Street. WALTHAMSTOW—230, Wood Street.

It will pay you always to watch WIRELESS WEEKLY Advertisements.

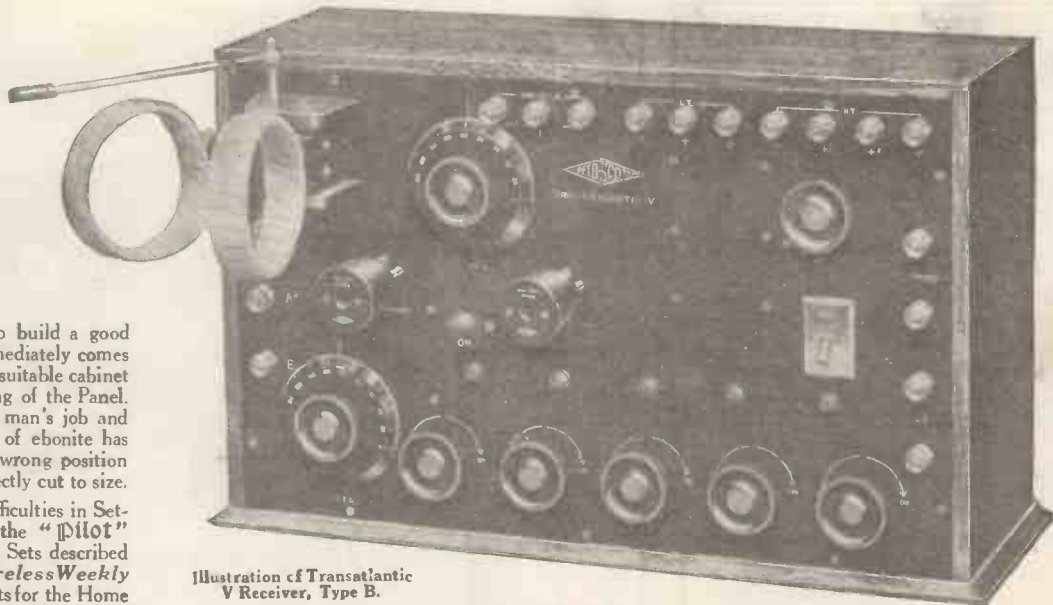

Illustration of Transatlantic V Receiver, Type B.

The All-Britain Receiver

(*"Modern Wireless," Sept. issue.*)

The new All-Britain Receiver in the September issue of "Modern Wireless" is proving one of the most popular Sets of the season. A 3-valve Set, it has much to recommend it on account of its simplicity and ease of operation. By including it in our "Pilot" Panel Service experimenters are able to build it up at a big reduction in cost. It should be noted that the author's design of the All-Britain Receiver is so similar to our own standard Type B Receivers that the Cabinets for both types are identical. The fundamental difference is that in Type A the Valves project outside the panel in a horizontal position, while in Type B they are totally enclosed at rear of panel entirely out of harm's way. Therefore, in the list of prices it will be seen that Pilot Cabinet B is fitted with an additional baseboard to screw on to the ebonite panel to carry all the components.

PRICES:

Type A.—Ebonite Panel, guaranteed Post Office quality, of highest grade, 10 in. by 16½ in., drilled, tapped and fully engraved 16/-
 Polished Oak Cabinet, with sliding back, to take above panel 15/6
 Complete kit of components, exactly as author's specification, but with Max-Amp Transformer and Peto-Scott all-ebonite improved Coil Holder £4 12 0

Type B.—Ebonite Panel, guaranteed Post Office Ebonite of highest grade, drilled and tapped to take Peto-Scott guaranteed components, size 10 in. by 16½ in., matt finished by hand 10/-
 Engraving extra 3/-
 Polished Oak Cabinet, with sliding back, but fitted in addition with panel baseboard 17/-
 Complete kit of guaranteed Peto-Scott Components. In this kit we include Polar Condensers and Lissenstats, but otherwise everything else is of our own manufacture and fully guaranteed in every respect £4 2 6

The Family 4-Valve Set

(*Radio Press Envelope No. 2.*)

Exactly as Author's specification, except that an ebonite panel is used instead of one made of wood. This permits components being mounted flush on the panel and greatly improves the appearance of the whole Set. Valve-Holders are of the same anti-capacity type, but of our own manufacture. Two Max-Amp Transformers are supplied instead of one Max-Amp and one Igranic, and an Igranic Potentiometer is substituted for the T.C.B.

Complete kit of Components, only as above amended specification, £6 1 0
 Ebonite Panel, 24 in. by 8 in. by 4 in., drilled, matt finished, and fully engraved £1 2 6
 Panel only (undrilled and not engraved) 12 6
 Polished Oak Cabinet, 24 in. by 8 in. by 4 in. £1 5 0

Gilbert Ad. 1413

No. 5 of a Series of
Advertisements on behalf
of Radio Press, Ltd.

C O U R A G E

GALILEO for his statements that the earth is round was cast into a dungeon until he should recant. Although offered his freedom he steadfastly stood by his beliefs and suffered intense agonies—eventually losing the sight of both eyes.

To-day we are often faced with decisions that may make or mar our reputations for straight dealings and honest convictions. We of the Radio Press often feel it necessary for the betterment of the Industry to criticise fearlessly. At one time, perhaps, a Trade organisation which may be adopting unfair tactics—at another time, a Manufacturer making extravagant claims for an inferior article. Any of these honest criticisms may be the direct loss of advertising revenue.

But readers of Modern Wireless and Wireless Weekly know that the power exercised by Radio Press, Ltd., is an important factor in maintaining a high standard of journalism and in preserving the interests of the broadcast listener and experimenter.



Gilbert Ad. 1391.

STERLING PRIMAX LOUD SPEAKER

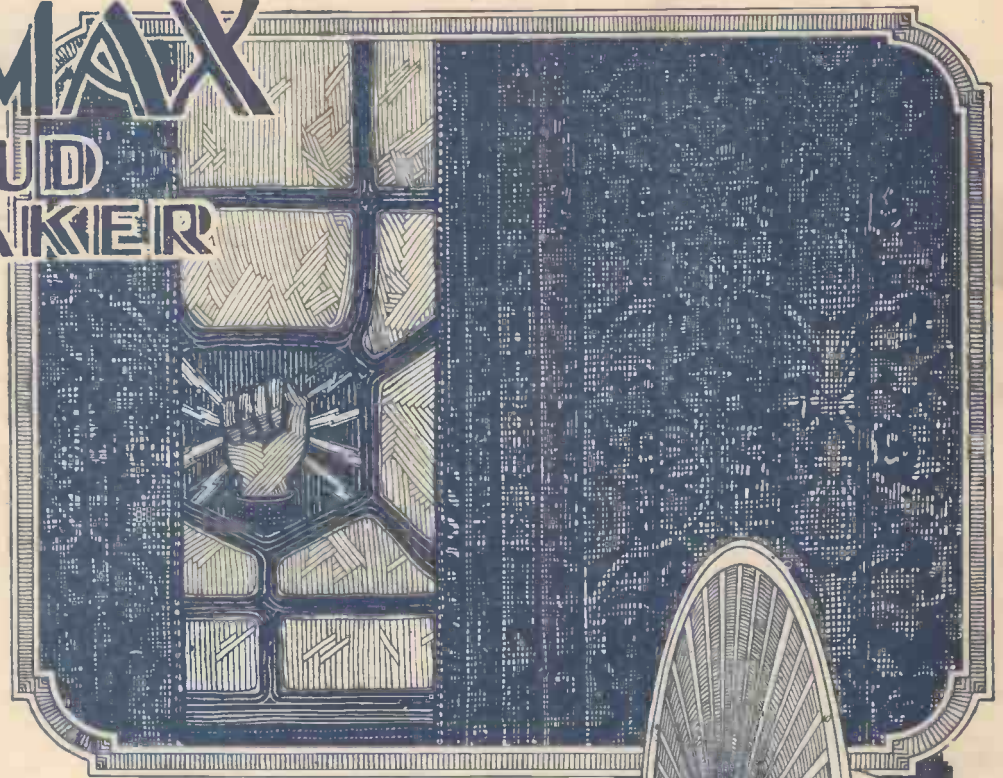

Widespread Interest in this—the greatest of Loud Speakers

The advent of the Sterling "Primax" Loud Speaker has created intense interest all over the country. Its performance, charm and novelty are everywhere commented on. New in conception, new in design, the "Primax" provides better reproductive quality and sound distribution than has ever been attained before.

The Sterling "Primax" Loud Speaker consists of a very attractively shaped aluminium standard, attached to which is a neat cylindrical case containing electro-magnetic mechanism. This in turn is connected with a white pleated circular diaphragm, specially prepared and surrounded with an aluminium rim. The "Primax" is connected in the usual way with the receiving set and a knurled knob provides absolute control of volume.

Ask your dealer for explanatory leaflet

Advt. of **STERLING TELEPHONE & ELECTRIC Co., Ltd.**, Manufacturers of Telephones and Radio Apparatus, etc.
210-212 TOTTENHAM COURT ROAD, LONDON, W.1

Visit the Sterling Exhibit, Palace of Engineering, Avenue 15, British Empire Exhibition.

(Lumiere's
Patent)

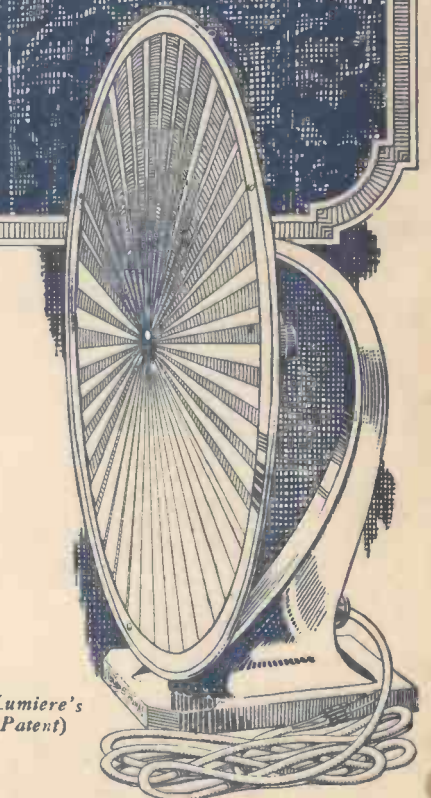

The Sterling "Primax" Loud Speaker
(Patent Nos. 11015/09, 205418, 205578, and
208665), 2,000 ohms resistance, complete with
12 feet of flexible cord.
PRICE **£7:7:0**



Wireless Weekly

Radio Press, Ltd.

BUSH HOUSE, STRAND, W.C.2.

Tel.—Central 3763.

EDITED BY JOHN SCOTT-TAGGART, F.Inst.P.,
A.M.I.E.E.

Assistant Editor:
PERCY W. HARRIS.

Scientific Adviser:
Prof. G. W. O. HOWE,
D.Sc., M.I.E.E.

Advisory Editors:
Prof. R. WHIDDINGTON,
M.A., D.Sc.
Prof. C. L. FORTESCUE,
M.A., M.I.E.E.

Staff Editors:

E. H. CHAPMAN,
M.A., D.Sc.
A. D. COWPER,
M.Sc.
R. W. HALLOWS,
M.A.
G. P. KENDALL,
B.Sc.
S. G. RATTEE,
Member I.R.E.

Vol. 4, No. 21

SEPTEMBER 24, 1924.

Price 6d. net.

A Call to Amateur Transmitters

In February last, after considerable discussion, the Radio Transmitters' Society, which had been formed by a dissentient group in the Radio Society of Great Britain, decided to amalgamate with the Transmitters and Relay Section of the Radio Society of Great Britain. In this way it was hoped that the benefit attaching to unity would be adequately obtainable. There is no question that at the time of the formation of the Radio Transmitters' Society the dissatisfaction with the R.S.G.B. was justified, and had not there been a reconstitution of this latter Society, it is doubtful whether many of the transmitters would have agreed to the fusion of the two organisations.

The time has now arrived when amateur transmitters should consider whether they are adequately represented, and we are afraid that the truly British position of *laissez faire* has prevented them from realising the true position. Those who study the list of amateur transmitting stations in the current issue of *Modern Wireless* will immediately realise that the T. and R. Section of the Radio Society of Great Britain is representative of only a small minority of licence holders, many of whom, we gather, have not joined the section because, seemingly, they do not get a satisfactory answer to the question "What have you to give us if we join?"

Before answering this question let us consider the benefits of a thoroughly representative society of transmitters. Obviously in the production and presentation of papers to members, the best material can only be drawn upon when everyone who counts is a member. Again, a large majority of members are themselves carrying out experiments with a view to solving problems which have already been solved, so that much needless experimenting is done which could be prevented by the circulation among members of results obtained. Here again it is

necessary for all amateurs to combine and work together. The actual control of the Society, being in the hands of an elected committee, will depend for its efficiency upon this committee, which, in turn, can only be elected from existing members. In passing, it should be noted that we are not criticising the present committee, but merely pointing out that those members who may criticise it should bear these facts in mind.

touch with distant transmitters and to know whether or not they are willing to conduct tests? Only by being a member of a representative society of transmitters all of whom are willing to assist one another. There is an immense amount of valuable work to be done by even the simplest of transmitting stations if only there is adequate co-ordination of effort. In the United States the co-operation of the Bureau of Standards with the amateur transmitters has been largely due to the fact that these latter have a live and strong society. Furthermore, the authorities cannot be expected to give full consideration to the claims of a transmitters' society unless it is truly representative of the whole transmitting community.

We would therefore suggest that amateur transmitters do not ask "What can you give us?" but consider "Why should I not join the T. and R. Section of the Radio Society of Great Britain?" The society as it exists, with its committee elected from members, is obviously representative of things as they are, and can only be improved if there is a considerable increase in the membership, which, from every point of view, is fully desirable. It is not a question whether the present Society is ideal or whether there are many obvious advantages of joining at present. Every transmitter should make a point of joining, and the advantages will grow simultaneously with the membership.

Incidentally, we refer our many transmitter readers to the letter from the G.P.O., published in this issue. We are very seriously concerned at the implied suggestion that Mr. Philip Coursey and Mr. Gerald Marcuse sent as representatives of the R.S.G.B. and the Transmitters' Section, acquiesced in the new attitude of G.P.O. towards transmitters, which attitude is merely another example of the G.P.O.'s attempts to tighten up the reins generally. We shall have more to say on this serious matter,

CONTENTS

	Page
Non-Radiating Regenerative Receivers	668
Jottings By The Way	670
Valve Notes	672
Anti-Capacity Valve Adapters ..	674
A Handy Screwdriver	676
When Your Set Goes Wrong ..	677
A Compact Single Valve Panel	678
A Clix Adapter	681
A Neat Low-Tension Plug	682
How Every Crystal User May Become a Valve Expert	684
Regular Programmes from Continental Broadcasting Stations	687
Hours of Leading Continental Transmissions	690
Test Report Upon "A Long Range Two-Valve Receiver"	692
Random Technicalities	693
Some Useful Gadgets	695
Correspondence	697
Apparatus We Have Tested ..	702
Information Department	703

As soon as an experimenter gains a transmitting licence he begins work full of enthusiasm, and for a month or two has quite enough to occupy him in working out new ideas and circuits. After a time, however, he feels a desire to know what other workers are doing, and as far as possible fixes up schedules to work with distant stations and to conduct proper tests with them.

Now how is he best able to get into

Non-Radiating Regenerative Receivers

By CLYDE J. FITCH.

This article is presented more as food for thought than as a practical remedy for the radiation difficulty.

IT has often been quoted that any form of coupling which allows signals to pass from the aerial to the radio receiver will also allow radio-frequency currents generated by the receiver to pass out into the aerial system. Therefore several forms of blocking valve arrangements have been devised, the purpose of these valves being to localise the oscillations generated by the receiver and prevent them from entering the aerial. As such systems require an extra valve for blocking purposes, the owners of single-valve receivers, who no doubt cause most of the disturbance, do not care to double the expense of their set without increasing its receiving range. In order that the public will not be misled by these iron-bound rules, three non-radiating single-valve regenerative receiver circuits devised by the author will be described here-with.

Aerial Resistance

Before describing these circuits it may be well to state that the process of reacting into the aerial circuit has the effect of decreasing aerial resistance. Thus, if an aerial has a radio-frequency resistance of 30 ohms the current induced in it by a wireless wave will be infinitely small. By reacting on to this aerial the resistance is apparently wiped out, resulting in a vast increase in signal strength. In fact the apparent resistance may be reduced to zero, in which case the oscillations set up in the aerial by the passing wave continue flowing, and an oscillating current is generated by the receiver. This is where the trouble begins.

Waves are radiated from the aerial and cause interference in the neighbourhood. If we do not react on the aerial, which will be the case when using the following circuits, or when using any of the present blocking valve methods, the aerial resistance

remains high and the signals are considerably weakened. Therefore, those who contemplate building a non-radiating regenerative receiver are warned in ad-

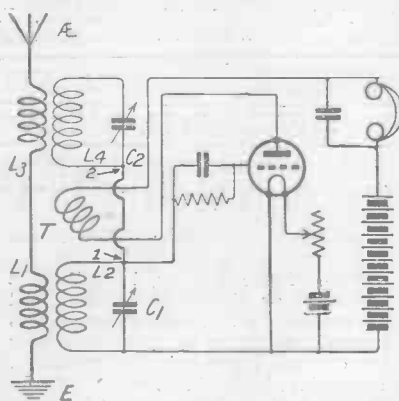

Fig. 1.—A reaction receiver using two tuned circuits, one of which opposes the other.

vance that the results which will be obtained from it will be very poor compared with the results possible if the non-radiating feature were eliminated. In giving these circuits, therefore, it is with the idea that they will be

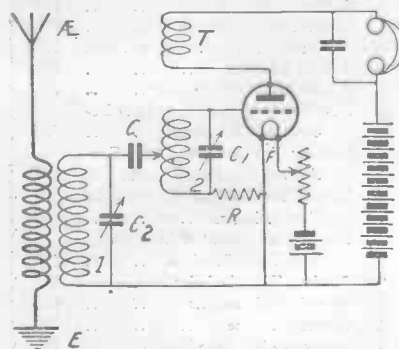

Fig. 2.—In this circuit radiation is prevented by connecting to the nodal point of circuit 2.

used as demonstrations to point out the fact that all present non-radiating schemes are inefficient from a practical standpoint, and to emphasise the following fact: A radiation eliminator, to be practical, efficient and a commercial success, must not prevent the use of reaction on the aerial. Instead,

it should allow of reaction being obtained in the aerial system up to a point where oscillation is just about to start, and then should automatically stop. There is no such circuit or device in existence to-day, to the best of the writer's knowledge. Experimenters should concentrate their efforts on such a system, and not try to devise one entirely eliminating reaction into the aerial circuit. If we do not react into this circuit but into some local tuned circuit that already has a low radio-frequency resistance, as is the case with the following circuits and those employing blocking valves, the signal strength will be increased only slightly. A simple single-valve circuit that will allow reaction up to the aerial up to a point just before oscillation begins, but no further, is the only practical solution of the problem. Otherwise it will require one or two stages of radio-frequency amplification to make up for the loss.

Circuit No. 1

This circuit is the first devised by the writer and is a very effective non-radiating regenerative one. Except for the addition of coils L3 and L4 and condenser C2, it is the standard double circuit arrangement. The signal current is transferred from L1 to L2, where it is impressed on the grid of the valve, appears in the plate circuit, and is fed back by means of the reaction coil T. Coil L4 is exactly symmetrical to coil L2 and is wound on the same tube and equidistant from the coil T. The action is as follows: When the circuit is oscillating, current is fed from T into both tuned circuits 1 and 2. From circuit 1 current passes into the aerial circuit via L1. From circuit 2 current also passes into the aerial circuit via L3. But L1 and L3 are wound so as to oppose each other and consequently the currents neutralise and nothing flows into the aerial circuit. Cir-

circuit 2 does not prevent the signal current from passing to the valve via circuit 1, but does prevent current generated by the valve from passing into the aerial. In this circuit the two condensers C1 and C2 must be adjusted simultaneously and must be mounted on the same shaft so as to be controlled by one knob. Otherwise radiation is not necessarily eliminated.

A Simple Test

When the circuits are correctly balanced, a simple test is to tune in the carrier wave of a station and then touch the aerial connection with the finger. If the pitch of the carrier wave does not

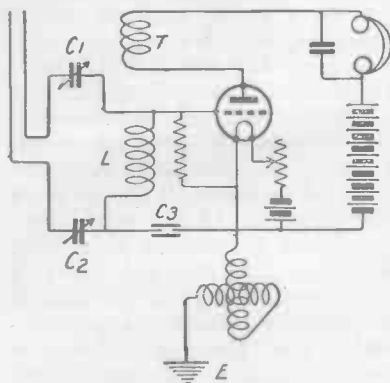

Fig. 3.—A circuit which uses a double aerial. C3 is a neutralising condenser.

change, the aerial is not radiating. In an actual set built, the radiation was not entirely eliminated, but considerably reduced. The amount of radiation depends upon the mechanical accuracy of the parts.

Circuit No. 2

This circuit will probably be recognised as the detector-oscillator or frequency changer of a Super-Heterodyne set, but makes a good non-radiating single-valve receiver.

The action is as follows: The signal current induced into tuned circuit 1 passes through grid condenser C to the nodal point of circuit 2. The current divides here, charging both sides of condenser C1 to the same polarity and hence induces no current in circuit 2. As the signal current is impressed on the grid, it is repeated in the plate circuit and fed back by means of reaction coil T to circuit 2 and amplified by reaction. Should oscillations be generated in circuit 2, none flows in circuit 1

and the aerial circuit, as the potential difference between the nodal point of circuit 2 and the filament F always remains constant. Resistance R should equal the grid to filament resistance of the valve. It is necessary that circuit 1 and circuit 2 be in non-inductive relation with each other. The two condensers may be controlled separately.

This circuit is very easy to build and to tune, but is more valuable as a first detector and oscillator in a Super-Heterodyne than as a non-radiating receiver.

Circuit No. 3

This circuit is a very interesting one in that a new kind of aerial is used. As shown in Fig. 3, the aerial consists of two wires placed close together, and for this purpose a twisted lamp cord is recommended. The condensers C1 and C2 must be mounted on the one shaft so

as to be controlled by one knob. The action is as follows: The signal current flows in both wires of the aerial in the same direction and is impressed on the grid of the valve. It is then repeated in the plate circuit and fed back by means of reaction coil T to coil L and amplified by reaction. Should oscillations start, the oscillating current induced in L flows in the two aerial wires in opposite directions and radiation is neutralised. To balance the valve capacity, the neutralising condenser C3 is used. A variometer may be included in the earth lead to tune the aerial circuit to the signal frequency. The disadvantage of this circuit is that audio-frequency radiations from light and power lines will be amplified.

The three circuits have now been described. It is up to the experimenter to improve upon them.

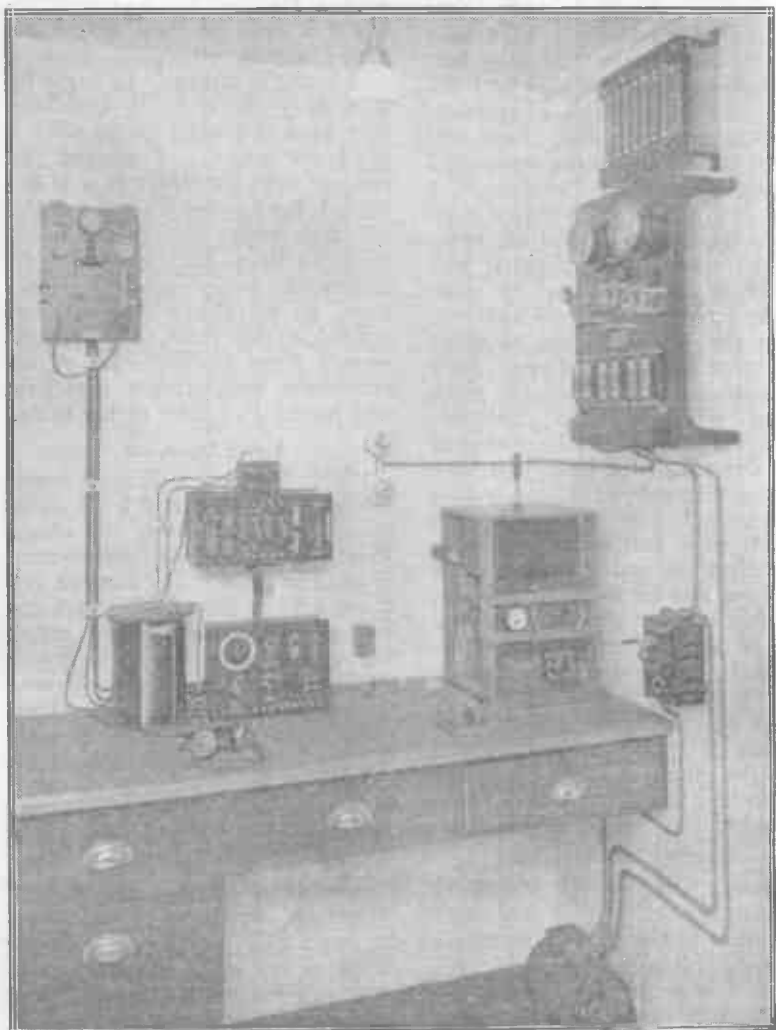

A Marconi 1-KW. Standard Ship Transmitter and Receiver.



JOTTINGS BY THE WAY

Poddleby Discourses

"THE whole secret of successful tuning," said Poddleby to me one night as we sat smoking in his wireless "den," "the whole secret lies in exercising a certain amount of ordinary common or horse sense. A little care, a little thought, and the thing is perfectly simple. When I see fellows like yourself (here I rose, crossed the room, helped myself to one of Poddleby's very best cigars, and returned kicking him hard upon the right shin as I did so, quite by accident, of course), fumbling and messing about and using neither sense nor method, I simply smile." "Poddleby," I said, "if it were not that a hard day's work had earned an evening's repose, and that I was therefore loth to get up once more, I would arise and kick you upon the left shin just to show you what I thought of you. As it is, extreme good nature combined with physical lassitude prevent me from giving you your just deserts. But since you have started the subject I am willing to take a lesson from you. Let us go now and bring out your mightiest set and you shall show me how one tunes in America or Timbuctoo, or any others you like of the distant places of the earth." When I said let us go I was, of course, using a mere figure of speech, for I had no intention of moving myself, and I thought that a little exercise would be good for Poddleby, who is rather inclined to adiposity.

Getting Under Way

Thus challenged, Poddleby heaved himself out of his chair and went to the glory hole where he keeps his numerous sets. He selected a ponderous five-valver and bore it to his wireless table. "I know—that you don't want

any help," I remarked, "and I will therefore not insult you by offering it. Perhaps you will let me know when you are ready to begin the demonstration; meantime, I will just close my eyes and meditate for a few moments over an important problem concerning super-heterodyne circuits that has just come into my mind." I was just dreaming—that is imagining that I was listening to Mars with a 75-valve set and wondering if a little reaction would improve signal strength, when I was brought abruptly to earth by a rude remark from Poddleby that even if I must go to sleep I need not snore. I treated the remark with contempt that it deserved, for I suffer from the slight affliction which makes me liable to make nasal noises when I do strenuous brain work. However, as all the wiring up appeared to be done, I extracted myself from the embrace of an extremely comfortable armchair and joined Poddleby at his table.

Long Distance

"This is going to be most interesting," I said, "and I am more than grateful to you, old chap. Now don't show me how to tune in 2LO or 5XX. Any ass can get them with a bit of wire, a knitting needle, and a chunk of coke. Let me see something which will do justice to your great powers. Suppose we try for the Hull relay station; that is a task worthy of you, and I should be delighted to see you do it." Poddleby shied rather at Hull, explaining that this was too advanced for a first lesson. He suggested that he should get Aberdeen, and that in doing so he could give an admirable exposition of the care, thought, common sense and method which are responsible for his own success in tuning in distant stations.

The First Lesson

"The thing that I want you to understand," said Poddleby, trying to stand about six inches taller than he really is, "is that we must never oscillate whilst searching for even a weak transmission. Any fool can try round for carrier waves, resolving one after another until he has found the transmission that he wants. Like myself, you have doubtless suffered to no small degree from the misdeeds of the semi-criminals who behave in this way. The first thing that I do before I even switch on is to ensure stability by moving the potentiometer over towards its positive end. This makes the set slightly less sensitive, but at the same time it prevents it entirely from any tendency to oscillation, and it therefore cannot radiate to the discomfort of others in Little Puddleton, who are doubtless enjoying the broadcast programmes at this moment." He twiddled his potentiometer, switched on, donned the headphones, gave the condenser a little tweak, and slowly turned the colour of a squashed raspberry, for even I could hear the howl which proceeded from the 'phones that he was wearing.

Bluebottles

When he turned round I was engaged in looking hard at the ceiling. "What a beastly noise those bluebottles make at this time of the year," I said. "If it had not been you, Poddleby, I should have said that the set howled; but as it is I know, of course, that the bluebottle must be guilty." Poddleby pulled himself together with a jerk. "It was a howl," he said, "but I did not do it. It must have been Gubbsworthy who, I know, is trying out a new set this evening." I suggested then that

it might be better if he placed two pairs of 'phones in parallel so that I might listen as well as watch, being thus able to observe both by eye and by ear everything that was happening. Poddleby explained that two pairs of telephones would reduce the signal strength and might make it difficult to pick up a weak signal, but as I insisted he eventually gave way. If your instructor consents to this arrangement you can always keep him in order by the exercise of a little of the care and thought that he has been drumming into you. When, for example, Poddleby was next tempted to make a rude remark I merely shifted my own headphones slightly so that they were not immediately over my ears, and deftly kicked out the high tension wander plug from the battery lying under the table. Then, before Poddleby could remove his own headset, I had swooped down and replaced it several times.

I Learn . . . and Live

As a humorous turn Poddleby's lesson in tuning would have gone, I think, extremely well on the music-hall stage, but as an instructional effort it fell distinctly flat. It was unfortunate, as I said to Poddleby, that every set in Little Puddleton should have been howling upon every portion of the broadcast waveband, for no matter where Poddleby put his condensers, bleats, squeals, yells, moans, groans and twitterings occurred. Once we picked up a faint signal. Poddleby tuned him in until it was just audible, and said with a smile, "In spite of all this howling, there is Aberdeen." . . . "2LO calling!" said a well-known voice, the rest of his remarks being lost in a wild banshee wail. "Poddleby," I said, "though it hurts me to say so, I believe that you are doing this howling, but we will soon see." Thereupon I picked up his Sealyham pup which was slumbering beneath the table, and placed its wet nose squarely upon the aerial terminal. The resulting plock fairly made Poddleby's hair stand on end. The pup, I am afraid, is not fond of wireless, for in the struggle which followed its flying legs dealt faithfully with two valves before I could earth it again. I

apologised, of course, and offered to provide Poddleby in the morning with a pair which I had just borrowed from Snaggsby. He moved across the room to his glory-hole with a step which seemed to have lost its spring and brought out two more valves. This gave me the opportunity of casting an eye over things, and of noticing something which I had not observed before. When he came back I spurred him on to renewed efforts, hurting his pride by suggesting that if he could not get 2BD, I would be quite satisfied with 5XX. "As this is the first lesson," I explained, "I don't want you to do anything too advanced." Poddleby said that it was to be Aberdeen or nothing. So I took off my headphones and returned to my chair, requesting him to let me know when Aberdeen was coming in at good strength.

The Pupil Takes a Hand

It must have been about an hour later when Poddleby informed me that, owing to an eruption of sun spots, magnetic storms were to be anticipated, and that there was now raging one of the worst that had ever occurred in all his long experience. It was, he averred, entirely impossible to tune in any station owing to the terrible things that electrons and positive ions were doing in the atmosphere.

"Poddleby," I said, "I quite realise that the atmosphere is in a state of electrical chaos, and probably aeriels and receiving

sets are going up in blue flames all over the country. But would you mind letting your pupil try his apprentice hand, putting into practice the great principles of care and thought which you have so truly driven home into his head?" "Well, of course, you can try if you like," said Poddleby, "but I warn you that you are in for a rough time. Still, have a shot if you want to, and good luck to you." I moved to the wireless table, Poddleby standing beside me. "The first principle of tuning, my dear Poddleby," I said, "is to exercise a little care. If now you will examine your wiring, you will find, I think, that you have connected the positive end of your low-tension battery to the L.T. negative terminal of the set and vice versa. So well have you taught me that I observed this quite early in the evening, but the respect due from a pupil to his instructor prevented me from calling attention to the fact since I supposed that you had done it purposely." I changed over the leads, fiddled with the condensers for a moment, heard the accents of Caledonia, and motioned to Poddleby to don his pair of phones. "There," said I, "is Aberdeen. It is all done, as you will observe, by common-sense and care, and thought and method. Wireless Wayfarer will now help himself to one more of your excellent and very expensive cigars and close down. Good night, Poddleby. Good night."

WIRELESS WAYFARER.

How to use the "Wireless Weekly" Key Chart of Continental Broadcasting

The key chart on pages 690 and 691 of this week's issue forms not only a rapid means of ascertaining what broadcasting stations are working at any particular hour, but also acts as a guide to which station it is advisable to listen to first. The time line is divided into quarter-hour intervals. The spaces between vertical lines indi-

cate the time occupied by the particular transmissions. Different stations are indicated by different heights, as shown by the names on the left. Thus at 4.0 p.m. (bottom line) Brussels and Geneva are working and finish together at 5 p.m. At 4.30 p.m. Eiffel Tower and Berlin will commence, Eiffel Tower finishing first, Berlin closing down at 6.0 p.m.



More About Resistance Amplification

WITH reference to my notes of last week regarding resistance coupling, there are one or two points which I would like to raise.

Although a wide range of gridleaks and grid condensers is specified in the notes, it must not be imagined that for any particular valve and high-tension voltage any values will give the same results. In the case of some valves, a change of anode resistance does not make an appreciable difference. The principal factor is the impedance of the valve, as compared with the impedance of the anode resistance.

Valves have not hitherto been designed for resistance amplification, but I am pleased to see that the General Electric Company have produced a Marconi valve especially for resistance capacity amplification. This valve is the D.E.5B. The filament voltage is 5 to 5.5, and the filament current is in the neighbourhood of .22 amps. The manufacturers state that the amplification factor is 20, and on actual tests, which we ourselves have conducted, using a 100,000 ohm anode resistance and a high-tension battery of 100 volts, the results were double those obtained with the ordinary type of valve.

Resistance Values

The manufacturers recommend using an anode resistance of 100,000 to 150,000 ohms and a high-tension voltage of 120 volts.

The tendency of responsible valve manufacturers to specify in detail the method of using their valves is one highly to be recommended. Much signal strength is lost through an improper knowledge of valve character-

istics and the most suitable type of apparatus to use with the valves. To use a high-capacity valve for high-frequency amplification is asking for trouble, and yet many experimenters do this because they find that the same valve, perhaps, makes an excellent low-frequency amplifier.

There is a general tendency of manufacturers to have valves for different purposes, and a really discriminating experimenter, who is fortunate enough to possess the necessary funds, will indulge in some of the luxury valves

the minimum effect on the passing on of the low-frequency currents to the next valve. Increasing the size of this by-path condenser will weaken signal strength, and this weakening will become distinctly pronounced when the by-path condenser has a larger value than .002 μ F. On the other hand, the decrease is noticeable even on lower values of condenser. The other effect is on the quality of the reception. The condenser will act as a partial short-circuit for the higher frequencies, and conse-

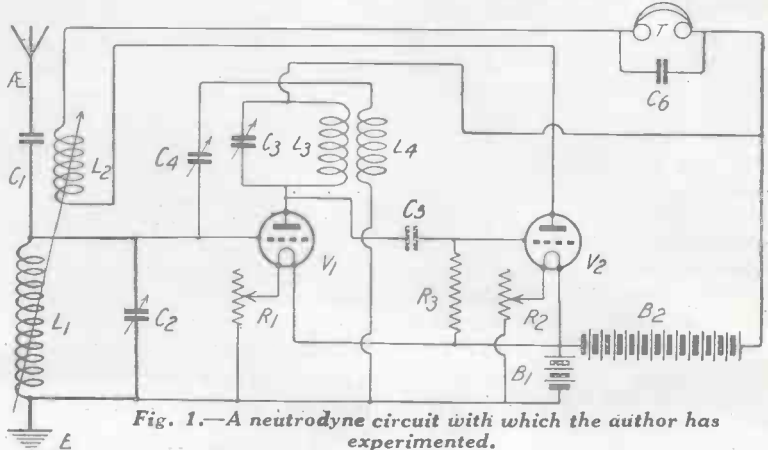

Fig. 1.—A neutrodyne circuit with which the author has experimented.

which are now on the market. No doubt if the demand for these increases sufficiently, the price will fall.

I am firmly of the opinion that the valve of to-day, as sold at 12s. 6d., will ultimately be regarded as an inefficient curiosity.

Returning to the subject of resistance amplification, the question of the size of the condenser across the anode resistance is not altogether unimportant. Wherever possible, no condenser at all is desirable across the resistance, but if a reaction coil is being used, some by-path condenser will be required. A value of .0001 μ F will suffice in nearly all cases and will obviously have

quently too large a capacity will tend to weaken the higher audio-frequencies; the S's will consequently be reduced in strength, and the size of the condenser may be used as a means of modifying the whole quality of the reception. This subject was entered into with considerable detail by H. J. Round in his article on pure reproduction which appeared in *Modern Wireless* dated April, 1924.

Readers of these notes will be interested to hear that Captain Round has written for this journal an article on resistance amplification generally. This article will appear in our issue of October 8.

The Cowper Neutrodyne Arrangement

I have been obtaining some interesting results with the type of neutrodyne control introduced by Mr. A. D. Cowper.

Fig. 1 shows the actual circuit of the set on which the experiments were carried out. It will be seen that tuned-anode coupling is employed between the first and second valves, a neutralising inductance and condenser, shown as L_4 and C_4 respectively, being employed to prevent the first valve oscillating. Reaction is now introduced from the anode circuit of the second valve into the aerial circuit, and also, indirectly, into the tuned-anode circuit L_3 , C_3 .

It might be asked whether neutralising control is necessary in a receiver using only one stage of high-frequency amplification. This depends almost entirely on the sizes of the parallel condensers C_2 and C_3 , and upon the efficiency of the coils L_1 and L_3 .

Advantages of the Neutrodyne

When using a tuned-anode circuit and using an appreciable amount of capacity across the anode coil, self-oscillation troubles are rare unless the spacing of the components is too close. If, however, the maximum value of anode inductance is used and only a very small variable condenser is used in shunt with L_3 , the first valve will oscillate quite readily, particularly if the negative of the filament accumulator is connected to earth, as shown in Fig. 1. In such circumstances there is practically no grid damping, and if the value of C_2 is kept very small also, a simple tuned-anode circuit may become quite unstable. When using these values, the best results are obtained, so that if a neutralising effect may be introduced so as to overcome the effect of the stray capacities and the inter-electrode capacity of the first valve, without causing any losses, it is possible to keep the advantages of small capacities without having the self-oscillation trouble.

In Fig. 1 the coil L_4 may be the same size as L_3 , and the variable condenser C_4 is of very small dimension, and consists of

two metal plates about the size of a penny, which may be moved to or from each other. These variable condensers are obtainable from Gambrell Bros., although it is rather surprising that no other manufacturers have attempted to place such a condenser on the market.

Adjustments

With this circuit the coil L_2 , of course, should be kept well away from L_1 when first tuning in, and L_4 may be tightly coupled to L_3 , two honeycomb coils being placed side by side. Variable coupling is not necessary, but it is important to see that the leads going to L_4 are the right way round, as otherwise, instead of self-oscillation being decreased, it will be increased. It is a matter of experiment to see which way round the leads should go to L_4 , and reversing leads and terminals may be provided on any sets using such a circuit.

The adjustment of C_4 is critical, and it will be found that when the value of C_4 is too small, the set will oscillate on all adjustments to wavelengths on or below that of the station being received. If, on the other hand, the capacity of C_4 is too large, the set will oscillate on and above

the wavelength of the station to be received.

When C_4 is just right, it is possible to tune C_2 and C_3 with great ease without the set oscillating, and this balance will hold good for a wide range of wavelength. Once this condition of stability has been obtained, reaction may be introduced by means of L_2 , the condensers C_2 and C_3 , of course, being carefully readjusted whenever the reaction is varied. It will not, however, be necessary to alter C_4 .

A Practical Receiver

The circuit using this method of control was described by Mr. Underdown in the issues of *Wireless Weekly* dated August 6 and 13, and excellent results have been obtained with the set there described by other members of the Radio Press staff.

The Fig. 1 circuit, of course, may be varied by altering the tuning arrangements, constant aerial tuning being shown in the diagram. Constant aerial tuning, of course, lightens the load on the grid circuit of the valve, and consequently there is a greater tendency towards self-oscillation under these conditions, which, in some cases, may be beneficial, and in others not so.

AN "ALL CONCERT" RECEIVER.

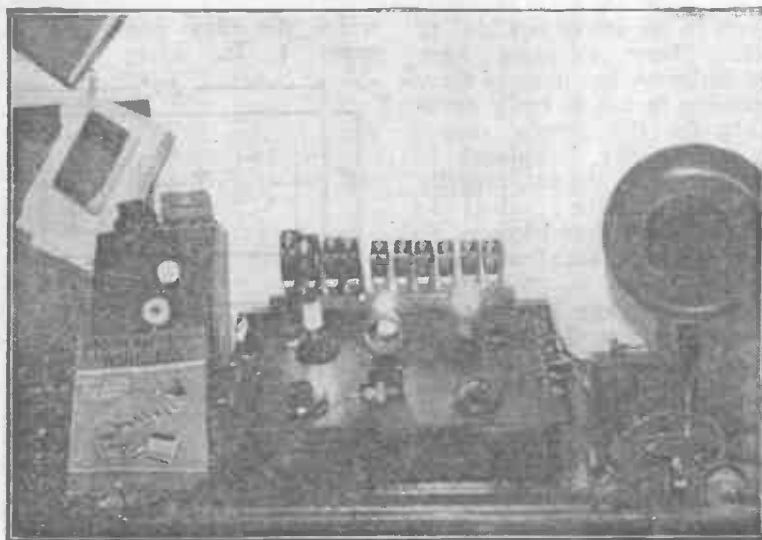

Our photograph shows an "All Concert" Receiver as built by a "Wireless Weekly" reader

Anti-Capacity Valve Adapters.

By R. W. HALLOWS, M.A., Staff Editor.

MOST people realise nowadays the advantages of using, especially for short-wave work, anti-capacity valves, such as the M.O. V24 and QX, the dull emitters DEV and DEQ, the Mullard Ora B, S3 and S7, the Myers or the Ex-R.A.F. "C" valve. The way in which capacity is reduced in all these valves is that they are provided with special clip mountings instead of with pins to fit the ordinary 4-socket holder. A feature common to all is that the plate and grid leads are brought out as far away from each other as possible. In the Myers they are at the opposite ends of the valve, whilst in the other types they are on the opposite sides of it.

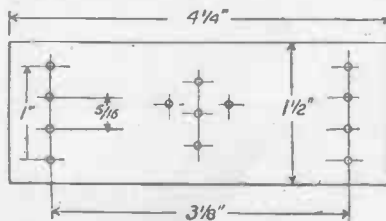

Fig. 1.—Layout for Myers valve adapter.

The trouble that the average amateur experiences when using these valves is that his set is made up with 4-socket holders and he does not wish to go to the trouble of altering these; further, if he does so he limits himself to the use of one kind of valve. Many adapters have been designed, but none of these at present in use is really satisfactory for the simple reason that the capacity introduced in them neutralises the anti-capacity properties of the valve so mounted which thus becomes no better than a standard 4-pin valve.

The writer has given some attention lately to the problem of making anti-capacity adapters and the solutions offered here will, it is thought, be of some use to amateurs. He used to employ vertical adapters, but has given these up since they necessitated either long leads or long clips. The horizontal pattern has very distinct advantages as will be seen.

A Myers Adapter

Fig. 1 shows the way in which the ebonite base of the Myers valve adapter is marked out and punched. It consists of a piece of $\frac{1}{4}$ -in. ebonite $4\frac{1}{4}$ in. long by $1\frac{1}{2}$ in. wide. Middle

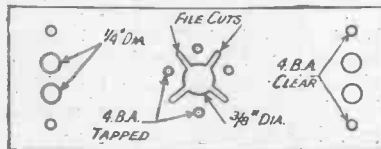
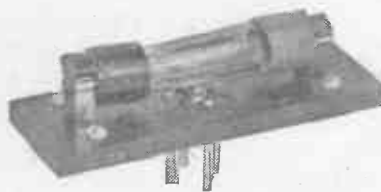

Fig. 2.—Drilling dimensions of ebonite base for Myers valve adapter.

lines are drawn with a scribe in both directions and two other lines parallel with the shorter sides are made $3\frac{1}{8}$ in. apart. A valve leg template is now centred over the middle point and holes



Photograph showing a Myers valve adapter mounted as described.

for the valve pins are centrepunched. The middle hole to clear the pip of the valve is next marked. On the two side lines centres are punched $\frac{5}{16}$ in. apart for the holes through which the clips pass and an extra $\frac{1}{8}$ in. apart for the

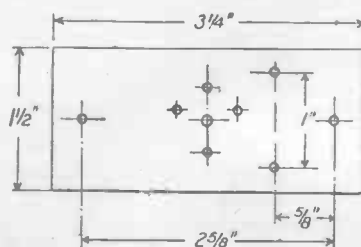

Fig. 3.—Layout for a V24 valve adapter.

clip screws. Begin by drilling the four valve pin holes, which should be 4 B.A. tapped. Then make a $\frac{3}{8}$ -in. hole in the middle of them. Though one might think that there would not be much room for this, it will be found that there is ample space. Go on to make the $\frac{1}{4}$ -in.

holes for the clips and the 4 B.A. clearance holes for their fixing screws. Take a small rat-tailed file and with it make cuts between each pair of valve pin holes as shown in Fig. 2, which gives a diagram of the finished base. The valve pins may now be screwed in and the clips mounted in the usual way. The connections from clips to plate and grid legs should be made with bare wire of No. 18 gauge. Those for the filament may be made with systoflex covered wire. One of these last will have to cross the plate lead and it should be arched up so as to clear it by about a third of an inch at the point of crossing. An adapter of this type makes a very neat job indeed, and, owing to the large air space between the valve legs, it introduces very little capacity. If it is used in connection with an anti-capacity valve-holder upon the panel of

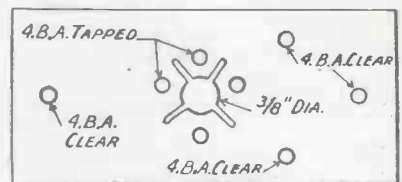

Fig. 4.—Drilling dimensions of ebonite base for V24 adapter.

the set, it will be found that there is little to choose in point of efficiency, even on the shortest waves, between the Myers valve so mounted and one placed in clips fixed direct to the panel. This holder can be made up in half an hour, and its cost is practically nothing, for a set of clips is given free with each valve, and the other components will usually be found in the scrap box.

A V24 Adapter

The next three figures show the stages in the construction of an adapter suitable for all other types of anti-capacity valves. The dimensions given are those actually required for the M.O. valves, but they will also do for the Mullard S3 and S7. For the Ora B and the R.A.F. "C" valve slight alterations will be necessary, as the distance between the plate and grid contacts is rather greater. The base in this case is a piece of $\frac{1}{4}$ -inch ebonite $3\frac{1}{4}$ inches by $1\frac{1}{2}$ inches. Centre lines are drawn in both directions as before, and on that

parallel with the long sides punch marks are made $2\frac{3}{8}$ in. apart; $\frac{3}{8}$ in. from one of these another line parallel with the short edge is drawn, and upon this centres are punched 1 inch apart. A valve template is used as before for marking the valve pin holes, and a central hole is also punched. In Fig. 4 is seen the base after it has been drilled and file-cut. The legs should again be tapped in if possible. If nuts are used to secure the valve pins in this or in any other kind of holder, they should be the smallest and thinnest that can be procured, and it would be better in this case to use 6B.A. valve pins. The clips are made from springy sheet metal. The upright members of each should be about $\frac{3}{8}$ inch long. Quarter-inch holes should be drilled in the filament clips to give the pointed bosses of the valve a firm seating. In this holder

there is no need for any leads to cross. Connections should be made with bare wire, and if they

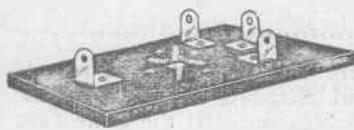

Fig. 5.—An adapter for V24 valves.

are kept well apart it will be found that no unwanted capacity is introduced by the adapter. This, again, is a very quickly-made contrivance, and its cost is, of course, trifling. The experimenter will find it well worth his while to make up both adapters described, for he will then be able without the least difficulty, and without any loss in efficiency, to use either anti-capacity or ordinary valves upon his set.

As regards the holder upon the panel of the set, the writer

much prefers to use separate valve legs shortened as much as possible and screwed in. Many amateurs appear to find it a difficult matter to lay out valve-holders properly. If the spacing is not quite correct they are most unsatisfactory, since so much force must be used to get the valve into place that one is liable to loosen the seating of the cap. The writer employs a Morris valve template, which he has always found perfectly satisfactory, most valves being a beautifully easy fit into legs fixed with its help. It must, however, be remembered that the valve-holder is not always to blame if there is undue tightness, since, owing to the lamentable lack of standardisation in wireless components, the spacing of the pins does appear to vary slightly in different makes of valves, and not all valve manufacturers use pins of precisely the same diameter.

A First-rate Varnish

SOME time ago the writer wanted to find a really good varnish for the bindings of fishing tackle. Shellac varnish is not of very much use since it cracks and peels off when it is subjected to wear, and so lets water into the bindings. Various recipes were tried and by far the best was found to be a varnish made from celluloid and amyl acetate. This sets very hard and besides being waterproof is to a certain extent elastic, and therefore does not tend to crack if applied to anything which is subjected to slight bending. Recently the varnish has been tried for wireless work, for which it has been found most satisfactory. It is excellent as a dressing for inductances or for finishing off the ends of flex and other leads. It can be used for practically any purpose where shellac varnish is usually employed, and it will be found excellent.

To make it is simplicity itself. One simply purchases from the chemist an ounce of either acetone or amyl acetate and dissolves in the solution as many

small pieces of celluloid as it will take. The result is a transparent varnish which can be made either thick or thin as desired, and which dries very rapidly when put on with a small brush. What actually happens when the varnish is applied is that the solution evaporates, leaving a coating of celluloid upon the bindings. Celluloid is both damp-proof and a good insulator.

It is important that pure celluloid should be used. Old photographic films may be pressed into service, but the resulting varnish is not nearly so suitable, since when it dries it goes a dirty white colour and has not the wearing qualities of that made with pure celluloid. This material is easily purchasable, and a very small quantity will suffice to make a supply of varnish sufficient to last some time.

One word of caution is needed. Both amyl acetate and acetone give off highly inflammable fumes; celluloid is also very inflammable. The varnish should therefore be made and used with a certain amount of care. It would be foolish, for instance, to

make it upon a table immediately below a gas burner or to smoke during the process.

A little of the acetone or amyl acetate purchased should be placed in a separate bottle, and not used for dissolving the celluloid. This bottle should be kept handy so that the brush may be washed out in it immediately after use. If this is not done the hairs will set into a hard solid mass, which will take some time to soften even if left to soak in one of the solutions.

It does not matter very much which of the two solvents is used, though the writer has a slight preference for amyl acetate, which seems to produce a rather tougher and clearer varnish.

R. W. H.

"Beam" Wireless.

According to the *Morning Post*, as soon as the Wireless Bill, which has been passed by the Australian Parliament, receives the Governor-General's assent, the construction of the "beam" station will be begun. It is understood that the Wireless Board, after weighing the merits of sites near Sydney and Melbourne, has decided on Broadmeadows, in Victoria.

A Handy Screwdriver

THOSE who do much constructional work will have found that an enormous amount of time is wasted in tightening up and undoing small screws. This is particularly irksome when one is taking to pieces either a whole set which is to be rebuilt or a small piece of apparatus which it is intended to alter or improve. A tool which might be described as the wireless constructor's friend is the spiral ratchet screwdriver, a most ingenious device hailing from America. It works on the principle of the archimedean drill. When the handle is pushed down the stem of the drill telescopes into it, and is caused to rotate. At the end of the stroke the pres-

sure on the handle is released, and a spring within it takes it back again. At the same time a ratchet device prevents the screwdriver bit from turning backwards during the return stroke. When driving home a screw one simply places the screwdriver bit in its nick and presses the handle down once or twice. A 1-in. 4B.A. screw can be driven right home in a couple of seconds. If there is a nut below it one simply holds this with a finger of the left hand and works the screwdriver with the right, one hand being all that is required for its operation. So much for the process of inserting screws. To remove them one simply presses upwards a little slide in the handle of the screw-

driver and then proceeds as before. The action is now reversed. Pressing down the handle rotates the bit in an anti-clockwise direction, and so turns the screw out. If desired the screwdriver can be used as an ordinary fixed tool, it being possible to throw the archimedean gear out of action, or it may be used as a fixed screwdriver with ratchet action only in either direction.

Besides screwdriver bits, various other fittings, such as drills and countersinks, can be obtained. The spiral ratchet screwdriver is thus an exceedingly handy tool for the workshop. The writer acquired one some time ago when an injured wrist made the use of an ordinary screwdriver very painful, and he now uses this handy screwdriver to the exclusion of any other for wireless work. D. S.

IT is surprising how often one sees an ambitious receiving set whose appearance is spoilt by the poor way in which its components have been fitted to the panel. As often as not there are gaping holes which have been made in the wrong places, and I rather suspect that the popularity of condensers fitted with moving dials is due in no small measure to the way in which, like charity, these cover a multitude of sins! Some makers are obliging enough nowadays to supply paper templates with their apparatus, but these are not always of the most satisfactory kind, for usually they show printed circles to represent the holes that must be drilled. Now it is quite easy not to hit the exact centre of one of these circles, and if one of the screw-holes is made a little bit out, difficulty will be experienced in getting the component in question neatly on to the panel. The centres of all holes should be marked by cross lines. If, therefore, you have to work with paper templates you will find it worth while to rule in centre lines before you start the business of marking it with a centre punch.

Whether proper templates are provided or not, the writer believes that the best method is to use the component itself whether

rheostat, condenser, transformer, or what not, as a guide to marking out. Take the case of variable condensers. Unless these have the one-hole fixing, which is not always very satisfactory, the drilling required is usually one 3/8-in. hole for the spindle and two 4B.A. clearance holes for the fixing screws. Now you know exactly where the spindle hole must come, for you will have designed your panel to take the condenser in a certain position. Therefore drill this hole straightaway and do not bother for the moment about the others. Insert the spindle of the condenser into the hole and place it in the exact

position you have decided for it. Then take a scribe and put its point into one of the fixing screw holes in the condenser's top plate. Work it round once or twice so that it scratches the ebonite and do the same with the other hole. There will not be the slightest difficulty in centre-punching and drilling the 4B.A. clearance holes for the fixing screws. This rule holds good for all components which require one large hole of known position, and two or more smaller ones for the fixing screws. For fixed condensers, L.F. transformers and so on, no central hole is, of course, required. These components should be placed in position, and the positions of the holes for the fixing screws marked out with a scribe as previously indicated. This means that in every case drilling must be done from the underside of the panel. Care must therefore be taken to place it upon a smooth piece of wood whilst drilling is in progress, otherwise the upper surface may be slightly chipped by the exit of the drill.

R. W.

Fitting Components

BLUE PRINTS

Full-size blue prints of the wiring of all the principal *Wireless Weekly* and *Modern Wireless Receivers* can be obtained from the Sales Dept. of Radio Press, Ltd. In some cases blue prints of the panel drilling can also be obtained, the price in each case being 1/6 post free.

When Your Set Goes Wrong

By A. J. BOYINGTON

A few hints regarding faults and simple tests which the beginner will find useful.

IT happens, alas! too often, that a modest, gentle-voiced, single-valve receiver, after having a stage or two of radio frequency amplification grafted on to the aerial side, and a brace of audio amplifiers connected where the 'phones had originally been, emits along with its intensified signals queer squeaks and jazz effects, so that quality has been sacrificed for quantity.

Adding Amplifiers

To produce both quantity and quality in the same set by amplification is more of a problem than merely connecting up the different elements of the circuits, as the neat, straight lines of the diagram on paper would suggest. Certain precautions must be taken in laying out a set or adding to an existing one, otherwise untold trouble may ensue.

The first of these is to arrange the parts in their proper sequence so that connections may be made as short as possible. This is particularly true of all leads to the grids of the valve sockets. To avoid capacity effects the connections should be kept at least half an inch apart, and where feasible the wiring should be crossed rather than parallel so that only small portions of neighbouring conductors are close together.

Rigid Connections

Wherever possible, rigid connections should be used within the set, so that drooping or accidental displacement is not likely to occur. Also the connections must be firmly clamped if soldering is out of the question, and the junctions of two wires should *always* be tinned over and soldered—twisted connections being anything but satisfactory.

Coils

Breaks in the fine leading-out wires of duo-lateral coils, or

within the coils of transformers, are a common source of trouble. The insulation may hold the severed ends closely enough together to make a more or less continuous path of very variable resistance, in which case there will be considerable noise mingled with the music in the phones. Or the ends may be separated entirely and the set rendered inoperative.

The most satisfactory method for detecting such a flaw is to separate the suspected part from the circuit (or at least be sure there is no other path for the current to take except that through the windings) and apply a galvanometer, in series with a small battery. If no reading is indicated after making certain contact with the affected parts it will be obvious that the windings are broken.

If this happens in a coil, the break can usually be traced to the point where the lead wires are fastened, since here they are subjected to the greatest mechanical strain. Sometimes, however, the galvanometer will indicate that the path is complete in spite of the break, but by making all outside connections tight and then moving or jarring the part, the fluctuations of the needle will show the presence of a poor contact.

An Alternative Test

Another test, which, though less sensitive, will at least detect complete breaks in the circuits of coils and transformers, may be made with an ordinary flashlight bulb and a battery of the bulb's rated voltage. Connections to the bulb should be made through an improvised socket, or its own socket if possible, and an unbroken circuit will naturally be proved by the bulb lighting.

Both the above tests may also be applied to such parts as condensers and valve sockets (with

the valve removed), neither of which should allow the passage of direct current if functioning properly. If the needle of the galvanometer shows a direct flow of current, or the flashlight bulb lights up, trouble is indicated; but the meter test will be found more preferable, since its sensitivity to high resistance leakage is considerably greater.

Battery Trouble

Further sources of trouble are often found in the batteries. A single bad H.T. cell in series can cause quite a lot of disturbance. Erratic discharge within the battery itself is the cause, and the most practical method of detecting the faulty unit is by a process of substitution and elimination. The L.T. supply is generally better behaved, providing always that it receives reasonable care.

The Transmitter's Position

The following letter addressed to Prof. W. H. Eccles, D.Sc., F.R.S., by the Post Office will be of interest to readers and is referred to in our editorial.

As promised, I am writing to explain the recent developments in regard to wireless experiments between British and foreign amateurs.

When the conditions respecting experimental wireless licences were settled immediately after the War, experiments were limited, as a general rule, to those carried out in co-operation with not more than four specified experimenters in this country. Later—in the spring of 1922—the limit of number was abandoned; but the scope of experimental communication was not extended to other countries. Nor did the Radio Society of Great
(Concluded on page 686)

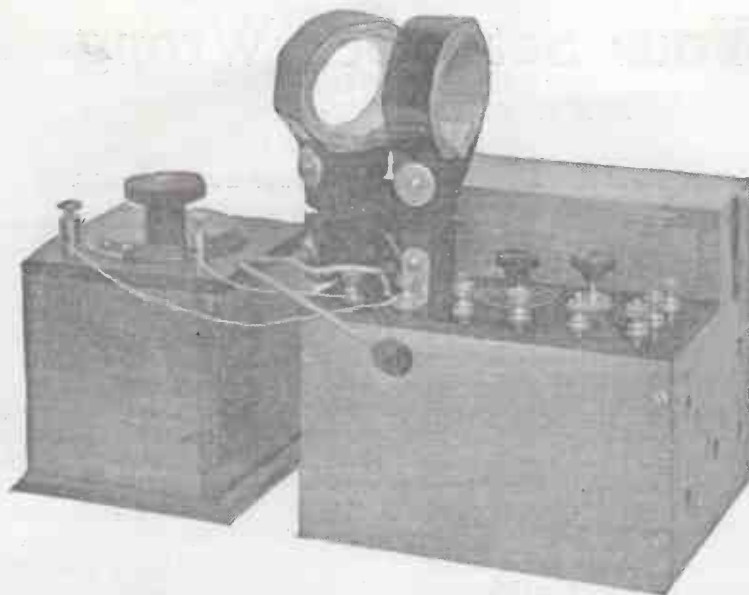

Fig. 1.—A photograph of the receiver with the condenser connected.

THE design of the single-valve panel to be described provides a neat and compact instrument, upon which the constructor may receive signals on both short and long wavelengths, according to the coils and condenser values chosen. He may also employ reaction, or not, as may be desired. To permit experiments to be tried the variable condenser is not embodied in the receiver itself, but is used as a separate unit. For the ordinary circuits, however, a variable condenser, having a capacity of 0.0005 μF , will be found most suitable. The valve is entirely enclosed within the cabinet, but is easily accessible by raising the hinged lid with which the cabinet is provided.

In the photographs given the complete receiver may be seen, as well as the underside of the panels. These latter are secured to a sliding partition, which enables the set to be lifted bodily out of the containing box for purposes of examination, etc.

Materials Required

To build an instrument to the specification here given the following components and materials are required:—

One piece of ebonite, measuring 6½ in. by 3 in. by 3/16 in. or ¼ in.

One piece of ebonite measuring 2 in. by 1½ in. by 3/16 in. or ¼ in.

Eight terminals.

Four valve sockets or one valve holder.

One variable gridleak (Bretwood).

One Lissenstat minor (Lissen, Ltd.).

Two fixed coil holders.

One fixed condenser, 0.002 μF capacity.

A Compact. Single-Valve Panel.....

By H. BRAMFORD.

One fixed condenser, 0.0003 μF capacity.

One small ebonite knob.

Two valve pins.

Four, five or six B.A. screws.

9 in. of 3/16 in. diameter brass rod.

Quantity of connecting wire.

Quantity of ¾ in. wood for constructing the containing box.

Panel Drilling

The panel drilling dimensions are clearly shown in Fig. 2. The smaller panel which is drilled to receive the valve sockets, may be made first from a piece of ebonite measuring 2 in. by 1½ in. by 3/16 in., or ¼ in. thick. The larger panel is made from a

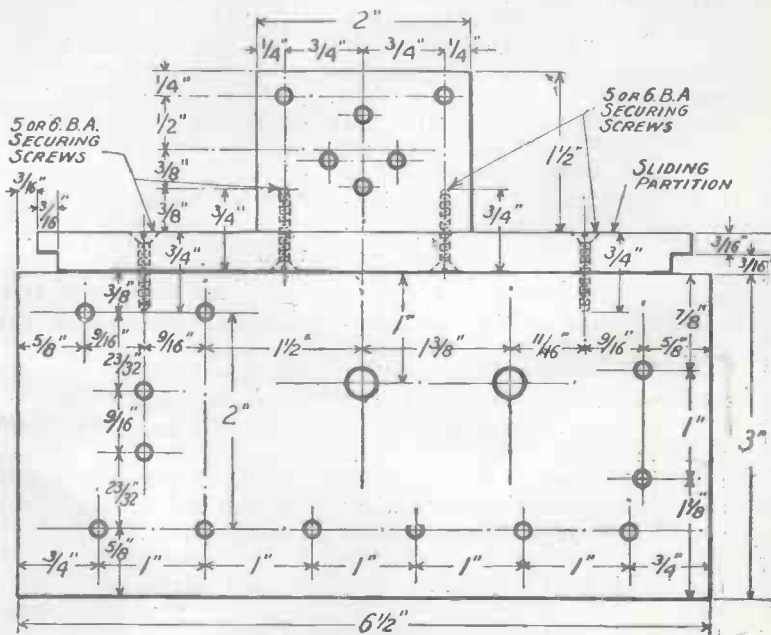

Fig. 2.—Drilling dimensions of the panels.

The following article gives full constructional details for the building of a neat and efficient single-valve panel.

piece of ebonite measuring $6\frac{1}{2}$ in. by 3 in., and of the same thickness as the smaller panel. The panels should not be secured to the sliding partition, as shown in the diagram, until all the components are securely mounted, but the holes for securing should be drilled in the positions shown.

Assembling

First mount a valve holder to the smaller panel. Alternatively four valve sockets will answer the purpose just as well, but the screwed portion of the sockets should be cut down to a length of $\frac{1}{2}$ in. in order to give clearance, the same remarks applying if a valve holder is used. Next secure to the panel two supporting posts (Fig. 6). These may

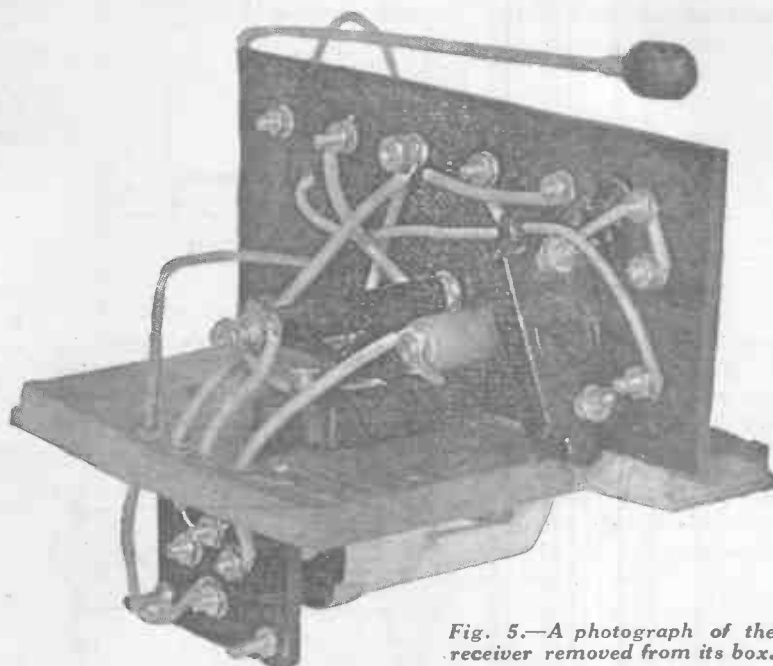

Fig. 5.—A photograph of the receiver removed from its box.

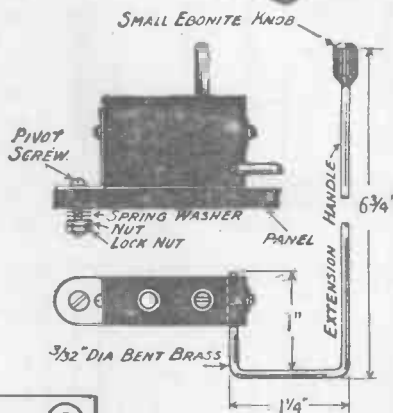

Fig. 4.—Details of the coil holder.

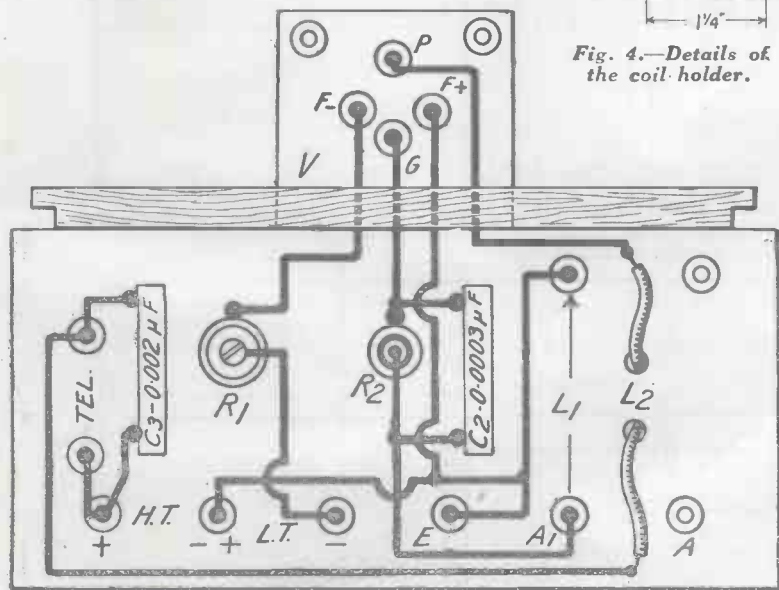

Fig. 3.—The wiring of the receiver.

be made from two valve pins, cut down to a length of $\frac{1}{8}$ in. This smaller panel may now be secured to the sliding partition, which is made as shown in Fig. 6. The partition itself is made from a piece of wood measuring $6\frac{1}{8}$ in. by $4\frac{1}{4}$ in. by $\frac{3}{8}$ in. Each end is grooved, as shown, the grooves working in slots provided in the containing box. The position in which the panel should be secured to the sliding partition is clearly shown in the diagram.

The larger panel should be assembled as follows:—First secure to the panel the eight terminals as shown in Fig. 3. Next secure the filament resistance (R1). A Lissenstat Minor has been chosen for this component owing to its small compass. The grid leak (R2) is of the variable type, but those desiring to use a grid leak of fixed value may do so; in this case the leak should have a value of two megohms. There is a certain advantage, however, in employing the use of a variable grid leak. The coil-holder (L1) is secured on one side by means of the terminal (A1), and on the other side by means of a 4B.A. screw and nut. A plain fixed coil-holder having a brass

A Clix Adapter

IT happens not infrequently that we wish to be able to make quite a number of connections to one terminal. One of the simplest ways of doing this is to make use of the Clix adapter shown in the drawing.

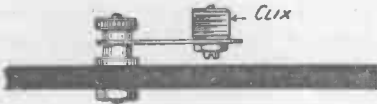

The adapter.

This is simply a strip of brass about $\frac{3}{8}$ in. wide and 1 in. long in which are drilled two holes, one for the shank of the terminal and the other for the Clix. The Clix is fixed in position by means of its own nut, and the surplus portion below the strip may be cut off if desired. These

adapters are particularly handy for telephone terminals, since any number of pairs of phones can be used in parallel without any trouble at all.

R. W. H.

Kingston and District Radio Society

The Kingston and District Radio Society will open their autumn-winter session on Monday, September 29, at 8 p.m., at its headquarters, St. Agatha's Hall, King's Road, Kingston. The evening will be of a social character, to which all wireless enthusiasts, also ladies, are cordially invited.

Particulars of membership can be obtained from R. C. Wilson, hon. sec., 8, Bloomfield Road, Kingston-on-Thames.

Regarding Terminal Spades

BEFORE fitting spades to aerial, earth or battery leads, put them in the vice and file a little off one side, as shown in the accompanying sketch. They will then be adaptable for the "telephone" type of terminal in use on certain sets

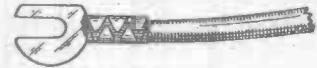

The terminal spade.

without their efficiency being impaired in use with the more usual "pillar" terminal. This will be found most useful for those who are constantly experimenting with different sets.

T. R. CALDICOTT.

THE EDINBURGH STATION.

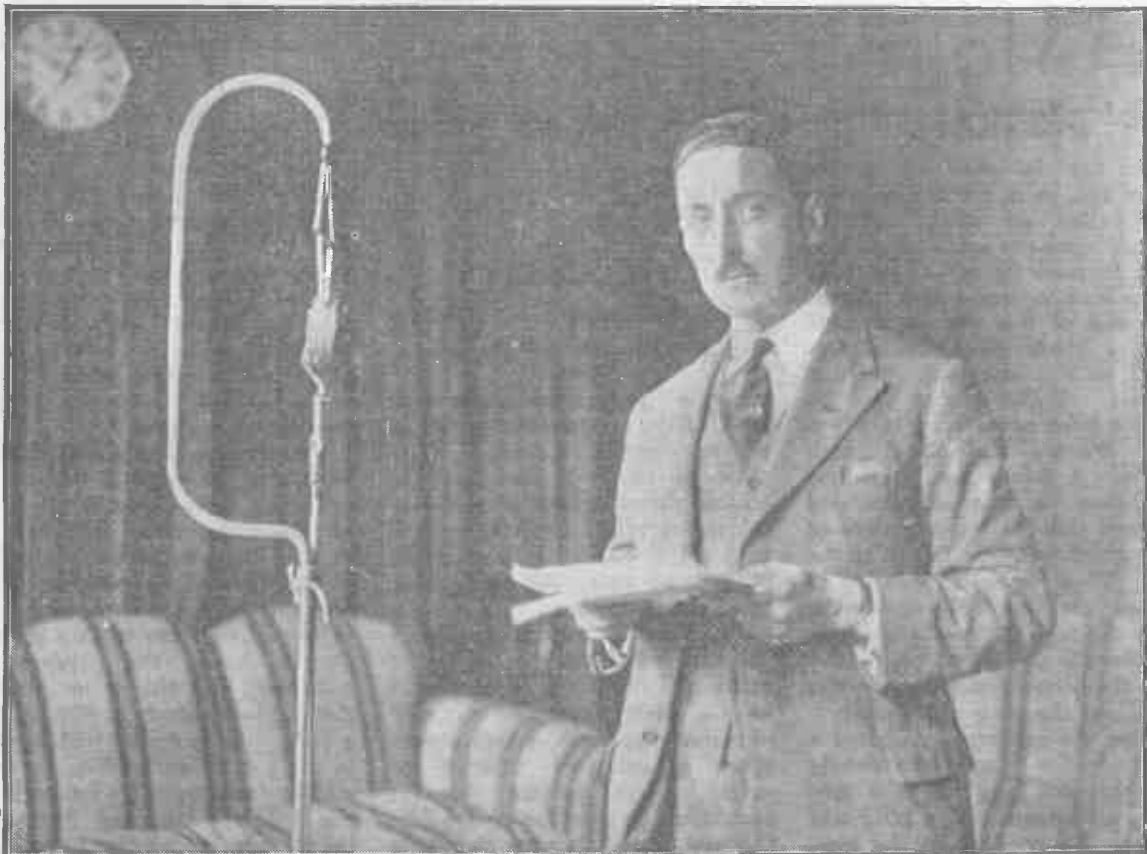

Our photograph shows Mr. G. H. Marshall (Uncle Leslie), the station director. Note how the microphone on the left is supported.

A Neat Low-tension Plug

IT is most convenient to have the accumulator well out of the way, and to make connection with the set by means of a two-point plug attached to a suitable length of flex. The writer keeps his low-tension battery out of sight and out of harm's way under a piece of furniture in a corner of the room. From the battery a length of double lead-covered cable, such as is used by electricians for house-wiring purposes, runs along the skirting-board and then up to a point below the window frame. The cable is simply stapled down, and when it is painted over it does not show in the least. Into the window frame a screw eye is inserted, to which is fastened a yard of 40/36 flex, such as is employed for radiators, with a plug and socket mounting. The end

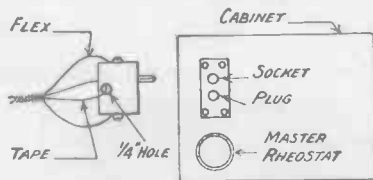

Fig. 1.—Illustrating the method of using the plug.

of the flex is attached to the screw eye, so that if it is accidentally pulled no strain will be thrown upon the soldered connections between its wires and those of the lead-covered cable. At the free end of the flex is a small ebonite block (see Fig. 1) provided with a standard plug and socket. These plugs can be bought from advertisers in *Wireless Weekly* for about 10d. apiece. A 1/4-inch hole is drilled as shown in the ebonite, and through this is passed a piece of tape which is firmly bound to the flex. Thus should anyone try to pull out the plug by grasping the wires the tape takes all the strain and there is no fear of interfering with the connections between the wires and the plug and socket.

Upon the cabinet is mounted a small ebonite block, the details of which will be given in a moment, also containing a plug and socket. To connect up the low-tension supply is the simplest matter, for one just plugs in. It

is a bad practice to switch on suddenly by simply plugging in, but at the same time it is rather annoying to have to find the correct settings of individual rheostats every time that the set is brought into use, especially if valves are employed whose filament potentials are rather criti-

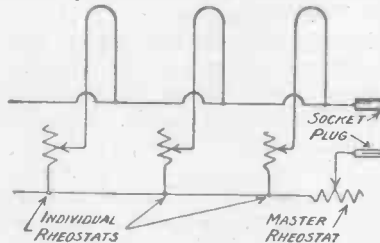

Fig. 2.—The wiring of the L.T. system.

cal. For this reason a master rheostat is mounted at the end of the cabinet, as shown in Fig. 1. At the end of a reception this is turned to the off position and the L.T. plug is removed. The individual rheostats are left untouched. When the set is brought into use again the plug is first inserted and then the master rheostat is turned rather slowly to the full-on position, where it is left. The valves are thus

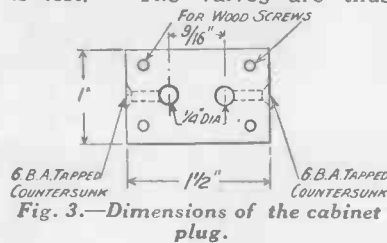

Fig. 3.—Dimensions of the cabinet plug.

brought gradually under full load. Fig. 2 shows the wiring of the low-tension system. Care must be taken to see that the master rheostat has a sufficient current-carrying capacity to deal with the L.T. supply during the process of switching on without overheating or burning out. As all the valves are in parallel a rheostat of about 2 ohms is quite sufficient, and this should have a current-carrying capacity of about 3 amperes, which should allow a sufficient margin of safety. The master rheostat should not be used for controlling filament potentials once the set is in use. If any of the resistance of the master rheostat is left in

circuit it will be found that the adjustment of one valve by means of its own rheostat affects all the rest, they becoming dimmer as it is made brighter, and so on. The master rheostat should therefore be used simply and solely as a switch and for no other purpose.

Details of the plug and socket mounting for the cabinet are shown in Figs. 3 and 4. In Fig. 3 is seen the drilling lay-out of the ebonite block, which measures 1 1/2 inches by 1 inch, and may be either 1/4 inch or 3/8 inch in thickness. Two holes 1/4 inch in diameter with their centres 9-16 inch apart are drilled for the reception of the plug and socket, which will be found a good push fit for them. Insert the plug so that its shoulder lies flush with its surface. Then place the block in a vice so that the end nearest the plug is uppermost and drill a 6 B.A. tapping hole (No. 42 drill) right

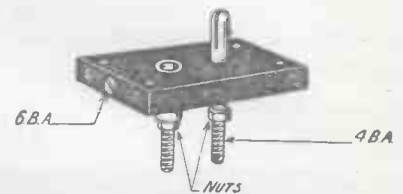

Fig. 4.—The finished cabinet plug.

through into the brass, countersinking so that the head of the screw will lie flush. Tap this hole. Next remove the plug temporarily and insert the socket drilling and tapping in the same way. The screw used for fixing the socket will have to be cut off so that its end does not protrude into the hole. Before mounting the block on to the cabinet, drill 1/2-inch holes right through the wood to allow the shanks of plug and socket to clear.

Connections with the L.T. bus-bars may be made if desired by soldering them direct to the ends of plug and socket. If this is to be done they should be thoroughly well tinned before inserting them into the ebonite. Even then it is rather difficult not to heat up the ebonite during the process of soldering, and the writer prefers the method shown in Fig. 4. A 4 B.A. hole is drilled and tapped in the end of each—No. 33 drill will be found suitable for making the required tapping holes in brass—and a 1-inch length of 4 B.A. studding is inserted, being locked into place by means of a

nut; & the studding may be soldered into the plug and socket, in which case it will be as firm as a rock. It is now a very easy matter to solder the necessary leads to both plug and socket on the inside of the cabinet, and, owing to the length of the shanks made by the pieces of studding,

there is no fear of loosening them in the ebonite block by overheating.

It is as well to provide a safety attachment for the plug attached to the flex lead when the set is out of use. This can be done very easily by mounting another plug and socket with no connec-

tions in a piece of ebonite, and fixing this to the window frame close to the screw eye to which the flex leads are attached. When the set is not in use the plug attached to the flex leads is inserted into this, and an accidental short circuit becomes quite impossible.

M. P. H.

A Universal Tool Handle

It is best, of course, to fit a wooden handle of its own to each of one's files. This is rather an expensive business if the outfit is a large one, and it usually happens that there are a good many files without handles. It is not at all easy to use these satisfactorily, and with small files the palm of the hand is not infrequently hurt by the pointed tang. Here is a very simple universal handle which anyone can make up at small cost and which will be found most convenient. Obtain a 1-in. length of 1/2-in. round brass rod and cut it in two longitudinally with a hacksaw. Trim up the flat face of one of the halves and file in it a deep V-shaped slot from end to end. Drill and tap two 4 B.A. holes as shown in the drawing at either side of the curved surface.

Obtain next a 4-in. length of stout metal tubing with an internal diameter of 1/2 in. In this drill 4 B.A. clearance holes to correspond with the tapped holes in the D-shaped piece; insert the latter and fix it in position with short screws. Make a plug of hard wood 3 in. long which will just fit into the tube. Drill a 3/16-in. hole 1 in. deep in one end of the plug, then drive it home and secure with a couple of countersunk wood screws driven into it through holes drilled in the tube. Drill and tap a 2 B.A. hole in the tube immediately above the V-cut in the D-piece. Into this insert a 2 B.A. screw, preferably one with a wing or milled head.

To use the handle push the file firmly into it so that the tang lies in the V-slot and its point goes into the 3/16-in. hole in the wooden plug. Then turn down the 2 B.A. screw tightly

on to it and the tool can be relied upon not to slip. The main purpose of the universal handle is to serve as a holder for small or medium files, but will

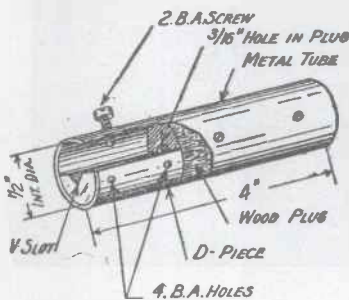

also act very well for screw-driver blades and for any other small tools that may be without handles of their own.

H. W. R.

ESPERANTO AND WIRELESS

After two years' consideration of the subject of an international language for radio, the American Radio Relay League, perhaps the largest and most influential amateur radio body in the world, has just decided, at its annual meeting in Connecticut, to endorse Esperanto as the international radio language. It has also decided to support Esperanto for adoption by the International Amateur Radio Union, the first conference of which will be held in Paris next Easter.

It is proposed to establish an Esperanto broadcasting station in Switzerland, to send out news and other items.

American Broadcasting Stations

The following particulars have been submitted by Mr. A. E. Davis for the information of readers.

Station.	Wavelength.	Town.
CKAC (La Presse) ...	430 metres.	Montreal, Canada.
WGY (General Electric Co.) ...	380 metres.	Schenectady, N.Y.
WHAM (Eastman School of Music)	283 metres.	Rochester, N.Y.
WEAF (American Tel. & Tel. Co.) ...	492 metres.	New York City.
WJZ (Radio Corp. of America) ...	455 metres.	New York City.
WOR, L. (Bamberger) ...	405 metres.	Newark, N.J.
WIP (Gimbel Bros.) ...	509 metres.	Philadelphia, Pa.
KDKA (Westinghouse Elect.) ...	326 metres.	East Pittsburgh, Pa.
KOV (Doubleday Elec. Co.) ...	270 metres.	Pittsburgh, Pa.
WCAE (Kaufmann & Baer Co.) ...	462 metres.	Pittsburgh, Pa.
WRC (Radio Corp. of America) ...	469 metres.	Washington, D.C.
WCAP (Chesapeake & Potomac Tel. Co.) ...	469 metres.	Washington, D.C.
WWJ (The Detroit News) ...	517 metres.	Detroit, Mich.
WBZ (Boston Herald Traveller) ...	337 metres.	Boston, Mass.
WLW (The Crosley Radio Corp.) ...	309 metres.	Cincinnati, O.
KYW (Westinghouse) ...	536 metres.	Chicago, Ill.
WMAQ (Chicago Daily News) ...	448 metres.	Chicago, Ill.
WLAG (Cutting Washington Co.) ...	417 metres.	Minneapolis, Minn.
WDAF (Kansas City Star) ...	411 metres.	Kansas City, M.O.
WOAW (Woodmen of the World)	526 metres.	Omaha, Neb.
KPO (Hale Bros.) ...	423 metres.	San Francisco, Calif.
KFI (Earle & Anthony, Inc.) ...	469 metres.	Los Angeles, Calif.
KGO (General Elect. Co.) ...	312 metres.	Oakland, Calif.
KGW (Morning Oregonian) ...	492 metres.	Portland, Ore.



A Compact Single Valve Flewelling Receiver.

IT is thought that this present series of articles, now concluding, would scarcely be complete without some reference to a comparatively new and interesting development in wireless reception—namely, super-regeneration.

As previously explained, a considerable increase in signal

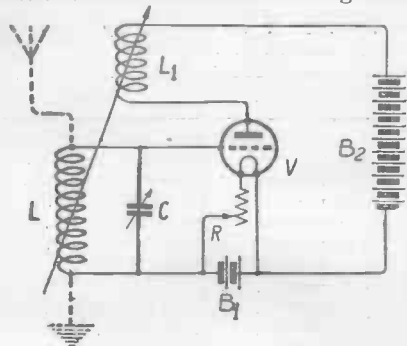

Fig. 1.—Illustrating ordinary regeneration.

strength may be obtained if the losses due to the resistance of the aerial circuit (or, of course, the resistance of the grid or input circuit of the second or subsequent valve of a multi-valve receiver) are compensated by the proper use of reaction.

By introducing an additional inductance coil, represented at L_1 in Fig. 1 herewith, in the anode circuit of the valve, and

coupling this coil in the correct sense to the grid coil L , energy is transferred from the anode circuit into the grid circuit, and assists the building up of oscillations in that circuit.

Regeneration

This is the principle of ordinary regeneration (or reaction as it is more popularly known in this country), and the effect of the transfer of energy between the coils is to reduce the effective resistance of the grid circuit LC , a process referred to as introducing negative resistance into the circuit.

Provided that the degree of coupling between L_1 and L is insufficient to maintain continuous oscillations in the circuit LC , the latter circuit will have positive resistance, and the complete system will remain stable and free from self oscillation.

If the coupling is increased until the effective resistance of the oscillatory circuit is exactly zero, the system will be in an extremely sensitive condition, and will remain so until, upon the slightest disturbance in the circuit, such as the removal of the operator's hand from the condenser or the arrival of a signal, the system will "trip over" into self oscillation.

How Every . . . Crystal User may become a Valve Expert

By E. Redpath.

In the following article the elementary principles of super-regeneration are briefly explained, and constructional details of a Flewelling Super-Regenerative Receiver are given.

The Practical Limit

It will thus be seen that, for all practical purposes, there is a very definite limit to which simple regeneration can be advanced, and that this limit leaves the oscillating circuit not at zero resistance, but with a small positive resistance which, though undesirable if extreme sensitivity is required, cannot be avoided if stability is to be maintained.

On further tightening the coupling between the coils L_1 and L , so as to more than overcome its natural resistance (i.e., giving it a definite negative resistance), continuous oscillations will be generated with consequent distortion of received

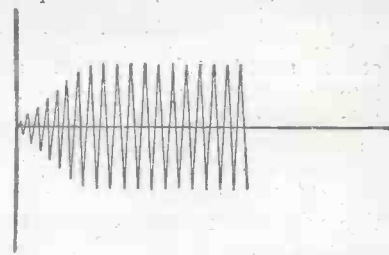

Fig. 1a.—The rapid build up of oscillations in an unstable regenerative receiver.

signals. Oscillations are built up rapidly, and then maintained at constant amplitude as illustrated graphically in Fig. 1a.

Super-Regeneration

A method whereby regeneration could be advanced well beyond its then existing limit was designed by Major E. H. Armstrong (U.S.A.). His invention consisted in arranging that the aerial-grid or input circuit of a valve receiver should be given a definite negative resistance by carrying regeneration beyond its

usual limit, with consequent rapid building up of an incoming signal, and at the same time arranging that, no sooner had the oscillation built up to a considerable value and the complete system just about to "trip over" into continued self oscillation, than the resistance values were altered so as to restore original conditions.

The change in resistance values was made to occur periodically and at a frequency beyond, or almost beyond, the upper limit of audibility, so that very little interference was caused with the actual incoming signals.

Alternative Methods

There are various methods by which the periodic changes in resistance values may be made to occur. In one method the

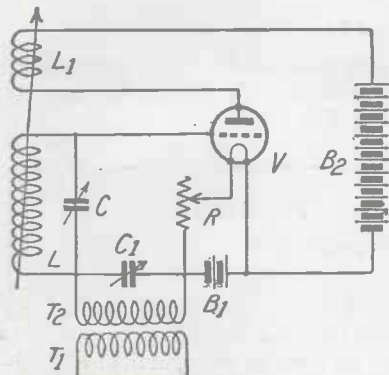

repeated periodically 10,000 times per second.

At this frequency (known as the "quenching" frequency) a very high but still audible note would probably be produced in

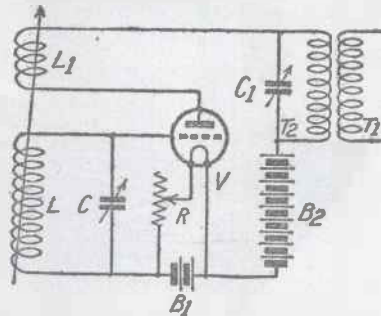

Fig. 3.—The quenching oscillations varying the regenerative effect.

telephone receivers. Increasing the quenching frequency to, say, 15,000 or 16,000 per second,

illustrates a method of varying the effective resistance of the input or grid circuit indirectly. In this case the quenching oscillations are applied to the anode circuit of the valve, so varying the current traversing the reaction coil L_1 , and consequently varying its regenerative effect upon the grid circuit.

In contradistinction to the continuous oscillations indicated in Fig. 1a, Fig. 3a will perhaps assist readers to visualise the effect of applying the quenching oscillation.

The Flewelling Super

Another method of obtaining super-regeneration is due to Mr. E. T. Flewelling. Fig. 4, herewith, is the theoretical circuit diagram of the original Flewelling receiver, as described by the inventor in *Wireless Weekly*

Fig. 2.—The quenching oscillations applied to the grid circuit direct.

Fig. 4.—The original Flewelling Circuit with three large-capacity condensers.

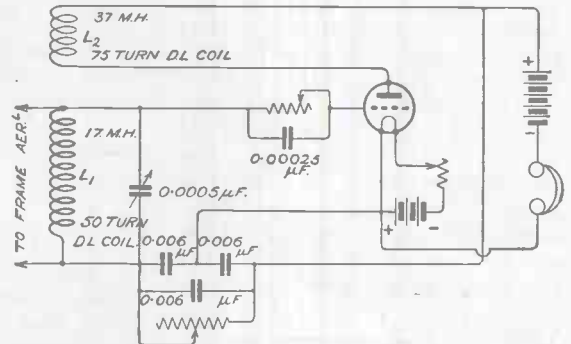

resistance of the grid or input circuit is varied directly on the principle illustrated in the theoretical diagram Fig. 2.

The coil T_2 (the secondary of an oscillation transformer T_1 , T_2), with parallel variable condenser C_1 , is introduced in the grid circuit, the coil and condenser being of such values that the oscillatory circuit which they together form is capable of being adjusted or tuned to have a frequency of, say, 10,000 per second.

Oscillations set up in this almost audio-frequency circuit will cause periodic variations in the resistance of the circuit and prevent continuous oscillation.

In other words, for one ten-thousandth part of a second the incoming signals will be permitted to build up towards oscillation point, then an interruption will occur and the amplitude of the oscillation will decrease, this cycle of events being

would practically eliminate the audible and characteristic whistling note, but would allow a shorter time for the building up of the incoming signal.

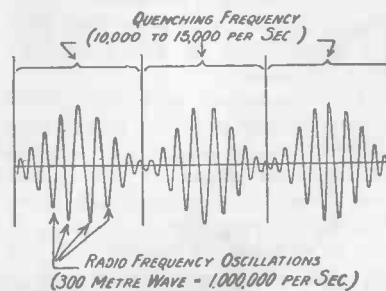

Fig. 3a.—Effect of quenching oscillations.

Conversely, reducing the quenching frequency would bring the whistling note to a lower pitch and greater prominence, but would allow a greater length of time for signals to build up into oscillations of considerable amplitude.

The circuit diagram (Fig. 3)

of August 15, 1923 (Vol. 2, No. 5).

The following short extracts from the article in question, together with the diagram, Fig. 4, will explain how the combination of large capacity condensers in conjunction with the variable grid leak produces the necessary quenching effect:—

"For those who may wish to study the fundamental idea of the Flewelling circuit, I can do no better than to call to their minds the action of a condenser periodically charged and discharged, remind them of the resulting ripple, and suggest that such ripple be applied to the grid of a regenerative or retroactive circuit at the proper time. What really happens in the circuit is that regeneration is advanced to the point of 'spill over,' and as the action goes beyond this point the tube is blocked, started again, the condensers charge and discharge,

and the resulting condenser ripple is used to control the receiver at a point of maximum regeneration. This point is considerably beyond that obtained in a plain regenerator, due to the fact that we now have a positive control over the positive or negative resistance condition of the circuit.

“One must have a hard valve and such variable grid leaks or high resistances as will enable one to secure proper control of the grid of the valve, and thus properly time the blocking action. It will be found that this action is audible in the 'phones, and results in the shrill, high-pitched whistle that is characteristic of the super-regenerative receiver. The adjustment of the receiver should be such that, as the incoming signal is tuned in, the pitch of the whistle rises until, at the point of maximum signal strength, the pitch is so high as to be almost inaudible.

“Care should be taken that none but the better types of apparatus is used. The 0.006 μF condensers are not critical in value, and may run from 0.005 μF to 0.01 μF with no serious effects. Any type of hard tube may be used,

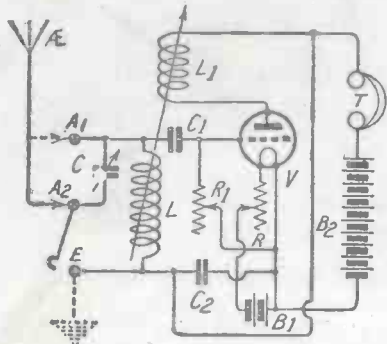

Fig. 5.—A modified Flewelling circuit with single condenser C2.

and the anode voltage will be in accordance with the tube used, generally being between 45 and 100 volts.”

A Simplified Flewelling Receiver

Fig. 5 is a modification, by the inventor, of his original circuit, and is the theoretical circuit diagram of the receiver illustrated in the photograph at the beginning of this article.

Those readers who constructed the earlier single valve receiver

may readily convert it to a Flewelling receiver, the position

for the benefit of others, a dimensioned plan and complete wiring

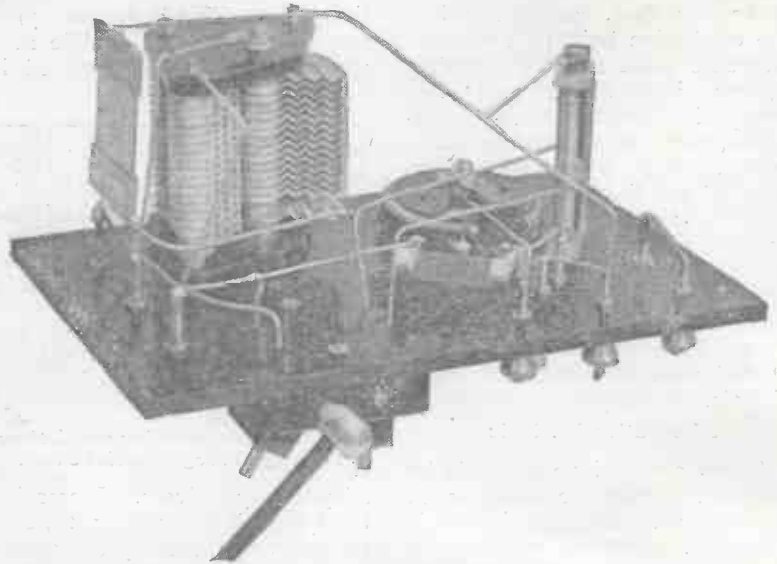

Fig. 6.—Back of panel view of Flewelling receiver.

of the variable grid leak and the large condenser being shown in the photograph, Fig. 6, whilst,

diagram will be given next week, together with details for operating this receiver.

The Transmitters' Position

(Concluded from page 677)

Britain suggest this course, either then or when the questions of wavelengths and trans-Atlantic facilities were discussed last autumn and early this year. It has been the recognised practice for licensees to apply for special permission where they wished to carry out experiments with places abroad, and I do not think an application of the kind has been refused.

In connection with a general issue of fresh permits, which was undertaken as a result of agreed changes in some of the other conditions, the recognised practice was expressly embodied in the new form of permit. I am sorry it was expressed in such a forbidding form. It would have been better, and more consonant with the policy, to have worded it: “Except with the special permission of the Postmaster-General, messages shall only be transmitted to stations in Great Britain,” etc., etc. Such permission has, as you know, been granted in many cases—with largely increased power in the case of the trans-Atlantic tests

which are now being carried on all the year round.

In view of the practical difficulties which might arise if communication with other countries were allowed as a matter of course to the many hundreds of persons holding sending permits, and especially in view of possible developments in the near future in international wireless telephony—I do not think we are unreasonable in asking (in accordance with the practice hitherto followed) that any experimenter desiring facilities for experiments with stations abroad should furnish particulars of the experiments and evidence of an arrangement for co-operation by a foreign or colonial experimental station or stations.

I should perhaps add that the general procedure was discussed orally with Mr. Philip Coursey and Mr. Gerald Marcuse, and I do not think that any difficulty was anticipated by the Transmitters' Section of the Radio Society.

(Signed) F. J. BROWN.
General Post Office.

Regular Programmes from Continental Broadcasting Stations

Telephony except when otherwise stated. Corrected up to September 21st, 1924.

Edited by CAPTAIN L. F. PLUGGE, B.Sc., F.R.Ae.S., F.R.Met.S.

Strictly Copyright.

Greenwich Mean Time.	Name of Station.	Call Sign and Wavelength.	Locality where Situated.	Nature of Transmission.	Closing-down time or approx. duration of Transmission.
WEEK DAYS					
a.m.					
6.40	Eiffel Tower	FL 2600 m.	Paris	Weather Forecast	5 minutes.
6.55	Persbureau M.S. Vaz Dias.	PCFF 2125 m.	Amsterdam	Stocks, Shares and News	10 minutes.
7.00	Munich	— 486 m.	Bavaria	Market Prices	10 minutes.
8.45	Persbureau M.S. Vaz Dias.	PCFF 2125 m.	Amsterdam	Stocks, Shares and News	10 minutes.
9.00	Voxhaus	— 430 m.	Berlin	Stocks and Shares	3 minutes.
9.15	Voxhaus	— 430 m.	Berlin	News	10 minutes.
9.23	Eiffel Tower	FL 2600 m.	Paris	Time Signal in G.M.T. (Spark)	3 minutes.
9.30	Lyons	YN 470 m.	Lyons	Concert	Until 10.00 a.m.
9.40	Eiffel Tower	FL 2600 m.	Paris	Cotton and Coffee quotations	5 minutes.
10.00	Eiffel Tower	FL 2600 m.	Paris	Time Signal in Greenwich Sidereal Time (Spark).	5 minutes.
10.10	Persbureau M.S. Vaz Dias.	PCFF 2125 m.	Amsterdam	Stocks, Shares and News	Until 10.30 a.m.
10.44	Eiffel Tower	FL 2600 m.	Paris	Time Signal in G.M.T. (Spark)	3 minutes.
10.55	Eiffel Tower	FL 2600 m.	Paris	Fish Market quotations (Mondays excepted).	5 minutes.
10.55	Frankfurt	— 467 m.	Frankfurt	Time Signal (spoken), followed by news.	10 minutes.
11.00	Persbureau M.S. Vaz Dias.	PCFF 2125 m.	Amsterdam	Stocks, Shares and News	10 minutes.
11.14	Eiffel Tower	FL 2600 m.	Paris	Time Signal in Greenwich Time (Spoken), followed by Weather Forecast.	5 minutes.
11.15	Voxhaus	— 430 m.	Berlin	Stock Exchange News	5 minutes.
11.30	Radio-Paris	SFR 1780 m.	Clichy	Items of News	15 minutes.
11.45	Radio-Paris	SFR 1780 m.	Clichy	Concert (Light Orchestra), followed by Exchange Opening Prices.	12.45 p.m.
11.45	Persbureau M.S. Vaz Dias.	PCFF 2125 m.	Amsterdam	Stocks, Shares and News	10 minutes.
11.55	Voxhaus	— 430 m.	Berlin	Time Signals (spoken), followed by News	10 minutes.
11.55	Breslau	— 415 m.	Silesia	Time Signal (spoken), followed by Weather Report and Stock News.	15 minutes.
11.57	Nauen	POZ 3100	Berlin	Time Signal in G.M.T. (Spark)	8 minutes.
12 noon	Haeren	BAV 1100 m.	Brussels	Weather Forecast	5 minutes.
12.00	Leipzig	— 452 m.	Leipzig	Stock Exchange—General News	5 minutes.
12.15	Geneva	HBI 1100 m.	Switzerland	Weather Forecast, followed by Lecture.	One half-hour.
1.00	Munich	— 486 m.	Bavaria	News and Weather Report	10 minutes.
1.15	Voxhaus	— 430 m.	Berlin	Stock Exchange News.	5 minutes.
1.40	Persbureau M.S. Vaz Dias.	PCFF 2125 m.	Amsterdam	Stocks, Shares and News	10 minutes.
2.10	Eiffel Tower	FL 2600 m.	Paris	Stock Exchange Intelligence (Saturdays excepted).	8 minutes.
2.55	Persbureau M.S. Vaz Dias.	PCFF 2125 m.	Amsterdam	Stocks, Shares and News	10 minutes.
3.00	Centocelle	ICD 1800 m.	Italy	Weather Report	10 minutes.
3.30	Stuttgart	— 437 m.	Wurtemberg	Light Orchestra, followed by Weather Report.	Until 5 p.m.
3.30	Frankfurt	— 467 m.	Frankfurt	Music by Station Orchestra	Until 5 p.m.
3.30	Leipzig	— 452 m.	Leipzig	Concert	Until 4.30 p.m.
3.30	Radio-Paris	SFR 1780 m.	Clichy	News, followed by Concert and late News.	Until 4.45 p.m.

Greenwich Mean Time.	Name of Station.	Call Sign and Wavelength.	Locality where situated.	Nature of Transmission.	Closing-down time or approx. duration of Transmission.
WEEK DAYS (Contd.)					
p.m.					
3.50	Haeren ...	BAV 1100 m. ...	Brussels	Weather Forecast ...	5 minutes.
4.00	Geneva ...	HB 1100 m. ...	Switzerland	Lecture ...	One hour.
4.00	Radio-Belgique ...	SBR 265 m. ...	Brussels	Concert, followed by News Bulletin	5 p.m.
4.30	Eiffel Tower ...	FL 2600 m. ...	Paris	Stock Exchange, closing prices (Saturdays excepted).	8 minutes.
4.30	Voxhaus ...	— 430 m. ...	Berlin	Light Orchestra, followed occasionally by Sporting News.	Until 6 p.m.
5.30	Munich ...	— 486 m. ...	Bavaria	Light Orchestra ...	Until 6.30 p.m.
5.30	Ravag ...	— 530 m. ...	Vienna	Concert ...	Until 7 p.m.
7.00	Voxhaus ...	— 430 & 500 m. ...	Berlin	Lecture ...	45 minutes.
7.00	Eiffel Tower ...	FL 2600 m. ...	Paris	General Weather Forecast	8 minutes.
7.00	Munster ...	— 407 m. ...	Westphalia	Concert ...	Until 8.30 p.m.
7.00	Konigsberg ...	— 460 m. ...	East Prussia	Concert ...	Until 8.30 p.m.
7.15	Leipzig ...	— 452 m. ...	Leipzig	Concert, followed by News	8.35 p.m.
7.15	Lausanne ...	HB2 850 m. ...	Switzerland	Concert (Thursdays excepted)	8.30 p.m.
7.15	Radio-Belgique ...	SBR 265 m. ...	Brussels	Concert, followed by News Bulletin	Till 9.10 p.m.
7.15	Ecole. Sup. des Postes et Telegraphes.	PTT 450 m. ...	Paris	Lecture, followed by Concert. (Usually Outside Broadcast, some times begins at 8 or 8.30) (Mondays excepted).	Two to three hours.
7.30	Radio-Paris ...	SFR 1780 m. ...	Clichy	General News Bulletin ...	One half-hour.
7.30	Frankfurt ...	— 467 m. ...	Frankfurt	Concert, followed by News	Between 9 and 10 p.m.
7.30	Stuttgart ...	— 437 m. ...	Wurtemberg	Concert, followed by News	Until 8.30 p.m.
7.30	Breslau ...	— 415 m. ...	Silesia	Concert ...	Until 10 p.m.
7.30	Hamburg ...	— 392 m. ...	Germany	Concert ...	Until 10 p.m.
7.30	Leipzig ...	— 452 m. ...	Germany	Concert, Short News Bulletin at 8.45 p.m.	Until 10 p.m.
7.30	Zurich ...	— 650 m. ...	Switzerland	Concert, followed by News	9.15 p.m.
7.30	Voxhaus ...	— 430 & 500 m. ...	Berlin	Concert, followed by Weather Report.	Until 9.15
8.00	Radio-Paris ...	SFR 178 m. ...	Clichy	Time Signal in Greenwich Time, followed by Concert.	8.50 p.m.
8.00	Munich ...	— 486 m. ...	Bavaria	Music and Speech, followed by News.	9.00
9.30	Madrid ...	— 392 m. ...	Spain	Concert ...	Until Mid-night.
10.00	Eiffel Tower ...	FL 2600 m. ...	Paris	Time Signal in Greenwich Sidereal Time (Spark).	5 minutes.
10.10	Eiffel Tower ...	FL 2600 m. ...	Paris	Weather Forecast ...	5 minutes.
10.44	Eiffel Tower ...	FL 2600 m. ...	Paris	Time Signal in G.M.T. (Spark)	3 minutes.
11.57	Nauen ...	POZ 3100 m. ...	Berlin	Time Signal in G.M.T. (Spark)	8 minutes.
SUNDAYS					
a.m.					
9.23	Eiffel Tower ...	FL 2600 m. ...	Paris	Time Signal in G.M.T. (Spark)	3 minutes.
9.30	Lyons ...	YN 470 m. ...	France	Concert ...	Until 10 p.m.
9.50	Konigswusterhausen ...	— 680 m. ...	—	Concert ...	1 hour.
10.00	Ravag ...	— 530 m. ...	Vienna	Instrumental Concert ...	Until 11.30 a.m.
10.00	Eiffel Tower ...	FL 2600 m. ...	Paris	Time Signal in Greenwich Sidereal Time (Spark)	5 minutes.
10.44	Eiffel Tower ...	FL 2600 m. ...	Paris	Time Signal in G.M.T. (Spark)	3 minutes.
10.50	Konigswusterhausen ...	LP 2800 m. ...	Berlin	Concert ...	Until 11.45 a.m.
10.55	Eiffel Tower ...	FL 2600 m. ...	Paris	Fish Market quotations ...	5 minutes.
11.45	Radio-Paris ...	SFR 1780 m. ...	Clichy	Concert, followed by News	12.45 p.m.
11.53	Nauen ...	POZ 3100 m. ...	Berlin	Time Signal in G.M.T. (Spark)	8 minutes.
p.m.					
1.40	Ned. Radio Industrie	PCGG 1050 m. ...	The Hague	Concert, followed by Announcements in English	Until 4.40 p.m.
3.45	Radio-Paris ...	SFR 1780 m. ...	Clichy	Concert, followed by News	4.45 p.m.
4.00	Radio-Belgique ...	SBR m. ...	Brussels	Concert ...	5 p.m.
5.30	Ravag ...	— 530 m. ...	Vienna	Concert ...	Until 7 p.m.
6.00	Voxhaus ...	— 430 m. ...	Berlin	Children's Corner ...	30 minutes.
7.00	Voxhaus ...	— 430 & 500 m. ...	Berlin	Concert preceded by Religious or Patriotic Address	Until 9.15 p.m.

Greenwich Mean time.	Name of Station.	Call Sign and Wave-length.	Locality where Situated.	Nature of Transmission.	Closing-down time or approx. duration of Transmission.
SUNDAYS (Contd.)					
p.m.					
7.00	Eiffel Tower	FL 2600 m.	Paris	General Weather Forecast	8 minutes
7.00	Munster	—407 m.	Westphalia	Concert	Until 8.30 p.m.
7.00	Konigsberg	—460 m.	East Prussia	Concert	Until 8.30 p.m.
7.10	Ned. Seintoestellen Fabr.	NSF 1050 m.	Hilversum	Concert	Until 9.10 p.m.
7.15	Radio-Belgique	SBR 265 m.	Brussels	Concert, followed by News Bulletin	Until 9.10 p.m.
7.30	Zurich	—650 m.	Switzerland	Concert, followed by Late News	9.15 p.m.
7.30	Breslau	—415 m.	Silesia	Concert	Until 10 p.m.
7.30	Hamburg	—392 m.	Germany	Concert	Until 10 p.m.
7.30	Leipzig	—452 m.	Germany	Concert, Short News Bulletin at 8.45 p.m.	Until 10 p.m.
7.30	Stuttgart	—437 m.	Wurtemberg	Concert, followed by Dance Music	Until 10.30 p.m.
7.30	Radio-Paris	SFR 1780 m.	Clichy	General News Bulletin	Until 8 p.m.
7.30	Ecole Sup. des Postes et Telegraphes.	PTT 450 m.	Paris	Concert or Lecture. (May begin a quarter-hour earlier or later.)	Ends between 9.30 and 11 p.m.
8.00	Radio-Paris	SFR 1780 m.	Clichy	Concert, followed from 10 p.m. until 10.45 p.m. by Dance Music	Until 9.45 p.m.
8.30	Petit Parisien	—340 m.	Paris	Concert (Items announced in English as well as French).	Until 10.30 p.m.
9.30	Madrid	—392 m.	Spain	Concert	Until 11.30 p.m.
10.00	Eiffel Tower	FL 2600 m.	Paris	Time Signal in Greenwich Sidereal Time (Spark).	5 minutes.
10.44	Eiffel Tower	FL 2600 m.	Paris	Time Signal in G.M.T. (Spark)	3 minutes.
11.57	Nauen	POZ 3100 m.	Berlin	Time Signal in G.M.T. (Spark)	8 minutes.

Greenwich Mean time.	Name of Station.	Call Sign and Wave-length.	Locality where Situated.	Day of Week.	Nature of Transmission.	Closing-down time or approx. duration of Transmission.
SPECIAL DAYS						
p.m.						
1.00	Ecole Sup. des Postes et Telegraphes.	PTT 450 m.	Paris	Fridays	Concert or Lecture	Two hours.
4.00	Lausanne	HB 2850 m.	Switzerland	Thursdays	Children's Stories	One hour.
5.15	Eiffel Tower	FL 2600 m.	Paris	Mondays, Wednesdays and Fridays.	Concert, followed by News.	Until 6.10 p.m.
5.30	Eiffel Tower	FL 2600 m.	Paris	Tuesdays, Thursdays, & Saturdays.	News Bulletin	10 minutes.
5.55	Ned. Radio Industrie	PCGG 1070 m.	The Hague	Mondays	Children's Hour	Until 7.10 p.m.
6.00	Voxhaus	—430 m.	Berlin	Wednesdays	Children's Corner	30 minutes.
6.40	Heussen Laboratory	PCUU 1050 m.	The Hague	Tuesdays	Concert	Until 8.40 p.m.
6.40	Smith & Hooghoudt	PA5 1050 m.	Amsterdam	Wednesdays	Concert	Until 8.40 p.m.
7.00	Svenska	—470 m.	Stockholm	Tuesdays and Thursdays.	Concert	Until 10 p.m.
7.10	Ned. Radio Industrie	PCGG 1070 m.	The Hague	Mondays and Thursdays.	Concert	Until 9.10 p.m.
7.10	Middelraad	PCMM 1050 m.	Ymuiden	Saturdays	Concert	Until 8.40 p.m.
7.40	Ned. Seintoestellen Fabriek.	NSF 1050 m.	Hilversum	Fridays	Concert	Until 8.40 p.m.
8.00	Le Matin	SFR 1780 m.	Paris	Every 2nd & 4th Saturday of the month.	Special Gala Concert with leading Parisian artists.	Till 9.55 p.m.
8.30	Petit Parisien	—340 m.	Paris	Tuesdays and Thursdays.	Concert (Items announced in English as well as French).	10.30 p.m.
9.00	Radio-Paris	SFR 1780 m.	Clichy	Wednesdays & Fridays.	Dance Music	Until 9.45 p.m.

HOURS OF CONTINENTAL

CORRECTED UP TO

SPECIAL DAYS

Thursdays.....	Lausanne.....	850 m
Mon, Wed. & Fri (Concert).....	Eiffel Tower.....	2600 m
2nd & 4th Saturdays.....	Le Matin.....	1780 m
Wednesdays & Fridays.....	Radio-Paris.....	1780 m
Saturdays.....	P.C.M.M. Ymuiden.....	1050 m
Fridays.....	N.S.F. Hilversum.....	1050 m
Thursdays.....	P.C.G.G. The Hague.....	1070 m
Wednesdays.....	Berlin.....	430 m
Tuesdays.....	P.C.U.U. The Hague.....	1050 m
Mondays.....	P.C.G.G. The Hague.....	1070 m
Tues & Thurs.....	Svenska (Stockholm).....	470 m
Thursdays.....	Petit Parisien.....	340 m
Fridays.....	Ecole Superieure des P&T.....	450 m
Tuesdays, Thurs & Sats.....	Eiffel Tower.....	2600 m

SUNDAYS

Nauen.....	3100 m
Königwusterhausen.....	2800 m
Eiffel Tower.....	2600 m
Lyons.....	470 m
Berlin.....	430 m
Rome.....	1800 m
Radio-Paris.....	1780 m
N.S.F. The Hague.....	1050 m
P.C.G.G. The Hague.....	1070 m
Zurich.....	650 m
Ecole Superieure des Postes & Tg.....	450 m
Brussels.....	265 m
Petit Parisien.....	340 m
Madrid.....	392 m
Munster.....	407 m
Breslau.....	415 m
Stuttgart.....	437 m

WEEK DAYS

Nauen.....	3100 m
Eiffel Tower.....	2600 m
Munich.....	486 m
Frankfort.....	467 m
Berlin.....	430 m
Rome.....	1800 m
Radio-Paris.....	1780 m
Haeren.....	1100 m
Geneva.....	1100 m
Lyons.....	470 m
Ecole Superieure des Postes & Tg.....	450 m
Brussels.....	265 m
Madrid.....	392 m
Zurich.....	650 m
Munster.....	407 m
Breslau.....	415 m
Stuttgart.....	437 m

G.M.T.

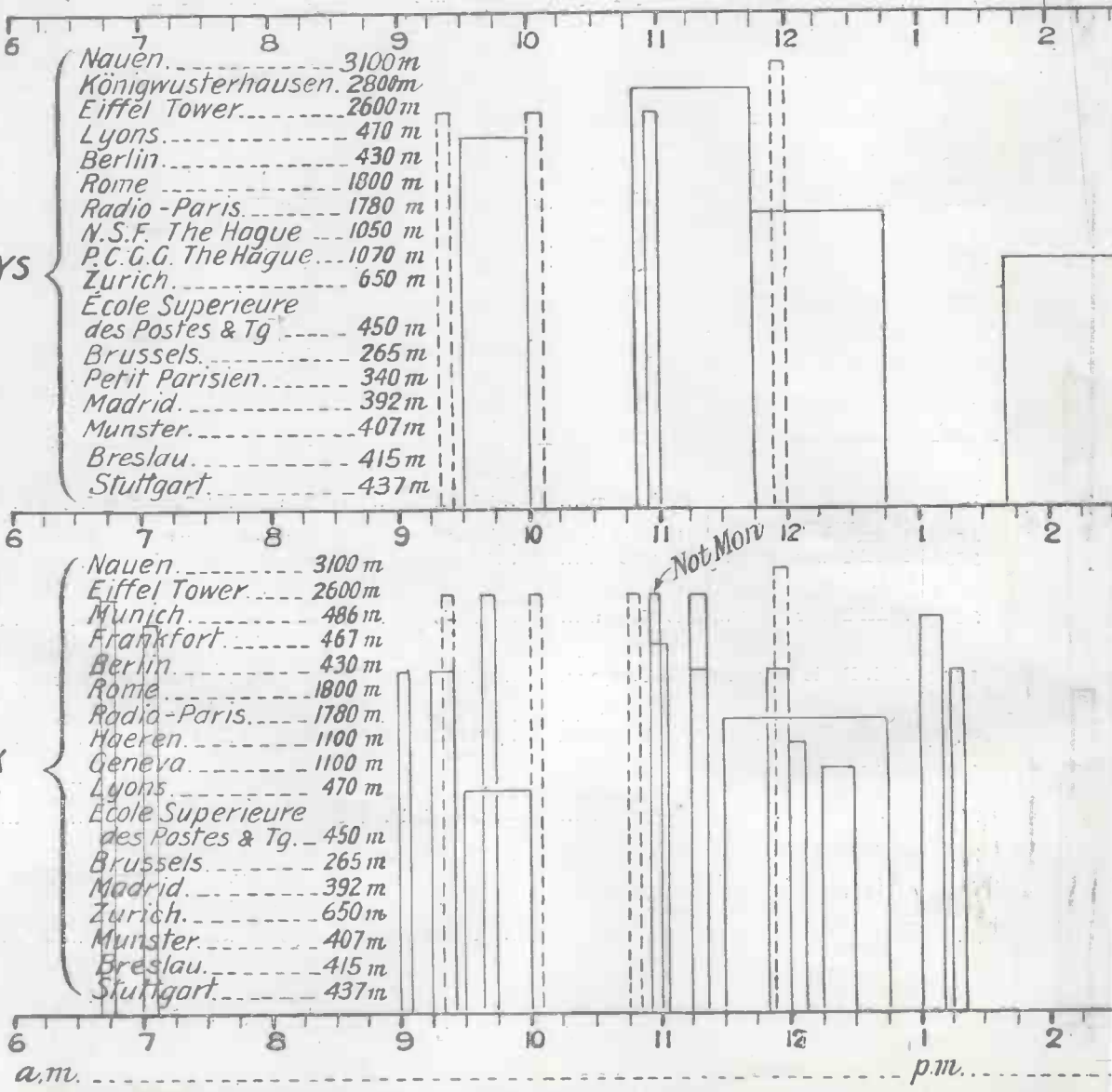

Strictly Copyright.

LEADING TRANSMISSIONS.

SEPTEMBER 21ST 1924.

— TELEPHONY.
 — SPARK TRANSMISSION.
 (Time Signal.)

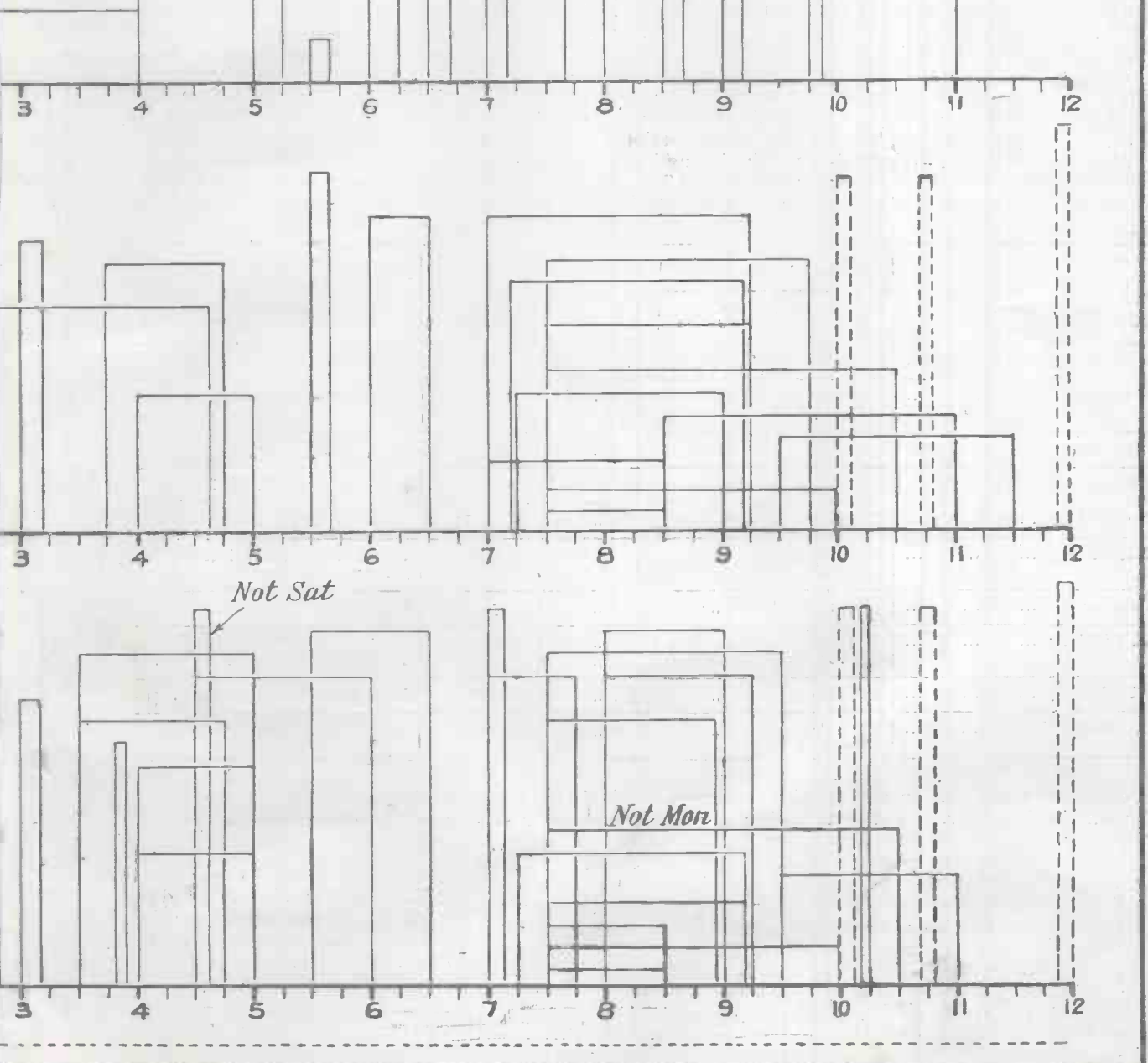

A Long-Range Two-Valve Receiver

By J. UNDERDOWN.

Full constructional details of this receiver were given in our last issue.

Test Report

The set was tested on an evening transmission on an excellent aerial 41 miles S.E. of London by the writer, and all the main B.B.C. stations were obtained. A Cossor pink-top valve was used in the H.F. socket with 54 volts on the plate, whilst the detector was a Mullard "Ora" with 60 volts high-tension. Gambrell coils and a Gent 50 H.F. transformer were used.

2LO was obtained at fair loud-speaker strength, the Savoy Band being pleasantly audible in

School of Posts and Telegraphs was also received on a previous test at good 'phone strength. After the British Station had closed down Madrid came through excellently with little interference after midnight, and the addition of a note-magnifier rendered this station pleasantly audible on the loud-speaker.

In reviewing these results it should, however, be noted that they were obtained in a district which is noticeably good for reception. The results conclusively demonstrate that the set

Tested on the longer wave-lengths 5XX, Chelmsford, was received at good loud-speaker strength. Magnum-tapped coils were used for the aerial and reaction circuits, that marked 450 to 3,560 metres in the aerial socket, and the one marked 150 to 1,050 metres in the reaction. The stud marked 200 gave the best results for the aerial circuit for Chelmsford, whilst the whole of the other coil was used for reaction. As a suitable high-frequency transformer was not available at the time, two Gambrell "F" coils, closely coupled in a two-coil holder, were used in place of the former, and found quite suitable. Alternately, in this position a 100,000 ohms resistance was used in the plate circuit, between OP and IP, and OP shorted to OS, thus making the high-frequency into a resistance coupled valve. With the arrangement 5XX was received, but not at such good strength as

Station.	Aerial Circuit.		H.F. Circuit.		Remarks.
	Condenser Reading.	Aerial Coil.	Reaction.	Condenser Reading.	
Cardiff	18°	A	a	2°	Excellent telephone strength.
London	32°	"	"	18°	Fair loud-speaker-strength. Uncomfortably loud in phones.
Manchester	37°	"	"	20°	Fair only.
Bournemouth... ..	40°	"	"	22°	Good 'phone strength.
Newcastle	48°	"	"	27.5°	Excellent in 'phones.
Madrid	55°	"	"	29°	Good strength, but interference from 5NO.
Glasgow	71°	"	"	31°	Good 'phone strength.
Birmingham	100° 10°	" B	"	5.2° 53°	Good 'phone strength. Better than with "A" coil.
Aberdeen	13°	"	"	55°	Very good 'phone strength.
600 metre Morse	50°	"	"	80°	—

a moderate size room on an Hi Brown loud-speaker. The set was only tested on the broadcast range, and above are given the readings and results on the various stations between 300 and 500 metres. Condenser readings are given, as these may prove helpful. The aerial readings will, of course, vary with every aerial, but the proportion should remain more or less constant.

The French station of the

is particularly suited to those living 50 miles or so from a station. The square law condensers were found to have decided advantages over the ordinary type, as the stations were not found to be crowded at the bottom of the condenser scale, making tuning consequently much easier. No hard capacity effects were noticed due to the moving plates and metal dials being connected to the low potential sides in both cases.

with transformer coupling. The variable condenser C2 was, of course, placed in the zero position during this test.

Radiola was also received at excellent 'phone strength, using the transformer-coupled arrangement.

Tested by another member of the staff in south-west London, all the B.B.C. stations except Aberdeen were received on an indoor aerial.

Random Technicalities.

By PERCY W. HARRIS, Assistant Editor.

Some Notes of interest to the Experimenter and Home Constructor.

A FEW weeks ago Radio Press were asked to investigate what was claimed to be a remarkable single-valve receiver, which, according to its inventor, or rather constructor, gave far better results than any other single-valve reflex set with which it had been compared. We were asked in fact to send a representative down with any single-valve receiver we liked to use, and our correspondent was prepared to show the superiority of his own receiver.

* * *

We are always on the look-out for good things, so we accepted the challenge, and a member of the staff visited the home of the man in question, taking with him a single-valve reflex set which has already been described in *Modern Wireless*. The two sets

were placed side by side and tested one after the other on a frame aerial. There was no comparison between the instruments—our own set gave infinitely better results, and the performance of our correspondent's set was quite ordinary when compared with single-valve standards; and this leads me to believe the need for telling this little story. I would like to emphasise the need of standards for every serious experimenter.

* * *

To the man who is constantly putting up and pulling down receivers, a new circuit often seems to give far better results than an old one. But is this always so? Receiving conditions vary from night to night, and unfortunately we cannot rely upon the Broadcasting Stations

themselves to maintain constancy either on modulation or on signal strength. For example, although no warning was given in the Press, I understand that the power of 2LO has been for some weeks lower than normal, owing to a defect in the apparatus. In common with other experimenters, I was naturally misled by the different results obtained, and I know of at least one case where quite a good set was misjudged because it gave lower signal strength than another receiver previously tried. The difference was due entirely to diminution in power of the transmitting station.

* * *

If this paragraph comes to the eye of Captain Eckersley I would ask him seriously to consider the harm done by variations in power



The German Army have now started their annual manœuvres with all the pre-war efficiency. Our photograph shows an infantry outpost with their wireless equipment.

which are not advised prominently to experimenters and the trade. A man who is prepared to spend thirty or fifty pounds on a receiver is not going to purchase the first one brought to his notice, and as like as not will spend a week or two (spare time moments, of course) listening to various sets in similar conditions. If now, without warning, the power is reduced at the broadcasting station, he will get quite an erroneous impression. The playing of gramophone records in the lunch hour on certain days is another matter with which I am in strong disagreement. What can be worse for trade than to have to demonstrate to likely customers a receiver which can only reproduce as gramophones can. The potential customer will obviously remark that it is no better than a gramophone, and certainly it cannot be. The strength of the chain is in its weakest link, and undoubtedly a very weak link is a gramophone record.

* * *

To return to the question of standards. It would be well if every experimenter kept handy a single-valve receiver of conventional type, with which he can compare any new circuit he is trying. This is far more satisfactory than relying on one's memory, for as I have remarked before, conditions change from night to night, and the variation is more pronounced when you are some distance from the broadcasting station.

* * *

Again, there is the matter of what constitutes loud-speaker standards in strength; many claims have been made for certain receivers as being able to work loud-speakers, yet few people would be satisfied for amusement purposes with any loud-speaker volume which did not comfortably fill the room. One morning, for example, I received three letters from readers who claim that a certain new crystal set of mine has been able to work a loud-speaker at distances of 5, 10 and 11 miles respectively from the broadcasting stations. Obviously, having made the instrument, I am well acquainted with its capabilities, but I would be the last to claim that it is a

loud-speaker crystal set. What my correspondents mean is that the words and music are audible two or three feet away from a loud-speaker when they listen intently (in one case it is specifically stated that music can be heard seven feet from a junior Amplion). Yet to give what I should call reasonable loud-speaker strength on signals which are just audible seven feet from a loud-speaker would require one stage of audio-frequency magnification following the crystal. If we can all agree on some kind of approximate standard such as this, readers will be quite clear as to what is meant.

* * *

Recently in an American wireless publication, speaking of the reception of signals from British amateurs, it was remarked that the strongest amateur to be heard in the United States was 2YM! If this paragraph comes to the eyes of those who wrote the article in question, I hope they will note that most British amateurs would be delighted if

Broadcast Receiving Sets on Board Ship

Under the Wireless Telegraphy Act, 1904, the Postmaster-General's authority is necessary before any wireless apparatus is installed or worked on board a British ship.

Licences to use wireless apparatus for the reception of broadcast programmes on British ships can now be issued.

Individual licences in the name of each passenger or member of the crew will not be necessary. One such licence will suffice for each ship, and any shipowner desiring such a licence should apply to the Secretary, General Post Office, London, E.C.1, giving the name of the ship concerned.

In the case of ships equipped with commercial wireless installations, the following special conditions are imposed in addition to the conditions printed on the licence:—

(1) The use of a ship's main aerial for the reception of broad-

cast programmes is prohibited except when the ship is in port.

(2) The broadcast receiving apparatus and aerial must not be connected in any way with the ship's main wireless installation.

(3) The broadcast receiving apparatus must not be worked by the ship's wireless operator during his hours of watch.

(4) Persons using the broadcast receiving apparatus must sign the usual declaration of secrecy if by such use they become able to intercept private telegrams to and from the ship.

Ship's wireless operators have instructions to report to the Master any interference with a ship's main wireless installation caused by a broadcast receiver on board, and it is, of course, within the competence of the Master to prohibit the use of wireless apparatus by passengers or crew, if he thinks it desirable to do so.

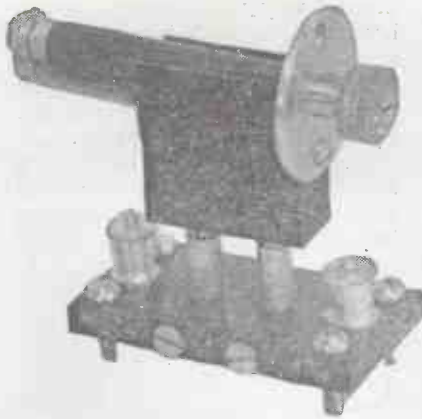

A mounting for variable resistances.

HERE are one or two useful little gadgets for the experimenter which can be very easily made in the home workshop. The first is a small mounting for clip-in fixed condensers which can be made from any odd piece of scrap ebonite measuring no less than $3\frac{1}{2}$ inches in length by $1\frac{1}{4}$ inches in breadth. The layout is shown in Fig. 1. On the middle line two centres are punched 3 inches apart, and 4B.A. clearance holes are drilled at these points. If the ebonite is thick it may be possible to countersink the nuts on the terminal shanks so that they do not come to the surface on the underside of the holder. But if material $\frac{1}{4}$ inch thick or less is used a 4B.A. tapped hole should be made at each corner. Into each of these is driven from the upper side a 4B.A. round-headed screw $\frac{1}{2}$ inch or $\frac{3}{8}$ inch in length. The points of these form little

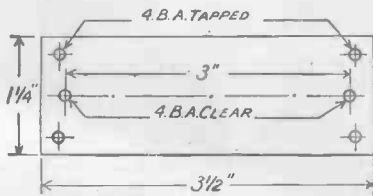

Fig. 1.—Layout for clip-in fixed condenser mounting.

feet for the mounting to stand on, and raise the nuts of the terminals above the surface of the table, thus keeping them insulated. As clips to take these condensers can be bought at trifling cost, there is no point in making them in the home workshop. A pair of them is fastened down by means of two screw terminals passed through clear-

Some Useful Little Gadgets

ance holes in the ebonite, and the mounting is complete.

The next gadget to be described is a small holder for single coils or fixed resistances. For this we require a little piece of ebonite which must not be less than $\frac{1}{4}$ inch thick, measuring $2\frac{1}{2}$

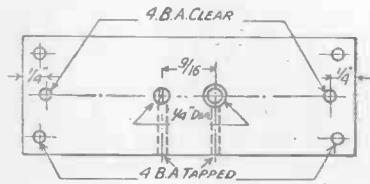
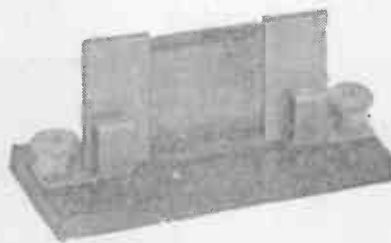

Fig. 2.—Dimensions for coil socket mountings.

inches by $1\frac{1}{4}$ inches. On the middle line punch marks are made $9/16$ inch apart to act as centres



The fixed condenser mounting.

for the $\frac{1}{4}$ inch holes into which fit the plug and socket. On the same line a quarter of an inch from each end is made a 4B.A. clearance hole. These are for the terminals. Close to each corner a 4B.A. tapped hole is made, these serving to take the screws which act as feet, as previously described. When the drilling and tapping referred to above have been done, drive a standard plug and socket into the $\frac{1}{4}$ -inch holes so that their bases are just flush with the under surface. Then drill and tap 4B.A. holes into each from the edge of the ebonite, as indicated by dotted lines in Fig. 2. Now drive a $\frac{3}{8}$ inch or $\frac{1}{2}$ inch round-headed 4B.A. screw right home into each of these holes. Mount a pair of terminals in the 4B.A. clearance holes and connect these to the screws, securing the plug and a socket by

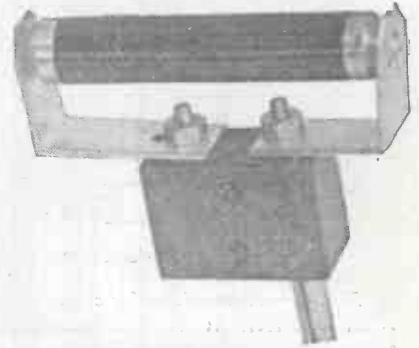

A fixed resistance mounting.

means of wires. The holder is now finished.

A most useful little fitting for this holder is a plug-in variable resistance, which can be made quite easily by mounting a Watmel anode resistance upon a standard plug and socket mounting such as can be purchased for a few pence from advertisers. Place the holder in a vice and with a round file make a slot in it, as shown in Fig. 3, wide enough to take the cylindrical body of the resistance. The depth of the slot should be such that when the resistance is laid in it one of the holes made in its brass top for the fixing screws should come opposite the screw retaining either plug or socket in place. Pass this screw through the hole and drive it in. The resistance will then be held firmly, and one of the contacts is made. The other is made by means of a brass clip of the size and shape shown in Fig. 4. If the resistance itself has been clamped by means of the screw running into the plug

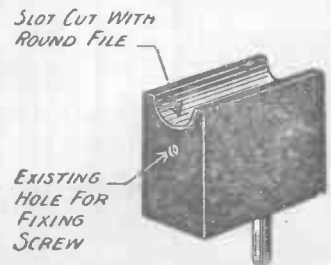

Fig. 3.—Details of the grooved socket.

the clip is fastened by that which goes into the socket. The screw at the end of the variable resistance is removed, passed through the 4B.A. clearance hole at the end of the clip, and reinserted at the end of the resistance. A plug-in resistance of this type is extremely useful for all kinds of

work. By means of it and the coil holder previously described a tuned anode circuit can be converted in a moment into a resist-

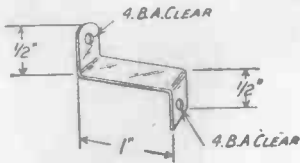

Fig. 4.—Dimensions for clip.

ance capacity by the simple process of removing the coil and plugging in the resistance. The correct value for any particular circuit can then be obtained by adjusting the knob of the resistance. A holder for fixed resistances made on the same lines has already been described in these notes.

W. R. H.

An Everlasting Tinning Plate

EVERYONE who solders, and most constructors do nowadays, is faced with the problem of keeping the point of his iron nicely tinned. There are all sorts of ways of doing this, but one of the handiest that I have ever come across is that shown in the drawing. The tinning plate consists simply of a piece of good tin plate 6 in. long by 2 in. wide, between which and

the wooden base is a layer of asbestos millboard. The three are clamped together by round-headed wood screws driven in at the corners. The purpose of the asbestos millboard is, of course, to prevent the wood from being charred in time by the heat of the iron. To use the tinner place a little flux upon it and rub the iron, which must first be filed smooth and bright over its surface. An iron can be tinned

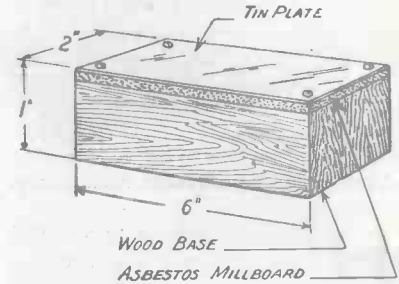

2
The tinning plate.

are obtainable very cheaply, and they are ideal for the purpose, since the iron can be kept constantly hot whilst wiring or some similar job is in progress.

R. W. H.

THE GLASGOW STATION



Our photograph shows some of the apparatus at the Glasgow station. The two figures are Mr. L. Holine, the chief engineer (standing), and Mr. H. M. Hill, assistant maintenance engineer.

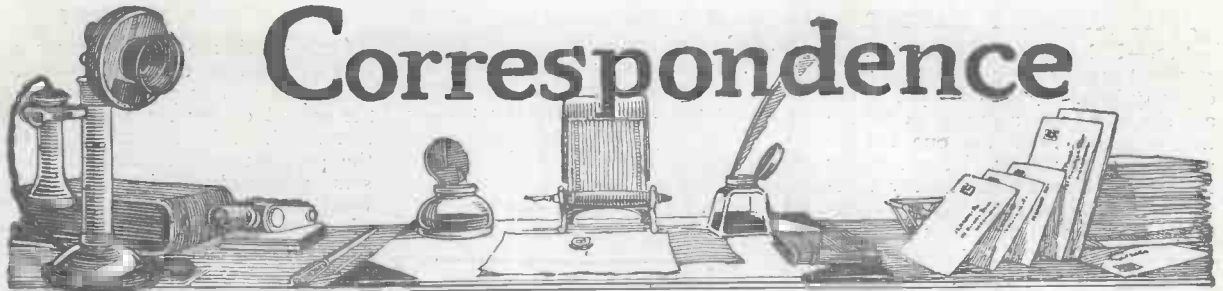

Correspondence

A TWO-VALVE COMPONENT SET

SIR,—This is a letter appreciating the two-valve "Component" set described in November 14, 1923, issue by Mr. Stanley G. Rattee. Radio-Paris (Radiola), Ecole Supérieure, 2LO, 5XX, 5IT, 5WA, 2BD, 5NO, 6BM, Eiffel Tower Telephony, Croydon Aerodrome, and a number of amateurs, including 5OX, 2KF, 6RM, 2PY, 2FP, 2AQ, 2TK, 2NM, 5LF, 2QS, 2AJA, 5VL, 2KG, 2VW and 2BZ are easily received. I have got Aberdeen, Newcastle, Birmingham and Bournemouth when 2LO is working, but have not had a chance of picking up Glasgow and Manchester. My aerial is 34 ft. high at each end, 70 ft. long, lead-in 10 ft., earth lead 30 ft.

I think these results are rather good, considering that no connec-

tions are soldered and that I am only 13½ years of age.

Wishing your paper every success,—Yours faithfully,

GEORGE W. EVETTS.

S.W.16.

A NEW STATION

SIR,—Your correspondent, S. Townsend, Gloucester, in September 3 issue, requires the name of a German broadcasting station.

I think this would be Frankfurt-Main—wavelength 467 metres.

I heard this station on Sunday, August 10, and also on the two following days. The announcer made a special request for reports from the British Isles.

I was using at the time an "All Concert" receiver, and on each day I tuned in Frankfurt whilst 2LO was working, using Type "A" wave-trap in series. Reception was

very loud in 'phones and just audible four yards away from an Amplion loud-speaker.

I have also received on this circuit the following Continental stations during the past fortnight:—

Le Petit Parisien (loud-speaker).
L'Ecole Sup. de Postes & T. (loud-speaker).

Radio-Clichy, Paris (loud-speaker).
Haaren, Belgium (loud-speaker).

Radio-Iberica, Madrid (good 'phones).

Rome (1,800 metres), 'phones.
Loud-speaker strength was, of course, not quite full volume, but very clear and quite loud enough in a small room.—Yours faithfully,

R. J. ORANGE.

S.W.19.

[Confirmation as to the name of this station has been received from Messrs. F. Newell, H. Edmonds Hall, E. Scudamore, T. A. St. Johnston (6UT) and others.]

The B.T.H. B.6.

A New Power-Amplifying Valve

3 VOLTS. 0.12 AMPS.

THIS new valve—the first of its type—is a dry-battery power-amplifying valve. One great advantage of the B.6 valve is that it can be used in conjunction with our well-known B.5 valve (0.06 amps) which also requires 3 volts on the filament.

Price 35/- each

Obtainable from all Electricians and Radio Dealers

We also make Crystal Sets, Valve-Crystal Sets, Valve Sets, Loud Speakers, Headphones, Amplifiers and Tungar Battery Chargers

The British Thomson-Houston Co. Ltd

Works: Coventry.

Offices: Crown House, Aldwych, W.C.2

Branches at Belfast, Birmingham, Bristol, Cardiff, Dub'in, Glasgow, Leeds, Liverpool, Middlesbrough, Manchester, Newcastle, Swansea, Glasgow

All British Wireless Exhibition

Albert Hall, Sept. 27-Oct. 8. Stand 41

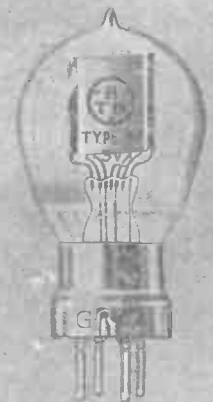

CHARACTERISTICS OF THE B.T.H. B.6 VALVE.

Filament Volts3
Filament Amps.....0.12
Anode Volts.....60-120

ANTI-CAPACITY HANDLES

SIR,—I have seen several suggestions with regard to anti-capacity handles, but have yet to see a simpler or a more effective arrangement than the one I have adopted, particularly if the receiver is in an enclosed case, as my four-valve family set is.

All I did was to cut a pronged handle about 8 in. long out of sheet ebonite $\frac{1}{8}$ in. thick, something after the shape given in the figure.

The inside of the prong is semi-circular and fits closely around the lower portion of the condenser knob. I then drilled holes near the edge of the condenser dial just large enough to enable me to insert tightly some 6BA screws—from beneath the dial. The projecting portion of the screws above the dial were then nipped off with a pair of pliers so as to leave only about $\frac{1}{4}$ in. in sight. The equi-distance of these small screw studs from the lower part of the knob will decide the spot at which the hole, already seen in the handle, should be drilled.

The number of studs required in the dial will depend upon the amount of elbow room you have for the handle, i.e., upon the number of degrees through which you can turn it without obstruction. Using only one stud, I can cover

more than the wave band of all B.B.C. stations. Using two studs, I get through over two-thirds of the dial, while the use of a third stud enables me to complete the revolution.

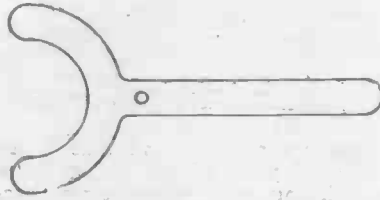

The extension handle suggested by Mr. Davies.

To use the handle you merely place the pronged end around the lower part of the condenser knob and then lower the handle so that a stud enters the hole. If carefully made, it will remain firmly in position and can be transferred from one stud to another with ease. To take it away is the work of an instant, and, needless to add, a considerable advantage when the receiver is enclosed or even with an open receiver, when the disposition of the parts causes the handle to project outside the set.—Yours faithfully,

D. T. DAVIES.

Pontypridd.

IS THIS A RECORD?

SIR,—If ST100 performances are still of interest to your readers, I think you will be pleased to hear of the record of my set which I built last April. I have noted with care the performances of various ST100 sets which have been published from time to time, but I have heard of none which approaches mine, every detail of which can be vouched for by my friends.

This house is situated three miles from 5IT. My aerial is T-shaped, 75 ft. long (counting lead-in), and is largely surrounded by trees. Using a Claritone loud-speaker, I have to date picked up the following stations at a strength sufficient to be heard with ease all over a room 20 by 15 ft.; Birmingham (immense volume), London, Bournemouth (good strength), Cardiff, Manchester (loud), Glasgow, Aberdeen, Newcastle (weak); of the relay stations, Sheffield, Edinburgh, Leeds and Liverpool (on headphones only); 5XX is only slightly less loud than Birmingham. Of the continental stations, Brussels, Radio-Paris, Eiffel Tower, Madrid, Petit Parisien, Ecole Supérieure and Berlin Vox Haus II come in at loud-speaker strength; while on the headphones I can usually pick up three or four German (?) stations between 420 and

HEAD PHONES

SIEMENS

UNEXCELLED FOR

PURITY OF TONE AND SENSITIVENESS

SIEMENS BROTHERS & CO LTD
WOLWICH, LONDON, S.E.18.
Also Manufacturers of:—
RECEIVING SETS, LOUD SPEAKERS, AERIAL PROTECTORS, BATTERIES, &c.

PRICES.
 120 Ohms £1.2.6.
 2000 " 1.4.0.
 4000 " 1.5.0.

Obtainable from all Dealers.

470 metres when 5T is not working. Birmingham only interferes with me between 420 and 500 metres. The set appears to me to be wonderfully selective. I can tune-in at will to either Cardiff or Petit Parisien stations, when both are working. For everything from Brussels to Vox Haus II I use a Lissen 50 in the aerial and a 75 in the anode. For the Radio-Paris and Chelmsford district I use two large-size Oojah coils!

I feel that the above record for an ST100 in a beginner's hands during the summer is quite noteworthy, and I should very much like to get into correspondence with anyone who has had similarly good results. I have already been accused of having a fisherman's imagination; my record for the winter months I may fear to tell even to you, sir!

Wishing your paper every success.
—Yours faithfully,

KENNETH LAWSON.

Birmingham.

P.S.—I may add that this is a preparatory school, and to my knowledge five ST100 sets have been constructed as a result of the good performances of mine.

A SINGLE VALVE AND CRYSTAL RECEIVER

SIR,—A line or so from an "Aussie." experimenter would

probably not go amiss. I have had every issue of *Wireless Weekly* and *Modern Wireless*, and have derived a great deal of pleasure and abundance of good, sound information from each and every one of them.

Wireless in this country is booming just now. Rules and regulations have been drawn up by the P.M.G.'s department and adequate facilities and encouragement are given for the experimenter. There is no really efficient broadcasting station in Melbourne yet, but there is now one in course of erection, which will be a duplication of the 5,000-watt station in Sydney (2FC). So for months we have had to be content with receiving local amateurs and listening-in to very distant stations on the West Coast of America. This has necessitated some very efficient sets and has been the means of putting the Australian amateur on his mettle. At the latter part of last year one of our Melbourne amateurs logged no fewer than 200 American stations, a good number of which were amateurs. That achievement was accomplished in connection with the trans-Pacific test.

But what mostly prompted me to write to you was in reference to the results I have obtained on a little single-valve reflex circuit which was described by Mr. G. P. Kendall

in *Wireless Weekly*, Vol. 3, No. 3 (December 26, 1923). The results, to me, seem marvellous, especially after dabbling with three- and four-valve circuits with varying results. I had no difficulty in receiving most of the local amateurs on a loud-speaker at medium strength which could be heard all over a six-roomed house. I was so struck with the way the circuit behaved that I wound a couple of coils in the endeavour to pick up the Sydney broadcasting station, 556 miles away (1,100 metres). To my great surprise that station came in at good loud 'phone strength, and I can tune them in now any evening I like. On occasions when the weather conditions have been favourable this little circuit has brought 2FC in on a small loud-speaker audible in a 12 ft. square room. Up to date I have also logged fourteen Sydney amateurs on 10 to 15 watts.

But my latest achievement makes all this appear insignificant, as recently I picked up KGO, Oakland, California, and held him from 5.45 p.m. till 7 p.m. The jazz orchestra was clearly audible, and the announcer's nasal accent as he announced "KGO broadcasting from Central Roof Garden, Oakland, California," was very pronounced. This was no freak re-



"Why didn't someone think of it before?"

Not so very long ago the common or garden pin, which positively won't "stay put," was a serious menace to the rising generation. Millions of babies howled their distrust of it. But ingenuity has domesticated it to-day in the far more comfortable safety-pin.

CLIX—the inexpensive universal contact—marks as great an advance in radio and electrical science as does the safety-pin in everyday life. It supercedes all forms of switches, plugs and terminals, for it does all their work—and does it better.



The Safety-Pin of the Radio and Electrical Industries.

Retail Prices

- CLIX with Lock-nuts.....3d.
 - Insulators (six colours)..... 1d. each
 - Bushes (Six colours) ... 1d. pair
- CLIX is patented all over the world.

The introduction of this ingenious combination plugsocket marks the advent of a standardised system of wiring. Obtainable from all good *Wireless Dealers* or direct from the Patentees and Manufacturers:

AUTOVEYORS LTD
Radio Engineers and Contractors
84 Victoria Street, London, S.W.1

Quality RADIO COIL HOLDERS & COMPONENTS

PANEL COIL HOLDER.

(Without Base).

All connections are made at the back eliminating flexible wires with their untidy appearance, added capacity and liability to breakage.

Best matt ebonite, anti-capacity handle with polished knob and polished and lacquered brass parts.

2-way, 3/-; 3-way, 5/-
N.P. 1/- extra. Postage 3d.
Drilling template supplied.

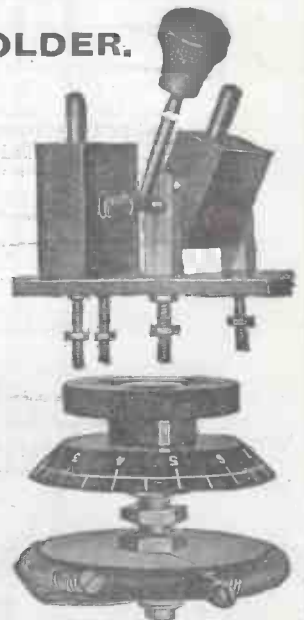

Quality RADIO FILAMENT RHEOSTAT

Guaranteed "Eureka" wire on realebonite former Phospor bronze contact arm giving smooth and silent movement. One centre hole fixing with divided ebonite dial.

Price 2/6. Postage 3d.

If your dealer has not got them we send post free if you mention his name and address. LIST POST FREE.

GOSWELL ENGINEERING CO., LTD.,
12a, PENTONVILLE ROAD, LONDON, N.1.
LIBERAL TRADE TERMS.

'Phone: North 3051.

ception as, a few days later, I had the same station from 6 p.m. until 7 p.m. KGO is regularly heard in Australia (7,700 miles distant) upon multi-valve sets, but I consider this one-valve reception to be something out of the ordinary, and it speaks volumes for the wonderful little circuit that you have put before your readers. It makes me wonder why it is necessary to employ three-valve sets in England to do the round of your high-powered broadcasting stations. Surely it must mean loud-speaker strength for them all.

For your edification or for the benefit of anyone who is interested here are a few details of components as used for the reception of KGO, 312 metres (refer to page 69, Fig. 13, of above-mentioned copy of *Wireless Weekly*):—L1, 40 turns on basket coil; L2, 60 turns ditto; C1, 0.0005; C2, 0.0003; Kellogg 4½ to 1 transformer; C3, 0.001; Ediswan AR valve; Hertzite crystal; R1, Bradleystat; C4, 0.002; B1, 6v.; B2, about 75v.; aerial, twin wire (7-20), inverted L, 90 ft. long and 30 ft. high both ends. No stabilising resistance was used with this particular circuit, which is of the component part type laid out on a table and connected up with No. 20 wire. The tuned anode coil was kept fully seven inches away from the A.T.I., and, of course,

C1 was in series with A.T.I. For the reception of KGO I switched off the A.C. lighting current at the meter, and on switching it on again found that I had to re-tune the set, a peculiarity which had never occurred to me on local stuff.

The truth of this reception can be vouched for by members of my household who heard KGO's programme on both occasions.

Wishing you and your helpful publications success,—Yours faithfully,

VAL SEYMOUR.

Melbourne.

BATTERY ECONOMY

SIR,—All experimenters should possess a milliammeter. How many readers have, like myself, turned down this advice as entailing an unnecessary expense? It is, however, not unnecessary, and not particularly expensive—30s. will purchase quite a sound instrument reading 0-10—just about the same initial cost as two new H.T. batteries, and its use soon enables one to cut down the unnecessary drain on the battery. Furthermore, its permanent insertion in the H.T. circuit enables one to keep a finger on the pulse of the instrument.

A practical example is worth a lot of theory—perhaps an experience of the writer will convince some sceptics.

The set in use has been a two-valve reflex, both valves doing double duty; quite an efficient set *apparently*, but six months has been quite a long life for the H.T. battery of first-class make. All possible sources of leakage were tried without result. The purchase of a milliammeter showed an anode current of 8 milliamps (100 volts on anode), which is far too heavy for an ordinary sized battery, and in any case is wasteful, and probably 50 per cent. is doing no work. Another set—a more usual one—crystal and 2 L.T., passed 6 milliamps. With the ammeter in circuit this was soon reduced to 3 milliamps by the suitable adjustment of H.T. and L.T., and, most important of all, *grid bias*—without any loss of signal strength. It was further reduced by the same means to 2 milliamps with only very slight signal reduction. Undoubtedly, the reflex would respond to the same treatment.

The money spent on the ammeter will be saved in running expenses, and there is any amount of interest in knowing just what your set is doing. No one who experiments with valve circuits can afford to be without a milliammeter.—Yours faithfully,

E. M. WAINWRIGHT.

Timperley.

VISIT THE SHOW BY POST

If you are unable to call in person and see our display at the Wireless Exhibition, drop a post-card to our office at Letchworth and we will send you literature concerning all our exhibits. We look forward to renewing acquaintances and making many new friends at the Show. Shall we see you?

Bowyer-Lowe Tested Components & Panels STAND 26

All - British Wireless Exhibition, ROYAL ALBERT HALL, September 27th to October 8th.

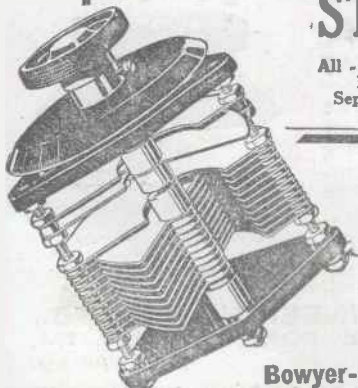

SEE our Square Law Condensers and examine the new "Four-Square" Condenser which will revolutionise standards of condenser efficiency.

Bowyer-Lowe Co. Ltd, Letchworth

H.F. "Discol" Transformer
L.F. "Tangent" Transformer

Success depends upon the efficiency of your components.

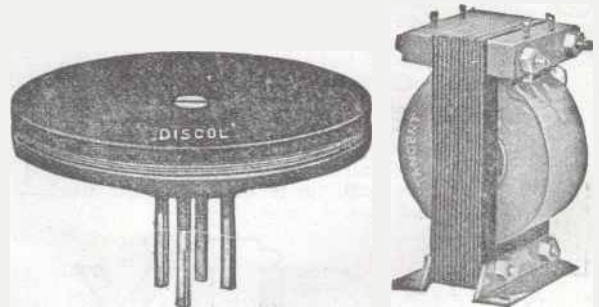

The "Discol" H.F. Transformer
Fitted with strong real ebonite cheeks—unbreakable.
Tested on actual Broadcasting.
Efficiency over all wavelengths from 75m. to 4050m.

PRICE 5/6 each.

The "Tangent" L.F. Transformer
Fitted with or without terminals. Extremely efficient and robust. Guaranteed for silence, speech and music.
Tested on actual Broadcasting.

PRICES 12/6, 14/6 & 25/-

Ask your dealer — or write us direct.

GENT & CO., Ltd., Faraday Works, LEICESTER

London: 25, Victoria St., S.W.1.
Newcastle-on-Tyne: "Tangent House," Blackett St.

APPRECIATION

SIR,—You would be doing me a great favour if you would convey my heartfelt thanks to Mr. Redpath for the wonderful one-valve with reaction set you published in Vol. 4, Nos. 16 and 17 of your splendid paper, *Wireless Weekly*. I have never attempted to make a valve set before, as I have always been rather afraid to tackle one. Consequently I have had to be content with a crystal set. But this set did not seem so difficult to my mind, so I made a start and finished it without meeting with any difficulties at all. It is really wonderful, and nobody can realise how pleased I am with same. So if there are any enthusiasts about who are feeling the same as I did before this attempt, I would advise them to make this set at once, for they do not realise what they are missing. Thanking you and wishing your paper and Mr. Redpath all I wish myself.—Yours faithfully,

EDWIN E. BENJAMIN.

RECEIVING 5XX

SIR,—I beg to advise you I have a four-valve set. Using H.F. and detection, I hear 5XX very clear on three valves. With the same number of valves I can work a Brown loud-speaker comfortably,

whilst with four valves it is overloaded and distorted; my aerial is rather badly shielded and low.

My friend next door can get 5XX on a crystal set every night after Brussels has closed down; it is faint, but when one is quiet one can hear distinctly.

Trusting this may be of interest to you,—Yours faithfully,

A. E. LICENCE.

Brussels.

SIR,—Mr. Brown, in your issue of the 3rd inst. takes some of us somewhat severely to task for presuming to give our experiences of reception of 5XX without having first read his letter "more carefully." Apart from the fact that it would appear to be open to anyone to give their experiences without having read his letter either carefully or at all, it is difficult to understand why he should take up this attitude, seeing that the conditions at distant stations are obviously entirely different from those which obtain at Clapham.

I have now again read and re-read his original letter, and I am afraid that I can extract nothing further from the very vague generalities which it contains.

If I have erred in giving my experiences I take courage from the fact that I have erred in good company of others for whose benefit

5XX was intended. That Mr. Brown and his immense clientele are dissatisfied does not, I fear, affect us at all.

It is, of course, quite possible that Mr. Brown may be situated in a semi-"blind" spot, although from the information in his original letter this is not by any means apparent, as, from the information now given as to his actual distance from 2LO and 5XX, the estimate which I gave of the relative strengths at which he can expect to receive these two stations erred considerably in favour of 5XX.

As Mr. Brown's receivers are presumably both perfect—I note that he is successful in receiving 2LO at 4½ miles and Croydon at 6 miles on his crystal set—and as he cannot alter either the laws of physics or those of nature, his remedy is obvious, viz.: either to prevail on the B.B.C. to remove the high power station to some position more suited to him or alternatively to move his residence into a district where he can receive 5XX at the strength he desires. A simple proportion sum will enable the choice of a new locality to be considerably narrowed.

Incidentally, Capt. Eckersley appears to have been quoted without the context—Yours faithfully,

MENDIP DENNIS, Col.

Co. Wicklow.

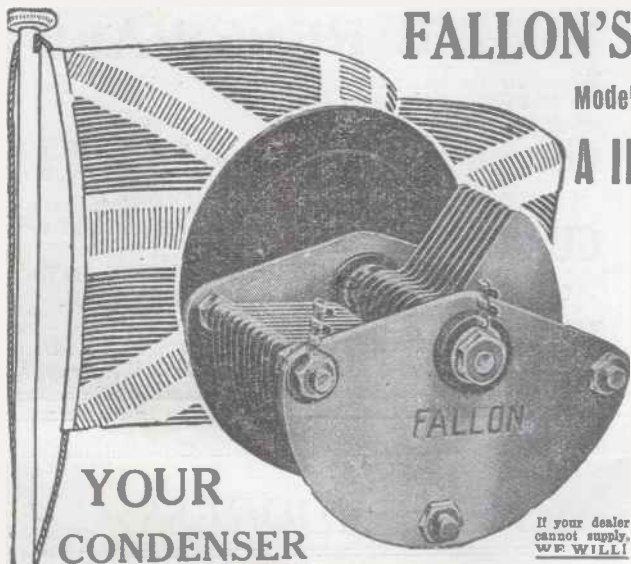

FALLON'S

Model

A II

**YOUR
CONDENSER**

If your dealer cannot supply, WE WILL!

Is not a "FALLON" unless the name "FALLON" appears on same. One Hole Fixing, Tag Connections, Heavy Aluminium Top and Bottom Plates. Metal to metal adjustable bearings, stout, well-cut aluminium vanes. Complete as illustration.

Plates	Price	Plates	Price	Plates	Price
001 .. 37	8/-	00025 .. 15	5/-	Vernier	3 .. 4/-
0905 .. 23	6/-	0002 .. 13	4/6	Vernier	3 .. 3/6
0003 .. 19	5/6				

"FALLON" SQUARE LAW CONDENSERS
COST NO MORE THAN THEIR FAMOUS MODEL II.
Write Direct for Trade Terms.—

FALLON CONDENSER COMPY., LTD.
The Condenser People. Phone: Tottenham 1932.

White Ribbon Works, BROAD LANE, TOTTENHAM, N.15
All Correspondence and Post Orders to the above Address.

CITY DEPOT—143, Farringdon Road, E.C.1 | MANCHESTER DEPOT—3, King St. West, Deansgate | GLASGOW DEPOT—120, Wellington Street

Barclays 64.

"Perfect Reception"
GUARANTEED
WITH OUR
REPAIRED VALVES

Whenever your valves burn out or filaments are damaged in any way

Send them to us

We repair them equal to new.

DON'T DELAY

*The actual valve you send us is repaired
and returned to you within 7 days.*

PRICE	POSTAGE	PRICE
6/6	3d.	6/6

(Bright Emitter Valves).

WE ARE ALWAYS AT YOUR SERVICE.

Price list for D.E. and Power Valves
on Application.

The North London Valve Repairing Co.,
22½, Cazenove Road, Stoke Newington, N.16.



Conducted by A. D. COWPER, M.Sc., Staff Editor.

Anode Coil

Messrs. Radiax, Ltd., have sent for test an anode coil for tuned - anode H.F. coupling, which is mounted in special clips on the panel, into which it slips, making rapid changes possible. This is in the form of a narrow coil, 4 in. diameter, covered with insulating fabric, and having a tab with two metal contact-pieces for mounting and electrical connections.

On test, it covered the broadcast range from 300 to 550 metres with a .00025 μ F parallel tuning condenser, and gave good amplification in reception of broadcasting from various stations, with sharp tuning.

Plug-in Anode Coil with Variable Reaction

From the same firm comes a H.F. coupling unit in the form of an anode inductance wound in a slot in a small disc, having four valve-legs after the manner of ordinary H.F. transformers, but arranged for tuned-anode coupling, the necessary connections being made to three of the four legs. Into the centre of this, plugs-in a fitting carrying a pivoted reaction-coil, with tapped winding and three terminals, giving a choice of reaction-power. With a .00025 μ F tuning-condenser, this was found to cover from 300 to 380 metres

wavelength, signal-strength and selectivity being good throughout, whilst the reaction (from the plate-circuit of the detector-valve following) was everywhere effective and under control. Thus several Continental stations were read on the two valves with average aerial equipment, in addition to English station. The appearance and finish of this instrument were good; it was noticed, however, that there was a certain amount of shake and back-lash about the pivoted reaction-coil, removal of which would make for considerable improvement in ease of tuning-in elusive distant stations.

IRISH EXPERIMENTERS & CONSTRUCTORS

Can obtain all apparatus at London prices from us. If you have not already had our new list, send for one to-day.

- | | |
|---------------------------------------------------|--------------------------|
| Polar Condensers 10/6 | Goswell Coil Holders 9/- |
| McMichael H.F. Transformers 7/- | F.T.H. Phones 17/6 |
| Pival Single Phones 6/- | Myers Valves 12/6 |
| L.F. Transformers 12/6, 15/-, 21/- and 25/- | |
| Square 1/16" rod 1/3 per doz. 2 ft. lengths | |
| Ormond Condensers, .001 8/-; .0005 6/-; .0003 5/- | |

THE IRISH RADIO STOCKISTS,
Wireless Specialists, 3, CROW STREET, DUBLIN.

VALVE RENEWALS

We repair by our patent process (for which we have NATIONAL PHYSICAL LABORATORY'S Report of efficiency)

ALL STANDARD TYPES OF VALVES AT **6/6**
AND CARRIAGE PAID

GUARANTEE (At least EQUAL EFFICIENCY to new valves.)
To RETURN IN THREE DAYS OR REFUND YOUR MONEY WITHOUT QUIBBLE.

THE EGLAT MANUFACTURING CO., LTD.
Spencer Works, Wimbledon, London, S.W.



THE NATIONAL ASSOCIATION OF RADIO MANUFACTURERS

NEW ADDRESS

AS and from the 20th September 1924, the address of The National Association of Radio Manufacturers will be changed from Kern House, Kingsway, to

Astor House - ALDWYCH LONDON, W.C.1

Information Department



SUPPLIED BY RADIO PRESS SERVICE DEPT., LTD.

A. P. M. (CAMPBELTOWN) asks (1) For dimensions for tuned anode and appropriate coupling coils for wavelengths from 180 to 450 metres.

(1) The tuned anode coil might be made from a cardboard tube 3 inches in diameter and $3\frac{1}{2}$ inches long, wound with 70 turns of No. 20 S.W.G. double cotton covered wire, tapped at every fifth turn. A small condenser such as you specify should be shunted across the coil. The reaction coil might consist of a tube of the same length and $2\frac{1}{2}$ inches in diameter, wound full of No. 26 S.W.G. double cotton covered wire, with three equal taps.

T. K. F. (SOUTHAMPTON) asks (1) Must his circuit be oscillating to receive continuous waves. (2) Whether certain coils in his possession give as good results as could be expected. (3) Whether his tuning apparatus is interfered with by the magnetic field from generators situated 300 yards away from the apparatus.

(1) It is essential that oscillation be introduced in the circuit to receive C.W., but this does not mean that it must radiate. This latter point depends entirely on the type of circuit used. (2) There is nothing to choose between the different types of coil you specify. (3) The field of the generators will not produce any direct interference with the tuning apparatus of your receiver, but you may be troubled with induction noises.

W. T. (N.W.3) asks whether it is correct to assume that there is no radiation from the aerial when telephony is received without distortion, using a circuit employing reaction. He also asks for information regarding certain amateur Call Signs.

Reaction effects may easily take place which cause radiation from the aerial, even though no noticeable distortion is introduced into the received speech. There is not, however, likely to be radiation if turning the tuning condensers does not produce any squeals or howls. Re-

THE NEW
"DEXTRAUDIION"
DULL
EMITTER

PRICE
21/-

MAXIMUM
CONSUMPTION
1 AMP. AT 1 VOLT.
10 WATT!

THE QUALITY OF THE
RECEPTION ENTIRELY SUR-
PASSES ANYTHING HITHERTO
OBTAINED WITH ANY OTHER VALVE.

Full particulars, with characteristic curves, together
with 40 PAGE RADIO LIST, sent post free on receipt
of 4d. in stamps and mention of this advertisement.

ECONOMIC
ELECTRIC LTD.

Head Office: 10, FITZROY
SQUARE, LONDON, W.1.

Showrooms:
303, EUSTON RD. N.W.1

A REVOLUTION IN H.T. EFFICIENCY

H.T. Batteries made up of units are recognised as the ideal.
The HOVIMO screw connection solves the problem of joining units
without soldering.

The HOVIMO assures perfect "silent" working—is
everlasting—allows easy replacement of units—will take
the ordinary wander plug—makes it possible to keep your
H.T. at an equal voltage. Is British made.

W. MOLBACK
27, High Holborn,
London, W.C.1.

Ask your dealer
for them.

1/6
Per Doz.

From
dealers
or direct.



FINSTON Fixed Condensers stand the Test of Time !!

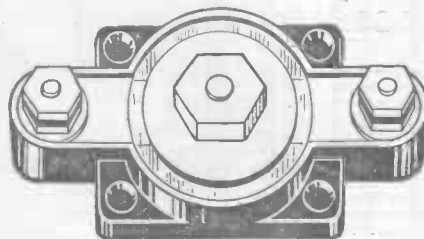

FINSTON FEATURES

Reliability of Capa-
city. Finest grade
Mica Dielectric.
Highest possible
quality Copper Foil.
Adapted for Ter-
minal or Soldered
connections.

CAPACITIES:

·001 to ·005 price 1/3 each ·002 to ·005 price 2/- each



The
Reliable &
Everlasting
Condenser.

LIGHTING SUPPLIES CO.
2, FINSBURY AVENUE, LONDON, E.C.2

ferring to your question about the amateur transmitters, we would refer you to *Modern Wireless* for September.

A. F. (DORNOCH) asks questions about a certain commercial pattern of receiver which he has purchased, and from which he gets satisfactory results under certain circumstances.

We regret we are not able to advise you on the merits and demerits of this receiver since our editorial position does not permit us to do so. We think you should get in touch with the manufacturers, whose address you will obtain from the advertisement pages of this journal.

R. R. (WEST NORWOOD) has a 4-valve receiver employing tuned anode intervalve coupling and wishes to know how to construct suitable coils to amplify up to 10,000 metres.

If you propose to use the ebonite tubes you mention, they will be of rather an unmanageable size if wound as single layer solenoid coils. We suggest you use the plug-in type of multi-layer coil, in which case you would require coils of 750 turns in the aerial and 1,000 in anode circuit.

C. A. F. (WEYMOUTH) asks (1) For the size of a frame aerial for the reception of broadcasting. (2) Whether certain condensers will be required to tune this circuit. (3) The merits of two different types of valves.

(1) If your frame is 3 feet in diameter, you will require 10 turns of wire spaced $\frac{1}{2}$ inch apart. This frame should be tuned by means of a small variable condenser in parallel with it, having a capacity not greater than 0.0005 μ F. No aerial tuning inductance in the apparatus will, of course, be necessary when using the frame. (3) We cannot pass opinions upon the merits of commercial products in this column.

H. W. R. (HORNSEY) reports that he is very much troubled by certain rushing and rustling noises, which he finds are located quite definitely on fixed wavelengths, one of the most troublesome being a band between about 420 and 440 metres, which he finds in position practically every night. He has tried the wavelength frequently with a wavemeter, and finds it approximately constant. His receiver employs two high-frequency valves of the tuned anode type, and a detector.

Our correspondent need not suspect his set, since his trouble is almost certainly that irritating form of interference known as "mush." This is a rather peculiar form of harmonic frequently radiated by high-powered arc stations, among whom certain post-office installations are notorious. There unfortunately appears to be no remedy as far as receiving apparatus is concerned, other than the use of really selective circuits, and even these do not appear to give very much relief. Fortunately, the particularly bad band to which H. W. R. refers does not cover one of the B.B.C. stations.

The Wonderful ST100 —still the most popular Receiver.

IN spite of all the new "dynes" and "supers" that have been produced during the last 18 months the ST100 still remains the most popular Set for Broadcast reception. To the sceptic its volume is amazing—in fact it is often necessary to de-tune it within 3 or 4 miles from a Broadcast Station because so few Loud Speakers can cope with the volume. For long distance work it is unique—from any position in the country all the B.B.C. Stations can be received at good headphone strength. Is any more required from a Set?

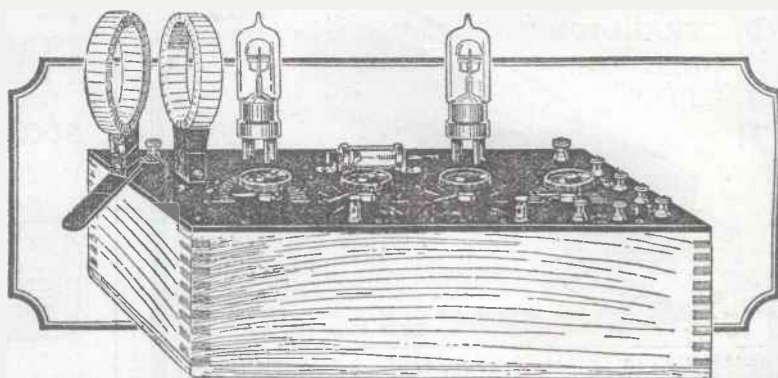

Build your own ST100 and we will guarantee you successful results.

Because the ST100 is a Reflex Set it is imperative that the lay-out of the Set—the disposition of its components and the wiring should be correct. The safest way of ensuring this is to build up a Peto-Scott ST100. If the instructions we give are followed exactly you are ensured of success from the commencement. Further, we will back this statement with the following guarantee:

If after building the Set from our kit of components it does not work satisfactorily, return it to us for testing. It will be put into thorough working order and should the defect be due to a mistake on the part of the constructor

only a nominal charge will be made. If it is due to some defective component, the part will be replaced entirely free of charge.

Thus, the Peto-Scott way will enable you to obtain the finest 2-Valve Reflex at the cost of the materials alone.

Complete kit of all components, including drilled and engraved panel, and all transformers, variable condensers, etc. (but without coils and valves) and including full instructions for assembly. Marconi Royalties paid £4 17 6
 Polished Cabinet extra 7 6
 Finished Instrument, aerial tested and Royalty paid £8 5 0

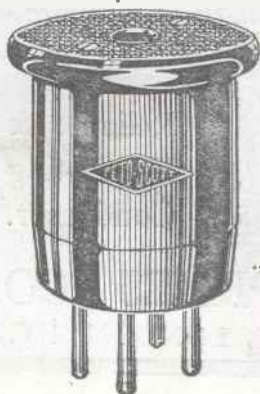

H.F. TRANSFORMER

A high grade H.F. Transformer made throughout by us. Guaranteed wavelength range. Supplied matched in pairs without extra charge.

300-600 metres ..	6/6
500-900 ..	7/-
900-1500 ..	7/-
1200-2300 ..	7/-
2200-4800 ..	7/-

PETO-SCOTT Co. Ltd. 77, CITY ROAD, LONDON, E.C.1.

Head Offices, Mail Order Department and Showrooms—
 Branches:—LONDON—62, High Holborn, W.C.1 PLYMOUTH—4, Bank of England Place. LIVERPOOL—4, Manchester Street. GILBERT AD. 1454.
 CARDIFF—94, Queen Street. WALTHAMSTOW—290, Wood Street.