

2.5GHz frequency meter for less than £100?

ELECTRONICS WORLD

Austria Asch. 66.00
Denmark DKr. 67.00
Germany DM 18.00
Greece Dra. 1100.00
Holland Dfl. 11.75
Italy L. 8800.00
Malta Lm. 1.55
IR £3.30
Singapore S\$7.50
Spain Pts. 850
USA \$5.95

INCORPORATING WIRELESS WORLD

DECEMBER 1997 £2.35

A REED BUSINESS PUBLICATION
SOR DISTRIBUTION

Fuel-saving ignition breakthrough

**Understanding
capacitors**

**MPEG quality
issues**

**New noise
theory**

**Microstrip
made easy**

**Design heat
sinks in
minutes**

**PC i/o for
Windows**

Internet

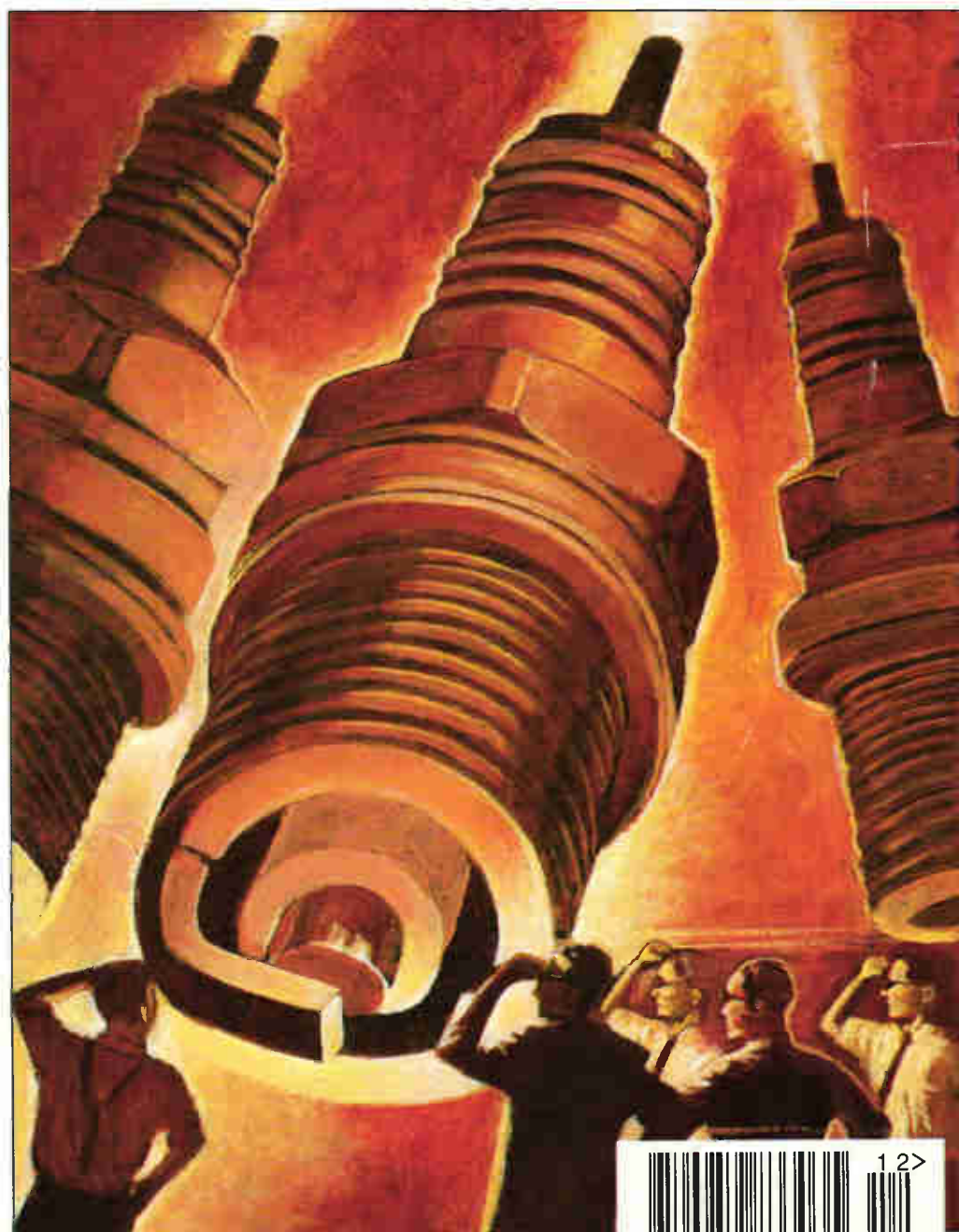

ISDN for all? See page 971



NEW

TINA *Plus*

The circuit design and analysis package which gives you a great deal more

■ More Power ■ More Functionality ■ More Value for Money



Special introductory offer, just

£199*

We challenge you to find a better circuit design and analysis package anywhere
*Price excludes V.A.T

- Analogue, digital and mixed mode simulation
- Powerful analysis tools include AC, DC, transient, pole zero, Fourier (series & spectrum), noise, digital step-by-step and digital timing
- Monte Carlo and worst case analysis
- Enhanced symbolic analysis (providing closed form formulas)
- Temperature and parameter stepping, sweeping and optimisation
- Programmable input to circuits
- Component library contains 5,000+ components (user extendible)
- New models, including analogue control elements

- Interactive components
- Faster algorithms for mixed-mode and large circuits
- Improved schematic entry
- Export to popular PCB packages
- Export/import in Spice format
- Display results in sophisticated diagrams or on a range of Analogue and Digital Virtual Instruments, including function generator, multimeter, oscilloscope, frequency analyser and logic analyser
- Comprehensive DTP functions

TANDEM
TECHNOLOGY

Try TINA *plus* for yourself. For free demo disk, contact:
Tandem Technology Limited Breadbare Barns, Clay Lane, Chichester, West Sussex, PO18 8DJ
Telephone: 01243 576121 Fax: 01243 576119
E-mail: 101626.3234@compuserve.com Visit our website: www.tina.com

CIRCLE NO. 102 ON REPLY CARD

Contents



Cover – Hashim Akib

982 BRIGHT SPARKS

Michael Ward's radically-new ignition system leads to a simpler, cleaner and more efficient petrol engine. And with the anti-pollution laws tightening up world wide, the big boys might just be forced to listen to him.

990 HANDS-ON INTERNET

Cyril presents tips for speeding up your searches plus news of circuit simulation software to be found on the net.

994 A WINDOW ON ANALOGUE I/O

Driven via the pc's printer port, Colin Attenborough's 12bit analogue i/o subsystem was designed with Windows control in mind.

998 UNDERSTANDING CAPACITORS

Most engineers know which type of capacitor to choose for a given job – but do they know why? Cyril Bateman explains.

1005 NEVER MIND THE QUALITY FEEL THE BANDWIDTH

John Watkinson explains how most movie frame sequences lend themselves to MPEG coding, but others certainly don't.

1013 SEEING THROUGH NOISE II

Breaking new ground, Patrick May shows how electrons emitted from the surface of a thin metal film equate to $1/f$ noise.

1017 SPEAKERS' CORNER

John Watkinson looks at the pitfalls of specifying the most difficult component in the audio chain – the loudspeaker.

1019 MICROSTRIP MADE EASY

Nick Wheeler shows how designing a microstripline board can be very simple for most applications.

1022 RADIO REFLECTIONS FROM RUSSIA

One of the world's oldest technical museums, in St Petersburg, holds a wealth of early British wireless equipment, as Khatskel Ioffe explains.

1036 DESIGNER HEAT SINKS

In six easy steps, Ray Fautley shows you how to find the heat sink area needed to cool a transistor, diode or power resistor.

1045 A BATTERY OF CHARGERS

Philip Darrington looks at simple single-chip solutions for charging advanced batteries.

Regulars

971 COMMENT

At last – ISDN for all.

973 NEWS

Job prospects, \$8 video camera, New PCI bus standard, Doubts over network computer technology, First FireWire products announced.

978 RESEARCH NOTES

Diamond coating stops disk head crashes, radar looks through closed doors, Organic computing.

1039 NEW PRODUCTS

Pick of the month – classified for your convenience.

1051 LETTERS

Reed relay advice, 1.3V mystery, Amplifier stability issues, Flat-panel speakers, Beating frequencies.

Special offer

With three ranges, this sensitive frequency meter works to 2.5GHz yet costs under £100 – exclusively to EW readers. See page 1010.



This is the secret to coating disks and heads with diamond to stop hard disk crashes – see page 978.

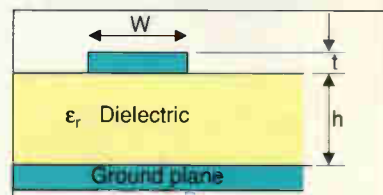

There are complex procedures for designing high performance microstripline circuits, but a few shortcuts result in a technique that is quick and easy to implement yet more than adequate for most applications, see page 1019.

1026 CIRCUIT IDEAS

- Trickier keypad lock
- Fast pulse monitor
- Analogue frequency doubler
- 5MHz triangle generator
- Precise mains volt measurement
- Lead acid battery saver
- Simple ac/dc indicator
- 50/60Hz sine oscillator
- Day indicator for digital clocks

JANUARY ISSUE
ON SALE 4 DEC

OLSON

®

**For all your Power Distribution
Distribution
Olson offer a varied
choice**

OLSON Distribution Units

OLSON ELECTRONICS LIMITED

OLSON DISTRIBUTION PANELS
FUSED, WITH R.F. FILTER
AND R.C.D. PROTECTION

OLSON ELECTRONICS LIMITED

OLSON FUSED WITH R.F. FILTER
AND R.C.D. PROTECTION

OLSON ELECTRONICS LIMITED

OLSON 'The Rack Range'
mains distribution panels
for 19" rack mounting

OLSON ELECTRONICS LIMITED

OLSON Office Furniture
Cable Management
Manufactured to BS 6396

OLSON ELECTRONICS LIMITED

OLSON Mains Distribution
Panels with
Non Standard Sockets

OLSON ELECTRONICS LIMITED

OLSON Mains Distribution Panels
INTERNATIONAL RANGE

OLSON ELECTRONICS LIMITED

OLSON Earth Leakage
Distribution
Units

PORTABLE UNIT Type PEL 1
WALL MOUNTED UNIT Type WEL 1
BENCH UNIT Type BEL 114

OLSON ELECTRONICS LIMITED

OLSON Distribution
Units

OLSON ELECTRONICS LIMITED

OLSON PANELS WITH 10AMP
CEE22/EC
SHUTTERED SOCKETS

OLSON ELECTRONICS LIMITED

OLSON 'The Rack Range'
mains distribution panels
for 19" rack mounting

OLSON ELECTRONICS LIMITED

OLSON Mains Distribution Panels
INTERNATIONAL RANGE

OLSON ELECTRONICS LIMITED

OLSON FUSED SUPPLY LINE
WITH R.F. FILTER
AND R.C.D. PROTECTION

OLSON ELECTRONICS LIMITED

OLSON DATA PROTECTOR
10 AMP SURGE FUSE WITH SHUTTERING
CONTACTS AND PROTECTIVE SUPPRESSOR

OLSON ELECTRONICS LIMITED

OLSON INDUSTRIAL RANGE
16 AMP 110V AND 240V
TO BS 4343/IEC 309

OLSON ELECTRONICS LIMITED

TYPE	NO. OF SOCKETS	INDUSTRIAL Grade of switching mechanism suitable for portable or wall mounting use
16A 110V	100	All units housed in equipment rated boxes of suitable construction
16A 240V	100	
16A 110V	100	Industrial 16 amp 2-pole Single phase safety
16A 240V	100	The sockets are for use in conjunction with BS 4343/IEC 309
16A 110V	100	All units are IEC/EN rated 12 amp

© 1988 OLSON ELECTRONICS LIMITED

OLSON Distribution
Units

OLSON ELECTRONICS LIMITED

OLSON 19" FAN TRAYS

OLSON ELECTRONICS LIMITED

OLSON 'The Rack Range'
mains distribution panels
for 19" rack mounting

OLSON ELECTRONICS LIMITED

OLSON SERVICE PILLAR FOR
THE OPEN-PLAN OFFICE

OLSON ELECTRONICS LIMITED

OLSON Distribution
Units

OLSON ELECTRONICS LIMITED

OLSON

ELECTRONICS LIMITED

FOUNTAYNE HOUSE, FOUNTAYNE RD., LONDON N15 4QL
TEL: 0181-885 2884 FAX: 0181-885 2496

CIRCLE NO. 106 ON REPLY CARD

At last - ISDN for all

EDITOR

Martin Eccles
0181 652 3128

CONSULTANTS

Jonathan Campbell
Philip Darrington
Frank Ogden

EDITORIAL ADMINISTRATION

Jackie Lowe
0181-652 3614

E-MAIL ORDERS

jackie.lowe@rbi.co.uk

ADVERTISEMENT MANAGER

Richard Napier
0181-652 3620

DISPLAY SALES EXECUTIVE

Joannah Cox
0181-652 3620

ADVERTISING PRODUCTION

0181-652 3620

PUBLISHER

Mick Elliott

EDITORIAL FAX

0181-652 8111

CLASSIFIED FAX

0181-652 8938

NEWSTRADE ENQUIRIES

0171 261 7704

ISSN 0959-8332

SUBSCRIPTION HOTLINE

01622 778000

SUBSCRIPTION QUERIES

rbp.subscriptions@rbi.co.uk
Tel 01444 445566
FAX 01444 445447

For a full listing of
RBI magazines:
<http://www.reedbusiness.com>



REED
BUSINESS
INFORMATION

A mass-market for ISDN was never in doubt; the only thing that blurred the vision was the cost of providing it. While large organisations found it easy to cost-justify the start-up charges, the cost of entry barred very effectively the wider army of hobbyists, home-based workers and small businesses from exploiting the undoubted benefits of ISDN.

Workarounds were promised to provide alternative routes onto the information superhighway 56kbit/s modems, XDSL techniques and cable modems but none of these have offered the total flexibility of real ISDN and users still waited for the cost of ISDN to fall.

And at last this fall is imminent, now that the key to providing affordable ISDN digital telephone service has been offered to UK network operators. British telecomms manufacturer GPT, which supplies the System X exchanges used by BT and many other providers, has come up with an easy-to-install package to enhance these switches. For the first time it offers a means of providing low-cost ISDN service for the mass market of small business and residential customers.

What is particularly elegant is that it achieves not one but two breakthroughs. First, the cost barrier which held back smaller users from exploiting the acknowledged benefits of digital data communication has been eliminated. In particular, home-based workers now have a cost-effective means of exchanging documents and sharing data with office-based colleagues, as well as gaining faster access to the Internet and a host of interactive information and entertainment services to come.

Small businesses requiring high-speed data transfer no longer need to install special private wires for the purpose.

The second advantage is the fact users can enjoy the benefits of ISDN without forfeiting their existing phones and numbers. Unlike previous implementations of ISDN, customers do not forfeit useful services such as call waiting, three-way calling, ring back when free, 1471 call return,

Centrex and so on. Analogue caller display devices, which cannot operate on normal digital ISDN lines, still work under this new implementation.

It adds up to a double bonus. For network operators it is a cost-effective delivery mechanism for providing twin-channel Basic Rate ISDN (ISDN2) service without the need for a second pair of wires. The customer benefits are equally significant; users gain the enhanced capability and 128kbit/s bandwidth of ISDN while retaining the convenience and established popular features of their existing analogue connection. Because the system can provide two simultaneous connections, users are spared the cost of having a second line installed.

The technical implications are relatively modest, involving an upgrade to System X exchanges and the provision of a compact plug-in unit at the customers end for connecting a customers existing telephone equipment with direct Plug-and-Play hook-up of a PC compatible. Installing this network terminator, which replaces the existing master phone socket, does not take long and setting up takes only a minute or two; the switchover from old-style analogue to ISDN service is effectively instantaneous and requires no access to customer premises.

The all-British technology is now being proposed to the European Telecommunications Standards Institute as a pan-European standard for narrowband multi-service delivery.

For network operators the new technique provides the opportunity to offer an extremely attractive ISDN package to a large and growing market. In the same way as high-speed modems soon became affordable and commonplace, it is reasonable to expect ISDN will make digital data communication the norm for small users as well as large.

For people working from home (the so-called teleworkers), low-cost ISDN will provide cost-effective means for exchanging documents and sharing data with office-based colleagues, as well as offering faster access to the Internet and a host of interactive

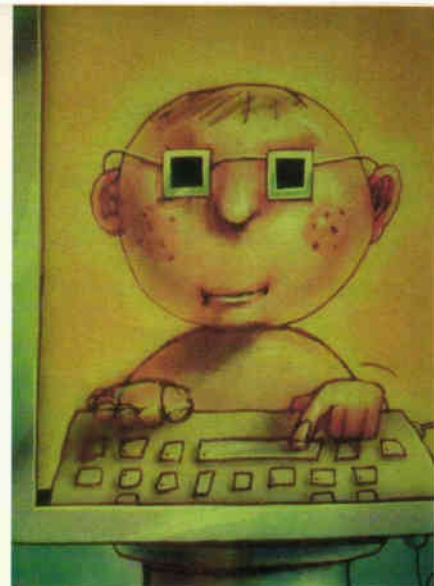

The entry cost of ISDN has barred very effectively the wider army of hobbyists, home-based workers and small businesses from exploiting its undoubted benefits.

information and entertainment services to come. Small businesses will be able to link up with one another electronically to create virtual enterprises, working together to provide a single concerted service to their clients. Faster connection and data transfer will give surfing the Internet a major new impetus, opening up new prospects of online shopping and multimedia information delivery from low-cost terminals alongside the domestic television set.

Supporting this, the market for low-cost user products and solutions for ISDN is maturing rapidly, with a broad range of mini-PBXs, line cards and multi-function devices selling at truly affordable prices. One vendor offers a PC card combining ISDN file transfer at up to an effective 412kbit/s, V.34 modem emulation, Group 3 fax operation and a digital voice answering machine. It comes bundled with video conferencing software and an electronic secretary capable of storing and forwarding voice, data and fax messages. This sells for an extremely affordable 99 and with this kind of functionality on offer, users cannot fail to reconsider their attitudes to ISDN. ■

Andrew Emmerson

Electronics World is published monthly. By post, current issue £2.35, back issues (if available) £2.50. Orders, payments and general correspondence to **L333, Electronics World, Quadrant House, The Quadrant, Sutton, Surrey SM2 5AS**. Tlx:892984 REED BP G. Cheques should be made payable to Reed Business Information Ltd **Newstrade**: Distributed by Marketforce (UK) Ltd, 247 Tottenham Court Road London W1P 0AU 0171 261-5108.

Subscriptions: Quadrant Subscription Services, Oakfield House Perrymount Road, Haywards Heath, Sussex RH16 3DH. Telephone 01444 445566. Please notify change of address. Subscription rates 1 year £32 UK 2 years £43.00 3 years £75.00. Surface mail 1 year £37.00 2 years £60.00 3 years £86.00 Air mail Europe/Eu 1 year £46.00 2 years £73.00 ROW 1 year £56.00 2 years £89.00

Overseas advertising agents: France and Belgium: Pierre Mussard, 18-20 Place de la Madeleine, Paris 75008. United States of America: Ray Barnes, Reed Business Publishing Ltd, 475 Park Avenue South, 2nd Fl New York, NY 10016 Tel: (212) 679 8888 Fax: (212) 679 9455

USA mailing agents: Mercury Airfreight International Ltd Inc, 10(b) Englehard Ave, Avenel NJ 07001. Periodicals Postage Paid at Rahway NJ Postmaster. Send address changes to above.

Printed by BPCC Magazines (Carlisle) Ltd, Newtown Trading Estate Carlisle, Cumbria, CA2 7NR

Typeset by Marlin Imaging 2-4 Powerscroft Road, Sidcup, Kent DA1 4 SDT.

© Reed Business Information Ltd 1997 ISSN 0959 8332

PROTEUS

The IVth Generation

Schematic Capture

NEW Version IV

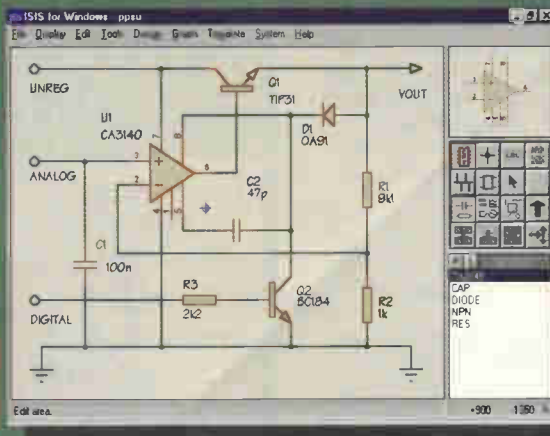

- Produces attractive schematics like you see in the magazines.
- Netlist, Parts List & ERC reports.
- Hierarchical Design.
- Full support for buses including bus pins.
- Extensive component/model libraries.
- Advanced Property Management.
- Seamless integration with simulation and PCB design.

New Features

- Component Auto-Placer
- Pinswap/Gateswap Optimizer
- Background Regeneration of Power Planes
- Enhanced Autorouting with Tidy Pass
- Full Control of Schematic Appearance
- Extensive New Component Libraries

Available in 5 levels - prices from £295 to £1875 + VAT.
Call now for further information & upgrade prices.

Simulation

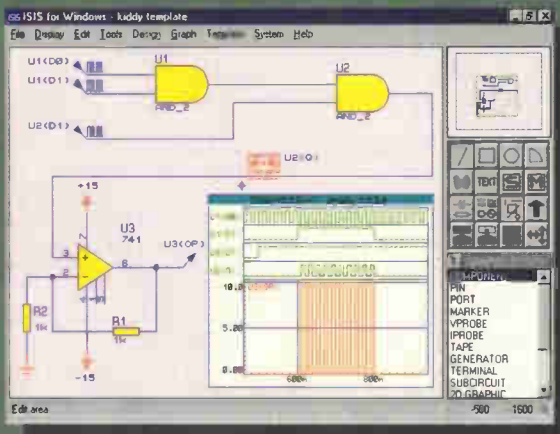

- Non-Linear & Linear Analogue Simulation.
- Event driven Digital Simulation with modelling language.
- Partitioned simulation of large designs with multiple analogue & digital sections.
- Graphs displayed directly on the schematic.

PCB Design

NEW Version IV

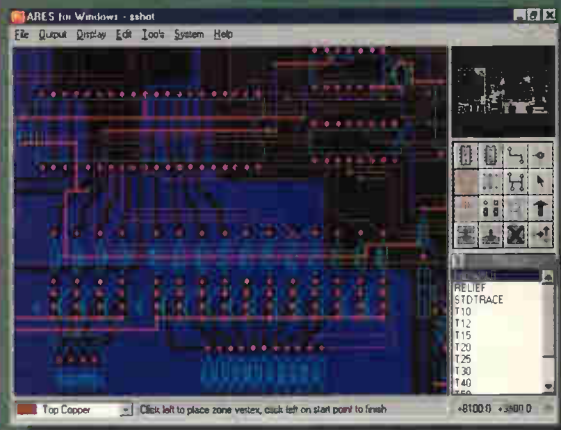

- Automatic Component Placement.
- Rip-Up & Retry Autorouter with tidy pass.
- Pinswap/Gateswap Optimizer & Backannotation.
- 32 bit high resolution database.
- Full DRC and Connectivity Checking.
- Shape based gridless power planes.
- Gerber and DXF Import capability.

"PROTEUS is particularly good with its rip-up-and-retry autorouter"
EWW January 1997

Labcenter
Electronics

Write, phone or fax for your free demo disk, or ask about our full evaluation kit.
Tel: 01756 753440. Fax: 01756 752857. EMAIL: info@labcenter.co.uk
53-55 Main St, Grassington. BD23 5AA. WWW: <http://www.labcenter.co.uk>

Fully interactive demo versions available for download from our WWW site.
Call for educational, multi-user and dealer pricing - new dealers always wanted.
Prices exclude VAT and delivery. All manufacturer's trademarks acknowledged.

UP DATE

Bright prospects for UK employment

Employers are forecasting more jobs within the UK's electronics industry, according to a recent survey conducted by Manpower.

Meanwhile, the September pay bulletin from the engineering employers' federation (EEF) has found that pay settlements within UK industry as a whole remain

subdued and below the headline rate of inflation.

The average pay settlement for the quarter up to August was 3.17 per cent compared to 3.5 for inflation.

Manpower's latest Survey of Employment Prospects, conducted amongst 2,339 employers around the country, found 33 per cent of

electronics employers expect to recruit during the fourth quarter of 1997, against seven per cent who expect to lay off staff, registering a balance of 26 per cent.

This quarter balance exceeds the national average of 23 per cent and the manufacturing sector average of 22 per cent.

Digital tv to miss World Cup

Digital Terrestrial Television (DTT) in the UK is set to be delayed by at least three months, following the deferment in the ITC's awarding of licences. Originally DTT was to be launched in July 1998, in time for the World Cup. Now October 1998 is the expected launch date.

"There has been a gentle slippage, but as is already known, the permission from ITC came out a bit

later," said Jim Slater, project coordinator for DTT at the Digital TV Group.

Currently, the set-top box makers are waiting for the reference design from British Digital Broadcasting (BDB) for the manufacture of the first DTT receivers.

"We are currently drawing up the specification for manufacturers to build the boxes to," said a BDB spokesman.

New video camera has \$8 price tag

Edinburgh-based c-mos camera specialist Vision has added a low cost sensor to its range. The 160 by 120 pixel digital cameras are aimed at the security, videophone, toys and games markets. Eight-bit resolution monochrome and colour cameras are available. The monochrome VV5300 is priced below \$8 in volume quantities. Vision also offers a \$450 development system which includes PC software, capture card and lens.

Fairchild to decide on Temic by Christmas

Fairchild Semiconductor will make its decision whether or not to buy Temic by December. The company is also considering buying GEC-Plessey Semiconductors (GPS).

"We're still at the discovery stage - asking: 'Does Temic make sense?'" said Joe Martin, chief financial officer at Fairchild. "We'll make the decision on Temic in four to eight weeks."

"We've looked at 50 companies around the world since we spun-off from National on March 11th," added Martin. Citicorp Venture Capital, part of Citibank, financed the \$550m Fairchild management buy out and gave it a brief to look for acquisitions.

"A lot of companies have a semiconductor subsidiary for strategic products. Some want to divest themselves of these companies and Fairchild provides them with an opportunity as a credible vehicle for consolidating these sort of operations. We are actively soliciting these companies as part of our acquisition strategy," said Kirk Pond, president

and CEO of Fairchild.

Asked if Fairchild was interested in buying GPS, Martin replied: "We could be. It's only recently become available. We haven't had time to look at it yet, but it could be a possibility."

Fairchild is interested in the

semiconductor side of Temic, not the automotive components side. The main attraction of the semiconductor side for Fairchild is the former Siliconix product line of power semiconductors, including small signal transistors and its *PowerMOS* line, explained Martin.



Flat and wide... NEC has put into production a 50-inch plasma display intended for the high definition television market. The Hi-Vision PlasmaX panel is capable of displaying one million pixels and will go on sale in Japan next February, in time says the company, to be used in high definition tv systems to be used during the Nagano Winter Olympic Games. But UK skiing enthusiasts - an exclusive bunch at the best of times - should be warned the selling price of the 50in flat format plasma televisions will be around ¥2.7m (£13000).

PCI bus is to get a refit

Power management and hot-plug capabilities are to be added to the PCI-bus, it was announced recently. Version 2.2 of the PCI specification is to be released early next year, said Donald Coffin of the PCI special interest group.

"Power management is the hardware side of Microsoft's ACPI or advanced configuration and power interface," explained Coffin.

ACPI allows parts of a PC to be powered down when not in use. Notebook PCs are already early

adopters of the technology. By adding ACPI to the computer's local bus, peripherals will be more energy efficient.

Hot plug is aimed for use in servers, so that disk and Ethernet cards can be swapped without shutting down the system.

The last major update to the PCI specification, version 2.1, was released two years ago. This extended the bus from 32-bit at 33MHz to 64-bit at 66MHz. Bandwidth quadrupled to 528Mbyte/s.

"We are now seeing 64-bit, 66MHz systems, especially in servers," said Coffin.

The move to the higher rate will continue in servers and workstations over the next year to 18 months, claims Coffin.

Desktop PCs are likely to continue with the 32-bit, 33MHz version. This is because Intel's accelerated graphics port (AGP), which links the graphics system directly to the microprocessor, has greatly reduced the burden on the PCI-bus.

Awareness funding for year 2000 bug redirected

The Government is to stop funding Taskforce 2000, the body assigned to raise awareness about the Millennium bug. Instead, £1m will be given to Action 2000, a new organisation tasked with taking a more active approach to the problem.

Robin Guenier, head of Taskforce 2000, criticised the decision, saying it would waste valuable time. "We're going to lose weeks while people are appointed to [Action 2000]," he said.

"Wouldn't it have been more sensible to continue with Taskforce 2000?"

A DTI spokesman countered: "Taskforce 2000's aim was to raise awareness and it did it very well. However, companies are not doing enough and a new impetus is required to turn awareness into action. We are showing our commitment, now it's up to industry to make its contribution."

Guenier insisted there is still a need to continue with his awareness programme, especially with regard to how Year 2000 affects embedded systems, to get the whole of industry and commerce tackling the problem rather than just helping the estimated 15 per cent that have already begun.

However, the DTI spokesman stressed the awareness campaign would continue as part of Action 2000's ambit.

UK electronics industry warned

The UK electronics industry faces a great threat from Eastern European-based manufacturing, according to a paper from Loughborough University.

Professor David Williams, presenting the paper to the Cambridge Centre for International Manufacturing, warned that Eastern Europe threatens "unrooted" inward

investments in the UK, and that even embedded foreign investment in Scotland is vulnerable.

"Screwdriver inward investments will probably go to places like Poland and the Czech Republic," he said, pointing out that IBM had already transferred disk drive manufacturing capacity from Havant to the Republic.

Williams believes UK electronics companies need a greater awareness of their global role if they are to survive well into the next century. Success will mainly come for firms that couple investment in high value-added activities with sales into mature economies like the US. "Should we sell expensive products to rich Americans or cheap products to the Chinese?" he said.

But the UK must not pass up opportunities in the Far East for long term investment in areas of industrial growth. "We can't afford to miss another trick like we did with Singapore, where a low value region becomes a high value one," said Williams.

NEC details handheld Risc chip

NEC has released details of its latest microprocessor for the handheld computer (HPC) market.

The VR4111 is a 64-bit Risc microprocessor based on the R4000 core from MIPS Technologies. It is an updated version of the VR4101 and 4102. The new devices are pin-compatible with the previous processors to allow easier design upgrades.

Performance reaches a claimed 130Mips at 100MHz by moving the device to a 0.25µm manufacturing process. Power consumption has been reduced from 250mW to 180mW by running the device at 2.5V.

To reduce memory requirements, the devices can execute a 16-bit instruction set, similar to the ARM Thumb.

NEC has integrated HPC-specific peripherals for LCDs, keyboards, infra-red and serial I/O, audio and touch screen interface.

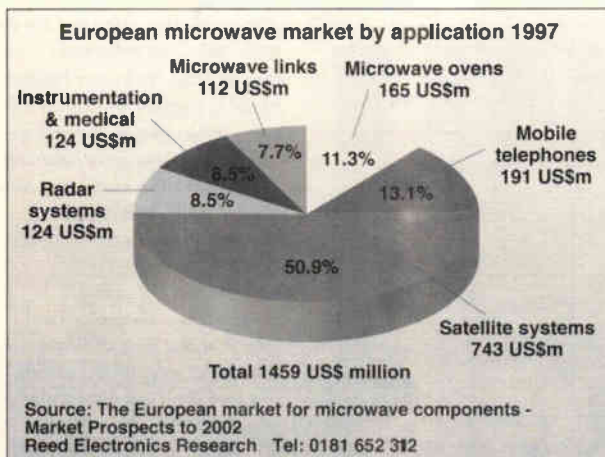

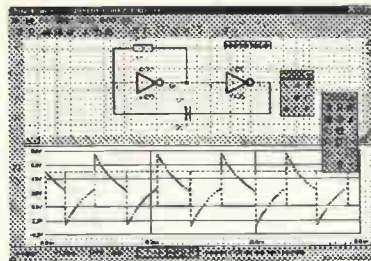

Schematic Capture with a FREE mixed mode simulator.

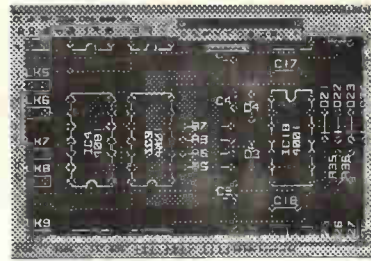

Integrated PCB Design with autorouter & CAD/CAM support.

Looks like Quickroute 4.0 has Got It All!

FREEphone 0800 731 2824
FAX 0161 476 0505
FREE Demo on www.quickroute.co.uk
Ref 401

The new Quickroute 4.0 is here and with it a revolution in our price/performance structure. We've kept the features the same at all levels of Quickroute and just varied the number of pins you can use in a design. So now you can get started FAST with Quickroute 4.0 for just £79 (300 pins), £149 (800 pins) or £249 (full access). Prices exclude P+P and VAT.

All versions of Quickroute 4.0 now include:
*New user interface with dockable tool bars *Multi-sheet schematic capture *Power rail & data bus support *1-8 layer autorouter *For a limited period a FREE integrated 32 bit mixed mode simulator *Copper Fill *Engineering Change *Gerber import and export *Export NC-Drill, WMF, DXF and SPICE files *Netlist import and export *Over 1000 library parts

Send me a FREE DEMO. My name, address & phone number are:



Send To: Quickroute Systems Ltd, FREEPOST 13136, Stockport, SK4 1BS
Outside the U.K please fax this coupon. (c) 1997. All rights reserved. Ref 401.

CIRCLE NO. 108 ON REPLY CARD

Circuit simulation can be seriously good fun

Those Engineers Ltd

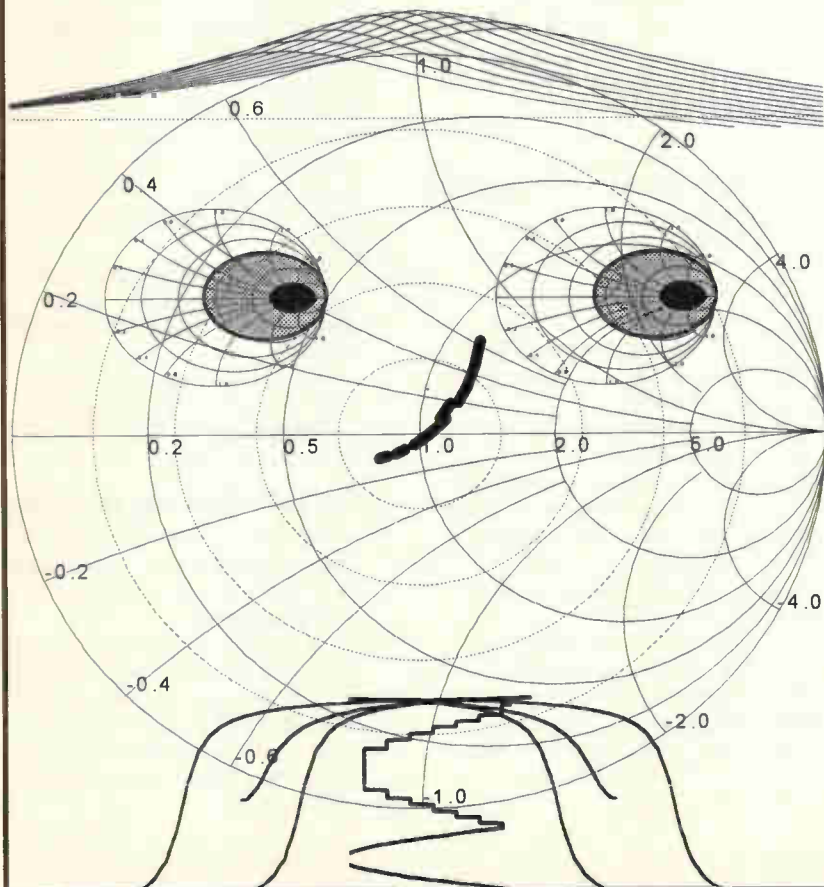

When you have the engineering edge, enjoy your work and catch subtle circuit behaviour before it's too late, you can afford to be light hearted. Add to this technical support from practising engineers who take a genuine interest in your work and you are really laughing.

With a free evaluation kit, you can test SpiceAge on your own circuits. The kit comes with an introductory booklet to show you how.

To hear more about this and other nice touches in SpiceAge, please contact the friendly people at

Those Engineers Ltd,
31 Birkbeck Road,
LONDON NW7 4BP.

Tel 0181 906 0155
Fax 0181 906 0969
Email those_engineers@compuserve.com
Web <http://www.spiceage.com>

CIRCLE NO. 109 ON REPLY CARD

Future bleak for NCs

Network computers (NCs) could be dead in the water as network managers decide to stick with existing network equipment.

This message emerged from a Fodor Wyllie survey commissioned from Pin Point Software, the network management tools supplier.

According to the survey, 56 per cent of companies questioned did not believe the NC would make a significant impact on their organisations even though network management would be made easier.

"The momentum for network computers has been lost. We were amazed at the ambivalence towards the network computer. Clearly there is a belief that the NC can help but there's a lot of pessimism about its

implementation," said Iain Franklin from Pin Point Software. "Although the NC saves a lot of time managing the network, companies prefer to stick to what they have rather than switch their whole networks to NCs."

According to Pin Point Software this is a surprising revelation as the market for network management devices is growing at a rate of 30 per cent per year and it has already reached the \$1bn mark.

Another analyst, Bloor Research disagrees. "I don't believe the momentum for NCs is lost," said Rob Hailstone, chief analyst at Bloor Research. "I suspect until we see the first successful implementation of NCs people will think it's not going to happen."

Guidelines aimed at cutting keyfob interference

The chance of getting locked out of your car by EMC problems should be reduced if guidelines by RAKE, the Radio Activated Key Committee, are adopted.

Problems arise because EU legislation added automotive keyfobs to the list of legitimate users of 433.93MHz in the UK, which already included the MoD and radio amateurs. "We are in no position to ask the other user to get off the frequency – the radio amateurs have been using it for over 40 years," said Peter Brill, RAKE spokesman at the RAC.

This said, the guidelines contain the paragraph: 'As a first step, in the UK, the next two years will see the removal of some users of the 433MHz band to other parts of the spectrum'.

The guidelines are split into two parts: a guide to motorists and a guide to manufacturers for future products.

"One of the simple things we are encouraging manufacturers to do is ensure there is an alternative method of entry," said Brill.

Other guidelines suggest marking 'hot spots' on and in the vehicle where it is most sensitive to the keyfob being held, visible instructions to remind drivers what to do if the fob fails to operate the car and a reduction in receiver bandwidth.

Motorist Web update:
<http://www.rac.co.uk/html/fut/pr971008.htm>

Initial products for FireWire announced

The first FireWire products are to start appearing on the market in the next six months, two years after the IEEE1394-1995 standard was agreed.

"We had the standard two years ago. It's time to start generating products this and next year," said Hiro Tsutsui, marketing manager at Sony Image Sensing Products in Japan.

Intel will deliver a prototype motherboards with the FireWire-1995 digital interface early next year. The software by Microsoft will also cater for this type of linking then and Apple will introduce Power Macs with this interface.

Last week, Sony announced its DFW-V300 digital colour camera, one of the first FireWire peripherals, with this high-speed

serial bus standard on board. In 1998, Sony hopes to launch another six products from its image sensing portfolio.

"The real benefit is that IEEE-1394 standard allows digital data to be imported directly into a PC or device, meaning the DFW-V300 camera provides a very quick and very scalable solution for transferring video data for processing by computer," said Steve Hearn, business manager at Sony Image Sensing Products.

The next FireWire specification, IEEE1394-1998 or IEEE1394-2000, is being discussed between the industry players and the standardisation bodies including the 1394.b Working Group that is working towards the 3.2Gbit/s specification.

In brief

New specs for DVD

The latest specification for the write-once DVD-Recordable (DVD-R) format has been published by the DVD Forum. The version 1.0 specification offers a 3.95Gbyte single-sided or 7.9Gbyte double-sided storage capacity that will be compatible with other DVD formats such as DVD-ROM and DVD-Video. The next generation 4.7Gbyte DVD-R is currently under discussion by the DVD-R Working Group. Meanwhile, Matsushita Electric Industrial expects first-year total worldwide sales of DVD players to be half of that first envisaged. Initial forecasts were for sales of up to two million units, however, the forecasts have been downgraded to below one million units.

Risc processor for hand-helds

NEC has released details of its latest microprocessor for the handheld computer (HPC) market.

The VR4111 is a 64-bit Risc microprocessor based on the R4000 core from MIPS Technologies. It is an updated version of the VR4101 and 4102. The new devices are pin-compatible with the previous processors to allow easier design upgrades.

Performance reaches a claimed 130Mips at 100MHz by moving the device to a 0.25µm manufacturing process. Power consumption has been reduced from 250mW to 180mW by running the device at 2.5V.

To reduce memory requirements, the devices can execute a 16-bit instruction set, similar to the ARM Thumb.

NEC has integrated HPC-specific peripherals for LCDs, keyboards, infra-red and serial I/O, audio and touch screen interface.

CO₂ will affect chip production

Global warming will affect the semiconductor industry, says a report from the Economic Strategy Institute of Washington DC.

The Institute warns that if proposals to cut CO₂ emissions proposed by the Kyoto global warming summit are adopted, then the global economy will slow down leading to an eight per cent reduction in the demand for semiconductors. ■

WE PUT EVERYTHING INTO OUR NEW 48-PIN UNIVERSAL PROGRAMMER

1.8V
2.7V
3.3V
5V

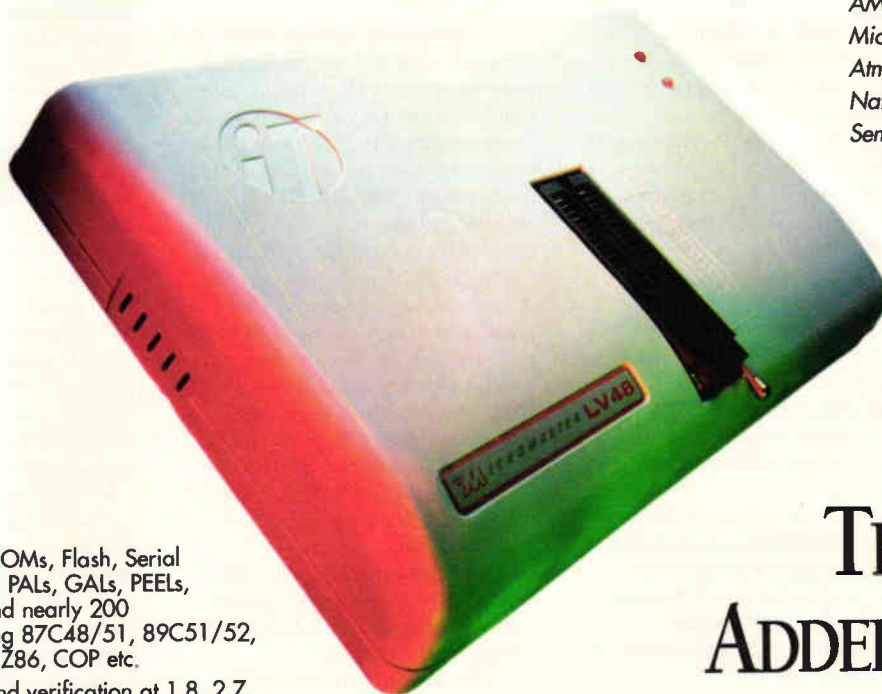

Approved by major
manufacturers
including:
AMD
Microchip
Atmel
National
Semiconductor



FEATURES

- Supports EPROMs, EEPROMs, Flash, Serial PROMs, BPROMs, PSDs, PALs, GALs, PEELs, MACH, MAX, EPLDs, and nearly 200 Microcontrollers including 87C48/51, 89C51/52, PIC, MC705/711, ST6, Z86, COP etc.
- Correct programming and verification at 1.8, 2.7, 3.3 and 5V
- No adapters required for DIL parts upto 48-pins. Universal adapters for 44-pin PLCC, 44-pin PSOP and 48-pin TSOP parts
- High speed: programmes and verifies National 27C512 in under 11 seconds
- Connects directly to standard parallel port - no PC cards needed
- Built in chiptester for 7400, 4000, DRAM, SRAM
- Lightweight and mains or battery operation
- Complete with parallel port cable, software, re-charger and documentation

Only
£695

THEN ADDED MORE

- FREE software device support upgrades via bulletin board and ftp
- Next day delivery
- Full range of adapters available from £65 for upto 84-pins for PLCC, SOIC, PSOP and TSOP

PROGRAMMER MODELS AND PRICES

LV MODELS (SUPPORT 1.8V, 2.7V, 3.3V and 5V DEVICES)		SPEEDMASTER 1000+	EPROMs, EEPROMs, Flash, NVRAMs, Serial PROMs, Serial EEPROMs, BPROMs, GALs, 8748/51	£395	
EPMASER LV	EPROMs, EEPROMs, Flash, Serial PROMs, Serial EEPROMs 8 to 40 pins all without adapters. Built in emulator modules: 128k by 8: £395 128k by 16: £465	£295	MICROMASTER 1000+	EPROMs, EEPROMs, NVRAMs, Flash, Serial, BPROMs, PALs, GALs, PEELs, MACH, MAX, PSD, nearly 200 microcontrollers without adapters.	£525
SPEEDMASTER LV	EPROMs, EEPROMs, Flash, NVRAMs, Serial PROMs, Serial EEPROMs, BPROMs, GALs, PALs, EPLDs, MACH, MAX, 8748/51.	£495	SPEEDMASTER GLV32	High speed EPROM/Flash 8 way Gang/Set Programmer. Supports 3.3V and 5V	£695
MICROMASTER LV	EPROMs, EEPROMs, NVRAMs, Flash, Serial, BPROMs, PALs, GALs, PEELs, MACH, MAX, PSD, nearly 200 microcontrollers without adapters.	£625	COP GANG PROGRAMMER	8 way Gang programmer for National Semiconductor COP family of micros COP87xxC, COP87Lxx and COP8SAx	£1500
LV40 PORTABLE	All devices supported by Micromaster LV, plus completely portable with built in keypad and LCD display.	£995	SOCKET ADAPTERS	for PLCC, TSOP, SOIC, etc.	from £65

All prices exclude VAT and delivery

For a copy of our catalogue giving full details of programmers, emulators, erasers, adapters and logic analysers, call, fax or e-mail us. You can also access our BBS or Home page. All our products are in stock now for next day delivery - call our credit card hotline now.

CE



ICE Technology Ltd. Penistone Court, Sheffield Road, Penistone, Sheffield, UK S36 6HP
Tel: +44 (0)1226 767404 Fax: +44 (0)1226 370434 BBS: +44 (0)1226 761181 (14400,8N1)
Web: www.icetech.com. Email: sales@icetech.com



CIRCLE NO. 110 ON REPLY CARD

RESEARCH NOTES

Jonathan Campbell

Diamond coating adds twinkle to disk storage

One of the major stumbling blocks in the design of ultra-high storage disk drives is that the read/write heads must be located ever nearer to the disc surface to be able to resolve the data. At these tiny distance, impacts are inevitable so the heads must be coated. But any protective coating must be super thin too, so as not to disturb magnetic performance.

Now, a way has been found to shield disks and sliders – reader heads – with ultra-thin ‘overcoats’ of diamond-like carbon that can survive repeated crash landings at 3600rev/min. Success is being welcomed as a breakthrough in progress to high density storage devices.

The work has been carried out by Simone Anders of the Accelerator and Fusion Research Division at the Ernest Orlando Lawrence Berkeley National Laboratory and her colleagues from IBM and University of California, Berkeley.

IBM has already brought to market disks that store 4Mbytes/mm² of data, while densities almost twice that have been demonstrated, and researchers are aiming for 16Mbytes/mm² and more. To read a disk where magnetic domains are packed only 25nm apart, disk surface and slider will have to move so close to each other that it’s almost a matter of semantics whether they will actually be touching.

Typical high-quality commercial overcoats now in use are made of sputtered-on, hydrogenated carbon 12 to 15nm thick. But higher data densities require reduced magnetic spacing between heads and disks – so disk coatings must be thinner and made of even harder material. Sputtering can’t do the job, but a technique called cathodic arc deposition can.

Unlike sputtering, cathodic arcs produce a fully ionised plasma of whatever material, including carbon, is used for the cathode.

A fully ionised carbon plasma

allows electrons and carbon nuclei to reassemble themselves as diamond, in a three-dimensional lattice in which each atom is bound to four others by electron pairs – a tetrahedral bond. In contrast, atoms in graphite are bound to only three other atoms, forming a much less stable configuration. By tuning the energy of the incoming carbon ions, the tetrahedral-bond content of the deposited film can be optimised, so films have been made that, while technically amorphous, are 85% diamond.

“Still, the method hasn’t been practical for coating disks,” says Anders, “because micron-sized chunks of the cathode boil off and contaminate the films.”

For cathodic arc deposition to be useful in coating disks and sliders, a way must be found to completely filter out the macroparticles. What Anders and her team has achieved is to devise a filter so good that all the goals of thin, flat, hard, macroparticle-free carbon are fulfilled.

The secret is a magnetic coil that looks much like a Slinky toy, placed between the plasma source and the substrate to be coated. The fully ionised plasma is easily bent through this S-shaped magnetic field – effectively two fields at right angles – but the massive macroparticles of carbon can’t turn easily; they fly right through the sides of the coil or pile up on its walls. A coil that has been used for some time is thickly coated with a dust of macroparticles near the plasma source, yet dust-free at the substrate end.

Tests show that disks coated with cathodic arc carbon have a coefficient of friction half that of those coated with hydrogenated carbon and cause 20 times less wear on the slider. In additional studies, when a silicon wafer coated with cathodic arc carbon has been examined at nanometre scale after repeated loading, it shows virtually no scratches.

Contact, Simone Anders, Accelerator and Fusion Research Division, Ernest Orlando Lawrence Berkeley National Laboratory, Berkeley, California, USA

Towards more reliable hard disk drives – ionised plasma follows the curves of the magnetic field, but unwanted macroparticles just hit the wall.

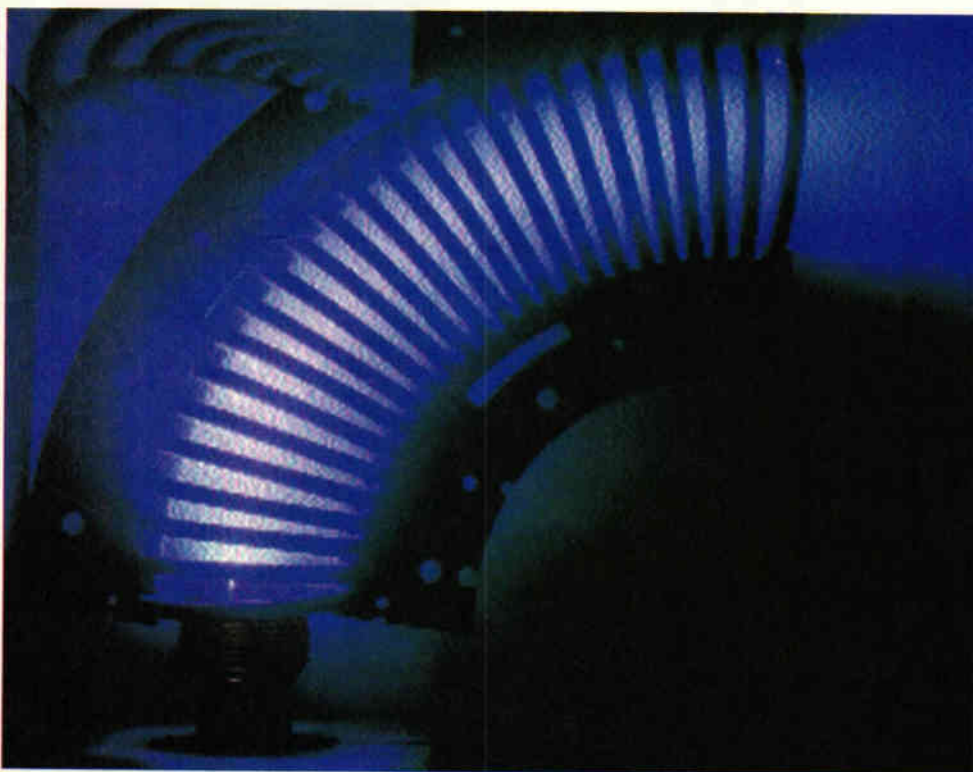

Radar finds people behind locked doors

Lives could be saved by a prototype radar system, developed at Georgia Tech Research Institute, that can sense someone moving or breathing up to 3m behind a locked door. For police and hostage negotiators, the device, little bigger than a torch could provide vital information about where people are located inside a room. The sensor could also be used to find survivors in the rubble of accidents or earthquakes.

A narrow radar beam of about 15 to 20° and a specialised signal processor is used to detect the body movement generated by breathing.

Research that evolved into the radar torch began in the mid-1980s, with the patenting of a frequency modulated radar for remotely checking vital signs of battlefield wounded before sending in medical teams. This early technology was also tested for its ability to monitor vital signs of soldiers clothed in chemical or biological warfare suits, without requiring them to risk contamination by removing the protective gear. Now the technology has been refined for more general use.

Radar has some advantages over other technologies. The signal from the radar will penetrate clothes and detect respiration through a heavy jacket, and requires a body movement of only a few millimetres to detect human presence.

"Based on respiration signature alone, the radar flashlight allows us to detect a stationary individual behind a solid wooden door, or standing 1.2m



behind a 200mm block wall," explains Gene Greneker, a principal research scientist at the GTRI.

Even so, the amount of electromagnetic radiation exposure from the device is still small – said to ten times less than the voluntary exposure leakage level for microwave ovens in the United States. Exposure is estimated to be about the same as a person receives when walking under an automatic door opener triggered by a microwave sensor.

For now, the signal processor is

external to the radar sensor, and the respiration signature is displayed on a monitor driven by a computer-based radar signal processor. But Greneker plans to make everything small enough to fit inside the torch body by incorporating high-speed signal processing technology.

Contact: Gene Greneker, Georgia Institute of Technology, 223 Centennial Research Building, Atlanta, Georgia 30332-0828. Tel: 00 1 770-528-7744 email: gene.greneker@gtri.gatech.edu

The radar torch can detect the presence of a human through a wall or door (Stanley Leary, Georgia Tech)

Chill settles on car electronics

Electronics are now almost as an important component of cars as the engines and bodies themselves. Over at the Daimler-Benz Research Centre in Ulm, scientists are putting the next generation of microwave circuitry through its paces, using a specially-constructed low-temperature measuring station allows researchers to investigate the characteristics of new microwave circuits at temperatures far below freezing point. In this way, any adverse effects on the performance of superconductor elements can be predicted.

At the measuring station, tests can be carried out at temperatures as low



Daimler-Benz has constructed a rig specially designed for low temperature testing of microwave components.

as -250°C , allowing the scientists to examine new components for high-power radar sensor units or for compact narrow-band receivers in communications technology, while detailing their behaviour at extreme sub-zero temperatures. On the basis of these results, the characteristics and capabilities of

superconductor elements can be precisely predicted.

The use of superconductor materials in place of metals and the resulting new approaches to modelling in hybrid combination are seen as milestones along the road to new, highly sensitive receiver systems for the microwave

band. The objective is to benefit from the advantages of various available components and unite them in a single overall system.

Automotive researchers currently regard this as the most cost-effective solution for the production of such components in small and medium volumes.

Organic computer comes closer...

Researchers at Yale University in the US have succeeded for the first time in measuring an electric current flowing through a single organic molecule sandwiched between metal electrodes. The feat could pave the way for a new generation of transistors so small that a beaker full would contain more transistors than exist in the world today, according to Yale electrical engineer Mark Reed, team leader.

The accomplishment is a fundamental step toward creating computers and sensors that are smaller, faster and cheaper than today's silicon-based computers. The next step is to design computer chips whose wires are made of self-assembling strings of organic molecules that grow in a beaker, since the wires would be far too small to produce any other way. The organic wires would adhere to metal electrodes, a revolutionary strategy for fabricating electronic devices for which Professor Reed and Yale hold a joint patent.

But Reed warns that it could take a decade to learn how to make useful devices out of quantum components made from organic compounds.

To capture the historic measurement of current across a single organic molecule, the researchers made a mechanically controllable break junction by gluing a notched gold wire to a flexible substrate, then fracturing the wire to make an adjustable gap. Next, they sandwiched a single molecule of benzene (a hexagonal ring made up of six carbon and six hydrogen atoms) flanked by

two sticky sulphur atoms between the two gold electrodes. The process required self-assembly of benzene molecules onto the electrodes.

For the future, perhaps the greatest obstacle to be overcome in fabricating useful quantum devices is to find better, faster ways to make large quantities. Electron beam lithography is used at the moment and this is just not practical for volume production.

The answer could be to find materials that will assemble themselves into quantum components.

Reed says his goal is to find organic chemicals that will combine to form a substrate of conducting molecules.

Contact: Professor Mark Reed, Yale University, New Haven, Connecticut, USA, Tel: 00 1 203 432 4306 email: reed@yale.edu

...But can silicon wait?

Progress to ever smaller, faster and cheaper computers may soon come to a grinding halt because microscopic silicon chips are getting so small that eventually they will contain too few atoms to work, warn two University of Florida researchers.

By the year 2010 the limit will be reached, and microprocessors will be as small and as fast as they can get, says Kevin Jones, professor of materials science and engineering and co-director of UF's SoftWare and Analysis of Advanced Material Processing (the Swamp Center).

Jones and Swamp co-director Mark Law are concerned that the heart of the Pentium processor transistor, a layer that once was thousands of atoms thick, is getting so small that it soon will be only 50 atoms thick. They say the Pentium processor may eventually shrink itself out of function when it gets to be fewer than 10 atoms thick, in just over a decade. That means unless there is a revolutionary change in computer technology, the trend toward smaller, faster computers

will have reached its limit.

Effectiveness of shrinking processors is also threatened by the impurities in microscopic silicon chips. Law and Jones are currently using 3d computer simulation to investigate the nature of the impurities in silicon which can cause current to flow where it is not supposed to.

Impurities can cause catastrophic failure when the impurities run into the crystal and cause electronic switches to short circuit.

The researchers are currently making predictive models for the industry, primarily using computer simulation because testing with real materials is so expensive.

"We need to know how impurities diffuse, at what rate and at what temperature," says Law.

"We can then code that data and build predictive models that allow the industry to build better chips." ■

Contact: Kevin Jones, University of Florida, Gainesville, USA. Tel: 00 1 352 392 9872.

The Balance Box

Microphone or line level amplifier for balanced or unbalanced signal lines

Professional portable units operating from an internal PP3 battery or external mains adaptor

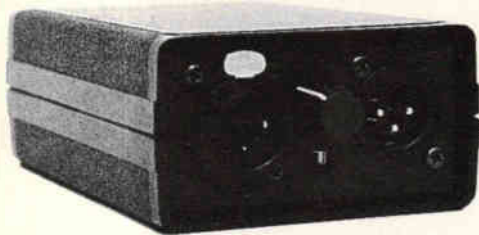

- ★ Precision true floating transformerless balanced input and output at microphone or line level
- ★ Simple interfacing and conversion between balanced and unbalanced signal lines
- ★ Low noise and distortion
- ★ High common mode rejection
- ★ Switchable gain selection
- ★ Extensive RFI protection

The Phantom Power Box – The Headphone Amplifier Box - The OneStop DIN rail mounting radio frequency interference filter and voltage transient protector for voltage and current loop process signal lines

Conford Electronics Conford Liphook Hants GU30 7QW
 Information line: 01428 751469 Fax: 751223
 E-mail contact@confordelec.co.uk
 Web <http://www.confordelec.co.uk/catalogue/>

CIRCLE NO. 111 ON REPLY CARD

MARCONI 2370 Spectrum Analyser (as new)

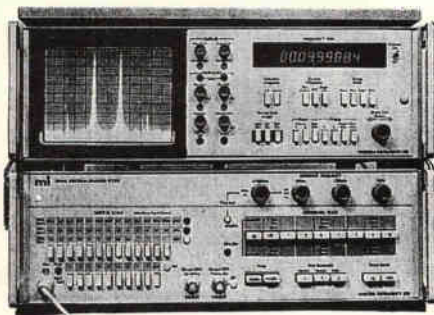

30Hz – 110MHz Frequency range
1Hz Resolution/phase lock tuning
Digital storage with dual display
Built-in tracking generator
9 digit frequency counter

£750 + carriage/vat

Includes 30 day unconditional warranty

M&B Radio, 86 Bishopgate Street, Leeds LS1 4BB

Tel: (+44) 0113 2435649

Fax: (+44) 0113 2426881

CIRCLE NO. 112 ON REPLY CARD

Radio Technology Direct

Top quality, top technology, top service. That's our commitment to you. We build both standard and custom modules and ship direct. We've been doing so for 20 years. No-one is better. Every product is made in England, with pride.

Here are some of our products. To order, just ring us direct (credit cards accepted).

If you want something you don't see here, ring us. We can almost certainly help.

SX450

The Wood & Douglas Flagship



- 500mW output
- UHF operation
- Fully synthesised
- Fully ETSI approved

£250

Volume Orders

RSX450

Intelligent Radio Modem

- 500mW output
- 9600 baud on air data rate
- Fully synthesised
- Fully ETSI approved



£450

Volume Orders

ST/SR450

The Discerning Discretes



- 500mW output
- Separate TX and RX units
- UHF operation
- Fully synthesised
- Fully ETSI approved
- VHF options available
- Rich in features

TX £120

Volume Orders

RX £140

Volume Orders

TT/TR

Low Cost Modules

- 100mW output
- Separate TX and RX modules
- UHF operation
- Crystal controlled
- Fully ETSI approved



TT £50

Volume Orders

TR £80

Volume Orders



Wood & Douglas Limited

Lattice House, Baughurst, Tadley, RG26 5LP United Kingdom
 Tel: +44 (0)118 981 1444 Fax: +44 (0)118 981 1567
 e-mail: info@woodanddouglas.co.uk
<http://www.woodanddouglas.co.uk>

CALL NOW

+44 (0)118 981 1444

CIRCLE NO. 113 ON REPLY CARD

In petrol-engine efficiency terms, an increase of 5 to 10% is exceptional. Automotive engineer **Michael Ward** says that his ignition system can achieve this – and it can do so with the side benefits of cheaper emission-control systems together with simpler engine mechanics.

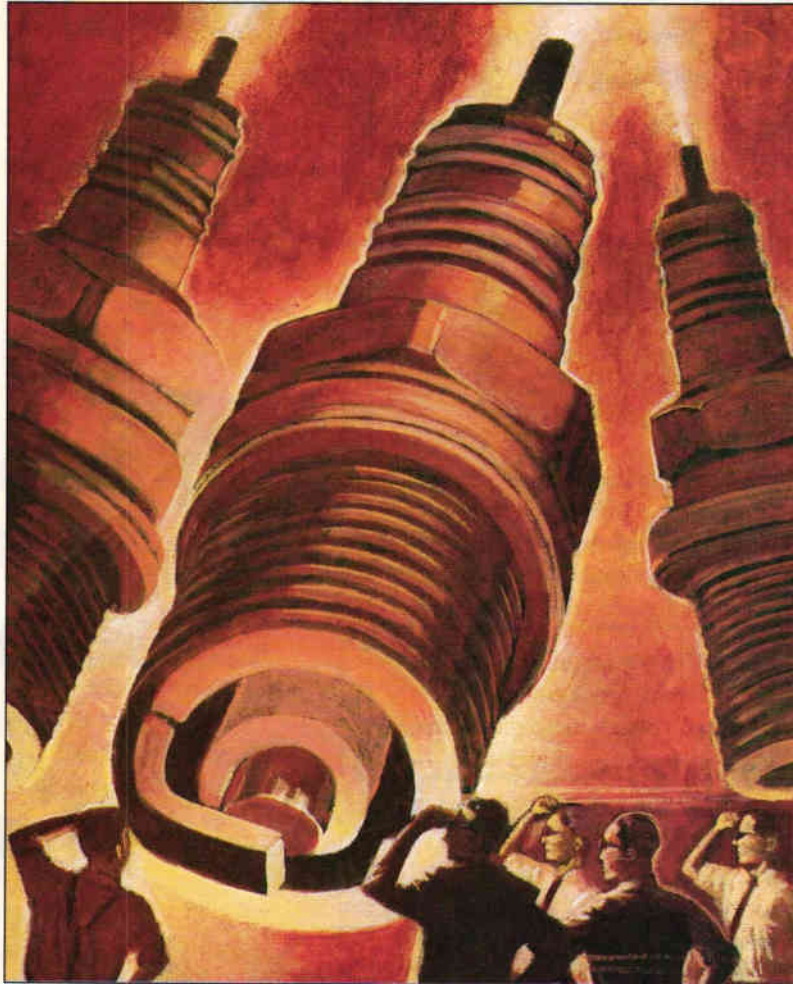

Bright sparks

The conventional inductive ignition system, based on the flyback circuit, has survived without significant challenge for almost a century. Invented and developed by Charles Kettering, circa 1910, it powers essentially all passenger cars and trucks today. It features simplicity, low cost, and reliability.

However, it masks several shortcomings – including low spark energy relative to what is required for best engine efficiency. These shortcomings are taking on a particular importance with the industry's call for one-coil-per-plug ignition and with the international call for improved fuel efficiency to counter ever growing carbon emissions worldwide – which equates to global warming.

Related concerns of high fuel costs in Europe and Japan, and failing Corporate Average Fuel Efficiency standards, CAFE, in the US further increase the concerns. The increased popularity of minivans, sport-utility vehicles, and light trucks in the US is leading to a reduction in vehicle gas mileage – the lowest since 1985 – and to growth in US oil imports to over 50%.

In the latter seventies, Robert Bosch and General Motors showed that for best engine efficiency, an ignition system needed to deliver 150 to 250 millijoules of spark energy. Yet today's inductive ignition systems

deliver only a small fraction of that – typically 30 to 50mJ as measured by an 800V zener load, which is the industry standard.

Without a substantial increase in coil weight, from the state-of-the-art 200g to an unacceptable 500g, the required minimum spark energy of 150mJ cannot be achieved. Moreover, today's inductive ignition systems deliver a spark with a current of 50 milliamps. This equates to a spark power of just 20 watts. But to achieve the optimum combustion power in the initial propagating flame demands a spark of around a 100W. More importantly, such spark discharges are susceptible to break-up by the high mixture flows found in engine cylinders of modern engines.

Why a bigger spark?

From the 20 years of research conducted at CEI on ignition and early flame propagation, we have found that spark power more closely equal to that produced by the initial flame is better suited for ignition of dilute mixtures. This equates to lean or high exhaust-gas recirculation, or EGR, mixtures which increase engine efficiency and lower emissions.

Such higher-power spark discharges require spark currents above 200mA, which is the demarcation

Dr Michael Ward is President of Combustion Electromagnetics Inc., Arlington MA.

between a low current 'glow discharge' with its high electrode drop and low efficiency, and the 'arc discharge' with its low electrode drop and higher efficiency. The arc discharge has a much greater resistance to flow segmentation, allowing the spark to be located in a more central portion of the combustion chamber where it can interact with the flow to provide the greatest lean burn capability – as we have demonstrated to the Japanese and General Motors.

Existing ignition shortfalls

Meeting the combined goals of high energy, light coil weight, high spark current, and high spark flow resistance needs a different approach to inductive ignition. To this end, we have developed of a new type of hybrid inductive ignition, which we call HBI. It is based on improvements in insulated-gate bipolar transistor, or *igt*, technology and innovations in circuit and component design.

The basic inductive ignition system is made up of the car battery of voltage V_b , the ignition coil T , the power switch S , the clamp D , and the load which is a spark gap G on the coil secondary winding, Fig. 1.

In operation, the system is fired to sequentially store magnetic energy in the core of the coil through current flow in the primary winding of inductance L_p to a maximum peak 'break' current I_p . This current produces a positive sense voltage in the sense resistor r which is measured by a sense and control circuit.

When switch S opens, the voltages on the primary and secondary windings rise. Initially, the primary voltage rises due to the coil leakage inductance L_{pe} energy charging the primary circuit capacitance and getting clipped and dissipated by a clamp D . Primary voltage then rises in phase with the secondary voltage V_s to charge the secondary capacitance C_s . It continues up to the spark gap breakdown voltage V_{br} , to deliver the remaining energy stored in the core to the spark gap.

Breakdown voltage V_{br} depends mainly on spark-gap size and engine load – as measured by the cylinder volumetric efficiency. It is typically 5 to 30 kilovolts.

Peak output voltage, V_{spk} , is controlled by the clamp D , which for a coil turns ratio N of 90, and assumed clamp voltage V_{cl} of 380V, limits the peak voltage to approximately 36kV as a result of transformer action. This value is greater than $N \times V_{cl}$ due to imperfect winding coupling.

The energy that can be stored in the core, E_p , must satisfy limitations on the peak core magnetic flux density B_p given below, where N_p is the primary winding turns and A_p is the core

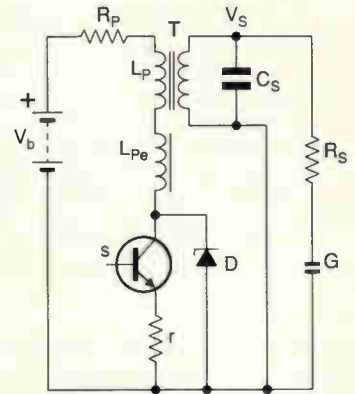

Fig. 1. In the basic ignition system, arcing at the load, i.e. the spark plug, is caused when the switch opens to transfer the energy stored in the coil.

Advances in spark plug design

Significant work has been taking place recently in improving the design of spark plug tips to minimise their quenching effects on the ignition spark and on the early flame propagation, as well as to increase spark plug life.

Such plug designs are of particular interest in this application since the HBI system produces a spark with a higher spark current which is much less susceptible to being quenched or segmented, i.e. broken up by high in-cylinder flow velocities.

HBI would preferably use such spark plugs with a larger spark gap enabled by the higher output voltage of the ignition. The plug tip would be placed well within the combustion chamber within the flow stream to provide even greater capability for dilute combustion, i.e. lean or high EGR burn, to further improve engine efficiency.

CEI has developed its own patented version of a spark plug, called halo-disc, which was successfully tested at one of the Big Three and gave an actual fuel economy improvement in and of itself. The spark plug features a thin, suspended, ground ring electrode to minimise electrode obstruction and quenching. The electrode is best made of erosion resistant material such as tungsten-nickel-iron, and has a recessed insulator to minimise fouling of the insulator end.

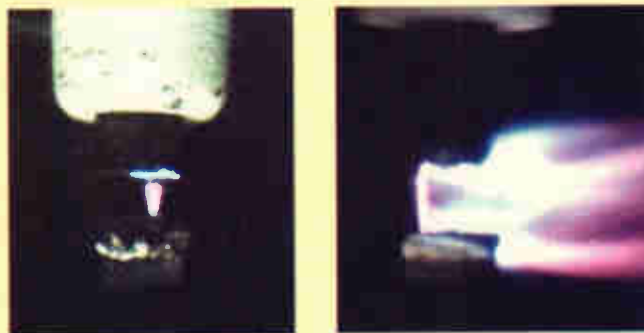
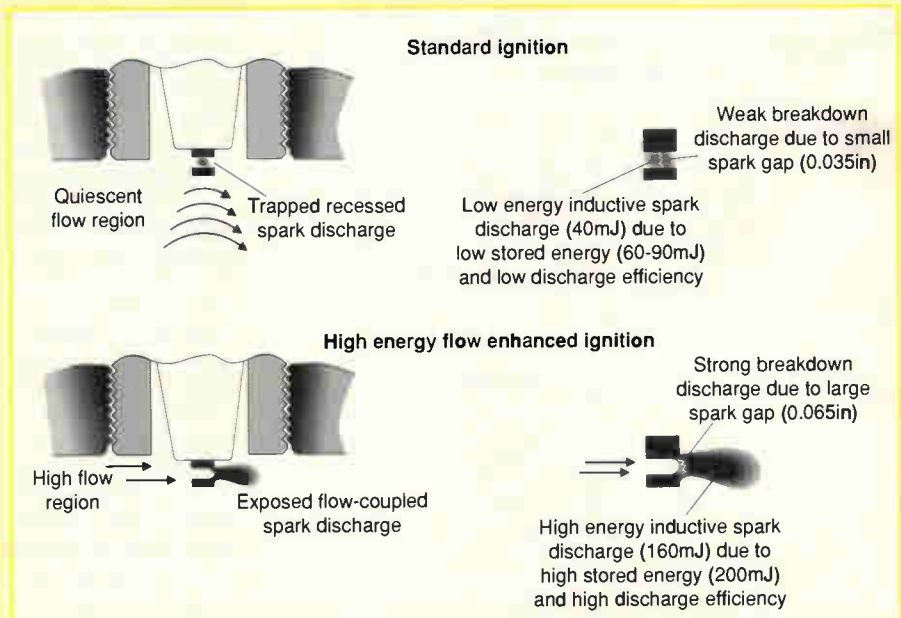

Being deeper in the cylinder and three times more powerful, the spark on the right acts with fuel/air turbulence to become a far more effective igniter than the traditional spark on the left.

Having a large spark well down in the cylinder allows a leaner burn. When a car slows down with its clutch engaged, fuel is sucked into the engine and wasted. Driving around town, this fuel waste is significant. With existing ignition systems, shutting off the fuel during deceleration is problematical because of lean surges during the deceleration-acceleration transition. But the leaner burn of the new system should allow a more complete fuel shut off during deceleration as one of its several benefits.

Tests carried out using the new ignition system on a traditional twin-valve push-rod engine show clear benefits. Could this route to a cleaner, more efficient engine be better than increasing the number of valves and injecting fuel? Note that 1lb/hp-h is the equivalent of 608g/kW-h.

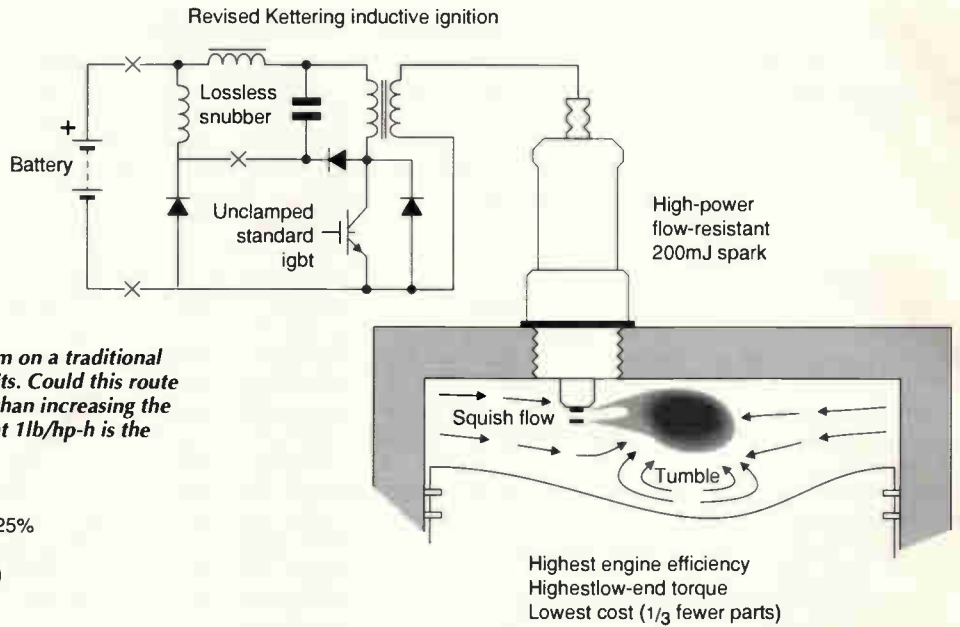

Might we be better off without 16 valves and fuel injection?

The most effective application of the HBI system is with engines that possess some degree of controlled in-cylinder air flow, such as swirl, tumble-flow, or squish flow. Squish flow is the most desirable as it provides high flows at low engine speeds, when combustion is normally poorest.

Unlike the four-valve-per-cylinder alternative, the twin-valve push-rod engine has natural squish flow, making it an ideal candidate. It has powered more cars and trucks than any other engine in the world. And as has been pointed out in the Wall Street Journal, the twin-valve push-rod engine has a third the parts of the four-valve overhead cam engine and it does not suffer the same friction losses in the valve train.

Traditionally, the spark gap has been located in a recessed, quiescent part of the cylinder for fear of being blown out, or broken-up. With HBI, the ignition spark is positioned in a more central part of the combustion chamber. Here, it is in the squish zone and can be directly coupled to the flow fields to spread combustion efficiently, without the fear of break-up.

In turn, the higher spark voltage associated with the flow coupling will maximise the ignition circuit efficiency. In this way, the maximum of the available, much higher, stored energy is delivered to the flow-coupled spark discharge, as in the drawing.

In tests using an early version of high energy flow resistant ignition on a Ford-Europe engine sponsored by Dr. Tony Jarrett – Group Director of Product Technology for Lucas Industries, Birmingham, England – the air-fuel ratio of the twin-valve push-rod engine tested was improved by three to four air-fuel ratios at low speeds of 1500rev/min and low flows. Gains in fuel economy were substantial, as the graphs illustrate.

At higher speeds, around 3000rev/min, and loads where the flows were much higher, but not sufficient to break up the higher flow-resistant spark, the air-fuel ratio was improved by a remarkable eight air-fuel ratios to provide the lowest possible NOx emissions with significant gains in fuel economy.

The new HBI system, and its equivalent capacitive discharge version which has comparably high spark energy and even greater resistance to flow-segmentation, can substantially improve the conventional twin-valve push-rod engine. Only a slight modification is needed to place the spark plug at the inside edge of the squish zone.

Such an approach would revitalise the twin-valve push-rod engine and make it competitive with the most advanced high-efficiency engine technologies – including the diesel engine and the recently developed gasoline direct injection (GDI) stratified charge engine. Added bonuses would be a much simpler design and lower cost than either alternative.

This would also be the case for two-stroke engines, which suffer from poor combustion at low speeds.

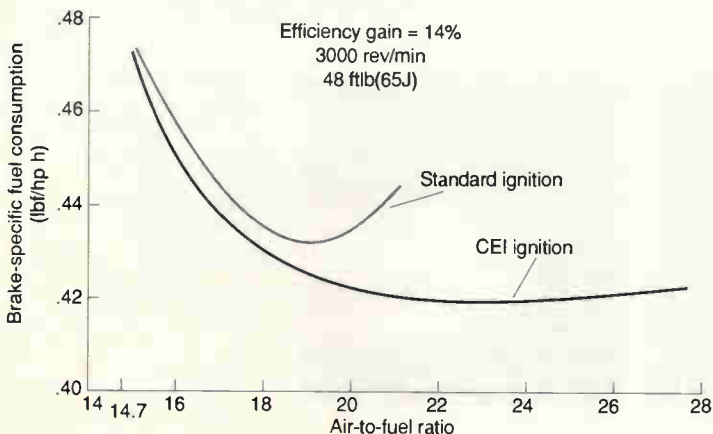
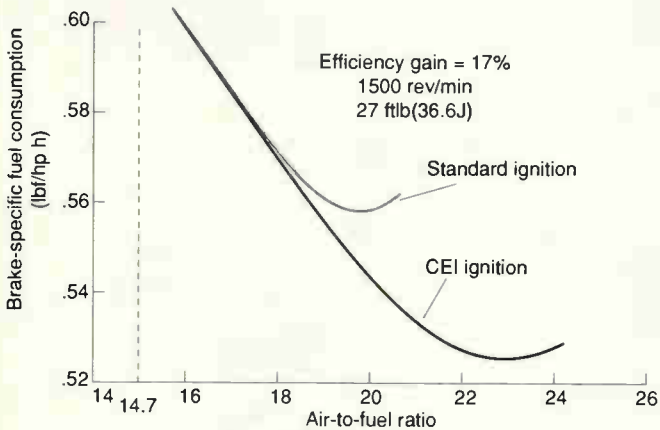
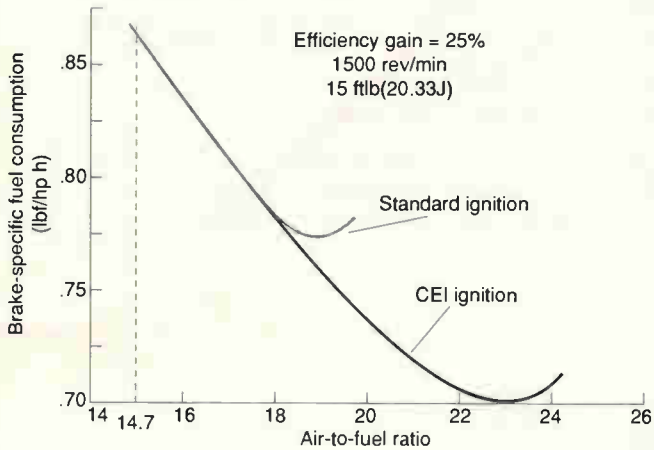

area. In addition, the coil windings must be designed to have acceptably low primary and secondary resistances R_p , R_s to limit the resistive heat dissipation during coil operation. This prevents the coil from overheating at high engine speeds.

For the same stored energy, current, and winding length, the winding resistances R_p and R_s increase inversely with the fourth power of the coil diameter, increasing by a factor of 16 times when the coil diameter is halved.

More revealing, the primary circuit dissipation during coil energising, E_{dp} , for fixed coil size and peak flux density B_p , is proportional to the cube of the stored energy E_p and inversely proportional to the power delivered to the primary winding. This means that it is inversely proportional to the product of the primary-winding voltage V_p and the current I_p through the winding.

Coil energising time, or 'dwell' time, T_p , is also given below assuming T_p is less than the primary circuit time constant L_p/R_p , recognising that the voltage V_p across the primary winding is less than the supply voltage by the switch voltage drop V_{ce} .

$$E_p = \frac{1}{2} L_p I_p^2$$

$$B_p = \frac{L_p I_p}{N_p A_p}$$

$$E_{dp} = \frac{C \times E_p^3}{V_p I_p}$$

$$T_p = \frac{L_p I_p}{V_p}$$

Higher output – more dissipation

Doubling the stored energy E_p increases the dissipation E_{dp} by a factor of eight. This makes it impracticable to maintain the higher spark energy for the same size coil, supply voltage and peak current, i.e. by increasing the inductance L_p , as is preferred with conventional ignition systems.

Only by increasing the primary power in proportion can the same dissipation be maintained. This is a criterion we choose to use for a properly designed ignition coil – assuming the base coil has been properly designed for heat dissipation.

For the case of a state-of-the-art inductive ignition system of Fig. 1 and ideal coil of weight 200g, the theoretical stored energy E_p is 60mJ, as given below. Assuming a high coil charging efficiency of 60% and spark energy transfer efficiency of 75%, overall efficiency is high, at 45%. Resulting spark energy E_s is 45mJ.

Typical parameters for such an inductive ignition system are given below, where a peak magnetic flux density B_p of 1.4 tesla is assumed as the practical maximum value for standard ignition. This assumes a magnetic core material of silicon iron.

The charge or dwell time T_p is calculated at full battery voltage of 13.7V, or V_p of 12.4V assuming a switch drop V_{ce} of 1.3V.

- $L_p=2.4\text{mH}$
- $I_p=7\text{A}$
- $A_p=1.2\text{cm}^2$
- $N_p=100$
- $N=90$
- $B_p=1.4\text{T}$
- $E_p=60\text{mJ}$
- $E_s=45\text{mJ}$
- $T_p=1.4\text{ms}$

Doubling the stored energy E_p to 120mJ and maintaining the same dissipation E_{dp} requires that the break current I_p be raised from 7A to 56A for the standard inductive ignition powered by the car battery. Even assuming state-of-the-art logic-level switching 400V igbts with low saturation voltages, this remains impracticable in view of the high switching losses.

Switching losses are proportional to the peak current I_p and increase further with temperature. The higher switching losses would be a source of further internal heating of the igbt which would not be tolerable in the high temperature environment of the engine compartment.

Losses due to switching can reach 60mJ – or half the stored energy – offering no improvement in energy delivery. Moreover, even if you could attain the spark energy of 90mJ, you still have a 60mJ energy shortfall relative to the minimum 150mJ requirement.

Peak spark current I_s , of 620mA, would also be higher than desired. Without some significant change in strategy for inductive ignition, it is not possible to meet the competing goals of one-coil-per-plug ignition with very small coils, and the need for high spark energy for improved fuel economy, within the additional constraints of acceptable costs and other preferred features.

A new approach to ignition

The equation for dissipation E_{dp} suggests the direction needed to be taken. It is necessary to make the system independent of the battery voltage – assumed to vary between 6 and 14V.

It is also necessary to raise the voltage V_p , or generalised supply voltage V_c to a higher value of approximately three times maximum battery voltage. A value of 42V is represents a good compromise between an even higher voltage V_c and a value required to limit the output voltage upon switch closure to prevent false firing of the spark plug.

By using the moderately high operating voltage of 42V, then a higher primary current I_p of approximately 30A can be used. A proviso is that a snubber circuit needs to be included to reduce the otherwise high switching losses at the higher current I_p .

Proper design of the snubber allows for a best trade-off between conduction losses and switching losses, to the point where conduction losses dominate to allow for the use of the lowest cost, standard speed igbt, versus more expensive fast or ultra-fast devices.

Table 1 shows measured values of switching and conduction losses of 600V standard speed and fast igbts under operating conditions, i.e. with a peak current I_p of 30A, a stored energy E_p of 200mJ, and a peak snubber capacitor voltage of 440V.

As is clear from the table, conduction losses dominate, suggesting use of the standard speed igbt. Among such devices, there are two choices. One is the present logic level, 400V, 15 or 20A voltage-clamped, n-channel ignition igbt. The second is the 600V, 20A, unclamped n-channel general purpose igbt.

In the case of the 400V ignition igbt, the coil turns ratio N and snubber capacitor would be adjusted to accommodate the peak voltage of 400V.

The 400V alternative has three main advantages. Firstly it has a low drive requirement of only 5V for a peak current I_p of 30A. At this level, collector-to-emitter voltage drop V_{ce} is only 2.5V. Secondly, the 400V igbt has a low V_{ce} of only 2.0V at 30A at the battery rated drive of 12V. And finally, its internal 400V clamp allows greater flexibility in use of the device including placing it at remote locations such as on the ignition coil.

The 600V general-purpose igbt also has several advantages. Its collector-to-emitter voltage V_{ces} is high, at 600V, and it has a low V_{ce} of 2.5V at 30A at the battery rated drive of 12V for

Table 1. Measured switching and conduction losses of standard and fast igbts for a peak current of 30A, stored energy of 200mj and 440V peak snubber capacitor rating.

Device	Conduction loss	Switching loss	Total losses
Fast igbt	26.9mJ	10.2mJ	37.1mJ
Standard igbt	22.4mJ	12.4mJ	34.8mJ

Fig. 2. Circuit of the new high-power ignition system uses standard low-cost components to produce a spark with over three times more energy than that of a conventional system. The spark also has a higher flow resistance, allowing it to be initiated deeper in the cylinder, resulting in more efficient combustion and a cheaper engine design.

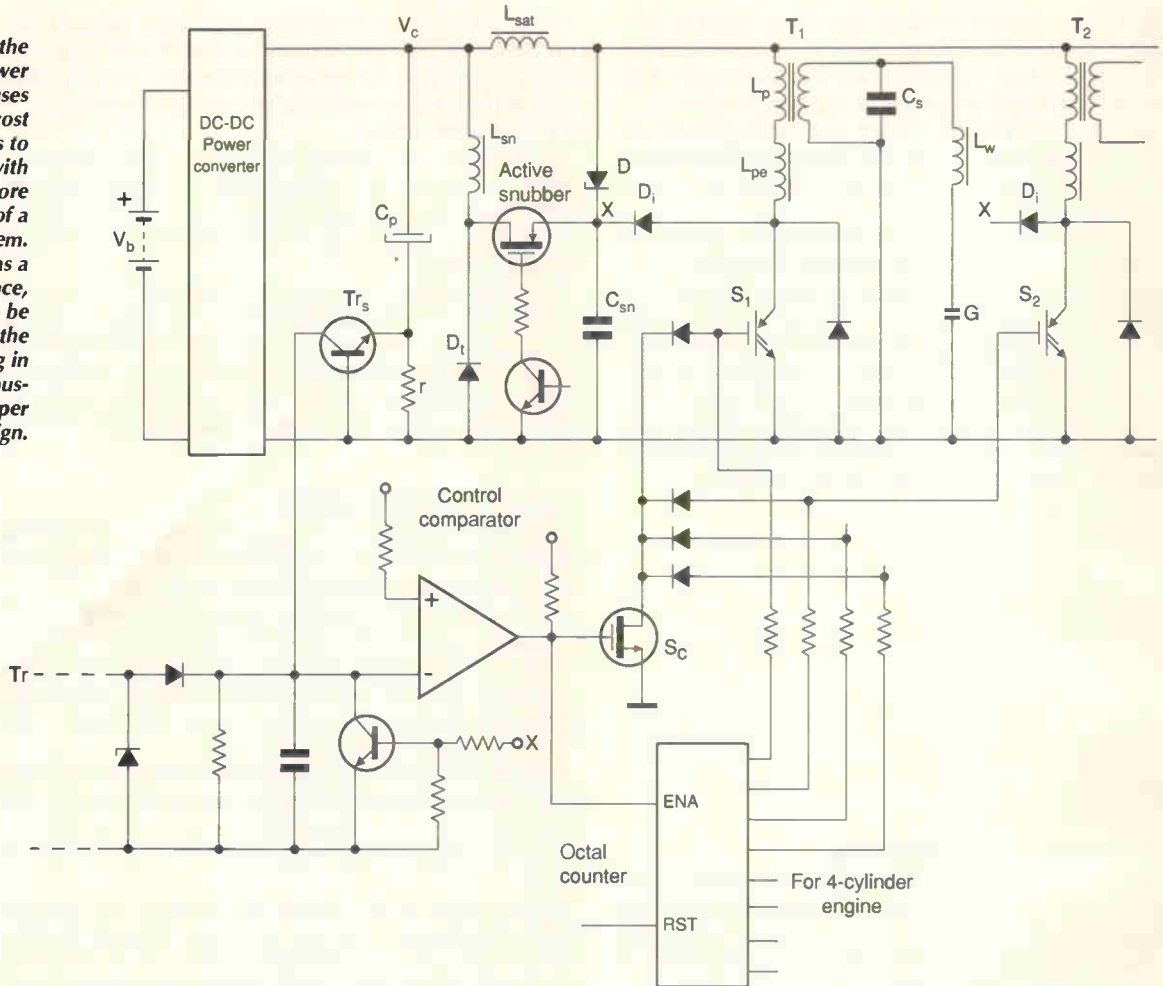

fourth-generation devices. This igbt also exhibits fast switching, of 1 to 2 μ s, at high junction temperatures of 150°C. It has the lowest number of masks and few critical alignments in the manufacturing process, resulting in high yields and low cost.

No clamping necessary

For the application involved here, the internal clamp of the ignition igbt is not necessary. A snubber circuit is used with a single external clamp. Neither is the low switch drive required, as a result of the higher available voltage V_c under all conditions – including 6V engine cranking.

On the other hand, the 600V rating of the general purpose igbt allows for the use of lower coil turns ratio N of 75 instead of 90 and provides higher output voltage of 42 versus 36kV. Also, its switching time is acceptably fast as seen above.

The lower turns ratio reduces the peak output voltage upon switch closure and reduces the number of coil secondary winding turns. This allows a heavier, lower cost wire and an easier to wind secondary to be used. In addition, the cost of the general purpose 600V, 20A, standard switching speed igbt, quoted at under \$1 a unit, is lower than that of the 400V igbt.

As a result, the general purpose igbt is the preferred candidate for this particular application. But note that in other ignition applications, the low drive and internal clamping of the 400V ignition igbt may make it the device of choice despite its higher cost. Such applications are the coil with integral switch, and a new ignition application developed by us that is yet to be announced.

With the general purpose 600V igbt, a saturating inductor and a low-loss active snubber, it is possible to achieve an energy storage two and a half times the value of 60mJ. A further effective increase of 20% to three times the energy, or 180 mj, is possible as a result of certain parallel improvements in coil design arising from a new approach, discussed later.

Ignition circuit details

Analysis of the HBI system features, shown in Fig. 2, begins with the supply capacitor C_p . It is charged to voltage V_c by the power converter, and is typically made up of two or more high-efficiency, high-temperature electrolytic capacitors which store many times the coil energy.

Included in the capacitor is a current sensor advantageously located at its low end, with a simple form of current sensing system. This sensor is based on a resistor and n-p-n transistor Q_s whose base-emitter junction is across the sense resistor with grounded base. The base-emitter junction voltage V_{be} decreases with temperature to provide a preferred lower current and energy with temperature to conform to typical engine ignition requirements.

The next relevant component is the low-cost saturating inductor L_{sat} . In combination with the low turns ratio N and preferred large spark gap made possible by the higher output voltage, this inductor eliminates the problem of false firing of the spark plug upon switch closure. False firing is aggravated by the higher voltage V_c .

The inductor is designed to have an initial inductance approximately equal to the coil primary inductance L_p , and then made to drop rapidly with current to an inductance of one order of magnitude smaller. Its function is to reduce the high-frequency peak voltage $V_{s(0)}$ upon switch closure, equal to $2N \times V_p$, to one half its value, Fig. 3.

This high-frequency, voltage doubling effect was discovered and mathematically analysed by us in 1989 (see references).

Assuming a lower turns N of 75 through use of the 600V igbt, the output voltage reaches a peak value of only 3000V on switch closure. This is less than the minimum spark gap breakdown voltage.

Our HBI coil has a short energising or charge time T_p of

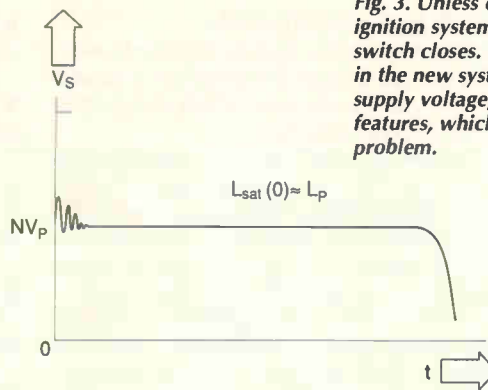
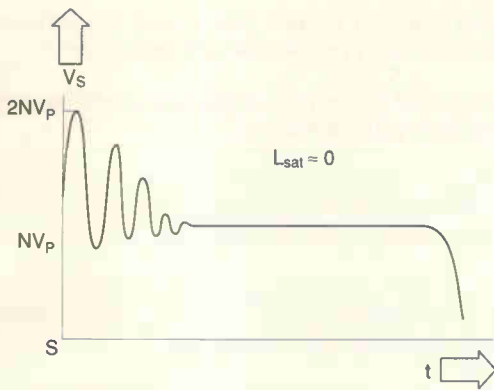

Fig. 3. Unless counter measures are taken, in an ignition system, false firing can occur when the switch closes. This problem would be aggravated in the new system due to the significantly higher supply voltage, were it not for L_{sat} and other features, which completely eliminate the problem.

approximately 400µs versus 1.5 to 5ms for standard ignition. Because of this, the time of switch closure will occur later in the engine compression stroke at a higher cylinder pressure to further reduce the possibility of false firing.

The preferred larger spark gap of 0.060in made possible by the higher output voltage of the HBI system also helps reduce false firing – i.e. sparking upon switch closure. Moreover, energy associated with the saturating inductor at the end of the charge time is not wasted, but returned in large part to the power supply by the low loss active snubber discussed next.

Low-loss active snubber

The third key circuit feature is the low-loss active snubber already mentioned. It reduces switch-opening losses and provides other benefits.

The snubber is made up of isolating diode D_i , snubber capacitor C_{sn} , a p-type fet switch, snubber inductor L_{sn} , and return diode D_r . It serves two main functions. First, it smoothes and lowers the high-voltage transient that occurs when the switch opens. This transient is associated with the energy remaining in the saturating inductor and in the coil leakage inductance. It delivers the energy onto the snubber capacitor, minimising switching losses and electromagnetic emissions.

Secondly, the active snubber delivers most of the energy stored on the capacitor back to the power supply. This minimises clamp, switch, and resistive losses, as well as raising the ignition system efficiency, in turn reducing demands on the power converter to maximise system efficiency.

The snubber capacitor is selected to reach a peak voltage V_{sn} less than the clamp voltage V_{ct} , from transfer of the circuit leakage energy to the capacitor. Typical ignition parameters for the HBI system operating at the preferred 42V (V_c) are,

- $L_p=0.4mH$
- $I_p=32A$
- $A_p=1.35cm^2$
- $N_p=60$
- $N=75$
- $B_p=1.55T$
- $E_p=200mJ$
- $E_s=150mJ$
- $T_p=0.35ms$

A higher core area is assigned to the HBI system to compensate for its smaller coil size, Fig. 4. In addition, a higher flux density is assigned due to a better lamination design and the larger effective air-gap which allows for greater stressing of the core.

Peak current drawn from the battery is comparable to that of today's inductive ignitions, ranging typically between 5 and 10A. It has a very low ripple resulting from using a fast-switching power converter design.

Controlling the switch

To complete the HBI system, a particular simple and low cost form of switch controller and driver has been developed, Fig. 2.

Assuming multiple switches for one-coil-per-plug ignition,

the controller holds the gates of ignition coil power switches low. It does this by means of an n-type fet switch S_c , whose drain interconnects the igt gates through isolation diodes.

On ignition firing, i.e. the controller receiving a conditioned trigger signal at the inverting input of a control comparator, control switch S_c is turned off. This enables the gates of the igt and sequences an octal counter.

The counter provides a turn-on signal through a resistor to one of the igtbs to begin energising its associated coil. This continues until the set peak current I_p is reached. At this point, sense transistor Q_s is turned on, pulling the comparator inverting-input low and turning on control switch S_c .

Control device S_c disables the switches by rapidly discharging the igt input capacitances C_{ies} for rapid turn-off of the energised switch. It also disables the remainder of the igt switches.

Supply voltage for the octal counter is derived from the output voltage V_c . This is because there would not be enough voltage to drive the gate of the igt at the lower battery voltages encountered in automotive systems during cranking.

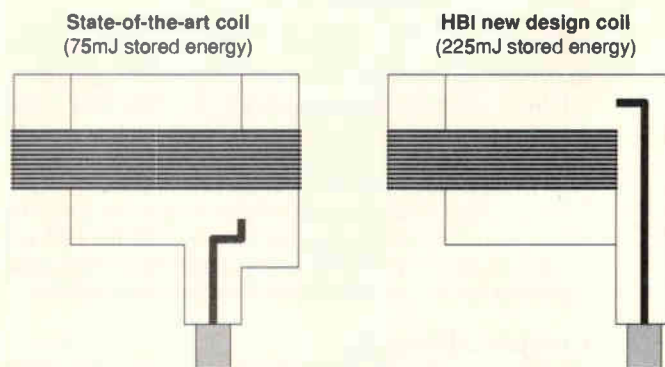

Fig. 4. State-of-the-art coil on the left has a two-piece welded core, 10000 turns of 42AWG secondary and a difficult-to-implement HT terminal. The new coil on the right has a one-piece E core, 5000 turns of thicker, easier to wind wire on its secondary and provides easier access to the HT end of the secondary. Benefits are,

- One piece lamination requiring no welding and easy packaging.
- 20% lighter weight coil due to the open E design.
- 40% lower primary wire turns, i.e. 60 versus 100 turns, ideally suited for a two layer winding.
- 50% lower secondary wire turns and use of 36 versus 42AWG wire which is much cheaper and easier to handle on a winding machine (less breakage) and takes half the time to wind.
- 20% lower cost due to the above listed advantages despite the three times higher energy.

Performance with low-volatility fuels

Once this new strategy for inductive ignition is realised, numerous advantages follow. A particularly interesting one is the ability to fire the ignition with closely spaced high-energy spark pulses under engine cranking conditions.

Long-duration spark firing during cold start is possible due to the rapid charge time T_p , which is an order of magnitude shorter than that of conventional inductive ignition. A much higher spark energy and longer spark duration are provided. This allows the ignition of lower volatility fuels, such as further reformulated gasolines, neat alcohol, JP5 fuel – used because of its reduced fire hazard – water-gasoline mixtures, and others.

Low volatility fuels can have a major impact on volatile organic compound, or VOC, emissions. As cars become progressively cleaner and tail-pipe emissions are reduced, evaporative VOCs become the principal hydrocarbon emission.

Evaporation of fuel upstream of the engine is projected to account for approximately 80% of the total VOCs from new cars sold in California in the year 2003. The remaining 20% will come from the tail-pipe. Ignition of low volatility fuel can be accomplished even at low battery voltages of 5 to 6V. Such voltages occur in extremely cold climates during engine cranking.

In addition, 4kV diodes may be used at the coil secondaries, allowing for even closer spaced spark firing pulses, further improving cold-start capability. Such diodes are cheaper to implement than the 8kV types.

To take full advantage of the low-cost, high voltage diodes, high inductance magnetic core spark plug wire is preferred to limit peak spark breakdown currents to under 10A. Use of such wire also reduces electromagnetic interference.

Other advantages of the new system

A particularly important advantage of the HBI system is the development of a simpler and lower cost coil resulting from the low coil primary inductance dictated by the new approach. The low inductance permits use of single open E-core coils versus the two piece welded design shown in Fig. 4.

When considering the benefits mentioned in Fig. 4, keep in mind that new coil delivers around 150mJ of spark energy versus approximately 50mJ for the current inductive ignition.

Table 2 compares ignition characteristics of the HBI system against various standard and state-of-the-art ignition systems. These were measured, in part, by a reputable car manufacturer conducting testing of the various ignition systems.

Where biasing magnets in the magnetic cores are needed to reduce size, this can be done more easily with the HBI coil because of its larger inherent air gap, retaining its three times higher energy density over the standard inductive ignition.

Unexpected benefits

There are other significant advantages than that of the ignition coil which follow from implementation of the HBI system. Most of these were not anticipated at the outset of the work to develop the HBI system and therefore only add to the motivation for use of this new system.

- Higher peak voltage to allow use of larger spark gap to further improve ignitability.

- Greater resistance to spark plug fouling due to the much lower inductance, faster rise times, and higher energy.

- Elimination of the need for computerised dwell – making the ignition universally retrofitable.

- Elimination of power switch (igbt) operation in the linear mode with its high dissipation and possibility for destructive oscillations due to unstable feedback loop in linear mode.

- Lower overall switch dissipation despite the much higher energy and peak currents as a result of the rapid charging of the coil and use of the low-loss snubber.

- Higher spark current characterised by higher spark power and greater resistance to spark segmentation by the high engine flows in modern high-output engines

Three important questions remain regarding the new HBI system – what is the system cost, can it easily be implemented on a typical four-cylinder engine and what fuel efficiency gains can be expected?

Cost comparison

System cost can be analysed in a preliminary, general way by comparing costs of the three new critical systems of HBI against cost savings associated with the power switches and ignition coils. This assumes that biasing magnets are used in the coils of the conventional inductive ignition to bring its spark energy to 100mJ – a value which is still short of the 150mJ offered by the new system.

From data on switch costs, savings of \$1 to \$3 are achieved based on the prices quoted for the 400V, 20A ignition igbt which would be required for the improved standard ignition, versus that quoted for the 600V general purpose igbt. For the new ignition coils, 20% reduction results from the use of one piece lamination, half the number of secondary turns, 36AWG wire versus 42AWG, and removing the cost of biasing magnets.

The estimated overall cost savings are equal approximately to the cost of the additional components making up the HBI system. That includes the power converter with its input filtering capacitors, output capacitors, the transformer, the fet switch, and output diode. It also includes the saturating inductor, the active snubber and various other low-cost components.

Elements of the HBI system, i.e. power converter, saturating inductor, and the low-loss snubber, and the associated igbt switches can be mounted in the controller box. Preferably though, they would be mounted in a separate box located near the ignition coils, but sufficiently remote to avoid overheating.

On the other hand, predictions have been made by Kassakian (MIT), Wolf (Mercedes-Benz), Miller (Ford), and Hurton (G.M.) as reported in *IEEE Spectrum*, August 1996, that 42V will be made available in the passenger car engine compartment for operating motors and actuators. If this is the case, the HBI system can be fully integrated with an equal cost or cost savings despite its numerous advantages and benefits.

Fuel economy

On the issue of improved fuel economy, with high-energy ignition, extensive experience over a 20 year period – which has included testing at GM, Mazda Motors, Lucas Industries, and Chrysler Corporation – has shown fuel economy to be improved by up to 20%. This is based on dilute combustion, principally lean burn.

Typically, the fuel economy gains would be largest under light load where air-throttling losses are high, and minimal at high loads. A conservative estimate over the typical driving cycle is 6% assuming air dilution is used at the light loads where NOx is low, and EGR is used at the higher loads where NOx is high.

Table 2. Comparison between standard, state-of-the-art and HBI ignition systems reveals high energy output and efficiency of the new system.

Ignition	Inductance	Resistance	Spark energy	Coil weight	Efficiency
HEI	6.6mH	0.4/9500Ω	40mJ	750g	<20%
Waste Spark	3.5mH	0.4/6000Ω	35mJ	260g	25%
Make 1	3.0mH	—	60mJ	265g	—
Make 2	2.5mH	0.6/—	50mJ	190g	35%
Make 3	2.8mH	0.7/7800Ω	50mJ	210g	35%
HBI	0.4mH	0.15/500Ω	150mJ	200g	50%

These figures assume a full implementation of the HBI system which includes, in addition the electronics described, a larger spark gap and better penetration of the spark plug tip in the combustion chamber. Placing the plug deeper in the cylinder allows the spark to interact more fully with the high in-cylinder air flows, resulting in higher output at cold start, etc.

A 6% improvement in fuel economy on an average of 25 miles per gallon would bring the mileage closer to the current CAFE standard of 27.5 miles per gallon – a target which car companies are currently missing. It translates to a 1.5 miles per gallon improvement, or a saving in CAFE penalties of \$75 per vehicle – a far greater cost than any additional cost associated with the HBI system.

In terms of gasoline savings over the life of a car, assumed at 125 000 miles, this comes to a savings of 300 gallons of gasoline, which in the US would amount to \$400 based on a fuel price of \$1.33 per gallon and in Europe and Japan to \$1000 based on a price of \$3.33 per gallon. Even the smaller cost savings in the US would be well over ten times the projected additional small cost increase of the HBI system.

In summary

A new form of inductive ignition system has been developed which provides the required three times higher energy density of state-of-the-art inductive ignition systems and numerous other benefits not initially anticipated when this development program was begun some two years ago.

This new inductive ignition uses a higher, independently generated, constant voltage source of 42V – the value projected as

best suited for other vehicle systems. It incorporates a standard speed, low-cost, 600V general purpose unclamped igt as the switching element. It also uses a low cost saturating inductor to handle the switch closure false-firing problem and an active low loss snubber to minimise switching losses, rfi and system heating, as well as maximising system efficiency.

Complementing the system is a unique, low cost, 85% to 90% efficiency high-output power converter based on the use of state-of-the-art low cost 60V fets, a ferrite core transformer, a 150V ultra-fast output diode, and a simple form of controller made up of a dual comparator.

Applied to current engines, HBI provides the small, high-energy coils of the one-coil-per-plug ignition the industry seeks, and a range of other benefits. These include short dwell time, fast rise-time, resistance to plug fouling and high efficiency.

More importantly, given the current growing concerns over fuel efficiency and emissions, HBI has the potential for up to 10% improvement in fuel economy and large savings in capital investment to car manufacturers willing to revitalise their current power plants – such as their twin-valve push-rod engines – to make them cleaner and more efficient.

My thanks to Dr Tony Jarret of Lucas Industries and Joe Franklin, both of London, England, for their unwavering support of this work. ■

Reference

Ward, M, 'A new spark ignition system for lean mixtures based on a new approach to spark ignition,' Society of Automotive Engineers' Technical Paper Series, No 890475, Warrendal, PA.

A Powerful 12Bit Virtual Measuring Instrument For The PC

Four integrated instruments are giving you all the possibilities for different kind of measurements and good documentation features

NEW



OSCILLOSCOPE

Special developed controls make controlling the oscilloscope very easy and intuitive.



FFT ANALYZER

Spectra with records of 8K long and 6 window types. Simultaneous display of the signal in the oscilloscope and spectrum analyzer.



VOLTMETER

The voltmeter has up to six fully configurable displays. A bar graph is added to each display for a quick signal size overview.



RECORDER

With the transient recorder slowly changing events, like temperature, can be measured.



CURSOR READOUT

For each channel there are two cursors. With the cursors several quantities of the signal can be measured.



DOCUMENTATION

To document the measured signals an option to place text balloons is available. In each text balloon specific text can be placed.



£ 299.00
COMPLETE SYSTEM

Handyscope 2 specifications: 32KWord memory, 100% pre- post triggering, 12 bit resolution, 200 kHz sampling on each channel, 0.1 to 80Volt full scale, no external power supply, connected to printer port. Price are excluding VAT

TiePie engineering (UK): 28 Stephenson Road, Industrial Estate, St. Ives, Cambs, PE17 4WJ, UK Tel: +44 1480 460028, Fax: +44 1480 460340

TiePie engineering (NL): P.O. Box 290, 8600 AG SNEEK, The Netherlands, Tel: +31 515 415 416, Fax: +31 515 418 819.

Call for a free demo disk or see our website: <http://www.tiepie.nl> Email: info@tiepie.nl

Hands-on Internet

Cyril Bateman presents tips for speeding up your searching and downloading, and an update on circuit simulation software.

Internet provides designers with the ability to locate then download sources of needed information into a personal computer. Tracing through random links can sometimes be surprisingly successful, but methodical use of a search engine is more reliable.

Benefits of the net are maximised by quick search responses and fast download times for Web pages or files.

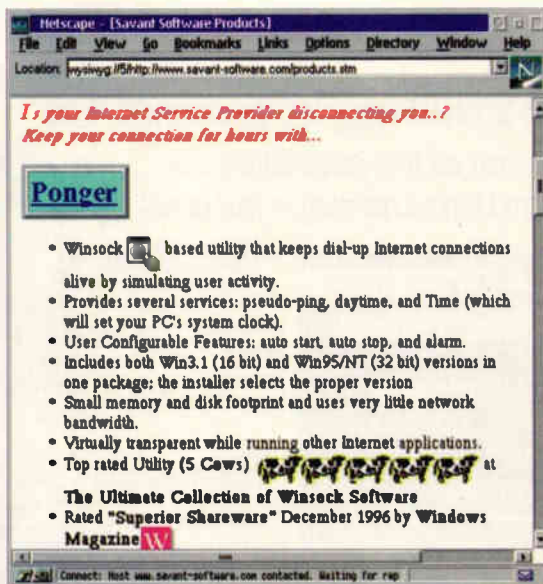

Fig. 1. 'Ponger' is designed to help maintain your Internet connection to prevent aborted file loads and the like. If moving your mouse or sending 'Pings' improves your connection, try this utility.

Internet access can be extremely slow during peak times, and of late, this slowness is extending well outside the peak periods for many popular sites.

Traditionally, one sent a 'Ping' to check that an address was 'on-line'. I now find sending regular 'Pings', say one a second, can help in maintaining my route. A utility called 'Ponger', which runs on Win3.1 or Win95, can be obtained from Tucows¹, the specialist Winsock archive, to automate this task, Fig. 1.

Two years ago relatively few Web pages existed, so today's popular search engines had not been devised. Archie, Gopher, Veronica and Wais² were the methods then used to locate sources. FTP was the only practical method available to download files from Internet.

One year ago, Java applets and the Netscape2 browser were introduced. Direct software downloads using a browser became commonplace, effectively supplanting use of FTP. As the numbers of Web pages increased, the AltaVista, Excite and Infoseek keyword search engines were developed to supplement the older directory searching methods.

There has since been an explosion of Web pages, to the extent that some companies now host 1000 Web pages on their site. This rapid expansion has resulted in major changes to all search engines – the largest now maintaining indexes covering more than 50 million Web pages and more than two-million URL site addresses.

This enormous increase of activity is linked to the trend towards larger and more glossy corporate Web pages,

Where to surf

- The Ultimate Collection of Winsock Software.
<http://tucows.ip.pt>
- Surfing with intent. C. Bateman. *EW&WW* June 1995
- Micro-Cap V version 2.0
<http://www.spectrum-soft.com/down/demo.zip>
- Software Explorer
<http://www.windowcentral.com/reviews/internet/getright>
- Headlight Software.
<http://www.headlightsw.com>
- Tracing a Route Back
<http://noc.nwn.noaa.gov/traceback/traceback.html>
- Vital Signs Net.medic http://www.vitalsigns.com/product/netmedic_preview
- HotBot Search Engine <http://www.hotbot.com>
- LookSmart Search Engine
<http://www.looksmart.com>
- News.Com
<http://www.news.com/News>
- PCWeek Online.
<http://www8.zdnet.com/pcweek/news>
- Demo of Browser Security Hole
http://neurosis.hungry.com/~ben/msie_bug
- Number One Systems Ltd.
<http://www.numberone.com>
- Mental Automation Inc.
<http://www.mentala.com/SUPERCAD.HTM>

large graphical images and extensive use of Java applets. My present Internet access speed is frequently no faster using a V34 modem than it was two years ago with slow hardware. A recent and growing tendency for links to work initially quite quickly then slow considerably – or worse, simply drop out – has become apparent when downloading Web pages or transferring files.

In the November issue, I reported on the new Micro-Cap V software. I abandoned several attempts to download the 1.7 Mbytes evaluation version³ because my Netscape browser closed down the transfer before completion of the file. On one occasion this happened when the transfer was more than 90% complete.

One obvious solution is to use a traditional FTP client, but FTP from a Web page is only possible if that page provides an FTP address. Having only an http link, my FTP client could not be used to download the Micro-Cap V software file.

When a browser download slows or stalls, requesting a second download which you immediately cancel, often seems to 'wake-up' the route. Sending regular 'Pings', even continuously moving your mouse, sometimes helps maintain the route. Combining these techniques, I completed the download.

The Software Explorer page⁴ recently reviewed a potentially better transfer method for browsers. The 'GetRight' utility is a mini FTP client add-on which can even permit resumption of a broken transfer. Windows 3.1 users should first read the special instructions on the Headlight Software⁵ page.

Routing

Internet's growth has resulted in two aspects contributing to these problems. You may have noticed that the time taken by your browser to look up Internet addresses has increased. These addresses are stored in increasingly large subnet tables on dedicated servers, used to determine the routings used.

Transfer from the Web server to your computer does not happen in a direct fashion, but as a number of 'hops'. Each hop determines the next hop location. Of course Internet uses many supplementary routes, rather like having a number of bucket chains, with each handler passing its bucket to whichever chain is next ready to accept.

A secondary problem results from data packets queuing at these routers. When their buffer memory overflows, routers lose data packets. Packet loss is an increasing problem, thought to result in e-mails going missing and to contribute to file transfer problems. While not generally relevant, any data packet which requires 255 or more hops to reach its destination, is automatically killed.

'Ponger' and 'GetRight' are palliatives. A diagnostic approach is needed to identify whether problems are caused by Internet, your provider or your phone line or hardware. Most modern operating systems provide usable utilities. 'Ping' has already been mentioned; Traceroute, IPTrace and TCPdump, or variations on these names, can help.

Traceroute can identify your outgoing Internet routing, but the return route might be quite different. 'Traceback' is a more difficult problem when running from your own computer, but it can be run using software at the NCDC site.⁶ My recent test indicated 18 hops were needed from Spectrum-Soft, several packets were lost and seven routings delayed, Fig. 2.

NetMedic⁷ is an excellent diagnostic utility and Internet tuning aid for Win95/NT. Its 'hop' monitor can

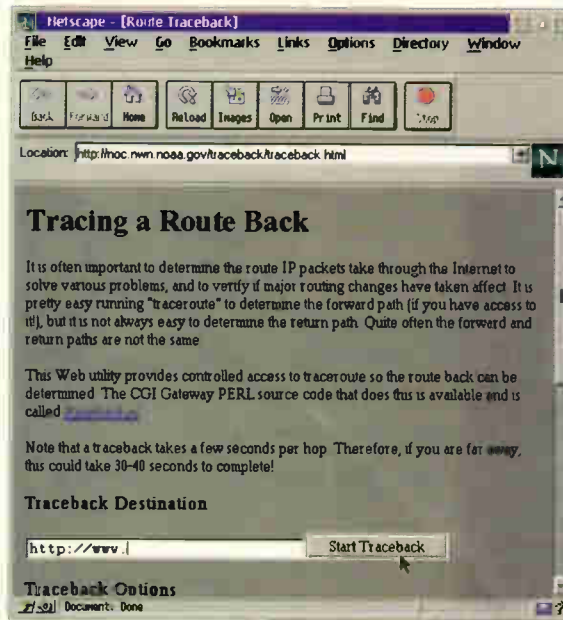

Fig. 2. If slow transfers bug you, route tracing can highlight problems. Find out how many lost packets and exactly where your delays occur.

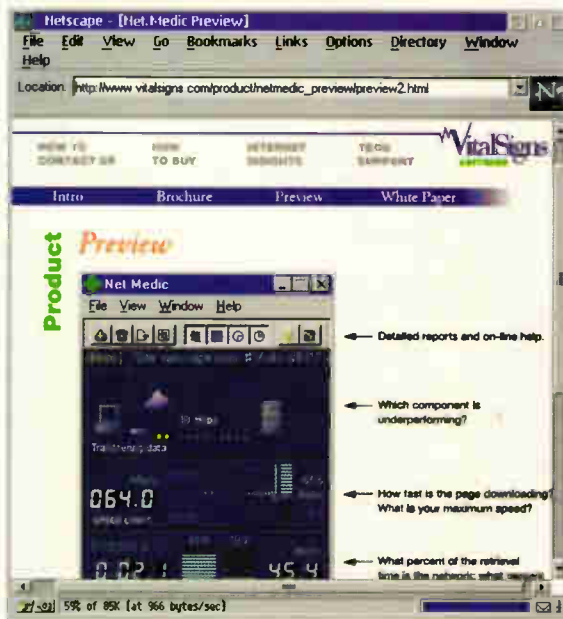

Fig. 3. 'NetMedic' provides short term and diagnostic long term logging of on-line problems. Using Win95 or NT, find where and when your Internet response problems occur.

be installed onto Netscape's toolbar, for continuous use, Fig. 3.

Search engines

Launched in May 1996, HotBot is Wired's entry into the search engine market. It uses Inktomi technology and has more than 50 million Web pages indexed.⁸ It provides an easy menu selection for your desired search parameters, Fig. 4.

LookSmart⁹, launched by Reader's Digest in October 1996 using AltaVista technology, was redesigned in June this year and provides two search modes. Clicking on one of the border categories reveals more menu selections, thus combining the AltaVista keyword virtues with a simplified directory search.

More bugs

Following on from last month's WinNuke problem, two bugs, affecting Microsoft or Netscape's browsers have been reported. *News.Com*¹⁰ reports of 5 and 11 September detail the bug discovered by the Massachusetts Institute of Technology. This problem affects Microsoft's Explorer 3, and its beta 4 version, software. It results from the Java

Fig. 4. HotBot – Wired’s search engine – now indexes more than 50 million pages. Offers easy search control to finds results others miss.

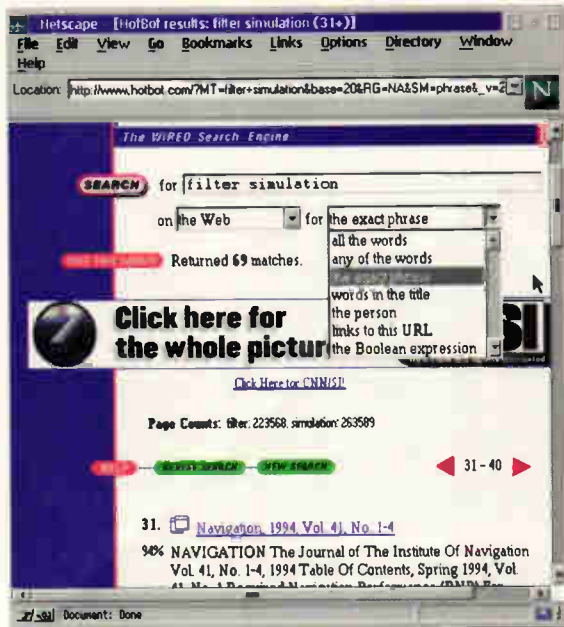
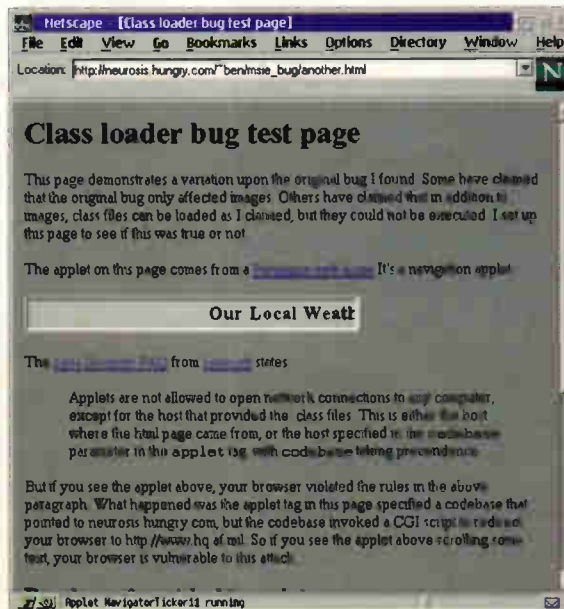

Fig. 5. Essential reading if you use IE3.0 or IE4 beta browsers. Macintosh users are not affected but Windows users should install the final Explorer4 version.



Fig. 6. Java applets cannot open connections to other hosts – or can they? Prove or disprove your browser's Java security in the safety of this test site.



methods used within the browser, not a function of Java itself, Fig . 5.

A *PC Week* article¹¹ dated 12 September details that Microsoft is actively removing all Java applets from its Web sites. This is apparently part of a campaign to speed up the downloading rate for its pages. Where needed, Java applets will be replaced by HTML code or Javascript.

The second bug, discovered by Ben Mesander and reported by *News.Com* 8 and 12 August, affects both Microsoft and Netscape browsers. It can be demonstrated using Ben's¹² test page which houses two demos, demonstrating the two variations.

Ben first uses a harmless applet to redirect and download an image from Microsoft's pages. For security, Java applets are only permitted to communicate with their host page, so should not transfer this image. I tried my machine, which passed this test.

Ben's second test demonstrates the 'Class Loader Bug'. In this test, the applet tries to download a harmless text 'ticker' again by redirection, from <http://www.hq.af.mil>. I also tried this out on my system, running Netscape 2.02 under OS/2 Warp4, and failed this test. The running ticker can be clearly seen.

While Ben's tests were deliberately designed to be harmless, others could as easily use these techniques, to cause harm. Fig. 6.

Simulation and design software

Not all circuit simulation software is based on Spice. Many vendors specialise in providing frequency-domain-only simulation to extremely good effect.

One such system originates from Number One Systems¹³ – a long established UK developer. My very first commercial simulator was their original *Analyser* of 1983, running on the *BBC model B* microcomputer.

Since then I have regularly relied on the company's Windows suite of integrated packages, for quick look-see simulation and final pcb design. Number One's unique *Layan* simulator is able to extract printed circuit layout traces as circuit elements. These combine with conventional elements for *Analyser* simulation. If desired the results can be exported seamlessly to their Smith-chart program.

If you are looking for a low-cost, easy-to-use integrated suite of Spice based simulator, schematic editor and pcb layout tool, which you can download and evaluate before purchase, *SuperCAD* from Mental Automation¹⁴ is worth a look. The company's *SuperSpice* simulator displays results using a virtual oscilloscope like display, having volts/division adjustment for each of four traces. Mental claims its *SuperCAD* schematic editor is fast becoming an industry standard.

Circuit applications

The Mc Graw-Hill Encyclopedia of Electronic Circuits is a cd rom containing 1000 circuit designs taken from industry leaders.

Also developed by Mental Automation this rom is based on the popular six-volume book series from Mc Graw-Hill and the circuits used were selected by the original author of the series, Rudolf Graf. Each circuit can be viewed or printed out using the supplied schematic viewer or can be edited with the *SuperCAD* schematic editor.

ELECTRONICS WORLD

INCORPORATING WIRELESS WORLD

Electronics World incorporating Wireless World is applied electronic design. We'll show you how to use the latest silicon technology plus...

- ✓ CAE software
- ✓ New product reviews
- ✓ Technology reports
- ✓ Detailed circuit diagrams
- ✓ Innovations
- ✓ Explanations of complex technology
- ✓ Comment and much more in your issue.

So whether you are designing your own system or you're curious about your competitors, *Electronics World* will help you keep the leading edge.

Money back Guarantee.

Receive a full refund on your subscription within the first 90 days if you are not completely satisfied. Thereafter, we'll refund the unused portion of your subscription should you wish to cancel.



SAVE UP TO 10%

Yes, I would like to subscribe to Electronics World incorporating Wireless World.

1 Year UK £32 Europe £46 Rest of world £56

2 Years UK £58 **SAVE 10%** Europe £83 **SAVE 10%** Rest of world £101 **SAVE 10%**

Name _____

Job Title _____

Company _____

Address _____

Post Code _____ Country _____

Telephone _____ Fax _____ Internet Address _____

THREE WAYS TO PAY

1 I enclose a cheque made payable to **Electronics World incorporating Wireless World** for £ _____

2 Please charge my Mastercard/Access/Visa/Diners Club/American Express (please delete appropriate card) with the sum of £ _____

Card number _____ Expiry Date _____

Signed _____ Date _____

3 Please invoice me/my company. Purchase order number _____

Company VAT registration number _____

Please allow 28 days for delivery of your first issue. Please tick here if you do not wish to receive direct marketing promotions from other companies.

Post in the UK to Electronics World Subscriptions, FREEPOST RCC 2619, PO Box 302, Haywards Heath, RH16 3BR. Telephone 01444 445566

041

Post from elsewhere to Electronics World Subscriptions, PHQ-D/1700/RH, PO Box 302, Haywards Heath, RH16 3BR, UK. Telephone +44 1444 445566

TRANSFORMERS FOR BALANCED LINES IN HIGH PERFORMANCE AUDIO SYSTEMS



E A SOWTER LTD

PO Box 36 IPSWICH IP1 2EL ENGLAND

Tel: +44(0)1473 252794

Fax: +44(0)1473 236188

E.Mail: sales@sowter.co.uk

Web: <http://www.sowter.co.uk>

Design and Manufacture
of all types of Audio Transformer using
Nickel and Grain Oriented cores

Free catalogue
Free technical support service
Popular types from stock

CIRCLE NO. 114 ON REPLY CARD

RF Power Modules from TDC & Mitsubishi



Standard parts stocked, replacement parts for many
Yaesu/ Icom transceivers, ideal for linear PA designs.

Part	Frequency	Pwr/Mode	Price (1 off)
M57726	144-148MHz	43W/FM	£43.71
M57729	430-450MHz	30W/FM	£42.00
M57737	144-148MHz	30W/FM	£27.23
M57762	1.24-1.3GHz	18W/SSB	£67.53
M57788M	430-450MHz	40W/FM	£66.99
M67715	144-148MHz	13W/FM	£36.48
M67727	144-148MHz	37W/SSB	£124.59
M67728	430-450MHz	60W/SSB	£99.04
MI407-01	Pin diode up to 800MHz/25W		£1.21

Many other frequencies/ power combinations
available, please call with your requirements.
Data sheets available for specific items on request.

Call for Amateur/ Education discounts or volume pricing

COMING SOON - Linear
power amplifier 'Starter
Packs' for 2M & 70cm.



TDC also stock Modem, Networking and GPS receiver and antenna
products, visit our web site at <http://www.tdc.co.uk> for more information.



Stroudley Road
Basingstoke
Hampshire
RG24 8FN

Telephone : 01256 332800 Fax : 01256 332810
e-mail : sales@tdc.co.uk

Access/Visa accepted, prices include VAT @ 17.5%, Postage & Packing £5

CIRCLE NO. 115 ON REPLY CARD

December 1997 ELECTRONICS WORLD

Data Acquisition
Virtual Instrumentation
Environmental Monitoring ▶

Pico Technology

'Pico's PC Converters monitor and record temperature and humidity'.

EnviroMon

Temperature / Humidity Logger & Alarm System

EnviroMon has many applications in:

food processing - storage
and distribution, **energy
management** - waste energy,
heating and processing,
agriculture - monitoring
humidity in greenhouses, and
in **hospitals** - accurate
monitoring of temperature
sensitive items.



- ▼ Monitors up to 30 channels of temperature over a 400 m. distance.
- ▼ -55 to 100°C temperature range (typical accuracy $\pm 0.2^\circ\text{C}$).
- ▼ Data can be downloaded to PC.

EnviroMon

Starter Kit from £393.00

3 temperature Sensors on 5m lead, 3 channel
Converter, Enviromon Logger, cables & fittings.
Expandable at any time for around £50 / channel

TC-08

8 channel Thermocouple to PC Converter

Simple to use thermocouple to
PC interface.

- ▼ Connects to serial port -
no power supply required.
- ▼ Supplied with PicoLog data
logging software.
- ▼ Resolution 0.1°C.

TC-08 £199.00

Supplied with serial cable and adaptor.
Calibration certificate £25.00.
Thermocouple probes available.

TH-03 3 channel Thermistor to PC Converter

NEW

- ▼ Connects to serial port -
no power supply required.
- ▼ PicoLog data logging software.
- ▼ -55 to 105°C temperature range
- ▼ Resolution 0.01°C.

TH-03 £79.00

Supplied with serial cable and adaptor.
Thermistor sensors available.



**Call for free demo disk
or download our web site:
<http://www.picotech.com>**

All prices exclusive of VAT.

Broadway House, 149-151 St Neots Rd,
Hardwick, Cambridge. CB3 7QJ UK
Tel: (0)1954 211716 Fax: (0)1954 211880
E-mail: post@picotech.co.uk

CIRCLE NO. 116 ON REPLY CARD

993

A window on analogue i/o

Colin Attenborough outlines a 12-bit analogue input and output subsystem that runs via the pc's printer port. Colin is also making available his Visual Basic software for controlling the port via Windows.

In the April 1997 edition of *Electronics World*, I showed how to read and write 16-bit digital words through a standard pc printer port, under the control of the Visual Basic language. I used a dynamically-linked library, written in C, to drive the hardware.

This article extends the earlier one to transfer 12-bit analogue data through the printer port – again under Visual Basic control. My software is available on disk; you need only Visual Basic and the disk to control the hardware. For interest, I have added the source code for the necessary dynamically-linked library on the disk, but you do not need a C compiler to use the software.

The circuit of the analogue input/output hardware shown here can be built on its own or added to the digital i/o subsystem previously described. Both clock and data lines use the same pins on the printer port in both cases. Analogue and digital functions available in Visual Basic when the analogue and digital circuitry of the present and previous article are combined are listed in the appendix.

Levels between 0 and 2.5V are accepted by the analogue input; the d-to-a converter output generates between 0V and 4.095V.

Analogue input

The analogue section of the *LTC1286* a-to-d

Subroutines and functions available to Visual Basic

These subroutines and functions are included in my software, which is available on 3.5in disk for £12.50 fully inclusive by writing to Department VB2, Electronics World Editorial, Quadrant House, The Quadrant, Sutton, Surrey SM2 5AS. You need Visual Basic only to run this software.

With the two combined, you can control the analogue i/o port hardware shown via the graphical user interface shown in the screen shot here.

The address of the printer port is represented by, `_port`. This is usually `37816`, but watch the screen as the computer wakes up to check. Function are as follows.

`initialise(int _port)`

Sets the d-to-a converter chip enable, and clears all other lines on the printer port.

`shutdown(int _port)`

Clears all lines on the printer port.

`AdcOn(int _port,int _d)`

Sets the a-to-d converter power line to turn on the a-to-d converter, and takes some dummy readings to allow the supply voltage to settle. Variable `_d` is the delay parameter already mentioned.

`AdcOff(int _port)`

Clears the a-to-d converter power line to turn off the a-to-d converter.

`in_A(int _port,int _d)`

Returns an integer representing the a-to-d converter output. Variable `_d` is the delay parameter.

`in_D(int _port)`

Returns a long representing the state of the digital inputs.

`out_A(int _port, int _data)`

Gives an output of `_data` millivolts from the d-to-a converter.

`out_D(int _port,long _data)`

Sets the digital outputs to `_data`.

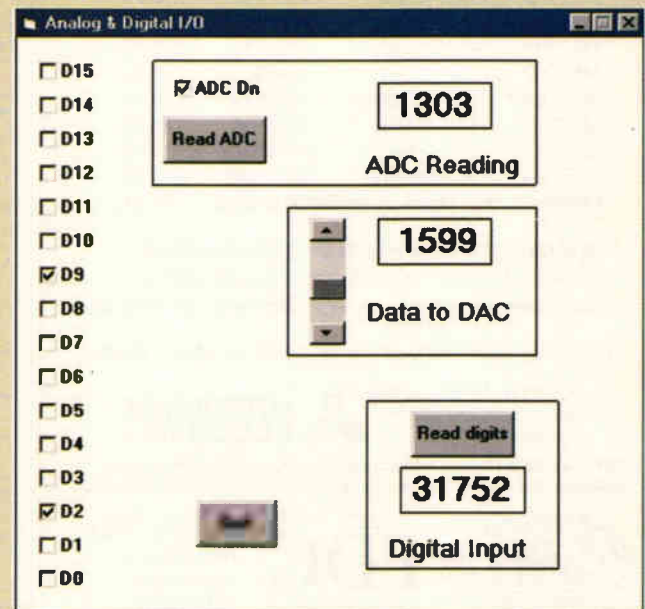

B² Spice & B² Logic

£199

Not Just a Pretty Interface

Software for the professional design engineer

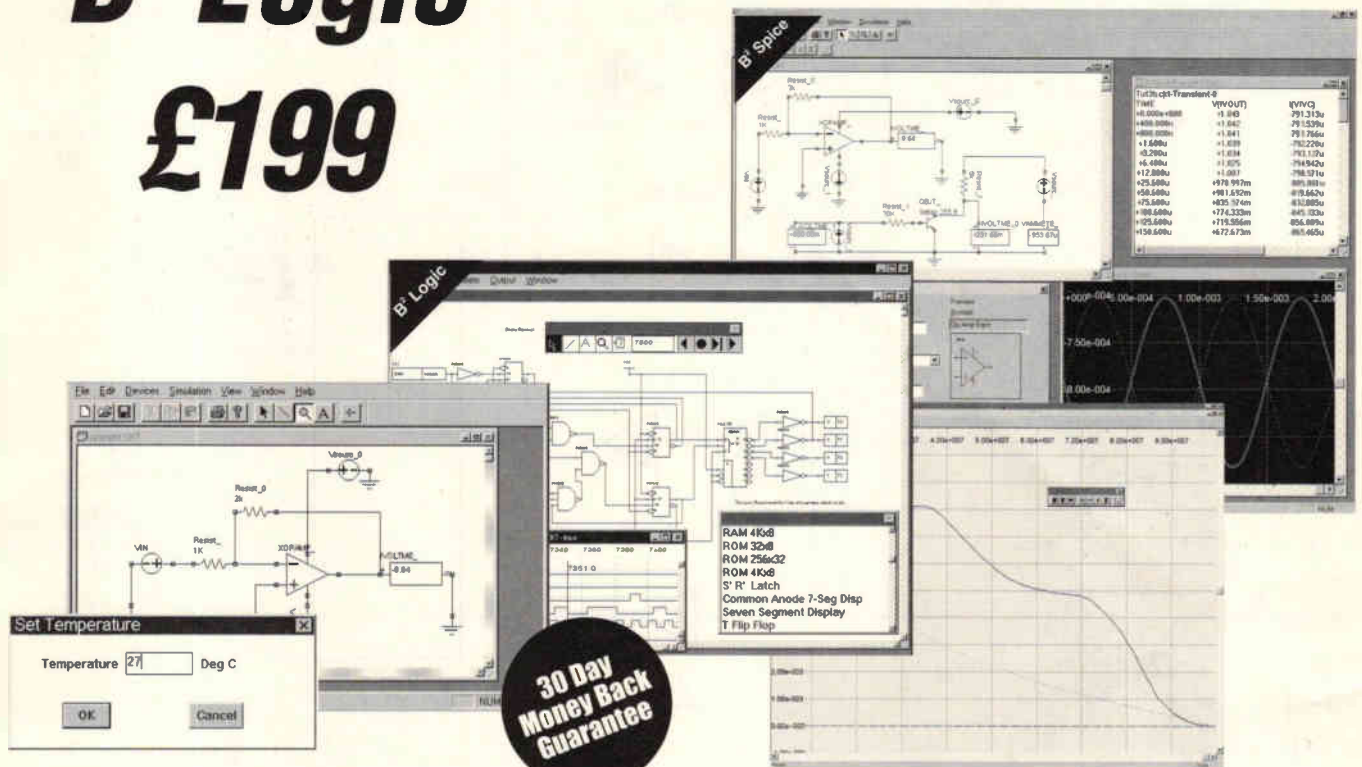

Just some of the features

Fully Integrated and Interactive

Build the circuit on the screen and set up the simulations by choosing options from menus and dialogues. Run the simulation and view your results

Flexible Visualisation of Results

In B² Spice results can be displayed in graphs tables or directly in voltmeters and ammeters. Change from typical to worst case analysis and include the effects of temperature on components. You can customise everything, right down to the colour of an individual trace

Versatility

A plethora of components include resistors, capacitors, inductors, mutual inductors, transformers, controlled sources, bipolar junction transistors, zener diodes, power MESFETs, JFETs, MOSFETs, voltage regulators, operational amplifiers, opto-couplers, voltage comparators, quartz crystals, IBIS I/O buffers and switching matrix connectors and much more. **All devices and model parameters can be edited to suit your needs.** Implement hierarchical circuits in your designs quickly and easily

No Limits

With B² Spice and B² Logic there is no limit on the number of components in the circuit.

Models

There are thousands of models included. The complete Berkeley SPICE model library as well as commercial libraries from manufacturers such as, **Motorola, Texas Instruments, Burr-Brown, Maxim, National Semi, APEX Comlinear, AMP, Elantec, Linear Tech.** and many more. Included with B² Spice is a full model and symbol editing package so you can create, import and edit custom models.

Cross Probing

Cross probing allows you to display waveform results simply by marking pins, wires and devices on the circuit drawing. Monitor results while the simulation is in progress then plot analogue results on linear or log scales

Waveform Analysis

Display and compare multiple response curves in a single graph at the same time. B² Spice simulation results can be selectively displayed and analysed graphically and in numerical format as well as exported to other applications. All of B² Spice and B² Logic's display capabilities are completely flexible

Devices & Stimulus for Simulation

In B² Spice sinusoidal, constant, periodic pulse, exponential, single frequency FM, AM, DC voltage, AC voltage, VCO, Vcc, piecewise linear, exponential, polynomial/arbitrary source, voltage-controlled voltage, voltage-controlled current, current-controlled voltage, current-controlled current, Lossy and ideal transmission line, MESFET, uniform RC, current and voltage switches are all available

Graphs

In B² Spice analogue traces may be displayed as raw voltages and current values or further processed using arithmetic expressions, functions and Fast Fourier Transforms. View plot values corresponding to the cursor position on the graph and get data from multiple simulations in one graph. Multiple graphs to be aligned and compared

Data Analysis

Position detection with mouse for data points. Import and export data to and from other industry standard SPICE programs.

Digital Options.

B² Logic is completely flexible. Set up ROM, RAM and PLA to your own requirements. Shrink a whole circuit to a block and use it as a component in a new design. Run the simulations in real time or step by step. Customise rise and fall time of all components. Results displayed in a logic analyser or table. Select parts from all major logic families. Create your own custom libraries. Create and run pre-programmed simulations.

Professional engineers need software that produces results they can rely on. Anything less is a liability. B² Spice & B² Logic will give you the accurate results you need fast.

The best way to find out if a package is really what you need is to try it, which is what we're giving you the chance to do... risk free for 30 days.

We guarantee you will be 100% satisfied with the results or your money back.

For more information and to order call:

01603 872331

<http://www.paston.co.uk/spice>
email: rd.research@paston.co.uk



RD Research

Research House, Norwich Road, Eastgate, Norwich. NR10 4HA

Postage & packing £4.50. Prices quoted are ex VAT. All trademarks are acknowledged.

CIRCLE NO. 117 ON REPLY CARD

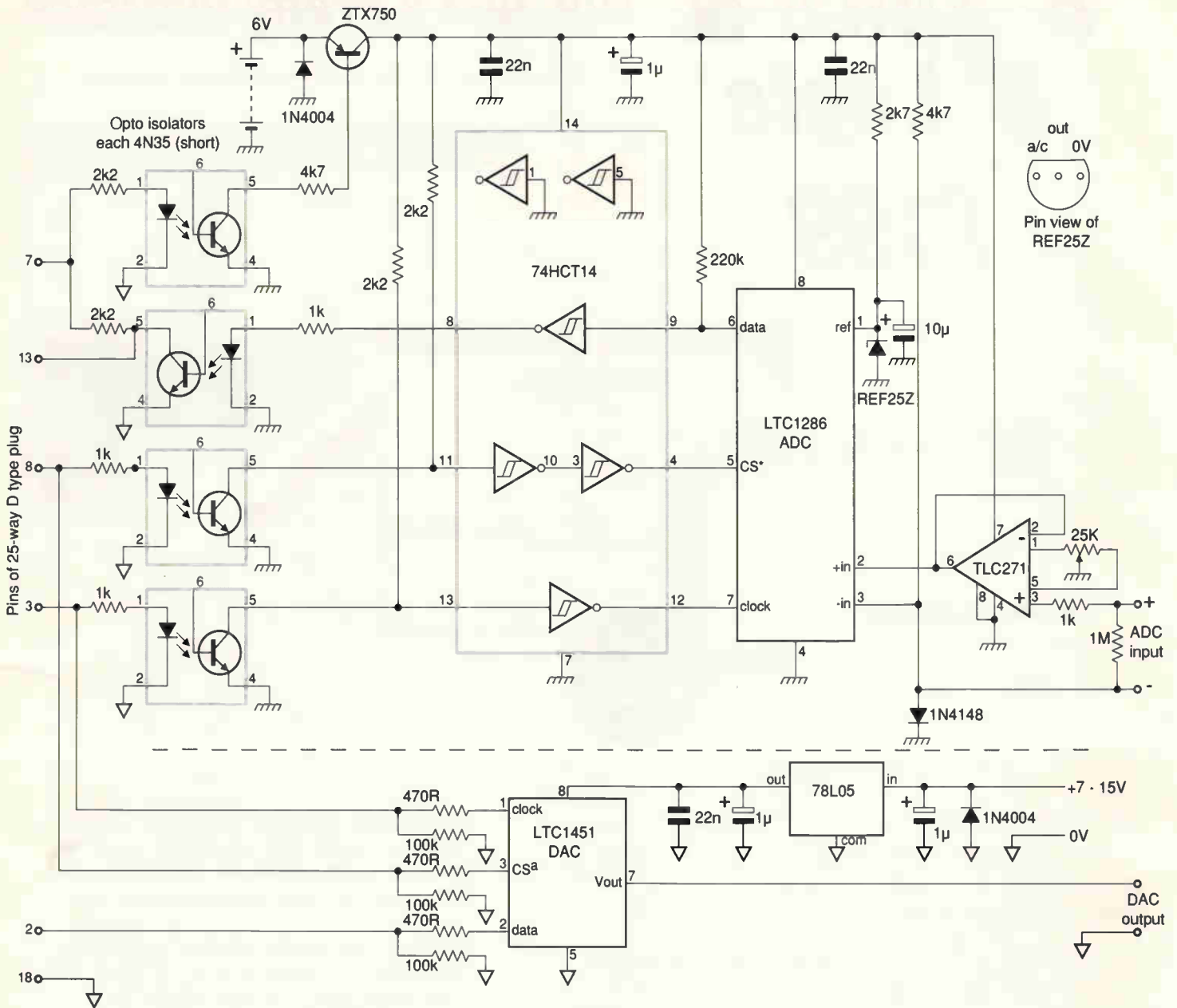

Fig. 1. Designed for battery-powered operation, this 12-bit accuracy analogue-to-digital and digital-to-analogue i/o subsystem is controlled via the pc's printer port. Optoisolators not only provide protection, but also allows floating measurements and removes ground-loop problems.

converter accepts a differential input voltage and a voltage reference; when appropriately clocked, it gives a serial digital output of,

$$code = \frac{4095 \times V_{in}}{V_{ref}}$$

By default, chip enable is at logic 1 to power down the a-to-d converter. To make a conversion, clear chip enable to logic 0 and apply fifteen clock pulses; read data at the rising edge of each clock pulse, most significant bit first, and then set chip enable to logic 1.

Opto isolators convey the chip select, clock and data signals; a fourth opto isolator switches power to the whole analogue input system. Since the system is powered by a battery – of typically four AA cells – power conservation is important.

I've chosen to isolate the analogue input section from the computer via opto isolators;

this allows floating voltage measurements to be taken, and avoids earth loops with their attendant errors.

The a-to-d converter is most accurate when fed from a low source resistance, so a TLC271 op-amp is inserted as an input buffer. This op-amp also has the virtue of buffering the voltage being measured from the capacitive switching input current spikes which occur during conversion.

To allow the op-amp some headroom (shouldn't that be footroom?) I have exploited the differential input of the a-to-d converter, putting the negative input a diode drop above the system 0V line. This means that the op-amp output is always comfortably above its negative supply.

The system needs a supply voltage of between 4.5 and 6V. While the optoisolators specified have a breakdown voltage of 2.5kV,

Did you read Colin's previous article?

Colin points out that there was an error in the listing in his article in the April 1997 issue, near the start of page 333. The line,

```
Declare i_o Lib "<full path name>\IO8.dll" (ByVal ip As Integer,
ByVal op As Integer, ByVal Written)
As Integer
```

should have read,

```
Declare Function i_o Lib "<full path name>\IO8.dll" (ByVal ip As Integer,
ByVal op As Integer, ByVal Written)
As Integer
```

This omission did not occur in the software on the disk that we offered. Apologies.

other factors may limit the voltage that can safely be applied. Layout of whatever pcb or other form of construction is used in the area of the optoisolators is an example. *In any case, consider your own safety when there are large voltages across the optoisolators.*

Converter setup and accuracy issues

I have deliberately run the optoisolators at low currents to extend battery life. The penalty is that the comparatively high load resistors mean that the rise times at the phototransistor outputs are quite long.

To guarantee correct clocking, I have included a delay parameter in the function which reads the a-to-d converter. This is just a counter for a delay loop; a large value gives a large delay. Start with a large value, of say 2000, read the a-to-d converter with a known input voltage, and reduce the delay as far as possible while reliably getting the same output reading.

The delay does *not* affect accuracy. With a 100MHz 486 machine, a delay parameter of

250 gave stable results; the conversion time was about 1.5ms. Faster machines will need a larger value for the same a-to-d converter clock pulse width.

The offset adjustment potentiometer should be adjusted so that with no input voltage the output code flickers between 0 and 1.

Input voltage is defined by,

$$V_{in} = \frac{\text{code} \times V_{ref}}{4095}$$

If you want to obtain best accuracy from the system, take into account that the reference generated by the REF25Z can be between 2.475 and 2.525V. If you have a sufficiently accurate voltmeter you can measure it and take into account its real value when you use the converter. Alternatively, you can calibrate it against a known voltage with a voltage source more accurate than the REF25Z.

Analogue output

I've used an LTC1451 serial d-to-a converter. Rather like the a-to-d converter, chip enable,

referred to as CS* in circuit diagram, is at logic 1 by default.

To convert a digital data stream – most significant bit first – to an analogue output voltage, clear chip enable to logic 0 and apply twelve clock pulses, with the bits of the data stream valid at the rising edge of the clock pulses, and then set chip enable to logic 1.

The d-to-a converter gives an output of,

$$V_{out} = 2V_{ref} \times \frac{\text{code}}{4096}$$

For the nominal reference voltage of 2.048, this simplifies to,

$$V_{out} = \text{code} \times 1\text{mV}.$$

There is a maximum offset error of $\pm 12\text{mV}$ at room temperature; the nominally 2.048V reference has a maximum error of $\pm 40\text{mV}$.

I would like to thank Cambridge Consultants Ltd for permission to publish this article. ■

NOW AVAILABLE

RANGER 2 for Windows 95™

The Complete, Integrated Schematic & PCB Layout Package

Windows Ranger 2

For Windows 95 & NT

- New Hierarchical Circuit
- Split Devices • Gate & Pin Swap
- New Edit Devices in Circuit
- Copper Fill • Power Planes
- Autorouter • Back Annotation

£250

Ranger 2 Outputs:

Full Windows Outputs
Plus - HP-GL
Gerber
NC Drill
AutoCad DXF

Windows Ranger 2 with Spectra SP2

Ranger & Spectra Autorouter provide the most cost effective PCB Design system available. A powerful, intuitive system at an outstanding price!

£500

Windows Ranger 2 Upgrade

Upgrade your existing PCB Package to Windows Ranger 2.

£150

Demo disc available £5.00 (Prices exc VAT/P&P)

Call 01730 260062

Fax 01705 599036

Old Buriton Limeworks, Kiln Lane,
Buriton, Petersfield, Hants. GU31 5SJ



CIRCLE NO. 118 ON REPLY CARD

SEETRAX

Advanced Systems & Technology for PCB Manufacture

You may know which capacitor technology to choose for a given task, but do you know why it's the best choice? Having spent thirty years designing, specifying and troubleshooting capacitors, Cyril Bateman shares his expertise.

Understanding capacitors

To my surprise, recent review of my publications library revealed a scarcity of capacitor articles. Perhaps I should have anticipated this since on reflection, many text books and circuit simulators all consider capacitors as ideal, so why delve further. On the other hand, capacitors have also been called 'strange devices', i.e. *unfamiliar*, which this article seeks to remedy.

Thirty years of experience as a capacitor design and applications engineer has convinced me that over-stressed or mis-applied capacitors are involved either directly or indirectly in most circuit failures. All components wear out in time, but mis-applied capacitors can fail extremely quickly. Worse still, before the capacitor ultimately fails, it can directly contribute to failure of semiconductors, masking the prime failure mechanism.

The best way to understand unfamiliar components is to perform measurements on representative samples, then dismantle them to understand their differing constructions. But with capacitors, not all the significant details are immediately apparent.

Capacitor overview

The fundamental definition of capacitance

relates to charge and voltage, measured statically. Descended from the Leyden jar, a capacitor is essentially an energy storage device. Since its stored energy can be charged or discharged extremely quickly, alternative common usage ac definitions have been derived, as discussed in the panel entitled 'Defining capacitors'.

Of these definitions, the most important relates a capacitor's impedance to frequency,

$$|Z| = \sqrt{R_s^2 + (X_{C_s} - X_{L_s})^2} \quad (1)$$

Where,

$$X_{L_s} = 2\pi f L_s \quad (2)$$

and,

$$X_{C_s} = \frac{1}{2\pi f C_s} \quad (3)$$

Throughout this article, the series equivalent expressions are used, denoted as X_{C_s} , R_s etc., unless otherwise stated.

At any frequency, the term $X_{C_s} - X_{L_s}$ can be simplified to jX_s , giving the fundamental vector equation for impedance, $Z = R_s \pm jX_s$.

This vector equation leads to the common usage expressions for impedance magnitude $|Z|$,

$$|Z| = \sqrt{R_s^2 + X_s^2}$$

and phase angle,

$$\theta = \tan^{-1} \frac{X_s}{R_s}$$

This phase angle definition results in the second most important quantity for capacitors – loss factor,

$$\tan \delta = \text{abs} \frac{R_s}{X_s}$$

An ideal capacitor would have a phase angle, hence $\tan \delta$, that remained constant regardless of frequency. Since by definition, eqn 3, a capacitor's reactance, X_{C_s} , is totally dependent on frequency, so also must be the capacitor's series resistance, R_s , known as esr. This is clearly demonstrated by the results measured for a very high quality polystyrene capacitor, **Table 1**.

What is a capacitor ?

Any two conducting surfaces, separated by an insulator, exhibit capacitance. The value of this capacitance increases with surface area and reduces with separation.

The fundamental definition of capacitance assumes this insulator is a vacuum, thus directly relating to the permittivity of free space.

Capacitance =

$$\text{Free space permittivity} \times \frac{\text{Area}}{\text{Separation}}$$

But area and separation alone are insignificant compared to the contribution provided by a change of insulation material. Each insulation material used is rated for dielectric constant, or

Table 1. Clear demonstration of how esr changes significantly with frequency. Measured results of a high quality 10nF polystyrene foil/film capacitor, made using a four terminal Wayne Kerr 6425 precision component analyser at a test voltage of 1V.

Frequency	Capacitance (nF)	Tan δ	'Q'	ESR (Ω)
100Hz	9.9982	0.00010	9000	17.0
1kHz	9.9988	0.00005	20 000	0.8
10kHz	9.9986	0.00015	6000	0.26
100kHz	10.0000	0.0005	3000	0.05

'K' value. This represents its permittivity relative to free space.

In practical materials used to make commercial capacitors, this 'K' ranges¹ from 1.00059 for air, 2 to 4 for plastic films, 8 for aluminium, 28 for tantalum electrolytics, and from 6 up to 12000 for differing ceramic formulations.

Given this wide range of dielectric constants, it is natural to loosely categorise all capacitors by the dielectric material used. While in general this is valid, the final capacitor's size and electrical properties also vary according to the construction methods used.

For a given dielectric, thickness – or rather thinness – is all important in determining the capacitance achieved in a given physical size. Usable dielectric thinness is limited by its ability to sustain the required voltage as well as surviving manufacturing methods. Common plastics which can be manufactured in micrometre thicknesses², withstand around 500V dc per micrometre, at room temperature, short term.

Since the dielectric for electrolytic capacitors is 'formed' in situ on the base foil, it doesn't need a minimum thickness to provide handling strength, as do plastic films. Together with certain multilayer and disc ceramic construction techniques, electrolytic dielectric thinness is limited only by the voltage that needs to be sustained.

To minimise the final size, the dielectric together with its conducting surfaces – the electrodes – may be compacted using winding, stacking, folding or layering techniques. These processes lead to supplementary descriptions including wound, stacked and multilayer.

Electrodes formations

The conducting surface for paper or plastic dielectric materials is produced by one of two common techniques. In one of them, an extremely thin, visually transparent coating of metal, generally aluminium, is vapour deposited on to the insulator in a vacuum chamber, resulting naturally in the description metallised capacitor. This method however cannot be used with polystyrene.

When the dielectric itself is not metallised, the alternative and electrically superior method uses thin flexible soft metal foils or discrete metallised plastic foils, as electrodes. These foils are interlaid with the dielectric during assembly.

The surface of ceramic dielectrics is generally made conductive by coating with suitable metal inks. After air drying, these are 'fired' at high temperature.

With aluminium electrolytics, the aluminium base anode foil has the dielectric oxide, i.e. Al_2O_3 , pre-formed electrolytically on its surface prior to assembly. The anode foil acts as one conducting electrode.

This electrolytically formed dielectric's thickness is self regulating, attaining some 14Å for each volt applied in manufacture. At 10V working for example, this represents only

0.02µm dielectric thickness (1µm, or micron, is 0.00394in). The true second electrode is the electrolyte material with which the separating tissue paper is impregnated.

Assuming a polarised capacitor, connection to the electrolyte is made using a second, usually thinner, aluminium foil or cathode. While this cathode is not deliberately formed, it inevitably possesses a much thinner naturally occurring aluminium oxide, electrically equivalent to a few volts. In this way, a pair of back to back capacitors is created. One has the desired capacitance and voltage capability while the other has a much greater capacitance but only a few volts capability, applied in reverse.

With a non-polarised, or bi-polar capacitor, this unformed cathode is replaced by a second deliberately formed anode foil. This results in two capacitors back to back, usually having the same capacitance and voltage capability.

Depending on the desired life-length characteristics, the pre-forming voltage used can range from 1.2 times to more than double the working voltage, trading size and cost against leakage current, and hence endurance.

Properties of capacitors

Every capacitor needs conducting surfaces, or electrodes, which inevitably have some intrinsic resistance. Having a physical cross section and length equates automatically to inductance, called self-inductance. As a result, a capacitor must be represented as a series CLR combination circuit.

This CLR network results in a circuit whose resonant frequency depends on the capacitor's value and construction. At the resonant frequency, the capacitor represents a dc blocking low value resistance, and a dc-blocking but inductive reactance at frequencies above this resonance.

At any frequency, a perfect capacitor, having neither resistance nor inductance, would sustain a voltage in quadrature with the applied current. Analysed on a polar display, voltage would be -90° and current 0° , so the complementary angle delta would be zero. Having no resistive element, this perfect capacitor cannot lose or dissipate energy.

The self-inductance results in a voltage at $+90^\circ$. This subtracts magnitude from the capacitive voltage, increasing the apparent capacitance value which would be measured.

With a near perfect capacitor, the above resistance, appearing in series with the capacitive reactance, degrades this -90° angle, resulting in the complementary angle delta increasing. This change in phase angle represents the resistive element which dissipates energy as heat in the capacitor, Fig. 1.

With capacitors, it is usual to refer only to this delta loss angle, which is generally described as $\tan\delta$.

Dielectrics

Unfortunately, all dielectrics other than vacuum contribute their own particular degra-

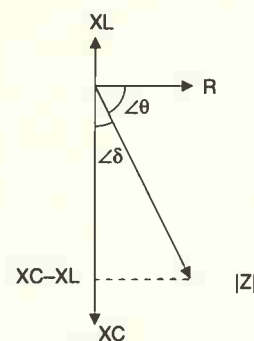

Fig. 1. This simple vector diagram shows the relationship between $\tan\delta$ and $\cos\theta$. Both are essentially equal only with small loss angles. The interaction between the capacitance X_c and inductance X_l vectors is also visible.

dations from this near ideal capacitor. In general the more highly stressed the dielectric, in volts per micron, the greater the degradations.

Since the characteristics of both vacuum and air capacitors depend principally on the particular insulators used to support their assembly, they are excluded from these discussions.

Depending on the symmetry of its molecular structure, each plastic dielectric can be described as having either polar or non-polar characteristics. A symmetrical-molecule plastic, or other non-polar dielectric, has electrical characteristics effectively constant with changing frequency, and exhibits minimal dielectric absorption effects.

If this polymer molecule is not symmetrical, it has a dipole moment resulting in increased dielectric constant. Similarly, ferroelectric ceramic crystal poles and domains can produce extremely high dielectric constants. Such types are known as high-K dielectrics.

Both result in polar characteristics, i.e. a capacitance that reduces and a $\tan\delta$ that increasing with frequency. These are functions of the basic materials used – not to be confused with the constructional terms polarised and non-polarised or bi-polar, as applied to electrolytic capacitors.

While manufacturing techniques cannot change a polar dielectric into a non-polar, they can enhance the polar effect. Stressed with dc voltages, polar materials exhibit a reluctance to accept or release their full charge instantaneously – a behaviour called dielectric absorption.

What is dielectric absorption?

If a capacitor is fully charged, to say 10V, for a considerable time, briefly discharged using a short circuit, then left to recover, a voltage is found which develops with time. The ratio of this resultant voltage compared to the initial charge voltage, is described as dielectric absorption.

In past years dielectric absorption was only

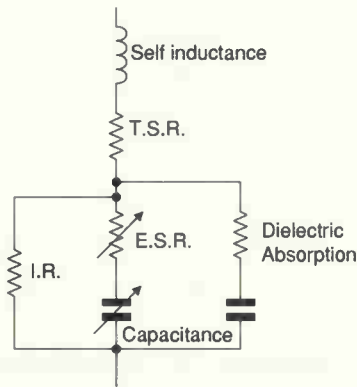

Fig. 2. Full equivalent circuit for a practical capacitor. In practice esr includes the tsr resistance, which is only shown separately to aid explanation.

considered relevant to high voltage capacitors, as a safety hazard. With modern techniques it becomes relevant at very low voltages.

Measured values of dielectric absorption vary with measurement technique, but more importantly with dielectric stress applied, in volts per micron. Typical figures range from 0.05% for polystyrene², 0.25% for polyethylene terephthalate, or PET, to 5% for aluminium.

Some dielectric materials also have a small degree of piezoelectric effect, which can result in a voltage when they are mechanically constrained, whether physically or from temperature changes while rigidly or surface mounted. Some care is needed to differentiate this effect

from that of dielectric absorption.

Both effects are small and are irrelevant for most applications. However when working with sample/hold circuits, charge amplifiers, etc., capacitor choice should account for these effects.

According to manufacturing techniques used, every practical capacitor exhibits some dielectric absorption effect. However polystyrene or polypropylene film/foil and COG NPO dielectric ceramic capacitors, show minimal effects.

With the inclusion of this dielectric absorption mechanism, it is now possible to deduce the equivalent circuit for a practical capacitor, Fig. 2.

How temperature affects capacitors

Ceramic COG NPO type capacitors are restricted to $\pm 30\text{ppm}/^\circ\text{C}$ change of capacitance with temperature and are the most stable available. With the exception of these, all dielectrics show easily measured larger capacitance changes over their temperature range.

General-purpose ceramic capacitor dielectrics are categorised under the EIA classification scheme. The popular X7R material is thus restricted to a box envelope allowing $\pm 15\%$ change in capacitance over its working temperatures. However the exact profile within this envelope, differs with manufacturer.

Change in temperature also results in a change of measured $\tan\delta$ for most common dielectric materials. Non-polar dielectrics show very small changes, but with a polar dielectric, the maker's data should be consulted.

The behaviour of plastic-film capacitors however tends to be consistent according to the materials used and less dependent on specific manufacturer.

Voltage effects

Many polar dielectrics have a capacitance which changes with applied ac or dc voltage. With voltage, capacitance tends to increase above that measured at 1V then declines. Since this behaviour depends on the precise dielectric chosen and manufacturing technique, makers data should be consulted.

Frequency effects

As shown in published data, almost all capacitors exhibit a frequency-dependent capacitance change. Less well known, the dielectric strength or voltage withstand of film dielectrics, can reduce² with increasing frequency. For many applications this is not important since the power or current rating constraints which should be applied, dominate.

With pulse waveforms having large peak-to-mean ratios, power constraints no longer dominate, so it is essential to consult makers' data when choosing a capacitor for pulse duty

More significant for general applications, every capacitor regardless of dielectric has frequency dependent $\tan\delta$ losses, which increase with frequency.

Power limitations

Having mentioned power ratings, surely since current and voltage are in quadrature, no power is dissipated in a capacitor?

I mentioned that a near ideal capacitor has

Fig. 3. This PSpice simulation shows the affect of 1nH inductance with 0.01Ω esr or tsr on four near ideal capacitors, 100µF through 0.1µF. The 1µF capacitor highlighted also shows comparison of increased esr of 0.1Ω and reduced esr of 0.001Ω, giving dramatically changed plot shape, with small values of esr.

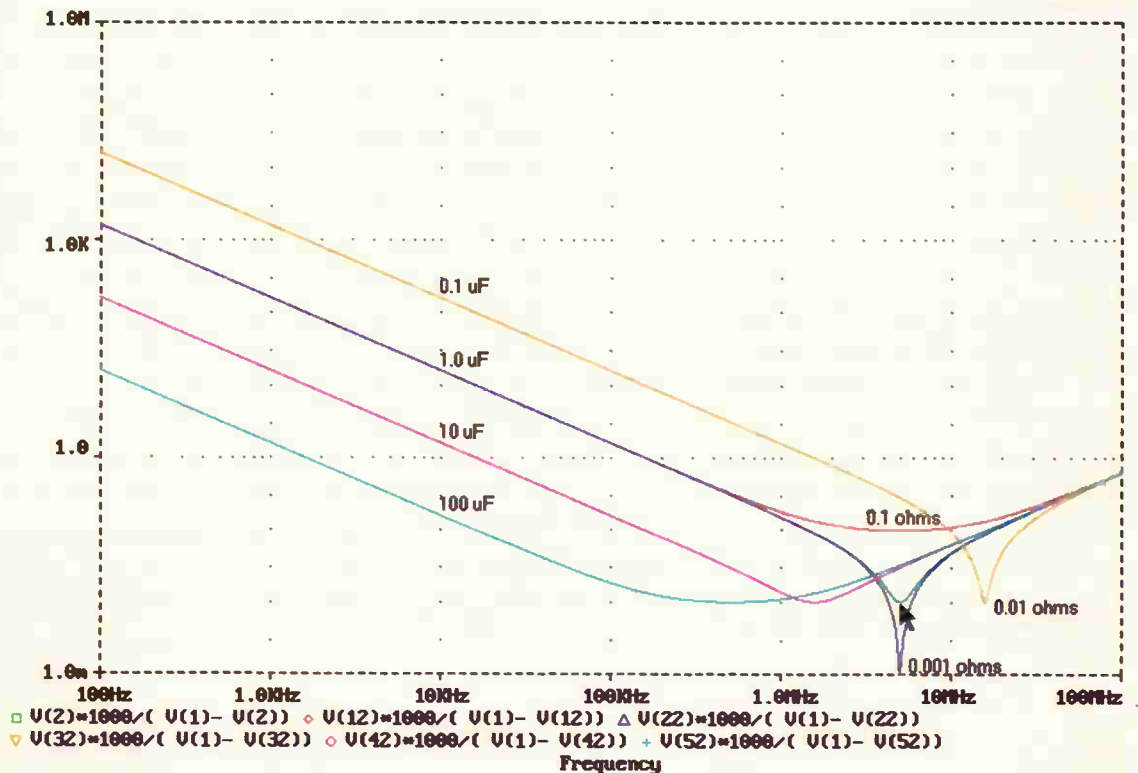

conducting surfaces with a finite resistance. These electrodes must connect to the outside world using one of a variety of means, inevitably adding resistance. The sum of these metallic resistances, true series resistance, or t_{sr} , is a very low value fixed resistance. For convenience, since it cannot be otherwise separately measured, it is sometimes viewed as being the minimum impedance, seen at resonance, on a conventional impedance and frequency plot, Fig. 3.

However other, usually much larger, loss

resistances are found in practical capacitors. Every capacitor exhibits a leakage current, which is voltage and temperature dependent. A rule of thumb based on the Arrhenius law, is to assume this current doubles for each 10°C increase in temperature. Obviously this current can be represented by a high value insulation resistance in parallel with the dielectric. More conveniently, following the parallel-to-series conversion rules, it equates to a very small fixed value series loss resistance.

With most capacitors, the dielectric's $\tan\delta$,

frequency, voltage and temperature related losses dominate. These are also expressed as series resistance.

The sum of all these resistances, at any one frequency, is called the equivalent series resistance or esr. As can readily be seen, esr is frequency, voltage and temperature dependent, so when quoted in makers' data, it only applies to the particular conditions quoted.

To aid understanding, it is perhaps easier to consider esr as a combination of the above leakage resistance and t_{sr} , together with a

Defining capacitors

The fundamental definition¹ of capacitance C in farads is the ratio of charge acquired in coulombs Q to the applied voltage V .

$$C=Q/V$$

For two flat conductive plates separated in vacuum, the fundamental capacitance formula becomes,

$$\text{Capacitance} = \text{Free space permittivity} \times \frac{\text{Area}}{\text{Separation}}$$

where free-space permittivity, ϵ_0 , is $8.854188 \times 10^{-12} \text{F/m}$

All other insulating materials have a dielectric constant, K , relative to this free space value,

$$\begin{aligned} \text{Capacitance} &= K \times \text{Free space permittivity} \times \frac{\text{Area}}{\text{Separation}} \quad \text{F/m} \\ &= 0.0885 \times K \times \frac{A}{S} \quad \text{pF/cm} \end{aligned}$$

In essence any two conducting surfaces, separated by an insulator, exhibit capacitance, with a value which increases with surface area and reduces with separation. Subjected to an ac voltage, an ideal capacitor resists or impedes the passage of current according to its reactance value,

$$X_c = \frac{1}{2\pi fC}$$

developing a voltage lagging the current by 90° .

In practice, every capacitor incorporates a resistive component. Expressed using the conventional series notation, this resistance further resists or impedes the passage of current,

$$Z = \sqrt{R^2 + X_c^2}$$

Each practical capacitor also incorporates an inductive element, which incorporated in the above provides the full equation for impedance,

$$Z = \sqrt{R^2 + (X_c - X_l)^2}$$

where $X_l = 2\pi fL$.

At any given frequency, the term $X_c - X_l$ can be simplified into its series equivalent, jX_s , giving the vector equation, $Z = R \pm jX_s$. This results in the magnitude/angle expressions,

$$|Z| = \sqrt{R^2 + X_s^2}$$

$$\angle\theta = \tan^{-1} \frac{X_s}{R}$$

In the above expressions the R term represents the equivalent series resistance of the capacitor, while the X term represents the series reactive component. When viewed as a vector diagram, a

polar plot, or on a Smith chart, this X term has a negative value for capacitors, Fig. 1.

The commonly used expressions,

$$\tan\delta = \text{abs} \frac{R_s}{X_s} \quad \text{and} \quad C = \frac{-1}{2\pi fX_s}$$

also apply.

Series or parallel?

The impedance vector of a practical capacitor at any one given frequency can be represented using an equivalent circuit of the device with a resistor. The resistor, used to degrade the phase angle to that measured, can be either a high value in parallel with the device, or a low value in series with the device, leading to the term 'equivalent series resistance' or esr.

While the parallel equivalent values have use for certain calculations, the series equivalent values are more commonly used. Throughout this article, the series equivalents are used unless otherwise stated.

Take this practical example. An impedance vector, magnitude 100Ω and phase angle -84.3° at 1kHz , represents a capacitor having a $\tan\delta$ of 0.1 and a Q of 10 . This vector would result from a series combination of 9.95Ω resistive and -99.5Ω reactive, i.e. a $1.6\mu\text{F}$ capacitor or a parallel combination of 1005Ω and $1.584\mu\text{F}$. A difference in equivalent capacitance value of 10% . The equivalent series resistance would be 9.95Ω .

Parallel impedances

Certain measuring instruments or mathematical calculations are more suited to the equivalent parallel expression, which can easily be converted to or from the series values.

$$R_p = \frac{R_s^2 + X_s^2}{R_s} \quad \text{and} \quad X_p = \frac{R_s^2 + X_s^2}{X_s}$$

Sometimes the measured results are needed as admittance rather than impedance; conversion from the parallel impedance expression is simple,

$$Y = \frac{1}{R_p \pm jX_p} = G_p \pm jB_p$$

$$G_p = \frac{R_s}{R_s^2 + X_s^2} \quad \text{and} \quad B_p = \frac{X_s}{R_s^2 + X_s^2}$$

The conversion from parallel impedance back to series impedance format, following,

$$R_s = \frac{R_p \times X_p^2}{R_p^2 + X_p^2} \quad \text{and} \quad X_s = \frac{R_p^2 \times X_p}{R_p^2 + X_p^2}$$

is equally simple.

number of variable contributions dependent on frequency, voltage or temperature. This esr, together with the alternating current passing through the capacitor, can be used to calculate the power dissipated in the capacitor.

When the capacitor is subjected to a sine wave, simple calculations suffice. Given a complex waveform, the only method^{3,4} that ensures accurate results is to use Fourier transforms to characterise the waveform into its discrete frequency components.

Only when a capacitor is measured at its final working frequency, temperature and voltage can its esr be derived directly from bridge measurements of $\tan\delta$ and capacitance. But in most applications it is not practicable to make bridge measurement under such conditions. Consequently esr must be estimated taking account of each variable in turn.

I have stressed that esr is frequency dependent, but does it really change by a significant amount, or am I simply being pedantic?

Consider the esr of a high-quality 10nF polystyrene foil/film capacitor. I selected such a device as one of the standard capacitors when building my capacitance bridge. All measurements were taken using a four terminal Wayne Kerr 6425 precision component analyser, with a test voltage set to 1V, Table 1.

These results show clearly how esr values do change significantly with frequency, for this high quality capacitor. Many writers on this topic have confused these esr and tsr terms. Obviously they differ substantially, except at that frequency when the capacitor is self resonant.

Since correct understanding of esr is essential to avoid over-stressing capacitors, I make no apology for labouring the point.

Implications of voltage ratings

Many years ago, when impregnated metallised paper capacitors were the standard workhorse, it was considered that a capacitor rated for 400V dc or above could be used on 250V ac mains. Since these capacitors were impregnated, this was just about feasible. Unfortunately this premise tends to continue even today.

When the then new unimpregnated met-

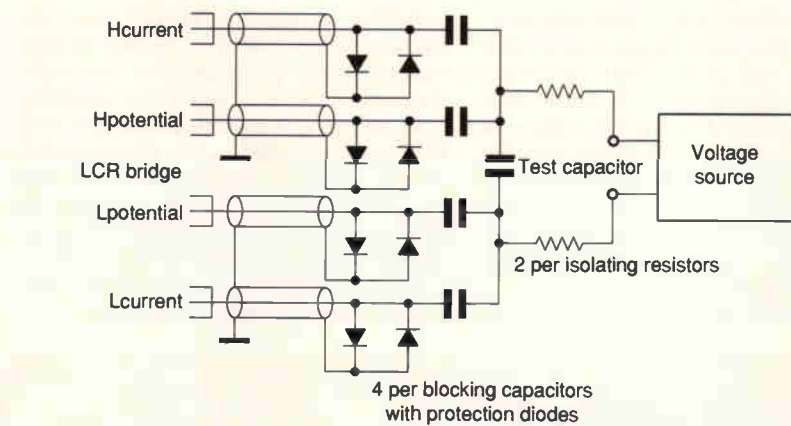

Fig. 4. This simple dc blocking buffer circuit allows measurement of capacitance change with applied dc volts. The isolating resistors should each present at least ten times greater impedance than the test capacitor. Likewise, the dc blocking capacitors must withstand the dc test voltage and have at least ten times the test capacitor's capacitance.

allised PET capacitors became commonly available thirty years ago, 400V dc parts were used for many of these 250V ac mains requirements. Result – misery. If you were lucky, the end terminations eroded, disconnecting the capacitor. If you were unlucky, the capacitor caught fire.

Even today, I have vivid recollections of this unhappy time, when my task was to withdraw from all 250V ac applications and re-rate the capacitors to 160V ac, on behalf of my employer, for this particular construction.

Why should this problem arise ?

Given an impregnated or otherwise solid, void free, capacitor construction, 250V ac and above causes no insuperable problems. However with non-impregnated non-solid constructions, air voids occur within the capacitor.

According to Paschens curve of ionisation, an air-filled void having optimum size and air pressure can exhibit ionisation inception at voltages as low as 185V ac. This is why 160V ac was adopted in the previously-mentioned application to provide a safety margin.

Once triggered, the ionisation current is self sustaining at lower voltages – in fact almost to zero volts. Thus once triggered, the resulting

discharge continues for at least 50% of the periodic waveform.

This ionisation discharge is damaging to almost all dielectric materials, resulting ultimately in a short circuited capacitor.

From these experiences, international and national safety rules for class X capacitors, used across the 250V ac domestic mains, were developed. Two main capacitor styles emerged. These were a much updated resin impregnated metallised paper capacitor⁵ and the two-in-series metallised polypropylene style, which worked since its two series capacitor elements shared the applied voltage.

Manufacturing measurements

National and international capacitor approvals require manufacturers' measurements to be 'true' values, i.e. traceable to nationally held standards. In general, this means that measurement equipment must have an inherent accuracy ten times better than any claimed component parameters. Measured values must be 'inset' sufficient to eliminate all known measuring equipment errors.

With low-loss or close-tolerance capacitors, these requirements are not easily attained. A test frequency of 1kHz is standard for capacitors of value greater than 1nF except for electrolytic types, which are generally tested at 100Hz. Resulting from their high impedance at 1kHz, capacitors equal to or less than 1nF are tested at 1MHz. In general, test voltages of 1V ac or lower are used.

Experimenters' measurements

Commercially available capacitance test equipment can supply a DC polarising voltage to the component, but is generally restricted to a maximum of 20V dc.

However an adapter permitting much higher voltages can be simply made. Hewlett Packard application note 346 – a Guideline for Designing External DC Bias Circuits⁶ – provides details of adapters for their ranges of precision meters. However these principles can easily be extended to any equipment

Wheatstone bridge

A capacitance bridge⁷ that can be used at audio frequencies to directly measure capacitance and esr is shown. It is easily built using standard resistor and capacitor decade boxes together with one known high-quality standard capacitor.

With range switching resistors to replace R_A and three switchable standard capacitors, this circuit has been used to measure both capacitance and esr from a few picofarads to a hundred thousand microfarads. For best accuracy with the

larger capacitors, four-terminal connections and switching of the low-impedance current paths is advised.

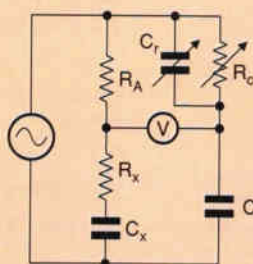

Power stress circuit

When designing switching supplies, much benefit derives from measuring a capacitor at its final working voltage and frequency. While low power measurements using a bridge are possible, other techniques are essential for higher powers or voltages.

These power or voltage limitations result because taking current in quadrature with voltage stresses any power amplifier. The amplifier's power dissipation increases rapidly when driving a capacitive load, leading to instability or failure.

If this capacitive load is resonated using a suitable inductor, the power amplifier is presented with a zero phase load. The inductor provides either the voltage needed to the capacitor, or the current. Since it also needs to supply only voltage or current and not both, amplifier power dissipation can be low, **Fig. 5**.

Using a series-resonant circuit, the amplifier supplies the required through current but at a much reduced voltage. With a parallel resonant circuit, the amplifier supplies the

required voltage at a much reduced current. The inductor's stored energy supplies the missing voltage or current drive required by the capacitor. The amplifier only supplies the power needed to replace that lost due to capacitor dissipation, inductor resistive losses and the protection resistor.

Using a stable air cored inductor with a Q of ten or better, and a 100W mosfet audio power amplifier, capacitor voltages of 250V can be easily attained using the series circuit. An air cored inductance provides the stability needed for meaningful calculations.

Conversely the parallel configuration easily provides 5A. The schematic circuit suggests using a series resistor to protect the amplifier in the event of capacitor failure. Much higher levels are possible if this resistor value is reduced.

Capacitance change with frequency, voltage or current can be calculated from the circuit's change in resonant frequency, the voltage drop and through current measurements of the test capacitor.

which might need to be used, **Fig. 4**.

Commercially available capacitance testers can often measure using more than 1V ac test voltage, but they rarely extend above 20V ac. Higher test voltages are possible using Wheatstone bridge methods but care is needed not to overload either the test source or the bridge measurement arms – especially with increasing frequency.

A low accuracy alternative method which can measure to very high voltages and frequencies requires use of a power amplifier together with suitable high 'Q' inductors. Depending on whether higher voltage or greater current than can be sourced by the amplifier is needed, these inductors are used to either series or parallel resonate with the capacitor. Using these techniques, satisfactory measurements to 500V ac and several amps at frequencies to 1MHz have been performed, **Fig. 5**.

Capacitor life

Qualification testing requires capacitors to survive continuous operation at maximum ratings and maximum temperature for typically 1000 hours. In some instances the capacitors are required to be stressed in excess of claimed levels, or for much longer times. To understand the implied life-test claims, you need to read the specification.

Compared to actual end use 1000 – and even 10000 – hours endurance is extremely short. But components in end use are not generally continuously stressed, certainly not to their maximum capability and temperature.

Arrhenius law suggests that insulation resistances halve, alternately leakage currents double, for each 10°C increase in temperature. Consequently 1000 hours at 125°C can represent a useful life⁴ under normal end use conditions, of 10 to 20 years – even assuming maximum applied voltage.

A secondary benefit results from reduced voltage. All capacitors, including electrolytics, exhibit prolonged life with reduction in operating voltage, even to zero dc, provided any applied ac does not otherwise contravene the capacitor specifications.

One common mis-statement – that electrolytics exhibit no capacitance with zero or reverse bias – is completely unfounded. The dielectric film is chemically robust and cannot in the short term be changed. Long term, assuming reverse voltage is within the permitted levels, leakage current increase can result in parametric failure.⁴

However if an electrolytic which has been operated for some time at reduced voltage, is then subjected to increased voltage, a temporary increase in leakage current results. The capacitor may then fail to meet its specification. Since the converse also applies,

any capacitor subject to excess temperature, voltage or current or mechanical stress, will fail quite quickly.

One special aspect which certainly causes electrolytic failure, is unwitting excessive repetitive reverse bias. This can arise when a polarised capacitor is used to couple the drive waveform into a switching transistor base and at the same time block dc. This mis-use is especially common. I have personally experienced this failure mechanism many times, in both television and satellite receivers.

With switching power supplies, an early indication of an electrolytic being reverse biased is increased transformer noise and notable temperature increases. However with television line and frame timebase generators being less audible, the first indication can be either reduced drive amplitude or semiconductor failure.

Such abused capacitors usually show visible signs of overheating or electrolyte leakage, measurable loss of capacitance and increased esr and reverse voltage withstand. I hope to delve further into this topic in a subsequent article which explores and measures various capacitor constructions. ■

References

1. Reference Data for Radio Engineers, pub Newnes.
2. Capacitors for electronic equipment, 1995, Wilhelm Westermann KG.
3. Bateman, C, 'Power dissipation in capacitors,' *EW&WW*, April 1995.
4. Data Handbook Electrolytic Capacitors, 1994, Philips Components.
5. Safety requirements for EMI suppression capacitors, <http://www.rifa.se>
6. A guideline for designing external dc bias circuits, Hewlett Packard Application Note No 346.
7. Bateman, C, 'Looking into impedance,' *Electronics World*, August 1997.

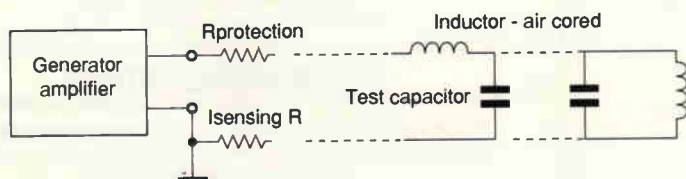

Fig. 5. Taking advantage of inductor Q to produce high test voltages on the capacitor while maintaining the amplifier load near unity power factor. Variations on this circuit enable much investigation into capacitor behaviour using only minimal equipment.

IF HELICAL BPF FILTERS (7H series)

for Set-top Box/Video Sender/WLAN/WLL/CDMA/REPEATER/MCA...
640M/ 612M/ 480M/ 460M/ 410M/ 350M/ 325M/ 240M/ 140M/ 135M/ 110M/ 89M.....
YOU MAY SPECIFY ANY OF IF-FREQUENCY & BANDWIDTH (3M-35MHz).

TEMWELL BRAND	Fo (MHz)	ILAR TP	-3dB BW (MHz)	Fo(-)M (dBc)	Fo(+)M (dBc)	Group Delay
T67861A-612M(7H2)-5.5W	590-640M	6.0	5.5W	(10)17	(10)15	75.0ns
T6796A-612M(7H2)-8W	590-640M	4.0	8.0W	(40)53	(40)41	59.0ns
T67110A-612M(7H2)-10W	595-640M	4.5	10.0W	(50)37	(50)32	40.0ns
T6796D-612M(7H2)-20W	590-640M	3.0	20.0W	(50)31	(50)25	23.0ns
T6751D-612M(7H2)-25W	595-640M	2.6	25.0W	(50)25	(50)18	20.0ns
T6862A-612M(7H3)-7W	590-640M	7.0	7.0W	(20)42	(20)31	75.0ns
T67112A-612M(7H3)-9W	610-640M	5.0	9.0W	(50)53	(50)50	67.0ns
T67104D-612M(7H3)-19W	590-640M	3.0	19.0W	(50)50	(50)38	37.0ns
T67108A-612M(7H3)-22W	595-640M	3.0	22.0W	(50)48	(50)35	32.0ns
T6848A-480M(7H2)-4.5W	460-515M	5.5	4.5W	(20)34	(20)26	76.0ns
T6746A-480M(7H2)-6W	460-515M	5.3	6.0W	(40)44	(40)43	72.0ns
T6793D-480M(7H2)-10W	460-515M	3.5	10.0W	(50)35	(50)28	38.0ns
T6746D-480M(7H2)-18W	460-515M	3.0	18.0W	(50)34	(50)24	26.0ns
T6747F-480M(7H2)-24W	460-515M	2.0	24.0W	(50)18	(50)19	19.0ns
T67159B-480M(7H2)-29W	460-515M	2.0	29.0W	(60)18	(60)20	14.0ns
T6849A-480M(7H3)-4W	460-515M	7.0	4.0W	(10)27	(10)19	92.0ns
T67101A-480M(7H3)-8W	460-515M	5.0	8.0W	(20)43	(20)32	72.0ns
T67101D-480M(7H3)-12W	460-515M	4.0	12.0W	(20)32	(20)24	51.0ns
T6774D-480M(7H3)-18W	460-515M	3.0	18.0W	(20)21	(20)14	35.0ns
T67158-480M(7H3)-23W	460-515M	2.0	23.0W	(60)38	(60)26	24.0ns
T67758-480M(7H3)-30W	460-515M	2.0	30.0W	(60)38	(60)26	20.0ns
T6711A-410M(7H2)-7W	405-455M	4.5	7.0W	(40)40	(40)40	57.0ns
T6791D-410M(7H2)-10W	405-455M	3.0	10.0W	(20)20	(20)18	45.0ns
T6711F-410M(7H2)-13W	405-455M	3.0	13.0W	(50)38	(50)26	33.0ns
T6745F-410M(7H2)-18W	405-455M	2.0	18.0W	(50)35	(50)23	23.0ns
T67159B-410M(7H2)-21W	405-455M	2.0	21.0W	(50)18	(50)28	20.0ns
T6799D-410M(7H3)-9W	405-455M	4.0	9.0W	(20)41	(20)30	66.0ns
T6772F-410M(7H3)-14W	405-455M	3.2	14.0W	(20)30	(20)20	46.0ns
T67157B-410M(7H3)-17W	405-455M	3.0	17.0W	(50)44	(50)35	35.0ns
T6773F-410M(7H3)-23W	405-455M	2.0	23.0W	(50)50	(50)28	32.0ns
T6790A-360M(7H2)-5W	350-400M	4.5	5.0W	(40)38	(40)38	66.0ns
T6790D-360M(7H2)-7W	350-400M	3.5	7.0W	(50)46	(50)30	46.0ns
T6742F-360M(7H2)-10W	350-400M	3.0	10.0W	(50)40	(50)26	38.0ns
T6743F-360M(7H2)-20W	350-400M	2.0	20.0W	(50)27	(50)19	30.0ns
T6841A-360M(7H3)-4W	350-400M	8.0	4.0W	(10)35	(10)25	85.0ns
T6798D-360M(7H3)-7W	350-400M	5.7	7.0W	(10)23	(10)16	70.0ns
T6770F-360M(7H3)-10W	350-400M	5.0	10.0W	(20)33	(20)24	60.0ns
T6771F-360M(7H3)-20W	350-400M	3.0	20.0W	(20)17	(20)10	35.0ns
T6789D-325M(7H2)-6W	310-350M	3.6	6.0W	(10)16	(10)15	66.0ns
T6740A-325M(7H2)-8W	310-350M	3.5	8.0W	(30)45	(30)31	57.0ns
T6741B-325M(7H2)-14W	315-355M	2.0	14.0W	(50)26	(50)36	31.0ns
T6797D-325M(7H3)-4W	300-340M	8.5	4.0W	(8)30	(8)24	133.0ns
T6797D-325M(7H3)-9W	300-340M	5.0	9.0W	(10)25	(10)18	80.0ns
T6789B-325M(7H3)-15W	310-355M	3.0	15.0W	(50)60	(50)46	35.0ns
T6831B-240M(7H2)-3W	220-245M	5.0	3.0W	(10)16	(10)25	94.0ns
T6701B-240M(7H2)-9W	220-245M	3.0	9.0W	(30)23	(30)35	50.0ns
T6735B-240M(7H2)-15W	225-250M	2.0	15.0W	(50)28	(50)38	34.0ns
T6832B-240M(7H3)-4W	200-245M	7.0	4.0W	(10)35	(10)38	160.0ns
T6762B-240M(7H3)-9W	225-250M	3.0	9.0W	(20)39	(20)37	70.0ns
T6763B-240M(7H3)-15W	225-250M	2.5	15.0W	(50)68	(50)66	55.0ns
T6727D-140M(7H2)-5W	130-145M	3.6	5.0W	(10)14	(10)15	67.0ns
T6756B-140M(7H3)-2W	130-145M	8.0	2.0W	(8)33	(8)34	173.0ns
T6757B-140M(7H3)-4.5W	135-145M	6.0	4.5W	(8)26	(8)23	116.0ns
T6812A-110M(7H2)-3W	107-115M	4.5	3.0W	(20)30	(20)39	101.0ns
T6813A-110M(7H3)-3W	107-115M	6.0	3.0W	(10)40	(10)35	160.0ns
T67113D-89M(7H2)-3W	85-95M	5.0	3.0W	(10)27	(10)32	154.0ns
T67114D-89M(7H3)-2W	85-95M	6.5	2.0W	(10)53	(10)45	214.0ns

**** RF SECURITY 315-320M/418M/433.9M/447M ****
**** SPECIAL PRICE : @US\$1.40/PC FOR 5K PCS / 7H2 ****

T6740A-318M(7H2)-8W	310-355M	4.0	8.0W	(30)50	(30)30	60ns
T6741B-315M/325M(7H2)-19W	310-355M	2.0	19.0W	(50)23	(50)29	40ns
T6711A-418M(7H2)-7W	405-455M	4.5	7.0W	(30)50	(30)30	60ns
T6711A-433.9M(7H2)-7W	405-455M	4.5	7.0W	(30)50	(30)30	60ns
T67106B-418M/433.9M(7H2)19W	405-455M	2.0	19.0W	(50)23	(50)23	40ns

**** RF FRONTEND 0.8-1G BPF FILTERS(7H2/3) ****

T67160A-800-820M(7H2)	800-820M	2.0	> 26.1M	(80)30	(80)24	20ns
T67161A-835-855M(7H2)	835-855M	2.0	> 26.1M	(80)30	(80)25	20ns
T67162A-861-881M(7H2)	861-881M	2.0	> 26.1M	(80)30	(80)24	20ns
T67163A-880-900M(7H2)	880-900M	2.0	> 26.1M	(80)30	(80)26	20ns
T67164A-900-920M(7H2)	900-920M	2.0	> 26.1M	(80)30	(80)27	20ns
T67165A-935-955M(7H2)	935-955M	2.0	> 26.1M	(80)29	(80)25	20ns
T67166A-950-970M(7H2)	950-970M	2.0	> 26.1M	(80)29	(80)25	20ns
T67167A-975-995M(7H2)	975-995M	2.0	> 26.1M	(80)26	(80)22	20ns
T67139A-800-820M(7H2)	800-820M	4.5	9.0W	(50)50	(50)35	40ns
T67140A-835-855M(7H2)	835-855M	6.5	10.0W	(50)50	(50)33	40ns
T67141A-861-881M(7H2)	861-881M	5.5	9.0W	(50)50	(50)32	30ns
T67142A-880-900M(7H2)	880-900M	5.0	9.0W	(50)40	(50)30	30ns
T67143A-900-920M(7H2)	900-920M	5.5	10.0W	(50)38	(50)28	30ns
T67144A-935-955M(7H2)	935-955M	5.5	11.0W	(50)38	(50)28	30ns
T67145A-950-970M(7H2)	950-970M	5.5	12.0W	(50)38	(50)27	30ns
T67146A-975-995M(7H2)	975-995M	6.0	13.0W	(50)32	(50)25	30ns
T67168B-800-820M(7H3)	800-820M	2.0	> 26.1M	(80)40	(80)30	25ns
T67169B-835-855M(7H3)	835-855M	2.0	> 26.1M	(80)40	(80)30	25ns
T67170B-861-880M(7H3)	860-880M	2.0	> 26.1M	(80)36	(80)28	25ns
T67171B-880-900M(7H3)	880-900M	2.0	> 26.1M	(80)36	(80)27	25ns
T67172D-900-920M(7H3)	900-920M	2.5	> 26.1M	(80)42	(80)30	25ns
T67173D-935-955M(7H3)	935-955M	2.5	> 26.1M	(80)42	(80)27	25ns
T67174D-950-970M(7H3)	950-970M	2.5	> 26.1M	(80)42	(80)22	25ns
T67175D-975-995M(7H3)	975-995M	3.0	> 26.1M	(80)36	(80)20	25ns

SIZE:7H2:14.9 X 7.4 X 13.0mm, 7H3 :22.4 X 7.4 X 13.0mm
We designed over 250 specifications from 55M-1600M, You may select any Fo & BW,
Full set of catalog suggest to you, please FAX us today.

Manufacturer : MADE IN TAIWAN

TEMWELL CORPORATION

6F, No.2, SEC.2, MIN SHENG E., RD., TAIPEI, TAIWAN

FAX:886-2-5515250 / 5652287, TEL:886-2-5652500 (7L)

E-mail: temwell@ms12.hinet.net (C:\A:\FALLAD3.DOC)

CIRCLE NO. 119 ON REPLY CARD

COLOMOR (ELECTRONICS) LTD

170 Goldhawk Road, London W12 8HJ

Tel: 0181 743 0899 Fax: 0181 749 3934

Email: giacomelli@colomor.demon.co.uk

★ CELEBRATING 30 YEARS 1967-1997 ★

DG732	£9.40	EL84 MUL	£10.60	UBF89	£1.55	6B57	£5.60
E180F	£3.80	EL84W	£6.00	UBL1	£4.80	6BW6	£6.25
EAF42	£1.50	EL86	£3.80	UCH21	£5.20	6BW7	£1.55
EBL1	£5.80	EL95	£1.85	UCH81	£1.20	6BZ6	£3.60
EBL21	£4.80	EL360	£7.60	UCR2	£1.65	6C4	£1.65
ECC81	£2.50	EL503	£38.50	UF41	£3.25	6CD6GA	£4.80
ECC82	£2.90	EL821	£7.65	UF42	£1.50	6CH6	£3.50
ECC83	£2.90	EM34	£18.50	UF89	£1.90	6CX8	£4.70
ECC83 MUL	£9.90	EM81	£2.60	UL41	£14.10	6F6	£4.95
ECC91	£2.25	EM91	£3.60	UL84	£1.55	6GF7A	£4.10
ECP80	£1.00	EZ80	£2.20	UM84	£1.30	6K7	£2.25
ECH35	£2.60	EZ81	£2.85	UY41	£3.65	6L6GT/C	£2.95
ECH42	£1.20	GZ33	£7.00	UY85	£1.55	6L6	£7.50
ECH81	£1.90	GZ34S	£6.00	VU39	£4.50	6V6GT	£5.10
ECL80	£1.00	GZ34 MUL	£17.65	Z759	£11.00	6X4	£3.55
EF37	£3.45	GZ37	£4.70	ZC51	£4.50	6X5GT	£2.50
EF37A MUL	£5.60	GZ37 MUL	£8.25	ZK25	£29.35	7Z4	£3.80
EF50	£1.90	KT66 RUS	£9.00	5R4GY	£6.80	12AT7	£2.90
EF80	£2.35	KT88	£20.95	5U4G	£5.80	12AU7	£2.50
EF86	£5.10	MU14	£3.50	5Y3	£3.55	12AX7	£7.05
EF86 MUL	£12.95	N78	£10.10	6A86	£1.95	12AX7	£7.05
EF89	£1.60	QQV03-6	£12.00	6AK5	£1.45	12E1	£18.00
EF91	£1.55	QQV03-10	£7.65	6AL5	£1.00	12H6	£4.70
EF95	£1.45	QQV03-20A	£14.00	6AM6	£1.65	12HG7	£7.70
EL32	£1.45	QQV06-40A	£22.00	6AMS8A	£4.10	13CW4	£32.90
EL34S	£7.10	QY4-250	£103.85	6AT6	£1.95	813	£29.15
EL34B	£7.20	SP61	£3.25	6AUSGT	£5.20	5744WB	£8.70
EL36	£3.50	TD03-10	£33.50	6AU6	£1.80	5763	£8.85
EL41	£4.75	U19	£12.20	6B8J	£4.10	5963/ECC82	£4.90
EL84							

Never mind the quality – feel the bandwidth

As MPEG video and audio compression becomes increasingly popular, there are signs that the quality is suffering. Here John Watkinson explains why compression artifacts occur and – more importantly – what can be done to reduce them.

In audio/visual program material, the advantages of compression are many – hence its popularity. Compressed material requires less bandwidth which is ideal for broadcasting, where the radio spectrum is under increasing pressure from other mobile services.

Compression also allows the cost of storage or recording to be reduced, although as recording economics improve year on year this may be a transient advantage.

Compression principles

Figure 1a) shows that in all real digital program material the bit rate is the product of the sampling rate and the word length. In practice the overall bit rate is made up of a varying mixture of unpredictable or novel material, known as entropy, and the remainder which could be deduced from first principles, known as redundancy.

An ideal compressor would separate the two perfectly so that only the entropy need be sent. An intelligent decoder would work out the redundancy for itself and reproduce the source signal without loss.

Entropy is a characteristic of the signal and varies. Figure 1b) shows that if all of the entropy is not sent there is quality loss. The ideal is a variable rate channel which allows constant quality. If a fixed rate channel has to be used, the quality will vary.

In an MPEG-2 transport stream, several compressed signals can be statistically multiplexed together. It is unlikely that all will

reach an entropy peak together, consequently a transport stream can be divided into a number of varying bit rate channels.

Provided that the overall bit rate remains constant, individual channels can demand more bandwidth when difficult material is encountered on the assumption that other channels are probably handling easier material at that time.

In the DVD – digital video disk, also known as digital versatile disk – a variable bit rate is supported in a single program stream simply by changing the rate of disk accesses.

Unfortunately the ideal coder of Fig. 1 is infinitely complex and has an infinite processing delay. Practical coders have to constrain both. When either of these constraints are applied, the bit rate has to go up to maintain quality, as Fig. 1c) shows. Figure 2 shows that for constant quality the bit rate will reduce as the latency increases.

Video compression

In MPEG-2, the temporal compression is obtained by sending motion compensated difference pictures, and further spatial compression is obtained by transform coding the differences.

Differential coding simply subtracts the previous picture from the current picture and sends the difference. When there is motion differences increase. This is handled by measuring the motion between pictures on a 16-by-16 pixel block, or macroblock, basis

John Watkinson, FAES, B.Sc., M.Sc.

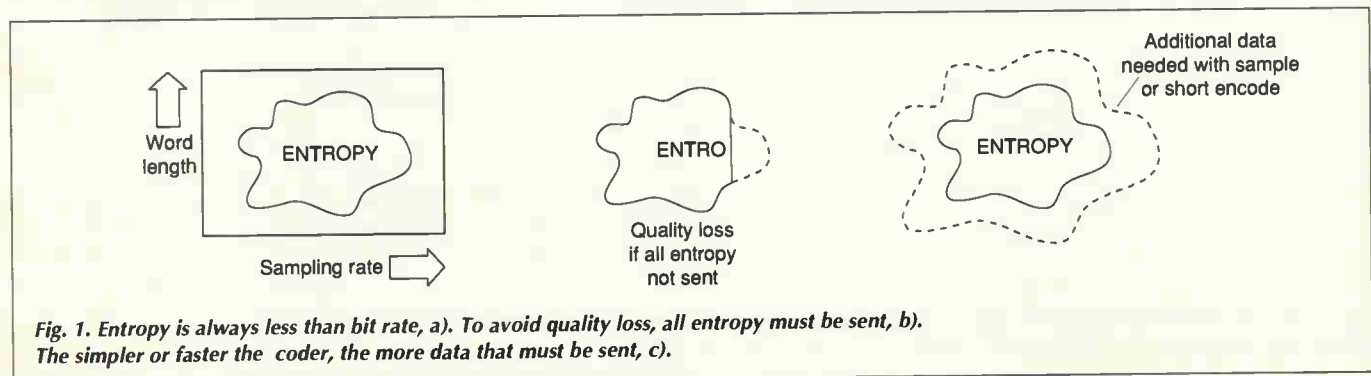

and transmitting a vector for each block. The decoder and the encoder both shift the previous picture using the vectors and only the difference between the shifted previous picture and the current picture need be sent.

Pure differential coding fails if there is a transmission error because that error propagates indefinitely. It also makes it hard for the viewer to change channel! In practice periodic whole pictures have to be sent to prevent error propagation and to create decoder entry points. These are known as intra-coded, or I,

pictures because they make no reference to any other picture and are only spatially compressed. In between these I pictures differential coding is used.

Moving objects cause problems in differential coding because they reveal background at their trailing edge which is previously unknown.

This is overcome by using information from future pictures. Figure 3 shows that in bidirectional coding a picture can be decoded using information from pictures before or after. The decoder does not need a crystal ball to obtain the future pictures: instead, pictures are sent out of sequence.

Figure 4 shows that after an I picture, a future picture is differentially coded in the forward direction only. This future P (predicted) picture is sent immediately and stored in the decoder.

Pictures between the I picture and the P picture can now be sent these B (bidirectional) pictures can be created by forward or backward motion compensated differences on an individual macroblock basis.

The pictures and difference pictures are spa-

tially compressed. The process begins by performing a dct, or discrete cosine transform, which expresses an 8-by-8 pixel block as a set of 64 coefficients. In typical video material, many of the coefficients will have zero or negligible values so that only the significant ones need to be transmitted.

Compression artifacts

Compressors are generally iterative and are driven by a bit-budget measurement. If the output bit rate is too high for the channel the dct coefficients will have to be expressed in fewer bits. In the case of large value coefficients, when low order bits are lost they become less accurate. In the case of small value coefficients, they may be truncated to zero.

This has a number of side effects. Coarse quantising of large value coefficients means that after the inverse dct at the decoder the eight-by-eight pixel block may have considerable errors in the sample values.

While these are not necessarily visible in themselves, the errors in adjacent blocks will mean that there is a discontinuity in the block boundaries so that the blocks become visible as shown in Fig. 5a). If high frequency coefficients have been truncated to zero the block will lack detail and resemble a tile as in 5b).

This effect occurs in both the luminance and colour difference paths. In luminance the effect is called contouring whereas in colour the effect is called posterising, where gradual colour changes have been replaced by a limited colour set, as might be available in a box of poster paints. In MPEG the colour posterising can be quite obvious because the chroma blocks are the size of a macroblock and have four times the screen area.

Effects of truncating hf coefficients

Where high-frequency coefficients have been truncated to zero, the effect is to introduce ringing on edges. This is because an edge contains high frequencies and removing them is the equivalent of a sub-optimal low pass filter, hence the ringing. This is particularly noticeable on graphics and captions, less so on natural subjects.

When the prediction of the temporal coding fails, the data in the difference pictures will necessarily increase and this will force the compressor to quantise more heavily, raising the artifact level. This is particularly noticeable on B pictures since they are generally allocated only 10% of the data rate.

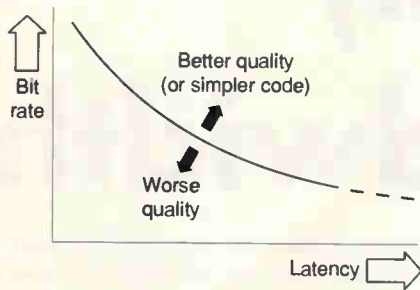

Fig. 2. Shorter latency needs a higher bit rate.

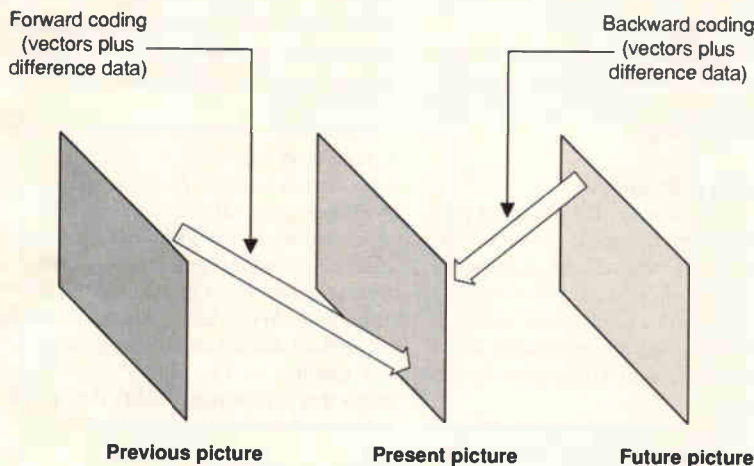

Fig. 3. Bidirectional coding uses information from both past and future picture frames.

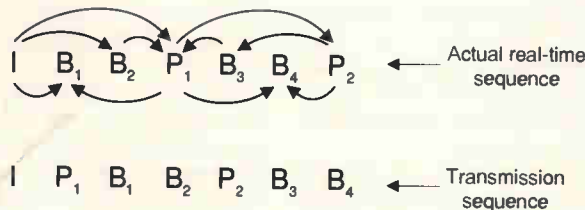

Fig. 4. Bidirectional coding requires pictures to be transmitted out of sequence.

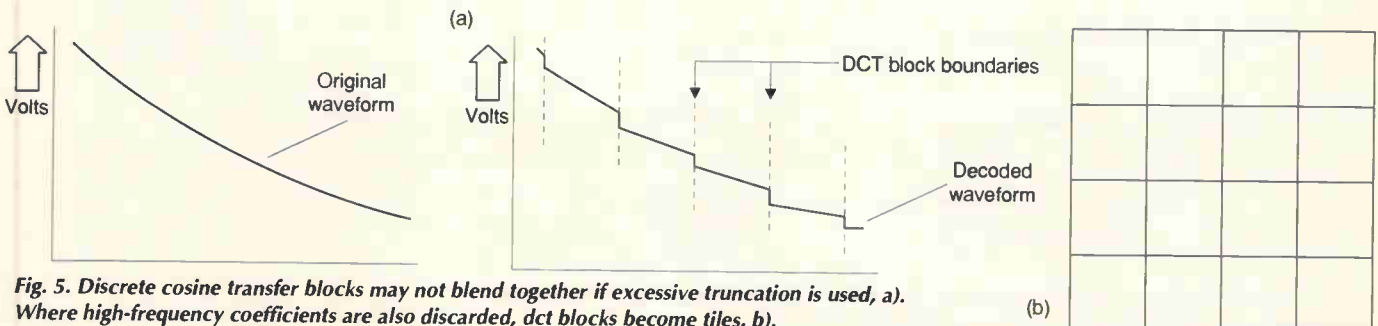

Fig. 5. Discrete cosine transfer blocks may not blend together if excessive truncation is used, a). Where high-frequency coefficients are also discarded, dct blocks become tiles, b).

Temporally difficult material, such as when frequent cuts are made, may overload an encoder. Cuts remove temporal redundancy and defeat bidirectional coding. Following a cut, several pictures may contain serious blocking artifacts.

The real MPEG killer material is video from a press conference where flashguns are firing. Each flash drives up every single pixel value for one picture, and then in the next picture the values come back to normal. This causes temporal chaos and most MPEG coders substitute a picture of the designer's bathroom wall under these conditions.

Pre-processing controls artifacts

The level of artifacts can be controlled by pre-processing. There are three levels at which a pre-processor can operate,

- By removing noise from the source material.
- By removing entropy from the source material.
- By aligning the I pictures in the coder output with the temporal entropy of the source.

Noise in a source pixel block creates more coefficients than a noise free source would.

Thus all coefficients have to be truncated more aggressively to carry them, raising artifact level. Noise also increases data in difference pictures. Hence noise reduction will lower artifact levels by reducing spurious coefficients and reducing picture difference data.

If, after other steps, the artifact level is still too high, then the only approach is to restrict the entropy entering the coder. This is done by down-sampling the source images either spatially, so they contain less pixels, or temporally, so there are fewer pictures per unit time, or both.

In source material from telecine, the use of 2:2 and 3:2 pull-down creates what could be called false entropy, because in 2:2 frames are interlaced to make fields, giving a false doubling of picture rate.

The ratio 3:2 gets its name because 24Hz film frames are alternately converted to two and three fields to give a 60Hz output. One in five fields is redundant. Prior to MPEG coding telecine material has to have redundant fields discarded and remaining field pairs are de-interlaced to obtain the original frames.

The largest usage of data in MPEG is the I picture. This is because it does not use any previous information from the source.

Consequently it makes no difference if the source I picture is radically different from the ones which went before. In contrast both P and B pictures will require significantly more difference data if there is a cut.

It follows that a significant reduction in artifacts can be obtained if I pictures are temporally aligned with source cuts. The only drawback of this approach is that to do it in real time a great deal of memory is needed to pipeline a stack of frames so that picture type decisions can be taken.

The alternative is to use a time coded source recording and use a two-pass encoding process. On the first pass the cuts are detected and used to design a picture type structure which is stored, and on the second pass the structure is implemented. ■

John is an independent consultant in digital audio, video and data technology and is the author of fifteen books on the subject, including *Compression in Video and Audio*. He is a Chartered Information Systems Practitioner, a Fellow of the Audio Engineering Society.

The Low Cost Controller That's Easy to Use

Features

The K-307 Module provides the features required for most embedded applications

- | | |
|------------------|---------------------------------|
| Analogue | • 4 Channels in 1 Channel out |
| Digital | • 36 Digital in or out & Timers |
| Serial | • RS-232 or RS-485 plus I2C |
| Display | • LCD both text and graphics |
| Keyboard | • Upto 8 x 8 matrix keyboard |
| Memory | • > 2Mbytes available on board |
| Low Power | • Many modes to choose from |

Development

The PC Starter Pack provides the quickest method to get your application up & running

- | | |
|-------------------------|--|
| Operating System | • Real Time Multi Tasking |
| Languages | • 'C', Modula-2 and Assembler |
| Expansion | • Easy to expand to a wide range of peripheral cards |

Other Features

Real Time Calendar Clock, Battery Back Up, Watch Dog, Power Fail Detect, STE I/O Bus, 8051 interface, 68000 and PC Interface

Cambridge Microprocessor Systems Limited



Units 17 - 18 Zone 'D'
Chelmsford Road Ind Est
Great Dunmow Essex CM6 1XG
E-mail cms@dial.pipex.com

Phone 01 371 875 644

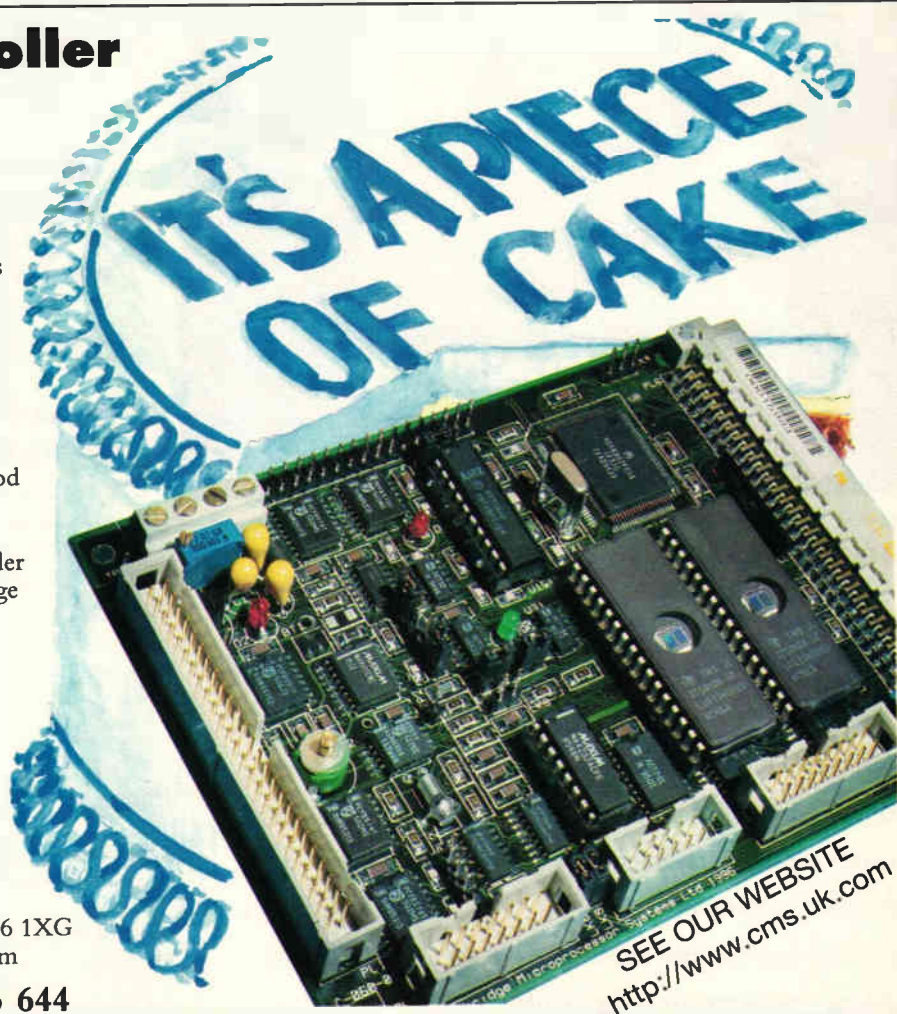

SEE OUR WEBSITE
<http://www.cms.uk.com>

Interfacing with C

**ELECTRONICS
WORLD**
+ WIRELESS WORLD

Interfacing



Howard Hutchings



Without an engineering degree, a pile of money, or an infinite amount of time, the revised 289-page **Interfacing With C** is worth serious consideration by anyone interested in controlling equipment via the PC. Featuring extra chapters on Z transforms, audio processing and standard programming structures, the new **Interfacing with C** will be especially useful to students and engineers interested in ports, transducer interfacing, analogue-to-digital conversion, convolution, digital filters, Fourier transforms and Kalman filtering. Full of tried and tested interfacing routines.
Price £14.99.

Listings on disk – over 50k of C source code dedicated to interfacing. This 3.5in PC format disk includes all the listings mentioned in the book **Interfacing with C**. Note that this is an upgraded disk containing the original **Interfacing With C** routines rewritten for Turbo C++ Ver. 3. Price £15, or £7.50 when purchased with the above book.

Especially useful for students, the original **Interfacing with C**, written for Microsoft C Version 5.1, is still available at the special price of £7.50. Phone 0181 652 3614 for bulk purchase price.

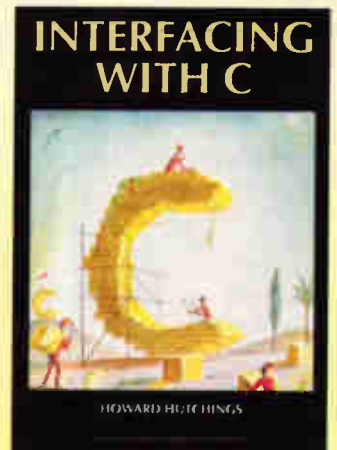

Use this coupon to order

Please send me:

Title	Price	Qty	Total
Enhanced Interfacing with C book @	£14.99	£.....
Enh. Interfacing with C book + disk @	£22.49	£.....
Interfacing with C disk @	£15	£.....
Original Interfacing with C book @	£7.50	£.....
Postage + packing per order UK	£3.50	£.....
Postage + packing per order Eur	£7	£.....
Postage + packing per order ROW	£12	£.....
Total			£.....

Name

Address

Phone number/fax

Make cheques payable to Reed Business Publishing Group Ltd
Or, please debit my Master, Visa or Access card.

Card type (Access/Visa)

Card No

Expiry date

Mail this coupon to Electronics World Editorial, Quadrant House, The Quadrant, Sutton, Surrey, SM2 5AS, together with payment. Alternatively fax full credit card details with order on 0181 652 8956 or e-mail them to jackie.lowe@rbp.co.uk. Orders will be dispatched as quickly as possible, but please allow 28 days for delivery.

**8 CAVANS WAY,
BINLAY INDUSTRIAL ESTATE,
COVENTRY CV3 2SF**
Tel: 01203 650702
Fax: 01203 650773
Mobile: 0860 406683

(Premises situated close to Eastern-by-pass in Coventry with easy access to M1, M6, M40, M42, M45 and M69)

MISCELLANEOUS

Anritsu ME482B - DS-3 transmission analyser	£3000
Anritsu MG542A - Pulse pattern generator	£1500
Bar & Stroud - EFS variable filter (0.1Hz-100KHz)	£150
Danbridge JP30A - 30KV Insulation Tester	£1500
Dranetz 525 - A/C/Dc Multifunction Analyser	£850
Farnell AP70-30 P.S.V. - (0-70v, 0-30A) auto ranging	£750
Fluke 5100A - Calibrator	£2500
Fluke 5100B - Calibrator	£3500
Fluke 5205A - Precision power amplifier	£1500
Fluke 7105A - Calibration system (As new)	£5000
Guidline 9152 - T12 Battery standard cell	£950
Hewlett Packard 331A - Distortion analyser	£200
Hewlett Packard 435A or B - Power Meter (with 8481A/8484A)	from £750
Hewlett Packard 16300 - Logic Analyser (43 channels)	£650
Hewlett Packard 16500A - Fitted with 16510A/16515A/16530A/16531A Logic analyser	£4000
Hewlett Packard 1651A - Logic analyser (As new)	£5000
Hewlett Packard 3314A - Function generator	£2250
Hewlett Packard 3325A - 21MHz synthesiser/function gen.	£1500
Hewlett Packard 3336A - Synthesised signal generator (10Hz-21MHz)	£1000
Hewlett Packard 3455A - 5 1/2 digit multimeter (autocal)	£750
Hewlett Packard 3456A - Digital voltmeter	£750
Hewlett Packard 3478A - Multimeter (5 1/2 digit) HPB	£550
Hewlett Packard 3488A - HP-IB switch/control unit (various plug-ins available)	£650
Hewlett Packard 35660A - Dual channel dynamic sig-analyser	£3750
Hewlett Packard 3711A/3712A/3715B/3719B - Microwave link analyser/Sensor	£2495
Hewlett Packard 3776A - PCM Terminal test set	£1500
Hewlett Packard 3779 A/C - Primary mux analyser	£500/£900
Hewlett Packard 4275A - Multi-frequency LCR meter	£3500
Hewlett Packard 4278A - 1Hz/1MHz capacitance meter	£3750
Hewlett Packard 4279A - 1MHz, C-V meter	£6500
Hewlett Packard 4338A - Milliohmeter (as new)	£2000
Hewlett Packard 4342A - Q meter	£995
Hewlett Packard 4946A - Transmission impairment measuring set	£2000
Hewlett Packard 4953A - Protocol analyser	£1995
Hewlett Packard 4972A - Lan protocol analyser	£2000
Hewlett Packard 5314A - (new) 100MHz universal counter	£250
Hewlett Packard 5328A - 100MHz universal frequency counter	£250
Hewlett Packard 5384A - 275MHz frequency counter	£995
Hewlett Packard 5395A - Frequency counter (1GHz (HP-IB) with Opts 001/1003/004/005)	£995
Hewlett Packard 6031A - 1000 Watt auto-ranging P.S.U. (20v-120A)	£1550
Hewlett Packard 6261B - Power supply 20V-50A DISCOUNT FOR QUANTITIES	£450
Hewlett Packard 8011A - Pulse gen. 0.1Hz-20MHz	£500
Hewlett Packard 8152A - Optical average power meter	£1250
Hewlett Packard 8158B - Optical attenuator with opt's 002 & 001	£1100
Hewlett Packard 8165A - 50MHz programmable signal source	£1650
Hewlett Packard 8180A - Data generator	£1500
Hewlett Packard 8182A - Data analyser	£1500
Hewlett Packard 8349B - Microwave broadband Amp (as new) 2-20MHz	£3250
Hewlett Packard 8355A - Millimeter wave source 26.5GHz-40GHz	£4000
Hewlett Packard 8355A - Millimeter wave source 33GHz-50GHz	£4250
Hewlett Packard 8405A - Vector voltmeter	£500
Hewlett Packard 8620C - Sweep oscillator mainframe	£400
Hewlett Packard 8656B - Synthesised signal generator	£2950

TELNET

Hewlett Packard 8750A - Storage normaliser	£375
Hewlett Packard 8756A - Scalar network analyser	£2000
Hewlett Packard 8757A - Scalar network analyser	£2750
Hewlett Packard 8801A - Modulation Analyser	£2500
Hewlett Packard 8900A - Audio analyser (20Hz-100KHz)	£1995
Hewlett Packard 8920A - RF Comms test set	£5000
Hewlett Packard 8958A - Cellular radio interface	£3500
Hewlett Packard 11729B - Carrier noise test set	£2000
Kroh-Hite 2500 - Sweep function generator	£350
Leroy-Low 420 - Arbitrary waveform gen. (New) + 1MHz/CH opt.	£14000
Leroy-Low 2019 - 80KHz-1040MHz synth signal generator	£1750
Marconi 2019A - 80KHz-1040MHz synthesised sig. gen	£1950
Marconi 2022A - 10KHz-1GHz - AM/FM signal generator	£2000
Marconi 2960A - Radio Comms test set with cellular adaptor	£3500
Marconi 2871 - data communications analyser	£1000
Marconi 2955 - Radio Comms test set	£3000
Marconi 2955B - Radio Comms test set	£4250
Marconi 2958 - Radio Comms test set + tacs adaptor	£3500
Marconi 2960A - Radio Comms test set with cellular adaptor	from £950
Marconi 6860 - Power Meter + sensor	from £1050
Marconi 6860A - Power Meter + sensor	£400
Philips PM 5167 - 10MHz function gen	£800
Philips PM 5190 - LF synthesiser with GPIB	£325
Philips PM 5716 - 50MHz Pulse generator	£350
Philips PM 6673 - 120MHz high resolution universal counter	£350
Philips PM 6670 - 120MHz high resolution timer/counter	£350
Philips PM 6652 - 1.5 GHz programmable high resolution timer/counter	£900
Racal Dana 1996 - 1300MHz frequency counter opts 48+95	£800
Racal Dana 9010 - Synthesised Sig Gen 500MHz	£900
Racal Dana 9084 - Synth. sig. gen. 104MHz	£400
Racal Dana 9301A - True RMS R/F millivoltmeter	£350
Racal Dana 9303 - True RMS R/F level meter	£650
Racal Dana 9521 - 3GHz frequency counter	£450
Rohde & Schwarz SMDU - 15Hz-528MHz (FM & AM) Sig Gen	£500
Schaffner NSG 200E - Mainframe	£1000
Schaffner NSG 203A - Line voltage variation simulator	£995
Schaffner NSG 222A - Interference simulator	£995
Schaffner NSG 223 - Interference generator	£750
Schaffner NSG 431 - Electrostatic discharge simulator	£1250
Schaffner NSG 433 - Electrostatic discharge simulator	£1950
Schlumberger 2720 - 1250MHz Freq. Counter	£600
Schlumberger 7060/7065/7075 - Multimeters	£350
Syrston Donner 1980B - Microwave Sweeper (12-18GHz)	£2500
Tektronix 577 - Curve Tracer	£1150
Tektronix - Plug-ins - Many available such as PG508, FG504, SC504, SW503, SG502 etc	
Tektronix TM5003 + AFG5101 - Arbitrary Function Gen.	£1750
Tektronix TM510 - Logic Analyser	£750
Tektronix AM503 + TM501 + PG302 - current probe amplifier	£995
Tektronix AA5001 + TM5006 - Mainframe programmable distortion analyser	£1995
Tektronix PG506 + TG501 + PG503 TM503 - Oscilloscope calibrator	£1995
Time 9814 - Voltage calibrator Sig Gen 500MHz	£750
Wandel & Gottormann - PC/M (with options)	£9950
Wandel & Gottormann - PRA 1 Frame simulator/analyser	£5750
Wavetek 172B - Programmable sig. source (0.0001Hz-13MHz)	£250
Wavetek 184 - Sweep generator	£450
Wayne Kerr B905 - Precision LCR meter	£850
Wayne Kerr 4225 - LCR bridge	£600
Wayne Kerr 6425A - Precision component analyser	£2750
Wiltron 6620S - Programmable sweep gen. (3.6-6.5GHz)	£650

Hewlett Packard 54100A - 1GHz digitizing	£1400
Hewlett Packard 54100D - 1GHz digitizing	£2995
Hewlett Packard 54200A - 50GHz digitizing	£750
Hitachi V152/V121/V222/V302B/V30F/V353F/V550B/V650F - From	£125
Intron 2020 - 120MHz digital storage (as new)	£650
hwatsu 55 5710/55 5702 - From	£125
Meguro MSO 1270A - 120MHz digital storage (as new)	£650
Kikusui 5100 - 100MHz dual channel	£350
Kikusui QDS 6100 - 100MHz 5 channel 12 trace	£475
Lecroy 9450A - 300MHz/400Ms/s D.S.O. 2ch	£2250
Nicolet 310 - LF DSO with twin disc drive	£550
Nicolet 3091 - Low freq D.S.O.	£900
Philips 3095 - 50MHz 2ch	£450
Philips PM 3211/PM 321/PM 3214/PM 3217/PM 3234/PM 3240/PM3243/PM3244/PM 3261/PM 3262/PM 3263/PM 3540 - From	£125
Philips PM 3295A - 400MHz dual channel	£1750
Philips PM 3335 - 50MHz/20Ms/s D.S.O. 2ch	£1500
Tektronix 434 - 25MHz 2 channel + analogue storage	£250
Tektronix 454 - 150MHz 2 channel	£400
Tektronix 455 - 50MHz dual channel	£350
Tektronix 464/466 - 100MHz storage	from £350
Tektronix 465/465B - 100MHz dual ch.	from £350
Tektronix 468 - 100MHz D.S.O.	£750
Tektronix 475/475A - 200/250 MHz dual channel	from £475
Tektronix 2213 - 60MHz dual ch.	£425
Tektronix 2215 - 60MHz dual ch.	£450
Tektronix 2221 - 60MHz digital storage	£1500
Tektronix 2225 - 50MHz dual trace	£450
Tektronix 2235 - 100MHz Dual channel	£900
Tektronix 2235 - 5100MHz dual ch. (portable)	£1600
Tektronix 2440 - 300MHz/500Ms/s D.S.O. 2ch	£4250
Tektronix 2445A - 150MHz - 4 channel	£1600
Tektronix 5403 - 60MHz 2 or 4 channel from	£250
Tektronix 7313, 7603, 7613, 7623, 7633 - 100MHz 4 ch	from £250
Tektronix 7704 - 500MHz 4 ch	from £500
Tektronix 7854 - 400MHz Waveform processing oscilloscope	£1500
Tektronix 790A - 500MHz	from £700
Tektronix 7934 - 500MHz with storage	from £1000
Tektronix TDS520 - 500MHz/500Ms/s D.S.O. 2ch	£4000
Tequipment DB3 - 50MHz dual channel	£200
Tequipment DM63 - 20MHz 4 channel	£150
Trio CS - 1022 - 20MHz dual channel	£125

SPECTRUM ANALYSERS

Advantest 4131 - 10KHz - 3.5GHz (GIPB)	£4500
Advantest 4138B - 10KHz - 3.5GHz	£4750
Advantest 4138B - 10KHz - 2.0GHz (60GHz with external mixers)	£7250
Altech 757 - 10KHz-22GHz	£2750
Ando AC 8211 - Spec analyser 1.7GHz	£2950
Hewlett Packard 141T + 8552B + 8555A - (10MHz-18GHz)	£1600
Hewlett Packard 182T with 8558B - (10MHz-1500MHz)	£2750
Hewlett Packard 853A with 8558B - (0.01-1500MHz)	£3250
Hewlett Packard 3562A - dynamic signal analyser, dual channel	£7500
Hewlett Packard 3580A - 5Hz-50KHz	£995
Hewlett Packard 3709B - Constellation Analyser with 15709A High Impedance interface (as new)	£4750
Hewlett Packard 8505A - Network analyser (500KHz-1.3GHz)	£3950
Hewlett Packard 8591E - 9KHz-1.8GHz (Calibrated)	£6500
Hewlett Packard 8754A - Network analyser 1300MHz	£2750
Meguro MSA 4901 - 1-300MHz (as new)	£1250
Meguro MSA 4912 - 1-1000MHz (as new)	£1750
Marconi 2370 - 110MHz spec analyser	£750
Tekeda Riken 4132 - 1000MHz	£2750

Many more items available send large S A E FOR LIST - ALL EQUIPMENT IS USED WITH 30 DAYS GUARANTEE, PLEASE CHECK FOR AVAILABILITY BEFORE ORDERING CARRIAGE & VAT TO BE ADDED TO ALL GOODS

CIRCLE NO. 125 ON REPLY CARD

Control Essentials from Milford Instruments

BASIC Stamps - low cost alternative to PLCs

BASIC Stamps are small, low cost re-programmable controllers running easy-to-programme BASIC. They can source/sink up to 20mA and support buttons/keypads/LCDs/LEDs/Comms/Serial Driver Chips etc. Once programmed from the PC, Stamps are fully autonomous and will find many uses in ATE equipment, one-offs and as an alternative to expensive PLCs.

B51-IC
£25

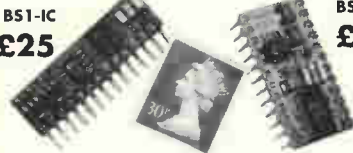

Development kits from £79 which include application notes, software, cable and Stamp.

B52-IC
£39

B51-IC
8 I/O lines
Up to 80 programme lines
2,000 lines/sec
Comms to 2,400 baud

B52-IC
16 I/O lines
Up to 500 programme lines
SPI, DTMF etc
Comms to 19,200 baud

Data Logging

B52-IC based Data collection board with real-time clock/calendar, up to 32kBytes EEPROM, dual 12-bit ADC and user development area. Kit complete with extensive manual and ready-to-go software routines that may be user customised.

£65

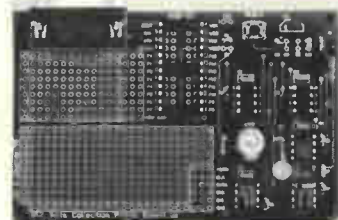

Serial Maths Processors

Number crunching? Let our serial maths processors take the strain

- 32-bit floating point • SPI (3-wire) interface
- Multiply, divide, add, subtract, sine, log, square-root, • 32-programmable counter,
- 4-channel ADCs

£20

All prices exclude shipping and VAT

Serial LCD Modules

- banish lcd hassle

Three quality, backlit LCD modules each fitted with an easy-to-use serial driver board. Simple 3-wire interface to PC, micro or Stamp (+5vdc, Gnd and signal). Enhanced driver board supports full-screen height numerals, standard characters and software switchable backlight. RS232 interface at 2,400 or 9,600 baud. Standard driver boards (without lcd) and bulk driver chips for OEM use also available.

£85

£125

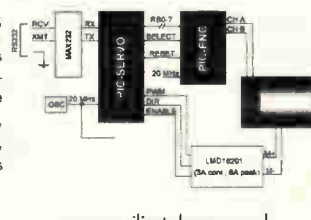

£35



DC Servo Control

DC Motor control chipset for use with incremental encoders. RS232/RS485 interface capability, Positional control, Velocity control and Trapezoidal profiling, Programmable P.I.D filter. 32-bit position, velocity and acceleration. Evaluation board available.

£29

To order or request further information, please call Milford Instruments at 01977 683665, fax 681465

CIRCLE NO. 126 ON REPLY CARD

2.5GHz frequency meter for under £100?

Hand-held and battery-powered, the FC2500 costs just **£99** exclusively to *Electronics World* readers.

Normally, the FC2500 2.5GHz frequency meter retails at £116.33 including VAT. But for a limited period, Electronics World in conjunction with Vann Draper Electronics is making this instrument available exclusively to Electronics World readers at the special price of **£99** – including VAT and postage, representing a discount of £17 on an already low price. Simply fill in the coupon and post it to Vann Draper at Unit 5, Premier Works, Canal Street, South Wigston, Leicester LE18 2PL. Tel. 0116 2771400, fax 0116 2773945.

Specifications

Range 1 2.5GHz
Span 50MHz-2.5GHz
Sensitivity $\leq 100\text{mV}$, 50-75MHz
 $\leq 50\text{mV}$, 76MHz-2.5GHz
Gating 2.75s sample, 100Hz resolution
1.5s sample, 200Hz resolution
0.75s sample, 500Hz resolution
0.5s sample, 1000Hz resolution

Range 2 500MHz
Span 10MHz-500MHz
Sensitivity $\leq 120\text{mV}$, 10-35MHz
 $\leq 50\text{mV}$, 35-350MHz
 $\leq 120\text{mV}$, 351-450MHz
Gating 0.75s sample, 100Hz resolution
1.5s sample, 50Hz resolution
5s sample, 20Hz resolution
6s sample, 10Hz resolution

Range 3 10MHz
Span 10Hz-10MHz
Sensitivity $\leq 50\text{mV}$
Gating 0.5s sample, 10Hz resolution
1.25s sample, 1Hz resolution
6s sample, 0.2Hz resolution
11s sample, 0.1Hz resolution

Range 4 Period
Span 10Hz-10MHz
Sensitivity $\leq 50\text{mV}$

Basic accuracy $\pm 4\text{ppm}$, +1d

I/p limit 5V pk-pk 2.5GHz and 500MHz ranges
250V pk-pk 10MHz and period ranges

Features of the FC2500

- High sensitivity at VHF and UHF
- Battery operated
- Hand-held and fits in the pocket
- 0.1Hz resolution on 10MHz range
- Measures frequency and period
- Data hold
- Relative measurement feature
- Records min., max. and average readings
- Auto power down
- High-contrast 13mm, 8-digit LCD
- Precision time-base
- Optional antenna for checking tx output



Use this coupon to order your FC2500

Please send me FC2500 2.5GHz frequency meter at the fully inclusive special offer price of **£99** each – fully inclusive, plus AT20 Tx measurement antenna at £6.95 inclusive.

Name

Company (if any)

Address

Phone number/fax

Total amount

£.....

Make cheques payable to Vann Draper Electronics Ltd
Or, please debit my Master, Visa or Access card.

Card type (Access/Visa)

Card No

Expiry date

Please mail this coupon to Vann Draper Electronics, together with payment. Alternatively fax credit card details with order on 0116 2773945 or telephone on 0116 2771400. Address orders and all correspondence relating to this order to Vann Draper Electronics at Unit 5, Premier Works, Canal Street, South Wigston, Leicester LE18 2PL.

*Overseas readers can also obtain this discount but details vary according to country. Please ring, write or fax to Vann Draper Electronics.

ANCHOR SUPPLIES Ltd



The Cattle Market Depot
Nottingham NG2 3GY, UK

Telephone: +44 (0115) 986 4902/
+44 (0115) 986 4041 24hr answerphone

Fax: +44 (0115) 986 4667



ONCE IN A LIFETIME OFFER MANUFACTURERS SURPLUS OSCILLOSCOPES

Every one is NEW and BOXED and comes complete with Probes, leads and Manuals

Note: We can't advertise the makers/distributors name but be assured it is one of the UK's Leading Electronics Companies

DSM 3850A Hand held Digital storage Oscilloscope

50MS/sec, 8 bit resolution. 2 channels
5" LCD display Built-in RS232 port
Horizontal and Vertical Cursors
Built-in 4 digit Digital Multimeter featuring
AC/DC Volts/Current. Resistance. Conductivity. Capacitance
Frequency, Data Logger
Internal battery/ext DC operation (7.5-9V DC @ 300mA)
Size only: 50mm x 235mm x 153mm Weight only 11.1kg
Complete with Soft Carry Case
VERY LIMITED QUANTITY.
ONLY £399+£9.95 UK del+vat



DTV 100 3 channel 8 trace 100MHz Oscilloscope

DC-100MHz (-3db) bandwidth
Twin timebases with Delay
Size: 146mm x 360mm x 384mm Weight 10kg
Including Probes, Leads, Manual
VERY LIMITED QUANTITY.
ONLY £399+£9.95 UK del+vat

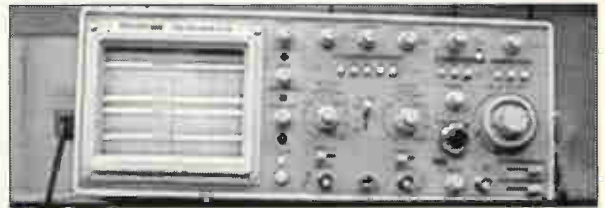

DTS 40 40MHz Dual channel Digital storage Oscilloscope

On Screen Readout with Cursors. DC-40MHz (-3db) Bandwidth
20MS/sec max Digital sample rate giving an effective 4MHz B/W
Size: 145mm x 357mm x 445mm Weight 10.5kg
Including Probes, Leads and Manual
VERY LIMITED QUANTITY.
ONLY £399+£9.95 UK del+vat



DTA 20/DTA 40...20/40 MHz Twin channel 4 trace Oscilloscope

Size: 140mm x 335mm x 375mm Weight 7.3kg
Including Probes, Leads and Manual
VERY LIMITED QUANTITY.
DTA 20 ONLY £225+£9.95 UK del+vat
DTA 40 ONLY £299+£9.95 UK del+vat



**NOTE: All Surplus Equipment is Unconditionally Guaranteed for 30 Days
OPEN 6 DAYS A WEEK**

Mon-Fri 9am-6pm Sat 8am-4pm

**NO APPOINTMENTS NEEDED. CALLERS ALWAYS WELCOME
NATIONAL AND INTERNATIONAL MAIL ORDER A SPECIALITY
VISIT OUR NEW WEB SITE**

**<http://www.anchor-supplies.ltd.uk>
e-mail sales@anchor-supplies.ltd.uk**

Please note: Requests for catalogues MUST be accompanied by a first class SAE



SMART CARD READER/PROGRAMMER



Extremely versatile unit to enable the user to Read and Write to all types of Smart Card. A must for the serious development engineer.

Requires an IBM PC and a power supply between 12-18 volts.

Supplied with all operating software and 'useful' data on various subjects relating to Smart Cards.

• £79.95

UNIVERSAL PIC PROGRAMMER

Runs on IBM PC, plugs into centronics printer lead and requires 12-18 volt power supply.

Powerful menu-driven software to Read, Write, Copy and Edit PIC 16C54, 55, 56, 57, 58A 61, 64, 65, 71, 74, 84, 620, 621, 622 & Memory Chip 24C01 thru to 24LC65.

Supplied with operating software and 12 months parts and labour guarantee.

• £69.95



GAL/PAL PROGRAMMER



- Programs 16V8, 16V8A, 20V8, 20V8A, 20V8Z.
- Works on IBM PC compatible, laptops, Notebooks etc.
- Plugs in Centronics port.
- Easy to use software.
- Supplied with PLAN Logic compiler software.
- Complete with examples, connection lead, PSU and user manual.

• £89.95

PICICE II



OSC2 output, RTCC Input
On board 4 channel A/D for PIC16C71 with A3 ref or VCC ref
Analogue to Digital conversion 17us.
Top quality components used throughout.
Complete package consists of:-
PIC software for 16C54-55-56-57-71-84, PIC ICE hardware, leads and headers to connect to target board, ASM examples and Circuit Schematics for hardware projects.

• £99.95

MEGAPROM II



- Programs from 2k to 8 Meg
- Programming voltage from 12-25 volt covering all types of Eprom, EEprom and Flash memory.
- Supplied with operating software and 12 month guarantee.

• £89.95

CROWNHILL ASSOCIATES LIMITED
THE OLD BAKERY
54 NEW BARN ROAD
ELY
CAMBS CB7 4PW
Tel: 01353 666709
Fax: 01353 666710

MASTERCARD
VISA
SWITCH
accepted

Visit our WEB site at
<http://crownhill.cambs.net>

CIRCLE NO. 127 ON REPLY CARD

NEW

Radio Receiver Trainer

An Invaluable Learning and Design Tool for all Experimenters

NEW

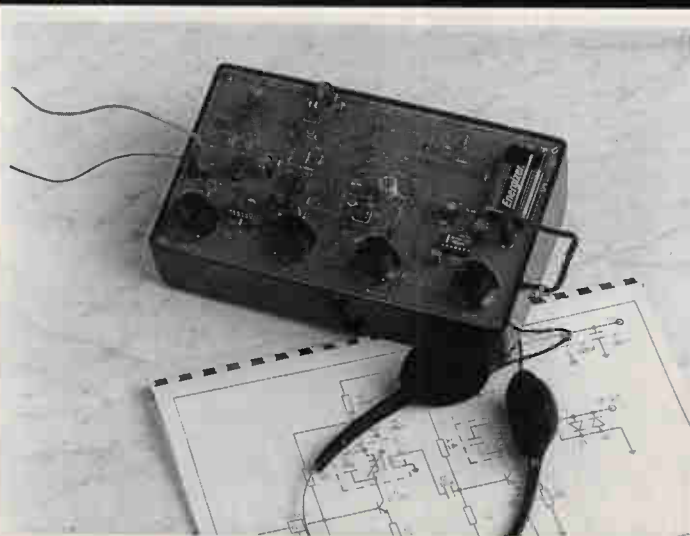

The manual contains complete schematics and theory of operation of all the building blocks. Use this trainer to receive frequencies from 500KHz to 110MHz!

A set of proven alternate building block designs are included in the manual for you to get started with your own designs. There is no need to get your complete receiver design working all at once. Build and test each block one at a time.

The Radio Receiver Trainer contains nine receiver building blocks and a comprehensive training manual.

Simply connect the building blocks to build AM, SW, Superhet and Direct Conversion receivers. Decode SSB, CW & FM! Use proven building blocks to develop and test your own designs.

Full technical support and advice given.

Pricing: Complete £129.00
Kit £89.00
(Kit excludes case & headphones)

P&P is £5 (UK), £8 (EC), £12 (World)
Add 17.5% Vat to Total Price

Building Blocks: RF Input Tuner
RF Oscillator
Mixer
IF Filter
IF Amplifier
AM Detector
Beat Frequency Oscillator
Audio Filter
Audio Amplifier

Mail Order To: Pyramid Electronics Ltd.

204 Ferndale Road, Brixton, London SW9 8AG

Phone (0171) 738-4044

Fax (0171) 274-7997

Out of office ordering by answering machine.



Seeing through noise II

Patrick May extends his new noise theory to deal with surface diffusion as a $1/f$ noise source in thin metal films and explains how this work leads to a better understanding of low-frequency noise in thin-film resistors and semiconductors.

I show here that the impulses due to the emission of electrons from the surface of a continuous thin film of metal into the electron cloud at the surface produce a diffusion current in the metal. For the first time, I show that this effect in thin films equates to $1/f$ noise.

My mathematical analysis reveals that this gives rise to a time varying component of electron carrier density in a layer near the surface; the square of the Fourier transform of this time function has a $1/f$ characteristic which manifests itself as $1/f$ noise.

Calculations of this noise are made using a modified form of the Richardson-Dushman equation to estimate the rate of electron emission from the surface. These show that the estimated noise in copper thin films is equal to that measured and reported by others in the field. Also, there is good agreement with the strong temperature dependence, observed during experiments.

Current thinking on $1/f$ noise

In semiconductor devices, holes and electrons recombine in the surface under the auspices of the 'fast surface' states. It has been shown that the impulses produced by the ejecting carriers give rise to a diffusion current which produces a time varying component in carrier density in a layer near the surface¹.

It is assumed that a similar phenomenon occurs in metals. But in the case of metals it is the thermionic emission of electrons from the bulk to the 'electron cloud' at the surface which provides the impulses. The analysis for a semiconductor strip has

already been presented^{1,2}. A similar analysis for a thin metal film is presented here. Next, I present a study of the thermal emission of electrons from the surface of a metal into the 'electron cloud' surrounding the surface.

Electron emission

Figure 1 shows a thin film resistor on a substrate. The rate of electron emission per unit area from the bulk into the 'electron cloud' covering the surface of the metal is derived from the Richardson-Dushman³ equation,

$$J = AT^2 e^{-\frac{\phi}{kT}} \quad \text{Am}^{-2} \quad (1)$$

where J is the current density, A a constant for metals, T the absolute temperature, k Boltzman's constant and ϕ the work function of the metal.

The current is due to electrons having an energy greater than the work function. The energy of electrons emitted from the surface into the 'electron cloud' is much lower. According to the image theory, there is no potential barrier at the surface, but the image theory does not hold for short, atomic, distances from the surface. If there is a small barrier potential ψ at the surface of the metal, equation 1 must be modified³ as,

$$J = AT^2 \left[e^{-\frac{\phi}{kT}} + \frac{1}{4} e^{-\frac{2\psi}{kT}} + \frac{1}{9} e^{-\frac{3\psi}{kT}} \right] \text{Am}^{-2} \quad (2)$$

Electron emission per unit area, v , is given by J/e where e is the electron charge.

Metal thin-film $1/f$ noise - a thermal problem

One of the earliest manifestations of $1/f$ noise was in directly-heated thermionic valves, these had tungsten filaments which also formed the cathode. In the model I propose here, I show that $1/f$ noise in thin metal films is due to thermionic emission from the surface of the metal.

Aspects of the analysis are based on thermionic valve technology dating back to the early part of this century.

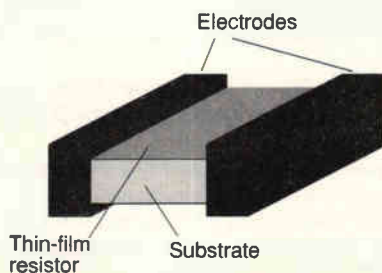

A practical application of this work is in precision thin metal film resistor design. The $1/f$ noise in the film can be estimated over a wide range of temperatures using constants that are readily available in physics text books.

The ideas presented here reinforce the surface-diffusion theory of $1/f$ noise in semiconductors.^{1,2,14} They can be used to study 'fast surface states' in semiconductor devices, enabling optimisation of low-frequency noise performance.

The constants involved in the calculations are readily available in physics textbooks. There is no credible alternative model that predicts $1/f$ noise in thin metal films and no attempt has been made to explain its strong temperature dependence.¹¹



Picture courtesy Alexander S Popov Museum, St Petersburg

Fig. 1. In a thin-film resistor, electrons being emitted into the electron cloud due to current flow are a cause of low-frequency noise.

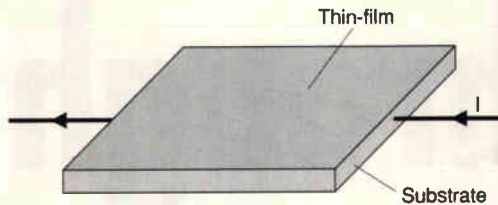

Diffusion current

The emission of electrons from the bulk gives rise to a diffusion current in the metal. The analysis appertaining to the diffusion process is based on the continuity equation,

$$\nabla \cdot J = -\frac{\partial \rho}{\partial t} \tag{3}$$

where J is the current density and ρ is the charge density.

The metal film can be visualised as a strip of metal on a substrate having a thickness less than 1µm, Fig. 1. Thermal emission of electrons from the main face produces a diffusion current in one dimension perpendicular to the surface. You can assume that the emission is evenly distributed but uncorrelated.

If current density, J , is assumed to be a diffusion n type current, equation 3 for currents in the x -direction perpendicular to the main faces becomes,

$$\frac{dn}{dt} = D_n \frac{d^2n}{dx^2} \tag{4}$$

where $n=n(t,x)$ is electron density and D_n the diffusion constant.

The solution to equation 4 for an impulse of unit strength is,

$$n = \frac{1}{(\pi D_n t)^{1/2}} \exp\left[-\left(\frac{x^2}{4D_n t}\right)\right] \tag{5}$$

This equation expresses the probability of the absence of an electron at any point in the bulk after the ejection of an electron from the surface. For $t>0$ the boundary condition below must prevail,

$$\int_0^\infty n dx = 1$$

The square of the modulus of the Fourier transform of n is,

$$|N(\omega, x)|^2 = \frac{1}{D_n} \cdot \frac{1}{\omega} \exp\left[-\sqrt{\frac{2}{D_n}} \omega\right] x \tag{6}$$

Note that expression 6 gives the amplitude of the square of the fluctuating component of n^2 – the carrier density squared – in the frequency range ω to $\omega+\omega\delta$. The amplitude of these fluctuations are only significant for the condition,

$$x \sqrt{\frac{2\omega}{D_n}} < 1 \tag{7}$$

when the expression 6 becomes,

$$|N(\omega, x)|^2 \cong \frac{1}{D_n \omega} \tag{8}$$

It is evident from equation 7 that there is a cut off frequency for a given thickness of film. The time varying component of n^2 is many orders of magnitude lower than n^2 in the sample. It depends on the spectral expression given in equation 8, the rate of emission of electrons per unit area expressed in 2 and the thickness of the sample, L . It is given by,

$$S_n(\omega) = \frac{J}{eLD_n\omega} \tag{9}$$

This can be expressed in hertz as,

$$S_n(f) = \frac{J}{eLD_n f} \tag{10}$$

If $S_v(f)$ is the power spectrum when the mean square of the voltage across the sample is, \bar{V}^2 .

$$\frac{S_v(f)}{\bar{V}^2} = \frac{S_n(f)}{n^2} = \frac{1}{n^2} \cdot \frac{J}{eLDf} \tag{11}$$

Estimating noise

The expression for $1/f$ noise in equation 11 shows a strong temperature dependence. The quotient J/D gives its temperature dependence. By making ψ in the expression for J , in equation 2, equal to 0.01eV, the temperature dependence of,

$$\frac{S_v(f)}{\bar{V}^2}$$

expressed in equation 11 follows that obtained experimentally for copper thin films⁴. The experimental value of,

$$\frac{S_v(f)}{\bar{V}^2}$$

has been measured⁵ for a sample of thickness $L=10^{-7}$ m at 330K as $6.4 \times 10^{-16} \text{Hz}^{-1}$ at 10Hz. This was repeated independently and confirmed⁴.

The evaluation of,

$$\frac{S_v(f)}{\bar{V}^2}$$

from equation 11 for copper is obtained from the following physical constants: n is the effective number of free electrons, $m^{-3}=2.5 \times 10^{27} m^{-3}$ (from reference 9), $e=1.6 \times 10^{-19} C$,

$$J = 0.65 \times 10^6 T^2 \left[e^{\frac{-\psi}{kT}} + \frac{1}{4} e^{\frac{-2\psi}{kT}} + \frac{1}{9} e^{\frac{-3\psi}{kT}} \right] A m^{-2}$$

and $D=0.8 \times 10^{-4} m^2 s^{-1}$. For $T=330K$, $\psi=0.01eV$ and $L=10^{-7}m$, the calculated value is $7.2 \times 10^{-16} \text{Hz}^{-1}$ at 10Hz. The result is very close to the value obtained experimentally by Voss.⁵ This can also be shown to be true for silver films.

In summary

The basis of the diffusion current analysis lies in the equation for an impulse of unit strength, equation 5. This equation only applies in practice when a very large number of electrons is ejected – or injected – evenly from a plane surface. This insures a one-dimensional diffusion current in the bulk of the thin film perpendicular to the surface.

The absence of an electron per unit area in the bulk as a result of the ejection, or injection, of an electron from the surface is described by a density probability function. This function applies to every single ejected or injected electron. This means that in the transient case, when all the N electrons per unit area are ejected, the solution is given by the product of N and the expression in equation 5.

The result agrees with that of the Haynes-Shockley experiment⁶. Note that equation 5 holds when the electrons are ejected or injected evenly from a plane surface irrespective of whether they are ejected simultaneously as a transient or whether they are ejected continuously and randomly in time as a steady state process. This is the case in the diffusion-current analysis, and leads to the application of Carson's theorem⁷.

The expression in equation 5 fulfils the necessary condition of absolute integrability⁷. This results in equation 6 leading to the conclusion in equation 11.

From the proposed model it is clear that the origin of $1/f$ noise – like Johnson noise – is the kinetic energy of the electron carriers. Their kinetic energy is responsible for both the thermal emission at the surface and the consequent diffusion current in the bulk which is accompanied by a fluctuation in

electron concentration.

Under equilibrium conditions, the diffusion current is opposed by an equal drift current from the 'electron cloud' resulting in a zero average current. The average carrier concentration is that normally quoted for the metal but it fluctuates about this value.

The fluctuations are not affected by the bias drift current because it makes a negligible contribution to the electron thermal velocities responsible for the diffusion process. The fluctuations involve the whole of the carrier population under equilibrium conditions. Hence the argument by Weissman⁸, that the 'tied individual electrons must remain in the sample' for periods well in excess of the actual time they spend in transit does not apply to my model.

On the other hand, Weissman's argument does invalidate some theories on 1/f noise; it shows that the N term - total carrier population - in the empirical Hooge formula⁹ is unacceptable. Accordingly, equation 11 does not contain N. But it shows that 1/f noise is inversely proportional to the thickness of the film as has been demonstrated experimentally^{8,10}.

Hooge's formula⁹ does not predict temperature dependence. Nor does it allow for the wide scatter in experimental results.¹¹⁻¹³ My model predicts the noise level and is the only proposed model to predict temperature dependence.

The wide scatter in experimental results is also accounted for; thermionic emission is very sensitive to surface treatment. There is, however, a component of 1/f noise in continuous thin films which is not temperature dependent¹³ and may be associated with the substrate.

My thanks to University of Exeter's School of Engineering for providing library facilities and to Drs MR Belmont, J Baker and MK Horwood for their encouragement and advice. ■

References

1. May, EJP, 'On the Origin of 1/f Noise', *Int. J. Electron.*, Vol. 65, No 4, pp. 805-807, 1988.
2. May, EJP, 'On the Origin of 1/f Noise in MOS Transistors', *ESSDERC 1988, J. De Physique*, pp. 161-163, Sept 1988.
3. Kittel, C, 'Introduction to Solid State Physics', John Wiley and Son, New York, 3rd Edition, pp. 246-247, 1967.
4. Eberhard, JW and Horn, PM, 'Temperature Dependence of 1/f Noise in Silver and Copper', *Phys. Rev. Lett.*, Vol. 39, pp. 643-646, 1977.
5. Voss, RF, and Clarke, J, 'Flicker (1/f) Noise: Equilibrium Temperature and Resistance Fluctuations', *Phys. Review B*, Vol. 13, No 2, pp. 559-560, 1976.
6. Sze, SM, 'Physics of Semiconductor Devices', Wiley-Interscience, p.70, 1969.
7. van der Ziel, A, 'Flicker Noise in Electronic Devices', *Advances in Elect. and Phys.*, 49, pp. 229-30, 1979.
8. Weissman, MB, '1/f Noise and other Slow Nonexponential Kinetics in Condensed Matter', *Rev. of Mod. Phys.*, Vol 60, pp. 539-40 & 559, 1988.
9. Hooge, FN, 'The Relation between 1/f Noise and Number of Electrons', *Physica B*, 162, p. 347, 1990.
10. Zimmerman, NM, Scofield, JH, Mantese, JV and Webb WW, 'Volume Versus Surface Origin of 1/f Noise in Metals', *Phys. Rev.*, B34, p. 773, 1986.
11. Buckingham, MJ, 'Noise in Electronic Devices and Systems', Ellis Horwood, Chichester, pp. 161,173 and 175,1983
12. Dutta, P, Eberhard, JW and Horn, PM, '1/f Noise in Copper Whiskers', *Solid State Comm.* 21, pp. 679-681, 1977.
13. Dutta, P, Eberhard, JW and Horn, PM, '1/f Noise in Metal Films: The Role of the Substrate', *Solid State Comm.* 27, pp. 1389-1391, 1978.
14. May, EJP, 'Seeing through noise', *Electronics World*, Vol. 103, No 1739, Nov 1997.

M&B RADIO (LEEDS)

THE NORTH'S LEADING USED TEST EQUIPMENT DEALER

OSCILLOSCOPES

HP 3411D 500 MHz digitizing scope (colour display)	£2350
HP 3411D 100 MHz 4 channel scope (colour display)	£1750
HP 17420B 300 MHz 2 channel digitizing (27 channels logic state triggering)	£1750
HP 17420 100 MHz 2 channel	£1295
TEKTRONIX 2465A/2465 100 MHz 4 channel (digital multimeter, GP-I/O opt 09)	£2400
TEKTRONIX 2230 100 MHz 2 channel digital storage	£1750
TEKTRONIX 2240 60 MHz 2 channel digital storage	£1500
TEKTRONIX 2445 150 MHz 4 channel	£1400
TEKTRONIX 2445 150 MHz 2 channel opt 05	£1500
TEKTRONIX 2246 100 MHz 4 channel	£1200
TEKTRONIX 7903/7A/2424/27B/2400 100 MHz 4 channel	£450
TEKTRONIX 7903/7A/18A/27B/51A 4 channel	£250
TEKTRONIX 475A 250 MHz 2 channel	£600
TEKTRONIX 475 200 MHz 2 channel	from £400
TEKTRONIX 444 100 MHz 2 channel	£450
TEKTRONIX 465B 100 MHz 2 channel opt 05	£500
TEKTRONIX 465 100 MHz 2 channel	from £350
TEKTRONIX 434 25 MHz 2 channel storage	£300
TEKTRONIX 2215 60 MHz 2 channel	£225
TEKTRONIX 2225 50 MHz 2 channel	£450
TEKTRONIX 2235 100 MHz 2 channel	£700
TEKTRONIX TM 504 4 slot mainframe	£1150
PHILIPS PM 3217 30 MHz 2 channel	£325
PHILIPS PM 3055 50 MHz 2 channel	£425
PHILIPS PM 3057 50 MHz 2 channel	£400
PHILIPS PM 3264 50 MHz 4 channel	£300
PHILIPS PM 3263X 100 MHz delay/elements	£400
PHILIPS PM 3310 60 MHz digital storage	£600
PHILIPS PM95 50 MHz scope/mer (BOXED NEW)	£500
IWATSU SS 6122 100 MHz 4 channel with cursors	£600
IWATSU SS 5710 60 MHz 4 channel	£400
IWATSU SS 5416A 60 MHz 2 channel	£250
HITACHI V190 100 MHz 4 channel with cursors	£245
HITACHI V134 10 MHz 4 channel digital storage	£1250
GOULD 420 20 MHz digital storage 2 channel 4 colour hardcopy	£400
GOULD 1401 20 MHz digital storage 2 channel	£195
GOULD OS100 20 MHz 2 channel	£160
GOULD OS4000 10 MHz digital storage 2 channel	£160

SPECTRUM ANALYSERS

TEKTRONIX 7P10 10 MHz (1 year cal & warranty)	£9000
TEKTRONIX 7L12 10 KHz-1800 MHz + mainframe	£1000
TEKTRONIX 7L13 L3 OPT 25 tracking gen. + mainframe	£1000
TAKEEDA RUKEN TR172 400 Hz-1800 MHz spectrum/network analyser	£8000
ANRITSU MS610A 10 KHz-2 GHz spectrum analyser	£2750
HP 8754A 4 MHz-1300 MHz network analyser	£2000
HP 6807A/813B network analyser 0.1-110 MHz	£400
HP 8590A 10 MHz-1.5 GHz spectrum	£4250
HP 8559B/182T 10 MHz-2 GHz	£3900
HP 1832A 0.02 Hz-25 KHz dual channel signal analyser	£1850
HP 3562A 64 units-100 KHz dynamic signal analyser (1 year cal & warranty)	£4000
HP 1407/8551B/8553B 10 KHz-110 MHz	£450
HP 1417/8551B/8553B 100 KHz-1250 MHz	£1700
HP 1417/8551B/8553A 10 MHz-18 GHz	£1500
MARCONI TP2370 30-100 MHz 10 MHz digital storage (as new)	£250
BRUEL & KJAER 2013 20 Hz-20 KHz audio	£750

SIGNAL GENERATORS

HP 8904A DC-500 KHz multifunction synthesizer	£2500
HP 1325A 1 MHz function generator	£1350
HP 1314A 0.001 Hz-19.99 MHz selective waveform monitor	£1400
HP 1386C 50 Hz-32.5 MHz function selective level meter	£1500
HP 6883D 2.3 GHz-13 GHz OPT 001/003 solid state generator (as new)	£2950
HP 8656A 10 KHz-990 MHz signal generator	£2500
HP 8640C/86431B/86403A	£600
HP 8620C/86230A 10-1300 MHz sweeper	£1000
HP 8620C/86230B 1.8 GHz-4.2 GHz sweeper	£1000
HP 8620C/86241A 3.3-6.5 GHz sweeper	£1000
HP 8620C/86242A 5.9-9 GHz sweeper	£1200
HP 8620C sweeper mainframes (as new)	£250
HP 8640B 500 KHz-512 MHz signal generator	£400
HP 8654B 10 Hz-500 MHz RF generator	£400
HP 3200B 10 MHz-500 MHz oscillator	£200

HP 3336B 10 Hz-21 MHz synthesizer/level meter	£600
HP 3312A 0.1 Hz-10 MHz function generator	£450
HP 3310B 0.0005 Hz-5 MHz function generator	£200
HP 8085B 0.3 Hz-20 MHz pulse generator	£275
TEKTRONIX 2901 time mark generator	£200
ADRE7 1000 300 KHz-1300 MHz signal generator	£1500
MARCONI TP2018 10 KHz-100 MHz signal generator	£1500
MARCONI TP2017 10 KHz-1024 MHz signal generator	£2000
MARCONI TP2018 80 KHz-520 MHz signal generator	£1000
MARCONI TP2017 71 10 MHz-120 MHz with synchronizer	£450
MARCONI TP2015 10 MHz-520 MHz	£300
MARCONI TP2008 10 KHz-510 MHz RF generator	£300
MARCONI TP2016 10 KHz-120 MHz (CS0) TP2016A	£295
MARCONI TP2016/2173 10 KHz-120 MHz with synchronizer	£400
WAVETEK 1000 520 MHz generator	£450
FARNELL PG520 10 Hz-520 MHz synthesized	£250
FARNELL S5G1000 100 KHz-1000 MHz synthesized	£1500
FLUKE 6011A 10 Hz-11 MHz synthesized signal generator	£1000
ROHDE & SCHWARTZ APM62 0.1 Hz-250 KHz LF gen. (new)	£2000
WILTRON 110D/S91 1 MHz-1500 MHz sweeper + log meter	£500
GIGA GR1101A 12 GHz-18 GHz pulse generator	£600
HP 4954A protocol analyser 10 KHz-135 MHz RF generators	£400
ADRE7 2210A 200 Hz-1 MHz synthesised source	£195
WAVETEK 193 20 MHz sweep modulation generator	£400
ADRE7 221 2 MHz synthesized function generator	£450
WAVETEK 193 0.002 Hz-2 MHz function generator	£175
SAYROSA MA 30 10 Hz-100 KHz	£175

TEST EQUIPMENT	
ELECTRO-METRICS EPC-25 MKIII interference analyser 10 KHz-1 GHz	£995
BALL EFFRATRON MHT-18 Rubidium frequency standard	£600
WAVETEK VGI8A log lin RF peak power meter DC-26 GHz	£1000
ANRITSU MS665A 2 GHz RF detector	£950
GRUNDIG VG1800 video generator	£300
TEKTRONIX 1141/SPG1/77SG11 pal video generator	£1500
TEKTRONIX 145 pal gen. lock test signal generator	£100
TEKTRONIX 521A vector scope	£450
TEKTRONIX 1502 TDR cable tester	£400
SCHLUMBERGER 7702 digital transmission analyser (new)	£500
SCHLUMBERGER AP405 3 tone generator/modulator	£150
MARCONI TP2385 mod meter 50 MHz-2.3 GHz	£2000
MARCONI TP2387I data communications monitor	£900
MARCONI 6460/6421 10 MHz-1.24 GHz RF power meter	£695
MARCONI 6950/6910 10 MHz-20 GHz RF power meter	£800
MARCONI 6593A VSWR indicator	£250
MARCONI 6460/6421 10 MHz-1.24 GHz RF power meter	£250
MARCONI TP2306 portable interface unit	£100
MARCONI TP2437A 10 Hz-560 MHz frequency counter	£2000
HP 4124A/474A 10 Hz-10 GHz RF power meter	£1750
HP 8508A vector voltmeter	£3250
HP 8970A noise figure meter	£3500
HP 8507A universal systems counter	£2750
HP 5342A 500 MHz-18 GHz microwave frequency meter	from £900
HP 5334A universal systems counter	£750
HP 5345A 1.5 MHz-26.5 GHz counter/S355A/S356A+B sensors	£2000
HP 5328A universal frequency counter + dvm	£1000
HP 4158B/481A/4844A/1700A 10 MHz-18 GHz (new/HP case/manuals)	£1000
HP 4158B/481A 10 MHz-18 GHz RF power meter	£800
HP 415A/4812A/1 100 KHz-4.2 GHz RF power meter	£250
HP 4124A/474A 10 Hz-10 GHz RF power meter	£275
HP 416A RF power meter	£400
HP 8477A RF power meter calibrator	£225
FLUKE 5205A precision power amp	£750
FLUKE 5381C 15 Hz-50 KHz selective voltmeters as new	£400
FLUKE 533A absorption analyser	£295
HP 1171B down converter	£250
HP 59401A bus system analyser	£200
HP 408E 10 Hz-10 GHz AC voltmeter	£125
HP 3446A AC digital averaging multimeter	£200
HP 3437A 3.5 digit high speed system voltmeter	£200

HP 3455A 6.5 digit bench multimeter	£495
HP 3468A 5.5 digit multimeter/auto cal (LCD)	£400
HP 5004A signature analyser	£150
HP 5005A signature multimeter	£200
HP 6448A DC power supply 0-600V/0-1.5 amp	£750
HP 6253A dual DC power supply 2x 0-20V/0-3 amp	£250
HP 6815A power supply/amplifier -20v to +20V/0-2 amp	£350
HP 11645B 150 MHz-18 GHz modulator	£500
HP 11582A attenuator set DC-18 GHz	£195
HP 355C RF step attenuators 0-12 dB DC-1 GHz (NEW)	£195
HP 355D RF step attenuators 0-120 dB DC-1 GHz (NEW)	£195
BIRD 43 RF wattmeters from 695 (as new with case and 6 inserts)	£170
BIRD 8323 30 db coaxial attenuator 100V	£200
BRADLEY 192 oscilloscope calibrator	£500
KEMO DPI 1 Hz-100 KHz phase meter (new)	£150
WAYNE KERR CT48 LCR meter battery portable	£75
WAYNE KERR 4225 LCR meter	£400
AVO 215-L/2 AC/DC breakdown/ionisation tester	£400
FARNELL RB1030/35 electronic load	£400
FARNELL PDD3503 dual power supply 0-35v 2 amp	£250
FARNELL TSV70 power supply 0-70v 0-10 amp	£300
FARNELL AP60-50 power supply 0-60 volt 0-50 amp	£300
SIEMENS O2108 200 KHz-30 MHz level meter	£350
SIEMENS W2108 200 KHz-30 MHz level oscillator	£350
NARDA 3041-20 500 MHz (1000 MHz) directional coupler 20db	£125
NARDA 3044B-20 3.7 GHz-8.3 GHz 20db directional coupler	£150
NARDA 60132 solid state amplifier 8 Hz-12 GHz	£100
SAYROSA APHM 1.5 MHz-2 GHz automatic modulation meters	£175
REDFON RA500 100 Hz-30 MHz receivers	£400
RACAL RA17 30 MHz valve receivers	£150
RACAL RA1218 30 MHz receivers	£350
RACAL RA1772 30 MHz receivers	£650
RACAL 2309/219/229/230 20 MHz-1000 MHz receivers	£1000
RACAL RA1779/MA 1107 30 MHz receiver	£1500
TEKTRONIX 1502 TDR cable tester	£400
SCHLUMBERGER 7702 digital transmission analyser (new)	£500
SCHLUMBERGER AP405 3 tone generator/modulator	£150
MARCONI TP2385 mod meter 50 MHz-2.3 GHz	£2000
MARCONI TP2387I data communications monitor	£900
MARCONI 6460/6421 10 MHz-1.24 GHz RF power meter	£695
MARCONI 6950/6910 10 MHz-20 GHz RF power meter	£800
MARCONI 6593A VSWR indicator	£250
MARCONI 6460/6421 10 MHz-1.24 GHz RF power meter	£250
MARCONI TP2306 portable interface unit	£100
MARCONI TP2437A 10 Hz-560 MHz frequency counter	£2000
HP 4124A/474A 10 Hz-10 GHz RF power meter	£1750
HP 8508A vector voltmeter	£3250
HP 8970A noise figure meter	£3500
HP 8507A universal systems counter	£2750
HP 5342A 500 MHz-18 GHz microwave frequency meter	from £900
HP 5334A universal systems counter	£750
HP 5345A 1.5 MHz-26.5 GHz counter/S355A/S356A+B sensors	£2000
HP 5328A universal frequency counter + dvm	£1000
HP 4158B/481A/4844A/1700A 10 MHz-18 GHz (new/HP case/manuals)	£1000
HP 4158B/481A 10 MHz-18 GHz RF power meter	£800
HP 415A/4812A/1 100 KHz-4.2 GHz RF power meter	£250
HP 4124A/474A 10 Hz-10 GHz RF power meter	£275
HP 416A RF power meter	£400
HP 8477A RF power meter calibrator	£225
FLUKE 5205A precision power amp	£750
FLUKE 5381C 15 Hz-50 KHz selective voltmeters as new	£400
FLUKE 533A absorption analyser	£295
HP 1171B down converter	£250
HP 59401A bus system analyser	£200
HP 408E 10 Hz-10 GHz AC voltmeter	£125
HP 3446A AC digital averaging multimeter	£200
HP 3437A 3.5 digit high speed system voltmeter	£200

SPECIAL OFFERS

FLUKE 8505A digital multimeter	£750
FLUKE 8506A thermal RMS multimeter	£1000
RF MICROSYSTEMS INC. AN/TRC-176 VHF/UHF K&L filters	£450
FLUKE 5200A AC calibrator	£2000
FLUKE 5205A precision power amp	£750
FLUKE 5440B direct volt calibrator	£4950
RF MICROSYSTEMS INC. AN/TRC-176 VHF/UHF K&L filters	£450
SPECIAL OFFERS	
FLUKE 25 high spec digital multimeters with manual & probes (as new)	£70
SPHITS 3" dia. dimeters	£65
SIEMENS PORM82 portable LCD radiation meters (new)	£50

ALL PRICES PLUS VAT AND CARRIAGE • ALL EQUIPMENT SUPPLIED WITH 30 DAYS WARRANTY

86 Bishopgate Street, Leeds LS1 4BB
Tel: (0113) 2435649 Fax: (0113) 2426881

Visit our Web site
<http://www.mb-radio.co.uk>
e-mail info@mb-radio.co.uk



Cooke International

Second User ELECTRONIC TEST & MEASURING INSTRUMENTS

Tel: (+44) 01243 545111/2 Fax: (+44) 01243 542457

ANALYSERS & ACCESSORIES

- GORE FBOHAQB025.0. Flexible 3.5mm Test Port Cable Set. (In Box) (1) £250.00
- H.P. 141T. Spectrum Analyzer Display (1) £300.00
- H.P. 8413A. Phase Gain Indicator. (To Suit 8410 Analyzer) (1) £200.00
- H.P. 8501A. Storage - Normalizer. (To Suit 8505A Analyzer) (1) £200.00
- H.P. 8552A. IF Section. (Plug In for 141T) (2) £250.00
- H.P. 8552B. IF Section. (Plug In for 141T) (2) £300.00
- H.P. 8555A. RF Section. 10MHz-18GHz. (Plug In for 141T) (1) £750.00
- H.P. 8555B. RF Section. 20Hz-300kHz. (Plug In for 141T) (1) £250.00
- H.P. 8558B. Spectrum Analyzer. 100kHz-1.5GHz. 11.1P. 1821 Display (1) £1750.00
- H.P. 8903B. Audio Analyzer. 10Hz-20kHz. Measure Distortion: Sinad, (signal to noise), True RMS Vol, 20dB/Dec Filter
- Frequency, fitted 100Hz to 10kHz. (To Suit H.P. 8903B Interface) (1) £2275.00
- H.P. 85131-60012. True RMS 3.5mm Test Port Cable (1) £120.00
- H.P. 85131-60013. True RMS 3.5mm Test Port Cable (1) £120.00

OSCILLOSCOPES & ACCESSORIES

- Gould. OS3000A. 100MHz Portable Dual Trace Scope with Delay (1) £80.00
- H.P. 1725A. DC-275MHz. Portable Dual Trace Scope with Delay etc. (1) £425.00
- Hitachi. V203F. DC-20MHz. Portable Dual Trace Scope with Delay (1) £100.00
- Hitachi. V212. DC-20MHz. Portable Dual Trace Scope (2) £100.00
- Kikusui. COS5021. DC-20MHz. Portable Dual Trace Scope with Delay (1) £100.00
- Philips. PM3234. DC-10MHz. Portable Dual Beam Variable Persistence; Storage Scope, True Dual Beam Operation, Mains or 24 Volt DC I/P
- Philips. PM9355. A.C. Current Probe & Amplifier. 12Hz-70MHz (1) £200.00
- Tek. S-2. Sampling Head Unit. DC-4.6GHz. (3) £175.00
- Tek. 7A13. Differential Comparator Amplifier. DC-105MHz (1) £150.00
- Tek. 7A15AN. DC-80MHz. Single Trace Amplifier. 5mV-10 Volt (1) £60.00
- Tek. 7A16A. DC-225MHz. Single Trace Amplifier. 5mV-5 Volt (1) £70.00
- Tek. 7A18. DC-75MHz. Dual Trace Amplifier. 5mV-5 Volt (1) £90.00
- Tek. 7A18A. DC-75MHz. Dual Trace Amplifier. 5mV-5 Volt (1) £80.00
- Tek. 7A18N. DC-75MHz. Dual Trace Amplifier. 5mV-5 Volt (1) £45.00
- Tek. 7A19. DC-600MHz. Single Trace Amplifier (1) £150.00
- Tek. 7A22. DC-1MHz. Differential Amplifier. 10mV-10 Volt (2) £100.00
- Tek. 7A26. DC-200MHz. Dual Trace Amplifier. 5mV-5 Volt (1) £95.00
- Tek. 7B52. Dual Time Base. 5ns-5s. Triggering to 100MHz (1) £90.00
- Tek. 7B53A. Dual Time Base. 5ns-5s. Triggering to 100MHz (4) £60.00
- Tek. 7B70. Time Base. 2ns-5s. Triggering to 200MHz (2) £70.00
- Tek. 7B80. Delayed Time Base. Triggering to 400MHz (1) £40.00
- Tek. 7B85. Delaying Time Base. Triggering to 400MHz (3) £40.00
- Tek. 7D11. Digital Delay Unit. 100ns-1s (1) £85.00
- Tek. 7D15. 225MHz. Counter. 100ns-1s (14) £95.00
- Tek. 7S11. Sampling Amplifier. 100MHz (5) £200.00
- Tek. 7T11. Sampling Sweep Trigger Base (2) £250.00
- Tek. 465. DC-100MHz. Portable Dual Trace Scope with Delay etc. (1) £375.00
- Tek. 7403N. DC-60MHz. Mainframe. 3 Slot (1) £95.00
- Tek. 7613. DC-100MHz. Variable Storage Mainframe, with Read-Out (1) £300.00
- Tek. 7623A. DC-100MHz. Storage Mainframe, with Read-Out. (Sub Std) (1) £250.00
- Tek. 7704A. DC-200MHz. Mainframe. 4 Slot (2) £280.00
- Tek. 7704A. DC-200MHz. Mainframe. 4 Slot, with Read-Out (2) £300.00

TEKTRONIX TM 500 SYSTEMS

- Tek. DC 504A. DC-100MHz. Counter/Timer. 5 Digit Display (1) £100.00
- Tek. DD 501. Digital Events Delay Unit. (10-99,999) (2) £30.00
- Tek. DL 502. Digital Latch. (16 Channel) (1) £10.00
- Tek. FG 507. Sweeping Function Generator. 0.002Hz-2MHz (1) £300.00
- Tek. LA 501. Logic Analyzer. (16 Channel) (1) £95.00
- Tek. PG 502. Pulse Generator. 10Hz-250MHz. 5 Volt O/P (2) £200.00
- Tek. SG 503. Levelled Sine Wave Generator. 250kHz-250MHz (1) £350.00
- Tek. TM 501. Mainframe Power Supply. 1 Slot (2) £100.00
- Tek. WR 501. Word Recognizer with Digital Delay (2) £45.00

POWER METERS, AF, RF, MICROWAVE

- B & K. 2425. Electronic AC Voltmeter. 0.5Hz-500kHz 1mV-300V (1) £100.00
- Bird. 67. Termaline Watt Meter. 30-500MHz. 0-500 Watt. 50 Ohm (1) £200.00
- Bird. 6104. Termaline Watt Meter. 25-512MHz. 0-60 Watt. 50 Ohm (1) £200.00
- H.P. P-486-A. Thermistor Mount. 12.4-18GHz. 100 Ohm 4mm Watt (1) £200.00
- H.P. 432A. RF Power Meter. (Analog) (1) £100.00
- H.P. 432A. RF Power Meter, with OPT. 002. Front & Rear. (Analog) (1) £200.00
- H.P. 435A. RF Power Meter. (Analog) (1) £120.00
- H.P. 436A. Digital RF Power Meter (1) £400.00
- H.P. 478A. Thermistor Mount. DC-10GHz. 0-30mW. (suit 432 etc.) (1) £100.00
- H.P. 3400A. True RMS Analog Voltmeter. 10Hz-10MHz. 50 Ohm (1) £80.00
- Levell. TM3A. AC Analog Microvoltmeter. 1Hz-3MHz. 5uV-500V. Battery (1) £40.00
- Marconi. 893B. AF Power Meter. 20Hz-35kHz. 300uW-10W. Sin Fil (1) £180.00
- Marconi. 6420. Power Head. 0.01-12.4GHz. 10m Watt. "N" Type (2) £100.00
- Marconi. 6421. Power Head. 0.01-12.4GHz. 100m Watt. "N" Type (1) £150.00
- Marconi. 6423. Power Head. 0.01-12.4GHz. 3 Watt. "N" Type (1) £300.00
- Marconi. 6427. Power Head. 18-26.5GHz. 10m Watt. WG-20 (1) £300.00
- Marconi. TF-2600A. Video Voltmeter. 1mV-100V. 10Hz-10MHz (1) £30.00
- Racal. 9302. Wide Band Level Meter. 30uV-316V. 5Hz-10MHz (1) £225.00
- Racal. 9302. True RMS RF Millivoltmeter. 10kHz-1.5GHz; 100uV-300 Volt, with Case & Accessories (2) £100.00
- W & G. SPM-3. Level Meter. 300Hz-612kHz. 0.1mV-10V. Battery Meter (1) £30.00

ATTENUATORS

- Flann. Programmable/Manual Rotary Attenuator. R-120. 0.5-15GHz (1) £50.00
- H.P. X-382A. Variable Attenuator. WG-16. 12.4GHz. 60dB (2) £50.00
- Narda. 757-3. Fixed "N" Type Attenuator. 1GHz. 60dB (1) £20.00
- Weinschel. 200-34. High Power Attenuator. DC-8GHz. 20W, 10dB (2) £45.00
- Weinschel. 200-34. High Power Attenuator. DC-8GHz. 20W, 20dB (2) £45.00

COUNTER-TIMERS

- H.P. 915A. Universal Counter-Timer. DC-100MHz. 8 Digit Display. (with OPT. 001 = High Stability (10MHz) Time Base) (1) £200.00
- H.P. 916A. Universal Counter-Timer. DC-100MHz. 8 Digit Display. (with OPT. 001 = High Stability (10MHz) Time Base) (1) £375.00
- H.P. 915A. Universal Counter-Timer. DC-500MHz. 11 Digit Display (1) £400.00
- Racal. 9514. Universal Counter-Timer. DC-50MHz. 7 Digit Display (2) £50.00
- Racal. 9514. Universal Counter-Timer. 100MHz. 9 Digit Display. GPIB (1) £150.00
- Racal. 9901. Universal Counter-Timer. DC-50MHz. 6 Digit Display (1) £50.00
- Racal. 9903. Universal Counter-Timer. DC-50MHz. 7 Digit Display (2) £50.00
- Racal. 9903. Universal Counter-Timer. DC-50MHz. With Battery Opt (1) £75.00
- Racal. 9906. Universal Counter-Timer. DC-200MHz. 8 Digit Display (1) £100.00
- Racal. 9906A. Universal Counter-Timer. DC-200MHz. 8 Digit Display (1) £150.00
- Racal. 9915. Frequency Meter. 10Hz-520MHz. 8 Digit Display (1) £80.00

GENERATORS

- Adret. 2230A. Synthesized Frequency Generator. 10Hz-1MHz (1) £125.00
- B & K. 1405. Noise Generator. 25Hz-1MHz. 0-2 Volt O/P (1) £200.00
- Eigen. 624A. Gaussian Noise Generator. 100Hz-10MHz (2) £20.00
- Farnell. LF2M. Sine Square Oscillator. 1Hz-1MHz. 1mV-12V. O/P (1) £25.00
- H.P. 315A. Function Generator/Frequency Synthesizer/Sweeper; 1Hz-1MHz. Sine, Square, Triangle, Negative & Positive Ramps; 11 Digit Resolution. HP-1B Programmable, 1mV-10 Volt 50 Ohm O/P (1) £1850.00
- H.P. 3722A. Noise Generator. 15Hz-50kHz. Binary/Gaussian O/P (2) £150.00
- H.P. 8002A. Pulse Generator. 0.3Hz-10MHz. 0-5 Volt O/P (1) £130.00
- H.P. 8620A. Sweep Oscillator Mainframe with BCD Interface. (2) £200.00
- H.P. 8621B. RF Plug In. 0.1-4.2GHz. (to suit 8620) (1) £450.00
- H.P. 8654A. AM/FM Signal Generator. 10MHz-100MHz. 10dBm to -13dBm (1) £550.00
- H.P. 8655A. AM/FM Synthesizer Signal Generator. 100kHz-990MHz. Direct Keyboard Entry, Store and Recall Sequence, Internal AM/FM Variable Modulation, HP-1B Programmable, +18dBm to +127dBm O/P. Reverse Power Protection to 50 Watt level. 6666 Transistor Decade Oscillator. 0.2Hz-1.22MHz (1) £1850.00
- Levell. TG200D. R.C. Oscillator. 1Hz-1MHz. Sine/Square. 600 Ohm (2) £20.00
- Levell. TG200DM. R.C. Oscillator. 1Hz-1MHz. Sine/Square. 600 Ohm (2) £40.00
- Levell. TG200DMP. R.C. Oscillator. 1Hz-1MHz. Sine/Square. 600 Ohm (1) £40.00
- Lyons. PG73N. Bipolar Pulse Gen. 50ns-1s. 0-10V O/P 50 Ohm (1) £30.00
- Magnet. 125A. Noise Generator. 0.01-1.5GHz. BNC. 28V I/P. N. O/P (1) £150.00
- Marconi. 2019. AM/FM Synthesized Signal Generator. 80kHz-1040MHz; Direct Keyboard Entry with Memory Facilities, Internal AM/FM Variable Modulation, GPIB Programmable, 100MHz O/P 2V e.m.f., Reverse Power Protection to 50 Watt (2) £1850.00
- Philips. PM936B. Pulse Generator. 1Hz-100MHz. 80mV-10 Volt. 50 Ohm (2) £250.00
- Philips. PM936B. Pulse Generator. 1Hz-125MHz. 0.2-5 Volt. 50 Ohm (1) £250.00
- Witek. 100. Wideband Synthesizer, Programmable. 100uHz-1MHz (1) £150.00

OFF ALL PRICES THIS MONTH ONLY!! HURRY!!!

ALL STOCK MUST GO

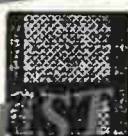

Operating & Service Manuals Catalogue Now Available on DISK

POWER SUPPLIES

- Advance. MG12-43. Modular Enclosed 12Volt 43Amp P.S.U. (1) £45.00
- Coutant. LA2002. 0-30 Volt 0-2 Amp. Metered, Variable P.S.U. (2) £50.00
- Farnell. C-1. 0.50 Volt 0-1 Amp. Metered, Variable P.S.U. (1) £55.00
- Farnell. L30-1. 0-30 Volt 0-1 Amp. Metered, Variable P.S.U. (1) £70.00
- Farnell. L30-2. 0-30 Volt 0-2 Amp. Metered, Variable P.S.U. (1) £300.00
- Farnell. L30-3. 0-30 Volt 0-3 Amp. Metered, Variable P.S.U. (3) £75.00
- Farnell. L30-4. 0-30 Volt 0-4 Amp. Metered, Variable P.S.U. (3) £120.00
- Farnell. L30-5. 0-30 Volt 0-5 Amp. Metered, Variable P.S.U. (2) £40.00
- Farnell. L30-6. 0-30 Volt 0-6 Amp. Metered, Variable P.S.U. (7) £50.00
- Farnell. L30-7. 0-30 Volt 0-7 Amp. Metered, Variable P.S.U. (7) £90.00
- Farnell. L30-8. 0-30 Volt 0-8 Amp. Metered, Variable P.S.U. (2) £100.00
- Farnell. L30-9. 0-30 Volt 0-9 Amp. Metered, Variable P.S.U. (1) £130.00
- Farnell. TOPS-3D. 4-6 Volt 4 Amp. -5 to +17 Volt 1 Amp. Triple O/P. Solar Tracking. Digital Display P.S.U. (2) £85.00
- Farnell. 19. Adjustable Power Supply System. IEEE 488 Interface Kingsley. EC IV. 0-15 Volt 0-20 Amp. Metered, Variable Bench P.S.U. (1) £175.00
- Marconi. TF2154. 0-30 Volt 0-1 Amp. 0-15 Volt 0-2 Amp. 0-7.5 Volt 0-4 Amp. Fixed 5 Volt 4 Amp. Metered, Variable P.S.U. (3) £50.00
- Marconi. TF2154-1. 0-30 Volt 0-1 Amp. 0-15 Volt 0-2 Amp. 0-7.5 Volt 0-4 Amp. Fixed 5 Volt 4 Amp. with Centre Tap. Metered Variable P.S.U. (3) £55.00
- Marconi. TF2155-1. 0-60 Volt 0-0.5 Amp. 0-30 Volt 0-1 Amp. 0-15 Volt 0-2 Amp. Fixed 5 Volt 2 Amp. with Centre Tap. Metered Variable P.S.U. (1) £60.00
- Marconi. 158. 0-30 Volt 0-2 Amp. Metered Variable TWIN P.S.U. (2) £70.00
- Weir. 430. 0-20 Volt 0-2 Amp. (To suit 3245 Analyzer) (1) £500.00
- Weir. 430. 0-60 Volt 0-0.5 Amp. 0-30 Volt 0-1 Amp. 0-15 Volt 0-2 Amp. Fixed 5 Volt 2 Amp. Metered Variable P.S.U. (2) £55.00
- Weir. 430. 0-30 Volt 0-3 Amp. Metered Variable P.S.U. (1) £55.00
- Weir. 460. 0-60 Volt 0-1 Amp. Metered Variable P.S.U. (2) £60.00
- Weir. 761. 0-15V 0-4A or 0-30V 0-2A. Metered Variable P.S.U. (1) £80.00
- Weir. 762. 1. 0-30V 0-2A or 0-60V 0-1A. Metered Variable P.S.U. (1) £80.00
- Weir. 4000. 0-30 Volt 0-1 Amp. Digital Display, Variable P.S.U. (1) £60.00

Much More Equipment Available Not Yet Listed. Phone or Fax Your "Wants"



ORDERING & DELIVERY

PHONE - FAX - WRITE or CALL IN. We accept Payment by most major Credit Cards. Bank to Bank or Cheque with Order. Prices are Exclusive of VAT and CARRIAGE. World Wide & U.K. Delivery Service.

Cooke International
Second User ELECTRONIC TEST & MEASURING INSTRUMENTS
Unit Four Fordingbridge Site Barnham Bognor Regis West Sussex PO22 0HD (U.K.)
Tel: (+44) 01243 545111/2 Fax: (+44) 01243 542457
CIRCLE NO. ON REPLY CARD to Receive Our Free Monthly Catalogue.

E.&O.E.

SPEAKERS' CORNER

John Watkinson looks at the problems involved in specifying a loudspeaker.

There is no point in designing a loudspeaker without a clear idea of the technical specification it should meet. Without a technical specification, objective testing is impossible and development proceeds in the dark.

As the loudspeaker is only for human indulgence, the technical specification must be derived from psychoacoustic considerations. A good general specification for a loudspeaker is that over the audible frequency range it should reproduce the original electrical waveform as an acoustic waveform. It should do this both on-axis and within a reasonable angle off axis at a realistic sound pressure level.

Microphones, recorders and amplifiers have to do this and so it seems a reasonable goal for a loudspeaker. This goal implies a flat frequency response which is phase linear and a transfer function which is also linear. True phase linearity is virtually impossible to achieve in a transducer.

Fortunately this also includes the human ear. Consequently an acceptable goal is a minimum phase characteristic. Rapid phase changes, particularly within a critical band, should be avoided which requires a greater degree of discipline in crossover design.

The audible frequency range requires some defining. At the top end, we usually pay lip service to a 20kHz bandwidth in recorders and circuitry even though many of us cannot hear such a frequency. It does no harm to specify such a bandwidth in the hope that a good transient response will result, but I am not convinced that a ruler-flat response to that frequency is necessary. A mild but monotonic roll-off is quite acceptable provided it is truly monotonic.

Interestingly enough the same argument applies at low frequencies. The lowest frequency to be reproduced is debatable and depends upon the material to be reproduced. If we want to be able to reproduce all musical instruments, response has to be maintained to around 20Hz. Low frequency roll-off is unavoidable but it must be monotonic and preferably have a slope of no more than 12 dB/octave.

Tuned speakers having ports or auxiliary bass radiators use resonance to extend the low-frequency response, but the result is that the ultimate roll-off is much steeper, leading to a now-you-hear-it, now-you-don't effect. In any case such tuning techniques are undesirable because they introduce linear distortion, audible as hangover.

While porting allows more sound-pressure level, or lower cost, accurate low-frequency requires phase linearity and only an unported unit can achieve that.

The ported speaker is so common that many people think of it as the norm. The trouble is that it doesn't bear comparison with the original. A clear example is the offset – i.e. the opposite of onset – transient which occurs when the air supply to an organ pipe is cut off. On a linear-phase woofer this is audible whereas on a tuned woofer it is masked by hangover.

Music editors prefer phase linear woofers because if the low and high-frequency components of a transient do not arrive time aligned there is some ambiguity over where the edit point should be.

An unported woofer still has a fundamental resonance due to the moving mass and the compliance it sees, but in a correctly designed unit this resonance is damped by the negligible output impedance of the amplifier. The result is that the damped speaker acts as a high-pass filter, rolling off monotonically at 12dB/octave.

When considering the power of a speaker, quoting the input power is a waste of time. What matters is what comes out. If realism is the goal, the sound-pressure level must be the same as the original.

Musical instruments – especially the piano – and the human voice change timbre as they get louder. With a good recording there is only one level at which it sounds right.

The threshold of hearing is irregular and rises at low frequencies. While active techniques can extend low frequency response almost arbitrarily, there is no point in doing this if sufficient sound-pressure level is not available as it simply won't be heard.

Non-linear distortion is the generation of harmonics due to the transfer function not being straight. This is critical in stereo because the creation of multiple images assumes linear superposition of the pairs of signals belonging to each image. Non-linearity causes intermodulation which results in phantom sound objects in the stereo image.

At high frequencies cabinet diffraction must be carefully controlled otherwise it causes multiple re-radiation which puts ripples in the on-axis response and makes the polar diagram extremely uneven. This causes colouration in the reverberant field which contributes to listening fatigue.

While these are strict requirements, they should not discourage. The market for mediocre loudspeakers is well supplied by traditional products. The only hope for a newcomer is to create a new market by attempting the impossible. Sometimes, however, the barriers are self-imposed rather than technological and the impossible becomes a product. ■

Speaker criteria

- Frequency response accurate enough to avoid timbral change.
- Linear distortion or phase linearity accurate enough to reproduce transients.
- Non-linear distortion low enough to eliminate false sound objects in stereo.
- No resonant or tuned behaviour to prevent hangover.
- Realistic sound-pressure level over whole frequency range.
- Enclosure diffraction controlled to give clean polar diagram.
- Wide dispersion so that reverb has same frequency response as direct sound.
- Fatigue free to allow extended listening.

Microstrip made easy

Nick Wheeler explains that although there are complex procedures for designing high performance microstripline circuits, a few shortcuts result in a technique that is quick and easy to implement yet more than adequate for most applications.

Micro stripline consists of conductive traces of defined width on low-loss dielectric superimposed on a conducting ground plane. It can be created by etching one side of ordinary double-sided printed circuit board material.

Stripline on the other hand consists of flat, thin conductors sandwiched between two ground planes and usually embedded in dielectric. It has many useful properties such as inherently good screening, but it is difficult to use and is not further discussed here.

For micro-stripline, glass-reinforced epoxy is the preferred dielectric. The cheaper phenolic type is too lossy, and PTFE or ceramic substrates are both much more costly – PTFE boards cost in the region of £100 a square foot – and are difficult to work with. On the other hand, PTFE boards are usable far into the microwave region. In this article I refer only to G-10 and FR-4 substrates. Apart from being fire-resistant, FR-4 is very similar to G-10.

This article is directed towards those of you wanting to make high-performance equipment with relatively limited resources. I have interpreted this as meaning that trace widths are defined to an accuracy of no better than 0.01in. This means, roughly, that characteristic impedance Z_0 of a typical trace will be accurate to one or at worst a few per cent.

A down-to-earth attitude is adopted in the ARRL Handbook.¹ What I have done below

is to explain how their results can be replicated, while referring to more rigorous treatments of the subject to reassure readers that readily available techniques are virtually indistinguishable from the very best that can be done.

Microstripline principles

Most microstripline calculations refer to traces of width W on an infinite layer of dielectric whose dielectric constant is ϵ_r and of thickness h backed by an infinite ground plane, Fig. 1.

In practice – and more so with increasing frequency – the electric field is concentrated in the volume of dielectric lying directly under the trace. However, some of the field is in air, leading to the concept of ϵ_{eff} , the effective dielectric constant, which is lower than that of the dielectric.

The greater the width of the trace the more ϵ_{eff} tends towards ϵ_r . If the ground plane and dielectric are truncated, as in Fig. 2, there is little effect upon Z_0 if $T > 2W$. If only the dielectric is truncated², as in Fig. 3, Z_0 is raised by less than 0.5% when T/W is greater than 0.5.

Because W/h is dimensionless, if the dielectric thickness is halved, the same Z_0 is achieved with half the trace width. There are many published formulae for accurately calculating Z_0 . These take into account the thickness t of the trace and even whether the etching process has resulted in a trace of

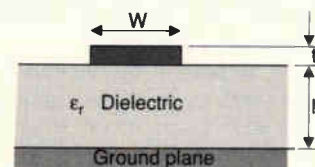

Fig. 1. Most microstrip calculations refer to traces of width W on an infinite layer of dielectric with constant ϵ_r and of thickness h backed by an infinite backplane.

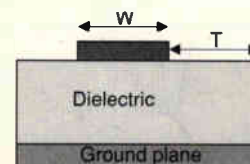

Fig. 2. In this microstripline example, both ground plane and dielectric are truncated.

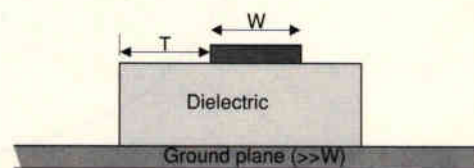

Fig. 3. If only the dielectric is truncated, Z_0 is raised by less than 0.5% for when T/W is more than 0.5.

trapezoidal rather than rectangular cross section.

For traces produced by etching ordinary 1oz circuit board material, with a thickness t of 0.0014in, and for typically useful values of Z_0 , these considerations are very much second-order effects. The effect of varying t from 0.0014in to 0.0056in on ordinary G-10 board of 0.0625in thickness is to reduce the trace width for $Z_0=50\Omega$ from 0.11984in to 0.11691in. Incidentally, the trace width for 50 Ω on this board is commonly specified as 0.1in but 0.12in is clearly a better approximation. This can be achieved by carrying out the following.

Evaluating complex formulae is tedious and there are many published tables relating W/h , ϵ_r and Z_0 . The graph of Fig. 4, derived from several sources, gives trace widths for a useful range of Z_0 using commonly available double-sided glass-epoxy pcb material. It should be accurate enough for most purposes. This is particularly so since G-10 and FR-4 are supplied by various manufacturers with ϵ_r varying over a range from 4.22 to 4.9. The most commonly quoted range though is 4.3-4.5.

Applying microstripline

There are in print several well-documented project descriptions.¹ These give a good overview of what can be done using this technique. Quarter wavelength, or $\lambda/4$, transformers for frequencies around 1GHz are particularly easily implemented, but bear in mind that the electrical length of microstripline is the reciprocal of $\sqrt{\epsilon_{eff}}$ multiplied by the physical length. The term λ_g is commonly used to describe the on-board wavelength.

Perhaps one of the most useful applications is in conjunction with monolithic microwave ICs, or mmics, as these are 50 Ω devices in

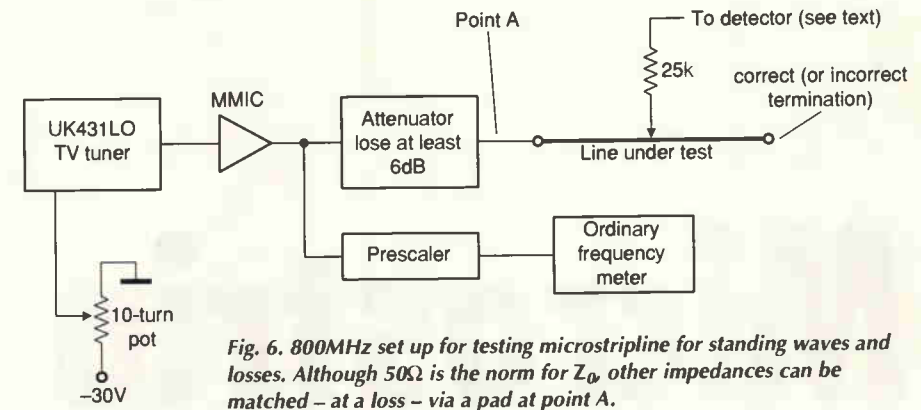

Fig. 6. 800MHz set up for testing microstripline for standing waves and losses. Although 50 Ω is the norm for Z_0 , other impedances can be matched – at a loss – via a pad at point A.

most cases. On the other hand, many other devices can be matched.

It is important to bear in mind that the cross-section of the trace of a typical microstripline is very small. If it is operated at significant power levels in a mismatched condition, destructive current antinodes may lead to failure.

Some general-purpose microstripline applications are dealt with below.

Applying microstrip

As reference 1 suggests, microstripline can be implemented by attaching, with superglue, 0.1in strips, or other widths, of thin copper foil to the plain side of single-sided pcb material. This works quite well, but I will now describe a reproducible photo-etch approach.

I use Windows 95 with one of the many available graphic design programs, in my case *Serif Draw Plus*, an *HP Deskjet 693C*, and the appropriate Premium Transparency Film. This combination I can vouch for, but there are doubtless other suitable films and many other

software packages and printers that will work too. Do not attempt to use films designed to take spirit-based felt pens or films made for overhead projector transparency work.

The transparencies produced are fine as masters for conventional photo-etching. It is important to remember that printer ink takes a long time to dry on transparency film. I recommend leaving for at least half an hour. I will not describe this well-known technique, except to point out that the transparency should be flipped so that the pattern ends up in face down, in direct contact with the pcb material before exposure.

Serif Draw Plus V2.0 has the option of selecting a grid based on 0.1in, with a spatial increment of 0.01in. You will suffer serious problems if you try to create circuit boards on a metric grid of any coarser resolution than this. I've tried it.

Graphic programs define line widths in 'points.' As far as *Serif Draw* is concerned, 7 points closely approximate to 0.1in*. This makes 8 points a good line width for 50 Ω on 0.0625 G-10 board.

Most transmission-line configurations can readily be implemented in microstripline. References 1-3 give many examples. The attraction here is that any Z_0 , within a range generally quoted as being from 16 Ω to 125 Ω can be achieved without resorting to tedious methods such as replacing the inner conductor of co-axial cable with wire of a different diameter.

A few practical points. Parallel traces, separated by a distance of W or less couple and can be used to effect directional couplers. Undesired coupling can be virtually eliminated by making the spacing $>2W$. The design parameters for couplers are highly interactive, and the empirical approach – i.e. suck it and see – may be the least difficult.

Bends can be radiused or mitred. Bends through any angle with a radius, to the centre line of the trace, $>4W$ do not have a significant effect on standing-wave ratio. Mitred bends, which occupy less board space, are theoretically complicated. However, using the approach of Fig. 5 seems to yield generally satisfactory results.

The advantage of using the computer-graph-

*A point is 1/72 of an inch – Ed.

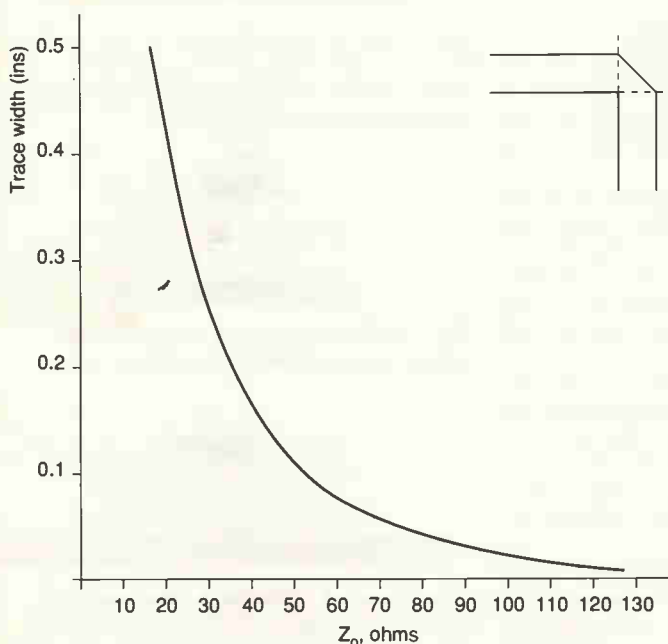

Fig. 4. Derived from several sources, this graph gives trace widths for a useful range of Z_0 assuming common glass-epoxy pcb.

Fig. 5. Not an ideal microstripline bend shape, but it does the job for most applications.

ic approach is that your artwork is stored and can easily be altered before committing to transparency. Good results – within the limitations of the transfer sheets available – can be obtained much more directly by the use of etch-resistant pcb transfers. Note that not all transfers are etch-resistant, though they can save a lot of time in producing artwork for photo-etching.

Making measurements

In many cases, the success of a microstripline circuit design can be estimated by driving it from a source of the right impedance, terminating it correctly and looking for standing waves or excessive losses.

I made a line 210mm long on G-10 board. One source quotes ϵ_{eff} for a 50 Ω line as about 3.4, when ϵ_r is 4.4. Using a test frequency of 800MHz, this accommodates just over a wavelength. An ϵ_r of 4.5 is favoured in reference 1.

Figure 6 shows a test setup. The signal source is a UK431LO television tuner, which has a local-oscillator output ranging from 431 to 900MHz. Many other tuners have local-oscillator outputs. This signal is buffered by a suitable mmic. Almost any of those currently available will suffice.

Frequency is measured using the gigahertz

prescaler of reference 4. The detector probe is connected to the 75 Ω input of the low-cost spectrum analyser described in reference 5.

A 25k Ω series resistor at the probe tip ensures negligible loading effects when applied to the line under test. Measurements are made by the null method of varying the attenuator to produce the same outputs at the points being tested.

As the spectrum analyser uses a television tuner there is obviously plenty of scope for the use of other tuners. Although I have not tried it, the raw intermediate frequency from any tuner could be amplified and inspected on a modest oscilloscope.

In the case of my test line, probing it when properly terminated with 50 Ω disclosed no perceptible standing wave pattern. Operating with no termination produced deep voltage nodes separated by 100mm – almost exactly – on the board. These are, of course, $\lambda_g/2$ apart.

Working backwards through the relationships outlined above, you can deduce that in this case the apparent ϵ_{eff} is 3.5. This degree of agreement lies well within the limits which might be expected.

An error of 1% in the measurement of the distance between the nodes could account for more than half the difference. Because of the element of empiricism inherent in all

microstripline calculations this seems to be a very good first attempt, and easily good enough for almost all applications.

In summary

I have shown that microstripline is a versatile technique, easily implemented to useful accuracy for many uhf applications. I recommend a computer-graphic approach for the generation of the artwork, since this gives quite precise control over trace widths.

The rigorous treatments of references 2 and 3 are available to those of you wanting to use more precise techniques. This will not normally be necessary unless high power levels are to be involved. ■

References

1. ARRL Handbook.
2. Waddell, BC, Transmission Line Design Handbook, Artech House 1991.
3. Edwards, TC, 'Foundations for Microstrip Circuit Design', Wiley 1981
4. Wheeler, NPE, Gigahertz prescaler. *Electronics World*, Sep. 1996
5. Wheeler, NPE, 'Spectrum Analyser on the Cheap,' *Electronics World*, Mar 1992.

The Autorouter for EASY-PC!

MultiRouter is "the best Autorouter that I have seen costing less than £10,000!" R.H. - (Willingham, UK)

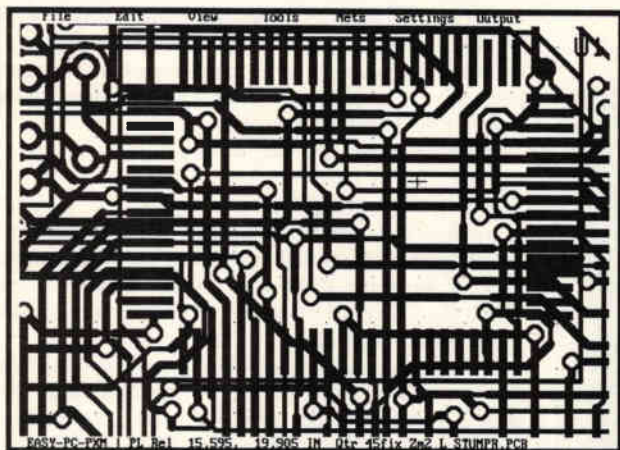

- Award Winning MultiRouter uses the latest 32 bit, Shape based, Rip-up and Re-try Technology.
- From single sided to 8 layers!
- 100% Completion where other autorouters fail!
- 100% routed 140 Components on a 210mm x 150mm board in less than 10 minutes! (75MHz Pentium)
- From £295! - Could Easily Pay For Itself On The First Project!

Prices exclude VAT& P&P

Number One Systems

Write, fax, phone or e-mail for full information.

UK/EEC: Ref: WW, Harding Way, St.Ives, Cambridgeshire, ENGLAND, PE17 4WR. e-mail: sales@numberone.com
 Telephone UK: 01480 461778 (7 lines) Fax: 01480 494042
 International +44 1480 461778/494042

USA: Ref: WW, 126 Smith Creek Drive, Los Gatos, CA 95030
 Telephone/Fax: (408) 395-0249

CIRCLE NO. 131 ON REPLY CARD

<http://www.numberone.com>



adh/mu

Radio reflections from Russia

St Petersburg's Alexander Popov Museum of Communications – one of the world's oldest technical museums – houses a wealth of early British wireless apparatus – as Khatskel Ioffe reveals.

Founded in 1872 as a telegraph museum, the Alexander S. Popov Central Museum of Communications in St. Petersburg has a collection of British equipment dating from the earliest stage of the development of wireless. Building on last month's article, which described artefacts ranging from Flemming's diode to a Marconi direction finder, this article covers our Marconi 250-1300m receiver, 500W transmitter and a wavemeter – Fleming's cymometer.

A standard for 250 to 1300m

A receiver for 250 to 1300m from our collection is shown in **Photo 1**. An identical receiver is depicted in a magazine printed in 1915, where it makes part of a field wireless outfit.¹ At around the same time, a receiver for this range also made part of the Marconi Company's 0.5, 1.5 and 5kW ship and coastal wireless stations.

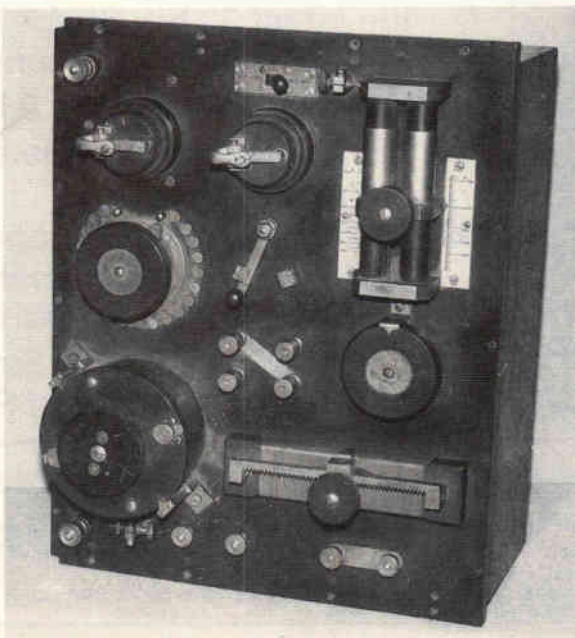

Photo 1. This Marconi Company receiver from circa 1915 was designed for reception between 250 to 1300m. It represented a standard in coastal and marine communications.

We consider this receiver to be Marconi's standard apparatus for 250 to 1300m during WWI. The receiver is complete with two carborundum contact detectors, one of which was a spare.

The receiver also has terminals for connecting a magnetic or another external detector. This allowed reception of strongly damped oscillations in addition to the undamped or feebly damped oscillations then coming into use.

The receiver has two subranges, 250–800m, and 500–1300m, selected by placing an aerial tuning capacitor in parallel or in series with an aerial tuning inductance coil, respectively. Placed into the aerial circuit, in addition to the variable inductance coil, is a moving detector-coupling coil.

Along with the Billi condenser, the detector and the telephone, this coil makes up the detector circuit. Connected to the receiver is an external storage battery which secures a required mode of operation of the receiver using a potentiometer. Provided along the periphery of the top panel are holes for screws fastening the receiver at its location on the frame of the transmitter-receiver station.

Our museum has two such receivers.

500W field transmitter

A wireless transmitter with a rotary spark discharger for a 0.5kW field wireless station mounted on a cart is shown in **Photo 2**. In the late 1900s and early 1910s wireless telegraph with a shock-excited transmitter generating a musical spark were becoming popular.

The Marconi Company obtained this effect by means of a rotary, toothed, spark discharger wherein a spark arose as each tooth passed under fixed high-voltage electrodes. The use of shock excitation meant a transition to feebly damped oscillations, which increased the energy sent by the station and enhanced its efficiency.

Installed on a two-wheel cart, the Marconi Company's 0.5kW wireless station was used in the Russian Army during WWI. In our set, a 7hp air-cooled two-cylinder Douglas petrol motor and an electrical generator are installed on a cast-iron base. The shafts of the motor and generator are connected by a bilateral coupling. A toothed spark discharger is

fixed on the shaft of the electrical generator.

The spark discharger is separated from the electrical generator by a chamber made of an aluminium alloy. The spark discharger has a copper disc, 7mm thick, fixed on a hard-rubber hub, through which a shaft supported in ball bearings passes.

Mounted in the chamber case are two fixed electrodes constituted by two copper rods, 4mm in diameter, placed inside hard-rubber insulators, the disc tooth-to-electrode spacing being set at 0.15-0.2mm.

The electrical generator has a stator with 12 poles arranged as 6 pairs. In the magnetic field formed by these poles, an anchor rotated with dc and ac windings. The current of the dc winding was fed into the collector and used in the excitation circuit while the current of the ac winding was fed into the rings. The ac voltage, transformed via an external high-voltage transformer, was fed to the electrodes of the spark discharger.

The spark discharger is of the synchronous type. It has the same rotational speed as the electrical generator and discharges at each peak of the ac voltage, ie at each alternation. Running at 1900rev/min, the electrical generator produced a 190Hz alternating current and the spark discharger produced 380 discharges per second. This corresponds to a relatively good tone – the musical spark effect.

On air in the air

The transmitter of an aeroplane wireless is shown in **Photo 3**. This is one of the first transmitters designed for the purpose.

It dates back to the times of WWI. It is a low-power spark transmitter consisting of an induction coil with a mechanical interrupter, an adjustable spark discharger in the form of two cylindrical aluminium electrodes, and an oscillatory circuit. The latter is comprised of a fixed capacitor and a variometer whose fixed coil is placed in the aerial circuit.

Using the variometer, the 230–430m wavelength range is covered. The induction coil was operated from an external dc power supply. A telegraph key was hooked into the power supply circuit. At the front of the transmitter case, access is provided to the spark discharger. Also provided is an inspection window to inspect the spark discharger.

Fleming's cymometer

The earliest type of the Marconi Company's wavemeter was Fleming's cymometer. I believe that the instrument that we have dates from 1906–1907.

This cymometer opened up the use of scientific methods for tuning transmitters and receivers. Earlier methods involved trial and error. It comprises a variable inductor and a variable capacitor. In the inductor, a coil of bare copper wire is wound around an ebonite tube. The self-inductance is variable by means of a slide contact.

The variable capacitor – a Billi condenser – consists of two thin-wall brass tubes separated by a hard-rubber bushing. The capacitance is varied by moving the outside tube using a handle. As the tube moves, the slide contact of the coil also moves so that the values of both elements of the measurement circuit are varied at the same time and in the same direction.

In order to find the instant that the measurement circuit is at resonance with the transmitter frequency, a neon tube was connected in parallel to the capacitor.

The scales of the instrument are calibrated in the values of an 'oscillation constant' – the term used by Fleming to denote the expression \sqrt{LC} . There are also scales for wavelength in metres, wavelength in feet, and the numbers of oscillations per 1/1,000,000th of a second.

It is known that the Marconi Company produced four types of cymometers to cover the ranges 33–700m, up to 1400m,

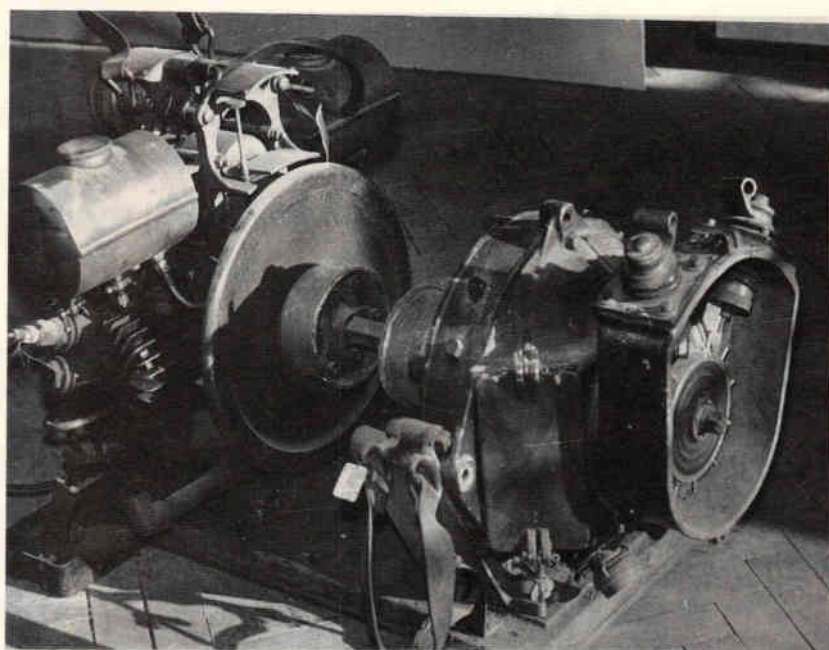

up to 2000m and up to 3000m.

Our cymometer is for 33–700m. To determine the wavelength of a transmitter, the cymometer was installed parallel to an antenna section. The operator moved the handle of the instrument in either direction so as to attain the brightest glow of the neon tube. The scale indicator, rigidly bound with the handle lever, ensured direct readings of the wavelength and frequency from scales.

To measure capacitance and inductance, the operator connected these components to a standard self-inductance or standard capacitance, respectively. The components excited oscillation via an ancillary inductor with a spark gap. The cymometer was used to determine \sqrt{LC} , whereafter the unknown value of C or L could be calculated.

Rounding up

All of the above-described apparatus were received by our museum in the 1920s from Russia's various communications establishments and educational institutions.

The British equipment presented in this article along with the apparatus of the Popov-Ducretet, Slaby-Arco and Telefunken systems of the early 20th century, also in the keeping of our museum, preserves the memory of the first steps in the development of wireless worldwide.

I cannot guarantee the accuracy of the dating and operating descriptions of the instruments described since my collection of literature is limited. Any corrections will be gratefully received. ■

Translated from the Russian by L.N. Kryzhanovsky. Khatskel Ioffe is with the A.S. Popov Central Museum of Communications, St. Petersburg.

Reference

1. 'Wireless Telegraphy in the War', *The Wireless World*, August 1915, p. 299.

Photo 2. Transmitter apparatus with rotary discharger for a 0.5kW field wireless station from circa 1916.



Photo 3. Transmitter for aeroplane wireless station from circa 1915 – one of the first transmitters designed specifically for aviation.

For more information about any of the products or services in this issue of **ELECTRONICS WORLD**, simply ring the relevant enquiry number. Enquiry numbers may be found at the bottom of each individual advertisement.

- 101 102 103 104 105 106 107 108 109
- 110 111 112 113 114 115 116 117 118
- 119 120 121 122 123 124 125 126 127
- 128 129 130 131 132 133 134 135 136
- 137 138 139 140 141 142 143 144 145
- 146 147 148 149 150 151 152 153 154
- 155 156 157 158 159 160 161 162 163
- 164 165 166 167 168 169 170 171 172
- 173 174 175 176 177 178 179 180 181

Name _____
Job title _____
Company Address _____ _____ _____
Telephone _____
DECEMBER 1997
Only tick here if you do not wish to receive direct marketing promotions from other companies. <input type="checkbox"/>

Newsagent order form

Pass this order form to your newsagent to ensure you don't miss the next issue of *EW*.

To
(name of Newsagent)

Please reserve me the January issue of *Electronics World*- on sale 4th December - and continue to order every month's issue until further notice

Name.....

Address.....
.....
.....
.....

Thank you

Subscribe today!

Guarantee your own personal copy each month

Save on a 2 year subscription

Subscribe today!

Guarantee your own personal copy each month

Save on a 2 year subscription

MICROWAVE

Continental Mic	Transmitter Control VML TR-240-1/1	£750.00
Digital Microwave	12GHz TX/RX (new)	£1,200.00
HP H 752A	Directional Coupler 10dB	£150.00
HP X 382A	Variable Attenuator 0-50dB 8.2-12.4GHz	£120.00
HP11691D	Dual Directional Coupler	£600.00
HP11692D	Dual Directional Coupler	£700.00
HP11720A	Pulse Modulator 2-18GHz	£720.00
HP11722A	Sensor Module	£600.00
HP33304A	Programmable Attenuator 18GHz 0-11dB	£175.00
HP33305A	Programmable Attenuator 18GHz 0-110dB	£175.00
HP33320A	Attenuator 11dB	£250.00
HP33320B	Attenuator 21dB	£250.00
HP33322A	Attenuator 1210dB	£250.00
HP33350	VHF Attenuator 120dB DC-1GHz	£300.00
HP3575A	Gain Phase Meter	£650.00
HP3529	Frequency Meter	£200.00
HP356A	Frequency Meter 3.7-12.4GHz	£200.00
HP44111A	2GHz-SWS Test Set	£560.00
HP4405A	Vector Volt Meter	£250.00
HP4410		£200.00
HP4414A		£175.00

GOOD SELECTION OF 18-20 GHz COAXIAL SWITCHES IN STOCK: £65.00 EACH

HP8502A	Transmission/Reflection Test Set 500kHz-1.3GHz	£750.00
HP8743B	Reflection: Transmission Test Unit 12-12.4GHz	£600.00
HP8745A	S-Parameter Test Set 0.1-2GHz	£560.00
Marconi 6019/2	Calibrated Variable Attenuator 12.4-18GHz	£200.00
Marconi 6030/10	Directional Coupler X-Band	£200.00
Marconi 6052/3	Rotary Vane Attenuator 8.12-12.4GHz	£120.00
6960+6910	Power Meter 10MHz-20GHz	£900.00
Marconi Microwave	Sliding Termination 80dB up to 20GHz	£600.00
NEC	Passlink 50 50GHz TX/RX	£500.00
Racal 9303	True RMS Level Meter	£800.00
TEK TR502	Tracking Generator	£750.00
Waveguide	X-Band WG16 10m Lengths	£300.00
Wenschel	Adaptor APC-7 SMA (new)	£85.00
Witron	87450 VSWR Bridge 2-18GHz	£600.00
Witron	64NF50 VSWR Bridge 3-9GHz	£400.00

OSCILLOSCOPES

Gould 4030	Digital Storage 20MHz 20MS/S	£350.00
Gould 05250	TV	£40.00
Gould 05300	20MHz	£120.00
HP54111D	500MHz Digital	£1,950.00
HP54200A	50MHz Digital	£750.00
HP54501A	100MHz Digital	£1,600.00
Isco Tech	SR40 40MHz	£300.00
Isco Tech DM56430	Digital Memory	£475.00
Iwatsu SAS8130	Waveform Analyser DC-3.5GHz	£1,500.00
Leader	LBO-522 20MHz	£200.00
Philips	PM3217 50MHz	£350.00
Philips	PM3340 2GHz Digital	£3,000.00
Tek 2215	60MHz	£350.00
Tek 2225	50MHz	£375.00
Tek 2235	100MHz	£600.00
Tek 2236	100MHz	£750.00
Tek 2245A	100MHz	£950.00
Tek 2336	100MHz	£750.00
Tek 2430A	150MHz 100MS/S Digitizing	£3,100.00
Tek 465	100MHz	£350.00
Tek 466	100MHz	£300.00
Tek 475	200MHz	£425.00
Tek SC502	15MHz	£300.00
Tek TDS420	150MHz 4 Channel 100MS/S	£2,350.00
Telecup	D61A 10MHz	£75.00

SIGNAL GENERATORS

Adret 7100B	300kHz-650MHz	£700.00
Adret 740A	0.1-560MHz	£750.00
Cushman CE12	Two Tone Generator	£150.00
Farnell DS62	Synthesised 0.1MHz-110kHz	£185.00
Farnell PSG1000	10kHz-1GHz	£1,200.00
Farnell PSG520	10-520MHz	£200.00
Farnell SSG520	10-520MHz	£200.00
Flann 4311A	12-18GHz	£50.00
Fuke 6010A	10Hz-11MHz Synthesised	£175.00
HP1171B	Down Converter (#995-08B)	£275.00
HP214B	Pulse Generator 100V 2A	£1,500.00
HP3325A	Synthesizer Generator 1Hz-21MHz	£1,500.00
HP3325B	Synthesizer Generator 1Hz-21MHz	£3,000.00
HP4204A	Oscillator 10Hz-1MHz	£125.00
HP654A	Test Oscillator 10MHz	£225.00
HP8005B	0.3Hz-10MHz	£300.00
HP8008A	10Hz-200MHz	£450.00
HP8015A	1Hz-50MHz Pulse	£450.00
HP8165A	Programmable Signal Source	£1,200.00
HP8601A	Generator/Sweeper 0.1-110MHz	£300.00
HP8620C		
+HP8622B	0.01-2.4 GHz Sweeper	£1,500.00
HP8642M	0.1-210MHz	£12,500.00
HP8647A	250kHz-390MHz	£2,300.00
HP8656A	100kHz-390MHz	£1,500.00
HP8684B	5.4-12.5GHz	£1,350.00
Marconi 2019A	90kHz-1040MHz	£1,450.00
Marconi 2022	10kHz-1GHz	£1,250.00
Marconi 6057	Signal Source 5.5-8.5GHz	£200.00
Marconi 6059A	12-18GHz Signal Source	£200.00
Marconi		
TF2015/2017	10-520MHz	£300.00
Racal 9053	Two Tone	£120.00
Racal		
9084+9934A	0.01-104MHz	£500.00
Racal 9087	10kHz-1.3GHz	£2,300.00
Syston Donner		
1702	Audio-1GHz	£600.00
Tek 504	0.001-240MHz	£350.00
Tek FG501A	2MHz Function	£250.00
Wavetek 1080	1-100MHz Sweeper	£800.00
Wavetek 157	Programmable Waveform	£150.00
Wavetek 159	Waveform Generator 1Hz-3MHz	£300.00
Wavetek 171	Synthesizer/Function	£400.00
Wavetek 185	Sweeper/Function 0-5MHz	£350.00
Wavetek 2001	1-140MHz	£600.00
Wavetek 907A	7-12.4GHz	£900.00
Witron		
6100+6223B	Sweeper 4-12.4GHz	£500.00

PLOTTERS/RECORDERS

Dowdy	Maritime Systems 3710	£300.00
HP	Draft Master RX	£500.00
HP Colour Pro		£45.00
HP Draft Pro-DXL	7575A	£250.00
HP-XL	Plotter	£50.00
HP7475A	Plotter RS232	£150.00
HP7550A	Plotter	£250.00
Racal Recorder	4DS & 7DS	from £200.00
Roland	X-Y Plotter DIXY-1300	£120.00
Roland	Drafting Plotter GRX-400AG	£500.00

AERIAL FACILITIES EQUIPMENT:

Receiver Splitter Amplifier
Type RSA-460-4M
Price: £250.00

Bandpass Duplexer,
Type BPD-453-460-6N
Price: £300.00

Transmitter Cavity Resonator,
Type SC-450-2N
Price: £190.00

Transmitter Cavity Resonator
Type SG-450-ZN c/w DT-453-2NV
Price: £190.00

DATA/TELECOMS

Anritsu BT (Furukun)	MS334A PCM Error Detector	£120.00
Cushman	CE24 FX Selective Level Meter	£400.00
Databal D1000	Programmable Transient Recorder	£250.00
GN Elm EPR31	PCM Signalling Recorder	£5,000.00
HP1350A	Graphics Translator	£200.00
HP1631D	Logic Analyzer	£650.00
HP3336A	Synthesizer/Level Generator	£1,300.00
HP3375A	Data Acquisition/Control Unit	£400.00
HP3586B	Selective Meter	From £850.00
HP3717A	70MHz Modulator/Demodulator	EPOA
HP37201A	HP-IB Extender	£300.00
HP37202A	HP-IB Extender	£300.00
HP3752A	Data Generator	£350.00
HP3763A	Error Detector	£800.00
HP3764A	Digital Transmission Analyser	£3,200.00
HP3770B	Telephone Line Analyser	£200.00
HP3780A	Pattern Generator/Error Detector	£1,100.00
HP3781A	Pattern Generator	£500.00
HP3782A	Error Detector	£500.00
HP4935A	Transmission Tester	£1,100.00
HP4984A	In-Service Tester/Impairment Measuring Set	EPOA
HP5005B	Signature Analyser	£950.00
HP5006A	Signature Analyser	£50.00
HP6942A	Multiprogrammer	£200.00
HP8016A	Word Generator	£150.00
HP8170A	Logic Pattern Generator	£600.00
HP8954A	Tranceiver Interface	£600.00
Iwatsu DM2350	Digital Memory 10 Bit/20ns	£400.00
Marconi 2826A	Digital Simulator	£200.00
Marconi 2829	Digital Analyser	£200.00
Marconi 2831	Channel Access Switch	£200.00
Marconi DA2805	PCM Regenerator Test Set	£250.00
Marconi TF2019C	Noise Generator - Many Filters Available	£250.00
Marconi TF2092C	Noise Receiver	£250.00
Marconi TF2808/2	Pattern Generator and SLMS (Brand New/Boxed)	£120.00
Marconi TF2807A	P.C.M. Multiplex Tester	£200.00
Marconi TF2830	Multiplex Tester	£200.00
Mequra	MKG12A VTR Jitter Meter	£75.00
Phoenix	5500A Telecommunications Analyser	£1,500.00
Racal 202, 205	State Logic Analyser	£1,500.00
Schlumberger	7700 140 m Bit/s Filler/Meter	£125.00
Schlumberger	7710 Mainframe Set 34/140 M Bits	£125.00
Siemens	D2155 Level Meter/W3155 Tracking Oscillator	£150.00
Siemens P2032	Bit Error Measuring Set	£900.00
Tek 834	Programmable Date Comms Tester	£150.00
Thurby	LA4800 Logic Analyser	£500.00
W&G	SPM15 Level Meter	£800.00
W&G	PS12 Level Generator	£300.00
W&G	SPM12 Level Meter	EPOA
W&G	PCM 3 PCM Test Set	£300.00
W&G	SDS-1 SSB Level Generator	£150.00
W&G	DLM3 Data Line Test Set	£500.00
W&G	SPM19 Level Meter	£2,500.00
W&G	MU3 Test Point Selector	EPOA
W&G	PJM-1 PCM Jitter Meter	£250.00

SIGNAL ANALYZERS

AD 352	FFT Analyser	£300.00	
B&K 2033	Signal Analyser	£2,000.00	
HP1821+HP8557A	Spectrum Analyser 01-350MHz	£800.00	
HP1821+HP8558B	Spectrum Analyser 100kHz-1.5GHz	£1,350.00	
HP334A	Distortion Analyser	£250.00	
HP339A	Distortion Measuring Set	£1,200.00	
HP3581C	Selective Volt Meter	£600.00	
HP3582A	0.02Hz-25.999kHz Spectrum Analyser	£1,500.00	
HP8753C	6GHz Network Analyser	£14,500.00	
HP8901A	Modulation Analyser	£2,000.00	
HP8903B	Audio Analyser	£3,200.00	
Marconi 2305	Modulation Meter	£2,000.00	
Marconi	2382+2380	400MHz Spectrum Analyser	£3,500.00
Marconi 2601	True RMS Voltmeter	£500.00	
Marconi 2955	Test Set+2960 TACS Unit	£2,400.00	
Marconi TF2370	110MHz Spectrum Analyser	£600.00	
R&S	Polyskop SWOB 5	£1,500.00	
R&S	SMU Z1	£400.00	
R&S	Ure RMS Voltmeter	£800.00	
R&S CMS52	Comms. Service Monitor	£5,500.00	
Racal 9302	RF Millivolt Meter	£350.00	
Spectra DV S037	FFT Analyser	£1,800.00	
Tek 7L12	100kHz-1.8GHz	£800.00	
Tek DA4084	Programmable Distortion Analyser	£700.00	

MISCELLANEOUS

PYE CHARGERS TYPE BC21C
NEW & BOXED: £25.00

MOTOROLA BATTERY CHARGER TYPE NTN4922A
GOOD CONDITION: £85.00

FARNELL MP30-80, 1KW, 30V, 80A
AUTO RANGING POWER SUPPLY: £500.00

MATCH EFFICIENCY METER MODEL MB800
FREQUENCY RANGE 775-1025MHz
SWR (VSWR) INDICATION RANGE 1.0:1 TO 5.0:1
£150.00

CLEARANCE (NOT TESTED)

Adret	5104 Driving Synthesizer 90-120MHz	£125.00
Boonton	82AD Modulation Meter	£200.00
Farnell	830/20 Power Supply Stabilised	£120.00
Farnell	E350 Stabilised Voltage Supply	£120.00
Farnell	RB1030/35 Electronic Load 1kW 30A 35V	£300.00
Farnell	TSV70 Mk2 Stabilised Power Supply	£180.00
Ferrogaph	RT52 Recorder Test Set	£200.00
Fuke	8520R Digital Multi Meter	£250.00

Fuke	8860A Digital Multi Meter	£150.00
Giga	GR1101A 12-18 GHz Microwave Signal Generator	£25.00
Giga		£150.00
Giga	GU1328A 2-8GHz Microwave Signal Generator	£150.00
Harris	RF2305 Receiver/Exciter	£200.00
HP	V5508 50MHz Oscilloscope	£200.00
HP	11713A Attenuator Switch Divider	£300.00
HP	17414A 100MHz Oscilloscope	£300.00
HP	1742A 100MHz Oscilloscope	£275.00
HP	181A Main Frame c/w 1840A+1825A	£125.00
HP	3400A RMS Volt Meter	£120.00
HP	3570A Network Analyser 50Hz-13MHz	£150.00
HP	4333A Distribution Analyser	£300.00
HP	435A Power Meter	£175.00
HP	435B Power Meter	£250.00
HP	489A Microwave Amplifier 1-2GHz	£125.00
HP	5315A Universal Counter	£200.00
HP	5328A Universal Counter	£120.00
HP	5363A Time Interval Probes	£150.00
HP	8412B Phase Magnitude Display	£175.00
HP	8443B Tracking Generator/Counter	£250.00
HP	8445B Automatic Preselector	£300.00
HP	8552B IF Section	£250.00
HP	8553B RF Section 0-100MHz	£200.00
HP	8553L RF Spectrum Analyser 0-110MHz	£200.00
HP	8556A LF Spectrum Analyser	£200.00
HP	86501A RF Section 0.1-110MHz	£200.00
HP	8750A Storage Normalizer	£300.00
HP	491C Microwave Analyser 2-4GHz	£125.00
HP	8413A Phase Gain Indicator Unit	£175.00
HP	SC7103 Frequency Counter	£160.00
Iwatsu	192 Programmable Digital Multimeter	£200.00
Keithley	6056B Signal Source 2-4GHz	£150.00
Marconi	TF2337A Auto Distortion Meter	£150.00
Philips	PM5519 Colour TV Pattern Generator	£200.00
Polarad	1105EFT 0.8-2.4GHz Signal Generator	£250.00
Philips	9008 Modulation Meter (Old Type)	£175.00
Racal	9009 Modulation Meter (Old Type)	£150.00
Racal	9104 RF Power Meter	£200.00
Racal	9300 RMS Volt Meter	£175.00
Racal	9301A RF Millivoltmeter True RMS	£180.00
Racal	9291 UHF Frequency Counter	£275.00
Racal	MA1720 Drive Unit	£300.00
Schlumberger	1170 Frequency Response Analyser	£150.00
Schlumberger	7055 Micro Volt Meter	£150.00
Syston Donner	5000A Sweeper c/w Oscillator 5014/26 3.2-6.5GHz	£250.00
Tektronix	464 Oscilloscope	£300.00
Tektronix	PM604 Current Probe DC-50MHz	£200.00
Tinsley	5761 Resistance Bridge	£200.00
W&J	3737A/10 HF Receiver	£120.00
W&J	DMS107 Demodulator	£120.00
W&J	565 Receiver	£200.00
W&J	DM112 Demodulator	£250.00
W&J	MTR106A Microwave Tuning	£150.00
W&J	WJ9518AE/9 FDM Demodulator	£250.00
Adret	2232A Frequency Synthesizer 1MHz	£250.00
Adret	6303B Signal Generator	£75.00
Avance	TC17 Timer/Counter	£15.00
Aiken	SH2400P 20-100MHz	£75.00
AMF	7736 Digital Counter	£15.00
Aplab	UV3072 Regulated Power Supply 0-30V 0-2A	£25.00
Brookdale	411 Phase Sensitive Detector	£25.00
Cossor	333A Test Set	£75.00
Cröhn/Meile	5300A Function Generator	£40.00
Dana	4200 Digital Multimeter	£25.00
Datron	1030 RMS Volt Meter	£25.00
Datron	1030A RMS Volt Meter	£25.00
Datron	1055 DC Volt Meter	£25.00
Farnell	2085 AF Power Meter	£40.00
Farnell	DM131 Digital Multimeter	£30.00
Farnell	FG1 Function Generator	£30.00
Farnell	LF1 Sine/Square Oscillator	£60.00
Farnell	5G1B Signal Generator Interface	£30.00
Feedback	EW604 Electronic Watt Meter	£50.00

CIRCUIT IDEAS

Over £600 for a circuit idea?

New awards scheme for circuit ideas

- Every circuit idea published in *Electronics World* receives £35.
- The pick of the month circuit idea receives a Pico Technology ADC42 – worth over £90 – in addition to £35.
- Once every six months, Pico Technology and *Electronics World* will select the best circuit idea published during the period and award the winner a Pico Technology ADC200-50 – worth £586.

How to submit your ideas

The best ideas are the ones that save readers time or money, or that solve a problem in a better or more elegant way than existing circuits. We will also consider the odd solution looking for a problem – if it has a degree of ingenuity.

Your submission will be judged on its originality. This means that the idea should certainly not have been published before. Useful modifications to existing circuits will be considered though – provided that they are original.

Don't forget to say why you think your idea is worthy. We can accept anything from clear hand writing and hand-drawn circuits on the back of an envelope. Type written text is better. But it helps us if the idea is on disk in a popular pc or Mac format. Include an ascii file and hard-copy drawing as a safety net and please label the disk with as much information as you can.

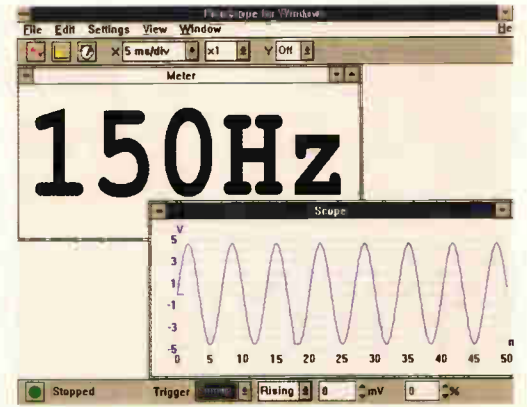
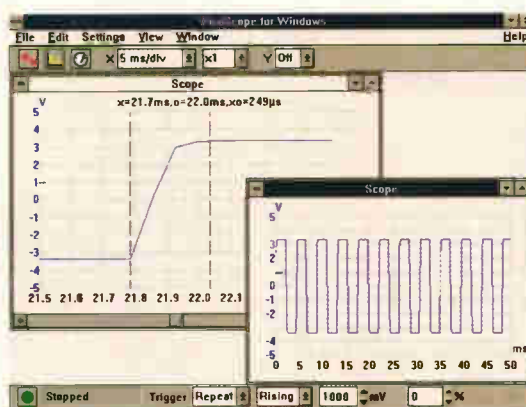
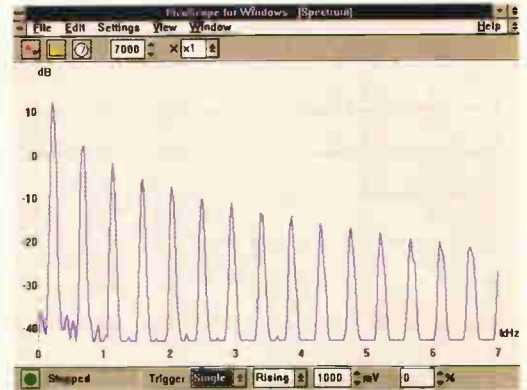
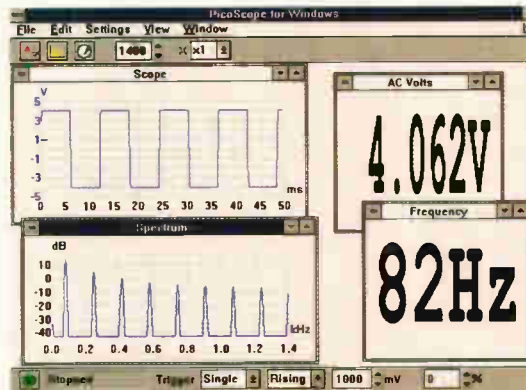

Turn your PC into a high-performance virtual instrument in return for a circuit idea.

The ADC200-50 is a dual-channel 50MHz digital storage oscilloscope, a 25MHz spectrum analyser and a multimeter. Interfacing to a pc via its parallel port, ADC200-50 also offers non-volatile storage and hard-copy facilities. Windows and DOS virtual instrument software is included.

ADC42 is a low-cost, high-resolution a-to-d converter sampling to 12 bits at 20ksample/s. This single-channel converter benefits from all the instrumentation features of the ADC200-50.

Ac/dc indicator for 7-segment display

This is possibly the simplest idea yet seen in this column and is ingenious. It indicates whether the input is ac or dc by virtue of the fact that, if it is dc, the "a" element does not light and the display reads lower-case "dc". If ac, the element lights and the display shows "ac". Resistor R should be $V_{in} - 1.7/0.01\Omega$.

Raj K Gorkhali
Kathmandu
Nepal
(A38a)

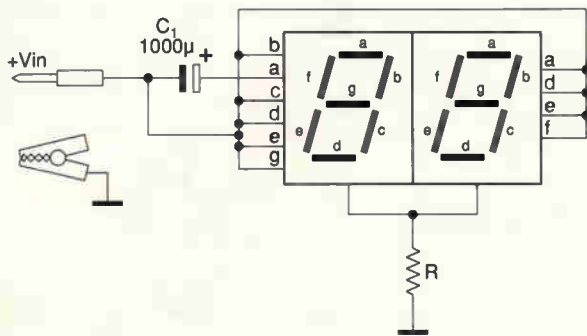

Switched motor drive for 12V dc motors, driven by a pwm signal.

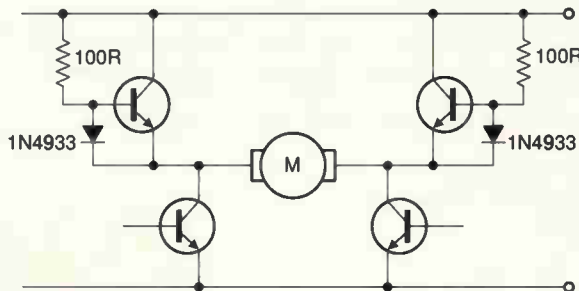

Small motor drive

This drive for small dc motors is a variation on those described by Peter Hale in his article 'Driving and controlling small motors' in *EW*, May 1997, p.397. It uses a single supply rail and consists of two drive transistors, the two upper devices acting as voltage-dependent resistors. At low voltage, resistance is low, the reverse applying, so that the bridge halves behave as switches.

Ray Stead
Hampton,
Middlesex
(A35)

Amplitude-stable phase-shift oscillator

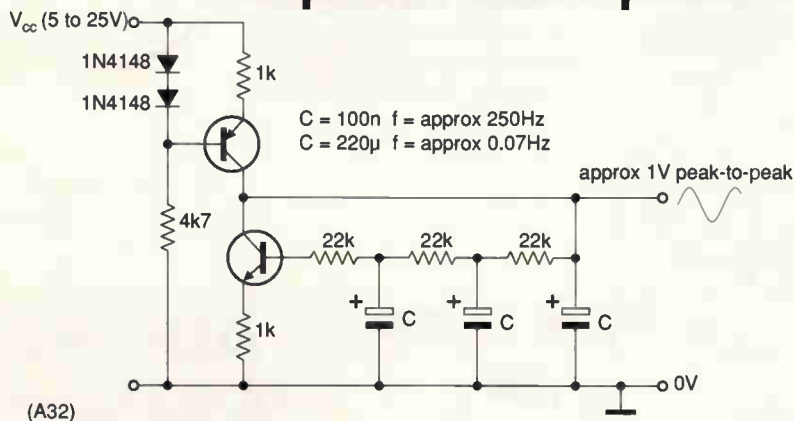

This low-frequency oscillator runs from an unregulated supply and is meant for use where precise frequency setting is not a requirement.

It is based on the classic design of RC sinewave oscillator, each RC contributing 60° towards the necessary 180° phase shift from collector to base. Unlike the standard design, amplitude stability comes from the p-n-p current source instead of a thermistor or an agc circuit.

Capacitors are grounded to allow the use of electrolytics. Components are not critical, except that the n-p-n transistor should have an h_{FE} of at least 180. Amplitude and frequency remain within about 10% with double the supply voltage.

L S Whitlock
Taunton
Somerset
(A32)

Variation on the classic phase-shift oscillator, having a constant-current collector load to avoid the use of thermistors or an agc circuit.

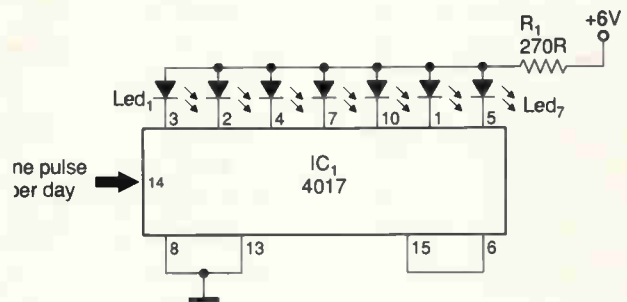

Counter and leds indicate whether it is Sunday or Monday and you have to get up.

Digital clock day indicator

For those who, on waking, are often unsure not only of where and possibly who they are, but also what day it is, this little addition to a digital clock will reassure them. If the clock has an am/pm signal, applying it to the counter steps it on once per day, the relevant led being illuminated.

Raj K Gorkhali
Kathmandu
Nepal
(A38b)

Surplus always wanted for cash!

THE ORIGINAL SURPLUS WONDERLAND!

THIS MONTH'S SELECTION FROM OUR VAST EVER CHANGING STOCKS

Surplus always wanted for cash!

LOW COST PC's -

SPECIAL BUY 'AT 286'

40Mb HD + 3Mb Ram



LIMITED QUANTITY only of these 12MHz HI GRADE 286 systems Made in the USA to an industrial specification, the system was designed for total reliability. The compact case houses the motherboard, PSU and EGA video card with single 5 1/4" 1.2 Mb floppy disk drive & integral 40Mb hard disk drive to the front. Real time clock with battery backup is provided as standard. Supplied in good used condition complete with enhanced keyboard, 640k + 2Mb RAM, DOS 4.01 and 90 DAY Full Guarantee. Ready to Run!
Order as HIGRADE 286 **ONLY £129.00 (E)**

Optional Fitted extras: VGA graphics card	£29.00
1.4Mb 3 1/2" floppy disk drive (instead of 1.2 Mb)	£19.95
Wordperfect 6.0 for Dots - when 3 1/2" FDD option ordered	£22.50
NE2000 Ethernet (thick, thin or twisted) network card	£29.00

LOW COST 486DX-33 SYSTEM

Limited quantity of this 2nd user, superb small size desktop unit. Fully featured with standard simm connectors 30 & 72 pin. Supplied with keyboard, 4 Mb of RAM, SVGA monitor output, 256k cache and integral 120 Mb IDE drive with single 1.44 Mb 3.5" floppy disk drive. Fully tested and guaranteed. Fully expandable
Only **£399.00 (E)**
Many other options available - call for details.

FLOPPY DISK DRIVES 3 1/2" - 8"

5 1/4" or 3 1/2" from only £18.95!

Massive purchases of standard 5 1/4" and 3 1/2" drives enables us to present prime product at industry beating low prices! All units (unless stated) are BRAND NEW or removed from often brand new equipment and are fully tested, aligned and shipped to you with a 90 day guarantee and operate from standard voltages and are of standard size. All are IBM-PC compatible (if 3 1/2" supported on your PC).

3 1/2" Panasonic JU363/4 720K or equivalent RFE	£24.95(B)
3 1/2" Mitsubishi MF355C-L 1.4 Meg. Laptops only	£25.95(B)
3 1/2" Mitsubishi MF355C-D 1.4 Meg. Non laptop	£18.95(B)
5 1/4" Teac FD-55GFR 1.2 Meg (for IBM pc's) RFE	£18.95(B)
5 1/4" Teac FD-55F-03-U 720K 40/80 (for BBC's etc) RFE	£29.95(B)
5 1/4" BRAND NEW Mitsubishi MF501B 360K	£22.95(B)
Table top case with integral PSU for HH 5 1/4" Flopp or HD	£29.95(B)
8" Shugart 800/801 8" SS refurbished & tested	£195.00(E)
8" Shugart 810 8" SS HH Brand New	£195.00(E)
8" Shugart 851 8" double sided refurbished & tested	£250.00(E)
Mitsubishi M2894-63 8" double sided NEW	£275.00(E)
Mitsubishi M2896-63-02U 8" DS slimline NEW	£285.00(E)
Dual 8" cased drives with integral power supply 2 Mb	£499.00(E)

HARD DISK DRIVES

End of line purchase scoop! Brand new NEC D2246 8" 85 Mbyte drive with industry standard SMD interface, replaces Fujitsu equivalent model. Full manual. Only **£299.00 or 2 for £525.00 (E)**

3 1/2" FUJI FK-309-26 20mb MFM I/F RFE	£59.95(C)
3 1/2" CONNER CP3024 20 Mb IDE I/F (or equiv) RFE	£59.95(C)
3 1/2" CONNER CP3044 40mb IDE I/F (or equiv) RFE	£69.00(C)
3 1/2" RODIME R03057S 45mb SCSI I/F (Mac & Acorn)	£69.00(C)
3 1/2" WESTERN DIGITAL 850mb IDE I/F (Brand New)	£185.00(C)
5 1/4" MINISCRIIBE 3425 20mb MFM I/F (or equiv) RFE	£49.95(C)
5 1/4" SEAGATE ST-238R 30 mb RLL I/F Refurb	£69.95(C)
5 1/4" CDC 94205-51 40mb HH MFM I/F RFE tested	£69.95(C)
5 1/4" HP 9754B 850 Mb SCSI RFE tested	£89.00(C)
5 1/4" HP C3010 2 Gbyte SCSI differential RFE tested	£195.00(C)
8" FUJITSU M2322K 160Mb SMD I/F RFE tested	£195.00(E)

Hard disc controllers for MFM, IDE, SCSI, RLL etc. from **£16.95**

THE AMAZING TELEBOX

Converts your colour monitor into a QUALITY COLOUR TV!!



TV SOUND & VIDEO TUNER
CABLE COMPATIBLE

The TELEBOX is an attractive fully cased mains powered unit, containing all electronics ready to plug into a host of video monitors made by makers such as MICROVITEC, ATARI, SANYO, SONY, COMMODORE, PHILIPS, TATUNG, AMSTRAD etc. The composite video output will also plug directly into most video recorders, allowing reception of TV channels not normally receivable on most television receivers* (TELEBOX MB). Push button controls on the front panel allow reception of 8 fully tuneable 'off air' UHF colour television channels. TELEBOX MB covers virtually all television frequencies VHF and UHF including the HYPERBAND as used by most cable TV operators. A composite video output is located on the rear panel for direct connection to most makes of monitor or desktop computer video systems. For complete compatibility - even for monitors without sound - an integral 4 watt audio amplifier and low level Hi Fi audio output are provided as standard.

TELEBOX ST for composite video input type monitors	£36.95
TELEBOX STL as ST but fitted with integral speaker	£39.50
TELEBOX MB Multiband VHF/UHF/Cable/Hyperband tuner	£69.95

For overseas PAL versions state 5, 5 or 6 MHz sound specification. *For cable / hyperband reception Telebox MB should be connected to a cable type service. Shipping code on all Telebox's is (B)

DC POWER SUPPLIES

Virtually every type of power supply you can imagine. Over 10,000 Power Supplies Ex Stock
Call for info / list.

IC's - TRANSISTORS - DIODES

OBSELETE - SHORT SUPPLY - BULK

6,000,000 items EX STOCK

For MAJOR SAVINGS - CALL FOR SEMICONDUCTOR HOTLIST

VIDEO MONITOR SPECIALS

One of the highest specification monitors you will ever see -
At this price - Don't miss it!!

Mitsubishi FA3415ETKL 14" SVGA Multisync colour monitor with fine 0.28 dot pitch tube and resolution of 1024 x 768. A variety of inputs allows connection to a host of computers including IBM PC's in CGA, EGA, VGA & SVGA modes, BBC, COMMODORE (including Amiga 1200), ARCHIMEDES and APPLE. Many features: Etched landscape, text switching and LOW RADIATION MPR specification. Fully guaranteed, supplied in EXCEL-

LENT little used condition.
Tilt & Swivel Base £4.75
VGA cable for IBM PC included.
External cables for other types of computers CALL
Only **£119 (E)** Order as MITS-SVGA

As New - Used on film set for 1 week only!!
15" 0.28 SVGA 1024 x 768 res. colour monitors.
Swivel & tilt etc. Full 90 day guarantee. **£145.00 (E)**

Just In - MicroVitec 20" VGA (800 x 600 res.) colour monitors.
Good SH condition - from £299 - CALL for info

PHILIPS HCS35 (same style as CM8833) attractively styled 14" colour monitor with both RGB and standard composite 15.625 kHz video inputs via SCART socket and separate phono jacks. Integral audio power amp and speaker for all audio visual uses. Will connect direct to Amiga and Atari BBC computers. Ideal for all video monitoring / security applications with direct connection to most colour cameras. High quality with many features such as front concealed fan controls, VCR correction button etc. Good used condition - fully tested - guaranteed
Dimensions: W14" x H12 3/4" x 15 1/2" D.
Only **£95 (E)**

PHILIPS HCS31 Ultra compact 9" colour video monitor with standard composite 15.625 kHz video input via SCART socket. Ideal for all monitoring / security applications. High quality, ex-equipment fully tested & guaranteed (possible minor screen burns). In attractive square black plastic case measuring W10" x H10" x 13 1/2" D. 240 V AC mains powered.
Only **£79.00 (D)**

KME 10" 15M10009 high definition colour monitors with 0.28" dot pitch. Superb clarity and modern styling. Operates from any 15.625 khz sync RGB video source, with RGB analog and composite sync such as Atari, Commodore Amiga, Acorn Archimedes & BBC. Measures only 13 1/2" x 12" x 11". Good used condition.
Only **£125 (E)**

20" 22" and 26" AV SPECIALS

Superbly made UK manufacture. PIL all solid state colour monitors, complete with composite video & optional sound input. Attractive teak style case. Perfect for Schools, Shops, Disco, Clubs, etc. In EXCELLENT little used condition with full 90 day guarantee.

20"....£135 22"....£155 26"....£185 (F)

SPECIAL INTEREST ITEMS

MITS. FA3445ETKL 14" Industrial spec SVGA monitors 2kW to 400 kW - 400 Hz 3 phase power sources - ex stock	£245
IBM 8230 Type 1, Token ring base unit driver	£950
IBM 53F5501 Token Ring ICS 20 port lobe modules	£750
IBM MAU Token ring distribution panel 8225-23-5050N	£95
AIM 501 Low distortion Oscillator 9Hz to 330kHz, IEEE	£550
Trend DSA 274 Data Analyser with G703(2M) 64 I/O	£650
Marconi 6310 Programmable 2 to 22 GHz sweep generator	£3750
HP1650B Logic Analyser	£950
HP3781A Pattern generator & HP3782A Error Detector	£3750
HP APOLLO RX700 system units	£950
HP6621A Dual Programmable GPIB PSU 0-7 V 160 watts	£1800
HP3081A Industrial workstation c/w Barcode swipe reader	£175
HP6264 Rack mount variable 0-20V @ 20A metered PSU	£675
HP5412A DC to 22 GHz 4 channel test set	£950
HP75801A A1 8 pen HPGL high speed drum plotter	£1850
EG+G Brookdale 95035C Precision lock in amp	£950
View Eng. Mod 1200 computerised inspection system	£650
Ling Dynamics 2kW programmable vibration test system	£1425
Computer controlled 1056 x 560 mm X Y table & controller	£1425
Keithley 590 CV capacitor / voltage analyser	£950
Racal ICR40 dual 40 channel voice recorder system	£3750
Fliskers 45KVA 3 ph On Line UPS - New batts Dec. 1995	£9500
ICI R5030UJ34 Cleanline ultrasonic cleaning system	£950
Mann Tally MT645 High speed line printer	£2200
Intel SBC 486/133SE Multibus 486 system. 8Mb Ram	£1200
Zeta 3220-05 A0 4 pen HPGL fast drum plotters	£1150
Nikon HF-X-11 (Ephiphot) exposure control unit	£1450
Motorola VMC Bus Boards & Components List. SAE / CALL	£950
Trilo 0-18 vdc linear, metered 30 amp bench PSU. New	£1950
Fujitsu M3041R 600 LPM band printer	£1250
Fujitsu M3041D 600 LPM printer with network interface	£950
Perkin Elmer 2998 Infrared spectrophotometer	£3750
VG Electronics 1035 TETEXTECH Decoding Margin Meter	£950
Andrews LAFGE 3.1 m Satellite Dish & mount (For Voyager)	£950
Sekonic SD 1508 18 channel digital Hybrid chart recorder	£1995
TAYLOR ROBSON Tallysurc amplifier / recorder	£750
System Video 1152 PAL wavetform / recorder	£485
Test Lab - 2 mtr square quietised acoustic test cabinets	£300
Kenwood 9601 PAL Vectorscope - NEW	£650

Please call for further details on the above items



19" RACK CABINETS

Superb quality 6 foot 40U
Virtually New, Ultra Smart
Less than Half Price!

Top quality 19" rack cabinets made in UK by Optima Enclosures Ltd. Units feature designer, smoked acrylic lockable front door, full height lockable half louvered back door and louvered removable side panels. Fully adjustable internal fixing struts, ready punched for any configuration of equipment mounting plus ready mounted integral 12 way 13 amp socket switched mains distribution strip make these racks some of the most versatile we

have ever sold. Racks may be stacked side by side and therefore require only two side panels to stand singly or in multiple bays. Overall dimensions are: 7 1/2" H x 32 1/2" D x 22" W. Order as:
OPT Rack 1 Complete with removable side panels. **£335.00 (G)**
OPT Rack 2 Rack, Less side panels **£225.00 (G)**

32U - High Quality - All steel RakCab

Made by Eurocraft Enclosures Ltd to the highest possible spec, rack features all steel construction with removable side, front and back doors. Front and back doors are hinged for easy access and all are lockable with five secure 5 lever barrel locks. The front door is constructed of double walled steel with a 'designer style' smoked acrylic front panel to enable status indicators to be seen through the panel, yet remain unobtrusive. Internally the rack features fully slotted reinforced vertical fixing members to take the heaviest of 19" rack equipment. The two movable vertical fixing struts (extras available) are pre punched for standard 'cage nuts'. A mains distribution panel internally mounted to the bottom rear, provides 8 x IEC 3 pin Euro sockets and 1 x 13 amp 3 pin switched utility socket. Overall ventilation is provided by fully louvered back door and double skinned top section with top and side louvers. The top panel may be removed for fitting of integral fans to the sub plate etc. Other features include: fitted castors and floor levelers, prepunched utility panel at lower rear for cable / connector access etc. Supplied in excellent, slightly used condition with keys. Colour Royal blue. External dimensions mm=1625H x 635D x 603 W. (64" H x 25" D x 23 3/4" W)
Sold at LESS than a third of makers price !!



A superb buy at only **£195.00 (G)**

Over 1000 racks - 19" 22" & 24" wide
3 to 44 U high. Available from stock !!
Call with your requirements.

TOUCH SCREEN SYSTEM

The ultimate in 'Touch Screen Technology' made by the experts - MicroTouch - but sold at a price below cost !! System consists of a flat translucent glass laminated panel measuring 29.5 x 23.5 cm connected to an electronic controller PCB. The controller produces a standard serial RS232 or TTL output which continuously gives simple serial data containing positional X & Y co-ordinates as to where a finger is touching the panel - as the finger moves, the data instantly changes. The X & Y information is given at an incredible matrix resolution of 1024 x 1024 positions over the entire screen size !! A host of available translation software enables direct connection to a PC for a myriad of applications including: control panels, pointing devices, PMS systems, controllers for the disabled or computer un-trained etc etc. Imagine using your finger with 'Windows', instead of a mouse !! (a driver is indeed available !!) The applications for this amazing product are only limited by your imagination!! Complete system including Controller, Power Supply and Data supplied at an incredible price of only: **£145.00 (B)**
Full MICROTOUCH software support pack and manuals for IBM compatible PC's £29.95 RFE - Tested

LOW COST RAM & CPU'S

INTEL 'ABOVE' Memory Expansion Board. Full length PC-XT and PC-AT compatible card with 2 Mbytes of memory on board. Card is fully selectable for Expanded or Extended (286 processor and above) memory. Full data and driver disks supplied. RFE. Fully tested and guaranteed. Windows compatible. **£59.95 (A1)**
Half length 8 bit memory upgrade cards for PC AT XT expands memory either 256k or 512k in 64k steps. May also be used to fill in RAM above 640k DOS limit. Complete with data.
Order as: XT RAM 4U, 256k. **£34.95 or 512k £39.95 (A1)**

SIMM SPECIALS	
1 MB x 9 SIMM 9 chip 120ns	Only £16.50 (A1)
1 MB x 9 SIMM 3 chip 80 ns	£19.50 or 70ns £22.95 (A1)
1 MB x 9 SIMM 9 chip 80 ns	£21.50 or 70ns £23.75 (A1)
4 MB 70 ns 72 pin SIMM - with parity-	Only £95.00 (A1)
INTEL 486-DX33 CPU	£55.00 INTEL 486-DX66 CPU £65.00 (A1)

FULL RANGE OF CO-PROCESSOR'S EX STOCK - CALL FOR EXT

FANS & BLOWERS

EPSON DO412 40x40x20 mm 12v DC	£7.95 10 / £65
PAPST TYPE 612 60x60x25 mm 12v DC	£8.95 10 / £75
MITSUBISHI MMF-D6D12D 60x60x25 mm 12v DC	£4.95 10 / £42
MITSUBISHI MMF-08C12DM 80x80x25 mm 12v DC	£5.25 10 / £49
MITSUBISHI MMF-09B12DH 92x92x25 mm 12v DC	£5.95 10 / £53
PANCAKE 12-3.5 92x92x18 mm 12v DC	£7.95 10 / £69
EX-EQUIP AC fans. ALL TESTED 120 x 120 x 38 mm specify 110 or 240 v. £6.95. 80 x 80 x 38 mm - specify 110 or 240 v. £5.95	
JMHOF B26 1900 rack mnt 3U x 19" Blower 110/240v NEW	£79.95

Shipping on all fans (A). Blowers (B). 50,000 Fans Ex Stock CALL

Issue 13 of Display News now available - send large SAE - PACKED with bargains!



ALL MAIL & OFFICES
Open Mon-Fri 9.00-5.30
Dept WW. 32 Biggin Way
Upper Norwood
LONDON SE19 3XF

LONDON SHOP
Open Mon - Sat 9.00 - 5.30
215 Whitehorse Lane
South Norwood
On 68A Bus Route
N. Thornton Heath &
Selhurst Park SR Rail Stations

NEW DISTEL ©
The Original
FREE On line Database
Info on 20,000 + stock items!
RETURNING SOON!

ALL ENQUIRIES
0181 679 4414
FAX 0181 679 1927

All prices for UK Mainland. UK customers add 17.5% VAT to TOTAL order amount. Minimum order £10. Bona Fide account orders accepted from Government, Schools, Universities and Local Authorities - minimum account order £50. Cheques over £100 are subject to 10 working days clearance. Carriage charges (A)=£3.00, (A1)=£4.00, (B)=£5.50, (C)=£8.50, (D)=£12.00, (E)=£15.00, (F)=£18.00, (G)=CALL. Allow approx 6 days for shipping - faster CALL. Sootland surcharge CALL. All goods supplied under Standard Conditions of Sale and unless stated guaranteed for 90 DAYS. All guarantees on a return to base basis. All rights reserved to change prices / specifications without prior notice. Orders subject to stock. Discounts for volume. Top CASH prices paid for surplus goods. All trademarks etc acknowledged. © Display Electronics 1996. E & O. 06/6

CIRCLE NO. 133 ON REPLY CARD

Analogue frequency doubler

Two comparators may be connected either a difference amplifier or to a summer to produce a frequency doubler or a variable-width output pulse.

Basic comparator operation in Fig. 1 shows the effect of reversing inputs, the arrangement in Fig. 2 producing, in response to a sawtooth input waveform, positive pulses at pins 1 and 7, the width of which depend on the rectangular V_{ref1} , V_{ref2} waveforms and V_{in} . Subtracting one from the other in the LM301 difference amplifier gives the output shown in Fig. 3.

Alternatively, connecting the comparator outputs to a summer combines the comparator outputs to give a pulse proportional to the input and reference voltages, variable from zero to 100%. Output spectrum is variable in this way, so that given harmonics may be eliminated or created by varying the reference voltages.

Kamil Kraus
Rokycany
Czech Republic
(A40a)

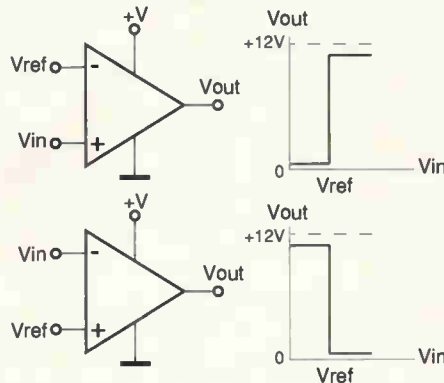

Fig. 1. Comparator output with rectangular wave applied to either of the inputs.

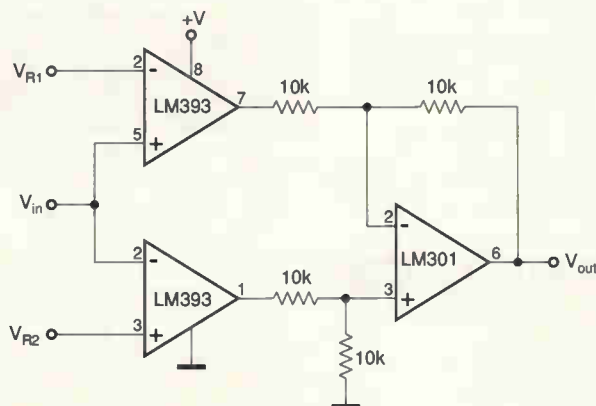

Fig. 2. Full circuit of frequency doubler. Replacing difference amplifier with summing amplifier produces a pulse variable in width from zero to 100% of the input.

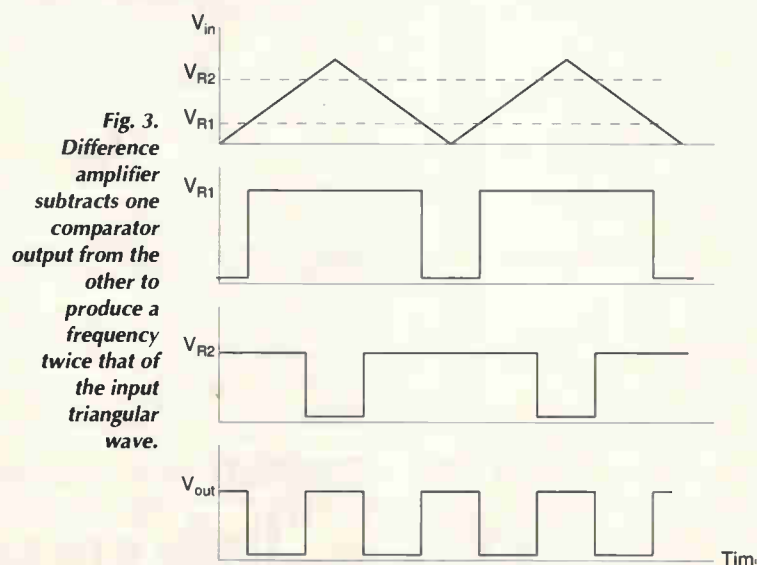

Fig. 3. Difference amplifier subtracts one comparator output from the other to produce a frequency twice that of the input triangular wave.

Input signal	Comment	LEDs			
		Red	Green	Orange	Yellow
[High level]	High	On	Off	N/A	N/A
[Low level]	Low	Off	On	N/A	N/A
[Transition low to high]	Transition low to high	On	Off	On	Off
[Transition high to low]	Transition high to low	Off	On	Off	On
[Single pulse]	Single pulse	Off	On	On	On
[Single pulse]	Single pulse	On	Off	On	On
[Pulsing]	Pulsing	Blinking	Blinking	On	On

Fast pulse capture/analysis

Needing to detect the presence of a single 1µs pulse, which was too fast for a logic analyser to see, I made the circuit shown here, which will show the presence of a pulse down to 10ns in width and also indicates the activity on a signal line.

Indication is by a series of leds. Logic high at the input causes the red led to illuminate, a low lighting the green one. Inverted and non-inverted versions of the input form clock signals for the two edge-triggered flip-flops; a low-to-high transition triggers the Q output at pin 5 to light the orange led, a high-to-low triggering the pin 9 Q output to illuminate the yellow led; a single pulse turns on both orange and yellow leds, the red and green indicating whether it is negative or positive going, as shown by the table.

Switch S_1 resets both flip-flops. Continuous activity on the line causes the red and green leds to flash.

Ken Yang
La Jolla
California
USA
A43

Using only two ics, this logic-level indicator will capture a single pulse of around 10ns in width and analyses the state of a signal line.

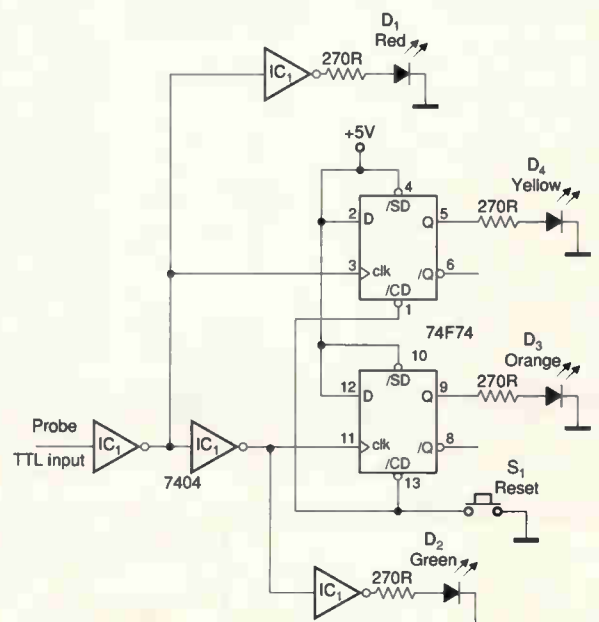

Micro Video Cameras

Direct from the sole authorised importer

- * **Wire up in minutes.** Only three connections – ground, +12V and composite video output for feeding straight to your Scart connector or monitor input.
- * **Tiny and lightweight.** Ideal for surveillance and security, the A-721 Micro-video camera pcb measures just 32 by 32mm. The complete camera weighs only 30g.
- * **Integral lens.** 3.6mm 5-element lens, interchangeable with our wide range of replacement lenses.
- * **Low cost.** The A-721 Micro-video camera costs just £65 – including VAT.
- * **Incredible low light performance.** The A-721 has a light sensitivity of < 0.1 lux (normal light).
- * **Reliable.** The A-721 is manufactured using state-of-the-art equipment and under strict quality control.
- * **Fast delivery mail order.** We endeavour to dispatch all orders same day.
- * **12 months guarantee.**

And more ... This is just a small sample of the huge range of Camera and Video Surveillance equipment we stock.

**Ring 0115 986 4902 now,
or fax us on 0115 986 4667**

* Prices include VAT but exclude carriage at £6.00 UK mainland



The A-721-S Micro-video camera with lens outputs composite video and costs just £65*/3 for £150



Priced at £125*/3 for £300, the PC-CAM colour camera is ideal for video conferencing and PC video digitising.



With the same performance as the A-721-S the A-721-P is optimised for use as a pin-hole camera and costs just £65*

NEW FULL COLOUR CATALOGUE AVAILABLE NOW

*** Free Catalogue ***

Send an A4 envelope with 1st class stamp marked 'Camera catalogue' to receive comprehensive data on our entire range of cameras and video surveillance equipment.

Anchor Supplies Ltd.

Callers are welcome at our massive showrooms on weekdays from 9am until 6pm and on Saturdays from 8am to 4pm. Anchor Supplies Ltd is at the Cattle Market in Nottingham, NG2 3GY (opposite Notts. County FC). Unlimited parking adjacent. Visit our web site: <http://www.anchor-supplies.ltd.uk> or send email to: sales@anchor-supplies.ltd.uk

CIRCLE NO. 134 ON REPLY CARD

TOROIDAL TRANSFORMERS

High Quality Low Prices

In addition to our standard range we will be pleased to quote for your special requirements.



PRICE LIST

VA	Mail Order	Quantity Price Excluding VAT & Carriage				
		2+	10+	25+	50+	100+
15	14.59	10.21	7.69	5.69	5.52	5.35
30	16.04	11.23	8.45	6.25	6.06	5.89
50	17.83	12.48	9.40	6.95	6.74	6.53
60	18.02	12.61	9.49	7.02	6.82	6.61
80	17.98	12.60	9.49	7.02	6.81	6.60
100	21.07	14.74	11.11	8.21	7.96	7.72
120	21.54	15.08	11.35	8.39	8.15	7.89
150	25.98	18.19	13.70	10.12	9.82	9.53
160	23.83	16.68	12.56	9.28	9.00	8.73
225	30.10	21.07	15.87	11.73	11.39	11.04
300	34.32	24.02	18.09	13.38	12.98	12.58
400	46.19	32.32	24.35	17.99	17.47	16.94
500	50.48	35.34	26.61	19.67	19.09	18.51
625	53.09	41.36	31.14	23.02	21.24	20.57
750	58.39	44.23	33.30	24.62	23.89	23.17
1000	78.80	55.16	41.54	30.70	29.80	28.89
1200	82.45	57.72	43.46	32.12	31.17	30.23
1500	105.10	73.63	55.40	40.94	39.74	38.53
2000	114.45	96.13	72.39	53.51	51.93	50.36
2500	163.04	114.13	85.94	63.51	61.64	59.79

These prices are for 240volt primary and two equal secondaries with 8" colour coded fly leads.

Each transformer is supplied with a mounting kit (steel dish washer pads, nut and bolt)

Mail order prices include vat and postage.

Please do not hesitate to telephone or write with your particular requirements.



Airlink Sales Co

16 Knight Street, Sawbridgeworth, Herts CM21 9AT
Tel: 01279 600139 Fax: 01279 726379

CIRCLE NO. 135 ON REPLY CARD

ADVANCED ACTIVE AERIAL



The aerial consists of an outdoor head unit with a control and power unit and offers exceptional intermodulation performance: SOIP +90dBm, TOIP +55dBm. For the first time this permits full use of an active system around the lf and mf broadcast bands where products found are only those radiated from transmitter sites.

- General purpose professional reception 4kHz-30MHz.
- -10dB gain, field strength in volts/metre to 50 Ohms.
- Preselector and attenuators allow full dynamic range to be realised on practical receivers and spectrum analysers.
- Noise - 150dBm in 1Hz. Clipping 16 volts/metre. Also 50 volts/metre version.

★ Broadcast Monitor Receiver 150kHz-30MHz. ★ Stabilizer and Frequency Shifters for Howl Reduction ★ Stereo Variable Emphasis Limiter 3 ★ 10-Outlet Distribution Amplifier 4 ★ PPM10 In-vision PPM and chart recorder ★ Twin Twin PPM Rack and Box Units. ★ PPM5 hybrid, PPM9 microprocessor and PPM8 IEC/DIN -50/+6dB drives and meter movements ★ Broadcast Stereo Coders ★

SURREY ELECTRONICS LTD

The Forge, Lucks Green, Cranleigh GU6 7BG
Telephone: 01483 275997 Fax: 01483: 276477
s.e@ndirect.co.uk www.ndirect.co.uk/~se/se.html

Precise mains voltage measurement

Having a need to display high-resolution mains voltage readings in the 190-250V ac range at the input of an uninterruptible power supply which has an 8-bit a-to-d converter, I had to convert the range into a 0.5-4.5V dc swing, that being the input range of the converter. In addition, I needed overvoltage and undervoltage warnings on a seven-segment display.

Ups output is transformed, full-wave rectified (the 6-0-6V transformer was handy) and passed through two second-order 15Hz filters. Output is adjusted to give 7V dc for a 190V ac input, the swing being 7-9.22V dc for the full 190-250 ac mains excursion.

This goes to a difference amplifier, of which the other input is 6.8V, so that the 0.2-2.4V swing, having been amplified by a factor of two, is within the limits of the a-to-d converter at B.

An out-of-range signal results from the action of the window comparator, which takes its input from B and has comparison levels of 4.9V and 0.4V, producing a logic 1 at the output when the input is within range.

Jayant Kathé
Bombay
India
(A33)

High-resolution mains voltage measurement in the 190-250V ac range, requiring a 0-5V dc output to an 8-bit a-to-d converter. Rest of the circuit is in range/out of range warning.

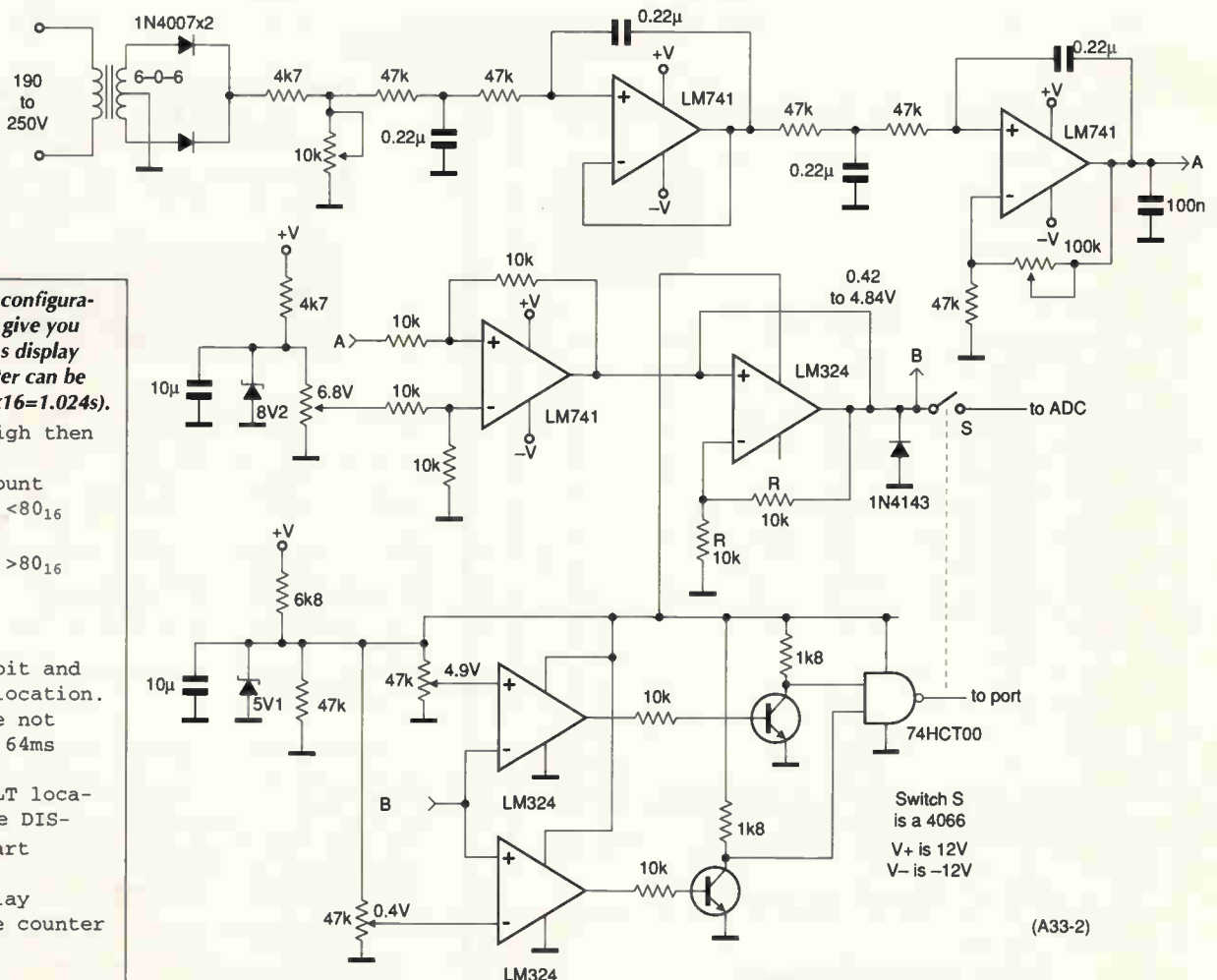
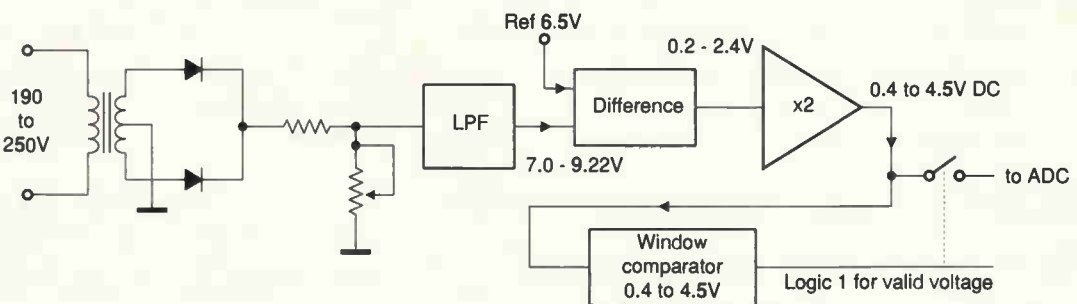

Software depends on the configuration, but this flow should give you some ideas. Assuming a 1s display update, an a-to-d converter can be taken every 64ms ($64ms \times 16 = 1.024s$).

- 1 If port pin is high then goto 6
- 2 Get stored ADC count
- 3 If I/P ADC count $< 80_{16}$
Display
- 4 If I/P ADC count $> 80_{16}$
Display
- 5 goto 1
- 6 Get ADC count
- 7 Right shift one bit and ADD to MAINS-VOLT location.
- 8 If 16 samples are not over than wait for 64ms goto 1.
- 9 Add the MAINS-VOLT location $_{16}$ value to the DISPLAY-DATA-TABLE start address.
- 10 Update the display
- 11 Reset the sample counter to 0 goto 1

(A33-2)

HOW DOES YOUR EQUIPMENT MEASURE UP? ???



PHILIPS PM3217 (This is a proper scope)
 Dual Trace 50MHz Delay Sweep Incl 2 Probes
 £400



HC3502
 Dual Trace 20MHz 5mV/20V/Div; 0.2 µ Secs - 0.5
 Sec/Div. X-Y; X5 magnifier; TV Sync etc
 Hardly Used £150 Un-used £200

THE CLASSIC TEKTRONIX 400 SERIES



468 Digital Storage Dual Trace 100MHz Delay £660
 466 Analogue Storage Dual Trace 100MHz Delay £395
 475 Dual Trace 200MHz Delay Sweep £500
 465 Dual Trace 100MHz Delay Sweep £400

FLUKE PM3082 2+2Ch 100MHz Delay TB Cursors £1200
 PHILIPS PM3296A Dual Trace 400MHz Dual TB Delay Cursors IEEE £1750
 TEKTRONIX 2456A 4 Trace 350MHz Delay Cursors etc £2300
 TEKTRONIX T54455 Dual Trace 100MHz Delay Cursors £900
 TEKTRONIX 2215 Dual Trace 50MHz Delay Sweep £400
 PHILIPS 3055 2+1 Ch 50MHz Dual TB/Div £475
 PHILIPS PM57 Dual Trace 50MHz SCOPEMETER Dig. Storage £600
 GOULD OS1100 Dual Trace 30MHz £200 With Delay £240
 GOULD OS3000 Dual Trace 20MHz £200

AND REMEMBER ALL OUR EQUIPMENT IS TESTED PROPERLY!



MARCONI 2019A Syn AM/FM Signal Gen 80MHz-100MHz £1800
 MARCONI 2029S AM/FM Signal Gen 80MHz-100MHz £1500
 MARCONI 2018 Syn AM/FM Signal Gen 80MHz-520MHz £800
 MARCONI 2017 AM/FM Signal Gen 100Hz-1024MHz £1750



FARNELL SSG520 Syn AM/FM Signal Gen 100Hz-520MHz £225
 FARNELL PSG520 Syn AM/FM Signal Gen 100Hz-520MHz Portable £450
 MARCONI 6311 Programmable Sweep 10MHz-200Hz £4500
 MARCONI 2029S AM/FM Signal Gen 10MHz-10Hz £2000
 H.P. 8656A Syn Signal Gen 0.1-999MHz £1500
 H.P. 8640S PhaseLock/Syn Sig Gen 500MHz-517MHz £750
 H.P. 8640A AM/FM Signal Gen 500MHz-1024MHz £850
 PHILIPS PM5193 Programmable Syn Func Gen 0.1MHz-50MHz £1900
 PHILIPS PM5192 Programmable Syn Func Gen 0.1MHz-20MHz £1000
 H.P. 3325A Syn Function Gen 21MHz £1250
 PHILIPS PM5134 Sweep Func Gen 0.001Hz-20MHz Sine/Sq/Tri etc £400
 PHILIPS PM5132 Sweep Func Gen 0.1Hz-2MHz Sine/Sq/Tri etc £250



CLASSIC AV08 Mk5 in Case FLUKE 770MM 3 1/2 digit with
 with Batteries & Leads £50 Carrying Case & Leads £60

RACAL COUNTERS
 9918 10Hz-560MHz £125
 9916 10Hz-520MHz £150
 9904 DC-50MHz £60

RACAL 1998 Counter 1.3GHz £650
 RACAL 1991 Counter/Timer 160MHz £450
 RACAL 1990 Counter 120MHz £300

SOLARTRON 7151 DMM 6 1/2 digit IEEE £450
 SOLARTRON 7150 DMM 6 1/2 digit IEEE £300
 True RMS

SPECTRUM ANALYSERS

H.P. 8565A 0.01-22GHz £3500
 H.P. 8590A 10MHz-1.8GHz 75 ohm £2750
 AILTECH 727 0.001-20GHz £1500
 H.P. 182 with 8559A 0.01-21GHz £3000
 H.P. 182 with 8558B 100kHz-1500MHz from £1500
 H.P. 3582A Dual Channel 25kHz £2000
 H.P. 141T with 8555A & 8552B 10MHz-18GHz £1500
 Other 141T Systems available



MARCONI TF2370-110MHz £700-£1000
 MARCONI TF2370 with TF2373 30Hz-1.25GHz £1600
 H.P. 8620C Sweep osc with 86290B 2-18GHz £1750
 H.P. 8620C Sweep osc with 86222B 0.01-2.4GHz £1750
 MARCONI TF2015 AM/FM Sig Generator 10-520MHz £150
 FARNELL DSG-2 Syn Osc 0.0001Hz-109.99Hz Sine/Sq/Sweep/IEEE £200
 GOULD J38 Sine/Sq Oscillator 10Hz-100kHz £150
 FARNELL LF1 Sine/Square Oscillator 10MHz-1MHz £75
 H.P. 8160A Programmable Precision Pulse Gen 50MHz £950
 MARCONI 2610 True RMS Voltmeter GPIB £500
 H.P. 3455A 6 1/2 digit Multimeter £700
 DATRON 1061A 1061A 6 1/2 digit True RMS with IEEE £800
 SOLARTRON 7081 7 1/2 digit Multimeter £1600
 EIP 371 Source Locking Microwave Counter 20Hz-18GHz £1500
 H.P. 5342A Frequency Counter 10Hz-24GHz £1750
 MARCONI 2440 Frequency Counter 10Hz-20GHz IEEE £1250
 MARCONI 2437 Universal Counter/Timer DC-100MHz Un-used £125
 MARCONI 2430A Frequency Counter 10Hz-80MHz Un-used £95
 H.P. 44275A Multi Frequency LCR Meter £3000
 H.P. 4261A LCR Meter £1250
 RACAL 9343M LCR Databridge IEEE £250
 MARCONI 2305 Modulation Meter 500kHz-2GHz £2250
 RACAL 9009 Automatic Mod Meter 30MHz-1.5GHz £250
 SAYROSA 252 Automatic Modulation Meter £150
 FARNELL AP100/30 PSU 0-100V; 0-30A Autorangeing £1000
 FARNELL H60/25 60V; 0-25A PSU £400
 FARNELL TSV70M42 70V 5A/35V 10A PSU £200
 THURLEY TSX1820 Precision PSU 18V 20A £275
 THURLEY TSP3222 Prog PSU 32V 2A Twice GPIB Digital £450
 THURLEY PL320 30V 2A Digital PSU with GPIB £150
 RACAL 9104 RF Power Meter 1MHz-1GHz 10mW-300W £325
 MARCONI 2167 RF Amplifier 50kHz-80MHz 10W 47dB Gain £50
 HUNTRON TRACKER Model 1000 in Carrying Case £125
 STABLOCK 4021 Radio Test Set £700

BIRD 43 ELEMENTS

Types SA, 10A, 100A, 5B, 10B, 100B; SC, 25C, 250C, 5D, 25D, 50D;
 100D; E25 each, 100H, 250H, 1000H; E35 each, 1000P E65

Used Equipment - GUARANTEED. Manuals supplied.

This is a VERY SMALL SAMPLE OF STOCK. SAE or Telephone for lists. Please check availability before ordering.
 CARRIAGE all units £16. VAT to be added to Total of Goods and Carriage.

NEW AND HARDLY USED



PANASONIC VP8177A FM/AM SIGNAL GENERATOR
 100kHz-100MHz; FM 0-100kHz; Output -19dB-99dB AM
 0-60%; 32 Preset Memory; Digital Display Frequency &
 Output.

Used £450 Un-used £750

PANASONIC VP7637A STEREO SIGNAL GENERATOR
 Generates Broadcast FM-RDS/ARI. Preset memory, GPIB
 Used £400 Un-used £700



KENWOOD FL180A WOW/FLUTTER METER 0.003%-10%; Freq
 3kHz/3.15kHz RMS/AVERAGE/
 PEAK; Weighted Filters; Digital
 Display of rpm; 4 digit Freq/
 Counter (0.01kHz-9.999kHz/
 0.01kHz-55kHz)

Used £400 Un-used £500



POWER SUPPLY Model HSP3010
 0-30Volts; 0-10 Amps Current
 Limiting, 2 Meters.
 Used £160 Un-used £200



GOODWILL GVT427 DUAL CHANNEL AC MILLIVOLTMETER
 10µV 300V in 12 Ranges
 Frequency 10Hz-1MHz
 Used £100 Un-used £125



GOODWILL GAG-808G AUDIO GENERATOR Sine/Square
 10Hz-1MHz in 5 Ranges 0.1%
 Low Distortion 5 Steps Output
 Attenuator Un-used £80



GOODWILL GFC 8010G FREQUENCY COUNTER Range 1Hz-120MHz 8
 Digit Display 15mV RMS Sensitivity
 Un-used £75

ANALOGUE MULTIMETER Model HC2670R AC/DC Volts, DC
 Current 10Amps; 17 Ranges; Continuity Buzzer; Transistor Tester
 Un-used £15

STEREO AUDIO BALANCE TO UNBALANCED CONVERTER
 for Car Radio Servicing Un-used £20

STEWART OF READING

110 WYKEHAM ROAD, READING, BERKS. RG6 1PL
 Telephone: (0118) 9268041. Fax: (0118) 9351696
 Callers Welcome 9am-5.30pm Monday to Friday (other times by arrangement)

CIRCLE NO. 136 ON REPLY CARD

AT STEWART OF READING THERE'S ALWAYS ROOM FOR IMPROVEMENT!

LOOK!

BRAND NEW OSCILLOSCOPES! NEVER USED!! LIMITED STOCK!!!



DMS 3850A Digital Storage/DMM
 Handheld LCD display 2 Channel 50MS/S. Auto
 Range. 4 digit DMM/Capacitance/Frequency
 Counter. Battery Operation or external 7.5-9VDC
 ie. AC Adaptor (Not supplied). RS232 Comes in
 Black Carrying Pouch complete with 2 scope
 probes; DMM leads; manual.
 New Boxed For Only £400



DTS 40 Digital Storage
 Dual Trace 40MHz. 20MS/S Storage. Cursors +
 On Screen Readout. Sweep Delay; Interface etc.
 etc. Supplied Unused in original box complete
 with 2 Probes & Manual.
 Amazing Value at £400

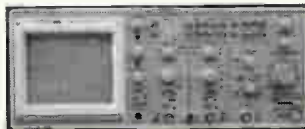

DTA 20/40/60 Dual Trace
 with Alt Magnification; TV Trig etc. etc. Lots of
 Specification.
 DTA20 Dual Trace 20MHz; £225
 DTA40 Dual Trace 40MHz - 12KV EHT; £300
 DTA60 Dual Trace 60MHz - 12KV EHT; £375
 All unused & boxed supplied with 2 probes &
 Manual



DTV 100 3 Channel 100MHz
 Sweep Delay etc; £425
DTV 60 3 Channel 60MHz
 Sweep Delay etc; £375
DTV 20 Dual Trace 20 MHz; £200
 All unused, boxed with 2 probes & manual



CIRCLE NO. 137 ON REPLY CARD

COMPONENTS & SYSTEMS FROM IOSIS

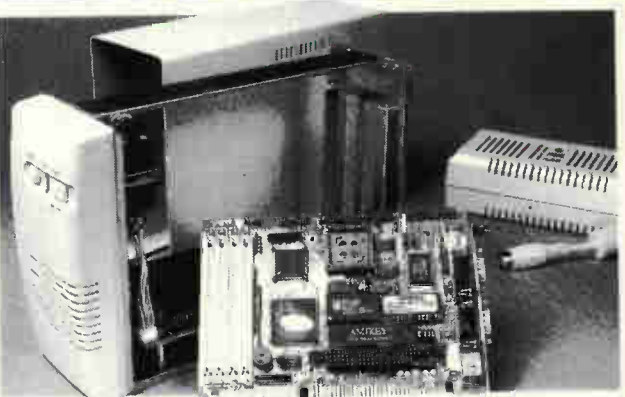

System Components from ISO9001 Source
 Half Size Single Board Computers
 386SX to Pentium with ISA and PC/104 Bus
 2 Serial Ports, IDE, FDD & Printer Port
 Flash/ROM Disc, Cache, SVGA CRT/Flat Panel Controller
 PC/104 Modules
 386 & 486 CPUs, Solid State Disc, Isolated RS232/485
 VGA CRT/Flat Panel Display & SVGA Controllers
 PCMCIA types I, II & III
 Fast SCSI, Ethernet, Fax/Modem
 System Enclosures with Passive Backplanes
 System Integration and Support
 All-In-One Standard Motherboards & Cases
 486/586 to 200MHz Pentium

4 Somerville Rd, St Andrews
 Bristol BS7 9AA
 Tel 0117 924 9231
 Fax 0117 924 9233
 Email:sales@iosis.co.uk



Details on our website <http://www.iosis.co.uk>

CIRCLE NO. 138 ON REPLY CARD

PIC listing on disk

Because the assembly language routine for the PIC would have taken up around four magazine pages we were unable to publish it. If you want a copy of this fully-annotated listing and the Excel spreadsheet shown, on 3.5in disk, send £10 to cover administration and copying to Electronics World's editorial offices, Quadrant House, The Quadrant, Sutton, Surrey SM2 5AS, with a clear note of what you are requesting and your address.

50/60Hz sine oscillator

A Wien-bridge oscillator is the obvious type of circuit to use for a vlf oscillator, providing a low-power, stable output while using low-voltage, low-current supplies – particularly if op-amps providing rail-to-rail output are used. However, the circuit shown offers good initial accuracy and low-frequency drift by virtue of the crystal clock oscillator, and amplitude stability. No adjustments or high-value precision capacitors are needed.

The R,2R ladder is driven by the logic-level i/o lines from a PIC microcontroller, data coming from a software look-up table. Resolution is to seven bits and amplitude 0.02V-2.61V. A 3-bit counter output is also available. High ladder resistance provides a light load for the logic outputs, although they are capable of much more current. The circuit takes 52µA as shown, and may be reduced by scaling up resistor values at the risk of increased emi.

At a standard clock frequency of 32.768kHz, output frequencies are 49.951Hz and 60.235Hz; to make these exact, the clock should be 32kHz. You can do this, at the expense of a higher quiescent current and a greater number of components, by using a 4.096MHz crystal and dividing it in, say, a 74HC4060 binary counter/divider to give exactly 32kHz.

MAX951 contains an op-amp, a comparator and band-gap reference, the op-amp and reference providing a 2.63V supply for the microcontroller and the comparator converting the microcontroller's msb to a 'phase' signal that goes high during positive half-cycles of the output.

As well as the look-up table for both frequencies, the

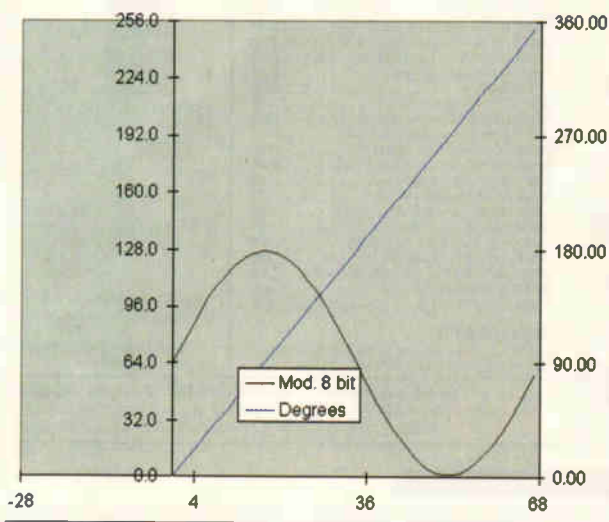

Begin and end of the Excel file, below, used to determine values in the PIC program illustrates how a spreadsheet can break the back of a digital design.

Address	Degrees	Angle	Mod. 8 bit	Rounded	PIC Instruction												
0	0.00	0.000	64.0	64	movlw 0x	C0	0	at 60Hz is	64.0	rounded to	64	Q	movwf port_b	:			
1	5.29	0.092	69.8	70	movlw 0x	C6	1	at 60Hz is	69.8	rounded to	70	Q	movwf port_b	:			
2	10.58	0.184	75.6	76	movlw 0x	CC	2	at 60Hz is	75.6	rounded to	76	Q	movwf port_b	:			
3	15.88	0.274	81.2	81	movlw 0x	D1	3	at 60Hz is	81.2	rounded to	81	Q	movwf port_b	:			
4	21.18	0.361	86.8	87	movlw 0x	D7	4	at 60Hz is	86.8	rounded to	87	Q	movwf port_b	:			
5	26.47	0.446	92.1	92	movlw 0x	DC	5	at 60Hz is	92.1	rounded to	92	Q	movwf port_b	:			
6	31.76	0.526	97.2	97	movlw 0x	E1	6	at 60Hz is	97.2	rounded to	97	Q	movwf port_b	:			
7	37.06	0.603	102.0	102	movlw 0x	E6	7	at 60Hz is	102.0	rounded to	102	Q	movwf port_b	:			
8	42.35	0.674	106.4	106	movlw 0x	EA	8	at 60Hz is	106.4	rounded to	106	Q	movwf port_b	:			
9	47.65	0.739	110.6	111	movlw 0x	EF	9	at 60Hz is	110.6	rounded to	111	Q	movwf port_b	:			
10	52.94	0.798	114.3	114	movlw 0x	F2	10	at 60Hz is	114.3	rounded to	114	Q	movwf port_b	:			
11	58.24	0.850	117.6	118	movlw 0x	F8	11	at 60Hz is	117.6	rounded to	118	Q	movwf port_b	:			
12	63.53	0.895	120.4	120	movlw 0x	F8	12	at 60Hz is	120.4	rounded to	120	Q	movwf port_b	:			
13	68.82	0.932	122.7	123	movlw 0x	FB	13	at 60Hz is	122.7	rounded to	123	Q	movwf port_b	:			
14	74.12	0.962	124.6	125	movlw 0x	FD	14	at 60Hz is	124.6	rounded to	125	Q	movwf port_b	:			
15	79.41	0.983	125.9	126	movlw 0x	FE	15	at 60Hz is	125.9	rounded to	126	Q	movwf port_b	:			
16	84.71	0.996	126.7	127	movlw 0x	FF	16	at 60Hz is	126.7	rounded to	127	Q	movwf port_b	:			

Address	Degrees	Angle	Mod. 8 bit	Rounded	PIC Instruction												
0	0.00	0.000	64.0	64	movlw 0x	C0	0	at 60Hz is	64.0	rounded to	64	Q	movwf port_b	:			
1	5.29	0.092	69.8	70	movlw 0x	C6	1	at 60Hz is	69.8	rounded to	70	Q	movwf port_b	:			
2	10.58	0.184	75.6	76	movlw 0x	CC	2	at 60Hz is	75.6	rounded to	76	Q	movwf port_b	:			
3	15.88	0.274	81.2	81	movlw 0x	D1	3	at 60Hz is	81.2	rounded to	81	Q	movwf port_b	:			
4	21.18	0.361	86.8	87	movlw 0x	D7	4	at 60Hz is	86.8	rounded to	87	Q	movwf port_b	:			
5	26.47	0.446	92.1	92	movlw 0x	DC	5	at 60Hz is	92.1	rounded to	92	Q	movwf port_b	:			
6	31.76	0.526	97.2	97	movlw 0x	E1	6	at 60Hz is	97.2	rounded to	97	Q	movwf port_b	:			
7	37.06	0.603	102.0	102	movlw 0x	E6	7	at 60Hz is	102.0	rounded to	102	Q	movwf port_b	:			
8	42.35	0.674	106.4	106	movlw 0x	EA	8	at 60Hz is	106.4	rounded to	106	Q	movwf port_b	:			
9	47.65	0.739	110.6	111	movlw 0x	EF	9	at 60Hz is	110.6	rounded to	111	Q	movwf port_b	:			
10	52.94	0.798	114.3	114	movlw 0x	F2	10	at 60Hz is	114.3	rounded to	114	Q	movwf port_b	:			
11	58.24	0.850	117.6	118	movlw 0x	F8	11	at 60Hz is	117.6	rounded to	118	Q	movwf port_b	:			
12	63.53	0.895	120.4	120	movlw 0x	F8	12	at 60Hz is	120.4	rounded to	120	Q	movwf port_b	:			
13	68.82	0.932	122.7	123	movlw 0x	FB	13	at 60Hz is	122.7	rounded to	123	Q	movwf port_b	:			
14	74.12	0.962	124.6	125	movlw 0x	FD	14	at 60Hz is	124.6	rounded to	125	Q	movwf port_b	:			
15	79.41	0.983	125.9	126	movlw 0x	FE	15	at 60Hz is	125.9	rounded to	126	Q	movwf port_b	:			

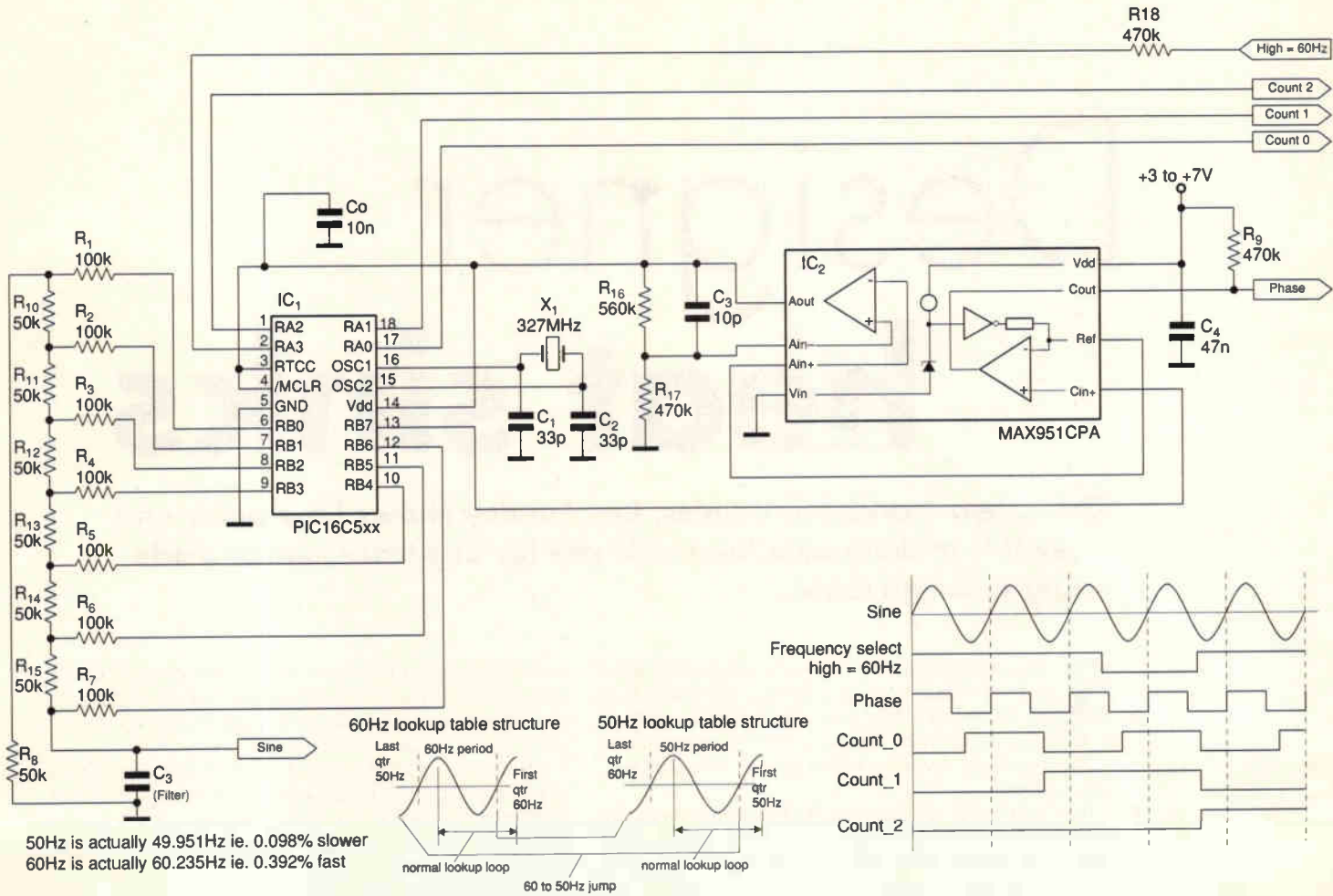

Microcontroller drives resistive ladder from a look-up table to produce an accurate sine output at selectable 50Hz or 60Hz frequencies, with a 3-bit period timer output and a sync. signal.

software produces a continuous wave train by repeatedly jumping from the end of the table to the start at the positive peak, ensuring a smooth 50-60Hz change by having a sequence of the last quarter-period of the other frequency. Changes occur at rising zero crossings, as happens in frequency-shift keying.

Tim Herklots
Maxim Integrated Products
Reading
Berkshire
(A42)

Lead-acid battery saver

When a lead-acid battery is flattened completely, it is little further use. This circuit, which is small enough to use in a battery pack, prevents such abuse, automatically disconnecting the battery if its voltage drops below 10V. It allows the occasional voltage drop caused by equipment drawing a high inrush current and also automatically connects the battery to a correctly applied charging voltage.

Starting from the condition when the relay is on, the battery voltage appears at the output terminals and the potential divider applies 0.81V to the transistor base, assuming battery voltage is more than 10V, the resulting base current turning it on and maintaining the relay.

Falling battery voltage reduces base current and eventually, at about 9.5V, the transistor turns off and the relay drops out, disconnecting the battery; the same result is brought about by the off button.

Starting from the odd condition, pressing the on button momentarily injects current into the transistor base and turns it on.

Daniel Greenspan
Jerusalem
(A44)

This protective circuit prevents lead-acid batteries completely discharging and is inexpensive and small enough to be used in the battery pack itself.

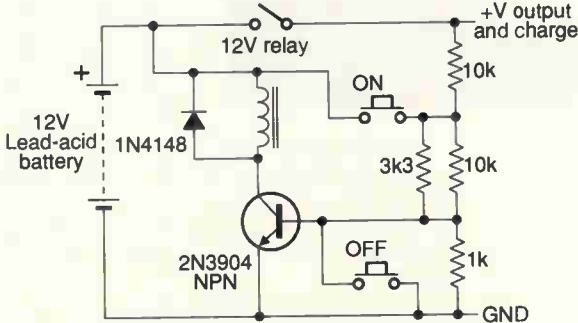

Designer heat sinks

Using two worked examples, Ray Fautley shows how quick and easy it is to determine heat sink size for any transistor or diode using a design table.

Semiconductor devices need to be mounted on metal panels of sufficient size and thermal conductivity to be able to conduct excessive heat away from the junction of the transistor or diode. This is necessary to prevent the temperature of the device's junction from exceeding its maximum rating.

The total thermal path between the device junction and the ambient temperature existing inside the case of the equipment is measured as a thermal resistance. It is referred to as $R_{th(j-amb)}$, or as $\theta_{(j-a)}$. This term that is easy to assess. You

only need to know three things. One is the maximum allowable junction temperature – which for most discrete silicon devices may be assumed to be about 200°C. Secondly you need to know the ambient temperature, which, inside electronic equipment is usually about 50°C, and finally you need to know the power dissipated in the semiconductor.

This total thermal path $R_{th(j-amb)}$ comprises three parts,

- The thermal path from device function to its case, $R_{th(j-c)}$, also called $\theta_{th(j-c)}$ or $R_{th(j-mb)}$.
- The thermal path between the case of the device and the heat-sink to which it is fitted, $R_{th(c-hs)}$, also called $\theta_{th(c-hs)}$.
- The thermal path between the heat-sink and the ambient temperature inside the equipment, $R_{th(hs-amb)}$, or $\theta_{(h-a)}$.

All of these three paths – and of course, the total path $R_{th(j-amb)}$ are measured in °C/W. This makes the total thermal path $R_{th(j-amb)} = R_{th(j-c)} + R_{th(c-hs)} + R_{th(hs-amb)}$.

The first of the three terms, $R_{th(j-c)}$, can be found in the data sheets provided by the manufacturer of the semiconductor device.

Path $R_{th(c-hs)}$ depends on the method used to mount the

transistor or diode to the heat-sink. In some cases the device may be mounted directly on to the heat-sink, but in others it may be necessary to provide some form of electrical insulation between the device and the heat-sink.

Unfortunately, electrical insulation also means some degree of heat insulation so a compromise is necessary. A thin mica washer can provide the electrical insulation. As the semiconductor's working voltage does not exceed a few tens of volts, a thick insulator is unnecessary.

Heat conduction is assisted by the use of silicon grease between the surfaces. Path $R_{th(c-hs)}$ can be considered to be between 0.1 and 0.7°C/W. In practice, a value of 0.4°C/W is usually acceptable for this term. This leaves the third term, $R_{th(hs-amb)}$, which needs to be evaluated.

Heat sink design steps

1. From the semiconductor data sheet, find $R_{th(j-c)}$ in °C/W.
2. Determine $R_{th(c-hs)}$ in °C/W. This value depends on the effectiveness of the thermal contact between the case of the semiconductor and the surface of the heat-sink. A value of 0.4°C/W will be a good enough approximation if the actual value is unknown.
3. Determine the power dissipated in the device,

(a) For power-amplifier transistors the power dissipated is,

$$P_D = P_{in} - P_{out} \\ = V_{ce} \times I_c - P_{ac}$$

(b) For rectifier diodes,

$$P_D = V_D - I_{ave}$$

4. Find,

$$R_{th(j-amb)} = \frac{T_j - T_{amb}}{P_D} \text{ in } ^\circ\text{C/W}$$

For silicon devices, maximum junction temperature T_j is usually 200°C, but to be safe it is better to design around 150°C. In some cases T_j may be specified lower than 200°C, so always check with the manufacturer's data before proceeding with the heat-sink design. Inside the equipment, the ambient temperature T_{amb} can be assumed to be 50°C.

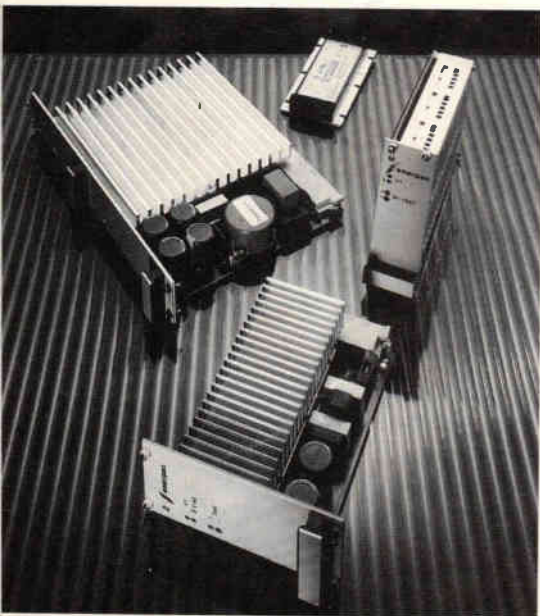

Ray Fautley, C Eng, MIEE

5. Determine,

$$R_{th(hs-amb)} = R_{th(j-amb)} - R_{th(j-c)} - R_{th(c-hs)}$$

6. The surface area of the heat-sink required to provide the necessary $R_{th(hs-amb)}$ can be found from Table 1.

A variation of the thickness of the heat-sink between 1mm and 5mm does not have very much effect. It is surface area that counts. These figures should provide adequate design margins.

Note that the surface areas in the table are for one side of the heat-sink only, the total surface area is thus twice the table figure – plus twice the thickness of the metal.

All heat-sink surfaces are assumed to be painted matt-black and mounted horizontally. Vertical mounting increases the cooling effect and adds a further margin of safety. But bright metal surfaces will need the figures of Table 1 to be increased by some 33%.

Note that the figures were arrived by experimentation. After comparing various results using different methods for arriving at the necessary surface area for the same value of $R_{th(hs-amb)}$, agreement was not 100%.

Design examples

These two worked examples should help clarify the design procedure for you.

Example 1. A rectifier diode, for which the manufacturer's data gives $R_{th(j-c)} = 5^\circ\text{C/W}$, has a forward voltage drop 1.0V when the average current through it – or dc load – is 5A. The maximum junction temperature T_j of the diode is given as 100°C . Inside the equipment that the rectifier is to be used in, the ambient temperature will be assumed to be 50°C .

Design procedure

1. $R_{th(j-c)}$ is known to be 5°C/W .
2. Assume that $R_{th(c-hs)}$ will be 0.4°C/W .
3. Power dissipated in the diode is,

$$P_d = V_d \times I_{ave} = 1.0 \times 5 = 5\text{W for a } T_j \text{ of } 100^\circ\text{C}$$

$$4. R_{th(j-amb)} = \frac{T_j - T_{amb}}{P_D} = \frac{100 - 50}{5} = \frac{50}{5} = 10^\circ\text{C/W}$$

$$5. R_{th(hs-amb)} = R_{th(j-amb)} - R_{th(j-c)} - R_{th(c-hs)} = 10 - 5 - 0.4 = 4.6^\circ\text{C/W}$$

6. Referring to Table 1 gives the following dimensions for a suitable heat-sink.
 For copper, 84cm^2 or $9.2\text{cm} \times 9.2\text{cm}$
 For aluminium, 100cm^2 or $10\text{cm} \times 10\text{cm}$
 For brass, 113cm^2 or $10.6\text{cm} \times 10.6\text{cm}$
 For steel, 128cm^2 or $11.3\text{cm} \times 11.3\text{cm}$

Example 2.

A BLW81 transistor is to be used as a vhf power amplifier to provide a cw output of 10W.

Design procedure

1. The thermal resistance from junction to case $R_{th(j-c)}$ is given by its manufacturer as 4.3°C/W .
2. Say R_{th} is 0.4°C/W .
3. Efficiency of the BLW81 is given as about 60% as a cw

Heat sink terms

Term	Description	Units
I_{ave}	Average current through diode	A dc
I_c	Transistor collector current	A dc
P_D	Power dissipated in transistor	W
P_{in}	Power input to device, dc	W
P_{out}	Output power – rf or af from transistor	W
$R_{th(c-hs)}$	Thermal resistance between device case and heat-sink	$^\circ\text{C/W}$
$R_{th(hs-amb)}$	Thermal resistance between heat-sink and T_{amb}	$^\circ\text{C/W}$
$R_{th(j-amb)}$	Thermal resistance between device junction and T_{amb}	$^\circ\text{C/W}$
$R_{th(j-c)}$	Thermal resistance between device junction and case	$^\circ\text{C/W}$
T_{amb}	Ambient temperature inside equipment	$^\circ\text{C}$
T_j	Maximum temperature of device junction	$^\circ\text{C}$
V_{ce}	Potential between collector and emitter of device	V
V_d	Voltage drop across diode at stated current	V dc

amplifier, so the input power for 10W output will be,

$$P_{in} = \frac{P_{out}}{0.6} = \frac{10}{0.6} = 16.7\text{W}$$

So,

$$P_D = P_{in} - P_{out} = 16.7 - 10 = 6.7\text{W}$$

$$4. R_{th(j-amb)} = \frac{T_j - T_{amb}}{P_D} = \frac{150 - 50}{6.7} = 14.9^\circ\text{C/W}$$

$$5. R_{th(hs-amb)} = R_{th(j-amb)} - R_{th(j-c)} - R_{th(c-hs)} = 14.9 - 4.3 - 0.4 = 10.2^\circ\text{C/W}$$

6. From Table 1, suitable heat-sinks are,
 For copper, 29cm^2 or $5.4\text{cm} \times 5.4\text{cm}$
 For aluminium, 35cm^2 or $5.9\text{cm} \times 5.9\text{cm}$
 For brass, 37cm^2 or $6.4\text{cm} \times 6.4\text{cm}$
 For steel, 130cm^2 or $11.4\text{cm} \times 11.4\text{cm}$

My thanks to Anglia Microwaves of Billericay, Essex for their help in providing semiconductor data. ■

Table 1. These figures give you the surface area in cm^2 for one side of the heat sink for a known value of

$R_{th(hs-amb)}$ $R_{th(hs-amb)}$ $^\circ\text{C/W}$	Material	Copper	Aluminium	Brass	Steel
1		734	—	—	—
1.5		342	—	—	—
2		220	376	477	—
2.5		175	277	302	711
3		135	187	210	338
3.5		116	149	175	222
4		94	120	150	165
4.5		85	102	115	132
5		70	83	90	109
6		53	68	72	82
7		41	61	63	66
8		37	55	58	61
9		33	39	44	47
10		29	35	37	41
11		26	30	33	36
12		24	29	30	32
13		22	27	29	30
14		20	25	26	27
20		14	17	18	20

COMPUTER ICs

TMS 9900NL-40 PULLS	£20 ea
MC8802 PROCESSOR	£2 ea
HD68HC009P8	£5
P8271 BBC DISC CONTROLLER CHIP EX EQPT	£25
2817A-20 (2K X 8) EPROM ex eqpt	£2
D41256C-15 256K X 1 PULLS	9 FOR £5
MK48202-20 ZERO POWER RAM EQUIV 6116LP	£4
USED 4184-15	£6p
BBC VIDEO ULA	£10
8051 MICRO	£1.25
FLOPPY DISC CONTROLLER CHIPS 1771	£16
FLOPPY DISC CONTROLLER CHIPS 1772	£17.50
27C4001 USED EPROMS	£4
27C2001 USED EPROMS	£2.50
1702 EPROM NEW	£8
2114 EX EQPT	£6p
6264-15 8K STATIC RAM	4416 EX EQPT 70p
Z80A SIO-C	£1.50
7126 3 1/2 DIGIT LCD DRIVER CHIP	£2 ea
2818A-30 HOUSE MARKED	£2
USED TMS2532JL	£2.50
HM6167L-P-8	2708 USED £2
8255-5	£6p
2114 CMOS (RCA 5114)	£1.40
WD16C550-PC UART	£1.80
ZN448J	£3
TC55257BP1-65L 32K 8-BRAM	£1.11
27C256-25 USED/WIPED	£2.50
TMS9995	£50

REGULATORS

LM338K	£8
LM323K 5V 3A PLASTIC	£3
LM323K 5V 3A METAL	£3
LM350K (VARIABLE 3A)	£3
78H12ASC 12V 5A	£5
LM317H T05 CAN	£1
LM317T PLASTIC TO220 variable	£1
LM317 METAL	£2.20
7812 METAL 12V 1A	£1
7805/12/16/24	30p
7905/12/15/24	30p
CA3085 TO99 variable reg	2/£1
78HGASC + 79HGASC REGULATORS	£30 ea
LM123 ST93 5V 3A T03 REGS	£3 ea
UC3524AN SWITCHING REGULATOR IC	60p
78L12 SHORT LEADS	10/£1
LM2950ACZ5.0	60p
STR451 SANKEN switch mode regulator	£10
78S05/78S24 2 amp TO-220	£1
78L05	5/£1

CRYSTAL OSCILLATORS

307.2KHZ 1M000000 1M8432 2M000 2M1432 2M304 2M4576 3M000	
5M000000 5M06800 5M760000 6M000000 6M1440 7M000000	
3M372800 7M5 8M000000 9M21810M000 10M0 12M000000	
14M318 14M3818 16M00 17M825600 18M000000 18M432 19M050	
19M2 19M440 20M000 20M0150 21M0676 22M1184 23M587	
24M000000 25M1748 25M175 25M1889 27M + 36M 28M322	
32M000000 32M0000 *SMOUNT 33M3330 35M4816 38M100	
40M000 41M639 42M000000 44M444 44M900 44M0 48M00000	
50M00 55M000 58M00920 64M000000 68M867 76M1 80M0 84M0,	
48M9152 71M429404 40M17904. £1.50 each	

CRYSTALS

32K788 1MHz 1M8432 2M000 2M1432 2M304 2M4576 3M000	
3M2788 3M4000 3M579545 3M58564 3M600 3M6864 3M93218	
4M000 4M190 4M194304 4M2056 4M33614 4M608 4M9152 5M000	
5M0989 6M000 6M041952 6M200 6M400 7M37280 8M000 8M06400	
8M448 8M863256 8M8670 9M3750 9M8304 10M240 10M245	
10M369 10M70000 11M000 11M062 11M88135 12M000 12M5	
13M000 13M270 13M875000 14M000 14M318 14M7450 14M7456	
15M000 16M000 17M8250 18M432 20M000 21M300 24M000	
25M000 28M995 27M045 RD 27M095 OR 27M145 BL 27M145	
YW 27M195 GN 28M4696 30M4696 31M4696 31M4696 34M368	
36M75625 36M75675 36M78125 36M79375 36M80825 36M81875	
36M83125 36M84375 36M900 48M000 51M05833 54M1918	
55M500 57M7416 57M7583 69M545 69M550 96M000 111M800	
114M8 48M9152 71M429404 40M17904 £1 ea	

TRANSISTORS

MPSA42	10/£1
MPSA92	10/£1
2N2907A	10/£1
BC477, BC488	10/£1
BC107 BCY70 PREFORMED LEADS	10/£1
full spec	£1 £4/100 £30/1000
BC238C, BC308B	£1/30 £3.50/100
2N2907 PLASTIC CROPPED	£1/15 £4/100
BC548B SHORT LEADS	£3/100 £20/1000

POWER TRANSISTORS

OC29	£2 ea
2SC1520 sim BF259	3/£1 100/£22
TIP 112/42B	2/£1
TIP 140F	£1
IRF620 TO-220 5A 200V MOSFET	2/£1
SE9301 100V 1DA DARL SIM TIP121	2/£1
BD680	4/£1
BUS48AP	£1
BUW13A	£2
2SC1556 900V 6A 120W	£3
2SD1397 npn TV/MONITOR O/P TRANSISTOR	£2

TEXTUOL FIBER SOCKETS

28 PIN USED	£3
ZIF 64 WAY SHRINK DIP SKT TEXTUOL 264-1300-00 1.78mm	
SPACING ON PCB WITH 4MHz RESONATOR	£10
SINGLE IN LINE 32 WAY CAN BE GANGED FOR USE WITH ANY DUAL IN LINE DEVICES . . . COUPLING SUPPLIED	2/£1.50

KEYTRONICS

TEL. 01279-505543
 FAX. 01279-757656
 e-mail keytronics@btinternet.com
 PO BOX 634
 BISHOPS STORTFORD
 HERTFORDSHIRE CM23 2RX
 http://www.btinternet.com/~keytronics

POWER FETS

IXFH75N10 75A 200V 20 Milli-ohm 200 WATT Ideal for UPS . . . £5	
IRFP450 500V 14A 0.4ohm 180 W	£2

SOLID STATE RELAYS

zero volts switching. Control volts 3.5V to 28V DC	
40AMP Dual	£20
50AMP 240V ac D2450-10	£18
80AMP 240V ac D240D80-10ep	£20
25AMP 240V ac	£10

MISCELLANEOUS

AAA NICADS HI CAPACITY 240mA/HR 3 CELL PACK	£3
XENON STROBE TUBE	£1.50
OPTO ICS also available TLP550 TLP666GF	
68 way PLCC SKT 100 available	£1 each
100 wa PLCC SKT 100 available	£1.50 each
1250pF POSTAGE STAMP COMPRESSION TRIMMER	£1
LM324 (Quad 741)	4/£1
MINIATURE FERRITE MAGNETS 4x4x3mm	10/£1
TL071 LO NOISE OP AMP	5 for £1
TL081 OP AMP	4 for £1
12 way di1 sw	£3 for £1
10NF 63V X7R PHILIPS SURFACE MOUNT 100K available	
SWITCHED MODE PSU 400 WATT UNCASED QTY. AVAILABLE +5V	£30/4000
5A, +12V 2A, 12V 500mA FLOATING	£9.95 (£2)

CMOS 555 TIMERS	2/£1
2/3 AAA LITHIUM cells as used in compact cameras	2/£1.50
PASSIVE INFRA RED SENSOR CHIP + MIRROR + CIRCUIT	£2 ea
EUROCARD 96-WAY EXTENDER BOARD	£10 ea
290 x 100mm	
DIN 41812 96-WAY A/B/C SOCKET PCB RIGHT ANGLE	£1.30
DIN 41812 96-WAY A/B/C SOCKET WIRE WRAP PINS	£1.30
DIN 41812 64-WAY AC SOCKET WIRE WRAP PINS	£1
DIN 41812 64-WAY AC PLUG PCB RIGHT ANGLE	£1
DIN 41812 64-WAY AB SOCKET WIRE WRAP (2-ROW BODY)	£1
BT PLUG + LEAD	3/£1
MIN. TOGGLE SWITCH 1 POLE c/o PCB type	5/£1
LCD MODULE sim. LM018 but needs 150 to 250V AC for display	
40 x 2 characters 182 x 35 x 13mm	£10
6-32 UNC 5/16 POZI PAN SCREWS	£1/100
NUTS	£1.25/100
PUSH SWITCH CHANGEOVER	2/£1
AMERICAN 2/3 PIN CHASSIS SOCKET	2/£1
WIRE ENDED FUSES 0.25A	30/£1
NEW ULTRASONIC TRANSDUCERS 32kHz	£2/pr
SMALL CYLINDRICAL MAGNETS	3/£1
SMALL MICROWAVE DIODES AE1 OC1026A	2/£1
D.I.L. SWITCHES 10-WAY E1 8-WAY 80p 4/5/6-WAY	80p
180VOLT 1 WATT ZENERS also 12V & 75V	20/£1
MIN GLASS NEONS	10/£1
MINIATURE CO-AX FREE PLUG RS 456-071	2/£1
PCB WITH 2N2846 UNIJUNCTION WITH 12V 4-POLE RELAY	£1
400 MEGOHM THICK FILM RESISTORS	4/£1
STRAIN GAUGES 40 ohm foil type polyester backed	
balco grid alloy	£1.50 ea 10+
ELECTRET MICROPHONE INSERT	2/£1
Linear Hall effect IC Micro Switch no 613 S54 sim RS 304-267	
	£2.50 100+ £1.50

1 pole 12V rotary switch	4/£1
AUDIO ICS LM380 LM386	£1 ea
555 TIMERS £1 741 OP AMP	6/£1
COAX PLUGS nice ones	4/£1
COAX BACK TO BACK JOINERS	3/£1
INDUCTOR 20µH 1.5A	5/£1
1.25 inch PANEL FUSEHOLDERS	3/£1
12V 1.2W small wire lamps fit most modern cars	10/£1
STEREO CASSETTE HEAD	£2
MONO CASE HEAD E1 ERASE HEAD	50p
THERMAL CUT OUTS 50 77 85 120°C	£1 ea
THERMAL FUSES 200°C/121°C 240V 15A	5/£1
TRANSISTOR MOUNTING PADS TO-5/TO-18	£3/1000
TO-3 TRANSISTOR COVERS	10/£1
PCB PINS FIT 0.1 inch VERO	20/£1
TO-220 micas + bushes	10/50p 100/£2
TO-3 micas + bushes	15/£1
POTS SHORT SPINDLES 2K5 10K 25K 1M 25M	£1
LM3352 10MV/decade	£1
LM2342 CONST. CURRENT I.C.	£1
BNC TO 4MM BINDING POST SIM RS 455-961	£1
MIN PCB POWER RELAYS 10.5v COIL 6A CONTACTS 1 pole c/o	£1
LCD MODULE 16 CHAR. X 1 LINE (SIMILAR TO HITACHI LM10)	£5
OP11264A 10KV OPTO ISOLATOR	£1.35 ea 100+ £1 ea
'LOVE STORY' CLOCKWORK MUSICAL BOX MECHANISM	
MADE BY SANKYO	£1 ea
Telephone cable clips with hardened pins	500/£2
10,000µF 16V PCB TYPE 30mm DIA x 31mm	2/£1
EA CHASSIS FUSED PLUG B-LEE L2728	3/£1
2A CERAMIC FUSE 1.25 inch OB	10/£1
48 WAY IDC RIBBON CABLE 100 FOOT REEL	£5 + CARR
20mm PCB FUSEHOLDER	5/£1
ASTEC MODULATOR VIDEO + SOUND UM1287	£2.25
BARGRAPH DISPLAY 9 RED LEDS	£1.50
NE567 PHASE LOCKED LOOP	2/£1
NE564	£1
TL084	4/£1
IR2432 SHARP 12 LED VU BAR GRAPH DRIVER	£1.25
10A CORCOM MAINS RFI FILTER EX. EQPT	£2 100 + £1.50
8 OHM MYLAR CONE LOUDSPEAKER 55mm DIA x 10mm	
DEEP	2/£1
AD592AN Temperature sensor TO-92 package with	
1.5m lead	2/£1
DC FANS 12V 50, 62, 80, 92mm	£5 each

A115M 3A 600V FAST RECOVERY DIODE	4/£1
1N5819 1A 60V SCHOTTKY wire ended	4 for £1
1N5407 3A 1000V.	6/£1
1N4148.	100/£1.50
1N4004 SD4 1A 300V.	100/£3
1N5401 3A 100V.	10/£1
BA158 1A 400V fast recovery	100/£3
BY25-4 600V 3A.	8/£1
6A 100V SIMILAR MR751	4/£1
1A 600V BRIDGE RECTIFIER	4/£1
4A 100V BRIDGE	3/£1

DIODES AND RECTIFIERS

6A 100V BRIDGE	2/£1
10A 200V BRIDGE	£1.50
25A 200V BRIDGE £2.50	10/£22
25A 400V BRIDGE £2.50	10/£1
BY297	4/£1
KBPC304 BRIDGE REC 3A 400V	4/£1
24A 200V double diode in T0247 case	
S24LCA20 fast rectifier	£1.25

6A 100V BRIDGE	2/£1
10A 200V BRIDGE	£1.50
25A 200V BRIDGE £2.50	10/£18
25A 400V BRIDGE £2.50	10/£22
BY297	10/£1
KBPC304 BRIDGE REC 3A 400V	4/£1
24A 200V double diode in T0247 case	
S24LCA20 fast rectifier	£1.25

SCRs

PULSE TRANSFORMERS 1.1..+1	£1.25
MEU21 PROG UNIJUNCTION	3/£1

TRIACS

2N6073 4A 400V.	3 for £1 100/£22
NEC TRIAC ACC8F 6A 800V TO220	5/£2 100/£30
TXAL225 6A 500V 5mA GATE	2/£1 100/£35
BTA 08-400 ISO TAB 400V 5mA GATE	90p
TRAL22300 30A 400V ISOLATED STUD	£5 ea
TRIAC 1A 800V TLC381T 16k AVAILABLE	5 FOR £1 £15/100

DIACS 4/£1

PHOTO DEVICES

HI BRIGHTNESS Leds COX24 RED	5/£1
SLOTTED OPTO-SWITCH OPCOA OPB815	£1.30
2N5777	90p
TL181 PHOTO TRANSISTOR	£1
TL38 INFRA RED LED.	5/£1
4N25, OP1252 OPTO ISOLATOR	80p
PHOTO DIODE 50P	6/£2
MEL12 (PHOTO DARLINGTON BASE n/c)	
LEDs RED 3 or 5mm 12/£1.	100/£55
LEDs GREEN OR YELLOW 10/£1	100/£55
FLASHING RED LED 5mm 50p	100/£40
HIGH SPEED MEDIUM AREA PHOTODIODE RS651-995	10/£1 ea
OPTEK OPB745 REFLECTIVE OPTO SENSOR	£1.50
RED LED - CHROME BEZEL	3/£1
OP1108 HI VOLTAGE OPTO ISOLATOR	2/£1
Narrow angle infra red emitter LED55C	£1
PD410PH Sharp photo diode RS 195-619	2/£1 100/£35
TLP371 opto isolator	3/£1

STC NTC BEAD THERMISTORS

G22 220R, G13 1K, G23 2K, G24 20K, G54 50K, G25 200K, RES 20°C	
DIRECTLY HEATED TYPE	£1 ea
FS228W NTC BEAD INSIDE END OF 1 inch GLASS PROBE RES	
20°C 200R	£1 ea
A13 DIRECTLY HEATED BEAD THERMISTOR 1k res. ideal for audio Wien Bridge Oscillator.	£2 ea

CERMET MULTI TURN PRESETS 1/4 inch

10R 20R 100R 200R 500R 500R 2K 2K2 2K5 5K 10K 47K 50K	
100K 200K 500K 2M.	50p ea

IC SOCKETS

14/16/18/20/24/28/40-WAY DIL SKTS	£1 per TUBE
8-WAY DIL SKTS	£2 per TUBE
32-WAY TURNED PIN SKTS	3 for £1
SIMM SOCKET FOR 2 x 30-WAY SIMMS	£1

TURNED PIN IC SKTS

14/18 PIN	4 for £1
18/20 PIN	4 for £1
24 PIN 0.3" and 0.6"	2 for £1
28/32 PIN	3 for £1
40 PIN	2 for £1

POLYESTER/POLYCARB CAPS

330nF 10% 250V AC X2 RATED PHILIPS TYPE 330	£20/100
100n, 220n 63V 5mm	20/£1 100/£3
10n/15n/22n/33n/47n/68n 10mm rad.	100/£3.50
10n/25V radial 10mm	100/£3
100n 600V Sprague axial	5 for £1
2µ 100V 15mm rad.	100/£10
10n/33n/47n 250V AC x rated 15mm	10/£1
1µ 600V MIXED DIELECTRIC	50p ea
1µ 0 100V rad 15mm, 1µ 0 22mm rad.	100/£5
0.22µ 250V AC X2 RATING	4/£1
0.22µ 900V	4/£1

RF BITS

FX3286 FERRITE RING ID 5mm OD 10mm	10 for £1
ASTEC UM1233 UHF VIDEO MODULATORS (NO SOUND) 1250	
STOCK	£1.50
MARCONI MICROWAVE DIODES TYPES DC2929, DC2962, DC4229F1/2	£1 ea
XTAL FILTERS 21M4 55M0	£1 ea
ALL TRIMMERS	3 for 50p
VIOLET	5-105pF
RED 10-110pF GREY 5-25pF SMALL MULLARD	
2 to 22pF	3 for 50p £10/100
TRANSISTORS 2N4427, 2N3866	80p ea
CERAMIC FILTERS 4M5/8/M9M/10M7	60p ea
FEED THRU CERAMIC CAPS 1000pF	10/£1
(BFY51 TRANSISTOR CAN SIDE)	
2N2222 METAL	5/£1
P2N2222A PLASTIC	10/£1
2N2369	5/£1
2N3866 + 2N4427	£1 ea
74N16 TACS CAR PHONE O/P MODULE	
EQUIV MHW806A-3 RF IN 40mW O/P8-8w 840-910MHz	

NEW PRODUCTS CLASSIFIED

Please quote "Electronics World" when seeking further information

ACTIVE

Discrete active devices

15W rf power. Ericsson's surface-mounted, *PTB20220* rf power transistor provides 15W of rf power in the 915-960MHz cellular radio band. It is a Class AB n-p-n, common-emitter device for pep and cw use, efficiency being 54% and power gain a typical 10dB at 15W. Ericsson Components AB. Tel., 01793 488300; fax, 01793 488301.

Efficient small-signal mosfets.

Using the company's high cell-density mos process, Motorola's new range of SOT 23-packaged, low- $r_{DS(on)}$ mosfets show a 50% power-loss reduction over earlier types. On resistances vary from 5 Ω at 10V in the 60V *MMBF170LT1* down to 0.085 Ω at 10V in the 20V *MGSF1N02LT1*. Four of the six new devices are n-channel types; two 20V p-channel devices give 0.1 Ω and 3.5 Ω at 10V. Motorola. 001 602 244 6108; fax, 001 602 244 4597.

Linear integrated circuits

High-power op-amp. *OPA547* by Burr-Brown is designed to drive a variety of heavy loads, such as motors and actuators, for use in power supplies or in audio amplifiers. It will take a single 8-60V supply or dual $\pm 4V$ to $\pm 30V$ lines and produces a continuous current output of 500mA. It is protected against excess temperature and current overload and there is provision for an accurate, user-set current limit of up to 750mA, not using a power resistor but by means of an indirectly sensed current, a limit pin accepting input from a potentiometer or d-to-a converter. Thermal shutdown is indicated by a status pin. Burr-Brown International. Tel., 01923 233837; fax, 01923 233979.

Hybrid 4kW pwm amplifiers. Apex Microtechnology *SA03/04* pwm amplifiers are for use in applications from motor control to low-frequency sonar, providing continuous current output up to 30A and handling an input voltage range of 16-200V; all circuitry is contained in hermetically sealed MO-127 power packages rated at temperatures in the -55°C to 125°C range. These devices accept analogue or digital input and switching frequency is 22.5kHz or, for lower frequencies, external oscillator

input is provided. Ashwell Electronics Ltd. Tel., 01438 364194; fax, 01438 313461.

Memory chips

4Kb SPI eeprom. *25C040* from Microchip is the newest member of the 8, 16 and 32Kbit Serial Peripheral Interface eeprom family, designed to interface directly with the SPI port of many microcontrollers, including PIC16CXX and PIC17CXX types. This 3MHz device has several security features, including user-selected write protection and up to 10 million erase/write cycles are guaranteed. A serial eeprom designers' kit is available. Arizona Microchip Technology Ltd. Tel., 01628 851077; fax, 01628 850259.

Non-volatile sram. In a single ic, the *STK 14C88* from Simtek, there is a fast 32K by 8-bit static ram with an access time of 25ns in the fastest version, backed up by a eeprom. By means of a function called Autostore, the device monitors the 5V supply and starts a backup cycle if power is switched off or low. If one cannot be sure that the supply will stay above 3.6V during the 10ms backup time, a 100 μ F capacitor can be used to hold it up. On reappearance of the power supply, the data is automatically copied back to the sram, this being possible at any time under the user's control. Pronto Electronic Systems Ltd. Tel., 0181-554-5700; fax, 0181-554-6222.

Motors and drivers

Ac motor power conversion. International Rectifier's series of *PowerRtrain* power conversion systems for ac motors is increased to handle 1.1kW (*IRPT2055*) and 5.6kW (*IRPT4052*) motors, each device containing all necessary circuitry to make motor drives and controls, with or without braking, in packages 75% smaller than competing types. Both types take 460V ac inputs, the former being in a chip-and-wire module and the latter a surface-mounted assembly on a metal substrate. Both include a board containing a driver with fault protection and shutdown facilities. A new brochure on *PowerRtrain* devices is available. International Rectifier. Tel., 01883 732020; fax, 01883 733410.

Optical devices

Dual-wavelength wdm transceiver. Using the company's active silicon integrated optical circuits technique

(ASOC), Bookham Technology's *BKM 2400* dual-wavelength transceiver, provides full duplex, single-mode, single-fibre, dual-wavelength operation on 1310nm and 1550nm at data rates of 155Mb/s or faster. It is meant for use in bidirectional networks such as point-to-point and passive optical networks for fibre-to-the kerb, fibre-to-the building and fibre-to-the-home. Transmission is on 1310nm and reception on 1550nm, a wavelength-dependent waveguide structure routing the signals to the appropriate circuitry. Bookham Technology. Tel., 01235 827200; fax, 01235 827201.

PASSIVE

Cameras

Camera chipset. Sony's *SS-1* three-chip set, together with a single colour ccd, forms a low-cost, light PAL/NTSC camera meant for use in security and multimedia. It carries out all ccd driving and signal-processing functions, working with Sony ccds from 0.2in, 180k-pixel types to 0.5in, 380k-pixel versions. A *CXD2163* signal processor has an 8-bit a-to-d converter, or a 9-bit or 10-bit converter may be used externally for better resolution, generates sync and luminance/chrominance processing for both standards. Both analogue and CCIR601-compatible digital output is available. Silicon Concepts Ltd. Tel., 01428 751617; fax, 01428 751603.

Passive components

Low-esr electrolytics. Sanyo *Poscap* surface-mounted electrolytics are for use in high-frequency power supplies, offering low equivalent series resistance and impedance; they use a conductive organic polymer for electrolyte. There are two versions: as examples, the AP (aluminium) 16V, 2.2 μ F capacitor has an esr of 120m Ω and 800mA rms ripple, while the tantalum TP 4V, 220 μ F handles ripple current of 1.2A rms and has an esr of 80m Ω . Semicom UK Ltd. Tel., 01279 422224; fax, 01279 433339.

Membrane pots. *M-POT 890* is part of a range of membrane potentiometers developed by CTS Corp., in which the resistive layer is formed by a carbon deposit on a substrate providing a resistive

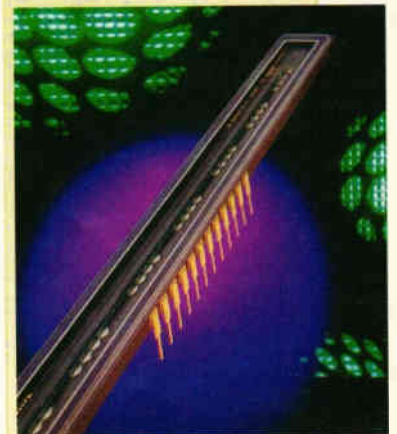

Linear document reader. A colour ccd linear sensor for A4 image scanners is announced by Sony. *ILX734K* is a reduction-type sensor having a shutter for each colour and, with 8 μ by 8 μ pixel size, has 31500 effective pixels to read an A4 document at 1200dots/in, anti-reflection coating on the lower glass reducing unwanted signals. The sensor is contained in a 24-pin dip, requires 12V and a 5V clock pulse. Sony Semiconductor Europe. Tel., 01256 478771; fax, 01256 818194.

gradient between the ends. A slider on the top surface connects conductive and resistive layers to vary the resistance from zero to over 500k Ω . These devices are immune to the effects of humidity and static discharge to 18kV. Thickness is 2mm. Quiller Switches Ltd. Tel., 01202 436777; fax, 01202 421255.

Audio products

MPEG2 decoders. Philips has announced a family of multi-channel audio decoders to the MPEG2 standard for use with DVD-Video players, set-top boxes, multimedia pcs and the rest. The first to emerge is the *SAA 2503* decoder, which provides a down-mix of the datastream and so enables 5+1 (5 main speakers and an lf one) or 7+1 (7 and the lf) to be preserved when heard as a stereo output; this would not be the case without this chip, as the additional audio information in MPEG2 would be lost and the MPEG1 data only heard. For this reason, MPEG standards are reverse

Please quote "Electronics World" when seeking further information

and forward compatible. Further chips in the family, to the AC-3 standard for NTSC, will appear later, as will dual-standard devices. Philips Semiconductors (Eindhoven). Tel., 00 31 40 2722091; fax, 00 31 40 2724825.

Connectors and cabling

Thin s-m connectors. Up to 30 contacts are possible within a mounted height of only 2mm in the JAE LZ Series of wire/board connectors. Pitch is 1.25mm and there is a polarising key to prevent misalignment. Current rating is 1A and dielectric strength 500V ac. Flint Distribution. Tel., 01530 510333; fax, 01530 510275.

Surface-mounted coax connectors. Transradio's MMT series of s-m coaxial connectors provide very low vswr, low insertion loss and good shielding. There are models for use at frequencies from zero to 6GHz and a designers' kit and an extraction tool are available. MMT connectors consist of a s-m receptacle, mating with a right-angled plug, the receptacle having a male centre contact. The plug is nickel-plated, die-cast, and has a crimp ferrule, being suitable for cable types including RD316 double-screened 2.6mm diameter cable, RG174 and RG178 types. Receptacles are stamped and formed and has a gold-plated body and centre contact, standing 6.8mm off the board. Transradio Ltd. Tel., 0181-997-8880; fax, 0181-997-0116.



Vibrators. Vibrator motors by Copal, intended for use in mobile telephones and pagers, use gold commutators to avoid the need for grease and to prolong their life - around 1000h continuous. LA series motors are 6mm in diameter, from 19.1mm to 22.8mm long and run at speeds from 5700rev/min to 7700rev/min, all being rated at 1.3V. Eccentric tungsten weights provide the vibration. A recent introduction is a motor for 5mm card pagers, measuring 5mm by 4.2mm by 22mm. electronic Ltd. Tel., 01993 778000; fax, 01993 772512.

Displays

RGB dot-matrix led module. The American company Lumex announces a 5-by-7 dot-matrix RGB array of leds, 2.09in high. There are three leds per dot, giving a minimum of 300mcd at 10mA in blue and a viewing angle of 100°. Each colour of every dot may be addressed either individually or collectively and response time is short enough for fast animation. Dots are 0.3in diameter on 0.3in centres, two rows of 11 pins on the back, in 0.1in pitch being suitable for pcb mounting. Non-standard sizes or patterns can be made to order. Lumex Opto/Components Inc. Tel., 001 847 359-2970; fax, 001 847 359-8904

Filters

Drive-bay signal conditioners. Kemo has a range of active filters and signal conditioners that fit into the 5.25in floppy drive bay, which is now usually little used. Benefits of this type of mount are that screening is much better than when mounted in a card slot, and that the larger space allows better layout; filtering, too, is independent of the computer type and operating system. The Model 100 range has front-panel BNC connectors for inputs and cabling at the rear to connect the relevant data acquisition card. Signal conditioning may be computer-controlled or manual, the latter having front-panel switches to set functions. Kemo Ltd. Tel., 0181-658-3838; fax, 0181-658-4084.

Hardware

Desiccators. Brownell has a range of desiccators designed to eliminate humidity and condensation inside equipment housings. They are small polycarbonate mouldings in two types: one uses silica gel for general use, the other having molecular sieves for use with optical and laser equipment. Both types protect enclosures with volumes up to 100l, the type selected depending on volume and IP rating or equivalent. Each unit has a saturation indicator to show the need for reactivation or replacement. Brownell Ltd. Tel., 0181-965-9281; fax, 0181-965-3229.

No-tooling enclosures. K Box, a new division of Boss, has a new method of making low-cost plastic enclosures that need no tooling and are designed to order. They are made entirely of flat sheet material, so that no moulding or forming is needed and prototypes are available in a few days, modifications being easily accommodated. The cases can be produced in several materials in 2-10mm thickness, may be internally coated for shielding and designed to take rough handling. Boss Industrial Mouldings Ltd. Tel.,



01638 716101; fax, 01638 716554.

Access to bgas. Difficulties in attaching probes to ball-grid arrays for test purposes are eliminated by the adaptors now produced by Winslow International. They consist of a solder-down module to suit any device with a square matrix down to 1mm pitch (interstitial), using a hard-ball process with pins coming from the top, for which any interface arrangement can be supplied. Winslow International Ltd. Tel., 01874 625555; fax, 01874 625500.

Test and measurement

Analogue oscilloscope. Hitachi's V-252 20MHz, dual-channel oscilloscope is claimed to be the best value for money and, since the information supplied says it costs £0000, there is no arguing with that. Unfortunately, further enquiry reveals a price of £435, which is still pretty good; its warranty lasts three years. Y sensitivity is 1mV/div using x5 magnification and timebase speed a maximum of 0.1µs/div with a 10x magnifier. All the usual X and Y facilities are provided, as are accessories including a viewing hood, although an electrostatic charge repellent blue screen filter helps with high ambient light levels. Hitachi Denshi (UK) Ltd. Tel., 0181-202-4311; fax, 0181-202-2451.

Accessible oscilloscopes. While sacrificing nothing in the way of performance, Hewlett-Packard has reduced the resemblance of digital storage oscilloscopes to 747 flight decks, so that the new *Infinium* family of instruments looks rather more like a 'real' oscilloscope, with controls like the older, purely analogue types. Even so, with bandwidths to 1.5GHz, sampling rates to 8Gsample/s and memory depths up to 64K/channel, these are top-end instruments. A Windows '95-based graphical user interface eases access to advanced

400MHz dso. The Tek TDS380 digital storage oscilloscope is the fastest in the TDS300 series, sampling at 2Gsample/s and having a bandwidth of 400MHz. It is able to collect enough samples to show waveforms at full bandwidth to make single-shot acquisitions at timebase speeds to the maximum of 1ns/div, the high-speed sampling also reducing aliasing. There are 21 automatic waveform measurements and the four acquisition modes of sampling, peak detection, envelope and average with, in addition, live FFT analysis. A package called Option 14 provides GPIB and RS232-C interfaces, a VGA monitor and a Centronics port, all for remote control of the instrument from a pc. Waveforms displayed may be saved in TIF, PCX, BMP and EPS file formats. Thurlby Thandar Instruments Ltd. Tel., 01480 412451; fax, 01480 450409.

features via dialogue boxes and icons and an information system gives a guide to measurements of noise and jitter, to setting up advanced facilities such as FFTs and other, even basic procedures. Hewlett-Packard Ltd. Tel., 01344 366666; fax, 01344 362269.

Emissions testing. Laplace has added two new facilities to its 1.1GHz emc emission test SA1000 hardware and software, addressing problems of test site anomalies and widespread unfamiliarity with the subject. Ideally, test sites should be open, free of reflections and using a 4m mast, a set of conditions that is rarely met. The new software automatically corrects for test site errors. To take account of unfamiliarity with the process, the software now includes the

Please quote "Electronics World" when seeking further information

TestDirector mode, essentially an expert system that guides the user in the procedure. Laplace Instruments Ltd. Tel., 01692 500777; fax, 01692 406177.

Oscilloscope/recorder. Yokogawa's *DL708* is the first in a series of instruments that combine the capabilities of oscilloscopes and recorders, costing less than either of similar performance. Display is on a 10.4in colour tft screen and there is a built-in thermal printer for hard copy. Data can be saved on the 1.2Gbyte hard disk or on a 3.5in floppy, the drive also being built in. There is a number of signal-conditioning modules, with bandwidth to 2MHz and 16-bit resolution, and up to eight channels may be plugged into the mainframe for simultaneous capture or recording. Analysis comprises voltage measurement, timing and FFT and waveforms can be analysed in terms of overshoot, period, standard deviation and rise time. Martron Instruments Ltd. Tel., 01494 459200; fax, 01494 535002.

Recorder with memory. The Hioki Model 8806 400ksample/s memory recorder is a battery-powered, two-channel recorder that uses pc

Inrush protection. Joyin JNR thermistors are ntc metal-oxide ceramic types capable of suppressing inrush currents up to 12A in power supplies, lighting and in motor starting circuitry. They are available in cold resistances of 0.7 Ω to 220 Ω , maximum hot resistance being down to 32m Ω . Five body sizes and characteristics can be had, from the 10mm diameter JNR08 to the 25mm JNR20, with time constants of 36s to 115s. Anglia. Tel., 01945 474747; fax, 01945 474849.



sram cards to extend its capacity and to allow data to be analysed on the pc, operating in both recorder and memory modes. It will handle two analogue inputs and two logic signals, which are displayed on a 5in screen and printed immediately or saved for later printing. Telonic Instruments Ltd. Tel., 01734 786911; fax, 01734 792338.

Surface resistance tester. *SRM100-3/B* from Practical Power checks surface resistivity in the 10-100V range and displays the result on an analogue panel meter. It uses a single 2.5kg weight with a square probe and conforms to BS EN100015, has CE marking and EMC approval. Practical Power Ltd. Tel., 0118 9699170; fax, 0118 9699171.

Three data recorders. Gould has introduced three new recorders. *DL250* performs the functions of data logging, multipoint recording, alarm annunciation and digital indication and is available in 16-64 input form, any combination of thermocouples, rtds, current and voltage being simultaneously monitored. RS232 or RS485 communication is provided. With up to 15 channels, the *DL100* is a 100mm type having four direct inputs for mV, V and mA input and a variety of thermocouples and rtds, inputs being scalable for linear, square root and/or log. characteristics. Finally, the *Digigraf* is a paperless recorder for six channels, a 16-bit a-to-d converter giving good resolution; data points are stored in a buffer for display, alarm, calculation or archive. Many maths functions are available and results are displayed on a 5in colour lcd with touchscreen menus. Gould Instrument Systems Ltd. Tel., 0181-500-1000; fax, 0181-501-0116.

Curve tracer. Hameg's *HM6042* semiconductor curve tracer is simple to use, is suitable for the testing of two and three terminal devices and gives an on-screen display of five curves, with additional information on an lcd. The five displayed curves indicate base voltage, base current, collector current, collector voltage and beta, characteristics of the device under test being entered by means of a front-panel keypad. A power limiter prevents damage to the device. Sets of curves may be stored in memory to ease comparison with other devices. Feedback Test and Measurement. Tel., 01892 653322; fax, 01892 663719.

Interfaces

Eight-channel driver Ic. Allegro offers the *UDN2987LW*, designed as an interface between standard low-level logic and higher-power devices such as relays, motors and lamps. It is in a 20-pin, wide-body soic

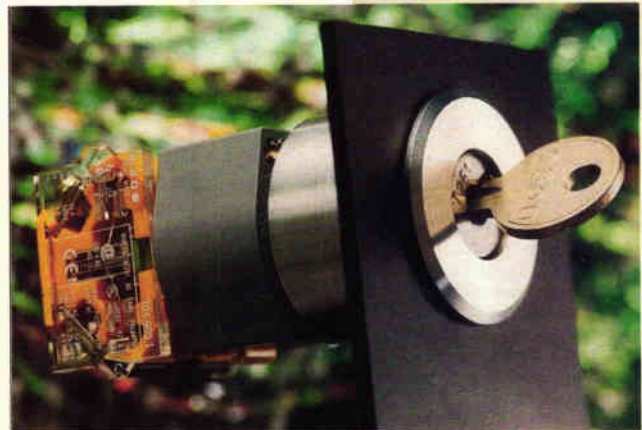

and has thermal shutdown and output transient protection with clamp diodes for use with sustaining voltages up to 35V. Each channel has a latch to turn the channel off in the presence of excessive current, all channels being turned off in thermal shutdown, either condition being indicated by a common fault output. All outputs produce over 100mA continuously and inputs handle 5V and 12V logic, including ttl, Schottky ttl, dtl, pmos and cmos. Allegro MicroSystems Inc. Tel., 01932 253355; fax, 01932 246622.

Literature

Burr-Brown CD-ROM catalogue. On one CD-ROM, Burr-Brown has collected the data from two 1300-page data books of analogue and mixed-signal devices and an applications handbook, together with search facilities. It is free and can be obtained by e-mail on cd-rom@burr-brown.com, from the website on <http://www.burr-brown.com/> or from Burr-Brown International. Tel., 01923 233837; fax, 01923 233979.

Rf transistors. Two catalogues from Ericsson on rf power transistors describe around 100 devices, ranging from 0.25W to 175W at frequencies from 300MHz to 2.2GHz, in both ldmos and bipolar types and contained in flange and surface-mounting packages. One of the publications is a short listing with a selection guide, while the other is a 350-page data book. Ericsson Components AB. Tel., 01793 488300; fax, 01793 488301.

DC-to-dc converters. Power Convertibles offers a six-page selector, giving details of the company's modules in the 0.75W to 100W range, including the new, low-cost 2W and 3W types. Those models in the 0.75-5W area are isolated-output types in s-m and sip/dip packages, providing 5V, 9V, 12V and 15V, while the *WFC02R* and *WFC03R* 2W and 3W models are

Keylock switches. New two and three-position, flush-mounted keylock switches in EAO-Highland's 04 family for use in control gear are tamper-proof and easy to clean. They fit a 30.5mm diameter hole and protrude a mere 2mm from the panel. Switches are sealed to IP65 and are rated at 500V, 10A, each being fitted with up to four snap-action, tactile contact blocks with plug-in screw terminals and a choice of silver or gold-on-silver contacts. EAO-Highland Electronics Ltd. Tel., 01444 236000; fax, 01444 236641.

lower in cost and are 81% efficient, in 32mm by 20mm by 10mm packages and 24-pin dils. There are also 8000V isolation types with output noise down to 1mV pk-pk. Power Convertibles Ireland Ltd. Tel., 00353 61 474133; fax, 00353 61 474141.

Power supplies

100W power supply. Weir Lambda's new *Excel 100* is a 100W, four-output, convection-cooled supply for general-purpose use. It meets EN61000-3-2 but is available without power-factor correction for those applications in which it is not needed, in which case it costs less. It stands 42mm high without its cover (43mm with) and fits a 1U rack. As standard, outputs are three positive and a common zero, in a variety of arrangements. Input is 85-127V and 170-254V. Weir Electronics Ltd. Tel., 01243 865991; fax, 01243 868613.

60W dc-to-dc converters. The *PKG 2000 I* family of 11mm high converters by Ericsson have a power density of 20W/cm³, working at an efficiency of more than 84%. The units are intended for use in decentralised 24V dc systems and accept inputs of 18-36V, turning off at 16V. *PKG 261 I* provides one output of 5V at 12A, the

Please quote "Electronics World" when seeking further information

PKG 2623 giving two of 12V at 4A, and all can be connected in parallel or series. If forced convection cooling is applied, the units need no heat sink up to 60°C. Acal Electronics Ltd. Tel., 01344 727272; fax, 01344 424262.

Radio communications products

Full duplex wlan chipset. Harris's *Prism 8-chip* set forms a full duplex, heterodyne radio transceiver with agc and carrying voice and data for use in wireless lans, point-to-point microwave, hand-held data transceivers and personal communications. It operates in the 1.7-2.7GHz band and carries out all necessary functions of amplification, up/down conversion and modulation/demodulation. Receiver sensitivity is -11dBm and agc range 90dB. Harris Semiconductor UK. Tel., 01276 686886; fax, 01276 682323.

PLL synthesisers. Vari-L *PLL300/400* series of phase-locked loop synthesisers for mobile communications, industrial use and wireless modems use a patented single-ended voltage-controlled oscillator for very low phase noise, low harmonic content and stability. The devices contain all necessary circuitry, including programmable dividers, phase detectors and loop

filter to make a complete circuit. There are frequency-agile devices, requiring serial programming and fixed-frequency units, with or without programming. In 13 variants, centre-frequency coverage is 755-992MHz, swinging ±15MHz, and two units of 2150MHz and 2450MHz centre frequency swinging ±50MHz. Acal Electronics Ltd. Tel., 01344 727272; fax, 01344 424262.

Protection devices

600W transient suppressors. Surface-mounted components from Semitron, using the glass passivated TVS diode technique as the axial-lead types, are now available. *SMB Series* transient suppressors have large contacts to handle fast rising pulses caused by lightning, inductive switching and esd and are rated at 600W during a 10x1000µs double exponential waveform. Fast turn on, a low clamping factor and low on impedance make them suitable for the protection of cmos ics, the surface-mounted form with its lower lead inductance leading to an application on high-speed, low-voltage data lines. Voltage stand-off range is 5-170V, clamping to 9V taking place in under 1ps. The devices are unidirectional or bidirectional; in the forward direction the SMB series sustains 100A for 8.3ms. Surtech Distribution Ltd. Tel., 01256 840055; fax, 01256 479785.

Fused resistor networks. Ericsson offers the *PBR53001/1* and *PBR53201/1*, which protect telecommunications line cards against induced voltages or direct shorts from underground power lines; they have integral thermal fuses and open safely when temperature in the device is greater than 240°C for 20s, protecting the pcb from melting or charring and reducing the risk of fire. Sustained overvoltage causes the resistive elements to crack and open, the fuses taking care of slow-burn conditions caused as above. Resistances are 50Ω and 20Ω respectively, matched to within ±0.5%. Ericsson Components AB. Tel., 01793 488300; fax, 01793 488301.

Switches and relays

Pcb switches. A new range of tactile, sealed switches for board mounting are 12.5mm square and allow keyboard layouts to be designed on a 12.7mm grid. All models in the Secme *Cosmos* range are proof against dust, splashing, wave soldering and cleaning solvent and are provided with removable covers in various shapes and colours. Silver or gold-plated dome contacts are used and the switches can have a red, green or yellow led. Ratings are 24V, 125mA, the gold ones switching down to 500µA. Insulation at 100V is over 1GΩ. Hawnt Electronics Ltd. Tel., 0121-784-3355; fax, 0121-783-1657.

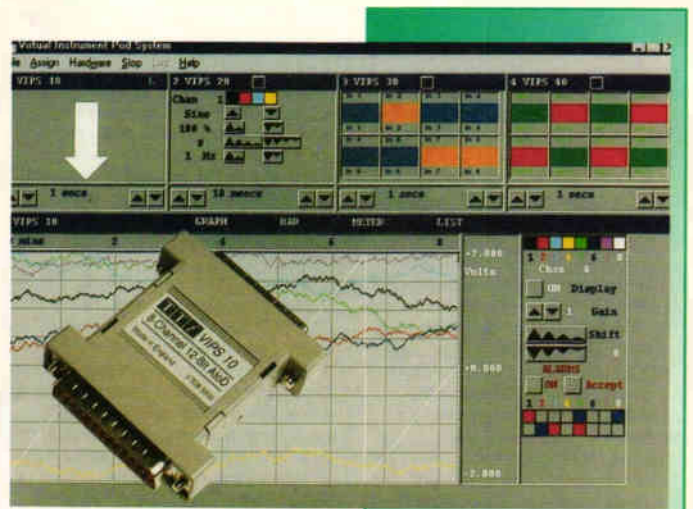

Transducers and sensors

Digital thermometer. *DS1624* from Dallas is a direct-to-digital temperature sensor having 256byte of eeprom on-chip to store temperature-related compensation information, eliminating the need for an external eeprom or the use of a microcontroller's memory; no external components at all are needed. It is chiefly intended for use in crystal compensation, in which the eeprom contains data on the frequency/temperature curve of the crystal. Temperature information is in the form of a 13-bit, two's-complement word, equivalent temperature measurement being in the -55°C to 125°C in 0.03125° steps, which Dallas says is the smallest available. Supply is 2.7-5.5V and the device uses the two-wire bus with three-bit addressing for up to eight chips on the bus. Sensors come already calibrated. Dallas Semiconductor. Tel., 0121-7822959; fax, 0121-7822156.

Vision systems

Video conference kit. Premier's H.324-compliant kit consists of a PCI card, a colour camera and cable, the software providing facilities for video conferences, moving picture storage and frame grabbing, with set-up assistance for user details, e-mail address, resolution and picture quality. PAL, SECAM and NTSC formats are available and the system copes with communication between computers or connection to the internet over standard lines, ISDN or lan. The software allows storage of motion video direct to disk in an AVI file. Requirements are a 33MHz 486, 16Mbytes, 5Mbyte hard disk space and Windows '95. Premier Electronics Ltd. Tel., 01922 634652; fax, 01922 634616.

Data acquisition

Data acquisition pod for pcs. From Thurlby-Thandar, the *VIPS 10* is a software/hardware package consisting of an 8-channel analogue/digital converter pod that fits a pc's parallel port to form a multi-channel system for applications from low-speed data logging to fast, 12-bit data acquisition, up to four such pods working from one printer port, from which the pods take power. *VIPS* Windows software ('95 or 3.1) gives display and control for up to four pods and supports direct data exchange between *VIPS* and other Windows applications. There are five types of pod for input/output in analogue/digital form, operating in any combination. And there are more to come. Thurlby Thandar Instruments Ltd. Tel., 01480 412451; fax, 01480 450409.

COMPUTER

Computers

Hardy palmtop. Fully proofed against most of the hazards of this world, *Ultimax* palmtop computers are 386SX-based (*Ultimax 2000*) and 486DX2 66MHz-based (*Ultimax 4000*) and operate for long periods on four AA batteries; they are made by ST Research Corp. Both models are provided with two PCMCIA slots, memory upgrade from 4Mbyte to 16Mbyte in the 2000 and from 8Mbyte to 32Mbyte in the 4000, a backlit display and keyboard, which is a sealed membrane, tactile type. The *2000* is dos-based and has a CGA lcd, while the *4000* runs Windows or dos software, has two serial ports, one external configurable connector,



Please quote "Electronics World" when seeking further information

a parallel port and an external keyboard connector, with a full-colour VGA lcd. Workstation Source Ltd. Tel., 0118 9227888; fax, 0118 9227820.

Development and evaluation

78K/IV development. New from NEC, a software system simulator for the 16-bit, 32MHz 78K/IV microcontroller family. The simulator is Windows-compatible and simulates all peripheral functions of family devices, including timers, interrupt controller and i/o ports, allowing the simulation of waveform output, pull-up/down resistors, leds, keypads and external interrupt sources. In program development, there is single-step operation with a trace and access to source-level debugging. Cost of the simulator is £85. Sunrise Electronics Ltd. Tel., 01908 263999; fax, 01908 263003.

PIC emulator. RF Solutions' new single-board, in-circuit emulator for PIC microcontrollers provides real-time, non-intrusive development to 20MHz and costs less than £300. ICEPIC Junior 5X rapidly identifies system bugs in all members of the

Microchip PIC 12C5XX and 16C5X families. Source-level debugging is in either assembler or C, running in Windows; the system can therefore set an unlimited number of hardware breakpoints and arrange real-time emulation or single, multiple and procedure step execution. The emulator contains a Microchip emulation ic, 8K of emulation memory and an RS232 interface for data transfer at 115kb/s. RF Solutions Ltd. Tel., 01273 488880; fax, 01273 480661.

Mass storage systems

Rewritable disk/cd-rom drive. Panasonic's LF-1196 is a removable, rewritable optical disk drive, combining an IDE ATAPI interface and Seagate software to provide 650Mbyte of storage on optical disk or to allow reading of 80-120mm cd-roms at up to 8x. There is no need to install an additional SCSI board, and Windows 3.1 and '96 versions of Seagate Backup Exec simplify backup and restore facilities by means of its easy Wizard interface for simplified backup and restore and an advanced interface for customised work. The drive is a half-height device, mounted vertically or

horizontally, with seek times of 92ms for both optical disks and CD-roms, data transfer proceeding at 1141Kb/s and 1200Kb/s respectively. Panasonic Industrial (Europe) Ltd. Tel., 01344 853157; fax, 01344 853081

Software

WorkBench PC v.3.0. Strawberry Tree's *WorkBench PC for Windows* has undergone a major upgrading to produce version 3.0 of this graphical data acquisition package, which allows the collection, analysis, display, logging of data and the control of external systems, the only programming needed being the shuffling of icons. A choice of modules provides for the representation of data inputs and outputs, controls, displays and functions for data reduction, signal analysis, maths and statistical operations, the modules being selected from a pull-down menu and "connected" on screen. The new version has a cut-and-paste facility for the selection of modules by mouse for copying to other parts of the worksheet or to a macro box. An optional tool caters for up to 20 pages to be designed either in this program

or to be imported as .BMP files and virtual instruments may be integrated into the design. Five new modules include a counter/timer, a formula interpreter, an RS232 output, trigger modules and a min/max module. Adept Scientific Micro Systems Ltd. Tel., 01462 480055; fax, 01462 480213.

Bar-code labels. *BAR-ONE Platinum v.4.0* from Zebra Technologies is the company's newest bar-code label design and print software, which allows users to access, process and combine variable information, including text and graphics, from many sources, this latest version having improved networking capability. It meets Microsoft's Open DataBase Connectivity standard and runs under Windows, so that a preview feature in the print queue allows a sight of the label before it is loaded for printing. Zebra Technologies Europe Ltd. Tel., 01494 472872; fax, 01494 450103. ■

ADVERTISE FREE OF CHARGE

Subscribers* to *Electronics World* can advertise their electronic and electrical equipment completely free of charge

Simply write your ad in the form below, using one word per box, up to a maximum of twenty words. Remember to include your telephone number as one word. **You must include your latest mailing label with your form.**

* This free offer applies to private subscribers only. Your ad will be placed in the first available issue.

This offer applies to private sales of electrical and electronic equipment only.

Trade advertisers - call Joanna Cox on 0181-652 3620

All adverts will be placed as soon as possible. However, we are unable to guarantee insertion dates. We regret that we are unable to enter into correspondence with readers using this service, we also reserve the right to reject adverts which do not fulfil the terms of this offer.

Please send your completed forms to:

Free Classified Offer: Electronics World, L333, Quadrant House, The Quadrant, Sutton, Surrey SM2 5AS

HART

The Home of *Hi-Finesse*. Its not what you do, its HOW you do it that counts!.

Hart Audio Kits and factory assembled units use the unique combination of circuit designs by the renowned John Linsley Hood, the very best audiophile components, and our own engineering expertise, to give you unbeatable performance and unbelievable value for money.

We have always led the field for easy home construction to professional standards, even in the sixties we were using easily assembled printed circuits when Heathkit in America were still using tagboards! Many years of experience and innovation, going back to the early Dinsdale and Bailey classics gives us incomparable design background in the needs of the home constructor. This simply means that building a Hart kit is a real pleasure, resulting in a piece of equipment that not only saves you money but you will be proud to own.

Why not buy the reprints and construction manual for the kit you are interested in to see how easy it is to build your own equipment the HART way. The FULL cost can be credited against your subsequent kit purchase.

'AUDIO DESIGN' 80 WATT POWER AMPLIFIER.



This fantastic John Linsley Hood designed amplifier is the flagship of our range, and the ideal powerhouse for your ultimate hi-fi system. This kit is your way to get £K performance at bargain basement prices. Unique design features such as fully FET stabilised power supplies give this amplifier World Class performance with startling clarity and transparency of sound, allied to the famous HART quality components and ease of construction. Standard model comes with a versatile passive front-end giving 3 switched inputs, with ALPS precision "Blue Velvet" low-noise volume and balance controls, no need for an external preamp. Construction is very simple and enjoyable with all the difficult work done for you, even the wiring is pre-terminated, ready for instant use! All versions are available with Standard components or specially selected Super Audiophile components and Gold Plated speaker terminals and all are also available factory assembled.

K1100 Complete STANDARD Stereo Amplifier Kit,	£415.21
K1100S Complete SLAVE Amplifier Kit,	£353.62
K1100M Complete MONOBLOC Amplifier Kit,	£271.20
RLH11 Reprints of latest Amplifier articles	£1.80
K1100CM Construction Manual with full parts lists	£5.50

ALPS "Blue Velvet" PRECISION AUDIO CONTROLS.



Now you can throw out those noisy ill-matched carbon pots and replace with the famous Hart exclusive ALPS "Blue Velvet" range components only used selectively in the very top flight of World class amplifiers. The improvement in track accuracy and matching really is incredible giving better tonal balance between channels and rock solid image stability. Motorised versions have 5v DC motor.

MANUAL POTENTIOMETERS

2-Gang 100K Lin.	£15.67
2-Gang 10K, 50K or 100K Log.	£16.40
2-Gang 10K Special Balance, zero crosstalk and zero centre loss.	£17.48

MOTORISED POTENTIOMETERS

2-Gang 20K Log Volume Control	£26.20
2-Gang 10K RD Special Balance, zero crosstalk and less than 10% loss in centre position	£26.98

TOROIDAL MAINS & OUTPUT TRANSFORMERS for EL34, 32W VALVE AMPLIFIER

Special set of toroidal transformers, 2 output & 1 mains for the "Hot Audio Power" valve amplifier design described in the Oct. 1995 Issue of "Wireless World". Total Wt 4.8Kg. Special price for the set, £99, Post £8
RJM1. Photocopies of the Article by Jeff Macaulay. £2

PRECISION Triple Purpose TEST CASSETTE TC1D.

Are you sure your tape recorder is set up to give its best? Our latest triple purpose test cassette checks the three most important tape parameters without test equipment. Ideal when fitting new heads. A professional quality, digitally mastered test tape at a price anyone can afford.
Test Cassette TC1D. Our price only

SHUNT FEEDBACK PICKUP PREAMPLIFIER

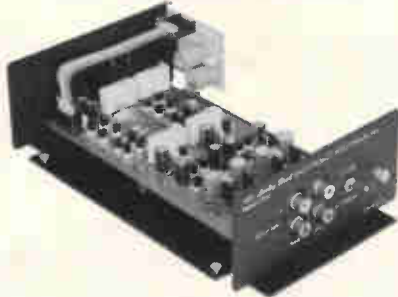

If you want the very best sound out of vinyl discs then you need our high quality preamplifier with Shunt Feedback equalisation. The K1450 also has an advanced front end, specially optimised for low impedance moving coil cartridges as well as moving magnet types. Selected discrete components are used throughout for ultimate sound quality. The combination of John Linsley Hood design, high quality components and an advanced double sided printed circuit board layout make this a product at the leading edge of technology that you will be proud to own. A recent review in "Gramophone" magazine endorsing this view. Bought in kit form our step by step instructions it is very easy and satisfying to assemble, or you can buy a factory assembled version if you wish.

This magnificent kit, comes complete with all parts ready to assemble inside the fully finished 228 x 134 x 63mm case. Comes with full, easy to follow, instructions as well as the Hart Guide to PCB Construction, we even throw in enough Hart Audiograde Silver Solder to construct your kit!

K1450 Complete Kit	£116.58
K1450SA Audiophile Kit	£138.94
A1450SA Factory assembled Audiophile unit	£188.94

"CHIARA" HEADPHONE AMPLIFIER.



Highest quality, purpose designed, 'single ended' class 'A' headphone amplifier for 'stand alone' use or to supplement those many power amplifiers that do not have a headphone facility. Easy installation with special signal link-through feature, the unit uses our 'Andante' Ultra High Quality power supply. Housed in the neat, black finished, Hart minibox it features the wide frequency response, low-distortion and 'musicality' that one associates with designs from the renowned John Linsley Hood. Volume and balance controls are Alps "Blue Velvet" components. Very easy to build, or available factory assembled, the kit has very detailed instructions, and comes with Hart audiograde silver solder. A valuable personal listening option and an attractive and harmonious addition to any hi-fi system.

K2100 Complete Standard Kit	£112.50
K2100SA 'Series Audiophile' Kit with selected audiophile components	£115.46
A2100SA 'Series Audiophile', Factory Assembled	£115.46
CM2100 Construction Manual	£2.50

"Andante" Linear Technology AUDIOPHILE POWER SUPPLIES

The HART "Andante" series power supplies are specially designed for exacting audio use requiring absolute minimum noise, low hum field and total freedom from mechanical noise. Utilising linear technology throughout for smoothness and musicality makes it the perfect partner for the above units, or any equipment requiring fully stabilised $\pm 15v$ supplies. There are two versions, K3550 has 2 $\pm 15v$ supplies and a single 15v for relays etc. K3555 is identical in appearance and has one $\pm 15v$. Both are in cases to match our "Chiara" Headphone Amplifier and our K1450 "Shunt Feedback" Pickup preamp.

K3550 Full Supply with all outputs	£94.75
K3555 Power Supply for K1450 or K2100	£84.42
A3550 Factory Assembled Full Supply	£147.25

SPEAKER DESIGN SOFTWARE.

VISATON "Speaker Pro 6" is a complete speaker design program for use on IBM machines. Covers cabinet and crossover design and contains a full expandable database of drive units. Earning a "most recommendable" accolade it tests this program is ideal for the professional speaker builder or serious audiophile.

0303 Speaker Pro 6, 3.5" Disk	£45.51
0309 Demo Version with Database	£9.28

SPEAKER DAMPING MATERIALS

Polyester Wool and Pure Lambs Wool both have optimal damping properties and are pleasant to handle. Standard 125g bag is sufficient for 20 litres enclosure volume.

5070 Polyester Wool, 125g	£3.20
5069 Pure Lambs Wool, 125g	£6.73

ROARING SUBWOOFER.

A full revised kit will be available soon for this excellent and imaginative design from Russel Bredon (WW Feb.97). The latest design will use the 30mm maximum cone displacement of the 10" VISATON GF250 Driver to give even better performance at slightly reduced cost. Featuring a rubber suspended fibreglass cone, extended pole piece, vented magnet, Kapton cam and dual 4ohm voice coils the GF250 is unbelievably good value at only £111.45 each.

SPECIAL OFFER! SOLENOID CONTROLLED FRONT LOAD CASSETTE DECK SFL800

High quality (0.08%W&F) cassette mechanism with capability of using standard or downstream monitor R/P head. Offers all standard facilities under remote, logic or software control. The control requirements are so simple that for many applications not needing all functions manual switches will suffice. Power requirements are also simple with 12v solenoids and 12v speed controlled Motor, total power requirement being under 300mA. Logic control and wiring circuits are included free with each deck.

SFL800 Deck with Standard stereo head	£29.50
SFL800D Fitted with High Quality Downstream monitor head	£44.90

(The Head alone is normally over £60!)

HART TECHNICAL BOOKSHELF

Try us for:- Bigger Range of Books, Better Prices,
NO "28 Day Wait"

"AUDIO ELECTRONICS" John Linsley Hood	£18.99*
"THE ART OF LINEAR ELECTRONICS" John Linsley Hood, 1994	£16.95*
"THE ART OF ELECTRONICS" Horowitz & Hill	£35.00*
"DIGITAL AUDIO AND COMPACT DISC TECHNOLOGY" 3rd. Edn. 0-240 51397 5	£19.95*
"INTRODUCING DIGITAL AUDIO CD, DAT AND SAMPLING" ISBN 1870775 22 8	£7.95
"ACTIVE FILTER COOKBOOK" Don Lancaster	£19.95
"THE ART OF SOLDERING" 0-85935-324-3, 0	£3.95
"TOWERS' INTERNATIONAL TRANSISTOR SELECTOR" 0-572-01062-1	£19.95*
"AUDIO" F.A. Wilson, BP111	£3.95
"HOW TO USE OSCILLOSCOPES & OTHER TEST EQUIPMENT" R.A. Penfold, BP267	£3.50
"THE HART PRINTED CIRCUIT BOARD CONSTRUCTION GUIDE."	£2.50
"A SIMPLE CLASS A AMPLIFIER" J.L.Linsley Hood M.I.E.E. 1969. RLH12	£2.75
"CLASS-A POWER" Single Ended 15W Amp. J.L.Linsley Hood M.I.E.E. 1996. RLH13	£2.50

LOUDSPEAKERS; THE WHY AND HOW OF GOOD REPRODUCTION. G.Briggs, 1949.	£8.95
"THE LOUDSPEAKER DESIGN COOKBOOK" Vance Dickason, (5th Edn.)	£23.95*
ELECTROSTATIC LOUDSPEAKER DESIGN AND CONSTRUCTION Ronald Wagner BKT6	£15.95
"THE ELECTROSTATIC LOUDSPEAKER DESIGN COOKBOOK" Roger P. Sanders, 1995	£24.95
"BULLOCK ON BOXES" Bullock & White	£10.95
"AN INTRODUCTION TO LOUDSPEAKERS & ENCLOSURE DESIGN" V. Capel, BP256	£3.95
"LOUDSPEAKERS FOR MUSICIANS" BP297	£3.95
"THEORY & DESIGN OF LOUDSPEAKER ENCLOSURES" J.E. Benson	£21.95
"QUICK & EASY TRANSMISSION LINE SPEAKER DESIGN" Larry D. Sharp	£8.95
"THE COUPLED CAVITY HANDBOOK" David Purton	£4.90
"VISATON. HOME HI FI CATALOGUE." Full Specifications and Thiele Small Data on all Drive Units	£4.50
"VISATON. CAR HI FI CATALOGUE." In car guide	£3.50
"VISATON. CABINET PROPOSALS" Book 1. In GERMAN	£6.50
"VISATON. CABINET PROPOSALS" Book 2. In GERMAN	£6.50
"SPEAKER PRO 6." VISATON Cabinet Design Software	£45.51
"SPEAKER PRO 6." Demo Version with drive unit database	£9.28

"VALVE AMPLIFIERS" Morgan Jones, 1995/6	£24.50
THE VTL BOOK David Manley 1994. BKVT1	£17.95
MULLARD TUBE CIRCUITS FOR AUDIO AMPLIFIERS BKAA27	£11.95
"THE WILLIAMSON AMPLIFIER." 0-9624-1918-4	£6.95
AN APPROACH TO AUDIO FREQUENCY AMPLIFIER DESIGN. GEC 1957	£17.95
AUDIO ANTHOLOGIES, articles from Audio Engineering. Six volumes covering the days when audio was young and valves were king! BKAA3/1 to 6. All £12.95 each	
"THE RADIOTRON DESIGNERS HANDBOOK" (CD)	£49.00
"PRINCIPLES OF ELECTRON TUBES" H.D.Reich PH.D.	£25.95
"POWER AMP PROJECTS" Anthology, 1970-1989.	£15.50
"WORLD TUBE DIRECTORY" 1996-7 Sourcebook of valve related products	£5.95

Fuller descriptions of the contents of all our books is given in our full catalogue, price

£4.50

Postage on all books, unless starred, is only £2 per book, maximum £4.50 for any number, any size. Starred items are heavy books costing £3.50 to send.

Don't forget No waiting at HART! All listed books are normally in stock! Just ring with your Credit Card Number for instant despatch!

POSTAGE on UK Orders up to £20 is £2. Over £20 is £4.50.

OVERSEAS Please Enquire.

Fuller Details of ALL kits are given in our List, FREE on request.

Send for Your FREE copy
of our LISTS

24 Hr. ORDERLINE 01691 652894
Fax. 01691 662864

All Prices include
UK/EC VAT.

CIRCLE NO. 139 ON REPLY CARD

HART

HART ELECTRONIC KITS LTD.
1 Penylan Mill, OSWESTRY,
Shrops. SY10 9AF.
UK

A battery of chargers

Battery design being what it is, battery chargers are not the simple devices they used to be. They even talk to computers, as Philip Darrington explains.

Ever since people decided they needed to carry computers, tape players, radios, telephones and all those life-enhancing games around with them, and the parking-meter reader stopped writing the numbers in a little book, the battery makers have had an extended birthday. But the one-discharge type of battery came a bit expensive – and a bit too big and heavy – for some of the current-hungry devices, so rechargeable types were needed.

Cue for new chemistry: you can now be faced with nickel-cadmium, nickel-metal hydride, rechargeable alkaline and lithium ion batteries all in the same household and all needing chargers with various protective limiting facilities. Maxim makes ics for the purpose, described in the *Maxim Engineering Journal* vol.27, from which this is an extract.

NiCd versus NiMH

If you need a high current in short bursts, nickel-cadmium (NiCd) batteries are the choice; they have a lower capacity than lithium ion (Li+) or nickel-metal hydride (NiMH) types, but possess low impedance.

NiMH batteries are in some ways similar to NiCd ones, but have more capacity, although self-discharge rate is about double at 1% of capacity per day and they do not, therefore, hold a charge for long periods. Both types can be fast-charged in about an hour by a current equal to the capacity in amp-hours, although this process will not give a full charge because of losses; to get a full charge, charge for longer or with a higher current.

Charge termination is slightly different for the two types: charging a NiCd battery should stop when its terminal voltage begins to decrease, because the thing will probably explode if provoked for much longer; an NiMH charge should be stopped when the voltage peaks.

You can trickle-charge both types without worrying about stopping the charge or checking the voltage because temperature rise is not nearly enough to cause any trouble. Trickle current should be around (capacity in Ah)/15.

Lithium-ion batteries

Li+ batteries have the edge over other rechargeables as

regards capacity. Compared with NiMH types, energy per unit volume is 10%-30% better, but energy per unit mass is about double, since they are lighter.

But they are not perfect; current and voltage both need watching in both charge and discharge regimes (if you keep discharging the battery to a low voltage, it loses capacity). For these reasons, Li+ packs usually have a fuse to prevent overcurrent and a switch to disconnect the battery if it looks like venting or, to put it another way, exploding.

Li+ battery packs usually use mosfets to disconnect the battery if it is being subjected to under or overvoltage. These mosfets also make a different charging method possible, in which a constant-current charge without voltage limit is applied, the mosfets turning on and off as needed to maintain the battery voltage. Battery capacitance slows

Fig. 1. Simple linear charger for one lithium ion cell. Heat generated by this type confines its use to the cradle type of separate charger.

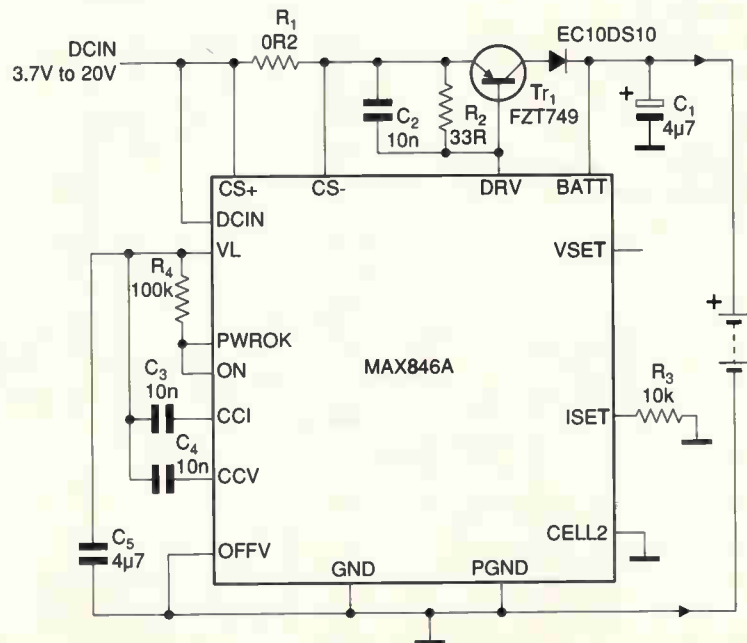

battery reversing the process and supplying current to the source. In response to controller signals on pins D0 and D1, there are three modes of working: fast charge, pulse-trickle charge and top-off charge. Fast charging produces a current of 1.5A, in top-off the current is about a quarter of the fast-charge current, or 381mA, and in trickle charge it is the same but pulsed with a 12.5% duty cycle. All these current levels are produced by the voltages on SET and REF pins and the value of the current-sense resistor, in this case 0.1Ω, all selected by the microcontroller input signals.

If everything goes according to plan, the circuit stops the charge when the battery voltage rise becomes zero or negative, depending on whether the battery is an NiMH or NiCd type. If it doesn't, the potential divider R_{6,7} are there to set a limit to which the battery voltage may rise, in this case 8V.

Smart-battery chargers

One has the thought that battery design might perhaps be getting a little out of hand when even battery packs have microcontrollers. Nevertheless, they do and are useful in that one type of charger is able to cope with any kind of battery that conforms to the smart-battery standard.

You can also replace a battery with any other that conforms to the standard, which is concerned with the manner in which the battery pack connects to the equipment it powers and the way in which it communicates with it using the Intel SMBus, itself derived from the I²C protocol. There

are many I²C-compliant ics around already. Figure 3 shows a charger with an SMBus interface.

Currents under 31mA, which corresponds to the five least significant bits from the a-to-d converter in the host controller, come from an internal linear current source, since the switching regulator and its low-value current-sense resistor cannot handle the 1mA resolution needed. Currents over 31mA are provided by a switching regulator to maintain an efficiency of 89%, but the linear source remains active so that monotonicity at the a-to-d doesn't suffer whatever the value of the sense resistor or current-sense amplifier offset.

If the input voltage is much greater than the battery voltage, transistor Q₁ helps to relieve the power dissipation in the internal linear regulator; inputs up to 28V are acceptable and outputs are selectable at 1A, 2A and 4A. Switching is at 250kHz, the size of the inductor reflecting the fact. ■

Technical support

Maxim, Unit 3, Theale Road, Theale, Berkshire RG7 4XX. Tel., 01734 303388; fax, 01734 305577.

ADVERTISERS INDEX

Airlink Sales	1031
Anchor Supplies	1011 and 1031
CMS	1007
Cook International	1016
Conford Electronics	981
Colomor Electronics	1004
Crownhill Associates	1012
Dataman	OBC
Display Electronics	1029
Equinox Technology	IBC
Halcyon Electronics	1004
Hart Electronics	1044
Ice Technology	977
IOSIS	1033
John's Radio	1050
JPG Electronics	1047
Keytrons	1038
Labcenter Electronics	972
M&B Radio	981 and 1015
Milford Instruments	1009
Number One Systems	1021
Olson Electronics	970
Pico Technology	993
Pyramid Electronics	1012
Quickroute Systems	975
Rafte Electronics	1055
RD Research	995
Seetrex	997
Sowter Transformers	993
Stewart of Reading	1033
Surrey Electronics	1031
Tandem Technology	IFC
TDC	993
Telford Electronics	1025
Telnet	1009
Temwell	1004
Those Engineers	975
Tie Pie	989
Wood & Douglas	981

New Special Offers

Mini waterproof TV camera 40x40x15mm requires 9 to 13 volts at 120mA with composite video output (to feed into a video or a TV with a SCART plug) It has a high resolution of 450 TV lines Vertical and 380 TV lines horizontal, electronic auto iris for nearly dark (1 LUX) to bright sunlight operation and a small lens with a 92 degree field of view, it focuses down to a few CM. It is fitted with a 3 wire led (1.2v in gnd and video out). Now also available with wall mount kit and swivel case (at the same price) £93.57 + VAT = £109.95 or 10x 589.32 + VAT = £104.95	Nickel Metal Hydride AA cells high capacity with no memory. If charged at 100ma and discharged at 250ma or less 1100 mAH capacity (lower capacity for high discharge rates).....£3.75
Board cameras all with 512 x 582 pixels (4 x 3.3mm sensor 9-13 volts power supply and composite video out. All need to be housed in your own enclosure and have fragile exposed surface mount parts. 47MR size 60 x 36 x 27mm with 6 infra red leds (gives the same illumination as a small torch would) £50.00 + VAT = £58.75	Special offers please check for availability:- Stick of 42 x 16mm nicad batteries 171mm x 16mm dia with red and black leads 4.8v.....£5.95 5 button call 6V 280mAh battery with wires.....£2.45 (Varta 5 x 2500K) Orbital 866 battery pack 12v 1.6AH contains 10 mah C cells with solder tags (the size most commonly used in cordless screwdrivers and drills 22 dia x 42mm tall). It is easy to crack open and was manufactured in 1994.....£8.77 each or £110.50 per box of 14
40MP size 39 x 38 x 22mm spy camera with a fixed focus pin hole lens for hiding behind a very small hole.....£57.00 + VAT = £66.98 40MC size 39 x 38 x 28mm camera for 'C' mount lens this gives a much clearer picture than with the small lenses.....£68.78 Standard 'C' mount lens F1.6 16mm for 40MC.....£26.43 + VAT = £31.06	BCI box 190 x 106 x 50mm with slots to house a pcb the lid contains an edge connector (12 way 5mm pitch) and screw terminals to connect to wires and 5 slide in cable blanks.....£2.95 7 segment common anode led display 12mm.....0.45 GoAs FET low leakage current 58873.....£12.95 each£9.95 10+ £7.95 BC547A transistor 20 for £1.00
High quality stepping motor kits (all including stepping motors) "Comstep" independent control of 2 stepping motors by PC (through the parallel port) with 2 motors and software kit = £67.00...Ready built = £99.00 Software support and 4 digital inputs kit.....£27.00 Power interface 4A kit.....£36.00 Power interface 8A kit.....£46.00	SL952 UHF limiting amplifier L.C. 16 surface mounting package with data sheet.....£1.95 DC-DC converter Reliability model VI2P5 12v in 5 v 200ma out 300v input to output isolation with data.....£4.95 each or pack of 10 £39.50 Airpas AB2903-C large stepping motor 14v 7.5' step 270ohm 68mm dia body 6.3mm shaft.....£8.95 or £200.00 for a box of 30
Stepper kit 4 (manual control) includes 200 step stepping motor and control circuit.....£23.00 DTA30 Hand held transistor analyser. It tells you which lead is the base, the collector and emitter and if it is NPN or PNP or faulty (NEW VERSION does not say FETs & SCRs are transistors) DTA30.....£38.34 HMA20 hand held MOSFET analyser identifies gate drain and source and if P or N channel HMA20.....£38.34	Polyester capacitors box type 22.5m lead pitch 0.5uf 250Vdc.....18p each, 14p 100+, 9p 1000- 1uf 250Vdc.....20p each, 15p 100+, 10p 1000- 1uf 50v bipolar electrolytic axial leads.....15p each, 7.5p 1000- 0.22uf 250v polyester axial leads.....15p each, 7.5p 100- Polypropylene 1uf 400Vdc (Wima MKP10) 27.5mm pitch 32 x 29 x 17mm case.....75p each, 60p 100- Philips 123 series solid aluminium axial leads 33uf 10v & 2.2uf 40v.....40p each, 25p 100- Philips 108 series long life 22uf 63v axial.....30p each, 15p 1000- 500pf compression trimmer.....60p
Speaker cabinets 2 way speaker systems with Motorola tweeters Speaker dia 15" 12" 8" Power rating 250WRMS 175WRMS 100WRMS Impedance 8ohm 8ohm 8ohm Frequency range 40hz-20kHz 45hz-20kHz 60hz-20kHz Sensitivity (1W/1M) 97dB 94dB 92dB Size in mm 500x720x340 450x640x345 315x600x230 Weight 21.1kg 16.8kg 7.4kg Price each for black vinyl coating £139.95 £99.99 £54.94 Grey felt coating £159.97** £119.97** £64.99 (** = not normally in stock allow 1 week for delivery)	PC. 400W PSU (final part 201035-001) with standard motherboard and 5 disk drive connectors, fan and mains inlet/outlet connectors on back and switch on the side (top for tower case) dims 212 x 149 x 149mm excluding switch.....£26.00 each, £138.00 for 6
Power amplifiers 19" rack mount with gain controls & VU meters STAS300 2 x 190WRMS (4ohm load) 11kg.....£339.00 STAS900 2 x 490WRMS (4ohm load) 15kg.....£585.00 LED's 3mm or 5mm red or green.....7p each.....yellow 11p each Cable ties.....1p each.....£5.95 per 1000.....£49.50 per 10,000	Verbatim R300NH Streamer tape commonly used on ric machines and printing presses etc. It looks like a normal cassette with a slot cut out of the top.....£4.95 each (£3.75 100+)
Rechargeable batteries AA (PP7) 500mAh.....8.99.....AA 500mAh with solder tags.....£1.55 AA 950mAh.....£1.75.....C (PP11) 1.2AH.....£2.20 C 2AH with solder tags.....£3.60.....D (PP2) 1.2AH.....£2.60 D 4Ah with solder tags.....£8.95.....PP3 4.4V 110mAh.....£1.95 1/2AA with solder tags.....£1.55.....Sub C with solder tags.....£2.50 AAA (PP19) 100mAh.....£1.75.....1/3 AA with tags (galpa CTV).....£1.95	HM555 timer ic 16p 8 pin DIL socket.....6p

All products advertised are new and unused unless otherwise stated. Wide range of CMOS TTL 74HC 74F Linear Transistors kits, rechargeable batteries, capacitors, tools etc always in stock. Please add £1.95 towards P&P (orders from the Scottish Highlands, Northern Ireland, Isle of Man, Isle of Wight and overseas may be subject to higher P&P and heavy items). VAT included in all prices.

JPG Electronics, 276-278 Chatsworth Road, Chesterfield S40 2BH
Mastercard/Visa Orders (01246) 211202 Fax: 550959
Callers welcome 9.30am to 5.30pm Monday to Saturday

CIRCLE NO. 140 ON REPLY CARD

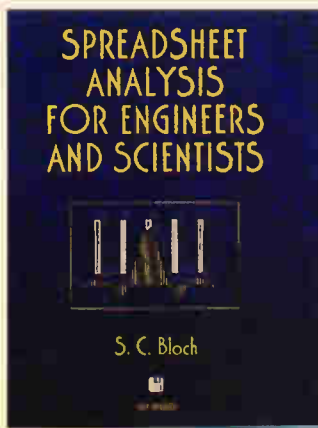

Spreadsheet Analysis for Engineers and Scientists

With this practical, hands-on guide, engineers and researchers learn, quickly and easily, the latest and most useful electronic spreadsheet methods. Using a variety of interactive techniques, including worksheets, self-test and practical programs on the included disk, *Spreadsheet Analysis for Engineers and Scientists* show you how to harness the power and versatility of spreadsheet programs, including those that contain the fast Fourier transform, complex operations and Bessel functions, and how to customise your own applications.

Includes disk

0471 126837, 336pp
UK £37.50, Europe £39.50, ROW £49.50

Electronic Component Reliability

Fundamentals, Modelling, Evaluation and Assurance

This text approaches the quality and reliability of electronic components from a unique standpoint. Traditionally the twin subjects of reliability physics and reliability statistics have been treated as separate entities. Here, the author examines both areas and reveals how components fail and how failures develop over a period of time.

0471 952966, 374pp
UK £50.50, Europe £53.50, ROW £66.50

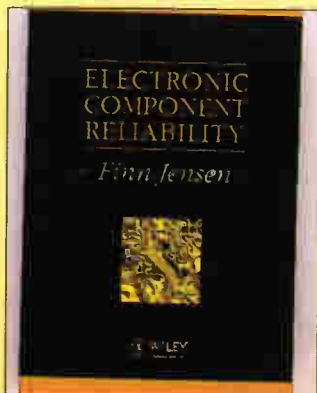

Fuzzy Logic

Implementations and Applications

Offering a new perspective on a growing field, this text explores the many hardware implications of fuzzy logic based circuits. As use of AI increases, so the VLSI area of circuits is becoming a growth subject. Opening with an overview of fuzzy sets and fuzzy logic the book moves on to cover a range of non-standard solutions for fuzzy logic VLSI circuits. Future trends, new concepts and ideas are all examined and supported with practical examples from the author's research.

ISBN 0471 950599, approx 346pp,
UK £50.50, Europe £53.50, ROW £66.50

Microelectronic Switched-Capacitor Filters

Switched-capacitor filters and associated MOS integrated circuits are now an established technology finding applications in the telecommunications and instrumentation fields. With unrivalled breadth of coverage, this book surveys the design techniques of an important class of analogue signal processing systems. An accompanying diskette containing a comprehensive computer-aided design package (ISICAP) enables readers to gain a greater depth of understanding of the described techniques. Containing both source code

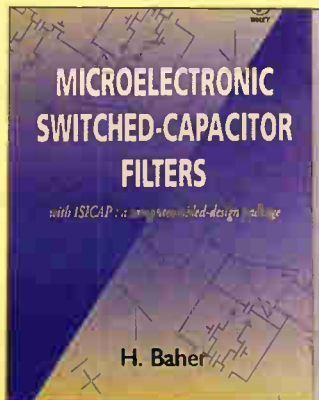

files and an executable version of the main design package, this alone will be an indispensable tool for many circuit designers.

Includes disk

0471 954047 384pp
UK £75.50, Europe £79.00, ROW £92.00

The I²C Bus

From theory to Practice

With a special emphasis on the I²C Bus, this guidebook through the world of micro controller-managed serial buses presents comprehensive coverage of the theory necessary to design the best possible communications bus for any particular application. The book examines typical industrial and consumer applications and enables the reader to design effectively in a real-world environment. A disk containing software for the I²C bus is also included.

Includes disk

0471 96268 6, 314pp
UK £54.50, Europe £56.50, ROW £65.00

High Frequency Analog Integrated Circuits

As one of the first textbooks to discuss integrated circuit design considerations and

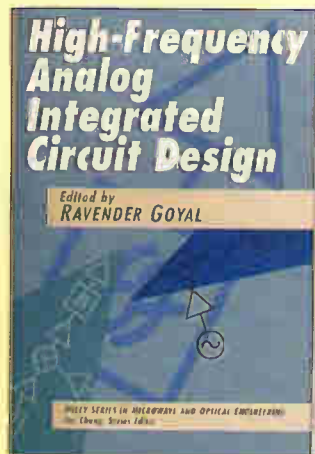

actual designs from the basic concepts, this title provides a solid background in designing basic circuits, advanced circuits and synthesis techniques.

0471 530433 424pp
UK £80.00, Europe £83.00, ROW £95.00

Speech Coding

A Computing Laboratory Textbook

This is one of the first lab manuals with software dedicated exclusively to speech processing and coding. It takes advantage of the development of the personal computer by making this technology accessible to a wider audience. The manual and Dos based software together create a user-friendly digital signal processing lab which allows the user to

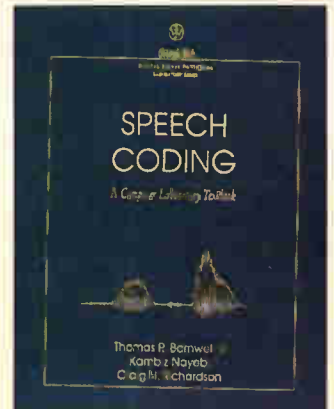

perform a wide variety of speech coding and speech processing experiments. The text presents and explains a set of basic speech coders analytically and in terms of the specific parameters controlling each coder. The manual leads the student through the experimental process of understanding how speech coders work and sound via over 70 exercises and projects. The class-tested menu-driven, Dos-based software can be operated by students with little or no training.

Includes disks

0471 516929, 194pp,
UK £31.97, Europe £33.97, ROW £39.97

Solar Cells and their Applications

The past decade has witnessed numerous important breakthroughs in solar cell technology, many of which have occurred in just the past few years. Far cheaper to produce and maintain, exhibiting a longer lifetime, and considerably more efficient than ever before, solar cells are, at last, in a position to compete with traditional technologies for both small and large-scale energy conversion applications. Including contributions from some of the world's leading experts in the field, this book reports the most important recent advances in solar cell technology. From in-depth discussions of breakthroughs in cell, module, and system technologies to a probing look at important environmental, health, and safety issues in the photovoltaic industry, it covers a broad range of topics of vital interest to solar cell researchers, power systems designers, and all those with professional interest in current and future capabilities of this important technology. Offers a detailed look at cutting-edge solar technology from an international team

SOLAR CELLS AND THEIR APPLICATIONS



Edited by
LARRY D. PARTAIN

of researchers. Covers silicon, GaAs, InP, CdTe, a-Si:H, CuInSe₂₉ and GaSb solar cells, cells, concentrators, multijunction cell configurations, space cells, and more. Describes a wide range of applications – from space cells to terrestrial systems. Provides an informal look ahead at the future of solar cell technology.

0471 574201, 596pp,
UK £71.50, Europe £75.00, ROW £92.00

Introduction to High-Speed Electronics and Optoelectronics

Lasers, fibre optics, and high-speed optical systems share many concepts with microwave devices. Furthermore, semiconductor-based optoelectronics and microwave integrated circuits share evolving process technologies. It is only natural, therefore, that students of optoelectronics be introduced to high-speed concepts in a unified manner. This highly practical intensive introduction enables electrical engineers, applied physicists, and students to develop and identify tools for understanding, analysis, design, and characterisation of high speed components. Broad in scope, this unique

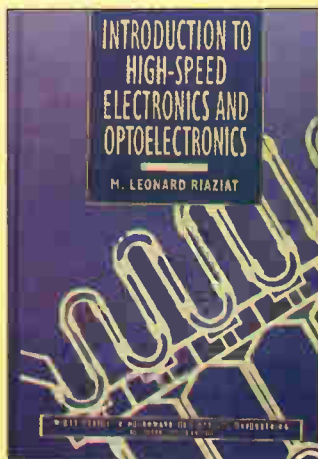

text/reference examines the complementary nature of electronics and optics and emphasizes high-speed technology in which the two fields are less differentiated. Beginning with an overview that develops a perspective and appreciation of analog high-speed technology in general, the book goes on to cover devices and circuits used at microwave and millimeter-wave frequencies, optical components, and optoelectronic integrated circuits and subsystems. Particular attention is paid to applications in the area of high levels of interest in this area and because many of the concepts are applicable in other fields. The book concludes with important coverage of the often-overlooked area of measurement and characterization of high-speed devices. Fully referenced and supplemented with hundreds of helpful illustrations, *Introduction to High-Speed Electronics and Optoelectronics* is equally useful as a professional reference or a textbook for senior undergraduate and first-year graduate courses. 0471 015822, 312pp, UK £65.00, Europe £67.00, ROW £77.00

Risc Systems and Applications

Professor Daniel Tabak has completely revised and updated his two previous books on Reduced Instruction Set Computer architecture to produce this new book, RISC Systems and Applications. The text is a unique, concentrated, detailed description of the architecture and implementation of most recent high-performance RISC systems, such as DEC Alpha AXP21164, IBM/Motorola/Apple PowerPC 620, Sun Microsystems and Texas Instruments UltraSPARC and SuperSPARC, MIPS technologies R10000, Intel i860 XP, Motorola MC88110, Hewlett-Packard PA-7100/8000 and the transputer. It also includes details of pioneering devices such as Berkley's RISC II and Stanford's MIPS and multiprocessor, real-time and workstation systems. ISBN 0863 801889, 452pp, UK £50.50, Europe £54.00, ROW £67.00

All prices are fully inclusive of packing and delivery

Return to Jackie Lowe, Room L333, Quadrant House, The Quadrant, Sutton, Surrey, SM2 5AS

Please supply the following titles:

Qty	Title or ISBN	Price

** All prices on these pages include delivery and package **

Total _____

Name _____

Address _____

Postcode _____

Telephone _____

Method of payment (please circle)

Access/Mastercard/Visa/Cheque/PO

**Cheques should be made payable to
Reed Business Publishing**

Credit card no _____

Card expiry date _____

Signed _____

Please allow up to 28 days for delivery

SMALL SELECTION ONLY LISTED - EXPORT TRADE AND QUANTITY DISCOUNTS - RING US FOR YOUR REQUIREMENTS WHICH MAY BE IN STOCK

HP New Colour Spectrum Analysers
 HP141T+8552B IF + 8553B RF - 1KHz-110Mc/s - £700.
 HP141T+8552B IF + 8554B RF - 100KHz-1250Mc/s - £900.
 HP141T+8552B IF + 8556A RF - 20Hz-300KHz - £700.
Special Offer just in from MOD Qty 40 HP8555A RF Units 10Mc/s - 18GHzS.
 HP141T+8552B IF + 8555A 10Mc/s-18GHzS - £1200.
HP ANZ Units Available separately - New Colours - Tested
 HP141T Mainframe - £350.
 HP8552B IF - £300.
 HP8553B RF 1KHz to 110Mc/s - £200.
 HP8554B RF 100KHz to 1250Mc/s - £500.
 HP8555A RF 10Mc/s to 18GHzS - £800.
 HP8556A RF 20Hz to 300KHzS - £250.
 HP8443A Tracking Generator Counter 100KHz-110Mc/s - £300.
 HP8445B Tracking Preselector DC to 18GHz - £350.
 HP3580A 5Hz - 50KHz ANZ - £750 - £1000.
 HP3582A .02Hz to 25.6KHz - £2k.
 HP8568A 100Hz-1500Mc/s ANZ - £6k.
 HP8569B 10Mc/s-22GHz ANZ - £6k.
HP Mixers are available for the above ANZ's to 40GHz
 TEK 492 - 50KHz - 18GHz Opt 1+2 - £4k-£4.2k.
 TEK 492 - 50KHz - 18GHz Opt 1+2+3 - £4.5k.
 TEK 492P - 50KHz - 21 GHz Opt 1+2+3 - £5k.
 TEK 494AP 1KCS - 21 GHz - £7k.
 TEK 496P 1KHz-1.8GHz - £4k.
 TEK 5L4N 0-100KHz - £400.
 TEK 7L5 + L1 - 20Hz-5Mc/s - £700.
 TEK 7L5 + L3 - Opt 25 Tracking Gen - £900.
 TEK 7L12 - 100KHz-1800Mc/s - £1000.
 TEK 7L18 - 1.5-60GHz - £1500.
 TEK 491 10Mc/s-12.4GHz-40GHz - £750. 12.4GHz-40GHz with Mixers.
Tektronix Mixers are available for above ANZ to 60GHz
 Systron Donner 763 Spectrum ANZ + 4745B Preselector .01-18GHz + Two Mixers 18-40GHz in Transit Case - £3k.
 HP8673D Signal Generator .05-26.5GHz - £20k.
 Systron Donner 1618B Microwave AM FM Synthesizer 50Mc/s 2-18GHzS
 R&S SWP Sweep Generator Synthesizer AM FM 4-2500Mc/s - £3.5k.
 ADRET 3310A FX Synthesizer 300Hz-60Mc/s - £600.
 HP8640A Signal Generators - 1024Mc/s - AM FM - £800.
 HP3717A 70Mc/s Modulator - Demodulator - £500.
 HP8651A RF Oscillator 22KC/S - 22Mc/s.
 HP5316B Universal Counter A+B.
 HP6002A Power Unit 0-5V 0-10A 200W.
 HP6825A Bipolar Power Supply Amplifier.
 HP461A-465A-467A Amplifiers.
 HP81519A Optical Receiver DC-400Mc/s.
 HP Plotters 7470A-7475A.
 HP3770A Amplitude Delay Distortion ANZ.
 HP3770B Telephone Line Analyser.
 HP8182A Data Analyser.
 HP59401A Bus System Analyser.
 HP6260B Power Unit 0-10V 0-100 Amps.
 HP3782A Error Detector.
 HP3781A Pattern Generator.
 HP3730A + 3737A Down Converter Oscillator 3.5-6.5GHz.
 HP Microwave Amps 491-492-493-494-495-1GHz-12.4GHz - £250.
 HP105B Quartz Oscillator - £400.
 HP5087A Distribution Amplifier.
 HP6034A System Power Supply 0-60V 0-10A-200W - £500.
 HP6131C Digital Voltage Source + 100V 1/2 Amp.
 HP4275A Multi Frequency L.C.R. Meter.
 HP3779A Primary Multiplex Analyser.
 HP3779C Primary Multiplex Analyser.
 HP8150A Optical Signal Source.
 HP1630G Logic Analyser.
 HP5316A Universal Counter A+B.
 HP5335A Universal Counter A+B+C.
 HP59501B Isolated Power Supply Programmer.
 HP8901A Modulation Meter AM - FM - also 8901B.
 HP5370A Universal Time Interval Counter.
 Marconi TF2370 - 30Hz-110Mc/s 750HM Output (2 BNC Sockets + Resistor for 500HM MOD with Marconi MOD Sheet supplied - £650.
 Marconi TF2370 30Hz-110Mc/s 50 ohm Output - £750.
 Marconi TF2370 as above but late type - £850.
 Marconi TF2370 as above but late type Brown Case - £1000.
 Marconi TF2374 Zero Loss Probe - £200.
 Marconi TF2440 Microwave Counter - 20GHz - £1500.
 Marconi TF2442 Microwave Counter - 26.5GHz - £2k.
 Marconi TF2305 Modulation Meter - £2.3k.
 Rcal/Dana 2101 Microwave Counter - 10Hz-20GHz - £2k.
 Rcal/Dana 1250-1261 Universal Switch Controller + 200Mc/s PI Cards.
 Rcal/Dana 9303 True RMS Levelmeter+Head - £450. IFFE - £500.
 TEKA6902A also A6902B Isolator - £300-£400.
 TEK 1240 Logic Analyser - £400.
 TEK FG5010 Programmable Function Generator 20Mc/s - £600.
 TEK2465A 350Mc/s Oscilloscope - £2.5k + probes - £150 each.
 TEK CT-5 High Current Transformer Probe - £250.
 TEK J16 Digital Photometer + J6523-2 Luminance Probe - £300.
 TEK J16 Digital Photometer + J6503 Luminance Probe - £250.
 ROTEK 320 Calibrator + 350 High Current Adaptor AC-DC - £500.
 FLUKE 5102B AC-DC Calibrator - £4k.
 FLUKE 1120A IEE - 488 Translator - £250.
 Tinsley Standard Cell Battery 5644B - £500.
 Tinsley Transportable Voltage Reference - £500.
 FLUKE Y5020 Current Shunt - £150.
 HP745A + 746A AC Calibrator - £500.
 HP8080A MF + 8091A 1GHz Rate Generator + 8092A Delay Generator + Two 8093A 1GHz Amps + 15400A - £800.
 HP54200A Digitizing Oscilloscope.
 HP11729B Carrier Noise Test Set .01-18GHz - LEF - £2000.
 HP3311A Function Generator - £300.
 Marconi TF2008 - AM-FM signal generator - also sweeper - 10Kc/s - 510Mc/s - from £250 - tested to £400 as new with manual - probe kit in wooden carrying box.
 HP Frequency comb generator type 8406 - £400.
 HP Vector Voltmeter type 8405A - £400 new colour.
 HP Sweep Oscillators type 8690 A & B + plug-ins from 10Mc/s to 18GHz also 18-40GHz. P.O.R..
 HP Network Analyzer type 8407A + 8412A + 8501A - 100Kc/s - 110Mc/s - £500 - £1000.
 HP Amplifier type 8447A - 1-400Mc/s £200 - HP8447A Dual - £300.
 HP Frequency Counter type 5340A - 18GHz £1000 - rear output £800.
 HP 8410 - A - B - C Network Analyzer 110Mc/s to 12GHz or 18GHz - plus most other units and displays used in this set-up - 8411b - 8412 - 8413 - 8414 - 8418 - 8740 - 8741 - 8742 - 8743 - 8746 - 8650. From £1000.
 Rcal/Dana 9301A - 9302 RF Millivoltmeter - 1.5-2GHz - £250-£400.
 Rcal/Dana Modulation Meter type 9009 - 8Mc/s - 1.5GHz - £250.
 Marconi RCL Bridge type TF2700 - £150.
 Marconi/Saunders Signal Sources type - 6058B - 6070A - 6055A - 6059A - 6057A - 6056 - £250-£350. 400Mc/s to 18GHz.
 Marconi TF1245 Circuit Magnification meter + 1246 & 1247 Oscillators - £100-£300.
 Marconi microwave 6600A sweep osc., mainframe with 6650 PI - 18-26.5GHz or 6651 PI - 26.5-40GHz - £1000 or PI only £600. MF only £250.
 Marconi distortion meter type TF2331 - £150. TF2331A - £200.

Tektronix Plug-Ins 7A13 - 7A14 - 7A18 - 7A24 - 7A26 - 7A11 - 7M11 - 7S11 - 7D10 - 7S12 - S1 - S2 - S6 - S52 - PG506 - SC504 - SG502 - SG503 - SG504 - DC503 - DC508 - DD501 - WR501 - DM501A - FG501A - TG501 - PG502 - DC505A - FG504 - 7880 + 85-7892A
 Gould J3B test oscillator + manual - £150.
Tektronix Mainframes - 7603 - 7623A - 7613 - 7704A - 7844 - 7904 - TM501 - TM503 - TM506 - 7904A - 7834 - 7623 - 7633.
 Marconi 6155A Signal Source - 1 to 2GHz - LED readout - £400.
 Barr & Stroud Variable filter EF3 0.1Hz-100Kc/s + high pass + low pass - £150.
 Marconi TF2163S attenuator - 1GHz. £200.
 Farnell power unit H60/50 - £400 tested. H60/25 - £250.
 Rcal/Dana 9300 RMS voltmeter - £250.
 HP 8750A storage normalizer - £400 with lead + S.A. or N.A. Interface.
 Marconi TF2330 - or TF2330A wave analysers - £100-£150.
 Tektronix - 7S14 - 7T11 - 7S11 - 7S12 - S1 - S2 - S39 - S47 - S51 - S52 - S53 - 7M11.
 Marconi mod meters type TF2304 - £250.
 HP 5065A rubidium vapour FX standard - £1.5k.
 Systron Donner counter type 6054B - 20Mc/s - 24GHz - LED readout - £1k.
 Rcal/Dana 9083 signal source - two tone - £250.
 Systron Donner - signal generator 1702 - synthesized to 1GHz - AM/FM - £600.
 Tektronix TM515 mainframe + TM5006 mainframe - £450 - £850.
 Farnell electronic load type RB1030-35 - £350.
 Rcal/Dana counters - 9904 - 9905 - 9906 - 9915 - 9916 - 9917 - 9921 - 50Mc/s - 3GHz - £100-£450 - all fitted with FX standards.
 HP4815A RF vector impedance meter c/w probe - £500-£600.
 Marconi TF2092 noise receiver. A, B or C plus filters - £100-£350.
 Marconi TF2091 noise generator. A, B or C plus filters - £100-£350.
 Marconi 2017 S/G 10KHz - 1024MHz.
 HP180TR, HP182T mainframes £300-£500.
 Philips panoramic receiver type PM7900 - 1 to 20GHz - £400.
 Marconi 6700A sweep oscillator + 18GHz PI's available.
 HP8505A network ANZ + 8503A S parameter test set + 8501A normalizer - £4k.
 HP8505 network ANZ 8505 + 8501A + 8503A.
 Rcal/Dana VLF frequency standard equipment. Tracer receiver type 900A + difference meter type 527E + rubidium standard type 9475 - £2750.
 HP signal generators type 626 - 628 - frequency 10GHz - 21GHz.
 HP 432A - 435A or B - 436A - power meters + powerheads - Mc/s - 40GHz - £200-£1000.
 Bradley oscilloscope calibrator type 192 - £600.
 HP8614A signal generator 800Mc/s - 2.4GHz. new colour £400.
 HP8616A signal gen 1.8GHz-4.5GHz. new colour £400.
 HP 3325A syn function gen 20Mc/s - £1500.
 HP 3336A or B syn level generator - £500-£600.
 HP 3586B or C selective level meter - £750-£1000.
 HP 3575A gain phase meter 1Hz - 13Mc/s - £400.
 HP 8683D S/G microwave 2.3 - 13GHz - opt 001 - 003 - £4.5k.
 HP 8660 A-B-C syn S/G. AM + FM + 10Kc/s to 110Mc/s PI - 1Mc/s to 1300Mc/s - 1Mc/s to 2600Mc/s - £500-£2000.
 HP 8640B S/G AM-FM 512Mc/s or 1024Mc/s. Opt 001 or 002 or 003 - £800-£1250.
 HP 86222B Sweep PI - 01 - 2.4GHz + ATT - £1750.
 HP 8629A Sweep PI - 2 - 18GHz - £1000.
 HP 86290B Sweep PI - 2 - 18GHz - £1250.
 HP 86 Series PI's in stock - splitband from 10Mc/s - 18.6GHz - £250-£1k.
 HP 8620C Mainframe - £250. IEE - £500.
 HP 8615A Programmable signal source - 1MHz - 50Mc/s - opt 002 - £1k.
 HP 8601A Sweep generator .1 - 110Mc/s - £300.
 HP 3488A HP - IB switch control unit - £500 + control modules various - £175 each.
 HP 8160A 50Mc/s programmable pulse generator - £1000.
 HP 853A MF ANZ - £1.5k.
 HP 8349A Microwave Amp 2 - 20GHz Solid state - £1500
 HP 3585A Analyser 20Hz - 40Mc/s - £4k.
 HP 8569B Analyser .01 - 22GHz - £5k.
 HP 3580A Analyser 5Hz - 50kHz - £1k.
 HP 1980B Oscilloscope measurement system - £600.
 HP 3455A Digital voltmeter - £500.
 HP 3437A System voltmeter - £300.
 HP 3581C Selective voltmeter - £250.
 HP 5370A Universal time interval counter - £450.
 HP 5335A Universal counter - 200Mc/s - £500.
 HP 5328A Universal counter - 500Mc/s - £250.
 HP 6034A System power supply - 0 - 60V - 0 - 10 amps - £500.
 HP 5150A Thermal printer - £250.
 HP 1645A Data error analyser - £150.
 HP 4437A Attenuator - £150.
 HP 3717A 70Mc/s modulator - £400.
 HP 3710A - 3715A - 3716A - 3702B - 3703B - 3705A - 3711A - 3791B - 3712A - 3793B - 3712A - 3793B - microwave link analyser - P.O.R.
 HP 3730A + B RF down converter - P.O.R.
 HP 3552A Transmission test set - £400.
 HP 3763A Error detector - £500.
 HP 3764A Digital transmission analyser - £600.
 HP 3770A Amp delay distortion analyser - £400.
 HP 3780A Pattern generator detector - £400.
 HP 3781A Pattern generator - £400.
 HP 3781B Pattern generator (bell) - £300.
 HP 3782A Error detector - £400.
 HP 3782B Error detector (bell) - £300.
 HP 3785A Jitter generator + receiver - £750-£1k.
 HP 8006A Word generator - £100-£150.
 HP 8016A Word generator - £250.
 HP 8170A Logic pattern generator - £500.
 HP 59401A Bus system analyser - £350.
 HP 59500A Multiprogrammer HP - IB - £300.
 Philips PM5390 RF syn - 0.1 - 1GHz - AM + FM - £1000.
 S.A. Spectral Dynamics SD345 spectroscope 111 - LF ANZ - £1500.
 Tektronix R7912 Transient waveform digitizer - programmable - £400.
 Tektronix TR503 + TM503 tracking generator 0.1 - 1.8GHz - £1k - or TR502.
 Tektronix 576 Curve tracer + adaptors - £900.
 Tektronix 577 Curve tracer + adaptors - £900.
 Tektronix 1502/1503 TRR cable test set - £1000.
 Tektronix AM503 Current probe + TM501 m/frame - £1000.
 Tektronix SC501 - SC502 - SC503 - SC504 oscilloscopes - £75-£350.
 Tektronix 465 - 465B - 475 - 2213A - 2215 - 2235 - 2245 - £250-£1000.
 Kikusui 100Mc/s Oscilloscope COS6100M - £350.
 Nicolet 3091 LF oscilloscope - £400.
 Rcal 1991 - 1992 - 1988 - 1300Mc/s counters - £500-£900.
 Fluke 80K-40 High voltage probe in case - BN - £100.
 Rcal Records - Store 4 - 4D - 7 - 14 channels in stock - £250 - £500.
 Rcal Store Horse Recorder + Controller - £400-£750 Tested.
 EIP 545 microwave 18GHz counter - £1200.
 Fluke 510A AC ref standard - 400Hz - £200.
 Fluke 355A DC voltage standard - £300.
 Wiltron 610D Sweep Generator + 6124C PI - 4 - 8GHz - £400.
 Wiltron 610D Sweep Generator + 61084D PI - 1Mc/s - 1500Mc/s - £500.
 Time Electronics 9814 Voltage calibrator - £750.
 Time Electronics 9811 Programmable resistance - £600.
 Time Electronics 2004 D.C. voltage standard - £1000.
 HP 8699B Sweep PI YIG oscillator .01 - 4GHz - £300. 8690B MF - £250. Both £500.
 Schlumberger 1250 Frequency response ANZ - £1500.
 Dummy Loads + power att up to 2.5 kilowatts FX up to 18GHz - microwave parts new and ex B&K items in stock - ask for list.
 equip - relays - attenuators - switches - waveguides - Yigs - SMA - APC7 plugs - adaptors.
 W&G items in stock - ask for list.
 Power Supplies Heavy duty + bench in stock - Farnell - HP - Weir - Thurlby - Rcal etc. Ask for list.

ITEMS BOUGHT FROM HM GOVERNMENT BEING SURPLUS. PRICE IS EX WORKS. SAE FOR ENQUIRIES. PHONE FOR APPOINTMENT OR FOR DEMONSTRATION OF ANY ITEMS, AVAILABILITY OR PRICE CHANGE. VAT AND CARRIAGE EXTRA

ITEMS MARKED TESTED HAVE 30 DAY WARRANTY. WANTED: TEST EQUIPMENT-VALVES-PLUGS AND SOCKETS-SYNCS-TRANSMITTING AND RECEIVING EQUIPMENT ETC.

Johns Radio, Whitehall Works, 84 Whitehall Road East, Birkenshaw, Bradford BD11 2ER. Tel. No: (01274) 684007. Fax: 651160

CIRCLE NO. 141 ON REPLY CARD

LETTERS

Letters to "Electronics World" Quadrant House, The Quadrant, Sutton, Surrey, SM2 5AS

Why Wien?

I was interested to read Bryan Hart's article on the design of Wien bridge oscillators in October issue of *Electronics World*. But why would anyone nowadays want to build a Wien bridge oscillator? I find a double-integrator oscillator – such as described on pages 53-57 of the 'Analog Circuits Cookbook' by Ian Hickman – much more reliable and predictable. Moreover, its effective filtering action makes it possible to use diode limiting in the feedback path for level control, and still obtain a low level of harmonics.

True, this alternative requires two more op-amps, but as you can buy four high quality op-amps in one package for about £1 retail, it is a price well worth paying.

J S Linfoot
Oxford

Flat-panel speakers

The article on solid-diaphragm speakers, 'Flat but not flat' in the August issue, rather bypasses the matter of woofers with polystyrene diaphragms of maximum strength.

Two or three decades ago you published two remarkable articles I cannot trace, by the same author. One showed that acoustic gramophone records could give a useful audio power at reasonable fidelity, provided the grooves were cut not with a diamond profile, but shaped with a solid of revolution so as to give line contact with a suitably shaped stylus.

The other showed that a very rigid diaphragm for a loudspeaker could be made from polystyrene foam with stretched aluminium foil glued to each side, and possibly because of this the Kefkit 3 I used to listen to mono on a woofer of solid polystyrene – without the foil. It has the advantage of zero colouration. It does not sound like a loudspeaker.

I see a 1949 book 'The Why and How of Good Reproduction' By G H Briggs is still on offer from one of your advertisers and wonder if the people who worry about cabinet resonances would not be happier following his suggestion for students of using a drainpipe on a cabinet with a speaker set on top of it and locks spacing it off the floor: in such configurations one can set an inverted cone over the centre of the speaker to disperse the higher frequencies and of course add a tweeter, though I think he was probably using Wharfedale speaker (his own firm) intended for all

frequencies. To make more of a port at the bottom a rectangular-section port could be built with blocks taking its plan view up to the size of the pipe. Alternatively owners of rectangular speaker cabinets could glue in large numbers of light wooden spars going in all directions but favouring the centres of the panels, damping the spars with felt.

With regard to the letters on speaker design suggesting that speaker cabinets can be tuned to match the room. I very much doubt the room affects what happens at the speaker front panel, and also I've been told that in judging levels people use only the direct speaker sound. On the other hand Cecil B Watts used to say that solo instruments should be recorded without reverberation as the reverberation in the listening room did the trick. Who is right?

Sometimes I wish we could stop worrying about speakers, but we don't.

Name not available
London

The attraction of reed relays

Specifications of a reed-relay can be made to change drastically with the aid of a permanent magnet. With increasing magnetising influence, depending on the magnet's position relative to the axis of the relay and its 'strength', the permanent magnet can,

- make the relay pull in and release at smaller currents than without the permanent magnet (normally open),
- make the pull-in current still smaller, latching and opening only if the current is reversed (memory), and
- make the relay normally closed, opening only with the current reversed. And closing again at further increase.

The use of the permanent magnet affects both speed and reliability and increase the pull in to release current ratio. Less than 1cm of the magnetic PVC strip that kept the door of your old refrigerator closed will do the job. Just cut it with scissors and glue it to the top of your reed-relay.

Scott Arnesen
Oslo
Norway

Stability in audio amplifiers

Electronic stability. Audio amplifiers must remain electronically stable during normal

– and sometimes abnormal – operation, if only to avoid writing off output transistors and possibly speakers.

A solution adopted by many designers including Doug Self,¹ is to connect a capacitor of say 100pF across the voltage amplifying stage (VAS). Ed Cherry recommends that this capacitor be connected to include the output devices so as to gain a useful reduction in crossover distortion. There is perhaps understandably some reluctance to try this, but I can concur with Ed that it can indeed work and result in stable amplifiers.

I discovered this after reading Ed's comment about instability in driver stages. Firstly, I connected 39pF capacitors between base and collector of the *BD139/BD140* drivers of my type II emitter follower output stage. A clearly discernible improvement in sound quality was noted.

I do mount my drivers on short leads, but clearly the pcb track inductance is sufficient to cause instability in this stage when using transistors having frequency responses up to 100MHz or so. The output devices are *BD911/BD912*. Many thanks Ed.

The C_{dom} capacitor of 100pF was connected between the output stage and the input base of the VAS stage. A 1kHz square wave response showed only a small amount of overshoot with a reactive load (8Ω in parallel with 2μF). Response was optimised by means of a 22pF capacitor in series with 150kΩ, connected between VAS collector and the negative feedback point on the input pair.

Final response and stability are good. Audible results are very satisfactory. Again, thanks Ed.

The amplifier circuit includes a cascode stage and three transistor current mirror on the input pair, and a cascode VAS stage. Drivers and output devices are operated on ±35V rails. Input and VAS stages are fed from similar, but voltage stabilised rails. Input impedance of the amplifiers are around 35 kΩ and voltage gain is 20.

I always check and do initial setting up of amplifiers with drivers and outputs stages supplied via ±15V 1 A current limited supplies – just in case

Thermal stability. It can be difficult to ensure that optimum quiescent current is maintained during operation of class B emitter follower driver/output stages. Common practice is to mount drivers and output devices on a

common heat sink and to use a single – or perhaps double – transistor V_{be} multiplier, also mounted on the heat sink – or possibly on one of the output devices. This is far from ideal as the drivers and output devices invariably operate at different temperatures.

A better solution is to use a conventional V_{be} multiplier connected in series with two forward biased diodes. The V_{be} multiplier transistor should be mounted as closely as possible to one of the output devices and the diodes should be mounted in contact with each of the driver devices. This arrangement has provided me with very good thermal stability in type II emitter follower circuits. An advantage of the arrangement is that driver devices can be located more conveniently, possibly away from the main cooling fin.

I claim no credit for the use of diodes to control quiescent current. This was done by B J Codd³.

Ken Hough
Amersham,
South Bucks

1. Self, D, 'Distortion in Power Amplifiers,' *Electronics World*, Feb. 1994 p137.
2. Cherry, E., 'Ironing out distortion,' *Electronics World*, July 1997, p577.
3. Codd, BJ, 'Low distortion amplification,' *Wireless World*, Oct. 1979, p81.

1.3V mystery

I have been an electronics engineer for 30 years and I have just realised that I do not know how a quartz watch can work so efficiently from only one 1.3V cell. The same goes for calculators and thermometers with liquid-crystal displays.

So what is the secret and why don't many other things use the same technology? One single cell is so convenient and contains size for size, much more energy than say a PP3.

You never see a circuit diagram of one of these single cell devices. Is there a conspiracy by the battery makers? Is there a parallel universe that uses a semiconductor that only needs a bias voltage of a millivolt?

While we are on the subject of the unknown, how do hearing aid makers squash all the electronics into such a small space, and without feedback? Do they use normal smt or again is there another Flint in this parallel universe that supplies $1/100$ size components?

Ken Hawes
London SW17

On beating frequencies

In the September 1997 issue on page 786, Chris Bulman raised a question about beating frequencies. This query prompted an unusually high response. These are the last few responses that we are able to publish on the subject, but many thanks to everyone who replied. Ed

Chris Bulman is correct in thinking that a sinewave signal very close to the Nyquist frequency will, when sampled, produce a set of data points which encode a "wuhwuhwuh" (sic).

Fourier analysis of the wuh (forgive the abbreviation) would show in his example at 19.999kHz and one at 20.001kHz. There are also pairs of tones at 59.999k/60.001k and all subsequent odd multiples of the Nyquist frequency, with gradually reducing amplitude.

If you fed the data to a d-to-a converter and listened to the output, I'm sure those with a reliable aural response to 20kHz would hear this pulsating effect.

But this is not what happens in a proper digital audio system. A proper system uses an anti-imaging filter whose primary role is to remove the higher of the wuh tones, leaving the lower one pristine, smooth and un-wuhed.

This filter would indeed have a delay of many seconds if it had to resolve the 2Hz frequency difference between the wuh tones, which is why a 'guard band' is used between the highest encoded frequency and the Nyquist frequency. It makes the anti-imaging – as well as the anti-aliasing – filters economically realisable, whether they are 'traditional' analogue or computational exercises in silicon.

Kendall Castor-Perry, Kemo Ltd, Kent

Chris Bulman asks about the behaviour of a digital sampling system, and the effect on it of signals at or close to the Nyquist frequency – i.e. half the sampling frequency.

In his example, Chris Bulman explains that a signal at 19.999kHz passed through a system that is sampling at 40kHz, and has a brick-wall filter that cuts off at 20kHz, will result in the d-to-a converter producing a 20kHz signal that is modulated at 1Hz, reversing in phase every half cycle. He believes his analysis of the signal, but does not believe that this is what really happens, and would like a non-mathematical explanation of the paradox.

A simple argument is to observe that Chris's waveform is a 20kHz signal modulated at 1Hz. Since modulation produces sidebands, this signal is impossible, as the brick wall filter removes sidebands above 20kHz.

A more complete answer to the paradox (but unfortunately requiring a small amount of maths) is as follows:

Chris's description of the signal is in fact a correct one if the brick wall filter is ignored. Ignoring the brick wall filter has no effect on Chris's argument, except that signals appear around a series of harmonics of the 40kHz sampling square wave.

The signal as described, viz. a 20kHz signal modulated at 1Hz, reversing in phase every half cycle, is actually a suppressed-carrier, double-sideband signal. In this case, the sidebands are 1Hz either side of the suppressed 20kHz carrier at 19.999kHz and 20.001Hz.

A way of understanding this is to look at it the other way round: there are two sidebands, and they are beating together. To find out

what happens when two sinusoidal signals are added together, consult an A-level maths book, where you will find the identity,

$$\cos A + \cos B = 2 \left[\cos \left(\frac{A+B}{2} \right) \cos \left(\frac{A-B}{2} \right) \right]$$

which is also known as 'two cos semi-sum cos semi-diff.'

This formula shows that sinusoidal waves of 19.999kHz and 20.001kHz will beat together to give a result that is a 20kHz sinusoidal wave (the $\cos(A+B)$ term) multiplied by a 1Hz sinusoidal wave (the $\cos(A-B)$ term), which is the waveform originally described by Chris.

Once you realise that C.B.'s fluctuating signal is actually a pair of frequencies, then all you have to do is put the brick-wall filter in, and, since it removes everything above 20kHz, what is left is 19.999kHz, as per Nyquist's theory. The 20.001kHz signal that has been removed is known as an alias signal.

Incidentally, a true brick wall filter is impossible to realise. The more brick-wall-like a filter is, the more delay the filter have, and an infinitely steep brick-wall response would require an infinite delay. However, replacing the brick-wall filter with a real filter, and leaving a guard band between the highest signal frequency and the Nyquist frequency, as is done in practice, does not in any way alter the paradox as described by Chris, and its explanation as given above, since the delay in the filter – ideally – affects all frequencies by the same amount.

*Brian Pollard
Maidstone
Kent*

The 'paradox' is easily resolved if one bears in mind what the spectrum – or Fourier transform – of a sampled signal looks like, and the practicalities of designing an appropriate reconstruction filter.

Shannon's sampling theorem¹ states that if a signal is bandlimited to W Hz then it may be reconstructed from its values taken at $1/2W$ (s) intervals.

Consider the process of sampling and reconstruction in the time and frequency domains. In the frequency domain the act of sampling causes the spectrum to be made periodic, in a way that is best represented by the diagram, and the reconstruction process consists in filtering out the copies. If the copies overlap the resulting reconstruction is not the original signal and an aliasing error has occurred. In the time domain the reconstruction involves a convolution – an averaging process in which a 'window' is slid along the data and the weighted average of the samples in the window is computed.

The form of the weights determines the frequency characteristics of the filter. To pass frequency f_1 Hz and reject f_2 Hz requires a window of at least $1/|f_1 - f_2|$ seconds in duration: over a shorter period, $\cos(2\pi f_1 t)$ and $\cos(2\pi f_2 t)$ are not significantly different.

The Shannon reconstruction filter has a vertical cut-off at W , and therefore requires a window of infinite time extent.

Considering Mr Bulman's example, when a 19.999kHz sinewave is sampled at 40kHz, the spectrum of the samples contains components at 19.999kHz, 20.001kHz, 59.999kHz, 60.001kHz, and so on. Exact reconstruction requires a filter that passes all frequencies up to 20kHz and

rejects higher ones: in particular, it must pass 19.999kHz and reject 20.001kHz.

Can this be done in practice? In practice the window length is restricted to, perhaps, 100ms. This gives a selectivity of 0.01kHz, and so if 19.999kHz is to be passed then 20.001kHz will come through as well.

Having established that a practical reconstruction contains both the desired sinusoid and its first alias, it is easy to see what happens: the two frequencies beat together in the way that Mr Bulman describes. Note that the beat frequency does not actually occur in the spectrum – though if the signal were nonlinearly distorted it would. The problem will not arise if the difference between the signal and Nyquist frequencies is reasonably large – perhaps 1kHz –

because then the signal's aliases can be removed very effectively.

It is therefore a good idea, once the sampling rate has been selected as $2W$, to remove all frequencies above rW (for some r less than 1) before sampling. This creates a guard band between the highest frequency present, rW , and the Nyquist frequency, W , and makes accurate reconstruction a much more practical proposition. Helms and Thomas were the first to discuss this in a classic paper² on rapidly-convergent sampling expansions; since the sampling expansion gives the filter weights, their work is of immediate relevance in the design of reconstruction filters.

*Richard Martin
GEC Marconi Research*

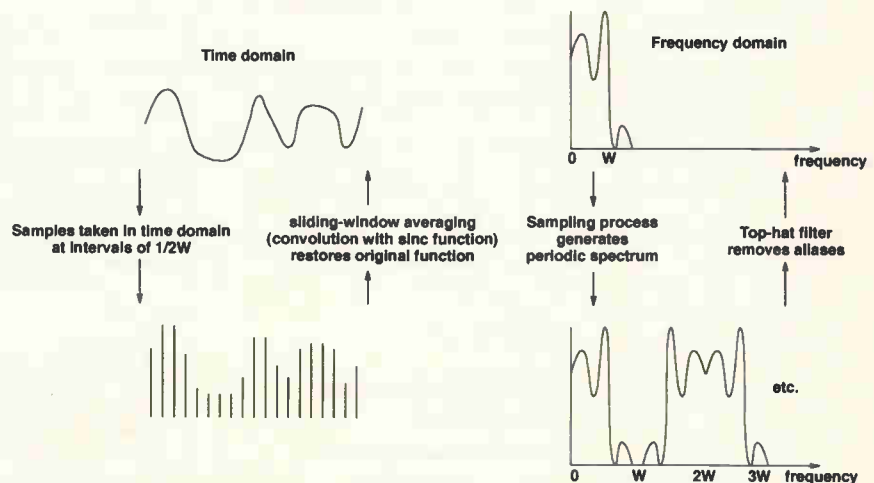

CLASSIFIED

TEL 0181 652 3620

FAX 0181 652 8956

ARTICLES FOR SALE

PCB CAMERA £39.00+VAT B/W MODULES

32mm. 3.5 lens or pinhole £39.00 + vat each
42mm • lens with audio add £10 + vat
(UK CARRIAGE/PACK/INSURANCE £4 UP TO 10 PIECES)

DISCOUNT FOR QUANTITIES

SEE OUR WEB SITE
OPEN 6 DAYS A WEEK FOR CALLERS
MAIL-ORDER OR EMAIL.

HENRY'S 404 EDGWARE ROAD
LONDON W12 1ED

Tel: 0171 258 1831 Fax: 0171 724 0322
email: sales@henrys.demon.co.uk internet address: http://www.henrys.co.uk

AUDIO & RF DESIGN - DC to 3GHz

- ◆ Stereo Coders & processors
- ◆ RF Amplifiers & Transmitters
- ◆ Wireless Control Systems
- ◆ 2.4 GHz Audio & VideoLinks
- ◆ Aerial combining Systems

So whatever your need call us!
LIBRA solutions
Tel. 0181-428 2776
mnoar@globalnet.co.uk

Surplus Stock - Capacitors

Large volume availability of capacitors
direct from manufacturer in pitch sizes 5,
7.5 & 10. VDC 63, 100, 250, 400 & 630.
µF 0.001 - µF 0.68

For further details please contact:

Pala Capacitors

Tel: 01483 565090
Fax: 01483 566050

RF DESIGN SERVICES

All aspects of RF hardware
development considered from
concept to production.

WATERBEACH ELECTRONICS

TEL: 01223 862550
FAX: 01223 440853

SALE - INDUSTRIAL ELECTRONICS

Test equipment, Transducers, Valves,
Connectors, Computers, Analysers,
Components, Gauges, Meters, Printers,
Rummage items, HP, Racal, IBM etc.
Near Southampton, 12-13 December

Technical and Scientific Supplies

Tel: 01703 891879 Fax: 01703 897079
e-mail: R.J.F@CompuServe.com

MICRO CCD CAMERA

High definition and sensitivity
>380 lines < 0.1 Lux 92 deg. lens
1/3" b/w PCB, 12V 75mA
38*38*30mm

Standard 1 Volt 625 line video o/p.

ONLY £64.95

inc uk. p&p, and VAT

Send cheque or PO. to
ReTech Ltd., Unit 1,
Dorcan Business Village,
Swindon, SN3 5HY.

Send sac. for details and latest
list of AV. and Satellite offers

AUDIO & RF DESIGN - DC to 3GHz

- ◆ Stereo Coders & processors
- ◆ RF Amplifiers & Transmitters
- ◆ Wireless Control Systems
- ◆ 2.4 GHz Audio & VideoLinks
- ◆ Aerial combining Systems

So whatever your need call us!

LIBRA solutions

Tel. 0181-428 2776
mnoar@globalnet.co.uk

INTERESTED IN A HIGHER DEGREE?

Why not read *Gaining a Master's Degree* by
Allen Brown. Available from book shops or
HowToBooks, Plymouth House, Estover Road,
Plymouth PL6 7PZ. Tel: 01752 202301, Fax:
01752 202301, £9.99.

CAPACITORS

Large volume availability of capacitors
direct from manufacturer in pitch sizes
5, 7.5 & 10. VDC 63, 100, 250, 400 & 630.
µF 0.00 - µF 0.68

For further details please contact:

PALA CAPACITORS

Tel: 01483 565090
Fax: 01483 566050

Adret 740A Signal Generator 0.1 - 1120 MHZ

Price: £1,500

TELFORD ELECTRONICS
(0044) 01952 605451

DAT RECORDER Sony Portable TCD-D8 £299
(half new price), boxed in perfect condition. Used
for 2 hours only. Telephone: (01904) 426696
(Evenings).

FLUKE 867B graphical multi meter, five months
old, with leads and manual: £550 ono. Tel: 01482
815625.

JRC RADIO TEST SET NJZ 900E. £450. Tel:
01635 552285.

ARTICLES WANTED

VALVES and CRTs AVAILABLE

ONE MILLION VALVES stocked for Audio, Receiving, Transmitting & RF Heating. Rare brands such as Mullard & GEC available. Also MAGENTRONS, KLYSTRONS, CRTs and SOCKETS.

Large stocks of Russian and Sovtek items.

Please ask for our free catalogues of valves or CRTs.

VALVES, etc, WANTED

Most types considered but especially KT88 (£60), PX4/PX25 (£60), KT66 (£38), KT77 (£18), EL34 (£15), EL37 (£15), ECC83 (£3). Valves must be UK manufacture to achieve prices mentioned. Also various valve-era equipment e.g. Garrard 301, (up to .£80). Ask for a free copy of our wanted List.

BILLINGTON EXPORT LTD., Billingshurst, Sussex RH14 9EZ

Tel: 01403 784961 Fax: 01403 783519

VISITORS STRICTLY BY APPOINTMENT.

MINIMUM ORDER £50 plus VAT

TOP PRICES PAID

For all your valves, tubes, semi
conductors and IC's.

Langrex Supplies Limited

1 Mayo Road, Croydon
Surrey CR0 2QP

TEL: 0181-684 1166
FAX: 0181-684 3056

WANTED - Old cipher equipment and "spy
radio sets". OZ8RO Rag Otterstad, Hosterkobvej
10 DK-3460 Birkerod, Denmark. Fax: ++45
44681514.

WANTED - W.W.II. German and S.O.E. clandestine
sets, receivers. Also incomplete sets. OZ8RO
Rag Otterstad, Hosterkobvej 10 DK-3460
Birkerod, Denmark. Fax: ++45 44681514.

WANTED - any AVO model 8 with hopelessly
damaged movement. Tel: 01326 312901.

SWITCHING PSU REQUIRED? Surf:
www.directou.mcmill.com Loads'a bargains.

RECRUITMENT

SALES MANAGER

We are a small company supplying transmission systems to
the broadcast radio market and are looking for a Sales
Manager to take over the running of our sales department.
You should have a technical background, ideally with some
experience of radio.

Please apply with letter and CV to:

Alan Brown, Radica Broadcast Systems Ltd.,
18 Bolney Grange Industrial Park, Hickstead,
Haywards Heath, West Sussex, RH17 5PB

PLEASE MENTION
ELECTRONICS WORLD
WHEN REPLYING TO ADVERTISEMENTS

Grad/Engineer/Leader/Manager

Senior RF Engineer

This leading Radio design company who is focused on the automatic meter reading (AMR) market is leading the way in AMR throughout Europe and beyond. You will lead up a team of strong Engineers who have the desire to be part of the successful team. You will also play a key role in the European equipment range and laboratories. Ideally you will come from a comms background and be educated to Degree level with the minimum of five solid years in RF design in a management or supervisory role. This is an excellent opportunity for a talented and ambitious Engineer to join a worldclass RF design company which offers an outstanding allround package - grab this one with both hands!

David Tillyer - Ref: DT112/EWo

Driving Technology

Essex £18-28K
We are looking for a number of good academic Engineers (2:2 Honours or better) to join the Audio, Power Train, Body Electronics and In-Car Control Systems depts of a well known automotive manufacturer. You will join multi-discipline teams working on NEW European and Worldwide commercial vehicles projects to go into production at the turn of the Century. We are keen to talk to Engineers with a good Degree, at least 12 months in industry plus experience of digital/microprocessor and/or analogue electronics. Experience of automotive, electronics, control systems, powertrain, audio, instrumentation or sensors would also be useful. Please call for further details.

Andrew Langridge - Ref: AL426EWo

Peter Gabriel Has One !..

£22-28K

So does Phil Collins, Sting and the BeeB to "name drop" just a few customers - we are talking serious SOUND MIXING! To continue their success in the professional audio and broadcast arena, this company have an URGENT requirement to recruit innovative, practical, team minded Design Engineers who don't mind dabbling in a mixture of: Hardware, FPGA's, Analogue etc, etc. We need to talk to you, if you have a hobby or interest in electronics, are a hands-on Engineer, you want to engineer, and you want your electronics to work!

Andrew Langridge - Ref: AL424EWo

Power Supply/Electronics

Snr PSU Designer	Slough	£30K
2yrs+ SMPS	Suffolk	£26K
Power Supply - Avionics	Middx	£18-26K
PSU's, TVs	Midlands	£open
Hi Voltage PSU	S.Coast	£28K
Commercial SMPS	Devon	£28K
R&D SMPS	Herts	£25-30K
DC Power Systems	Essex	£28K
SMPS/PSU	Scotland	£30K
SMPS/Avionics	Camb	£29K

Andrew Langridge - Ref: AL420EWo

Test Development Team Ldr - Radio/RF

N.Home Counties £26K
A leading systems/board level development house responsible for R&D activities into the PMR/Radio field require a Test Equipment Team Leader. You will be responsible for the co-ordination of a small Test Development Team, project managing new developments, also acting as a functional part of the team - yourself being involved in Test Development activities. You will liaise with R&D on DFT/ Testability issues and on determining test strategies. HND/Degree Electronics, 5 years+ test development experience, knowledge of I/O interfaces, IEEE-488, RS232, HPBASIC/QUICKBASIC, RF/Radio principals.

Peter Starling - Ref: P5200EWo

RF, RF, RF

RF Design	Hampshire	£18-40K
RF/GSM Design	Wiltshire	£25-30K
RF and System	Hampshire	£24-37K
RF Test	Hampshire/Bucks	£15-25K
RF Planner	Middlesex/Wiltshire	up to £27K
RF Support/Design	USA	up to £40K+ bens
RF Systems/Test Engineer	Cambridgeshire	£25K+ Car
Senior RF Engineer	Herts/Berkshire	up to £40K

David Tillyer - Ref: DT136/EWo

RF/MW Eng Mgr - RF/MW Comps/Modules

£440K

A company involved in the design/development of Microwave/RF components require an Engineering Manager. You will be responsible for determining the current and future direction of Product Development, you will setup and co-ordinate dedicated Development Teams in the development of components/modules for markets aimed at the Satellite/Wireless Comms, Space and Automotive industries. You will liaise with Marketing/Sales functions in the definition of future product direction. Degree qualified, 10 years+ in a Senior Engineer/ Product Development role, vast experience in RF/MW component development, project management.

Peter Starling - Ref: P5202EWo

Graduates of '96 & '97

2:2/2:1/1st/MSc/ PhD
Top companies who offer superb salaries, career prospects and training are now looking for bright articulate and ambitious graduates to join them. If you are experienced in:

- | | | |
|------------|--------------|-------------------|
| ★ Power | ★ Comms | ★ Telecomms |
| ★ RF | ★ DSP | ★ Audio |
| ★ ASIC/IC | ★ VHDL | ★ Imaging |
| ★ Control | ★ Automotive | ★ Instrumentation |
| ★ Analogue | ★ Digital | ★ Optoelectronics |

We offer excellent opportunities.

Caroline Papp - Ref: CP01EWo

Development Engs - Video/RF

N.Home Counties
A company who design/develop and manufacture network broadcast equipment primarily for the Cable/Consumer Network industry require Design Engineers. You will be responsible for the development of Video and RF circuits for consumer based products. You will take product development from conception to manufacture and will liaise with other parties along the way to ensure DFM/DFT criteria are met. HND/ Degree Electronics, component level design (Video/RF), use of design tools - PSPICE etc, knowledge of Set Top Box/Cable TV products an advantage.

Peter Starling - Ref: P5190EWo

DSP Engineers

Continuing European growth has led to the immediate requirement for a couple of good all-round DSP Engineers to join this small interactive team. You will be responsible for Hardware and Software Design (algorithm design, coding and testing) used in the development of new GSM and PMR comms products. Experience, allied to a degree level qualification should include real-time embedded software experience in C/C++ and Assembler with solid exposure to Texas DSPs.

Frazer Martin - Ref: FM/EWo70

Software Test

Testing times indeed! We can't find enough good experienced Software Test Engineers, therefore we have numerous vacancies from Junior to Team Leader level with clients in Telecomms, Datacomms and Consulting industries. Their requirements are similar, in that they all seek qualified, well trained Engineers to take responsibility for this critical production area, whether you have just one years experience or whether you develop test strategy, enhancements, procedures and seek a move into Consultancy - we have probably got a good move for you.

Frazer Martin - Ref: FM/EWo753

Fraud/Security Systems

As part of this major network provider/operator you will be responsible for the design/ integration of security and fraud systems into the existing comms infrastructure. You should possess a good knowledge of systems and protocols, encryption and authentication techniques. Additional exposure to GSM or RF would be advantageous.

Frazer Martin - Ref: FM/EWo40

Software Tools/Billing/CTI

The UK's most popular Mobile Telecomms company require talented qualified Engineers to join them in developing software tools for their next generation GSM cellular systems, CTI, business critical software, designing subscriber admin/billing systems software or simply planning/optimisation tools for their new and current networks. You will have a good Degree plus experience of development in C, C++, OOAD, RDBMS.

Frazer Martin - Ref: FM/EWo63

Development Manager

Our client is a leading blue chip company who require an experienced Development Manager. Based in Hampshire you will be developing a wide range of satellite based (GPS) positioning and using a range of communication systems including RF tagging products. You will also be involved in taking the designs through the complete product lifecycle and have some contact with customers and supplier. You will be qualified to Degree level in Electronics and/or will have a background in analogue and digital design and some knowledge of embedded microcontroller firmware design, a good allround package is offered to the ideal candidate.

David Tillyer - Ref: DT115/EWo

Midlands

£16-28K

Various companies in the East and West Midlands have a number of openings for Hardware Engineers with digital and analogue skills in the following fields:

- | | |
|-------------------|------------------|
| ★ Medical | ★ Automotive |
| ★ Instrumentation | ★ Avionics |
| ★ Power | ★ ASIC/IC Design |

Roma Das Gupta - Ref: RDG29EWo

Cash

World leader in the provision of transaction products and services based in the South of England are looking for Digital and Analogue Electronic Engineers at all levels. Digital position requires electronic design experience with 16/32 bit embedded microcontrollers, analogue position requires experience with low noise circuits, analogue circuit simulation and some knowledge of sensors. All positions require a good Degree and knowledge of EMC with software experience in assembler and C. Excellent company with benefits to match

Roma Das Gupta - Ref: RDG20EWo

Design Engineer

East £18-27K

A leader in the field of medical instrumentation is looking for a Hardware Design Engineer to develop new ideas. The company who are based in the East of England have just received a SMART grant to produce state-of-the-art medical equipment. The successful candidate must be prepared to work in a hands-on role, individually and as part of a team. We'd be keen to talk to Engineers with experience of digital and/or analogue hardware in addition instrumentation/laboratory equipment experience would be an advantage.

Roma Das Gupta - Ref: RDG25EW

Please call quoting the appropriate Ref. No. on 01442 212555 or fax/email/post your CV to:

SWP



Tel: 01442 212555
Fax: 01442 231555

2nd Floor,
89 The Marlowes,
Hemel Hempstead,
Herts, HPI 1XY

email: swprecruit@dial.pipex.com
(preferably WORD format please)

R&D

Telecomms Systems

E. Midlands **£20-35K**

Fast expanding internet company but small close knit group. You shall have wide systems experience in elite switching networks or mobile radio. Some UK travel is necessary. This is a good move from a pure technical role to a more commercial and customer focused activity.

Contact: Gordon Short

Ref: GS4900

ASIC

ASIC Design

UK Wide **to £50K & Benefits**

Exceptional opportunities with major semi-conductor companies, electronic manufacturers and design consultancies. The following skills are in high demand VHDL, VERILOG, CADENCE, SYNOPSIS, MOS/BIPOlar technology etc. Applications include Telecoms, Datacoms, Video/TV, Multimedia etc. Vacancies at all levels from Graduate to Project Leader some involving UK/European travel.

Contact: Brian Cornwell

Ref: BC4903

Research Assistant

Bucks **to £30K**

International standards and consultancy between design groups require an understanding of protocols and the ability to travel. You may be a research assistant in Telecommunications looking for your first career or you may already be established in switching, GSM or broadband systems. You will become the acknowledged company expert in your field.

Contact: Gordon Short

Ref: GS4901

Mixed Signal Designer

M3 **c£28K**

With this company only 2 years Analogue/Mixed Signal design will give you real responsibility and career development opportunities. If you have transistor level CMOS, BICMOS or Bipolar design experience with Mentor, VHDL, PSPICE, ELDO, LEDIT or Sabre skills phone me NOW!

Contact: Brian Cornwell

Ref: BC4904

Low Noise Amplifier Hardware Design

Hants/Bucks **£18-38K**

Whatever your RF skills or experience, our client will train you to do better. Worldwide projects include fixed access and satellite communications. Working at circuit, systems or advanced research level you will join a young dynamic team set to produce equipment to celebrate the millennium!

Contact: Gordon Short

Ref: GS4902



Communications

Ambassador House
575-599 Maxted Road
Hemel Hempstead
Herts HP2 7DX

Telephone (days): 01442 231691

Eves/wkends: 01442 253300

Fax: 01442 230063

Email: executive@dial.pipex.com

Web: <http://www.ers.co.uk/ers>

A member of Executive Recruitment
Services plc group of companies

T & M EQUIPMENT



ADVANTEST R3762AH 3.6GHz vector network analyser £5000
 ANRITSU ML93A optical power meter (MA96A 0.75-1.8uM) £1000
 ANRITSU MS420B 10Hz-30MHz network/spectrum analyser 75 ohms £3000
 ADVANTEST TR9407 ft spectrum analyser to 1MHz £3500

BRADLEY 192 oscilloscope calibrator £500
 HP8720C/6/10 microwave vector network analyser £4000
 HP35660A dynamic signal analyser, with 01 option £500
 HP8753C vector network analyser with 6GHz option £3500
 HP182T/8559A 21GHz spectrum analyser £2500
 HP3582A dual channel fft analyser £2500
 HP54620A 15 channel 500MS/sec logic analyser £1250
 HP83475A lightwave communications analyser £3250
 HP83572A sweeper plug-in (for 8350B) covering 26.5-40GHz £7500
 HP8557A/182T 350MHz £1000
 HP8591E 1.8GHz portable, 75ohm option 01 and TV option 301 £4000
 HP8756A scalar network analyser £1250
 MARCDNI 2019 synthesized signal generator 80kHz-1040MHz £1750
 MARCDNI 2380/2382 high specification, 400MHz spectrum analyser £4500
 FARNELL AP70-30 power supply 0-70V 0-30A 500W £650
 FARNELL SSG2000 10Hz-2GHz synthesized signal generator £2000
 PHILIPS PM5193 synthesized function generator £2000
 SCHAFFNER NSG500C/506C interference generator £3500
 SCHLUMBERGER 7081 8.5 digit precision voltmeter £1500
 WANDEL & GDTERMANN PCMA test set £15K
 WILTRON 560A scalar analyser. 8647B sweeper, 6669A sweeper Call

ralfe electronics exclusively professional T&CM ©

• 36 Eastcote Lane • South Harrow • Middx HA2 8DB • England •
 TEL (+44) 0181-422 3593 • FAX (+44) 0181-423 4009



**EST
45
YRS**

DISTRIBUZIONE E ASSISTENZA, ITALY: TLC RADIO, ROMA (06) 871 90254

TEST EQUIPMENT

★ URGENTLY REQUIRED ★

HEWLETT PACKARD 8720 series network analysers £20,000+paid for 'C'

HEWLETT PACKARD 8510 series microwave analysers, anything considered

HEWLETT PACKARD 8566B series spectrum analysers £10K-£20K paid

HP8753C + vector network analysers, we pay top prices for late models.

Guaranteed top prices paid for all current model spectrum/ network analysis.

HEWLETT PACKARD



1640B serial data generator £500
 11581A attenuator set £350
 3336A synthesizer/level generator £2000
 3235A switch/test unit £1000
 3325A synthesized function generator /01/02 £1500
 33320G/33322G programmable attenuators 4GHz, with driver 11713A £1000
 As above but 18GHz set £1500
 35650A mainframe £2000
 E3615A bench power supply £175
 3772A/04 digital hierarchy test set £9500
 37900D signalling test set with 2 x 37915A interface cards £5500
 4140B pA/meter, DC voltage source £4000
 4275A multi-frequency 1cr meter £3000
 4948A (/04) in-service TIM set £500
 4093B protocol tester base (PT300) £3500
 545100A 1GHz digitizing oscilloscope, now inc 2 x 1GHz active probes £1500
 54620A logic analyser £1200
 6633A systems power supply £600
 8019A serial data generator £1000
 8082A pulse generator 250MHz £2000
 8111A pulse generator 20MHz £1250
 83411C lightwave receiver 1300/1550nm £1750
 83440C lightwave detector 20GHz 1300/1550nm £2000
 8350B with 83592A 10MHz-20GHz sweep generator £ call
 86222A/8620C 10MHz-2.4GHz sweep generator £1500
 87510A gain-phase analyser 100kHz-300MHz £6500
 8901B modulation analyser £4500
 J2215A FDDI portable multimode test set £1500
 J2304 internet advisor with ethernet interface £2500

FOR EXCLUSIVE ACCESS TO OUR COMPLETE STOCK INVENTORY AND SPECIAL BARGAIN DISPOSAL DEALS PLEASE CHECK OUR WEBSITE
<http://www.ralfe-electronics.co.uk>



ISO9002 ACCREDITED STOCKIST MEASUREMENT & TEST EQUIPMENT

CIRCLE NO. 139 ON REPLY CARD

ELECTRONIC UPDATE

Contact Joannah Cox on
 0181-652 3620

A regular advertising feature enabling readers to obtain more information on companies' products or services.

PXI Modular Instrumentation

PXI delivers the high-precision instrumentation, synchronisation and timing features of more expensive platforms at an affordable price. Combining mainstream PCI computing technology and Windows software with rugged industrial packaging. PXI offers high performance test, measurement, data acquisition and industrial computing solutions.

For your free brochure call National Instruments on: 01635 523545

New for '97 Free Data Acquisition Software Tool

DAQ Designer 97 is a free system configuration software tool for the PC that takes you through your application step-by-step, asking you questions, and recommending all the right equipment, including: PC plug-in DAQ boards, PCMCIA DAQ cards, Signal Conditioning and Sensor Interfacing, Cabling and Software.

Call National Instruments for your free copy on (01635) 523545

CIRCLE NO. 141 ON REPLY CARD

NEW Feedback T&M Catalogue

The latest edition of the Feedback Test & Measurement catalogue is now available. Over 60 pages packed with more than 800 products divided into over 20 sections. The catalogue is indexed for both product and manufacturer and is fully illustrated. Whether you are looking for an individual product, a complete workstation, or a solution to a particular Test & Measurement need the NEW Feedback catalogue will solve your problems, send for a copy NOW!

CIRCLE NO. 142 ON REPLY CARD

NEW JENSEN TOOLS CATALOGUE

Colourful new Catalogue, hot off the press from Jensen Tools, presents unique new tool kits for service/support of communications equipment. Also latest test equipment from many major manufacturers. Includes hard-to-find tools, PC/LAN diagnostics, bench accessories, static control, technical manuals and more.

Ring 0800 833246 or Fax 01604 785573 for a free copy.

Jensen Tools, 10-12 Ravens Way, Northampton NN3 9UD

CIRCLE NO. 143 ON REPLY CARD

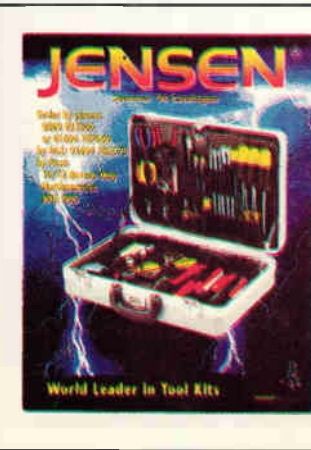
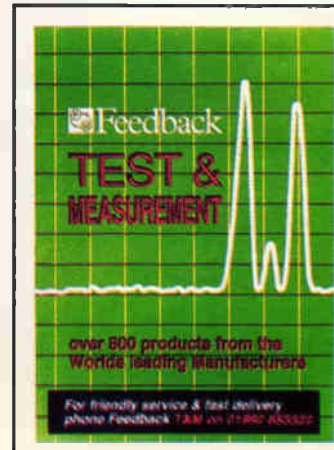



AVR™ Professional Starter System

Features:

- Supports programming of Atmel 90S(AVR) microcontroller families
- Supports both Parallel and Serial programming modes

Comes complete with:

Serial programming cable, AT90S1200 microcontroller, assembler, CD ROM Databook, Parallel cable and Power supply

£59.95 Order Code: AVR-ST ▲



MICRO-ISP Serial Programming System

"Now you can program the 8051 without removing the device from the socket!"

£39.95 Order Code: UISP-V2-SYS ▲

89S Socket Stealer Module

Simply plug this into your existing 8051 or AVR socket for INSTANT In-System Programming NO Target System redesign required.

£49.00 Order Code: SS-89S-DIL40 ▶

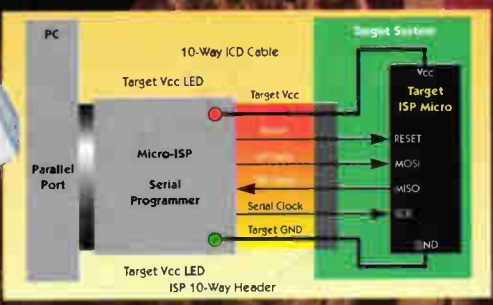

The Ultimate 8051 Microcontroller Programmer

- Supports Atmel FLASH 89C +895, Generic 87C51/52/FA/FB/FC microcontroller derivatives
- FLASH & E2 libraries also available as chargeable update

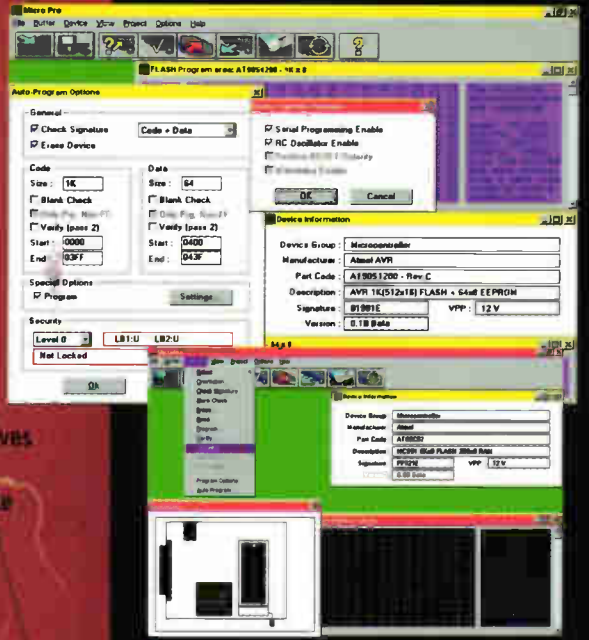

▲ The above software is now available with all our programmers featured in this ad



The Embedded Solutions Company

PROVIDING THE SOLUTIONS TO YOUR PROBLEMS!

For product information visit our web site at: www.equinox-tech.com

E-mail: sales@equinox-tech.com

229 Greenmount Lane Bolton BL1 5JB UK

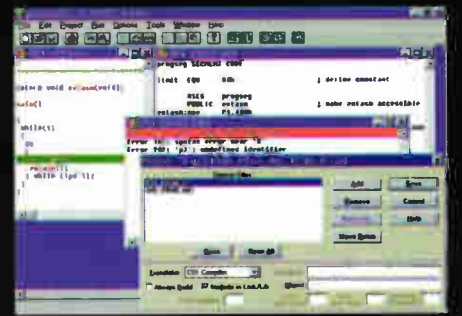

▲ A comprehensive range of 51 Starter & Development Systems are also available

EQUINOX DISTRIBUTORS: BELGIUM Alcom Electronics Nv/sa +32 3 458 30 33 ENGLAND Abacus Eiger +44 1925 626626, Farnell Components +44 1132 790101, GD Technik +44 1734 342277, Rapid Electronics +44 1206 751166, Quarndon Electronics +44 1332 332651 FRANCE Newtek +33 1 4687 2200 GERMANY Inteltek GmbH +49 7321 93850, MSC Vertriebs GmbH +49 08 9945532 12 GREECE Micrelec +30 1 5395042 4 ITALY Grifo Italian Technology +39 51 89 20 52, Newtek Italia +39 2 33 10 53 08 NETHERLANDS Alcom Electronics BV +31 10 4519533, NORWAY ACTE NC Norway +47 63898900, Jakob Hatteland Electronic AS +47 53763000 PORTUGAL Anatronc +35 119 371 834 SPAIN Anatronc SA +34 1 366 01 59 SWITZERLAND Anatec Ag +41 41 748 32 41 USA Hitools Inc +1 408 298 9077, Peachtree Technology +1 770 888 4002

Equinox reserves the right to change prices & specifications of any of the above products without prior notice. E&OE. All prices are exclusive of VAT & carriage AVR™ is a trademark of the Atmel Corporation

Money-Back
30 day Trial

If you do not agree that these truly are the most powerful portable programmers you can buy, simply return your Dataman product within 30 days for a full refund

Surely not. Surely someone somewhere has developed a portable programmer that has even more features, even greater flexibility and is even better value for money.

Actually, no. But don't take our word for it. Use the feature summary below to see how other manufacturers' products compare.

Dataman-48LV

- Plugs straight into parallel port of PC or laptop
- Programs and verifies at 2, 2.7, 3.3 and 5V
- True no-adaptor programming up to 48 pin DIL devices
- Free universal 44 pin PLCC adaptor
- Built-in world standard PSU - for go-anywhere programming
- Package adaptors available for TSOP, PSOP, QFP, SOIC and PLCC
- Optional EPROM emulator



Enq no 179

FREE
30 DAY TRIAL

still
the world's most
powerful, portable
programmers

free software

upgrades +

technical support

for life

3
year

GUARANTEE

Support

- 3 year parts and labour guarantee
- Windows/DOS software included
- Free technical support for life
- Next day delivery - always in stock
- Dedicated UK supplier, established 1978

DATAMAN

Dataman Programmers Ltd, Station Road,
Maiden Newton, Dorchester, Dorset, DT2 0AE, UK

Telephone +44/0 1300 320719

Fax +44/0 1300 321012

BBS +44/0 1300 321095 (24hr)

Modem V.34N/FCV.32bis

Home page: <http://www.dataman.com>

FTP: <ftp://ftp.dataman.com>

Email: sales@dataman.com

Dataman S4

- Programs 8 and 16 bit EPROMs, EEPROMs, PEROMs, 5 and 12V FLASH, Boot-Block FLASH, PICs, 8751 microcontrollers and more
- EPROM emulation as standard
- Rechargeable battery power for total portability
- All-in-one price includes emulation leads, AC charger, PC software, spare library ROM, user-friendly manual
- Supplied fully charged and ready to use

S4 GAL module

- Programs wide range of 20 and 24 pin logic devices from the major GAL vendors
- Supports JEDEC files from all popular compilers

Still as unbeatable
as ever!

Beware of cheap imitations. Beware of false promises. Beware of hidden extras.

If you want the best, there's still only one choice - Dataman.

Order via credit card hotline - phone today, use tomorrow.

Alternatively, request more detailed information on these and other market-leading programming solutions.



hotline
01300 320719



Orders received by 4pm will normally be despatched same day.

Order today, get it tomorrow!