

## Recreation in Sound

IN spite of sundry skirmishes behind the scenes between rival factions in the organization it is pleasant to be able to record that the Audio Fair—now renamed the International Audio Festival and Fair—has once again been held in London this Spring, and has drawn the crowds to the point almost of suffocation on four successive days.

Hotels in the off season are ready-made for multiple sound demonstrations, but one could wish that rooms and suites were larger, or that “walk through” arrangements similar to those organized by Leak, Lowther and a few other firms were more general. It is frustrating to have to queue outside a room for a quarter of an hour or more and then to be held captive for a similar period when five minutes would have been sufficient to form a reasonable judgment. Much better to be able to make a quick round of the possibles and still have plenty of time for a second or third visit as one’s choice narrows.

It may be objected that the principle of the ever open door would lead to pandemonium and a babel of sound. Not if sound levels are kept to domestic volume and sound traps in the form of L-shaped screens are placed inside each door to act as two-way attenuators—after the fashion of the cowls sometimes fitted to telephone installations in public places. These could be quite simple temporary structures in sound-absorbing material, and need not be expensive. They could be stored flat between exhibitions.

What do people listen for when they go to a demonstration? There must be as many criteria as there are individuals, but broadly one might divide visitors into at least three categories.

First, if only because the noises produced for them are difficult to ignore, are the “hi-fi” enthusiasts. Their preoccupation is with sound for its own sake. The reproducing equipment must be extended to its limits, and if it wilts under the strain by as much as half a decibel or exhibits any signs of a hangover the weakness must be diagnosed and remedied at all costs. This is (one is tempted to say “should be”) a solitary pursuit. No two “hi-fi” enthusiasts have ever been found to agree that the job has been properly done, though each may claim that his favourite method has been successful. With success comes satiety, and having exhausted the list of friends who

can be inveigled into listening to snatches of larger than life test recordings the pastime begins to pall and the “hi-fi” enthusiast moves on to tuning sports cars.

Next, one may observe a sprinkling of the intelligentsia, a reserved and contemplative group, more often than not professionally engaged in the recording or broadcasting of sound, competent to apply all known techniques in the design of equipment of the highest quality, but as yet unsure of the scientific criteria by which good sound may be distinguished. Their patient work, mathematical in its precision even when taking into account subjective factors in the listener,\* is slowly improving the ratio of science to art in sound reproduction. Their penetrating questions do much to keep firm’s technical representatives on their toes. (Is this why some take refuge behind closed doors in the demonstration rooms?)

Finally, the most important group of all, the reasonable layman who wants natural reproduction of music at the lowest possible cost and who is prepared to spend time and effort in coming to a decision as to whether (and if so whose) commercial equipment meets his sense of value, or whether he must take the plunge and find out enough about the technicalities of the subject to assemble an installation which will satisfy his needs.

As our reporter has recorded elsewhere in this issue, this year’s Fair has produced no startling innovation; nothing to compare with say, the introduction of stereo records and all the national publicity in width and depth that went with it, and which attracted the public in its thousands to previous exhibitions. Yet attendances this year have been as high as ever; the interest in sound reproduction of a quality not normally purveyed by cheap domestic receivers (or expensive television sets) is now wide and sustained. It is no longer the exclusive cult of the *cognoscenti* but is sought by quite ordinary people, sometimes, one must admit, as a status symbol but more often for the genuine satisfaction which it gives them as a recreation. Like gardening it requires some technical knowledge and some skill and judgment founded on observation and experience; but these having been acquired the rewards are perennial.

\* See for example “New Distortion Criteria” by E. R. Wigan, *Electronic Technology*, April and May, 1961.

# FIELD EFFECT DEVICES

By DR. A. V. J. MARTIN, A.M. Brit. I.R.E.

## PRINCIPLES UNDERLYING THE TECNETRON AND ALCATRON

**T**HE familiar transistor relies on the transit effect of charge carriers, but this is not the only effect which can be used in semiconductors. It is sufficient to recall, for example, the Hall effect which creates a voltage between opposite faces of a semiconductor immersed in a magnetic field, or Peltier effect, used in purely electronic refrigeration systems. Another phenomenon is field effect, which appears when a semiconductor junction is reverse-biased.

**Resistance Modulation.**—Field effect can be put to work to control the resistance of a slab of semiconductor. For example (Fig. 1), a slab of n-type germanium is submitted longitudinally to a voltage  $V_1$  and a current flows. This slab carries two indium junctions on opposite lateral sides. Now, if a reverse bias  $V_2$  is applied to the junctions, a depletion layer appears as shown in the semiconductor underlying the junctions. The only conducting part of the germanium is the cross-hatched part, which is called the channel. The effect of the depletion layers is to reduce the cross-section of the conducting zone, hence to increase the resistance of the germanium slab, which in turn reduces the current due to  $V_1$ . This current can be controlled by modifying  $V_2$ . Since  $V_2$  provides almost no current through

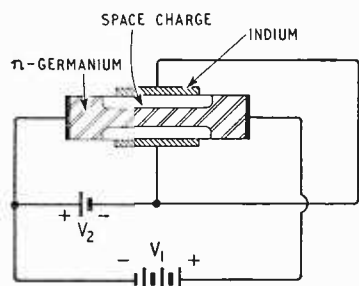

Fig. 1. Resistance modulation by field effect.

the reverse-biased junction, the device gives power gain and behaves as an amplifier. The negative connection to the germanium is the (electron) source electrode S (Fig. 2). The positive contact is the drain D. The control electrodes are the gate G.

**Geometry.**—The semiconductor slab can be plane and carry two gate electrodes on opposite faces, as has been described. It is in this form that the device was first proposed by W. Shockley, under the name of unipolar transistor<sup>1</sup>. This denomination is due to the fact that the device uses charge carriers of one polarity only, contrary to ordinary

transistors which use both electrons and equivalent positive charges or "holes."

Some secondary considerations come into play when practical applications are envisaged<sup>2,3,4</sup>. First, the depletion layer thickness is never large. If efficient resistance modulation is to be obtained, the semiconductor must be very thin between the

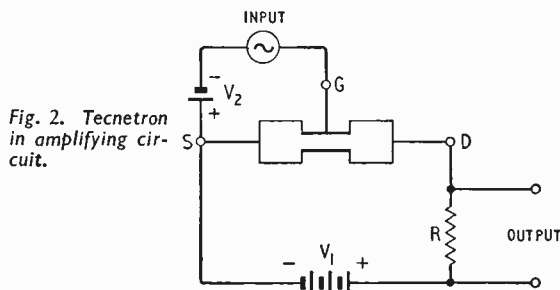

Fig. 2. Tecnetron in amplifying circuit.

gates. A few tens of microns is a common value. Second, the working frequency limit is determined by the time-constant associated with the space charge capacitance, that is, by the time it takes for this capacitance to charge up through the channel resistance. When frequency is too high, the capacitance charge cannot follow variations quickly enough and the device is useless. It can be seen that both considerations dictate small devices. Unfortunately, reducing the dimensions reduces the power-handling ability, since heat produced by the current flowing through the germanium has to be dissipated somehow. This becomes more difficult as the device becomes smaller.

A planar geometry is not the only one which can be utilized. The device can be designed with a symmetry of revolution. For example, rotating the device of Fig. 1 around its longitudinal axis to produce cylindrical symmetry yields the tecnetron. Rotating the same device about an axis passing through the drain yields the alcatron.

### Tecnetron

The tecnetron was simultaneously studied by Tetzner at the French CNET Laboratories and by the author at Carnegie Tech. in Pittsburgh (U.S.A.) (References 5 to 13). It is made (Fig. 2) of a cylindrical rod of n-type germanium carrying source and drain ohmic contacts on its ends. A groove has been cut in the germanium in which is deposited the indium collar constituting the gate electrode.

$V_1$  is the drain voltage and  $V_2$  is the gate reverse bias.

The similarity with Fig. 1 is apparent. It can be added that the drain contact is an n+ electrode to avoid injection of unwanted minority carriers (holes). The germanium rod has a progressive, or gradient-type, n-doping.

Representative dimensions would be: length 1 mm, maximum diameter 0.5 mm, gate diameter 50 microns, gate length 100 microns. Average performances of a laboratory sample are summarized here:

Drain voltage .. ..	50 V
Drain current .. ..	1.5 mA
Gate voltage .. ..	-15 V
Transconductance ..	0.1 mA/V
Power rating .. ..	0.1 W
Input impedance ..	1 M $\Omega$ + 2 pF
Output impedance ..	1 M $\Omega$ + 2 pF

**Advantages and Drawbacks.**—What are the drawbacks? The most important is probably power limitation. When field effect pinches the channel, maximum striction occurs near the drain end. The greater part of the voltage drop occurs across this small length of the channel. The problem is then to remove the resulting heat from this small and inaccessible spot. Thermal qualities of germanium from this point of view are not too good.

There is also the problem of fragility. A germanium filament 100 microns long and 50 microns in diameter does not constitute an example of ruggedness!

Finally, transconductance is low. With unavoidable external parasitic capacitances, the merit coefficient is low and the stage gain is limited.

Advantages, on the other hand, are numerous: small dimensions, high input and output impedances, frequency limit reaching several hundred Mc/s, simple fabrication processes lending themselves easily to automatic production, etc.

### Alcatron

The alcatron has been developed by C.S.F. Laboratories in collaboration with CNET (Post Office) laboratories. As has been said before, it is developed, starting with Fig. 1, by rotating the device about an axis passing through the drain.

Practically, an alcatron looks like Fig. 3. It is made essentially of an n-type germanium wafer carrying electrodes. The upper face carries a central anode, and around the periphery of the disc

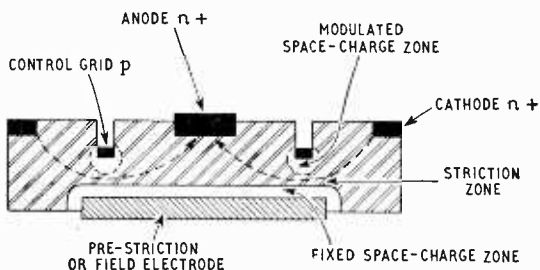

Fig. 3. Cross-section of the alcatron.

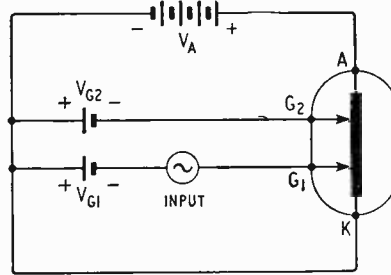

Fig. 4. Symbol and circuit for alcatron.

is a circular cathode. Both anode and cathode contacts are n+ to avoid minority carrier injection. Between cathode and anode, a deep, narrow circular groove has been cut in the wafer. Its bottom receives the indium electrode, producing a p-n junction and constituting the control grid.

Notice the use of the familiar terminology cathode, anode and grid, which is justified in this case.

The lower face carries an auxiliary electrode, made of a large indium p-n junction on the germanium. It is called the field or pre-striction electrode. Its rôle is to produce an initial striction of the channel. It receives a negative bias and creates a depletion layer inside the semiconductor.

The control grid on the upper face receives also a negative bias and produces a depletion layer. The conducting channel appears between the depletion layers due to the two grids. Its cross-section is controlled by varying the voltage of the control grid, thus modulating the flow of current and producing amplification by field effect. The frequency limit is again determined by the resistance and capacitance associated with the control grid. Since the groove is very thin, alcatrons reach 150 Mc/s or more in existing samples.

The power is evidently dependent on the device geometry, which is easily identified with that of a power transistor. The alcatron holds promises of high power at high frequencies, which is welcome news in the realm of semiconductors.

Up to now, development work has been performed on germanium, whose technology is well known. Other semiconductors, with more interesting characteristics, could be used with advantage. Higher charge-carrier mobility and lower resistivity would increase notably the frequency limit and the power rating. Powers of several watts at frequencies of several hundred Mc/s are immediate possibilities.

**Characteristics.**—Alcatrons are actually tetrode structures. The nearest equivalent in electron valves is probably the beam tetrode.

The proposed circuit symbol is given in Fig. 4. It corresponds to the physical device.  $V_A$  is the voltage between anode and cathode.  $V_{G2}$  is the bias voltage on grid 2, or field-grid.  $V_{G1}$  is the fixed bias for grid 1, or control grid, which receives also the input signal.

Anode characteristics resemble that of a pentode valve.

Typical alcatron dimensions would be: cathode diameter, 3 mm; control grid diameter, 2 mm; field grid diameter, 2.5 mm; groove width, 50 microns; groove depth, 50 microns; overall thickness, 200 microns; thickness between grids, 40 microns.



*Electrolytic etching of grid groove of alcatron.*

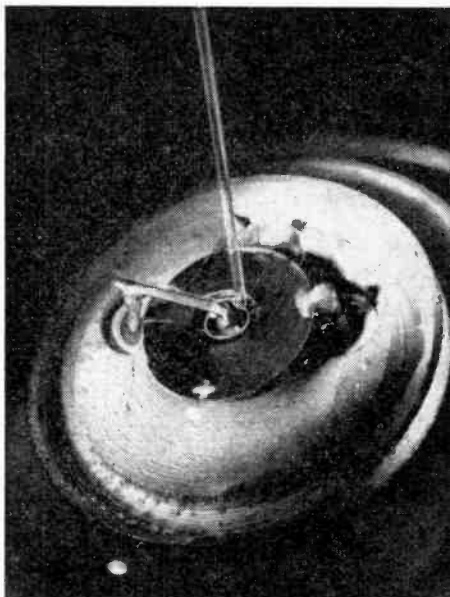

*Cleaning the alcatron prior to grid connection.*

Average performances of a laboratory sample are as follows:

Anode voltage .. ..	50 V
Anode current .. ..	100 mA
Field-grid bias .. ..	-15 V
Control-grid bias .. ..	-6 V
Transconductance .. ..	6 mA/V
Power rating .. ..	6 W (min.)

This sample worked satisfactorily on 120 Mc/s.

### Advantages and Drawbacks

Let us first mention some of the more evident drawbacks. Although using well-tried power transistor technology, alcatrons are undoubtedly a complex device as far as production is concerned. Frequency performance, although good, is rather limited with the present state of the art. Also, the large exposed area sets some problems of surface states.

Advantages are no less evident: high power, high transconductance, high input and output impedances, ruggedness.

An auxiliary point is worth mentioning. If the dimensions of the device are increased to increase power handling ability, control grid capacitance

evidently increases. However, total channel resistance decreases simultaneously. The paradoxical result is that the control grid time-constant does not change much, so that frequency performance is not much impaired. This is important as far as high powers at high frequencies are concerned.

### Possible Improvements

Upper frequency limits, it has already been said, can be improved by using a better semi-conductor. For example, using gallium arsenide would multiply by 4 the frequency limit, as a first approximation. (It may be mentioned that commercial production of germanium alcatrons is not planned). Another advantage accruing from the use of gallium arsenide would be a better temperature performance.

Superficial doping of the upper face with diffused arsenic, to a depth of 25 microns, significantly increases performance. This doping produces a superficial layer of n+ material, which reduces the cold resistance of the anode-to-cathode channel from 200 to 15 ohms. In fact, this n+ layer extends the anode and cathode ohmic contacts right to the sides of the grid groove. In so

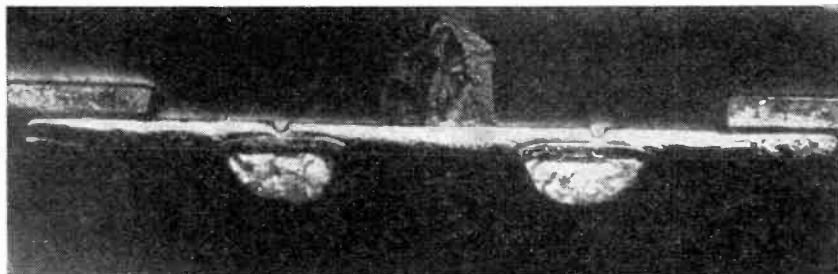

*Photomicrograph of a cut through alcatron. Notice this is an early model, which had an annular field grid instead of a circular field grid.*

Completed alcatron. Notice grid connection by spring of gold wire, and large Kovar disc soldered to cathode.

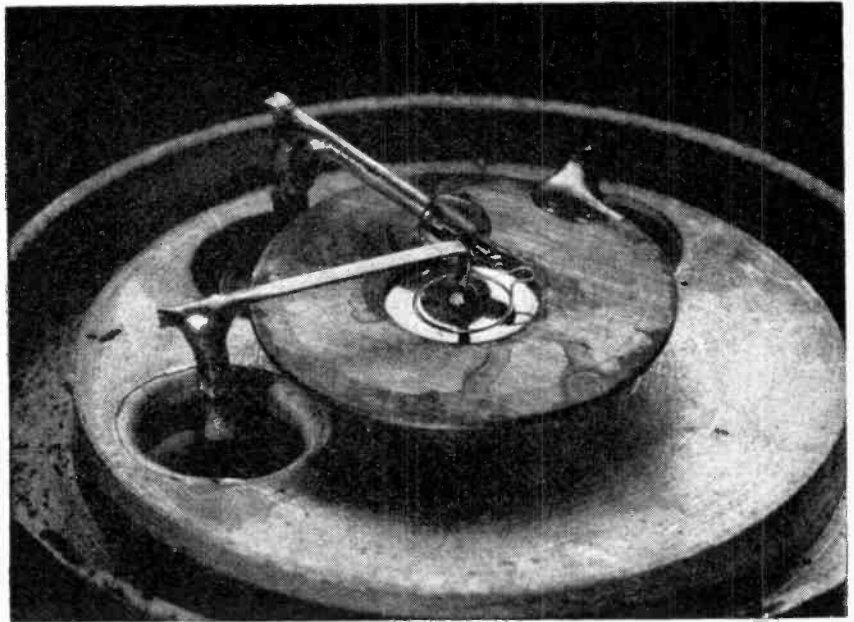

doing, it reduces the total channel resistance, reduces the grid time-constant, and increases the frequency limit. It can be noticed that, with this technology, separate ohmic contacts for anode and cathode are no longer necessary. Their elimination would, of course, simplify production.

Referring now to the photomicrograph showing a cut through the alcatron, it will be remarked that the field-grid is annular. This arrangement was used in development work and has been abandoned in favour of a circular field-grid as shown in Fig. 3.

Two birds are thus killed with one stone. On the one hand, the space charge capacitance charges up also through capacitance to the field grid. This reduces the effective time-constant and improves

frequency performances. On the other hand, the field-grid electrode is made of indium, which is a good thermal conductor, and reaches the vicinity of the striction zone. This ensures good heat removal and consequent improvement in power rating, specially when the field-grid electrode is directly soldered to the metal case for heat sinking. This can be done since no r.f. signal is applied to the field electrode.

The device being apparently electrically symmetrical, it may be asked why the central electrode is the anode, and not the cathode. This arrangement has been adopted because experience has shown that it leads to best results. The reason for this is probably to be found in secondary effects, which modify somewhat the distribution of the internal field.

Finally, the circular symmetry makes the alcatron particularly well adaptable to coaxial circuits.

#### REFERENCES

- <sup>1</sup> W. Shockley, *Proc.I.R.E.*, Vol. 40, Nov., 1952.
- <sup>2</sup> Aigrain, Lagrenaudie, Liandrat, *J. Phys.Radium*, Vol. 13, 1952.
- <sup>3</sup> Dacey, Ross, *B.S.T.J.*, Nov., 1955.
- <sup>4</sup> Dacey, Ross, *Proc.I.R.E.*, Vol. 41, August, 1953.
- <sup>5</sup> S. Teszner, *C.R. Acad. Sci.* 246, 1958.
- <sup>6</sup> S. Teszner, *Bull. Soc. Fr. El.*, Vol. 94, 1958.
- <sup>7</sup> S. Teszner, *Rev.Mar.*, Oct., 1958.
- <sup>8</sup> A. V. J. Martin, *Electronic Ind.*, March, 1958.
- <sup>9</sup> A. V. J. Martin, *Electronic Ind.*, July, 1958.
- <sup>10</sup> A. V. J. Martin, *I.R.E. Convention Records, Electron Devices*, March, 1959.
- <sup>11</sup> A. V. J. Martin, *Electronic Ind.*, Dec., 1959.
- <sup>12</sup> A. V. J. Martin, *J.Phys. Radium*, 21, 1960, March and July (suppt) and following issues.
- <sup>13</sup> A. V. J. Martin, *U.S. O.N.R. Reports*, 1958, 1959, 1960.

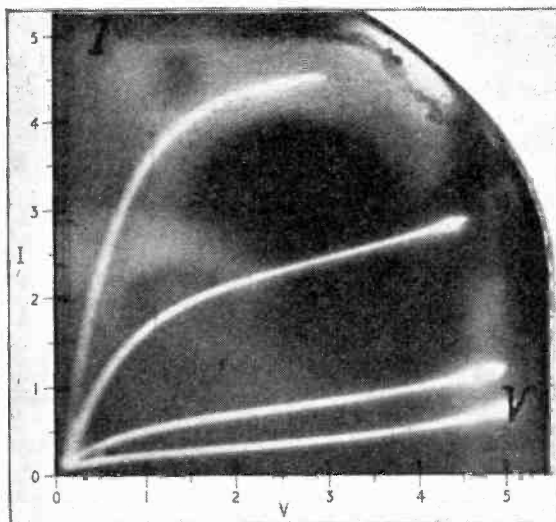

Family of anode characteristic curves for alcatron, displayed on oscilloscope.

# Suppressed-Carrier Double-Sideband

## METHODS OF CONTROLLING PHASE OF REINSTATED CARRIERS

FROM time to time one sees references, in American technical literature, to a communications system which is known as d.s.b.s.c. (double-sideband, suppressed carrier). Although some details of this were published nearly four years ago, it appears to be almost unknown in Britain. This is a pity, since an essential part of the d.s.b.s.c. system is a new kind of radio receiver which can be regarded as a synchrodyne with its main limitation (the method of locking the oscillator) removed. As such, it should have applications to normal a.m. reception as well as to single-sideband reception.

In 1956 the American Institute of Radio Engineers held a symposium on single sideband communications systems. At that time s.s.b. was being tried for ground-to-air working and for military purposes. J. P. Costas pointed out that, as a matter of practical politics, the expected increase in usable channels due to the narrower bandwidth requirements of s.s.b. could not always be realized<sup>1</sup>. Serious interference by the nominally suppressed sideband can occur. Suppose, for instance, that an aircraft a few miles from an airfield is transmitting on the channel adjacent to that of a very distant aircraft, and that the distant transmission occupies the same band of frequencies as the *suppressed* sideband of the near transmission. The distant transmission may suffer an attenuation of, say, 60dB more than the near transmission. If the suppressed sideband of the near transmission is attenuated only 50dB (a typical figure in this kind of application) then it will arrive at the airfield at a level of 10dB greater than the distant signal, completely blotting out the latter.

Even if there is not much point in s.s.b. on a bandwidth-saving basis, however, there would seem to be a good case for it on the grounds of power economy. Why transmit all that useless carrier power? Why, indeed! At this point Mr. Costas comes up with an idea that has every appearance of being a winner. Why not transmit *both* sidebands, but no carrier? Each sideband contains useful information; so no power is wasted, and it is far easier to produce a double-sideband suppressed-carrier signal than a single-sideband signal.

### Receiving Techniques

The snag—and in the past it has always seemed a very big snag—is in the requirements which have to be met at the receiver. Single-sideband reception is bad enough, since it requires the reinsertion into the signal of a carrier equal, or very nearly equal, in frequency to the original carrier\*. To receive a double-sideband suppressed-carrier signal, the locally generated carrier frequency must be *exactly* equal to the original carrier frequency, and,

in addition, it must be approximately in phase. Considering that the receiver has not got a sample of the original carrier to use as a yardstick, the position seems hopeless. However, the very exacting nature of these requirements contains the key to their solution. Suppose that by some feat of design and

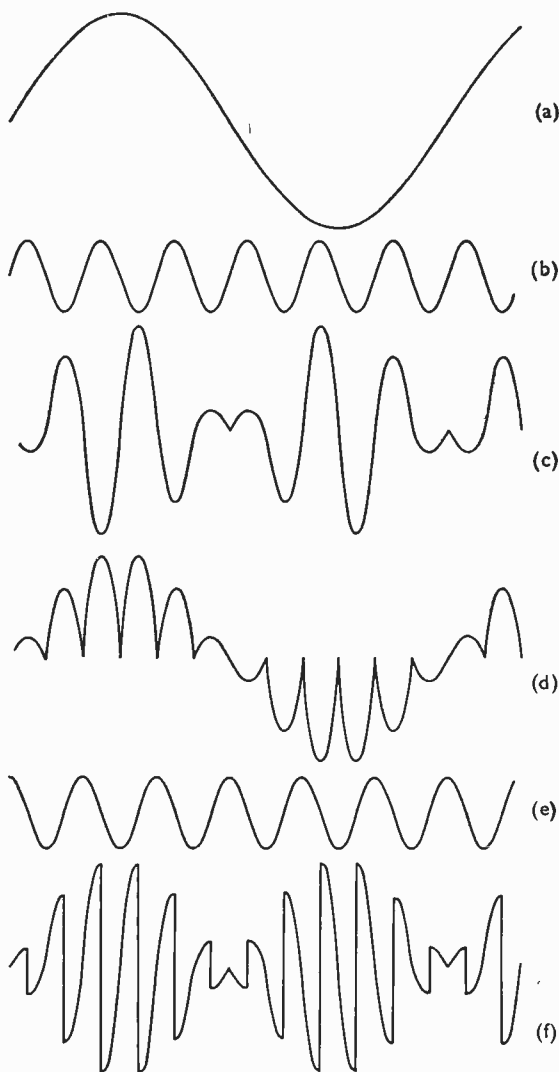

Fig. 1. (a) Audio waveform; (b) carrier; (c) double-sideband suppressed carrier [from (a) and (b)]; (d) output of full-wave phase-sensitive rectifier [from (b) and (c)]. This has an audio component; (e) carrier shifted 90°; (f) output of rectifier derived from (c) and (e). This has no audio component, since successive half-waves sum to zero

\*In a superhet receiver the sum or difference of the local oscillator and intermediate frequencies must equal the required carrier frequency.

# Systems

By G. W. SHORT

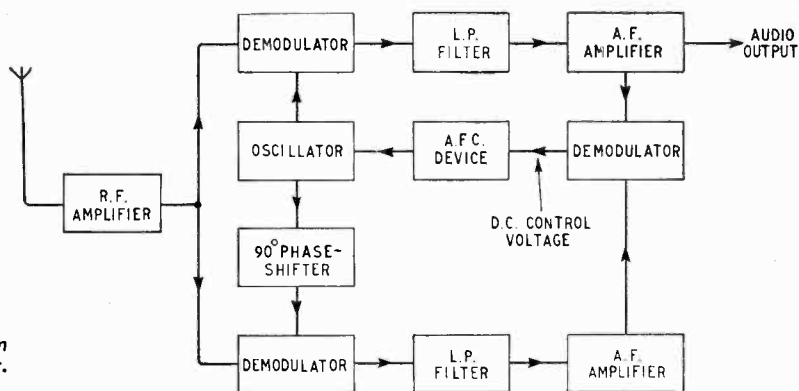

Fig. 2. Block diagram of d.s.b. receiver.

operating skill, the receiver can be made to provide the right carrier frequency and phase. What happens when the frequency starts to drift? The answer is that, as the phase angle between the required carrier and the actual oscillation increases, the audio output decreases, falling to zero at  $90^\circ$  phase difference and then rising to a maximum of  $180^\circ$ , and so on. This is illustrated by the waveforms of Fig. 1, which shows how there is no audio output for the quadrature condition. Now, the phase of the audio output reverses as the carrier phase passes through  $90^\circ$ . This provided Mr. Costas with the answer to the problem, for by incorporating an audio-frequency phase detector in the receiver a voltage suitable for automatic frequency control of the oscillator can be produced.

The receiver is shown in block diagram form in Fig. 2. There are two demodulators, supplied with locally generated carriers in phase quadrature. One of these (say the upper one) is in the main channel. If the phase angle between the original and the local carrier supplied to this demodulator is  $0^\circ$ , then the audio output is a maximum. The audio output from the lower demodulator is then zero. If the phase angle changes, owing to frequency drift, the audio output from the main channel is reduced, and an audio output appears in the second channel, its polarity (compared with that of the main channel) depending on whether the phase error is a lag or a lead. These two audio outputs are combined in a third demodulator, which, being "phase sensitive," yields an a.f.c. voltage of the required polarity with a magnitude depending on the phase error.

## System Advantages

The beauty of the arrangement, which resembles the synchrodyne, is that the selectivity is independent of the r.f. bandwidth. Only the wanted signal gives rise to an intelligible audio output. Other signals give rise to supersonic outputs, if they are remote in frequency, or "monkey chatter" if they are close. In the first case, they can be got rid of entirely by a low-pass filter, and in the second, a low-pass filter will usually reduce the annoyance. As a matter of fact, it is claimed that by combining the audio outputs of the two channels in particular ways with the aid of phasing networks certain types of interference can be reduced even if they yield audio-frequency outputs.

Although this system of reception has been developed, out of necessity, for double-sideband suppressed-carrier working it is not limited to this. Ordinary a.m. signals and s.s.b. signals can also be received.

The only obvious deficiency of the system is the absence of a.g.c. It is not possible to derive an a.g.c. voltage in terms of the carrier amplitude, since, even if the carrier is transmitted, the resulting d.c. output from the demodulator is not passed by the audio stages. It might be possible to obtain a.g.c. from a normal a.m. signal by interposing a modulator in the r.f. part of the receiver (Fig. 3). All signals would then be varied at the modulating frequency, but only the wanted signal would give rise to an audio output at this frequency. A filter

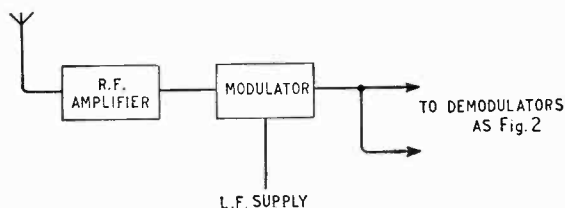

Fig. 3. Auxiliary modulator for a.g.c. system.

could therefore be used to separate the a.g.c. frequency, the filter output signal being amplified and detected. (This scheme was originally suggested by D. G. Tucker<sup>2</sup> as a means of receiving c.w. signals with a synchrodyne.)

Alternatively, the audio output could be rectified and used as a.g.c. This is not ideal in that there is no output during silent intervals. On the other hand, the audio and carrier levels are related in that the maximum peak audio voltage is fixed by the maximum depth of modulation permitted at the transmitter. There seems to be no reason why this "peak possible" audio voltage should not be stored in a capacitor and employed to operate an a.g.c. device.

## REFERENCES

- 1 Costas, J. P., "Synchronous Communications," *Proc. I.R.E.* Vol 44 Part 2; December 1956, p. 1713.
- 2 Tucker, D. G., "The Synchrodyne," *Electronic Engineering*. Vol. 19, November 1947, p. 366.



# London Audio Festival

## NEW LOUDSPEAKER DEVELOPMENTS

*The period since the last audio exhibition held in London would seem to have been occupied by manufacturers in consolidation—we use this term in preference to the possibly derogatory one of marking time.*

*One new small departure we were glad to note was that two exhibitors—Pamphonic and Chitnis—were issuing questionnaires to find out customers' requirements and preferences.*

**Loudspeakers.**—The main developments since last year were in loudspeakers, but we feel that this was just "how it turned out" and does not necessarily indicate any general trend.

The new Celestion Colaudio II incorporates a patented 12-in bass unit in which the diaphragm is made of "exploded" polystyrene so as to achieve a higher than usual stiffness-to-weight ratio. In this case this has resulted in the virtual elimination of cone breakup up in the useful frequency range. The diaphragm is actu-

ally shaped roughly in the form of a solid rather than the usual hollow cone. However, because the polystyrene from which the cone is made has a low density, the total weight of the solid cone is in fact only about the same as that of an ordinary hollow-cone woofer. Besides the normal suspension at its apex near the voice coil and at its rim, this diaphragm is also suspended (on the outside) about half-way along it by means of a corrugated surround.

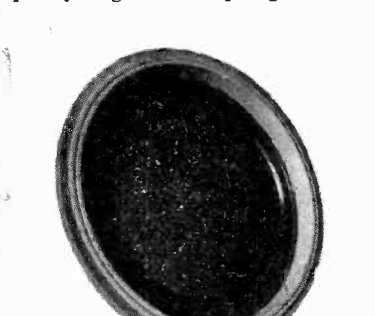

Front view of "solid-cone" bass loudspeaker used in Celestion Colaudio II.

ally shaped roughly in the form of a solid rather than the usual hollow cone. However, because the polystyrene from which the cone is made has a low density, the total weight of the solid cone is in fact only about the same as that of an ordinary hollow-cone woofer. Besides the normal suspension at its apex near the voice coil and at its rim, this diaphragm is also suspended (on the outside) about half-way along it by means of a corrugated surround.

The fundamental resonance of this unit is as low as about 10c/s in free air: it can thus be mounted in a small cabinet without producing too high a combined cabinet volume and loudspeaker resonance. In fact,

although the volume of the cabinet used is only about 1.8 cu ft, this resonance is raised to only about 40c/s. A 2¼-in pressure-driven tweeter crossing over at about 2kc/s is also incorporated. A higher than usual stiffness-to-weight ratio can also be achieved by making the diaphragm in sandwich form with a light filler between denser skins, as described by D. A. Barlow in our December 1958 issue. In the production version of a Leak 13-in bass unit made according to this principle, the sandwich filler is ¼-in thick expanded polystyrene, and this is backed on both sides by 0.001-in thick aluminium. The whole unit is conventionally cone shaped, but here the sandwich construction has resulted in a stiffness-to-weight ratio at least 200 times that obtainable with conventional cones. This virtually eliminates cone breakup up in the useful frequency range. Cabinet resonances are damped from Q's of about 40 to 6 by gluing ½-in thick bituminous felt to the walls. A 3-in tweeter crossing over at 1kc/s is also incorporated.

One of the problems in the design of coaxial double-cone loudspeakers is the elimination of resonances of the free edge of the inner cone. In a new Wharfedale 12-in unit—the I2/RS/DD—these rim resonances are damped by attaching the inner cone rim to the main outer cone by a ¾-in wide band of polyether. This band also absorbs the sound produced from that part of the main cone which lies behind the inner cone: this sound can cause interference effects in the region of mechanical crossover between the two cones.

Circumferential ribs have long been used to strengthen loudspeaker cones. Lowther, however, have preferred to use irregularly-placed nearly radial ribs—which look somewhat like the spokes of a bicycle wheel which has been in a collision!

**Amplifiers and Pre-amplifiers.**—More transistorized units were seen this year. Pre-amplifiers included a Wellington Acoustic Laboratories

unit compensated for use with tape heads but which could also be used with the compensation removed, as well as a Lowther uncompensated 8:1 step-up unit for low-level pickups. One the power amplifier side, completely transformerless units were introduced by Lowther and Pye.

Radford have recently introduced a range of valve power amplifiers which are characterized by being unconditionally stable under any load conditions and by having stability margins as high as 25dB with resistive loads. In the "ultra-linear" output transformer anti-resonant notches of rapid phase shift caused by cross coupling between the anode and screen windings are reduced by winding the sections with unequal sizes. An unusual feature of the associated pre-amplifiers is that the maximum filter slope is deliberately made only 12dB/octave because the designer considers that the "ringing" produced by higher slopes can introduce more noise than is removed.

Aveley Electric were showing American Dynaco amplifiers and other circuits for use with their output and mains toroidal transformers. A toroidal construction offers a number of advantages: the stray fields are less, the single-piece core and better utilization of grain-oriented core material gives reduced distortion and increased power at low frequencies, and the increase in the fraction of the core length which can be covered with windings results in reduced leakage capacities and high-frequency coupling effects.

A new triode-pentode introduced by Mullard—the ECL86—by comparison with their well-known ECL82 offers an increase in overall sensitivity by a factor of 3 and an increase in output power from 3.4 to 4W.

**Tape Recorders.**—A new two-speed, three-headed, four-track deck developed by the Gramophone Co. and used by them as well as by Wyndson in new recorders, is very unusual in that both tape and records can be played simultaneously by making use of an additional pickup kit. Basically this facility has been provided simply by extending the capstan motor spindle at both ends and driving the tape with one end and the record turntable with the other, using a conventional two-stepped pulley and rubber idler drive in both cases. The heavy record turntable is actually





Gramophone Company's "Voicemaster" tape deck shown with its additional pickup kit playing a record.

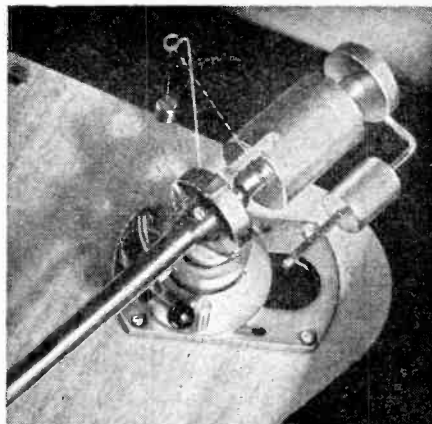

Pivot end of S.M.E. pickup arm showing offset counterweight for providing sideways balance for the head offset, as well as weight pulling device for counteracting side thrust.

under the deck, the record itself being carried on a three-pronged support.

A professional transistorized battery portable tape recorder was shown by Casian. At the single speed used (7½ in/sec) the total wow and flutter is stated to be <0.2%, the signal to noise ratio >55dB and the frequency response within 1dB from 30c/s to 12kc/s.

Unusual models and features in the range of Japanese Sony tape recorders shown by Tellux include the incorporation of a three-transistor radio in their Model 362, partial transistorization of their Model 101 and a professional spring-driven model.

An unusual feature of the Veritone "Sixteen" two-track recorder is that one tract can be recorded from the other (in the same direction) with, if required, additional material. To do this one half of a stereo head is used to record the signal replayed from the other half. By using the two halves of a stereo head rather than spaced separate heads, exact synchronism is obtained between the two recordings.

A new type of single-transistor sine-wave oscillator suitable for use in erase circuits has been developed by M.S.S. This gives an efficiency >75% so that, for example, 1W output can be obtained from an OC72.

**Tape Accessories.**—Semi-automatic splicers which besides providing the diagonal cut also longitudinally trim the tape edges around the cut by means of two slightly-curved blades (producing a wasted effect) were shown by Wilmax and Cine Accessories.

A head demagnetizer (WAL D-Mag) which was originally developed for erasing short lengths of sound film was introduced by Wellington Acoustic Laboratories. Instead of a single probe two are used, connected to opposite ends of a cylindrical coil and core. The demagnetizing field is, of course, produced between the probes.

**Microphones.**—In the new S.T.C. Type 4108 condenser microphone a

cardioid response is obtained by altering the phase of the sound impinging on one side of the diaphragm by passing it through a small block of compressed polystyrene granules. The valve head pre-amplifier is followed by a transistor impedance step down and buffer stage.

The new Lustraphone DRA66 incorporates an improved balanced-armature construction in which an extra "tail" attached to the armature vibrates in a very confined air space so as to damp the whole movement and reduce the distortion.

Gramplan showed a 24-in diameter parabolic reflector for focusing distant sounds on to a microphone. This can provide an increase in microphone sensitivity of about 14dB and has a directivity of 10° for 5dB down.

**Pickups and Arms.**—In the S.M.E. arm lateral and vertical movements (about intersecting axes) are provided by pairs of precision ball races and knife edges respectively so as to keep the equivalent frictional forces produced at the stylus down to as low as about 0.02gm. The tubular arm is damped internally with a fibre-wood insert, and the counterweight elastically decoupled. Part of the counterweight can be moved longitudinally and also laterally to provide a sideways counterbalance for the head offset. A recently-introduced accessory for this arm is a weight which acts via a fine thread on a lever attached to the arm so as to counteract the side thrust produced by stylus friction and head offset. A somewhat similar device was described by H. J. F. Crabbe in our May 1960 issue.

In stereo pickups in which two flexible arms transmit (by pushing) the stylus movements to the transducers, it might be expected that minimum crosstalk would be obtained by making the angle between the flexible arms a right angle, to correspond to the angle between the two cutting directions. In practice, however, a somewhat smaller angle may be preferable, and in two high-

compliance crystal pickups shown by Collel angles of about 65° were used.

A simple pressure gauge introduced by Cosmocord consisted of a long brass strip spring fixed at one end and with the other end free and carrying a stylus support. The deflection of the free end provides a measure of the stylus force in the range 0 to 15gm.

**Records.**—The new Philharmonic records are unusual in being pressed from vinyl in powder rather than the usual solid form. In this process lower pressures are used so that there is less risk of damaging the complex groove structure. Blue or red rather than the normal black colouring dye is added to the vinyl. This makes the records semi-transparent and thus allows flaws in them to be more easily detected. The coloured dyes are somewhat more soluble in the vinyl than the normal black dye and this more easily-obtained dispersion allows a low surface noise to be more readily achieved.

**Receivers.**—An unusual feature of the Armstrong Stereo 12 Mark 2 combined a.m./f.m. tuner and 2×8W push-pull amplifier is that the second a.m. i.f. amplifier uses a triode operated in Class A. This avoids the modulation rise and consequent distortion produced by the normally-used variable-μ valves.

Features of the new Quad a.m. tuner are the use of an r.f. stage and provision of a 9kc/s bridged-T whistle filter as well as of variable selectivity.

Transistor receivers shown by Denham and Morley included one covering the short waves down to 13 metres and also an a.m./f.m. set. The Japanese Sony 12-transistor a.m./f.m. portable was shown by Tellux.

# Elements of Electronic Circuits

## 25.—Using Delay Lines

By J. M. PETERS, B.Sc. (Eng.), A.M.I.E.E., A.M.Brit.I.R.E.

LAST month we dealt with the characteristics of delay lines and mentioned some of their applications, one of which was the production of rectangular pulses. As well as providing very precise pulses, delay lines can be built to handle great powers, so that they are frequently used for the production of the "h.t." for the transmitters of pulsed radar systems, where a peak of several megawatts may be needed for the production of the r.f. pulse.

### Generation of Rectangular Pulses

An important application of the delay line is the production of rectangular pulses of voltage or current, by terminating the applied voltage or current after a fixed time interval.

First of all let us refer to Fig. 1. A constant-voltage generator having an e.m.f.  $v_0$  (this is the open-circuit voltage, not to be confused with potential

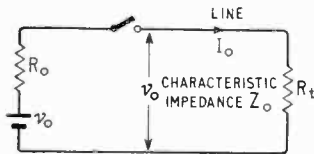

Fig. 1.

difference) is suddenly applied to the line when the switch is closed. A voltage "step" travels down the line, which draws a constant charging current from the supply. As the generator output impedance is made equal to the line impedance the voltage which is impressed on the line is  $v_0/2$ . The value of the constant charging current is therefore  $v_0/2Z_0$ . The voltage step eventually reaches the end of the line and sets up a potential difference across the terminating impedance  $R_t$ . Now if the terminating impedance is equal to the characteristic impedance of the line ( $R_t = Z_0$ ) the energy in the wave is completely absorbed in the termination, the line behaves as if it

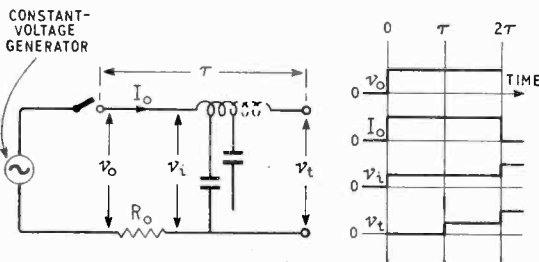

Fig. 2.

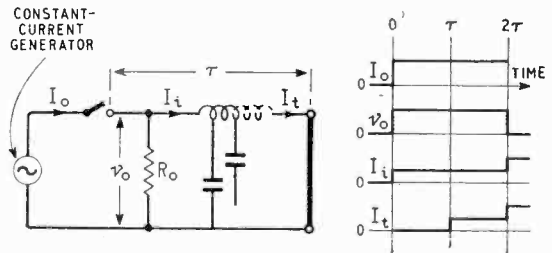

Fig. 3.

were infinitely long and there is no reflection from the end.

If the terminating resistor does not match the line impedance, then the travelling wave is not completely absorbed and dissipated in the resistor.

When  $R_t$  is greater than  $Z_0$  the voltage developed across the termination impedance is greater than the applied voltage; similarly if  $R_t$  is less than  $Z_0$  the current through the terminating impedance is greater than the current which flows in the travelling wave. In both cases a wave of either voltage or current is reflected back to the sending end taking twice the delay time  $\tau$  of the line to re-appear. The limiting conditions occur when the remote end of the line is either, as in Fig. 2, open circuit ( $R_t = \infty$ ), or as in Fig. 3, short circuit ( $R_t = 0$ ).

**Open-circuited Line.**—With no terminating impedance ( $R_t = \infty$ ) and nowhere for the energy to be dissipated, the voltage wave is reflected from the end of the line without any alteration in phase. The line continues to be charged at the same rate by the returning voltage step. When the step reaches the input (which is matched to the line) all the energy contained in the wave is absorbed in the input impedance so there is no longer a charging current and  $I_0$  falls to zero.

**Short-circuited Line.**—Here a constant-current source, represented by a high-impedance generator, is applied to a line which is short-circuited at its far end ( $R_t = 0$ ). The current divides equally at the matched input to the line: a voltage  $v_0$  is developed across the input and a current represented by  $I_0$  proceeds to charge the line. When the current step reaches the short-circuited end, it is reflected in phase. On its return to the sending end it produces a voltage across the input impedance in opposition to  $v_0$  and equal to it;  $v_0$  therefore drops to zero.

Summarising, we have an open-circuited line with a constant-voltage source producing a current pulse

equal in duration to twice the length of the delay line. Alternatively the line, short-circuited and fed from a constant-current source, can produce a voltage pulse of the same length. A suitable low-impedance voltage generator is the thyratron or some form of triggered spark-gap while a pentode can be used as the high-impedance current generator.

### Repetition of Pulses

It is often necessary to generate pulses for use as time markers. These pulses may be required to have the same sign as the input or to be inverted in phase, and delay lines with appropriate terminating impedances are nearly always used for this purpose, for example:—

(a) To generate one pulse all we require to do is to terminate the line in its characteristic impedance  $Z_o$ .

(b) Equally spaced pulses may be obtained by terminating both ends of the line with high impedances. Due to the mismatch, the pulse will be reflected from both ends, suffering attenuation during each excursion.

(c) If we require our equally spaced pulses to be inverted on each excursion it is necessary to make one of the terminating impedances less than  $Z_o$  but greater than zero.

Attenuation during each excursion is often undesirable, especially when we require continuous trains of waves. "Topping-up" of energy can be effected by making the reflected pulse trigger a circuit such as a blocking oscillator.

### Pulse-forming Networks for Modulators

Transmitting valves in pulse radar systems are caused to generate r.f. pulses lasting for a short time (usually between one tenth and ten microseconds). The unit which governs the pulsing of the oscillator is called the modulator and it also controls the duration of the output pulse. It is usual for the pulse-forming network in the modulator circuit to carry the whole of the pulse energy which is discharged into the oscillator in series with the modulator "switch," which may be a valve or spark-gap. The network is charged from an h.t. source in the intervals between pulses, we are therefore concerned with the main problem of charging

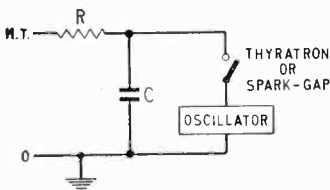

Fig. 4.

the network and causing it to discharge as and when required. First let us examine the simplest form of modulator circuit (Fig. 4). The switch is a gas-filled triode or thyratron which maintains conduction at a much lower voltage than its striking voltage.

Initially the triode is not conducting and C charges via a large resistor R. When the triode is caused to strike by application of a trigger waveform, C discharges through the oscillator until the potential

is insufficient to maintain ionization in the valve: the cycle then recommences. It will be noted that in this simple form of circuit the discharge pulse across the oscillator is exponential. If however we now replace C by an open-ended delay line (Fig. 5) a rectangular pulse can be obtained.

The series inductors of the delay line (which has  $n$  sections) have little effect on the charging time constant (which is  $nCR$ sec.) because this period is usually very long compared with the transmitted pulse. When the gas triode conducts the line discharges through the oscillator. The more sections there are comprising the line, the more nearly

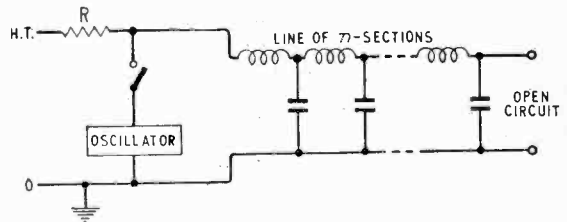

Fig. 5.

rectangular is the pulse which energizes the oscillator for  $2n\sqrt{LC}$ sec.

Various improvements of this circuit will be encountered, for example, the replacement of the resistor R by a charging choke. The effective charging circuit is now a series resonant L-C circuit which is shock-excited into oscillation by the application of the h.t. voltage. If the gas triode can be arranged to conduct after each half period of oscillation ( $\pi\sqrt{nLC}$  sec.) then the amplitude of the output pulse which energizes the oscillator will equal the supply voltage. A diode, known as a "hold-off" diode, is often inserted between the charging choke and line. This ensures that if the pulse recurrence period is greater than  $\pi\sqrt{nLC}$  the charging current cannot reverse, and the line voltage is maintained constant at its maximum value. It should be noted that the line must be capable of withstanding twice the supply voltage, as the voltage across both choke and capacitor of a series-resonant circuit is twice that of the supply. Not surprisingly, the charging of the delay line by this method is called "resonant charging."

An alternative method known as "symmetrical charging" is often preferred. In this case the line is not subjected to a charge of twice the supply voltage, as the excursion of this voltage across the line is arranged to swing equally above and below zero.

Finally it may be noted that although it is easier to understand the charging of the line from a d.c. source; a.c. can be used, provided that the supply frequency is kept constant within close limits. A.C. charging has many advantages, e.g., the absence of high voltage rectifier and smoothing circuits—consequently the modulator is much lighter in weight. The recurrence frequency (p.r.f.) is, however, tied to the supply. In many cases this is not a disadvantage because, as with the frame- or field-scan speed in television, locking to the supply-frequency allows less stringent specification to be adopted for smoothing throughout the system.

# WORLD OF WIRELESS

## **Tape Recording Copyright**

ONE of the consequences of a legal battle between GEMA (the German copyright society representing composers, authors and music publishers) and tape recorder manufacturers was that advertisements for tape recorders in West Germany must carry a note stating that the recording of copyright music is forbidden unless written permission has been granted by GEMA. As only a few owners of tape recorders have voluntarily paid fees to the society it has now demanded a flat payment of 5% of the list price of every tape recorder sold to cover copyright fees.

Manufacturers have, however, declined to pay the fees. GEMA claim that German gramophone record production has declined due to the fact that more and more broadcast receiver owners make their own tape records of broadcast popular music.

## **Technical Writing Awards**

THE 1960 winners are announced by the Electronic Engineering Association and the Radio Industry Council of the six 25-guinea premiums awarded for technical articles "likely to enhance the reputation of the industry and focus attention . . . on Britain's leadership in radio, television and electronics." The panel of judges under the chairmanship of H. E. F. Taylor who succeeded the late Air Marshal Sir Raymund G. Hart, comprised Professor H. E. M. Barlow, B. C. Brookes, A. H. Cooper, F. Jeffrey, G. Reeves and Dr. R. C. G. Williams.

There is a growing interest in the scheme, introduced by the R.I.C. in 1952, and last year 93 articles were submitted compared with 63 the year before.

The 1960 prize-winners are:—

A. E. Crawford (Brush Crystal Co.), "Piezoelectric Voltage Transformers," *Wireless World*.

Dr. G. L. Grisdale and D. A. Paynter (Marconi's W/T), "A Tropospheric Scatter Link Over a 200-mile Path," *Point-to-Point Telecommunications*.

D. L. Swale (Decca Radar), "Integrated Electro-mechanical Design as Applied to Electronic Equipment," *British Communications and Electronics*.

C. M. Cade (Kelvin & Hughes), "Infra-red Radar Surveillance and Communications," *British Communications and Electronics*.

E. N. Rowlands (Central Middlesex Hospital) and H. S. Wolff (National Inst. of Medical Research), "The Radio Pill," *British Communications and Electronics*.

P. L. Owen, M. F. Partridge and T. R. H. Sizer (R.A.E.), "The Differential Analyser and its Realization in Digital Form," *Electronic Engineering*.

## **Commonwealth Technical Training**

AT the suggestion of the Duke of Edinburgh a Commonwealth Technical Training Week is being held from May 29th. Its aim is, to quote H.R.H., "to draw attention to the very wide range of apprentice schemes and technical training programmes which are open to bright and ambitious young people." Most education authorities in the U.K. are participating. At the Royal Exchange, London, the City and Guilds of London Institute is staging an exhibition to illustrate the training and educational opportunities in industry, commerce and the professions. A special service is being held at St. Paul's Cathedral on June 1st.

## **Component Production**

THE year's total of 2,650M components (approximately 10M each day of a five-day week) is recorded in the 28th annual report of the Radio and Electronic Component Manufacturers' Federation covering 1960. This output, an all-time record valued at £130M, is an increase of more than 10% on the previous year's figure despite the recession in the sale of domestic television equipment.

The total value of the 1960 exports of components and associated products (audio equipment and test instruments) was £26.4M which was an increase of approximately 17%. The U.S.A. again headed the list of buyer countries with purchases valued at £4.8M, with Australia next (£2.1M) followed by Canada (£1.8M) and India (£1.2M). China was the leading buyer of British test-gear in 1960 taking a total worth £186,000.

## **Multi-standard TV Gear**

TO facilitate contributions to Eurovision and the making of video-tape recordings for use in other countries, without standards conversion, the five new mobile control units ordered from Pye by the B.B.C. are capable of operating on the 625- and 525-line standards as well as on 405 lines.

These mobile control units are each fitted with four Pye 4½in image-orthicon camera channels. Power consumption and heat dissipation from the equipment will be minimized by the use of transistors wherever possible. An innovation is that the vision mixer control panel will be detachable and can be operated when required up to 300 feet from the main equipment. Each camera will be capable of operation with up to 2,000 feet of cable. Production facilities will include electronic "wipe," permitting parts of two pictures to be transmitted simultaneously.

## **Communications Satellites**

FRANCE, the U.K. and the U.S.A. are to co-operate in a programme of trans-Atlantic tests of communications satellites. Ground stations are to be built in England and France for the reception and transmission of telephone, telegraph and television signals across the Atlantic using satellites to be launched by the U.S. during 1962 and 1963.

The first project, Relay, will utilize a low-altitude active repeater satellite scheduled to be launched in 1962. The second, Rebound, will involve the placing of several inflated spheres in orbit. The first launch to orbit three spheres is scheduled for 1963.

**Northern Nigeria**—Heads of agreement to provide television and sound broadcasting in Northern Nigeria have been signed by the Northern Nigerian Radio Corporation, E.M.I. Electronics and the Granada Group. A new company is being formed, in which the Radio Corporation—a government body—will operate in partnership with E.M.I. and Granada. A television

centre and studios will be built in Kaduna, the capital of the Northern Region, and there will be two linked transmitters—one to cover Kaduna and Zaria and the other in Kano. All transmitting and studio equipment for both television and sound broadcasting, is to be supplied and installed by E.M.I.

**New A.T.V. Studios.**—Opened on 7th April by Dr. Charles Hill, A.T.V.'s new Studio Centre at Elstree, Herts, covers some 340,000 sq ft and cost £4M. At present Studios C and D are in operation and, together with Studios A and B—to be completed shortly—the total studio floor area available will be 32,000 sq ft. Equipment includes five cameras (Pye) (using  $4\frac{1}{2}$ -in English Electric image-orthicon tubes) and "push-button" lighting control with automatic dimming and "memory" (Strand Electric) so that a given plot can be returned to. All the vision chain equipment can operate on 405-, 525- and 625-line standards: transistors and semiconductor diodes have been used widely in the mixing and distribution equipment which has been designed and made by A.T.V. staff.



P. A. Fleming

**Closer liaison** between U.S. and U.K. valve and tube makers may be expected from a conference recently held in Syracuse, New York, by the Joint Electron Device Engineering Council of the Electronic Industries Association of America. British manufacturers of valves, cathode-ray tubes and semiconductors were represented at the conference by P. A. Fleming, the technical secretary of B.V.A. and V.A.S.C.A.

**V.A.S.C.A.**—Following the retirement of G. A. Marriott, who was the first president and chairman of the Electronic Valve and Semi-Conductor Manufacturers' Association (V.A.S.C.A.), S. S. Eriks, O.B.E. (managing director of Mullard), has been elected president and chairman of the Council with C. A. W. Harmer, O.B.E. (a director of Pye), as chairman of the Association and also of the general management committee.

**B.V.A.**—The new vice-chairman of the British Radio Valve Manufacturers' Association in succession to G. A. Marriott is, J. Bell, managing director of the M.O. Valve Company.

**Receiving Licences.**—During February the number of combined television-sound licences throughout the U.K. increased by 38,023 bringing the total to 11,186,486. Sound-only licences totalled 3,940,859, including 468,806 for sets fitted in cars, giving an overall total of 15,127,327.

**Technical Writing.**—A course of six lectures on "Some Problems of Technical Writing" will be given at the Borough Polytechnic, Borough Road, London, S.E.1, at 7.0 on Wednesdays from April 26th. The fee is £1.

**Dubilier.**—It is regretted that some figures were dropped from Dubilier's advertisement, page 107, of the April issue. It was a 1961 capacitor that was compared with a 1930 condenser.

**"Multivibrator Design"**—a correction. On pages 221 and 222 of the April issue, Figs. 2 and 3 (but not their captions) should be interchanged.

**R.E.C.M.F.**—The new president of the Radio and Electronic Component Manufacturers' Federation, in succession to E. M. Lee, is Arthur Bulgin, and the vice-presidents, H. V. Slade (Garrard) and K. G. Smith (N.S.F.). The member firms and, in parentheses, their representatives elected to the council for 1961-62 are: Belling & Lee (N. Dundas Bryce), A. F. Bulgin & Co. (R. A. Bulgin), A. H. Hunt (S. H. Brewell), Multicore Solders (R. Arbib), Painton & Co. (C. M. Benham), Plessey Co. (J. A. Clark), Standard Telephones & Cables (L. T. Hinton), Telcon Metals (Dr. G. A. V. Sowter) and Bakelite (G. J. Taylor). The new chairman of the council is Dr. G. A. V. Sowter.

**Radio Amateurs' Exam.**—The City & Guilds report on the 1960 Radio Amateurs' Examination records a decline in the percentage of passes compared with the previous two years. Of the 1,274 candidates in 1960 only 55% passed compared with 60% of the 1,102 in 1959 and 72% of 716 in 1958. It is reported that the majority of failures were the result of a general inadequacy in all questions attempted.

**Jack Binns**, the first ship's wireless operator to demonstrate the value of radio in saving life at sea, who died in New York in December 1959, had requested that the citations and medals awarded to him commemorating the occasion in 1909 when he was instrumental in the saving of all the passengers on board the two vessels (*Republic* and *Florida*), should be presented to Peterborough, his home town. The presentation was made on April 11th on behalf of his widow by R. Ferguson, managing director of the Marconi International Marine Company, with whom Jack Binns was an operator from 1905 to 1912.

**Back Numbers.**—A reader has for disposal copies of *Wireless World* from April 1913 to November 1917. Anyone interested in acquiring these should write to L. Mawer c/o the Editor.

**Secondary Radar.**—The Ministry of Aviation has announced that secondary surveillance radar will be introduced shortly to serve the Southern Air Traffic Control Centre. It is intended that this service, experimental at first, should become part of the normal operational facilities in the United Kingdom, together with such other stations as are necessary to cover other U.K. air-space areas.

**School TV.**—The use of closed-circuit television to link two schools in an area to facilitate the teaching of special subjects was recently demonstrated by Pye in Hayes and Harlington, Middlesex. The schools are two miles apart and were linked by radio. An advantage voiced by some of the pupils in a science class was that experiments can be seen much more clearly on the 27-inch monitors than under normal class-room conditions.

## OBITUARY

Since preparing the obituary notices on page 251, we regret to learn of the recent death, at the age of 70, of **Walter S. Barrell**, who had been associated with the recording industry for over 35 years. He retired at the age of 67, from the position of technical liaison officer of the E.M.I. group's recording activities. He was previously manager of E.M.I. Studios, for 10 years. Mr. Barrell joined the Columbia Graphophone Company in 1925 where he became chief engineer of the recording studios, a position he continued to hold after the merger in 1931 of Columbia and H.M.V. to form E.M.I. It was about this time that Blumlein developed a system of stereophony and Barrell co-operated with him in producing some of the earliest stereo records. He was elected president of the B.S.R.A. in 1948 and an honorary member of the Audio Engineering Society of America in 1956.

# Personalities

**Professor Harold E. M. Barlow, Ph.D., B.Sc.(Eng.), M.I.E.E.,** Dean of the Faculty of Engineering, and Pender Professor of Electrical Engineering and Director of Laboratories in the University of London, has been elected a Fellow of the Royal Society "for his work on engineering aspects of microwaves, particularly waveguides and semi-conductors." Professor Barlow, who has been a member of the Editorial Advisory Board of our sister journal *Electronic Technology* since 1956, is also on the panel of judges of the Technical Writing Scheme sponsored by the Radio Industry Council and the Electronic Engineering Association. He has also served on the Radio Research Board of the D.S.I.R. for some years.

**E. Allard, B.Sc., A.M.I.E.E.,** has been appointed acting general manager of Associated Transistors, Ltd., following the resignation of **Dr. C. B. Mephram.** Mr. Allard is assistant to the general manager of the English Electric Valve Company. The English Electric Co. is one of the three which jointly own Associated Transistors; the others are A.T.E. and Ericsson Telephones.

**H. B. Dent** has retired from the editorial staff of *Wireless World* which he joined in 1927. His wide knowledge enabled him to contribute to all sides of editorial work but his particular interest was in short waves and he has been an active amateur transmitter (G2MC) for many years. Towards the end of the first World War he transferred from the Army to the Royal Flying Corps for special radio duties. After demobilization he spent a few years in Yugoslavia and then joined Igranic Electric from which he came to *Wireless World.* He was commissioned in the R.A.F.V.R. early in 1939 and was posted to Fighter Command HQ in August of that year and was closely associated with the operation of the radar chain and fighter control. In September 1941, he went to the Directorate of Communications Development in the Ministry of Aircraft Production. From August 1943 until he returned to *Wireless World* in 1945, Wing Commander Dent was in the Air Ministry Directorate of Signals.



H. B. Dent



Dr. A. C. Robb

**A. C. Robb, M.Eng., Ph.D., A.M.I.E.E.,** has been appointed technical manager of Belling & Lee Ltd. Dr. Robb graduated at Liverpool University, and obtained a masters' degree for post-graduate work. Subsequently he was awarded a research fellowship at Glasgow University to work on the design of high-voltage particle accelerators, and gained his Ph.D. for related studies.

**A. B. Howe, O.B.E., M.Sc., M.I.E.E.,** who retired some months ago from his position as assistant head of the B.B.C. Research Department, is now employed in a consultative capacity by the Independent Television Authority. He is a special assistant to the chief engineer and is concerned mainly with both the national and international aspects of the planning of a television service. He was a representative of the I.T.A. at the C.C.I.R. meeting of experts recently held in Cannes in preparation for the European Broadcasting Conference to be held in Stockholm from 26th May which he will also attend.



A. B. Howe

**C. H. Colborn, B.Sc., M.I.E.E.,** has retired from the B.B.C. Engineering Division after 37 years' service. He is succeeded as head of the Television Studio Section of the Planning and Installation Department, by **D. R. Morse, A.M.I.E.E.** Mr. Colborn joined the B.B.C. as a maintenance engineer at Cardiff. In 1926 he transferred to London to do development work and after service with the Research and Equipment Departments he became head of the Low Frequency Section of the Station Design and Installation Department, as it then was, in 1941. He has been in charge of the Television Studio Section since 1949 and has been responsible for the technical installations at all B.B.C. television studios, including the new London Television Centre. Mr. Morse joined the B.B.C. in 1947 as an engineer in the London Control Room and transferred to the Designs Department in 1949. He has been head of the Film Unit of the Television Section of the Planning and Installation Department since 1956.

**D. N. H. Lambert, B.Sc.(Eng.), A.M.I.E.E.,** has been appointed resident engineer of the B.B.C. Far Eastern Station, Singapore, in succession to **R. J. Keir, O.B.E., B.Sc., A.M.I.E.E.,** who has completed his term of duty. Mr. Lambert joined the Operations and Maintenance Department of the B.B.C. in 1934 and transferred to the Research Department the following year. He returned to the Operations and Maintenance Department in 1946 and became assistant engineer-in-charge of the Burghead transmitting station in 1951. He was seconded as chief broadcasting engineer to Radio Belize, British Honduras, in 1955 and since his return to the United Kingdom in 1958 has been engineer-in-charge of the Clevedon transmitting station. The new engineer-in-charge at Clevedon is **V. A. E. Hember,** who joined the B.B.C. in 1940. He has been senior maintenance engineer at Brookmans Park since 1952.

Other B.B.C. appointments include: **K. G. Nicholas,** who becomes engineer-in-charge of the television studio at Southampton, and **E. S. Ahl, A.M.Brit.I.R.E.,** who has been in charge of the Penmon and Llandona sound transmitting stations since 1958 and now becomes engineer-in-charge also of the Bangor studios in succession to **S. Hett** who is retiring after 37 years' service with the Corporation.



# News from Industry

Dr. A. V. J. Martin, A.M.Brit.I.R.E., editor of our Paris contemporary *Electronique et Automatisation*, writes in this issue on field effect and its applications. After 10 years in journalism first as editor-in-chief of the French journal *Television* and later of *La Radio Professionnelle*, Dr. Martin went to the United States in 1956 where he was for three years assistant professor of electronics at the Carnegie Institute of Technology, Pittsburgh. He returned to France in 1959. Dr. Martin, who received his doctorate (sciences) from the University of Paris in 1956, served in the R.A.F. during the last war and was for a year teaching at an R.A.F. radio school. He is 39.

W. A. C. Maskell, B.Sc.(Eng.), M.I.E.E., Sen.M.I.R.E., general manager of The General Electric Company's Telecommunications Group at Coventry since 1959, has been appointed managing director of the Group. Mr. Maskell, who is 55 and is a graduate of London University, joined the Coventry Telephone Works of G.E.C. as a post-graduate apprentice in 1925. Three years later he became an equipment designer in the Radio Development Laboratory. In 1942 he became chief engineer to the G.E.C. war-time factories at Bradford. He returned to London in 1946 to become deputy manager of the Radio Department at the company's headquarters and five years later went to Coventry as general manager of the Radio Works.



W. A. C. Maskell

## OBITUARY

The Rt. Hon. Sir Walter Womersley, Bt., president of the Relay Services Association of Great Britain since 1948, died on March 15th at the age of 83. Sir Walter was from 1935 to 1939 Assistant Postmaster-General.

W. Witt Burnham, whose association with radio dates back to the days before broadcasting, died on April 3rd aged 80. He founded the firm of Burnham and Company, of Deptford, from which grew the original Burndept Company. As managing director of Burndept he was one of the original directors of the British Broadcasting Company. He later joined Edison Swan, where he was manager of the Radio Division when he retired 20 years ago. He was for many years chairman of the Radio Manufacturers' Association and also of the British Radio Valve Manufacturers' Association.

Gerald Marcuse, the internationally well-known radio amateur, died on April 6th. He was 73. Gerald Marcuse was an honorary member of the R.S.G.B. of which he was president in 1929-30 and was one of the founder vice-presidents of the International Amateur Radio Union. He will be remembered by "old-timers" as a pioneer in Empire broadcasting, for in 1928 he set up a studio at his home from which he regularly broadcast over G2NM programmes to overseas listeners.

F. W. Endicott, who as Scottish Engineer was responsible for the engineering services of the B.B.C.'s sound and television studios and outside broadcasting units in Scotland, died on March 21st aged 60. He joined the Corporation in 1929 as an assistant in the technical correspondence section at Broadcasting House.

E. A. Taylor, sales director of Belling and Lee, died on March 19th at the age of 53 after a long illness. He joined the company in 1932.

**A.E.G.**—The 1959/60 turnover of Allgemeine Elektrizitäts Gesellschaft and its subsidiaries in which it has a majority holding was DM 2,497M. This was an increase of 16% over the previous year's figure. Exports accounted for 24% of the group's total turnover. The net profit for the year amounted to DM 43.5M. Telefunken, the capital of which was recently raised to DM 125M, and Ludw. Loewe & Co., are wholly owned subsidiaries of A.E.G.

Marconi's W/T Company and Wilcox Electric Company Inc., of Kansas City, Missouri, have signed an agreement for collaboration in the field of airborne radio and radar equipment. It covers the full interchange of design, engineering and production information and includes the manufacture and sale by either firm of equipment designed by the other. The Wilcox company is one of the two companies who have received development contracts for air traffic control transponders from the U.S. Federal Aviation Agency.

Ekco Electronics Ltd. has granted a 10-year contract to Wilcox Electric Company, Inc., of Kansas City, to produce airborne weather radar equipment under licence in the U.S.A.

Griffiths Electronic Guns Ltd. has been set up jointly by Griffiths Electronics Inc., of the U.S.A., and the Sam Carpenter Group of Companies in this country, to manufacture at Bray, County Wicklow, Eire, magnetic and electrostatic guns for cathode-ray tubes. The factory's initial production is at the rate of 10,000 guns per week, and these are mainly for Cathode Ray Tubes Ltd., another of the Carpenter companies. Production will later be increased to meet anticipated demands from the Continent and Commonwealth countries.

J. E. Dallas and Sons have been acquired from Keith Prowse by G. S. Lee, chairman and managing director of Lee Products. Keith Prowse acquired a 51% holding in Dallas about two years ago. Mr. Lee is now chairman of the company in succession to Mr. P. E. Cadbury who has resigned.

Multisignals Ltd., opened on March 28th its first wired television system in Wales—at Cwmbran New Town, Monmouthshire. The company was formed in 1959 with the backing of Thorn, Ekco, Ultra, Anglia TV and the Granada Group, to provide through the co-operation of local dealers a sound and TV distribution service. E.M.I. Electronics Ltd. supplied the equipment for the Welsh distribution system which provides three TV programmes (B.B.C., Television Wales & the West, and Westward TV), the three B.B.C. sound programmes on v.h.f., and Radio Luxembourg also distributed on v.h.f.

Closed-circuit television, both monochrome and colour, links the new *Daily Mirror* headquarters in Holborn, London, with one of its subsidiaries in Farringdon Street, a quarter of a mile away. The Marconi equipment has been installed to enable documents etc. to be seen by executives without wasting time travelling between offices. Similarly the recently opened branch of Coutt's Bank in Lombard Street, London, has been equipped by E.M.I. Electronics with closed-circuit television linking the ledger room with various administrative offices.



Racal have supplied two of their RA17 communications receivers with i.f. converters and an s.s.b. adaptor to the R.A.F. Frequency Measuring and Monitoring Station at Stoke Hammond, Bucks, where all R.A.F. transmitters are constantly checked for frequency accuracy. A Racal SA21B digital frequency meter is used in conjunction with the radio equipment for direct reading of the measured frequencies.

**Decca River Radar**, Type 215, has been fitted in *Fireflair*, a 66-ft fire-boat which is based near Gravesend for service in the lower reaches of the Thames and the Thames Estuary. It will enable the vessel to answer emergency calls more rapidly in all conditions of visibility. Decca also announce that they have received an order for harbour radar for the River Medway. The installation includes three 16-in radar displays and Pye v.h.f. communications equipment.

## EXPORTS

Decca are to supply their Type 424 airfield control radar to the Portuguese Air Force. To meet mobility requirements the radar will be mounted on a trailer which will also incorporate Ekco C.R.D.F. and Pye v.h.f. equipment.

**Surveillance Radar**.—Marconi's are to supply a second S232/2 50cm radar to the Centre d'Essais en Vol, the French counterpart of our Royal Aircraft Establishment. It will be installed at Istres. This latest version of the S232 series can be used simultaneously for long-range surveillance and for close-control of aircraft.

**E.M.I.** recording equipment has recently been supplied to the Rumanian record industry. Each of the two recording suites supplied includes the new 10-way mono-stereo mixing control console. The consoles record stereo by the established spaced-microphone method or can be adapted to employ the E.M.I. "sum and difference" technique. Ten TR90 stereo tape-recording consoles, dubbing-mixing consoles, disc replay units, monitor speakers and other equipment are included in the order.

**Marconi** television equipment has been installed at Ottawa—the third Canadian commercial station to be supplied by Marconi's. The equipment includes a 4-kW Band III vision transmitter, an 18-kW vision amplifier, and a 9-kW sound transmitter. The aerial and ancillary equipment has also been supplied. The amplifier incorporates patented "anti-ghost" circuits to avoid the effects of snow and ice on the aerial. Marconi's are also supplying a further seventeen Mark IV television cameras to Radio Italiana Televisione. The new cameras will be installed in the Rome and Naples studios and will be used for the second television service scheduled to commence later this year.

**Pye** have been awarded a contract worth £40,000 for instrument landing and v.h.f. ground-to-air communication equipment to be used at the Schoenefeldt airfield in East Germany. The landing system employs a directional localizer and stabilized glide path.

**Cossor** packet, series CC.3, v.h.f. portable transmitter-receivers, have been ordered for the Rhodesian police. The instrument, which weighs only 5 lb, employs transistors and features a built-in speaker/microphone and power supply.

## MAY MEETINGS

*Tickets are required for some meetings; readers are advised, therefore, to communicate with the secretary of the society concerned.*

### LONDON

1st. I.E.E.—"Progress report on the development of a photo-electric beam index colour television tube and system" by R. Graham, J. W. H. Justice and J. K. Oxenham at 5.30 at Savoy Place, W.C.2.

3rd. Brit.I.R.E.—Symposium on "Computer control of air traffic" at 3.0 at the London School of Hygiene, Keppel Street, W.C.1.

5th. I.E.E.—Discussion on "Artificial muscles" opened by Dr. A. B. Kinnear Wilson at 6.0 at Savoy Place, W.C.2.

8th. I.E.E.—"The corona-discharge and its application to voltage stabilization" by E. Cohen and Dr. R. O. Jenkins; "Impedance frequency characteristics of glow-discharge reference tubes" by Dr. F. A. Benson and P. M. Chalmers; and "Comparison of argon, krypton and xenon as admixtures in neon glow-discharge reference tubes" by Dr. F. A. Benson and G. P. Burdett at 5.30 at Savoy Place, W.C.2.

12th. I.E.E.—Discussion on "The place of transistors in national certificate courses" opened by B. F. Gray and W. B. K. Ellis at 6.0 at Savoy Place, W.C.2.

12th. Institute of Navigation.—"Airborne weather radar" by Capt. R. C. Alabaster and P. L. Stride at 5.15 at the Royal Geographical Society, 1, Kensington Gore, S.W.7.

12th. British Interplanetary Society.—Symposium on "Communication satellites" from 10.0 to 5.0 at the Federation of British Industries, 21 Tottenham Street, S.W.1.

15th. I.E.E.—Six papers on the

banana tube colour television display system at 5.30 at Savoy Place, W.C.2.

15th. I.E.E. Graduate and Student Section.—Annual General Meeting followed by "The experimental investigation of space" by Dr. P. J. Bowen at 6.30 at Savoy Place, W.C.2.

17th. I.E.E.—"Air traffic control" by Dr. E. Eastwood and Dr. B. J. O'Kane at 5.30 at Savoy Place, W.C.2.

17th. Brit.I.R.E.—Discussion on "Television wireless distribution" at 6.0 at the London School of Hygiene, Keppel Street, W.C.1.

18th. I.E.E.—Annual General Meeting followed at 6.30 by "Experimental investigation of space" by J. A. Ratcliffe at Savoy Place, W.C.2.

19th. Institution of Electronics.—"Aerial techniques" by C. F. Whitbread at 7.0 at the London School of Hygiene, Keppel Street, W.C.1.

### ARBORFIELD

1st. I.E.E. Graduate and Student Section.—"Aural properties of spaced loudspeaker systems" by J. B. Helder at 7.0 at the Unit Cinema, 3 (Tels.) Training Bn., R.E.M.E.

### BIRMINGHAM

1st. I.E.E.—"Silicon power rectifiers" by A. J. Blundell, A. E. Garside, R. G. Hibberd and I. Williams at 6.30 at the James Watt Memorial Institute.

17th. Television Society.—"Tomorrow's television" by D. C. Birkinshaw at 7.0 in the New Physics Lecture Theatre, University of Birmingham.

18th. Institution of Electronics.—"Tunnel diode circuit applications" by I. Aleksander at 7.0 in the Byng Ken-

rick Suite, New College of Technology, Gosta Green.

### FARNBOROUGH

2nd. I.E.E.—"The potentialities of artificial earth satellites for radio communication" by W. J. Bray at 6.15 at Farnborough Technical College, Boundary Road.

16th. Brit.I.R.E.—Annual General Meeting of the Southern Section followed by "Electronic techniques in the measurement of acoustic noise" by K. R. McLachlan at 7.0 at Farnborough Technical College.

### LEICESTER

15th. Television Society.—"The Neveve vidicon camera" by N. S. Rutherford at 7.30 at the College of Technology and Commerce.

### MANCHESTER

18th. Society of Instrument Technology.—Annual general meeting of Manchester Section followed by "The thermocouple" by Dr. A. W. Foster at 6.45 at the Nags Head, Jacksons Row.

### PRESTON

3rd. I.E.E.—Annual general meeting of the N. Lancashire Sub-Centre followed by "Electronic aids to banking and commerce" by Dr. R. Feinberg at 7.30 at the N.W.E.B. Demonstration Theatre, Friargate.

### SHEFFIELD

17th. I.E.E.—Annual general meeting of Sheffield Sub-Centre followed by "Progress in permanent magnet material" by J. E. Gould at 6.30 at the Grand Hotel.

# Ceramic I.F. Transformers

USE IN TRANSISTOR RADIO RECEIVERS

By R. C. V. MACARIO\*, Ph.D.

THE behaviour of piezoelectric ceramics is similar in many respects to that of piezoelectric crystals. When a voltage is applied across electrodes enclosing a region of either material, mechanical motion is induced, thus giving rise to conditions of electrical and mechanical resonance. One difference, however, is that the ceramics must be polarized, that is to say, subjected to a high electric stress, before they show piezoelectric properties. However, since ceramics may be more readily shaped and polarized in convenient directions, this gives them an advantage, compared with crystals, in that a larger variety of mechanical modes may be exploited. Examples of shapes in use are circular discs resonating in a radial mode and longitudinal bars resonating in longitudinal or shear modes: both of these shapes behave electrically like simple tuned circuits of differing characteristic impedances. Moreover, by selectively silvering the surfaces of the material, the ceramic devices may be made to behave like band-pass transformers<sup>1, 2, 3</sup>. They appear to have a much greater selectivity per unit volume and are attractive as an adjunct to solid-state circuitry.

Clearly, the properties and the usefulness of the devices depend very much on the nature of the ceramic. Suitable ceramics appear to be titanates and zirconates and the lead compositions<sup>4</sup> have the

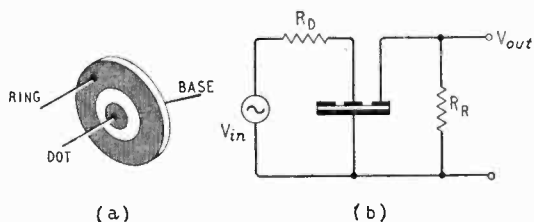
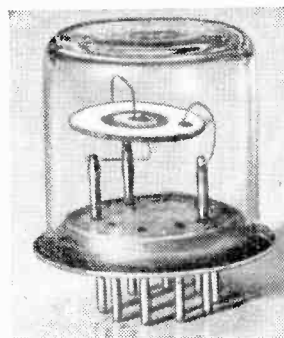

Fig. 1 (a) Construction of a ceramic i.f. transformer. (b) Circuit for measuring the response of a ceramic i.f. transformer.

desirable property of strong piezoelectric coefficients which are stable with time and temperature.

On the other hand, other properties of the devices are independent of the exact composition of the ceramic, but are pertinent to all types. The most important of these properties is that a given structure can resonate at several frequencies. The other frequencies correspond either to harmonics of a particular mode or to other modes. Frequencies higher than the fundamental response of a particular mode are referred to as overtones, or tones<sup>5</sup>, and they

\* Now at IBM British Laboratories (formerly at The Plessey Co., Ltd.)



Experimental radial-mode resonator made by Plessey.

can be very troublesome in band-pass amplifiers. Also, the amplifier circuit loads the resonators and thus the choice of ceramic and structure is not only a function of its piezoelectric properties but also of the amplifier arrangement.

This article discusses the principles underlying the use of the radial mode resonator<sup>1, 2</sup> as an interstage filter network and a replacement for i.f. transformers in broadcast radio receivers. A description of the resonator is given from the viewpoint of its circuit properties and the article is concluded with an illustration of a design for a standard receiver.

## Description of the Radial-Mode Resonator.—

The photograph shows an experimental radial-mode resonator displayed at the Physical Society's Exhibition, 1960. The component consists essentially of a thin disc of ceramic, polarized in the axial direction, and having a divided silvered surface on one side and a completely silvered surface on the other. The inner area of the divided surface forms the *dot* electrode, the outer the *ring* electrode, whilst the undivided surface is known as the *base* electrode. With an input signal applied between the dot and base, say, an output signal is observed between the ring and base electrodes. The signal is transferred from input to output by the mechanical coupling between the inner and outer regions of the disc and the electromechanical properties of the ceramic material. The response is a maximum when the dimensions of the disc are so that it is mechanically resonant at the frequency of the input signal. Because different electrode areas have different electromechanical coupling with the motion of the disc, an impedance transformation results and we arrive at the concept of a ceramic i.f. transformer. Fig. 1 illustrates the details of the device and the type of circuit by means of which the response may be investigated. For the connection shown the response is a series resonance, but the shape or selectivity of the response curve depends both on the ceramic itself and on the load across each pair of electrodes. The response, together with the transformer action, is very similar to that of a wound i.f. transformer, but clearly, if the ceramic device is to

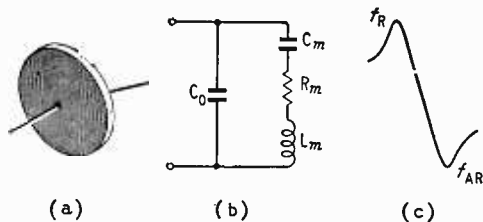

Fig. 2 (a) Uniformly silvered disc basic resonator. (b) Equivalent circuit of the basic resonator of Fig. 2 (a). (c) Voltage/frequency response of the basic resonator of Fig. 2(a).

compete with the wound component in all respects, it must respond to exact design.

**Basic Resonator.**—The approach used is to develop a design equation for the ceramic counterpart by extending the equivalent circuit of a uniformly silvered disc. We call this the basic resonator and the response about resonance of this two-terminal device is shown in Fig. 2 together with the equivalent circuit which very nearly describes the response. The characteristics are very similar to those of a quartz crystal, but resonance is less sharp, indicating a much lower mechanical Q-factor. The values of the components of the equivalent circuit can be readily measured, and use is made of these values in the design of the concentric-ring transformer.

The radial mode is used because of its relative freedom from spurious responses, and because the overtone frequencies are farthest apart<sup>1</sup>. To gain an idea of the dimensions and frequencies involved, Table I gives typical values for two sizes of disc<sup>2</sup>,

TABLE I

Resonant Mode	$f_R$ kc/s	Radius cm	$C_0$ pF	$\Delta f$ kc/s	$C_m$ pF	$R_m$ $\Omega$
Overtone { Funda- mental	180	0.611	1290	12.0	178	17
	465	0.611	1290	4.15	23	50
Disc { 1st overtone	465	0.236	194	31.0	26	43
Fundamental { Funda- mental	465	0.236	194	31.0	26	43

both 0.8mm thick, composed of a ceramic with the following properties:—

Electromagnetic

coupling coefficient,  $k_R = 40\%$

Dielectric constant,  $\epsilon = 1000$

Mechanical Q-factor,  $Q_m = 300$

Radial mode frequency

factor (fundamental frequency  $\times$  radius),  $f_R = 110$  kc/s-mm

Here,  $\Delta f = f_{AR} - f_R$  where  $f_R$  and  $f_{AR}$  are the resonant and anti-resonant frequencies respectively, indicated in Fig. 2. A more detailed description of the derivation of these values and their variation with ceramic composition is given elsewhere<sup>3</sup>. The important parameters of the ceramic are  $k_R$ ,  $Q_m$  and  $\epsilon$ ; Table I shows typical values, but wide variations are possible<sup>4</sup>.

From Table I it will be seen that the first overtone frequency is some 2.5 times higher than the fundamental. In practice, however, because of the small dimensions that are involved in the preparation of the electrodes of a fundamental 465 kc/s resonator, 465 kc/s overtone resonators are preferred. A second

overtone then appears some 1.5 times above this frequency. However, this is in general a much weaker response<sup>1</sup> and the main problem is that of eliminating the fundamental resonance in the i.f. amplifier. This is considered below.

Before leaving the basic resonator, however, it is worthwhile noting that in certain instances it may be used to increase selectivity, but usually at the expense of a few decibels of gain.

**Equivalent Circuit.**— Fig. 3 shows an equivalent circuit that quite closely describes the behaviour of the three-terminal resonator of Fig. 1. The series-resonant components with the subscript 'm' are the equivalent mechanical components described in Fig. 2, whilst  $R_D$ ,  $C_D$  and  $R_R$ ,  $C_R$  refer to the dot and ring loads and electrode capacitances respectively. The two transformers of turns ratios  $n_1$  and  $n_2$  are introduced to take into account the partial coupling of the loads into the mechanical circuit. Both depend on the mode of resonance and the placement of the silvered electrodes.

It can be shown that the working Q of the device, called  $Q_w$ , at the centre frequency  $f_0$  in a circuit such as Fig. 1 is given approximately by

$$Q_w = \frac{2\pi f_0 R_D C_0^2}{C_m F(N)} \quad \dots \quad (1)$$

In this equation  $f_0 \approx f_R$  and  $R_D$  is the load across the dot electrode which is correctly matched to a load  $R_R$  across the ring electrode by a disc having electrode areas in the ratio 1:N. Clearly  $N = C_R/C_D$ , whilst the matching ratio is given by

$$\frac{R_D}{R_R} = \frac{n_1^2}{n_2^2} N \quad \dots \quad (2)$$

The values of  $n_1$  and  $n_2$  can be measured and hence equation (2) solved.  $C_0$  is the total electrode capacitance and

$$C_0 = C_D + C_R \quad \dots \quad (3)$$

$F(N)$  is a function which depends on the position of the electrodes, the ratio of their areas, and the extent of the silvering. Even so for a typical overtone disc  $F(N)$  is very nearly equal to unity, which leads to a simple design equation. Thus  $Q_w$  depends merely on the working load and on the ratio of the inter-electrode capacitance to the equivalent mechanical capacitance. The latter ratio depends on the radial electromagnetic coupling coefficient  $k_R$  which increases as  $C_m/C_0$  increases. Thus, summarizing conveniently,

$$\text{Working Bandwidth} \propto \frac{\text{Ceramic Coupling Coefficient}}{\text{Load} \times \text{Electrode Capacitance}}$$

The mechanical  $Q_m$  does not enter into the expression provided it is high. Moreover, for a given ceramic and resistive load, we are able to vary the working  $Q_w$  by adding external capacitances. Also we note

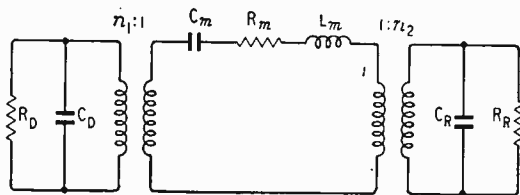

Fig. 3. Equivalent circuit of a ceramic i.f. transformer.

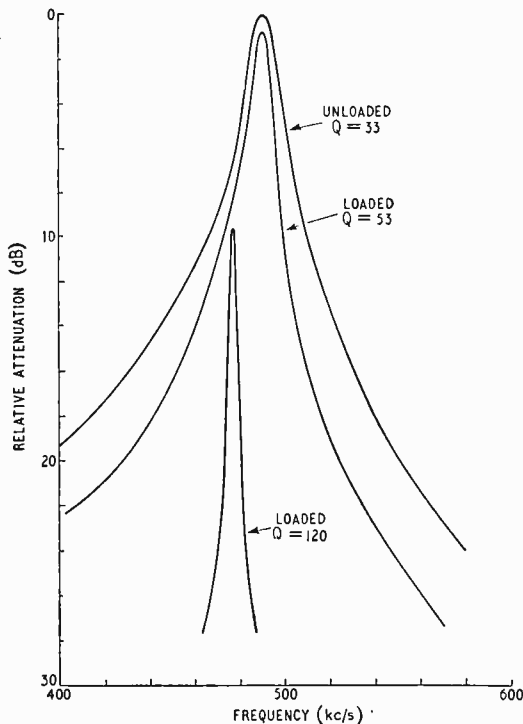

Fig. 4. Measured response curves for a single ceramic i.f. transformer with various external capacitive loads.

there is no limit on the value of  $R_D$  provided that  $2\pi f_0 R_D C_D > 1$ .

Fig. 4 shows some measured response curves for a single disc with various external capacitive loads.  $Q_w$  calculated from Equation (1) was 27, compared to the measured  $Q_w$  of 30 with the disc not loaded.

**Practical I.F. Amplifier Design.**—The ceramic i.f. transformer is utilized in a practical amplifier circuit in the manner shown in Fig. 5. As there is no d.c. path through the device it may be connected directly between the collector and base of successive transistors (or other components) but, in order to supply the current to the driving transistor without losing the signal, a resistive feed must be included in the collector circuit<sup>1, 2</sup>. This clearly has disadvantages as well as advantages. It is seen that the arrangement is identical with Fig. 1 but with the loads indicated in Fig. 5.

Practical values of the collector load  $R_C$  are limited by the transistor current to  $< 10k\Omega$ . This is usually less than the transistor output impedance and hence  $R_D \approx R_C$ . The load on the ring electrode is that of the base of the succeeding transistor,  $R_{in}$  and  $C_{in}$ ; bias resistors can usually be ignored. It is then possible to calculate the power gain and the working bandwidth. The centre frequency  $f_0$  is dictated by the diameter of the ceramic resonator; for a 470kc/s overtone disc this is about half an inch.

The power gain is given<sup>7</sup> by

$$\text{Stage gain} = \frac{1}{4} g_m^2 R_D R_R \dots \dots (4)$$

when the loads are correctly matched. With practical values of the transistor mutual conductance  $g_m$  this works out to be about 30dB. Though this is

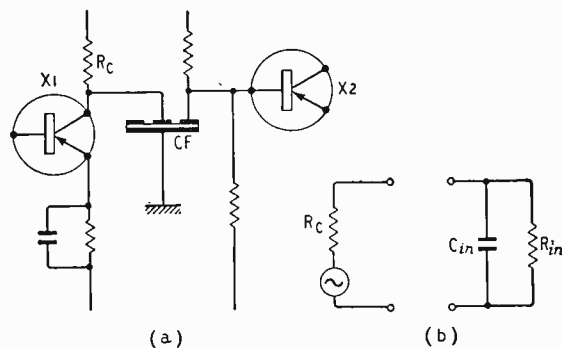

Fig. 5 (a). Connection of a ceramic i.f. transformer in a transistor amplifier. (b) Effective dot and ring loads in the circuit of Fig. 5 (a).

somewhat lower than the maximum power gain frequently quoted, there is very little power insertion loss due to the disc. This loss depends on the ratio  $Q_m : Q_w$ , but is negligible when

$$Q_w \leq Q_m^{1/4}$$

Typically  $Q_m = 300$ , hence Equation (4) gives the working power gain.

Conventional i.f. transformers are often designed with an attendant power loss to overcome transistor amplifier instability. With ceramic i.f. transformers the resistive load  $R_C$  achieves the same effect, and it turns out that there is no real need to include neutralizing components in stages such as Fig. 5.

To achieve the desired working bandwidth for given loads, the disc must be designed to have the electrode capacitance dictated by Equation (1), or the correct padding capacitance must be added. The process is relatively straightforward and a wide range of interstage selectivities may be designed. This makes possible the design of synchronous or stagger-tuned amplifiers. The requirements on centre frequency and other parameters are not found to be serious.

**Removing Unwanted Responses.**—Since we have considered an overtone resonator, the chief problem is to eliminate the response at the lower fundamental frequency, usually 180kc/s. At the present time the method recommended is to retain one double-tuned i.f. transformer in the first stage of the amplifier. The advantages of this arrangement are

- (i) Unwanted signal protection  $> 60\text{dB}$ .
- (ii) The amplifier frequency response can be adjusted for balance.
- (iii) Placing the transformer in the mixer stage ensures minimum breakthrough of the oscillator signal into the i.f. amplifier.
- (iv) A diode may be placed across the coil to provide signal overload protection.

**Receiver I.F. Stages.**—Fig. 6 illustrates the pertinent section of a broadcast receiver utilizing ceramic i.f. transformers. Comparison with the well-known conventional i.f. arrangement shows how the ceramic device fits into the circuit. The detector stage is as described in a previous issue of *Wireless World*<sup>8</sup>. Component values have not been included in Fig. 6 as these may be varied to suit the requirement of battery supply voltage,  $-V_B$ , and the a.g.c. action.  $D_1$  is a signal overload protection diode.  $C_1$  and  $C_2$  are capacitors which may

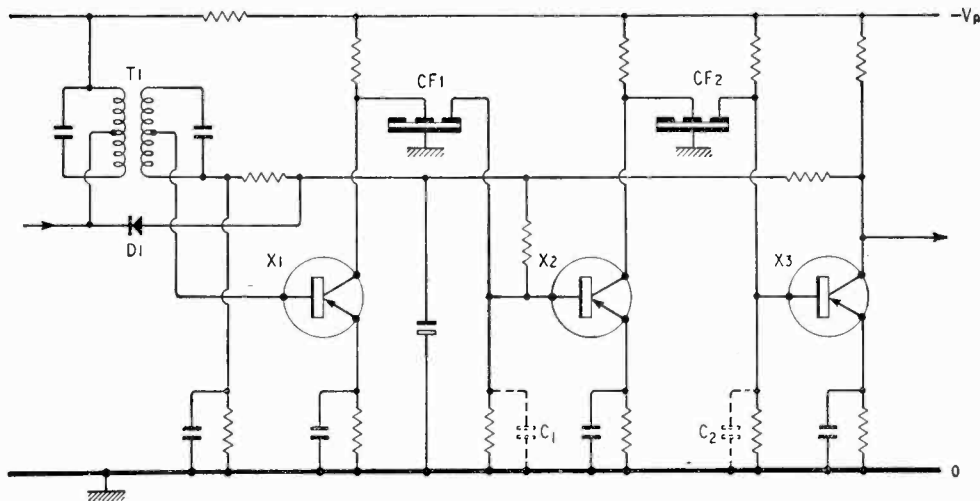

Fig. 6. Broadcast receiver i.f. stages using ceramic i.f. transformers.

be included if the ceramic discs are not in themselves correctly matched to the circuit.

Finally we quote a typical performance for this circuit:—

Centre frequency	480kc/s
6dB bandwidth	7kc/s
24dB bandwidth	18kc/s
Second channel	64dB down
Voltage gain per i.f. stage	28dB

In setting up the circuit two ceramic discs are selected having centre frequencies within 1-2 kc/s of each other, and the wound transformer is tuned for peak output.

Experience with this device in practical circuits of this kind suggests a wide field of application for filters of this type.

#### REFERENCES

<sup>1</sup> "Application of Piezoelectric Resonators to Modern Bandpass Amplifiers," A. Lungo and K. Henderson, *I.R.E. Nat. Con. Rec.*, p. 235, (1958).

<sup>2</sup> "Ceramic I.F. Filters match Transistors," D. Elders and E. Gikow, *Electronics*, p. 59, April 25, 1958 (Vol. 31).

<sup>3</sup> "Solid State Magnetic and Dielectric Devices," H. Katz (Ed.), J. Wiley, Inc., N.Y., (1959).

<sup>4</sup> "Piezoelectric Properties of Polycrystalline Lead Titanate Lead Zirconate Composition," D. A. Berlincourt, C. Cmolik and H. Jaffe, *Proc. I.R.E.*, p. 220, Feb. 1960, (Vol. 48).

<sup>5</sup> "Vibrations of Free Circular Plates," Mary D. Waller, *Proc. Phys. Soc.*, p. 70, 1938, (Vol. 50).

<sup>6</sup> "Design Data for Bandpass Ladder Filters Employing Ceramic Resonators," R. C. V. Macario, *Electronic Engineering*, p. 171, March 1961, (Vol. 33).

<sup>7</sup> "The Junction Transistor and its Applications," E. Wolfendale (Ed.), Heywood & Co., Ltd., (1958), Chap. 5.

<sup>8</sup> "Transformerless Circuits for Broadcast Receivers," R. C. V. Macario and N. E. Broadberry, *Wireless World*, p. 110, March 1960, (Vol. 66).

## SHORT-WAVE CONDITIONS

Prediction for May

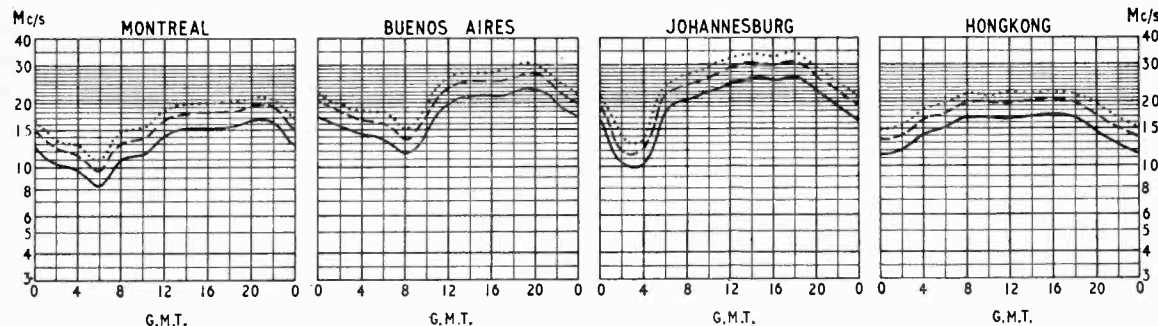

THE full-line curves indicate the highest frequencies likely to be usable at any time of the day or night for reliable communications over four long-distance paths from this country during May.

Broken-line curves give the highest frequencies that will sustain a partial service throughout the same period.

- ..... FREQUENCY BELOW WHICH COMMUNICATION SHOULD BE POSSIBLE FOR 25% OF THE TOTAL TIME
- PREDICTED MEDIAN STANDARD MAXIMUM USABLE FREQUENCY
- FREQUENCY BELOW WHICH COMMUNICATION SHOULD BE POSSIBLE ON ALL UNDISTURBED DAYS

# Multivibrator Design

## 2.—TRANSISTOR CIRCUIT WITH GOOD FREQUENCY STABILITY

By R. C. FOSS, B.Sc., Grad.I.E.E. and M. F. SIZMUR, B.Sc.

**I**N the previous article of this series, the authors discussed the principle of using a known constant current to improve the reliability and simplify the design of a simple multivibrator circuit. In this article, a multivibrator having excellent frequency stability is discussed and the principle is extended to include both valve and transistor circuits.

The usual type of transistor multivibrator is shown in Fig. 1. This uses "bottoming" to determine the voltage swings and is analogous to the pentode circuit previously mentioned. It has a further disadvantage, however, in that there is an additional delay in switching off the bottomed transistor due to hole-storage phenomena.

The circuit of the cathode-coupled multivibrator described previously does not willingly suffer "transistorization". The difference between base

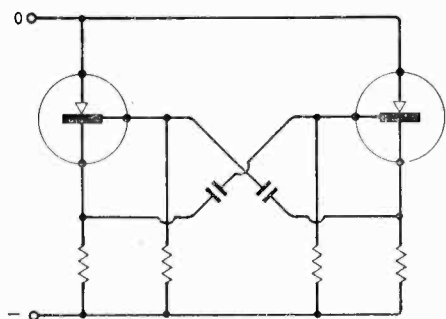

Fig. 1. Conventional transistor multivibrator.

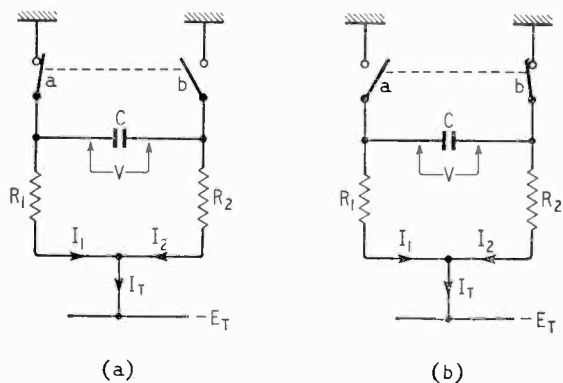

Fig. 2. Equivalent circuit of transistor version of White's multivibrator. In (a)  $I_1 = E_T/R_1$ ,  $I_2 = (E_T - V)/R_2 \approx E_T/R_2$  if  $V \ll E_T$ ;  $I_T = I_1 + I_2 \approx E_T(1/R_1 + 1/R_2)$ . In (b)  $I_1 = (E_T + V)/R_1 \approx E_T/R_1$  if  $V \ll E_T$ ,  $I_2 = E_T/R_2$ ;  $I_T = I_1 + I_2 \approx E_T(1/R_1 + 1/R_2)$ .

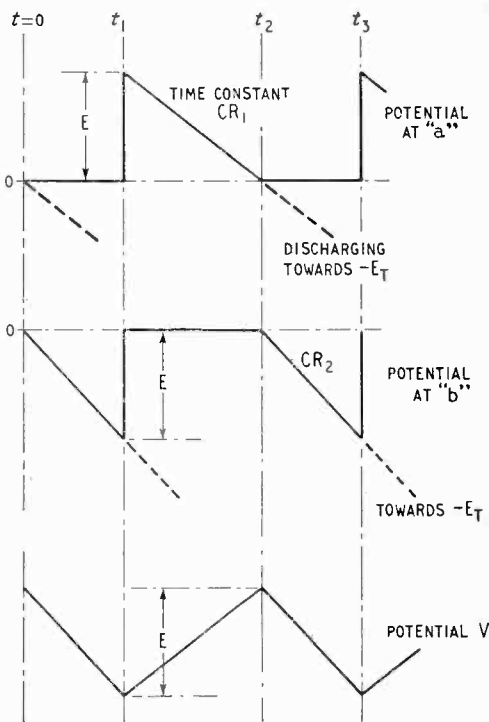

Fig. 3. Waveforms of Fig. 2.

currents in the on and off states gives rise to a large and unpredictable difference in mark and space times. (C.f. valve version, when V2 draws grid current.) To avoid this difficulty the timing components must be removed from the base circuit and placed in the emitter circuit.

A suitable arrangement was pointed out to the authors by E. L. White\* and is shown in Fig. 4. Although at first sight it may not be apparent how the constant-current principle may be applied, Fig. 2, in which the two transistors are replaced by equivalent switches, and the waveforms of Fig. 3 should help to make this clear.

Referring to Fig. 2(a), suppose both switches are initially closed. At time  $t = 0$  the right-hand switch is opened. A constant current  $I_1$  flows in  $R_1$  while  $C$  charges towards  $-E_T$  through  $R_2$  on an exponential  $e^{-t/CR_2}$ . If  $V$ , the potential across  $C$ , is limited to a value  $E \ll E_T$ , the total current through the switch

\* In Ref. 4 of the previous article he describes the valve version of this arrangement as well as the circuit previously discussed.

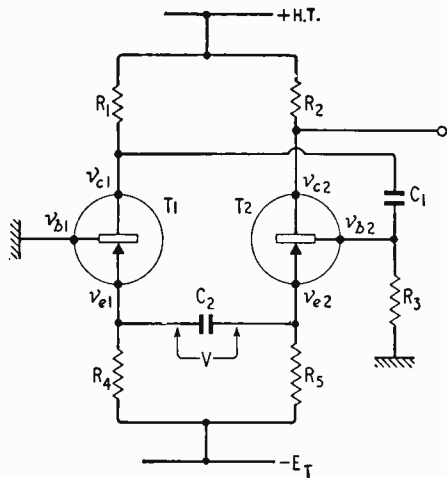

Fig. 4. Transistor version of White's multivibrator.

$I_T$ , is approximately  $E_0 (1/R_1 + 1/R_2)$ . When this limit is reached at time  $t_1$  the switches are changed over; see Fig. 2b. Point "b" is now earthed and as  $V$  cannot change instantaneously, point "a" rises to a potential  $E$  above earth. A constant current now flows in  $R_2$  while  $C$  discharges towards  $-E_T$  through  $R_1$  on an exponential  $e^{-t/CR_1}$ . Again provided  $E \ll E_T$ , the current in the switch is approximately constant and of value  $E_T(1/R_1 + 1/R_2)$ . Hence if  $E \ll E_T$  the assumption of constant current is justified and the "tail" current is  $I_T \approx E_T(R_1 + R_2)/R_1R_2$ . In the circuit of Fig. 4 the transistors are used to provide the switching action and a positive feedback loop is provided to maintain the regeneration.

The operation of this practical circuit will now be discussed with transistors of n-p-n polarity. This is to clarify the analogy with the operation of a valve circuit: p-n-p transistors will perform equally well, with all polarities reversed. Fig. 5 gives the waveforms, and the assumptions made are listed below:—

- (1) The change in emitter potentials is much less than  $E_T$ ; i.e. the constant-current principle.
- (2) The emitter-base voltage for emitter current cut-off is zero.
- (3) The emitter-base voltage for emitter current  $I_T$  is  $-e_b$  and independent of collector voltage.
- (4) Both transistors have identical characteristics.

(5)  $C_1$  is large, so that the change in its potential due to base current may be neglected during the period when T2 conducts.

(6) T2 base voltage swings between 0 and  $+E$ . The significance of this will be discussed later.

Suppose initially that T2 is conducting and T1 is cut off, and let T1 be switched on at time  $t=0$ . Then T1 collector potential falls, and the change is coupled to T2 base via  $C_1$ , cutting off T2. T2 base is now at earth, and the emitter of T1 is held at  $-e_b$  by emitter-follower action.  $C_2$  charges towards  $-E_T$  through  $R_5$ , and when it has reached earth, T2 starts to conduct. Since the tail current is constant, less current flows through T1 and its collector potential rises. This rise is coupled to T2 base via  $C_1$ , and the emitter of T2 follows, lagging

by  $e_b$ , completely cutting off T1. This is a cumulative action giving a rapid rate of rise of emitter voltage to  $E - e_b$ , and since the potential across  $C_2$  cannot change instantaneously, T1 emitter rises by  $E - e_b$ . T2 emitter is held at  $E - e_b$  by emitter-follower action and  $C_2$  now discharges towards  $-E_T$  through  $R_4$ . When it reaches earth, T1 starts to conduct and the cycle repeats. As T1 is cut on its emitter must fall from 0 to  $-e_b$ . This small drop is coupled by  $C_2$  to the emitter circuit of T2 also.

The collector current of T1, when "on", will be less than the tail current by its base current. To calculate the swing at the collector of T1 accurately, this second-order effect must be allowed for. Less obvious, perhaps, is the need to allow for the base current of T2 when it conducts. Although T1 is then cut off, this base current flowing in  $R_1$  and  $R_3$  in parallel prevents the collector of T1 reaching the collector rail voltage. Thus the net change of current in  $R_1$  and  $R_3$  is the tail current less the sum of the two base currents, and the collector voltage swing is given by:—

$$E = (I_T - 2i_b)R_1R_3/(R_1 + R_3) \quad \dots \quad (i)$$

In a valve version of the circuit,  $R_3$  could be made sufficiently large compared with  $R_1$  to be neglected. Here, however, the mean base current flows through  $R_3$ . Thus if  $R_3$  is made too large the mean base potential will not be accurately known and the circuit will be markedly temperature dependent.

Having chosen  $R_1$  and  $R_3$  to give a desired value of  $E$ ,  $C_1$  can then be chosen such that  $C_1(R_1 + R_3)$  is long compared with the period when T2 conducts and satisfies assumption 5 previously listed.

The collector of T2 is "free" in that it takes no part in the regenerative action and so the performance of the circuit is virtually independent of the collector load  $R_2$ , provided that T2 is not forced into bottoming. Thus  $R_2$  is chosen to give the desired output swing, given approximately by:—

$$E_2 \approx I_T R_2$$

The other apparently "free" electrode in the circuit, the base of T1, can be used to synchronize the circuit to an external waveform. Care must be taken, however, to ensure that a low-resistance path from base to earth exists for the base current of T1, or the performance will be drastically affected. When free-running, the first part of the cycle has a duration controlled by the exponential decay of the voltage on  $C_2$  through  $R_5$  from an initial value of  $E_T + E - 2e_b$  to  $E_T$ . i.e.,

$$E_T/(E_T + E - 2e_b) = e^{-t_1/C_2R_5} \quad \dots \quad (ii)$$

Similarly the second part of the cycle is given by:—

$$E_T/(E_T + E - 2e_b) = e^{-t_2/C_2R_4} \quad \dots \quad (iii)$$

and  $t_1$  and  $t_2$  may be calculated by taking logarithms or graphically by the method described in the previous article. The mark/space ratio is thus not necessarily unity but determined by the ratio:—

$$\frac{t_2}{t_1} = \frac{R_4}{R_5}$$

which can be large. The tail current  $I_T$  is determined by  $E_T$  and the resistance of  $R_4$  and  $R_5$  in parallel. These relationships are normally the starting point in a practical design.

Before considering an example, however, assumption 6 above will be discussed. If this assumption



is satisfied then the starting points of each of the exponential decays is exactly the same, ensuring that the mark/space ratio is  $R_4/R_5$ . But with the swing  $E$  coupled to the base by  $C_1$  and  $R_3$  as shown, the mean base potential must be zero, neglecting the effect of base current. In practice this determines the actual limits of the base swing. For example, if the mark/space ratio is unity, the limits of base swing will be  $\pm E/2$  and the emitter potential of T2 will then decay from  $(E_T + E/2 - 2e_b)$  to  $(E_T - E/2)$ , and the decay time will be given by:—

$$(E_T - E/2)/(E_T + E/2 - 2e_b) = e^{-t_1/C_2 R_5} \quad \dots \quad (iv)$$

This would make the mark/space ratio no longer equal to  $R_4/R_5$  as  $t_2$  would still be given by equation (iii). From the first assumption, which is usually easily satisfied in practice,  $E \ll E_T$  and so the discrepancy in mark/space ratio is small. For precise results care can be taken to ensure that the base of T2 does not swing between the assumed limits, either by clamping the base to earth with a junction diode or by returning the base resistor  $R_3$  to a small positive bias  $E_T/t_1$ . If the mark/space ratio is such that  $t_2/t_1$  is small, this bias is negligibly small and  $R_3$  may be returned to earth as shown in the circuit of Fig. 4 and in the design example which follows.

This is for a multivibrator using OC71 p-n-p transistors. The repetition frequency is to be 50 c/s and the mark/space ratio 50 : 1 with T2 conducting for the short period. The supplies available are

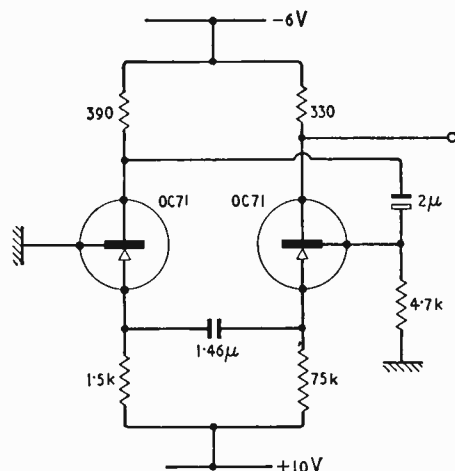

Fig. 6. Design example of a transistor multivibrator.

—6 and +10V and the tail current is to be about 6mA. As the ratio of  $R_5$  to  $R_4$  is 50 : 1,  $R_4$  determines the total tail current to within 2%. Using permissible resistor values gives  $R_5 = 75k\Omega$ ,  $R_4 = 1.5k\Omega$  and a tail current of 6.8mA. From manufacturer's data for the OC71 the nominal base current for this emitter current is  $120\mu A$  and the emitter-base voltage is 200mV. With a base resistor  $R_3$  of  $4.7k\Omega$  and collector load resistor  $R_1$  of  $390\Omega$ , the swing  $E$  is, from equation (i) given by

$$E = (6.8 - 0.24) \frac{0.39 \times 4.7}{0.39 + 4.7} = 2.36V$$

The resulting changes in emitter potentials are sufficiently small compared with the tail voltage (+10) to justify the assumption of constant tail current. Lastly,  $C_2$  is calculated for  $t_1$  equal to 19.6msec., using equation (ii)

$$\frac{10}{10 + 2.36 - 0.4} = \frac{10}{11.96} = e^{-t_1/C_2 R_5}$$

Using the graphical method as before

$$t_1 = 0.179 C_2 R_5, \text{ whence } C_2 = 1.46\mu F.$$

The measured periodic time of the circuit of Fig. 6 constructed to this design corresponded exactly to the design values within the limits of normal measuring techniques. Furthermore, these times are not critically dependent on precise transistor parameters which appear only as second order terms in the design equations. Because of this and because the timing circuit is in the emitter circuit where leakage currents are normally lowest, temperature stability is good. A change from  $20^\circ C$  to  $50^\circ C$  in transistor temperature was found to give about 4% decrease in periodic times. Changes in supply voltages also have remarkably little effect on the timing. Provided that the collector supply is sufficient to avoid bottoming and yet not so great as to exceed transistor ratings, it is apparent that variations in this supply will have very little effect on the circuit timing. At first sight the emitter supply appears much more critical because  $E_T$  appears in the timing equations (ii) and (iii). This is not so, however, because the tail current and therefore  $E$  are also proportional to  $E_T$ . Thus all the major terms on the left hand

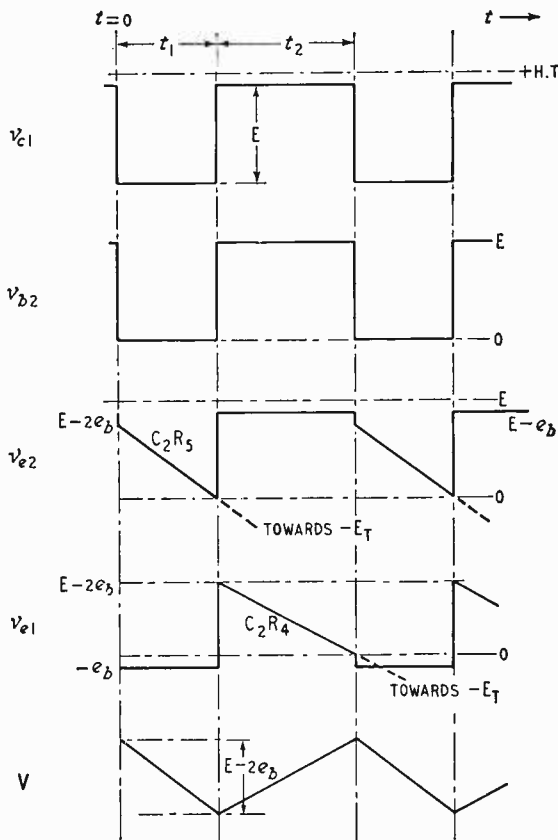

Fig. 5. Waveforms of Fig. 4.

sides of equations (ii) and (iii) alter in proportion and so do not affect the ratio. Voltage changes of  $\pm 25\%$  in the emitter supply alone or in the collector and emitter supplies together, were found to give a total variation in repetition frequency of only 6%.

*Acknowledgements.*—The authors wish to thank Professor Russell of the Department of Electrical Engineering, King's College, Durham University, for permission to publish this article and to Mr. F. J. U. Ritson for his help and encouragement.

They also acknowledge their debt to Dr. E. L. C. White and Mr. R. T. Clayden of E.M.I. Electronics Ltd. and to their former colleagues in the computer division there.

When preparing this article the authors were unaware that a transistor circuit similar to that described had been developed by R. C. Bowes ("A New Linear Delay Circuit based on an Emitter-Coupled Multivibrator"—*Proc. I.E.E.*, 1959, Vol. 106, Part B, Supplement No. 16, p. 793).

# Transmission-Line Attenuation Measurement

USE OF SHORT-CIRCUITED RESONANT LINES

By MICHAEL LORANT

**A** NEW method of measuring the attenuation of balanced, unshielded transmission lines, such as those used in television and f.m. receivers, has been developed by R. C. Powell at the U.S. National Bureau of Standards. The new procedure is simple and rapid and requires only easily-obtainable laboratory equipment. By using a grid-dip meter and a microammeter, for example, results reproducible to better than ten per cent can be obtained. With more elaborate apparatus, reproducibilities of better than one-tenth of one per cent and attenuation values to an estimated accuracy of one per cent are possible.

The apparent attenuation of unshielded, balanced, parallel-conductor transmission lines is sensitive to the amount of radiation that occurs along the line. In determinations of attenuation at frequencies between 30 and 300 Mc/s, external effects arising from the test apparatus, connectors, terminations, and bends often cause variations in the measured attenuation. A suitable measuring method must allow for these inconsistencies either by reducing the external effects, or by evaluating them.

The new method of measuring unshielded lines is based on the fact that if a section of line a number of half wavelengths long is resonated when both ends are shorted, then the standing wave ratio depends only on the attenuation in the line. The attenuation is, in fact, approximately equal to the arc hyperbolic cotangent of the standing wave ratio.

To avoid errors introduced by improper terminations, the test transmission line is rigidly fastened and held in tension by clamps made of low-resistance material. These clamps also act as good short circuits to the electric field. A coupling loop built into the input-end terminal loosely couples the output of a conventional power source to the line. A similar loop is part of the receiving-end termination, and its output is connected to a crystal rectifier. The standing waves are detected by a sliding probe made of polystyrene foam or a similar material. The probe is designed to hold a small pick-up loop at a constant distance from the line. In this way, irregularities in the line are compensated and, at the same time, the loop interferes as little as possible

with the fields of the line. An additional rectifier is also built into the probe.

Although galvanometers and extensive generating equipment are used for these measurements by the U.S. National Bureau of Standards, very acceptable results can still be obtained by using a low-power generator, such as a grid-dip meter, as the signal source to be coupled into the line. Likewise, the standing waves along the line, detected by the probe, can be measured by a sensitive microammeter.

Other methods previously developed for this type of transmission-line attenuation measurement attack the problem from various directions. Some use substitution methods in which known attenuators are inserted in series with the line and the output power is adjusted to the same value for both conditions. Others depend upon the change in the resonant frequency of a system containing the line to be measured; such techniques require accurate measurement of the operating frequency in order to obtain accurate values of attenuation.

When the new method is used to measure the attenuation of the transmission line, matching of the line to the measuring circuit is unnecessary because the line is terminated in short circuits. The necessity of changing the lines during a measurement and using connectors of any kind is also eliminated. With the shorted input, balanced conditions are easily obtained. If the generator is capable of supplying sufficient power, the effect of the probe and coupling loops is negligible. The great advantages of this system, however, are its simplicity and speed, and the fact that only easily-obtainable apparatus is needed.

**Post-graduate Course.**—The University of Birmingham is running a one-year course in electrical machines for honours graduates in electrical engineering leading to the degree of M.Sc. It will deal primarily with the fundamentals of electro-mechanical energy conversion, mathematical analysis techniques (including the use of computers) and automatic control systems. The fee is £81. The University is also running for the fifth year a graduate course in information engineering leading to the M.Sc. degree. Both courses begin on October 1st.

# Cathode-Follower Distortion

By "CATHODE RAY"

**M**Y closing words last month were a half-promise to deal now with the distortion likely to be caused when a negative-feedback amplifier is handling steep pulses or high-frequency signals. This undertaking was rather rash, because the task of making it as simple as last month I was editorially said to be capable of doing has turned out to be even more formidable than I expected. In fact, it is highly unlikely that we shall get beyond that simplest of negative-feedback amplifiers—the cathode follower.

For the simplicity of the cathode follower is confined mainly to its basic circuit diagram, Fig. 1. Anybody who tends to judge the complexity of a

Right: Fig. 1. The simple(?) cathode follower.

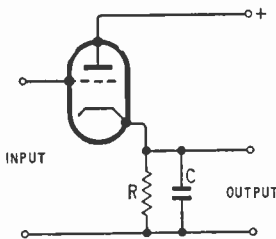
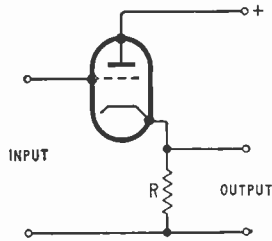

Fig. 2. Whether visible in the circuit or circuit diagram or not, there is always some capacitance, marked here as C, which must not be ignored.

circuit by the number of components in it will be gravely deceived by this one. For example, some time ago\* I surprised myself as well as others with the complications that can arise in providing grid bias for cathode followers. As a supplement to last month's historical survey it might be mentioned that we have to go back farther still—March 1946—for the first warning in *Wireless World* of the phenomenon now lying on our plate for inspection. It was given by W. T. Cocking, and, as one would expect of such an authority on television circuit design, was concerned mainly with television pulse waveforms. True, a graph was given for sine-wave signals, but without any account of how it was derived. Having looked up the reference cited by Cocking† I appreciate his discretion. Though no doubt full of mathematical elegance, Goldberg's

argument was such that I for one found it too subtle. On the assumption that a large proportion of *Wireless World* readers would share this view, I tackled it straightforwardly with school mathematics, with the result that follows.

Roughly the trouble is easy enough to understand. There is bound to be a certain amount of stray capacitance across R, shown as C in Fig. 2. In practice there may be quite a lot, because successive intakes of students have been informed that one of the main uses of a cathode follower is for feeding a high-capacitance circuit from one which would not stand direct connection to it. This, of course, is perfectly true, and is due to the very low output resistance of the cathode follower— $r_d/(\mu+1)$ , which is commonly less than  $200\Omega$ . It is effectively in parallel with R and enables C to charge and discharge rapidly. If however the input voltage drops suddenly from a positive peak, C may prevent the large positive cathode bias that has been built up during that peak from falling equally suddenly, with the result that the anode current is cut off. Once this happens, the valve ceases to exist so far as C is concerned, and its discharge, now through R alone, is considerably slower. In the meantime the input signal is completely disconnected and powerless to influence the course of events.

A large instantaneous rise of input voltage could, because of C, find itself in grid current (not very desirable in a device that is supposed to have a phenomenally high input impedance!) which would also cause distortion; but this state of affairs would very soon be over, because the resulting exceptionally large anode current would quickly charge C and allow the cathode potential to catch up.

A really steep input pulse, shown at Fig. 3(a), is therefore likely to be reproduced at the output with the distorted form shown at (b). Note that although this can only happen if the amplitude of the pulse is large, it doesn't have to be more than the cathode follower is quite capable of handling when the fall is less steep.

Those who like to think in time constants will

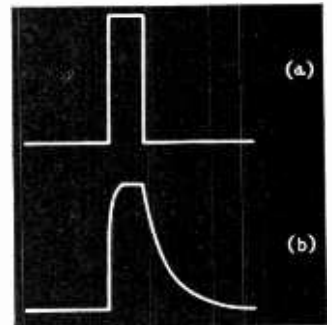

Fig. 3. One effect of C in Fig. 2, when the input is a large-amplitude pulse with steep sides as at (a), is to distort it as at (b).

\*June 1955 issue.

†"Some Consideration Concerning the Internal Impedance of the Cathode Follower," by H. Goldberg. *Proc. I.R.E.*, Nov. 1945.

probably have realized that the rise in Fig. 3(b) is exponential with a time constant equal to  $C$  multiplied by  $R$  and  $r_a/(\mu+1)$  in parallel:

$$\frac{CRr_a}{(\mu+1)R+r_a}$$

whereas the fall corresponds to the longer time constant,  $CR$ .

In practice, this phenomenon is obviously most troublesome with steep pulse waveforms. Television has been mentioned, and in radar the difficulty is perhaps even more acute. And anyone who supposes that the problem of measuring pulses by oscilloscope or valve voltmeter without distorting their waveforms can be solved merely by interposing a cathode follower clearly has to think again. So pulses have received most attention. But the effect does exist with sine waves if their frequency and amplitude are high enough for their down-swing to be more than critically steep. And, anyway, a pulse can be regarded as made up of a mixture of pure sine waves (Fourier's principle).

Fig. 4(a) shows a cathode follower, and (b) the corresponding vector diagram ("Cathode Ray" unambiguous pattern) for the condition in which the signal frequency is low enough for the effect of the capacitance  $C$  to be negligible. The important thing to remember in feedback systems is that the valve

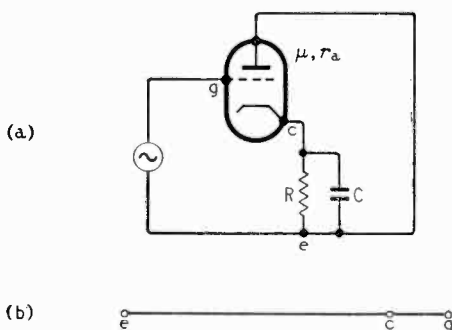

Fig. 4. (a) The cathode-follower circuit diagram has here been marked so as to identify the voltage vectors in the vector diagram (b) which has been drawn for the condition that the effect of  $C$  is negligible.

itself is unaffected thereby. So any signal voltage (and no other kind is considered in Fig. 4) existing between  $g$  and  $c$  is amplified in full just as if there were no feedback. The voltage developed across  $R$  is therefore (shall we say)  $A$  times greater, where as usual

$$A = \frac{\mu R}{R + r_a}$$

This is represented in the vector diagram by making  $ce$   $A$  times longer than  $cg$ . And being, also as usual, in opposite polarity, their vectors are drawn on opposite sides of  $c$ . The gross input from the generator shown, applied between points  $e$  and  $g$  on the circuit diagram, is therefore represented by the vector  $eg$ . (Why doesn't everybody use this kind of vector diagram, without any confusing and unnecessary arrow heads and voltage labels?) We see at once that the output voltage is inevitably

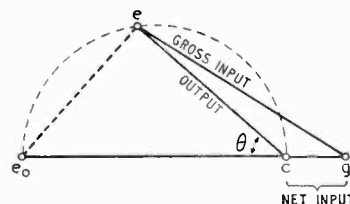

Fig. 5. As the frequency of the generator in Fig 4(a) rises, and its voltage is adjusted to keep the net input constant, point  $e$  in the vector diagram moves around a semicircle.

less than the input, and that reckoned from  $e$  they are in phase—familiar cathode-follower facts.

Next, Fig. 5 shows what happens to the vector diagram when the frequency is high enough to cause an appreciable phase shift,  $\theta$ . (Note that the phase shift between gross input  $eg$  and output  $ec$  is considerably smaller; this is one of the benefits of negative feedback.) The original position of  $e$  is now marked  $e_0$  to distinguish it from the new position. The fact that the length  $cg$  is the same as before (implying that the net input is the same) is just for convenience in drawing; it could only be so in practice if the gross input  $eg$  happened to be less at the higher frequency, in the ratio  $eg/c_0g$ . The right angle  $e_0ec$  corresponds to the  $90^\circ$  phase difference between the signal current through  $C$  and that through the resistance of  $R$  and the valve ( $r_a$ ) in parallel. As it is always a right angle, Proposition-I-forget-which in geometry proves that, as the frequency varies,  $e$  must trace out a semicircle, shown dotted. The angle  $\theta$  is calculable from the fact that  $e_0e$  and  $ec$  must be in the ratio of the two signal currents just mentioned, which in turn are proportional to the susceptance of  $C$  ( $=1/\text{reactance} = 2\pi fC = \omega C$ ) and the combined conductance of  $R$  and the valve ( $=1/R + 1/r_a$ ).

$$\text{So: } \tan \theta = \frac{\omega C}{\frac{1}{R} + \frac{1}{r_a}} = \frac{\omega CRr_a}{R + r_a} \quad \dots \quad (1)$$

At this point someone will probably be wondering why we have here taken the valve's output resistance as  $r_a$ , whereas in connection with the rising slope in Fig. 3(b) we took it as the much lower  $r_a/(\mu+1)$ . The answer is that  $\theta$  is the phase angle of the output with reference to the net input—directly between grid and cathode, so that feedback is outside the scope and the ordinary valve parameter  $r_a$  applies.  $C$ , however, sees the valve as modified by feedback, because any changes of voltage across it not only affect the anode current of the valve directly, in proportion to  $1/r_a$ , but much more through the grid connection, where they are multiplied by  $\mu$ .

The next problem is to define the condition that

§Anyone who is not quite sure about this should stop now to think it out. Imagine  $C$  to be disconnected and charged so that its upper terminal is positive with respect to the lower one. It is first connected to  $R$  alone, and by driving a current through it from  $c$  to  $e$  discharges at a rate depending on the value of  $R$ . Next, repeat the operation with the valve connected, but its grid joined to cathode to prevent it from affecting the anode current. Because the charge on  $C$  opposes the h.t. source (not shown) it reduces the total anode current. This can be regarded as being because it is driving a signal current through the valve from  $c$  to  $e$ . This current is therefore an additional discharge path, of resistance  $r_a$ , so  $C$  discharges quicker. Lastly, restore the connection between  $g$  and  $e$ . Applying the charged  $C$  now additionally makes  $g$  negative with respect to  $c$  and thereby causes a reverse signal current through the valve  $\mu$  times as great as that due to the direct effect on the anode to cathode voltage. So  $C$  discharges much quicker, its discharge path being  $R$ ,  $r_a$  and  $r_a/\mu$  all in parallel.

Fig. 6. This shows the d.c. conditions of the cathode follower.

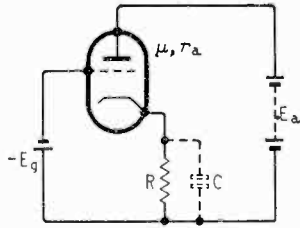

just cuts the anode current off, because that is where distortion of the kind we are discussing begins. We can then calculate how much the gross input has to be reduced at high frequencies as compared with low, to meet this condition.

We may have become so used to thinking about valve equivalent circuits, which take account of signal currents only, that a problem involving the d.c. component stumps us for a moment. One might hastily suppose, for example, that the overloading point was reached with the same net input to the valve in each case. But in fact the net input required to cut the valve off depends on the impedance of the load formed by R and C.

Since even Mr. Goldberg had to keep the problem within reasonable bounds by assuming an ideal linear valve, we are not likely to disgrace ourselves if we fail to allow for the baffling curvature of real valve characteristics. The starting point, then, is the current/voltage equation of the ideal or linear triode:

$$I_a = \frac{V_a + \mu V_g}{r_a} \dots \dots (2)$$

where  $I_a$  denotes the anode current and  $V_a$  and  $V_g$  the voltages applied to anode and grid respectively, with reference to cathode. It regards the valve, between anode and cathode, as being a resistor of  $r_a$  ohms, to which the effective voltage applied is the actual voltage,  $V_a$ , plus  $\mu$  times the grid voltage. In practice  $V_g$  is usually negative. The equation can be used for d.c., or for signal current, or for both together, but it is invalid if  $(V_a + \mu V_g)$  from all sources is negative. In our case we are interested in what makes it just zero.

Fig. 6 shows the d.c. situation. C is there, but being just an open-circuit to d.c. it takes no part and is drawn dotted. The h.t. and bias voltages are called  $E_a$  and  $E_g$  to distinguish them from  $V_a$  and  $V_g$  which are the voltages of anode and grid relative to the cathode. To get at  $(V_a + \mu V_g)$ , then, we have to allow for the drop across R:

$$I_a = \frac{E_a - I_a R + \mu(E_g - I_a R)}{r_a} = \frac{E}{r_a}$$

There is no need to pay much attention to this, because it is the cathode-follower designer's job to choose  $E_a$ ,  $E_g$  and R so that E is positive and of such a value that  $I_a$  is a suitable standing current. The important thing for us is that when the signal current is superimposed its negative half-cycle will subtract from  $I_a$  and at a certain peak amplitude will momentarily bring the net current to zero. This condition obviously corresponds to an effective signal voltage exactly equal and opposite to E. Now E is the same regardless of the frequency of the signal; that is why the details of how it was made up were not worth memorizing. In making a comparison between two signal frequencies, all we need know about E is that it exists and that it is constant.

We have already noted that even in the simplest negative-feedback situations the way not to get stuck is to start with the net signal input voltage, which in conformity with Figs. 4 and 5 we shall call  $v_{eg}$ . This corresponds to  $V_g$  in equation (2).  $V_a$  is also affected, by the signal voltage drop across the load impedance, which we shall call Z. The effective signal voltage is therefore  $\mu v_{cg} - i_a Z$  where  $i_a$  is of course the anode signal current, to be made equal and opposite to  $I_a$  at the negative peaks. And since this is done by making  $-(\mu v_{cg} - i_a Z)$  equal to E, which is constant, it means that at the threshold of distortion  $(\mu v_{cg} - i_a Z)$  must be the same at all frequencies.

So to compare the gross input  $v_{eg}$  allowable at some frequency f, at which C is significant, with  $v_{eog}$ , the gross input when f is low enough for C to have negligible effect (so that  $Z=R$ ), all we have to do is equate  $(\mu v_{cg} - i_a Z)$  in the two cases. In both,  $i_a Z$  is of course the output voltage, represented in our two vector diagrams by ce.

For the first case, Fig. 7 repeats Fig. 4(b), with the addition of the vector cp,  $\mu$  times the length of cg, and in the opposite direction, to represent  $-\mu v_{cg}$ . The length ep therefore represents the difference between  $i_a R$  and  $\mu v_{cg}$ .

Fig. 8 is the corresponding elaboration of Fig. 5. Again, ep represents the difference between  $i_a R$  and  $\mu v_{cg}$ , to be equated to the constant E. We could solve the problem graphically by redrawing Fig. 8 on a reduced scale so that its ep was the same length as Fig. 7's, and then noting how much shorter cg turned out to be there than in Fig. 7. That would be a measure of how much the maximum allowable signal input would have to be reduced because of C.

But no doubt we would like to have it as a ratio that we can compute, if only to check it against Goldberg's equations and Cocking's graph. Let us distinguish the quantities in Fig. 8 from those in Fig. 7 by a dash (or prime, as some call it). Then the ratio we want is  $v'_{eg}/v_{eg}$ , for the condition  $v'_{ep} = v_{ep}$ .

At first, lest we fail to see the sense for the symbols, let us use A as before to denote the amplification

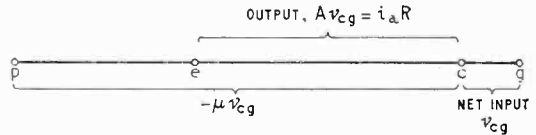

Fig. 7. Vector diagram corresponding to Fig. 4(a), with the addition of a vector representing the voltage of the equivalent internal generator of the valve.

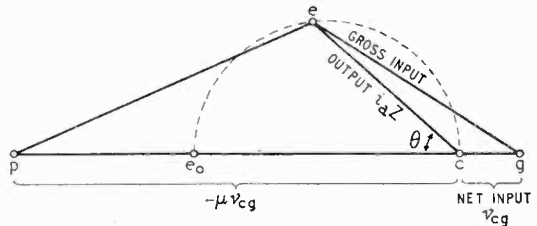

Fig. 8. This diagram is related to Fig. 7 as Fig. 5 is to Fig. 4(b).

of the valve itself with resistive load— $\mu R/(R+r_a)$ . Then, as Fig. 7 shows,

$$-v_{ep} = \mu v_{cg} - A v_{cg} = (\mu - A) v_{cg}$$

To find  $v'_{ep}$  in Fig. 8 we make use of the well-known formula for solving triangles:

$$ep^2 = cp^2 + ce^2 - 2cp \cdot ce \cos \theta$$

$$\text{So: } -v'_{ep} = \sqrt{(\mu v'_{cg})^2 + (A v'_{cg} \cos \theta)^2 - 2\mu A (v'_{cg} \cos \theta)^2}$$

$$= v'_{cg} \sqrt{\mu^2 + A(A - 2\mu) \cos^2 \theta}$$

So to fulfil the condition  $v'_{ep} = v_{ep}$ ,

$$v'_{cg} = \frac{v_{cg}(\mu - A)}{\sqrt{\mu^2 + A(A - 2\mu) \cos^2 \theta}} \quad \dots (3)$$

$$\text{Now } v_{eg} = v_{cg}(A + 1) \quad \dots (4)$$

and by applying the triangle formula again, this time to egc in Fig 8, in similar fashion we get

$$v'_{eg} = v'_{cg} \sqrt{1 + A(A + 2) \cos^2 \theta} \quad \dots (5)$$

Putting (4) and (5) together to form our wanted ratio, and substituting for  $v'_{cg}$  from (3) we get

$$\frac{v'_{eg}}{v_{eg}} = \frac{(\mu - A) \sqrt{1 + A(A + 2) \cos^2 \theta}}{(A + 1) \sqrt{\mu^2 + A(A - 2) \cos^2 \theta}} \quad \dots (6)$$

We found  $\tan \theta$  a long time ago—eqn. (1),  $\omega CR r_a / (R + r_a)$ , and as  $1/\cos^2 \theta = (1 + \tan^2 \theta)$  we can substitute for  $\cos^2 \theta$  in (6). Before we do this, it will pay to divide by  $\cos^2 \theta$  under both square root signs in (6), because our formula is for  $1/\cos^2 \theta$ . We must also fill in the full details of A, and after using the rules of algebra to tidy up the result I get (and I hope you do too)

$$\frac{v'_{eg}}{v_{eg}} = (\text{say}) D = \frac{\sqrt{a^2/b^2 + 1}}{\sqrt{a^2/r_a^2 + 1}} \quad \dots (7)$$

where for brevity

$$a = \omega CR r_a$$

$$b = (\mu + 1) R + r_a$$

Goldberg didn't express his conclusion in quite the same terms, but that can very quickly be adjusted, with the satisfactory result that the two agree. To be quite sure (especially as we both assumed ideal linear valves) I did some measurements on an actual cathode follower, in which R

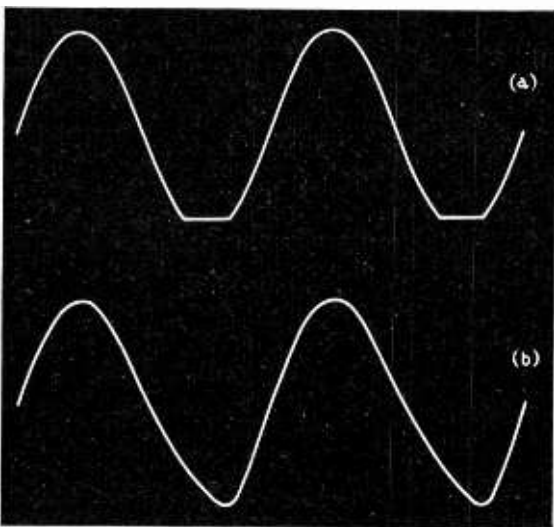

Fig. 9. With a purely resistive load, overloading of a cathode follower by cut-off shows up as at (a); with capacitance shunt, as at (b).

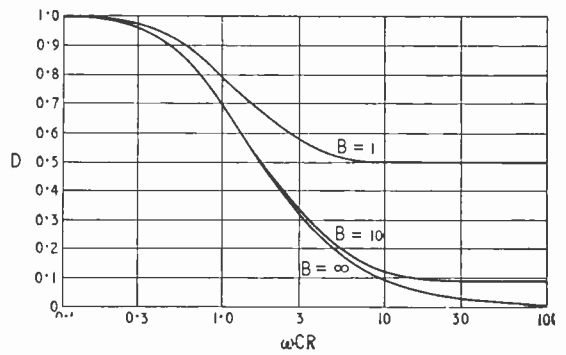

Fig. 10. The relation between the sine-wave distortion-threshold factor, D, and the load resistance/reactance,  $\omega CR$ , is shown here for several values of a parameter B, which is the ratio of  $(\mu + 1)$  times the load resistance to the valve resistance.

was several times  $r_a$ , and two different large capacitances (0.5  $\mu F$  and 1  $\mu F$ ) were connected across it in turn, so that their effect was considerable at the low test frequency of 50 c/s. The validity of the Goldberg-“C.R.” formula was remarkably well confirmed. The onset of distortion was noted by looking at the waveform across R with an oscilloscope. Whereas it was very easily detected with the unshunted R by the negative peak being cut off, as in Fig. 9(a), the inequality of rising and falling slopes (b) caused by C had to be looked for more attentively.

What about Cocking? His graph was (in our symbols) D plotted against  $\omega CR$  for various values of a parameter B, which is our  $(\mu + 1)R/r_a$ . It appears here as Fig. 10. Dividing by  $r_a$  under the root sign in our formula (7) we get the alternative form

$$D = \sqrt{\frac{(\omega CR)^2 + 1}{(B + 1)^2 + 1}}$$

from which it is easy to plot D against  $\omega CR$ , and the result again is an encouraging agreement. Incidentally, B is usually at least 10, so except perhaps for the values of D that mean that C is too large for reasonable signal-handling ability, one curve gives the necessary information.

It is always a help to take a typical example. Suppose R is 3k  $\Omega$ , C is 25 pF,  $\mu$  is 20,  $r_a$  is 5k  $\Omega$ , and one wants to find the frequency at which the maximum allowable signal input is 3 dB less ( $D=0.707$ ) than at low frequencies. B works out at 12.6, so the 10 curve will do, and it shows  $\omega CR$  to be 1. Dividing this by  $2\pi CR$  to get  $f$ , we have 2.1 Mc/s.

That concerns maximum allowable input. The output for a given input—the cathode follower's voltage “amplification”—at that or lower signal levels falls off as the frequency rises, as can easily be seen by watching the output and gross input vectors in Fig. 8 as the point e moves round towards c. But the negative feedback in a cathode follower (100%, actually) considerably raises the frequency at which this effect begins to be noticeable. In our example, although  $\theta$  is as much as 32°, the “amplification” is reduced only from 0.882 to 0.880—a negligible difference. We conclude that, as the

(Continued on page 265)

frequency is raised, signal-handling ability of a cathode follower deteriorates considerably before its performance for small signals is appreciably affected. As Fig. 10 shows, the frequency could be raised to 21 Mc/s, or the capacitance at 2.1 Mc/s to 250pF, so long as the signal amplitude was not much more than one-tenth of the low-frequency maximum.

Nor must it be supposed that the ordinary anode-loaded amplifier is free from the maximum input and output reduction effect at high frequencies. And of course its amplification falls off at a much lower frequency. But when using cathode followers it certainly is necessary to remember that they cannot

work into a capacitive load without drastic reduction of signal amplitude at high frequencies. It may be necessary to use a simple low-pass CR circuit in front.

The same sort of effect occurs in negative-feedback amplifiers with more than one stage, but, as I predicted, we have no time left for that. I'm yet to be convinced that I'll ever have time for it, because there are so many variables that it is difficult to draw general conclusions. However, anyone who is sufficiently interested can find some in an article by J. E. Flood, *Wireless Engineer*, August 1952, p.203.

## Data Logging and Alarm-Scanning Equipment

FULLY SOLID-STATE PROCESS-MONITORING

**WHEN** the number of measuring points in process-monitoring equipment reaches a certain point, it becomes possible to justify the cost of a comprehensive data-logging system. The separate channels are sampled by a central equipment, which then operates read-out devices, alarm-systems, etc., and which forms the control unit for the system.

A very flexible data-logger and alarm-scanner has been evolved by Microcell Electronics, which will handle up to a thousand information channels at the rate of 150 a second. The output of the system may take one of several forms—printed records, punched paper or cards, or magnetic tape. It will also give an alarm signal by flashing lights or Klaxons if selected channels exceed predetermined limits.

The equipment is made up of "building bricks" to fulfil any particular specification, a high degree of flexibility thereby being possible. Many of the units are selected from a range of high-quality American and British instruments; the remainder have been designed by Microcell. A systems-engineering service is provided by this method of design, each individual equipment being custom-built.

Applications of the data-handling equipment include wind-tunnel instrumentation, component-testing and process-monitoring, while a typical alarm-scanning requirement is in nuclear power-station burst fuel-can detection.

The master unit of the equipment is the Programme Unit, which controls the scanning rate and sequence. The scanning rate is controlled by dividing circuits which give outputs to the signal sampling units at selected sub-multiples of 50c/s.

The signal sampling unit is, in effect, a high-quality commutating switch consisting of banks of sealed dry-reed relays with gold-plated contacts. The relays are driven from ring counters which, in turn, are triggered by the pulses from the programme unit. At the onset of a pulse, the ring counters step on and operate the relays, so connecting the information channels to the input in turn. Any sequence of relay operation may be selected by a front-panel patch board.

Several different types of input amplifier are available, depending on the input conditions. Both differential- and single-ended-input amplifiers are used, the necessity for common-mode rejection being the deciding factor. With certain types of input transducer having a non-linear transfer characteristic, for instance, thermocouples, it is necessary to linearize the output of the amplifier by means of transistor function generators.

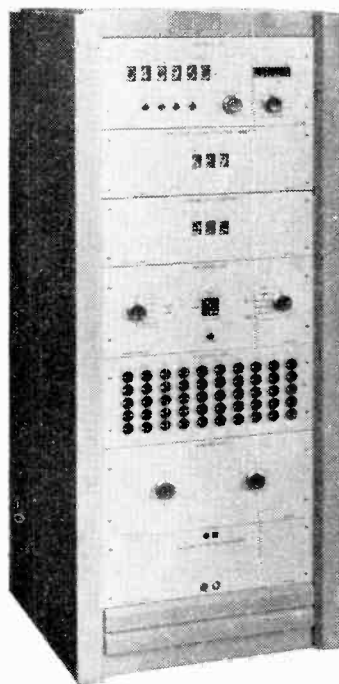

Microcell transistor data logger/alarm scanner (Type 300).

The "end-product" of the system, whether it is punched tape or printed paper, is driven from the analogue-to-digital converter. The instrument used is the Mullard L281, which is a high-speed device having an accuracy of 0.1%. For higher accuracies where the speed of encoding requirement is not stringent, one of the range offered by Non-linear Systems is employed.

The system described is applicable to measurements in many fields of industrial process control and has the advantages of being digital in form and completely automatic. The modular conception of the design makes it possible for the customer to be supplied with exactly the units he requires; no compromise between cost and performance is necessary.



# LOW-COST STEREO AMPLIFIER

## 2.-CONSTRUCTIONAL DATA: ALTERNATIVE INPUT SYSTEMS

By E. JEFFERY, A.M.I.E.E.

(Concluded from page 190 of the April issue)

**T**HE left-hand and right-hand channel amplifiers were constructed on a common chassis with a common power supply unit. The following notes relate to the left-hand channel and where there are differences in approach between the two channels attention is drawn to the point concerned.

The general layout of the chassis is given in plan view in Fig. 6, a view of the underside of the chassis is given in Fig. 7. Particular attention is drawn to the orientation of the cores of the output transformers in relation to each other and to the mains transformer, this is done in order to minimize inter-channel coupling and hum pick-up. Transformer dimensions are approximate and will depend on pattern chosen. Constructors who choose to use a larger chassis and are willing to experiment with orientations could possibly improve on the author's figures for crosstalk and hum.

The layout for the tag board which relates to the left-hand channel, is given in Fig. 8. An elementary point (but one not to be overlooked!) is that the sequence of the components on the right-hand channel tag board is the mirror image of this.

The output valve grid and screen stoppers are

terminated on a 5-way tag strip mounted between V3 and V4, i.e., they are not mounted on the main tag board. This auxiliary tag strip could also serve to mount any anode/screen capacitors which might be required if a constructor wishes to use up an early pattern of "ultra-linear" output transformer (such transformers were sometimes prone to give rise to parasitic oscillations).

In the discussion of circuit principles it was noted that the effective load impedance on V1 (i.e., the effective grid-earth impedance of V2) is several megohms and the a.c. resistance of V1 is also of this order. It follows that the V1 anode to V2 grid connection is at a very high impedance level with respect to earth, it is therefore most vulnerable to the effects of stray capacitance and also to electrostatic pick-up of hum. Fortunately, the use of the 6BR8 enables these difficulties to be minimized; the critical electrodes concerned are, of course, on the same valvoholder and the critical capacitor C<sub>3</sub> can therefore be connected directly on the holder between the electrodes concerned. The capacitor should also be as small as the voltage rating allows and no liberties should be taken with this part

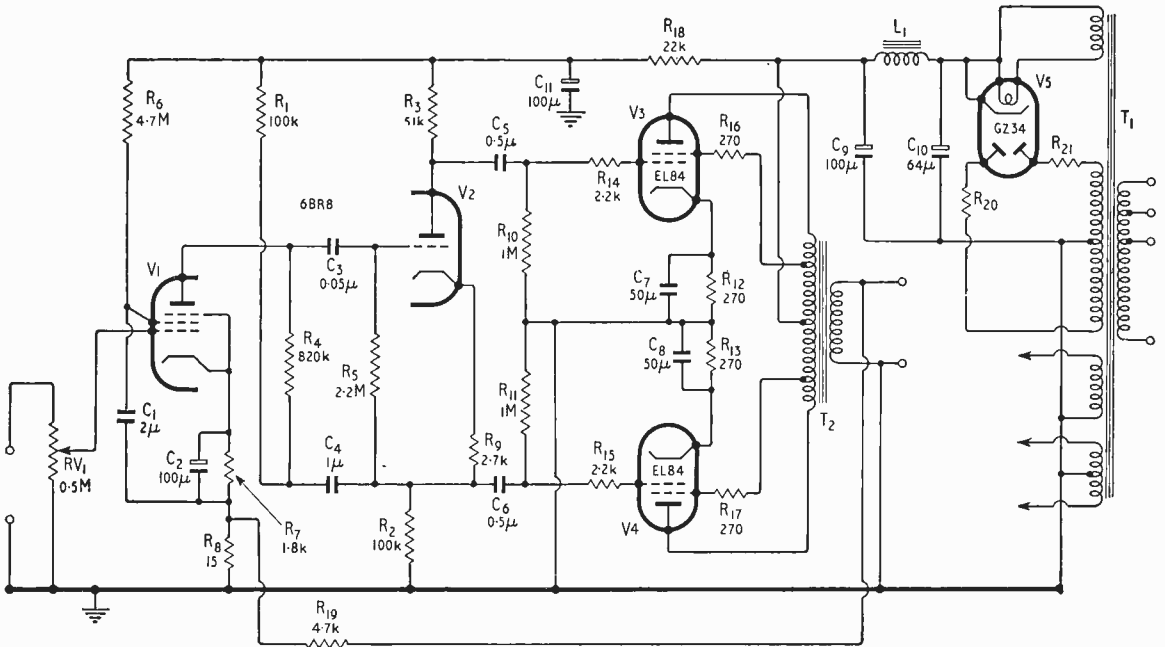

Fig. 3 (Repeated for convenience). Circuit of one channel of main amplifier and power supply for both channels.

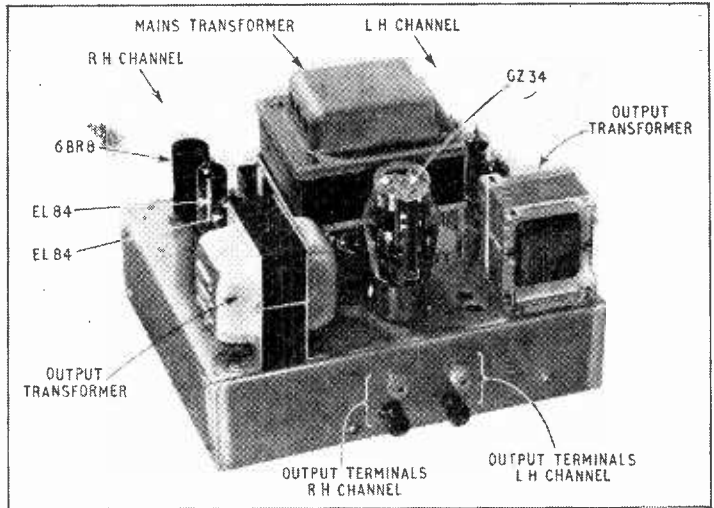

Fig. 6. Plan of chassis showing relative positions of transformer cores.

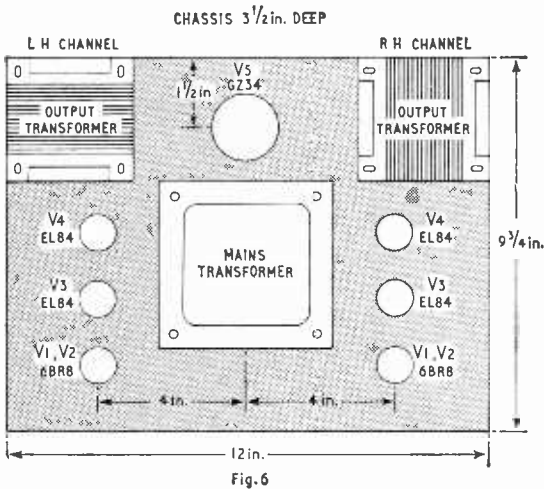

Fig. 6

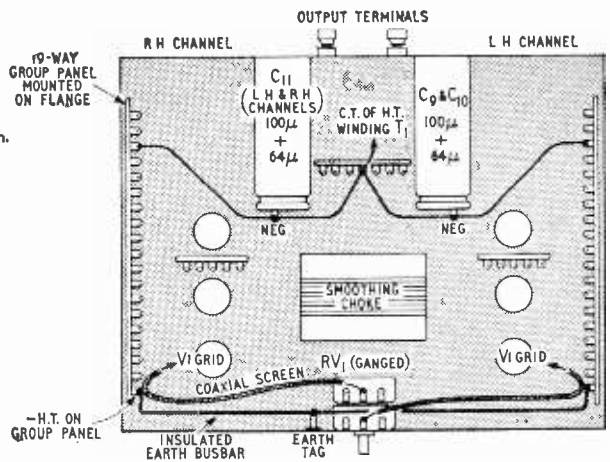

Fig. 7

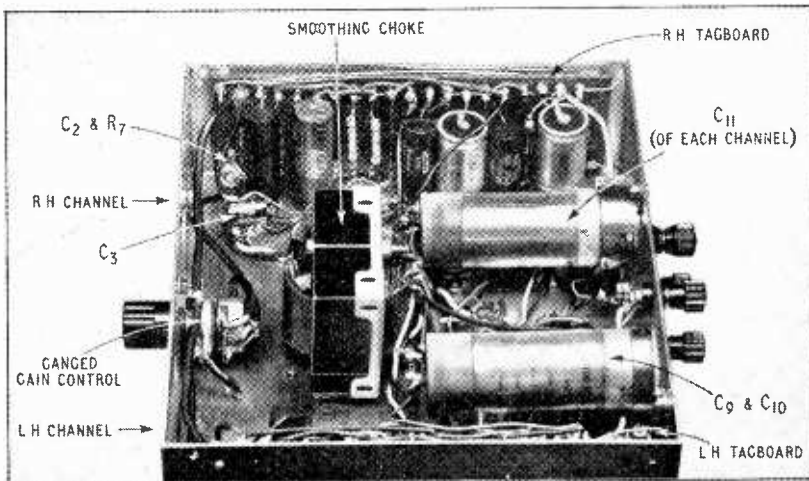

Fig. 7. Layout of principal components on underside of chassis.

of the circuit. Since a great deal of gain is packed into the curtilage of this valve base it should be of the highest quality, preferably nylon-loaded or of p.t.f.c., with a screening skirt.

One of the most important factors in achieving a good hum level in a combined stereo amplifier is earthing (or rather not earthing) and it is most important that fortuitous earths should not be created.

The problem is especially difficult in a stereo system because, by the nature of the beast, certain earth connections exist whether one likes it or not. Thus in the interests of economy a common power-supply is used and this means that the h.t. negative point is common to both amplifiers, on no account should this h.t. be connected to chassis at any additional point other than that recommended.

Small-diameter, p.v.c.-covered coaxial cables are used for connecting the input circuits to the gain controls and from the gain controls to the input grids of each amplifier. Again care must be taken to ensure that, if coaxial input sockets are used, these are isolated from chassis, otherwise one of the fortuitous earth connections referred to will occur.

As a further precaution against accidental earths the two smoothing electrolytic capacitor cans should be isolated from earth by inserting a polythene layer between each can and its mounting clip.

If gain control values higher than  $\frac{1}{2}M\Omega$  are used (e.g., with certain crystal pickups) there is some advantage in providing a hum-balancing potential divider of  $50\Omega$  across the heater supply, in place of the direct connection to the side of the heater shown in Fig. 3 (repeated here for convenience).

The amplifier should first be tested without the negative feedback connected, i.e., the connection from the "live" side of the output transformer

should not be soldered to  $R_{19}$ . The secondary of the transformer should be connected to a loudspeaker via a series 100-ohm resistor; this series resistor is intended to safeguard the loudspeaker against any errors which may have been made in wiring. The negative feedback connection may now be made; if the phasing of the connection is correct no change should be heard in the loudspeaker (except that any slight background noise heard initially should disappear). If the phase of the feedback connection is incorrect a loud continuous oscillation will be heard in the loudspeaker and the connections from the output transformer will have to be reversed.

If, for any reason, it is desired to use the amplifier without negative feedback, or to carry out measurements in this condition, attention is again drawn to the very high sensitivity of the basic system, i.e., full output is obtained for only 3mV input compared with, for example, the Williamson type of circuit which requires 190mV for full output.

The author has never experienced any instability with any version of the circuit as recommended although a number of different output transformers have been used. If an oscilloscope is not available it is, however, possible to make a few simple checks to ensure that neither low-frequency nor high-frequency instability is present. Any low-frequency instability is normally easily discernible visually as a movement of the loudspeaker cone. If the speaker is replaced by a 15-ohm  $\frac{1}{4}W$  resistor any continuous high-frequency oscillation present will cause the resistor rapidly to overheat. The gain control should be set at zero for these tests to ensure that any random pick-up of extraneous signals, which might mask internally-generated oscillations, does not occur.

It will be noted that a number of high-stability

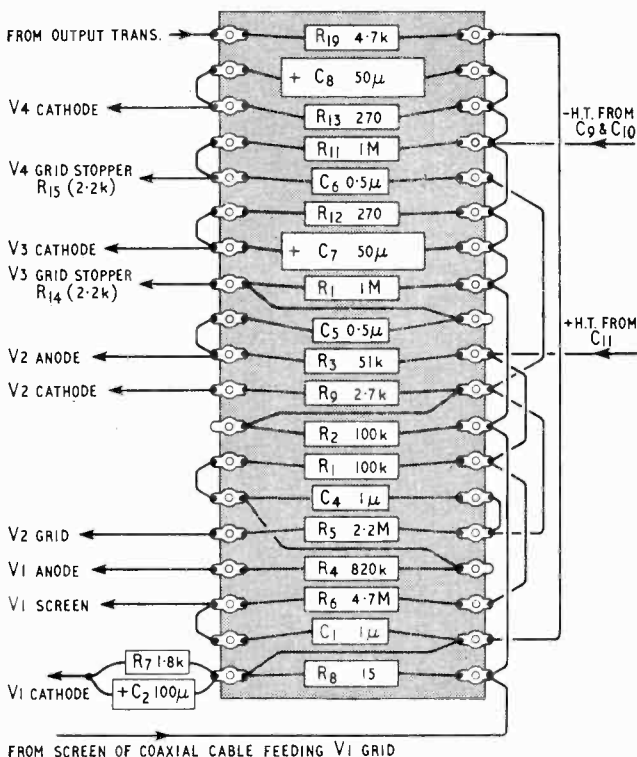

Fig. 8. Layout of LH tag board. In the RH channel which is the mirror image of the sketch, the h.t.-connection is taken to the negative tag of the  $100+64\mu H$  capacitor in the RH channel side. The earthy side of the input of each channel is earthed only via the coaxial cable screens and the earth bus bar.

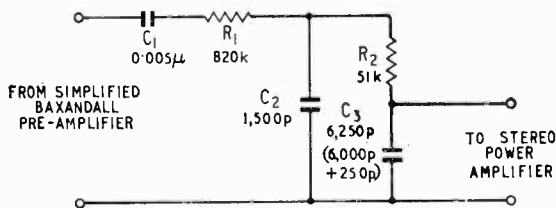

Fig. 9. Passive BS1928:1960 equalizer for use with Baxandall pre-amplifier.

resistors are recommended; these are necessary to prevent the generation of resistance noise in the high-gain part of the system. They are also used in the feedback circuit to ensure that the basic gains of the two channels are equal and remain equal.

A table of d.c. checks taken on a prototype is given in Appendix II; d.c. measurements should normally be within  $\pm 10\%$  of the values given.

### Stereo Systems and Pre-amplifiers

One of the difficulties in presenting any article on amplification systems for stereo, and to a lesser extent for monophonic gramophone reproduction, resides in the wide variety of sensitivities and characteristics which the pickup selected may offer to the system. If the designer tries to cater for every possible contingency then for a very great proportion of readers the system may be ludicrously complex and expensive. The present design has therefore concentrated on a basic power amplifier of high sensitivity and low cost.

A number of alternative systems are however now discussed, the majority of pickups available should fall into one of the following categories and although in an earlier section the author has inveighed against overelaborate tone control systems (which seem to be aimed at obtaining a fair performance of the records of Dame Clara Butt on a wide-range stereo system), the fact remains that some users do want some measure of tone control and are prepared to accept a little more elaboration and cost.

**Low-sensitivity Magnetic Pickup Systems.**—Pickups of this type are usually of a very high quality and tend to have an output in the order of  $1\text{mV/cm/sec}$ . Since the record manufacturers admit to maximum velocities of about  $30\text{ cm/sec}$  the maximum output from a pickup of this type should be about  $30\text{ mV}$ . However, amplifier designers tend to play safe and make the basic sensitivity of the corresponding system of the order of  $10\text{--}15\text{ mV}$ , i.e. a pre-amplifier with a minimum overall equalized gain of about  $2\frac{1}{2}$  at  $1\text{ kc/s}$  is required.

Since a pickup of this type is a velocity-operated device the pre-amplifier must also provide equalization to the BS1928:1960 (R.I.A.A.) characteristic; this implies that the minimum basic gain of the pre-amplifier before equalization is applied must be of the order of 25. If tone controls are required then, of course, the pre-amplifier gain must be correspondingly more.

**Valve Pre-amplifiers.**—A number of very satisfactory pre-amplifier designs already exist, one of the most elegant and economical is the Baxandall which has been adopted, usually without acknow-

ledgement, on a considerable scale in commercial equipment.

Two such pre-amplifiers (one for each channel) can be easily fed from the spare power supply capacity of the main amplifier unit. As published, the Baxandall simplified pre-amplifier circuit<sup>8</sup> gives adequate tone control but does not provide equalization for the BS1928:1960 recording characteristic. The sensitivity of the power amplifier now described is such, however, that a passive equalizer network can be interposed between the Baxandall pre-amplifier and the power amplifier; a suitable network to give the BS1928 characteristic is shown in Fig. 9. This circuit has a basic loss at mid frequencies of  $1/12$  or  $-24\text{ dB}$ , since the Baxandall pre-amplifier has a nominal gain of about 90 the combination requires only 7 or 8 mV input to load the power amplifier.

Of the alternative systems referred to, this combination (set out in block schematic form in Fig. 13(a)) is the best overall solution. Since the Baxandall circuit uses only one valve per channel and the stereo power amplifier uses three per channel a complete stereo system, sensitive enough for a low-output pickup, can be made using a total of only four valves per channel, plus the common rectifier, i.e. nine valves in all. This compares very favourably with the majority of systems of similar performance which frequently require six valves per channel or a total of 13 valves for the system.

The complete system will then have an overall equalized sensitivity  $7.5\text{mV}$  and will of course have the tone control characteristics of the Baxandall

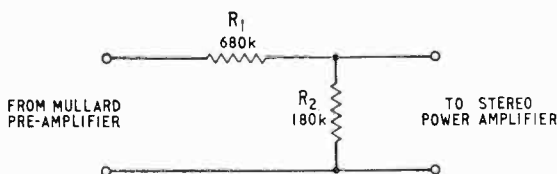

Fig. 10. Attenuator for use with Mullard Stereophonic Pre-amplifier.

circuit as well as equalization to the BS1928 specification.

The Mullard Stereophonic Pre-Amplifier<sup>9</sup> provides similar facilities; as published the sensitivity is some six times greater than that required for the power amplifier and it is necessary to attenuate the output of the Pre-amplifier as shown in Fig. 10.

**Transistor Pre-amplifiers.**—The use of transistors in pre-amplifiers is a very attractive proposition for the following reasons:

- (i) The impedance level of the circuits minimizes the probability of hum pick-up.
- (ii) The elimination of heater wiring reduces the probability of hum pick-up in all wiring associated with input and output circuits.
- (iii) The low current consumption enables the units to be self contained with their own batteries, this together with their small size enables them to be mounted immediately adjacent to the motor plate.

The disadvantages of high cost have largely disappeared; the OC71, for example, is cheaper than a valve and needs fewer associated components; but transistors are still more liable to scatter of

characteristics than valves and therefore it is correspondingly more difficult to design circuits which are reproducible without minor modification to obtain optimum results. Furthermore, some transistors are noisier than the best valves designed for low-signal audio use. Even so, many users would consider this a fair exchange for a negligible hum level. The principal disadvantage of the transistor for gramophone pickup pre-amplification is its low impedance. This can be raised by inserting series resistance or by applying feedback, but both methods result in a loss of gain which is directly related to the rise in input impedance required.

**Transistor Pre-amplifier for Low Sensitivity Pickup.**—The simple circuit of Fig. 11 provides amplification for the low-sensitivity type of pickup and at the same time gives equalization to within  $\pm 2$  db of the BS1928 characteristic from 30 c/s to 15,000 c/s.

The pre-amplifier consists of two basically similar stages each using an OC71 in the grounded-emitter configuration. Each stage has a measure of d.c. stabilization provided by the resistor  $R_1$  (or  $R_5$ ) connected from collector to base. This method does not give such good stabilization against very wide temperature variations as a potential divider chain but if the pre-amplifier is mounted in a location away from major heat sources (i.e. usually the main amplifier and power unit) no difficulty should be experienced. The author has been using a similar amplifier for monophonic reproduction for four years without trouble.

The majority of magnetic pickups of this category require a load impedance of the order 50k $\Omega$ ; this is obtained by inserting the feedback resistor  $R_3$  in the emitter circuit and raises the input impedance to a measured value of 65k $\Omega$ .

The h.f. roll-off above the nominal crossover frequency of 2130c/s is provided by shunting the collector load  $R_2$  by the capacitor  $C_2$ . The low-frequency equalization, i.e. the rise in gain below the nominal corner frequency of 500c/s, is provided by shunting the feedback resistor  $R_5$  (on Tr2) with the network  $R_7, C_4$ ; the resistor  $R_4$  is included to define, more precisely, the impedance level of the base-to-earth circuit.

The values of the network parameters may not appear to align strictly with those computed from

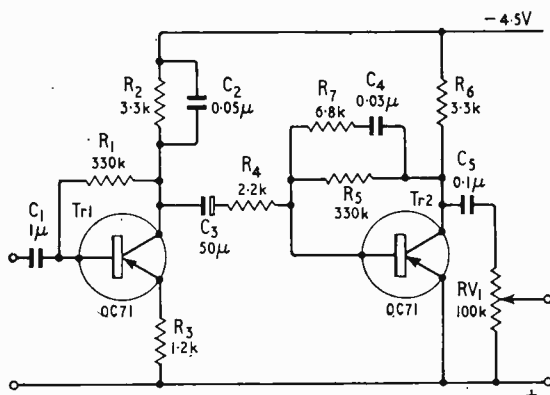

Fig. 11. Transistor amplifier-equalizer circuit.

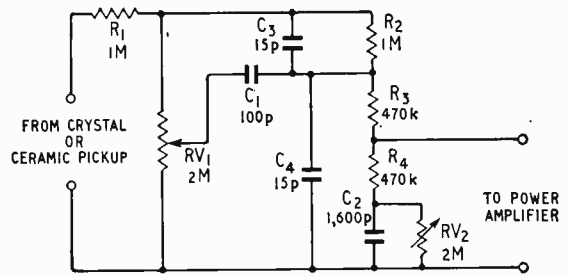

Fig. 12. Passive tone control network.

the nominal crossovers, this is because the values were finally determined experimentally.

The value of  $C_5$  has been chosen in association with  $RV_1$  to give significant attenuation below 20c/s in order to minimize the transmission of motor rumble.

The overall gain of the pre-amplifier equalizer at 1kc/s is such that 16mV in gives 40mV out, thus the sensitivity is more than adequate to load the main amplifier. The total distortion content is less than 1% at 50mV out, this distortion is almost entirely second harmonic in structure. As might be expected the hum contribution from the transistor pre-amplifier is negligible (i.e. too small to be measured). Even so, the usual sensible precautions should be taken: screened leads should be provided at the input and output. Fortunately the low-wattage components required permit a very compact layout which makes the reduction of hum loops comparatively easy. The author recommends that the two channel pre-amplifiers be mounted on opposite sides of an 18 s.w.g. aluminium sheet which should be made somewhat larger than the amplifier tag boards, this minimizes inter-channel cross-talk and if the aluminium screen is earthed the hum pick-up is reduced.

The pre-amplifiers should, of course, be mounted away from the motor and any a.c. wiring. The ease with which the pre-amplifiers can be located on or near the motor plate enables the volume adjustments to be made from the same point.  $RV_1$  and the corresponding volume control on the right-hand channel should therefore be two sections of a ganged control, suitable matched volume controls are now offered for this special purpose.

### Passive Tone Control Networks

It has been stated earlier that the sensitivity of the power amplifier is sufficient to allow the insertion of a tone control system consisting entirely of passive elements between the pickup and the amplifier.

A simple but quite effective system is shown in Fig. 12. The network has a basic attenuation at mid-frequencies of 8:1 (or 18dB) and provides:

- Bass-lift up to a maximum of 8dB at 50c/s.
- Treble-cut up to a maximum of 12dB at 10kc/s.
- Treble-lift up to a maximum of 4dB.

The range of control is somewhat less than that provided by many valve pre-amplifier units; this

(Continued on page 271)

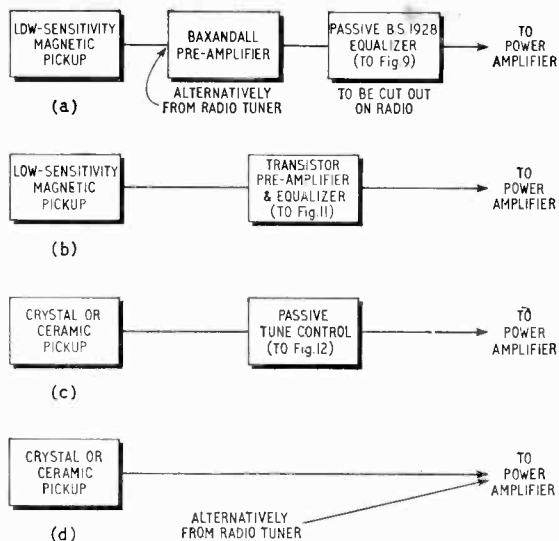

Fig. 13. A selection of typical input systems for coupling pickups to the main amplifier.

has been adopted because: (a) there is a practical limit to the amount of gain which can be thrown away for this purpose, and (b) modern recordings do not require drastic correction (they are scarcely worth listening to if they do!).

Bass cut has not been provided as this is rarely required in practice whilst the degree of treble lift amounts to little more than a "presence" control.

Ceramic and crystal cartridges normally require to be presented with a load impedance of about  $2M\Omega$  to give adequate low-frequency response. This is ensured by inserting the swamping resistance  $R_1$  ( $= 1M\Omega$ ) although this does double the insertion loss of the network. If the pickup will tolerate a 1-megohm load, then  $R_1$  can be omitted and the insertion loss of the network is halved.

The degree of bass lift is adjusted by  $RV_2$  but the degree of lift is also restricted by the input resistance of the following circuit, i.e. the input impedance of the power amplifier. If the passive tone control is used the input volume controls (or replacement resistors) should be of 2 megohm value.

### Typical Systems

As an illustration of the way in which different systems may be made up from the available "bricks" a number of typical arrangements is shown in Fig. 13. The author cannot claim to have tried each and every possible combination and his bitter experience suggests that the particular arrangement which suits the reader will be different anyway. If, however, a few simple commonsense rules are followed no undue difficulties should be met.

In general, tone controls and pre-amplifiers will be located in the vicinity of the pickup for operational convenience so that with reasonable care the pickup to pre-amplifier connection should not give rise to hum generation. If, however, in Fig. 13(a) the passive equalizer is located with the

Baxandall pre-amplifier, then the pre-amplifier to power amplifier connection is at a high-impedance level and suitable shielding and earthing precautions should be taken. If this particular system is devoted entirely to gramophone reproduction then advantage should be taken of the fairly low output impedance of the Baxandall Pre-amplifier, and the passive equalizers should be located at the input to the power amplifier unit.

In the case of the transistor amplifier equalizer the output impedance cannot exceed the collector load on Tr2 which is only  $3.3k\Omega$  so that no trouble should be experienced with the interconnections.

In the arrangement of Fig. 13(c) the passive tone control will probably be mounted near the pickup and the network to power amplifier connection will therefore be at a high impedance level, the appropriate precautions should therefore be taken.

### Conclusions

The object of the foregoing article has been to provide without any sacrifice of quality a stereo power amplifier design of high sensitivity which will enable an overall stereo system to be made with a minimum of elaboration and at a low total cost. The money saved can, if the reader wishes, be devoted to the transducers in which (begging their pardon) there are still sources of distortion which render academic arguments on the relative merits of amplifiers of 0.14% or 0.15% distortion. The author has had good results using a number of different pickups including the Cosmocord "HiLight" played directly into the stereo power amplifier; the loudspeakers used differed slightly, one being the Wharfedale W4 and the other a similar speaker combination in a McProud corner horn<sup>10, 11</sup>.

### REFERENCES

- "Inexpensive Pre-Amplifier," P. J. Baxandall, *Wireless World*, May 1957, pp. 209-12.
- Stereophonic Pre-amplifier in "Mullard Circuits for Audio Amplifiers."
- "A New Corner Speaker Design," C. G. McProud, *Audio Engineering*, Jan., Feb., 1949.
- "Corner Speaker for 12in Cones," C. G. McProud, *Audio Engineering*, May, 1949.

### APPENDIX II

#### Voltage Checks on a Prototype

Taken at an a.c. supply voltage to primary of mains transformer of 230V.

Unsmooth h.t. voltage (across  $C_{10}$ ) = 350V  
 Smoothed h.t. voltage (across  $C_9$ ) = 330V  
 Filtered h.t. voltage (across  $C_{11}$ ) = 292V

V1 measurements  
 Cathode/earth (across  $R_7$ ) = 0.55V

V2 measurements  
 Anode/earth = 210V  
 Across bias resistor ( $R_8$ ) = 3.3V  
 Across cathode load ( $R_2$ ) = 115V

V3 measurements  
 Anode/earth = 312V  
 Screen/earth = 319V  
 Cathode/earth = 11V

V4 measurements  
 Anode/earth = 312V  
 Screen/earth = 319V  
 Cathode/earth = 11V

### APPENDIX III

#### Schedule of Components

The schedule shows representative components; all possible manufacturers' versions cannot, of course, be included, but provided wattage tolerance and voltage ratings are satisfied any suitable alternative should be acceptable.

#### Stereo Power Amplifier and Power Supply Unit (Fig. 3)

The number of components shown cover both channels of the Stereo Amplifier.

Resistors	Qty.	Value	Tolerance (%)	Wattage
R <sub>1</sub>	2	100kΩ	5	½
R <sub>2</sub>	2	100kΩ	5	½
R <sub>3</sub>	2	51kΩ	5	½
R <sub>4</sub> *	2	820kΩ	5	½
R <sub>5</sub> *	2	2.2MΩ	20	¼
R <sub>6</sub> *	2	4.7MΩ	5	½
R <sub>7</sub> *	2	1.8kΩ	10	¼
R <sub>8</sub> *	2	15Ω	5	½
R <sub>9</sub>	2	2.7kΩ	10	¼
R <sub>10</sub>	2	1MΩ	20	¼
R <sub>11</sub>	2	1MΩ	20	¼
R <sub>12</sub>	2	270Ω	5	3
R <sub>13</sub>	2	270Ω	5	3
R <sub>14</sub>	2	2.2kΩ	20	¼
R <sub>15</sub>	2	2.2kΩ	20	¼
R <sub>16</sub>	2	270Ω	20	¼
R <sub>17</sub>	2	270Ω	20	¼
R <sub>18</sub>	2	22kΩ	10	1
R <sub>19</sub> *	2	4.7kΩ	5	½
R <sub>20</sub>	1	... Will depend on resistance of mains transformer. GZ34 requires a total effective resistance of 75 ohms per anode. In practice resistors will rarely be needed.		
R <sub>21</sub>	1			
R <sub>V1</sub> †	1			

Notes: \*Indicates a high-stability resistor.

†Matched pair of ganged potentiometers, e.g. Reliance, for both channels.

Capacitors	Qty.	Value (μF)	Voltage Rating	Remarks
C <sub>1</sub>	2	2	250	Hunts
C <sub>2</sub>	2	100	6	Electrolytic
C <sub>3</sub>	2	0.05	350	Hunts
C <sub>4</sub>	2	1	350	Hunts
C <sub>5</sub>	2	0.5	350	Hunts
C <sub>6</sub>	2	0.5	350	Hunts
C <sub>7</sub>	2	50	50	Electrolytic
C <sub>8</sub>	2	50	50	Electrolytic
C <sub>9</sub>	1	{ 100	450	Electrolytic capacitors in single can
C <sub>10</sub>				
C <sub>11</sub>	1	{ 100	450	Electrolytic capacitors in single can, for LH and RH channels.
C <sub>12</sub>				

Valves	Qty.	Valve type	
V1 and V2	2	6BR8	(Brimar)
V3 and V4	4	EL84	(Mullard)
V5	1	GZ34	(Mullard)

#### Transformers and choke

T<sub>1</sub> mains transformer (Drake Type WW.184. Gardner Type R178).

Primary 250V tapped at 220, 230, 240V.

H.T. secondary 300-0-300V at 250mA.

L.T. secondaries. 5V at 2A  
6.3V at 4A  
6.3V at 1A (centre-tapped)

Output Transformer T<sub>2</sub> (Drake Type WW.185. Aresco Type Mullard Ultra Linear. Partridge Type P.4131). To match 8000Ω to 15Ω with "ultra-linear" primary taps at 43% 12W power rating.

Smoothing Choke L<sub>1</sub> (Drake Type L/WW.186. Partridge Type C5/200). 4 (or 5) henries at 250mA, d.c. resistance approximately 100 ohms.

#### Chassis.

Recommended chassis size, using 18 s.w.g. aluminium, 12in × 9½in × 3½in.

#### Stereo Balance Circuit Modification (Fig. 4)

Resistors	Qty.	Value	Tolerance (%)	Wattage
R <sub>8</sub> (Exists in each amplifier (Fig. 3)).				
R <sub>22</sub>	1	8.2kΩ	10	¼
R <sub>23</sub>	1	6.8kΩ	10	¼
RV <sub>2</sub>	1	20kΩ		

Alternative Stereo Balance Modification (Fig. 5)  
Two sections of ganged logarithmic/antilogarithmic potentiometers following 10% law.

#### Passive BS1928: 1960 Equalizer (Fig. 9)

Resistors	Qty.	Value	Tolerance (%)	Wattage
R <sub>1</sub>	2	820kΩ	10	¼
R <sub>2</sub>	2	51kΩ	5	¼

Capacitors	Qty.	Value	Tolerance (%)	Voltage rating
C <sub>1</sub>	2	0.005Ω	—	350 wkg.
C <sub>2</sub>	2	1500pF	5	
C <sub>3</sub>	2	{ 6000pF + 250pF }	5	

#### Attenuator for use with Mullard Pre-amplifier (Fig. 10)

Resistors	Qty.	Value	Tolerance (%)	Wattage
R <sub>1</sub>	2	680kΩ	20	¼
R <sub>2</sub>	2	220kΩ	20	¼

#### Transistor Amplifier Equalizer Circuit (Fig. 11)

Resistors	Qty.	Value	Tolerance (%)	Wattage
R <sub>1</sub>	2	330kΩ	10	¼
R <sub>2</sub>	2	3.3kΩ	5	¼
R <sub>3</sub>	2	1.2kΩ	10	¼
R <sub>4</sub>	2	2.2kΩ	10	¼
R <sub>5</sub>	2	330kΩ	10	¼
R <sub>6</sub>	2	3.3kΩ	10	¼
R <sub>7</sub>	2	6.8kΩ	5	¼

Capacitors	Qty.	Value	Tolerance (%)	Voltage Rating
C <sub>1</sub>	2	1μF		150
C <sub>2</sub>	2	0.05μF	5	150
C <sub>3</sub>	2	50μF		6
C <sub>4</sub>	2	0.03μF	5	150
C <sub>5</sub>	2	{ (consisting of 0.02 + 0.01 in parallel). 0.1μF }	20	150

RV<sub>1</sub> and corresponding control in RH channel may be ganged potentiometers.  
Transistors Tr1 and Tr2 are OC71s.  
Supply battery 4.5V.

#### Passive Tone Control Networks (Fig. 12)

Resistors	Qty.	Value	Tolerance (%)	Wattage
R <sub>1</sub>	2	1MΩ	20	¼
R <sub>2</sub>	2	1MΩ	20	¼
R <sub>3</sub>	2	470kΩ	20	¼
R <sub>4</sub>	2	470kΩ	10	¼
RV <sub>1</sub>	2	2MΩ		
RV <sub>2</sub>	2	2MΩ		

Capacitors	Qty.	Value	Tolerance (%)	Wattage
C <sub>1</sub>	2	100pF	10	
C <sub>2</sub>	2	1600pF	10	
C <sub>3</sub>	2	15pF	10	
C <sub>4</sub>	2	15pF	10	



# LETTERS TO THE EDITOR

*The Editor does not necessarily endorse the opinions expressed by his correspondents*

## Response Curves and Tone Quality

MR. SCROGGIE'S review of the public reaction to tape recorder frequency response revives the old controversy over the advantages of a flat overall response.

Though the need for a flat overall response curve appears eminently reasonable, all attempts to confirm the point have only shown that an uneducated (in the "high-fi" sense) audience prefer a monophonic reproducer system to have a response that falls off at the high-frequency end of the spectrum. In the only well-founded experiment to produce a contrary result, Olson allowed the panel to listen binaurally. This is I think the significant difference between the technique used by Chinn and that used by Olson.

It is worth noting that Somerville and Brownlees (*B.B.C. Quarterly*, Jan. 1949) found that an untrained audience listening monophonically preferred loudness levels some 20dB below that of a typical concert hall performance. (Approximately one quarter as loud.) No well-grounded experimental evidence is available on the preference of an audience listening stereophonically; but supported by a short series of tests in one of London's leading cinemas I believe that preferred levels are some 10-15dB higher when a good stereophonic technique is employed.

A reproducer that provides an indication of the size of the original source always sounds softer and easier on the ear than a monophonic system having the same frequency and loudness ranges. Similarly a given amount of objectively assessed distortion is less distressing subjectively when a stereophonic reproducer is employed.

There is little doubt that an untutored audience unaware of any technical criteria will always choose the "most pleasing" rather than the "most accurate" reproduction. Deficiencies in the technical performance such as the presence of noise, non-linearity distortion, high-Q resonances, a polar diagram that changes rapidly with frequency, or a failure to produce a virtual source subtending the same angle as the original will all result in a preference for restricted frequency range. The importance of source size is only just being recognized, for until relatively recently the other distortions mentioned were subjectively more significant.

I would guess that in the tape recorder tests, all these distortions were more important than any restriction of frequency range and that in consequence the listening panel were making a choice based on other factors.

Chipperfield, Herts.

JAMES MOIR.

## Television Standards—NOT a World Problem

TELEVISION standards are not a world problem—as is suggested by the heading of your March editorial. The world at large knows where it is going—it is Great Britain (and to a lesser extent, France and Belgium!) that is muddled.

There has been international agreement on an 8-mega-cycle channel width for television. A 625-line system makes the best-known use of such a channel width, especially bearing in mind the inclusion of colour information. Therefore, Great Britain should make arrangements for a progressive change to such a system.

But what do we find? The B.B.C. and a number of people in authority—backed, for other reasons, by a well-known daily paper—wanting to start a new colour service on a system which is known to be outmoded. Additional programme channels are also under consideration; surely this is the stage at which new trans-

mission equipment should be made to the 625 standard? Most modern studio equipment, already in use, is capable of switching to that standard. (Industrial television equipment also already uses 625 lines—another reason for standardizing this system.)

If 405-line colour broadcasts start and the public are inveigled into buying receivers at £250 a time, do you seriously consider that it will ever then be practical to change the standard? Not for 25 years or more. Naturally, the colour viewers would not want their expensive sets made obsolete by a change of standard.

Few people realize that vertical picture resolution is not equal to the number of picture lines. Merely elongating the spot or wobbling it to "fill the gaps" is not the answer. This fact would become apparent if the B.B.C. turned Test Card C through 90°. You would then have difficulty in resolving the 1½ mega-cycle bars! The actual vertical resolution is little more than half (Kell Factor) the number of scanning lines at best and it is, of course, in this respect and in inter-line flicker, that the 405 system is most deficient.

These facts account for the lack of popularity of the 21in/23in tubes in this country whereas in the rest of the world these tubes are standard. (You seem happy enough to stay with a smaller tube!)

By proper planning and looking a little beyond our noses, a 625 system could be brought in without disruption in service or to the industry.

Clacton-on-Sea.

D. W. HEIGHTMAN.

## Bootstrap-Follower Amplifier

I FEAR that I did J. R. Ogilvie an injustice in my comments on his letter in the March issue, by hinting that a gain of 2,500 is more than can be expected from a 6BR8 bootstrap-follower amplifier. In the same issue, E. Jeffery reports a gain of 3,500 from the same valve!

The reason why the gain obtained is greater than the amplification factor of the pentode part of the valve under the makers' typical operating conditions is, as Jeffery suggests, that  $\mu$  is increased in the low-current circuits employed. The reason for the increase was explained by the late W. A. Ferguson (*Mullard Technical Communication* No. 6, Jan. 1954) as follows:—

"If a pentode is operated under constant bias and with constant anode voltage, and the screen voltage is reduced below the value normally adopted for a resistance-capacitance coupled amplifier, the mutual conductance is reduced, but initially this reduction is more than compensated by an increase in the internal resistance of the valve, so that the amplification factor ( $\mu = g_m r_a$ ) increases."

In both Mr. Ogilvie's circuit and Mr. Jeffery's, screen resistors of very high value are used (2.7M $\Omega$  and 4.7M $\Omega$ ). The screen voltage in these circuits must be much lower than in the manufacturer's data.

Croydon.

G. W. SHORT.

WHILST largely agreeing with all that Mr. Short states in his article in the January and February issues, I do feel that in some respects he is unduly blackening the bootstrap follower.

First, regarding the low-frequency response, there is no necessity for using such a low value of C, as 0.1 $\mu$ F, as this capacitor is in the positive feedback to the anode of V1 (Fig. 9, p. 79, February, 1961). As he states in the text, this can be an electrolytic capacitor and a 4 $\mu$ F

capacitor will give a frequency response very close to that of the cascade amplifier.

Regarding the use of a 5pF feedback capacitance between output and input, I feel that this is a rather artificial device and it would be interesting to know the effect of a 5pF capacitor fed back from output to input on the cascade amplifier. I may be wrong, but I suspect that it would go into self-oscillation.

This brings me to what is definitely an advantage of the bootstrap follower for constructional purposes, and this is that there is very little tendency for the circuit to go into self-oscillation. Anyone who has constructed high-gain amplifiers will have normally encountered this problem.

Finally, I would like to congratulate Mr. Short on producing a very interesting and accurate treatise on the performance of this rather unusual circuit.

Bradford, 7.

A. R. BAILEY,

Senior Lecturer in Electrical Engineering,  
Bradford Institute of Technology.

## Nodal Analysis

MY applause goes to Mr. Jones for his excellent pair of articles on "Nodal Analysis" (Nov. and Dec. 1960 issues). There was one slight blemish in the first, however, and I wish to correct this. Mr. Jones used as an example the case of tuned coupled circuits and arrived at the result that the response has maxima at frequencies  $1/2\pi[C(L \pm M)]^{1/2}$ . This can be shown to be false by differentiating the expression for the secondary current. It can easily be seen to be wrong when we remember that if  $M$  is very small (undercoupling) there is only one peak.

Mr. Jones' answer does not behave in this manner and therefore cannot be correct. The real point is that Mr. Jones has implicitly assumed  $R$  is zero. If  $R$  is increased from zero the peaks in the response move inwards until they coalesce (critical coupling). Any further increase in  $R$  results in a single peak smaller than the above peaks. This is indicative of the fact that matching is no longer properly achieved.

Cambridge.

B. J. AUSTIN

### The author replies:

Mr. Austin's remarks are correct—in both the examples on tuned coupled circuits the effects of resistance were ignored. This is in part due to the fact that the treatment was intended to be indicative, not exhaustive, since a reasonably full treatment of tuned coupled-circuit theory in the space available would have been impossible, and indeed irrelevant.

Again the equation  $\omega_1(L+M) = 1/\omega_1 C$ , given in the first example, leads directly to  $f_1 = f_0/\sqrt{1+k}$  which is so often quite good enough for radio work, where  $Q$  commonly lies between 50 and 100. (See *Solutions of Problems in Telecommunications*, by C. S. Henson. Pitman 1956, page 31.)

However, apart from this, I agree with Mr. Austin that it should have been explicitly stated in the first example—as was in fact done in the second—that, to a first approximation, the effects of resistance were ignored.

F. R. B. JONES

## Why Xtal?

"FREE GRIDS" heart-rending cry "Why Xtal?" (page 154 of the March issue of *W.W.*) has affected me so deeply that I hasten to dry the undoubtedly accompanying tears of the interrogator.

I doubt whether the abbreviation "xmitter" might have any relation to St. Andrew's cross. As far as I know this word is derived from the Latin expression—alas, another "X"—"exmittere" that means: to send out, emit, radiate, and finds its manifestation, for instance, in the term "class-of-emission." The ancient

Latins known not only for their exceptionally precise grammar, but also for their extraordinarily delicate feeling of euphony have, therefore, omitted the letter "x," and have abbreviated the word "exmittere" to "emittere." But, nevertheless, after some odd 2,500 years have passed the unabbreviated term "ex" is always present in our minds—and is still being found either in words like: express, expel, export where there is no danger to some kind of "hiatus" or, in commercial language, in expressions like ex ship, ex works or so. "Ex" means "out of." Why not simply substitute it by the single letter "x" which is pronounced exactly the same way. So far "xmitter."

The letter "X" in the word "Xtal" has a different origin. The Christians, in ancient times, used a combination of the capital letters chi and rho as a symbol for their fraternity. Try to pronounce the word "Christ" and add the letters "al," and please don't take any offence at the difference between an open syllable and a closed one. There you are, or are you?

There is indeed another not so far-fetched interpretation of the letter "X." The lazy American amateur-hams—or am I to say: they are always in a hurry?—used to abbreviate all they deemed possible or desirable in order to get their message through as quickly as possible, cf. shorthands like: tx for transmitter, rx for receiver, dx for great distance, xyl for a married woman (ex-young-lady), and—don't mind it—xtal for crystal.

Now, please, you may make a selection that suits you.  
Berlin-Siemensstadt. PAUL HAMEYER

## Fettered by Physics

"FREE GRID," in last month's issue slipped up a little in his paragraph "Fettered by Physics." Several writers have written "science fiction" stories in which the characters moved and had their being in sub-atomic or wave form. One American writer (I think in 1939) wrote a series concerning two characters who "lived" in some such states. So let us be fair to the science fiction writers who have not overlooked  $\psi$  waves as a means of expression.

Birmingham.

A. S. WARBURTON.

## Commercial Literature

**Miniature Lever Keys**, offered as an alternative to the full-size type often used for line-switching, are only  $1\frac{1}{2} \times \frac{3}{16} \times \frac{2}{16}$  in overall and are available mounted as single, double and triple units which can be "nested" to make up switch boards. Negligible wear or loss of contact pressure is claimed after one million operating cycles. Leaflet from Ericsson Telephones Ltd., 22, Lincoln's Inn Fields, London, W.C.2.

**Vacuum Coating** for optical, electric and decorative use is described together with illustrations of equipment in a book from Edwards High Vacuum Ltd., Manor Royal, Crawley, Sussex. Among the electrical uses covered are aluminizing of c.r.t.s., deposition of contacts and quartz crystals, manufacture of selenium rectifiers and roll-coating of paper for capacitors.

**Gamma-radiation Detector**, built up as a self-contained "prod" 33in long, weighing only 4½lb, is one of the many items described in a catalogue of Ekco and Dynatron nucleonic equipment. Apply to Ekco Electronics Ltd., Southend-on-Sea, Essex.

**Bimetals** produced by Henry Wiggin and Co., Ltd., having a wide variety of characteristics and capable of withstanding immersion in water or steam, or use at high temperature, are described in a booklet entitled *Wilco-Wiggin Thermometals*, from the company's office at Thames House, Millbank, London, S.W.1.

**R.f. Coaxial Cables** using a helical spacer of polythene or p.t.f.e. on to which an aluminium sheath is drawn have attenuation as low as 2.2dB/100ft at 3Gc/s and can operate at peak r.f. voltages up to 12kV: in addition bending radii as small as 7in can be used. Booklet from Telegraph Construction and Maintenance Co., Ltd., Mercury House, Theobald's Road, London, W.C.1.

# Applications of Frequency-Sweep Oscillators

3.—CABLES AND FILTERS

By R. BROWN

*Concluded from page 133 of the March 1961 issue*

SO far we have explored the use of the swept oscillator mainly for alignment of active pieces of equipment; that is, equipment which gives gain or employs deliberately non-linear elements such as demodulators. The frequency-sweep oscillator's utility is not, of course, confined to these items—it can be an immense time-saver in the setting-up of filters and the matching of cables. This latter, incidentally, makes use of one of the snags that can be encountered in its employment for amplitude/frequency and phase/frequency measurements.

## Impedance Matching for Cables

The variations in output level that can be caused by mismatched cables can be put to good use when checking and adjusting cables which are terminated in resistive loads or radiating elements<sup>6</sup>.

This can best be seen by looking into the principle

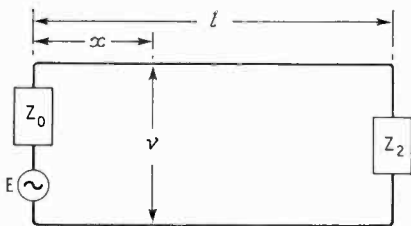

Fig. 16. Generator of e.m.f.  $E$  volts connected via line of characteristic impedance  $Z_0$  to load  $Z_2$ .

of operation a little more closely. Consider a generator of e.m.f.  $E$  volts and internal impedance  $Z_0$ . This is connected to a load  $Z_2$  via a length ( $l$ ) of lossless cable, which has a characteristic impedance of  $Z_0$ , (Fig. 16). If the load  $Z_2$  is equal to the characteristic impedance  $Z_0$  of the line, then the line will be matched and the energy in the wave travelling down the line from the generator will be absorbed in the load, and there will be no energy reflected. Should, however,  $Z_2$  have a value different from the characteristic impedance of the cable, then some of the energy in the wave travelling down the line from the generator will be reflected at the load, and will travel back up the line to the generator.

Under these conditions the voltage  $v$  at any point, say  $x$ , along the line will be the vector sum of the outgoing wave from the generator, and the returning reflected wave. This voltage will have a maximum value when the two vectors are in phase

and a minimum value when the two vectors are out of phase, and a standing wave pattern will be set up along the line (Fig. 17). The number of maxima and minima depends upon the electrical length of the line.

The degree of mismatch can be expressed in terms of a reflection coefficient  $P_2$ , which is the ratio of reflected voltage to forward voltage, and is given by

$$P_2 = (Z_0 - Z_2) / (Z_0 + Z_2) \dots \dots \dots (6)$$

This reflection coefficient can be deduced from the standing-wave ratio on the line, which is the ratio of the value of the voltage at a point on the line at which a maximum occurs to the value of the voltage at a point on the line at which a minimum occurs.

The conventional fixed-frequency method of checking the accuracy of matching, is to measure the standing-wave ratio on the line by moving some form of detector along the line.

**Practical Sweep Technique.**—If the fixed-frequency generator of Fig. 16 is now replaced with a swept-frequency generator, then the electrical length of the line will vary continuously as the frequency is swept. Thus the number of standing waves in the cable will vary, and the position of the various maxima and minima will move along the line. If a detector is connected across the line at some point and its output is displayed on an oscilloscope then it will be found that the standing-wave pattern on the line is, in effect, moving past this point.

For convenience the point chosen for the detector is the sending end of the cable, and the block diagram of a suitable set up is shown in Fig. 18. The output from the swept oscillator is connected to the input end of the cable; this cable is terminated in a load  $Z$  which should have an impedance equal to the characteristic impedance  $Z_0$  of the cable over the

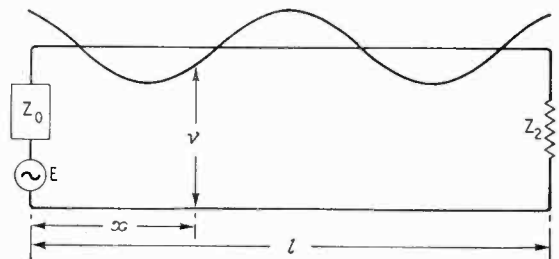

Fig. 17. Standing waves on a line terminated in load other than the line's characteristic impedance.

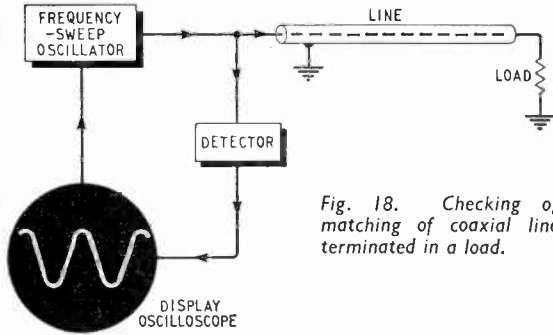

Fig. 18. Checking of matching of coaxial line terminated in a load.

frequency band of interest. A detector is connected across the input end of the cable, and its output is taken to the y amplifier of the display oscilloscope.

This arrangement will produce accurate results provided that the output impedance of the generator is equal to the characteristic impedance ( $Z_0$ ) of the line over the frequency band of interest—so that the input reflection coefficient  $P_1$  is zero. Also the output voltage of the generator must be constant over the same frequency band.

The actual value of the voltage at a frequency where a maximum occurs is:—

$$v_{max} = (E/2)(1 + P_2) \dots \dots \dots (7)$$

while the value of the voltage at a frequency where there is a voltage minimum is given by:—

$$v_{min} = (E/2)(1 - P_2) \dots \dots \dots (8)$$

and when the load is correctly matched to the cable, so that  $Z_2 = Z_0$ , and  $P_2 = 0$  we have:—

$$v_{matched} = E/2 \dots \dots \dots (9)$$

The s.w.r., which is  $v_{max}/v_{min}$ , is thus given by:—

$$s.w.r. = (1 + P_2)/(1 - P_2) \dots \dots \dots (10)$$

The values of voltage which will be produced for any given swept oscillator and cable can be calculated from the above equation and marked up on the display oscilloscope as s.w.r. values (Fig. 19).

**Sweep-width Required.**—The width of the frequency band being swept must obviously be sufficient to allow at least one maximum and one minimum of the standing wave pattern to be displayed. This minimum frequency sweep depends entirely upon the electrical length of the cable, and if  $f_1$  is the frequency at which a maximum (or minimum) occurs, and if  $f_2$  is the frequency at which the next minimum (or maximum) occurs, then:—

$$\begin{aligned} f_1 - f_2 &= s [(1/\lambda_1) - (1/\lambda_2)] \\ &= s [(n/2l) - (2n-1)/4l] \\ &= s/4l \dots \dots \dots (11) \end{aligned}$$

where  $s$  is the velocity of electromagnetic waves in the cable,  $l$  is the length of the cable in metres and  $n$  is the number of half wavelengths in the length  $l$  at  $f_1$ .

Taking a typical cable, the Uni Radio No. 1, as an example, the value of  $s$  is 0.66  $c$ , where  $c$  is the velocity of e.m. waves in free space. A length of 15m would thus call for a minimum sweep width of  $0.66 \times 3 \times 10^8 / 60 = 3.3$  Mc/s.

These equations hold for conditions where  $P_2$  is real and constant with frequency, its modulus is independent of frequency and its phase varies with frequency.

In the general case where  $P_2$  varies in both modulus and phase with frequency, the conditions are very much the same, provided that the power is being delivered to the load over a very wide frequency

range. The requirements for a minimum sweep width will, of course, normally ensure that this is so.

Equations (7) and (8) will, however, have to be modified to:—

$$v_{max} = (E/2)(1 + |P_2|\lambda_1) \dots \dots \dots (12)$$

$$v_{min} = (E/2)(1 - |P_2|\lambda_2) \dots \dots \dots (13)$$

where in Equation 12 the value of  $|P_2|$  used is the value at a wavelength  $\lambda_1$  at which a maximum occurs, while in Equation 13 the value of  $|P_2|$  used is the value at a wavelength  $\lambda_2$  at which a minimum occurs.

Equn. 10 for the s.w.r. now holds at  $\lambda_1$  and at  $\lambda_2$ .

Equations (9) and (12) can now be used to calculate  $|P_2|$  at  $\lambda_1$  and the s.w.r. can then be evaluated from the expression

$$s.w.r. \lambda_1 = (1 + |P_2|\lambda_1)/(1 - |P_2|\lambda_2) \dots \dots \dots (14)$$

The voltage standing wave ratio at  $\lambda_2$  can be calculated in a similar manner. The minimum frequency sweep ( $f_1 - f_2 = s/4l$ ) is the same as before.

**Effect of Cable Losses.**—So far the cable connecting the swept-frequency oscillator to the load has been assumed to be lossless. This is, of course, impossible in practice and the cable will attenuate to some degree both the outgoing and reflected waves. For most applications however this effect is not important. For example consider a cable which introduces 1.9dB attenuation: this corresponds to a voltage ratio of 0.8, and it can be shown that a s.w.r. of 2 : 1 on a loss-free cable would show up as a s.w.r. of 1.8 : 1 on this cable.

The effect of the attenuation ( $\alpha$ ) on the display is greatest when  $|P_2|=1$ . In this condition  $v_{min}$  should be zero: but it will in fact fail to reach zero by an amount depending upon the attenuation. The effect of the attenuation can be allowed for in calibrating the display. Equations 7 and 8 become

$$v_{max} = (E/2)(1 + |P_2|\alpha) \dots \dots \dots (15)$$

$$v_{min} = (E/2)(1 - |P_2|\alpha) \dots \dots \dots (16)$$

The y axis is calibrated by calculating the voltages which correspond to s.w.r.'s of 1, 2, 3 and 4, and marking these values on the face of the tube (Fig. 19).

For the x-axis markers can be introduced in the usual way. The display is to some extent self-calibrating because for any given length of cable the frequency difference between a maximum and a minimum is constant and can be determined from Equation 11,  $f_1 - f_2 = s/4l$ .

Some typical matching displays are shown in Fig. 20. The x-axis represents frequency, and the y-axis represents the modulus of the vector sum of the outgoing and returning voltage waves at the generator end of the cable.

The first oscillogram (Fig. 20(a)) shows a line which is short circuited at its far end.  $Z_2=0$ , and the reflection coefficient  $P_2=1$ . With a lossless line this would give an infinite s.w.r. But, as has

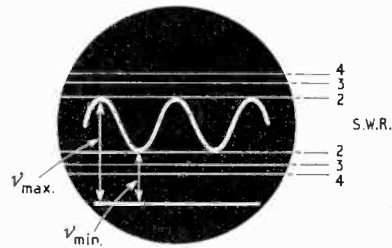

Fig. 19. Calibration of display for matching measurements. S.w.r. lines are drawn from calculated values.

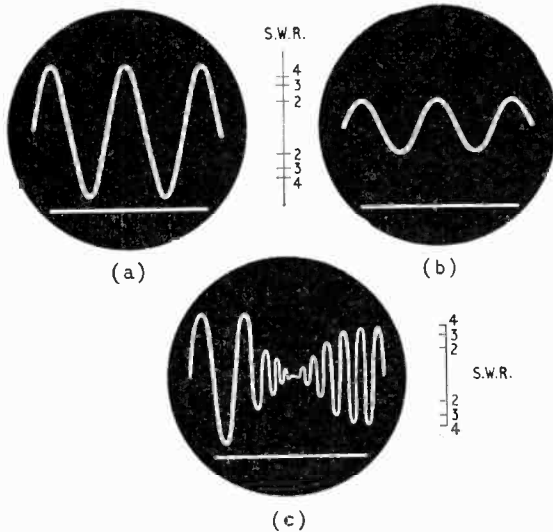

Fig. 20. Displays produced when a length of line is terminated in (a) short-circuit; (b) resistor equal to twice its characteristic impedance; (c) half-wave dipole.

already been mentioned,  $v_{min}$  fails to reach zero by an amount depending upon the line attenuation.

The second oscillogram (Fig. 20(b)) shows a s.w.r. of 2:1. This could be produced when using a cable of, say,  $70\Omega$  characteristic impedance terminated by a resistance of  $140\Omega$ , the termination being purely resistive and independent of frequency.

In the third oscillogram (Fig. 20(c)) the line is terminated in a half-wave dipole. This is a good example of a line which is terminated in a load which varies in both modulus and phase with frequency. Over a small frequency range in the centre of the oscillogram the aerial is resonant and has an input impedance about equal to the characteristic impedance of the cable. The s.w.r. is approximately one. Above and below this frequency band, however, the mismatch becomes progressively greater, and the s.w.r. rapidly increases.

### Impedance Measurement

A common method of measuring impedance at the higher frequencies is by slotted line techniques<sup>7</sup>. The impedance to be measured is connected to the end of a standard line and the s.w.r. on the line is then measured by sliding a probe along a slot in part of the line. From a knowledge of the s.w.r., the characteristic impedance of the line and the frequency, the impedance can be determined. Fig. 21(a), shows a typical standing-wave pattern on a line (characteristic impedance  $Z_0$ ) which is terminated in a load  $Z_2$  which has an impedance different from  $Z_0$ . With a fixed frequency measurement the s.w.r. is first determined with the load  $Z_2$  connected and the position on the line of a convenient voltage minimum is noted. Then the load is short circuited which will cause a shift in the standing-wave pattern (Fig. 21(b)). The length of this shift can be measured by measuring a distance ( $d_1$ ) the voltage minimum previously noted has moved. Finally a measurement of the distance ( $d_2$ ) between two voltage minima will give the length of one half wavelength of the signal in the line. From the two distances,  $d_1$  and  $d_2$ , the electrical

shift in the position of the minimum can be calculated (shift =  $d_1/d_2 \times 180^\circ = \phi^\circ$ ). This is equal to the distance between the load and the nearest voltage minimum.

From these two quantities, the s.w.r., the distance between the load and nearest voltage minimum in degrees and the impedance can be evaluated with the aid of a transmission-line chart.

An arrangement similar to that used for cable-matching display will enable the impedance to be measured with a swept-frequency oscillator<sup>8</sup>. The swept-frequency method of impedance measurement will provide all the required information without slotting the line.

At frequencies where there is a maximum or a minimum at the sending end of the cable, the input impedance of the cable is resistive. The impedance at the receiving end can be found, as with fixed frequency measurements, by measuring the s.w.r. at one of these frequencies, the cable attenuation and the distance between the load and the nearest voltage minimum.

The s.w.r. can be measured as was done for impedance matching measurements. The attenuation can be calculated from the display.

**Electrical Length of Line.**—To find the distance between the load and the nearest voltage minimum, the electrical length of the line must be determined.

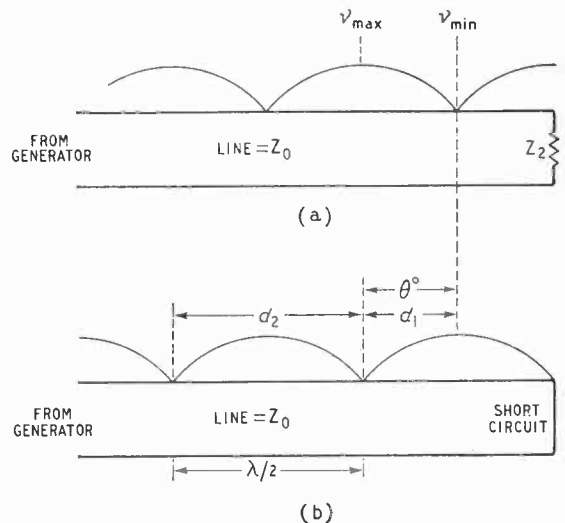

Fig. 21. Impedance measurements using slotted-line technique.

This can be done in the following manner. The cable is short-circuited at the receiving end and a frequency at which a voltage minimum occurs at the sending end is measured. At this frequency, call it  $f_1$ , there will thus be a voltage minimum at both the sending and receiving ends, there are consequently a whole number of half wavelengths in the line at this frequency. The actual number of half wavelengths in the line and therefore its electrical length can be determined from the length of the line and the phase velocity in the line. A typical co-axial cable has a phase velocity of  $2c/3$ . If the frequency ( $f_1$ ) is  $100\text{Mc/s}$ , and the cable is  $10\text{m}$  long, then there are  $(2c/3)/f_1 \times 10 = 10$  half wavelengths in the cable.

The phase velocity and the physical length of the line need not be known with any great accuracy, as they are only needed to identify the nearest integer.

The electrical length in degrees of this particular 10-m length of cable at 100Mc/s, is given by:— number of half wavelengths in line  $\times 180^\circ$ . That is, in this case  $10 \times 180^\circ = 1800^\circ$ .

The impedance to be measured is now re-connected to the receiving end of the cable, and the frequency, say  $f_2$ , at which a minimum occurs is accurately measured. The electrical length of the line at this frequency  $f_2$ , is found by multiplying  $f_2$  by the electrical length of the line at  $f_1$ , and dividing the result by  $f_1$ . The number of half-wavelengths in the line at  $f_2$  can then be determined, as was done at  $f_1$ . This will not be a whole number, normally, but will include a fraction of half a wavelength. This fraction is the distance between the load and the nearest voltage minimum.

Supposing the frequency  $f_2$  was 111Mc/s. The electrical length at this frequency, of the cable in the previous example, would be:—

$$111 \times 10^6 \times 18 \times 10^2 / 10^8 = 1998^\circ$$

The number of half wavelengths in the line is, therefore 11 : 1.

The electrical length from the load to the nearest voltage minimum is therefore  $18^\circ$ , (Fig. 22).

Thus, all the required information has been obtained from the display, and a transmission line chart can be used to determine the impedance.

### Display of Filter Characteristics

Complex filters containing a large number of reactive components present a rather special problem. It is usually necessary to adjust the amplitude characteristic to be reasonably flat over the pass-band while ensuring that the input impedance is reasonably constant over the same frequency range. Any change made in a component with the object of improving the amplitude characteristic will, however, also alter the input impedance. Filter adjustment, then, usually means a tedious swapping backwards and forwards from an examination of the amplitude characteristic, to an examination of the input impedance/frequency characteristic.

A considerable amount of the work can be avoided by displaying, simultaneously, the amplitude/frequency characteristic, and, indirectly, the input impedance/frequency characteristic. A suitable set-up is shown in Fig. 23. A double-beam oscilloscope is used and the amplitude/frequency characteristic is displayed by one beam. The sweep generator is

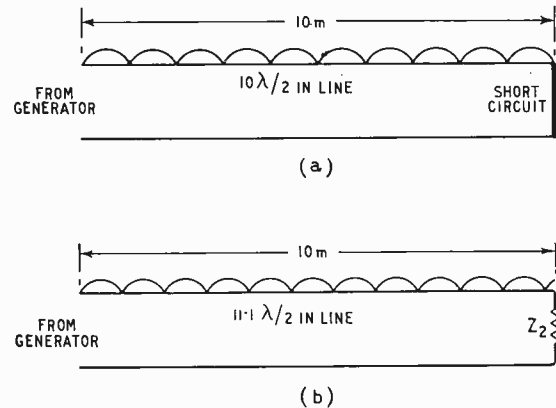

Fig. 22. (a) Line-length is  $1800^\circ$  at 100Mc/s and (b)  $1998^\circ$  at 111Mc/s.

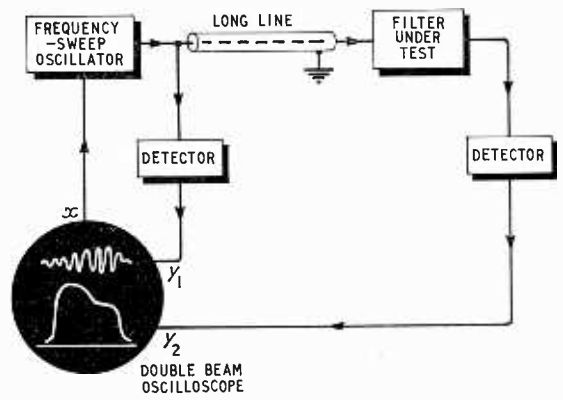

Fig. 23. Simultaneous sweep display of amplitude/frequency and input-impedance/frequency characteristics of a filter.

connected to the input of the filter via a long length of cable whose characteristic impedance is equal to the required input impedance of the filter. A detector is connected to the sweep generator end of the cable, and the output from the detector is displayed on the second channel of the oscilloscope.

When the input impedance of the filter is correct, the connecting cable will be correctly matched, there will be no standing waves on it, and the voltage across the sweep generator end will be independent of frequency. Under these conditions, therefore, the second trace of the oscilloscope will simply show a straight line. When, however, the input impedance of the filter differs from its correct value the cable will be mismatched; the voltage across the sending end will vary with frequency and this variation will be shown on the oscilloscope.

The best results will be achieved when the length of the connecting cable and the sweep width are such that the voltage at the sending end of the cable goes through a large number of maxima and minima. The sweep width will, of course, be fixed by the pass-band of the filter. The cable length required can then be determined using Equation 11.

### REFERENCES

(Complete List)

1. H. Lucius. The Polyskop. Rhode und Schwarz-Mitteilungen, Vol. 10 (1958), p.145, and Hor. Gunner. Response of Linear Resonance Systems to Excitation of a Frequency Varying Linearly with Time. *J. App. Phys.*, Vol. 19 (1948), p.242.
2. D. G. Haley. 20Mc/s Sweep Generator Type TF 1099. *Marconi Instrumentation* Vol. 6 (1958), p.166.
3. G. C. Davey. The Derivative Test Set. *Marconi Instrumentation* Vol. 6 (1958), p.161.
4. C. J. Heuvelman and A. Van Weel. Group-Delay Measurements. *Wireless Engineer*, Vol. 35 (1956), p.107.
5. J. J. Hupert and A. M. Reslock. A method of Band-Pass Amplifier Alignment. *Proc. I.R.E.*, Vol. 41 (1953), p.1668, and J. J. Hupert. A Method of Evaluation of the Quasi-Stationary Distortion of F.M. Signals in Tuned Interstages. *Proc. N.E.C. (Chicago)*, Vol. 8 (1952), p.445.
6. R. Dalziel and A. Challands. Visual Impedance-Matching Equipment. *Wireless Engineer*, Vol. 34 (1955), p.99, and C. J. Heuvelman and A. Van Weel. Reflection and Impedance Measurements by Means of a Long Transmission Line. *Philips Technical Review*, May 1955.
7. P. M. Ratcliffe. Slotted-line Measurements. *Marconi Instrumentation*, Vol. 5 (1956), p.187.

# TECHNICAL NOTEBOOK

**Solid-State Filter** described by W. M. Kaufman in the September 1960 issue of *Proc.I.R.E.* is basically a distributed bridged-T device. Its lumped circuit analogue is shown in the lower part of the diagram and a schematic of the actual device in the upper part. In the device the p-type

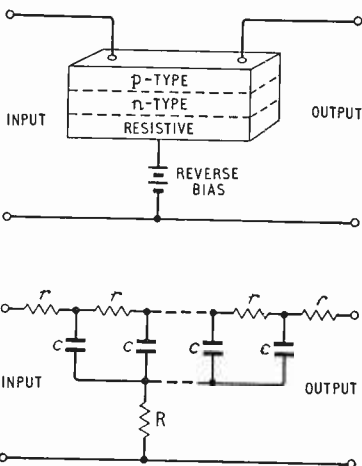

layer provides the distributed series resistance  $r$ , the reverse-biased p-n junction the distributed shunt capacitance  $c$  (short circuited at one end by the low resistance n-region) and the resistive material the shunt resistance  $R$ . (Alternatively  $R$  may be provided by an actual resistor.) Such filters can be tuned by varying the reverse bias. (This alters the width of the p-n junction depletion layer and thus both the distributed resistance and capacitance.) In a practical case tuning from 1.5 to 6Mc/s was obtained by varying the bias from 0.3 to 6V. Such filters can be made very small, for example, only 0.09in by 0.04in by 0.003in for a 1Mc/s device.

**Two New Piezoelectric Compounds**—lithium-doped zinc oxide and cadmium sulphide—have been recently discovered by Dr. A. R. Hutson of the Bell Telephone Laboratories. These two substances are normally n-type semiconductors and so have resistivities which are so low that they short out any piezoelectric effect. However, by diffusing lithium into these substances so as to neutralize their excess conductivity electrons, their resistivities were increased sufficiently to allow their piezoelectric properties to be measured. After such neutralization zinc oxide and cadmium sulphide were

found to be about four times and twice as piezoelectric as quartz respectively.

**Portable Tape Recorders** necessarily have to use a d.c. motor for driving the capstans, and a high degree of accuracy and constancy of speed is desirable. An article "Speed Control of D.C. Motors" in the February issue of *Electronic Technology* describes two methods of controlling small d.c. motors. A phonic wheel is mounted on the motor and used to generate a.c., the frequency of which depends on motor speed.

In one system, this frequency is locked in phase by means of a servo system and a phase comparator to a reference source derived from a stable local oscillator. Transistors are employed in the amplifier and a speed stability better than 0.1% can be achieved. A useful feature in some applications is the ability to control the frequency of the reference oscillator.

The second system is a simpler one but does not give such good control, the limit of stability being about 0.2%. No local oscillator is used, a frequency discriminator providing the reference for frequency. The system embodies a d.c. transistor amplifier and is basically a velocity-feedback control.

**Generators** of electricity from motion consist basically only of a magnetic field and a conductor which are in relative motion. Since the field and conductor must form part of two closed circuits, these circuits must be completed by extra magnetic and conducting material which does not generate any electricity. The problem is then to find a geometrical configuration for the conductor and field which minimizes the "cost" of completing the electrical and magnetic circuits, and different configurations may be preferable depending on whether this "cost" is measured in weight, volume or money. Usually generators use rotational motion with axial conductors and a radial magnetic field. In a generator developed by the Electrical Engineering Department of the University of Bir-

mingham, however, radial conductors move in an axial magnetic field. The simpler magnetic circuit reduces the weight of magnetic material required, but unfortunately the proportion of end winding to total rotor conductor has to be considerably increased.

**"Sandwich" Record Turntable** is used in the new Garrard Laboratory Series Auto Turntable Type A. In this unit the turntable comprises, from the bottom upwards, an inner steel shell which magnetically screens the pickup head from the motor, a foam polyurethane disc (forming the sandwich filling), and a heavy non-magnetic outer turntable thick enough to separate magnetic pickups sufficiently from the magnetic inner shell.

**Mossbauer Effect** allows realization of the inherent extreme narrowness of certain  $\gamma$ -ray spectral lines (with widths less than  $10^{-12}$  of their wavelengths). Unfortunately, normally atomic thermal movements produce random Doppler shifts in the  $\gamma$ -radiation which effectively greatly broaden these lines. For certain types of crystal binding, however, thermal movements are taken up by the crystal as a whole rather than each single radiating atom. This reduces the thermal velocities and thus the random Doppler shifts so much that the inherent narrowness of these  $\gamma$ -ray lines can be realized. This narrowness has already been made use of in measuring the very small red shift of lines in a gravitational field which is predicted by Einstein's general relativity theory.

**10kV E.h.t. Supply** derived from a 1.5V Type U-2 cell by means of a transistor blocking oscillator and Cockroft-Walton multiplier has been developed by Plessey.

A medium-power transistor is used as the blocking oscillator with a small

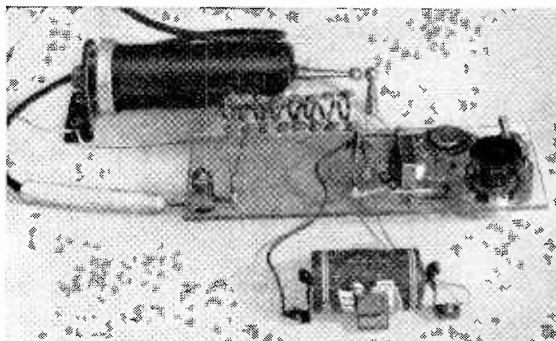



transformer: the high-voltage peak appearing across the transformer is multiplied up by a chain of 32 silicon rectifiers (16 stages with two rectifiers in series in each leg) to charge a final capacitor.

**Microminiature "Dot" Diode** developed in the U.S.A. by Hughes is in the form of a cylinder only 0.03in long by 0.05in in diameter. It is a silicon unit and features a low leakage current (0.1 $\mu$ A at 50V) and high forward current (100mA at 1V).



For ease of handling, the cathode end of the cylinder is made of a magnetic material.

**Automatic Weighing** tends to conjure up visions of apparatus capable of handling tons of material rather than decimals of grams. However, Oertling have developed two precision chemical balances arranged for automatic weighing.

The Model FO5 beam-balance is fitted with a lamp and photocell unit to monitor the balance-beam position. If this deviates from the level state an electromagnet is energized to restore the level; the amount of current flowing is used to give a weight indication and the time for response to a change in weight is a few milliseconds.

The other balance gives a digital output suitable for operating a reversible counter which, of course, can be arranged to feed any convenient form of display or recording. Here a multiple photocell unit measures the beam position giving a pulse output.

**Magnetic Field Measurement** from the Zeeman splitting of the spectral lines of rubidium 85 is being used at the Signals Research and Development Establishment. In a magnetic field each spectral line is split up into a number of components (called Zeeman components) whose separation is equal to the magnetic field strength multiplied by an accurately known constant. At S.R.D.E., instead of measuring the separation between the spectral line Zeeman components, transitions between two of these components are induced by applying an r.f. field of the correct frequency (from which the magnetic field strength was determined), and these

transitions are detected by the increased light-scattering produced as such transitions take place.

To enable such transitions to be induced, changes must be made in the normal proportions of rubidium atoms in each Zeeman component level. In this new method such changes are produced by exciting the rubidium atoms by "pumping" them with rubidium light of a certain frequency such that, when the rubidium atoms return to their original levels, the quantum theory transition rules secure the required changes in the proportions of rubidium atoms in each Zeeman component level. Pumping with suitable radiation so as to produce changes in the proportions of atoms in their various energy levels and thus to allow transitions between these levels to be induced is also, of course, made use of in masers.

**High-voltage Surges** caused on switching off the ordinary mains transformer can cause breakdown of silicon rectifiers. For instance, a 350V secondary winding may produce a pulse greater than 1kV at switch off—this could exceed the peak-inverse voltage rating of a rectifier connected to the transformer. G.E.C. have developed a means of damping out this surge by the connection of a 33-V Zener diode clipper between two taps of the transformer's primary winding. This does not break down with the working potential induced between the mains voltage adjustment taps, but it conducts during the switch-off surge limiting the pulse to a few hundred volts.

**Storage Tube** by Mullard, called the Tenicon, has a resolution of about 550 points along a line when scanned with a television raster. The Tenicon is very much like the Vidicon type of camera tube—in fact, it is designed so that it can be plugged in instead of a Vidicon—except that the photoconductive coating and "window" is replaced by a plate of insulating material backed, on the outside, by a metallic layer.

To write, the electron beam is just cut off and, starting with the insulated target stabilized at cathode potential, the incoming signal is allowed to cut on the electron beam, modulating its intensity. Secondary

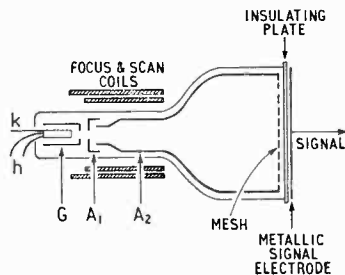

emission causes the target to become positive by an amount determined by the instantaneous beam current (scanning speed, secondary-emission coefficient and target capacity also govern the amount of charge), so that after the writing scan an action identical with that of the camera tube can be employed for read-out—an unmodulated beam scans the target, discharging it to zero. The discharge current from the capacitor formed by the charge on the target and the metallic coating produces an output signal across the target load. If the beam current is sufficiently large only a small part of the stored information remains and further writing-in can start immediately.

**Switching Circuit** developed by Texas Instruments uses two complementary (pnp and npn) silicon transistors and can be used for switching the speech path between two telephones. This is a particularly demanding task, as an extremely high "off" resistance is required—1,000M $\Omega$  is realized in the circuit shown. When a pulse greater than

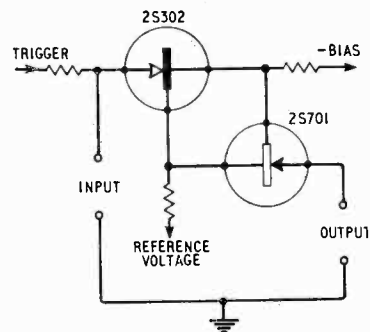

the triggering level (about 25V) is applied to the trigger input the speech path between input and output is completed by only about 10- $\Omega$  resistance. Maximum current is about 100mA.

**Airbrasive tool** can make cuts as narrow as 0.008in wide by means of a gas-propelled stream of very fine particles. The cutting action is cool and shockless, permitting ready handling of very brittle materials such as germanium, silicon, ferrite, glass and tungsten, for example. This tool can also be used as an abradant for deburring and surface cleaning. Ten to fifty micron diameter particles are used, and these are ejected at a speed of about 1,100ft/sec by means of carbon dioxide or nitrogen gas at a pressure of 75lb/in<sup>2</sup>. The cutting or abrasion speed can be varied by altering the tool nozzle tip distance or the rate of flow, particle size or material of the abrasive. This tool was developed in the U.S.A. by S. S. White Industrial Division and is distributed in this country by Elliott Brothers (London).

# Sensitive Photoelectric Trigger

"PLANE OF LIGHT" TECHNIQUE FOR MEASUREMENT OF PROJECTILE SPEED

By D. E. O'N. WADDINGTON, Grad. Brit. I.R.E.

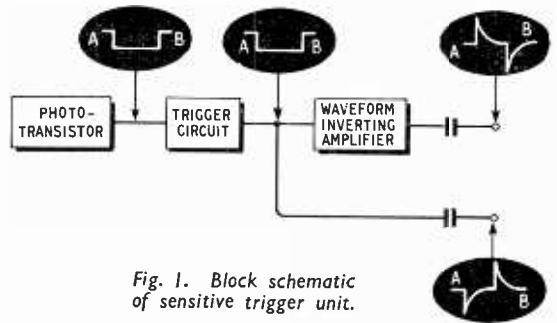

Fig. 1. Block schematic of sensitive trigger unit.

Using the "Transistor Stopwatch,"\* together with the photo-electric trigger circuit described in the same article, to measure the velocity of arrows shot from a bow, two main difficulties were experienced. Firstly, the sensitivity of the trigger circuit proved to be too low for this exacting task, and, secondly, it was found difficult to shoot an arrow accurately enough to break a beam of light. This latter difficulty is complicated by the fact that an arrow is oscillating violently as it leaves the bow. Obviously the answer to the first point was to design a more sensitive version of the photo-trigger circuit and, at the same time, the usefulness of this circuit was also enhanced by making it provide two outputs which could be used to start and stop the timer. The second difficulty was overcome by designing an optical system which produced a "plane" of light of sufficient size to make it comparatively easy to shoot through it.

## Electronic Trigger System

To operate the timer it is necessary to produce positive-going "run" and "stop" pulses. In view of this, the logical approach was to make the photo-

sensitive device operate some form of trigger circuit providing the right outputs. The block diagram (Fig. 1) and the circuit (Fig. 2) show how this is done.

To obtain maximum sensitivity from the photo-transistor it was operated in the earthed-emitter configuration and the output was fed direct to an emitter follower. This means that the load resistor is only shunted by the input resistance of V2, which is high. The variable resistor R1 is used to adjust the bias on the base of V1 and thus sets the operating threshold. Normally the photo-transistor is illuminated and current flows through V1 driving its collector towards the positive line. R1 is then adjusted so that V3 is cut off. V3 and V4 are connected so as to form a conventional Schmitt-trigger circuit. Reducing the illumination on V1 will reduce the current flowing through it, with the result that its collector becomes more negative. This switches V3 on and V4 off: the voltage at the collector of V4 is thus negative going. (Point "A" on the waveform). As has already been stated, a positive-going pulse is necessary to start the timer. This could possibly have been obtained from the collector of V3, but the voltage swing at this point is only of the order of 2.5, whereas the voltage swing at the collector of V4 is nearer 4. The voltage at the collector of V4 is thus fed, via an emitter

\* Wireless World Vol. 65, p. 521 (Transistor timer measuring 0.5 m sec to 5 sec.)

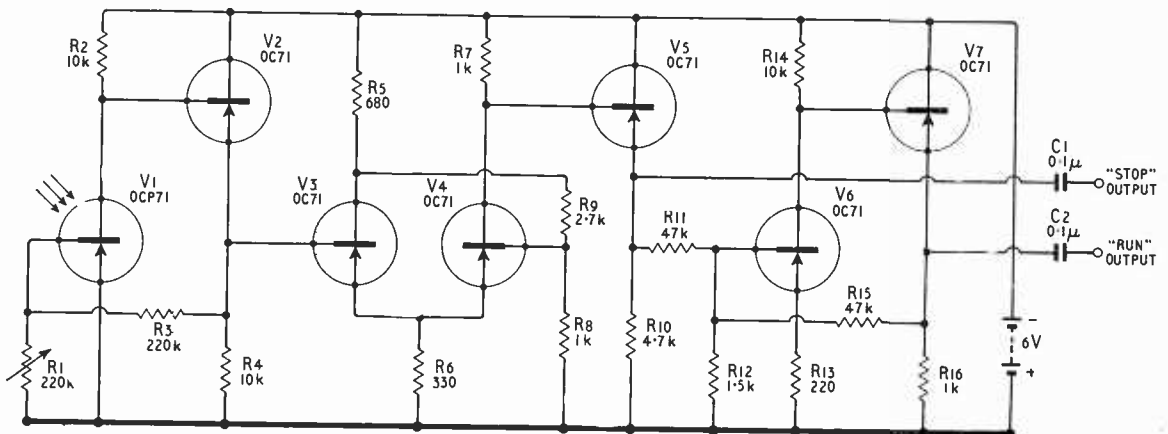

Fig. 2. Circuit diagram of sensitive trigger unit. V1 (OC71) is phototransistor.

follower (V5) to a wave-form-inverting amplifier (V6 and V7). A two-stage amplifier is used here as it was desirable to have a low-impedance output. This output is coupled by means of the capacitor  $C_2$  to the "run" input of the timer.

When the illumination on the photo-transistor is returned to normal the current through V1 increases, thus driving its collector positive. (Point "B" on the wave-form.) This switches V3 off and V4 on, so giving rise to a positive-going voltage at the collector of V4. This is fed via the emitter follower V5 and the capacitor  $C_1$  to the "stop" input of the timer. Consequently reducing the illumination starts the timer and increasing it again stops it.

## Optical System

The average diameter of an arrow is  $\frac{5}{16}$ in and it is easily seen that this will cause very little reduction in illumination when it passes through a simple plane of light. In order to increase the reduction of illumination, the author hit on the idea of folding a narrow beam of light so that it formed a plane. This was done by placing two strips of plane mirror parallel to each other and about four inches apart. (See Fig. 3(a).) If a light source producing a parallel-sided beam of light is placed at Point "C" and directed at the opposite mirror at a slight angle to the normal, the beam of light will be reflected back and forth between the two mirrors until it finally illuminates the photo-electric device placed at "D." Any opaque object placed between the mirrors, provided that it has a diameter equal to twice the width of the beam should, theoretically, prevent any light from reaching the photo-electric device. Due to dispersion of the light and imperfections in the mirrors, this state of affairs is not obtained in practice: however very satisfactory operation may be obtained. In order to prevent the ambient light upsetting the sensitivity of the device, suitable masking was fitted so that the ambient light could not produce any great illumination of the mirrors. (See Fig. 3(b).) This produced an effective "plane" of light.

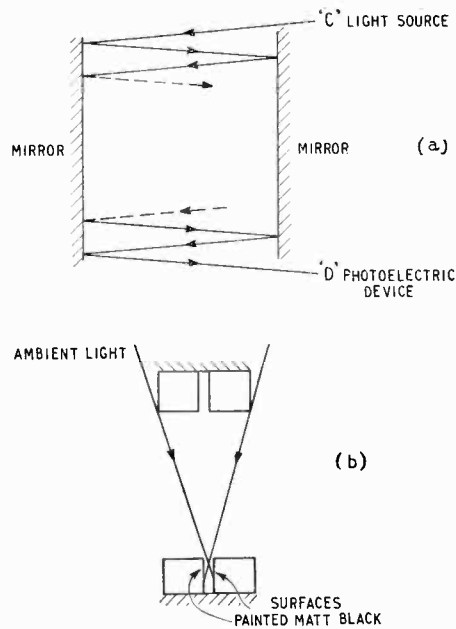

Fig. 3. (a) Method of production of "plane of light" through which projectile passes. (b) Shielding of mirror system from ambient light.

Using the new sensitive photo-electric trigger, the "plane" of light and the "Transistor Stop Watch" together it was a simple matter to carry out arrow speed measurements. The actual plane was made  $3 \times 4$ in, which is a relatively easy mark for an archer to shoot through. The errors due to the thickness of the light plane were reduced to a minimum by making it only  $\frac{1}{16}$ in thick. (The error due to this would be of the order of 0.3%, which was negligible with the speeds and arrow lengths encountered.)

The "plane of light" technique probably has many other possible applications, particularly in the realm of industrial control.

## BOOKS RECEIVED

**From Tinfoil to Stereo—Evolution of the Phonograph** by Oliver Read and Walter L. Welsh. A history, in readable style, of the development of sound reproducing equipment. From a description of early attempts at "talking machines" the authors go on to describe the problems, both technical and legal, which beset the design of audio equipment and records, from the earliest tinfoil and celluloid cylinder records to modern, electrically-recorded, high-fidelity stereophonic discs and tape. Many previously unpublished photographs of early equipment are presented and the bibliography is extensive. Pp. 524; profusely illustrated. Howard W. Sams & Co. Inc. Price \$9.95.

**Numerical Methods for High-Speed Computers** by G. N. Lance. An exposition of methods which have been specifically developed for use with automatic high-speed digital computers. In the introduction, the author explains the fundamental differences in methods required by hand and automatic machines. Three chapters are then devoted to the solution of problems using matrices or differential equations, while the last chapter deals with a variety of miscellaneous processes. A practical book for the programmer or engineer. Pp. 166. Published for "Data Processing" by Iliffe Books Ltd.,

Dorset House, Stamford Street, London, S.E.1. Price 42s (42s 11d by post).

**An Introduction to the Cathode-Ray Oscilloscope** by Harley Carter. A simple explanation of the operation and application of the oscilloscope. Intended for the experimenter and student, the book is elementary in treatment and presupposes only a small knowledge of electronics. Descriptions are given of timebase circuits, vertical amplifiers and power supplies, with a chapter on some common cathode-ray tubes. The last chapter gives details of three complete oscilloscopes. Pp. 132; Figs. 99. Cleaver-Hume Press Ltd., 31 Wright's Lane, London, W.8. Price 15s.

**Applications of Electronics** by Bernard Grob and Milton S. Kiner. A review, intended for the technician, of basic circuit principles and their application to modern electronic equipment. Industrial and military equipment is described. There is a chapter on test equipment and appendices give useful data such as frequency allocations, a time-constant graph and colour codes. Questions are set at each stage in the book. Pp. 628; Figs. 497. McGraw-Hill Publishing Co. Ltd., 95 Faringdon Street, London, E.C.4.

# MANUFACTURERS' PRODUCTS

## NEW ELECTRONIC EQUIPMENT AND ACCESSORIES

### D.C. Amplifier

THE type A.2 transistor d.c. amplifier made by Fenlow Electronics is intended for process control and computing applications. A zero-drift of less than  $200\mu\text{V}$  is combined with an output of  $\pm 9\text{V}$  at  $50\Omega$  impedance, the stability being achieved by means of a drift-correction feedback circuit employing a transistor chopper. The gain of the amplifier is 5000 and the bandwidth  $1\text{k}/\text{s}$ . Details are obtainable from Fenlow Electronics, Ltd., Springfield Lane, Weybridge, Surrey.

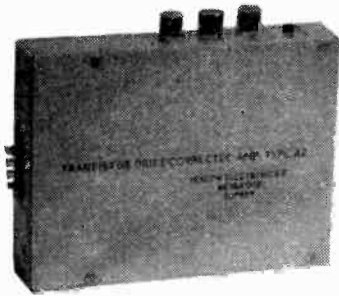

Left: Fenlow d.c. amplifier.

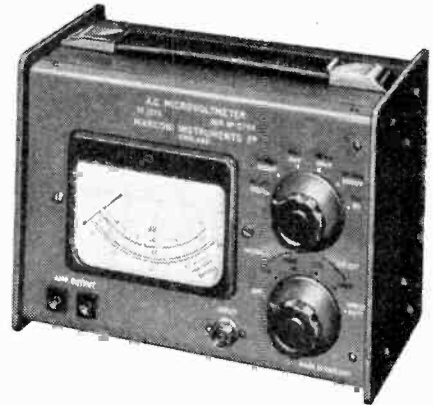

Marconi Instruments TF1375 Microvoltmeter.

response is  $\pm 2\text{dB}$  from  $50\text{c}/\text{s}$  to  $1\text{Mc}/\text{s}$ . Alternatively, the lower end of the range may be curtailed when it is desired to reject external  $50\text{c}/\text{s}$  signals, the attenuation then being  $-20\text{dB}$  at  $50\text{c}/\text{s}$ . The amplifier output is taken to sockets on the front panel; the gain is X1000, and the output is  $250\text{mV}$  r.m.s. maximum at  $3\text{k}\Omega$  impedance. The instrument is especially useful for measurements of field strength, or as an oscilloscope pre-amplifier. Obtainable from Marconi Instruments, Ltd., Longacres, St. Albans. Price £66.

Right: Printed-coil, panel-mounting meter introduced by Painton.

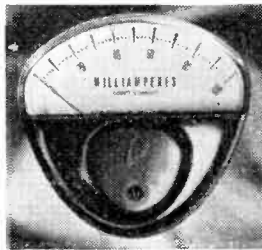

### New Printed-circuit Meter

AN exceptionally robust and elegant panel-mounting meter has been introduced by the Parker Instrument Corporation of America, and is marketed in this country by Painton. Extremely light weight and slimness has been achieved by the use of a ceramic ring magnet and printed-circuit coil.

Overloads of 250 times and transients of 20,000 times the instrument rating produce no detrimental effects, except that the nylon pointer may be bent, in which case straightening is a simple matter. Operation in a magnetic field has no effect on performance. The instrument is manufactured in ranges of  $1\text{mA}$  to  $1\text{A}$  and  $10\text{V}$  to  $500\text{V}$ . Full information on the range of meters, which are obtainable in several colours, may be obtained from Painton and Co., Ltd., Bembridge Drive, Kingsthorpe, Northampton.

### A.C. Microvoltmeter

MEASUREMENTS of the amplitudes of alternating currents down to  $5\mu\text{V}$  may be made with the Marconi TF1375. Completely self-contained, the instrument employs semiconductors throughout, and the frequency

### Displacement Meter

AN accurate and stable length-measuring instrument has been developed by Reilly Engineering, Ltd. The equipment combines the accuracy of the slip-gauge method of measurement with an electronic bridge as the reading and indicating system. Numbers of slip-gauges in the form of cylinders are arranged end to end to form a round section rod. Each section is connected to a tap on a voltage-dividing transformer which is fed with an alternating voltage. A transducer head, also in the form of a cylinder, moves over the rod, and is capacitively

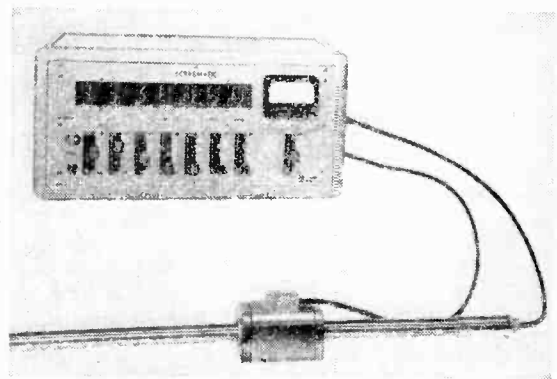

The Reilly Engineering Displacement Meter, showing the transducer and indicator unit.

coupled to it over a length exactly equal to the length of one slip-gauge. The voltage induced on the head is thus a linear function of its position on the rod. The transducer head and transformer are connected in a bridge circuit with transformer ratio arms arranged in decades. The out of balance voltage is amplified and indicated on a centre-zero meter. A typical ten-inch rod has six decade transformers, the last decade indicating to within 10 micro-inches. The meter is calibrated, and small deviations of 1 micro-inch are discernible.

The equipment may be used to measure length directly, or it may be employed to control the position of the moving part of a machine tool. In this capacity, the rod is attached to the bed of the tool, and the head to the moving part. The switches are set to the desired reading and the head moved until the meter reads zero. Alternatively, the error signal may be amplified and used to drive a servo-motor. Normally, the switch positions are indicated by an in-line read-out display.

A range of transducers are available, measuring from 1 inch at an accuracy of  $\pm 0.00003''$ , to 100" to within  $\pm 0.001''$ . The equipment is marketed by Reilly Engineering, Ltd., Forsyth Road, Sheerwater, Woking, Surrey.

### Valve Voltmeter

THE Taylor Model 172A has an input impedance on its d.c. ranges of 11M $\Omega$ , and greater than 830k when measuring a.c. Full-scale readings on d.c. and a.c. volts are 1.5V to 1.5kV, or 30kV when an e.h.t. probe is employed (d.c. only); the scales are calibrated in both r.m.s. and peak-to-peak. The instrument will measure



Taylor Model 172A Valve Voltmeter with d.c. probe in use.

resistance up to 1000M $\Omega$  and r.f. probe is available which extends the range to over 200Mc/s. Further information may be obtained from Taylor Electrical Instruments, Montrose Avenue, Slough.

### Switchless Capacitance Standards

STANDARD capacitances in the range 10pf to 10 $\mu$ f may be assembled from units made by the German firm of Jahre introduced to the U.K. by Aveley Electric. Capacitance units adding up to the required value may be connected in parallel by means of five- and six-sided connector blocks, the whole forming a convenient and rigid assembly. Air dielectric is used in units up to 400pf, which affords a loss factor of less than 1 part in 10<sup>5</sup>. Series inductance of the units is less than 0.06 $\mu$ H. Each capacitor is adjusted to within 0.1%  $\pm 0.1$ pF and calibration certificates are issued. Temperature coefficient of units up to 400pf is +20 parts per million per degree Centigrade and 30 p.p.m./ $^{\circ}$ C for larger units. Variable capacitors provide continuous coverage of 16

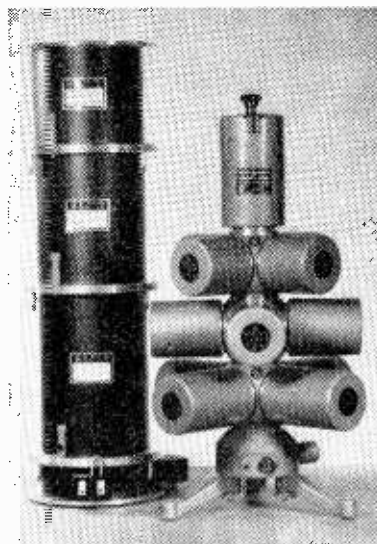

Jahre switchless standard capacitor assembly.

or 70pf. The units are obtainable from Aveley Electric Limited, Ayrton Road, Aveley Industrial Estate, South Ockendon, Essex.

### Transistor Tester

AN n-p-n/p-n-p transistor tester recently introduced by Grundy is designed for use in conjunction with all multi-range meters of 1mA basic movement or better, preferably with inbuilt overload protection. The mounting terminals enable the unit to be mounted directly on to a Universal Model 8 Avometer. A useful measurement of current gain can be made up to 800mW dissipation and a reasonable indication is given for higher powers. Transistor measurements also include collector-emitter and collector-base leakage currents at a potential of 4.5V. Diodes are tested in the forward direction by passing through them a current of up to 10mA (depending on the forward resistance). The reverse current can be checked at a potential of 9V. Two similar transistors or diodes can be compared under the same conditions using the two sets of terminals provided. Provision is made for testing the internal battery under load. The size of this instrument is 7in by 6in by 2 $\frac{1}{2}$ in and its weight is 1 $\frac{3}{4}$  lb (including batteries). This instrument costs £4 19s 6d and is made by Grundy & Partners Ltd., of 3 The Causeway, Teddington, Middlesex.

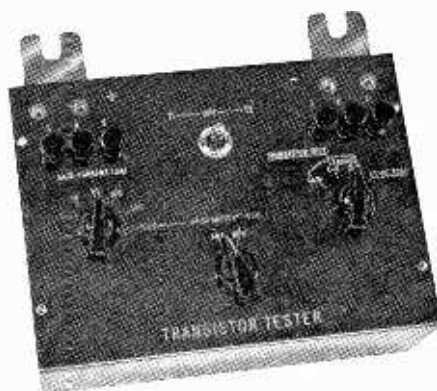

Grundy Transistor Tester.

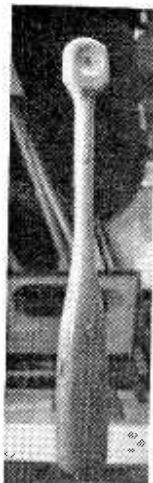

## ELECTRONIC GUIDE

A DEVELOPMENT of the inductive-loop paging system has been adopted by the Ministry of Works to provide guided tours of the South Kensington Science Museum.

Tape-recordings lasting about twenty minutes are used to amplitude-modulate an oscillator working in the range 50 to 86kc/s. The signal is applied to a loop of wire encircling the area in use, and is received on small, hand-held sets shaped like truncheons. Four channels are available, selected by a switch on the receiver, which employs an automatic volume-control system. The input to the loop, when a large area is being covered, is obtained from a transistor power amplifier, and is 3 watts maximum per channel.

The transistor receiver is contained in the lower part of the handle, and the output fed to a  $1\frac{1}{2}$  inch speaker in the earpiece, which is merely held close to the ear, and not inserted. There is, therefore, no problem of sterilizing. A volume-control is incorporated, and the receiver weighs only 7 ounces.

The equipment is a product of the Multitone Electric Company, Limited.

The accompanying photographs show a party of schoolchildren being conducted on a tour of the Sailing Ship Gallery at the Museum, and one of the receivers. The channel-selector switch is near the top of the handle, and the volume-control/on-off switch protrudes at the left.

## HONG KONG TRANSISTOR SETS

ONE of the first nations fully to exploit the commercial opportunities offered by the invention of the transistor was Japan and the mass production of transistor radio receivers was very firmly established there by 1958.

The manufacture of parts and the assembly of transistor sets did not, however, begin in Hong Kong until some 18 months later. Initial setbacks, due in some measure to the Hong Kong government's strict certification requirements, rendered early progress slow, but manufacturers are now producing sets which conform with the government's criteria for the issue of Certificates of Origin and Commonwealth Preference Certificates.

To qualify for the Colony's Certificate of Origin, manufacturers have to incorporate in each set a very large number of entirely locally made parts, ranging from the plastic cases, batteries and p.v.c. wiring to the transformers and tuning capacitors. Some also make the printed circuit boards, whilst others import these from the U.K. The currently manufactured Hong Kong receivers are exclusively small six-transistor models and the transistors themselves are imported from the U.K. They cover the medium-wave band with an i.f. of 455 kc/s. The sensitivity is given as 250  $\mu$ V/m.

Transistor radio manufacture in Hong Kong has brought additional business to other sections of the Colony's industry, amongst which may be mentioned the leather workers who make attractive carrying cases for the radios (as well as for sets of European manufacture) and the plastics factories, which, besides producing the injection-moulded cases for the sets, also turn out the wafer-thin p.v.c. strips used in the variable capacitors.

All Hong Kong sets are built to allow use of earphones and the earphone plug automatically cuts off the loud-speaker. The earphones supplied with the set are of the magnetic type with a low impedance.

Transistor radios from Hong Kong are arriving in the U.K. at approximately £6 c.i.f.

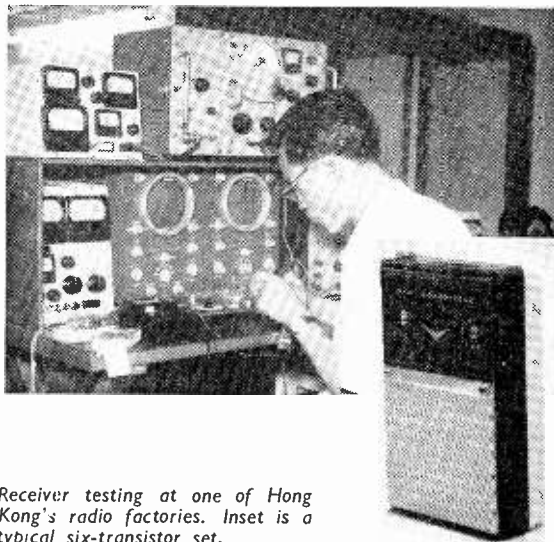

Receiver testing at one of Hong Kong's radio factories. Inset is a typical six-transistor set.



# RANDOM RADIATIONS

By "DIALLIST"

## Interesting Radio Telescope

THE Australians have recently brought into service a high-resolution telescope, described as a crossed-grating interferometer. It is designed or use of decimetre wavelengths, and one of its most important purposes is the observation of radiation from the sun. Since this largely originates in the sun's outer atmosphere, observation by optical instruments is very difficult. Each arm of the aerial array consists of 32 paraboloids, 19ft in diameter and equally spaced along a 1,200ft base line. When the instrument is in use the paraboloids are steered so as to be always pointing at the sun. The narrow beam "scans" the surface of the sun much as the spot of a television set scans the screen. The earth's rotation moves the beam from west to east and when it has scanned one strip of the sun's surface it is moved about a beam width southwards. In this way a complete radio picture of the sun is built up.

## Still Progressing Slowly

TO many it's extraordinary that television remains so slow in catching on in France. About 91% of French homes are within range of TV transmitters; yet not more than 12% of them have receiving sets, compared with over 80% in the U.S.A. and more than 60% in this country. Some people say that the

programmes are to blame and that there will be a rapid increase when the second chain gets to work, as it is due to do in the not-far-distant future. I rather doubt whether that's the real reason. My own belief is that the small demand for TV sets is largely due to the comparatively small amount of time that the average Frenchman spends in his home. He prefers to go out when he can for eating, drinking and entertainment. It's a curious thing that there's no French word for home. The nearest equivalent is "foyer," which simply means hearth. But a Frenchman's foyer doesn't mean quite the same thing to him as home does to our countrymen.

## Servicing Certificates

THE examinations for the sound radio and television servicing certificates conducted by the Radio Trades Examination Board and the City & Guilds of London Institute attract an increasing number of candidates every year. In sound radio there were 1,965 candidates in 1960 against 1,896 for 1959. Of these 911 passed, 471 have to retake the practical test, and 583 failed. There were 642 candidates for the television certificate in 1960 compared with 485 in 1959. Passes numbered 298, those referred 96 and failures 248. There are now 4,182 holders of the sound radio certificate and

1,074 of the TV certificate. Looking through the 1960 papers, one comes to the conclusion that the questions are well chosen and provide a fair and thorough test of the candidate's ability to do a good job as a serviceman. A typical composite question in the Radio exam. was: (a) Explain the differences between direct and alternating current; (b) Explain the terms (1) peak voltage, (2) r.m.s. or effective voltage; (c) A moving-coil meter movement with a metal rectifier unit may be used for measuring a.c. (i) What value of current does it measure? (ii) What value of current is indicated by the scale calibrations? The examiners report "Not many attempted this question, which is rather surprising." I agree. Still, the percentage of passes can't fail to be regarded as very satisfactory.

## Remarkable Valves

WONDERFUL things, some of the valves of to-day! Amongst the most remarkable of them are the frame-grid types such as PCC 89, PCF 86, EF 183 and EF 184. Their big advantage is that they enable a greater gain to be obtained without an increase in the noise factor. Their construction is quite remarkable, for the wire used for the grids is only 10 microns in diameter compared with about 75 microns for the average human hair. Further, the spacing between grid and cathode has been brought down to 50 microns, so that you could not pass a hair between the two. Frame-grid valves in themselves are no new departure, for special valves have been made in that way for some little time. What is new is their production in quantity for domestic TV sets.

## Solar Batteries

THOUGH they have severe limitations, since they can work only on sunny days and must be idle at night, solar batteries seem to have considerable possibilities. One of them has recently been set up at Toulon—not an ideal position though it's in one of the sunniest corners of France. It works on the thermo-junction principle, the hot side of each junction being attached to a heat-collector

### "WIRELESS WORLD" PUBLICATIONS

	Net Price	By Post
PRINCIPLES OF SEMICONDUCTORS M. G. Scroggie, B.Sc., M.I.E.E. . . . .	21/-	21/11
RADIO DESIGNER'S HANDBOOK Edited by F. Langford-Smith, B.Sc., B.E., Senior Member I.R.E. (U.S.A.), A.M.I.E. (Aust.). 4th edition (revised) . . . . .	55/-	57/3
PRINCIPLES OF FREQUENCY MODULATION B. S. Camies . . . . .	21/-	21/10
INTRODUCTION TO LAPLACE TRANSFORMS for radio and electronic engineers. W. D. Day, Grad.I.E.E., A.M.Brit.I.R.E. . . . .	32/6	33/6
BASIC MATHEMATICS FOR RADIO AND ELECTRONICS F. M. Colebrook, B.Sc., D.I.C., A.C.G.I. Revised by J. W. Head, M.A. (Cantab.). 3rd Edition . . . . .	17/6	18/6
PRINCIPLES OF TRANSISTOR CIRCUITS S. W. Amos, B.Sc.(Hons.), A.M.I.E.E. 2nd Edition . . . . .	21/-	22/-
LEARNING MORSE 13th Edition H. F. Smith, former editor, "Wireless World" . . . . .	1/6	1/10

A complete list of books is available on application.  
Obtainable from all leading booksellers or from

ILIFFE BOOKS LTD., Dorset House, Stamford Street, London, S.E.1.

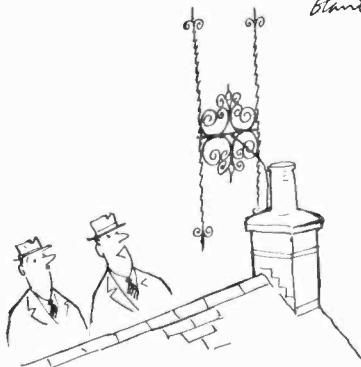

plate 1 decimetre square, while the cold sides are connected to metal plates which conduct the heat to radiator fins placed on the side away from the sun. In this way, it has been found possible to maintain a temperature difference of about 120°C between the hot and cold parts of the junction. The output in full sunshine is some 6W per square metre. In tropical countries a considerably larger output is possible. The efficiency of the battery is low, since the input of solar power enormously exceeds the electrical output; but that doesn't matter much, for solar power costs nothing. It should be possible to build in equatorial regions huge batteries producing during the daytime vast amounts of electricity which could be stored and used as and when required.

### Birds Like Them

IN East Anglia, where I now live, we use horizontal aerial arrays for both B.B.C. and I.T.A. television reception. These are regarded as heaven-sent perches by the birds. I can't look out of my sitting-room window in the daytime without seeing at least a score of them comfortably taking their ease and having a look round. And it isn't only small birds such as sparrows and starlings. Rooks, jackdaws and even seagulls find these horizontal arrays convenient seats. One mightn't have thought that a gull could curl its big webbed feet sufficiently to get a firm grip; but they can and do. One or two arrays near my place have been damaged by the weight of groups of large birds assembling on them. I expect that parts of these had previously been loosened by the winds, of which we certainly get our share, and that the feathered visitors just gave the final touch, like the straw that broke the camel's back.

*Bland*



"No, the picture's not so good, but it's a lot prettier."

WIRELESS WORLD, MAY 1961

# MAINS CONNECTORS

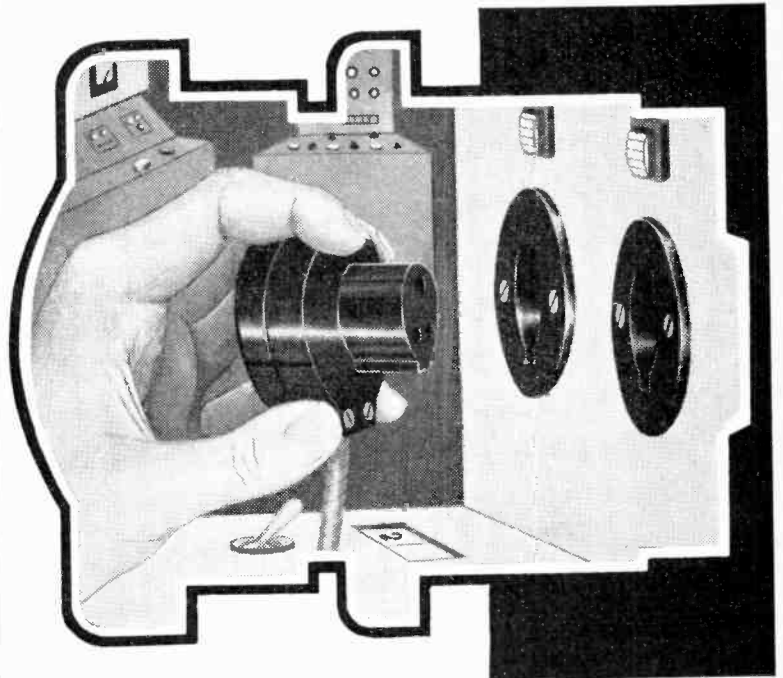

For reliable connection at all times, specify Bulgin Mains Connectors. The design and manufacture of these components, and the intensive research and testing ensures that every model leaving our factory will give perfect mating and electrical performance at all times.

We illustrate on the right two of our extensive range of 392 different varieties.

Our **P.73** one-hole-fixing model, non-reversible in mating and keyed to fit panels preventing rotation in use; Electrical rating: 3 Amps at 250 Volts or 1 Amp at 500 Volts. Also our **P.430** as above but with Electrical rating 5 Amps at 250 Volts.

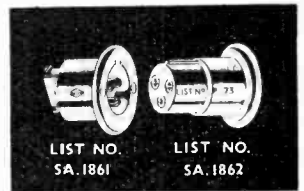

LIST NO. SA. 1861

LIST NO. SA. 1862

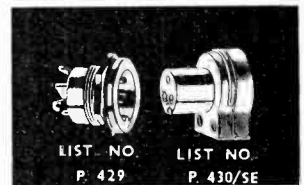

LIST NO. P. 429

LIST NO. P. 430/5E



Our 164-page technical catalogue published in **MARCH, 1960**, contains illustrations, full working details and dimensions of over **10,000 ELECTRONIC COMPONENTS**. Send for catalogue 201/C. Price 2/6 post free, or free to trade letterhead or order.



**A. F. BULGIN & CO. LTD., BYE-PASS ROAD, BARKING, ESSEX**  
Telephone: RlPpleway 5588 (12 lines)

# UNBIASED

By "FREE GRID"

## Wireless Museum

I HAVE often wondered why the Radio Industry does not establish a museum illustrating radio progress since the first wireless patent was taken out on June 2nd, 1896. But to establish and run a museum needs other things besides exhibits. It needs, for one thing, a building and quite a lot of money for its upkeep. I wonder, therefore, who would be likely to finance it? I suppose that firms belonging to the industry would have to put up the cash between them; in other words, the job of collecting the money would really devolve on an industrial organization such as the R.I.C. or the E.E.A.

However, radio firms are not in business just as a pastime. The bigger firms spend vast sums on research but the money so spent will, they hope, eventually return to them with interest. In the matter of a museum there is no hope of such a return for the money spent.

A very good museum of old motor cars is, of course, run by Lord Montagu at Beaulieu who regards it as his hobby. I wonder if there is a noble lord who is interested in old wireless receivers. I can't think of one, but then, I don't know many noblemen.

Of course, the Science Museum at South Kensington at once suggests itself as the ideal place. The authorities there certainly have got a good collection of pioneer wireless apparatus, and no doubt they have more in store for which they have no room in their display cabinets.

Maybe there is a radio museum

overseas and if so I should be very glad to hear of it. Possibly there is one behind the iron curtain, and I have often thought I would like to pop off (surely *le mot juste*) to Moscow and see for myself.

## Multi-screen TV

IT often happens that some members of the family wish to look at B.B.C. television while others prefer the I.T.A. offering with the result that the "peaceful hours I once enjoyed" have been shattered. This problem is much greater in the U.S.A. where they have several programmes to quarrel about. It is not surprising, therefore, that at least one American firm has produced a multi-screen television set for receiving several programmes simultaneously.

In essence it consists of three TV sets built into one cabinet as shown in my illustration. I wondered if some of the components, such as those of the power pack, would be common to all sets thus making for greater compactness; but no, "everything is completely independent so that you are never, never without TV."

In addition to the three TV sets it incorporates an f.m. receiver and a stereo record player which is revealed by sliding aside the top centre panel. The advertisement says "3-screen TV gives you all of the best all of the time. . . . You'll be surprised to find you can easily enjoy more than one channel at a time. . . ." You have your own control button with an individual earphone so that

"when the show you are hearing drags you can switch to another and then back in time to hear the important part of the first."

I don't think headphones would be very popular in this country. I have, therefore, been trying to think of a way out of the difficulty; the only answer seems to be for people to learn lip reading.

As, however, lip reading couldn't deal with any sounds save speech I'm afraid my idea is ruled out which is a great pity as it would mean that multi-screen TV sets—or even ordinary ones—could be produced very cheaply as no apparatus for reproducing sound would be necessary. Quite frankly I don't think the American multi-screen set with its headphones would catch on here.

## Photographic Panautomation

LAST October I chided the photographic industry for claiming that cameras, wherein stops and shutter speeds were self-adjusting, were panautomatic. Such a claim is, in my opinion, quite unjustified unless some automatic means be provided whereby the camera can focus itself.

As I pointed out last autumn, the camera experts have tried to get over the difficulty by using lenses of slightly subnormal focal length so that a minimum of manual focusing adjustment is called for. Maybe my complaint was read in the right quarters as at least one maker has now produced a camera, which, in effect, is claimed to be self-focusing.

The interesting point about it is that to achieve their end the makers have adapted a technique from the world of wireless which was popular in pre-war days. No doubt they thought that as the automatic stop and shutter adjustments employed an electronic technique, they could not do better than borrow yet another technique from us, albeit a completely non-electronic one.

You will probably remember that in pre-war days there were three main systems of push-button tuning. These were individual pre-set tuners for each station, motor-operated adjustment of one main tuner, and, finally, manually-operated adjustment of the main tuner by means of a number of cams or gears with stops, one to each push button.

It is this latter type which has been called out of obscurity by the photographic industry. Four buttons are provided, each labelled with a different zone of distance, the user presses whichever is the most appropriate for a given photograph. The first part of the button's travel adjusts the focusing, the shutter being fired at the end of its travel. I hope we shall be able to provide the photographic industry with further techniques as time goes on.

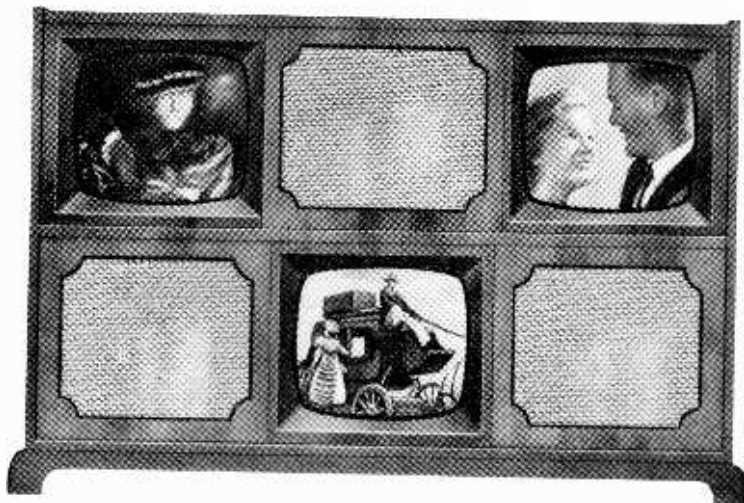

Three-screen television being marketed by de Forest