

Wireless World

APRIL 1951

VOL. LVII. No. 4

Middle-age Musings

WITH the last issue *Wireless World* completed its fortieth year of virtually continuous publication. That is not—and never will be—taken as justification for addressing our readers with the patronizing ponderosity that is the accepted privilege of middle age, but on this occasion we will take leave to think aloud on the background against which the whole of British radio must be viewed if it is to be seen in true perspective. For forty years we have been intimately concerned with these things, and, as the world's oldest wireless journal by far, can hope to have accumulated a specialized collective knowledge.

The Beveridge Report is, two months after its publication, still considered important enough to be a common topic of conversation in wireless circles. But when the vital subject of monopoly in broadcasting comes up, it seems to us that those participating would see the problems more clearly if they were reminded of the essentially monopolistic basis on which radio in Great Britain has always been organized. All our legislation, ever since the first Act of 1904, has been aimed at securing the Postmaster General's monopoly. There is no law giving any radio rights to the citizen; it is only when he becomes a licensee of the P.M.G. that he can claim certain privileges in return for the licence fee he has paid for the right to enjoy a specified (and generally very small) part of the monopoly.

Our fathers and grandfathers having agreed for better or worse nearly fifty years ago to make wireless a monopoly, is it strange that broadcasting, when it came, should also have been made monopolistic? As we believe, it is bound to remain so, and the most that can be done is to seek for safeguards against "the undeniable dangers" inherent in such a system of control. All this applies to medium- and high-frequency broadcasting; the Beveridge Report has happily left the door open—or perhaps we should say just ajar—for a less unified control of e.h.f. broadcasting, which is less in the nature of a natural monopoly.

Finally, may we enter a plea that debate on the Beveridge Report should not be bedevilled by

party politics? This should be a matter beyond party, and all the political catchwords customarily bandied about on such occasions are quite out of place. Readers may be reminded that the original and over-riding monopoly in radio was conferred by a Conservative government.

Home Broadcast Recording

ONE of the subsidiary subjects touched upon in the Beveridge Report was the uncertain position of those who record broadcast programmes for subsequent reproduction. Does this constitute an infringement of copyright?

The answer to that question is by no means clear. According to the Copyright Act of 1911 the acoustic recording of copyright material without licence or fee is reserved except for a few special purposes, such as study or research. But, of course, when that Act was passed, broadcasting was not even in sight.

We have recently been reading a copy of the Memorandum on this subject submitted by the British Sound Recording Association to the Beveridge Committee; this particular piece of evidence was not printed in the Report. The Association, after defining the nature and scope of home recording of broadcasting, went on to plead for clarification of the legal position and claimed that home recording should not be subject to any additional licence fee.

So far as recording for personal and domestic use and not for sale is concerned, we are very much in sympathy with the views expressed by the B.S.R.A. But there is one complicating factor: some holders of copyright in broadcast matter undoubtedly also derive a revenue from commercial gramophone records, and this revenue would presumably decline if home recording became widespread. This and related matters should be taken into account when the Copyright Act is amended.

Television and Sound by Wire

Brief Description of a Combined Broadcast Distribution System Designed for North America

By R. I. KINROSS,* M.I.E.E.

WHAT technical problems are involved in the design of a system for distributing television and sound broadcasting by wire and how can they be overcome? The simplest form of distribution system is one retaining the original sound and vision carrier frequencies and such a system was described in *Wireless World* of January, 1949. Whilst enabling the tenants in blocks of flats to operate normal receivers without the need for individual aerials this does not permit houses in a large built-up area to be covered economically. To achieve this a lower carrier frequency must be used, since the attenuation of cable varies roughly as the square root of the frequency. The lowest frequencies that could be used are the video frequencies, but the problems of frequency and delay distortion in the network, though by no means impossible of solution, are more difficult than when using a carrier frequency. Furthermore, if two or more vision programmes are required, as is the case in North America now, carrier frequencies must be used if distribution is to be made over one pair of conductors only.

This article gives a brief outline of the difficulties

involved in the design of a system of distributing two television programmes operating on American standards (together with their associated sound), plus six sound programmes. The problems, broadly, fall under two heads:

(a) coping with American instead of British standards, and

(b) the more general problems of wire distribution.

The latter will be of more interest to English readers and comments on the former can be restricted to reiterating that black and white television in America works on 525 lines, 60 frames per second and the modulation is in a negative direction.

The fact that eight sound programmes were required ruled out the possibility of distributing these at audio frequencies though this is generally recognized as the most economical way of distribution when up to six sound programmes are required. The choice of carrier frequencies finally adopted was:

Sound, 180-320 kc/s inclusive, at 20 kc/s spacing.

Vision, 16 Mc/s and 28 Mc/s.

The sound carrier frequencies are amplitude modulated, both sidebands being transmitted. The vision carrier frequencies are also amplitude modulated in a negative direction, but the lower sidebands in the

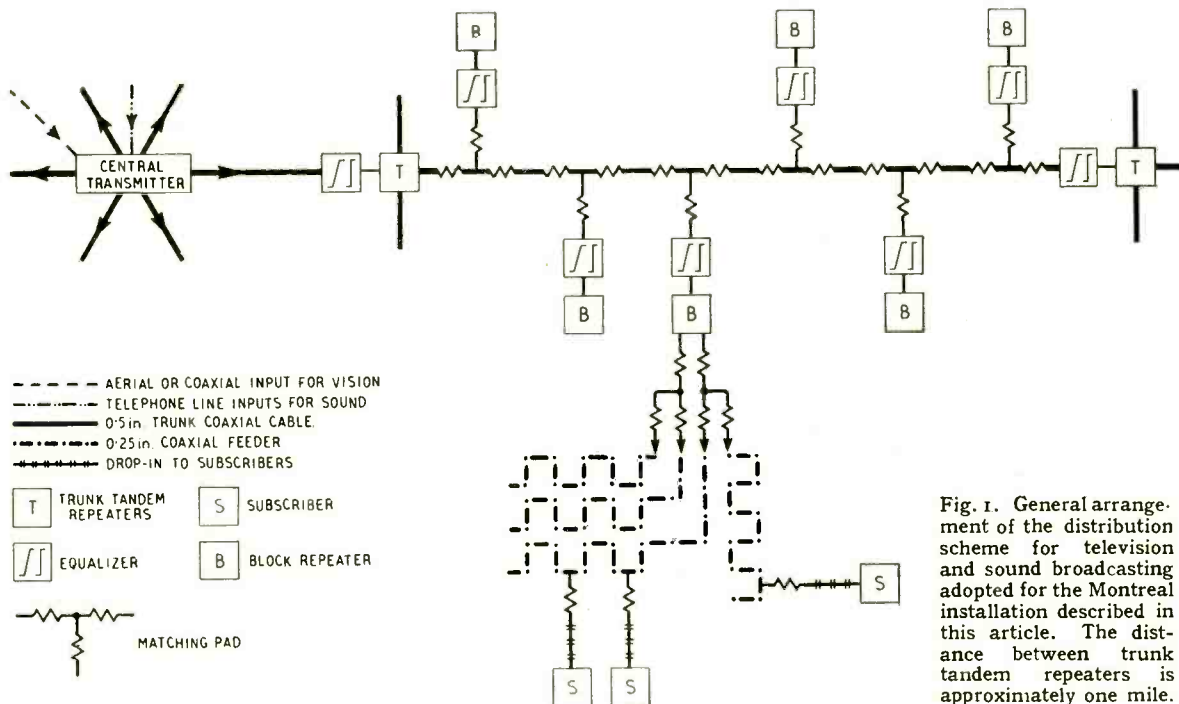

Fig. 1. General arrangement of the distribution scheme for television and sound broadcasting adopted for the Montreal installation described in this article. The distance between trunk tandem repeaters is approximately one mile.

case of 16 Mc/s and the upper in the case of 28 Mc/s are partially suppressed in accordance with normal vestigial sideband operation. The reason for arranging the vision sidebands in this manner is that, while occupying no greater bandwidth, the carriers, in which lie the greatest energy content, are kept as far apart as possible which simplifies the design of the receiver.

The choice of the carrier frequencies was governed by a necessity for keeping the sound group of frequencies and vision group of frequencies each within their own octave, so as to eliminate all risk of interference from harmonics. This enables all eight sound carriers to be amplified simultaneously by one repeater covering the range 170-330 kc/s and both vision programmes to be amplified by another repeater covering 15-30 Mc/s.

After the choice of frequencies the next most important decision to be made concerned the type of cable to be used. The cheapest type is an unscreened twin which can either consist of two wires spaced an inch or two apart or can be made up in the form of a twisted pair embedded in some low-loss dielectric such as polythene. The former has a lower attenuation, but is not sufficiently immune from external interference such as a powerful radio transmitter operating in the vicinity, and furthermore the presence of metal objects near the wires causes reflections which appear on the picture as ghost images. The unscreened twisted pair is better behaved as regards interference, but is subject to intolerably large changes in propagation characteristics due to rain. This leaves a choice of screened twin or co-axial cable. For a given size, cost and frequency, a co-axial type cable has an appreciably lower attenuation than a screened twin. Co-axial cable was therefore decided upon.

The first type of co-axial cable tried out had an outer sheath consisting of a copper braid, but it was found to be very subject to interference both at vision and carrier frequencies. Co-axial cable normally relies

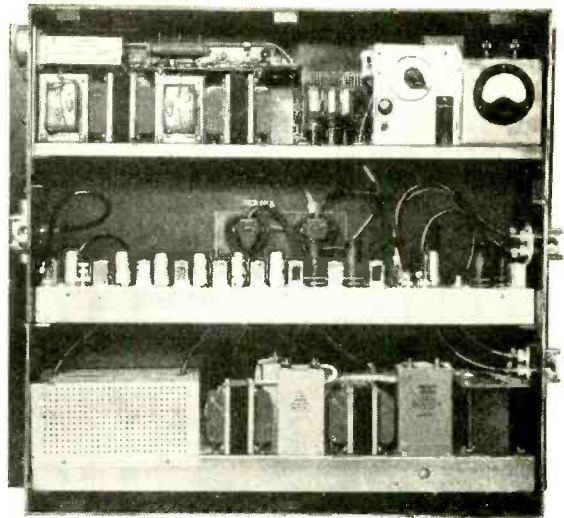

Repeaters comprise power pack (top chassis), vision repeater (centre) and sound repeater (bottom).

on wanted currents flowing on the inside surface of the outer sheath and unwanted currents flowing along the outside surface: the exact degree of penetration is a function of the permeability and the resistivity of the sheath and of the frequency. Measurements showed that interference was considerably greater using copper braid than calculation showed would be the case using a solid copper tube of similar thickness. Obviously adjacent wires in the braid were not making adequate contact with each other. A copper tube would have been too expensive, but aluminium tube was little or no more expensive than copper braid and provided a very much greater immunity from interference. By maintaining the wanted signal at an adequate level inside the cable, the system is immune from the highest field strength likely to be encountered in a built-up area, whether from industrial machinery, diathermy or radio transmitters. The radiation from the co-axial cable chosen is well below the requirements of the General Post Office.

Let us now consider the more general problem of distribution. Fig. 1 shows the general arrangement which has been adopted. The object of the trunk cable and trunk tandem repeaters is to carry the composite signal of sound and television as far across a town as possible. Clearly, the larger the cable the fewer tandem repeaters will be required. However, if this argument is taken too far one finds that one is spending more on the cable than is being saved on the repeaters, and a suitable compromise was decided upon by adopting 0.5-in co-axial cable which necessitates a tandem repeater about once a mile. The repeaters are designed to enable four to be used in tandem without excessive degradation of signal, and therefore the system as a whole can cover an area of 10 miles diameter, which should be adequate for most towns. In practice, the cable may not be able to run by the shortest route which will, of course, reduce the diameter.

Subscribers are fed by means of a 0.25-in diameter co-axial feeder energized by block repeaters which derive their input from the trunk distribution system. A cable equalizing stage and automatic gain control, working off the tips of the synchronizing pulses, is

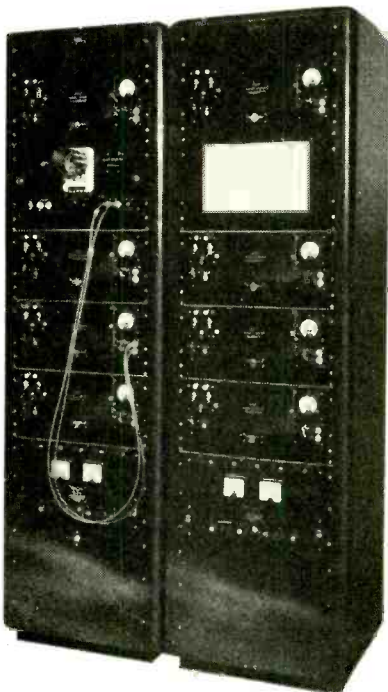

Eight-channel rack-mounted sound carrier transmitter with monitor. In the bottom sections are the two associated power packs. A block schematic of the carrier transmitters is given on the next page.

included in each vision repeater. A.G.C. is necessary due to the change in attenuation of the cable caused by variations of temperature. This, in a climate of extremes like Canada, can be as much as 8 decibels per repeater section or 40 db over the whole system. Tandem and block repeaters have the same external appearance and differ from each other only in gain and bandwidth. Each repeater houses three units. The top chassis is a power pack, the centre chassis a vision repeater and the bottom is the sound repeater. The latter is a three-stage resistance-coupled amplifier with negative feedback with a flat response between 170 and 330 kc/s. The attenuation of the sound carrier frequencies is so low (0.05 db per roof at 300 kc/s) that the sound repeater can often be omitted and replaced by a simple low-pass filter which bypasses the vision repeater. A block repeater can feed up to about 500 dwellings but the exact number depends on the density and layout of the streets. No difficulty has so far been experienced in the Montreal installation in housing these repeaters in private garages, etc., along the routes but if necessary they can be mounted on poles externally.

A block diagram of the central transmitter is shown

in Fig. 2 and this is largely self-explanatory. Television inputs are available either from aerials or vision inputs, which may come from a local transmitter, film equipment or a camera in the central transmitter.

The subscriber's vision receiver is simpler than a normal American set: It never has to deal with a signal of less than one millivolt, the flywheel type of time base normally used on American sets to combat interference is not necessary, and switching is limited to two vision programmes compared with the thirteen-position channel-selection switch which has to be provided on a standard American receiver—though only two or three stations may be receivable in any particular locality.

The superhet sound receiver is also simpler and gives better reproduction than a normal broadcast receiver, since the input signal to it is never less than 2 millivolts, there is a 20 kc/s separation between channels, there is no risk of second channel or other spurious interference and, all frequencies being below 320 kc/s, frequency drift of the local oscillator is negligible. One knob controls the selection of programmes, whether vision or sound, and also change over to gramophone reproduction.

Fig. 2. Block schematic of the central transmitter. The sound carrier frequencies are spaced 20 kc/s apart.

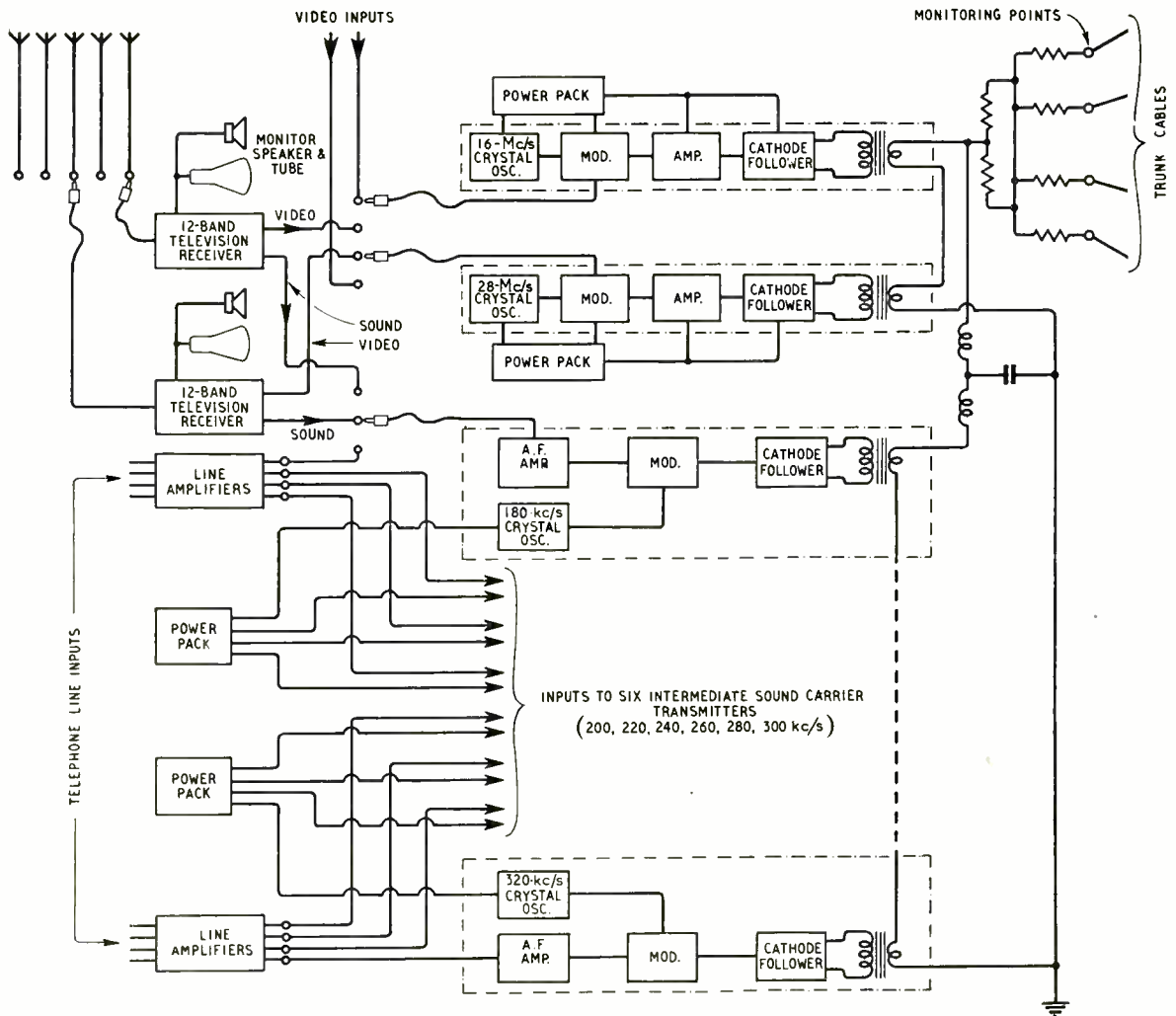



Left: Simplicity is the keynote of the controls on the subscriber's combined sound and vision receiver.

Below: Portable battery receiver for testing the overall frequency response at the subscriber's outlet.

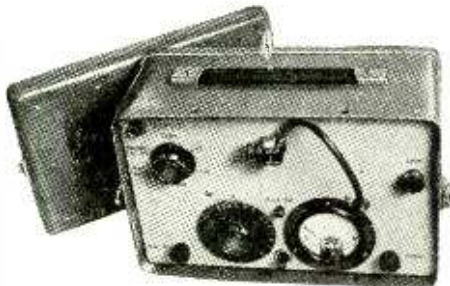

Above: Constant-output signal generator. One of the pieces of specially designed test equipment.

Special test equipment was developed to enable equalization of the network to be rapidly carried out by one man. A constant-output signal generator covering the band 15-30 Mc/s was designed as a sender, the band being swept slowly backwards and forwards about once every two minutes by incorporation of a small electric motor. A portable battery receiver which is directly calibrated in megacycles and millivolts is used at the receiving end from which an overall frequency response can be plotted. Calculation shows that over this band of frequencies and with the type of cable and equalizers used, a flat frequency response results in negligible phase distortion and this has been checked in practice by examining a square pulse transmitted over the system.

Two vision programmes (one derived from a film

and the other a stationary pattern) together with eight sound programmes have successfully been transmitted over a network $2\frac{1}{2}$ miles long using $\frac{1}{4}$ -in diameter trunk cable. This is electrically equivalent to 5 miles of $\frac{1}{2}$ -in diameter trunk cable. Several miles of the latter have now been erected in Montreal on pole routes, house property and underground, and field trials so far carried out indicate that the theoretical and experimental work in the laboratory will be confirmed as practical on a large scale.

All the development work leading up to the system of distribution here described was carried out in the laboratories of Central Rediffusion Services, and the author wishes to express his thanks to colleagues who were responsible for the design of individual items of equipment.

VALVE AND CIRCUIT NOISE

THE practical radio engineer cannot be blamed for regarding noise as a rather dull subject. It is one of those depressing and negative things which are always with us, like the poor, and which have to be overcome before any real progress can be made. What gives it an even more forbidding aspect is the fact that this single word "noise" covers nearly every kind of spontaneous fluctuation in radio, whether it is audible, visible or only detectable by instruments. Moreover, it is noise which ultimately determines the sensitivity of all electronic devices for detecting and amplifying signals—amplifiers, receivers, photocells and so on—for if the noise in the input circuit is greater than the incoming signal then the latter is incapable of being detected.

But when one comes to the mechanics of noise it proves much more interesting. Thanks to the work of the physicists, one is presented with a number of different physical phenomena, most of which have been analysed and placed on a quantitative basis. Historically, the first to be examined was shot noise in valves—not inappropriately by the scientist Schottky—in 1918, and it was he who showed that this phenomenon would set a limit to the useful gain of valve amplifiers. Since that time, many other sources of noise have been investigated. In valves, for instance, there is the "flicker effect" arising from variations in the activity of oxide cathodes; noise caused by the ioniza-

tion of gas molecules by collision with electrons; secondary emission noise; fluctuations due to current distribution in multi-electrode valves; and all the various types of noise caused by faulty construction. Then in other components there is the well-known thermal noise in resistors; noise caused by the flow of direct current in crystal rectifiers and semi-conductors; and Barkhausen noise in transformers arising from the non-uniformity of magnetization.

The progress of understanding in the last thirty years has not, however, run very smoothly. At the present time, some branches of the subject are understood completely, others have discrepancies between theory and experimental evidence, whilst the remainder provide only qualitative pictures. In view of this, and the general importance of noise, it is interesting to see a new publication on the subject which not only provides a competent survey of existing knowledge but points to the important problems which yet remain to be solved. This is the Radio Research Special Report No. 20, "Valve and Circuit Noise," published recently by H.M.S.O. for The Department of Scientific and Industrial Research. Although it is concerned only with the physical aspects of noise—not with the technical and engineering applications—the booklet is recommended because it provides background knowledge to an important subject in very concise form—and at a cost of only 9d.

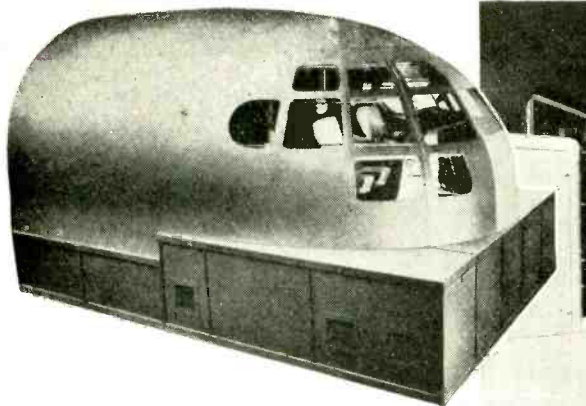

General views of the Redifon Type C. 700 flight simulator for the Boeing "Stratocruiser." In the interior foreground are the instructor's fault panel (right) and (left) the flight recorders and radio signal sources.

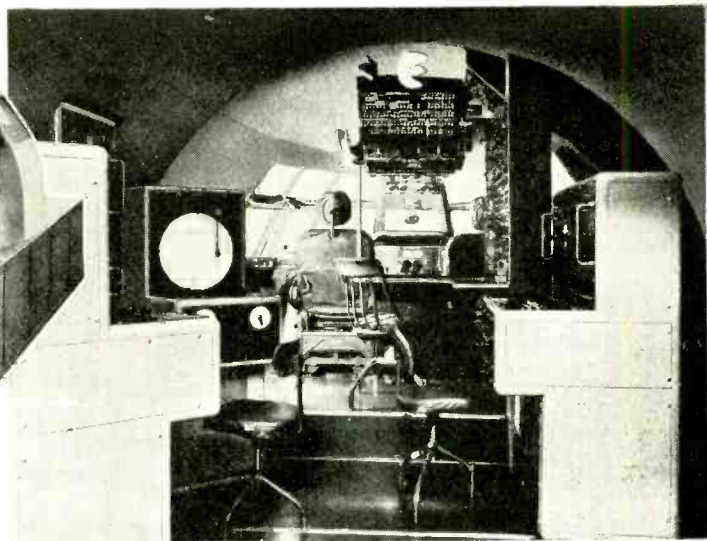

Electronic Flight Simulator

Equipment for Training B.O.A.C. Pilots

THE growing complexity of modern aircraft has raised problems of time and cost in the training of crews which are being successfully met by the application of electronic methods. Normally an expenditure of over £6,000 (about 21 hours flying time at a cost of £300 per hour) is necessary for conversion training of air crews to an aircraft such as the Boeing 377 "Stratocruiser," but with a flight simulator of the type to be described, flying time can be reduced to 8 or in some cases 4 hours, and all preliminary training effected at a cost estimated to show a reduction of 45 to 65 per cent.

British Overseas Airways Corporation, which uses the Stratocruiser on the North Atlantic routes, has hitherto sent crews to an American airfield, where a Curtis-Wright flight simulator for the Boeing 377 aircraft has been available on hire. Now a British-built simulator is to be installed at Meadowbank, Cranford, Middlesex, both for training and routine crew checks. It has been made by Redifon Ltd., Broomhill Road, London, S.W.18., who have already acquired considerable experience of this type of work in making synthetic trainers for bomber crews during the war. Arrangements with the Curtis-Wright Corporation of America have been made for exchange of technical information, but the model being built here incorporates several modifications arising from differences between the B.O.A.C. and American versions of the Stratocruiser.

First, an exact replica of the nose of the aircraft has been built, complete with controls and instruments for the captain, co-pilot and flight engineer. All controls are fitted with potentiometers which supply voltages, depending in their position, to electro-mechanical servo mechanisms grouped in three computer units dealing respectively with the flight parameters

and with inner and outer pairs of engines. The servos and their associated amplifiers are given characteristics, corresponding to the performance of the part of the aircraft which they simulate, which are incorporated in the form of potentiometer cards of specially calculated contours. The servo outputs are integrated in such a way that all inter-related aspects of flight performance are varied simultaneously and in the correct ratio. Appropriate meter readings are then passed back to the cockpit instruments.

For example, loss of power in one engine puts a calculated yaw on the aircraft which affects the synthetic compass reading and also provides a physical reaction which the pilot can feel in the controls. Changes of airspeed follow manipulation of the engine throttles and these are associated with appropriate changes in the "feel" of the flying controls. Engine noises (one loudspeaker for each engine) are accurately related in intensity to the brake horsepower readings and in frequency to the revolutions per minute shown on the indicator, so that the engineer can effectively check synchronization. Aerodynamic noise is supplied by a separate unit coupled to the airspeed indicator, and there is even a replica of tyre noise which is injected at precisely the right moment to indicate touch-down.

The instructor, who sits behind the flying crew, is provided with a "trouble panel" from which he can simulate no fewer than fifty different faults or changes in flight conditions. This panel injects the appropriate signals into the computers which in turn transmit all relevant changes to the instruments in the flying control panels. The instructor can then assess the crew's reactions in appreciating the nature of the trouble and the appropriateness of the measures taken to rectify it.

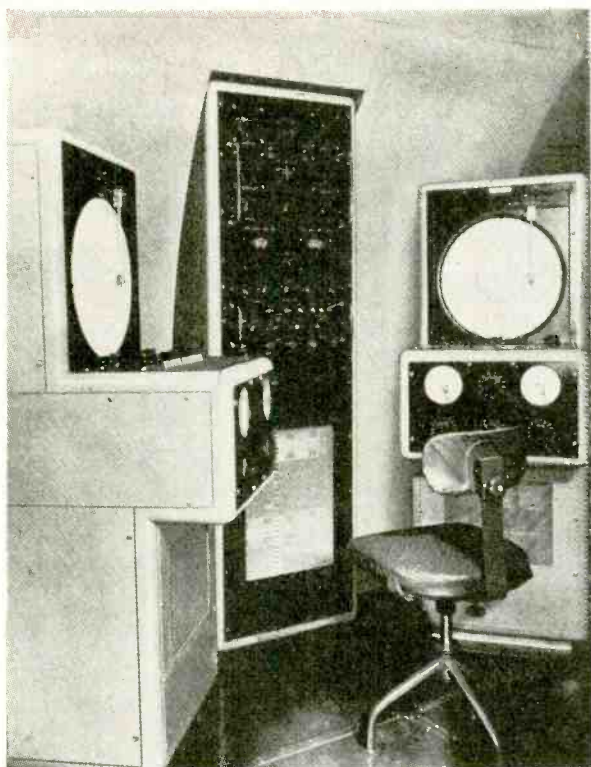

Radio aids and flight recorder units from which synthetic beacon and other radio signals are transmitted to the pilot. Cross winds and simulated beacon failures can also be presented to the crew from these panels.

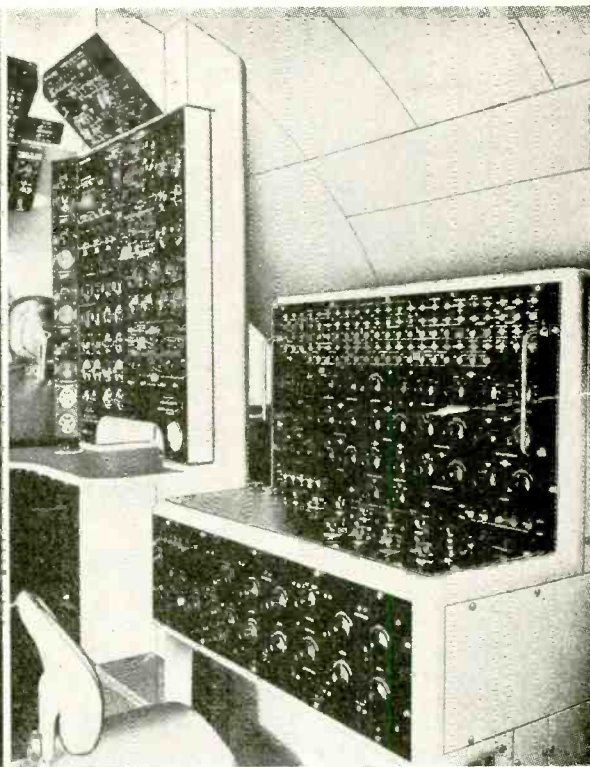

Chief Instructors' "trouble panel" from which up to fifty different faults or changes in flight conditions can be presented to the crew via their normal instruments.

Also behind the crew stations and to the left-hand side of the instructor, are the radio navigational signal generators. Two flight recorders are provided, which can be set up to correspond with four-course radio range signals or other radio navigational facilities, both at the point of departure and arrival of the synthetic flight. The centres of the discs represent the positions of the two beacons, and the track of the aircraft during flight is recorded by a moving pen. Altitude throughout the flight is registered on a separate drum recorder. Signal strength from the beacons is automatically varied according to the distance. Cross winds and beacon failures can also be presented to the crew with other flight problems from these panels.

The rack between the two flight recorders provides normal radio-telephone communication facilities.

An obvious advantage of a trainer of this scope over actual flight training is that crews can be subjected to rapid sequences of events which could not be deliberately contrived in the air, and refresher courses in dealing with abnormal circumstances can be given at regular intervals, in complete safety and at reasonable cost.

The Redifon Type C.700 flight simulator for the Stratocruiser is now in the final calibration and test stage and will shortly be dismantled and installed in the special building which has been provided for it at the B.O.A.C. school. This building will contain a briefing room for crews, an air-conditioned room for the computer cabinets, the Chief Instructors' office and, of course, the main room containing the full-scale replica of the nose of the aircraft.

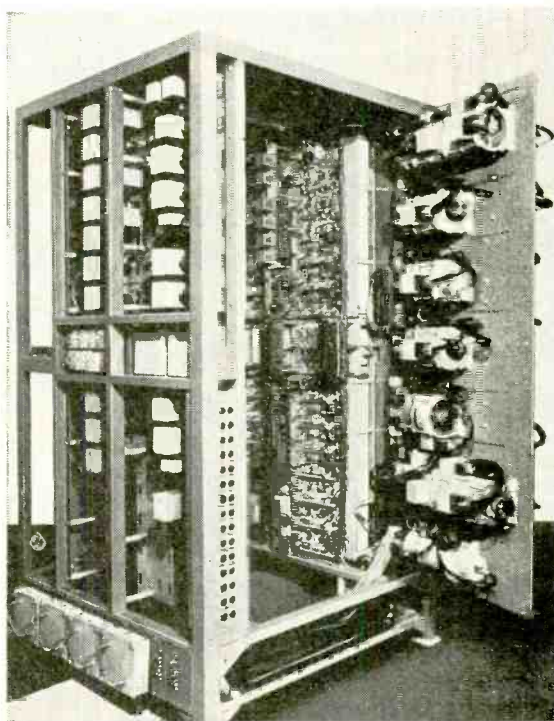

Computer cabinet for one pair of engines

Bass Without Big Baffles

Subjective Synthesis from Artificial Harmonics

By K. A. EXLEY

MODERN amplifiers, attractive as they may be in their aesthetic achievements, still suffer, in the opinion of the writer, from certain practical disadvantages.

First, in consideration of the question of initial cost and complexity of equipment, many constructors cannot afford the time, money or even perhaps patience, required to produce a high-fidelity amplifier containing ten or twelve valves in its main and pre-amplifier stages, apart from the power-supply units.

Secondly, few enthusiasts can erect a large enough baffle system in their small living rooms to radiate the low frequencies so faithfully presented to the loudspeaker by such an elaborate amplifier. Due usually to complaints from their less scientifically minded cohabitants, enthusiasts resort to using small baffle systems in which (in the case of cabinets) to house their loudspeakers. The result is loss and wastage of the bass tones which can never reach the ear in sufficient volume for musical requirements. In addition, damage to their loudspeakers is probably due to insufficient air loading at low frequencies.

It is worthy of note, that a 50-c/s note suffers a loss of 8 db when the loudspeaker is mounted on a baffle board as large as 6 feet square.

Regarding the reproduction of middle and high audio frequencies, few will disagree with the statement that it is easy, with a modern moving-coil speaker and negative feedback, to obtain a high standard of fidelity. The main difficulty in achieving realistic reproduction in the home seems to be in making the lower bass frequencies audible with reasonably small baffle systems.

There are two possible modes of approach to the problem. The first lies in the adoption of either a vented or an infinite baffle type cabinet. Such cabinets require special construction and if the range of frequencies radiated is to extend down to 30 or 40 c/s, a cabinet of considerable dimensions is required. The second approach to the problem is utilized in the amplifier to be described, and has the advantage of economy and simplicity. The method consists essentially of increasing the harmonic content of the lower bass frequencies by introducing harmonics from a second channel in which amplitude distortion has been allowed to occur.

The Human Ear

Before proceeding further we must consider one or two basic points. First, it is wished to stress that the human ear, with its physiological imperfections, and the pleasurable or unpleasurable impressions that it is

capable of receiving from a sound, should be the ultimate and final judge of the performance of any amplifier intended for the reproduction of music. Second, the term "realism of reproduction," involves the use of a subjective sense which is not interested, necessarily, in either linearity or freedom from distortion. It is not a term, therefore, to be assessed on cathode-ray oscilloscope appearances.

The human ear is far from being distortionless in itself, and, due to its properties of adding subjective tones, finds it almost impossible to distinguish between a pure fundamental tone, and suitably mixed

harmonics with the original fundamental removed. For similar reasons, the aural senses are particularly tolerant to the addition of harmonics to a fundamental tone whose frequency lies

below 100 c/s, and tend to interpret the phenomenon as an increase in volume of the fundamental. Above 100 c/s, however, the addition of random harmonics to a fundamental tone becomes increasingly unpleasant to the ear.

These facts are made use of by organ builders, who, in order to economize in space, replace lengthy bass pipes by several shorter ones in harmonic relation which are sounded in unison instead of a fundamental pipe. We are quite justified in deceiving the ear if the results are pleasurable from a musical standpoint.

Similarly, in the case of an amplifier, harmonics can be added to a low fundamental frequency by the introduction of non-linearity, and the ear notices little alteration in the sound from the loudspeaker. But, due to their shorter wavelength, harmonics can be radiated from a small speaker and baffle with greater efficiency than their fundamental. Using this principle it is possible to obtain an apparently full and realistic bass response from quite small baffles or cabinets.

Amplifier Details

Referring to the accompanying diagram, it will be seen that the circuit is designed with a view to economy of components, and comprises three stages of amplification, the final of which is a single output pentode V_4 , with negative feedback.

The additional valve V_3 , in the second stage is for the purpose of generating the required harmonics. Gain will be found adequate for many of the popular gramophone pickups.

The first stage of the amplifier comprises a high-gain triode V_1 , preceded by a volume control at the input end of the circuit.

In the second stage, the low-gain triode V_2 , is preceded by a simple but versatile tone compensation

The idea underlying this article may not find ready acceptance with high-fidelity purists, but it is one which has proved of value in other branches of music-making.

circuit. Three controls alter separately the levels of bass, middle and high audio frequencies over a relative range of up to 26db. It is not claimed, however, that *accurate* correction of recording characteristics can be obtained with this simple tone control circuit. It may be thought strange that the middle frequency level is made variable, but this enables the full power output of the amplifier to be used if required, without the addition of a further stage of amplification.

The output stage consists of a 4.5-watt pentode, loaded through a high-inductance output transformer. Negative feedback, which is linear, is taken from the secondary of the transformer to the cathode of V_2 , but not to the distorting valve V_3 . Resistive values quoted for the feedback circuit pertain to the use of a speech coil of impedance 15 ohms.

The distorting valve V_3 , receives its input from the anode of V_1 , through a low-pass filter R_5C_4 , and is, for all practical purposes, functional only below about 100 c/s, with the usual settings of the tone controls. A high-gain triode is used in which grid distortion is produced by providing a high anode load R_{12} , of 0.5 megohm, and zero cathode bias. The distorted output from V_3 , (which is equivalent to the fundamental plus multiple harmonics), is coupled to the grid of the output valve by means of a condenser C_8 , and a switch. The latter allows the "harmonic bass" component to be switched in or out of the main amplifier as desired.

It will be noted that V_3 , is not included in the feedback loop for obvious reasons, but further distortion of the harmonic component in the output stage is

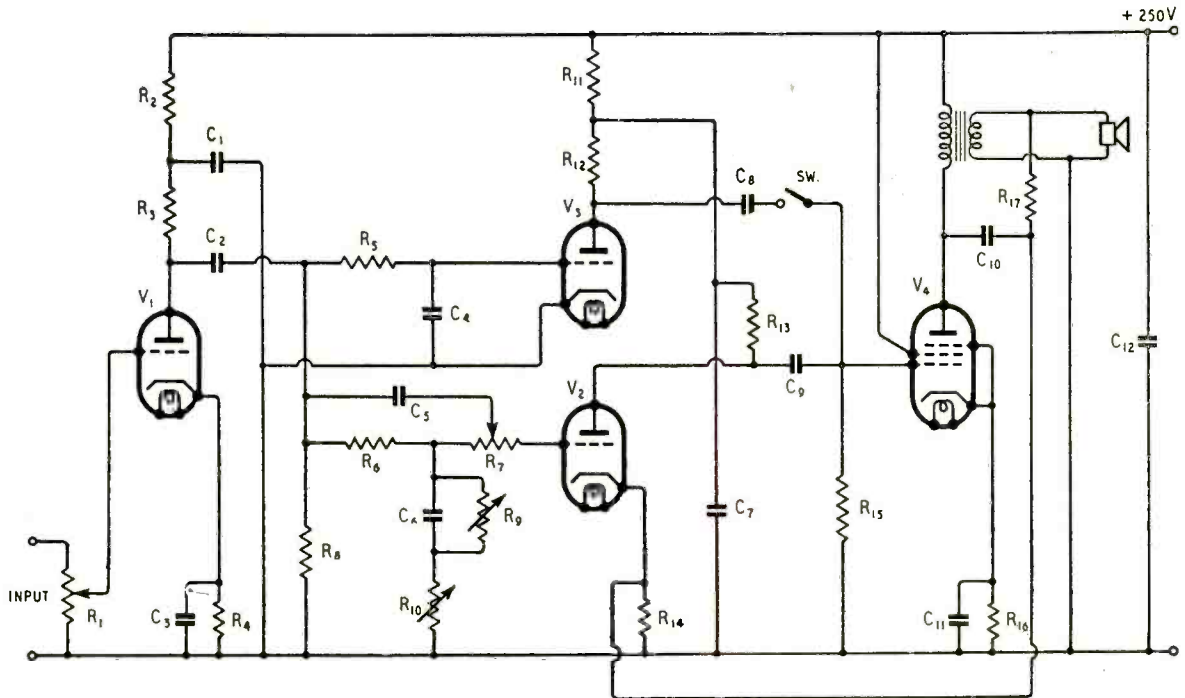

Fig. 1. Circuit diagram of amplifier with non-linear stage, V_3 , for producing artificial harmonics at low frequencies.

List of Component Values for Circuit of Fig. 1

- | | |
|---|---|
| R_1 50 k Ω , variable (or other value suitable to source impedance.) | R_{17} 2 k Ω , (for 15-ohm speech coil) |
| R_2 22 k Ω , (1 watt) | All resistors are $\frac{1}{4}$ -watt rating unless otherwise stated. |
| R_3 0.1 M Ω | C_1 8 μ F, electrolytic, 350 V working |
| R_4 2 k Ω | C_2 0.1 μ F, paper |
| R_5 0.1 M Ω | C_3 50 μ F, electrolytic, 25V working |
| R_6 0.1 M Ω | C_4 0.1 μ F, paper |
| R_7 0.25 M Ω , variable (treble control) | C_5 500 pF, silvered mica |
| R_8 0.5 M Ω | C_6 0.05 μ F, paper |
| R_9 0.25 M Ω , variable (bass control) | C_7 16 μ F, electrolytic, 350 V working |
| R_{10} 100 k Ω , variable (middle-frequency control) | C_8 0.1 μ F, paper |
| R_{11} 10 k Ω , (1 watt) | C_9 0.1 μ F, paper |
| R_{12} 0.5 M Ω | C_{10} 100 pF, silvered mica |
| R_{13} 47 k Ω , (1 watt) | C_{11} 50 μ F, electrolytic, 50V working |
| R_{14} 1 k Ω | C_{12} 32 μ F, electrolytic, 350 V working |
| R_{15} 0.25 M Ω | V_1 and V_3 , 6SF5 (or equivalent high-gain triode) |
| R_{16} 180 Ω , (3 watt) | V_2 6J5 |
| | V_4 EL33 (Mullard) Sw, switch, panel type. |

minimized by reflex negative feedback through V_2 . The final bass product reaching the loudspeaker is a mixture of the "pure" bass component from V_2 , and the "harmonic" bass component from V_3 , with a slight, though unimportant, phase difference between the two. The middle and high audio frequencies do not pass through the non-linear channel and are therefore not themselves distorted or modulated.

The small feedback condenser C_{10} , is merely to avoid troubles with the leakage inductance of the output transformer at high frequencies.

It is advisable to use with the amplifier a loudspeaker whose diaphragm has a soft suspension, with a bass resonance below 60 c/s. Some commercial manufacturers produce a type of artificial bass by forcing the low frequencies into a speaker with a high bass resonant frequency e.g., 150 c/s. Although this may make a bass note "audible" using a small baffle, the results are unnatural and displeasing to the ear on music and even more so when reproducing speech, owing to boom and accentuation of the upper bass region.

R.E.C.M.F. Exhibitors

WE give below the list of manufacturers who will be exhibiting at the eighth annual exhibition organized by the Radio and Electronic Component Manufacturers' Federation, which will be held at Grosvenor House, London, W.1, from April 10th to 12th. It is not a public exhibition and tickets (obtainable from the R.E.C.M.F.

22, Surrey Street, London, W.C.2) are limited to those who have a professional, industrial or trade interest in components.

The Show, which will include components, measuring instruments, valves and accessories, will be open from 10 a.m. to 6 p.m., except on last day when it closes at 5.

STAND		STAND		STAND	
A.B. Metal Products	36	Enthoven, H. J., & Sons	47	Plessey International	65
Acoustic Products	56	Eric Resistor	24	Permanent Magnet Association	84
Advance Components	73	Ever Ready Co. (Great Britain)	82	Pye	107
Antiference	68				
Associated Technical Manufacturers	74	Ferranti	9	Reliance Electrical Wire Co.	22
Automatic Coil Winder & Electrical Equipment Co.	86	Fine Wires	108	Reslosound	23
Belling & Lee	12	Garrard Engineering Co.	69	Salford Electrical Instruments	35
Bird, Sydney S., & Sons	8	General Electric Co.	93	Sangano Weston	87
Birmingham Sound Reproducers	66	Goodmans Industries	18	Scharf, Erwin	52
Bray, Geo., & Co.	111	Guest, Keen & Nettlefold	106	Scott, Geo. L., & Co.	103
British Electric Resistance Co.	59			Simmonds Aerocessories	30
British Insulated Callender's Cables	57	Hallam, Sleigh & Cheston	104	Stability Radio Components	78
British Mechanical Productions	27	Hellermann Electric	42	Standard Telephones & Cables	7, 10
British Moulded Plastics	88	Hunt, A. H.	20	Static Condenser Co.	77
British N.S.F. Co.	61			Steatite & Porcelain Products	28
British Rola	48	Igranic Electric Co.	72	Suflex	6
Bulgin, A. F., & Co.	21	Imhof, Alfred	89	Symons, H. D., & Co.	110
Bullers	75				
		Jackson Bros.	37	Taylor Electrical Instruments	1
Carr Fastener Co.	60	London Electrical Manufacturing Co.	39	Taylor Tunncliffe (Refractories)	5
Clarke, H., & Co. (Manchester)	105	London Electric Wire Co. & Smiths	76	Telegraph Condenser Co.	44
Colvern	51	Long and Hambly	16	Telegraph Construction & Maintenance Co.	50
Cosmocord	71			Telephone Manufacturing Co.	45
		McMurdo Instrument Co.	70	Thermo Plastics	14
Daly (Condensers)	81	Magnetic & Electrical Alloys	33	Truvox Engineering Co.	19
Dawe Instruments	49	Marconi Instruments	97	Tucker (Geo.) Eyelet Co.	4
Decca Record Co.	94	Measuring Instruments	109		
De La Rue, Thomas, & Co. (Plastics Division)	96	Micanite and Insulators Co.	41	Vitavox	43
Dubilier Condenser Co.	29	Ministry of Supply	92		
Diamond "H" Switches	3	Morganite Resistors	54	Walter Instruments	80
Du Bois Co.	2	Mullard Electronic Products	31, 101	Walter, J. & H.	79
Duratube & Wire	40	Multicore Solders	17	Wego Condenser Co.	34
		Murex	100	Welwyn Electrical Laboratories	11
Edison Swan Electric Co.	38	Mycalex Co.	83	Westinghouse Brake & Signal Co.	13
Egen Electric	26			Weymouth Radio Manufacturing Co.	46
Electro Acoustic Industries	58	Oliver Pell Control	25	Wingrove & Rogers	53
Electronic Engineering	85	Painton & Co.	62	Wireless Telephone Co.	63
Electrothermal Engineering	102	Parmeko	32	Wireless World	112
English Electric Co.	95	Partridge Transformers	55	Woden Transformers	67
		Plessey Co.	64	Wright & Weaire	15

Operating Airborne Equipment

Are Radio Officers Essential in Civil Airliners?

By BASIL R. CLARKE

IS modern airborne radio-telephone equipment reliable and consistent enough to provide continuous intelligible communication between air and the nearest ground station throughout a flight of whatever length? If it is, then a case can be made out for abandoning the radio officer and placing the onus of operating the radio gear on the second pilot. But this is by no means the only factor which should be considered before taking a decision. The carrying—or not—of radio officers in civil airliners is a matter affecting a large number of men whose skill is of the highest order.

Let us therefore examine the technical implications of the problem first. Where flights are over well-populated land masses a system of e.h.f. repeater stations can be established which will ensure clear 'phone communication between air and ground at any point in the flight. Here then a case of a sort can be made out for leaving the radio officer on the ground. Even in the event of a communication breakdown there are enough emergency landing grounds to eliminate all but an almost negligible danger of disaster attributable to lack of radio control.

However, an almost negligible danger is still too great a danger when passenger and crew lives have to be considered. We shall come back to this question of technical failure again later.

When the flight is on a trunk route passing over oceans or large unpopulated land masses, such as the Sahara or the Andes, the whole picture becomes a very different one. While it might still be technically practicable (in some areas) to lay down an automatic repeater chain for e.h.f. communication it is unlikely that it would be an economic proposition and the difficulties of maintenance would be almost insuperable.

Consequently it would be necessary to fall back on h.f. systems. Here we come straight up against formidable problems. Every radio operator, professional or amateur, knows that there are occasions when h.f. communication fails and that occasions are not too infrequent when R/T and not W/T is in use.

Let us be fair and admit that if an aircraft, in trouble over the Andes, lost radio communication and was unable to announce the location of its intended force-landing point it is unlikely that it would matter much since there would probably be no survivors anyway. But there are recorded cases of crashes in the Alps, the Andes and other mountain areas where there have been many survivors. Those survivors only lived to tell the tale because an efficient search and rescue system came into immediate operation and was able to concentrate on a relatively small search area.

On the other hand there are dozens, probably hundreds, of crashes in remote areas that have never been found because of lack of radio communication.

If this is true on land, how much more true is it of the ocean trunk routes where the time factor is vastly more important even if a successful "ditching" has been achieved. Nearly two years ago I took

part in a search for a ship in distress on the North Atlantic and, although the final result was all that could be desired, the search was prolonged by many hours because the ship in trouble had only a short-range R/T equipment whose signals were picked up by a trawler without d.f. gear. Had longer-range W/T equipment been available the search would have been reduced by at least 12 hours and probably more. And it may be pointed out that this rescue system was using all the aids known. There were four ships and relays of aircraft from both Iceland and Scotland. All the aircraft and two of the ships were radar fitted.

In 1949 a strike of radio officers in the Pan-American Airways company was caused by the firm's decision to set up h.f. R/T communication on their overseas routes and to dispense with W/T. I interviewed the leader of these radio officers and some very illuminating facts came out.

They were not primarily concerned about the possible loss of their jobs as certain guarantees had been offered. They were, however, genuinely worried about the danger which they considered would be experienced in the air if this policy were adopted.

Several cases of R/T communications failing during the preliminary tests were cited and one in particular is worth quoting. An aircraft carrying a full load of passengers was flying westbound and was only using R/T although W/T was available. All went well until they reached 35° West longitude. From there to 49° West they were completely out of touch by R/T with either side of the ocean. So, as far as their R/T went, for about 14 degrees, which in those latitudes represented about 520 nautical miles, that aircraft had no contact with any possible emergency helpers.

Now let us return to the question of equipment breakdown. Such things can and do occur and, whilst it must be admitted that an aircraft is not the ideal place in which to do a servicing job and that the radio officer is not of necessity a highly skilled mechanic armed with a full range of test gear, there is at least an even chance that he will get the gear into some sort of working order. It is most unlikely that the pilot, second pilot, navigator—if any—purser or air hostess will have the skill to do that.

What is the case against carrying a radio officer? Two main objections by the airline operators appear to complete it. One is the officer's salary—and we admit the need for economy—the other is his weight, representing the loss of one passenger per trip or the revenue from an equivalent weight of freight.

Apart from communication systems airborne radio aids to flight and landing become more important and more complex. Therefore there is an even stronger case for having on board at least one man who has some chance of dealing with a breakdown. So long as vital communications can suffer at all through lack of a radio officer that radio officer must be present "to take good care of you."

Training Technicians and Technologists

*Government and
Industrial Proposals*

A FEW months ago two reports dealing, respectively, with the education and training of technologists and of technicians were issued, and in this article we propose reviewing the schemes recommended. Before attempting, however, to outline the plans proposed by the Ministry of Education for higher technological education and those for the training of electrical technicians outlined by a committee on which the radio industry was represented, it would be well to define the technologist and the technician.

In the Ministry publication, "The Future Development of Higher Technological Education—Report of the National Advisory Council on Education for Industry and Commerce,"* it is suggested that the simplest practical definition of technological or higher technological education is that which, at the minimum, is of a standard comparable either with that of a first degree at a university or with that accepted by major professional institutions as satisfying their educational requirements for corporate membership. The second report, "The Education and Training of Electrical Technicians," was prepared by a committee appointed jointly by the British Electrical and Allied Manufacturers' Association, the Radio Industry Council and the Institution of Electrical Engineers, by whom it is published, price 1s.

In this report the electrical technician is defined as one who "carries out in a responsible manner approved techniques which are either common knowledge amongst those who are technically expert in his branch of industry or specially prescribed by professional electrical engineers." It adds that to become a technician a person must have received a technical education up to a standard at least that of the Ordinary National Certificate in Electrical Engineering.

To deal with the technician first. The committee's inquiries have revealed two main facts. First, that the status of technicians is not nearly so well-defined, nor the importance of their systematic training so fully appreciated, as is the case with professional engineers on the one hand or with craftsmen on the other. Secondly, the facilities for the education and training of technicians to meet their needs are quite inadequate in quantity and extent.

No attempt has been made in the report to prescribe in detail either the training of the many different types of technicians engaged in the electrical industry, or the courses of education that should be available for them; it was considered sufficient to concentrate attention on the underlying principles and other relevant considerations on which courses of education and schemes of training should be planned. The principal method of providing for these needs should be a four- or five-year apprenticeship or training (the period depending on the standard of entry),

* H.M.S.O. Price 1s.

with concurrent education at a technical college. An alternative method is the "works-based" sandwich scheme which may be particularly appropriate where a number of firms can join together to provide adequate training in a co-operative scheme which they would be unable to do individually.

When this report was presented by the chairman of the committee, Sir Arthur Fleming, at a meeting of the I.E.E. it created considerable interest and discussion. The committee members nominated by the R.I.C. were D. A. Bell, T. E. Goldup, C. Grad and N. C. Stamford.

The main proposal in the Government report is the establishment of a national body with the title Royal College of Technologists. Its main function would be to approve (a) suitable courses of advanced technology submitted by technical colleges and (b) the appointment of suitable external examiners to assist the colleges in setting and marking their own examinations.

A number of suggestions concerning the awards to be made by the proposed college were considered by the National Advisory Council, and it is recommended that an Associateship is granted for the first award, Membership for the second, and Fellowship and Honorary Fellowship for those who further distinguish themselves in the field of technological education and research.

To allay fears which might arise regarding the place to be occupied by the universities and existing technical colleges in the scheme, the report concludes thus: "Within the wide range of educational provision for technology, both universities and technical colleges have played, and will continue to play, most important parts. Their respective contributions may differ in type, but are complementary in character. The distinctive feature of the technical college is that the main emphasis in its courses is on the practical application of scientific principles to design and production. We feel that there is an urgent need for the provision of new courses in the colleges at the first-award level, mainly though not exclusively on a full-time or sandwich basis, organized to concentrate more on the fundamental sciences than is usual at the present time, and yet at the same time more readily adaptable to the changing university course. Both technical colleges and universities have much useful work to perform in the post-graduate or advanced fields of technology by the provision of courses of study of a high standard in specialized fields. . . . We are of the opinion that the whole future planning of courses, facilities and awards is likely to be unrealistic unless steps are taken concurrently at the national level to provide a permanent focus for the broad examination of needs and assistance in the promotion of technological education to a position in the national economy commensurate with its importance to the national well-being."

WORLD OF WIRELESS

National Radio Exhibition ♦ Signals Reserve ♦ Cinema
Television ♦ Metre-wave Broadcasting ♦ New B.B.C. Stations

Earls Court Show

THE change this year from Olympia to Earls Court for the 18th National Radio and Television Show (August 28th—September 3th) has made available a larger floor space than ever before and the scope of the exhibition is to be broadened. In addition to covering as usual every branch of the radio and electronic industry there will be gramophones, records and accessories.

For the demonstration of broadcast receivers, sound-proof enclosures will be provided and a medium-frequency radio signal will be "piped" to them from the exhibition control room. It will be modulated with good-quality speech and music obtained from magnetic-tape recordings.

A new service which it is hoped to provide this year for the benefit of exhibitors of high-grade audio apparatus, will consist of a high-quality audio signal superimposed on the cable network carrying the radio programme already mentioned.

It is proposed to have an e.h.f. radio link between Alexandra Palace and Earls Court, giving an interference-free channel for the television demonstrations. There will also be better facilities for comparing the makes of television receivers in a gallery 250ft long.

The first day is to be "Invitation Day" for oversea and other special visitors, and, subject to his official duties, Earl Mountbatten will open the exhibition to the public on August 29th.

R.A.F. Voluntary Radio Service

WITH the object of building up an adequate and efficient reserve behind the Signals Branch of the R.A.F. a Voluntary Radio Service is to be formed. Candidates for enlistment must be able to receive morse code at 20 w.p.m. and must have had experience in the operating and minor servicing of communication receivers.

Members will, in the main, be enlisted into the R.A.F. Volunteer Reserve and will be liable to call-up in emergency. Selection will be confined to men aged between 18 and 45. Training will be undertaken by volunteers in their own homes on radio receivers lent by the Air Ministry for which an upkeep allowance will be paid. Occasional attendance at a R.A.F. Reserve Centre will be required.

Candidates must undertake to serve for five years, and those who are enlisted in the R.A.F.V.R. and have not previously served in the R.A.F. must attend, during the first year in the Reserve, a continuous training period of up to 15 days at a Royal Air Force station. Enlisted R.A.F.V.R. members will be eligible for the annual bounty of £7 10s and the annual efficiency payment of 30s.

Applications and inquiries should be addressed to the Air Officer Commanding-in-Chief, Home Command, R.A.F., White Waltham, Maidenhead, Berks.

Cinema Television

CONSIDERABLE interest has been aroused by the findings of the Beveridge Committee on the vexed question of television in the cinema which, as we stated Editorially last month, we consider has nothing to do with broadcasting or the B.B.C. The outcome, therefore, of an application by Granada Theatres, Ltd., for the P.M.G.'s permission to build a television station to transmit newsreels, etc., to its 35 cinemas in and around London, will be awaited with interest. The basic plan was formulated in the evidence given by Granada Theatres to the Beveridge Committee.



DAVENTRY TRANSMITTER. To facilitate the removal of the high-power valves in the new Marconi air-cooled transmitters, the valve holders are mounted on runners.

Europe's V.H.F. Stations

WITH a view to preparing an appreciation of the present position of v.h.f. broadcasting in Europe and the problems involved should its use be extended, the European Broadcasting Union is sending a questionnaire to each broadcasting authority in the European Area. It is hoped that as a result of the study of the replies it may be possible to outline some common principles which might form the basis of a frequency allocation plan.

It is felt by the Union that some of the conclusions regarding the propagation of metre waves are based upon "serious over-simplifications" and published material which does not necessarily apply to European conditions.

New Daventry Transmitter

A FEATURE of the new medium-wave (647 kc/s) B.B.C. transmitter at Daventry, which is shortly to be put into service for improving the coverage of the Third Programme, is that all the valves of each of the two 100-kW transmitters are air-cooled. The transmitters will be operated in parallel, but in order to conform to the Copenhagen Plan the actual power to the aerial feeder will be limited to 150 kW.

The new Marconi transmitters are installed in the hall that housed the old long-wave 5XX transmitter. Installed by Marconi's in 1926, it was in service until 1948.

Holme Moss Delayed

WEATHER conditions which have prevailed during the winter months must be held responsible for the delay which is being experienced in completing the Holme Moss television station. It had been hoped by the B.B.C. that the station would have been opened by the middle of this year but the schedule has had to be amended. Preliminary transmissions on medium power are planned to begin in July with the official opening of the station towards the end of September.

It has been suggested that there has been a delay in the delivery of equipment but, so far as the major radio manufacturers are concerned, we understand that the equipment was completed on time.

The 35-kW vision transmitter

and the 12-kW sound transmitter are being supplied by Marconi's W.T. Co. who are also manufacturing the feeders, diplexer and the eight-dipole array for the 750-ft mast being erected by B.I. Callender's Construction Co.

Television Convention

THE Institution of Electrical Engineers is to organize a Convention to be known as "The British Contribution to Television," to be held in April, 1952.

This date has been chosen to give authors ample time in which to prepare their papers, and to avoid following too closely on this year's Joint Engineering Conference (4th-15th June), one session of which will be devoted to a survey paper on television (June 8th).

It is intended that the Convention shall consist of the reading and discussion of a number of papers, supported by demonstrations, together with visits of inspection to appropriate organizations. The Convention will probably last five days.

Exported Components

IT is revealed in the eighteenth annual report of the Radio and Electronic Component Manufacturers' Federation that almost 30 per cent of the total value of the radio industry's exports during 1950 was accounted for by components. The comparative figures (in £ millions) for 1949 and 1950 for each of the main sections of the industry are:—transmitters, 3.2, 6.5; receivers, 3.4, 3.25; components, 4.0, 5.3; valves (including valves in equipment), 1.9, 2.7.

The geographical distribution of exported components is interesting. Of the total direct exports the British Commonwealth absorbed 40 per cent compared with 49 per cent in 1949. The other broad geographical areas accounted for the following percentages (1949 figures in brackets): Europe 31 (33.5), South America 18 (11), North America 6 (0.5), Asia 3 (3.5) and Africa 2 (2.5).

Australian Time Signals

Details are given in the December, 1950, issue of the *Proceedings of the Institution of Radio Engineers* (Australia) of the transmissions of both Mean and Rhythmic Time Signals from the Belconnen Naval Wireless Station on 8.43 Mc/s. The mean signal is transmitted from 0025-0030 G.M.T. and the Rhythmic signal from 1025-1030, 1455-1500 and 1855-1900 G.M.T.

Communications regarding the transmissions should be addressed to the Commonwealth Astronomer, Commonwealth Observatory, Mount Stromlo, via Canberra, Australia.

R.S.G.B. Convention

BRIEF details are now available of the arrangements made by the R.S.G.B. for the National Convention organized as a contribution to the Festival of Britain.

The first two days of the Convention (June 21st and 22nd) are to be devoted to technical visits to research establishments including the D.S.I.R., B.B.C., Mullard and Standard Telephones and Cables. For the evening of the 22nd a conversation with films has been arranged at the Coventry Street Corner House, London, W.C.1, where there will be a lunch and dinner on June 23rd. The last day (24th) will be devoted largely to business.

Anglo-French Exhibition

AN exhibition of British scientific instruments which is to be held from May 11th to 17th, at the Sorbonne in Paris, is in the nature of a return gesture for the exhibition of French scientific instruments held in London in February last year.

Among the forty odd exhibits, most of which will be working models, will be an automatic ionosphere recorder developed at the Radio Research Station of the D.S.I.R. and a millimetre-wave spectrometer lent by the Telecommunications Research Establish-

ment of the Ministry of Supply. Among the industrial exhibits are a square-wave pulse generator (Cintel), vibrating reed electrometer (Ekco), dielectric test set (Marconi Instruments) and precision cathode-ray tubes (20th Century Electronics).

B.S.I.

IN June, 1949, the President of the Board of Trade announced the appointment of a committee under the chairmanship of Mr. Geoffrey Cunliffe "To consider the organization and constitution of the British Standards Institution, including its finance, in the light of the increasing importance of standardization and the extended size and volume of work likely to fall on the B.S.I. in future and to make recommendations." The report of the committee has now been issued by H.M. Stationary Office, priced 1s.

The Committee finds that the constitution and organization of B.S.I. is well adapted for carrying out its present work and the increased work which may be expected to fall upon it.

PERSONALITIES

Sir A. Stanley Angwin, K.B.E., D.S.O., T.D., is to relinquish the appointment of chairman of Cable & Wireless, which he has held since the State acquired the company's share capital on January 1st, 1947, in order to take up a post with the Commonwealth Telecommunications Board. He will act as technical adviser to the Board. Prior to joining Cable & Wireless he was for eight years Engineer-in-Chief of the Post Office.

Major General L. B. Nicholls, C.B., C.B.E., who has been managing director of Cable & Wireless for the past year, is to succeed Sir Stanley Angwin as chairman of the company. During the war he was Chief Signal Officer in various theatres of war.

N. C. Chapping is the new managing director of Cable & Wireless. He has been traffic manager of the company for the past four years.

Paul Adorian, M.I.E.E., M.Brit.I.R.E., assistant managing director of Broadcast Relay Service Ltd., has been appointed chairman of Redifon Ltd. He joined the Redifon Group in 1932, and has been largely responsible for the development of its manufacturing company, Redifon Ltd. Mr. Adorian is this year's president of the British Institution of Radio Engineers.

Dr. R. L. Smith-Rose, A.R.C.S., D.Sc., Ph.D., director of radio research in the Department of Scientific and Industrial Research, has been elected a Fellow of the City and Guilds of London Institute (F.C.G.I.).

P. H. Spagnoletti, B.A., M.I.E.E., director and general manager of Kolster-Brandes, Ltd., and manager of Brimar Valves (S.T.C.) was elected chairman of the British Radio Equipment Manufacturers' Association at the annual general meeting. He graduated at Trinity College, Cambridge, and

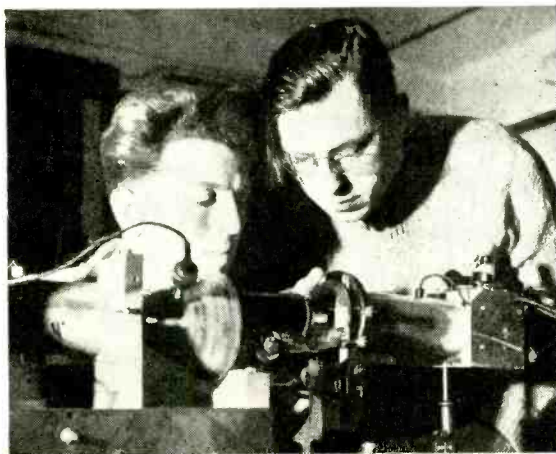

TELEVISION MICROSCOPE described on page 162 is here shown with Dr. F. Roberts (right) of University College, London. The scanning tube can be seen on the left, part of the microscope in the centre and the multiplier photocell on the right. Automatic counting of particles will be one application of the instrument.

joined S.T.C. in 1929. He first worked in an engineering capacity on the high-power short-wave transmitters on the transatlantic radio-telephone link and ship-to-shore transmitters, and in 1932



P. H. SPAGNOLETTI,
B.A., M.I.E.E.

was put in charge of the planning, engineering installation and testing of the first two Empire broadcasting stations at Daventry. During the War he was in charge of the aviation development work in the Radio Division of S.T.C.

R. G. D. Holmes, M.I.E.E., M.Brit.I.R.E., has rejoined Vidor Ltd. as chief engineer, the position he held with Burndept Ltd., a subsidiary, from 1934 to 1940, when he joined the Admiralty. Since leaving the Admiralty he has been chief engineer of McMichael Radio.

Louis Pacent, president of the Pacent Engineering Corp., New York, has been awarded the Marconi Memorial Medal of Achievement by the U.S. Veteran Wireless Operators' Association for his pioneer work in radio communication.

OBITUARY

We record with regret the death at the age of 58 of Arthur W. Lay, B.Sc., A.M.I.E.E., who has contributed to *Wireless World* on electro-medical matters. He joined Marconi's in 1924 as a draughtsman and later turned his attention to diathermy on which he worked for over 20 years with the company. In 1948 he opened his own laboratory—The Lay Laboratory—at Galleywood, Chelmsford, Essex.

IN BRIEF

Licences.—The largest monthly increase in television licences since the resumption of the television service in 1946 was recorded by the Post Office in January—nearly 72,000, bringing the total to 657,950. The number of sound broadcasting licences current in the U.K. at the end of the month was 11,664,200.

Electrical Interference.—In reply to a question in the House on a particular instance of television interference, the Postmaster General stated that it was due to nearby high-voltage electricity supply lines. He added that such interference from supply lines—due to weather conditions and variations in the load carried—was a general problem to which no complete solution had yet been found.

Festival Amateur Station.—Since publishing the note in our last issue on the operation of the amateur transmitting station which is to form part of the Festival of Britain Land Travel Exhibition, we have been notified by V. M. Desmond, G5VM, that he has undertaken to be responsible for maintaining a rota of operators when the exhibition visits Birmingham (August 4th-25th). Holders of 150-watt licences resident within easy reach of Birmingham are invited to attend a meeting at the Sydenham Hotel, Pershore Street, Birmingham, at 7.30 p.m. on May 8th to discuss plans for operating the station. Mr. Desmond's address is 90, Worcester Street, Birmingham, 5.

Consol Charts.—A new series of Consol navigation charts has been issued by the Ministry of Civil Aviation. The six charts, which cost 3/- each, between them cover the area from 36°N to 72°N and from 15°E to 45°W. Each chart is over-printed with the theoretical cover of three stations, two primary and one reserve.

Grad.Brit.I.R.E. Exam.—The next Graduateship Examination of the British Institution of Radio Engineers will be held on the 16th, 17th and 18th May at 38 centres throughout the world. Arrangements have already been made for 234 overseas candidates to take the exam. at centres in Australia, Canada, Guatemala, India, Malaya, New Zealand, Pakistan and South Africa.

Rectangular Metal C.R.T.—The R.C.A. have produced a rectangular metal-shell television tube providing a picture area of 14½in by 11in with slightly curved sides and rounded corners. The 17CP4, as it is called, is said to be considerably lighter in weight than a comparable all-glass tube and can be mass produced. The overall length is 19in. It has a frosted glass face plate which reduces halation.

I.P.R.E.—A North-East Section of the Institute of Practical Radio Engineers was recently formed in Newcastle-on-Tyne and regular monthly meetings of the forty or more members are being held. Details are available from the secretary, S. Hutton, 22 Boston Avenue, Newcastle-on-Tyne, 7.

B.T.R. Technical Society.—At the second annual dinner of the Technical Society of British Telecommunications Research, Ltd., at Taplow Court, Taplow, Bucks, the principal guests were Brigadier L. H. Harris, C.B.E., Controller of Research, G.P.O., and Captain P. P. Eckersley, manager, Engineering Department, Telephone Manufacturing Co.

"Vector Diagrams": A Correction.—The discussion of the circuit shown in Fig. 3 of Part 2 of the Vector Diagram series (February issue, p. 62) has caused readers some difficulty. This was due to an unfortunate slip in the reproduction of Fig. 3 (and 5)—the addition of a third lead coming in from the left, obscuring the fact that the source of e.m.f. was via the two upper leads, and therefore (so far as the series circuit being discussed was concerned) in effect V_1 . Although this fact was mentioned in the discussion it was not clear (as was intended) from the start.

R.S.G.B. Officers.—The president, W. A. Scarr (G2WS), and vice-president, J. Charman (G6CJ), of the Radio Society of Great Britain were re-elected at the recent annual general meeting.

American Amateurs were described by President Truman in his report on Civil Defence as possessing facilities which can make an important contribution to civil defence communications. It has now been announced by the Federal Communications Commission that the following frequency bands have been earmarked for use by U.S. amateurs in civil defence communications in the event of war:—1.8-2, 3.5-3.51, 3.99-4.0, 28.55-28.75, 29.45-29.65, 50.35-50.75, 53.35-53.75, 145.17-145.71, 146.79-147.33 and 220-225 Mc/s.

Power Cuts.—We learn from our associate journal *Electrical Review* that the Yorkshire Electricity Board has decided that the only practical way of warning industrial consumers of intended load shedding is to use the Board's existing three short-wave radio transmitters which are capable of covering about a third of the area. Although this involved the Post Office in a departure from normal practice, as "business radio" licences so far issued stipulate that one station must be mobile, permission has now been given for preliminary experiments to be carried out and prototype equipment has been made available by the G.E.C.

G.R.S.E.—Following an agreement between the Guild of Radio Service Engineers and the War Office, the Army Council has issued an instruction giving details of the conditions of admission of certain Regular Army tradesmen into the Guild. They are: Armament Artificer (Radio Field and Radio Anti-aircraft), Foreman of Signals, Telecommunication Mechanic and Radio Mechanic. Fuller details are available from H. Hill, 2, Stevenson Road West, Accrington, Lancs, who is now full-time secretary to the Guild.



R. G. D. HOLMES, M.I.E.E.,
M.Brit.I.R.E.

(See "Personalities.")

Appointments Bureau.—The new secretary of the Professional Engineers Appointments Bureau, J. Muir, has sent us a statement on the work of the Bureau during 1950. Of the 409 engineers on the register at the end of the year, 115 were electrical engineers, whilst of the 1,111 vacancies notified during the year, 266 were for electrical engineers. Details of the Bureau, which is open to members of the Institutions of Civil, Mechanical and Electrical Engineers, are available from 9, Victoria Street, London, W.1.

Metal Reflectors have been used to "bend" the v.h.f. radio links round

the mountains in the pulse time modulation communication system being installed to provide a link between the hydro-electric plants in the mountainous lake area north of Seattle, Washington, and sub-stations in the city.

Indian Exhibition.—It is proposed to hold an "International Radio and Electronics Exhibition of India" in Bombay in February, 1952. Invitations are being extended to radio interests throughout Asia to participate.

INDUSTRIAL NEWS

Canberra's Radio.—The radio equipment carried by the English Electric Canberra jet-bomber on its recent transatlantic flight was supplied by Marconi's. This was the first occasion on which the R.A.F. has used this equipment (AD107 transmitter, AD108 receiver and AD7092A automatic radio compass) which is the successor of the famous T1154/R1155 introduced by Marconi's in 1939. The aircraft was fitted with suppressed aeriels).

Theatre Stereophony.—Philips Electrical, Ltd., have recently installed a stereophonic amplifying system at the Regent Theatre, Kings Cross. Apart from the loudspeakers specially designed for the installation, the remainder of the equipment is standard, but, of course, separate channels are used for each side of the stage.

Decca.—It is recorded in the annual report of the Decca Record Co. that Decca Radar, Ltd., a subsidiary, has so far received orders to equip 750 ships, some 50 per cent of which are for foreign vessels. Decca Navigator equipment has been installed in 1,000 vessels. It is also recorded that the first chain of Decca stations to be erected primarily to provide navigational aid for civil aircraft is to be constructed in West Germany by the Telefunken Co.

B.R.E.M.A. Council.—At the annual general meeting of the British Radio Equipment Manufacturers' Association—the set makers' section of the Radio Industry Council—the following firms were elected to the Council:—A. J. Balcombe, Bush, E. K. Cole, A. C. Cossor, English Electric, General Electric Co., Gramophone Co., Kolster-Brandes, McMichael, Philips, Pilot and Ultra.

Ekco.—It is announced by E. K. Cole Ltd. that Kenneth H. Williman has been appointed radio sales manager. Prior to joining the R.A.F. in 1940 he was with Roberts Radio. On his release from the Service he became sales manager of Tannoy, and was more recently in charge of export sales for Bonochord Ltd.

M.I.M.C.—Among the eight vessels being fitted with radio installations by the Leith depot of the Marconi International Marine Communication Co. is the Dutch ship *Billiton* which includes in her radio equipment an aerial splitter permitting the use of a single aerial for an indefinite number of broadcast receivers.

Rally Radio.—Many of the 365 entrants in the recent Monte Carlo Rally used e.h.f. radio equipment in their cars to aid them in their 2,000-mile journey, and a Silver Cup was awarded for the best radio installation. It was

won by the team of three privately entered Humber Hawks fitted with Marconi/B.C.C. Type L67 transmitter-receivers giving an output of 4.5 to 6 watts.

MEETINGS

Institution of Electrical Engineers

Radio Section.—"The Automatic Monitoring of Broadcast Programmes," by H. B. Rantzen, B.Sc.(Eng.), F. A. Peachey and C. Gunn-Russell, M.A., on April 2nd.

"A V.H.F. Field-Strength Survey on 90 Mc/s.," by H. L. Kirke, C.B.E., R. A. Rowden, B.Sc.(Eng.), and G. I. Ross; "The Propagation of Metre Radio Waves beyond the Normal Horizon"—Part I: "Some Theoretical Considerations, with particular reference to Propagation over Land," by J. A. Saxton, Ph.D., B.Sc.—Part II: "Experimental Investigations at Frequencies of 90 and 45 Mc/s.," by J. A. Saxton, Ph.D., B.Sc., G. W. Luscombe, B.Sc., and G. H. Bazzard, B.Sc., on April 11th.

Discussion on "The Trend of Design of Television Receivers"; opener, A. J. Biggs, Ph.D., B.Sc., on April 23rd.

Education Circle.—Discussion on "The Presentation of Laboratory Experiments"; opener, G. F. Freeman, M.Sc.(Eng.), at 6.0, on April 13th.

London Students' Section.—Address by Sir Archibald J. Gill, B.Sc.(Eng.) (President), at 7.0, on April 30th.

The above meetings will be held at 5.30 (unless otherwise stated) at the I.E.E., Savoy Place, London, W.C.2.

Cambridge Radio Group.—"A Survey of V.H.F. Communication Development," by J. R. Brinkley, at 6.0, on April 3rd, at the Cambridgeshire Technical College.

North Midland Centre.—Informal lecture on "The Nervous System as a Communication Network," by J. A. V. Bates, M.A., M.B., B.Chir., at 6.30, on April 3rd, at the British Electricity Authority, Yorkshire Division, Whitehall Road, Leeds.

North-Western Centre.—"The London-Birmingham Television Radio-Relay Link," by R. J. Clayton, M.A., D. C. Espley, O.B.E., D.Eng., G. W. S. Griffiths and J. M. C. Pinkham, M.A., at 6.15, on April 10th, at the Engineers' Club, Albert Square, Manchester.

North-Western Radio Group.—Discussion on "Electronic Computers"; opener, Prof. F. C. Williams, O.B.E., D.Sc., D.Phil., at 6.30, on April 4th, at the Engineers' Club, Albert Square, Manchester.

Northern Ireland Centre.—Informal lecture on "Modulation," by T. P. Allen, M.Sc., at 6.45, on April 10th, at Queen's University, Belfast.

South Midland Radio Group.—Discussion on "The Trend of Design of Television Receivers"; opener, A. J. Biggs, Ph.D., B.Sc., at 6.0, on April 3rd, at the James Watt Memorial Institute, Great Charles Street, Birmingham.

Southern Centre.—"Crystal Diodes," by R. W. Douglas, B.Sc., and E. G. James, Ph.D., and "Crystal Triodes," by T. R. Scott, D.F.C., B.Sc., at 6.30, on April 4th, at the Technical College, Weymouth.

Maidstone.—Lecture on "Fifty Years' Development in Telephone and Telegraph Transmission in Relation to the Work of Oliver Heaviside," by

W. G. Radley, C.B.E., Ph.D.(Eng.), at 7.30, on April 2nd, at the New Inn, Sandling Road, Maidstone.

Scottish Students' Section.—Discussion on "High Quality Sound Reproduction," at 7.30, on April 20th, at the Engineering Centre, Sauchiehall Street, Glasgow.

British Institution of Radio Engineers

London Section.—"An 8-channel Transmitter for an Experimental Carrier Wire-Broadcasting System," by R. G. Kitchenn, B.Sc.(Eng.), at 6.30, on April 26th, at the School of Hygiene and Tropical Medicine, Keppell Street, London, W.C.1.

Merseyside Section.—"The Silicon Carbide Resistor as a Circuit Element," by W. Needham, M.Sc., at 7.0, on April 4th, at the Electricity Service Centre, Whitechapel, Liverpool.

South Midlands Section.—"The Germanium Triode," by E. G. James, at 7.15, on April 11th.

North-Western Section.—"Frequency Modulation and F.M. Measuring Equipment," by E. D. Hart, M.A., and A. G. Wray, M.A., at 7.15, on April 11th, at the College of Technology, Manchester.

North-Eastern Section.—"The Elements of Pulse Code Modulation," by Major S. R. Rickman, at 6.0, on April 11th, at Neville Hall, Institute of Mining and Mechanical Engineers, Westgate Road, Newcastle-on-Tyne.

West Midlands Section.—"Some Physical Principles used in Electronic Equipment," by T. Emmerson, at 7.0, on April 25th, at Wolverhampton and Staffordshire Technical College, Wulfruna Street, Wolverhampton.

Scottish Section.—"Rare Metals in Radio and Electronics," by D. A. Wright, M.Sc., F.Inst.P. (G.E.C.), at 6.45, on April 5th, at the Institution of Engineers and Shipbuilders, 9, Elmbank Crescent, Glasgow, C.2.

Television Society

"Ferguson Television Receivers," by R. E. Norman, M.A. (Ferguson Radio Corp.), at 7.0, on April 12th.

"Time Bases," by J. E. Rhys-Jones (Plessey Co.), at 7.0, on April 27th.

The Television Society meetings will be held at the Cinema Exhibitors' Association, 164, Shaftesbury Avenue, London, W.C.2.

"Simple (H.C.) Pattern and Alignment Generators," by G. T. Clack, at 7.0, on April 10th, at the Leicester College of Technology, The Newarke, Leicester.

British Sound Recording Association

"The Design of Magnetic and Dynamic Pick-ups," by H. J. Leak, M.Brit.I.R.E., at 7.0, on April 20th, at the Institution of Electrical Engineers, Savoy Place, London, W.C.2.

Institution of Electronics

Midlands Branch.—"F.M. Measuring Equipment," by E. D. Hart, M.A., and A. G. Wray, M.A. (Marconi Instruments, Ltd.), at 7.0, on April 3rd, at the Warwick Room, Imperial Hotel, Temple Street, Birmingham, 2.

Society of Relay Engineers

"The Savage Automatic Monitoring System, including the Telemonitor for fault signalling, remote listening, programme restoration and telephone facilities," by P. Taylor (Bryan Savage, Ltd.), at 2.30, on April 24th, at the Gaumont British Large Theatre, Film House, Wardour Street, London, W.1.

Wrotham Transmitting Station

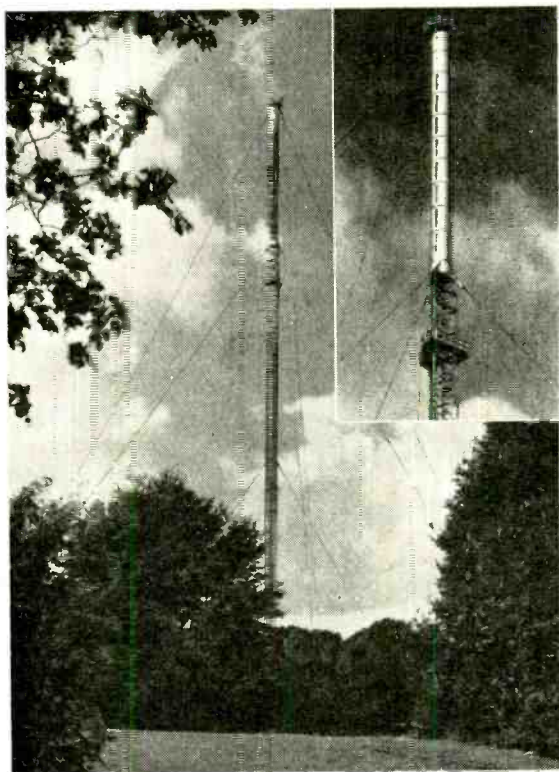

General view of the Wrotham v.h.f. slot aerial which is supported by a 360-ft. lattice steel mast. Inset: Close-up of the 110-ft slotted aerial section. There are 32 slots arranged in eight tiers of four, equally spaced round the surface.

Transmitting hall at Wrotham; the f.m. transmitter is in the foreground. It is a typical example of modern design with all units totally enclosed.

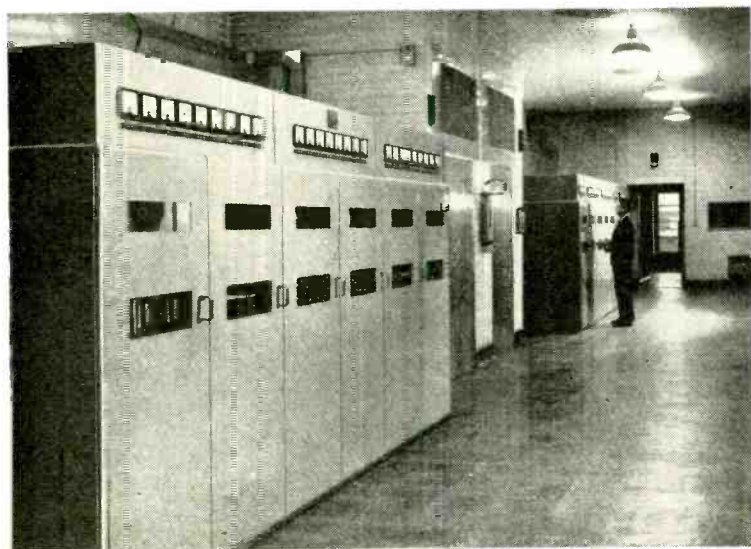

B.B.C.'s Experimental A.M./F.M.

Broadcasting on 3 metres

INVESTIGATIONS into the possibilities of metre-wave broadcasting were instituted by the Engineering Department of the B.B.C. as far back as 1945, the frequency used being in the region of 90 Mc/s. The two rival systems, amplitude and frequency modulation, were employed from time to time.

These early tests were definitely encouraging, but the power employed was low and so it was decided to carry out a more comprehensive programme of test transmissions on high power, simultaneously on a.m. and f.m., so that direct comparisons could be made. This plan was implemented last year when a new station was completed on the summit of Wrotham Hill, which is about 20 miles south-east of London and adjoining the London-Folkestone road. If a more precise location is desired, the national grid reference is 51/594604.

It is ideally situated for v.h.f. transmissions, as the hill rises to 730 feet above sea level and it is now surmounted by a 470-ft mast of similar design to that used at Sutton Coldfield, but without the television top section. The aerial in this case is the 110-ft tubular section at the top, which is 6 ft in diameter and has 32 vertical slots cut in its circumference. These are arranged in eight tiers of four, spaced equi-distant round the surface of the mast.

For explanatory purposes, a slot cut in a sheet of metal behaves as an aerial in much the same way as would the piece of metal removed if it were employed as a conventional dipole. There are certain differences in general characteristics, however, one is that a *vertical* slot propagates, or responds to, *horizontally* polarized waves and a horizontal slot is, of course, vertically polarized. Wrotham, therefore, is *horizontally* polarized and a horizontal dipole, or other aerial system, should be used for best reception.

Each slot measures 8ft x 1ft and with this vertical dimension the aerial elements are approximately three-quarters of a wavelength long at the frequencies used. The slot being wide compared with its length behaves as would a dipole of similar shape and exhibits wide-band characteristics, being sensibly "flat" over the range of frequencies 87.5 to 95 Mc/s. The power gain of the system in all horizontal directions is 8 db.

Each slot is fitted with a quarter-wavelength long vertical rod, so positioned and connected that it has



Comparison between the giant BR128 v.h.f. air-cooled transmitting valve and a typical modern receiving valve.

the effect of converting the aperture into a folded slot, the counterpart of a folded dipole, but curiously enough, with a lower input impedance than unfolded. In the case of the Wrotham aerial the slot impedance is 150 ohms. The outputs of the f.m. and the a.m. transmitters are fed simultaneously into the one aerial system.

"FMQ" System of Modulation

The f.m. transmitter is of unusual design in that it embodies a quartz crystal oscillator and the crystal is actually frequency modulated by the audio signals. This system of modulation, developed by Marconi's Wireless Telegraph Company, is known as "FMQ." The frequency deviation at the crystal is not large, being of the order of a few parts in a thousand, but a comparatively low frequency crystal is employed and its output passed through four frequency multiplying stages before the actual radiated frequency of 91.4 Mc/s (3.28 metres) is reached. In the case of the Wrotham transmitter, which is made by Marconi's, the multiplication amounts to 24 times.

The frequency deviation, or modulation range, or depth, is multiplied by a similar amount and at this working frequency a deviation of ± 75 kc/s is obtainable. This is a measure of the depth of modulation and bears no direct relationship to the range of frequencies that can be handled.

Frequency multiplication takes place at a comparatively low power level, the output at the 24-th harmonic being of the order of a few watts only. Six stages of amplification at the working frequency are consequently employed, the first two are conventional push-pull amplifiers and the final four are single-ended earthed-grid stages with co-axial line tuning elements. The final, or output, stage consists of a pair of giant BR128 air-cooled valves operating in parallel and giving an r.f. output of 25 kW, an unusually high power for v.h.f. equipment of this kind.

The r.f. portion of the a.m. transmitter is identical to the f.m. set, the only difference being that the

"FMQ" circuits are rendered inoperative. The quartz crystal is chosen to give a frequency, after 24 times multiplication, of 93.8 Mc/s (3.2 metres) and the r.f. power output is, in this case 18 kW. These are quiescent carrier figures; while the aerial power does not change in the case of the f.m. transmission, it undergoes considerable variation in the case of a.m. An increase of anything up to 50 per cent is possible depending on the depth of modulation and the waveform. In this equipment the final r.f. amplifier, again a pair of BR128 valves, is modulated by a class "B" push-pull stage fitted with two ACT14 valves.

Some idea of the giant size of the special v.h.f. power amplifier valve BR128 can be obtained from one of the illustrations, which shows a typical receiving valve held alongside for comparison. These, and other valves in the transmitters, are cooled by air circulated under pressure.

Feeder System

Both transmitters are controlled and monitored in a single room adjacent to, and with windows looking into, the transmitting hall. In addition to switches and meters for controlling and monitoring the voltages and currents at each stage of the transmitters, there is also included special apparatus for measuring the frequency deviation (modulation depth) and for checking any shift in the mean carrier frequency.

A concentric feeder system connects the output from each transmitter, via an harmonic filter, to a combined filter unit which prevents power from one transmitter being fed into the other, but diverts it into a common concentric feeder and thence to the aerial. The aerial system is common to both transmitters, as explained earlier.

Various methods have been evolved to enable one aerial to be used simultaneously for two or more transmitters. The diplexer as used at Sutton Coldfield is one and the Wrotham system, which consists of sections of concentric line, is another. The feeder is a large copper tube of some 6 to 7 in outside diameter and with a surge impedance of 51 ohms. Dry air is pumped into it and into the combined filter in order to exclude moisture, which, if allowed to accumulate, would change the characteristics of the feeder system to such an extent that it would upset the loading at the transmitters and very likely cause serious damage to the output valves unless a drastic reduction in power were made.

The slotted aerial system was designed by the Engineering Research Department of the B.B.C., the associated feeder system was developed by Marconi's and the mast designed and erected by British Insulated Callender's Construction Company.

Visits to the N.P.L.

THE National Physical Laboratory "Open Days" for industrial representatives, to be held this year in conjunction with the Festival of Britain, afford scientific and technical workers in industry the opportunity of seeing the scientific research work and investigations undertaken. The Laboratory will be open on May 28th and 29th from 10.30 a.m. to 5.30 p.m.

A number of tickets is being reserved for postal applications from accredited representatives of industrial organizations. They should be made to the Director, National Physical Laboratory, Teddington, Middlesex, by May 8th, stating the preferred day.

Automatic Course Plotting

Flight Computer Giving

Continuous Map Display of Position

EVER since the magnetic compass was first used in aircraft the ultimate purpose of all navigational aids has been to enable a pilot or navigator to put his pencil on a map and say "This is where we are now." Unfortunately, however, most of the radio aids available at present can only give a fix in terms of co-ordinates indicated on dials, and a certain amount of thought and calculation is necessary before a point can actually be plotted—by which time the aircraft has flown on several miles. As a result, the pilot never gets a true and accurate picture, either on the map or in his own mind, of where he is in relation to the rest of the world.

The arrival of the Decca flight log computer with its pictorial presentation is therefore something of an event in the world of navigation. This device, which has been designed by the Decca Navigator Company for operation with a normal Decca receiver, not only gives navigational fixes but plots them continuously on a map so that a complete record or log is made of the aircraft's course. No mental effort is required, even when the pilot has no navigator, for he can see at a glance exactly where he is, and where he has been, in relation to the surrounding country. If he wishes to keep to a pre-determined course drawn on the map, he has only to fly so that the plotting stylus follows it along.

Two-dimensional Drive

The idea developed originally from a recognition of the disadvantages of straightforward Decca in aircraft, especially high-speed aircraft. It was realized, for instance, that a great deal of time and trouble could be saved by some device for translating the "Decometer" readings straight into position fixes on the map. This was achieved first by a manual flight plotter in which a travelling cursor was moved horizontally and vertically over a map by two rotatable knobs in accordance with the readings of two Decometers. It was then only a logical step to couple the Decometer shafts directly to the knobs so that the whole process of plotting was accomplished automatically without human intervention. Thus, with position fixes obtained from, say, Red and Green co-ordinates, the Red Decometer could be arranged to drive the cursor vertically and the Green Decometer to drive it horizontally. In the actual instrument, however, the same effect is obtained more conveniently by arranging one Decometer to drive the cursor horizontally through a lead-screw whilst the other drives the map itself by means of a sprocket mechanism.

But, as a result of this type of drive, the original hyperbolic Decca co-ordinates, which intersect at a variety of angles, are now being converted into rectilinear co-ordinates that always intersect at right angles. So, to allow for this unavoidable distortion

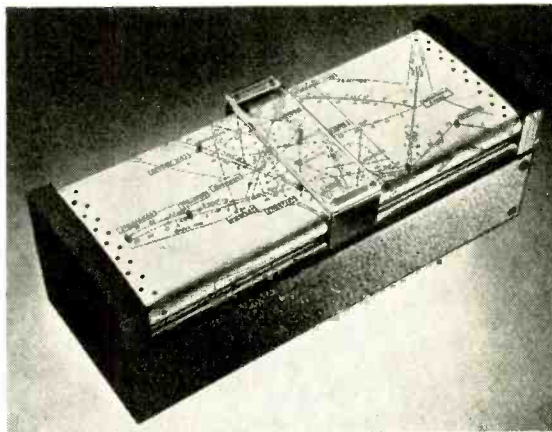
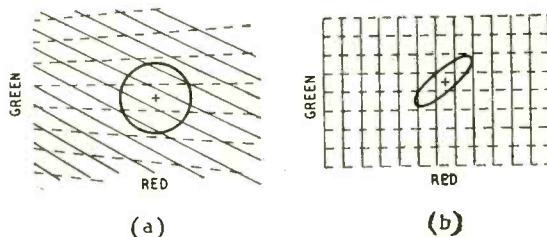

Fig. 1. Display unit of the flight log computer. The course of the aircraft is traced on the map by a stylus attached to the cursor.

Fig. 2. Illustrating map distortion caused by the conversion of Decca hyperbolic co-ordinates into rectilinear right-angled co-ordinates. An outline which is circular on a Decca chart (a) becomes distorted when the Red and Green patterns are slewed round (b) and made to intersect at right angles.



of the Decca lattice, the map has to be distorted also. (A similar situation occurs when the co-ordinates on a globe are transferred to a Mercator's chart.) For example, Fig. 2 (a) shows a map of a hypothetical and circular desert island, overprinted with Decca hyperbolic co-ordinates. At (b) is the same island when the two hyperbolic patterns are twisted round into rectilinear patterns at right angles to each other, with the Red lines vertical and the Green lines horizontal.

In the earlier models of the computer the maps were distorted in this fashion and, even so, proved themselves quite satisfactory for navigation. Nevertheless, it was obvious that the ideal was a map with as little distortion as possible, and this has now been achieved in the later models (Fig. 1) by making use of secondary Decca patterns which are a near approach to the desirable right-angled lattice. These secondary patterns are sum and difference patterns derived from the primary hyperbolic patterns, and a typical pair is illustrated in Fig. 3. Here, the

primary intersecting patterns (thin lines) are Red and Green whilst the two secondary patterns (thick lines) derived from them are Red + Green and Red - Green.

It will be seen, then, that within a certain area the two secondary patterns are intersecting nearly at right angles, so if they are arranged to drive the plotting stylus instead of the primary patterns given by the Decometers the map distortion will be greatly reduced. The desert island in Fig. 2 would then be represented as something more like a true circle than the ellipse at (b). However, the secondary patterns shown are only at right angles in that particular area, so in other areas different combinations of the primary patterns have to be made to get similar results. Simple addition and subtraction of primary patterns

makes possible a large number of secondary combinations, but the nine most useful ones are made available in the computer and these are selected according to which areas the aircraft is to fly through.

Mechanical Computing

Derivation of the secondary patterns is done in the computer itself mechanically by differential gears. Mechanical devices are, in fact, used extensively throughout the instrument as these prove much lighter and simpler than their electronic equivalents. A block diagram is shown in Fig. 4. The receiver outputs feed into three torque converters, which are really servo-mechanisms for converting the electrical phase changes into shaft rotations of sufficient torque to drive the rest of the computer. The lane-width converters are merely gear boxes that compensate for the different lane widths of the primary patterns; here the Red and Purple lanes are made the same width as Green lanes so that all three are standard. From the differential gear box, then, two secondary patterns are obtained, one being a sum pattern and the other a difference pattern—as, for example, in Fig. 3. These now pass through two 16-ratio gear boxes, by means of which any one of sixteen map scales can be selected for plotting. Finally, the secondary patterns are connected through two servo mechanisms to the map-drive and stylus-drive motors in the remote display head (Fig. 1). The purpose of the clock is to generate small time markers along the trace on the map so that the pilot can estimate his ground speed and time of arrival.

Two extra motors are provided in the display head for manual setting of the stylus, and this and other setting-up operations are all done from a remote control panel before the flight begins. For instance, a total of 15 charts can be stored in the display head all joined in a continuous roll, and the control panel enables these to be pre-selected in the required order and scale together with their associated secondary patterns. Then, in flight, as the stylus moves off the edge of one chart the pilot has only to press a push-button to bring on the next and put all its associated mechanisms into operation. To set up the tracing stylus at the beginning of the flight a light is switched on behind the chart in the display head and this shows up a primary Decca lattice printed on the back. A navigational fix is then obtained from the Decometers in the normal way and by means of this the stylus can be set to the correct co-ordinates.

Highly successful flight trials have already been conducted by the Ministry of Civil Aviation, using the original experimental model.

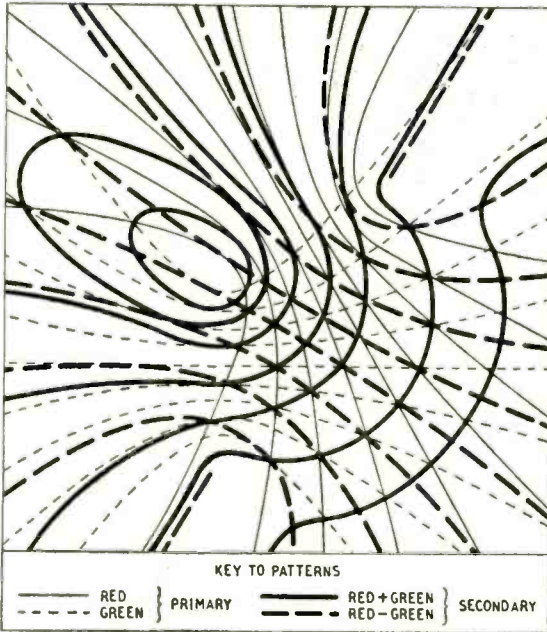
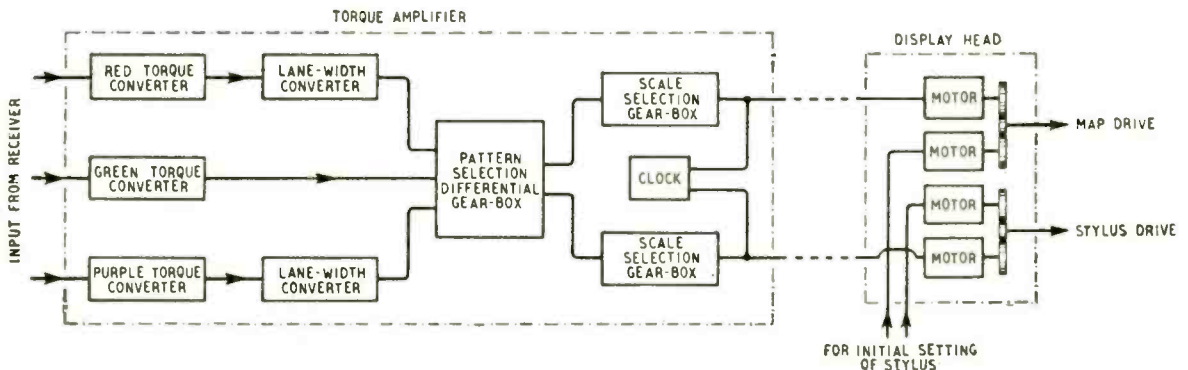

Fig. 3. To avoid map distortion, secondary patterns (thick lines) are used for driving the display system. These are sum and difference patterns derived automatically from the primary Red and Green patterns (thin lines) shown underneath.

Fig. 4. Simplified block schematic of the flight log computer.



LETTERS TO THE EDITOR

The Editor does not necessarily endorse the opinions expressed by his correspondents.

Stereophonic Sound

SOME years ago I tried the headphone system of binaural telephony mentioned by Mr. Moir in the March issue, and found it disappointing. I came to the conclusion that unless elaborated by the fitting of sel-syns to the heads of the listener and the dummy, to ensure that the movements of the former are copied by the latter, the method is unsound, because any movements of the listener's head result (so far as his sense of hearing is concerned) in the entire concert hall or other source of sound revolving with his head as if it were rigidly attached to it. This experience is so unlike anything that he (if a reasonably sober individual) is accustomed to that the illusion of direct hearing is shattered.

If only two communication channels were available, an audience of listeners would either have to keep perfectly still or else turn in unison like a flock of starlings.

It would be interesting to have the comments of Mr. Moir, or any other exponents of binaural telephony, on this aspect.

M. G. SCROGGIE.

Bromley, Kent.

Television Fire Hazard

IN the February issue you quote some extracts from the Fire Protection Association Journal.

One of the points is that it is advisable to disconnect television sets at the mains when not in use. I think it should be made clear that if this is done the normal switch should be operated first, and an interval of a few minutes should elapse before the mains switch is operated (or the plug withdrawn).

Many television sets contain special switch arrangements to avoid the danger of damage to the cathode ray tube due to the tube bias disappearing before the c.h.t. voltage. Such arrangements usually do not come into action if the set is switched other than by its own on-off switch.

K. S. PHILLIPS.

The Edison Swan Electric Company,
London, W.C.2.

Television Relay Loss

I AGREE with C. Lawson (your December issue) that we often suffer from degrading of the picture in the Midlands. I cannot, however, agree that the radio link is to blame, as much of the finest quality comes up from London, but, and here I think it is the point, *not* from Alexandra Palace.

I will quote, as a good example, the really superb quality of "The Season's Greetings" from the Star and Garter Home, an outside broadcast with perfect detail and beautiful gradation, followed by "A Christmas Carol" that was barely passable in quality, and yet which originated, of course, from well-equipped studios.

I make no attempt to explain why this should be, and still more am I puzzled as to why the viewing public are so content to accept the mediocre. In closing I would like to add that my receiver is carefully trimmed and reproduces the three-Mc/s signal well.

Nottingham.

G. H. BALL.

Thorn Needles

IN the March issue Mr. Kelly and Mr. Watts make one or two observations which I should like to answer. I can quite understand that Mr. Kelly finds the size of the thorns hard to believe. The accompanying photograph which shows Figs. 1 and 2 as they were originally taken—on the same negative—may reassure him. The sapphire is a standard Decca stylus.

As regards the sharpening process, I agree that the

fine point cannot be obtained by a few brisk rubs on even the finest glasspaper normally on sale nowadays. Indeed, I am inclined to doubt whether glasspaper is really suitable for the purpose; glass dust might very easily become embedded in the thorn point and accelerate record wear.

After trying a variety of abrasive wheels, I found that an extremely finely cutting grinding wheel of approximately $\frac{1}{8}$ inch diameter, cast integrally on its shaft (supplied by Bond's of 357, Euston Road, London, N.W.1) was just what was required. I held the wheel in a chuck on the spindle of a d.c. model electric motor I happened to have available, and, running this motor quite slowly, I held the thorns in a pin chuck at the required acute angle to the wheel surface and rotated with the fingers. Only the lightest pressure is necessary to finish off the sharpening of the point.

This method is, of course, hardly suitable for use in the drawing room during a record recital. I myself get over the difficulty by preparing a dozen or two points in advance, taking perhaps ten or twenty minutes on the job. I usually glance at the finished points through a pencil "microscope," particularly if I want to use them on microgroove records, simply to satisfy myself that a satisfactory point has been obtained. It also helps to avoid unnecessarily wearing away the thorn once the point is sharp enough.

Mr. Kelly's remark regarding the quick wearing of his thorns to the full size of the record groove has, I suggest, little significance without details of the weight on the point and the condition of the record, i.e., whether it was new or worn by steel or sapphire styli. My article attempted to bring out the importance of light downward pressure and, naturally, non-abrasive records.

I am also surprised to hear that the bottom of the groove is rougher than the sides. This is not my experience using thorns and I can see no reason for it. Surely the cutting stylus at least will be as well polished as possible over all its surfaces in contact with the blank. It would be interesting to know at what stage of manu-

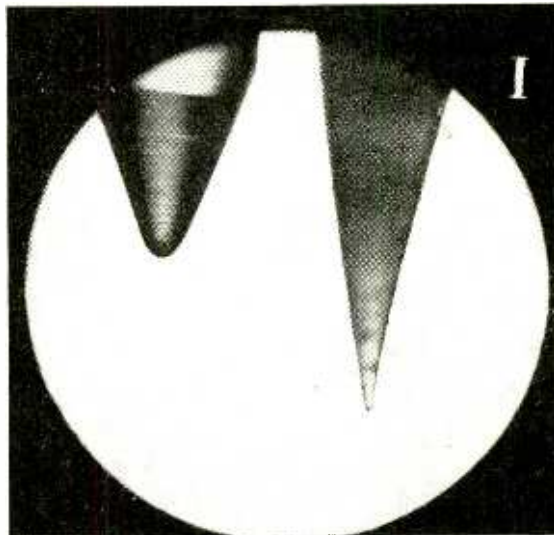

This block is made from an unretouched print from the negative supplied by Mr. Pollock, from which Figs. 1 and 2 of his article in the December 1950 issue of this Journal, were reproduced.—ED.

fracture the bottom of the groove gets rough and if this is universal with all makes of record.

With regard to the question of resonances giving a spurious effect of good h.f. reproduction, it may be of interest to note the result of a test of the amplifier and pickup, with thorn needle, using Decca test record K 1802 (which is cut to the firm's "frr" characteristic). Starting level at 3 kc/s, the voltage across the loudspeaker voice coil rose smoothly to plus 3 db at 8.5 kc/s and then fell smoothly to minus 2 db at 10.5 kc/s. From this point it tailed off gradually to 13 kc/s, where incidentally the tone was still audible above the scratch level. This test, of course, leaves out of account harmonic distortion and loudspeaker resonances. However, a separate test with gliding tone oscillator failed to reveal any noticeable audible peakiness in the equipment.

Many readers have written asking for particulars of the pickup used. It is home-made with moving-coil element, and a description of its construction appeared in the issue of the *Model Engineer* for September 28th, 1950.

In connection with Mr. Watts' remark concerning the "nice noise" produced by thorns, one rather hesitates to point out that it is pleasurable listening we are after and that a severely restricted range, even without harmonic distortion would not be accepted by the enlightened thorn enthusiast who does sometimes know what the original sounds like. Other types of harder styli sometimes give a rather nasty noise, though I do not wish to rest the case for thorns on any alleged defects of other types beyond the fact that they cause more record wear. Mr. Watts accepts this last point, but considers that thorn reproduction is just not good enough. With care and under proper conditions I am persuaded that there is little to choose between the thorn and sapphire as regards sound reproduction *in the home* and I would like to suggest that the phrase "in the home" may perhaps be the key to the difference of opinion. The extraordinary change in balance and other factors of psychological importance when the volume of sound is reduced from the level suitable for a hall or lecture theatre to that used in the normal home will have been remarked by most quality enthusiasts at one time or another.

For geographical reasons I am afraid I cannot make use of Mr. Kelly's very kind offer of his laboratory facilities for further testing of my apparatus and thorns, but I really doubt whether comparative aural tests in the home, on the same amplifier and loudspeaker equipment can be improved upon in the last resort.

Manchester.

A. M. POLLOCK.

A.M. Versus F.M.

WITH reference to the letter from R. C. Burnell in the January issue, I took particular note of the remarks regarding the reception of a.m. as compared with f.m. and I have found that the f.m. signal comes in much stronger than a.m. At first when I constructed the receiver and got it working I found that a.m. came in stronger, but according to my understanding f.m. should be the stronger signal of the two so I made another effort at aligning the discriminator and after this I found that the signal on f.m. was stronger than on a.m.

If, as I imagine, Mr. Burnell has reconstructed the R.1147B he will find that if he tries again with the alignment of his discriminator with an accurately calibrated signal generator, he will probably find that f.m. comes in stronger than a.m.

For this alignment procedure I studied K. R. Sturley's *A Home-Built F.M. Receiver* and I have found that by extracting the iron core from the secondary that the resonant frequency of primary and secondary were almost identical and that the Q of

the secondary without the iron core was higher than that of the primary with an iron core.

You will notice that my location is more distant from the transmitter than Mr. Burnell's and this is my reason for supposing that he has not correctly aligned the discriminator. In fact, as originally reconstructed, the R.1147B had two i.f. stages but I have been able to completely bypass one i.f. stage and still get a really good signal on an "L" type aerial.

Hanworth, Middx.

W. C. CRUTTENDEN.

Hum in Pickups

I SHOULD like to comment on the recent correspondence on signal-to-hum ratio in moving-coil and ribbon pickups, since I am of the opinion that the theory of the problem has not, as yet, been very clearly, nor even entirely correctly, presented.

To start with, it is convenient to distinguish between three separate ways in which the presence of 50-c/s stray magnetic fields may cause hum to accompany the intended signal input to the amplifier. These are:—

(1) By induction of hum voltages into the moving-coil or ribbon loop.

(2) By induction of hum voltages into the loop, if any, formed by the leads and terminal connections between the generating element and the transformer primary.

(3) By induction of hum voltages into the transformer windings by stray 50-c/s fields passing into the transformer core.

Hum due to cause (3) may be reduced to negligible proportions by using one or more Mumetal screening boxes, though a screening box may be unnecessary, in some cases, if an "astatic" design of transformer is adopted. The difficulty in eliminating trouble from cause (2) depends very much on the magnitude of the signal output voltage from the generating element in the pickup, and the ribbon type of element, which generates a very small output voltage at very low impedance, clearly represents the most difficult case in this respect. If one goes in for a multi-turn moving-coil element, then the coil is best wound with the finest wire considered reliable, so that, for a given permissible mass of winding, the number of turns is large and the signal output voltage is therefore large relative to the hum voltage induced in the lead system. The use of fine wire on the coil also ensures that the resistance of the leads may easily be made small compared with the coil resistance, even though quite a fine gauge of flex be used. It should, however, be emphasized that, so far as hum due to causes (1) and (2) is concerned, the presence of appreciable resistance in the connecting leads will not alter the signal-to-hum ratio but will merely reduce both the signal and hum inputs to the amplifier in the same ratio.

It now remains to consider cause (1), and it is here that I do not see the justification for one of Mr. Brierley's statements. I refer to the argument in his letter published in the June, 1950 issue, in which he says: "If, on the other hand, we add nine more turns, equal in size to the original one turn, we shall get $\times 10$ the output voltage into $\times 10$ the impedance, or $\times \sqrt{10}$ the voltage into a given output load, whereas the voltage due to stray magnetic fields will have increased by only a small amount depending on the coil dimensions." Surely, one would expect 10 times the hum output, since the stray flux will link with 10 turns instead of with one turn. In practice, it may not be exactly 10 times, since the stray flux will not, in general, be uniform in the space between the pole-pieces; but I see no justification for assuming, as Mr. Brierley appears to have done, that the nine extra turns are situated in a position of almost zero stray flux and therefore contribute almost no extra

hum. If this were the case, then one would do well to remove the first turn and use only the 9 extra turns!

Since I do not agree with Mr. Brierley's introductory argument, I find I cannot agree with the conclusions he draws, such as that the signal-to-hum ratio is proportional to rather less than $\sqrt{\text{coil mass}}$. If one assumes that the stray field is uniform in the space occupied by the coil or ribbon, then one obtains the following proportional relationships, which are based on the very fundamental fact that the voltage induced is always proportional to the number of turns times the rate-of-change of the flux linking with them.

Signal voltage \propto (number of turns) \times (area inside turns) \times (angular velocity) \times (flux density of magnet field).

Hum voltage \propto (number of turns) \times (area inside turns).
Hence:—

Signal-to-hum ratio \propto (angular velocity) \times (flux density of magnet field).

The signal-to-hum ratio due to cause (1) is thus, ideally, independent of the coil mass, number of turns and coil dimensions. In practice, as mentioned above, the stray field between the poles will not be uniform, but the argument is still applicable if one keeps the general shape of the parts the same and alters all dimensions in the same proportion.

I conclude, therefore, that a good design of pickup, from the signal-to-hum point of view, will employ a magnet system giving a high value of flux density, and will have the axis of rotation of the generating element fairly near to the stylus tip. To give low stylus and record wear, the moving system will have an extremely low moment of inertia, and it is in this respect that the ribbon principle does seem to offer a very real advantage. A good design of ribbon pickup is thus a very sound proposition, but I cannot agree that it is an easy matter to make a ribbon pickup in which the signal-to-hum ratio, taking all effects into account, is better than in a good moving-coil pickup. However, with careful design, which may include the use of balancing or "hum-bucking" coils or loops (which should, for really satisfactory results, be placed very close to the offending element), either type of pickup can be made to give a satisfactorily low hum-level with any normal gramophone motor.

PETER J. BAXANDALL.

Malvern.

I HAVE been very interested in the recent correspondence in your columns on the subject of hum in ribbon and moving-coil pickups, and I have found difficulty in reconciling practical experience with some of the conclusions reached.

I cannot agree with one portion of the argument put forward by Mr. Brierley in the June, 1950 issue. Surely the ten "thick" turns will have as much hum e.m.f. induced into them as the ten "thin" turns, since they occupy more or less the same bit of space. This correction lends even greater force to this part of Mr. Brierley's argument.

I would like to take it further and consider also the hum (magnetic) induced into the leads. This also includes those parts of the ribbon which are not generating, either by flexure or by not being between the pole tips. Incidentally these parts cannot easily be twisted to reduce hum pick-up.

To illustrate my point, I have prepared four simple diagrams. In each case the pickup is given a load equal to its own impedance (assumed resistive, as in the June letter), but any other load will not alter the signal/hum voltage ratios quoted—open circuit merely doubles all voltages at the secondary terminals.

The e.m.f. and load values are purely arbitrary, chosen to keep the mathematics within the bounds of mental arithmetic.

Note that induced hum is not normally a function of movement, whereas induced signal is solely due to movement of a conductor.

It seems then, on the score of hum induced into the

generating member itself, the signal/hum ratio is inversely proportional to mass for a given coil mass \times coil velocity product. By redesigning to lower the coil velocity with 10 "thick" turns, both signal/hum ratios fall by a factor of 10, not $\sqrt{10}$. This would appear to lend even more force to the argument! However, I cannot agree that point impedance is proportional solely to armature mass \times armature velocity, as one cannot assume that the whole moving mass is concentrated in the armature and that the stylus or mounting, however long, is mass-less. Thus much of the reasoning breaks down.

From the point of view of hum induced into the (primary) leads, diagram (2) scores very heavily indeed, i.e., it is better to use the allotted mass in the form of more turns of finer wire, and work at a higher coil impedance.

Hum induced into the transformer will afflict all four similarly, since all the cores and secondary windings are alike.

One point of design that will help the signal/hum ratio on all scores and in all designs, is the provision of

(1) ONE "THICK" TURN

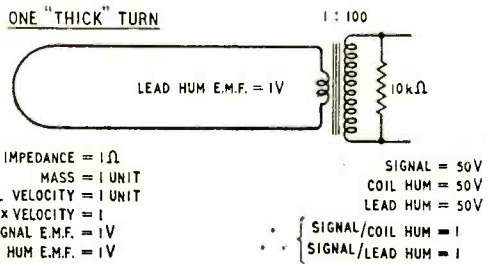

(2) TEN "THIN" TURNS

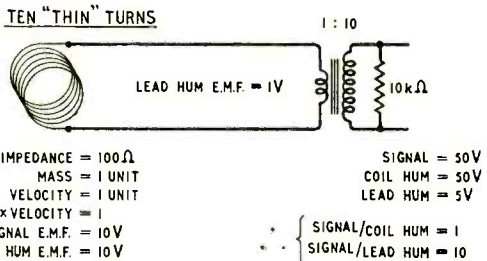

(3) TEN "THICK" TURNS

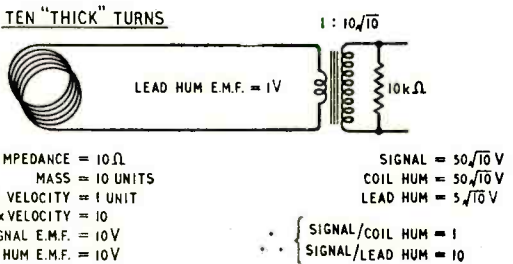

(4) TEN "THICK" TURNS

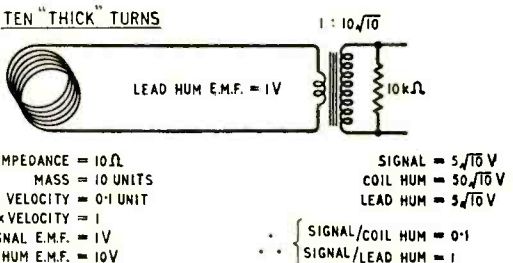

the strongest possible field for the generating member to move in. This will increase the signal e.m.f. without altering any other figure. It is probable that the multi-turn types do utilize the field space better than the single-turn types, and hence are able to produce a larger signal across a given load, i.e., they are capable of greater efficiency for ordinary forms of design.

On the "mass" side of the problem, it should be pointed out that there are at least three members

involved; the generating conductor, the stylus tip, and something to hold these two together (or apart), call it what you will. Therefore, doubling the mass of any one of them will not double the mass or inertia of the whole system.

Even so, our appreciation to Mr. Brierley for blazing the trail for us in the common pursuit of the smallest possible moving masses and tracking pressures.

London, N.11. RALPH L. WEST.

Countering Mains Fluctuations

Improved Heater Arrangement for Television Receivers

By GRAHAM WOODVILLE*

THE present wide fluctuations in the voltage of the electric supply mains have produced conditions under which satisfactory operation of a television receiver is difficult. This is especially pronounced with the more popular receivers in which the heaters of the valves and cathode ray tube are connected in series and operated directly from the supply mains, owing to the bigger variations which can exist with such an arrangement.

Many of the valves, e.g., the Z77 used as an amplifier, are capable of giving a satisfactory performance—at the expense of a shorter life—even though the voltage fluctuation may exceed $\pm 10\%$, but the cathode ray tube and those valves used as blocking oscillators and in the line and frame output stages cannot be expected to function properly if their cathodes are operated outside the normal temperature range.

The valves of a typical receiver may be divided into two groups (1) critical and (2) non-critical according to their function in the set. The receiver is assumed to have fourteen valves and one cathode ray tube in addition to the e.h.t. and selenium rectifiers.

ate chains. The critical chain, which totals about 94 volts, would be connected in series with an Osram type 304 barretter across the mains and would then be run with a closely controlled heater current within the limits 0.29–0.31 ampere.

The remaining valves in the non-critical stages do not require such a close tolerance on heater current, and the use of a barretter is unnecessary. Furthermore, an additional chain at 0.3A would probably render ventilation difficult with the usual table-model receiver. If, however, the valves are exchanged for their counterparts in the 0.1A series, e.g. DH107 for DH77 and N108 for N37, the increased wattage would amount to only 20–25.

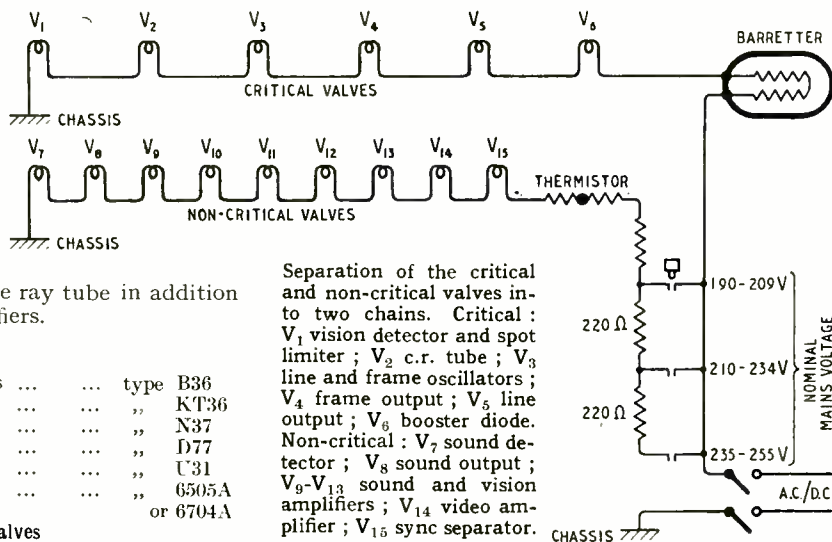

Separation of the critical and non-critical valves into two chains. Critical: V₁ vision detector and spot limiter; V₂ c.r. tube; V₃ line and frame oscillators; V₄ frame output; V₅ line output; V₆ booster diode. Non-critical: V₇ sound detector; V₈ sound output; V₉-V₁₃ sound and vision amplifiers; V₁₄ video amplifier; V₁₅ sync separator.

Critical Valves

1 line and frame blocking oscillators	type	B36
1 line output	"	KT36
1 frame output	"	N37
1 vision detector and spot-limiter	"	D77
1 booster diode	"	U31
1 cathode ray tube	"	6505A or 6704A

Non-Critical Valves

5 sound and vision amplifiers	type	Z77
1 sync. separator	"	Z77
1 sound output	"	N37
1 video amplifier	"	Z77
1 sound detector	"	DH77

These two groups may now be connected into separ-

A chain composed of this range of valves would total 190–200 volts and would be connected to the mains in series with a thermistor in the usual way. An additional series resistor should be provided with alternative tapping points to cater for high and low mains.

The proposed arrangement is shown in the figure.

* M-O Valve Company.

Magnetic Recording Tape

(Concluded from page 91 of the previous issue)

Properties of "Low," "Medium" and "High" Coercivity Coatings

By H. G. M. SPRATT,* B.Sc., M.I.E.E.

IT is known that the normal magnet, and particularly the bar magnet, is subjected to a demagnetizing effect due to its own induction and that the extent of this effect is determined by its ratio of cross-section to length. A number of mathematical expressions for this demagnetizing effect, as applied to magnetic tape, have been given by various writers, but the validity of them all is somewhat dubious. This is because of the sinusoidal flux distribution, due to the nature of the signals recorded, along the elemental magnets, in contrast to the uniform distribution which one normally associates with a bar magnet. Accordingly, we will make a qualitative study only of this effect assisted, however, by the knowledge that the demagnetizing force is proportional to the flux density, and that it can never be sufficiently strong to reduce the induction to zero. The essential variable is the magnet length, which is proportional to the wavelength or inversely proportional to the frequency. Thus at a speed of $7\frac{1}{2}$ in/sec the magnet length for a 50 c/s note is $1/50 \times 7.5 \times \frac{1}{2} = 0.075$ in, while for a 5 kc/s note it is 0.00075 in. Accordingly, at the latter frequency the demagnetization effect is far greater than at the former. In Fig. 7 the remanent induction is indicated by B_r and this will in fact be, to all intents and purposes, the induction remaining in a magnet of appreciable length after it has been subjected to a magnetizing force H subsequently reduced to zero. The reduction in remanent induction due to demagnetization for magnets of short length is indicated by the construction shown in the figure. Lines such as OM and ON , known as shear lines, are drawn at angles determined solely by the geometrical form of the magnet, ON being associated with a shorter length than OM . The projected lengths OM' and ON' , corresponding to the intercepts of OM and ON on the hysteresis loop are measures of the induction remaining after demagnetization has occurred. This value is obviously smaller for a short than for a long magnet length. Hence, for a constant recording signal, the flux from the tape will be smaller for a high than for a low frequency, resulting in a falling off of h.f. response as indicated by the dotted curve of Fig. 2.

We have so far ignored the possible effects of a change in the magnetic characteristics of the coating, though they are, of course, implicit in the construction shown. Actually, a change in remanence or coercivity of the material will have a big effect in this connection. Demagnetization was stated above to be proportional to the remanent induction and so, from the point of view of frequency characteristic, it is

advantageous for the remanence to be low. But in Fig. 7 OD is the magnetizing force which must be applied in a negative direction to reduce the induction from the remanent value B_r to zero, i.e., the coercive force H_c , and if this value is increased, as in the case of the dotted curve $B_r M' D'$, the demagnetizing effect will be smaller. It has in fact been shown by Hobson⁴ that the loss due to demagnetization is given by $20 \log R/(R + D)$, where $D = \tan B_r OM$ or $\tan B_r ON$, as the case may be, and R is the ratio coercivity/remance. D , it will be noted, takes into account the geometrical conformation and R the relevant magnetic characteristics. It will, accordingly, pay us to make this ratio high in order to extend as far as possible the frequency response, though the limiting effect of the air-gap length must not be ignored. The shape of the hysteresis loop is not precisely defined by the values of B_r and H_c and so the above expression must be used with some reserve.

Noise in magnetic recording tape may be divided into two categories, d.c. noise and modulation noise. D.c. noise is the greater and arises when the tape has been subjected to any constant magnetizing

* Durex Abrasives Ltd.

⁴ "Developments in Magnetic Recording," by P. T. Hobson. *Electronic Engineering*, 19, Dec. 1947.

Fig. 7. Graphical determination of the demagnetizing effect.

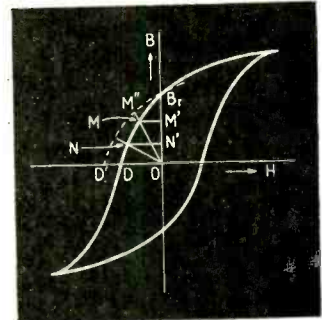
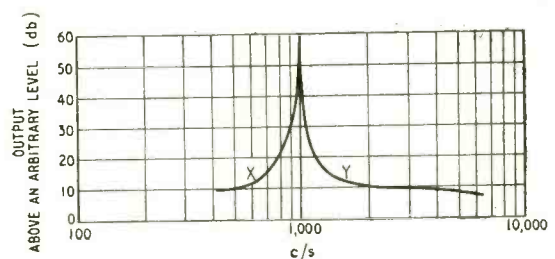

Fig. 8. Spread of response from a 1-kc/s recorded frequency due to modulation noise.



field, reaching its highest value when the field intensity is sufficient to cause saturation. By contrast, virgin tape is the quietest. Theoretically, erasure by means of an intense a.c. field, into and out of which the tape is steadily passed, should leave the tape in an equally noiseless state. Such conditions, however, are probably never reached with any conventional erase head. The fields from these heads are usually somewhat asymmetrical, due either to an imperfect erase-current waveform or to accidental magnetization of the head. Furthermore, in spite of the relatively large air gap employed, the erase field may be inadequately spread, while the time of exposure of the tape to the field is probably too short.

Modulation noise reveals itself as sidebands forming on either side of a recorded note. Fig. 8 demonstrates this effect in the case of a tape on which a pure 1 kc/s note has been recorded. Here it is clear that the recorded note has given rise to noise bands between X and Y on either side of the note. Modulation noise always increases with the strength of the recorded signal and with the d.c. noise level of the tape. In reproduction it manifests itself as a roughening of an otherwise pure note and is, one must admit, not easily detected with a good quality tape.

It is not unnatural that the d.c. saturation noise of a tape should be frequently used as a measure of its noise quality. Likewise, it is not surprising to find that, where a permanent magnet is used for erasing instead of the more expensive a.c. erase head, the noise level is inevitably higher. Finally, because of the virtual impossibility of separating completely the performance of a tape from that of its associated equipment, coupled with a lack of agreement or standardization on conditions of test, it is rare today for signal/noise figures to be quoted.

Apart from noise arising from the tape's magnetic characteristics, irregularities of coating or cyclic patterns brought about by the coating method employed, rough coating surface, or the use of an unsuitable base material can also be a source of noise. With good quality tapes, however, the noise level arising from these sources should be insignificant compared with d.c. and modulation noise.

Transfer

One weakness occasionally observed in magnetic recording is that of transfer. This effect is the duplication, by magnetic induction, of a signal from one point on the tape to an adjoining layer or layers. When a recorded tape has been wound up, the remanent induction due to the impressed signal is capable, even in the absence of a bias field, of magnetizing magnetic material in the immediate neighbourhood, the nearest portions above and below. As the spurious signal generated may reach a value of 55db below the true signal, it will occasionally be audible on replay if the true signal level is sufficiently high and the signal/noise ratio of the tape and equipment low. The degree of transfer increases with time of storage and is dependent upon temperature. Unfortunately, there is little variation amongst tapes as regards this effect, although those of medium coercivity seem to be superior to the extent of some 5 to 8db.

The amount of transfer would naturally increase if the tape were subjected to a biasing field after winding up. Use is made of the effect in duplicating copy tapes from a master.⁶ The master recording is

generally made on a tape of higher coercivity than that of the copy tape and the bias field is adjusted to be of sufficient strength for recording on the copy tape, but too weak to affect the master.

Increase of Coercivity

It is now proposed to discuss the qualities associated with magnetic materials of increased coercivity, the use of which, it will be recalled, was stated earlier to be the outstanding advance since the development of the Magnetophon.

As far as magnetic tapes are concerned, there are to-day three generally recognised grades of coercivity; low, about 80-100 oersteds; medium, 200-250 oersteds; and high, about 350 oersteds. Earlier tapes were of the low-coercivity type and accordingly required a high running speed, e.g., 30 in/sec. to provide a good frequency response. They are characterized by their ease of erasure. Medium-coercivity tapes give a better frequency response and they too are not difficult to erase. High-coercivity tapes provide yet a slightly better frequency response, but the difficulty of erasure is such as to exclude their use from any but the most expensive and elaborate recording equipments. They will, however, probably find an important application as master tapes for duplicating purposes.

In the above paragraph, it should be noted that the tape is said to "provide," not to "have," a good frequency response. A tape of itself has no frequency response, the term being meaningless unless a definite recording speed is specified. It has, on the other hand, a wavelength characteristic, knowledge of which will assist in predicting the frequency response of a recording equipment when the particular tape is employed, as compared with that obtaining if another tape were used.

Because of the combination of good wavelength characteristic and ease of erasure, the medium-coercivity tapes are undoubtedly superior for all types of recording. They enable studio quality to be easily achieved at 15 in/sec instead of the previous uneconomical 30 in/sec, while 7½ in/sec is quite high enough for medium-quality reproduction and 3¾ in/sec for good speech quality and mediocre musical quality.

The use of a magnetic material whose coercivity happens to lie within the medium range does not, of course, alone result in an acceptable tape, and some elaboration of what has already been said is necessary to make this clear. First, we know that as far as demagnetization, and hence frequency response, is concerned, it is the ratio coercivity/remance rather than the value of the coercivity alone which is the important factor. Therefore, when the coercivity is raised, the remance must not be allowed to rise to the same extent. A small increase may, however, be advantageous because of the additional output obtained as a result. Secondly, there is some reason to believe that, by the use of an indifferent recording head, the advantage of the higher coercivity may be offset by the increased leakage field resulting from the higher bias current required. This increase in leakage field may tend to have an erasing effect at the higher frequencies. For all that, the substitution of a medium- for a low-coercivity tape will extend the frequency response

⁶ "Duplicating Magnetic Tape by Contact Printing," by M. Camras and R. Herr. *Electronics*, 22, 78-83, Dec. 1949.

some 25 to 50 per cent for the same speed, if good-quality equipment is employed.

Before concluding, a brief reference to the desirable mechanical properties of magnetic tapes is essential, as these can make or mar an otherwise satisfactory product. First of all, the finished tape should be as strong under tension as the original material used to form the base. This means that in coating, this base must not be subjected to severe etching by the dispersion employed, to undue heating or stretching, nor should it be creased, wrinkled, or scored. Slitting, too, must leave the finished tape with a clean serrated edge. After tight winding on to the spool and prolonged exposure to everyday variations of temperature and humidity the tape should not reveal a stretch exceeding 0.3 per cent. If this figure is exceeded, the resulting pitch change will be detectable by the critical ear. Again, unless positive preventive measures are taken in manufacture, a length of tape is liable to exhibit cupping, curling, twisting or curvature along the length. Any one of these faults may result in bad winding and irregular recording, poor frequency response or loss of sensitivity, due to imperfect movement and variable contact past the heads. Similarly, a rough coating surface will

degrade uniformity and frequency response. Finally, "blocking" or a tendency towards adhesion between layers during unwinding will cause snatching and hence speed irregularities.

Conclusion

An attempt has been made to outline the properties of magnetic tape, these properties being isolated as far as possible from the associated equipment. There are in all some fifteen magnetic and physical characteristics of the tape which affect its performance and, as the technique is still adolescent, it is hardly surprising to find that there is room for some improvement in most of them. At the same time, however, the need for improvement in the recording and reproducing equipment, particularly in head design, must also be borne in mind. Apart from the desirability of enhancing the a.f. performance, there is considerable scope for magnetic tape recording at higher frequencies, but such development will be retarded unless the equipment advances with the tape.

In conclusion, the author wishes to acknowledge gratefully the help afforded by his colleague Mr. P. T. Hobson in the preparation of this article.

DIRECTORY OF CLUBS

SINCE publishing the directory of clubs in our January issue we have been notified of the following additions and amendments:—

BELFAST.—Radio Society of Northern Ireland.—J. Milliken, "Fortfield," Upper Dunmurry, Belfast, N.I.

BRIGHTON.—Brighton and District Radio Club.*—R. T. Parsons, 14, Carlyle Avenue, Brighton, 7.

BRISTOL.—Bristol and Bath Television Club.—J. Archer, 100, Beaulieu Road, Southville, Bristol, 3.

BURTON-ON-TRENT.—Burton and District Radio Society.—E. T. Ward, 21, Rangemore Street, Burton-on-Trent, Staffs.

CAMBRIDGE.—Pye Short-Wave Club.*—T. L. Simpson, Pye, Ltd., Cambridge.

CHATHAM.—Medway Amateur Receiving and Transmitting Society* (G2FJA).—C. R. Hawkins, 9, Sanctuary Road, Gillingham, Kent.

DARLINGTON.—Darlington and District Amateur Radio Society.—D. Graham, 21, Hamsterley Street, Darlington.

DERBY.—Derby and District Amateur Radio Society.—E. Shimmian, Leafmoor Mount, Derby Lane, Derby.

HAMBLE.—Air Service Training Amateur Radio Society* (G3FDI).—J. N. Tracey, School of Marine Radio, Hamble, Hampshire.

HULL.—Hull Radio Group.*—J. R. Borrill, 321, Priory Road, Hull, Yorks.

JERSEY.—QAU Club (misquoted QUA). Jersey Radio Society no longer active.

LIVERPOOL.—Liverpool and District Short Wave Club (G3AHD)—D. E. Murray, 40, Barkhill Road, Liverpool, 17.

LONDON AREA.—Cray Valley Radio Transmitting Club.—G. Miles, 33, Silverdale Road, Petts Wood, Kent.

Dulwich and New Cross Radio Group.*—H. F. Knott, 7, Red Post Hill, S.E.24.

South-West Essex Radio Society.—I. G. Barratt, 367, Rush Green Road, Romford, Essex.

LOWESTOFT.—Lowestoft and Beccles Amateur Radio Club.—B. J. Basey-Fisher, Home Farm, Ditchingham, Bungay, Suffolk.

MALVERN.—Malvern and District Radio Society.*—E. Dandy, 213, Pickersleigh Road, Malvern, Worcs.

NORTHAMPTON.—Northampton Short-Wave Radio Club (was Northampton Radio Society).—V. R. Hartopp, 22, Purser Road, Northampton.

OLDHAM.—Oldham Amateur Radio Society (G3GUZ).—W. Howarth, 41, King Street, Oldham, Lancs.

SHEFFORD.—Shefford and District Radio Society.—N. A. Eaton, 25, Stanford Road, Shefford, Beds.

STROUD.—Stroud and District Amateur Radio Club.—B. L. Horton, "Prestcott," Haven Avenue, Bridgend, Stonehouse, Glos.

TYNESIDE.—Tyneside Radio Society.—L. Bergna, 121, Addycombe Terrace, Heaton, Newcastle-on-Tyne, 6.

WARRINGTON.—Risley Radio Society* (G3CIC).—D. E. Harper, Risley Club, Warrington, Lancs.

WISHAW.—Wishaw and District Radio Club.—A. Craig, 16, Houldsworth Street, Newmains, Wishaw, Lanarkshire.

WORCESTER.—Worcester and District Amateur Radio and Television Club* (G3GJL).—H. M. Rudge, 21, Teme Road, Tolladine, Worcs.

* Affiliated to the R.S.G.B.

Attenuation of Screened Rooms

THE effectiveness of screened rooms for housing industrial r.f. equipment is the subject of a report issued by The British Electrical and Allied Industries Research Association. It shows the attenuation afforded by cubicles of different materials for a wide range of radio frequencies and from measurements made calculated and achieved performances are compared.

Four cubicles of the same size, but made of different materials, are studied in detail, the materials being perforated zinc sheet, electro-galvanized expanded steel, tinned iron mesh and galvanized iron wire netting.

Transmitters of conventional design and with a loop aerial were installed inside the rooms with battery supplies to avoid mains-borne interference confusing the results. The receiver was outside the rooms.

Results showed that rooms of simple design give adequate attenuation for most purposes, provided the bonding is good and special attention given to the electrical sealing of the doorway.

A limited number of copies of this report (reference M/T104) are obtainable from The Electrical Research Association, Thorncroft Manor, Dorking Road, Leatherhead, Surrey. The price being 7s 6d each (7s 9d by post).

That Other Valve Equivalent

How to Substitute the Constant-Current Generator

By "CATHODE RAY"

AS a "P.S." to last month's instalment I mentioned that in addition to the well-known voltage generator equivalent of a valve there is a less well-known current generator equivalent. Both of these equivalents are dodges for bringing valves within the scope of ordinary simple circuit calculations. It would be rather discouraging if every time one wanted to calculate the amplification to be expected from a given valve with a coupling of given impedance one had to work it out in terms of space charges and three-dimensional electric field patterns. So we imagine that the valve is replaced by a generator giving μ times the voltage applied to the grid, and having an internal resistance equal to r_a . Applying the principle of Ohm's Law then gives us the voltage amplification or gain as $\mu Z / (r_a + Z)$, where Z is the impedance of the coupling. The values of μ and r_a can be obtained from the valve maker's catalogue. So the whole thing is quite easy. We have to remember, of course, that if Z is not a pure resistance it must be added to r_a vectorially, by one of the methods explained in a.c. theory. And to get the correct phase with reference to the input voltage it is necessary (with the usual assumptions) to put a minus sign in front of μ . And another thing to bear in mind is that the values of r_a and (to a less extent) μ are not fixed but

depend on the anode and grid bias voltages, and although nearly correct for small signal amplitude they cease to hold when the signal is large. With these various reservations, then, the valve can be treated as if it consisted of the voltage generator shown inside the dotted line in Fig. 1. Two versions are shown: (a) for those who stick to orthodox symbols, and (b) for those (if any) who prefer the methods I have been advocating recently.

Last month I gave some examples of calculations based on this substitution. With triodes, r_a is generally smaller than Z , and μ is less than 100 and easily measurable; it is then quite satisfactory to deal with the problem in this way. But with pentodes r_a is generally very much larger than Z , and μ is also very large and difficult to measure accurately and may even not be quoted at all in the catalogue. In these circumstances it is much better to substitute a current generator for the valve, rather than the voltage generator. But somehow or other there seem to be a lot of people who, though familiar with the voltage generator equivalent, are not equally so with the current generator. Seeing that pentodes are more commonly used than triodes, this ought not to be. Perhaps one reason is that the generators we are most at home with (quite literally!) give a more or less constant voltage, and the current depends almost entirely on the load we connect. Constant-current generators, although they did make a brief appearance in the history of electrical power supply, have long been obsolete. However, there is no reason at all why we should not use them on paper for the purpose of making valve circuit calculations easier and more accurate.

Fig. 2 is a diagram of the current generator equivalent, corresponding to the voltage generator diagram Fig. 1(b). Apart from the question of triodes or pentodes, it has obvious advantages if (as is often the case) Z consists of two or more items in parallel; just as Fig. 1 is easier to calculate if Z consists of items in series. Fig. 1 can conveniently be tackled, as illustrated last month, by a voltage vector diagram; Fig. 2 lends itself to solution by a current vector diagram. When the output current is known, the output voltage follows by multiplying by the load or coupling impedance, Z . The output current can be found by deducting from the generator current the current "lost" in r_a . Of course there is no such current in a real valve, just as there is no voltage in a real valve corresponding to V_{ab} in Fig. 1(b); but so long as the right answer comes out, why worry?

Both methods (if correctly worked, of course) give the same answer. The choice of method depends partly on which makes the better use of the known data, and partly on which is easier. The equivalents themselves are basically the same; and in case you have doubts about this I am going to prove it.

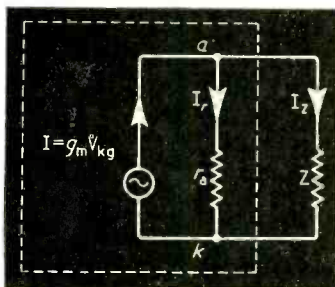
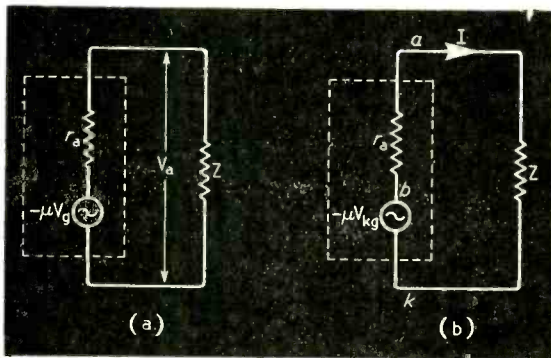

Above: Fig. 1. Voltage generator circuit equivalent to a valve and load impedance (Z), drawn according to (a) usual and (b) "Cathode Ray" recommended conventions.

Left: Fig. 2. Current generator circuit corresponding to Fig. 1(b).

As we have already seen, the current in the first circuit (Fig. 1) is due to an e.m.f. equal to $-\mu V_{kg}$ acting on two impedances in series, r_a and Z . So by Ohm's Law (with its extended a.c. significance) we have:

$$I = -\frac{\mu V_{kg}}{r_a + Z} \quad \dots \quad (1)$$

And the output voltage V_{ka} is therefore

$$V_{ka} = IZ = -\mu V_{kg} \frac{Z}{r_a + Z} \quad \dots \quad (2)$$

Now we know that $\mu = g_m r_a$. Substituting in (2) we have

$$V_{ka} = -g_m V_{kg} \frac{r_a Z}{r_a + Z} \quad \dots \quad (3)$$

The latter part of this, $r_a Z / (r_a + Z)$, is the impedance of r_a and Z in parallel, so $-g_m V_{kg}$ must be the total current flowing into them, I . This is the situation represented by Fig. 2. The current I_r flowing into r_a is easily found, for by Ohm's Law it is V_{ka}/r_a and therefore

$$I_r = -g_m V_{kg} \frac{Z}{r_a + Z} \quad \dots \quad (4)$$

Similarly

$$I_z = -g_m V_{kg} \frac{r_a}{r_a + Z} \quad \dots \quad (5)$$

So the formula for the output current in this system corresponds closely in form with that for output voltage (2) in the other system.

As usual, the best way to get a grasp of all this is by trying it on something. Suppose a pentode has a working g_m of 3.5 mA/V and an r_a of 1.5 MΩ, and the coupling values are as in Fig. 3. What is the voltage gain at 1 Mc/s?

We can dispose of C_c as soon as we calculate its reactance at 1 Mc/s ($X = 1/2\pi fC$) and find that it works out at less than 16Ω, which can be entirely neglected in comparison with the 100kΩ in series. So the anode coupling resistor and the grid leak are as good as in parallel with one another, making a net resistance of $10 \times 100 / (10 + 100) = 9.1k\Omega$. The stray capacitance C_s is a parallel reactance of 6.4kΩ. So we can represent the situation by the equivalent circuit Fig. 4.

Now let us start making a current vector diagram. When drawing a voltage vector diagram we began with the current through all the components in series. In the present case we reverse the procedure and begin with the voltage across all the components in parallel. It is V_{ka} (reckoning in the direction of rising potential); and following previous practice we represent it by a detached line ka pointing in the conventional zero direction as in Fig. 5.

Since the current it drives through a pure resistance is in phase, we must draw the current vectors representing I_r and I_R in the same direction. One method is to assume any convenient value of V_{ka} —say 50V—and work out the resulting currents. I_r would be $50/1500 = 0.033mA$, and I_R would be $50/9.1 = 5.5mA$. To a scale of 1 mA per centimetre, I_r would be hardly visible. I_c is $50/6.4 = 7.8mA$, and its phase is of course 90° ahead of V_{ka} . I is the vector sum of the whole lot.

The diagram shows plainly that I_R , and hence the output voltage, lags I by a fairly large angle, which a protractor shows to be close on 55°. And as $I = -g_m V_{kg}$, the signal voltage between grid and cathode is opposite in phase, so we can attach its vector to the

V_{ka} vector. The magnitude of V_{kg} is I/g_m , and as the diagram shows I to be 9.5mA, it works out at $9.5/3.5 = 2.7V$. To the same scale as V_{ka} it doesn't show up very well on the diagram. But the thing in which we are probably most interested—the voltage gain—is easily calculated: $50/2.7 = 18.5$.

The foregoing procedure is more complicated than it need be, and my only reason for going through it in full is that some people are a bit shy about working in conductances and prefer to do a longer journey in order to tread the familiar path of resistances. Those who are accustomed to conductances, or who don't mind venturing on to them, are advised to proceed as follows.

Express all resistances and reactances as conductances and susceptances, in mA/V (i.e., millimhos); which simply means taking the reciprocals. Thus, using standard symbols, r_a becomes $g_a = 1/1500 = 0.00067$, R becomes $G = 1/9.1 = 0.11$, and X becomes $B = 1/6.4 = 0.156$. The result of adding them all together in a vector diagram is 0.19, which is the number of milliamps (of I) per volt (of V_{ka}). But we know the number of milliamps per volt of V_{kg} —it is g_m , 3.5 in this case. So the voltage gain is $3.5/0.19$, or 18.5 as before. The phase angle is shown by the

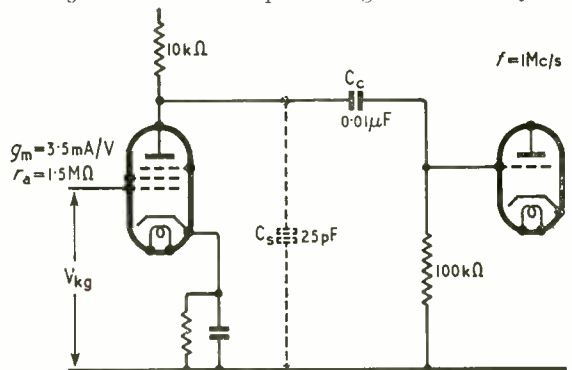
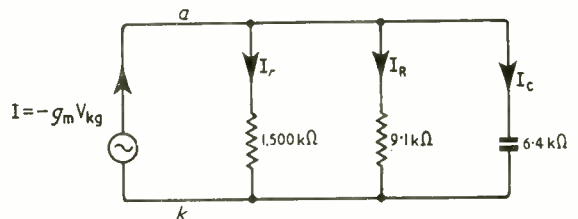
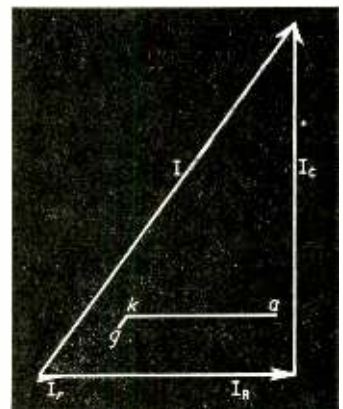

Fig. 3. An example of a valve circuit suitable for solving by the current generator method.



Above: Fig. 4. Current generator circuit corresponding to Fig. 3.



Right: Fig. 5. Vector diagram for Fig. 4.

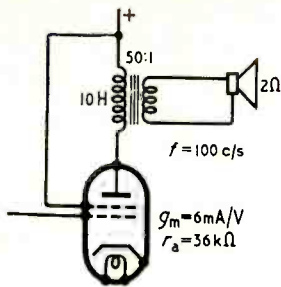

Left: Fig. 6. Another example for practice.

Below: Fig. 7. Circuit equivalent to Fig. 6.

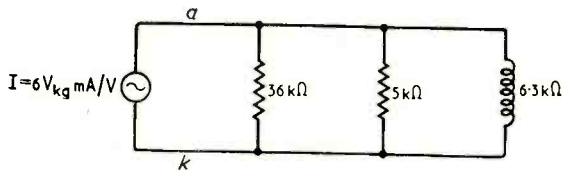

diagram, also as before; in fact, if one happened to choose a scale of 50 cms per millimho the diagram would be exactly the same as before except for labels.

Readers with scrupulous minds, who must have been offended by the dragging in of an arbitrary voltage such as 50 (so far as correctness of the result was concerned it might equally well have been 0.005 or 50,000!) will appreciate the second procedure.

The example we have just considered is typical of the many in which r_a is so much larger than the load impedance that the fictitious current through it can be neglected. This shows up very strikingly in a scale diagram. Reverting to equation (3) we see that the voltage gain, V_{la}/V_{kg} , is g_m multiplied by the impedance of r_a and Z in parallel. But if r_a is vastly greater than Z , there is negligible difference between the parallel combination and Z alone. And so we get the well-known approximate formula for the gain: $g_m Z$. The vector diagram then really boils down to one of the several methods of calculating Z , given R and C (or whatever its constituents may be).

The current-generator equivalent circuit, such as Fig. 4, helps one to visualize how r_a , when it has a very high value as in pentodes and tetrodes, has little effect on the gain unless Z is quite exceptionally high, and how the gain depends practically entirely on g_m and Z .

If the voltage-generator equivalent is used instead, the result is theoretically the same, but the presence of a relatively very large r_a in series with Z does rather obscure the situation, and it is necessary to know both r_a and μ accurately. Unless one realizes that what actually has to be known accurately is the ratio of μ to r_a (i.e., g_m), it is quite possible to find oneself employing values that separately are not nearly as accurate as the available figure for g_m , and consequently the answer may not only be more complicated to find but also less reliable than if the valve equivalent were used in its current-generator variety.

In case anybody would like some practice in the art, Fig. 6 is an example to work on. It is to be supposed that you are examining the behaviour of this output stage at a fairly low frequency: 100 c/s. Not to make it too complicated, the loudspeaker impedance, 2Ω , can be assumed to be purely resistive at this frequency, and the transformer to be perfect, except for its primary inductance of $10H$, which acts as a shunt across the true load. The problem is to find the input voltage required to give an output of $50mW$,

and the phase shift due to the inductance. Also how these results would be affected by raising the inductance to $25H$. The next paragraph gives the method and the answers, so should not be read before having a go.

A resistance of 2Ω across the secondary of a perfect $50:1$ transformer is equivalent to $2 \times 50^2 = 5k\Omega$ across the primary inductance, which at 100 c/s has a reactance of $2\pi \times 100 \times 10 = 6.3k\Omega$. So the equivalent circuit is as in Fig. 7. The power due to a voltage V across a resistance R is V^2/R , so for the power in the $5k\Omega$ load to be 0.05 W, the voltage across it (V_{la}) must be $\sqrt{(5,000 \times 0.05)} = 15.8$. The current resulting is $15.8/5 = 3.16$ mA, to which must be added $15.8/36 = 0.44$ mA, in phase through r_a , and $15.8/6.3 = 2.5$ mA, 90° lagging through the inductance. The vectorial sum (as can be found from a current vector diagram, or alternatively a little arithmetic or trigonometry) is 4.4 mA, lagging the output voltage by 35° . The output voltage therefore leads the fictitious generator current by that amount. And as g_m is 6 mA per volt, the input voltage required for 4.4 mA is $4.4/6 = 0.73$ V. All the currents and voltages, being based on a figure of power, are in r.m.s. values. For an inductance of $25H$ the voltage and phase shift, calculated in the same way, are 0.62 V and 15.7° respectively. The output power with the original input, 0.73 V, would be $50(0.73/0.62)^2 = 68.5$ mW.

CLUB NEWS

Birmingham.—At the April meeting of the Birmingham and District Short-Wave Society, which will be held at 7.45 on the 9th at the Colmore Inn, Church Street, Birmingham, N. Shirley will talk on building a receiver.

Bradford.—The third of a series of lectures for junior members of the Bradford Amateur Radio Society will be given by A. W. Wahmsley (G3ADQ) on April 3rd. The subject is "Simple Transmitters." Meetings are held at the Club headquarters, 66, Little Horton Lane, Bradford, on alternate Tuesdays at 7.30.

Brighton.—T. W. Bennington, who regularly contributes to *Wireless World*, will speak to members of the Brighton and District Radio Club on April 3rd on "Long-Distance V.H.F. Propagation."

Coventry.—"Mathematics, Why?" is the subject of the lecture by T. R. Theakston, B.Sc., to be given to members of the Coventry Amateur Radio Society at their meeting on April 9th at the B.T.H. Social Club, 64, Holyhead Road, Coventry.

Exeter.—On April 5th members of the Exeter and District Radio Society will take part in two contests—one for home constructed equipment and the other for servicing tips.

Manchester.—Readers in the Cheetham Hill district of Manchester interested in the formation of a radio club are invited to communicate with J. C. Henderson, 47, Maple Street, Cheetham, Manchester, 8.

Retford.—Since the disbanding of the Retford and District Amateur Radio Club, the name of which was inadvertently included in the directory of clubs in our January issue, the co-ordinating body for amateur radio activities in the town has been the Retford Group of the R.S.G.B. The Town Representative is D. Smith, 13, Rockley, Nr. Retford, Notts.

Southend.—The contests for the Pocock and Hudson Cups, which are held annually by the Southend and District Radio Society for home-built gear, will take place on April 13th.

W.F.S.R.A.—The World Friendship Society of Radio Amateurs, which was formed sixteen years ago to promote friendship among members of the radio fraternity throughout the world, has recently extended its scope by forming a Junior Section for members between the ages of 13 and 20. The Society has arranged a special broadcast from OTC, Leopoldville, on 9.767 Mc/s at 1920 G.M.T., on April 24th. Particulars of the Society are obtainable from the Secretary, A. H. Bird, 35, Bellwood Road, Waverley Park, Peckham Rye, London, S.E.15.

The names and addresses of the secretaries of local clubs were given in the directory published in our January issue.

The Radar Sonde

New Automatic System for Meteorological Sounding

A PART from a certain amount of confusion with flying saucers, the radio sonde has now become well known as a balloon-borne instrument for telemetering meteorological information, such as temperature, pressure and humidity, from the upper atmosphere to the ground. It is not generally realized, however, that the radio sonde is also required to measure the velocity and direction of winds by virtue of its own speed and direction as it is carried along. These wind measurements are usually done from the ground, and one method has been to use direction-finding stations to give successive plots of the sonde's plan position, from which its direction and speed can be calculated. Another method has involved the use of primary radar, which gives measurements of bearing, elevation and range with more accuracy and far less trouble. This, however, has the disadvantage that it is limited to ranges of the order of 30 miles when, in fact, the balloons often travel distances up to 100 miles before bursting.

A logical development, therefore, has been to adopt secondary radar: in other words, to make the sonde into a mobile transponder which transmits its own signal when triggered from the ground. This, in fact, is the distinguishing feature of a new instrument—the radar sonde—designed by the Telecommunications Research Establishment for the Meteorological Office and described in a symposium of papers on electrical meteorological instruments at the I.E.E. on 30th January.* On the ground the reply signals from the transponder are picked up by an automatic following aerial; this consists of a dipole which is automatically moved with respect to its parabolic reflector so that it always follows the source of radiation. Values of azimuth and elevation are thus given by the position of the dipole, and from them and the range the position of the radar sonde in space can be calculated. So, as the sonde is carried about, the aerial follows it and the resulting changes taking place in azimuth, elevation and range are used for computing the speed and direction of the winds.

Otherwise, the system is a straightforward distance measuring equipment. Interrogating pulses of 2- μ sec duration are transmitted at a repetition rate of 400 per sec from a 70-kW ground transmitter working on about 2 metres. These are received in the radar sonde and are fed to a modulator, where they are arranged to trigger a phantastron circuit to generate pulses of 1- μ sec duration. The phantastron output is modulated on to a concentric-line oscillator, working at a wavelength of 10.7 cm, and so the 1- μ sec reply pulses are transmitted. On the ground the total transit time is measured on the usual radar principle, thereby giving the range of the radar sonde.

An interesting feature is that the telemetering of meteorological information is done through the radio link provided by the secondary radar itself. Pressure, temperature and humidity are measured by simple expansion devices mechanically coupled to variable inductors, and these are switched by a com-

mutator at a regular sequence into the filter output circuit of an oscillator. The fluctuations of amplitude thus caused are turned into d.c. variations, which are arranged to control the delay time between the normal 1- μ sec reply pulse and a second, identical, pulse following it. (Another phantastron, triggered by the first one, generates the second pulse.) By this method a movement of 1 mm of one of the met. instruments can be made to change the variable delay from 200 to 1,200 μ secs, with an instability not exceeding $\pm 2\mu$ secs. On the ground, then, two reply pulses are received for every one interrogating pulse sent out, the time interval between them being proportional to pressure, temperature and humidity in regular sequence. It is then a matter of demodulating this pulse code and conveying the result to automatic recorders.

Another feature of the radar sonde is its high telemetering accuracy of 0.1 per cent of the total excursion of each meteorological parameter: conventional radio sondes have rarely achieved anything better than 1 per cent. This high accuracy is largely due to the fact that the airborne equipment, apart from the temperature and humidity instruments, is enclosed in a thermally insulating container which keeps it at approximately room temperature throughout the flight. Temperatures as low as -75 deg C can be encountered towards the stratosphere, so the performance of the apparatus would certainly be affected without this insulation.

Since balloon-borne instruments are hardly ever recovered they must be regarded as expendable items, and their cost is therefore of some importance. As might be expected, the radar sonde does cost a little more than a conventional radio sonde: it is estimated, however, that this increase will be more than outweighed by the saving in personnel made possible by the automatic features of the new equipment.

Interior of the airborne transponder. The receiving aerial projects through the top and provides the means of suspension from the balloon.

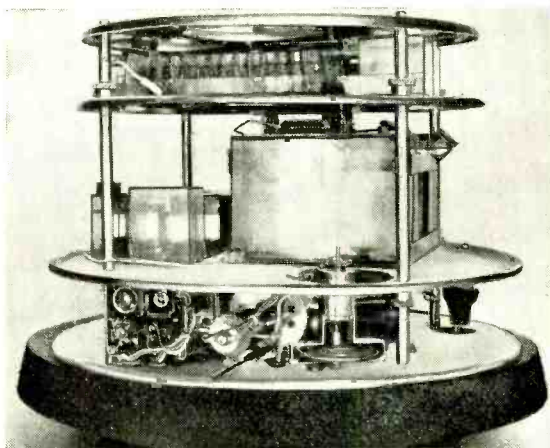

* Jones, F. E., Hooper, J. E. N., Alder, N. L. "The Radar-Sonde System for the Measurement of the Upper Wind and Air Data."

High-Definition Television

New Bandwidth Compression System

The system described in this article has not yet been set up and field-tested. Certain fundamentals have, however, been laboratory-tested. The system has been proposed by R. B. Dome of the General Electric Company's Receiver Division in Syracuse, N.Y. An outline of the system has been submitted to the Federal Communications Commission, and this description is based on it.

THE fundamentally new feature of this system is the unique treatment of small detail in the picture as compared with the larger areas and larger detail of the picture. Observations indicate that the eye is not so susceptible to flicker in small areas as it is to flicker in large areas.

Based on this observation, a normal video band may be divided into two approximately equal portions. The low-frequency portion is transmitted in regular 60-c/s sequence as in present-day American monochrome transmissions. The upper portion of the video band may be utilized on *odd* frames for the transmission of picture detail normally transmitted by present transmitters on both odd and even frames. The super-high video band of frequencies, extending beyond the limits of the present video band, is transposed in frequency to fit into the upper section of the existing band and is transmitted on

even frames. Thus, if the present 6-Mc/s band were divided in half, the detail could be extended by a factor of 50 per cent, so that instead of 350-line detail an effective horizontal resolution of 525 lines could be obtained.

The system can be made compatible (i.e., receivable on existing receivers) by the simple expedient of using the principle of frequency-interlace when transmitting the super-high information. The system is inherently compatible for 75 per cent of the information without such treatment because the odd frames are exactly like present monochrome odd frames, and the even frames are like present monochrome even frames for the entire lower section of the frequency band.

The only remaining problem is to make the super-high information transmission have a minimum effect on present-day receivers. Since repetitive television

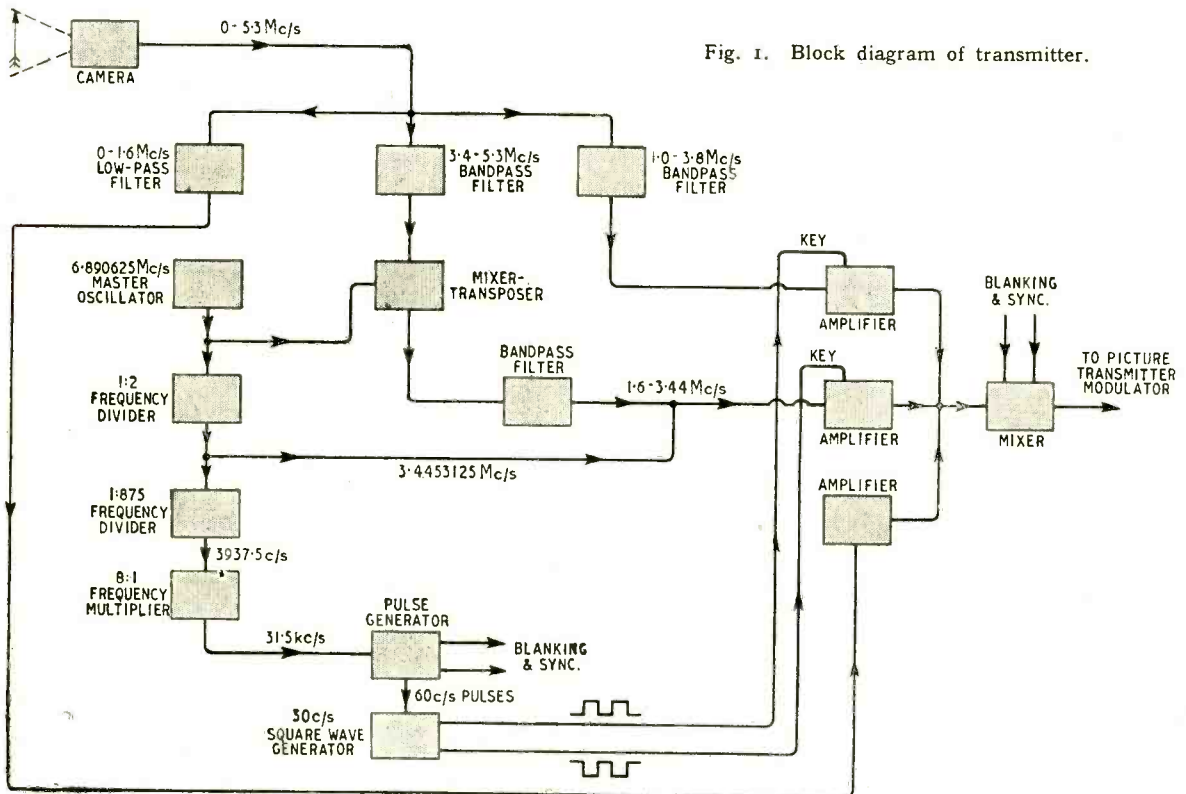

Fig. 1. Block diagram of transmitter.

information transmitted on alternate frames will largely integrate out because of persistence of vision (providing the frequencies making up such a signal lie at odd harmonics of half the line frequency) it is proposed to transmit the super-high information in that manner; i.e., by frequency interlace.

The advantages of this system are: (1) Sampling is not utilized so that no precision gating is required, as in dot interlace; (2) The texture of the picture is not marred by a fine dot structure.

In working out the technical details of the proposed system, the basic problem is to provide suitable circuitry for accomplishing the following end results:

(1) Odd frames to transmit coarse and fine details as in present monochrome transmissions.

(2) Even frames to transmit coarse and super-fine detail, with the super-fine detail transposed in frequency to fit into the space normally occupied by the fine detail.

(3) Provision for a retransposing carrier wave for the super-highs.

(4) Suitable circuitry at the receiver for restoring the picture signal to its full bandwidth.

The Transmitter

The first three items listed above are essentially transmitter problems. At the outset it must be assumed that a suitable camera signal is available. That is to say, the camera must provide video-frequency signals extending appreciably higher than 4 Mc/s, preferably up to 5.5 Mc/s. The block diagram of Fig. 1 shows one method of generating the required signal. The camera shown at the upper left produces video-frequency signals covering the range from 0 to 5.3 Mc/s. The output of the camera is passed through three wave filters which divide the frequency range into three sections: (a) 0 to 1.6 Mc/s, (b) 1.0 to 3.8 Mc/s, (c) 3.44 to 5.3 Mc/s.

The low-frequency portion is amplified by a continuously-operating amplifier shown at the lower right. The middle range, carrying the fine detail, is amplified by a second amplifier and the output of this amplifier is connected in parallel with the low-frequency amplifier. This amplifier is keyed on in alternate frames; i.e., it is made conductive, for example, on all odd frames.

The upper range of frequencies, carrying the super-fine detail, is fed to a suitable mixer-transposer to which is also fed a continuous wave of 6.890625 Mc/s, the 875th multiple of half the line frequency of 15,750 c/s. The mixer-transposer combines these waves, giving rise to sum and difference frequencies. The difference frequencies are selected by a filter which passes the frequency band of 1.6-3.44 Mc/s.

It will be observed that 1.6 Mc/s comes from 5.3 Mc/s, while 3.44 Mc/s comes from 3.44 Mc/s so that an inversion as well as a transposition of the super-highs has taken place. At the output of this filter, a continuous wave of 3.4453125 Mc/s is added for use by the receiver in retransposition.

The 1.6-3.44 Mc/s band is amplified by a third

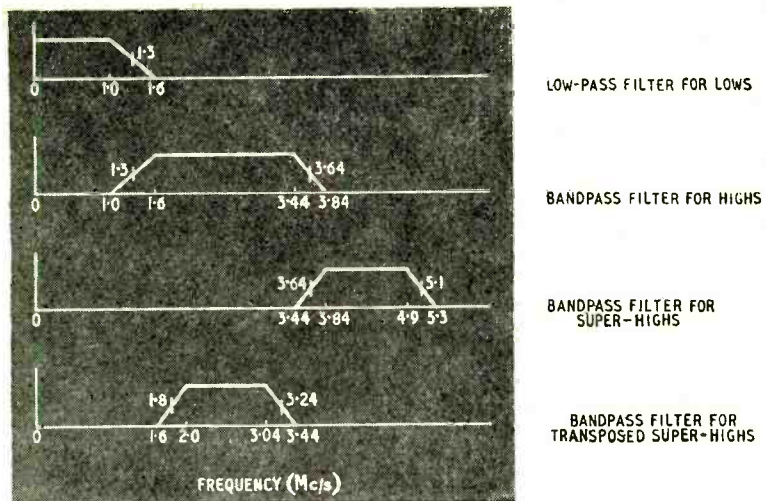

Fig. 2. The transmitter filters have gradual cut-off characteristics.

amplifier and combined by addition with the 0-1.6 Mc/s and the 1-3.8 Mc/s bands. The 1.6-3.44 Mc/s amplifier is keyed on in alternate frames to the 1-3.8 Mc/s amplifier or, in the example given, the 1.6-3.44 Mc/s band may be keyed on in all even frames. The combined signal is combined in a blanking and sync mixer shown at the upper right to form a composite television signal which may be fed to the modulator of a conventional television transmitter.

The pulse generator chain of the transmitter includes a master oscillator at 6.890625 Mc/s. This is used in the super-high transposer. This frequency is next divided by two to obtain 3.4453125 Mc/s for use by the receiver transposer. This divider is followed by a frequency divider having a ratio of 875 to 1. The factors of 875 are: $5 \times 5 \times 5 \times 7$. The resultant frequency is 3975.5 c/s, which is one-quarter of the line frequency of 15,750 c/s. This divider is followed by an 8 to 1 multiplier which gives 31.5 kc/s. This is twice the line frequency and is suitable for feeding into and controlling a standard picture transmitter pulse generator.

Pulses at 60 c/s from the pulse generator are fed to a 30-c/s square-wave generator which is used to key the two high-frequency video amplifiers already described. The transition in keying should take place during the normal vertical blanking period so that the transition is made while the picture tube is cut off, or is black. In this way no transition keying streaks will be seen by the observer.

The filter characteristics are shown in Fig. 2. Gradual cut-off characteristics are purposely provided so that ringing transients will be held at a minimum.

The choice of 6.890625 Mc/s for the master oscillator was made so that the high and super-high frequencies would be interleaved or interlaced to best advantage in the interest of achieving maximum compatibility as already explained. For example, the 300th harmonic of 15,750 c/s is 4,725,000 c/s and is consequently a super-high frequency. This becomes transposed to $6,890,625 - 4,725,000 = 2,165,625$ c/s, which is $137\frac{1}{2}$ times 15,750; i.e., half-way between the 137th and 138th harmonics of the line-scanning frequency. Such a frequency will be self-

cancelling on alternate frames in so far as its presence in the picture is observable to the eye.

The receiver is quite conventional except for the video-frequency amplifier. This amplifier may be constructed in a number of ways, one of which is shown in Fig. 3. The output from the detector is fed to three separate filters. The first is a low-pass filter passing the frequencies 0-1.6 Mc/s common to both odd and even frames. The output of this filter is amplified by the conventional video-frequency amplifier and the output fed to the picture tube gun.

A second filter connected to the detector passes the band of frequencies from 1.0 to 3.8 Mc/s. These are amplified by a keyed amplifier and then by a second high-frequency power amplifier before being combined with the low frequencies to feed the picture tube gun.

A side circuit, connected at the output of the 1.0-3.8 Mc/s filter, is tuned to the retransposing frequency of 3.445 Mc/s and this wave is amplified and then doubled in frequency to 6.890625 Mc/s where it feeds a modulator or detector. The d.c. component of the detector wave is fed to the keyed amplifier so that when 3.445 is present, the keyed amplifier is keyed off.

A third filter connected to the second detector passes the band of frequencies from 1.6 to 3.4 Mc/s, and the output of this filter is fed into the 6.89-Mc/s detector. The output of this detector will contain a difference band of 3.44 to 5.3 Mc/s. This band is passed by a band-pass filter which excludes the 1.6 to 3.4 Mc/s band as well as the 6.89 Mc/s carrier frequency and any traces of 3.445 Mc/s which may have passed the preceding filters. The output of the 3.44 to 5.3 Mc/s filter is amplified by a video amplifier and the output is connected in parallel with the output of the 1-3.8-Mc/s keyed amplifier.

The number of additional valve functions required for this receiver above those required for a conventional monochrome receiver are such that they may be obtained with four envelopes. In American type numbers, these are:—

Keyed amplifier	6AS6
Amplifier-doubler	12AX7
High-frequency power amplifier	12AU7
Detector and super-high amplifier	6SF7

The filter response characteristics would be substantially the same as those shown for the transmitter except transmission bands may be made slightly wider if desired.

Small sections of delay lines may be added as required in order to produce a uniform time delay for all components of the picture.

Fig. 4 shows the steps in the transmission and reception of this high-definition monochrome television system.

TABLE 1

Blanking	Present System	High Definition	Improvement
0%	457 lines	649 lines	192 lines or 42%
16%	384 lines	545 lines	161 lines or 42%

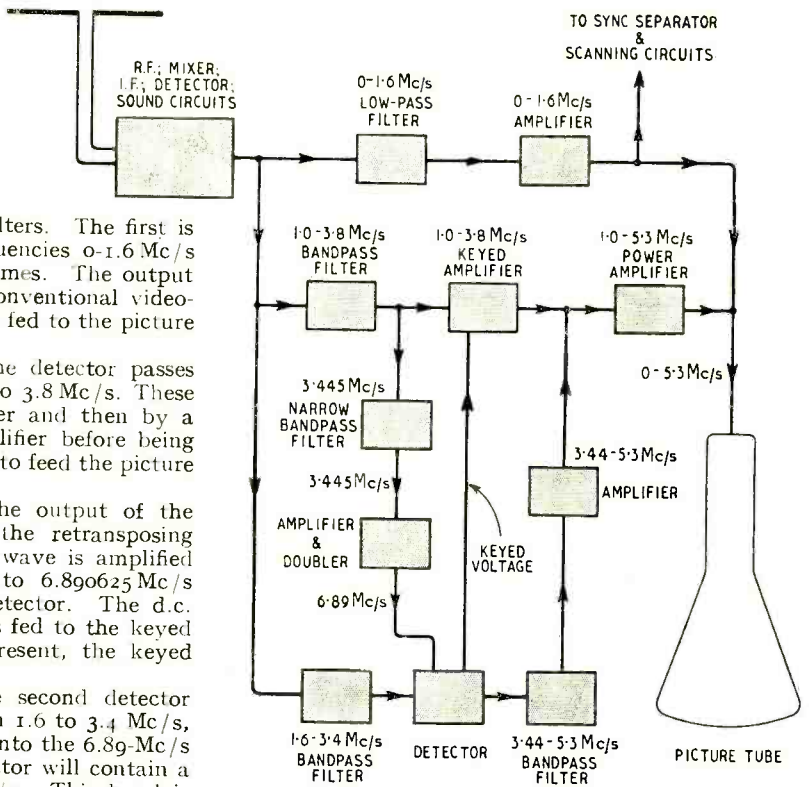

Fig. 3. High definition receiver.

Neglecting the effects of blanking, a conventional receiver with a video bandwidth of 3.6 Mc/s will have a limiting horizontal resolution of

$$R_h = \frac{2 \times 3.6}{0.01575} = 457 \text{ lines} \quad (1)$$

where 2 = impulses per cycle
3.6 = upper limit of video in Mc/s
0.01575 = line scanning frequency in Mc/s

The system described here, having an effective bandwidth of 5.1 Mc/s would resolve

$$R_h = \frac{2 \times 5.1}{0.01575} = 649 \text{ lines} \quad (2)$$

This represents an increase of 192 lines, or approximately 42 per cent.

When standard blanking of 16 per cent is employed the above resolution figures change to those shown in the last row of Table 1.

The signals of this high-definition system can be transmitted over any relay channel having a bandwidth of 4 Mc/s. If the relay bandwidth is 2.7 Mc/s no improved definition is possible under this system, although it is possible to add somewhat more complete terminal equipment so that the 2.7-Mc/s relay circuit can be made to have an apparent bandwidth of $2.7 \times 1.42 = 3.84$ Mc/s. This latter band could then be broadcast over a standard monochrome transmitter to provide detail substantially equivalent to local studio signals when using present (American) standards.

The propagation characteristics should be substantially the same for the high-definition signal as for a standard transmission. About the worst that could

happen would be a fade-out of the retransposing signal, in which case the resolution would drop from 545 lines to 384 lines. A shift in phase of the transposing frequency from its correct phase should not seriously affect resolution because the sidebands to be transposed lie adjacent to the retransposing signal and would be correspondingly shifted in phase to leave a net phase shift of substantially zero.

Compatibility as used here means the ability to receive the high-definition system signals on present-day monochrome receivers without alteration of any kind to the receivers. It is claimed that the high-definition system is compatible. Without altering the receiver, high-definition signals will provide a service having a horizontal resolution of 384 lines, which is substantially equivalent to present-day (American) monochrome service. Actually, the signal will not have the quality of present-day transmissions for these reasons: (1) The retransposing wave will be observable on present-day receivers as a weak, fine-grained pattern; (2) the transposed super-high signals cannot be utilized but do exist as spurious signals which, while theoretically self-cancelling, are not quite self-cancelling because the persistence of vision is not infinite in time and hence integration is not 100 per cent perfect; (3) the high-video frequencies, since they appear only in every other frame, will be reduced about 50 per cent in brightness over present-day theoretical levels. Actually, it is possible, of course, to make use of pre-emphasis so that this loss may be reduced in a practical system to something in the order of 5 per cent to 20 per cent, and hence can be made to be a relatively unimportant factor.

Reverse compatibility (i.e., the ability of the high-definition receiver to receive present-day transmissions) is automatic. Since the retransposing carrier wave is absent in present-day transmissions, the keyed amplifier is never shut off, so that the high-video frequencies are delivered continuously to the picture tube. No output appears in the super-high band because the detector for those signals is absent. This detector is normally biased beyond cut-off and spurious signals and moderate interference will not activate it.

A complete system has not yet been set up and field-tested. However, certain elements of the system have been tested.

A receiver has been tested using a total video bandwidth of approximately 3.6 Mc/s. A standard picture signal band was divided into three approximately equal segments. The band from 0 to 1.5 Mc/s was fed to the picture tube continuously. The remainder of the band was divided at 2.5 Mc/s so that a high band of 1.5 to 2.5 Mc/s and a super-high band of 2.5 to 3.6 Mc/s were available. These two bands were keyed in alternately so that on odd frames the frequencies presented were 0 to 2.5 Mc/s, and on even frames the frequencies presented were 0 to 1.5 and 2.5 to 3.6 Mc/s. Switches were provided so that any combination of bands could be delivered to the picture tube as desired.

With both high-frequency channels shut off a low-definition picture of about 150 lines horizontal reso-

Fig. 4. Summary of steps in transmission and reception of high definition monochrome television.

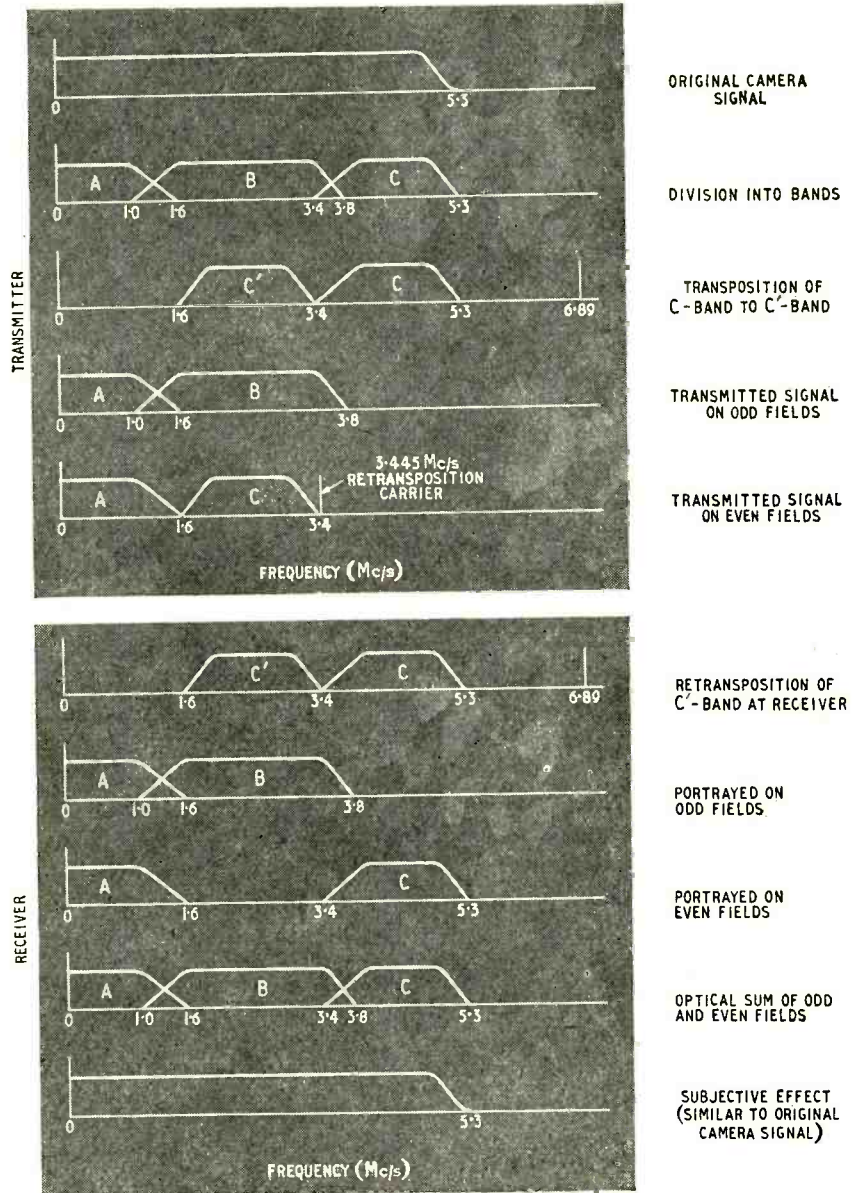

lution was observed. When the next band was cut in the horizontal resolution increased to about 250 lines, and when both bands were cut in, full 350-line resolution was obtained. When the low band and the very high band were combined (omitting the middle band) the test pattern showed an absence of lines in the region around 200 lines resolution.

Flicker in large areas was not observable under any conditions. No flicker was observed in small detail at normal settings of the controls, but if the high-frequency channels were given excessive amplification a flicker condition could be observed. However, under this condition the highs were grossly exaggerated and

the condition would not normally be encountered.

The conclusion reached from these tests is that it is entirely feasible and practical to subdivide the video-frequency spectrum and to transmit portions of the high-frequency end of the spectrum alternately. The tests do not show how practical it is to accomplish the transposition and retransposition of frequencies, but since this is only a question of circuit design and refinement, and not a question of subjective improvements, it is not believed that lack of tests on transposition would constitute serious grounds for questioning the ultimate successful performance of the complete system.

SHORT-WAVE CONDITIONS

February in Retrospect : Forecast for April

By T. W. BENNINGTON*

DURING February the average maximum usable frequencies for these latitudes decreased slightly, both by day and by night, instead of increasing, as had been expected. The exact reason for this is obscure, but it may have been due to the large amount of ionospheric storminess which occurred during the month.

Daytime working frequencies were, generally speaking, only moderately high, and those for night time very low.

For a few days during the early part of the month frequencies as high as 30 Mc/s were usable, even over the circuit to North America, but thereafter 22 Mc/s was about the highest usable daytime frequency, and on many days it was much lower than this. After midnight the highest usable frequency was of the order of 7 Mc/s.

There was a small increase in the amount of Sporadic E observed. A large sunspot was present on the sun, and the average sunspot activity was slightly higher than during the previous month.

February was a relatively badly disturbed month, ionospheric storms, some of them rather severe, occurring during the periods 1st-2nd, 5th-6th, 8th-13th, 22nd-24th and 27th-28th. A Dellinger fadeout was recorded at 1405 g.m.t. on 19th.

Forecast:—During April there is likely to be a considerable decrease in the daytime m.u.f.s. for these latitudes, whilst the night time m.u.f.s. should continue to increase.

The effect of the ionospheric variations upon working frequencies for long-distance communication should be as follows. Over practically all circuits the peak daytime working frequencies should become considerably lower, but the period of useful operation for the medium-high frequencies will be considerably extended. Night time working frequencies over nearly all circuits should become somewhat higher. The 28-Mc/s band may occasionally be usable over north/south circuits, but is unlikely ever to be so over that to North America, where the highest regularly usable frequency should be of the order 16-17 Mc/s. 9 Mc/s should be usable till well after midnight on most circuits, and throughout the night on those running in north/south directions.

There may be a small increase in the amount of Sporadic E capable of sustaining propagation on very high frequencies. Working frequencies for medium-distance communication are likely to be somewhat higher than during March for several hours around noon, because the E layer will control this type of transmission during that part of the day. There may be a considerable amount of ionospheric storminess during April.

The curves indicate the highest frequencies likely to be usable over four long-distance circuits from this country during the month.

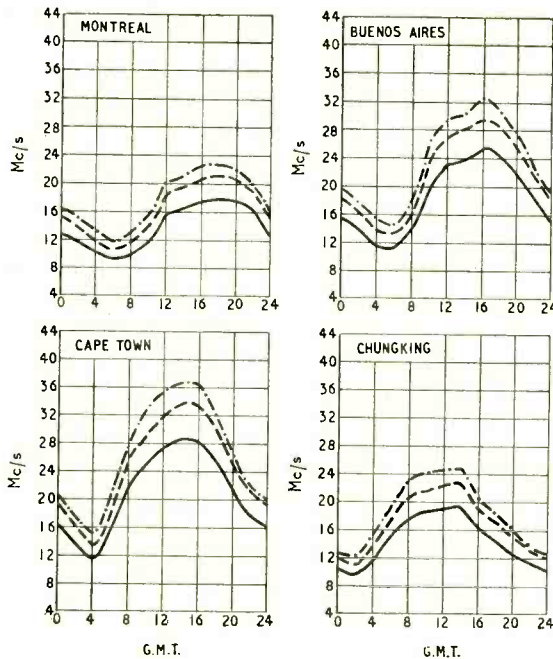

— FREQUENCY BELOW WHICH COMMUNICATION SHOULD BE POSSIBLE ON ALL UNDISTURBED DAYS
 - - - PREDICTED AVERAGE MAXIMUM USABLE FREQUENCY
 - · - · FREQUENCY BELOW WHICH COMMUNICATION SHOULD BE POSSIBLE FOR 25% OF THE TOTAL TIME

* Engineering Division, B.B.C.

Electronic Fluxmeter

A Useful Instrument Employing Readily Available Components

By P. L. TAYLOR, M.A.

FIRST, to make clear the method of calibrating the fluxmeter, let us revise briefly the method of measuring flux by inducing a voltage in a search coil. Consider a single loop of wire, of area A sq cm in a magnetic field of flux density B gauss. The total flux through it is $B \times A = N$ maxwells.

If the flux changes at a rate $\frac{dN}{dt}$ as the coil is moved through the field, then an e.m.f. is induced in the coil of value E volts where

$$E = 10^{-8} \frac{dN}{dt} \dots \dots \dots (1)$$

If, therefore, the coil is connected to some device that will integrate this voltage with respect to time, the result will be a measure of the total change in flux. For, if the flux is initially N_1 and at time t_1 the coil starts to move, so that the flux reaches N_2 at time t_2 ,

$$\int_{t_1}^{t_2} E dt = 10^{-8} \int_{t_1}^{t_2} \frac{dN}{dt} dt = 10^{-8} \int_{N_1}^{N_2} dN = 10^{-8} (N_2 - N_1) \dots \dots \dots (2)$$

We can note that the left-hand integral, being one of voltage with respect to time, represents a quantity whose dimensions are volts \times seconds or volt-

seconds. The simple example of Fig. 1 makes this clear, as this integral is the area under the voltage/time graph. Equation (2) shows that one volt-second is equivalent to a total flux of 10^8 maxwells.

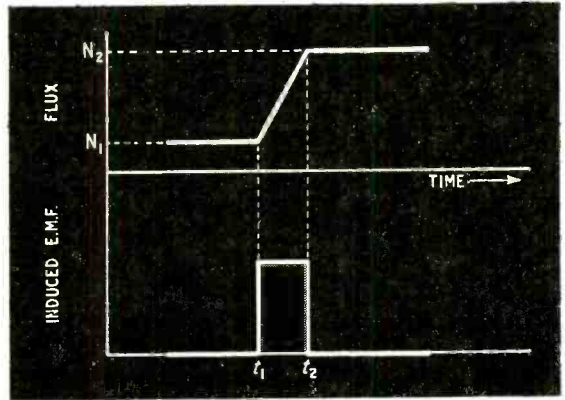
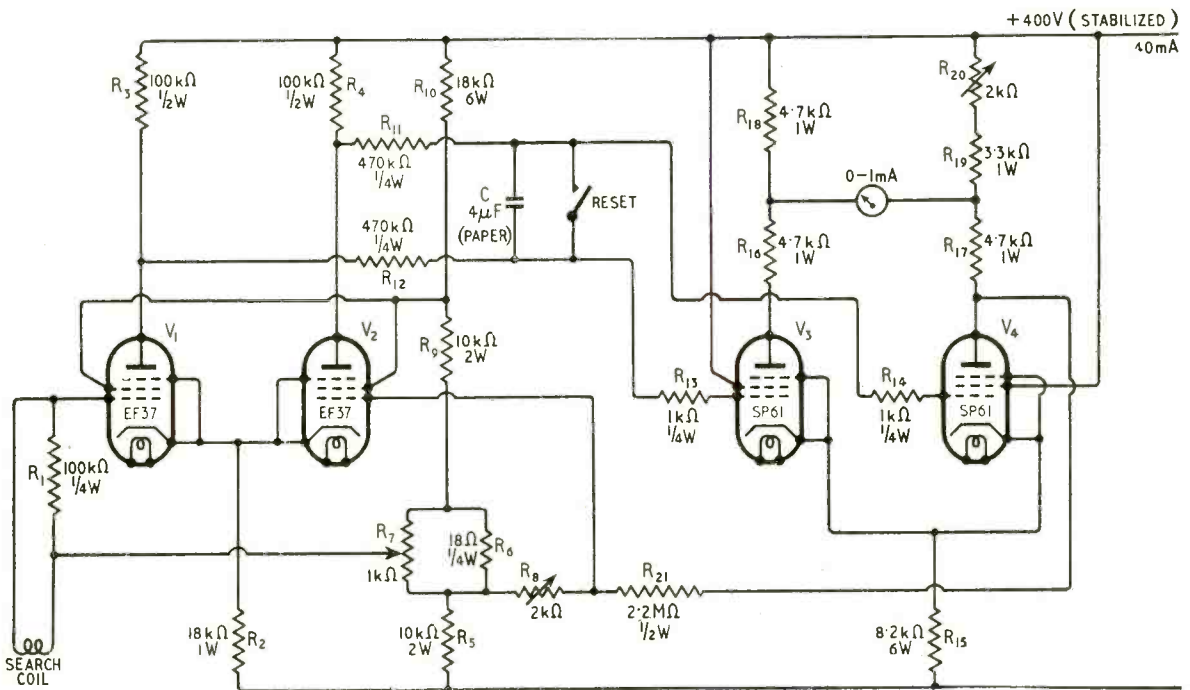

Fig. 1. Total flux in terms of voltage and time.

Fig. 2. Complete circuit diagram of electronic fluxmeter. All resistors should be ± 10 per cent.



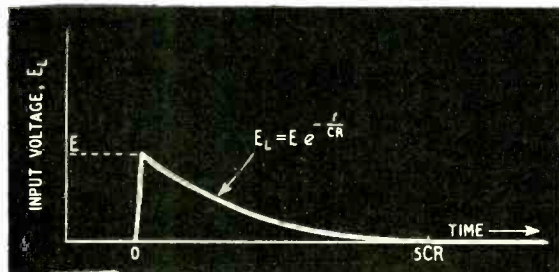
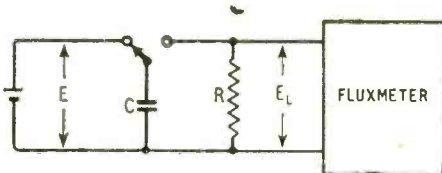

Fig. 3. Calibration by condenser discharge method.

In practice the e.m.f. induced in a single loop of wire is too small to operate an integrator or fluxmeter satisfactorily, so a coil of a number of turns is used. The fluxmeter is then calibrated in maxwell-turns, and to calculate the change in flux density represented by a reading it is first divided by the number of turns in the search coil, and then by the area of a single turn.

The circuit is shown in Fig. 2. A certain amount of amplification of the search-coil voltage is provided by the cathode-coupled amplifier¹ V_1 and V_2 , and the resultant voltage is integrated by the RC circuit² R_{11} , R_{12} , and C . The resultant voltage on C upsets the initial balance of V_3 and V_4 giving a meter reading. When the search coil becomes stationary in its new position the anodes of V_1 and V_2 would revert to their original potentials, with consequent discharge of C and drift of the meter reading. This is overcome by feeding back from the anode of V_1 through R_{21} and R_8 to the grid of V_2 a voltage which is just sufficient to maintain the out-of-balance. To reset the circuit C is discharged.

To set up, the reset switch is closed and R_{20} adjusted for zero reading of the meter. Then with the switch open and R_8 set to about $1k\Omega$, R_7 (which controls the balance of V_1 and V_2) is adjusted to give a mid-scale reading. The switch is then momentarily closed, when the meter reading will return to zero and then probably start to drift. If the drift is back towards midscale it indicates that the feedback is insufficient and R_8 should be increased; drift below zero indicates that there is too much feedback. R_7 and R_8 are interdependent, and every time R_8 is altered R_7 will have to be readjusted as outlined above.

Even with careful adjustment some random drift due to changes of supply voltage etc. will occur, and if possible stabilised h.t. and heater supplies should be used. The nuisance of drift can be minimized if the following procedure for taking a reading is used. The search coil is first placed in position in the field to be measured: the reset switch is then momentarily closed and the search coil fairly quickly withdrawn

to a position where the field is small, and the reading taken.

Calibration

The full-scale sensitivity is about 10^6 maxwell-turns, i.e. it will be obtained for an input of $10^6 \div 10^8 = 0.01$ volt-seconds.

Method 1. A known constant voltage is obtained from a battery and potentiometer, and applied to the input terminals for a known time. The voltage must not be too high or the required time will be too short for accurate measurement, not too low or the circuit may drift during the calibration period. Suitable values are 0.01 volt and 1 second.

Method 2. (Fig. 3.) This method in effect dispenses with the stopwatch. A known capacitance C is charged to a potential E and allowed to discharge through a known resistance R connected to the input terminals. The graph shows the variation of input voltage with time as C discharges. The input in volt-seconds is the area under the graph, i.e.,

$$\int_0^{\infty} E e^{-\frac{t}{CR}} dt = ECR$$

The process is virtually complete after a time equal to $5CR$. Suitable values would be $E = 0.1$ volt, $C = 1\mu F$, $R = 100k\Omega$. With this value of R , R_1 of Fig. 2 must either be temporarily disconnected, or be measured accurately and itself used as the required resistance.

The fluxmeter was originally developed for measurement of flux density in the writer's ribbon loud-speaker.³ The pole pieces of this are only $\frac{3}{8}$ in wide so the search coil had to be wound on a former only $\frac{1}{4}$ in diameter so that it would be in a reasonably uniform part of the field. The flux density being of the order of 10^4 gauss, the total flux through a single turn would be (cross-sectional area of former in sq. cm.) $\times 10^4$ maxwells, i.e., about 1.3×10^4 maxwells. Aiming for about $2/3$ full-scale deflection of the meter, we thus require $10^6 \div (1.3 \times 10^4) = 83$ turns, or say 80 for convenience in subsequent calculation. This means the use of fine wire to get the turns in the available space, but this does not matter as the input impedance of the circuit is high.

³ *Wireless World*, Jan. 1951, p. 7.

Television Microscopy

BECAUSE the size, brightness and contrast of a television picture can readily be made greater or less than that of the original image, closed-circuit television is now proving a valuable aid to microscopy. In a recent letter to *Nature*, J. Z. Young and F. Roberts describe how they have adapted a conventional microscope for scanning on the flying-spot principle. A cathode-ray tube producing a scanning raster is placed in front of the eyepiece so that, by virtue of the optical focusing, the specimen on the slide is scanned by a minute spot of light. After passing through the slide the spot—now varying in intensity—falls on a multiplier photocell, and the output of this is used to modulate a projection tube whose raster is synchronized to that of the scanning tube. The large and bright projection picture obtained in this way has obvious advantages for lecturing, especially as its contrast can be controlled.

¹ "Time Bases" by O. S. Puckle, p. 119. Chapman & Hall.

² "Time Bases," Appendix IV.

Manufacturers' Products

New Equipment and Accessories for Radio and Electronics

Television Receiver

A NEW 12-inch table-model television receiver has recently been announced by Philips Electrical, Ltd., of Century House, Shaftesbury Avenue, London, W.C.2. This is the model 1502U, a superhet on both vision and sound. The circuit follows the normal Philips design practice for television receivers, and the set works on either a.c. or d.c. mains, 200-250V, with a consumption of 120 watts. Interference limiters are incorporated in both the sound and vision channels; the sound interference limiter is fixed whilst the vision one is variable and can be set to suit local conditions. Four controls are provided: on/off and volume, focus, contrast and brightness. The price is 59 guineas, including purchase tax.

Printed Circuits

FURTHER developments in the technique of printing circuits on plastic bases have been announced by A. H. Hunt Ltd., of Garratt Lane, London, S.W.18, in conjunction with Ward Blenkinsop & Co. Ltd. Improvements in the process have resulted in a definite adhesion of the metallic elements to the plastic material and have made

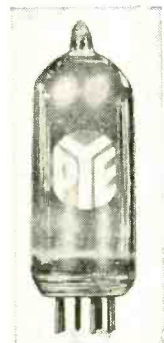
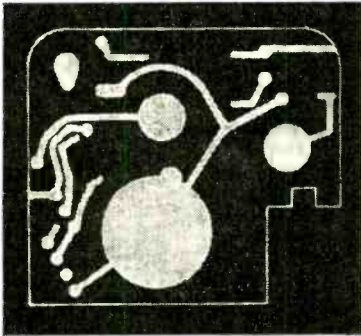

Left: Pye B7G quartz crystal unit.
Right: P43U receiver by the same firm

the task of soldering connections much less critical—although, of course, some care is needed to prevent damage to the plastic base. The firm recommends that low-voltage soldering irons, preferably of the pencil type, should be used, with 60/40 solder.

High-grade phenolic laminated sheet is being used primarily as the base, but the technique has been applied successfully to other plastic materials.

Miniature Crystal Oven

THE idea of mounting quartz crystals inside miniature valve envelopes has now been taken one step further by leaving in the valve heater so that the complete assembly becomes a miniature oven. This development is due to Pye Ltd., of Cambridge, who have recently produced a temperature-controlled quartz crystal unit in which the crystal, heater and a thermostat are all contained in an evacuated B7G glass envelope. With such a small size of oven the heater consumption is very economical, whilst the general method of construction makes the unit reliable for long periods of continuous operation.

Maximum frequency deviation obtained with the oven is ± 10 parts in a million over the temperature range -20 degrees C, to $+65$ degrees C, the average deviation being ± 5 parts over the same range. The heater is rated at 6.3V, 0.3A, and, because of the low current and the operation of the thermostat *in vacuo*, interference suppression is generally unnecessary. Crystals can be supplied in the frequency range 5-20 Mc/s, to specified accuracies of 0.01 per cent, 0.005 per cent or 0.003 per cent.

Transportable Receiver

RECENTLY introduced by Pye Ltd., of Cambridge, is a new table-model receiver, the P43U,



TRIX

Quality

SOUND EQUIPMENT

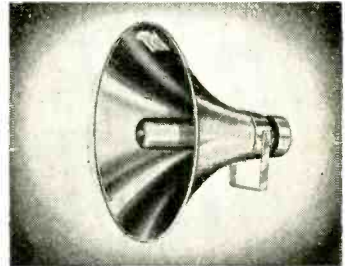

MODEL R.E.48

Reflex HORN SPEAKER

This is a heavy duty reflex type horn speaker suitable for both speech and music reproduction, having an air column 48in. in length, with flare diameter of 25in., thus providing a weatherproof horn of excellent performance for all public address work.

The horn is of novel construction incorporating a solid alloy casting at the base giving exceptional strength and rigidity. It is supplied complete with heavy steel swivelling stirrup, and is suitable for permanent installations in positions where a weatherproof speaker is essential as well as taking up a good deal less space than an equivalent straight horn.



MODEL E.M.3

MIXER-TONE CONTROL Unit

Another outstanding addition to the TRIX range of high-quality sound equipment—an improved design 3-way mixer pre-amplifier unit combined with tone controls for bass and treble boost. Inputs are provided for two microphones and one gramophone circuit, operating into a pre-amplifier stage with two individual tone controls. This model can be used with any of our standard AC amplifiers such as T613B, T633B, T663B, etc.

Full details of these and other models in the large Trix range of Sound Equipment available on request. Send for latest catalogue and price lists.

THE TRIX ELECTRICAL CO. LTD.
1-5 Maple Place, Tottenham Court Road,
London, W.1. Phone: MUSeum 5817
Grams & Cables: "Trixodio, Wesdo, London."

AMPLIFIERS · MICROPHONES · LOUDSPEAKERS

designed to work from 200-250V and 110-125V mains, a.c. or d.c. It is a 4-valve superhet, with a UCH₁₂ frequency changer, UBF80 i.f. amplifier and detector, and a UL₄₁ output pentode giving an a.f. power output of 1.9 watts; the mains rectifier being a UY₄₁. Two wavebands, medium and long, are provided, and the set has built-in frame aerials. In a compact moulded cabinet, the P₁₃U measures 12in x 6in x 9in, and costs 13 guineas, including purchase tax.

Zirconium

THE announcement by Murex Ltd., of Rainham, Essex, that they are now producing zirconium on a commercial scale in rod, sheet and wire form is of some interest to the electronics industry, for this

metal—one of the elements—has proved most effective as a getter in the manufacture of radio valves. When heated to 400 degrees C it will absorb five times its own volume of hydrogen, while at 1,400 degrees C it will absorb carbon monoxide and carbon dioxide as well as 40 times its own volume of oxygen and 20 times its own volume of nitrogen. The metal is also useful in valves for rapidly dissipating heat. Sprayed as a powder on to anodes, it will increase the thermal emissivity (as well as providing a continuous getter action) and when used for grids it will keep down the temperature and so reduce grid emission.

For other applications zirconium has excellent resistance to corrosion, and acids such as hydrochloric, nitric, phosphoric and sulphuric have very little effect on it.

on top of it, apply the iron for a moment and that is that. The trouble is that the wire will not always stay put and allow you to deal with it. You then wish you had one hand to hold the wire in position with pliers, a second to place the solder above it and a third to apply the bit. Various expedients may be used, provided that the place where the joint is to be made is accessible. One that I mentioned some time ago is to have on the workshop bench a flask-holder of the type used in laboratories and to clip the iron in it. Another utilizes one of those crocodile clips with a tubular shank and a knurled binding screw. Cut off about six inches of solder wire and pass one end through the tubular part; give the jaws of the clip something close to the joint to bite, pull the required length of solder through and clamp very gently with the binding screw. Keep that gadget handy and the six-inch length of solder will suffice for dozens of awkward joints.

RANDOM RADIATIONS

By "DIALLIST"

As She Is Wrote!

IN THE ENGLISH (!) section of a recent issue of a Continental publication I read that a certain assembly has: tuning for circuits aligning, two per waveband and function, tunable trimmers, tunable selfs with magnetic cores, fixed paddings with small losses, three points of concordance for each waveband. And there is heaps more about stationary condensers, middle frequency transformers, aerial branching, inlet circuits, departure capacities, characteristic magnitudes, utile capacities, the proprieties of materials, pantemeters and so on. In fact, I am not exaggerating when I say that the greater part of the alleged English sections would be either nonsensical or completely incomprehensible to English readers.

That Ha'porth of Tar

It seems a pity, don't you think, to spend a lot of money on getting out an attractive-looking production, intended to bring your country's wares to the notice of foreigners, and then to appeal to the said foreigners in words that just make them laugh. All countries, our own included, do the same sort of thing. It makes, I suppose, for the gaiety of nations, though that is hardly what is intended. Some years before the war the organizers of one of our minor radio exhibitions

were inspired to produce a descriptive booklet in French, German and Spanish which was handed to all visitors from across the Channel. The main result was that one saw Gauls, Teutons and Latins, singly or in groups, reading their copies and laughing fit to burst. I recall one particularly bright gem from the French part. One largish piece of apparatus was housed in a rack. The translator looked up "rack" in the dictionary, found amongst other words *crémallère* and used it in the description. Actually, that means the kind of rack which is partnered by a pinion! The French for the shelved framework affair is just "rack." Tip for British organizations, firms and so on who think of bringing out catalogues and the like in foreign tongues: by all means use competent British translators; *but* let a native of the country concerned cast a critical eye over the proofs.

Third Hand Wanted

THE ONLY DRAWBACK I know to the use of cored solder for radio jobs is that just on occasion the normal allowance of two hands seems to be one too few. Here is an instance of what I mean. The job in hand is the apparently dead simple one of soldering the end of a wire to the tip of a terminal or to a small tag. In perhaps ninety cases out of a hundred it is simple: lay the end where it ought to be, hold the solder

A Felt Want

One thing you must not do with cored solder is to take a "blob" of it on to the bit and then put it on to the joint. The flux then does not get to the work and the almost certain result is a dry joint. The ideal arrangement occurred to me some years ago—but like so many of one's inventions it had occurred to someone else before. The solder should be wound on a small reel attached to the iron; just before making a joint you pull a trigger, which gives the reel a fraction of a turn and causes solder to be fed through a tube to just below the point of the bit. Since then I have tried a number of such irons, for there are quite a few on the market; but so far I have not found one which did not suffer from one of two disadvantages—or from both of them. The first of these is that since the feed tube must be near the heater and the bit, the flux is apt to be "fried" out and not to be there when you want it. The second is that it is exceedingly difficult to regulate the feed so that you always get just enough solder for the joint and no more; the result is that you are likely to find a messy accumulation of solder on the bit after a short spell of work. There may be self-feeding irons which are without these drawbacks. If so, I have not been lucky enough to come across them. Nor have I found one small enough for those fiddling jobs that have to be tackled

when wires come adrift in awkward places.

A.M. or F.M.?

Will A.M. or F.M. be chosen for our v.h.f. system when the results of the long and careful Wrotham tests are published? I have no inside information and I would not, of course, give it away if I had. My forecast, then, represents nothing but my own views. In favour of a.m. you have possibly rather simpler and rather less costly receivers. It seems likely, too, that an a.m. receiver would need less frequent lining up. The man in the street knows (or thinks he knows!) all about handling an a.m. receiver, but might shy at an f.m. set as something strange and new-fangled. Lastly, it is claimed that a.m. can do everything that f.m. can, though using a much narrower channel. On the f.m. side of the account you have, first, the much smaller transmitter, since the modulator does not have to furnish any considerable amount of power. For equal power, the range of the f.m. transmitter is somewhat the greater because, so long as the received signal is strong enough to work the limiter reception is good. For the same reason less volume compression is needed, and this is also helped by the quieter background. F.M. appears, too, to be more effective against impulsive interference—which is the kind that you get most of on 90 Mc/s. I rather fancy that f.m. will have it; but it may be a pretty close thing.

MANUFACTURERS' LITERATURE

Switches of various kinds and Components; a loose-leaf book of engineering data sheets from British N.S.F. Co., Ltd., Keighley, Yorkshire.

Export Receivers, models A136 and A137; brief specifications on a leaflet from E.K. Cole, Ltd., Ekco Works, Southend-on-Sea, Essex.

Valve Manual of Mazda valves, available at 2s 6d post free, from the Technical Publications Dept., The Edison Swan Electric Company, Ltd., 155, Charing Cross Road, London, W.C.2. Also a Broadsheet of valves and cathode ray tubes, free of charge.

Valve Replacement Guide for 1933-1949 receivers; issued by Mullard Electronic Products, Century House, Shaftesbury Avenue, London, W.C.2, and available from wholesalers at 2s 6d.

"THE CHOICE OF CRITICS" THE WORLD OVER MIGHTY BULGIN MIDGETS

SMALL. COMPACT. STRONG. RELIABLE

Mighty in performance, Midget in size. Bulgin Switches have long been known for their superlative quality, precise workmanship, and long life. Bulgin Research and Development continually strives to produce even better and better designs, adding further and further types to the already extensive range of Bulgin Switches. These and many models have laminated structure for strength, and are all type-tested for 25,000 operations—at full load.



List No. S.332. Fitted with slotted-dolly for mechanical operation by $\frac{3}{16}$ " \emptyset pins or equivalent, moving on $\frac{1}{16}$ " radius. Average operating angle = 45°. Single pole, make-break silver-plated contacts and solder tags for connection. For 6-250 v. uses, rated at 50 ~, 6-3 a. A useful general purpose solder-tag switch.



List No. S.286. Another slotted-dolly switch. Single-pole, make-break action. Fitted with terminals for connection. Long-internal-earth-path construction for low- Ω earthing. Peak amps. (50 ~ rating) at 6 v. = 8; at 110 v. = 6; at 250 v. = 4. All metal parts highly plated. Insulation is of the highest grade.



List No. S.337. Slotted-dolly single-pole, change-over action, silver-plated connecting parts. Peak amps. (50 ~ rating) at 6 v. = 4; at 110 v. = 3; and at 250 v. = 2. Dry I.R. < 40M. Ω at 500 v. Max. test v., 750 (3 \times working). For panels > $\frac{1}{8}$ " thick; $\frac{3}{16}$ " \emptyset hole, may have location key ($\frac{1}{16}$ " \times $\frac{1}{16}$ " approx.) if required, to key against rotation, bush being grooved.



List No. S.277. Double-pole Q.M.B. make-break, two roller-action, general purpose, ON-OFF toggle-switch for 6-250 v. circuits. A.c. or d.c. Tested at 1,000 v. peak (= 4 times working v.) Insulation res. < 40M. Ω ; contact res. = > 0.01 Ω (10 m Ω) at 2 \times rated amps. Rated amps. may be doubled at 6-12 v. Peak amps. = 3, 50 ~ rating. A similar switch (List No. S.301) is listed, giving change-over (= alternative circuit). Peak amps. = 2.



List No. S.281. Double-pole, slotted-dolly, change-over action. Silver-plated solder-tags for ease of soldering. Peak* amps at 6-250 v. = 1. Note the NEW Solder-tags fitted to these Bulgin switches. Their design makes for easier working when soldering in confined spaces. * "Peak" = highest current value during first 25 ms. of making or breaking circuit.



List No. S.266. Make-break, double-pole Q.M.B., single roller toggle switch. Connects together all 4 tags in "ON" position. Peak amps. = 1. Max. connection leads, 18 S.W.G. or stranded equivalent. Escutcheon and indicator plates can be supplied at extra cost for this and all other Bulgin switches. Insist on Bulgin every time.

SEND FOR CATALOGUE 185/WW

The Bulgin 80 page catalogue No. 185/WW is packed with information and illustrations of all the latest Bulgin components. As well as hundreds of Switches, there are:— Crocodile-clips, Fuses, Fuseholders, Chokes (A. F. & H.F.), Tuning coils, Knobs, Jacks, Plugs and Sockets, Resistors, Signal-lamps, Suppressors, Test-prods, Group-boards, Transformers (A.F.), Valve-holders, Valve-top connectors, Potentiometers, etc., etc. Price 1/- post free.

MANUFACTURERS OF RADIO & ELECTRONIC COMPONENTS

BULGIN
Components

A.F. BULGIN & CO. LTD.
BYE-PASS ROAD BARKING
TELEPHONE Ripplaway 3474 (5 lines)

UNBIASED

By FREE GRID

The Genesis of Radar

TRUTH is said to be stranger than fiction, but I think it might also be said that it is more of a stranger than fiction. After a somewhat hectic time trying to find some concrete evidence as to who first thought of radar I can fully echo Pilate's famous question "What is truth?"

Before discussing the ancestry of radar I would like to make a suggestion about its name. The word radar and its official interpretation, which has been quoted by *Wireless World*, namely, "Radio Detecting And Ranging" are both of transatlantic origin. This is indisputable but it is equally indisputable that this interpretation leaves me with the same discontent as it does R. W. Hallows, who, in his book on radar, suggests that a better definition would be "Radio Angle, Direction And Range." But even with this interpretation the name radar would be equally applicable to the ordinary direction finding of Adcock, Bellini and Tosi. No indication is given that the word radar is only applicable to a reflected wave system.

On first thoughts it seemed to me to be impossible to remedy this defect and suggest an all-embracing interpretation without destroying the acoustic. I have, however, successfully sought inspiration from Mr. Alfred Jingle of Pickwickian fame and am, therefore, able to suggest something which, in addition to being accurate and all-embracing, is a



"Pulse Technique."

true staccato Jingle-ism and also a rhyming jingle, easy to remember, namely, "Range And Direction; All Reflection."

Now we know what radar really is we are in a position to discuss its ancestry; in other words, to discuss who took out the first patent for it and when. The answer will probably surprise some of you who immediately think of "the thirties" and the names of famous contemporary radio engineers. The first patent was actually taken out in 1904—a matter of a few months after the first flight of the aeroplane (Dec. 17th, 1903) against which it was to be used as an antidote.

The inventor was Hulsmeier, a German, but little can be said of his technique for, with the limitations of those days, he could scarce do more than juggle with parabolic reflectors and other focusing devices which Marconi's lengthening waves had outgrown. Even the valve was denied him, although, curiously enough, the same year saw the patenting by Fleming of the patriarch of the numerous "tron" family, including that brilliant great grandchild, the cavity magnetron which did for radar what the amplifying valve did for radio. But Hulsmeier seems entitled to be called the father of radar.

I doubt if the idea of echo-d.f. crossed the mind of anybody before Hulsmeier but it is not impossible. Hertz noticed that radio waves were reflected by solid objects and Marconi observed this too. But Marconi forsook short waves and their echo-d.f. potentialities for many years. But, as recorded in *W.W.* for November, 1948, by 1922 he foresaw the coming of radar. Two years later we come to the work of Appleton and Barnett in using echo-d.f. to ascertain the height of the ionospheric layers. But it is rather astonishing that until well into the thirties radar seems to have

been regarded as nothing more than a handy tool for the scientist. With the development of pulse technique radar really arrived and thence onwards it becomes "Watson Watt and all that." But if Watson Watt be regarded as the Stephenson of radar then Hulsmeier was its Trevithick.

Many Happy Returns

AS you read these words the Editor will, metaphorically speaking, be cutting up a large birthday cake with forty candles on it—actually, of course, they would be neon lamps lit by radio—to celebrate the fortieth birthday of this journal, which gave its natal heterodyne whistle in April, 1911. Much has happened in the world of wireless since then. In 1911 the amplifying valve had

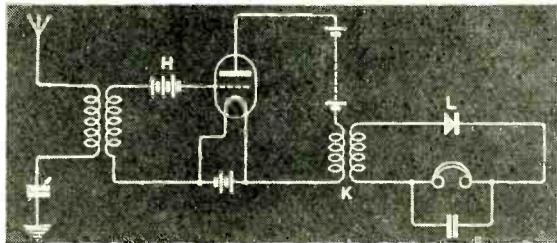

1911, or later?

not yet arrived or, at least, I have always supposed so, believing that De Forest first put the grid into Fleming's diode in 1912.

However, an article in the issue of *Wireless World* dated 21st July, 1926, dealing with patents, has caused me serious misgivings. The author, dealing with the first British patent for an r.f. amplifier which was communicated by a well-known German company in 1913, states that it may be taken that r.f. amplification was first known in this country in that year. He emphasizes in *this country*, and declares his belief that the first circuit in the patent specification (a triode followed by a crystal detector), which I reproduce herewith, was invented by a German engineer, von Bronk, in 1911. If that be true it means that the triode was known before De Forest used it in 1912; maybe, of course, it is only the date, 1912, that is wrong, De Forest having introduced it earlier than I have always supposed. Can any of you patent pundits help me?