

# Wireless World

RADIO AND ELECTRONICS

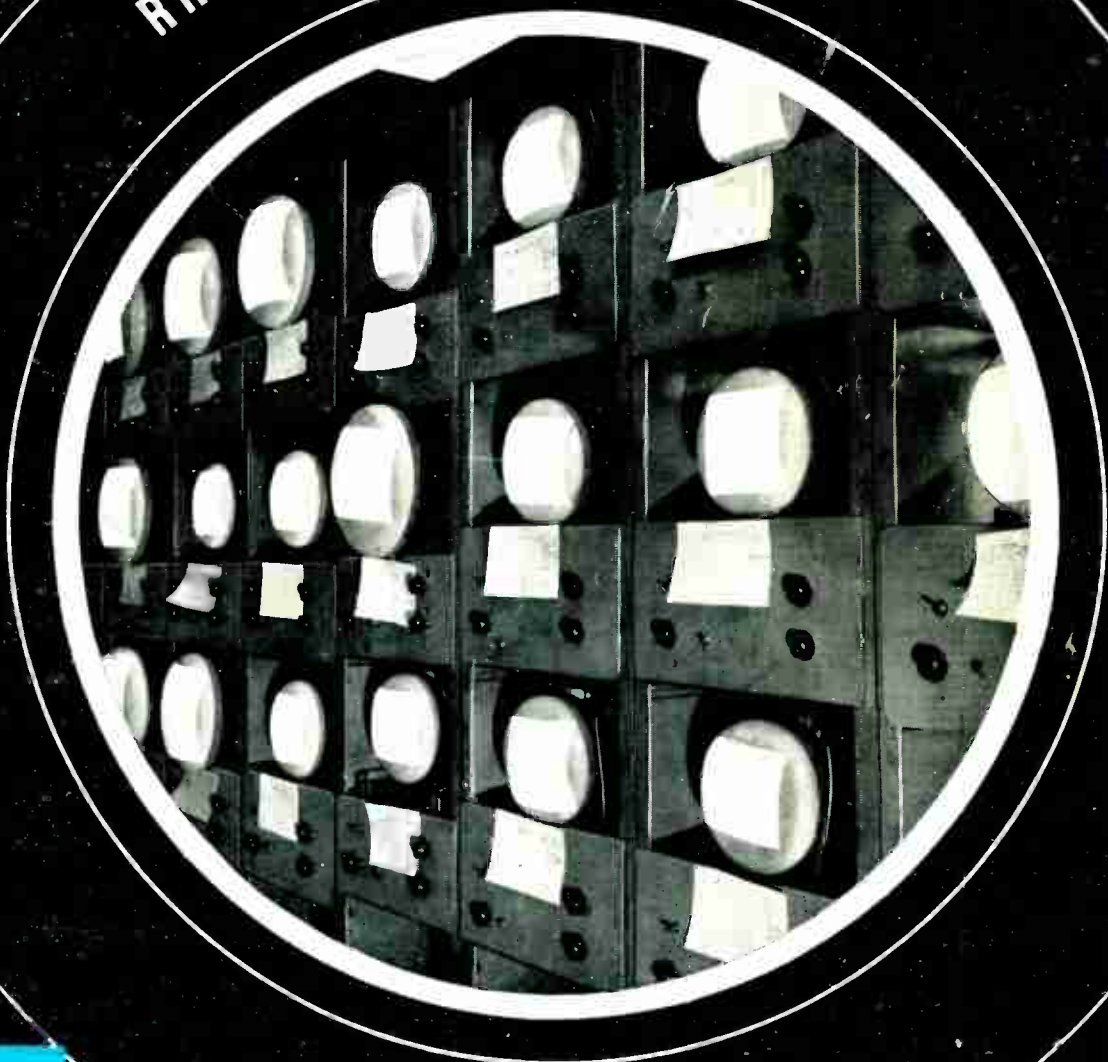

FEB. 1949  
**21-**  
Vol. LV. No. 2

IN THIS ISSUE: DESIGN FOR A SUPERHET TELEVISION SET

# You'll need this new handbook...

because it contains additional data on the B.I.C.C. range of Radio Capacitors. It gives dimensions, methods of connection, capacitance tolerance, temperature ranges, etc., for all paper dielectric and electrolytic types. Write for your free copy today.

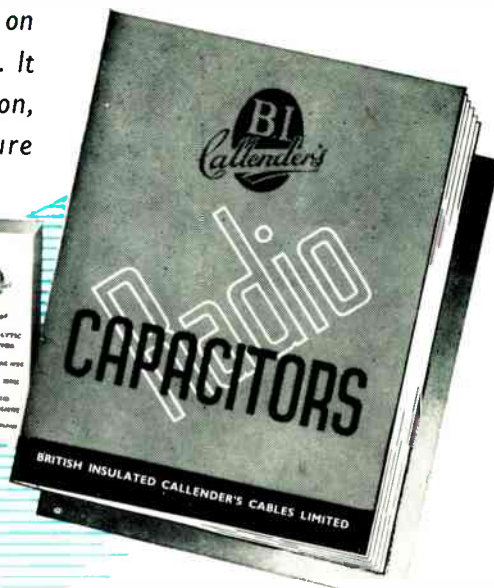

- 1** ECT (Electrolytic. Waxed carton). For domestic radio receivers—reservoir and smoothing.
- 2** EAC (Electrolytic. Aluminium can).\* For domestic radio receivers—reservoir and smoothing.
- 3** PTB (Paper dielectric. Steel case).\*† For amplifiers, power-packs, etc.—reservoir and smoothing.
- 4** PMT (Paper dielectric. Moulded Tube).\*\* For radio transmitters, receivers, radar and television—by-pass and coupling.
- 5** PPT (Paper dielectric. Bonded paper tube). For domestic radio receivers—by-pass and coupling.
- 6** ETU (Electrolytic. Bonded paper tube). For radio receivers and power-packs—smoothing and by-pass

\* Tropical type † Type-approved



## RADIO CAPACITORS

BRITISH INSULATED CALLENDER'S CABLES LIMITED  
 NORFOLK HOUSE, NORFOLK STREET, LONDON, W.C.2

# Servicing **MUST** be done

## Use this up-to-date SIGNAL TRACING method . . . .



"AVO"  
ELECTRONIC TESTMETER — £35

**1** Inject a signal from the "AVO" Signal Generator. This can be R.F. into the Aerial or I.F. circuits, or A.F. into the Audio Circuits.

**2** Trace the signal through the set with the A.C. Voltage ranges of the "AVO" Electronic Testmeter. (Accurate Voltage measurement from 20c/s to 300 Mc/s.)

**3** Having arrived at the point where the signal does not appear, then identify the nature of the fault by tests with the D.C. Voltage, resistance and capacitance ranges of the "AVO" Electronic Testmeter.

0-10,000 v. D.C.  
0-1,000 megohms  
100pF. —50uF.

## Time - saving & dependable

Fully descriptive leaflets available from the Manufacturers of "AVO" Electrical Testing Instruments—

THE AUTOMATIC COIL WINDER & ELECTRICAL EQUIPMENT CO., LTD.  
WINDER HOUSE · DOUGLAS STREET · LONDON · S.W.1 TELEPHONE: VICTORIA 3404/9

ETM 2



# AIRMEC the most advanced Electronic Heat Generator yet produced

The Airmec Heat Generator embodies latest electronic practice and is available in 5 kW and 2 kW models for both dielectric and induction heating. They are the most compact units of their power rating.

Specification includes latest type air-blast cooled oscillator valve, electrical and mechanical interlocks, efficient protection of electrical circuits against overloads. Repetition work by unskilled workers is facilitated by an automatic control with locked settings.

Both models are clean and attractive in appearance, finished in cream enamel. List GA157 explains fully the high standards reached in our equipment—we will gladly send you a copy and follow it with advice on any production problems you may care to raise. Please do not hesitate to ask.



**AIRMEC LABORATORIES LTD.**  
**CRESSEX, HIGH WYCOMBE, BUCKS**

Telephone: High Wycombe 2060

Manufacturers of all types of industrial electronic equipment and test gear.

## HUNTS *New Ranges of Special Replacements*

These additional ranges of electrolytics have been introduced in response to repeated requests from the Trade, and will be found invaluable in servicing older types of Radio equipment. Dimensions have been reduced considerably in a representative range of popular types. Supplies should be ordered without delay: full details on request.

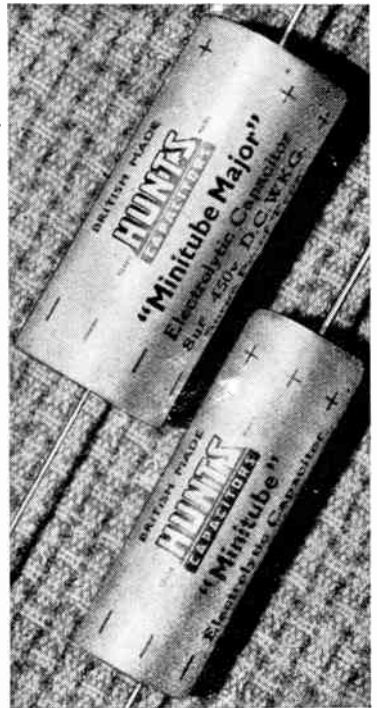

TYPE L.28. 'Minitube' & 'Minitube Majors.' Aluminium case, card insulating tube & wire leads.

"MINITUBE" TYPE L.28					
List No.	Cap. uF.	D.C. Wkg. Volts.	Dimensions L. D.		List Price s. d.
J542C	32	350	2 3/8	1 1/8	6 6
J543C	4	450	1 3/8	1 3/8	3 3
J544C	8	450	2 3/8	1 3/8	4 3
J545C	16	450	2 3/8	1 1/8	5 9

"MINITUBE MAJOR" TYPE L.28					
List No.	Cap. uF.	D.C. Wkg. Volts.	Dimensions L. D.		List Price s. d.
J503C	25	25	1 1/2	1 3/8	3 0
J508C	50	50	2 3/8	1 1/8	4 0
J524C	8	150	1 3/8	1 3/8	3 0
J520C	2	450	2 3/8	1 3/8	3 3
J521C	4	450	2 3/8	1 1/8	3 6
J560C	8	450	2 3/8	1 1/8	4 6



Also available are Types L.24 card-board cartons with fixing feet and 6" wire leads, and L.36 cylindrical aluminium cases with 6" leads and single hole mounting.

A. H. HUNT LTD · BENDON VALLEY · GARRATT LANE · LONDON · S.W.18



# THE FOREMOST NAME IN SOUND RECORDING

*Specified and used by such leading authorities as*

OXFORD UNIVERSITY  
AIR MINISTRY FILM UNIT  
NUFFIELD LABORATORY  
PAKISTAN BROADCASTING COMMISSION

B.B.C. use B.S.R. Recordings

*and in constant use by the discerning recordist in places as far apart as*  
ARGENTINA, MALAYA, EGYPT, SOUTH AFRICA, EIRE

- ★ **DISK RECORDING** provides *permanent* records which can be played back on standard gramophones. With the B.S.R. DR. 33M Disk Recorder you get unequalled fidelity of tone for orchestral or vocal recordings.
- ★ **DISK RECORDING** is growing rapidly both for home and business use. Make permanent records NOW of your family and friends for an Album of Sound. Produce your own Plays and Drama—the scope is unlimited.
- ★ **HIRE MAINTENANCE** B.S.R. Recording Equipment is now available on a Hire Maintenance basis. Write for details.

You are invited to make use of our unique Advisory Service. Technical help and advice on Recording is offered free. *Write now to:—*

**B.S.R. Recording Division, 88, High Street, Stourbridge.**

**'Phone 5556**

Designers and Manufacturers of Laboratory Equipment, Amplifiers, Supersonic and Subsonic Apparatus, Gramophone Motors and Pickups, Intercommunication Telephones, Works Call Systems, Transformers and Microphones.

*Agents in leading countries abroad*

**“ THE SUN NEVER SETS ON B.S.R. EQUIPMENT ”**

**BIRMINGHAM SOUND REPRODUCERS LIMITED, OLD HILL, STAFFS.**

*The*  
**MAGNAVISTA**  
TELEVISION LENS

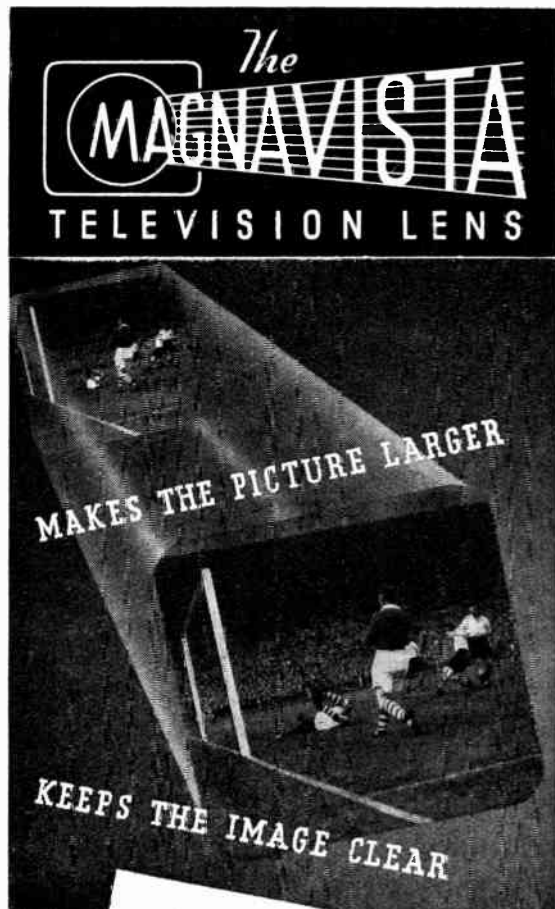

MAKES THE PICTURE LARGER

KEEPS THE IMAGE CLEAR

- ENLARGES THE PICTURE  
2½ TIMES
- ELIMINATES DISTORTION
- ENSURES GREATER DETAIL .  
ENHANCED CLARITY . . . MORE  
BRILLIANT CONTRAST
- MODELS AVAILABLE FOR ALL  
TYPES OF TELEVISION RECEIVER
- WRITE TO-DAY FOR DETAILS

**METRO PEX LTD**

71 Queens Road  
London, S.E.15

Phone: New Cross 2442

# KOLECTRIC

## AUTOMATIC COIL WINDING MACHINE

TYPE A11

This machine is the most modern on the market and it possesses many exclusive refinements including :

- *Dustproof construction throughout.*
- *Provision for winding up to four coils simultaneously.*
- *Micrometer traverse setting.*
- *Wire Gauge Indicator engraved with various wire gauges to which the machine can quickly be set.*
- *Instantaneous reset counter reading up to 100,000 Turns.*
- *Entirely new Wire Tensioning Stand to hold two reels of wire.*

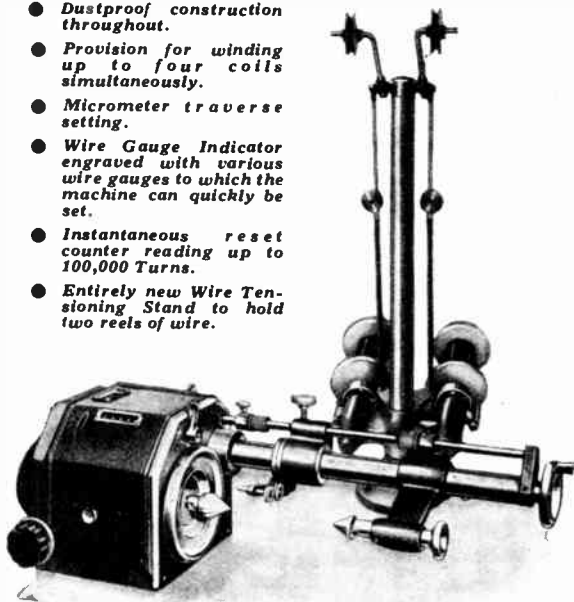

*We will be pleased to send you an illustrated leaflet giving a full technical specification, on request.*

# KOLECTRIC LTD

20, AVONMORE RD.  
LONDON · W·14

Telephone: Fulham 4211/2.

NEW  
**LEAK**  
"POINT ONE"  
AMPLIFIERS

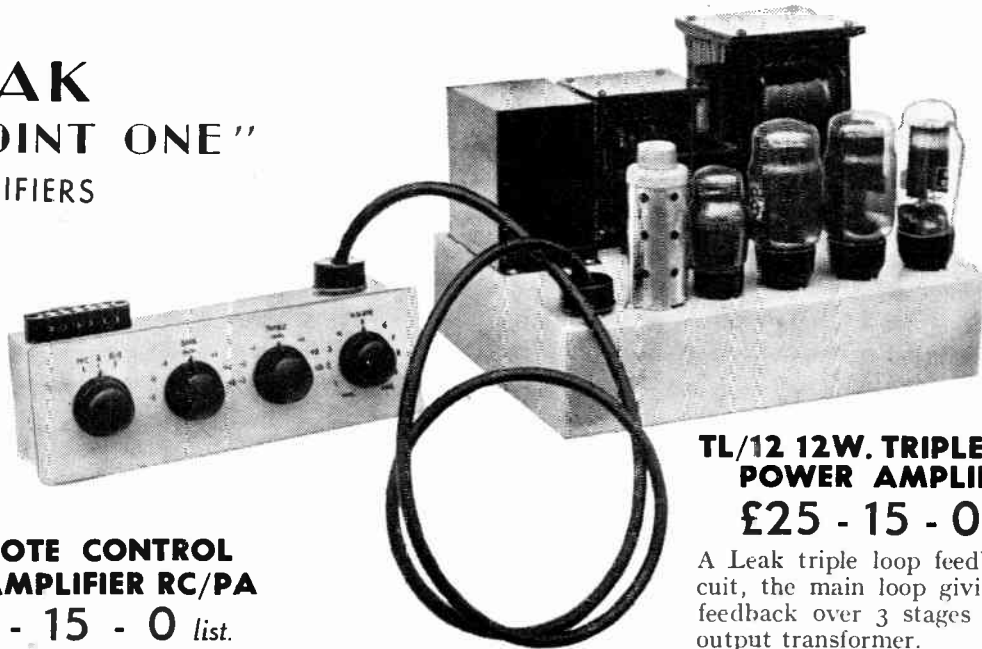

**REMOTE CONTROL  
PRE-AMPLIFIER RC/PA**

**£6 - 15 - 0 list.**

An original distortionless feedback tone-control circuit which will become a standard. No resonant circuits employed.

- Switching for Pick-up, Microphone and Radio, with automatic alteration of tone-control characteristics.
- High sensitivities. Will operate from any moving-coil, moving iron or crystal P.-U.; from any moving-coil microphone; from any radio unit.
- Controls; Input Selector; Bass Gain and Loss; Treble Gain and Loss; Volume. Output Impedance:—0-30,000Ω at 20 kc.p.s.

The unit will mount on motor-board through a cut-out of 10½in. × 3½in., or it can be bolted to the power amplifier, when, with a top cover, the whole assembly becomes portable.

For use only with LEAK amplifiers.

**TL/12 12W. TRIPLE LOOP  
POWER AMPLIFIER**

**£25 - 15 - 0 list.**

A Leak triple loop feedback circuit, the main loop giving 26db feedback over 3 stages and the output transformer.

- Push-pull triode output stage. 400V. on anodes.
- No H.T. electrolytic smoothing or decoupling condensers.
- Impregnated transformers; tropically finished components.
- H.T. and L.T. supplies for pre-amp. and radio units.
- Distortion: at 1,000 c/s and 10W output, 0.1%.
- Hum and Noise: — 80db on 10W.
- Frequency response: ± 0.1db, 20 c/s—20 kc/s.
- Sensitivity: 160mV.
- Damping Factor: 20.  
Input impedance: 1MΩ.  
Output impedances: 2Ω: 7-9Ω: 15-20Ω: 28-36Ω.  
25W. model available at £27. 10. 0.

**DO YOU KNOW** what these performance figures mean? :—

PHASE MARGIN 20° ± 10°

GAIN MARGIN 10db ± 3db

**YOU MOST PROBABLY DO NOT**, for they are uncommon. Yet they are of vital importance, for the "goodness" of a multi-stage feedback amplifier cannot be taken for granted in the absence of this information, however impressive the rest of the specification may seem. We believe ourselves to be the only organisation advertising these figures.

If you would like to know more about amplifiers in general, and the TL/12 and RC/PA in particular.

**WRITE FOR BOOKLET W/TL/12.**

**H. J. LEAK & CO. LTD. (Est. 1934)**

**BRUNEL ROAD, WESTWAY FACTORY ESTATE, ACTON, W.3.**

Phone: SHEpherds Bush 5626.

Telegrams: Sinusoidal, Ealux, London.

Foreign: Sinusoidal London.





Maximum sensitivity with uniform frequency response from a more compact speaker, appreciably reduced in weight—that is what Rola technicians have achieved with the new G.12. Special features include dust-proof suspension completely protecting coil and magnet gap and the powerful Alcomax II magnet. Write for details and also for particulars of Rola 3" and 4" P.M. models, dust-proofed and equipped with Alcomax II magnets.

**best  
of the  
BIG  
speakers**

BRITISH ROLA LTD. · FERRY WORKS · SUMMER ROAD · THAMES DITTON · SURREY  
Telephone : EMBERBROOK 3402 (5 lines)

## The Universal Taylormeter

90 Ranges · Sensitivity  
20,000 ohms per volt A.C. & D.C.



- Taylor Model 400 Meter with 4" scale and robust movement.
- Automatic Meter overload protection.
- Volt readings from .001 volt D.C. and 0.1 volt A.C. up to 5,000 volts D.C. and A.C.
- Current readings from 1 microampere to 10 amperes D.C. and A.C.
- Resistance readings from 0.1 ohm to 20 megohms in three ranges with self-contained batteries.
- Capacity readings from .0002 to 100 mfd and inductance readings from 0.2 to 1,000 Henries, with Adaptor.
- Buzzer for continuity tests.
- Size  $10\frac{1}{2} \times 7\frac{1}{2} \times 4\frac{3}{4}$ ". Weight 5 lbs.

**MODEL 85A**      **PRICE £19 · 19 · 0**

IMMEDIATE DELIVERY FOR MOST  
MODELS INCLUDING THE ABOVE

TAYLOR PRODUCTS INCLUDE: MULTIRANGE A.C. D.C. TEST METERS ● SIGNAL GENERATORS ● VALVE TESTERS ● A.C. BRIDGES ● CIRCUIT ANALYSERS ● CATHODE RAY OSCILLOGRAPHS ● HIGH AND LOW RANGE OHMMETERS ● OUTPUT METERS ● INSULATION TESTERS ● MOVING COIL INSTRUMENTS

**TAYLOR ELECTRICAL INSTRUMENTS LTD**  
419 · 424 MONTROSE AVENUE, SLOUGH, BUCKS. ENGLAND



Telephone SLOUGH 21381 (4 lines)  
Grams & Cables "TAYLINS" SLOUGH



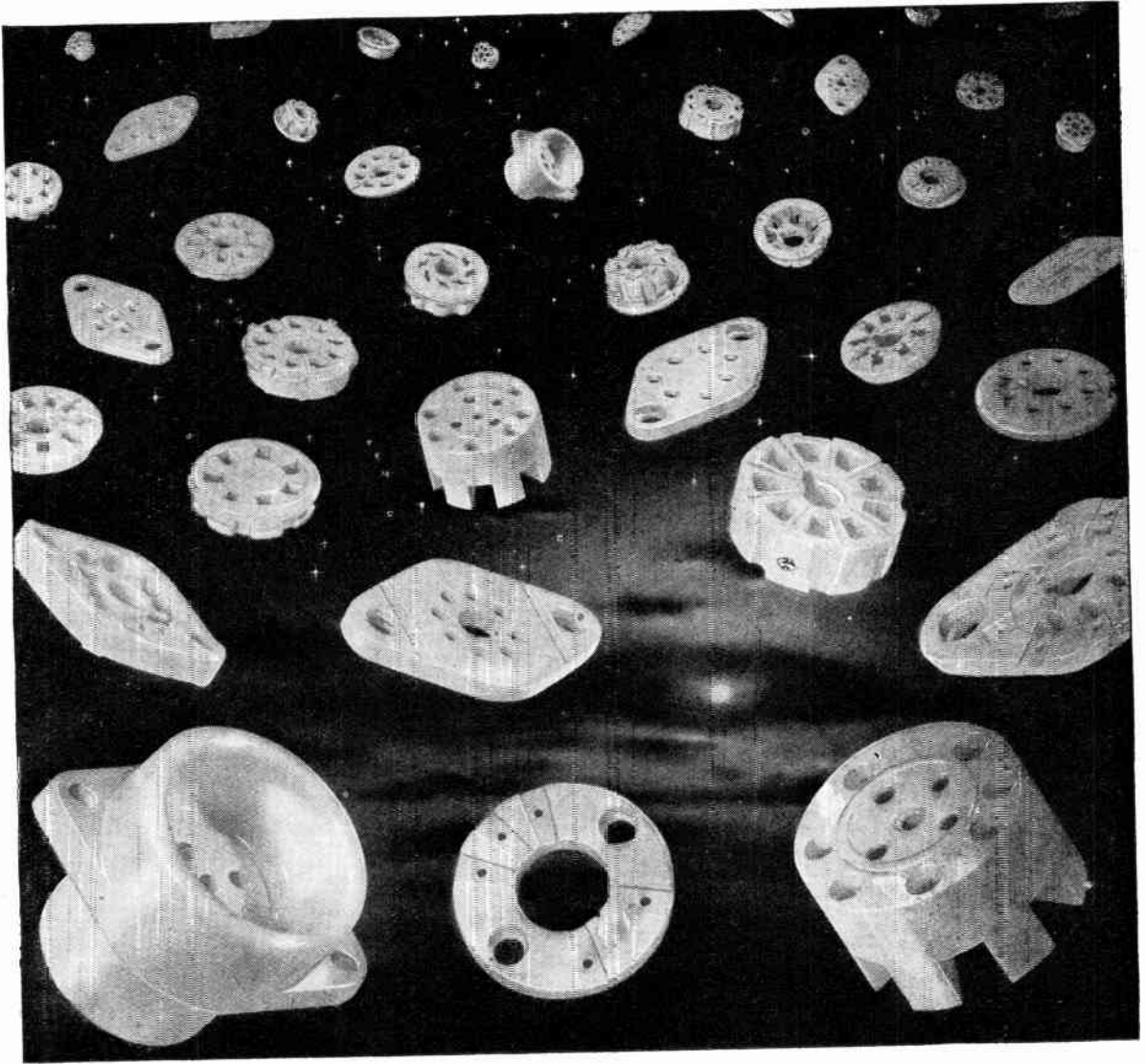

# CERAMICS

FOR VALVE HOLDERS  
and all radio components  
FREQUENTITE — FARADIX — TEMPRADIX

**STEATITE & PORCELAIN PRODUCTS LTD.**

Stourport on Severn, Worcester

Telephone: Stourport 111

Telegrams: Steatite, Stourport



S.P.55



Here are sets  
to delight the expert

★ WITH 2 YEARS' FREE ALL-IN SERVICE IN THE HOME ★

Apply any test you wish to these Sobell 5-valve superhet table receivers. You will find that every component is superbly engineered. Check the circuits, the signal rectification, the I.F. selectivity, the audio sensitivity—and any other points you like. They'll all satisfy your critical judgment.

We'll say nothing about the obvious—the pleasing cabinets, the simple controls, the easy-to-read 3 wave band tuning dials, the special gramophone pick-up sockets with automatic switches, the provision for external loudspeakers—because these are “musts” in sets designed to the highest standards.

The two models illustrated are 519P and 519W respectively, working on 200-250 volts A.C. only. There's a Sobell dealer in your district—he'll be glad to arrange a thorough demonstration.

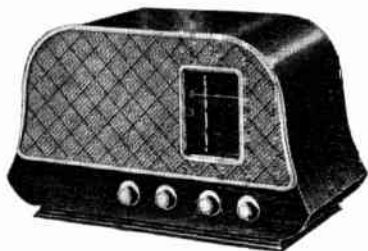

**SOBELL**  
RADIO  
AND TELEVISION

Advt. of Sobell Industries Limited, Langley Park, Nr. Slough, Bucks

\*Phone: Slough 2220115

# AN AUDIO-FREQUENCY D.C. OSCILLOSCOPE

DESIGNED FOR APPLICATIONS where the full facilities of the well-known 1684D are not required, this new model 1684N retains the basic advantages of the Symmetrical direct-coupled circuiting.

A high-sensitivity vertical amplifier is incorporated giving a deflection sensitivity of 1mV/cm from zero to 50kc/s.

The horizontal axis has only a simple amplifier intended primarily to provide sweep expansion for the time base, which runs from 5 to 10,000 c/s.

£75.

AVAILABLE  
FOR EARLY  
DELIVERY



For further particulars please write for our new brochure of Electronic Instruments.

*Furzehill*

LABORATORIES LTD.



BOREHAM WOOD · HERTFORDSHIRE  
TELEPHONE — ELSTREE 1137

# PRECISION DRAWN

## WAVE GUIDE TUBING

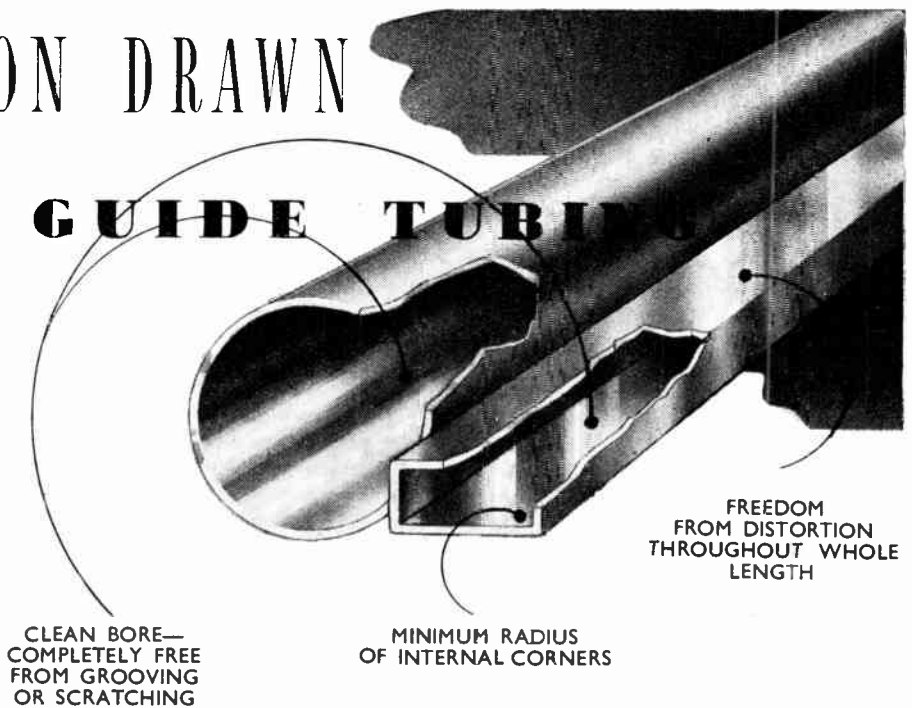

CLEAN BORE—  
COMPLETELY FREE  
FROM GROOVING  
OR SCRATCHING

MINIMUM RADIUS  
OF INTERNAL CORNERS

FREEDOM  
FROM DISTORTION  
THROUGHOUT WHOLE  
LENGTH

This seamless high accuracy wave guide tubing is designed to meet the requirements of modern Navigation, Radar and communication equipment. The tubing is hard drawn, has a highly finished bore and dimensional accuracy is maintained throughout each length. Non-preferred sizes can be manufactured to specification.

*Available in the following materials :*

COPPER	BRASS
7½% COPPER SILVER	10% COPPER SILVER
SILVER LINED COPPER	SILVER LINED BRASS

*Dimensions :*

Available in 10 ft. lengths  
Rectangular tubes up to 1" × 0.5"  
Round tubes up to 1.5" dia.

*Details of preferred sizes are available on request.*

One of the Specialised Products of

**Johnson**   
**Matthey**

*Success through constant research—can we help you?*

# LOW LOSS CERAMICS

by

## TAYLOR TUNNICLIFF

TAYLOR TUNNICLIFF (REFRACORIES) LTD.

Albion Works, Longton, Staffs

FAS/TT 68.

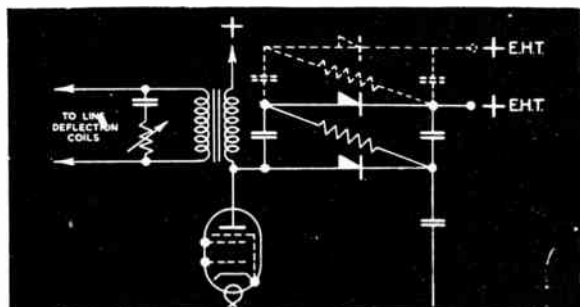

### **E.H.T. simplicity**

E.H.T. may be obtained from the standard line scanning output transformer without any alteration whatever. Simply add three 36EHT35 rectifiers in a tripler circuit and



Three type 36EHT35 rectifiers, each only 3" long X 1/8" dia, will, from a peak pulse input of approx. 2,500V obtained from the standard line scanning output transformer, give an output of about 6kV at 100µA, used in the tripler circuit shown on the left.

you will obtain 6kV for your tube anode supply. Simple . . . . . efficient . . . . . reliable. Other sizes of rectifier available for lower or higher outputs.



## 36EHT METAL RECTIFIERS

Write for data sheet No. 60, to Dept. W.W.2.

Westinghouse Brake & Signal Co., Ltd., 82, York Way, King's Cross, London, N.1.



**FREQUENCY RESPONSE.** In our last article we discussed the problems arising from the unavoidable compromise between selectivity and high audio response. Bearing in mind, therefore, this important limitation due to the radio portion of our reproducer, let us go on to the audio circuits themselves.

## \* Perfect Reproduction?

### \*PROBLEMS REFERRED TO IN PREVIOUS NOTES

Spatial Distribution of Sound.

Echoes in the Listening Room.

Limitations of Single Channel.

Limitations of the Human Ear.

Distortions and Faults caused by  
Apparatus.

The Radio Link.

As we said in our last issue, we have to maintain a level frequency response in them; they must be free from harmonic distortion and inter-modulation; they must not introduce unwanted noise or hum; and they must be capable of supplying sufficient acoustic power over the entire frequency range so that the loudness in our room is as great as we wish it to be.

Excluding the loudspeaker system — for it is here that the most severe difficulties are encountered and we shall deal with them separately — the maintenance of a level frequency response presents no great difficulty. It may not be cheap to provide the large number of component parts which will be found necessary, and there is always a temptation, for example, to cut short the high frequency response owing to difficulties with feed-back into the radio set. At the other end of the scale a good bass response may lead to sound-coupling, or “microphony”, for which again the cheapest cure may be to reduce the low frequency response.

We shall have to spend money on any transformers in the chain, both in making them large enough to provide the necessary inductance at low frequencies, and maybe also in sectionalising their windings to reduce the leakage inductance, which often causes a drooping high frequency response.

Remembering our selectivity troubles it is probable that we shall require a rapid attenuation above some fixed frequency, since it is more practical to attain it in the low frequency amplifier, than it is, for example, by large numbers of intermediate frequency circuits. If, for this purpose, we use inductive filters, we shall have to be very careful that they do not “ring”. It is certainly not generally recognised how difficult it is to design a multi-section filter, which is free from this defect; and one reason is that measurements with steady tones do not show up the trouble. One has to examine the behaviour of the amplifier when it is fed with pulses before the “ringing” becomes apparent.

On the whole, therefore, the frequency response to the low frequency amplifier does not give the designer any real headache.

***murphy radio  
limited***



# RM Extension SPEAKER



**LIST PRICE**  
**£2 14 6**  
Available through usual Wholesalers.

Here is an attractively styled Extension Speaker designed to provide entertainment in any room. It incorporates a highly efficient permanent magnet chassis, 6½" diameter, having an impedance of 2-3 ohms. The volume control is continuously variable.

R.M. ELECTRIC LTD., TEAM VALLEY, GATESHEAD II.

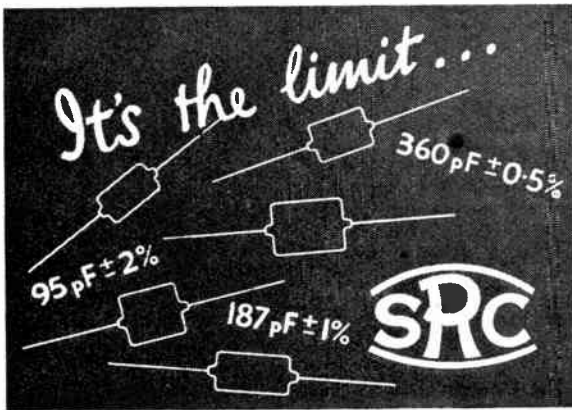

Our Silvered Mica Capacitors reach the limit of accuracy which can be achieved in a mass-produced radio component. Our recognised technical standards will satisfy those set manufacturers who wish their tuning scales to be "dead on line."

## STABILITY RADIO COMPONENTS LTD

14, NORMAN'S BUILDINGS,  
CENTRAL STREET, LONDON, E.C.1  
Telephone : CLErkenwell 5977.

### Why you should use ...



- 1 Maximum "Wetting" Capacity.
- 2 Accelerated Fluidity.
- 3 Moderatesoldering bit temperatures.
- 4 Mechanical bonding and perfect Electrical conductivity ensured.
- 5 Minimum amount of solder used per joint.
- 6 Residue sets hard, is non-corrosive, and of high dielectric strength.
- 7 No harmful fume deposits.
- 8 Continuous, unvarying core.
- 9 Even distribution of activator in core.
- 10 Approved by Air Ministry and General Post Office.

Supplied in a wide range of Gauges and Alloys on 1 lb and 7 lb reels, works coils, or as required. Prices on application.

Sole Manufacturers :

H. J. Enthoven & Sons, Ltd., 15-18 Lime Street, London, E.C.3.  
Phone: MANsion House 4533. Works: Rotherhithe, Croydon, Derbyshire.

# NINE EXAMPLES

*from the*  
"FLEXILANT"

(RUBBER BONDED  
TO METAL)

RANGE  
*of*  
MOUNTINGS

•  
OBTAINABLE  
FROM STOCK

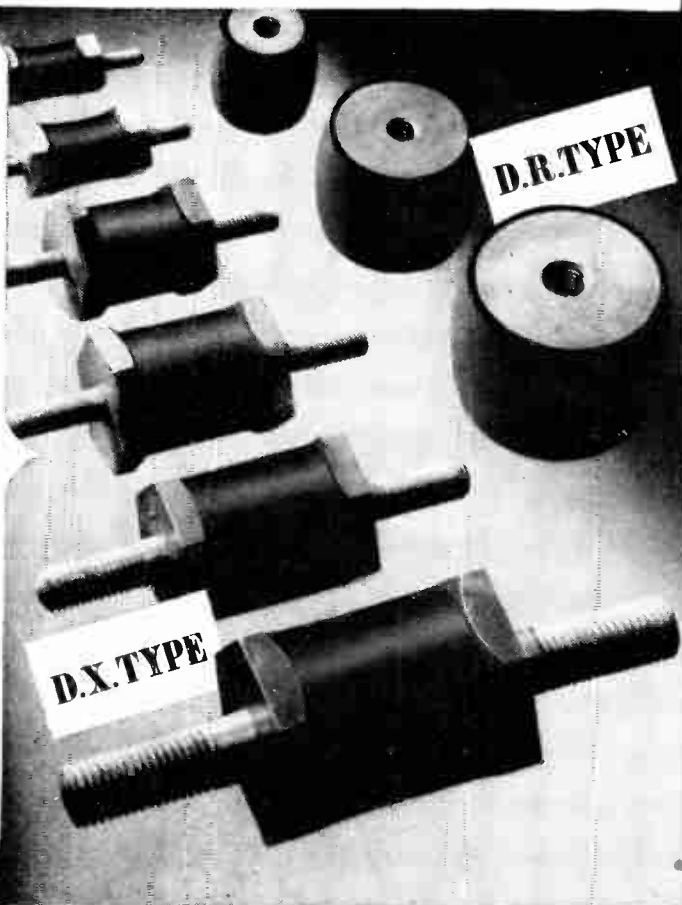

**OUR TECHNICAL STAFF investigates**  
**all mounting problems**  
**May it investigate yours?**



**RUBBER BONDERS LIMITED**

ENGINEERS IN RUBBER BONDED TO METAL

FLEXILANT WORKS

DUNSTABLE · BEDS.

TELEPHONE DUNSTABLE 603-45

R.B.67

# Webb's RADIO

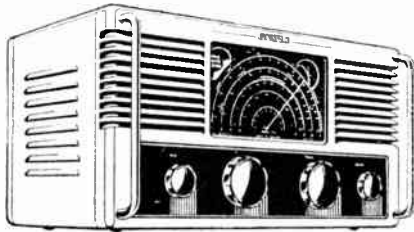

## THE EDDYSTONE

### '670' Receiver

IS NOW AVAILABLE FOR THE HOME MARKET

This interesting receiver was designed primarily for ship's cabin use, where good performance and utmost reliability is essential. Its specification will also appeal to the discriminating home user who wants a high performance receiver capable of giving first-class results from

A.C. or D.C. — 110 — 200 — 230 volts

## Eddystone '670' Receiver

PRICE **£37.10.**

PLUS PURCHASE TAX £8.10.7d.

Frequency Coverage:—30 to 5.8 Mc/s and 2.75 Mc/s to 522 Kc/s (10 to 51 and 110 to 575 metres) in four bands.

Valve Circuitry:—R.F. Stage—Freq. changer—I.F. Amplifier—A.F. Amp. and Sig. Det.—Phase Inverter and AVC—Push Pull Output.

INTERNAL LOUDSPEAKER — D.C. MAINS SAFETY PRECAUTIONS ADEQUATELY COVERED — THERMISTOR REGULATES INITIAL SURGE.

*The '670' is not a communications receiver but nevertheless carries all the EDDYSTONE hall-marks of high grade design.*

AVAILABLE EX STOCK AT WEBB'S RADIO.

**Webb's Radio, 14 Soho St., Oxford St., London, W.1.**

Phone : GERrard 2089. Shop Hours : 9 a.m.—5.30 p.m. Sats. 9 a.m.—1 p.m.

## The Portable Oscilloscope with a Fine Reputation



Illustration shows the Model 1200B Oscilloscope and the Model 1400B Visual Alignment Signal Generator.

The Oscilloscope has:

Identical high gain D.C. amplifiers on both axes linear in response from zero to radio frequency; linear time-base with perfect synchronisation at any frequency; controls which are completely independent in operation from each other.

The 1400B Unit will show the shape and characteristics of a tuned circuit response curve on the Oscilloscope screen. Thus perfect alignment of an I.F. or R.F. amplifier is easily accomplished. Overall size of combined instruments: 7" wide, 11" high, 9" long.

● Both instruments carry a 6 months' guarantee.

Early Deliveries.

● Model 1200B Oscilloscope £32 0 0

● Model 1400B Unit £8 10 0

Write for Specifications to:—

## INDUSTRIAL ELECTRONICS

99, Gray's Inn Road, London, W.C.1.

Tel.: HOLborn 9873/4.

Makers of Industrial Control Gear and Precision Instruments.

5.5 KV — £3. 15. 0.

## NEW MINIATURISED R.F. E.H.T UNIT

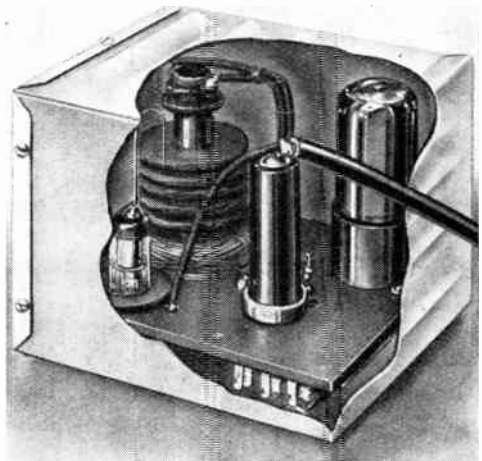

Intended specifically for television application, this unit is fed from the H.T. and L.T. lines of the receiver and will give up to 250  $\mu$ A at 5.5 KV. Efficient screening is achieved by the aluminium chassis-mounting case  $4\frac{1}{2}$ " high  $\times$   $4\frac{1}{2}$ "  $\times$   $3\frac{1}{2}$ ". The 5.5 KV. unit will be available from 1st February, 1949, the 8 KV. unit is now in stock. Units to give up to 25 KV. for industrial equipment can be supplied to order.

## HAZLEHURST DESIGNS LTD.

186, BROMPTON ROAD, LONDON, S.W.3.

Phone KENsington 7793



# MAZDA Battery Miniatures

Here are four miniature 1.4v battery valves from the Mazda range. They are mounted on B7G bases, and their small size (54 mm x 19 mm), low filament and economical H.T. consumption make them ideal for miniature battery superheterodyne receivers.

With filaments series connected they are suitable for use in receivers of the all-mains/battery-operated type. In addition, they are suitable replacements for U.S.A. "button-base" types 1R5, 1T4, 1S5 and 3S4. Full details will be given on request.

## 1C1 PENTAGRID FREQUENCY CHANGER

Filament voltage	....	$V_f$	1.4v
Filament current	....	$I_f$	.05A
Maximum anode voltage	....	$V_a(\max)$	90v
Maximum screen voltage	....	$V_{g2(\&4)\max}$	67.5v
Maximum mean cathode current	....	$I_k(av)\max$	5.5mA

LIST PRICE **13/-**

## 1F3 VARIABLE-MU R.F. PENTODE

Filament voltage	....	$V_f$	1.4v
Filament current	....	$I_f$	.05A
Maximum anode voltage	....	$V_a(\max)$	90v
Maximum screen voltage	....	$V_{g2(\max)}$	67.5v
Maximum mean cathode current	....	$I_k(av)\max$	5.5mA

LIST PRICE **11/6**

## 1FD9 DIODE R.F. PENTODE

Filament voltage	....	$V_f$	1.4v
Filament current	....	$I_f$	.05A
Maximum anode voltage	....	$V_a(\max)$	90v
Maximum screen voltage	....	$V_{g2(\max)}$	90v
Maximum mean cathode current	....	$I_k(av)\max$	3.0mA
Maximum mean diode current	....	$I_a(d)(av)\max$	0.2mA

LIST PRICE **13/-**

## 1P10 OUTPUT PENTODE

Filament voltage	....	$V_f$	2.8v† 1.4v*
Filament current	....	$I_f$	0.05A† 0.1A*
Maximum anode voltage	....	$V_a(\max)$	90v
Maximum screen voltage	....	$V_{g2(\max)}$	67.5v
Maximum mean cathode current	....	$I_k(av)\max$	5.5mA

LIST PRICE **11/6**

† Series filament arrangement

\* Parallel filament arrangement

ø For each 1.4v filament section

# EDISWAN

## MAZDA

### RADIO VALVES AND CATHODE RAY TUBES

(V.87)

THE EDISON SWAN ELECTRIC CO. LTD., 155 CHARING CROSS ROAD, LONDON, W.C.2

*synonymous with*  
**PLUGS & SOCKETS**

**PAINTON & CO LTD KINGSTHORPE NORTHAMPTON**

## Headphones which uphold British Prestige



TYPE "K."

**S. G. BROWN, Type 'K'**  
Moving Coil Headphones,  
supply that High Fidelity  
Reproduction demanded for  
DX work, monitoring and  
laboratory purposes, etc.

### OUTSTANDING CHARACTERISTICS.

- D.C. RESISTANCE, 47 Ohms.
- IMPEDANCE, 52 Ohms at 1,000 c.p.s.
- SENSITIVITY,  $1.2 \times 10^{-10}$  Watts at 1kc. = .0002 Dyno/cm<sup>2</sup>.

Descriptive Literature on request.

**PRICE £5.5.0 PER PAIR**

Your Local Dealer can supply

For details of other S. G. Brown Headphones (prices from 30/- to 63/-) write for illustrated Brochure "W.W."

HEADPHONES WHICH UPHOLD BRITISH PRESTIGE.

Telephone :  
Watford 7241.

# S. G. Brown, Ltd.

SHAKESPEARE STREET, WATFORD, HERTS.

## RADIOMART'S

### *Special Offers*

**STROMBERG-CARLSON (U.S.A.) AIRCRAFT TX.CCT-52208**  
3-4 mc/s 1626 M.O.2-1625 (in parallel) P.A. with 3.5 mc/s crystal for calibration checking in conjunction with 1629. (Valves equivalent to 6J5, 807, 6X5G but 12 volt) Compact unit measuring 5in. x 7in. x 1in. Make excellent E.C.O. units. Very stable M.O. .... Price £4

**HIGH VOLTAGE TRANSFORMERS**  
Pri. 115 v. 50 cycle. Sec. 1250-0-1250V 200 m/A. Connect two of these in series for 230 V working. (Secondaries in parallel 1250-0-1250V 400 m/A. Secondaries in series 2500-0-2500V 200 m/A capped 1250-0-1250V) or use an auto transformer. (Wt. 21 lbs.) ..... Price 30/- plus 5/- carriage.

**LARGE SLIDER TYPE POTENTIOMETERS**  
Wound on former 8in. x 2in. Suitable for battery charging boards, etc. .4 ohm, 25 amp. at only a fraction of original cost. Price 4/6 each. Postage 1/-.

**HEADSET ADAPTORS TYPE MC385**  
High to low frequency. Jack type fitting ..... Price 1/3

**CHARGERS**  
Well known make) Maximum D.C. output 75V 12 amps., capacity 20 6V batteries at 6 amps. or 5 12V batteries at 12 amps. Two circuits each with M.C. Ammeter. Three charging rates may be obtained simultaneously if desired. Brand new and complete with No. 68506 Rectifier Valves. Ideal for garage use ..... Price £18

**R.A.F. DIPOLE AERIAL**  
27in. (Approx. 215 mc/s) with 3ft. Co-ax. and Pye Plug and built-in matching transformer. Ideal for making into any frequency dipole. Price 2/6 plus 1/- postage.

Send S.A.E. for No. 7 Special Offers list and standard Raymart list.

## RADIOMART

GENI (CHAM) LTD.

48, HOLLOWAY HEAD, BIRMINGHAM, I.

Tel.: Mtd. 3254.

# Cold Cathode Triodes

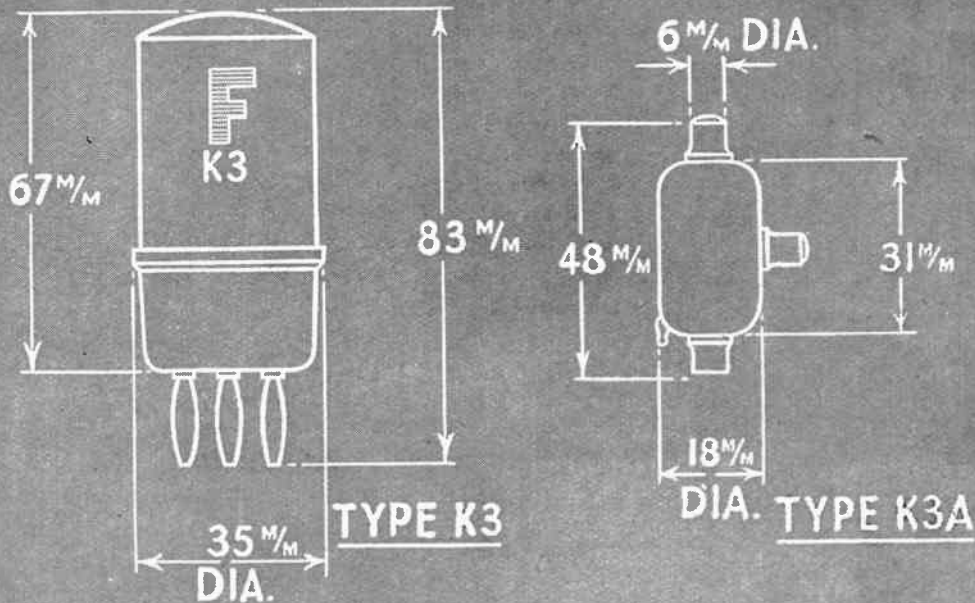

**IMMEDIATE DELIVERY**



Suitable for operation as relay tubes where the mean current does not exceed 5 milliamperes.

Operating Characteristics.	K3	K3A
Anode voltage	135	135
Trigger Breakdown voltage	79-84v.	85-95v.
Anode current (continuous)	5mA max.	5mA max.
Anode current (intermittent)	{ 20mA peak 5mA mean	{ 20mA peak 5mA mean
Trigger current	4/μA max.	4/μA max.
Recommended static bias	75 v.	75 v.
Gas filling	Neon	Argon

The K3 is supplied housed in a metal container, on an English 4 pin base. The K3A is supplied unmounted but with standard type valve caps for connecting purposes.

## FERRANTI LTD

**ELECTRONICS DEPT. MOSTON MANCHESTER 10**





**PICK-UPS** for

**Quality Reproduction**

MAGNETIC TYPES  
GP 6 & GP 7



A modest priced moving-iron instrument with outstanding performance; output .36v.; range 100-4,500 c/s.; needle pressure 2 oz. (adjustable). The GP 7 head for replacing acoustic sound boxes has similar characteristics.

GP 6, Price 27/- plus Tax  
GP 7, Price 21/- plus Tax

CRYSTAL TYPE  
GP 10



With an output of 1.7 v. at 1,000 c/s., range 70-8,000 c/s., this instrument combines great robustness with the enhanced performance of a well-designed crystal pick-up. The "acos" patented assembly makes the crystal unbreakable.

GP 10, Price 36/- plus Tax

HIGH FIDELITY CRYSTAL TYPE  
GP 12

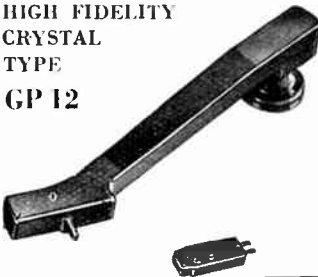

A model of exceptional performance for the connoisseur. With permanent sapphire stylus capable of 5,000 playings; output 1 v. at 1,000 c/s., range 30-14,000 c/s., needle pressure 22 gms.

GP 12, Price 72 - plus Tax

★ Post this coupon for informative folders

to **COSMOCORD LTD.**  
ENFIELD MIDDLESEX

Name .....

Address .....

W.W. 249



**Model 44**  
**SUBSTANDARD METER**  
Widely used for standardizing first grade single and multi-range meters.  
44 ranges ● 6 in. mirror scale ● Moving coil cut-out

**ELECTRONIC INSTRUMENTS LTD**  
17 Paradise Road, Richmond, Surrey

**M. R. SUPPLIES Ltd.**

offer only selected material which is sure to give satisfaction. All orders handled with the utmost diligence and despatch. All prices nett.

**U.S.W. SIGNAL GENERATORS**, Admiralty patt. W.4999. In new condition. Range, 5.5/12 Mc/s, then continuous in three ranges 16/95 Mc/s. Operation, 200/340 v. A.C. slide wire attenuator with multiplier. With dummy aerial, leads, etc., £25 (part des. 3/6). Also last few brand new R.C.A. type 719A. Range 370-560 Mc/s continuous. Operation 100/250 v. A.C. (transformer supplied). With leads, calibration charts and handbook, £18/10/- (des. 3/6). It should be noted that these high-class instruments are normally listed at about £30. Early application is now advised.

**ANODE CONVERTERS** (Rotary Transformers). Very useful model. Input, 12 v. D.C., output, 250 v. 125 mA D.C. Brand new, by Hoover, in original cartons, 21/- (des. 1/6).

**MOBILE POWER PACKS**. Very remarkable offer of brand new instruments. Input, 12 v. D.C.; output, 250 v. 30 mA. Very efficiently choke-capacity smoothed, contained in steel portable case, with leather handle, size 11in. x 7in. x 4 1/2in., with pilot light and switch. Rotary conversion. (Cost about £30.) Great opportunity at only 25/- each (des. 3/6).

**BLOWERS**, 12/24 v. A.C./D.C. (tapped). Inlet and outlet approx. 1 1/2in dia. Overall length 6 1/2in. Very powerful blast. With mounting bracket, 27/8.

**STIRRER MOTORS**, 6/12 v. A.C./D.C. With housing 4in. x 3in., spindle 2 1/2in. long, with concentric mounting brackets. Approx. 3,000 r.p.m., good torque, 12/8.

(We have a large range of the best types of small low voltage motors, including a special type, 6/12 v. D.C., with slip rings for rotary conversion, supplying about 20 watts A.C., 12/8.)

**MINIATURE M/COIL SPEAKERS**, with small high-flux magnet. Impedance, 24 ohms, 3in. dia. Ideal for small extension speaker, microphone, inter-communication, etc., 12/8.

**MORSE SETS**, for practice or transmission (in pairs). Ex-W.D., very superior key and 2-coil buzzer, on baseplate 8 1/2in. x 4 1/2in., designed to take standard 4 1/2 in. box battery. This remarkable offer should not be confused with the "toy" type of set commonly offered. 5/- each set (two sets for 10/-, post paid).

**M/COIL HEADPHONE SETS WITH MICROPHONE**, model No. 7 (the best). The microphone has a handle. The set can be used as three m/coil microphones, apart from high-quality headphones. 13/6 the set.

**A.C. MOTORS**, 110 v. 40/60 c. 1/8 h.p., 1,425 r.p.m., Can. G.E.C., 57/8 (des. 3/6).

**THERMOSTATIC SWITCHES** (new ex-A.M.). Capacity 1.5 amp. On at 32° F., off at 49° F., therefore right for frost protection, 4/6 each, 45/- doz.

**REMOTE THERMOMETERS** (thermo-coupled micro-ammeter type). Sealed - 35° to + 55° C. (covering 0/150° F.), 2in. luminous dial. With 10ft. wire to temperature rod. Ideal for reading soil-warming temperatures, and reading in situ, outside temperatures. Very handy instruments, 15/-.

**BOWL TYPE SEMI-PROJECTOR SPEAKERS** (Govt. surplus). Imp. 4 ohms. Handling 8 watts. Dia. of bowl, 7in., fitted in wood box 9in. x 9in. x 7in. (approx.). Right for small P.A. jobs on cars, factory calling systems, etc. The m/coil unit is well weather-proofed, 18/6 each (des. 2/6). Four for £3 (des. 4/6).

**SYNCHRONOUS ELECTRIC CLOCK MOVEMENTS**, 200/350 v. 50 c. Coils for hours, mins., sec. With dust cover and flex, 37/8. Hands for 5 1/2in. dial, 2 1/2 set. S.T.C. (Selenium) RECTIFIERS (for charging up to 12 v. at 4 amps., full-wave, 25/-, 80-p-down MAINS TRANSFORMERS to suit, tapped for 6 and 12 v. charging at 4 amps., 38/8. This popular pair again available for immediate delivery. AMMETERS, 3 1/2in. m/coil, 0/6 amps., 15/-.

Please include sufficient for packing/despatch

**M. R. SUPPLIES Ltd., 68, New Oxford Street, London, W.C.1**  
Telephone: MUSeum 2958





Ignoring the fact that in these days you may well have no shirt to put on my little horses, I yet make the suggestion. You may think we only supply drills, screwdrivers and nutrunners. Then you have another think coming.

If your production involves any operation that must be done by hand or with a handtool, it is likely that my little horses will enable you to produce more goods in less time. We make tools to unscrew the moulds in plastic products; to cut sheet metal, to drive woodscrews. In fact whatever your enterprise . . . (No! I shouldn't have said that) . . . whatever your problem (we do still have problems, don't we?) my little horses will come galloping to your aid.



*Specialists in Lightweight Pneumatic  
and Electric Portable Tools*

**DESOUTTER**

DESOUTTER BROS. LTD., THE HYDE, HENDON, LONDON, N.W.9. TELEPHONE: COLINDALE 6346-7-8-9. TELEGRAMS: DESPNUCO, HYDE, LONDON.

C.R.C. 190

**the  
'TOPS'  
in  
TELEVISION**



Aerialite Television Aerials are being installed as fast as they can be produced. Good technical design, ease of fitting and robust construction, are all strong points of the entire Aerialite range. For clear, sharp, steady pictures with never a "ghost", Aerialite, the television aerial for all circumstances, is the name to remember. Send for illustrated booklet giving full details.

*Sell*

**AERIALITE  
TELEVISION AERIALS  
and EQUIPMENT**

*for the  
Pictures at Home*



Made by AERIALITE LTD., STALYBRIDGE, CHESHIRE

**• CONSTANT VOLTAGE •  
POWER SUPPLY UNITS**

**NEW SERIES 101**

Our new Laboratory Power Supplies, Series 101, are based on our well-known Model 101-A, but incorporate a number of improvements and refinements.

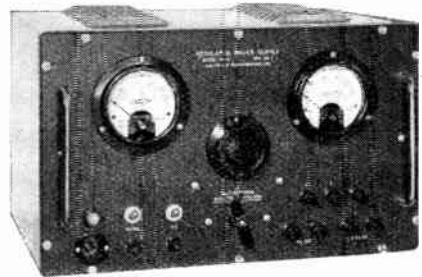

DETAILS ON REQUEST.

**ALL-POWER TRANSFORMERS LTD.**

8a, GLADSTONE ROAD, WIMBLEDON, S.W.19

Tel.: LIBerty 3303.

*Tonic when  
you're ill!*

Entertainment by your bedside relieves boredom, helps towards recovery.

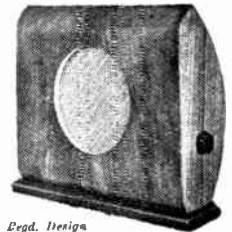

How welcome is the . . .

*Engd. Design  
No. 85150P*

**"BAFFLETTE"  
EXTENSION SPEAKER**

by

*Richard Allan*

STANDARD 4 gns. DE LUXE £4 15 0

CONSOLE £6 15 0 JUNIOR 59/6

Transformers 8/6 extra

*Walnut Cabinets (Mahogany, slight extra cost, except De Luxe model)*

AT ALL GOOD RADIO DEALERS

Made and Guaranteed by

**RICHARD ALLAN RADIO LTD.,  
Caledonia Road, Batley, Yorks.**

Tel. Batley 1123

'Grams: Acoustics, Batley

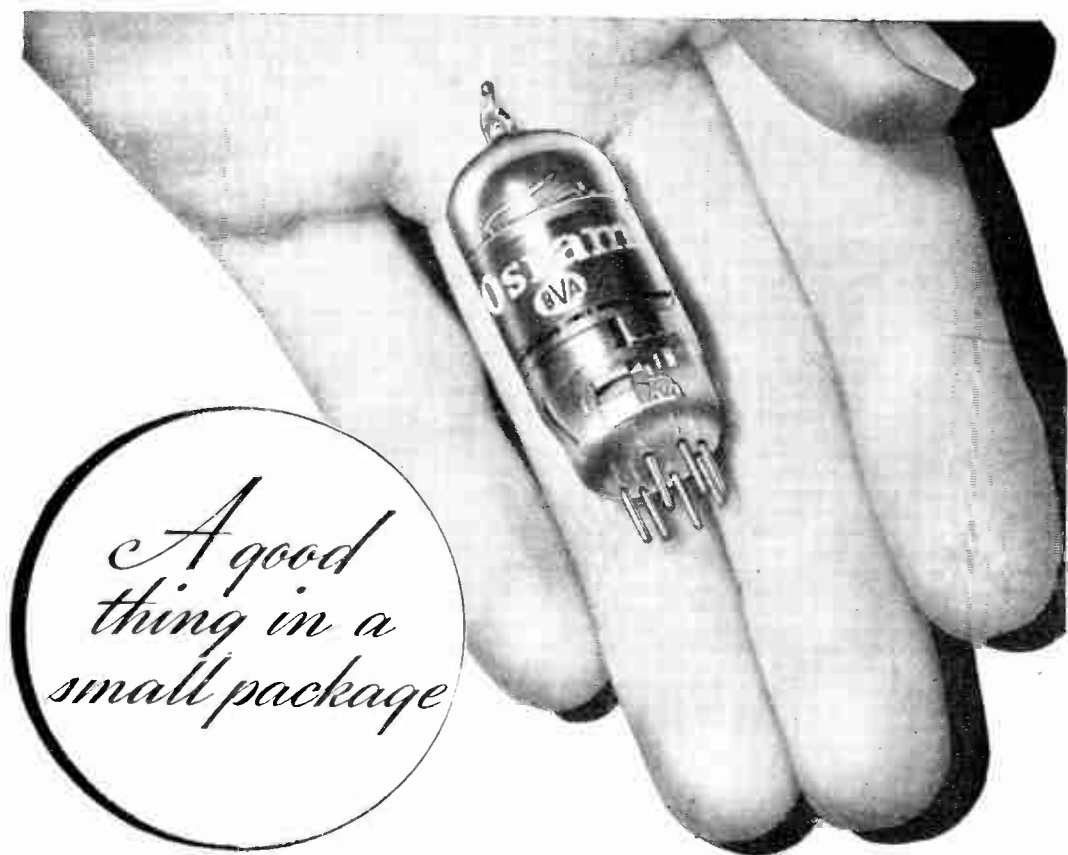

# OSRAM MINIATURE VALVE

TYPE Z77 HIGH-GAIN PENTODE

It is a high-gain pentode, mounted on the B7G base and is suitable for use in television, wide-band radio, amplifier and electronic instrument circuits.

### INTERESTING FEATURES

Small size and rugged construction make it an eminently suitable valve for use in mobile and portable equipment. Suitable for operation up to 100 megacycles per second. Owing to smallness of size and low thermal capacity the valve rapidly reaches a stable operating condition.

List Price 17/6. Purchase Tax 3/10 extra.



**Osram**

PHOTO CELLS

**G.E.C.**

CATHODE RAY TUBES

**Osram**

VALVES

THE GENERAL ELECTRIC CO., LTD., MAGNET HOUSE, KINGSWAY, W.C.2.



De  
Luxe  
&  
Potted  
Type



When **BETTER**  
**TRANSFORMERS**  
are made . . . . .

**WODEN** *will make them*

Until then our De-Luxe and Potted  
Types are the best available.

Send for Illustrated Catalogue and Price List of full range.

**WODEN TRANSFORMER CO LTD**

MOXLEY ROAD · BILSTON · STAFFS      TEL: BILSTON 41959.

J. P. I.

★ **Stars for Sale!** ★

USA field telephones with handset and ringer. Suitable for home or office. Complete with circuit & plan

**2 COMPLETE SETS for 63/-**  
Post 3/-

4-gang .0005 tuning condensers, ceramic insulation.  
4 1/2" x 2 1/2" x 1 1/2" **5/- each**  
Spindle 1/2" x 1" **Post 6/-**

Voltmeters 0-3500v DC 3 1/2" panel type, back mounting flange 3 1/2" sq Brand new **15/- each 9/-** Post  
**METRO VICK**

**Collars** RADIOGRAM UNITS latest type RP49 100-250v AC with magnetic pick-up & automatic stop fixing template and instructions **PRICE ONLY £5.15.6** including Tax.. Post free



**DENCO** Super Kit set with C76 Turret, 5 bands 10 to 2000m, 8" dial, magic eye wired and aligned IF unit FU sockets. Complete to the last nut & bolt, with CCH35 EF39 EBC33 CL33 C1C and EM34 Mullard valves. Metal rectifier. 32 page instruction book.

**ORDER with £11.11. 0.**  
**Confidence! pr 2. 9. 5.**  
**Carr. Paid £14. 0. 5.**

SATISFACTION GUARANTEED or CASH REFUNDED INSTANTLY !!

## PLAN YOUR CAREER

RADIO · TELEVISION  
and other INDUSTRIAL  
ELECTRONIC subjects  
ELEMENTARY and  
ADVANCED COURSES



**WRITE NOW FOR FREE BOOKLET** summarising the careers available in Electronics and giving particulars of Training Courses offered by E.M.I. Institutes Ltd.

The booklet contains full details of **CORRESPONDENCE COURSES** in Radio, Television, Telecommunications, Mathematics and Industrial Electronics.

Daytime and Evening Attendance Courses, and Special Courses for candidates taking examinations such as those of City & Guilds, Brit.I.R.E., etc. are also available. Payment for tuition can be made in easy instalments

## E.M.I. INSTITUTES LTD.

Dept. 16, 43 Grove Park Road, Chiswick, London, W.4. Telephone CHiswick 4417/8

E.M.I. Institutes — backed by the Electronic Organisation which includes "H.M.V.", Marconiophone, Columbia, etc.



**Frith**  
**RADIOCRAFT Ltd.**

69-71 CHURCH GATE · LEICESTER

PHONE 58927



**THE LEADERS  
IN THE FIELD  
OF MAGNETIC  
RECORDING**

# THE Soundmirror

MAGNETIC TAPE RECORDER

**RECORDS & REPRODUCES**

**ANY RADIO PROGRAMME**

**SPEECHES & LECTURES**

**BOARD MEETINGS Etc**

**PERSONAL EVENTS**



Made in England.

Protected by British and Foreign Patents and Patents pending.

Made by the Makers of the famous

**Recordon**

LOW COST  
DICTATING UNIT

THE "SOUNDMIRROR" IS HERE. Made in England by the electronic designers and engineers of Thermionic Products Ltd., the "Soundmirror" opens up enormous fields in the development of mobile or static recording and reproducing.

**RECORDING**—Using reels of magnetized tape, the "Soundmirror" gives 30 mins. of high fidelity, continuous recording. Changing of reels is quickly and simply done. The hand microphone packs easily into the handsome polished cabinet.

**REPRODUCTION**—Life-like tonal quality of any desired volume equal to the best radio receivers. The recordings are permanent and can be played an indefinite number of times without loss of quality. The recording tape can be cut and spliced to join up short recordings or edit unwanted parts. Recordings can be erased and the reels of tape used indefinitely.

The "Soundmirror" Recorder is a complete electronic unit. Contains speaker, amplifier, microphone and is equipped with jacks for easy hook up to radio, public address and other electronic audio systems. Enquiries invited.

## **THERMIONIC PRODUCTS LTD.**

*Leaders in the Field of Magnetic Recording*

Head Office: **Morris House, Jermyn Street, Haymarket, London, S.W.1.**

Phone : WHItchall 6422/3.



*Your designs*

LET US BRING THEM TO

*LIFE!*

**Made in Three Principal Materials**

**FREQUELEX**

An insulating material of Low Dielectric Loss, for Coil Formers, Aerial Insulators, Valve Holders, etc.

**PERMALEX**

A High Permittivity Material. For the construction of Condensers of the smallest possible dimensions.

**TEMPLEX**

A Condenser material of medium permittivity. For the construction of Condensers having a constant capacity at all temperatures.

the most difficult problems solved by . . .



**Bullers**

**BULLERS LOW LOSS CERAMICS**

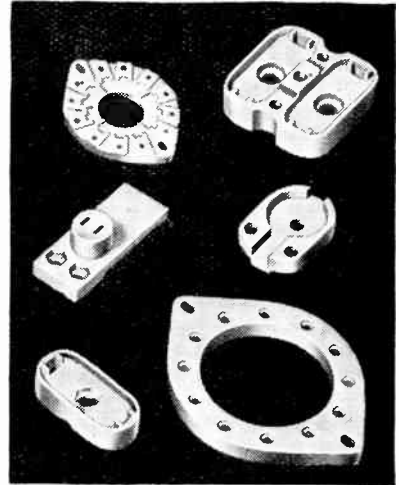

BULLERS LTD., 6, LAURENCE POUNTNEY HILL, LONDON, E.C.4  
Telephone: Mansion House 9971 (3 lines)    Telegrams: "Bullers. Cannon, London"

*Speaking  
of  
Operations*



Speaking of operations, a delicate but highly successful one has been carried out in striking the balance of correctly matched voice coil and curvilinear cone for our new 12" loud speaker. By carefully

suiting the weight of coil to cone we have reduced the peaks and secured a freedom from break-up, while the very high flux density of the large Alcomax magnet considerably increases the sensitivity, especially in the higher frequencies. All very worth while as you may see, or rather hear.

Overall diam. 12 1/2". Depth 6". Weight 7lb. 15 ozs. Voice Coil Impedance 15 ohms. Fundamental resonance 60 cycles. Flux density 14,000 lines per. sq. cm. Frequency range 50-7,000 c.p.s. Fixing holes 4 holes 1 1/2" diam. spaced 90° on P.C.D. 12 1/2".

DELIVERY FROM STOCK  
LIST PRICE £6-10-0

**GRAMPIAN**  
12" SPEAKER  
TYPE 3512/15

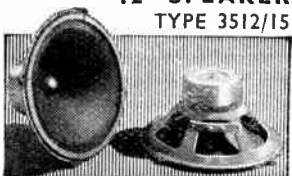

**GRAMPIAN REPRODUCERS LTD**  
Hampton Road, Hanworth, Middx. Phone: Felcham 2657

**A NEW B.P.L. INSTRUMENT**



THE VOLTASCOPE—A combined valve-voltmeter and oscilloscope. VALVE-VOLTMETER—Infinite Input Resistance for D.C. ranges 0 to 300 volts. A.C. ranges 0 to 150 volts in 5 ranges. 3 1/2 inch scale meter. OSCILLOSCOPE—3 inch screen tube provided with balanced amplifiers for Y and X plates giving a 5 times trace expansion. Maximum sensitivity 150mV/cm. Response from D.C. to 100 kcs.

Limited quantity available for early delivery.

**BRITISH PHYSICAL LABORATORIES**  
HOUSEBOAT WORKS, RADLETT, HERTS.

Tel: Radlett 5674-5-6

# PREMIER RADIO COMPANY

MORRIS & CO. (RADIO) LTD

NEW BRANCHES AT

**207, EDGWARE RD., W.2** Phone: AMBassador 4033  
**AND AT 152-153, FLEET STREET, E.C.4** Phone: CENtral 2833

All POST ORDERS to 167, LOWER CLAPTON ROAD, LONDON, E.5. Phone: AMHerst 4723.  
 Terms of Business: Cash with order or C.O.D. over £1. Send 2d. Stamp for list.

### GOVERNMENT SURPLUS MAINS TRANSFORMERS.

All are for use on 230 volt 50 cycle Mains.

Type		
33	38 v. 2 a. Tapped at 32, 34, 36 v.	15/-
42	500-0-500 v. 170 mA 4 v. 4 a.	35/-
44	10 v. 6 a., 10 v. 5 a., 10 v. 5 a.	35/-
50	12 v. 70 a. An Ideal Transformer for soil heating or welding.	80/-
51	350+350 v. 60 mA., 6.3 v. 1 a., 6.3 v. 3-5 a.	12/6
53	250-0-250 v. 60 mA., 5 v. 2 a., 6.3 v. 2-3 a.	15/-
54	275-0-275 v. 60 mA., 5 v. 2 a., 6.3 v. 2-3 a.	15/-
55	250-0-250 v. 100 mA., 5 v. 2 a., 6.3 v. 2-3 a.	17/6
56	330-0-330 v. 70 mA., 5 v. 2 a., 6.3 v. 2-3 a.	17/6
57	300-0-300 v. 70 mA., 4 v. 2 a., 4 v. 3-5 a.	17/6

E.H.T. TRANSFORMERS. For 200-230 v. 50 c. Input Half Wave. For use with Valve or Metal Rectifier. Used in a Voltage Doubling Circuit, these will give slightly over double the half wave output. We can supply suitable rectifiers.

E.H.T.1.	Output 800 v.	17/6
E.H.T.2.	Output 1,000 v. and 2-0-2 v. 2 a.	25/-
E.H.T.3.	Output 2,000 v. and 2-0-2 v. 2 a.	35/-

TANK AERIALS. Seven 2ft. lengths of tee tube which fit into each other, making a very efficient aerial.

		3/6 each
Rubber Bases to fit		2/6 each

**C.R. TUBES**  
 3-inch EMISCOPE, 4 1/2 (Marconi) as used in W.W. Scope (December '48), 17/6. Complete kit of 8 valves, £3/7/6. All other parts available.  
 V2 497. New, with socket, 35/- 5 CP1, with socket, guaranteed perfect, 20/-.

**MULLARD M.W. 18-2.** New, with base, 70/6.  
**V.C.S.188**, with socket, 19/6.

**RADAR OSCILLOSCOPE.** APN-4 contains 7-6H6, 1-6SJ7, 18-6SN7, 1-5CP1 and 100 kc. crystal, £23/19/6. Carriage and packing 10/-. Unit less valves, and crystal, with 5CP1, 25/-; 100 kc/ crystal only, 12/6.

**RECEIVER AND POWER SUPPLY** for above unit contains 1-6SN7, 1-6SJ7, 1-6H6, 4-6SK7, 1-V8105-30, 1-6SB7, 2-2-2, 1-5U4G, 3-6B4, 1-6SA7, 400/1200 cycle input, £3/7/6. Carriage and packing 7/6.

**RECEIVER TYPE 184.** Radar Unit containing 14 valves: 1 0UG7, 4 VE91, 7 VR65, 1VU111, 1 VR92. Unit contains a 45 mc/s I.F. strip suitable for use as a Vision Receiver. There is ample space for building Power Packs or Time Bases. Also included are 5 Potentialometer, .01 mfd. 2,500-volt Condenser, 2 Relays, 3 Neon Lamps, a quantity of Resistors, Condensers and Co-axial Sockets. £23/5/-.

**SPECIAL OFFER OF ELECTROLYTIC CONDENSERS.**

15	18 mfd. 500 v. working, Cardboard	4/11
8	48 mfd. 500 v. "	4/11
32	32 mfd. 350 v. " All. Cans	5/11
32	32 mfd. 350 v. "	2/6
18	18 mfd. 350 v. " Cardboard	3/9
8	8 mfd. 450 v. "	3/-
16	16 mfd. 450 v. " "	2/-
16	16 mfd. 450 v. " All. cans	4/11

**MOVING COIL EARPIECES**  
 Comprise a 1 1/2in. Moving Coil Loudspeaker fitted with noise excluding rubber caps. Make excellent Mikes. Phones or Speakers, 2/- each. 18/- doz.

**PLESSEY AUTO CHANGER** with magnetic pick-up, A.C. 200/250 v. 8-records mixed, £18/6/8.

**GARRARD ELECTRIC GRAMOPHONE UNIT** with magnetic pick-up, A.C. 100/250 v., £5/19/5. COLLARO AUTO CHANGERS with magnetic pick-up, A.C. 100/250 v. £22/4/4.

**COLLARO ELECTRIC GRAMOPHONE UNIT** with magnetic pick-up and auto stop A.C. 100/250 v., £9/13/6. With crystal pick-up, £11/2/2.

**COLLARO ELECTRIC GRAMOPHONE MOTOR** with 12in. turntable, A.C. 100/250 v. £5/18/4.

**CONRAD ELECTRIC GRAMOPHONE MOTOR.** 9in. turntable, 200/250 v. A. C. 57/6.

All above motors include Purchase Tax.

**H.T. ELIMINATOR AND TRICKLE CHARGER KIT.** Consists of a complete kit of parts to construct an H.T. Eliminator with an output of 120 v. at 20 mA. and provision for Trickle Charging a 2 v. Accumulator. Two Metal Rectifiers are employed. With circuit, 35/-.

**OSCILLOGRAPH POWER UNITS.** Input 230 volts. Consists of Kit of Parts incorporating Mains Transformer, metal rectifier, voltage doubling condensers.

175	Output 800 v.	25/-
409	Output 1,800 v.	30/-
25	Output 2,500 v. at 3 mA. and 4 v. 2 a. C.T. For use with 2 or 4 v. C.R. Tubes	49/6
55	Output 5,500 v. at 3 mA. and 4 v. 2 a. C.T. For use with 2 or 4 v. C.R. Tubes	81/-

### PREMIER KITS AT REDUCED PRICES

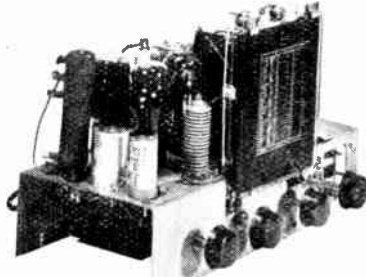

**ALL-WAVE SUPERHET KIT.** A Kit of Parts to build a 6-valve (plus rectifier) receiver, covering 16-60 metres. Medium- and Long-wave bands. Valve line-up, 6K8, 6K7, 6Q7, 6J7, two 25A6 in push-pull. Metal Rectifiers are incorporated for H.T. supply. Output impedance is for 3 and 15 ohms. The latest Weartite coil Pack incorporating Iron Dust Coils is used making construction and alignment extremely simple. A pick-up position on the wave-change switch and pick-up terminals are provided. A complete kit, including valves, but without speaker or cabinet. Chassis size, 1 1/4in. x 6in. Overall height 9in. Price £10/16/6, including Purchase Tax. Wired and tested, £12/10/-.

Suitable loudspeakers are the GOODMAN'S 16in. 6-watt P.M. at 47/6, or for superlative reproduction, the Goodman's 12in. P.M. at £8/15/-.

**NEW 2-VALVE ALL WAVE KIT.** 16 to 3,000 metres. Switched Coil Pack ready wired and tested. 2 Mazda H.123 Valves, Phones, H.T. and L.T. Batteries, Condensers, resistors, diagrams and steel case, all ready to assemble, £3/10/-, including Purchase Tax.

**ALL WAVE RECEIVER KIT.** 7-Valve (plus Metal Rectifier for H.T. supply) Superhet; for A.C./D.C. Mains 200/250 volts. 40/60 cycles. Four wavebands 13.6-52 metres (22-5.4 mc/s), 51-200 metres (5.9-1.5 mc/s), 200-550 metres and 900-2100 metres. The five position switch includes a Pick-up Position, and Pick-up Terminals are provided. Valve line-up 6K7 (R.F.), 6K8 (Frequency Changer), 6K7 (I.F.), 6Q7 (2nd Det. A.V.C. and 1st L.F. Amplifier), 6J7 (Phase Inverter) 2x25A6 (Push Pull Output). Specially designed Output Transformer to match the 25A6's to speaker of 3 or 15 ohms impedance. Negative feedback is applied over three stages, giving a very high fidelity output. The Coil Pack which is tested and calibrated is of the most modern type. Substantial smoothing gives an exceptionally low hum level. Large illuminated Geass Dial in colour.

The Complete Kit of Parts including Valves and Complete Instructions, £13/8/10, inc. tax. Completely wired and tested, £15. Recommended Loudspeaker, Rola Super (G.12) 85/-.

**NEW 1948 MIDGET SUPERHET RADIO KIT,** with illuminated Geass F Dial. All parts, including Valves, M.C. Speaker and Instructions, 4 valves plus Metal Rectifier. 16-50 metres and 200-557 metres. 200 to 250 v. A.C. or A.C./D.C. mains. Start which is required. Size, 10in. x 6in. x 6in., £8/5/-, including Purchase Tax.

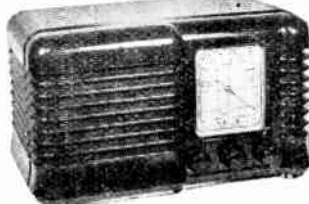

**MIDGET RADIO CABINETS** in Brown Bakelite. Can be supplied for the above kit at 25/-, including P.T.  
**NEW MIDGET T.R.F. RECEIVER.** Special offer of completely built and tested T.R.F. Receivers in bakelite cases. Medium and Long Wavebands. Size, 12in. x 6in. x 6in. As illustration. Two models are available, an A.C. and an A.C./D.C. Both for 200-250 v. mains. These are offered at the pre-war price of £7/19/6, including Purchase Tax.

**MINE DETECTOR PANELS,** include three 174 valves, 12-1 Midget Trans., three ceramic valveholders, 18 condensers and resistors, etc., 20/-, Without Valves, 5/-.

**WIRE WOUND RESISTORS.** 50K 200 watt, 4/-, 20K 200 watt, 4/-, 2K + 12K 150 watt, 4/-, 75K 100 watt, 4/-, 350Ω 75 watt, 2/-, All vitreous enameled.

**TELEVISION MAGNIFYING LENS.** Suit any 5in., 6in. or 7in. tube. Increase picture size considerably, 20/6.  
**P.P. DRIVER TRANS.** Split Sec., super quality, 10/-.

Full Scale Deflection	Scale Marking	Scale External Dimension	Movement	Price
1 mA	0-100	3 1/2"	M/C	15/11
1 mA	0-1	2 1/2" x 2 1/2"	M/C	7/6
5 mA	0-5	2 1/2"	M/C	5/-
30 mA	0-30	3 1/2"	M/C	10/6
50 mA	0-50	2 1/2" x 2 1/2"	M/C	8/6
150 mA	0-150	2 1/2"	M/C	6/-
250 mA	0-250	3 1/2"	M/C	10/-
2.5 amp.	0-2.5	3 1/2"	Thermoc.	5/-
15 v.	0-15	3 1/2"	M/I	7/6
20 v.	0-20	2 1/2" x 2 1/2"	M/C	5/9
40 v.	0-40	2 1/2" x 2 1/2"	M/C	5/9
5000 u.a.	0-5	4 1/2"	Elect.	50/-
500 u.a.	0-500	2 1/2"	M/C	7/6
500 u.a.	0-500	3 1/2"	M/C	19/6

**R.F. 1155 RECEIVERS.** Brand new, £12/12/-, Used but perfect, £8/8/-. Combined Output Stage and 230 v. Power Pack, £3/10/-, 10in. Rola Speaker in black crackle cabinet to match, 45/-.

**TEST UNIT TYPE 73** consists of a special purpose Oscilloscope that requires only rewiring and the addition of a few condensers and resistors to convert into a standard Oscilloscope, input 230 v. 50 c. A 3 1/2in. C.R. tube and 1 8U22A0, 1 8B34, 1 5Z4, 3 8P14, 2 EA50, are included. Price £8/6/-.

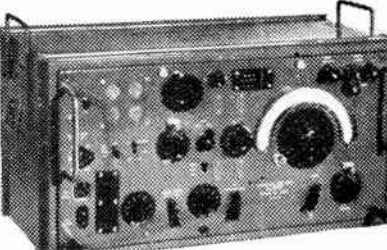

**B107. ONE OF THE ARMY'S FINEST COMMUNICATIONS RECEIVERS.** (See "W.W.", August, 1945.) 9 valves, R.F. amp. osc. Frequency Changer, 2 I.F.'s (465 kc.), 2nd Detector, A.V.C. Af. amp. B.F.O. A.C. mains, 100-250 v. or 12 v. accum. Frequency range 17.5 to 7 mc/s, 7.25 mc/s to 2.9 mc/s, 3.0 to 1.2 mc/s Monitor L8 built in. Complete. Write for full details. £16/16/-, Carriage paid.

**LOUDSPEAKERS BY FAMOUS MAKER**

6in. P.M. 2-3 ohms	10/11
6in. " 2-3 "	16/6
8in. " 2-3 "	17/6
10in. " 2-3 "	22/6
12in. " 15 "	35/-

**COLLARO AUTO CHANGERS.** Mixer-Changer Rim-Drive. High fidelity crystal pick-up. Repeat Reject mechanism. £14/8/8.

**COLLARO A.C./D.C. GRAMOPHONE MOTORS,** with turntable, but without pick-up or auto stop. £8/5/6.

**UNIT TYPE A.3592A.** Brand new, contains two Ceramic Base 807, one 5C44, one EF50, one EA50. A large quantity of Condensers, Chokes, Resistors, etc. 30/-.

**UNIT TYPE T.28/APT-1.** Contains two 832, two 6C4, two 8R4, one 6X5, three 6AC7, one 6V6, one 951A, and a huge variety of other material. £10. Valves available separately.

**ROTARY TRANSFORMERS.** Used in reverse will charge a 2 to 6 volt Accumulator at 3 amps from D.C. mains. Many other applications. 10/-.

**HALF WAVE OR VOLTAGE DOUBLING 250 v. 30 ma. 3/-.** Half wave 300 v. 75 ma., 4/-, 750 400 v. 2ma. 3/6 or six for 16/6. 15 v. la Bridge, 6/-.

**ALUMINIUM CHASSIS.** Substantially made of bright Aluminium with four sides.

7 x 2 1/2 x 5in.	4/6	9 1/2 x 4 1/2 x 2in.	5/6
10 x 8 x 2 1/2in.	7/-	12 x 8 x 2 1/2in.	7/9
14 x 9 x 2 1/2in.	8/3	16 x 8 x 2 1/2in.	8/6
20 x 8 x 2 1/2in.	10/6	22 x 10 x 2 1/2in.	13/6



WORKSHOP - KITCHEN - DINING ROOM - LOUNGE - BEDROOM  
 — switch the radio on or off from wherever you are!

# The 'LONG ARM' REMOTE CONTROL

The warm welcome accorded the "Long Arm" when it reappeared just before Christmas showed how much listeners need the added convenience of remote control.

Remember that this Whiteley "exclusive" operates any number of "Stentorian" speakers (Senior, Junior or Cadet models) from any radio receiver, and costs only 35/-. (Suitable speakers from £4.0.0.)

Other Whiteley products include Loudspeaker Chassis Units, Microphones, Valveholders, Switches, Transformers and Chokes.

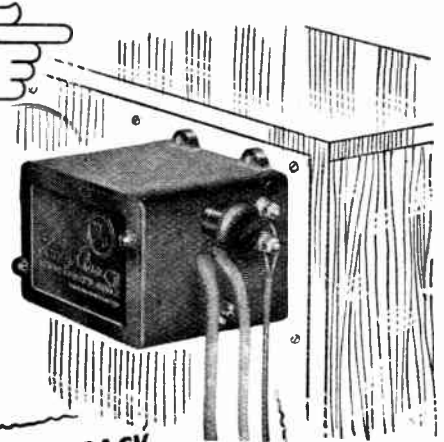

**BROUGHT BACK  
 BY POPULAR DEMAND**

# Stentorian

**LOUDSPEAKERS & RADIO COMPONENTS**  
 WHITELEY ELECTRICAL RADIO CO · LTD · MANSFIELD · NOTTS



## Inductance Meter TYPE MI 48 - 2

This instrument has been designed to provide simple and direct reading measurement of inductance values between 0.05 microhenry and 100 millihenrys. A stable variable-frequency oscillator is

used to resonate the unknown inductance with a fixed standard capacitor. Provision is made for the measurement of Q at resonance frequency. Price £38.5.0.



WAYNE KERR LABORATORIES LIMITED, NEW MALDEN, SURREY.

# Coils & Packs

IN a variety of combinations from 5 to 2,000 metres with all necessary padding and trimmer condensers. Write for descriptive literature stating your problem.

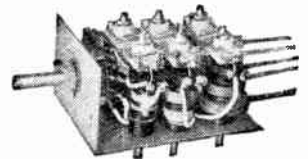

LABORATORY



TESTED

H. C. ATKINS Laboratories, 32, Cumberland Road, Kew, Surrey  
 Richmond 2950

47106



# LONDON CENTRAL RADIO STORES

Government Surplus - Immediate Delivery from Stock

## 10-VALVE COMMUNICATIONS RECEIVER. Type R1155.

Complete with Power Pack and Speaker.

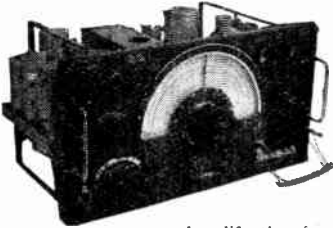

These sets are as new. Freq. range 7.5 mc/s., 75 kc/s in five wavebands. Complete with 10 valves, including magic eye. Every receiver is Aerial Tested. For A.C. mains 200-250 v. Enclosed in a metal cabinet and supplied complete with separate Power Pack and Loudspeaker. (Carr. and pkg. 10/6 extra).

**£17**  
FREE with each receiver!  
Complete circuit, description

and modifications for civil use, reprinted from "W.W." July, 1948

## THE FAMOUS EDDYSTONE 358 COMMUNICATIONS RECEIVER

Great Reduction in Price



Range 31 Mc/s to 90 kc/s, 9 Plug-in coils, 7 valves and rectifier, variable selectivity, B.F.O. standby switch, A.V.C. switch, bandspread dial, valve check meter. In heavy black crackle finished steel cabinet with chrome fittings. Complete with 200-250 v. A.C. Power Supply Unit **£20** Carriage and packing 17/6 extra.

## ROTHERMEL CRYSTAL MICROPHONE

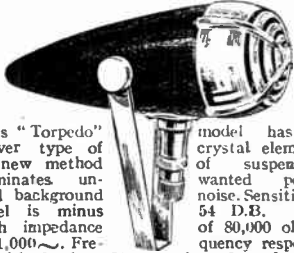

This "Torpedo" model has a driver type of crystal element. A new method of suspension eliminates unwanted peaks and background level is minus high impedance at 1,000 $\sim$ . Frequency response is fairly flat from 30 $\sim$  to above 6,000 $\sim$ . Dimensions 8 $\frac{1}{2}$  x 3 $\frac{1}{4}$  in.

crystal element. of suspension wanted peaks noise. Sensitivity 54 D.B. Has of 80,000 ohms. quency response

**£3-19-6**

## TELEPHONE LINE OR UNISELECTOR SWITCHES



3-Bank, 38/6. 5-Bank, 45/-.

3-Bank, 20/-.

Control Panels Only as Illustrated

## CHARGING BOARDS

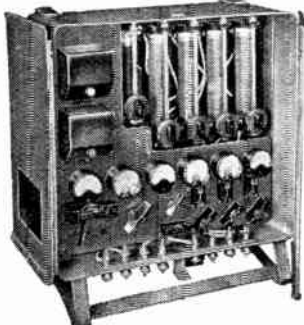

24 v., 1,200 watts. Includes five 1 $\frac{1}{2}$  in. moving coil ammeters (1, 0-40 a., 4, 0-15 a.). One moving coil voltmeter 0-40 v. Five heavy duty sliding resistances, etc., complete in metal case as shown with fold-back doors. Size, 18x17x8 $\frac{1}{2}$  in. Offered at less than half the component value. Price, **£4-19-6** carriage extra.

## MISCELLANEOUS BARGAINS

CO-AXIAL CABLE. 75 ohms, per doz. yds., 8/-.

FIVE-WAY RUBBER COVERED CABLE. Suitable for all purposes. Per doz. yds., 6/-.

EX-ADMIRALTY TRANSFORMERS. Primary 230 v. Secondary 14 v. C.T., 30 amps. Weight 69 lbs. Carr 12/6 extra, **25**.

ELECTRO MAGNETIC COUNTERS. Ex-G.P.O., every one perfect, electro-magnetic, 500 ohm coil, counting to 9,999, operated from 25 v.-60 v. D.O. many industrial and domestic applications **5/6**

PLUGS & JACKS, per set 2/8. Post 3d.

EX-G.P.O. TABLE MICROPHONES. With plug and lead **5/6**

NEW MILES H.T. UNITS. (Everlasting). 120 v. 600 mA. Will charge from 6 v. accumulator **67/6**

CATHODE RAY TUBES, Ex-Govt. 6in. VCR97 27/6; 6in. VOR517 22/6; 12in VCR140 27; 12in. VOR511 27.

METAL RECTIFIERS. 6 v. 21 amp **15/-**

EX-GOVT. TELEPHONE HANDSETS. Self-Energising. Needs no battery or current. Less Wall bracket. Each **5/6**

PHOTO ELECTRIC CELLS. Small infra-red image, glass converter tube. Type C.V. 143 50-100 v. Suitable for all purposes. See April issue for illustration. **14/6**

U.S. ARMY MIDGET LIGHT-WEIGHT HEADPHONES. 300 ohms. Suitable for Deaf Aids **15/-**

3-VALVE R.F. AMPLIFIERS V.H.F. Types 24 and 25. 40/50 mA. Complete with 3 8P41 valves. In metal case. Slightly used but in perfect working order. **10/6** Plus carriage & pkg. 1/6

N.B.—All carriage paid unless otherwise stated. We do not issue lists or catalogues. We have hundreds of items in stock too numerous to list. So when in Town pay us a visit.

RADAR VIEWING UNITS. Type 182A. With 6in. VCR517 C.R. Tube, three EF50, four 8P61, one 6U4 valves, 3 potentiometers, condensers, **37/6** etc. Carr. and pkg. 7/6

RECONDITIONED 5-VALVE 3 WAVEBANDS S.M.L. SUPERHET RECEIVERS. A.C. or D.C. mains, 200-250 v. Size 20 x 11 x 9in. As new **£9-17-6** Complete

EX-GOVT. 1000L COPPER AERIALS, with ebonite chain insulators, with 30ft. guy rope **4/3**

2-VALVE UNIVERSAL RECEIVERS, Type 1126. 13 v. heaters. Fixed frequency. Less Power Pack **10/6**

MOVING COIL HAND MICROPHONE. 5/8.

2-VOLT POWER PACKS. complete with Vibrator. Output approx. 200 v. 60 mA. Size 9 x 5 x 3 $\frac{1}{2}$  in. **£1-17-6** A first-class job.

VIBRATORS. 2 v. input. Self-rectifying type. Output approx. 200 v., 60 mA. **7/6**

TRIPLET UNIVERSAL TEST METERS. Ex-Govt. 1,000 ohms per volt, Volts A.O. or D.C. 0-10, 0-50, 0-250, 0-1,000, 0-5,000. Milliamps, 0-10, 0-100, 0-500. Ohms, 0-300, 0-1 meg. Slightly used **£4-10-6**

SMALL SLIDING RESISTANCES Ex-Admiralty. Finest quality. Suitable for Voltage Controls, Speed Regulators. 50 ohms. 0.5 amp. Dimensions 6in. x 4in. x 2 $\frac{1}{2}$ in. high **8/6**

7-VALVE U.H.F. RECEIVER. Type R1147A Range approx. 200 megacycles (with 4 Accura valves). A Real Opportunity. Beautifully constructed and fitted with micro-condenser drive. Valve types: two EF36, one EBC33, three 904, one 905. In black metal case, 8 x 7 x 6in. Set complete with valves **£1-17-6**

## AZIMUTH RELEASE RELAY

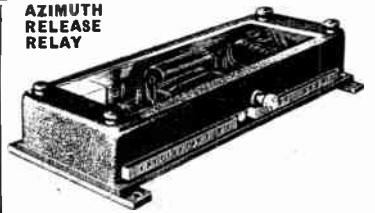

In glass fronted, cast aluminium case, size 12 x 4 x 2in. Contains A.C. Relay, D.C. Relay, Alarm Relay, etc. **£2-7-6**

## NEW 3-VALVE AMPLIFIER PANELS

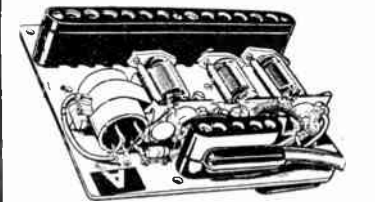

With three 1T4 valves, condensers, etc. **15/-** New spare valves for above 5/- each.

## R.A.F. 6-VALVE SUPERHET RECEIVING UNIT No. 25

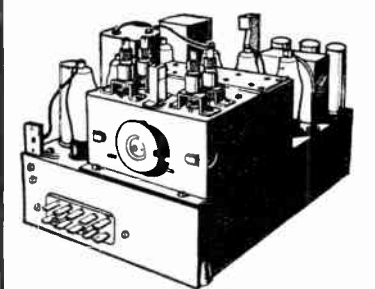

Easily adapted for short-wave reception for home use. Contains two EF36, two EF39, one EK32, one EBC33 valves, condensers, resistances etc. Free circuit diagram **25/-**

LONDON CENTRAL RADIO STORES, 23, LISLE ST. (GERrard 2969) LONDON, W.C.2

Closed Thursday 1 p.m. Open all day Saturday and weekdays 9 a.m.—5 p.m.

# COULPHONE RADIO PRODUCTS

## MAINS TRANSFORMERS

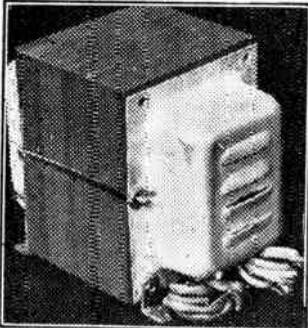
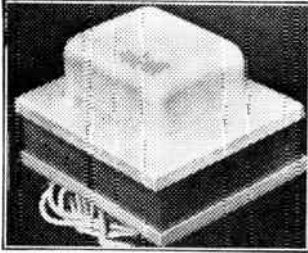

**15/6** Postage and Packing 1/- extra

Coulphone Mains Transformers are made to the highest electrical standards and are fully guaranteed. We supply them to the Ministry of Supply Atomic Research Stations, so they will no doubt meet your requirements. Special quotations for quantities and types to order.

- Standard Replacement Types. Drop-through chassis type with top shroud. Impregnated and interleaved. Screened Primaries tapped for 300/230/250 volts.
- (a) 250-0-250 v. 60 mA. 6.3 v. 3 A., 4 v. 2 A. . . 15 6
  - (b) 250-0-250 v. 60 mA. 4 v. 4 A., 4 v. 2 A. . . 15 6
  - (c) 250-0-250 v. 80 mA. 0/4/6.3 v. 4 A. C.T., 0/4/5 v. 2 A. . . 18 0
  - (d) 300-0-300 v. 80 mA. 0/4/6.3 v. 4 A. C.T., 0/4/5 v. 2 A. . . 18 0
  - (e) 350-0-350 v. 80 mA. 0/4/6.3 v. 4 A. C.T., 0/4/5 v. 2 A. . . 18 0
  - (f) 250-0-250 v. 100 mA. 0/4/6.3 v. 4 A. C.T., 0/4/5 v. 2 A. . . 21 0
  - (g) 300-0-300 v. 100 mA. 0/4/6.3 v. 4 A. C.T., 0/4/5 v. 2 A. . . 21 0
  - (h) 350-0-350 v. 100 mA. 0/4/6.3 v. 4 A. C.T., 0/4/5 v. 2 A. . . 21 0
  - (i) 350-0-350 v. 150 mA. 0/4/6.3 v. 6 A. C.T., 0/4/5 v. 2 A. . . 38 0
  - (j) 425-0-425 v. 180 mA. 6.3 v. 4 A. C.T., 6.3 v. 4 A. C.T., 5 v. 3 A. . . 43 6
  - (k) 425-0-425 v. 180 mA. 4 v. 8 A. C.T., 4 v. 4 A. C.T., 4 v. 4 A. . . 43 6
  - (l) 425-0-425 v. 180 mA. 6.3 v. 4 A. C.T. 4 v. 2 A. C.T., 4 v. 2 A. C.T., 5 v. 3 A. . . 46 0

Types (a) (b) (c) (d) (e) (f) (g) (h) (k) upper illustration  
Types (i) (j) (l) lower illustration.

### SMOOTHING CHOKES

- 40 mA. 360 Ω 5/-, 60 mA. 425 Ω 6/6, 90 mA. 180 Ω 7/-, 100 mA. 400 Ω 12/6, 200 mA. 150 Ω 21/-, 200 mA. 350 Ω 22/6, 250 mA. 220 Ω 25/-.

Terms: C.W.O. or C.O.D.

Send 2½d. Stamp for New 32-page Catalogue.

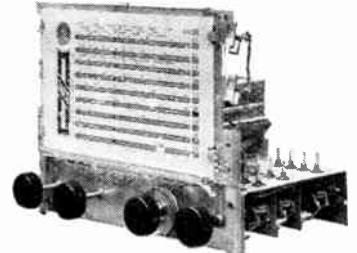

### FEEDEE UNITS

**MODEL B DE LUXE** (illustrated above). High gain R.F. stage operative on all nine wavebands, 45/145 M., 190/350 M., 900/2000 M. Plus six ranges of Bandspread, 13.5-14.8, 16-17.4, 19-20.5, 24.2-26, 30-32, 41-43.5 metres. Large colour printed glass dial, 10in. x 6in. aperture. Horizontal drive. Wave-range indicator and magic eye. Switched pick-up sockets. Volume and Tone Controls. Completely aligned ready for connection to audio amplifier. Price less valves £18/7/6. Valves required, 6F50, 6K7G, 6K7G, 6Q7G, Y83. Price for set of five valves, £23/11/5.

**MODEL A.** A first class feeder unit with R.F. stage operative on all wavebands, 16/50, 190/550, 900/2000 metres. Switched pickup sockets. Volume control. Glass dial 8in. x 8in. in colours. Completely aligned ready for connection to audio amplifier. Price less valves, £10/8/6. Valves required, 6K7G, 6K8G, 6K7G, 6Q7G. Price for set of four valves, £22/11/5. **A.F. AMPLIFIER POWER UNIT.** Specially designed for use with above units. Employs 6V6G output (4 watts) and 5Z4G rectifier. Price less valves £3/10/-. Two valves if required, £1/3/10.

NEW GOODS ONLY

**COULPHONE RADIO** 58 DERBY STREET, ORMSKIRK, LANCS. "The Return of Post Mail Order Service" Tel.: Ormskirk 496

WIRING IS EASIER AND QUICKER WITH A "PYROBIT" IRON



To the amateur assembler, the "ham," the serviceman and the manufacturer, the Special Radio "PYROBIT" Electric Soldering Iron is the first essential tool. Light weight, perfect balance and handy shape double the pleasure and speed of wiring.

See one at your Radio, Electric or Hardware Shop or write for full details.

SPECIAL RADIO MODEL  
7oz. 45watts  
**22/-**

**THE ACRU ELECTRIC TOOL MFG. CO. LTD.**  
123 HYDE ROAD, MANCHESTER 12. Tel: ARD. 4284

## THE NEW "75" SIGNAL GENERATOR Model 1



**Frequency Range** 110 to 50 Megacycles. With calibrated extension covering London, & Midland Television frequencies, at over 60 Megacycles.  
**Modulation** 400 C.p.s. sinusoidal.  
**Attenuator** 5-step ladder, with fine control.  
**Output** Switched via single test-lead, RF. and AF. 1 volt Max.  
**External Radiation** Less than 1 micro-v.  
**For A.C.** mains operation. Complete with Standard Dummy Aerial.

**SPHERE INSTRUMENTS** LIST **12½** GNS. SUBJECT.  
EXCELLENT PERFORMANCE  
ATTRACTIVE APPEARANCE  
LOW PRICE  
HIGH EFFICIENCY

INQUIRIES INVITED:  
**SPHERE RADIO LIMITED**  
HEATH LANE, WEST BROMWICH, ENGLAND

# Wharfedale

## NEW GOLDEN 10 inch LOUDSPEAKER...

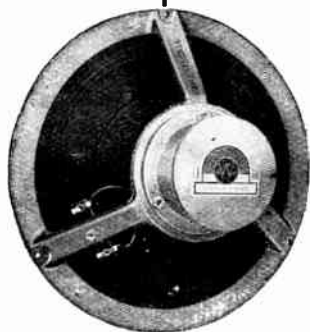

Speech coil  
3 or 15 ohms  
impedance  
**PRICE 75/-**

During the last eight years hundreds of Wharfedale Golden Units have been supplied to the B.B.C. and G.P.O.

The Speaker was selected by reason of its level response, and makes an ideal Unit for reproduction free from resonance peaks. It is fitted with precision die-cast chassis, improved spider and Alcomax II Magnet, with a flux density of 12,500 lines.

*Ask your dealer or send for book "Loudspeakers" by G. A. Briggs, 5/-, in which acoustic loading is fully explored.*

Made and Guaranteed by  
**WHARFEDALE WIRELESS  
WORKS**

BRADFORD ROAD, IDLE, BRADFORD  
Telephone : IDLE 461.      Telegrams : Wharfdel, Idle, Bradford

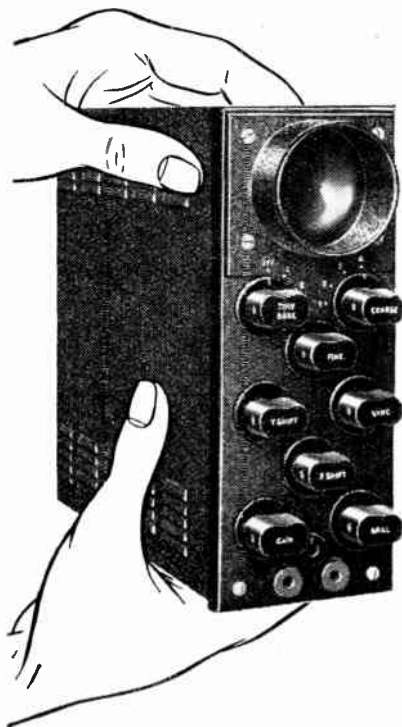

## MASTERPIECE IN MINIATURE

WIDTH	2½"
HEIGHT	6¾"
DEPTH	9¼"
C.R.T. DIAMETER	1½"
NETT WEIGHT	7½lbs

## Miniscope

MINIATURE CATHODE RAY OSCILLOSCOPE BY

**G.E.C.**

Full specification from: THE GENERAL ELECTRIC CO., LTD., MAGNET HOUSE, KINGSWAY, LONDON, W.C.2



## ...the Paragon of Instrument Virtues



Type TF867 excels even the best of previous Marconi SIGNAL GENERATORS. Its virtues are impressive both mechanically and electrically, for design and performance are alike superlative.

The expanding wide view scale is a unique innovation. So, too, is the concentric terminating unit which serves as dummy aerial, provides source impedances of 75Ω and 13Ω and shows diagrammatically the exact conditions of circuit. Prominent among other features are freedom from unwanted frequency modulation, crystal standardisation, deep-amplitude or carrier shift modulation and stabilised output level. Over the range 15 Kc/s to 30 Mc/s, output is continuously variable from 0.4 μV to 4V; calibration indicates true artificial signal e.m.f. irrespective of load. Full technical information is freely available.

### SIGNAL GENERATOR

Type TF 867

## MARCONI INSTRUMENTS LIMITED

ST. ALBANS, HERTFORDSHIRE • Telephone: St. Albans 6161/5  
 Northern Office: 30 Albion Street, Hull. Phone: Hull 16144 • Western Office: 10 Portview Road, Avonmouth  
 Phone: Avonmouth 434. • Southern Office and Showrooms: 109 Eaton Square, London, S.W.1. Phone: Sloane 8615



**"You're CERTAIN to get it at ARTHURS!"**

★ **VALVES:** We have probably the largest Stock of valves in the Country. Send your enquiries. We will reply by return.

**PICK-UPS.** Decca £6 14 6. Decca head for Garrard £4 11 0. Adaptors 5/-. Connoisseur £4 11 0.

**PERSONAL RADIO SETS IN STOCK**  
 New Olympic Romac, Long and Medium Wave £17 16 11  
 Ever Ready ..... £12 18 10  
 Marconi ..... £15 19 5  
 New Marconi ..... £14 14 9

**REMINGTON FOURSOME SHAVERS**  
 210-250 v. AC/DC ..... £7 17 6

**ALL AVO AND TAYLORS METERS.** List on request.

**PHILIPS CYCLE DYNAMO SET.....** £2 1 6

ALSO STOCKISTS OF ALL DOMESTIC APPLIANCES.  
**London's Oldest Leading Radio Dealers.**

**Arthur's** EST. 1919  
 PROPS: ARTHUR GRAY, LTD. Terms C.O.D. or cash with order.

Our Only Address: **Gray House, 150, Charing Cross Rd., London, W.C.2** TEMple Bar 5833/4  
**ELECTRICAL, TELEVISION & RADIO ENGINEERS.**



## FOR THE RADIO SERVICEMAN DEALER AND OWNER

The man who enrolls for an I.C.S. Radio Course learns radio thoroughly, completely, practically. When he earns his Diploma, he will KNOW radio. We are not content merely to teach the principles of radio, we want to show our students how to apply that training in practical, every-day radio service work. We train them to be successful.

Write to the I.C.S. Advisory Dept. stating your requirements. Our advice is free.

*You may use this coupon.*

**INTERNATIONAL CORRESPONDENCE SCHOOL Ltd.**  
 DEPT. 38, INTERNATIONAL BUILDINGS, KINGSWAY, LONDON, W.C.2

Please explain fully about your instruction in the subject marked X.  
 Complete Radio Engineering      Radio Service Engineers  
 Radio Service and Sales      Advanced Short-Wave Radio  
 Elementary Electronics, Radar, and Radio

And the following Radio Examinations:—  
 British Institution of Radio Engineers  
 P.M.G. Certificates for Wireless Operators  
 City and Guilds Telecommunications  
 Wireless Operators and Wireless Mechanics, R.A.F.  
 C.S. students for Examinations are coached till successful.

Name ..... Age.....  
 (BLOCK LETTERS PLEASE)

Address.....





# 12" P.M.

*... undeniably a most successful loudspeaker*

Goodmans 12" P.M. Loudspeaker T 2 is undeniably a most successful loudspeaker. Soundly constructed in every particular, it provides radiogram manufacturers and users of P.A. equipment with a medium, heavy duty reproducer that is robust yet capable of providing a very high standard of reproduction.

## GOODMANS Loudspeakers

GOODMANS INDUSTRIES LTD., LANCELOT ROAD, WEMBLEY, MIDDLE EX. TELEPHONE: WEMBLEY 1200 (8 LINE3)

Write for Technical Data Sheet D. 29 describing this and other loudspeakers

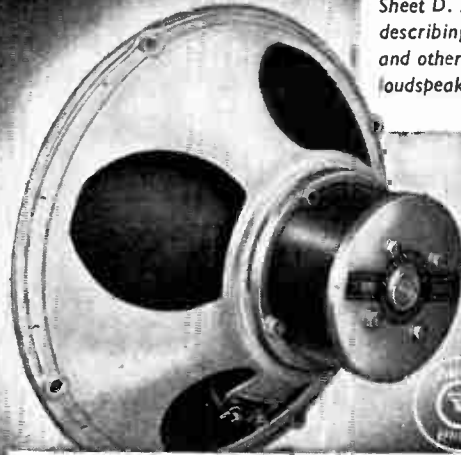

### SPECIFICATION: TYPE T2

Overall Diameter	12.5/16"	Overall Depth	6.9/16"
Fundamental Resonance	.....	.....	75 c.p.s.
Max. Power Capacity	.....	.....	12w. peak A.C. on 4ft. baffle (15w. horn loaded)
Voice Coil Impedance	.....	.....	15 ohms at 400 c.p.s.
Total Flux	.....	.....	145,000 maxwells
Nett weight	.....	.....	12 lbs.

Telegrams: Goodmans, Wembley 1200

# ★ The basis of world standards

Applications for copies of the Telcon R.F. Brochure should be addressed to Telcon Works, Greenwich.

**THE TELEGRAPH CONSTRUCTION & MAINTENANCE CO. LTD.**  
 Head Office: 22 OLD BROAD STREET, LONDON, E.C.2. Telephone: LONDON Wall 3141  
 Enquiries to TELCON WORKS, GREENWICH, S.E.10. Telephone: GREENWICH 1040

★  
It **PLAYS** to Advertise . . .

Invite your customers to hear the "De Luxe" Microgram play their favourite records — and they'll prove to you that the *Microgram* sells itself!



The "De Luxe" Microgram with the new Collaro Light-weight Crystal Pick-up, Automatic Stop and 6½" Speaker—complete in handsome imitation lizard-skin carrying case. Suitable for A.C. Supply 200/250 volts.

RETAIL PRICE £19 . 19 . 0  
Plus Pur. Tax : £8 . 12 . 11

The **COLLARO**  
"DE LUXE"  
**Microgram**  
*Portable Electric Gramophone*

Trade Terms and Literature from:

COLLARO LTD., RIPPLE WORKS, BY-PASS ROAD, BARKING, ESSEX (Telephone RIPPLEWAY 3333)

Proprietors : ILIFFE & SONS LTD.  
Managing Editor : HUGH S. POCOCK, M.I.E.E.  
Editor : H. F. SMITH

Editorial, Advertising and Publishing Offices :  
DORSET HOUSE, STAMFORD STREET,  
LONDON, S.E.1.

Telephone : Waterlooo 3333 (60 lines).  
Telegrams : "Ethaworld, Sedist. London."

PUBLISHED MONTHLY  
Price : 2/-

(Publication date 26th of preceding month)

Subscription Rate : 26/- per annum. Home and Abroad

Branch Offices :

Birmingham : King Edward House, New Street, 2.  
Coventry : 8-10, Corporation Street.  
Glasgow : 26B, Renfield Street, C.2.  
Manchester : 260, Deansgate, 3.

## In This Issue

OUR COVER: C.R.T. Aging Test (See Page 52)

EDITORIAL COMMENT .. .. .	41
TELEVISION IN THE CINEMA .. .. .	42
THE WARNING WINKER. By "Diallist" .. .. .	45
SHORT-WAVE CONDITIONS .. .. .	47
SIMPLE TONE CONTROL CIRCUIT. By E. J. James .. .. .	48
ELECTRONIC CIRCUITRY. By J. McG. Sowerby .. .. .	50
RADIO ARITHMETIC. By G. Stedman .. .. .	53
B.B.C. TELEVISION MAP .. .. .	55
IONOSPHERE REVIEW: 1948. By T. W. Bennington .. .. .	56
SUPERHETERODYNE TELEVISION UNIT .. .. .	61
WORLD OF WIRELESS .. .. .	66
MAGNETIC AMPLIFIERS. By "Cathode Ray" .. .. .	69
LETTERS TO THE EDITOR .. .. .	75
UNBIASED. By "Free Grid" .. .. .	77
RANDOM RADIATIONS. By "Diallist" .. .. .	78
RECENT INVENTIONS .. .. .	80

1845



# New Approach COMPONENTS

Keeping abreast of fast-moving technical development calls for a new approach to production problems. The "WEARITE" Pressed Circuit System represents a substantial advance in production science to speed assembly and lower costs. The first of these "Wearite" New Approach Components is a Coil Pack comprising coils, switches, trimmers and padders completely wired and ready for instant incorporation into any standard Superhet circuit.

Sides removed for clarity of illustration.

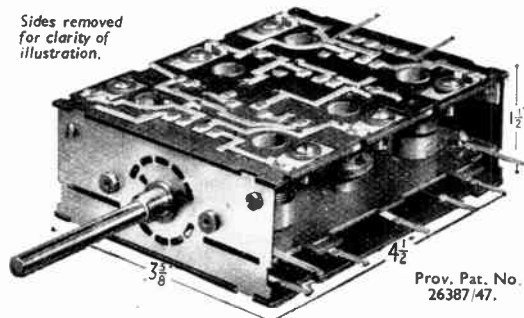

Prov. Pat. No. 26387/47.

- 3 ranges
- Gram switching
- 2-hole fixing at 1 1/8" centres
- All trimmers and adjusters conveniently placed in one surface

Manufacturers are urged to write for full technical details.

Owing to raw material restrictions supplies, for the time being, are confined to Radio Receiver Manufacturers at home and abroad.

# Wright and Weaire Limited

138, SLOANE ST. · LONDON · S.W.1 TEL SLOANE 2214/5 FACTORY: SOUTH SHIELDS, CO. DURHAM



## Valves and their applications

### R.F. Oscillator E.H.T. Supply\* derived from AC/DC Mains

Fig. 1 shows a practical circuit of an R.F. oscillator E.H.T. supply using a PL33 as an oscillator valve and an EY51 as a high voltage rectifying diode. The circuit is of the tuned anode oscillator

type, except that the feedback winding L3 is coupled to the high voltage secondary winding L2, which in turn is coupled to the primary winding L1. The secondary high

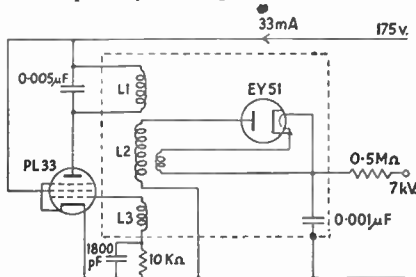

FIG. 1

voltage winding L2 is tuned by the effective capacitance appearing across it, which comprises the diode, coil and stray capacitance. The resonant frequencies of the primary and secondary circuits are approximately equal. Class C operation of the PL33 is employed, resulting in high efficiency. The hold-off bias on the control grid is provided by the capacitor included in the grid circuit, this being charged negatively with respect to earth by the flow of grid current during the periods of positive grid excursion.

The R.F. voltage appearing across the primary winding is stepped up by the square root of the ratio of secondary to primary impedance. The resulting R.F. voltage is rectified by the EY51 in a conventional half-wave circuit.

In an efficient design, the Q of the secondary circuit should be as high as possible. This may be achieved by  $\pi$ -winding in about five wave-wound sections. If the operating frequency is kept low (50 Kc/s) Litz is not necessary and single strand wire may be used with economical advantage. Due care must be exercised in winding the secondary to ensure that spacings are adequate to avoid corona and breakdown. The secondary should be wound on a low-loss former, this requirement excluding most bakelised tubing.

The primary winding may be wound on a separate former mounted inside the secondary former, thus obtaining the high

coefficient of coupling necessary for the maximum transfer of energy from primary to secondary. The feedback winding is coupled to the secondary rather than the primary to avoid trouble with Ziehn Effect (or frequency jumping) which would result in the output voltage jumping between two values.

The EY51 heater supply is derived from a further winding which should be insulated to withstand the high peak voltage appearing on it. The position, or number of turns, on this winding should be adjusted until the colour of the EY51 heater is the same as that of a similar diode fed from a 6.3V, 50c/s supply.

In order to prevent the R.F. field interfering with the receiver, the whole coil assembly should be screened in a box of low-loss material such as brass or copper.

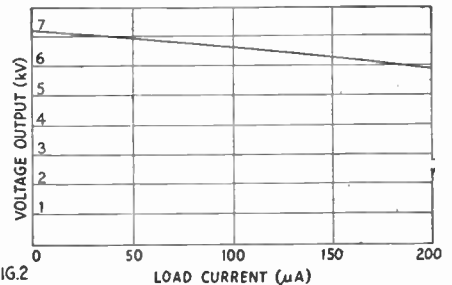

FIG. 2

Fig. 2 shows the regulation curve obtained with a practical R.F. oscillator. It will be noted that the effective source impedance is about  $5 M\Omega$  over the range of load current 0—100  $\mu A$ . This is suitable for operation with a television picture tube.

\* For an introductory article on E.H.T. supplies for Television Receivers, see "Wireless World," October, 1948.



Reprints of this report from the Mullard Laboratories, together with additional circuit notes and full coil assembly details, can be obtained free of charge from the address below.

**MULLARD ELECTRONIC PRODUCTS LTD.,  
TECHNICAL PUBLICATIONS DEPARTMENT,  
CENTURY HOUSE, SHAFTESBURY AVE., W.C.2**

(MVM83)



# Wireless World

VOL. LV. NO. 2

FEBRUARY 1949

RADIO AND ELECTRONICS

## Comments of the Month

### LEGAL

#### INTERFERENCE

THE Wireless Telegraphy Bill has not at the time of writing become law, but even at this early stage our attention has been drawn to an apparent omission which might have embarrassing consequences. The Bill envisages only positive injections of interference from emissive or reflecting sources, whereas in fact serious interference can be caused by absorption of electromagnetic energy. Though one has every sympathy with those called upon to draft a highly technical measure like this, it does seem strange that the third fundamental property—absorption—has been overlooked.

That this is not a mere academic criticism is proved by the fact that a concrete example of absorption interference with broadcast reception has just been brought to our notice.

As the Bill stands in the stage as amended in committee, sufferers from this kind of interference would, as we see it, have no legal redress. According to the restrictive definition of Clause 18, Subsection (4), there would seem to be no obligation to suppress interference due to absorption. It is interesting, though perhaps not very profitable, to speculate on how the absorption principle might be used—presumably with impunity—by ill-disposed persons in producing deliberate interference.

### A.M. versus F.M.

WE have urged for some time that this country should not be stampered into committing itself to a large-scale f.m. broadcasting service until the alternative methods of modulating e.h.f. were fully explored. We were consequently gratified when the B.B.C. decided that the first high-power e.h.f. station should provide for experimental parallel transmissions by alternative systems. The wisdom of this decision was emphasized when the ever-recurring topic of f.m. *versus* a.m. was debated early in

January by the Radio Section of the Institution of Electrical Engineers. The discussion of this vexed topic covered a very wide field.

H. L. Kirke (B.B.C. Research), who opened the discussion, rightly stressed from the start that this was not a matter that could be decided from severely technical considerations. He and subsequent speakers laid great stress on comparative receiver costs but, rather disappointingly, little in the nature of factual information on this highly important subject was forthcoming.

As an outcome of the meeting, we were all the more convinced that a process of trial and error is most likely to provide the right answer to the many problems involved.

### ANGLO-AMERICAN TERMINOLOGY

YET another example of the regrettable failure to achieve anything approaching uniformity in British and American radio terminology is brought to light in a pamphlet "Standards on Television; Definitions and Terms," published by the Institute of Radio Engineers.

"Tube" and "valve," "plate" and "anode," "ground" and "earth" are so well known that they cause no trouble, and none of these words are used in a conflicting sense in either country. But, in television, "frame" is defined in U.S.A. as "the total area, occupied by the picture, which is scanned while the picture is not blanked." In this country that is called a picture and frame is what the Americans call a field—"One of the two (or more) equal parts into which a frame is divided in interlaced scanning."

The dangers of misconception through errors of translation from one language to another are well known. When the same word is used technically in the same language in two countries with two different meanings the possibility of confusion is very serious.

*This article\* is based on a paper read before the International Television Convention, Zurich, by A. G. D. West, Managing Director of Cinema-Television Ltd., and Vice-President of the International Television Committee, by whose courtesy the accompanying illustrations are reproduced.*

# TELEVISION IN THE CINEMA

## Distribution Methods Described

RECENT announcements in the Press regarding the installation by Cinema-Television of large-screen television equipment in a London cinema have focused lively attention on a conception which has, in the past, been relegated to the background because of its apparent remoteness. It has always been realized that the ability of television to give a presentation of an event simultaneously with its occurrence constitutes a formidable advantage over conventional film reproduction. Until recently, however, the disparity of quality in pictures of cinema size has been too great to justify the exploitation of this attractive feature. The implication that this disadvantage has been overcome arouses natural interest in the means whereby it has been achieved.

Before proceeding to technicalities, however, it is desirable to indicate the character of the ultimate project which Cinema-Television has in view. This is outlined in Fig. 1, a diagram which is more or less self-explanatory. It is a long-term project, embodying a very high definition system which will link up cinemas all over the country with a variety

of television programmes, not necessarily associated with any B.B.C. service. A short-term project, with which we are more immediately concerned, is indicated in Fig. 2, and here it will be observed that programmes are to

selected London cinemas. The standard B.B.C. 405-line system will, of course, be used here and it is anticipated that this temporary service will enable a number of debatable factors to be settled and so pave the way for the detailed specification of the long-term project. We will now proceed to consider some of these factors.

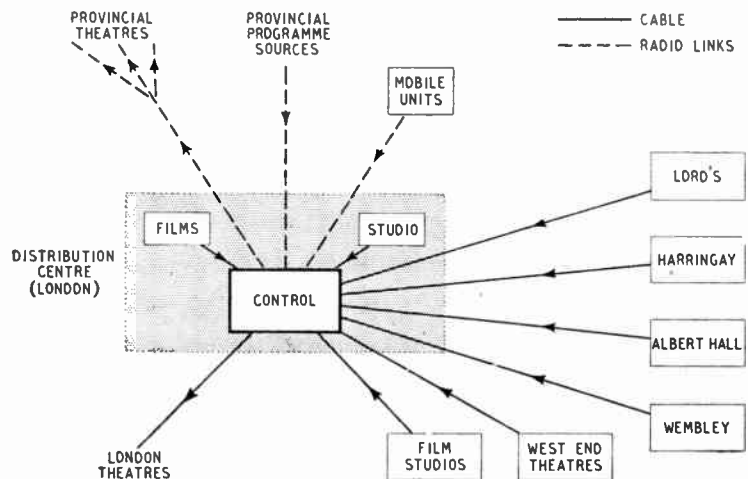

Fig. 1. Proposal for nation-wide theatre television network.

be received at the Crystal Palace direct from near-by studios and from the Alexandra Palace and Pinewood studios by radio link for beam radiation to a few

With regard to picture detail and definition, much has been written from time to time on the equivalent line structure of normal film reproduction in the cinema and figures ranging from 600 to 1,200 lines per picture have been suggested. Now, as the result of extended investigations carried out by a number of observers, Cinema-Television have reached the conclusion that for direct viewing 900 lines are adequate, but for recording on film with a view to subsequent reproduction, the figure should be raised to 1,200. Such figures would at first sight appear to demand bandwidths of the order of 20 Mc/s. It is argued, however, that there is still room for considerable improvement in the B.B.C. 405-line service within the

\* Since this article was written a demonstration of cinema equipment of the type described was given at Bromley, Kent, the programme being taken partly from the normal Alexandra Palace transmission and partly from a studio in the Cinema-Television factory at Sydenham and relayed *via* the Crystal Palace by 480-Mc/s radio links. The screen was 16ft by 12ft and a cathode-ray tube operating at 50 kV was used with a Schmidt optical system embodying the plastic lens system developed by I.C.I.

The demonstration was most impressive and results obtained were outstandingly good. The picture was a true black and white with a good contrast range. Definition was at least as good as the normal directly viewed picture and the line structure was no more evident, though brightness appeared rather less. Compared with a normal cinema picture both definition and brightness were poorer, but were very definitely adequate for public entertainment.

The demonstration greatly surpassed our expectations and has proved two things: first, that large-screen projection television has reached the stage of practical utility, and secondly, that the 405-line system is capable of providing really good pictures even under these conditions. We consider that all concerned with the development of the equipment are to be congratulated on their success.—ED.

present 3-Mc/s bandwidth. A careful study and correction throughout the whole transmission chain of such factors as response, phase and gamma\* have brought about a measure of improvement beyond all expectations. Of these

is 7-14ft-lamberts, a comparable figure of 8ft-lamberts is obtainable, at any rate down the centre line of the cinema, with the latest type of projection tube and opti-

definition of the orthicon is inferior, though shading is absent, while the image orthicon, which offers higher sensitivity, is a difficult manufacturing problem. On balance, the image iconoscope and image orthicon would appear to be the preferable types.

For film scanning, the cathode-ray flying spot scanner, and the Farnsworth image-dissector are put forward as alternatives. Of these the first named is preferred on the grounds of good definition, quality and freedom from shading.

Fig. 2. Proposed experimental cinema television distribution plan in the London area.

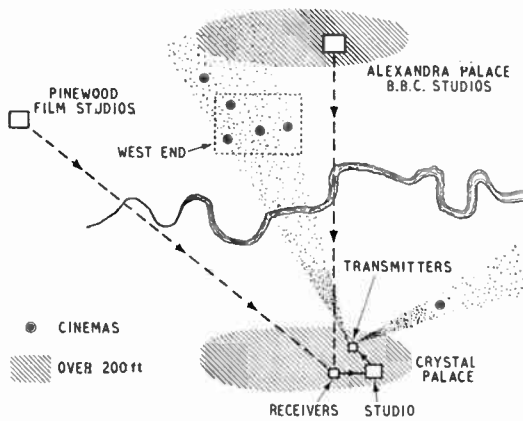

characteristics, gamma is looked upon as of particular importance and it is felt that, along with the other improvements, attainment of a constant value throughout the range from black to white will so raise the standard of picture quality that, by the same token, a bandwidth of about 12 Mc/s will be found to suffice for the later higher definition system.

**Interlacing**

To interlace or not to interlace is another matter that has been hotly debated. Interlaced scanning at 50 frames per second has, it is true, certainly reduced "lineness" and eliminated 25-c/s flicker with an economy in bandwidth requirements. Interlacing does, however, produce a flicker of its own in addition to line crawling and a subjective stroboscope effect, all of which are difficult, and some impossible, to eliminate. Which, therefore, of the two scanning methods is to be preferred for the ultimate system still remains undecided. At the same time, consideration has to be given to the optimum relationship of vertical and horizontal resolution and to the desirability, or otherwise, of some form of line broadening to reduce "lineness."

As regards brightness, it is gratifying to note that, while the standard accepted high-light level for film on a 16ft by 12ft screen

cal system, as is discussed more fully below. The maintenance of a constant gamma up to maximum brightness is, however, a more difficult problem and one which has yet to be solved. On the other hand, as an alternative to the projection tube there is the intermediate-film projector. The use of this equipment involves a processing delay time of 90 seconds but brightness and gamma are, of course, comparable with those of normal film projection. Storage tubes, it is recognized have not yet reached a standard where they can be considered seriously for this purpose.

In designing the presentation system, an important factor is the choice of screen. A variety of viewing screens, superior to the normal matt-white screen, either in reflection coefficient or directional properties, or both, can be selected for use with the projector. These include beaded or silver screens, screens coated with a combination of matt white and silver and others of the lenticular type. Total vertical and horizontal reflecting angles of 40° and 104° respectively are approved.

Turning to the transmitter end, there arises immediately the question of choice of camera. All types have their weaknesses: the definition of the iconoscope is offset by spurious shading effects which, though less pronounced, still exist in the more sensitive image iconoscope. At present, the

**Wire v. Wireless**

Interconnections and distribution requirements inevitably involve the familiar controversy of radio link versus cable. Radio has the advantage of lower cost, wider bandwidth accommodation and greater flexibility, while the use of cable ensures freedom from interference and "piracy." Furthermore, a radio link can generally be completed and established more quickly, but, to offset this, allocation of a desirable frequency band is often difficult to obtain.

Let us now turn to a consideration of the actual equipment intended for the immediate London

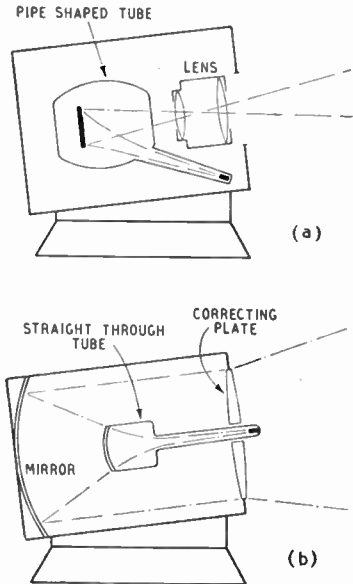

Fig. 3. Lens and mirror electronic projectors.

project. At the transmitter end, either the image iconoscope or the image orthicon will be used for indoor studio or exterior

\*Expresses the relationship between contrast of image and contrast of original subject.



**Television in the Cinema—** scenes, while the C.R.T. flying spot scanner will be employed for films and captions.

Distribution will be effected by radio links of a few watts just above and below 480 Mc/s and these are expected to operate satisfactorily up to a distance

lumens for an effective lens aperture of  $f/1$ . Measurements of the normal screen brightness give a figure of 8ft-lamberts, which for a 2:1 reflection factor corresponds to an illumination of 4ft-candles. The screen dimensions are 16ft by 12ft so the total incident flux is  $16 \times 12 \times 4 = 800$  lumens, a figure

Such then, is the scheme which is being put into operation to test public reaction and to act as a forerunner of the system whose standard of quality is intended to be on a par with that of normal film production. Apart from problems in other directions, much work remains to be done before a fully satisfactory standard of presentation is reached. This work will be directed towards the development of more efficient optical systems, the elimination of defocusing in the high lights, and the development of improved fluorescent materials.

It remains to refer briefly to the political and human considerations which, regardless of technical excellence, can make or mar this ambitious enterprise. General co-operation and the harmonious inter-change of programme material between the three main interested parties, the B.B.C., the promoters of sporting events and the cinema authorities, are essential for the success of this venture. Finally there is the question of public reaction to this marriage of television and the film. Will both be accepted in the same programme or must the two techniques be separated, either in time, by providing different programme hours, or in space, by providing distinct television theatres? Perhaps the next few months will indicate the trend, at any rate, of the cinema goers and of those who join them, attracted by the additional vital and intimate element which television alone can provide.

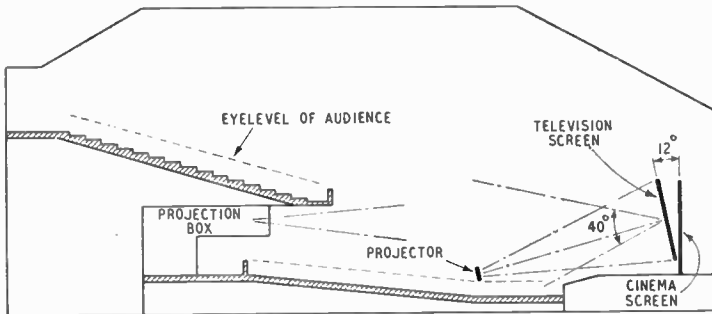

Fig. 4. Elevation of average theatre showing the angle required for screen reflection in the vertical plane.

of about 30 miles. The risk of interference, referred to above, is recognized, but it is hoped that legislation will help materially in reducing this risk.

The television projector is shown diagrammatically in Fig. 3, a photograph of the complete unit appeared on the cover of last month's *Wireless World*. The C.R. tube is provided with an aluminium-backed screen and operates with a peak current of 5mA at 50,000V. Its optical system consists of a centre-masked mirror of 27in diameter and an 18in diameter plastic correcting lens of the Schmidt type. A directive type of viewing screen will, of course, be provided and one possible form of installation is indicated in Fig. 4. As an alternative to the projection tube, an intermediate-film projection unit will be included.

It is of interest to study in some detail the present capabilities of the television projector. As regards illumination, the light flux from the equipment in lumens—(luminous intensity  $\times$  solid angle) which equals (power consumption  $\times$  luminous efficiency  $\times$  solid angle) where the luminous efficiency is given in candles/watt, in this case 5, and the solid angle is derived from the expression: solid angle =  $(\pi/4) \times (1/aperture)^2$ .

Then, the light flux =  $50,000 \times 5 \times 10^{-3} \times 5 \times (\pi/4) \times (1/1)^2 = 900$

in reasonable agreement with the computed value, particularly as no account has been taken of the losses in the optical system.

Turning to other factors, further brightness measurements indicate a contrast range from black to white of 50:1 with a constant gamma up to  $\frac{2}{3}$  maximum brightness. At an angle of 30° to the normal the maximum brightness is found to be 5ft-lamberts, a value which admits of some improvement. On the other hand, definition leaves very little to be desired, 3-Mc/s vertical bars being resolvable without visible phase shift, indicating a standard adequate for a 405-line system.



FERRANTI TELEVISION receivers undergoing an operating test during which a synchronized raster is focused on to the cathode-ray tube continuously for about four hours. This is done after all production tests have been carried out.

# THE WARNING WINKER

## Economical Indicator for Battery Sets

By "DIALLIST"

Everyone who uses a battery radio set, stationary or portable, must have had on more than one occasion the mortifying experience of finding the battery run down because the last user of the receiver had at the end of the programme inadvertently turned the switch to "L.W." or "G" instead of "OFF." The device described, though costing little to instal and placing a microscopically small extra load on the h.t. battery, gives a visual warning that the set is switched on of such a striking kind that it cannot fail to attract attention.

SOME time ago I suggested in "Random Radiations" that there was a very real need for a device which would call attention to the fact that a battery radio set was switched on, even if no sounds were coming from its loudspeaker. It is so easy—and so expensive with h.t.bs at their present price plus purchase tax—to believe that you have switched off when actually you have done nothing of the kind. This is particularly true if the set contains, as so many do, a combined on-off-wavechange switch of the continuously rotatable type. You are listening, let us say, to the home programme on the medium waves; the desired item having come to an end, you *ought* to turn

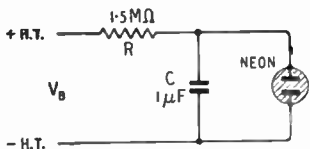

Fig. 1. The simple circuit of the warning device. C must be a high-grade capacitor with negligible leakage at 100–150V or the circuit will not work.

the knob one "click" clockwise in order to switch off. In a moment of abstraction you turn anti-clockwise. The set becomes silent because, though you have actually turned to "L.W." instead of "OFF," there may happen to be no long-wave station receivable at audible strength at that setting of the tuning capacitor. Still more deceptive and costly is "G," the gramophone pickup position of the switch, for there no warning noises due to atmospheric or to man-made interference are usually observable.

My note produced in the following month's issue of *Wireless World* a letter from D. A. Bell, suggesting that a neon lamp in some form of time-constant circuit might provide the answer—if only neons with a lowish striking voltage were available. Next came a letter to me from a reader of

*Wireless World*,\* who not only told me that he had acquired a large stock of apparently suitable neons, but also sent me some samples to play with.

Not knowing much of the peculiarities of low-voltage neons, I tried out the first by connecting it across an 80-V d.c. source of supply. A brief glow of typical "neon" colour was followed by the proverbial "blue flash" inside the bulb, and I realized that in less time than it takes to describe it, I had written off neon No. 1. Clearly a limiting resistor was called for, and subsequent experiments made with resistors with values of thousands of ohms showed that the current needed to produce a bright orange glow was minute.

The circuit shown in Fig. 1 was rigged up from components taken from the junk box. It did not work, and for a moment I could not quite see why. Then I tested the capacitor and found that with an applied e.m.f. of 100V the leakage was some 250  $\mu$ A. On substituting a high-grade capacitor rated at 1,000V d.c. working I found the neon behaving as in theory it should by "winking" at intervals of about one second.

The next step was to incorporate the "winker" in a battery re-

ceiver. Clearly it must be brought into action at any "ON" position of the switch and cut out in the "OFF" position. A small modification of the wiring of the set had to be made on the lines shown in Fig. 2. This was a fairly simple matter and, incidentally, it is about the best form of on-off switching for any kind of battery set since, if the insulation is as it should be, all components are relieved of electrical strain when the receiver is not in use. The necessary small alterations having been made, the device was found to function most satisfactorily. A  $\frac{1}{2}$ -in hole was drilled in the panel close to the knob of the switch. The neon was then mounted inside the set with its electrodes immediately behind the hole. The effect is that brilliant orange flashes at intervals of about a second compel even the most absent-minded of

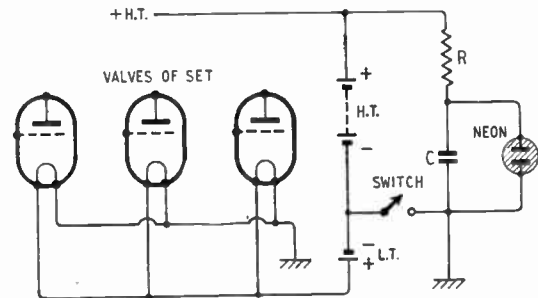

Fig. 2. In some sets minor alterations in the wiring of the on-off switch SW may be necessary. The arrangement illustrated is in every way satisfactory.

users to realize that his receiver is still switched on. Not until he moves the switch to the "OFF" position do the "winks" cease to insist upon his attention.

\* F. R. Lucas, 22, Hengrove Road, Knowle, Bristol, 4.

**The Warning Winker—**

So far so good ; but what sort of price do we have to pay for this insurance against carelessness ? We are putting an extra load on the h.t.b., and the h.t.b. is one of the most expensive sources of power ordinarily used by mankind. It happens seldom in wireless that any amenity can be obtained without one's having to pay handsomely for it ; generally it is a case of " nothing for nothing and darned little for half a crown." In this respect the warning device is quite exceptional ; it comes, in fact, nearer to giving something for nothing than any wireless gadget that I can bring to mind, except the crystal detector.

If the battery e.m.f.,  $V_B$ , in Fig. 1 is 100V, the maximum current at any instant through R cannot exceed  $100/1.5 \times 10^6 A = 67 \mu A$ . But the time constant of CR is 1.5 seconds, and the charging current of C falls off exponentially as shown in Fig. 3. The striking and extinguishing voltages ( $V_S$  and  $V_E$ ) of these little neons vary slightly ; but, generally speaking,  $V_S$  is close to 73V and  $V_E$  close to 48V, if the proper connections are made. At the instant of switching on  $V_C$  (the voltage across the plates of C) may be taken as zero.  $I_C$  therefore starts at  $67 \mu A$ . As

current from the battery flows into the capacitor a counter-e.m.f. is built up and at any instant the e.m.f. driving current through R

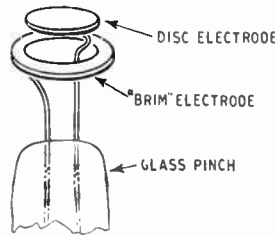

Fig. 4. Electrode assembly of low-voltage neon used. To obtain the lowest striking and extinguishing voltage the disc electrode should be negative.

is  $V_B - V_C$ . Until the striking voltage is built up across C the neon passes no current : it may be regarded as offering infinite resistance. By the time that  $V_S$  is reached  $I_C$  has dropped to about  $18 \mu A$ . At that moment the neon " fires " and the capacitor discharges through the almost negligible resistance that it now offers. Once started, the neon continues to conduct until  $V_C$  has fallen to about 48V. It then closes down and ceases to conduct until  $V_S$  is again reached.

Under working conditions  $I_C$

falls, as Fig. 3 shows, from about  $34.25 \mu A$  to approximately  $18 \mu A$  whilst the neon is quiescent. The average current drawn from the h.t.b. by the warning device is some  $25 \mu A$ —and there should be few h.t.bs that cannot stand up to such a minute extra load ! When I had made the preliminary calculations I could hardly believe them, for they seemed too good to be true. A kind friend, however, who has a splendidly equipped laboratory (including a calibrated c.r.o.) at his disposal was good enough to make a series of actual measurements, and his figures confirm mine. Here they are :

$V_B$	$I_B$
85V	20 $\mu A$
100V	25 $\mu A$
110V	30 $\mu A$
130V	40 $\mu A$
150V	50 $\mu A$
175V	70 $\mu A$

All figures are approximate for several reasons :

(1)  $V_S$  and  $V_E$  vary slightly with individual specimens of the same type of neon lamp.

(2) The accepted tolerances mean that R is unlikely to be of precisely 1.5 M $\Omega$  or C of precisely 1.0  $\mu F$ .

(3) The leakage across C varies with climatic conditions and may be considerable in damp weather, even if negligible in dry air.

Several other points of interest emerged during the tests. The first concerns the way in which the neons are connected to the source of e.m.f. These particular neons are constructed in the way shown in Fig. 4. One electrode is a disc about  $\frac{1}{4}$  in in diameter : the other is rather like the brim of a hat from which the crown has been removed ; its overall diameter is rather less than  $\frac{1}{2}$  in.

Now, which electrode is connected to + and which to - makes a great deal of difference to  $V_S$  and  $V_E$ . All the figures given so far are for the disc electrode connected to *negative*. If the connections are reversed  $V_S$  goes up to about 85V and  $V_E$  to 73V. Hence, if the h.t.b. is 100-120V when new, it is advisable to connect the disc electrode to negative ; if, however, the nominal

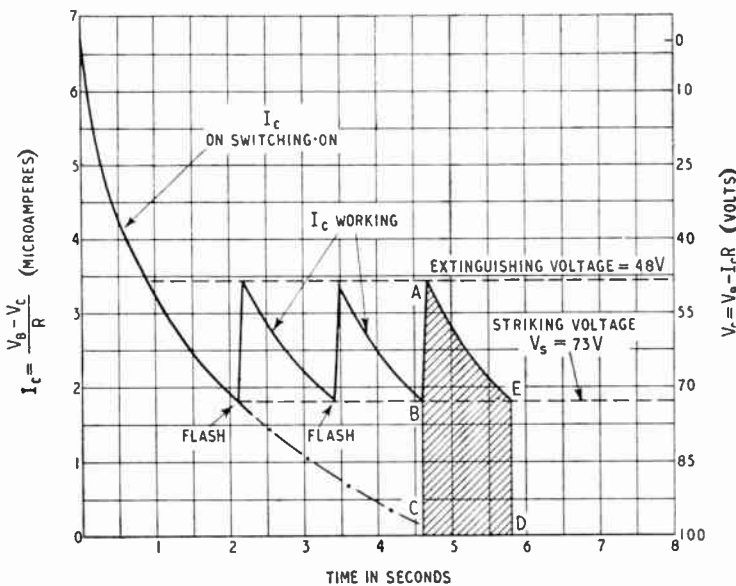

Fig. 3. Showing  $I_C$  and  $V_C$  on first switching on and under working conditions, where  $V_B = 100V$  ;  $R = 1.5M\Omega$  ;  $C = 1.0\mu F$  ;  $V_S = 73V$  ;  $V_E = 48V$ . Current drain from the battery can be determined from the shaded area.



battery e.m.f. is over 120V, the opposite connection should be made in order to cut down current.

The interval between flashes grows longer as the h.t.b. runs down; it would, in fact, be possible to construct a graph from which the battery e.m.f. at any time could be read off with the aid of a stop-watch! The current drain on the battery, by the way, is easily determined from a graph such as that of Fig. 3, if this is accurately drawn on good graph paper. The area ABCDE represents microampere-seconds. Since

$$ABCDE = I_c \times t, I_c = \frac{ABCDE}{t}$$

Count the small squares in the area and divide by the number of small-square divisions of the part of the time scale included.

Some may raise the objection that the device goes automatically out of action when the e.m.f. of the h.t.b. falls below about 75V. To that I can only reply that it does *not* go out of action: it continues to give warning—and this time its warning means that it is high time that you installed a new h.t.b.!

## SHORT-WAVE CONDITIONS

### December in Retrospect : Forecast for February

By T. W. BENNINGTON and L. J. PRECHNER (Engineering Division, B.B.C.)

**D**URING December maximum usable frequencies for this latitude decreased both by day and night. The daytime decrease, which was mentioned in this column for December, was due to the "Mid-winter Effect," while the night-time decrease was due to the normal seasonal trend.

As the month was stormy, working frequencies were rather lower than expected, and, so far as is known, very few long-distance contacts were made on the exceptionally high frequencies which became usable during the winter of 1947/48. However, the U.S.A. transmissions in the region of 40 Mc/s have been frequently received. The reception of the transmissions in the 28-30-Mc/s band from Australia, New Zealand and America was fairly good. The night-time frequencies were usable at unexpectedly low values, and occasional contacts have been reported at night with Australia, United States and Hong Kong on frequencies as low as 3.5 Mc/s.

Again, an abnormally high rate of incidence of Sporadic E for this time of the year was recorded, this value being, however, somewhat less than in November.

Long range tropospheric propagation was observed on very few occasions.

Sunspot activity in December was greater than in November. Two fairly large groups were observed, which crossed the central meridian of the sun on 14th and 24th.

The month was again exceptionally disturbed, disturbances usually lasting for a long period. Ionospheric storms were observed on 1st-

5th, 7th, 9th-13th, 15th-19th, 22nd-28th and 31st, those occurring on 9th and 11th being particularly violent.

The few "Dellinger" fadeouts recorded in December were very severe. They were observed on 9th, 11th and 23rd.

**Forecast.**—The "Midwinter Effect," which in the Northern Hemisphere causes a decrease in the daytime  $F_2$  layer ionisation, usually comes to an end by February. Consequently the daytime m.u.f.s may increase considerably. Owing to a seasonal trend there should also be an appreciable increase in the night-time m.u.f.s as compared with those for January.

Daytime working frequencies should thus again be very high, and of the same order as those which prevailed last November. Consequently, long-distance communication on exceptionally high frequencies should be possible quite often in all directions from this country. The 28-Mc/s amateur band should be *regularly* usable for long periods over daylight paths, and considerably higher frequencies than in January may be workable over certain circuits. Night-time working frequencies will be higher than during January, though frequencies as low as 7 Mc/s will still probably be necessary for many night-time circuits.

Below are given, in terms of the broadcast bands, the working frequencies which should be regularly usable during February for four long-distance circuits running in different directions from this country. (All times G.M.T.) In addition, a figure in brackets is given for the

use of those whose primary interest is the exploitation of certain frequency bands, and this indicates the highest frequency likely to be usable for about 25 per cent of the time during the month, for communication by way of the regular layers:—

<b>Montreal :</b>	0000	7Mc/s	(11Mc/s)
	1000	11 "	(15 " )
	1100	15 "	(21 " )
	1200	21 "	(26 " )
	1400	26 "	(32 " )
	1800	21 "	(27 " )
	2000	15 "	(21 " )
	2100	11 "	(17 " )
	2200	9 "	(14 " )
<b>Buenos Aires :</b>	0000	11Mc/s	(16Mc/s)
	0100	9 "	(14 " )
	0800	15 "	(21 " )
	0900	21 "	(27 " )
	1100	26 "	(32 " )
	1900	21 "	(26 " )
	2000	17 "	(25 " )
	2100	15 "	(21 " )
	2200	11 "	(16 " )
<b>Cape Town :</b>	0000	9Mc/s	(14Mc/s)
	0600	11 "	(17 " )
	0700	17 "	(23 " )
	0800	20 "	(35 " )
	1700	21 "	(27 " )
	1900	17 "	(24 " )
	2000	15 "	(20 " )
	2100	11 "	(16 " )
<b>Chungking :</b>	0000	7Mc/s	(10Mc/s)
	0500	9 "	(16 " )
	0600	17 "	(26 " )
	0700	21 "	(28 " )
	0900	26 "	(34 " )
	1100	21 "	(27 " )
	1200	17 "	(23 " )
	1300	15 "	(19 " )
	1400	11 "	(15 " )
	1600	9 "	(13 " )
	1900	7 "	(10 " )

February is not often a particularly bad month for ionosphere storms, though those which do occur are likely to be troublesome over dark transmission paths. At the time of writing it would appear that such disturbances are more likely to occur within the periods 7th-11th, 15th, 18th-19th and 26th-28th than on the other days of the month.

### "TRANSMITTER INTERFERENCE"

**T**HIS is the title of a new booklet issued by The Radio Society of Great Britain. Addressed to transmitting amateurs it gives really helpful advice on the suppression of interference with broadcast and television services.

Design data for a variety of filters and traps to cope with all foreseeable types of interference is given together with details of a useful harmonic indicator for use at the transmitter.

The list of television sets with their oscillator, intermediate and second channel frequencies provides some enlightening information and will be found invaluable when investigating reports of interference with television.

The price is 1s 3d (1s 6d by post from the R.S.G.B., New Ruskin House, Little Russell Street, London, W.C.2).

# SIMPLE TONE CONTROL CIRCUIT

## Bass and Treble, Cut and Lift

By E. J. JAMES, B.Sc.

**T**HE tone control system described here has the merit of requiring only resistors and capacitors. As a result it is unusually easy to fit to an existing amplifier, particularly as the absence of an inductance reduces the likelihood of trouble from hum pick-up.

While the circuit does not give the large amounts of lift which can be obtained by more complicated designs or by the use of resonating circuits, it is sufficient for normal requirements. The bass lift is not intended to compensate for the falling record characteristic below 300 c/s. This

distortion consists of the introduction of frequencies 2, 3, 4, etc., times the fundamental frequency, a rising frequency characteristic emphasizes any which is present in the signal prior to the tone-control stage. The higher order harmonics, which are the most disturbing to the ear, are the ones which receive the greatest amplification. This limit to the useful degree of top lift applies to all forms of top lift circuit, and is inherent.

The basic bass-lift circuit is shown in Fig. 1(a). The capacitor  $C_1$ , has a reactance which increases as the frequency decreases, so that the output increases at lower frequencies. By shunting it with a variable resistor, Fig. 1(b), the degree of bass lift can be controlled. In the same way Fig. 2(a) shows the circuit for bass cut, and in Fig. 2(b) a variable resistor controls the amount of bass cut.

The two circuits of Figs. 1(b) and 2(b) can now be combined to give that of Fig. 3, where bass lift

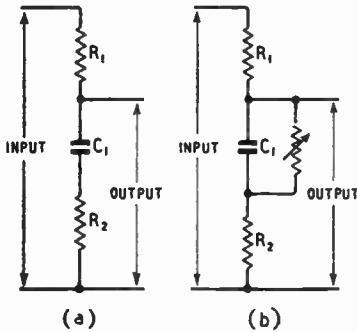

Fig. 1. The basic bass lift circuit is shown at (a). The lift is controllable by a variable resistor (b).

should be dealt with separately, so allowing the tone control to give extra lift for records abnormally deficient in bass or for listening at low volume. If required, however, a fair measure of compensation can be obtained.

It is not always realized that large amounts of bass lift cannot be achieved in a simple single-stage non-resonating circuit without lifting the lower middle register as well. The maximum rate of lift is fixed and it is only by starting at a higher frequency that greater lifts can be obtained. The amount of top lift which can be satisfactorily used is limited by amplitude distortion. Since this

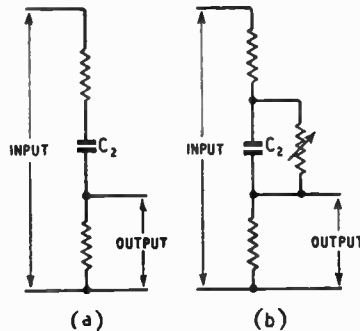

Fig. 2. Bass cut can be obtained with this circuit (a) and is controllable by a variable resistor (b).

and cut are controlled by the potentiometer  $R_3$ .

Fig. 4(a) shows a circuit giving top lift. Here the reactance of the capacitor  $C_3$  decreases as frequency increases, so that the output rises with frequency. In this case a variable resistor in

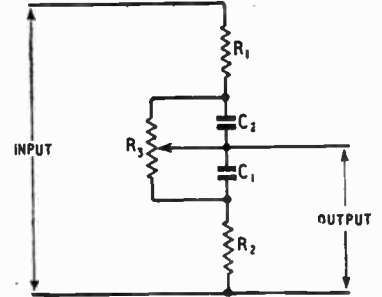

Fig. 3. This diagram shows the bass cut and lift circuits combined and controlled by the potentiometer  $R_3$ .

series with  $C_3$ , as shown in Fig. 4(b) gives control of top lift.

Similarly Figs. 5(a) and 5(b) show top cut and controlled top cut respectively. Once more the two circuits can be combined, Fig. 6, to give control of top lift and top cut by means of the potentiometer  $R_4$ .

The treble and bass controls can now be combined into the circuit shown in Fig. 7, and will normally be used as part of the coupling between two valves. For signal current the resistance,  $R_1 + R_2$ , is in parallel with the anode load resistance of the previous valve.  $R_1$  and  $R_2$  should therefore be as high as possible so that the valve does not work into too low a load. The minimum load should be about twice the valve impedance. On the other hand they must not be too high or the valve output capacitance and stray capacitances will affect response at high frequencies.

A simple method of finding

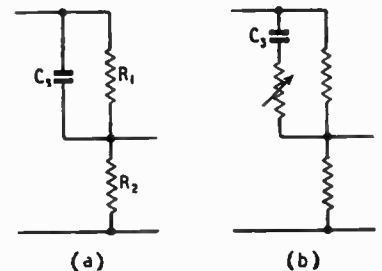

Fig. 4. Top lift is given by this basic arrangement (a) and can be varied by a series resistor (b).

suitable values is to use an anode resistor of at least 4-5 times the valve impedance and to make the sum of  $R_1$  and  $R_2$  rather larger than this. A ratio for  $R_1/R_2$  of 10/1 is suitable for normal tone control requirements. For a medium resistance triode of 7,000-10,000 ohms impedance, an anode resistor of 56,000 ohms could be used with  $R_1$  and  $R_2$  100,000 and 10,000 ohms respectively. The total anode load will then be about 35,000 ohms. This will vary, of course, as the controls are used to give lift or cut, but the only time any appreciable drop will occur in anode load will be at high frequencies when maximum top lift is used.

This type of tone control circuit should always be placed as far forward in the amplifier as possible so that the input to the valve preceding the control is low. There is then little chance of distortion being introduced by

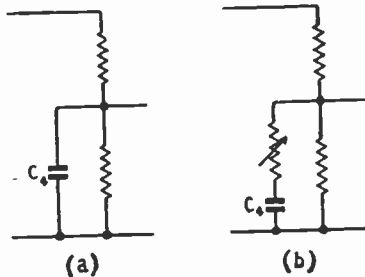

Fig. 5. Top cut is obtained from circuit (a) and controlled by a variable resistor as in (b).

the valve on account of the possible low load resistance. A smaller bias voltage than that normally employed will help to reduce distortion to a minimum. If the input to the valve is  $x$  volts, the optimum bias is  $(1 + x)$  volts since this is the least bias which will safeguard us from grid current. Thus, a bias of 1.3 volts is required if the input is 0.3 volts. The value of the cathode resistor required for this bias is best determined by trial and error, using a high-resistance voltmeter for measuring bias voltage, or measuring the anode current  $I$ , and calculating the bias voltage from  $IR$ , where  $R$  is the cathode resistance. A 1,000-ohm wire-wound potentiometer of the preset type is easily and cheaply obtainable these days and

would be a very suitable cathode resistor. The resistance in circuit can be estimated with sufficient accuracy from the degree of rotation.

A complete circuit suitable for feeding from a medium impedance triode such as the MHL4 is shown in Fig. 8. The values given provide a satisfactory degree of control. On test a similar circuit gave the following results:—

Bass control:— + 10 db to - 12 db at 50 c/s. Treble control:— + 10 db to - 16 db at 6,000 c/s.

If it is felt that more or less change would be an advantage, it is easy to alter the characteristics of the circuit by using different capacitor values. In-

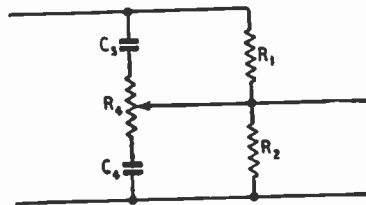

Fig. 6. Here the top cut and lift circuits are combined and controlled by  $R_4$ .

creasing the values of  $C_3$  and  $C_4$ , Fig. 7, will increase the amounts of top lift and top cut respectively, while a decrease in their values will reduce the amounts of control. Bass lift and bass cut can be increased by decreasing the values of  $C_1$  and  $C_2$ , and vice-versa. For example, if a greater bass lift is required, so that it can be used as compensation for the falling bass characteristic of gramophone records, the value of  $C_1$  should be reduced from 0.02  $\mu$ F to 0.01  $\mu$ F. The great ease with which the circuit characteristics can be altered in this way is one of the outstanding merits of the design.

The variable cathode resistor need only be used if it is required to introduce the very minimum of distortion, such as before one of the modern low-distortion amplifiers.

There is little point in reducing the distortion of the main amplifier to less than 0.1% and then introducing anything up to 0.5% or possibly more in a previous stage. In fact, some tone control stages using normal bias for the valve can introduce from 3% to 5% harmonic distortion. Where the variable re-

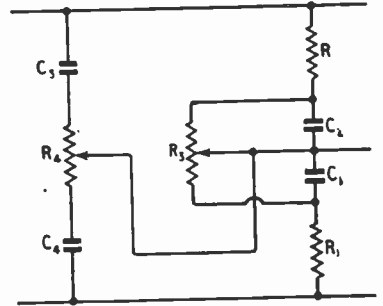

Fig. 7. The combination of the bass and top circuits is shown here.

sistor is not used a bias resistor of 100 $\Omega$ -1,000 $\Omega$  is suitable. In either case care should be taken to see that anode current does not exceed the manufacturer's stated maximum.

The amplification of the valve before the tone control circuit is reduced by the ratio  $\frac{R_2}{R_1 + R_2}$  so that little gain is obtained from the valve. This generally means that another valve must be added to an amplifier unless there is some reserve gain. If there is no room on an existing chassis for another valve, or if a compact lay-out is required, one of the double triodes such as the 6SN7 or ECC32 can take the place of one of the present valves and the

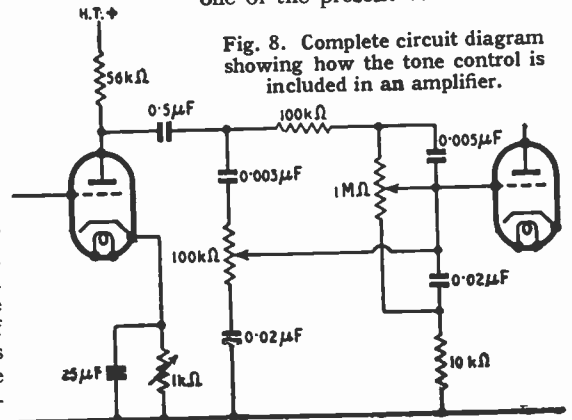

Fig. 8. Complete circuit diagram showing how the tone control is included in an amplifier.



**Simple Tone Control Circuit**—tone control circuit used as the coupling between the two halves of the double triode. Where 6-volt heaters are used this provides an easy method of introducing the tone control with the minimum of interference with the rest of the amplifier. If 4-volt heaters are used and there is a spare 4-volt winding on the mains

transformer, it is possible to obtain a 6-volt supply by connecting half the spare winding, giving 2 volts, in series with a 4-volt winding already in use. The two must be connected so as to give 6 volts and not 2 volts, as will be the case if the extra half-secondary is connected so as to oppose the 4-volt secondary. The right connection is most easily found by

trial, using the glow of the valve heater as an indicator. There is no difficulty whatsoever in determining by this means the correct coupling between the two secondaries.

If a double triode is used in place of a normal medium impedance triode it will generally be found that gain is about double that of the original.

# ELECTRONIC CIRCUITRY

## Selections from a Designer's Notebook

By J. McG. SOWERBY (Cinema Television Ltd.)

IN the July, 1948, issue some notes on the cascode circuit were presented, and as these aroused some interest it seems worthwhile to amplify the information originally given.

### The "Cascode" Again

A recent paper<sup>1</sup> has described a modification of the original cascode circuit and the elements of the new arrangement are shown in Fig. 1. This circuit was specifically designed as a low-noise r.f.

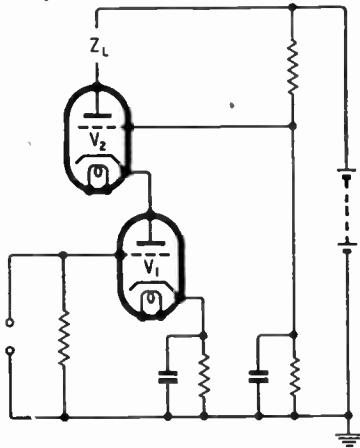

Fig. 1. Low-noise cascode circuit.

amplifier, the shot noise generated being virtually that of the triode  $V_1$ . Readers will remember that the shot noise in a pentode is much greater than in a triode—largely because of the splitting of the cathode current between

anode and screen. In a triode this splitting is absent and the noise is less; but if a grounded-cathode triode is used directly as an r.f. amplifier, neutralization must be employed to ensure stability. To avoid this difficulty grounded-grid triodes have been widely used, but then the input impedance is low.

At the expense of another valve the foregoing difficulties are overcome in the circuit of Fig. 1, because (a) provided the grid of  $V_1$  is negative with respect to its cathode, its input impedance is high; and because (b) the Miller

effect on  $V_1$  is small since the cathode of  $V_2$  presents a low impedance to  $V_1$ . In fact if the mutual conductances of  $V_1$  and  $V_2$  are the same, the gain from grid to anode of  $V_1$  is nearly unity. The second valve  $V_2$  contributes little to the noise, because any fluctuations occurring in it are reduced by a factor approximately equal to the amplification factor of  $V_1$  when referred to that valve's grid. The gain obtainable is approximately the product of the load ( $Z_L$ ) and the working mutual conductance of  $V_1$ . There seems no reason why  $V_1$  should not be a triode-connected variable-mu valve (to permit the application of a.v.c.) and then such a stage could be

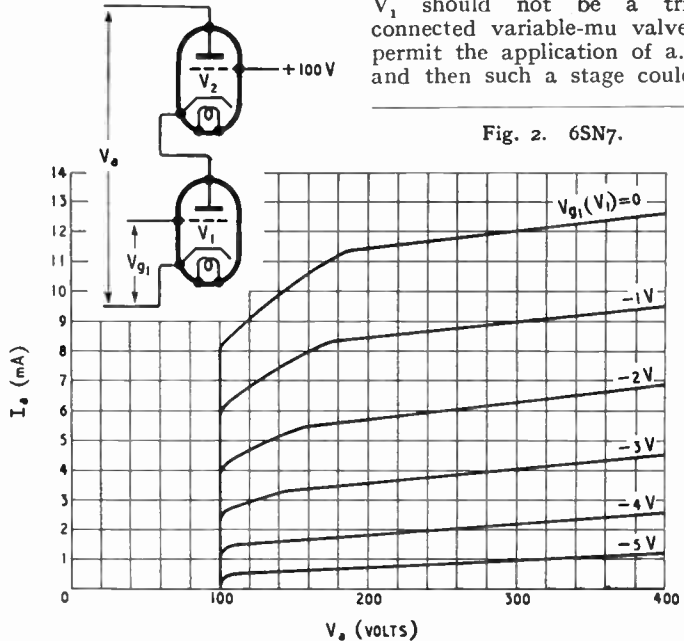

Fig. 2. 6SN7.

<sup>1</sup> H. Wallman, A. B. Macnee and C. P. Gadsden, *Proc. I.R.E.*, June, 1948, Vol. 36, No. 6, page 700.

used as the r.f. amplifier in the first stage of a normal receiver. The writer has not yet done any experimental work on these lines, however.

The usefulness of the circuit does not

Fig. 3. ECC 32.

end here, and it will be of considerable use in d.c. amplifiers. If an attempt is made to design a high-gain d.c. amplifier, then the obvious choice

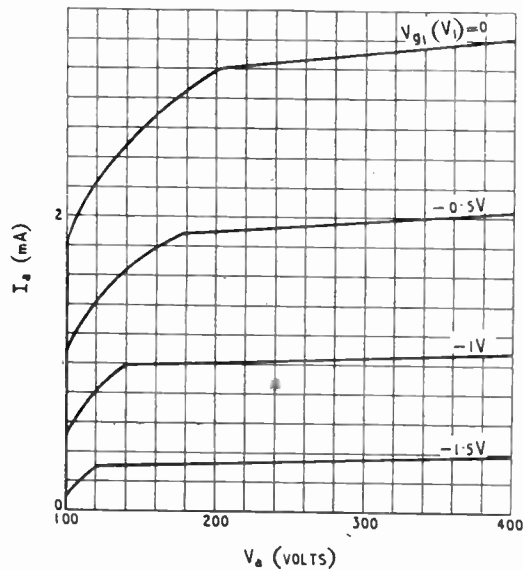
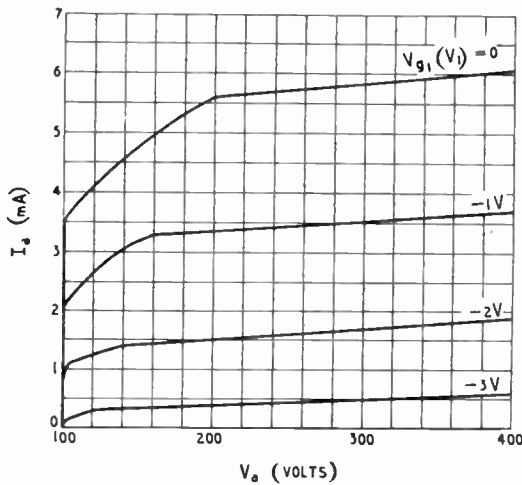

A clear picture of the behaviour of the circuit is perhaps best given by the characteristic valve curves<sup>2</sup> of Figs. 2, 3 and 4, which have been

Fig. 4. ECC 35.

plotted for three common double triodes. In each case the grid of the upper triode was taken to a positive supply of 100 volts, and the anode current plotted against anode voltage for various values of grid bias on the lower triode ( $V_1$ ).

of valve is a pentode. To realize the high gain the impedance of the screen-grid supply must be small, for otherwise screen feedback will be introduced. This low impedance is normally obtained with a by-pass condenser, but this becomes inoperative at zero frequency, so that some other device (cathode follower, neon stabilizer, etc.) has to be employed in a d.c. amplifier. From this point of view the circuit of Fig. 1 can be loosely regarded as a sort of pentode in which the screen grid is replaced by the grid of  $V_2$ . As it is a simple matter to arrange for this grid to take no current, the impedance of its supply circuit at l.f. is immaterial.

<sup>2</sup> Kindly supplied by the writer's colleague, F. L. Hill, B.Sc.

**W**HEN using mercury vapour thyratrons and rectifiers it is necessary to apply heater or filament power to the valve(s) for a considerable period before the anode supply is switched on. For example the minimum recommended heating time for the B.T.H. Type

B.T.5 thyatron, is five minutes. Consequently a relay is needed which will close five minutes after the heater supply is switched on. Furthermore—and this is perhaps controversial—it is desirable

that on the removal of the supply for a few seconds the relay should be de-energized only to close again after the pre-set delay time.

A circuit which meets the foregoing requirements is shown in Fig. 5. This presupposes that sufficient power to operate one valve is available from the instant the thyatron heater is switched on—for example the circuit might obtain its power from the same transformer as that which supplies the thyatron heater. Let us now consider one cycle of operation of the circuit of Fig. 5.

Initially C is uncharged, and h.t. and heater power are applied to V. The grid is therefore at earth potential and the cathode positive with respect to earth by the drop across  $R_c$ . Consequently current flows through R, and C begins to charge up, taking the grid (and cathode) in a positive direction. Provided  $R_c$  is not too low, there will be a considerable range of grid potential for which the cathode is positive with respect to the grid, so that current continues to flow through R. As the potential across R is always small (2-10 volts with a high-slope valve), the current through it is also small and consequently the grid and cathode potentials rise slowly. As the cathode potential rises the cathode current rises with it and eventually the relay operates, applying the anode supply to the thyatron.

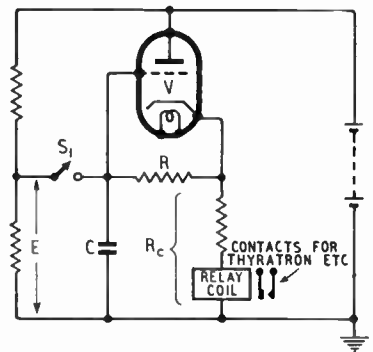

Fig. 5. Relay time-delay circuit.

A desirable but not essential feature is the inclusion of an extra pair of contacts  $S_2$  on the relay, which on closing hold the grid potential at E as long as the supply is maintained. This

**Electronic Circuitry—**

simply holds the valve under fixed conditions as a cathode follower. If the supply is interrupted, although the h.t. and heater supplies cease, the cathode will remain hot and emitting for several seconds by virtue of its thermal capacity. The grid-

cathode path of the valve then acts as a diode and C is rapidly discharged through  $R_c$ , so that even if the supply is re-applied at once, almost the full delay must elapse before the relay can operate again.

The writer has found no difficulty in obtaining a delay of five

minutes with  $C = 2.25 \mu F$  and  $R = 10 M\Omega$ , the valve being an EF91 (CV138). Informed readers will recognize this circuit as being but one more variant of the "bootstrap" circuit.\*

\* O. S. Puckle, *Time Bases* (Chapman and Hall), page 94.

## QUALITY APPRECIATION

### B.S.R.A. Discuss Physiological Aspects

AT a London meeting of the British Sound Recording Association on December 17th, 1948, E. A. Vetter read a paper on "Some Physiological Factors in Quality Appreciation." He thought that many people engaged in the reproduction and recording of sound would agree that success resulted from a combination of 75% art and 25% science. For the purpose of his argument the measurement and interpretation of the electrical performance of amplifiers and other physical components of the recording chain, representing 25% of the problem, would be taken as read.

With the aid of diagrams he explained the structure of the ear and showed how the non-linearity of coupling between the drum and the cochlea was adapted to afford protection from shock waves of large amplitude. He also stressed the variations which exist between individuals, and differences in structure in other animals.

Not only was the perception of sound modified by physical differences, but it could also change as the result of conditioned reflexes, much in the same way as visual appreciation of colour depended on preceding stimuli. Those who had experience of flying in noisy aircraft knew that some time after landing there was an almost complete cut-off of low frequencies, though high-pitched sounds could be heard quite well. Conversely, composers often wrote *pianissimo* passages before a *fortissimo* climax to enhance the effect. Although the total dynamic range of the ear was of the order of 120db there was reason to believe that no more than 60db was available at any one time.

Aural appreciation of surrounds, due to coloration of reverberation by frequency discrimination in the reflexing surfaces, was a keen subconscious faculty developed against a background of conditioned reflexes which had been built up from birth. The process was similar to that by which a good craftsman performed without effort the routine skilled

operations of his trade, thus leaving his conscious mind free to cope with the new or unusual in his work.

We had now reached the stage where it would be more profitable to discover the significant elements in sound than to strive for greater perfection in equipment. When we knew more about the world of sound to which our ears were accustomed and could establish standards showing how far the significant elements could be displaced, it would be a comparatively simple matter to provide apparatus which would perform within the permissible tolerances. To the pure scientist, there was no such thing as dirt; only a matter out of place. Translating this into terms of acoustic engineering, we should say: "There is no such thing as distortion; only phenomena out of place."

In the discussion which followed, several speakers gave examples confirming the accommodation of the ear to its acoustic surroundings, and it was generally agreed that the "memory" of the ear was much shorter than that of the eye.

It was thought that the modern

pianoforte with its equally-tempered scale had done much to destroy the appreciation of true pitch and that primitive peoples still making use of simple five-note scales had a keener sense of intonation.

Appreciation of auditory perspective was largely a matter of the different reverberation patterns associated with individual instruments and their positions relative to the microphone. Two channels, or even two ears were unnecessary to convey this quality.

"Scale distortion," which was generally discussed in relation to the balance of different parts of the frequency spectrum, had an even more important aspect. Musical instruments when played loudly gave out a much wider range of harmonics than when played softly. When reproduced at a level differing from the original, the effect would be immediately detected as untrue, however free from distortion the reproducing chain might be. Similar effects could be produced by distortion in the amplifier, or bad playing by the instrumentalist. Obviously, it was necessary to find which effect was out of place, and to resist the first impulse to reach for a soldering iron and do things to the amplifier.

### OUR COVER



CATHODE-RAY TUBES undergoing a 1,000-hour life test at Ediswan's Ponders End factory forms the subject for this month's cover illustration and twelve-inch tubes are here shown being tested for spot centrality, cathode emission, modulation sensitivity, heater current, and heater-cathode insulation, etc. They are also subjected to an over-voltage test for possible flash-over.



Two valves - very rare  
**★ BRIMARIZE**  
 - don't despair.

PUNCH HOLES HERE

**TYPES 35Z5GT and 45Z5GT** are half wave rectifiers commonly used in American AC/DC receivers. Both of these valves employ tapped heaters, across a section of which the dial lamp is usually connected.

Direct substitution by type 35Z4GT will render the lamp inoperative, the rest of the set functioning as before.

If dial illumination is necessary, the lamp may be connected directly in series with the heater chain provided it is shunted with a suitable resistor.

Alternately a 0.3 amp. lamp may be employed, wired in series with the negative mains lead i.e., between mains switch and chassis.

**35Z5GT  
45Z5GT**

INSTRUCTIONS: Punch holes where indicated and cut away this portion. Cut out and file them in the order in which they appear. This column will then give you a quick reference index.

<p>Type 35Z4GT</p>	<p>Type 35Z5GT 45Z5GT</p>	<p><b>CHARACTERISTICS</b></p> <table border="1"> <thead> <tr> <th></th> <th>35Z4GT</th> <th>35Z5GT</th> <th>45Z5GT</th> </tr> </thead> <tbody> <tr> <td>Heater Voltage</td> <td>35</td> <td></td> <td>45 volts</td> </tr> <tr> <td>Heater Current</td> <td></td> <td>0.15</td> <td>0.15 amp.</td> </tr> <tr> <td>R.M.S. Input</td> <td>250</td> <td></td> <td>235 volts</td> </tr> <tr> <td>Rectified Current</td> <td></td> <td>100</td> <td>100 mA</td> </tr> </tbody> </table>		35Z4GT	35Z5GT	45Z5GT	Heater Voltage	35		45 volts	Heater Current		0.15	0.15 amp.	R.M.S. Input	250		235 volts	Rectified Current		100	100 mA
	35Z4GT	35Z5GT	45Z5GT																			
Heater Voltage	35		45 volts																			
Heater Current		0.15	0.15 amp.																			
R.M.S. Input	250		235 volts																			
Rectified Current		100	100 mA																			

CHANGE VALVE		CHANGE SOCKET		OTHER WORK NECESSARY	PERFORMANCE CHANGE
FROM	TO	FROM	TO		
35Z5GT	35Z4GT		Int. Octal. NO CHANGE	Disconnect lamp leads from valve socket and connect in series with the lead to pin 7. Shunt lamp with suitable resistor. See note.	NONE
45Z5GT	35Z4GT		A5 ABOVE		

Note:—A 6.3 volt 0.2 amp. lamp requires a shunt resistor of 25-50 ohms 2 watt.

**BRIMAR** says..  
 Reprints of these data sheets are now available.

**BRIMAR**  
 RADIO VALVES

STANDARD TELEPHONES AND CABLES LIMITED, FOOTSCRAY, SIDCUP, KENT.

*Vortexion*

announce the

# “STEREOPHONIC” AMPLIFIER

This new amplifier with triode cathode-coupled output stages has the effect of making the reproduction more like the original than ever before. A small proportion of this improvement results from the reduction of the Doppler effect, which is achieved without lowering the damping factor on the speakers, with the consequent distortion and transient loss which would follow.

When listening to an orchestra the low frequencies are usually heard towards the right, and the high frequencies towards the left. When reproduced through the Vortexion “Stereophonic” amplifier with low and high frequency speakers suitably spaced according to required listening angle, the high and low frequencies are heard in their relative positions simulating the effect and appreciation of the original.

This speaker placing is necessary because our ears are on a horizontal plane. The effect would be lost if our ears were positioned one above the other, as can be proved by inclining the head sideways.

Our efforts to achieve “Stereophonic” results by the use of various choke and condenser cross-over networks between the amplifier and speakers were unsuccessful, due to the large variation of speaker impedance at various frequencies, unevenly loading the resonant circuits.

After many months of research we finally achieved our aim with what is basically two special low-distortion, high-damping factor amplifiers in one, each covering a portion of the audio spectrum with a 40 db cut per octave at change-over frequency. The acoustical efficiency of the bass and treble speakers may vary, so a balancing control is fitted to the amplifier. This simplifies the choice of speakers, since each speaker has only a narrow frequency coverage.

The “Stereophonic” amplifier is now in production, and we invite you to hear a demonstration of what we believe to be something new and which will add to your enjoyment of music.

**Price 36½ gns**

**VORTEXION LIMITED, 257-261 THE BROADWAY, WIMBLEDON, LONDON, S.W.19**  
 Telephones: LIB 2814 and 6242-3

Telegrams: “Vortexion, Wimble, London”

# RADIO ARITHMETIC

## How to Take Short Cuts Without Loss of Accuracy

By **GEOFFREY STEDMAN**, B.Sc.

The height of a cylinder is 2.1 in; the radius of the base is 3.2 in. Find its volume.

$$\text{Volume} = \pi r^2 h$$

$$= 3.1416 \times (3.2)^2 \times 2.1$$

$$= 67.5569664 \text{ cu in.}$$

**T**HIS is a problem and solution which I saw recently in the exercise book of a pupil of a junior technical school. The answer was marked right and full marks awarded by the teacher, so that here was one more potentially good engineer having his taste for mathematics nipped in the bud. Intelligent approximation is based not upon the number of decimal places, but upon the number of significant figures.

The proper answer to the above problem is 68 cu in, for since the data are given only to two significant figures, there can be no knowledge of the answer beyond that degree of accuracy. If the teacher had wanted 67.6 cu in for an answer, he should have quoted 2.10 in as the height and 3.20 in as the radius. Now radio engineering is peculiar in that while its theory is very mathematical in form, arithmetical results are seldom required to within  $\pm 1\%$ ; indeed, more often than not  $\pm 10\%$  suffices, since if the value of almost any component of a receiver is altered by as much as 10%, the effect upon overall performance is imperceptible except by the use of instruments. This means that if the radio engineer will so far overcome the pernicious habits implanted in him by his mathematical miseducation as to use suitably approximate methods of calculation, his arithmetic adventures will be more efficient, more pleasant and more frequent, which will reduce the wear and tear on his slide rule. It is usually difficult to persuade a student who has been through the usual school arithmetic course to dare to make approximate calculations. He is

ill at ease with arithmetic, and, instead of feeling that he is conducting the calculation himself, he feels rather as if he were invoking, by strange and imperfectly acquired magic rites, the awesome demon of mathematics to do the work for him, and that therefore the slightest variation of the rites may result in quite incalculably severe mutilations of the answer.

Let us calculate the volume of the above cylinder by approximate methods.

$$\text{Volume} = \pi r^2 h$$

$$= \frac{22}{7} \times 3.2 \times 3.2 \times 2.1$$

$$= 22 \times 3.2 \times 3.2 \times 0.3$$

$$= 22 \times 3.2 \times 0.96$$

$$= 22 \times 3.2 \text{ less } 4\%$$

$$= 70.4 \text{ less } 4\%$$

$$= 70.4 - 2.8 = 67.6 \text{ cu in.}$$

$$\text{Alternatively, volume} = \pi r^2 h$$

$$= \frac{25}{8} \times 3.2 \times 3.2 \times 2.1 \text{ plus } \frac{1}{2}\%$$

$$= 25 \times 0.4 \times 3.2 \times 2.1 \text{ plus } \frac{1}{2}\%$$

$$= 32 \times 2.1 \text{ plus } \frac{1}{2}\%$$

$$= 67.2 \text{ plus } \frac{1}{2}\%$$

$$= 67.2 \text{ plus } 0.3 = 67.5 \text{ cu in.}$$

In the second case the value of  $\pi$  is taken as  $3\frac{1}{8}$  plus  $\frac{1}{2}\%$  which is an extremely useful alternative to  $3\frac{1}{7}$  since  $\pi$  usually associates itself with even numbers in radio arithmetic, and a sufficient number of multiplications of  $25/8$  by 2, will cause it to assume the innocuous value of 100.

**EXAMPLE:** Find the capacity of a parallel plate condenser whose plate area is 7.5 sq cm and whose dielectric is 0.10 mm thick, and has a dielectric constant of 4.2.

$$\text{Capacity} = \frac{kA}{4\pi d}$$

$$= \frac{4.2 \times 7.5}{4 \times \frac{25}{8} \times 0.01} \text{ electrostatic units}$$

$$= \frac{4.2 \times 7.5 \times 8}{100 \times 0.01} \quad \text{''} \quad \text{''}$$

$$= 4.2 \times 60 = 252 \quad \text{''} \quad \text{''}$$

This result is correct to two significant figures; had we wanted three significant figures it would have been necessary to deduct  $\frac{1}{2}\%$

(since  $\pi$  is in the denominator) and the final result would be  $252 - \frac{1}{2}\% = 251$  electrostatic units.

If the reader now complains that I am choosing specially simple examples to exhibit my method to advantage, I would point out that *any* examples may be so treated by *making* them simple. Thus, had the radius of the cylinder of the first problem been 3.1 in, the working would have been

$$\text{Volume} = \pi r^2 h$$

$$= \frac{25}{8} \times 3.1 \times 3.1 \times 2.1 \text{ plus } \frac{1}{2}\%$$

$$= \frac{25}{8} \times 3.2 \times 3.0 \times 2.1 \text{ plus } \frac{1}{2}\%$$

$$= 10 \times 3.0 \times 2.1 \text{ plus } \frac{1}{2}\%$$

$$= 63 \text{ plus } \frac{1}{2}\% = 63.3 \text{ cu in.}$$

If the condenser of the last example had had an area of 73 sq cm we should have written  $73 = 75 - 2 = 75 - 3\%$ .

Efficiency in this kind of calculation depends upon a suitable modification of the actual numbers to near numbers which are easier to work with, and either noting the appropriate correction to be made to the result, or else effecting two contrary modifications whose corrections cancel each other to within the degree of accuracy aimed at. After very little practice the method has the ease of habit. Thus,  $4.4 \times 4.6 = 4.5 \times 4.6$  less  $2\% = 9 \times 2.3$  less  $2\%$ . Also,  $4.4 \times 4.6 = 4.5 \times 4.5 = 4.2 \times 4.8$ . Which of these or of the many other ways of writing the product, we choose, will depend upon the other factors of the calculation.

Powers and roots are easily extracted on sight to 2 or 3 significant figures, by a simple application of the binomial theorem. For this purpose, all we need to know about the binomial theorem is, that if a small fractional part of a number is added to that number, approximately double that fractional part is added to its square, and half the fractional part to its square root. Three times the fractional part is added to the cube, and so on. Readers familiar with the binomial theorem will know that we are taking the first and second terms



**Radio Arithmetic—**

only of the binomial expansion in this approximation. Thus—

$$\begin{aligned} 10^2 &= 100 \\ 10.1^2 &= 102.01 \text{ i.e. } (10 + 1\%)^2 \\ &= 100 + 2\% \text{ approx.} \\ 10.2^2 &= 104.04 \text{ i.e. } (10 + 2\%)^2 \\ &= 100 + 4\% \text{ approx.} \\ 9.9^2 &= 98.01 \text{ i.e. } (10 - 1\%)^2 \\ &= 100 - 2\% \text{ approx.} \end{aligned}$$

Similarly

$$\begin{aligned} \sqrt{101} &= 10.0499 \text{ i.e. } \sqrt{100 + 1\%} \\ &= 10 + \frac{1}{2}\% \text{ approx.} \end{aligned}$$

and so on. As examples.

$$\begin{aligned} \sqrt{50} &= \sqrt{49 + 1} = \sqrt{49 + 2\%} \\ &= 7 + 1\% = 7.07 \\ \sqrt{60} &= \sqrt{64 - 4} = \sqrt{64 \text{ less } 1/16\text{th}} \\ &= 8 \text{ less } 1/32\text{nd} = 8 - 0.25 \\ &= 7.75 \end{aligned}$$

Alternatively

$$\begin{aligned} \sqrt{60} &= \sqrt{49 + 11} = \sqrt{49 + 22\%} \\ &= 7 + 11\% = 7.77 \end{aligned}$$

This result is not quite so good since the correction is larger, but is still within about 1/4% of the truth.

The number  $\pi$  occurs so frequently in radio calculations that a variety of ways of dealing with it are useful. We have seen that  $\pi = 25/8$  plus 1/3%. Also,  $\pi^2 = 10$  less 4/3% so that  $\pi = \sqrt{10}$  less 2/3%. Since  $\sqrt{10} = 3.16$ , we have the following trio of easily remembered numbers:

$$\pi = 3.14, \sqrt{10} = 3.16, \frac{10}{\pi} = 3.18$$

**Multiples and Submultiples**

Let us now consider a simplified way of dealing with the prefixes milli, micro, kilo and mega. When one reads "2mA" one usually makes a mental division between the "2" and the "mA"; the number is 2 and the units are milliamperes. This is strange, because if the quantity is written  $2 \times 10^{-3}$  A, the whole of  $2 \times 10^{-3}$  is usually thought of as the number. Let us, then, take 2m as the number, and amperes as the units. The advantage of this in calculating is twofold. First, the letters m,  $\mu$ , k and M are more convenient to write and work with than  $10^{-3}$ ,  $10^{-6}$ ,  $10^3$  and  $10^6$ , and second, only one unit of any quantity will be used,—amperes for current, henrys for inductance, cycles per second for frequency and so on, so that the final business of the orthodox method of many computations, e.g.

expressing  $5.6 \times 10^{-5}$  amperes in terms of some more convenient submultiple, is entirely avoided. To pay for these advantages, all one needs to do is to become familiar with the following relationships which are obviously true, and place no strain on the memory as soon as one accustoms one's self to regard the symbols as numbers:

$$m = 1/k, \mu = 1/M, m^2 = \mu, k^2 = M.$$

EXAMPLES:

(i) Find the resistance of one metre of wire of diameter 0.0040 cm and specific resistance 50.7 microhm-cm.

$$\begin{aligned} R &= \frac{\rho l}{\pi r^2} \\ &= \frac{50.7\mu \times 100}{\pi(2m)^2} = \frac{50.7\mu \times 100}{4\pi\mu} \\ &= \frac{50.7 \times 100}{2^2 \text{ plus } \frac{1}{2}\%} = 50.7 \times 8 \text{ less } \frac{1}{2}\% \\ &= 405.6 \text{ less } \frac{1}{2}\% \\ &= 404 \text{ ohms.} \end{aligned}$$

(ii) At what frequency will 50 microhenrys and 0.000030 microfarads resonate?

$$\begin{aligned} f &= \frac{1}{2\pi \sqrt{LC}} \text{ cycles per sec.} \\ &= \frac{1}{2\pi \sqrt{50\mu \cdot 0.00003\mu}} \\ &= \frac{1}{2\pi\mu \sqrt{0.0015}} \\ &= \frac{1}{2\pi \sqrt{0.0016 \text{ less } \frac{1}{16}\text{th}}} \\ &= \frac{M}{2\pi \cdot 0.4} \text{ plus } \frac{1}{32}\text{nd} \\ &= \frac{M}{0.08 \frac{2}{5} \text{ plus } \frac{1}{2}\%} \text{ plus } \frac{1}{32}\text{nd c/s} \\ &= 4 M \text{ c/s plus } \frac{1}{32}\text{nd less } \frac{1}{2}\% \\ &= 4.00 + 0.125 \text{ less } \frac{1}{2}\% \text{ Mc/s} \\ &= 4.125 - 0.02 \text{ Mc/s} = 4.10 M \text{ c/s.} \end{aligned}$$

(iii) What inductance will resonate at 5.0 Mc/s with 300 micro-microfarads?

$$\begin{aligned} f &= \frac{1}{2\pi \sqrt{LC}} \text{ c/s} \\ \therefore L &= \frac{1}{4\pi^2 f^2 C} = \frac{1}{4\pi^2 (5M)^2 300\mu\mu} \text{ henry} \\ &= \frac{1}{4\pi^2 25 \times 300} = \frac{1}{1000 \times 300} \text{ henry} \\ &= \frac{1}{300k} \text{ henry} = \frac{1}{300} \text{ mH} \\ &= \frac{1m}{0.3} \text{ mH} = 3.3 \mu\text{H} \end{aligned}$$

This needs 1/3% added to correct

for writing 10 for  $\pi^2$ , if, as is unusual, the value of an inductance is needed to such a degree of accuracy.

(iv) What current will dissipate 1/2 watt in a 250,000  $\Omega$  resistor?

Since Watts =  $I^2 R$ ,

$$\begin{aligned} I &= \sqrt{\frac{W}{R}} = \sqrt{\frac{\frac{1}{2}}{250000}} \\ &= \sqrt{2\mu\text{A}} = \sqrt{2} \text{ mA} = 1.4 \text{ mA.} \end{aligned}$$

**I.E.E. STUDENTS**

TO provide a forum for students where they could discuss technical matters in a less formal atmosphere than that which generally prevails at meetings of learned societies, the Institution of Electrical Engineers formed a Students' Section some 60 years ago. Instead of the original small section in London there are now fourteen operating in different parts of the country with a membership of over 9,200.

Anyone up to the age of 28 who is studying or engaged in any branch of electrical engineering may become a student member of the Institution. When he has obtained academic qualifications of degree standard he may transfer to the class of Graduate, and on completing a further period of practical training followed by holding a responsible position he can apply to become an Associate Member.

One advantage of the Section is that the discussions at its meetings are not reported, so that reputations are not endangered by incautious statements. Abstracts of papers read at the meetings, which embrace the various branches of electrical engineering covered by the sections of the Institution—Radio, Utilization, Measurements and Supply—are published in the Students' Quarterly Journal.

**INDUSTRIAL CHOKES AND TRANSFORMERS**

A NEW range of totally enclosed iron-cored components has been produced by the Plessey Co., Ilford, Essex, for use in industrial control gear, test and communications equipment. Protection is provided by bitumen-filled, heavy gauge steel cases, and the electrical and material specifications are in accordance with British Standards. The range includes chokes, auto-transformers, single and multi-secondary transformers, mains and output transformers.

# B.B.C. TELEVISION MAP

## Service Areas of the Alexandra Palace Transmitter

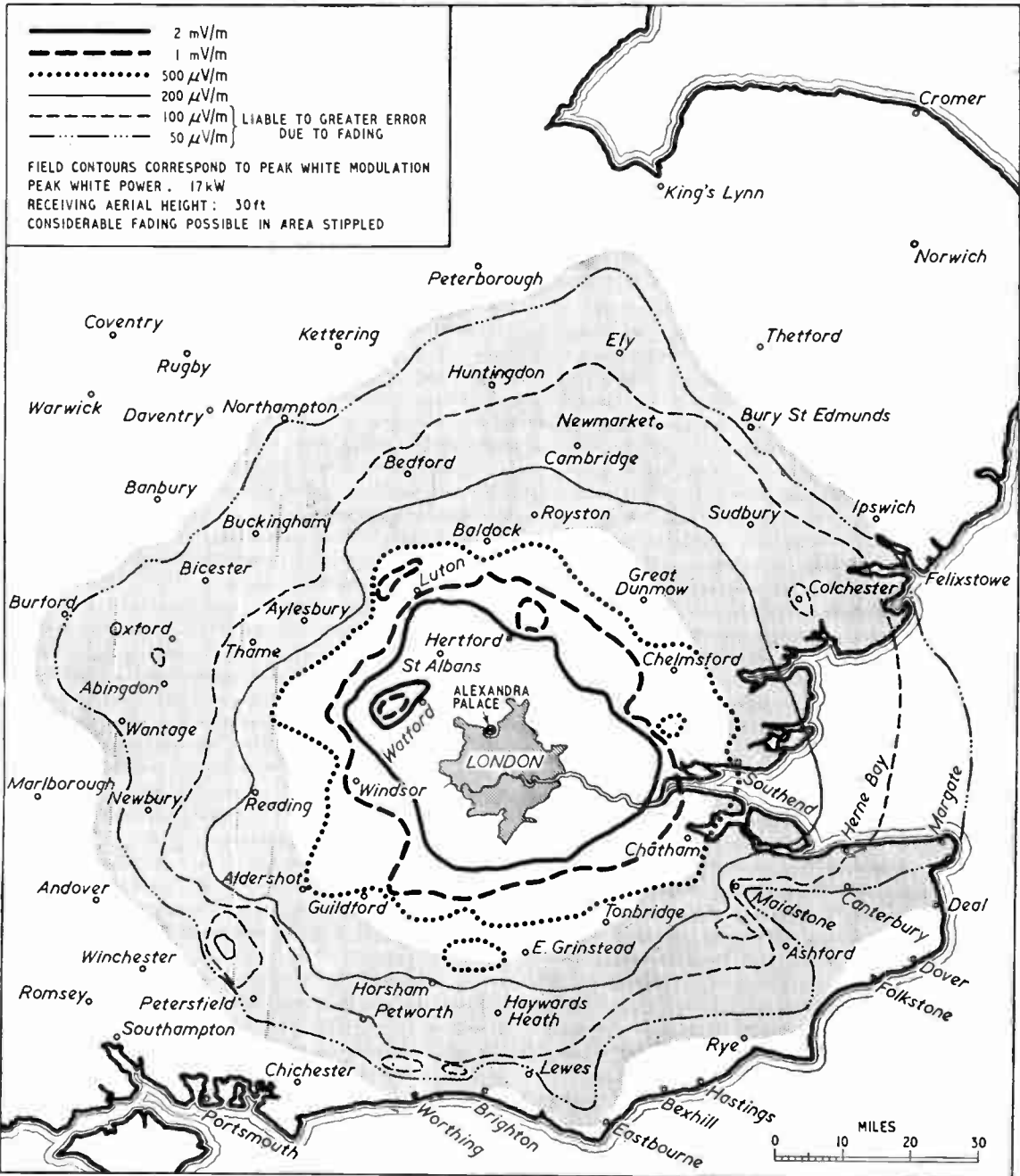

This map (based by courtesy on a larger one produced by a B.B.C. survey) shows approximate field strength contours of the London vision transmitter (45Mc/s). The contours give the average values in the areas concerned; probable degree of error is greatest in hilly or built-up areas and least in open flat country. A description of the map is on p. 74

# IONOSPHERE REVIEW: 1948

## Sunspot Cycle and Short-wave Propagation Survey, with Forecast for 1949

By T. W. BENNINGTON (Engineering Division, B.B.C.)

IN this article it is intended to review the course of the present sunspot cycle, giving special attention to the changes which took place during 1948, and to see what effects these had upon short-wave propagation during the year. We may then attempt to see how short-wave conditions are likely to vary during 1948. Since it is impossible to forecast accurately the variations in sunspot activity a long way ahead, and as the changes in short-wave conditions depend upon these variations, it follows that the prediction of a year's variations in short-wave propagation conditions is a somewhat difficult task. Nevertheless, from an examination of past and current trends, we may at least obtain an indication as to what 1949 may be like, from a short-wave propagation point of view.

Since there may be readers who are new to this subject and who have not followed these yearly *Wireless World* reviews of past conditions, a few brief explanatory words may not come amiss.

The ionization of the upper atmosphere—and thus the formation of the region there known as the ionosphere—is brought about in the main by the action of the sun's ultra-violet radiations, and, since the sun's activity, and hence the strength of its radiations, varies over a long period, which is the sunspot cycle, the condition of the ionosphere varies likewise. One property of the ionosphere is its ability to bend or refract radio-waves—particularly those in the short-wave range—and thus to guide them round the earth and, if its ionization level should vary over the sunspot cycle, the conditions for short-wave propagation will also change.

Among other evidence of the variations in the sun's activity are the sunspots which appear

upon its surface, and these are regularly examined at the various astronomical observatories, the information there obtained being published in the form of "sunspot relative numbers." The observations made at the different observatories are correlated at Zurich and the final number published from there. The final numbers for 1948 are not yet available, however, so for this review we shall use the provisional sunspot numbers obtained from the Royal Observatory at Greenwich. Measurements of the atmospheric ionization are regularly made at ionospheric observatories in many parts of the world and in some cases records go back as far as 1749. The correlation between the two sets of phenomena, solar and ionospheric, has been well established and the ionosphere does, in fact, respond in a marked way to variations in the activity of its producing agent, the sun.

The critical frequency of a layer is the highest frequency returned by that layer when the radio wave is sent vertically upwards, and it is proportional to the ionization existing in the layer. For communication over a distance the corresponding value is the Maximum Usable Frequency, which depends on the critical frequency, and on the angle of incidence made on the layer in order for the wave to be returned to earth at a particular distance. The M.U.F. thus increases from the critical frequency as the distance over which it is desired to communicate increases and, as a rough guide, we could assume that the M.U.F. for the maximum distance it is possible to cover in one hop is about 3.3 times the critical frequency of the  $F_2$  layer.

So far as radio-wave propagation is concerned 1948 was again a very interesting year during which the sunspot activity re-

mained, on the average, at an extremely high level. As a result the useful frequencies for long-distance communication were also of an extremely high order. In fact the general sunspot activity so far as we can yet tell was slightly lower than during 1947, yet it remained at a level which has been reached only very seldom since 1749. The last year—apart from 1947—when the activity was of a comparable value to that of 1948 was in 1870. So it is obvious at once that—whatever other conclusions we

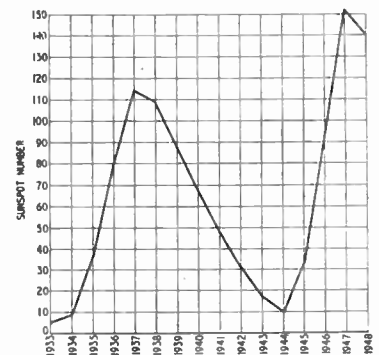

Fig. 1. Mean annual values of sunspot relative numbers.

may arrive at—1948 was an exceptional year for short-wave propagation; a year during which the usable frequencies were higher than usual and possibly higher than they may be for many years to come. Let us now examine things in a little more detail.

### Course of the Sunspot Cycle.—

In Fig. 1 are plotted the mean annual values of the sunspot relative numbers for a period covering the whole of the last and present cycles, it being stressed that the values for 1948 are provisional only. It is interesting to note that the publication of the final sunspot numbers for 1947 has not altered a fact which was pointed out in last year's review, namely, that the sunspot activity during 1947 has been exceeded once only during the 199 years covered by the continuous records and that was 170 years ago, in 1778. It would appear from the curve that the year of maximum



activity in the present cycle was 1947, although the activity during 1948 was only slightly less than during the previous year. We cannot, however, be absolutely certain about this until the final sunspot numbers for 1948 are published. It does seem to be strongly indicated, however, that the maximum in the present sunspot cycle is now past and that, for some years to come, we may expect the solar activity to go on decreasing. However, even when the final numbers for 1948 are available, and even supposing they do show a decrease in activity, we still cannot be quite confident that the statement at the end of the last sentence will be true, for sometimes the activity, after decreasing for a time, unexpectedly begins to increase again so as to bring about a subsidiary maximum.

We see, from Fig. 1, that so far the present sunspot cycle has been markedly different to its predecessor, notably in the time between the epoch of maximum activity and that of the preceding minimum, and also in the magnitude of the activity at the maximum. Even if 1948 was the first year of the decreasing phase in the present cycle, we see that the general activity was nevertheless greater than that during the maximum year of the preceding cycle, which itself was higher than that reached during the five preceding cycles. So that 1948, considered over a long period of time, was a year of exceptionally high sunspot activity and, consequently, one of very high usable frequencies for long-distance radio communication. During 1949 we should, always with the reservations already alluded to, expect the usable frequencies to decrease, and perhaps to do so somewhat more rapidly than they did during 1948, but still to be, on the average, relatively high.

**Ionospheric Variations.**—In Fig. 2 are plotted (top curve) the monthly means of the sunspot relative numbers for each month of the years 1945-1948, and (bottom curve) the monthly means of the noon critical frequencies of the  $F_2$  layer for the same period, as measured in England.

There are some interesting things to note about these two curves and about the correlation

between them, especially during 1948. The sunspot activity varied erratically month by month, of course, but showed a gradually increasing tendency from 1945— the year of minimum activity— towards 1947 and 1948. As to these two latter years it should be noted that although the general activity for the year was higher during 1947 than 1948, the actual sunspot maximum may have occurred during the latter year, for we see that the sunspot number for April, 1948, was greater than that for any previous month in the present cycle. There is, however, an element of uncertainty about this as the 1948 values are, as yet, only provisional.

It is interesting to observe that after a very considerable decrease lasting some months towards February, 1948, the sunspot activity then increased to very high values again, and remained exceptionally high for several further months. It is to be noted that the sunspot activity during

was 206.2, and in May, 1947, when it was 201.3.

From the bottom curve of Fig. 2 it is seen that there was a general rise in the noon  $F_2$  layer critical frequencies as the sunspot cycle progressed in its course, due of course, to the increasing power of the sun's ultra-violet radiations in ionizing the gases of which the layer is composed. Between the epochs of minimum and maximum activity the increase in the noon critical frequency is seen to be of the order of 3 Mc/s during the summer, and of 8 Mc/s during the winter, implying increases in the M.U.F. for longest distance transmission of about 10 Mc/s in summer and no less than 26 Mc/s in winter. If we were to examine the critical frequencies of the other layers, or of the  $F_2$  layer for other times of the day, we should see that they all showed an increase in accordance with the increasing sunspot activity, although the actual degree of increase would be different for different layers and times

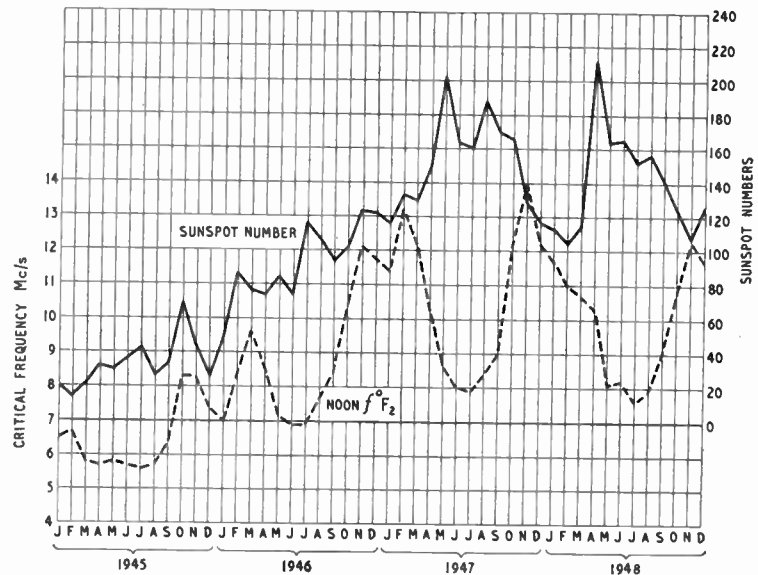

Fig. 2. (Top curve) Monthly mean values of sunspot relative numbers; (lower curve)  $F_2$  critical frequencies for the past four years.

April, 1948, might well be described as being phenomenally high, for only three times before within the period covered by the continuous records (from 1749) has the monthly mean reached a value exceeding 200. These were in May, 1778, when it reached 238.9, in December, 1836, when it

of day. It is, in fact, greatest for the  $F_2$  layer, and at noon.

In the bottom curve of Fig. 2 there are, of course, the large seasonal variations in the noon  $F_2$  critical frequency superimposed on those due to the sunspot cycle. It is seen that, generally speaking, these are such as to cause low

**Ionosphere Review: 1948—** values of critical frequency in summer, and high values in winter, except that there is a small fall in the critical frequency at the extreme mid-winter period. This mid-winter decrease in critical frequency has, in fact, occurred without exception during every year of the present cycle. Thus the highest values tend to occur each year about February and November.

It would appear, from the curve, that the highest critical frequencies—and thus the highest usable frequencies for long distance radio communication—occurred during the present cycle in November, 1947. In December there was a sharp fall in critical frequency, which would have been expected having regard to the mid-winter effect just mentioned, but early in 1948 there was no recovery from this depression in critical frequency values, as had been the case during each preceding year. There can be little doubt that the failure to recover from the mid-winter fall was due to the sharp decrease in sunspot activity which took place during the last few months of 1947, and which persisted during the first three months of 1948. During the summer of 1948 the sunspot activity was again at a high value, and the critical frequencies were but slightly lower than during the summer of 1947.

Towards the end of the year sunspot activity again decreased, and the critical frequencies were considerably lower than during the corresponding months of 1947. Nevertheless, the mean critical frequency for noon, which in November, 1947, was 14 Mc/s, had, by November, 1948, fallen to 12.3 Mc/s, implying a mean M.U.F. for longest distance working in these latitudes of about 41 Mc/s. Of course the M.U.F.s would have considerably exceeded this mean value on individual days, and they would, generally speaking, have been higher than this for places to the south of this country, because the ionospheric refracting point would then lie in latitudes where the critical frequency is often higher than it is in these latitudes. The above fall in critical frequency as between 1947 and 1948 was thus about what had been anticipated, for,

quoting from last year's "Ionosphere Review" (*Wireless World*, February, 1948, p. 47) "it would appear . . . that by November, 1948, the noon mean critical frequency would only have fallen to about 12.6 Mc/s" and "the mean noon M.U.F. for longest distance working in these latitudes should be of the order of 41.6 Mc/s.

**Correlation between Sunspot and Ionospheric Measurements.**— In Fig. 3 are given (full line curve) the twelve-months running average value of the sunspot number during the present sunspot cycle, and (dashed line curves) the twelve-month running average of the noon and midnight  $F_2$  critical frequencies over the same period, as measured in England. The object of taking a twelve-month running average of these values is to smooth out the month-by-month fluctuations in the sunspot activity, and the seasonal variations in the critical frequencies, and thus to render more apparent the long period effects in both quantities. It is done by taking for the mean for the epoch at the centre of any month the average of the twelve monthly means having that month as the centre.

An examination of these curves shows that both the noon and the midnight critical frequencies responded to the changing sunspot activity relatively faithfully, the increase as between sunspot minimum and maximum being greater at noon—when the sun's effect upon the ionosphere is more direct—than at midnight. Although over most of the cycle the correlation between the sunspot curve and that for the critical frequencies was remarkably good, towards the maximum the critical frequency does not appear to have increased so rapidly as the sunspot number. Also, there appears to have been a lag of about three months in the reversal tendency of both critical frequency curves as compared with that for the sunspot activity. After the maximum there apparently occurred a subsidiary maximum in the sunspot activity, and then there was a definitely decreasing tendency. We must remember that all these later values are based on provisional sunspot numbers only. These variations resulted in a flattening out of the critical fre-

quency curves after their initial tendency to decrease, although towards the end of the period a decreasing tendency again appeared. Nevertheless there has, as yet, been a relatively small decrease in the average values of critical frequency since the sunspot maximum.

It is interesting to note that, as between sunspot minimum and maximum, the noon critical frequency increased by about 2.08 times and that for midnight by about 1.96 times, implying increases in the actual ionization of the layer of about 4.35 times for noon, and 3.84 times for midnight. In the case of the E layer the increase in critical frequency as between sunspot minimum and maximum was about 1.26 times, implying an increase in the actual ionization of this layer of about 1.59 times.

The fact that 1948 was a year of higher critical frequencies and higher M.U.F.s for radio communication than usual justifies us in classifying it as a year of relatively good short-wave conditions, particularly on the higher frequency bands. This is so because, while the ionization of the  $F_2$  layer—the principal refracting layer for long-distance communication—was increased to an exceptional degree, that of the D layer—the principal absorbing region—would only have been increased to a moderate extent. Thus the M.U.F.s would be exceptionally high and L.U.H.F. (lowest useful high frequency) only moderately so, and the band of useful frequencies would therefore be exceptionally wide.

**Practical Results.**— An examination of the highest frequencies which were actually usable during 1948 shows that the high M.U.F. values indicated by the measured values of ionospheric critical frequencies were, in general, well borne out. The phenomenally high frequencies on which long-distance communication was effected in October and November of 1947 did not, apparently, again become workable, as might have been expected, during February and early March of 1948. A glance at Fig. 2 clearly shows the reason for this to have been the relatively low sunspot activity then prevailing and the failure of the critical

frequencies to rise again after the mid-winter fall. It is noteworthy that the highest frequencies usable in the early spring were lower than those which became usable in the late autumn of 1948. Nevertheless, in the early part of the year frequencies up to 35 Mc/s were occasionally propagated over long distances to this country, while communication on the amateur 28-Mc/s band was fairly common on a world-wide basis. In September communication on this band became much more extensive, and remained so throughout the remainder of the year. Reception of the Alexandra Palace television signals occurred in the West Indies during this time, and towards the end of October both sound and vision transmissions were received in South Africa. So far as is known

activity is likely to prevail during 1949, as towards the final months the future trend is by no means clearly indicated. Again, from Fig. 1 one cannot be certain that the decrease indicated by the 1948 annual mean will be maintained. However, all things considered, it does seem likely that during 1949 the activity will continue to decrease. We should even be justified in expecting, from an examination of past cycles, that the activity is likely to decrease somewhat more rapidly than it did during 1948, and in making an estimate for the running average sunspot number for the middle of 1949 to be about 113. It is probable that if this is the case the running average of the noon critical frequencies would only have fallen to about 9.6 Mc/s, and that for midnight

November, 1947, and about 41 Mc/s in November, 1948. The "Optimum Working Frequency" at this time should therefore be about 30.6 Mc/s.

The detailed specification of the predicted O.W.F.s for every direction from this country and for every month and time of day during 1949 is a very complex business, and is beyond the scope of this article. In general we should expect the daytime working frequencies for most circuits to increase somewhat from their present values towards the vernal equinox, as the daytime critical frequency is likely to rise after the mid-winter fall. At the same time the night-time working frequencies should be increasing. Then, about April, daytime working frequencies should begin to fall, rather rapidly for east-west directions, and slowly for north-south directions, and this effect should continue to about June. Night-time frequencies should continue their rise to a peak about June. From June towards November there should be a further increase in the daytime working frequencies, but of a smaller order than the fall from spring to summer. There should then be a slight fall towards mid-winter. The night-time working frequencies should fall from June towards mid-winter, and the fall should be greater than the increase from winter towards June. Thus one may anticipate that the year will close with somewhat lower frequencies being effective for long-distance communication than are generally usable at present.

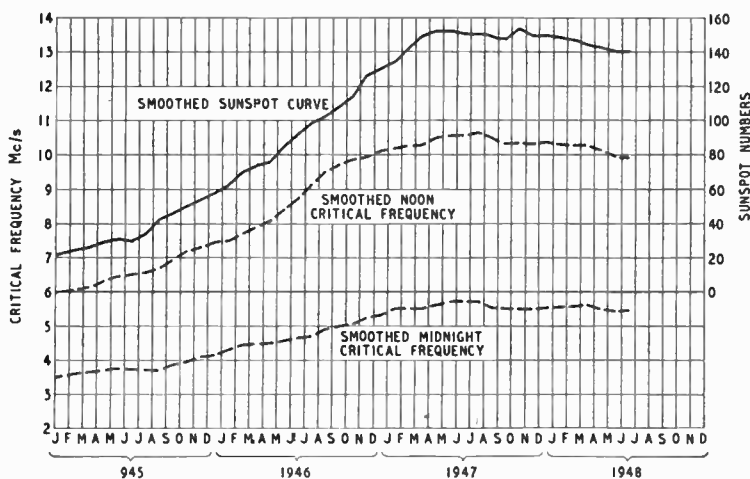

Fig. 3. The full-line curve shows the twelve-month running averages of sunspot numbers over the present sunspot cycle and the dashed-line curve the noon and midnight  $F_2$  critical frequencies in England.

very few (if any) long-distance contacts on the amateur 50-Mc/s band were made during October and November, although American police signals on the 40-Mc/s band were frequently received in this country. Thus, as had been indicated in last year's review, the highest workable frequencies were somewhat below those which prevailed in the autumn of 1947. Nevertheless, as has been said, working frequencies were, on the whole, relatively high throughout the year for all circuits.

**Forecast for 1949.**—It is difficult to tell, from the top curve of Fig. 3, what degree of sunspot

to about 5 Mc/s. So the decrease in the usable frequencies during 1949 would not appear to be likely to be very great.

It is not possible here to give the actual values of critical frequency likely to be reached during each particular month. But it would appear, from a study of Figs. 2 and 3, that by November, 1949, the noon mean critical frequency would have fallen to about 10.9 Mc/s. This implies that the mean noon M.U.F. for longest distance working in these latitudes should be of the order of 36 Mc/s, as compared with about 46 Mc/s in

There may, of course, be a good deal of medium-distance communication (up to 1,400 miles) on very high frequencies during the year, by way of the Sporadic E ionization, but this is not a dependable means of propagation, and is likely to be frequent only during the months of May to September. As to the 50-Mc/s amateur band, it is unlikely, if the expected decrease in sunspot activity occurs, to become workable for long-distance communication at any season of the year. It is quite possible that frequencies around 40 Mc/s may do so, both in the spring and autumn seasons. Summing up the prospects for 1949, therefore, since the sunspot



**Ionosphere Review: 1948—**

activity is likely to be of the order which occurred at the last sunspot maximum, good radio conditions should in general prevail, and conditions tend to favour the high, but not the exceptionally high, short-wave frequencies.

**NEWS FROM THE CLUBS**

**Barnet.**—The Barnet Radio Group of the R.S.G.B. has been renamed the Barnet Amateur Radio Society and continues to meet on the first Saturday after the 10th of each month at Bunny's Restaurant, 15, Station Road, New Barnet. Sec.: M. R. Jenkins (G3EIM), 1193A, High Road, Whetstone, London, N.20.

**Barnsley.**—Meetings of the Barnsley and District Amateur Radio Club are held twice a month at the King George Hotel, Peel Street, Barnsley. Sec.: R. Hickling, 179, Barnsley Road, Wombwell, Yorkshire.

**Birmingham.**—A lecture on test equipment will be given to members of the Slade Radio Society by W. F. Newall, of the Automatic Coil Winder Co., on February 4th. Meetings of the society are held on alternate Fridays at 8 in the Parochial Hall, Slade Road, Erdington, Birmingham. Sec.: C. N. Smart, 110, Woolmore Road, Birmingham, 23.

**Bristol.**—Although having been formed only four months, the Bristol and District S.W.L. Club has a membership of 44. Meetings are held every third Friday at 7.30 at the Redcliffe Community Centre, Guinea Street, Bristol, 1. Sec.: N. G. Foord, 71, Brynland Avenue, Bristol, 7.

**Chester.**—The recently formed Chester and District Amateur Radio Society meets on alternate Tuesdays at 7.30 at the United Services Club, Watergate Street, Chester. Next meeting is on February 8th. Sec.: S. H. Dutton, 17, Victoria Pathway, Queen's Park, Chester, Cheshire.

**Esher.**—The radio control of models will be discussed at the next meeting of the Thames Valley Amateur Radio Transmitters' Society on February 2nd at 8, at the Caernarvon Castle Hotel, Hampton Court. Sec.: A. Mears, (G8SM), Broadfields, East Molesey, Surrey.

**Harrow.**—A lecture on theoretical and practical circuit analysis will be given to members of the Radio Society of Harrow by S. W. Amos on February 8th at the Northwick Tea Rooms, 206-208, Kenton Road, Harrow. On February 2nd the society will hold a joint meeting with the Edgware and District Radio Club. Sec.: J. R. Pickett, 93, Whitmore Road, Harrow, Middlesex.

**Worthing.**—Meetings of the Worthing and District Amateur Radio Club are now held on the second Monday in each month at 7.30 at the Adult Education Centre, Union Place, Worthing. Sec.: F. T. Tooley, 62, Beckett Road, Worthing, Sussex.

**BOOK REVIEW**

**A Textbook of Radar.** By the Staff of the Radiophysics Laboratory, Council for Scientific and Industrial Research, Australia. Pp. 579 +v, with 31 plates and 347 diagrams. Chapman & Hall, Ltd., 37, Essex Street, London, W.C.2. Price 50s.

THIS is the Australian counterpart of the American M.I.T. Radiation Laboratory books on radar. Being all in one volume, even though a substantial one, the treatment of the whole of a subject which was due to an unequalled concentration of research on an international scale might be expected to be rather superficial. And being, as it is, the collective work of many authors, there was an obvious risk of overlapping and inconsistency. A third risk, which has certainly not been avoided in all books on radar, is that an organization engaged for so long on a war effort might be unable to generalize its outlook.

But all these three risks have evidently been recognized by the unnamed editor, and successfully averted. There are no recapitulations of radio engineering in general, or lengthy historical reminiscences, or details of obsolete systems—or indeed excessive details of any particular systems. Mathematics has been used as it should be, for conciseness and definiteness of treatment, and has not been misused in long theoretical by-ways. The standard of mathematics is, in fact, fairly advanced in places, but is presented very clearly. Overlapping hardly exists, and the consistency of style is remarkable when it is considered that each of the twenty chapters is the work of a different author, with collaborators.

The majority of the book is devoted to the principles of microwave radar, illustrated necessarily by war-time equipment and techniques, but not too closely bound to them. A very nice balance has been observed between theory and practice, and the faults of vagueness on the one hand and mere descriptiveness on the other have been skilfully avoided.

Judging from the fact that (except in the last chapter) none of the many references is dated later than 1945, the volume went to press some time ago. No doubt this accounts for the exceptionally high standard of proof reading and book production, but unfortunately it also means that the majority of the references are to unpublished reports, most of the published work on radar (especially in Great Britain) having appeared since 1945. It is presumably due to this that some important British

circuit techniques are either missing or rather inadequately treated.

Although a chapter is given to shipboard radar, it is exclusively from the naval point of view. Use on merchant ships is briefly referred to in the last chapter, on radar navigation, but harbour radar is not. This important post-war field is still marked by a gap in radar literature.

The use of symbols and terms is notably consistent and clear. A minor exception is that "concentric" is used by one contributor instead of "coaxial"; once erroneously in referring to the resonant cavities in a magnetron. The British nomenclature for waveguide and cavity modes is not given. A commendable feature is the adoption throughout of the rationalized M.K.S. system of units. Its value is particularly marked in the unified treatment of circuit and field impedance. M.G.S.

**MANUFACTURERS' LITERATURE**

Technical guide to "Aerialite" television aerials, and general catalogue of aerials from Aerialite, Ltd., Stalybridge, Cheshire.

New catalogue of acoustic baffles from Broadcast and Acoustic Equipment Co., Tombland, Norwich.

Leaflet describing demonstration audio-amplifier for schools from A. E. Cawkell, 7, Victory Parade, The Broadway, Southall, Middlesex.

Leaflet giving particulars of heavy-duty carbon resistors for transmitters from the Morgan Crucible Co., Battersea Church Road, London, S.W.11.

Brochure of electronic instruments, including c.r. oscilloscopes, valve voltmeters, a.f. oscillators and stabilized power supply units, from Furzehill Laboratories, Boreham Wood, Herts.

Catalogue of copper wire, strip and strand from E. and F. Kaye, Ltd., Ponders End, Enfield, Middlesex.

Illustrated leaflet describing the new Model PzoB "personal" portable from the Marconiphone Company, Hayes, Middlesex.

Leaflets describing the "Williamson"-type amplifier and bass reflex loudspeaker cabinets made by the Rogers Development Co., 106, Heath Street, London, N.W.3.

Descriptive leaflet of magnetic-tape home projector sound conversion kit, and list of fractional h.p. motors, from Scopphony, Ltd., Wells, Somerset.

Catalogue of television aerials and brochure describing installation service offered by Wolsey Television, Ltd., 75, Gresham Road, London, S.W.9.

# SUPERHETERODYNE TELEVISION UNIT

## Long-range Receiver

WHEN the WIRELESS WORLD Television Receiver was described\*, it was stated that it was suitable only for moderate-range reception and that a more sensitive receiver unit for long-range use would be described later. The original straight set has actually proved adequate for much greater ranges than were originally envisaged, and many reports of good reception at 30 miles and over have been received.

However, it was not intended for really long-distance reception and a great deal of time and effort has been put into the development of a suitable receiver. It is a superheterodyne. It is not the need for high sensitivity which has led to the adoption of this form of receiver, for it is easy to obtain all the gain needed from the straight set; it is the need for sound-channel rejection.

The problem of sound-channel rejection is quite a difficult one if the vision-channel response is maintained at the required value and it has been greatly increased by the standards chosen

considered it was decided that it should be of a type which would be basically suitable for the reception of this station. This decision alone was sufficient to justify the choice of the superheterodyne, for it demands changes to three coils only to make it suitable for Birmingham, whereas a straight set would need changes to at least sixteen.

The design of the set was started before the Birmingham standards were known. From the outset the use of single-sideband reception was decided on, partly because the bandwidth is halved and the stage gain doubled. The main reason, however, was that it enormously

The receiver is shown here in the normal position alongside the cathode-ray tube.

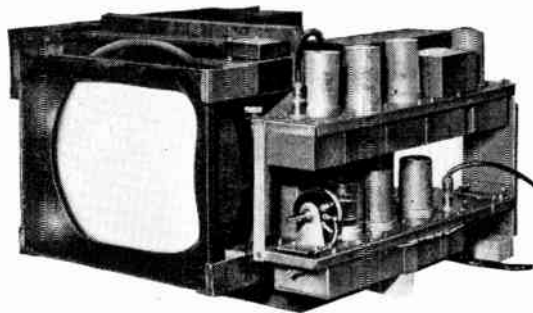

to obtain 40-db discrimination without using any rejector circuits.

When this receiver had been completed and was awaiting only final testing prior to being described, the Birmingham standards were announced and it was found that single-sideband transmission would be used, the sidebands retained being those nearer the sound channel. This is, of course, the natural choice for transmission, just as the alternative is the natural choice for reception.

The result of this choice of transmission standards was to make the receiver as developed useless for the Birmingham area. It also removed most, if not all, the advantage of single-sideband reception in easing the problem of sound-channel rejection, for it brought back the old problem of obtaining some 40-db discrimination for a 0.5-Mc/s change of frequency.

On the announcement of the Birmingham standards, therefore, it was necessary to redesign the i.f. and r.f. amplifier, and it is this which has in large measure been responsible for delaying the publication of this article beyond the date originally fixed for it. The main practical difficulty encountered in design has been that of securing adequate sound-channel rejection with the required bandwidth. In order to secure the necessary performance three rejector circuits have had to be included.

The receiver as now described is suitable for reception from Alexandra Palace. For Sutton

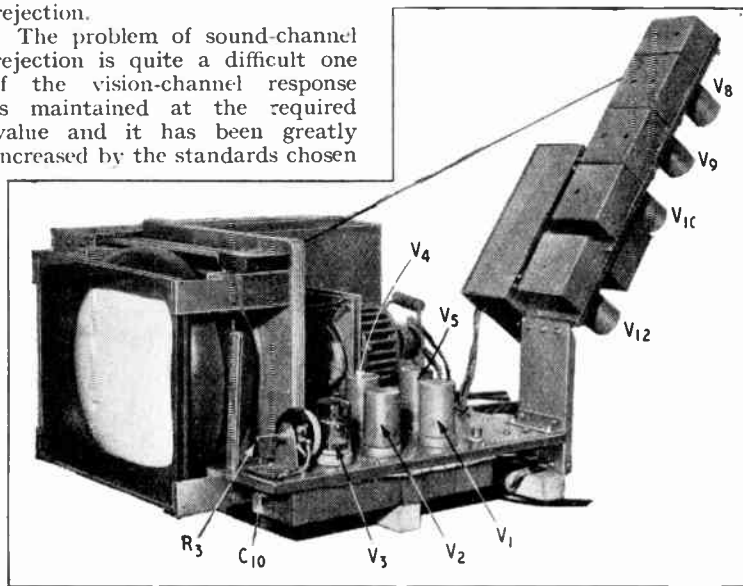

In this photograph the upper deck of the receiver is shown hinged up so that access to the underside can be obtained.

for the Birmingham station. When the design of the long-range receiver was first con-

helps sound-channel rejection. By picking the sidebands remote from the sound channel the spacing between sound and vision channels is 3.5 Mc/s instead of 0.5 Mc/s. It is then easily possible

\* *Wireless World*, January, February, March, May, July, August, September, October, November and December, 1947.

**Superheterodyne Television Unit—** Coldfield changes to three coils—two signal and one oscillator-frequency coils—will be needed. No other changes are expected to be necessary, but as the precise single-sideband standards have not yet been announced there is a remote possibility that a modified trimming procedure for the i.f. amplifier might be required. Details of the three Birmingham coils

ated in the anode circuit of the mixer. The vision channel comprises three stages followed by a diode detector, v.f. stage, and a diode noise limiter. The sound channel has two i.f. stages followed by a diode detector and diode noise limiter; as in the previous receiver, no a.f. stages are included, since it is assumed that most people already have an a.f. amplifier, or at least a broadcast

—3 db and the vision-channel pass-band is 3 Mc/s for —6 db. The latter extends from 10 Mc/s to 13 Mc/s, the vision carrier being at the latter frequency 6 db below the maximum response. This is important if the proper overall characteristic is to be obtained in single-sideband operation. The oscillator operates at 32Mc/s (= 45-13). This frequency was chosen instead of the alternative

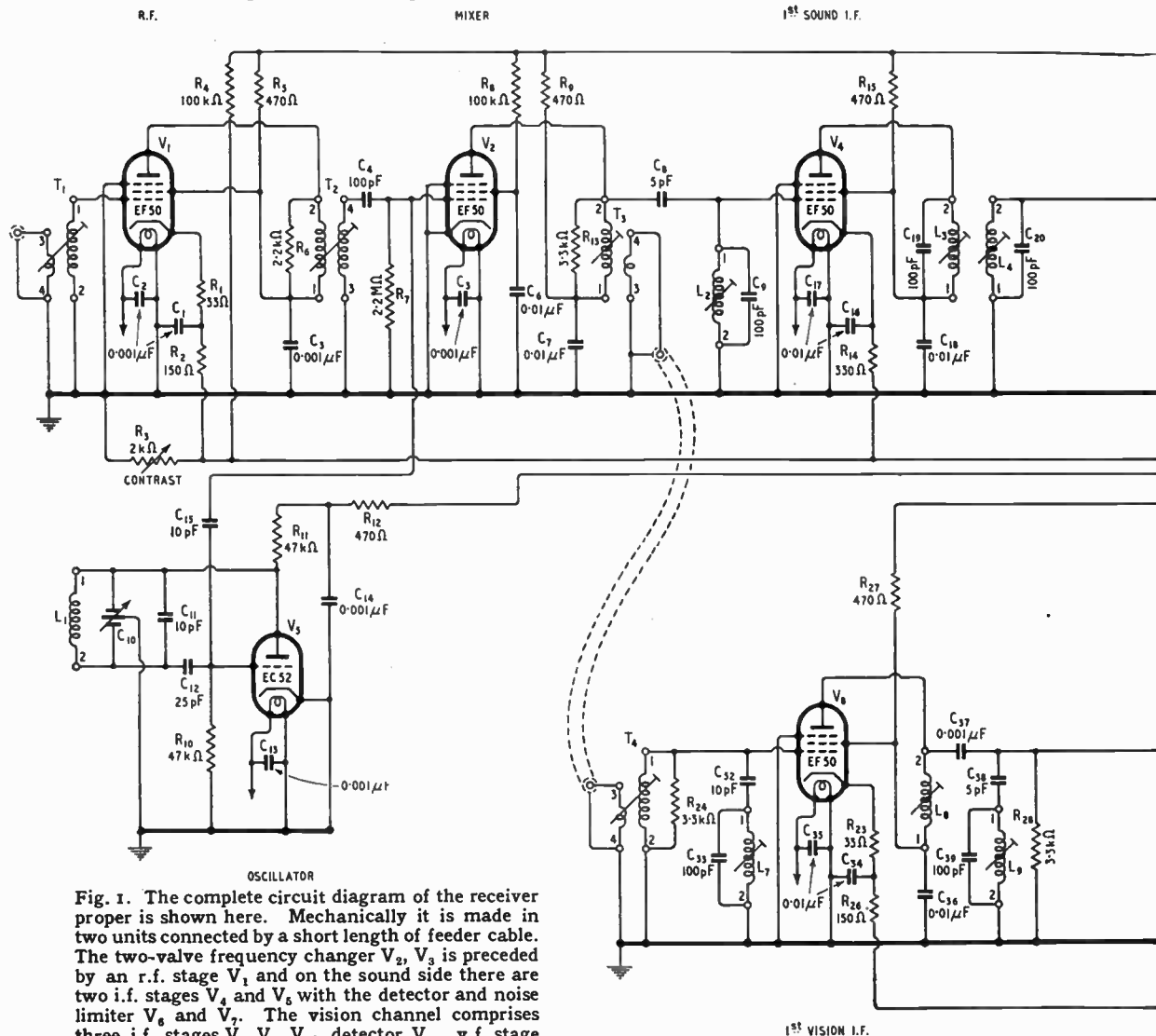

Fig. 1. The complete circuit diagram of the receiver proper is shown here. Mechanically it is made in two units connected by a short length of feeder cable. The two-valve frequency changer V<sub>2</sub>, V<sub>3</sub> is preceded by an r.f. stage V<sub>1</sub> and on the sound side there are two i.f. stages V<sub>4</sub> and V<sub>5</sub> with the detector and noise limiter V<sub>6</sub> and V<sub>7</sub>. The vision channel comprises three i.f. stages V<sub>8</sub>, V<sub>9</sub>, V<sub>10</sub>, detector V<sub>11</sub>, v.f. stage V<sub>12</sub> and noise limiter V<sub>13</sub>.

will be given nearer the opening date of the station.

The receiver has an r.f. stage, mixer and oscillator which are common to both sound and vision signals. These signals are separ-

ated in the anode circuit of the mixer. The vision channel comprises three stages followed by a diode detector, v.f. stage, and a diode noise limiter. The sound channel has two i.f. stages followed by a diode detector and diode noise limiter; as in the previous receiver, no a.f. stages are included, since it is assumed that most people already have an a.f. amplifier, or at least a broadcast

receiver with pick-up terminals, which can be used with it. The intermediate frequencies are 9.5 Mc/s for sound and 13 Mc/s for vision. The sound-channel pass-band is about 100 kc/s for

of 58 Mc/s since it was considered that greater oscillator stability could be achieved. The only objection to it is the fact that the second channel interference band is 16-19 Mc/s instead of 68-71 Mc/s.



Because stations in this band are generally stronger there is a greater probability of interference for the same image rejection in the receiver. However, the selectivity of tuned circuits naturally tends to be greater below than above resonance, and this, at least, partially offsets it. In practice no trouble at all from second-channel interference has been found.

signals in the i.f. band. It must be remembered that in a television superheterodyne the intermediate frequency lies in the crowded s.w. band, and at high gain complete screening is necessary if the direct pick-up of signals is to be avoided.

There is also the question of avoiding i.f. harmonic interference. In the superheterodyne harmonics of the intermedia e

intermediate frequency enables this to be overcome for any given signal frequency, but it is impracticable to secure freedom from it in this way over the whole of the television band. For this it is necessary to use thorough screening and to include an adequate filter after the detector.

The receiver is so arranged in its mechanical form that it will fit into the space allocated to it in the original design. This has necessitated building it in two units mounted one above the other. The lower unit includes the r.f. stage, mixer and sound channel and the upper the vision channel.

The circuit diagram is shown in Fig. 1. The received signal picked up by the aerial is passed through a coaxial feeder of 72 ohms nominal impedance to the input transformer  $T_1$ . This is resonant at 45 Mc/s with the stray capacitance, namely the input capacitance of  $V_1$ . Damping is provided mainly by the feeder.

This valve is coupled to the mixer  $V_2$  by  $T_2$ , damped by  $R_6$ . The two signal circuits give a bandwidth adequate to embrace

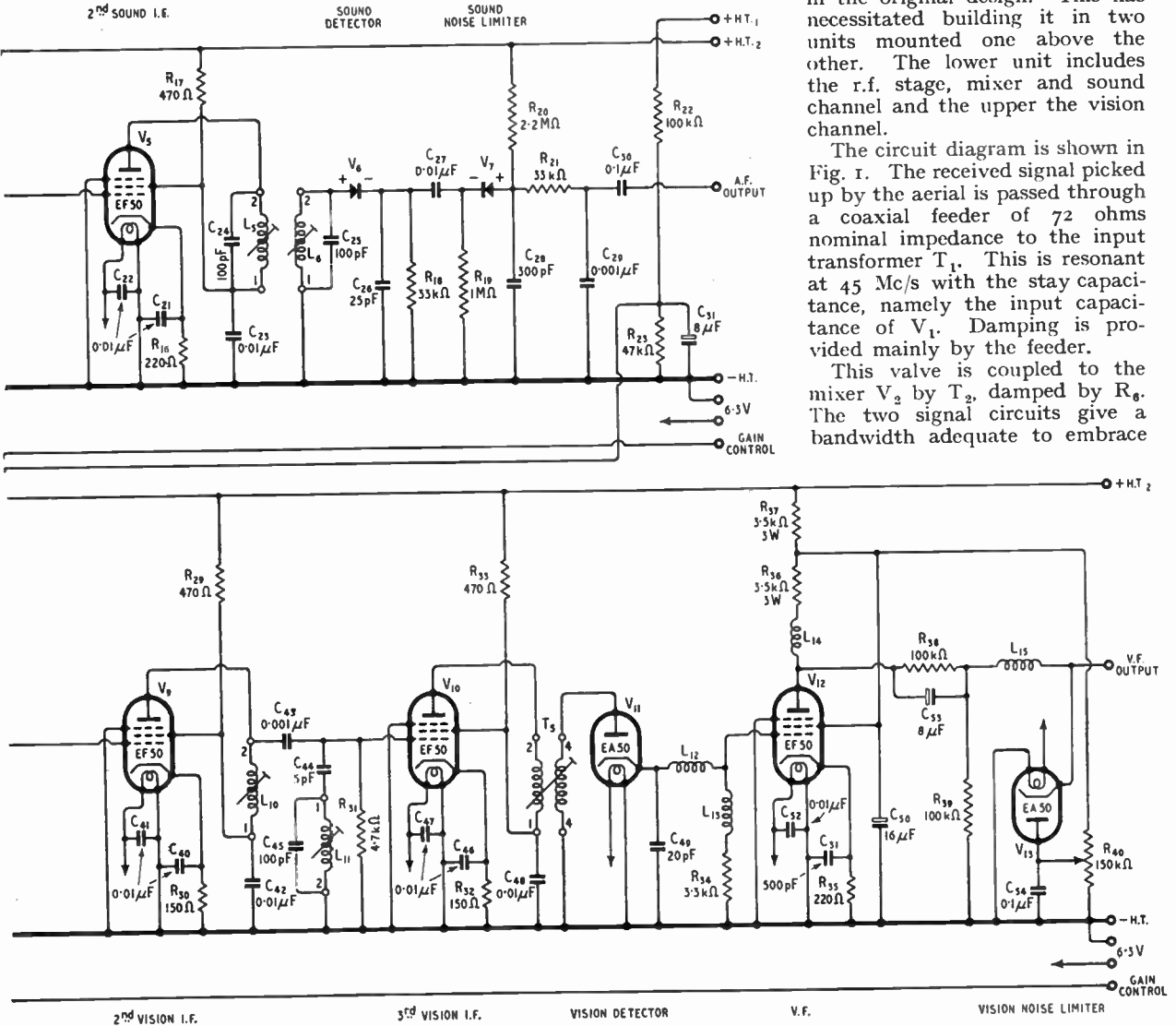

Very thorough screening of all parts of the receiver has been adopted. There is far more screening than is necessary for receiver stability, but it is needed to prevent the direct pick-up of

frequency are inevitably produced in the detector. If they are fed back to the signal-frequency circuits they may beat with the signal to produce a pattern on the picture. The correct choice of the

the sound and vision channels. A separate oscillator valve  $V_3$  is used in the interests of stability. The coil  $L_1$  is wound with heavy gauge wire on a polystyrene former and the turns are cemented

**Superheterodyne Television Unit—** in place. All the oscillator components are mounted on the lower chassis well away from anything hot and the H.T. supply is taken from the 480-V line via the potentiometer  $R_{22}$ ,  $R_{23}$ . This is done because the direct load on this line is a stable one—the line and frame time-base valves, whereas the 250-V line varies to some degree with the gain- and focus-control settings.

The mixer output at 13.10 Mc/s for vision and 9.5 Mc/s for sound appears in the network  $T_3$ ,  $R_{13}$ ,  $C_8$ ,  $L_2$ ,  $C_9$ .  $T_3$  is the vision coupling transformer tuned by the stay capacitance and damped by  $R_{13}$ . The coupling coil is connected to a short length of 72-ohm cable which conveys the vision signals to the upper chassis. The circuit  $L_2C_9$  is tuned to 9.5 Mc/s and applies the

Here both units are hinged up for access to the underneath of the r.f. and sound i.f. unit.

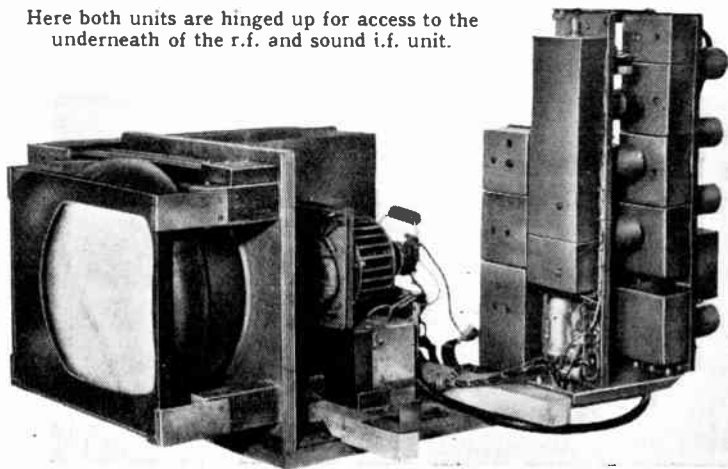

sound signal to the first sound i.f. stage  $V_4$ .

Coupled pairs  $L_3C_{19}$ ,  $L_4C_{20}$ , and  $L_5C_{24}$ ,  $L_6C_{25}$  are used between the two sound i.f. stages and for the 2nd i.f.-detector coupling respectively. The five circuits give a bandwidth of about 100 kc/s. This is adequate to prevent minor instability in the oscillator from affecting the performance and also to permit the peakiness of ignition interference to be retained so that the noise limiter can function. The selectivity is amply sufficient to avoid any trace of interference from the vision signals.

The detector is a diode  $V_6$ . A germanium crystal is actually

used, largely because of its small physical size, but there is no objection to the thermionic diode and the EA50 is an equally good alternative. The load resistor and by-pass capacitor  $R_{18}$  and  $C_{26}$  are made smaller than usual because it is imperative that the frequency response be good enough for the peaky waveform of ignition interference to be retained.

Another diode  $V_7$ —again a crystal, but again the EA50 can be used—acts as a noise limiter. It is normally conductive and is maintained so by  $R_{20}$  returned to + h.t. If the voltage across  $R_{19}$  changes at an audio-frequency rate it appears with negligible drop across  $C_{28}$  and is passed through the filter  $R_{21}C_{29}$  to the output. If the voltage changes very rapidly in the positive direction, however, as it does on an interference peak, the voltage

which in this case would be 11.5 Mc/s—and the coupling and damping adjusted to give the required bandwidth. With the type of coil used, however, it has been found impracticable to obtain sufficiently tight coupling between the two windings of  $T_3$  and  $T_4$  for adequate overall coupling.

About 1ft. of cable is used and its main influence is its capacitance of about 25pF. It is necessary to step-down at each end sufficiently to make this capacitance of negligible importance and with this step-down the coupling in the transformers is inadequate for the required bandwidth.  $T_3$  and  $T_4$ , therefore, have their resonance frequencies staggered somewhat. The bandwidth is obtained but the mixer—1st i.f. stage gain is reduced somewhat.

A trap circuit  $L_7$  and  $C_{33}$  is coupled to  $T_4$  by  $C_{32}$ . It is a sound-channel retractor and gives about 20db attenuation when adjusted so that  $C_{32}$  resonates with the combination of  $L_7$  and  $C_{33}$  at 9.5 Mc/s.  $L_7$  and  $C_{33}$  then exhibit parallel resonance at about 10 Mc/s and at this frequency they have negligible effect. The cut-off is thus very sharp. At higher frequencies the trap has the effect of loading the coupling capacitively so that  $R_{24}$  and  $T_4$  must be lower than would otherwise be necessary.

The first and second and second and third i.f. stages are coupled by  $L_8$  and  $L_{10}$  respectively, the circuits being tuned by stay capacitance and the resonance frequencies staggered. Traps comprising  $C_{38}$ ,  $C_{39}$ ,  $L_9$  and  $C_{44}$ ,  $C_{45}$ ,  $L_{11}$  are connected across the couplings. They are similar to the first trap already described but are more loosely coupled and give about 10-12-db rejection apiece. The overall sound-channel attenuation is then about 40-45db, all provided by the three traps.

A double-wound coupling  $T_5$  is used between the last i.f. valve and the detector  $V_{11}$ . This valve has a filter choke  $L_{12}$  which is wound to be self-resonant at the intermediate frequency and the load resistor  $R_{34}$  has a compensating inductance  $L_{13}$  in series with it.

The v.f. stage is  $V_{12}$  and this part of the circuit is identical

(Continued on page 65)

across  $C_{28}$  cannot change rapidly enough to follow it and  $V_7$  becomes non-conductive.  $V_7$  virtually disconnects the output from the detector while the interference peak lasts.

The circuit is very simple and quite effective in dealing with ignition interference. It should be understood, however, that it will do little or nothing to reduce other kinds of interference. On the vision side, the inter-unit cable feeds into  $T_4$  which is tuned in the 10-13 Mc/s band and damped by  $R_{24}$ .  $T_3$  and  $T_4$  together form a coupled pair of tuned circuits. Normally each circuit of such a system is tuned to the same frequency—to about mid-band

# THE "BELLING-LEE" PAGE

Providing technical information, service and advice in relation to our products and the suppression of electrical interference

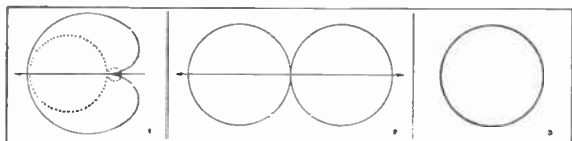

Polar Diagrams : 1. Dipole and Reflector. 2. Veerod. 3. Dipole

### "Veerod" Television Aerial to Combat Interference.

From correspondence received, there still appears to be doubt as to when a \*1 "Veerod" inverted "V" television aerial should be used.

If reasonably well situated within 10-15 miles of a television transmitter, but in a bad location for interference, say from cars, remember that this aerial, although directional along its axis, has a polar diagram with a very well defined minima. Fig. 2 in illustration. There is an excellent example of its performance in connection with an installation carried out near the "Belling-Lee" factory at the "Half-Way House," Erfield, on the Cambridge Arterial Road. The inverted "V" dipole looks at Alexandra Palace right up the road, it is parallel to the road, but car interference is at an absolute minimum.

It is worth while remembering that a dipole and reflector looking at the transmitter, has its minima behind it, whereas in the case of the inverted "V," the minima is at right angles to its axis, but do not forget that the dipole and reflector is advantageous at long distances.

### Suppression on Board Ship or elsewhere with 110 volts supply.

It is not a usual custom of ours to publish testimonials unless our

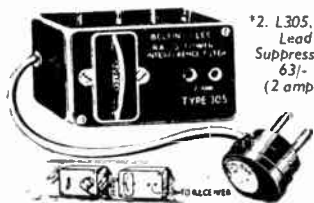

\*2. L.305. Set Lead Suppressor. 63/- (2 amp.)

readers are likely to derive some benefit therefrom. Recently we had a letter from the Chief Officer of S.S. "Empire Aldgate" as follows:—

"I feel that I must write and congratulate you on your model L.300 Suppressor which I have recently fitted to my 110 V. D.C. radio. Previous to my fitting it, dynamo interference was such that

I was unable to receive any of the medium wave stations unless they were close and powerful.

I had tried fitting condensers to the mains without success, the roar of interference being as strong as ever. You can imagine therefore that when a radio salesman claimed that the Belling-Lee L.300 would do the trick, I was, to say the least, sceptical.

The most that I hoped for was a reduction of interference but to my surprise, the interference was completely subdued after fitting your suppressor.

What a relief to tune from one station to another without having to almost switch off the set so that I wouldn't be deafened by inter-station roar and also to be able to listen to weak stations without interference.

Apart from the L.300 fulfilling the purpose for which it was designed, I am quite pleased with its compactness and workmanship. I would suggest that you could find a quick and ready sale for the L.300 to ship-board radio owners if you advertised in the appropriate publications."

Yours faithfully,  
(Signed) J. Richardson,  
Chief Officer.

Now in many cases the L.300\*3 is not the most suitable suppressor to use on normal ships' mains (110 volts D.C.) due to the fact that it is designed for a maximum current loading of 1 ampere at 240 volts, and the current drawn may be such as to cause overheating or continual rupturing of fuses. For this reason we would normally recommend the L.305\*2 suppressor which has a maximum current loading of 2 amperes.

### Set Lead Suppression on Large Radiograms.

The L.305 suppressor is also generally recommended on large radiograms or any equipment which might require up to two amperes.

### "Coronette" Silent Aerial Discharger.

Precipitation or rain static is rather a misleading term for the most amazing effect caused by rain under certain conditions, and in certain locations. The phenomenon was

described by us very fully in this page and subsequently was subject of an article written by F. R. W. Strafford and published in the December 1948 issue of "Wireless World." The answer to most cases is the "Coronette"\*3 which is in fact a silent discharger normally plugged into the top of the "Skyrod." This discharger is made up of a "wick" soaked in a partially conductive solution, the end of the wick is teased out and therefore presents a very large number of highly resistive points in parallel. It is not our object to re-print the article mentioned above, but we would add that if this conductive wick gets wet, it

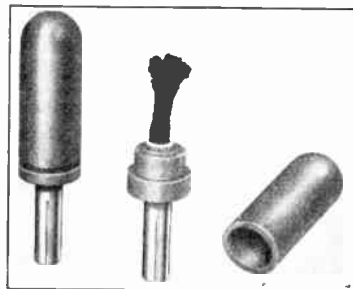

\*3. "Coronette" wick discharger L.643 U.K. Patent applied for.

would cease to function as desired, therefore it is enclosed in a plastic cover. An attenuation of nuisance noise of the order of 40 db is general on the control aerial. This cannot be guaranteed as conditions do vary and approximately similar noises may be due to entirely different causes.

### Humming or Whistling of Television Aerials.

We have reports of a very small proportion of these aerials setting up noises in wind. The noises appear to be amplified down the chimney, and are not confined to our aerials.

We are thoroughly investigating the matter and encourage any user of our aerials so troubled to write, giving dealer's name, date of installation and all relevant information.

1.\* "Veerod" Inverted "V" Television Aerial L.606 (London), L.635 (Birmingham). £4/10/-.

2.\* Set lead suppressor L.300/3 (1 amp.) all wave, 59/6.





G.E.C.



## QUARTZ CRYSTAL UNITS

### FOR STABLE FREQUENCY GENERATION

#### FEATURES

Low temperature co-efficient—less than 2 in 10 per cent.  
 Patented nodal suspension. Mounted in vacuum; performance independent of climatic conditions. Exceptionally high Q value.  
 High stability. Small size. 3" x  $\frac{1}{4}$ " overall excluding pins. Fits standard miniature deaf aid valve socket.

## FOR FREQUENCY SUB-STANDARDS

Type JCF/200, 100 KC/S. Available from stock adjusted to 0.01%. Higher accuracies supplied to special order.

The type JCF/200 unit illustrated is representative of the wide range of vacuum type unit available for low and medium frequencies.

PRICE

£2 - 15 - 0

**SALFORD ELECTRICAL INSTRUMENTS LTD.**  
 PEEL WORKS, SALFORD 3, LANCs. Telephone BLACKRIARS 6688 (6 lines) Telegrams & Cables SPARKLESS Manchester  
 Proprietors: THE GENERAL ELECTRIC CO., LTD., OF ENGLAND

A Happy New Year to our numerous supporters—

assisted by

The New Eleven Valve

## Polyphonic Console

which provides coverage for the Television Sound band, in addition to two Short, Medium, and Long Wave bands.

Circuit: R.F., Oscillator, two I.F. with Variable Selectivity, Diode Detection, Magic Eye indicator, two Tone Control Valves, terminated by our latest paraphase coupled push-pull amplifier with negative feedback, driving a Phase Inverter Dual Suspension Auditorium Speaker.

A combination that not only covers the Television Sound band, but provides the best possible reproduction, compatible with transmission.

PRICE £80.2.6 including purchase tax

**AGENTS:** Barnes & Avis, Reading; Bowers & Wilkins, Worthing; Binns Ltd., Newcastle; Dalton & Sons Ltd., Derby; Clark & Sons, Isle of Wight; Hickie & Hickie Ltd., Reading (and branches); Holley's Radio Stores, London, S.E.5; Jewkes & Co., Birmingham; Thomas Lynn & Sons, Andover; Merritts Ltd., Bristol; Needham Engineering Ltd., Sheffield; Pank's Radio, Norwich; Sound Ltd., Cardiff; Bernhard Smith, Barnstaple; Sound Services, Jersey, C.I.; Precision Services, Edinburgh; Seals Ltd., Southsea; G. E. Samways, Hazel Grove; Weybridge Radio Electric, Weybridge; West End Radio, Farnham; Vallance & Davison Ltd., Leeds (and branches).

Overseas Stockists in Canada, South Africa, Channel Islands, etc.

**Sound Sales Ltd.** WEST STREET, FARNHAM, SURREY

Telephone: Farnham 6461/2/3.

London Office: 57, St. Martin's Lane, W.C.2. Telephone: Temple Bar 4284.

**Superheterodyne Television Unit—** with that of the straight set previously described. A noise limiter V<sub>13</sub> has been added, however. This comprises V<sub>13</sub>, C<sub>54</sub> and

R<sub>40</sub>. The output signal is negative going and the control R<sub>40</sub> is set so that over the whole range of normal output voltages the diode is non-conductive and does

nothing. A peak of ignition interference, however, which makes the output voltage drop below the peak-white level brings the diode cathode below its anode potential. It then conducts and prevents the output voltage from falling appreciably further.

Its main function is to prevent the worst effect of ignition interference, the defocusing of the scanning spot. The normal white blotches of interference are replaced by white pin-points which are much less noticeable. The circuit is effective, but it requires careful adjustment of R<sub>40</sub>; of this, noise later.

(To be continued)

**COMPONENTS**

The parts in this list are the ones employed in the original model. Any components of the same electrical specification and suitable physical dimensions can be used.

**RESISTORS**

(½ watt unless otherwise stated)

R <sub>1</sub> , R <sub>25</sub> .. .. .	33 Ω .. .. .	Erie
R <sub>2</sub> , R <sub>26</sub> , R <sub>30</sub> , R <sub>32</sub> .. .. .	150 Ω .. .. .	Erie
R <sub>3</sub> .. .. .	2 kΩ, 3 W, variable wire-wound	Reliance Type T.W.
R <sub>4</sub> , R <sub>8</sub> , R <sub>38</sub> , R <sub>39</sub> .. .. .	100 kΩ .. .. .	Erie
R <sub>5</sub> , R <sub>9</sub> , R <sub>12</sub> , R <sub>15</sub> , R <sub>17</sub> , R <sub>27</sub> , R <sub>29</sub> , R <sub>33</sub> .. .. .	470 Ω .. .. .	Erie
R <sub>6</sub> .. .. .	2.2 kΩ .. .. .	Erie
R <sub>7</sub> , R <sub>20</sub> .. .. .	2.2 MΩ .. .. .	Erie
R <sub>10</sub> , R <sub>11</sub> , R <sub>23</sub> .. .. .	47 kΩ .. .. .	Erie
R <sub>13</sub> , R <sub>24</sub> , R <sub>28</sub> , R <sub>31</sub> .. .. .	3.3 kΩ .. .. .	Erie
R <sub>14</sub> .. .. .	330 Ω .. .. .	Erie
R <sub>16</sub> , R <sub>35</sub> .. .. .	220 Ω .. .. .	Erie
R <sub>18</sub> , R <sub>21</sub> .. .. .	33 kΩ .. .. .	Erie
R <sub>19</sub> .. .. .	1 MΩ .. .. .	Erie
R <sub>22</sub> .. .. .	100 kΩ, 1 W .. .. .	Erie
R <sub>31</sub> .. .. .	4.7 kΩ .. .. .	Erie
R <sub>36</sub> , R <sub>37</sub> .. .. .	3.5 kΩ, 3 W .. .. .	Erie
R <sub>40</sub> .. .. .	150 kΩ, 3 W, variable .. .. .	Reliance Type S.G.

**CAPACITORS**

C <sub>1</sub> , C <sub>2</sub> , C <sub>3</sub> , C <sub>5</sub> , C <sub>13</sub> .. .. .	0.001 μF, mica .. .. .	Dubilier Type 635
C <sub>14</sub> , C <sub>29</sub> , C <sub>37</sub> , C <sub>43</sub> .. .. .	100 pF, silvered-mica .. .. .	Dubilier Type 5811W
C <sub>4</sub> , C <sub>8</sub> , C <sub>19</sub> , C <sub>20</sub> , C <sub>24</sub> , C <sub>25</sub> , C <sub>33</sub> , C <sub>39</sub> , C <sub>15</sub> .. .. .	5 pF, ceramic .. .. .	T.C.C. Type CC31a
C <sub>8</sub> , C <sub>38</sub> , C <sub>44</sub> .. .. .	25 + 25 pF, split stator .. .. .	Eddystone Type 583
C <sub>10</sub> .. .. .	10 pF, ceramic .. .. .	Dubilier Type CTD310
C <sub>11</sub> , C <sub>15</sub> , C <sub>32</sub> .. .. .	25 pF, silvered-mica .. .. .	Dubilier Type 5811W
C <sub>12</sub> , C <sub>26</sub> .. .. .	0.01 μF, 500 V, tubular paper .. .. .	Dubilier Minicap T.C.C. Type 543
C <sub>6</sub> , C <sub>7</sub> , C <sub>16</sub> , C <sub>17</sub> , C <sub>18</sub> , C <sub>21</sub> , C <sub>22</sub> , C <sub>23</sub> , C <sub>27</sub> , C <sub>34</sub> , C <sub>35</sub> , C <sub>36</sub> , C <sub>40</sub> , C <sub>41</sub> , C <sub>42</sub> , C <sub>16</sub> , C <sub>17</sub> , C <sub>48</sub> , C <sub>52</sub> .. .. .	300 pF .. .. .	Dubilier Type 635
C <sub>30</sub> , C <sub>51</sub> .. .. .	0.1 μF, tubular paper .. .. .	T.C.C. Type 343
C <sub>31</sub> .. .. .	8 μF, electrolytic .. .. .	T.C.C. Micropack, Type CE19P
C <sub>49</sub> .. .. .	20 pF, ceramic .. .. .	Dubilier Type CTS310
C <sub>50</sub> .. .. .	16 μF, electrolytic .. .. .	Dubilier Type CT1650
C <sub>51</sub> .. .. .	500 pF, mica .. .. .	Dubilier Type 635
C <sub>53</sub> .. .. .	8 μF, electrolytic .. .. .	Dubilier Drilitic BR850

**VALVES**

V <sub>1</sub> , V <sub>2</sub> , V <sub>4</sub> , V <sub>5</sub> , V <sub>8</sub> , V <sub>9</sub> , V <sub>10</sub> , V <sub>12</sub> .. .. .	Mullard EF50
V <sub>3</sub> .. .. .	Mullard EC52
V <sub>6</sub> , V <sub>7</sub> , Germanium crystal-valves .. .. .	B.T.H. CG1
V <sub>11</sub> , V <sub>13</sub> .. .. .	Mullard EA50

**MISCELLANEOUS**

Coaxial-cable plugs .. .. .	Belling-Lee Type L604/1P
Coaxial-cable sockets .. .. .	Belling-Lee Type L604/S
Polystyrene tube, ¾-in outside diameter .. .. .	Denco
Polystyrene tube, ¼-in inside diameter .. .. .	Denco
Polystyrene varnish .. .. .	Denco
Coaxial cable (for aerial feeder and inter-unit connection) .. .. .	T.M.C. Type P.T.I.M

**NEW DOMESTIC RECEIVERS**

TWO new versions of the Model 500 have been introduced by Ace Radio, Tower Road, London, N.W.10. Model 500T covers the so-called trawler band (70-200 m) in addition to 16-50 m, 200-550 m and 900-2,000 m and costs £22 18s 10d including tax. Model 500E, which is for export only, has short-wave ranges of 13-45 m and 35-100 m to meet the requirements of those countries with services on the 60 m and 80 m bands, but where long-wave reception is not required.

Denco (Clacton), Ltd., 355/9, Old Road, Clacton-on-Sea, Essex, have developed an inexpensive uni-



Denco Model DR23 broadcast receiver.

versal superhet (3 valves + rectifier) covering medium and long waves. It makes use of the Mullard B8A range of valves and has a UCH42 frequency changer, UAF41 pentode-diode, UL41 output and UY41 rectifier. The price is £12 19s 9d including tax.

A new console television receiver Model TSC91 is announced by E. K. Cole, Southend-on-Sea. It is based on the TS46 table model and makes use of a 9in tube. The price is £75 including tax.

## WORLD OF WIRELESS

### Television at Home and Abroad ♦ Ship's Radio ♦ Components Show

#### Faraday Lecture

THIS year's I.E.E. Faraday lecture is on television, and will be given by Sir Noel Ashbridge, Director of Technical Services of the B.B.C., and H. Bishop, Chief Engineer, B.B.C. By means of demonstrations the evolution of television will be traced and the latest B.B.C. outside broadcast equipment will be used to televise from the platform to receiving sets standing amongst the audience.

The lecture will be delivered at the Central Hall, Westminster, London, S.W.1, on February 16th at 6.30 and also at various centres throughout the country. Admission will be by ticket obtainable from the I.E.E., Savoy Place, London, W.C.2, in the case of the London meeting and from I.E.E. local secretaries for other centres.

#### Second Thoughts in France

THE French decision to adopt 819-line standards for the national television service (reported in our last issue) has not met with general and warm approval in the French technical press. Fears of long delay are commonly expressed, and one journal (*La Radio Française*) goes so far as to say "The premature choice . . . has been a mistake . . . We should have done what has been done in England,

which has acted logically, and can boast today of having 80,000 receivers in London. I defy anyone to prove that there are more than 3,000 in Paris."

On the other hand, the journal *Radio Technical Digest*, after quoting the *Wireless World* Editorial for October in support of the British decision says, "Certainly, the arguments of our English friends are very convincing—for them. But they are hardly valid for us . . ." The writer goes on to express the view that the problems of international programme exchanges will be overcome.

It is announced that four channels in the band 162-216 Mc/s will be used for the new system.

#### Marine Single Sideband

THE new Cunard White Star liner *Caronia*, which recently made her maiden voyage to America, is of some 34,000 tons and although a big ship, space does not permit such lavish radio accommodation as in her sister ships the two *Queens*. Transmitting and receiving equipment is, nevertheless, segregated but in adjacent rooms.

As the new vessel will undertake lengthy cruising voyages, the single sideband system of radiotelephony has been installed so that passengers may telephone to Europe and America from almost any part of the world. Some of the advantages expected from the single sideband

installation can be stated briefly as: improved signal-to-noise ratio for a given transmitter power, less distortion due to selective fading and multi-path propagation and narrower bandwidth compared with double sideband working.

The transmitter is rated at 300 watts R.F. output and will transmit on a single channel with a single sideband and an attenuated carrier. Its frequency range is 4 to 22 Mc/s. Either sideband can be selected by the receiver and although it will initially operate on a single channel, it is actually a double channel set.

The single sideband equipment is designed by Standard Telephones and Cables and the radio installation has been supplied and fitted by the International Marine Radio Company.

#### R.C.M.F. Show

AS already announced the annual exhibition of radio and electronic components, materials and test gear, organized by the Radio Component Manufacturers' Federation will be held at Grosvenor House, Park Lane, London, W.1, from March 1st to 3rd (10 a.m.-6 p.m.).

There will be 106 exhibitors—a slight increase on last year's total—and valve manufacturers are included for the first time this year. Admission is restricted to holders of tickets which are obtainable from the R.C.M.F., 22, Surrey Street, London, W.C.2.

#### R.N.V.(W.)R.

FURTHER to our announcement in the December issue of the reformation of the Royal Naval Volunteer (Wireless) Reserve, we recently had an opportunity to see over the London training centre in the Admiralty building in Whitehall.

It has a well-equipped radio station consisting of a 300-watt C.W. and R/T transmitter, several CR100 and Hallicrafters receivers and the latest Naval V.H.F. telephony transmitter-receiver.

A part of the accommodation is laid out for instruction in morse, the wiring being arranged so that the exercises transmitted from an Admiralty station near Portsmouth especially for the R.N.V.(W.)R. on certain evenings of the week, can be relayed to all headphone points.

Reservists must attain a speed of 18 w.p.m. in sending and reading morse in order to qualify for a home station. This comprises a 30-watt C.W. transmitter, Hallicrafter receiver and power units.

#### E.M.I. Report

REFERRING to the manufacture of magnetic-tape recorders during his address at the seventeenth



RECEIVING ROOM in the S.S. *Caronia* showing the W/T receiver and, in the right background, the single sideband receiver.



annual general meeting of Electric and Musical Industries, Sir Ernest Fisk stated that instruments costing £550 have been shipped to 14 different countries including the U.S.A. Plant has been installed by the company for the manufacture of magnetic tape.

He also stressed, if it needed any emphasis, that, whilst British television had been standardized at 405 lines, manufacturers in this country are not limited to these standards, and are in a position to supply equipment to other specifications. In the case of E.M.I., equipment of 625 lines or even higher, if desired, can be supplied.

E.M.I. is standardizing two sizes of tubes for its receivers—10in and 15in.

### **PERSONALITIES**

A. J. Gill, B.Sc.(Eng.), engineer-in-chief of the G.P.O., was created a Knight Bachelor in the New Year Honours. From 1944 until he succeeded Sir Stanley Angwin in 1947 he was deputy engineer-in-chief. Mr. Gill was recently appointed a vice-president of the I.E.E.



**A. J. GILL, B.Sc. (Eng.), who is created a Knight Bachelor.**

R. T. B. Wynn, M.A., assistant chief engineer, B.B.C., has been appointed a C.B.E. He joined the B.B.C. from Marconi's W.T. Co. in 1926. He is a vice-chairman of the I.E.E. Radio Section for this Session.

V. Dodd, who has been appointed an O.B.E., held various posts in the Air Ministry—which he joined as a wireless operator in 1920—until his transfer to the Ministry of Civil Aviation, where he is now an assistant director of telecommunications.

J. Arnold, production manager at Dubilier's Kirkby (Liverpool) factory, has been made an M.B.E. He has been with Dubilier over 27 years.

J. K. Bradley, M.B.E., has been appointed chief engineer of the new company, Philco (Overseas), Ltd. He joined the Philco organization in this country in 1937, and during the war served as a Major in the R.E.M.E. Prior to joining Philco he was with Cossor's.

Hugh S. Pocock, our managing editor, has been appointed a director of our Publishers, Iliffe & Sons Ltd. He is also managing editor of our associated journals *Wireless Engineer* and *Electrical Review* and managing director of Electrical Review, Ltd.

Geoffrey Parr, who has been editor of *Electronic Engineering* since its inception in 1941, has resigned to join the Board of Chapman and Hall, Ltd., book publishers. H. G. Foster, M.Sc., late of Birmingham University, has been appointed to succeed Mr. Parr.

R. G. Clark has resigned his directorship of the Ferguson Radio Corporation and is taking up an appointment in the U.S.A.

### **IN BRIEF**

**Licences.**—With television licences totalling 82,400, the number of receiving licences in force in Great Britain and Northern Ireland at the end of November was 11,422,400. The month's increases in sound and television licences were 93,000 and 8,600, respectively.

**Marine Radar.**—Of the 430-odd British merchant ships fitted with radar gear at the end of the year, about 280 were equipped with the Admiralty Type 268 set. So far, only three civil sets—Cossor, Metrovick and Kelvin-Hughes—have received the Ministry of Transport's certificate of conformity with the agreed performance specification.

**Physical Society's Exhibition.**—The 33rd annual exhibition of scientific instruments and apparatus organized by the Physical Society will be held in the Physics Department of Imperial College, Kensington, London, S.W.7, from April 5th to 8th. Admission will be by ticket, valid for a specified session, available from Fellows of the Society, exhibitors and most of the learned societies.

**Piped Television.**—It is understood that the Westminster Council has approved the wiring of all its flats on the Pinlicko and Cambridge Street housing estates for relaying television. Each block of flats will be equipped with a receiving aerial, from which the signal will be fed via an amplifier and distribution units to each flat. The weekly rental will be 4s 5½d for the first year and subsequently 3s 6d. The tenants will, of course, need their own standard television receivers.

**Grad. Brit. I.R.E. Exam.**—Candidates for the next graduateship examination for the British Institution of Radio Engineers must make application by April 1st. The examination will be held in London, Manchester, Birmingham, Glasgow, Edinburgh, Cardiff, Bristol, Blackburn, Newcastle-on-Tyne, Belfast and Dublin on May 19th and 20th.

**Electrical Trades Union.**—A radio and electronic engineers' branch of the E.T.U. has been formed in Liverpool. Details of the weekly meetings are obtainable from the secretary, E. A. Stevenson, 6, Woodhall Avenue, Wallasey, Cheshire.

**Correction.**—The reference at the end of "Electronic Circuitry" (page 24, Jan. issue) should read "Dome, R.B. *Electronics*, Dec., 1946, p. 112."

**Consol.**—A brief description of the use of Consol and complete details of the service and coverage provided by the existing four stations—Bushmills, Stavanger, Lugo and Seville—are given in the pamphlet "Consol—An Aid to Navigation" (M.C.A.P. 50) published by H.M.S.O., price 1s.



**R. T. B. WYNN, M.A., who has been appointed a C.B.E.**

**Marconi V.H.F. gear** was recently used to transmit photographs from a warship at sea to a shore station by Kemsley Newspapers as a further extension of their "Business Radio" licence. Ten-watt transmitter-receivers, Type H16, were installed in the destroyer *Finnistere* during fleet manoeuvres, and at the Lizard (Cornwall) lighthouse. The received pictures were transmitted by line from the Lizard to London.

**G.E.C.**—To facilitate the control of marine traffic in the port of Dundee, pilot cutters have been equipped with G.E.C. two-way radio-telephones. The 10-watt F.M. shore station and the small transmitter-receivers installed in each cutter operate on about 70 Mc/s. The Abertay lightship in the Firth of Tay has also been equipped with similar gear.

**B.S.R. Recording.**—Birmingham Sound Reproducers, in co-operation with A. C. Farnell, Ltd., recently undertook the recording of the whole day's civic functions arranged in connection with the opening of Hull's new City Hall. It entailed the use of some 20 miles of special line and over sixty 13in records were made. The arrangements included the use of a radio-equipped car in the procession which was granted a frequency for that occasion. Standard B.S.K. recording equipment was used throughout.

### **FROM ABROAD**

**Canada-U.S. Television.**—Because of Canada's proximity to the United States and the possibility of exchanging television programmes between the two countries, the American standard of 525 lines is being adopted for the Canadian television service.

**S.T.C.**—Sweden's new 100-kW broadcast transmitter at Hörby, supplied by Standard Telephones and Cables, operates on 1,131 kc/s. It is believed to be the first medium-wave broadcast transmitter to have incorporated a

**World of Wireless—**

grounded-grid amplifier. It is claimed that the distortion products do not exceed 1 per cent up to 95 per cent modulation over the frequency range of 5 to 10,000 c/s with an average mains conversion efficiency of 38 per cent.

**International Exhibition.**—The French Radio Council advises us that an international exhibition of radio components, accessories and measuring instruments will be held from February 4th to 8th at the Exposition Park, Porte de Versailles, Paris (15<sup>e</sup> eme).

**Amateurs in Germany.**—With the introduction on January 1st of the various changes in the international allocation of call signs in accordance with the Atlantic City Convention, amateurs in Germany are now using a two-letter prefix. Only Allied amateurs are so far licensed in Germany and the prefixes used are: DL2, British zone; DL4, U.S. zone; and DL5, French zone. When Germans are licensed, which is expected very soon, they will be allocated DL1, 3, 6, 7, 8, 9, and 0.

**Radio Seac.**—The power of the Radio Seac transmitters at Colombo, which are to be taken over by the Ceylon Government, was given as 7.5 kW only in our last issue. A power of 100 kW is employed on some frequencies.

**INDUSTRIAL NEWS**

**Test Gear Exhibition.**—A two-week exhibition is being staged by Marconi Instruments at their London Showrooms, 109, Eaton Square, London, S.W.1. Admission to the show—open Monday to Friday from February 21st to March 4th—will be by ticket obtainable either from Marconi Instruments, Ltd., St. Albans, Herts, or the above address.

**Ekco in India.**—An agreement has been concluded between E. K. Cole and the National Radio and Engineering Co. of Bombay for the establishment and development of radio manufacture and distribution in India. Plans are provided for the production of receivers, components and electronic equipment.

**Philco.**—Reference was made last month to the formation of the new company, Philco (Overseas), Ltd., which is now responsible for the design and production of British-made Philco sets. Another company has now been formed, Philco (Great Britain), Ltd., which has been granted the franchise (sales, service and advertising) of Philco products in this country. These announcements have coincided with changes in the organization of the Radio and Television Trust which, through its subsidiary, Philco Radio and Television Corporation, has previously been responsible for marketing Philco products in this country. It has now discontinued the manufacture of radio and television receivers and has wound up the Philco Radio and Television Corporation.

**S.T.C.**—The Rectifier Division of Standard Telephones and Cables has now been established in new premises at Warwick Road, Boreham Wood, Herts. The premises were used as a

shadow factory for rectifier disc manufacture during the war. The sales, engineering and production sections are in adjacent buildings.

**Changes of Address.**—The Sheffield office of Wild-Barfield Electric Furnaces and G.W.B. Electric Furnaces is now at 4, Paradise Square, Sheffield, 1 (Tel.: Sheffield 22776). General Electrical Radio Co., manufacturers of the "Mighty Midget" receiver described on page 24 of the January issue, have moved to 21-24, Shene Street, London, E.C.1.

**L.R.S.**—The price of the Goodman's Standard 12in speaker was misprinted in the advertisement of the London Radio Supply Co. in our last issue. The correct price is £6 15s.

**Audix.**—A London sales office has been opened by Audix, Ltd., at 116, Gloucester Place, W.1 (Tel.: Welbeck 9525).

**Wolsey Television, Ltd.**—This company's telephone number was incorrectly quoted in the last issue. It is Brixton 6651/2.

**EXPORT**

**B.o.T.**—Organizational changes in the Board of Trade are announced. The Commercial Relations and Treaties Dept. and the Export Promotion Dept. have been amalgamated and are now known as the Commercial Relations and Exports Department.

**Uruguay.**—Tenders are called for by the Uruguayan Director-General of Communications for the supply of two "diversity" receivers for C.W. and R.T. The specification and further particulars are obtainable from the Board of Trade (Commercial Relations and Exports), Room 1076, Thames House North, Millbank, London, S.W.1, quoting reference EPD.55447/48.

**South Africa.**—Tenders are called for by the Department of Posts and Telegraphs, Pretoria, for E.H.F. frequency-modulated equipment to be used in conjunction with a carrier telephone-telegraph system. The specification is available from the above address, quoting reference EPD.42958/48.

**Argentina.**—Agencies for radio components are required by Compania Comercial "Meryland," of 1301, San Juan Stret, Buenos Aires. Particulars of the company, whose activities cover Uruguay as well as the Argentine, are obtainable from the above address, quoting reference EPD.42664/48.

**MEETINGS****Institution of Electrical Engineers**

*Faraday Lecture.*—"Television" by Sir Noel Ashbridge, B.Sc. (Eng.) and H. Bishop, C.B.E., B.Sc. (Eng.), at 6.30 on February 16th at the Central Hall, Westminster, London, S.W.1.

*Radio Section.*—"The Development of Magnetic-Tape Recorders," by E. M. Payne at 5.30 on January 26th. (Joint meeting with the Acoustics Group of the Physical Society.)

"Direction-Finding Site Errors at V.H.F.," by H. G. Hopkins, B.Sc., Ph.D., and F. Horner, M.Sc., and "Scattering of Radio Waves by Metal Wires and Sheets," by F. Horner, at 5.30 on February 2nd.

Discussion on "Water-Cooling versus

Air-cooling for High-Power Valves," opened by J. Bell at 5.30 on February 15th.

All Radio Section meetings will be held at the I.E.E., Savoy Place, London, W.C.2.

*Cambridge Radio Group.*—"Noise and Bandwidth," by L. A. Moxon, B.Sc., at 8.15 on January 31st, at the Cavendish Laboratory, Cambridge. (Joint meeting with the Cambridge University Wireless Society.)

"Television," by D. Jackson, at 6.0 on February 22nd, at the Cambridge-shire Technical College.

*Mersey and North Wales Centre.*—Faraday lecture on "Television" at 6.45 on February 2nd, at the Philharmonic Hall, Hope Street, Liverpool.

"The Application of F.M. to V.H.F. Multi-channel Radio-telephony," by J. H. H. Merryman, M.Sc., and R. W. White, B.Sc., at 6.30, on February 7th at the Liverpool Royal Institution, Colquitt Street, Liverpool.

*North-Eastern Radio Group.*—A discussion on "Energy Conversion Devices for Electrical and Electronic Measurement of Non-Electrical Quantities," opened by J. C. Findlay at 6.15 on February 21st, at King's College, Newcastle-on-Tyne.

*North-Western Centre.*—Faraday lecture on "Television" at 7.30 on February 9th at the Houldsworth Hall, 90, Deansgate, Manchester.

*North-Western Radio Group.*—"Aids to Training—The Design of Radar Synthetic Training Devices for the R.A.F.," by G. W. A. Dummer, M.B.E., at 6.30 on February 23rd at the Engineers' Club, Albert Square, Manchester.

**Television Society**

"Television Transmission and Reception at 480 Mc/s," by M. Morgan, M.Sc., at 7.0 on January 26th, at the C.E.A., 164, Shaftesbury Avenue, London, W.C.2.

**Radio Society of Great Britain**

Annual general meeting at 6.30 on January 28th at the I.E.E., Savoy Place, London, W.C.2. The discussion on 420-Mc/s work announced last month will not be included.

*London Meeting.*—"Impedance Matching" by H. A. M. Clark, B.Sc. (Eng.), at 6.30 on February 25th, at the I.E.E.

**British Sound Recording Association**

"Disc Recording and Reproducing Stylis," by S. R. Lance, at 7.0 on February 25th at the Royal Society of Arts, John Adam Street, London, W.C.2.

**Institute of Navigation**

A symposium of papers on operational aspects of marine radar at 2.30 on February 18th at the Royal Geographical Society, 1, Kensington Gore, London, S.W.7.

**British Institution of Radio Engineers**

*London Section.*—A discussion on "Electronic Equipment for the Engineer," at 6.0 on February 17th at the Royal Empire Society, Northumberland Avenue, London, W.C.2. (Joint meeting with the Institution of Production Engineers.)

*South Midland Section.*—"Ceramic Capacitors," by W. G. Roberts, B.Sc., at 7.0 on February 24th at the Technical College, The Butts, Coventry.

Take a look inside the  
**ERIE** Insulated  
 High Stability RESISTOR



**FULLY PROTECTED  
 AGAINST SOLDERING  
 AND MECHANICAL  
 DAMAGE DURING  
 ASSEMBLY**

**QUALITY IS BUILT INTO EVERY DETAIL**

ERIE High Stability Resistors, besides displaying characteristics well within the limits laid down in the current R.C.S.C. Specification, are fully insulated, fully tropical and extremely robust; and are, therefore, eminently suitable for operation in restricted spaces and under the severest of conditions. Type

100, 1/4 watt, illustrated above, is the first to be released and will be followed in due course by Type 108, 1/4 watt; and Type 109, 1/4 watt. All standard tolerances down to  $\pm 1\%$ . Manufacturers and Research Establishments are invited to write for full details.

**ERIE** Resistor Limited

CARLISLE ROAD, THE HYDE, LONDON, N.W.9, ENGLAND

Telephone: COLindale 8011

Cables: Resistor, London

Factories: London and Gt. Yarmouth; Toronto, Canada; Erie, Pa., U.S.A.

2756



# 25 WATT & 50 WATT AMPLIFIERS

New high standard of stability and reproduction. Very high degree of amplification. Simplicity of operation.



**EXTREME SENSITIVITY.** Perhaps the most noteworthy feature of these amplifiers is their high sensitivity, which allows wide-range pick-up with low-level high fidelity microphones.

For example, the 25-watt has an overall power amplification of 133 d.b. or twenty-million-million-times. This is mainly achieved by the inclusion of a high-gain input stage completely enclosed in a rubber-mounted magnetic screening case.

**OUTPUT.** The output transformer of each amplifier is of generous size, and has an eight-sectioned primary in order that it can be included in the inverse feed-back loop. The following outputs are provided:—

Max. undistorted voltage (R.M.S.) 100, 50, 25 volts.  
Load impedance (25-watt) - - 400, 100, 25 ohms.  
Load impedance (50-watt) - - 200, 50, 12.5 ohms.

These amplifiers are normally intended to use with the 100-volt-line system in which each loudspeaker has its own transformer. This allows simple parallel connection of the loudspeaker load, the use of long lines, and the rating of loudspeakers in terms of their actual power consumption in watts.

#### MICROPHONE INPUT

Input required for full drive  
0.8 millivolts

Impedance - - 1 megohm

#### GRAMOPHONE INPUT

Input required for full drive  
90 millivolts

Impedance - - 0.25 megohm

 **PHILIPS ELECTRICAL**  
LIMITED

AMPLIFIER DEPARTMENT,

CENTURY HOUSE, SHAFTESBURY AVENUE, LONDON, W.C.2

Only with **CO-AX**  
R.F. CABLES

AIR-SPACED ARTICULATED

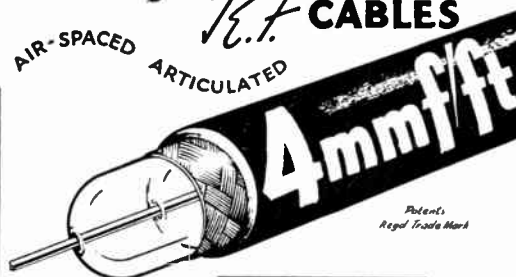

Patents  
Regd Trade Mark

THE LOWEST EVER  
CAPACITANCE OR  
ATTENUATION

IMMEDIATE  
DELIVERIES  
FOR HOME  
& EXPORT

Write or call for data sheets or literature to  
the originators of flexible air spaced R.F. Cables.

**TRANSRADIO LTD.**

CONTRACTORS TO H.M. GOVERNMENT  
138A CROMWELL ROAD LONDON SW7  
TRANSRADIO LONDON

LOW WATT TYPES	IMPED OHMS	ATTEN dB/100ft at 100 Mc	LOADING dB/100ft at 100 Mc	Q.D.*
A 1	74	1.7	0.11	0.36
A 2	74	1.3	0.24	0.44
A 34	73	0.6	1.5	0.88
LOW CAPAC TYPES	CAPAC pF/ft	IMPED OHMS	ATTEN dB/100ft at 100 Mc	Q.D.*
C 1	7.3	150	2.5	0.36
P.C.1	10.2	132	3.1	0.36
C 11	6.3	173	3.2	0.36
C 2	6.3	171	2.15	0.44
C 22	5.5	184	2.8	0.44
C 3	5.4	197	1.9	0.64
C 33	4.8	220	2.4	0.64
C 44	4.1	252	2.1	1.03

HIGH POWER  
FLEXIBLE

PHOTOCELL  
CABLE

VERY LOW  
CAPACITANCE

**If you are after ...**

- I.E.E.,
- BRIT.I.R.E
- CITY & GUILDS ...

IN YOUR OWN INTERESTS first find out the regulations governing the above examinations before taking a course of study.

We will gladly supply the necessary information together with our FREE BOOKLET which gives details of POSTAL and ATTENDANCE courses covering the above and other examinations—Postal Courses in Radio, Television, Maths, etc.—2 and 3 year Day Courses in Telecommunications Engineering. The booklet also contains particulars of EXEMPTIONS from I.E.E. and Brit.I.R.E. examinations to holders of C. & G. certificates covered by our courses.

Special terms for groups of five or more postal students enrolling together. Students not requiring full courses may take parts at correspondingly reduced fees.



Write for Booklet to:

**E.M.I. INSTITUTES LTD.**

Dept. 164 43 Grove Park Road, Chiswick, London, W.4.  
Telephone CHiswick 4417/8

E.M.I. Institutes—backed by the Electronic Organisation which includes  
"H.M.V.", Marconiophone, Columbia, etc.

E.108

# MAGNETIC AMPLIFIERS

## Principles, Operation and Functions

By "CATHODE RAY"

SOMETIMES magnetic amplifiers are called d.c. transformers. In appearance at least they might easily be mistaken for transformers, even when examined closely, because they consist mainly of iron cores wound with two or more coils. The name is further justified to the extent that if you put d.c. through one of the windings you can get a higher voltage or current from the other. But they differ fundamentally from a.c. transformers in that it is possible—in fact quite usual—for both voltage and current to be higher at the same time. The idea of perpetual motion having been long ago abandoned, it is hardly necessary to say that the extra power thus obtained must be put into the device somewhere, in some form. In principle, therefore, it is more like the valve amplifier, in which the output power is *controlled* by the grid input but is actually provided by the anode supply.

That is almost as far as the resemblance to a valve amplifier goes. There are plenty of differences, besides the appearance and construction. In spite of working at zero-frequency, the control input demands appreciable current. Its action is far from instantaneous, the time lag being of the order of hundredths or even tenths of a second. The source of power is a.c.; 50c/s is possible but 400-1,000c/s generally much more effective. The output is also a.c., of the same frequency (plus harmonics), which of course can be rectified if d.c. is preferred.

Although the basic principles of the magnetic amplifier are not new, they are probably unfamiliar to most *Wireless World* readers. And they are a little more difficult to follow than the principles of the valve amplifier. Whereas one can represent the characteristics of a valve in the form of a family of curves con-

necting control-grid voltage directly with anode current, and from such a diagram deduce the performance with fair accuracy, a magnetic amplifier's characteristics have an awkward middle-man—the magnetic flux in the core. His relationship with current can be expressed quite directly by a curve, but his relationship with voltage is of the rate-of-change sort. Although this is familiar enough in connection with ordinary iron-core chokes and transformers, the portions of magnetization characteristics worked over in magnetic amplifiers are by comparison unorthodox, to say the least. I am reminded of the shock the distortion-hunting quality-enthusiasts received when at the outbreak of war they were obliged to study how valves were used in radar.

Fig. 1 is a typical characteristic curve for iron. By "iron" I mean any metal or alloy suitable

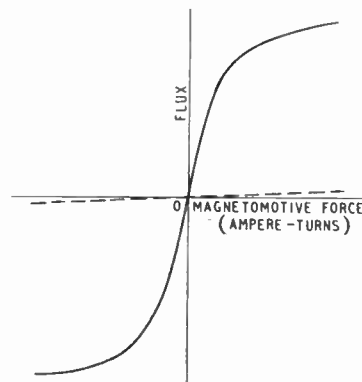
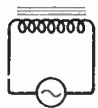

Fig. 1. Typical magnetization characteristic for iron (full line) compared with air (dotted).

for magnetic cores. Actually, owing to the effect called hysteresis, the upgoing and downcoming curves separate to form a loop; but that is one complication we can happily ignore for the purpose of this elementary treatise.

Consider now a simple iron-cored coil connected to an a.c. supply (Fig. 2). Assuming that the resistance is negligible, the current is limited only by the back-e.m.f. generated by the magnetic flux linking the turns of the coil, and that back-e.m.f. has to be practically equal to the applied voltage. As we know, the e.m.f. is proportional to the rate at which the flux changes, and to the number of turns. The rate at which the flux changes is proportional to the peak flux during each cycle, and to the number of cycles per second. (And to a minor extent on the waveform).

Fig. 2. The current in this circuit can be made extremely small if the slope of the magnetization curve is nearly vertical, as in Fig. 3.



So the current that flows is the amount which is necessary to set up the right amount of flux to generate the back-e.m.f. The greater the flux per ampere-turn, the smaller the current. Air and most other substances have a very low flux per ampere-turn (i.e. low permeability), as indicated by the small slope of the dotted line in Fig. 1. The advantage of "iron" is that it has a much higher—sometimes enormously higher—permeability, and so the magnetizing current is comparatively very small and the impedance of the coil very large.

This advantage is complicated by the fact that the permeability is not constant. As shown by the slope of the curve in Fig. 1, it decreases at first gradually and then very rapidly as the flux increases to saturation. The designer of chokes and transformers generally makes sure that his core section and number of turns are sufficient to generate the required back e.m.f. without departing from the steep and comparatively straight part of the curve at any point in the cycle of current.

The other familiar fact to recall is that the lower the frequency the greater the peak flux must be to maintain the same rate of change and generated e.m.f.

**Magnetic Amplifiers—**

Suppose now that a type of "iron" is selected which gives an almost vertical initial slope followed by rapid and complete saturation (Fig. 3). Provided that the coil has been designed so that the flux needed to generate the back-e.m.f. is less than saturation value, the ampere-turns required, and hence the current drawn, will be almost negligible. In other words, the impedance of the coil is nearly infinite. The working point can be pictured as moving up and down the precipitous slope in Fig. 3 at supply frequency.

Next, suppose that another coil is wound over the same core, and a small d.c. is passed through it. Except for the first few moments, when this current is growing, there is no rate of change of current and therefore no back-e.m.f. The current is limited only by the resistance of the circuit. With the Fig. 3 characteristic, anything more than a minute current must bring the working point over the upper or lower bend and into the saturation region; say to the point A.

Before we consider the obviously very upsetting effects of this on the a.c., let us dispose of the fact that, with a single core as imagined, the d.c. circuit acts as a secondary winding of a transformer and loads the a.c. supply. This effect can be avoided by

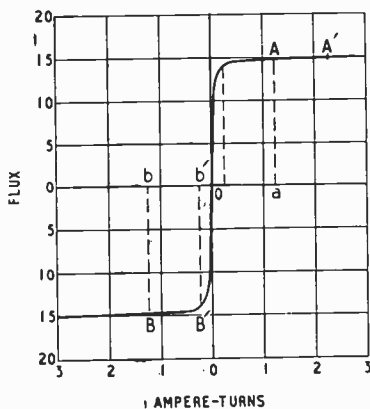

Fig. 3. Type of core characteristic suitable for magnetic amplifiers.

splitting the system into two halves, as in Fig. 4, with one d.c. winding reversed. The alternating voltages generated in the

two d.c. coils will therefore cancel one another out; and if one core works at point A (Fig. 3) the other will, from the a.c. point of view, work at B.

Now consider what happens during each cycle of the a.c. Remember that the current is still bound to make the flux vary in such a way as to generate an alternating back-e.m.f. of sine waveform (assuming a sine-wave supply). Let us start with the half-cycle in which the a.c. in coil A adds to the d.c. magnetization. This is represented by point A in Fig. 3 moving to the right. It is clear that the current can rise indefinitely without causing the flux to change very much, and no appreciable e.m.f. can be generated in this coil. But in

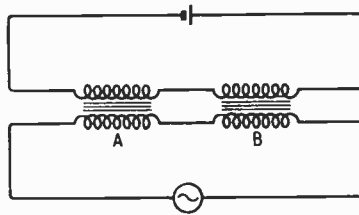

Fig. 4. Two-core system for balancing out alternating voltage in d-c circuit.

coil B the a.c. is opposing the d.c. and no sooner has it reached a value that brings the working point from B to B' than the flux begins to change at a very rapid rate indeed. A very small further rise in current is therefore sufficient to generate the whole of the required back-e.m.f. for this half-cycle in coil B alone. The current in coil A is, of course, the same, so actually goes only as far as A'.

The flux and current waveforms during this half-cycle will evidently be something like those shown in Fig. 5. The current waveform is nearly square, the uprights corresponding to the almost instantaneous shifts from A to A' and B to B' in Fig. 3, during which the flux-change and back-e.m.f. are negligible; and the nearly flat top corresponds to the steep slope up from B' To generate a sinusoidal e.m.f. the flux must vary sinusoidally. It does so in phase with the current, of course; and since one core is saturated all the time the varia-

tion of flux occurs almost entirely in the other.

Continuing the argument on the same lines for the second half-

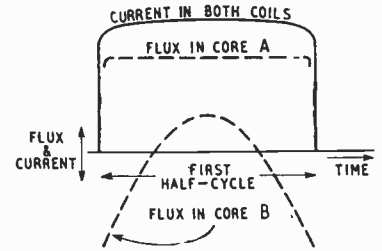

Fig. 5. Theoretical waveforms during one half-cycle in Fig. 4, with no a.c. in d-c circuit.

cycle we get the same shapes upside-down; so a sequence of waves would look like Fig. 6.

What we are most interested in, however, is not the waveform but the magnitude of the a.c. Instead of being negligible, as it was when no d.c. flowed, its value is now represented by AA' or BB' in Fig. 3, divided, of course, by the number of turns. Suppose the a.c. and d.c. coils have equal numbers of turns. The strength of the d.c. is then proportional to  $oa$ , and the a.c. to  $bb'$ , which is almost equal. But whereas quite a small voltage is likely to be sufficient to cause that d.c. to flow against only the resistance of the coil, a very much larger alternating voltage can be used without saturating the core in the no-d.c. condition. That voltage is, of course, proportional to the flux  $bB$  and to the frequency of the a.c. So to get a large step-up in voltage the iron should have a large saturation flux and the frequency should not be low. (For other reasons it should not be too high either; 400-1,000 c/s is usually recommended.)

As with a valve, the amplified voltage is not very interesting unless it is available outside the amplifier, in some sort of load. A load can be connected in series with the a.c. supply, and the a.c. will flow through it. Assuming that the supply voltage is constant, the voltage developed across the load (and hence the power in the load) must be at the expense of that across the coils. A little thought leads us to the conclusion that, with such remarkably suitable core material as



Fig. 3 indicates, the output current is only very slightly affected by a reduction in alternating voltage; so remains nearly equal to the d.c. even when the output voltage is substantially greater. In other words, the device is a power amplifier.

It is also its own output transformer, because there is no need to stick to a one-to-one a.c./d.c. turns ratio. If desired, the input current can be stepped up (hence the term "d.c. transformer").

Reversing the direction of the d.c. makes no difference to the external results. So a graph of a.c. ampere-turns against d.c. ampere-turns looks like Fig. 7. With perfect core material, having a characteristic made up of truly vertical and horizontal portions instead of the nearly perfect Fig. 3, the lines in Fig. 7 would slope at 45° from zero, and would be independent of the voltage of the a.c. supply; but in practice some a.c. flows even with zero d.c., and the slope is less than 45° and varies with supply voltage.

The foregoing explanation is all rather idealistic, because we have neglected a very awkward complication. We have been assuming all along that the balanced coil device of Fig. 4 would succeed in preventing a.c. from flowing in the d.c. circuit. To do so the alternating voltages induced in the two d.c. coils must be exactly opposite at every moment. That means that they must be identical

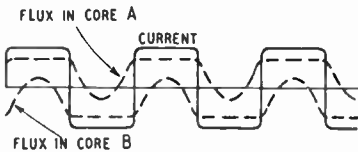

Fig. 6. Continuation of Fig. 5 for several cycles.

in waveform. When no d.c. flows, the fluxes in the two cores (if they and the windings are identical) are both sinusoidal, and the supply voltage is at all times divided equally between coils A and B. But look at Fig. 6, showing the two flux waves when d.c. flows. If you invert one of them, to represent the d.c. point of view, it is very far from being equal and opposite to the other. During any half-cycle, the flux

change is confined almost entirely to one of the two cores, so the alternating voltage generated by it in the d.c. winding is hardly opposed at all by the other, and, unless it were prevented by high-impedance chokes, would cause an a.c. to flow in the d.c. circuit and through the d.c. coils, upsetting our simple theory rather badly by making its own contribution to the magnetizing (or demagnetizing) of the cores.

In practice it is not usually convenient to prevent this a.c. from flowing. As a result, the wave-

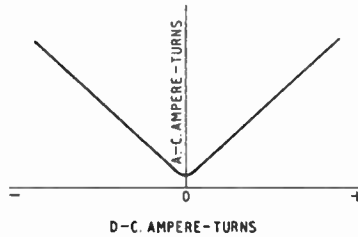

Fig. 7. Input/output characteristic of simple magnetic amplifier.

forms actually obtained are quite different from those in Figs. 5 and 6. The results as an amplifier, which are the important thing, are not so very different, however; and this is my excuse for having led you up a rather lengthy theoretical garden. Fig. 7, modified as necessary by the imperfections of the iron used, holds more or less good.

In case any readers are tiresome enough to insist on knowing what goes on inside the amplifier when the d.c. coils provide an a.c. path, I offer the following argument.

If we are not to be allowed to assume that the a.c. impedance of the d.c. circuit is infinitely large, the next simplest assumption is that it is zero. That being so, any a.c. which flows cannot set up an alternating voltage between the d.c. terminals. But we know that there are alternating voltages across the separate d.c. coils, because they are close-coupled to the a.c. coils. Assuming for simplicity that the turns ratio is 1:1, and that all the flux links all of both coils (i.e., no magnetic leakage from the core), the alternating voltages across the a.c. and d.c. coils are equal. On the a.c. side they add up (assuming zero load resistance) to be equal and oppo-



THE "FLUXITE QUINS" AT WORK

"Now hold that new aerial tight While we fix it firm with FLUXITE."  
 "Look out!" shouted OH,  
 "Too late! Drat the snow!  
 There'll be no television to-night."

See that FLUXITE is always by you — in the house — garage — workshop — wherever speedy soldering is needed. Used for over 40 years in Government works and by leading engineers and manufacturers. Of all Iron-mongers—in tins, 10d., 1/6 & 3/-.

TO CYCLISTS! Your wheels will NOT keep round and true unless the spokes are tied with fine wire at the crossings AND SOLDERED. This makes a much stronger wheel. It's simple—with FLUXITE—but IMPORTANT.

The FLUXITE GUN puts FLUXITE

where you want it by a simple pressure. Price 1/6, or filled, 2/6.



ALL MECHANICS WILL HAVE

**FLUXITE**

IT SIMPLIFIES ALL SOLDERING

Write for Book on the ART OF "SOFT" SOLDERING and for Leaflets on CASE-HARDENING STEEL and TEMPERING TOOLS with FLUXITE. Price 1d. each.

**FLUXITE LTD.**

(Dept. W.W.), Bermondsey Street, S.E.1

**Magnetic Amplifiers—**

site to the sinusoidal supply voltage; on the d.c. side they exactly cancel out. The only waveform

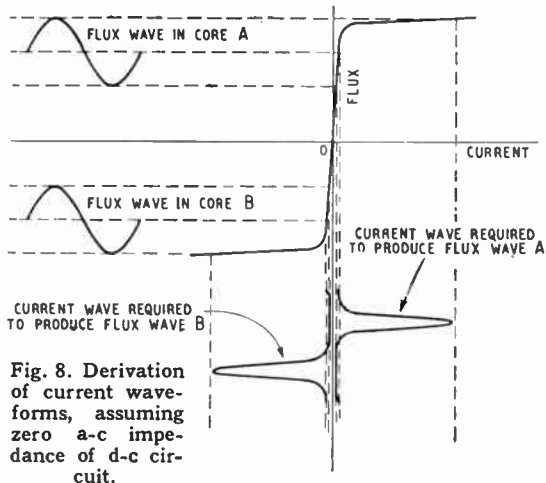

Fig. 8. Derivation of current waveforms, assuming zero a-c impedance of d-c circuit.

that can satisfy both these requirements at once is sinusoidal. To generate sinusoidal voltages in both coils, the flux waves in both cores must be sinusoidal. These flux waves are the result of the net current waves in a.c. and d.c. coils.

To generate sinusoidal flux waves from points A and B in Fig. 3 would seem to be impossible without fantastically high current peaks during the half-cycles working in the saturation region; but as you will see in a minute or two, the distortion of the current wave causes the mean flux for a given value of d.c. to be pushed round the saturation bends towards the origin.

This knowledge has been anticipated in Fig. 8, which reminds one of the diagrams used to show rectification of a signal by non-linear valve characteristics. The two current waves which this graph shows to be necessary to produce the sinusoidal flux waves are, as I have said, the net current waves acting on the two cores; that is to say, the combined effects of the currents in the a.c. and d.c. coils. But since the two a.c. coils are in series, the currents flowing through them must be identical; and similarly for the d.c. coils. The problem is to analyse these two current waves into the parts flowing in the a.c. and d.c. coils respectively.

That may sound difficult, but

actually is not. Let  $x$  stand for the current in each a.c. coil, and  $y$  for the current in each d.c. coil. Because one d.c. coil is reversed, we know that current wave  $A = x + y$  and  $B = x - y$ . Adding A and B together gives  $2x$ , and subtracting them gives  $2y$ . So we only have to add waves A and B and halve the result to get the current in the a.c. coils, and subtract A from B and have the result to get the current in the d.c. coils. This operation is performed graphically in Fig. 9.

Even this triumph of reasoning does not get us very near real practical waveforms, because we have made so many simplifying assumptions. When the impedances of control and load circuits and various other things are taken into account, the problem becomes very stiff. The amplitude of the a.c. still approximates to that of the d.c., however (for equal turns), and it can be seen that the fundamental frequency of the a.c. in the d.c. circuit is twice that of the supply.

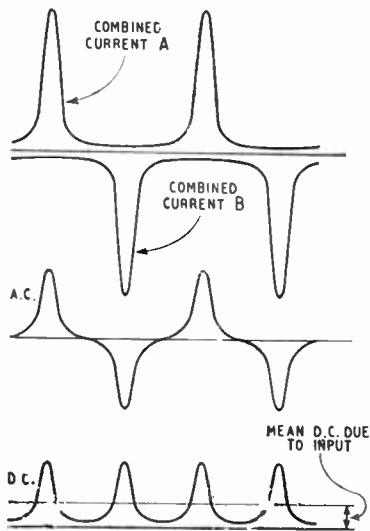

Fig. 9. Analysis of combined current waveforms from Fig. 8 into currents in a-c and d-c circuits.

There are many different kinds of "irons" from which to choose for making cores; some have only very gradual bends instead of the sharp saturation knee of Fig. 3; some have their knees higher up; and some climb to saturation less steeply. How do these features affect the performance of the amplifier?

If the steep slope is not so steep (that is to say, if the permeability is low or only moderate), then a correspondingly large control d.c. is necessary before saturation sets in and causes the a.c. to begin to rise at its full rate. In other

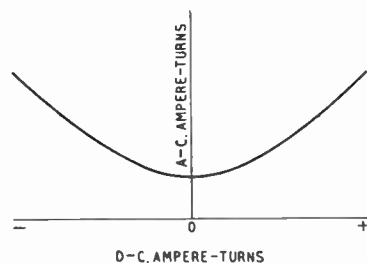

Fig. 10. Characteristic of amplifier using core material of lower permeability.

words, the amplifier is insensitive to small signals, and instead of Fig. 7 one gets a curve more like Fig. 10. The output also depends more on the supply voltage. We have already seen that the magnitude of flux at the knee determines the maximum alternating voltage (of a given frequency) that can be used. So if the core saturates at a low flux density it limits the output power.

Mumetal has a quite phenomenally steep slope, but a low saturation density; so it is particularly suitable for a low-power sensitive amplifier, but not so suitable when the power output is to be of the order of several watts, especially as it is expensive. For the higher powers it is much more economical to use Radiometal or even Stalloy, in spite of the lower gain. One can make up for the lower gain by using more than one stage of amplification.

An alloy recently developed for magnetic amplifiers and similar purposes is H.C.R. metal. Its maximum permeability is not quite so high as Mumetal's (about two-thirds) but is far ahead of most others; and in suddenness

of saturation it beats even Mumetal. Fig. 3 is, in fact, an H.C.R. metal characteristic, adapted from data supplied by the makers (Telegraph Construction and Maintenance Co., Ltd.). It has been simplified by taking a mean between the up and down tracks of the hysteresis loop. The flux scale refers to a core section of 1 sq cm, so is also a flux density scale in kilogauss, when the ampere-turn scale refers to 1 cm core length.

As I said earlier, if a d.c. output is wanted it can be obtained by rectifying the a.c. Selenium rectifiers are commonly used. If the whole or part of this d.c. is passed through coils wound on the cores, the amplifier characteristics are considerably modified. It is quite easy to find out how. Suppose PQR in Fig. 11 is the original amplifier characteristic. Now draw a curve, OS, showing rectified amp-turns (on the d.c. scale) against a.c. output. If the rectifier were perfect it would, of course, be a straight line. Now

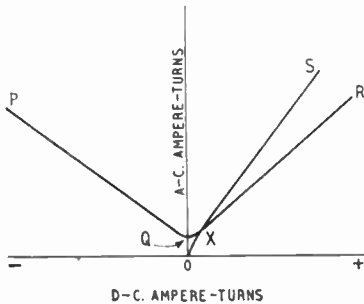

Fig. 11. Combination of amplifier characteristic (PQR) with "feedback" characteristic (OS) to give modified amplifier characteristic (Fig. 12).

the total d.c. magnetization is equal to the input (measured along the horizontal scale) plus the rectified output (indicated by the horizontal distance of the line OS from the vertical scale).

In Fig. 11 the "feedback" characteristic starts from O on the d.c. scale, so its intersection, X, with PQR marks the working point with no input. It can be transferred to a new diagram (Fig. 12), where it appears as Q'. To find working points corresponding to positive or negative inputs, move the curve OS bodily along so that its foot marks the

input, and transfer the intersections with PQR to Fig. 12. When joined up they give the new amplifier characteristic, P'Q'R'.

Its two outstanding features are its lack of symmetry, meaning that the polarity of the input now matters; and the increased steepness on one side, meaning that d.c. of that polarity is more highly amplified.

If the amount of rectified "feedback" is increased until its line OS in Fig. 11 runs nearly parallel to the simple amplifier characteristic QR, the amplification approaches infinity. But it may be inadvisable to work too close to this condition, because if the "feedback" slope cuts the other line at more than one place the amplifier becomes unstable and the working point flies suddenly to one end or the other—a condition which, however, has its uses, such as working relays. If the zero-input working point occurs in the middle of the steep part, the resulting characteristic (dotted in Fig. 12) indicates an output that corresponds to the input in polarity as well as in magnitude.

Another means of controlling the amplifier characteristics is familiar to valve users—"bias." The only difference, of course, is that it is current instead of voltage. Bias current can be conveniently obtained by rectifying the supply a.c.

I have persistently put "feedback" in inverted commas because although this scheme bears an obvious similarity to feedback in valve amplifiers, and is often so named in connection with magnetic amplifiers, it is not on all fours with it. For one thing, there is not the same distinction between positive and negative

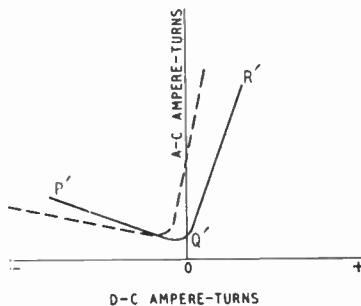
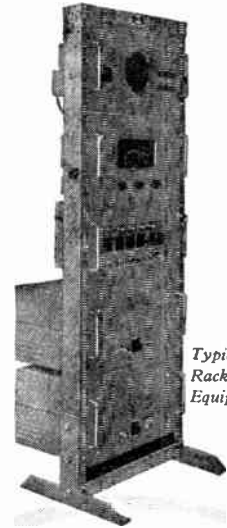

Fig. 12. Amplifier characteristic with self-excitation.



Typical Trix Rack-Mounted Equipment.

Whatever your  
**P.A.** requirements

**TRIX**

Quality  
SOUND EQUIPMENT

will do the job

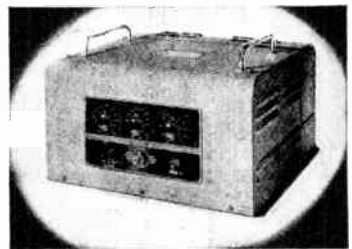

30-WATT AMPLIFIER T.633B

Three stage, high gain type. Push-pull output circuit with inverse feed back. Embodying all the features responsible for the success and efficiency of the original T.633, with up-to-date refinements of design and finish. The circuit provides facilities for speech music switching or mixing to suit all conditions of operation.

Other Models available 5-500 watts and full range of accessories.

THE TRIX ELECTRICAL CO., LTD.  
1-5 Maple Place, Tottenham Court Road,  
London, W.1. Phone: Museum 5817.  
Grams & Cables: "Trixradio, Wesdo, London."

AMPLIFIERS • MICROPHONES • LOUDSPEAKERS



**Magnetic Amplifiers—**

feedback. The polarity of the current fed back depends only on the connections; not on the polarity of the input, as in valve amplifiers. If the connections are reversed, the only difference is to reverse the + and - in Fig. 12.

(which, incidentally, worsens as the gain is increased), the magnetic amplifier is restricted to d.c. applications. Being current-controlled rules it out even from d.c. applications if the signal source resistance is very high.

The applications of magnetic

best with high-impedance circuits, magnetic amplifiers are easier to design and make for low impedances. They are more robust and long-lived than valves, more reliable and have no socket contacts or microphony. They incorporate their own impedance-matching transformers, are more stable than valve d.c. amplifiers, generally need no power smoothing systems, and enable several separate control inputs to be combined without conductive connection.

One typical use is for enabling a robust meter movement or a relay to be operated by a light- or heat-sensitive device such as a barrier layer cell or a thermocouple. Lights can be automatically turned on when daylight fades. Servo-mechanisms and power-control systems of many kinds find magnetic amplifiers a help. The V2 rocket was a rather unhappy example of this.

Working input can be as low as 0.001 microwatt, and power gains per stage are limited mainly by the necessary stability—anything up to 10,000 is within reason. For higher gain or stability more than one stage is preferred.

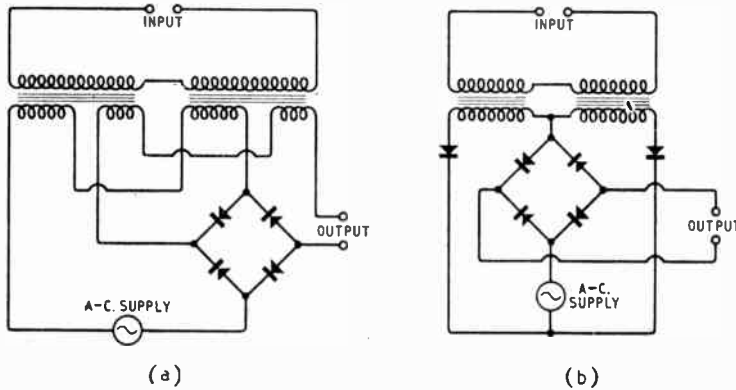

Fig. 13. (a) Example of self-excitation circuit. (b) Example of auto-excitation circuit.

With either connection, the effects of both positive and negative feedback can be obtained according to whether the working point is to left or right of the lowest point on the curve. So the description "self-excitation," which will be familiar to dynamo experts, is generally preferred. One obvious way of applying it is by passing the rectified output through a third pair of coils (Fig. 13a). An advantage of this method is that the amount of self-excitation can be adjusted very precisely. But, of course, the extra windings make the whole thing larger. An alternative, shown in Fig. 13(b), and described as "auto-excitation," is to rectify the current through the a.c. coils.

A difficulty about using "feedback" to get a very high stage gain is that the amplifier is made much more sensitive to the alternating supply voltage. One way of obviating this is to connect amplifiers in push-pull.

But there is no need to go into all the possible arrangements. What is likely to be of more concern to readers new to magnetic amplifiers is whether they are likely to supersede valve amplifiers. The answer should by this time be a fairly clear negative. Owing to its sluggish response

amplifiers are mainly outside the main stream of *Wireless World* interests, and non-competitive with valves. Whereas valves, being voltage-controlled, are at their

## B.B.C. TELEVISION MAP

(See Page 55)

THE map reproduced on p. 55 shows the results of a survey recently carried out by the B.B.C. Research Department. The survey was extended well beyond the boundary of the nominal service area.

The field-strength measurements, from which the contours plotted on the map have been derived, were made at several places along eight routes radiating from Alexandra Palace, up to distances of about sixty miles. Whenever possible, places in open country were chosen, where there were no nearby hills or buildings that might produce reflected components of field strength, which could give misleading results. In order to take account of the substantial variations in field strength that occur at these frequencies between points which are almost contiguous, a continuous record of the field strength at each place was made as the vehicle in which the measuring equipment was installed moved slowly along. The average value of field strength at each place was then determined from these records. The aerial on the vehicle was twenty feet above

the ground, and as the average height of television receiving aerials is nearer thirty than twenty feet, the measured values were subsequently corrected to get the field strength at thirty feet above ground, these corrections being made on the assumption that the gain of the aerial increased linearly with height. All the measurements were made while the transmitter was radiating either normal programme or the "artificial-bars" signal, and the results were then multiplied by a factor to obtain the peak field strength, which corresponds to the white elements in the picture.

Some additional measurements were made at each of the principal towns within the area. The field strength there was usually less than in the surrounding country by between three and six decibels, and this reduction should be remembered when using the contour map, since, to avoid undue complication, closed contour loops have not been drawn around the towns.

The stippling on the map indicates the area within which considerable fading may be experienced.

## LETTERS TO THE EDITOR

### Higher Definition Television? ♦ Inverted Omega for Inverted Ohm ♦ Clearing Up Scale Distortion ♦ Uses of Signal-strength Meters

#### Television Standards

**M**AY I make an emphatic plea in favour of an experimental high-definition television system, which I hold to be economically feasible. The gist of usual objections can be summarized as follows:—

1. Higher writing speed would be necessary.
2. Present sets do not do full justice even to existing standards.
3. The cost of a very wide band amplifier would be prohibitive.
4. Scanning power for the line time base would be much increased.
5. American sets working to higher standards show disappointing performance.
6. Land lines and cables would be unable to deal with higher definition transmissions.

I shall try to show that none of the above objections are as serious as they may appear at first glance;

1. *Spot size.*—Modern transmitting and receiving tubes are capable of resolving a raster corresponding to 800 lines; the plastic lens projection system, developed by I.C.I., is capable of dealing with even more lines.

2. *Present receivers.*—In the laboratories of our leading set and valve manufacturers receivers are demonstrated which make full use of the wide band transmission from Alexandra Palace, and some manufacturers maintain their high standard in actual production. It is now up to the transmitter to establish a new lead.

3. *Wide band amplifier.*—The new B.B.C. transmitters will operate in single-sideband mode, thus resulting in substantial frequency band economy. It can be stated generally, that due to selectivity demands (avoiding sound on vision and vision on sound) the number of tuned circuits of a vision amplifier cannot be reduced safely below 7 to 8 (including wavetraps), while it is possible to obtain satisfactory gain with three valves only of the modern miniature type. With a higher definition system and hence wider carrier spacing, the selectivity problem, if anything, might be eased, which means that the number of valves only, and not of tuned

circuits, would have to be increased and thus lead to a more balanced distribution of both. A single-sideband receiver for a 700-line system will perform adequately with five valves tuned by single staggered circuits, so that the additional complication and expense are less frightening than expected. Perhaps secondary emission valves of the EE50 type will return with a more reliable performance and simplify the problems of a very wide band amplifier.

4. *Scanning power requirements.* We witnessed in recent years remarkable improvements in the design of scanning systems. By efficient use of energy recovering diodes and optimal design of scanning coils the increased demands on line timebase power can be met easily, thus an experimental R.C.A. system requires 66 watts power input for a line frequency of 31.5 kc/s and an e.h.t. of about 10 kV.

5. *American picture quality.*—The big discrepancy between the American laboratory and production performances can be explained by indifferent transmitter quality, mass production methods, etc. If we in this country can obtain good pictures with 405 lines, they will be better still with 700 lines.

6. *Losses in coaxial cables and lines;* these are serious, and the obvious answer is: do not use them, but microwave links only.

A different matter has also to be considered, the problem of the transmitting system; the high-definition transmitters of the future might use the Videosonic method. Its advantages are obvious; saving in frequency band, omission of a separate high power sound transmitter, omission of a separate sound amplifier in the receiver and sound interference suppression due to properties of pulse modulation. The audio band, rather restricted at present, will be widened considerably with an increased number of lines, and the main objection to the Videosonic system would thus disappear.

Summing up, it seems to me, that a high definition receiver is feasible both technically and economically, and that the establishment of an experimental transmitter of about 650-700 lines in the near future is desir-

## NEW ECONOMICAL A Two-Purpose Loudspeaker which Saves Capital Expenditure



Pat. Applied For

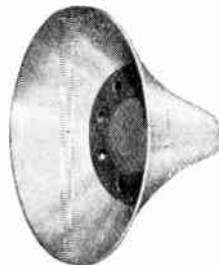

Always there has been the difficulty in many applications, whether the Horn type loudspeaker with its high power possibilities, or the Cone type with its greater frequency range for the same size, is to be used for any particular installation. Both types have their advantages and limits. This new design by F.I. enables the major components of two types to be interchangeable. Main flare, fixing device and assembling nut are common to either of two assemblies. Add centre section and L.S.7. unit for a complete re-entrant horn type 42 REH, or add PAC 6 and special mounting to have a cone and directional baffle system: 42 RC. Whichever type suits you most, you have the opportunity of acquiring the components for the alternative assembly when you are in need of them.

**F.I. for P.A.**  
HORN LOUDSPEAKERS  
CONE LOUDSPEAKERS  
MICROPHONES

**FILM INDUSTRIES LTD.,**  
60, PADDINGTON STREET, W.1

Telephone: WELbeck 2385

### Letters to the Editor—

able. Some countries are preparing television systems with 625 and 819 lines already. In 1936 the present B.B.C. 405-line system was considered by many to set too high a standard; let us set a new one once more to be replaced later by a colour or a stereoscopic system or both.

A. LANDMAN.

The Plessey Company,  
Ilford, Essex.

### “Cathode Ray” Articles

“Admittance.”—Since I proposed, under this heading, that the symbol “ $\mathcal{U}$ ” would be a suitable one to fill the gap which exists alongside the term “Mho,” my attention has been drawn to the fact that it has already been used for this purpose by the Dubilier Condenser Company in a technical booklet published some years ago. I am very glad to acknowledge this prior use, because it might suggest to the appropriate B.S.I. committee that it is about time they filled this gap in their book of standard Engineering Terms and Abbreviations. We have been writing “mA/V” too long and are tired of it.

“Scale Distortion.”—While making acknowledgments I must also admit that perhaps my comments on Mr. Casey’s article were rather harsh. I still hold, however, that his references to my pre-war dicta on Scale Distortion were misleading, and that the quotations he makes from them in his letter in the January, 1949, issue are, without their context, also misleading. To avoid perpetuation of misunderstanding may I briefly sketch in that context?

In the first article on Scale Distortion (24.9.37) I nowhere suggested that an enormous power was necessary to reproduce loud programmes at their original intensity; in fact, I gave at least equal prominence to scale distortion caused by reproducing speech at *above* its natural intensity, and the “weighting network” I advocated for listeners who were not technically intelligent was Music/Speech switch giving a bass cut, to correct this frequently heard condition, if they would not adjust the volume correctly.

But since some readers imagined the contrary, I wrote later (10.3.38): “there are some who thought that my idea of ‘original’ sound intensity meant the result that would be obtained if the whole B.B.C. Symphony Orchestra or other source of sound were performing in the listener’s back parlour; in other words, if the orchestra is capable of putting out 100 watts of sound, so must the loud speaker. I hope the subsequent correspondence

succeeded in making clear that such a dreadful thought was far from me. At the same time, I did feel that as my examples were based on assumed figures it would be much more satisfactory to work on actual measured sound intensities.”

I thus entered on the Queens Hall tests with an open mind rather than “to prove that there was such a difference between the actual and reproduced levels of sound that a weighting network was necessary.”

In the earliest article, and ever since, I have emphasized the fallaciousness of the more or less automatic “bass compensation” schemes. I suggested “a fairly comprehensive system of tone control” for intelligent listeners, so that they could get the balance of tone they liked best during each programme condition, since the setting of the volume control does not in general correspond in magnitude or even in sign with scale distortion, still less with the overall correction desirable.

“CATHODE RAY”

### “Antiference”

WE should like to draw attention to the fact that the use of the word “Antiference” in connection with anti-static devices (which sufficiently resembles our trade name and registered trade mark “Antiference”, to lead intending purchasers to believe that we are the manufacturers) is in our view a clear infringement. Legal steps will in future be taken to deal with all such infringements.

NORMAN S. BEEBE,

Director, Antiference, Ltd.

London, W.1.

### Value of an S Meter

YOUR correspondent G2MC, I think, puts the case a little strongly when he questions the need for the provision of an “S” meter in a communications receiver on the grounds of discrepancies in reports.

These discrepancies are all too familiar, of course, and for reports to be of the value they ought to be, some standard of meter calibration is required. Until such an ideal is attained we will continue to be inflicted with telephony reports of “50 db over S<sub>9</sub>” from DX stations or “100% readable and S<sub>1</sub>.”

However, the only alternative to an “S” meter is reliance on the human ear, which is far from being an accurate measuring device. All the anomalies and snags pointed out by 2MC apply equally to reports given by ear.

Surely the two obvious advantages of an “S” meter are (1) The ability to give accurate *comparative* reports on small changes of received

carrier level to a station conducting tests, and (2) the giving of reports when the a.v.c. is operating—for when it is operating properly the only marked difference to the ear between two signals of different level should be a change in background noise.

A third useful feature is in the checking of the receiver’s performance. A known signal such as that from the station’s own crystal calibrator can be used as a reference and if there is some doubt whether poor signals are due to loss of receiver performance or to “conditions” the “S” meter reading from this known source can be used as a check.

2MC is right when he says that the “S” meter depends on the design of the preselector. In fact, this is the commonest cause of discrepancies. The usual case is that the *gain*, though not necessarily the sensitivity, of the “front” end of the receiver varies widely from the h.f. to the l.f. end of a range and from one range to another, and thus the voltage passed to the i.f. amplifier and therefrom *via* the a.v.c. to the “S” meter will vary widely for a constant input at the aerial terminals.

In a receiver without constant gain the manufacturer should state what correction should be applied to the meter readings on various bands.

Questions of aerial efficiency and site conditions apply equally to aural reports; all the operator can do is to quote the aerial gain (or loss) compared to a simple dipole in its favoured direction.

For calibration, if we assume S<sub>0</sub> to be the receiver noise level, without site noise due to the aerial, and S<sub>1</sub> to be a signal just strong enough to be audible but not to move the meter, S<sub>2</sub> will be the absolute sensitivity of the receiver—the input voltage required to produce an audio output 10db above the receiver noise. In a good receiver this would be 1 $\mu$ V. If “S” points are graded every 6db thereafter S<sub>9</sub> would be 125 $\mu$ V. Someone can work out what 50db over this figure would be and then decide whether any amateur installation is likely to lay down such a signal at a great distance, whatever the conditions.

At most sites and with most aeriels an S<sub>1</sub> signal would not be audible in the practical case, and even with 100% modulation and a phenomenally low noise level only scraps of words would occasionally be heard though no intelligence could be conveyed. This lines up with the verbal description of S<sub>1</sub> as a “barely perceptible signal.”

Denco, Ltd., C. H. RANFT.

Clacton-on-Sea, G5RF.  
Essex.



# Unbiased

By  
**FREE GRID**

## Aurascope Radar

**M**OST of you will know what a halo looks like, but for those of you who stuck grimly to the modern note at school, perhaps I had better say that it is a sort of celestial coronet somewhat resembling the lines of force surrounding an electrostatic charge. This apparently is exactly what it is according to the latest scientific discoveries, but with the difference



Feeling very uneasy.

that it surrounds our entire bodies and, moreover, we do not have to wait until we have shuffled off this mortal coil and become static, for we have it here and now.

The American savants whose writings on the subject I have just been reading do not use the term halo, but speak of the human aura. Apparently it changes in configuration according to the state of our health and would appear, therefore, to be a handy diagnostic tool for the doctor, but unfortunately its presence is only perceptible to those who are "psychogenic," whatever that may mean.

But radio science has once more come to the rescue and it is no longer necessary to be "psychogenic" or even just plain "psychic" to perceive this human aura. Some genius has found that it is more or less opaque to radio waves of the order of one millimetre. I say "more or less opaque" advisedly, for it is this feature which raises its status immediately from that of a mere laboratory phenomenon to a valuable "effect" which can be put to instant use by the medical specialist. The writers state that the ratio between the percentage of one-millimetre waves absorbed and those returned to the sender varies with the health of the individual. Furthermore, these *ultrissima* short waves can be focused to such a fine point that the medico can pick out particular portions of our aura for

diagnostic examination. He can, according to what I have been reading, not only pick out and analyse the contents of a man's stomach but determine also the degree to which the process of digestion has advanced by plotting the local auric configuration.

Now doctors in America must have their fun just as much as the Bevan boys over here, but I must confess to feeling very uneasy when I read further on that it is not necessary for the apparatus to be virtually "juxtadermatous" (what philological fun these Americans have) as in the case of X-rays. It is suggested that by arrangement with a restaurant manager records of patrons' digestive processes analogous to the candid snapshots of a miniature camera may be taken from behind a screen.

This method of what I can only describe as "medical market research" has patient-getting potentialities undreamt of by the resourceful Mr. Bob Allen. Who could remain unmoved when the postman delivered a radar-graph (or should it be radar-gram) of his duodenum in action, with the simple footnote "Get it fixed before it fixes you"?

## Heresy in High Places

**S**ELDOM have I been so shocked and shaken as when confronted by the banner headline in *W.W.* last month "Distortion: Does It Matter?". I can only say that it had much the same effect on me as if one of the ecclesiastical journals came out with the headline, "Sin: does it matter?" or, to turn to the secular field, as if *Pravda* headed its leading article "Does Stalin Count?" or "Molotov no dobera."

It is true that *Wireless World* was merely reporting a discussion on this matter at one of the meetings of the I.E.E., but is not this the "Lambeth Conference" of the technical episcopacy. One might have expected it, therefore, to produce a radio Sancroft of equal stature to his ecclesiastical original who, with his six supporters, chose the Tower and the danger of corporal schism rather than have any truck with the legal heresy which was largely responsible for costing "Dismal Jimmy" his throne in 1688.

Truth, which is science's other name, always thrives on persecution, and suppression is its life-blood.

## THE COMBINED TELEVISION AND "EXSTAT" AERIAL

An aerial which provides for both television and interference-free radio reception and obviates the necessity for two separate installations. Available for the London or Birmingham transmissions. Utilises the 10ft. mast and  $\frac{1}{4}$  wave spreader as radio signal collector. As illustrated and complete with 20 yards coaxial Television cable and 20 yards screened "Exstat" cable.

LIST PRICE  
**£12 6 6**

or less feeder cables  
**£9 8 6**

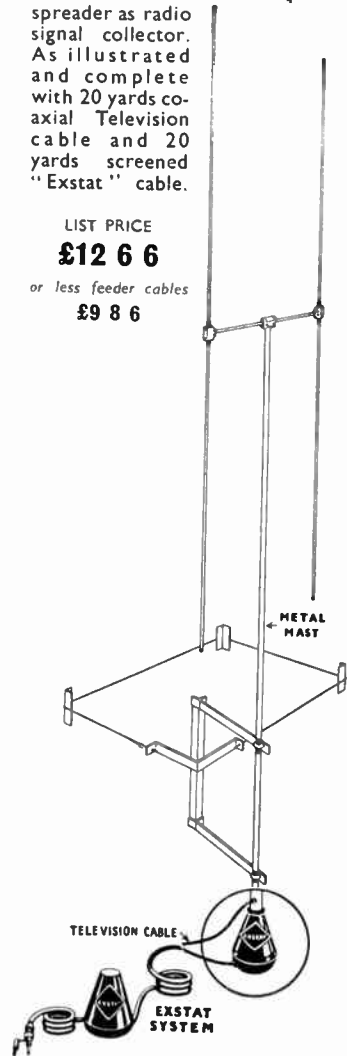

Regd. Design & Patents applied for.

# ANTIFERRENCE LIMITED

67 BRYANSTON ST., LONDON, W.1

A 14

# RANDOM RADIATIONS

By "DIALLIST"

## Portable Television

THAT, ANYHOW, is the name given to it by the American company which makes a new type of midget televisor; but it isn't quite the counterpart of the portable wireless set, for its power supply is not built in and you can't therefore do a spot of viewing whenever or wherever you feel like it. In point of fact the "portable" here means just what its name implies: it can be carried easily from here to there. The set is about the size of a weekend suitcase; it has the same sort of carrying handle and it weighs only 15 lb. There is a built-in telescopic dipole (horizontal, of course), and all you need for reception is a 110-volt, 60-c/s socket—and a television station within range. A 3-inch c.r.t. is used, but magnifying lenses are available which give three times the picture area obtainable with the unaided tube. The price of the complete outfit (with magnifying lens) is 153.95 dollars, or a little less than £38 10s. Would something similar catch on here? I really don't know. I have a feeling, though, that the  $7\frac{1}{2} \times 6$  in image is about the smallest that is genuinely acceptable to most potential viewers. Again, we have only one transmitter in being and another coming along in the near future, whereas there are few big towns in the eastern states of America which have not at least one service available. Over these, then, there's some point in including a lightweight televisor in your luggage if you are travelling over quite large areas. There's no similar advantages yet with us, unless your movements are limited to a 10-15 mile radius (remember that built-in dipole) of A.P.

## A New Menace

Writing of travelling and television brings to mind the latest short cut to eternity for members of the Suicide Club, which is described (but *not* recommended) in a recent issue of the New York *Radio-Electronics*. As a motorist of many years' experience—I wouldn't like to tell you when my first car was

built—the very last thing I should want is a television receiver installed alongside the steering column at an angle which gives the driver comfortable (!) viewing as he speeds over the open road or crawls through the traffic. I sincerely hope that car television won't be permitted in this country, or that if it is it will be limited to the passenger seats behind the driver.

## Puzzling

THIS MONTH I SEEM to be writing a lot about "TV" doings in the U.S.A. That's because things are developing pretty fast over there and there have been quite a few interesting innovations of late. One of these, I confess, has me completely beaten. A big American radio and television manufacturing company (Zenith) announces the appearance at an early date of a receiver with a "giant circle screen." An illustration shows a console set with a circular viewing screen which is completely occupied by the picture—there are no black borders. I'm frankly puzzled for two reasons: (1) How can you obtain a circular picture from a 5:4 aspect ratio rectangular transmission in any other way than by first cutting the received image to a 1:1 aspect ratio and then still further jettisoning part of what the transmitter sends out by limiting the picture on the receiver screen to the circle contained by the resulting square? The only other way I can think of would be deliberately to distort a 5:4 aspect ratio image into a 1:1 and then to round off the corners—but I can't think that that would give acceptable results. (2) Why should the circular image be described in the announcement as "what you have been waiting for"?

## Rectangle versus Square and Circle

Think it over for a moment and I believe you'll agree that the picture-shape least acceptable to the human eye is the circular. Next in order of unpopularity comes the square.

Visit a picture gallery and whether it contains the works of old masters or of outstanding recent and modern artists you'll find that the overwhelming majority of the paintings are rectangular in shape, with one dimension (normally the horizontal) greater than the other. Amongst the few great paintings with curved borders, the elliptical far outnumber the circular. The same is true of the drawing, the photograph, the newspaper or magazine illustration and the cine image. For some reason that I can't attempt to explain the eye seems always to have preferred an oblong or elliptical image and to have been best pleased by one of either kind in which the major axis is horizontal. The camera lens projects an approximately circular image, but from the very early days of photography prints have been rectangular. The square might have seemed the most likely kind of rectangle to be chosen; but it wasn't. Well, the round-picture televisor is being launched by a firm with a pretty good experience of the radio and television market. It will be interesting to see whether it catches on despite the apparent preference of the human eye for oblong images.

## In Defence of Siting

AT THE RISK of receiving a poke in the eye from "Free Grid's" gang, I must join I. B. R. Cater (correspondence, *W.W.*, January, 1949) in defence of the verb "to site." Actually it is a military technical word dating back to the spacious days before the first world war, when home-brewed beer was tuppence a pint and half a pound of good tobacco cost less than does a packet of gaspers to-day. It has always been used with one meaning only: to place something in a position deliberately and carefully chosen for it. I don't know of any word of unquestionable lineage which has the same signification; and when the language doesn't contain a word expressing an action or an idea that he wants to describe, the technical man has always been allowed to coin one. Unfortunately his coinage is not always very beautiful or very happy; but I don't find "siting" or "sited" particularly offensive. They are at any rate better than "positioning" and "positioned." Siting is surely the only word which describes what

is (or ought to be!) done whenever ground radar equipment is brought into action. If you just place or install or locate it here or there, you are liable to find standing breaks all over the screens and to be bothered by queer errors. But if you *site* it by choosing its position with the greatest possible care, perhaps after trying it in two or three likely looking spots before finally deciding, you are sure that you are getting the best out of it. "Siting" was in use in Army manuals long before radar was thought of.

**Four-dimensional Investigation!**

A MOST INTERESTING paper was read just before Christmas at the Institution of Mechanical Engineers by H. A. V. Bulleid. His subject was "Cinematography in Engineering." The author certainly has engineering in the blood, for his father, O.V.B. is chief mechanical engineer of the Southern Section of British Railways, his uncle H. G. Ivatt, C.M.E., of the Midland Section, and his grandfather H. A. Ivatt was C.M.E. of the old Great Northern Railway. We don't make anything like enough use of the cine either in the electrical research lab or in the lecture room. As Mr. Bulleid showed, it is capable of giving the research worker answers to puzzling problems which cannot be found in any other way. It enables him, for instance, to make four-dimensional investigations, for the high-speed camera and projector, with 8,000 frames a second, provide a magnification in time of 500 to 1. In one big American laboratory a speed of 40,000 frames per second has been claimed, with a corresponding time magnification of 2,500 to 1. One doesn't need to do much thinking to realize how useful the high-speed cine could be in the investigation of such things as the action of rotary switches and other moving contacts; of the filament vibrations which cause microphony in valves; of the movements of loudspeaker cones. . . . One great advantage of the cine is that it makes a permanent record, which may be referred to as often as required. It thus becomes the natural ally of the oscilloscope. From the instructional point of view the cine is invaluable. We certainly found it so during the war for teaching not only the practice, but also the theory of radar.

The name **BULGIN** is a



registered Trade Mark



"A COMPONENT for every use" has long been a slogan in the Bulgin organisation. The very large range of products which is available caters for every employment that can be thought of, and new components are continually being produced to meet new conditions as they arise. Recent introductions include additional Double-pole, all insulated Switches, for Export and other uses in connection with Electric Appliances, new types of Signal Lamps, new Connectors, with and without Cord Grip, Miniature Components, Miniature Plugs and Sockets, new Lampholders and Signalling devices, and many new types of Biased Press-button Switches. Paper supplies new permit circulation of a Catalogue to Wholesalers, and also to Retailers through Wholesalers. Enquiries for our products, stating the quantities wanted, are invited.

*Every Bulgin Product  
Guaranteed*

**A. F. BULGIN & Co. Ltd., - BARKING - ESSEX**



# RECENT INVENTIONS

## A Selection of the More Interesting Radio Developments

### Press-button Tuning

A SWITCH-TUNED superhet is provided with an extra push-button control which is used to broaden the bandpass response of the I.F. amplifier, in order to take advantage of the high musical standard of local transmissions when circumstances permit.

The drawing shows the input circuit to the I.F. stage A with the press-

Push-button variable selectivity control.

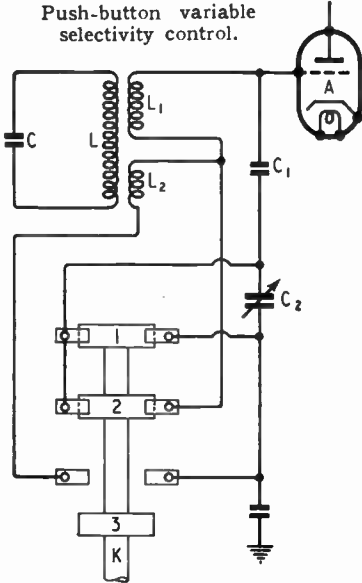

button control shaft K in its normal position. With this setting, the primary circuit LC is coupled directly to the secondary L1C1, the auxiliary coil L2 and condenser C2 being out of action. This arrangement gives a narrow bandpass characteristic for receiving ordinary or long-distance programmes.

By pushing in the shaft K, the contacts 1 and 2 are broken and the contact 3 connects the auxiliary coil L2 in series with the coil L1, to broaden the bandpass coupling. At the same time, the trimming condenser C2 is brought into action, to keep the new response curve symmetrical in shape.

E. K. Cole, Ltd., and H. Hunt. Application date, September 22nd, 1945. No. 599647.

### Large-scale Television

RELATES to television receivers of the kind in which the scanning stream of a cathode-ray tube is used to vary the point-to-point transparency of a sensitive screen, so that the picture can be projected through the screen on to a viewing surface mounted outside the tube. A suitable sensitive screen consists of a thin film of oil deposited on a glass disc, which is made of larger size than the actual scanning

raster, and is slowly rotated in order to present fresh areas to the stream. The effect of the scanning is to set free small static charges, which cause local surface deformations on the film of oil. These act as small lenses to vary the initial focusing of the projection beam against a cut-off grating, and so allow modulated light to reach the viewing-screen.

According to the invention, a second stream of electrons (unmodulated) is arranged to scan the area immediately surrounding the actual raster, in order to offset certain marginal distortions observed in the projected picture, and caused by abrupt changes in the static field strength produced on the film, near the edges of the raster.

W. Ehrenberg. Application date, September 11th, 1945. No. 598802.

### Aerial Switching

IN radar equipment it is necessary to decouple the receiving circuits from the high voltages fed to the aerial during transmission, and to restore the connection in time to accept the resulting echo signals. One form of high-speed switch used for this purpose consists of a toroidal resonator having a gas-filled discharge tube bridged across its poles. The device is located at a suitable point along the waveguide feeder, and is automatically operated as each outgoing signal produces a short circuiting flash through the discharge tube. The duration of the flash is important, since it determines the time during which the receiver is out of action, and, in practice, this tends to be unduly prolonged, owing to the slow de-ionization and recovery rate of the gases contained in the tube.

According to the invention, the discharge tube is filled with small particles of glass "shot," averaging one millimeter in diameter. By sub-dividing the discharge path into units of comparatively small volume and large surface area, the particles accelerate the "cleaning up" of the ions and electrons produced by each discharge, and increase the switching speed.

The M-O Valve Co., Ltd., and N. J. Harris. Application date November 30th, 1945. No. 600889.

### Frame Aerials

THE wire turns of a frame aerial are closely wound, and then cemented together with insulating material into the form of a flat pliable tape. This is laid, sandwich-fashion, in a shallow channel left between the two moulded halves of a frame, which is made from

The British abstracts published here are prepared with the permission of the Controller of H.M. Stationery Office, from specifications obtainable at the Patent Office, 25, Southampton Buildings, London, W.C.2, price 2/- each.

a synthetic resin previously impregnated with finely divided iron dust.

The high dielectric constant and magnetic permeability of the material surrounding the wire conductors is stated to increase the pick-up of an aerial of given size, the arrangement being intended for small portable sets.

Masteradio, Ltd., and R. Pollock. Application date, Oct. 17th, 1945. No. 598165.

### Electro-Mechanical Oscillators

AN electro-mechanical resonator, suitable for developing frequencies between 3 and 10kc/s, consists of a magnetic ring which is supported at nodal points of vibration and is coupled at anti-nodes to a valve oscillator.

As shown in the diagram, the resonator R is excited through electromagnets M, M1 coupled to the input and output circuits, respectively, of a valve V, for which the resonator provides a feedback path. It is supported, at the nodes N, between upper and lower contacts K, of which two pairs only are shown. Alternatively, the

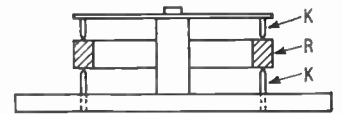
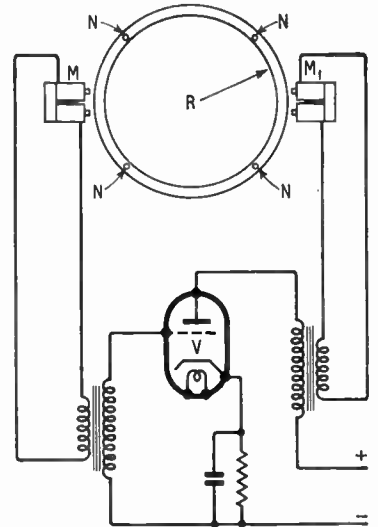

Magnetic ring resonator.

ring is fitted with a thin internal web to form a shallow cup-shaped resonator, which can then be supported at its centre.

For use within the specified range of frequencies, a resonator of this type can be made of more convenient size than an equivalent reed or magnetostrictive vibrator.

Marconi's Wireless Telegraph Co., Ltd., and P. J. Neilson. Application date, June 15th, 1945. No. 599274.

# Standard MAGNETIC MATERIALS

**PERMALLOY 'C'**

for highest initial permeability. Useful for wide frequency band transformers, current transformers, chokes, relays and magnetic shielding.

**PERMALLOY 'B'**

for higher flux densities than Permalloy 'C' and high incremental permeability. Suitable for low power and intervalve transformers.

**PERMALLOY 'D'**

for very high resistivity without undue lowering of maximum flux density or of the Curie point. Small variation of permeability with frequency. Ideal for H.F. applications.

**V—PERMENDUR**

for high permeability with unusually high flux density. Specially applied to high quality diaphragms and pole pieces

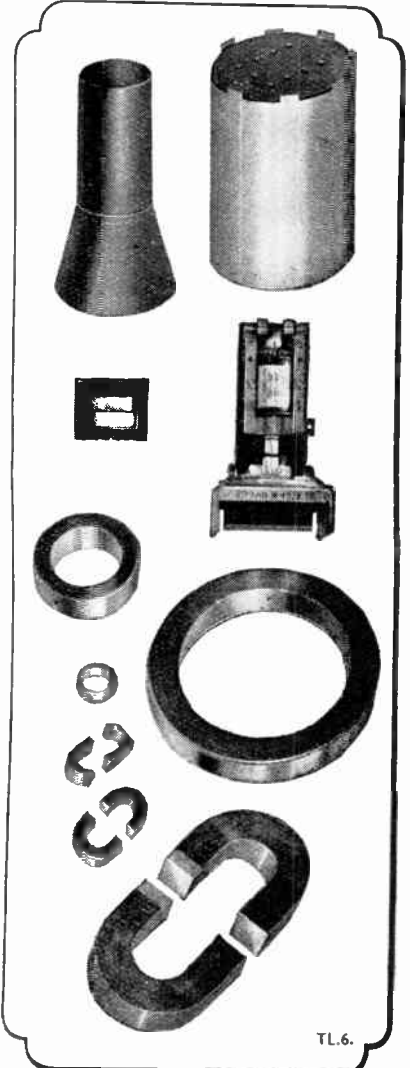

TL.6.

Standard Magnetic Materials, which have been steadily improved and extended in range over many years, are produced by a Company which has the unique advantage of being also a large scale user of these materials.

## Standard Telephones and Cables Limited

(Registered Office: Connaught House, Aldwych, London, W.C.2)  
(Telephone Line Division)

NORTH WOOLWICH, LONDON, E.16.

Telephone: Albert Dock 1401

## Stabilised Insulation BY MODERN IMPREGNATION METHODS

# HYMEG

### HIGH - SPEED PRODUCTION

Now, special methods of continuous conveyor impregnation and baking developed with the use of HYMEG have still further reduced processing times to a fraction of those previously believed necessary.

Often faster than infra-red baking with none of the defects, reduced handling, absence of special jigs, with complete freedom from blistering, bubbling and porosity, are some of the advantages claimed and substantiated for HYMEG High Speed Production methods.

HYMEG Synthetic Insulating Varnishes are recognised and widely used for their mechanical rigidity, improvement of electrical properties of windings; heat, moisture, oil, acid and alkali resistance as well as for the considerably reduced stoving time necessary.

# HYMEGLAS

### GLASS FIBRE INSULATION SYSTEM

This integrated system of development is successful in enabling machines to be designed and operated without weak links in the chain of insulation below 200°C. Thus the fullest advantage is taken of modern glass fibre insulation by providing a degree of bonding and insulation at every point in which the uniting of Hymeg impregnation with the Hymeg as used for subsidiary insulations gives a solid homogeneous winding of equally efficient characteristics and heat resistance throughout.

Hymeglas therefore virtually eliminates any risk of insulation failure and enables motors and the like to operate under abnormal conditions for long periods without risk of electrical breakdown.

Due to the excellent space factor of glass fibre as compared with the more usual asbestos and mica Class B insulations, it is often possible in redesigning with the Hymeglas system to employ larger copper sections with well-known advantages.

The Berger Technical Service—the research work of which produced "HYMEG" and "HYMEGLAS"—is available to advise manufacturers on all problems of insulation. Get in touch now with—

**LEWIS BERGER & SONS LTD. (Est. 1760)**  
35, BERKELEY SQUARE, LONDON. W.1.

*Telephone: MAYfair 9171.*

MANUFACTURERS OF HIGH - PERFORMANCE INSULATING VARNISHES AND ENAMELS

## AN ANNOUNCEMENT OF EXCEPTIONAL INTEREST . . . .

The **FOX HELICAL POTENTIOMETER** type **PXF 5H10** is now available for general release to the Electronic Industry.

#### BRIEF SPECIFICATION

Resistance Range 20 ohms to 50 K-ohms.  
Helical Turns 10.                      Rotation 3,600°.  
No. of wire turns 2,000 to 12,000.  
Wattage 5.

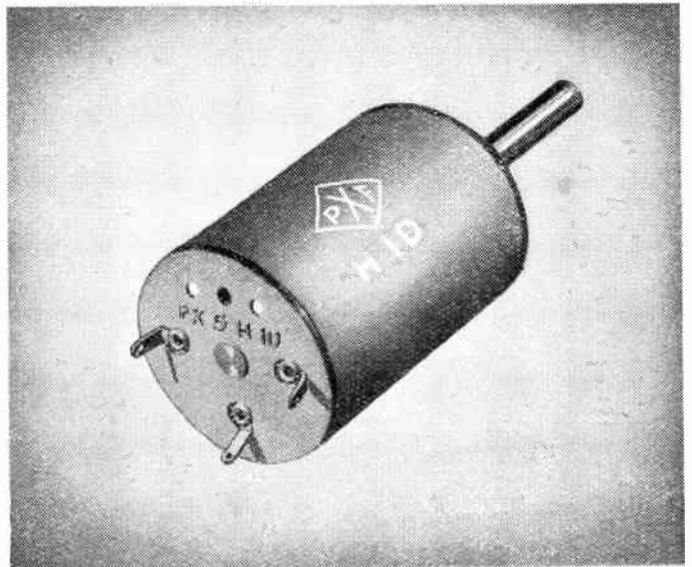

Write for full details to :

## P. X. FOX LTD.

TOROIDAL POTENTIOMETER SPECIALISTS

**HORSFORTH, YORKSHIRE, ENGLAND.**

Telephone: Horsforth 2831 2. Telegrams: "Toroidal, Leeds."



**PATIENCE  
NO LONGER  
A VIRTUE**

**DON'T BE PATIENT!**

**AMATEURS! SERVICE MEN! ENGINEERS!**

Do you still wait 10 to 15 minutes for your Electric Soldering Iron to heat up, every time you want to solder a few joints? Or do you leave it switched on all day? Then you are not only being unnecessarily patient, but wasting fuel as well! The BURGOYNE "INSTANT HEAT" GUN is the answer to all that nonsense. Not a welding device, not a complicated freak, but simplicity itself. Just press the button and solder AT ONCE, using it in the same way as an ordinary soldering iron. Bits changed in a few seconds. No other maintenance whatsoever. Costs more than a soldering iron but lasts a lifetime, and saves pounds otherwise lost in electricity and wasted time.



Send for fully descriptive folder free, to the sole manufacturers:  
**BURGOYNE ENGINEERING COMPANY LIMITED**  
1-3, ROBERT STREET, HAMPSTEAD ROAD, LONDON, N.W.1

EXPORT ENQUIRIES  
INVITED

**7  
SECOND**

PRICE COMPLETE

**79'6**

With Two spare Bits and 4 yards of  
Flex. Model S.471 for 100-130v. A.C.  
Model S.472 for 200-250v. A.C.

**INDUCTION SOLDERING GUN** ★

See Wireless World Test  
Report in July issue, Page 247

# VIBRATORS FOR RELIABLE REPLACEMENTS

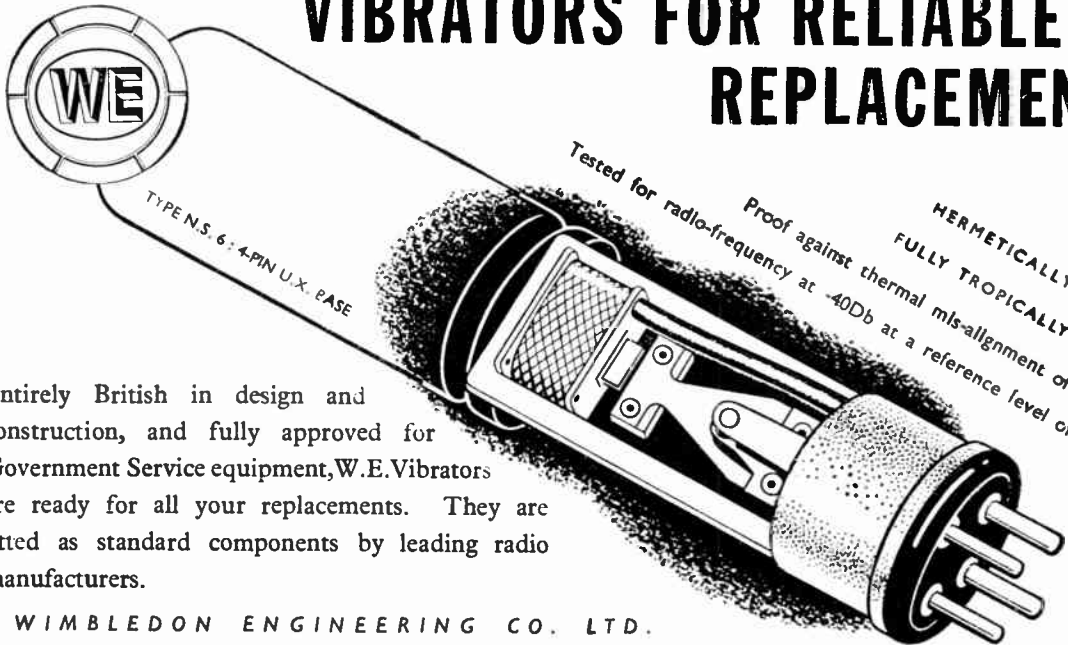

Entirely British in design and construction, and fully approved for Government Service equipment, W.E. Vibrators are ready for all your replacements. They are fitted as standard components by leading radio manufacturers.

**WIMBLEDON ENGINEERING CO. LTD.**  
GARTH ROAD · LOWER MORDEN · SURREY · TELEPHONE: DERWENT 4814, 5010.

HERMETICALLY SEALED  
FULLY TROPICALLY TESTED.  
Proof against thermal mis-alignment of contacts.  
Tested for radio-frequency at -40Db at a reference level of 500mW.

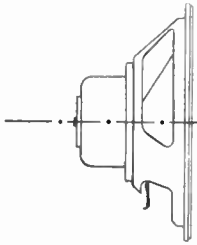

# perfect alignment by Co-axial Construction—

## FOR "BETTER LISTENING"

R. & A. Reproducers are perfectly aligned about their axis. Their assembly is so arranged that the voice coil can never, except under conditions of brute force, vary from its setting in the annular gap by more than .001 ins. Misalignment of the voice coil and/or mechanical failure is therefore almost impossible, no matter what the volume or frequency.

A co-axially constructed, distortion-free speaker is a necessity for Better Listening.

"The Story of Co-axial Construction" explains how our speakers are built. We will gladly send a copy to any manufacturer or Overseas Buyer who writes for one.



REPRODUCERS AND AMPLIFIERS LIMITED  
FREDERICK ST. WOLVERHAMPTON ENGLAND

R &  
R A



18, TOTTENHAM COURT ROAD, LONDON, W.1

Tel: MUSeum 2453

Tel: MUSeum: 4539

Shop hours: Monday-Friday 9—7.30, Saturday 9—1

**RAYMART SHORT WAVE COILS.** Plug-in coils wound on low loss dielectric material. Each coil marked with wavelength coverage. Both 4 and 6 pin types are interchangeable with those of competitive manufacture.

All ranges quoted are those obtained with .00016 mfd. variable tuning condenser. Average Q of coils is 130 for space wound type and 95 for close wound type.

**4-pin coils.** Primarily designed for aerial coil with reaction but they can also be used for aperiodic coupling or in oscillation circuit. Standard British 4-pin base—postage 6d. extra.

Type C.A. coverage 11—25 meters 8.25 microHy. Price 4s. each.

Type C.B. coverage 20—45 meters 16.25 microHy. Price 4s. each.

Type C.C. coverage 44—100 meters 57.35 microHy. Price 4/6 each.

Type C.D. coverage 80—180 meters 224 microHy. Price 4/9 each.

**6-pin coils.** Are similar to the 4-pin range with an extra primary winding for aerial coupling or can be used as a tuned secondary H.F. transformer with aperiodic primary, the third winding of course being used for reaction—postage 6d. extra.

Type C.A. 6 coverage 11—25 meters 7.81 microHy. Price 4/3 each.

Type C.B. 6 coverage 20—45 meters 16.25 microHy. Price 4/3 each.

Type C.C. 6 coverage 44—100 meters 61.35 microHy. Price 4/9 each.

Type C.D. 6 coverage 80—180 meters 239.5 microHy. Price 4/9 each.

Type C.E. 6 coverage 110—250 meters 825 microHy. Price 6/9 each.

Type C.H.58 chassis mtg. coil base to suit above Price 1/6 each.

**RAYMART SHORT WAVE CONDENSERS.** All condensers are microvariable and are of the all-brass construction type, using ball-bearing spindle and ceramic

insulation. Single hole fixing and double ended for gauging purposes. Postage 6d. extra.

Type V.C. 15X .025in. gap. 2.5 15pF. Price 3/9

Type V.C. 40X .025in. gap. 2.75 40pF. Price 4s.

Type V.C. 100X .023in. gap. 3.8 100pF. Price 5/6.

Type V.C. 160X .023in. gap. 6 160pF. Price 6/8.

Type V.C. 250X .023in. gap. 7.3 250pF. Price 7/9.

**TELEVISION COMPONENTS.** E.H.T. Transformer for VCR97 and similar tubes. 1.75Kv. R.M.S. (Approx 2250 volts D.C. smoothed). Two 4-volt heater windings each centre tapped for 2- or 4-volt rectifier and CRT. Rectifier winding insulated for 3500 volts. Postage 1/6. 22.

E.H.T. Transformer 1 Kv. R.M.S. (Approx. 1250 volts D.C. smoothed). Otherwise as above. Postage 1/6. 21/17/6.

Stewart Mains Transformer. 350—0—350V 250 ma.; 6.3 v. 6 a.; 14 v. 8 a.; 10—2—6.3 v. 2 a.; 4 v. 3 a.; size 4 1/2 x 6 1/2 in. Postage 1/6. 25/5.

Varley Mains Transformer F175 500—0—500 v. 200 ma.; 6.3 v. 3 a.; 1.5 v. 2.5 a.; 2—0—2 v. 6 a. Size 4 1/2 x 5 x 3 1/2 in. Postage 1/6. 23/12/6.

Elstone Mains Transformer M18 500—0—500 v. 250 ma.; 5 v. 3 a.; 6.3 v. 3 ACT 6.3 v. 6 ACT. Size 4 1/2 x 4 1/2 x 3 1/2 in. Postage 1/6. 23/7/6.

Rubber Masks for 9in. or 12in. tubes, postage 3d.

9in. black 9/6. 9in. stone, 11/3. 12in. black, 18s. 12in. stone, 21/6.

The latest 9in. Television lens for use with VCR97 tubes. Excellent magnification and minimum angular distortion. Converts your "surplus" television into a full-sized model. Postage 2s. Only 21/9/6.

Miscellaneous. Standard 1 1/2 gauge steel chassis 17 x 10 x 3 1/2 in. All corners welded. Black gloss stove enamel finish. Postage 1/6. Only 6s.

Standard 18 gauge steel panels 19 x 10 1/2 in. under 1 1/2 Black crackle finish both sides. Postage 1/6. Only 5/9.

Steel brackets for assembly of above. Black gloss stove enamel finish. Postage 1/6. Only 3/6.

Heater transformer in neat black crackle 1 clamp. Pri 230 v. 30cps. See 6.3 v. 15 a. Size 2 1/2 x 1 1/2 in. high. Postage 1/3. 9/9.

**QUALITY COMPONENTS.** Pickups—all with transformer.

Wilkins Wright Type "N." The Senior moving coil pickup of High Fidelity. Price 27/10/7.

Connoisseur Lightweight moving iron of excellent quality—24/11.

E.M.I.'s "14." The well-known hypersensitive pickup now vastly improved. Price 24/10/8.

SPEAKERS. Vitavox K12 20 12in. Good response heavy duty (20 watt) 15 ohm. Price 21/1.

Vitavox K12 10 12in. Excellent reproduction domestic type (10 Watts) 15 ohm. Price 27.

Goodmans "AX10M 12" Twin cone needs no description, 15 ohm. Price 28/8.

Goodmans 12in. Good standard reproducer, 15 ohm. Price 28/15.

Wharfedale W10 CS 10in. Cloth suspension 18Kc "Top" Response, 3 or 15 ohm. Price 27.

Wharfedale W10 CSB 10in. as above but with improved top, 3 or 15 ohm. Price 27.

Wharfedale "Golden" 10in. Good "all-round" speaker, 3 or 15 ohm. Price 23/15.

Celestion "44" 12in. Good general purpose speaker at reasonable cost—3 ohm. only. Price 23/15.

All the above items can be fully demonstrated and compared—but please avoid lunch hours

**OUTPUT VALVES** in matched pairs. (No extra charge.)

PX25 Osram, 18 watts output, 27/11 each. P27 500

Tungram as PX 25, 22/6 each. (No tax.) PX4 Osram, 10 watts output, 16/6 each. PP3 250 Mazda, as PX4, 16/6 each. KT68 Osram, as triode 15 watts, 18/3 each.

6L6 USA as Triode 30 watts, 18/1 each.

Also amplifier and driver valves for above.

Push-pull output transformers—Williamson 84s. Keston, 30s.



**THE COMPLETE SERVICE  
FOR SOUND RECORDING AND  
REPRODUCTION**

- ★ Mobile, static and specialised recording units
- ★ Recording amplifiers, speakers, microphones, etc
- ★ Sapphire cutting and reproducing styli
- ★ Blank recording discs from 5in. to 17in. Single and Double-sided
- ★ Groove locating and cueing devices
- ★ A comprehensive range of accessories to meet every requirement of the sound recording engineer
- ★★ A development of special interest to users of sapphire and delicate pick-ups—THE SIMITROL. This is a controlled micro-movement easily fitted for use with any type of pick-up
- ★★★ OUR CDR48A RECORDER UNIT complete and self-contained, measuring only 22in. x 14in. x 13½in., incorporating 7-valve amplifier, recorder unit, light-weight pick-up, speaker and microphone and with many exclusive features, is now ready for early delivery.



Portable  
Twin Channel Continuous  
Recording System incorporating  
CDR-8A Recorder/Amplifier  
DR48A Recorder and EM48A Electronic  
4 Channel Mixer

**OUR WELL-EQUIPPED WORKSHOPS ARE AVAILABLE FOR THE  
DEVELOPMENT OF EQUIPMENT TO MEET SPECIAL NEEDS.**

**SIMON SOUND SERVICE, Recorder House, 48/50, George St., Portman Square, London, W.1.**

CABLES: Simsale, London.

TELEGRAMS: Simsale, Wesdo, London.

TELEPHONE: Welbeck 2371 (4 lines)

*Optimum Characteristics from this*  
**EFFICIENT DOUBLE-TRIODE**

**A FEW OF THE APPLICATIONS  
OF THE MULLARD ECC33**

- ★ Counting and Scaling
- ★ Photocell Amplifiers
- ★ Balanced Bridges
- ★ Multi-Vibrators
- ★ Motor Control Circuits
- ★ Watt and Power Factor Meters
- ★ Voltage Control Circuits
- ★ Time Delay Circuits
- ★ Relay Circuits
- ★ R.C. Oscillators
- ★ Coincidence Circuits
- ★ Pulse Shaping Circuits

**ECC33 VALVE DATA**

Heater Voltage	6.3V
Heater Current	0.4A
Anode Voltage	250V
Anode Current	9mA
Anode Resistance	9,700 ohms.
Mutual Conductance	3.6mA/V
Amplification Factor	35

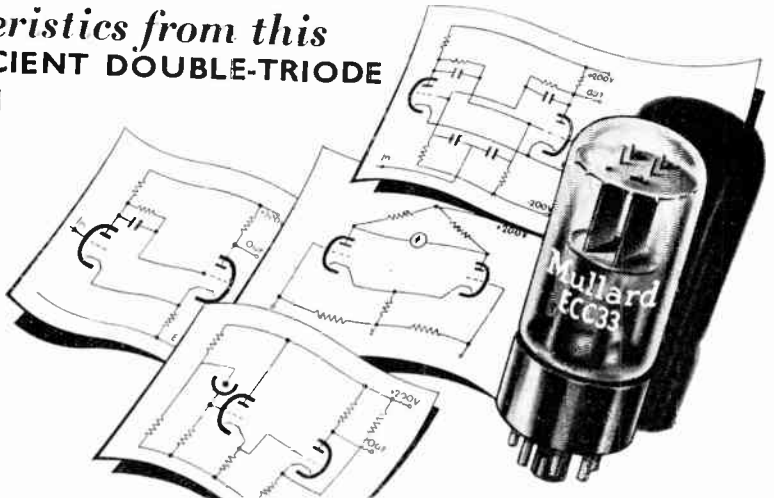

The combination of medium-low anode resistance, high working current, high slope and low heater current, make this new Mullard double-triode an ideal valve for an unusually large number of functions. One practical advantage of this versatility is that it is often possible for the one type of valve to be used throughout an equipment with obvious economies in design and maintenance. Manufacturers of electronic counters will especially appreciate the low heater current and G.T. size, whilst designers of industrial control equipment will welcome the series arrangement of the heaters.

**Mullard**  
THERMIONIC VALVES  
& ELECTRON TUBES

Please write to Transmitting & Industrial Valve Dept. for full technical details of this and other double-triodes in the Mullard range.

MULLARD ELECTRONIC PRODUCTS LIMITED, CENTURY HOUSE, SHAFTESBURY AVENUE, LONDON, W.C.2  
MVT38G



## H.P. RADIO SERVICES LTD.

### OFFER:—

Brand new American IFF receivers. Type BC 966A. 13 valves. Fitted with motor generator. Input 12 volts. Output 450 volts 60 ma.—easily converted to fractional h.p. electric motor for mains operation.

7 6SH7 3 7193  
3 6H6

Handsome metal case 12" x 12" x 8"  
100's of useful components.

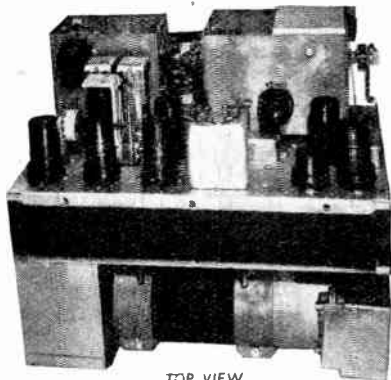

TOP VIEW

A magnificent piece of apparatus, containing over £50 worth of useful components. 3 speed motor gear box. Two 3 pole relays. One 2 pole relay incorporating the most useful 7193 valves. Ideal for 145 Megacycle operation.

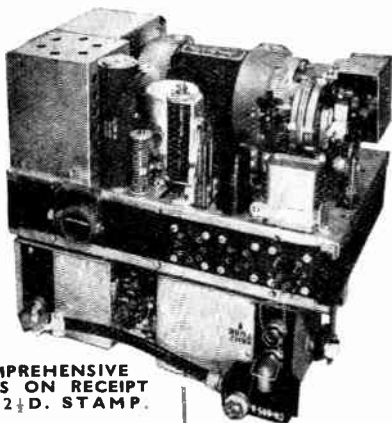

UNDER VIEW

COMPREHENSIVE  
LISTS ON RECEIPT  
OF 2½ D. STAMP.

AVAILABLE IN  
BRITISH ISLES  
ONLY.

**30/-**

PACKING AND  
CARRIAGE  
5/- EXTRA.

TRANSIT WEIGHT 40 LBS.

STATE NAME OF NEAREST RAILWAY STATION

## H.P. RADIO SERVICES LTD.

BRITAIN'S LEADING RADIO MAIL ORDER HOUSE

55, COUNTY ROAD, WALTON, LIVERPOOL, 4  
ESTAB. 1935 TEL.: AINTREE 1445

STAFF CALL SIGNS G3DLV G3DGL

## Dependable Di-electrics

# OKERIN waxes

### and DI-JELLS

—for insulating, filling, impregnating, waterproofing, sealing and finishing radio and electrical components, cables, etc.

ALL GRADES ARE DESIGNED TO MEET DEFINITE CHEMICAL, PHYSICAL AND ELECTRICAL STANDARDS.

For technical advice and samples, phone  
TEMPLE BAR 5927.

Sales Department

**ASTOR BOISSELIER & LAWRENCE LTD**  
NORFOLK HOUSE • NORFOLK STREET • STRAND • W.C.2

Works and Laboratories: West Drayton, Middlesex.

## Smallest — Best — Inexpensive! OSMOR "Q" COILPACKS

One-Hole Fixing

HIGH "Q"  
LOW-LOSS  
FORMERS  
ADJUST-  
ABLE CORES  
NO  
WHISTLES  
SIZE  
3½ x 2½ x 1;  
GIVES 20%  
IMPROVE-  
MENT.



ALIGNED  
IN ACTUAL  
RECEIVER

MAKES A  
FACTORY  
JOB OF A  
HOME-  
BUILT SET

8 SEPAR-  
ATE COILS

FULL  
CIRCUITS  
SUPPLIED.

S'HET (465 k c) L.M.S., 33/- M.S.S. and L.M. SHIPPING, 35/- T.R.F. (L. & M.W.), 30/- BATTERY MODEL, and other types available; also ATTRACTIVE GLASS DIAL ASSEMBLY in 3 colours, 7" x 7", calibrated for L.M.S. and L.M. SHIPPING.

INDIVIDUAL COILS, S'HET and T.R.F., 3/- each. PROGRESSIVELY WAVE-WOUND, PERMEABILITY-TUNED COILS, T.R.F.

MATCHED RADIO and TELEVISION COMPONENTS AT ATTRACTIVE PRICES.

Write for particulars (Trade enquiries invited).

**OSMOR RADIO PRODUCTS LTD.**

BRIDGE VIEW WORKS, BOROUGH HILL, CROYDON, SURREY  
Tel. CRO. 1220.

# Connoisseur

*Gramophone motor now ready!*

At last a gramophone motor to match the performance of the famous Connoisseur Pick-up.

## SPECIFICATION :

Voltage: 200-250 volts A.C., 50 cycles. Rim drive with speed variation. No governors and no gearing. Heavy non-ferrous turn-table, machined to run dead true, fly-wheel action—no "WOW." Main turn-table spindle hardened, ground and lapped to mirror finish, running in special phosphor-bronze bearings. Motor runs in needle-point, self-adjusting bearing



Board lin. plastic. Pressure on Drive-Wheel released when not in use, to obviate forming flats and noisy action.

Retail Price, complete with Pick-up £15 19s. 0d. plus £6 18s. 2d. P.T.  
 " " without Pick-up ... £13 5s. 0d. " £5 14s. 10d. P.T.  
 Coupling Transformer when required 13s. 0d.

Made by

A. R. SUGDEN & CO. (ENGINEERS) LTD., BRIGHOUSE, YORKS.

## One on top of the other ...

Looks easy, doesn't it? But it is the 'know how,' that comes only after years of experience, that successfully overcomes the difficulties of development and production that are inseparable from the manufacture of the highest quality sound equipment. The G.P.I. pressure type loudspeaker unit is an outstanding example of the advanced design and dependable craftsmanship, which, rising from wide experience, make certain that the reputation of VITAVOX is always on top.

*Write for full details.*

# VITAVOX

## G.P.I. PRESSURE UNIT

The result of twenty years' experience

Vitavox Limited, Westmorland Road, London, N.W.9. Tel: COLindale 8671

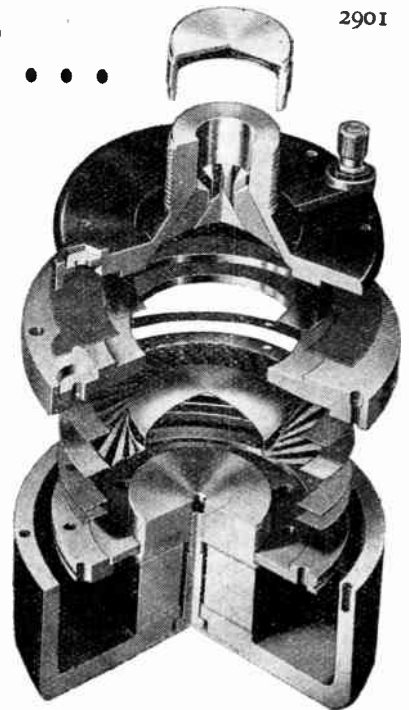

For all Electrical Tests

**PIFCO**

**ALL-IN-ONE RADIOMETER**



with internal battery and multi scale the PIFCO All-in-One Radiometer tests everything electrical, Radio and P.A. Equipments, Household appliances of all kinds. Car Lighting Systems, Bell and Teleprinter Circuits. May be used on AC or DC mains.

● **CIRCUIT TEST**  
Tests for open or faulty circuits in all radio and electrical apparatus and domestic appliances. Equally for testing car lighting and starting circuits.

● **L.T. TEST**  
0-6 volts AC or DC.  
● **MILLIAMPERE TEST**  
0-23 m.a. scale for testing total discharge from battery or testing single cell.

● **H.T. TEST**  
0-240 volts. May be used direct on any mains, AC or DC

● **VALVE TEST**  
Made by inserting valve in socket on front of meter.

Write for full details and Export terms. Overseas Agency enquiries invited.

**PIFCO LTD., PIFCO HOUSE, WATLING STREET, MANCHESTER, 4**  
and at **PIFCO HOUSE, GT. EASTERN STREET, LONDON, E.C.2**



**CHARLES BRITAIN (RADIO) LTD.**  
11, UPPER SAINT MARTINS LANE, LONDON, W.G.2  
BEST BUY AT BRITAIN'S

**INEXPENSIVE TELEVISION.** We now have available a descriptive and comprehensive booklet which sets forth in simple terms how to construct a 6in. Television from "surplus" equipment. The booklet is profusely illustrated and will prove most instructive. Price 1/6, post free.

Among the Units named by "Inexpensive Television" as being of prime importance in the construction of a Television are the **VIDEO RECEIVER R1355** and the **RF UNIT TYPE 25**. The R1355 is the ideal vision receiver; valve line-up: 1 5U4G, 1 HVR2A, and 1 8P61. Also incorporates 7.7 Mc/c IF Str.p.

We supply simple modification instructions with every Unit purchased, and it can be seen in operation at our premises in London. The R1355 is used in conjunction with the R1255 which plugs into the receiver. The R1355 is offered at the absurdly low price of 30/-, plus 5/- carriage.

**BRAND NEW R1355** Units in original manufacturer's wooden crates at 42/6, plus 7/6 carriage.

**RF UNIT TYPE 25**. This essential part of the Television is priced at 10/6, post free. For the month of February only both equipments at 37/6, plus the usual 5/- carriage charge. **BIRMINGHAM.** Prospective viewers in this area will require **RF UNIT 26**. These are in stock at 27/6, post free. Brand new and cartoned.

**BRAND NEW AMERICAN EQUIPMENT.** We proudly feature this month the American Synchronizer Unit **BC993**, housed in a handsome black crackle finished cabinet and containing 2 6SL7, 1 753, 3 6AG7, 1 2X2, 1 6X7, 2 95N7, 6 753. The tube is a 3in. CRT, 31/11. A bargain at 25/10/6, plus 7/6 carriage. **AND**

**RECTIFIER UNIT RA77B.** Comprises 3 5T4, 1 6SQ7, 1 VR150, 2 6Y6. At a price within the compass of all 59/6 plus 5/- carriage. **AND REMEMBER! BOTH UNITS ARE BRAND NEW!!**

**INDICATOR UNITS.** We have in stock at present a large selection of indicators for use in constructing a Television, and would estimate it a pleasure to furnish advice and relevant details relating to the choice of suitable apparatus.

Personal shoppers will appreciate the fact that all **CRT.s** are demonstrated prior to purchase.

**BET TRANSFORMERS.** 1,750 v. R.M.S. at a n.a. 4 v. tapped at 2 v. For 230 v. input. **IDEAL FOR VCR97 TUBES.** Brand New and guaranteed at 29/6 each, carriage paid, **RECEIVER UNITS TYPE 25 or 73.** Despite the consistent demand during the preceding month we can still supply from stock. These Units are actually the receiver portion of the TR1199. Among other things they contain 6 valves: 2 EF99, 1 EK32, 1 EBW33, 2 EF36, and one pair of 491 K's, a 1F Transformer, resistors and condensers. Easily converted into a medium wave superhet by replacing the two coils. Super value at 19/6, plus 5/- carriage. Suitable coils are Weatite P coils available at 6/- per pair.

**BRITISH IFF RECEIVERS.** Reckoned by many to be our outstanding bargain. Contains 10 valves, a motor generator, numerous condensers, potentiometers, resistors, etc. The generator is complete with all gears and other constituent parts and is readily convertible to a small motor for AC or DC operation. At the price of 19/6, plus 5/- carriage, this is indeed value beyond compare.

**AMPLIFIER UNIT TYPES 18 or 165.** A neat and compact Unit incorporating the following valves: 2 EF99, 1 EBW33, and 2 EL32. Together with microphone transformers, inter-valve transformers, count-leak condensers and resistors, etc. An experimenter's godsend for 25/-, plus 2/6 carriage.

**SHOP HOURS: 9 a.m. to 6 p.m.**

Open all day Saturday.

Telephone: TRMPL Bar 0545.



**THE NEW S.T.7 MODEL**  
7-valve superhet, 4 bands, A.C./D.C. 110 or 230/250.

Alternative wave bands:—

13-30, 30-70, 70-180, 200-550  
13-30, 30-70, 200-550, 800-2,000

Specify wave bands & voltage when ordering  
International octal valves—high gain R.F. stage—10" moving coil speaker. Radiogram input and extension speaker connections—all sets fully tropicalised.

**18 gns.**  
**PLUS 4 GNS.**  
PURCHASE TAX

**PARKER Radio**

**PARKER RADIO CORPORATION LTD., Paraco Works,**  
7, Regal Lane, Regents Park, London, N.W.1. Gulliver 1843



# CELESTION

Here are two excellent Celestion Speakers with dimensions which make them ideal for use in small domestic receivers, as extension speakers, for car radios and intercommunication sets.

Model P2V can also be used as a microphone.

**THE MIDGET 2 CABINET MODEL CT117** (as illustrated) uses the P2V Speaker in its bakelite cabinet of modern design which is available in a variety of pleasing colours.

### CHASSIS MODEL P3CO

Dia  $3\frac{1}{2}$ ". Baffle opening 3". Voice coil impedance at 400 cps., 3 ohms. Pole dia  $\frac{3}{8}$ ". Flux density gauss 7,700. Total gap flux 24,000. Peak power capacity 1 watt.

Price less transformer  
(Suitable for output 1-5 ohms).

**£1 : 19 : 6**

#### WHERE TO BUY CELESTION SPEAKERS

The Public are requested to order from their local Radio Dealer.

Wholesalers are supplied by the sole Distributors: **CYRIL FRENCH LTD.**, High Street, Hampton Wick, Middlesex. Phone: KINGSTON 2240.

Manufacturers should please communicate direct with

**CELESTION LIMITED, SUMMER RD., THAMES DITTON, SURREY.**

Telephone : EMBERBROOK 3402-5

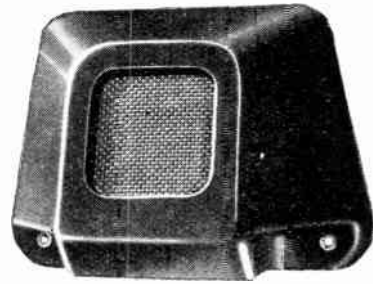

### MIDGET 2 CABINET MODEL CT117

Size ; Height  $4\frac{1}{4}$ " Width  $6\frac{1}{4}$ " Depth  $2\frac{3}{4}$ "

PRICE complete in cabinet **£2 : 3 : 6**

### TECHNICAL DETAILS OF CHASSIS MODEL P2V

Dia  $2\frac{1}{2}$ " Baffle opening  $2\frac{1}{4}$ ". Voice coil impedance at 400 cps., 3 ohms. Pole dia  $\frac{7}{16}$ ". Flux density gauss 8,500. Total gap flux 8,000. Peak power capacity  $\frac{1}{2}$  watt.

Price less transformer  
(Suitable for output 1-5 ohms).

**£1 : 7 : 0**

Write for Brochure "W.W." It gives details of all Celestion Chassis and Cabinet Speakers.

## NEW DESIGNS

in the range of

# U.I.C

High Stability  
CAPACITORS

## (3) METALLIZED CERAMIC HERMETIC SEALS

TYPE NUMBER	17055	27075	39105	45130
FLASHOVER KV DC (TOP)	9	12	13	21
MAXIMUM AMPS.	5	12	23	26

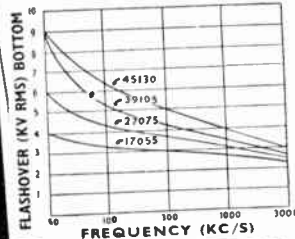

The new range of U.I.C Hermetic Seals guarantees air and moisture-tight sealing even with permanent pressure differences of up to 20 lbs. A specially developed metallizing technique ensures excellent adhesion between metal coating and ceramic body and permits soldering at temperatures between 220 C and 310 C. Full particulars of flashover voltages, current carrying capacity and behaviour at reduced pressure are available on request.

**UNITED INSULATOR CO. LTD., OAKCROFT RD., TOLWORTH, SURBITON, SURREY**

Telephone : Elmbridge 5241 (6 lines)

Telegrams : Caianel, Surbiton

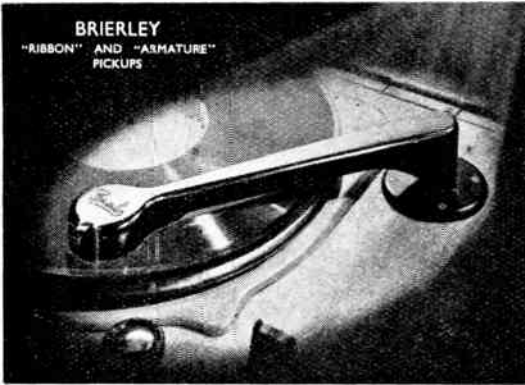

**RIBBON PICKUP, type JB/P/R/1**

(TYPE JB/P/R/1m FOR FINE LINE RECORDINGS)

Frequency range, 20 c/s to 40,000 c/s.  
 Permanent point 6 times harder than sapphire and more robust.  
 Point pressure, 1/8 oz.  
 Output voltage, 10 to 15 mV. across 15,000 ohms approx.  
 "Floating Element" design prevents arm torsional resonance.  
 Price in U.K., including special mumetal screened transformer and Purchase Tax, £10/14/11.

Downward pressure is not just a question of counter-balancing or taking up weight by the use of a spring.

The effective mass of the moving parts at the point at medium and high frequencies with the additional impedance of the restoring force at low frequencies are the main factors governing point pressure. At the same time, "wasted" forces absorbed by the inertia of the head and arm in vertical and horizontal directions, friction in the bearings as well as other considerations must be taken into account.

Our Pickup Booklet deals with general design factors and their specialised application, and will be sent together with details of our other products, including Amplifiers, Pre-Amplifiers, Filters, Silent Turntables, etc., on request.

**J. H. BRIERLEY (GRAMOPHONES & RECORDINGS), LTD.**  
 46, TITHEBARN STREET, LIVERPOOL.

**Mr. A. C. BARKER'S  
 NEW MODEL 148a SPEAKER**

is now released and is available from stock.

Built individually with meticulous care in the laboratory this new 12in. NATURAL sound reproducer approaches truth more closely than ever before.

No other speaker possesses the patented dual drive and graded cone corrugations which give such mastery over transients, such smooth, clean, extended top and bass without resonance or colouration.



Musicians, technicians and ordinary mortals who take pleasure in delicate tracery of fine chamber music; prefer sopranos who do *not* sing through their noses and commentators who do *not* speak through their boots; enjoy the true rasp of a double bass, the unblurred roll of tympani and all the rich colour of massed instruments, each clearly identifiable in its context, have all contributed their mede of appreciation. Eventually you will, too!

Write for details to

**BCM/AADU, LONDON, W.C.1.**

**LAMINATIONS**

**FOR**

**All Radio and Electrical Uses.**

**In Silicon, Dynamo, Intermediate and Transformer Qualities.**

**Permalloy, Mumetal, Radiometal.**

**Screens for all Electrical Uses.**

**Transformer Shrouds  
 for 35 and 74 Lams.**

**General Precision Engineers.**

**Heat Treatment.**

**Sheradising to the Trade.**

**Electrical Sound & Television Patents Ltd.**

12 Pembroke Street, London, N.1. — TERminus 4355  
 2/4 Manor Way, Boreham Wood, Herts. — ELSTREE 2138

**POTENTIOMETERS**  
*by* **RELIANCE**



Wire-wound and Composition types.  
 Single, Ganged, Tandem Units.

Characteristics: linear, log., semi-log., non-inductive, etc. Full details on request.

**RELIANCE MFG. CO. (SOUTHWARK), LTD.,**  
 Sutherland Road, Higham Hill, Walthamstow, E.17.

Telephone: Larkswood 3245

**"Cyldon"**

Type No. 16G.



4 to 40pF. 1 to 6 way. 1 1/2" between trimming plate centres. 1/2" between fixing screws. 1/2" high

**MICA-DIELECTRIC  
 Trimmer  
 CAPACITORS**

**SYDNEY S. BIRD & Sons, Ltd.**

CAMBRIDGE ARTERIAL RD., ENFIELD, MIDDLESEX  
 Phone: Enfield 2071-2 "Graes: "Capacity, Enfield"



Rate 6/- for 2 lines or less and 3/- for every additional line or part thereof, average lines 6 words. See Number 2 words plus 1/- Press Day. March 1949 issue, first post Tuesday, February 8th. No responsibility accepted for errors.

**WARNING**

Readers are warned that Government surplus components which may be offered for sale through our columns carry no manufacturer's guarantee. Many of these components will have been designed for special purposes making them unsuitable for civilian use, or may have deteriorated as a result of the conditions under which they have been stored. We cannot undertake to deal with any complaints regarding any such components purchased.

**NEW RECEIVERS AND AMPLIFIERS**

**21**-hr. television (not Radar conversions) uses 21-H.V.C.R.97 tube; send large s.a.e.—T.H. Products, 92, Leathwaite Rd., S.W.11. Bat. 4889. [2472]

**A**LL types of receivers, F.M., A.M. and T.V., test and control gear built to your specification; write for a quotation to—BCM, HIF IDEAL, London, W.C.1. [2755]

**19**49 bandwidth feeder unit with R.F. stage, nine wavebands, 13.5-2.000 metres; 2½d stamp for illustrated brochure.—Coughphone Radio, Ormskirk, Lancs. [2528]

**A**MPLIFIERS, new, 60-watt heavy duty P.A. models, built for continuous rating and rack mounting; £45; early delivery; send for spec. Broadcast and Acoustic Equipment Co., Ltd., Tonbridge, Norwich. [1855]

**L**OCAL station high fidelity feeder unit, 5gns.; 6-watt push-pull high fidelity amplifier, 12gns.; tone control unit, gives bass and treble boost and cut, 6gns.; technical data sheets on request.—Note new address, E. A. D., 18, Broad Rd., Lower Willingdon, Sussex. [2143]

**B**C.348 American 10-valve receivers, new, £18/10; R.28 American 10-valve receivers, new, 45/-; B.C.454 American 6-valve receivers, new, 35/-; British Navy Type 76 3-valve receivers, new, with circuit, 30/-; all carriage paid.—G. Lawrence & Co., 3, Slater Place, Liverpool. [2143]

**J**UNIOR version of Williamson's quality amplifier with 4-watt transformer, 12 watts, 7 valves, £16/16; 5-valve a.c. mains, 8-watt push-pull amplifiers, with output transformers, £9; Celestion 12in P.M. speakers, 3-ohm voice coil, 75/-—R. T., 64, St. Leonard's Rd., London, S.W.14. [2400]

**M**IDCO amplifiers 4-25watts, 4watt transformer, modern 5-tube chassis, 4-watt and volume controls, a.c. mains, £4/10; 10watt with p-p 6V6 output stage, high gain, twin input channels NFB, £10; 25watt p-p 6L6 output, bass and treble tone controls, 12mohm case, very high gain, £25; stamps for catalogue, exclusive products, trans supplied.—Midco radio, 19, Newcomen Rd., Welwynborough. [2539]

**A**STOUNDING year end offer, to clear stocks. Complete mains receiver kit, everything, including valves, beautiful cabinet, all components, assembly drawing, etc., right down to the last nut and bolt; not at odd kit set, but a first-class commercial 2-waveband receiver, ideally suitable for resale; offered for one month only at £9/10, carry paid; never again.—Radio Constructors, 28, Spital Hill, Sheffield, 4. [2472]

**M**ASON'S (W.W.), Wyvenhoe, Colchester. 5- and 10-waveband gram chassis, covering 3-60mc/s and 150-1,500kc/s, feeder units with r.f. stage and flywheel tuning, radio kits, auto-stop and 8 mixed changer units, amplifiers 5-500watts, Eddystone and Denco equipment and components, complete television chassis for London or Birmingham transmission and constructors' kits for London area from £45; s.a.e. for details or send 9d. now for our illustrated 54-page catalogue. [2020]

**C**ONNOISSEUR'S receiver—world-wide results on highly sensitive 10-valve communication receiver, or by change of switch, very high quality reception of local stations on non-superb high fidelity receiver; basis rebuilt R1155, 9-1,500 metres, P×4 push-pull quality amplifier, bass and treble controls (boost and cut), gram input, new panel, and other refinements; write for details, or call for demonstration; R1155 specialists, receivers repaired and re-aligned, also modified as above, or to your requirements; R1155 circuit and valves, 2/- post free.—R.T.S., Ltd., 5, Gladstone Rd., Wimbleton, S.W.19. Tel. Lib. 3503. [1266]

**W**ILLIAMSON amplifier, now universally recognised throughout the world (send large export orders) as the best quality reproducer manufactured to-day; the model made by R.T.M.C. (Ealing), Ltd., has been acclaimed as the best radio product on the market as no expense has been spared in producing a real quality job; we doubt whether any other amplifier even at 3 times the price has a better all-round performance; all seekers after quality reproduction should send for details; built of superb quality parts on extra heavy chassis with special cover; price £27/10; for use in the home or factory you should be the proud owner of a Williamson gram input speakers, transformers, etc., also supplied; also sets of transformers and chokes; stamp for full details from pioneer makers.—R.T.M.C., Ltd., Laurel House, 141, Little Ealing Lane, W.5. Ealing 6962

**Partridge News**

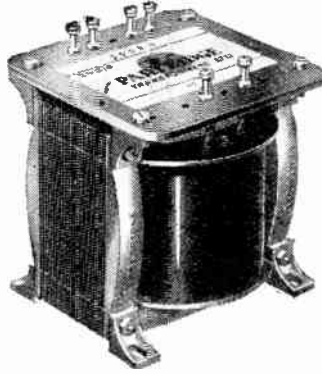

**TOLWORTH FACTORY**

Our new modern transformer factory and laboratory are now in operation and equipped with up-to-date machinery for the manufacture and testing of quality components. Increased facilities have enabled us to improve our service. As well as having 100 different types of transformers and chokes available from stock, we can wind to specification within 14-28 days depending on the quantity and types involved. Our range has been increased to cover power transformers up to 25 K.V.A. and we shall be pleased to send our catalogue and stock list upon request.

\*\*\*\*\*

**LONDON SALES OFFICE**

For the benefit of our many friends we have made arrangements for the immediate supply from stock of small quantities of our standard components. These can be collected from our address at King's Buildings, Dean Stanley Street, Millbank, Westminster, S.W.1. Tel.: Abbey 2244. (250 yards from Big Ben). Hours: 10 a.m.-1.0 p.m. and 2-5.30 p.m. (Mondays to Fridays only). Kindly note this address is for stock sales only.

\*\*\*\*\*

**NEW ADDRESS**

We should like to draw attention to our new address at Tolworth (situated just off the Kingston By-pass). This is now our sole factory. Callers and all correspondence should go to this address:—



**PARTRIDGE TRANSFORMERS LTD**

Roebuck Road, Tolworth, Surrey

**H**IGH quality amplifier and radio tuner units. 15 valve, 12 watts, 30 D.B. bass and treble lift; send for specification.—Broadcast and Acoustic Equipment Co. Ltd., Broadcast House, Tombland, Norwich 26910. [19562]

**S**END 2½d for bargain list, incl. range of 10 audio amplifiers (no fancy prices), e.g., 4watt A.A. with pickup and tuner inputs, volume, tone and neg. feedback controls, 110-250v a.c.; £5/19/6.—N.R.S., 102, Parkhill Rd., London, N.W.3. [2685]

**C**J.R. ELECTRICAL & ELECTRONIC DEVELOPMENT, Ltd., Hubert St., Birmingham, 3 (Aston Cross 2440); the Midlands specialist manufacturers of high fidelity equipment, for "W.W. Williamson", "Elect.onia", and other quality amplifiers built strictly to specification with finest components available; also tone control stages, loudspeaker cross over units, contrast expanders and radio feeders; send 2½d stamp for full details and prices. [2233]

**U**NIVERSAL ELECTRONIC PRODUCTS, 36, Marylebone High St., W.1, Welbeck 4058. Specialists in the design and manufacture of high grade fidelity gramophone reproducers and radio units. If you are interested in obtaining the finest possible reproduction from recorded music we invite you to hear our equipment demonstrated in conjunction with the Wilkins and Wright coil pick-up and the Wharfedale corner cabinet speaker. We will gladly give you a quotation for the conversion of your existing radio gramophone into a first-class reproducing instrument, or for the design and construction of equipment to your own special requirements. Write for descriptive leaflets of our range of fidelity amplifiers and radio tuning units.

**G**OODSELL, Ltd., 40, Gardner St., Brighton, G.1, Sussex.—The finest range of amplifiers available to Williamson's specification, K.T.66 at £22; P.X.4 version at £17/17/6; and without a doubt the finest of all, the P.X.25 amplifier with two chassis and two power packs for 500 and 275 volts n.t. at £28, carriage extra; all on black crackle steel chassis, £1.66 and P.X.4, 14×10×3, P.X.25, two chassis, 121×8½×21, paper condensers fitted on h.t. except in P.X.4, which has paper for reservoir Partridge transformers as standard, all valves B.V.A., beautifully finished with enclosed double fuse holder and recessed mains input; for use with above or any good amplifier, our tone control unit, separate 6-way treble and bass control boost and cut available by turning a switch, 2 valves, L.63s at £6, or high gain with E.F.37s at £6/6; also quality feeders, including a specially designed superhet (2-band) for better reception, variable sensitivity, distortionless detector. Components for Williamson; Partridge mains transformer, 57/-; chokes, 2/6 and 3/6; output transformer, £5; R.T.S. output, tropical finish, to specification, £3/7/6. Six useful books: The Brimar Valve Manual, 2/6; "Loudspeakers," by G. A. Briggs (Wharfedale), 5/-; Designing the DBT 1 (Practical Design of Receivers using Max-Q coils); DBT 2 (Design and Layout for Turrets 6 & 7); DBT 3 (Design and Layout for C.T.4 Turret), 3/- each; Partridge Manual, 5/-; please add 3d postage. [2747]

**RECEIVERS AND AMPLIFIERS—SECOND-HAND**

**R**.A.F. 1155, perfect; £6/10.—13, Sherwood Rd., Ilford, Essex. [2650]

**G**. W. SMITH & Co. (RADIO), Ltd., offers the following, sound and perfect:—**TELEVISION:** Ex-R.A.F. R.3585 receivers, brand new and boxed, a complete 45 mc/s 7V strip, using 5 T.R.7 stages (E.F.503), a diode stage (EA50) and video stage (EF50) complete with 17 other valves EF50, EA50, VR54, 55, 56, 65, together with dozens of resistors and condensers and complete with mod sheet, the finest T/V unit ever made, nothing on the market to compare with it, only £5/10.—R.A.F. Type 1135, a complete kit for long range television for use with the type 25UHF, range 35-45 mc/s, complete with all valves, including E.H.T. rectifier, 29/6 each, while they last; ex-Admiralty Type W 4790B responder unit, brand new in sealed boxes, very little mod needed for a complete 45 mc/s and sound pack, 52/6 each, limited number only; ex-R.A.F. frequency meters W 1191, coverage 100 kc/s-20 mc/s, complete with valves and crystal in sealed boxes, £5/10 each; special hams offer, first come first served, brand new in sealed boxes complete with full book of instructions and including 2 brand new 807 valves, crystal multipliers, range 2-7 mc/s with 0-10 m. meter, 29/6 each, limited number only; ex-R.A.F. Type 39 audio coupling units, with 0-3 and 0-6 amp thermo meters and 100-watt dummy amplifier, brand new, 7/6 each; constant voltage transformer, 130-250 volt, output 230 volt 150 watts, 32/6 each. **G. W. SMITH & Co. (RADIO), Ltd., 3, Lisle St., London W.C.2. Tel. Gerrard 8204. Open all day Saturday. [2742]**

**F**OR sale, Hallicrafters S20R, Sky Champion comm. rec. per cond. nearest £30.—Box 3520.

**R**.C.A. AR 86L.F. receiver, a brand new complete with handbook; £35.—Box 3610. [2693]

**L**AATEST 1948 Hartley Turner T.R.F.1, tuner, new, perfect; offers over £13.—Box 3519.

**J**BC348s, as brand new; £15 each, £28 pair; also R1116, £6.—7, Sherwin St., Crewe, Cheshire. [2691]

**A**R88—perfect, spare valves, s.p.r. £50.—Llewellyn, Nursery Av., Stockton Brook, Stoke-on-Trent. [2557]

**T**ELEVISION, Murphy V66CA console, 12in tube, perfect condition; £70; buyer collects. Tel. Darrford 3148. [2544]



## FURTHER REALISATION OF PERFORMANCE

Extract from a letter received by us a fortnight ago:

"I have toured various Hi-Fi experts to be duly thrilled. I came to you last and decided that yours was the best I had heard. Incidentally you were the only people who switched on and left it—the others had various excuses that we hear so often."

F. B. S., BATH

Many people have done the Grand Tour Hi-Fi before coming to us "just to make sure" that Hartley-Turner reproduction was the most realistic obtainable and we undoubtedly endorse this attitude, for we are confident in what we have achieved and the question does not afterwards arise that the customer made the wrong choice.

But we are surprised to find that some others, at least, do not seem to have achieved that unflinching certainty of operation we take for granted, since it is so fundamental to the listener's enjoyment. What on earth is the use of a hi-fi or any other equipment that only works when the other man isn't there? Hartley-Turner equipment is expected to work by touching a switch in our showroom or in the customer's home. If it didn't we shouldn't have the courage to sell it, because "service after sale" may be a good slogan but it isn't good business if it is necessary.

So if you call to see us you will be left to enjoy the music without our making excuses, and if you buy our equipment you won't have to make excuses to your friends.

The first and last part of the outfit is the Hartley-Turner 215 Speaker. You may have a good amplifier, pick up, radio unit, but without the 215 Speaker you miss far more than you think. Do the Grand Tour by all means, but make sure your speaker is a Hartley-Turner. Price only £9.

In case your records are not so good don't blame yourself too much for past mistakes. You can avoid them in the future by acquiring the Hartley-Turner Selected Record Catalogue which has once and for all "got rid of the bugs" in record buying. This invaluable guide to the best records is now ready, price 25/-, and supplements will be issued from time to time to make it complete and up to date.

And if you want honest advice in threading the tortuous path of hi-fi, you must have "New Notes in Radio," the only guide to high-fidelity reproduction in the world. Price 2/6d.

Catalogue free on request.

## H. A. HARTLEY CO. LTD.

152, HAMMERSMITH RD., LONDON, W.6. Riverside 7387

B.S.R. P.A.20 amplifier & Vibropack, as new, unused; £38 the pair to clear.—Box 3609  
CAR radios (Philips), 12volt. 5-valve, splendid value; £15.—Boydfield Electronics, Ltd., Prestwick, Scotland. [2704]

MARCONI CR 100 receiver. 60kc s-30mc.s. excellent cond. handbook and L.S.; £35 or nearest.—Box 3427. [2599]

MURPHY A10 Console all-wave, excellent condition.—Offers to Bryant, 11, Oxford Rd., Chiswick, London, W.4. [2639]

R.107 com. rec., 1.2-17.5mc/s, rectifier amplifier outout Vs. modified for i.s.; perfect condition. £14.—Box 3580. [2679]

R. and other gear for sale offers D. Plummer 20, Neven Place, London, S.W.5. [2639]

12-watt quality amplifier. 2 PX25 in push-pull, with spare valves, cracked steel cabinet, good condition; £15 10.—Box 3196. [2548]

WIRELESS World 2 R.F. 3 valve quality tuner for use with quality amplifier; £6 10 including valves; new and unused.—Box 1384. [2639]

19/6.—Receiving units, with 6 valves, 2 incl.—B. E. R., 39, Brighton Rd., Birmingham. [2607]

LEXUSON table all-wave universal, new kit, 1947, hardly used; offers over £14.—Rieu, 77, St. George's Drive, S.W.11, W. [2639]

3 only, as new Ferranti 12v car radio, surplus to requirements; to clear, £18, list price £36 19.—Enfields, 77, High St., Midsumer Norton. [2607]

PYE BIGT television receiver as brand new, reason for sale owner lives in very big radar, morse, interference area; best offer accepted.—Box 3521. [2641]

XR16, new valves, realigning, freq. range 61mc to 550kcs, carrier meter, etc.; nearest offer £30.—Tel. Ashford (Mdx) 3983. 98, Chertsey Rd., Feltham, Mdx. [2639]

MURPHY A78C quality console, purchased 1944, recently overhauled; manufacturer, with H.M.V. all-wave aerial; £80.—19, Windermer Rd., Bournemouth, Kent. Tel. Erith 3621. [2639]

MORRISON CHEYNE communication chassis, 16 valves, PX45; Vitavox K 12, 10, Colono auto changer, as brand new, superb quality; £60 or exchange, offers.—207, Lichfield Rd., Bloxwich. [2542]

W.W. qual. amp. PX4s and 3W.B. S.H. feeder unit, complete in new cabinet, Ambassador PA1 45amp, 12wts, with preset radio, in oak cab; Emerson 6v a.c./d.c./bty port.—Offers to 40, Morley St., Bury, Lancs. [2540]

RECEIVERS as new, 230 a.c., all manuals, National 173, latest model, £55; S27, two, £25-£20, S.K.1, £40; H.R.O., 9 coils, P.P., not ex-W.D., £55; 504, £37 10; and A.P.M. 4 unit T.N.16 unit, new, £20; near offers considered.—Box 3536. [2654]

7-Valve as new a.c./d.c. superhet radiogram chassis, 3 W.B. KT 33c P.P. output, 15in X 7 1/2 in X 7 1/2 in, illum. glass dial, 3 colours, 11grns; M.C.R.1 recr., crystal and lightweight phones, 4 coils, batts., £5.—25, Percy Ave., Kingsgate, Broadstairs. [2522]

A.R.85 receivers, offers invited; 1155 receivers, new delivery, £8, carr. paid; 1124D receivers, with universal valves, diagram and gen for television adaptability, to clear, 18.6, carr. paid; 1224A receivers, new, £4/10.—J. Rae, 39, Penn Rd., Wolverhampton. [2547]

LOOK! Two super jobs! 9-valve R.C.A. AR77E, 540 kc/s to 31 mc/s, S meter, less i.s.; 8-valve Howard 436A, 230v, 12v, 6d mc/s, with built-in spkr, both in original metal cabinets, 230v a.c.; sacrifice to clear.—Offers to Myhill & Son, Radio-Television, Attleborough, Norfolk. [2547]

### NEW LOUDSPEAKERS

WRITE for details of the new Flexicone conversion which considerably improves reproduction of speech and music to existing speakers.—Looker's Quality Radio, 106, Davidson Rd., East Croydon. [1923]

BEST makes only recommended and supplied. 5in Elac, 12/6; 6 1/2 in R. & A., 16/-; 8in R. & A., 18/6; 10in Rola, 26/-; output transformers, 5/- extra; 12in Celestion, £3 15; Rola G.12, 130/-; Wharfedale Golden 10in; 3 or 15ohms, 75/-; Goodmans Axiom, 8grns; sent by return c.w.o. or c.o.d.—N.R.S., 102, Parkhill Rd., London, N.W.3. [2686]

THE RD de Luxe corner cabinet is now being demonstrated by Mr. J. D. Rogers at Charlton, S.E.7; appointments to hear this reproducer may be made either by letter or phone; this reproducer has a level frequency range between 40-20,000 cps, and is considered the finest reproducer available in this country.—Rogers Developments Co., 106, Heath St., Hampstead, N.W.3, Hampstead 6901. [2667]

LOUSPEAKERS, SECOND-HAND  
VITAVOX K12 20, as brand new, in makers' carton; nearest £8.—Box 3537. [2655]

GOODMAN Axiom 12, perfect condition; £6.—Allbrooke, 19, Manor Rd., North Birmingham, E. [2661]

HARTLEY TURNER latest 215, as new; £7.—H. Kirby, 33, Bramley Way, W. Wickham, Kent, or Wat. 5871, Ext. 20. [2564]

VOIGHT twin diaphragm, new surround; first: £17 secure; carriage paid.—White, 90, Fairbank Rd., Bradford 42812. [2561]

ROLA G12 PM, unused, £5 15; G12 energised, used, £3 10; both carriage paid.—Colling, 312, Stafford Rd., Wolverhampton. [2566]

GOODMAN 12in, Premier 15w Xformer, as new, £5/15; other components; list.—Cutler, 143, Pollards Hill South, S.W.16. [2606]

## OPPORTUNITIES IN RADIO



Get this FREE Book!

"ENGINEERING OPPORTUNITIES"

reveals how you can become technically-qualified at home for a highly-paid key-appointment in the vast Radio and Television Industry. In 108 pages of intensely interesting matter, it includes full details of our up-to-the-minute home study courses in all branches of

TELEVISION and RADIO, A.M. Brit.

I.R.E., A.M.I.E.E., City & Guilds, Special Television, Servicing, Sound

Film Projection, Short Wave, High Frequency, and General Wireless Courses.

We definitely Guarantee

"NO PASS—NO FEE"

If you're earning less than £10 a week, this enlightening book is for you. Write for your copy today. It will be sent FREE and without obligation.

BRITISH INSTITUTE OF ENGINEERING TECHNOLOGY

388b, Shakespeare House, 17-19, Stratford Place, London, W.1.

## Pennine RADIO

MANUFACTURERS OF HIGH QUALITY RADIO RECEIVERS, RADIO GRAMOPHONES & AMPLIFIERS

AVAILABLE SOON FOR HOME AND EXPORT

ENTIRELY NEW RANGE OF ELECTRONIC TEST EQUIPMENT

ADDITIONAL DISTRIBUTORS REQUIRED THROUGH-OUT THE COUNTRY. INQUIRIES TO BE MADE DIRECT TO:—

PENNINE AMPLIFIERS

(Est. 1924).

Head Office and Factory:

SOUTHGATE, ELLAND, YORKS

WATCH THIS SPACE FOR FUTURE ANNOUNCEMENTS

**VOIGT** twin-diaphragm unit, h.c. horn with bass-chamber and field rectifier, nearest offer £33.—102, Birkby Hall Rd., Huddersfield.

**BAKER** super quality 12in triple cone speaker with Ticonal magnet, complete with infinite baffle cabinet in veneered walnut. 15ohms speech coil; £17.10; new and unused, half original price.—Box 386. [1764

**VALVES**—5Z4, 5U4, EF39, EF36, EF50, 12A6, 6X5, 5X4, 210VPT, and many more. 210LF & EL32, etc., new and at list prices; please enquire for any type not listed.—Duke & Co., 219, Ilford Lane, Ilford, Essex. Trade enquiries invited.

**VALVES**—Various valves!—Almost every type of valve in stock; in stock for use. All of our stocks are brand new at makers' list prices, no ex-Government stock; send no money, we will send c.o.d. return of post.—Hansard, Market Place, Spalding. [2249

**DYNAMOS, MOTORS, ETC.**

**GENUINE** plug-on dynamors for BC453, etc., 14v in, 23v out; 12/6. Lawrence's, 61, Byron St., Liverpool. Cen. 4430. [2737

**BATTERY** chargers, 4 models, 2-6-12v, 1-2-4 amps D.C.; any mains voltage; also larger types. special transformers, chokes, test gear, interior car heaters, etc.—The Banner Electric Co., Ltd., Hodeston, Herts. [2212

**ALL** types of rotary converters, electric motor sets, etc.; rotary transformers, input 12v d.c., output 600v at 250ma, price £4 10 each nett. post paid.—J.A.P. No. 2A engines, 1.2hp at 2,600 r.p.m., complete with new fly for use with net, ex works.—Ward, Lordcroft Works, Haverhill, [7503 folk. Haverhill 253-4.

**NEW** Onan pet. generators, 12-15v, 600watt. self-start air-cooled 4-stroke, vol. reg. auto cut-out, ammeter, complete with tools, spares and instructions. 12v, 24v plus car. Also Lyon 12-15v 360watt air-cooled 4-stroke engine, new or hardly used, ammeter, etc., £16/10, car. free. Chargers: H.D. 50v 50a 3ctt. m/c meter, control panel, switches, fuses, etc., input 200-250 v ph or 440/3 50, £20, plus car.; others; 200-250 v, 20v, in, 24v out, with steel case, 1 control panel, m/c meters, rheos, fuses, etc., £12, plus car.; also 6-24v 12w with meter and fuses in vent. steel case, £10 plus car.; rectifying units input 230 a.c., output 220v 3a d.c., metal rect. £8/10, plus car.—Pearce, 66, Gl. Percy St., London, W.C.1. See also under Components.

**97/6** charging switchboards, 12v, 30v, 500 and 1,260 watts, volts, amps, cut-outs, fuses, resistances, etc., 4 take-offs, superb unit, in case, or send £5 carriage paid; 75v dynamos, 24 volts, 1,000 watts, 9in x 7in, 3/4in spindle, or send 90v carriage paid; 75v, 230v 1/2hp, 1 1/2hp electric motors, 12v, 30v, 1,260 cycle converter, or send 80v carriage paid; 58v, mains transformer switchboards, 230v ac to 12v, 5 separate take-offs, complete distribution panel, all switches, fuses, amps, etc., brand new, or send 60v carriage paid; 55v, electric motor 12v and 24v carriage paid; 3in x 4in, with 1/4in spindle for drive, beautiful job, or send 60v carriage paid; 45v, dynamotor units, containing 12v, 24v, 130v and 300v dc dynamo or suitable as 6v, 12v or 24v motor, approx. 1 1/4hp, 1 1/2in x 5in, with spindle to take small grindstone, mop, etc.; also contain adjustable 24v cut-out automatic voltage control, smoothing condenser, resistances, and many other extremely useful fittings, beautifully made, or send 50v carriage paid; 38v, radio wavemeters, adjustment dial, 350-370 Mc/s, beautiful instrument in case, or send 40v carriage paid; host other valuable equipment, lists free.—Benmott's, Summerley St., Earlsfield, W.18, Wim. 3833, 100 yds S. Ry. Electric Line; 10 minutes Waterloo. [2660

**TESTER EQUIPMENT**

**COSSOR** 339 D.B. Oscillograph, perfect and in new condition; £34 or offer.—Box 3619.

**AVO** valve tester, as new, in maker's box, complete with charts, etc.; what offers?—Fletcher, 5, Clavering Walk, Bexhill. [2642

**MARCONI** TP1449 standard signal generator 100c to 25mc; excellent condition, guaranteed; £59 or near.—181, Lake Rd., Portsmouth. [2660

**AMERICAN** multi-range meter, 25 ranges, A 1,000 o.p.v., perfect; £10, or exchange for C.R. scope or valve tester.—25, Percy Ave., Kingsgate, Broadstairs. [2658

**N.R.S.** guarantee safe and immediate despatch of all current Avo test instruments; send 2/6 for new Avo catalogue.—N.R.S., 102, Parkhill Rd., London, N.W.3. [2647

**UNUSED** mains all-wave B.P.L. sig. gen., 100v; several 12v, 24v, 210 amp metal rectifiers, brand new, 14v, 7in Emiscope, C.R. good condition, £4.—Box 3538. [2660

**TAYLOR** model 65B sig. gen. £9; Taylor model 85A 20,000 o.p.v. test meter, £11; Avo valve tester complete, £10; Hunt's capacity bridge, £7, perfect order.—Box 3133. [2501

**DUMONT** 5in Oscilloscope model, as new, £40; Cossor model Oscillator, £13; B.T.S. precision R/C bridge, cost £18, accept £12; Avo valve tester, £12/10.—145, Merrivale Rd., Exeter. [2660

**IMPROVED** model A.C.4 meter kit, and conversion unit for older model available shortly.—Illustrated list of test equipment from L. A. MacLellan & Co., 16, Thistle St., Stirling. [2660

**CLEARANCE** Avometers, model 7, B.T.S. precision minors universal £7 5s; Avominors d.c., £3/12/6; Avo valve tester, £15; Hunts capacity analyser, £15; all instruments brand new and perfect; post free, c.o.w. please.—Young, 134, Old Shoreham Rd., Southwick, Sussex. [2750

**ELECTRADIX**

SPECIAL OFFER!

**21/-** for a pair of P.M. MOVING COIL HEADPHONES, less headband. Here is a wonderful opportunity to secure highly sensitive headphones with coils energised by the famous ALNI magnets. These moving coil sound units have a 45 ohm. 1/2in. coil.

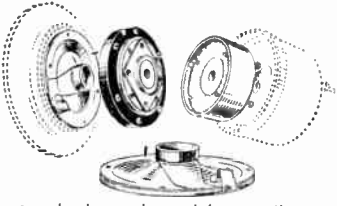

They can also be used as miniature mikes, or as a miniature loudspeaker if matching transformer is used. Size 1 1/2in. overall, in bakelite case with 3in. front flange. As new. PRICE EACH **12/6** Or price per pair 21/-.

**DYNAMOS**, D.C., 12 volt 10 amp, 1,400 r.p.m., £2; 30 volts 5 amp., 1,500 r.p.m., £4; 24 volts 30 amp., 2,000 r.p.m., £2/10/-; 24 volts 40 amp. 800/1,000 r.p.m., £2/10/- Special 12 volt 10 amp. dynamo, 600/1,000 r.p.m., for Windmill work, C.A.V., weight 24 lbs. 10 1/2in. x 5in., with double ended shaft, £5.

**THE DEM. CONTINUITY-TESTER**. A self-contained portable circuit tester for all electrical circuits, almost pocket size, 6 1/2 x 3 1/2 x 2 1/2in., a beautifully made Goo. instrument, new, totally enclosed Polish wood case with carrying strap and contact switch. The experimenter's best friend. Worth 2 guineas. A limited number are offered at 12/6 post free.

**DIMMER RESISTANCES**. Totally enclosed, panel type, 100 ohms 1/2 amp. or 50 ohms 1/2 amp., 2/6 each, post 6d.

**MICROPHONES.**

The New Lesdix Table Mike, high-grade carbon inset, in bakelite case and mounted on polished bakelite base with transformer, 12/6. G.P.O. mike button, 3/6. Self-energised magnetic microphones in solid rubber case, 1/4in. dia., 7/6 each. The Tannoy hand mike, multi carbon type, metal clad with neat switch in handle (as illustrated), 10/-.

Moving coil hand mike, first-class M.C. unit mounted in solid bakelite case with handle and switch, 10/-, or mike with pair of M.C. Headphones and cord, 27/6.

**LIGHTING PLANTS**. Stuart Turner and Pelapone, slow speed engines and dynamo set on C.I. bed plate. 500 watt single cylinder 2-stroke water-cooled self-ign. engine, mag. ign., coupled to 50/70 volts 10 ep. shunt dynamo, 1,000 r.p.m., £45. Villiers Portable plants, 1 1/2 kW, 35 volts 35 amps., £22/10/-, J.A.P. 300 watt 32 volts 10 amp. lightweight, £15. Chox-Horse 300 watt 12 volt 25 amp., £14/10/-, All ex-Battersea Stores.

**INDUCTOR ALTERNATORS**. 400 watts, totally enclosed, single or 3-phase 50 cy. 230 volts 4 pole ball bearings speed 2,800 r.p.m., need 6/8 v. 6/8 amp. separate excitation, £5, as new.

**MOTOR BLOWERS**. 24 volts D.C., Keith Blackman 5in. inlet and 5in. outlet, £3/10/-.

**TRANSFORMERS**. B.T.H. 200/230/250 volts, 50 cy., input 2 V. 20 amps., and 75 v. 6 amp., with 15 taps output G.P.O. transformer cores with lams and wire, 500 watts, 25/-.

**VALVES**. A.T. 40 transmitting triodes, 6.5 volts fil., 1,000 volts 40 watts, 3/6, post 9d

**SWITCHBOARDS**. 500 watt, in metal case 15in. x 15in., with doors, 5 mov. coil meters, 4 variable slider resistances, 3 enclosed cutouts switches, terminals, etc., £4, ex-Battersea Stores.

**PETROL ENGINES** 1 1/2 hp, single cylinder 2-stroke water-cooled, with petrol tank, £10, carriage extra.

**PARCELS**. 10 lb useful odds, 7/6 post free. (Not for Overseas buyers.)

Please include postage for mail orders

**ELECTRADIX RADIOS**

214, Queenstown Road, London, S.W.8  
Telephone: MACaulay 2159.

**AUDIO** signal generator model 205 AG. by Hewlett-Packard. Dumont oscilloscope type 168, Cossor and ultra oscilloscopes, cheap; Write—E.R. 39, Brighton Rd., Birmingham.

**OSCILLOSCOPE** and vibrator for complete £20; T.B. 10 c/s to 350,000 c/s. X and Y plate amplifiers, easy to handle and outstanding performance, brand new and fully guaranteed. Immediate delivery complete with set of leads and booklet on oscilloscope technique.—Write for further details to Erskine Laboratories, Ltd., Scaby, Scarborough. [1648

**NO** means? You can still use modern and efficient test gear: our Tracetec (signal tracer) Genete (generator) and Pocket Valve Voltmeter all work from midget batteries and each is enclosed in a pocket sized case, easy to build and amazing in performance; each plan 2/6 from—E.N.B., "Whinnie Knowe," Sennen, Cornwall; s.a.e. for Nupans list. [2698

**COMBINATION** portable valve tester and multi-range meters by famous U.S.A. makers, ranges d.c. volts, 0-10, 50, 250, 500, 1,000 at 10,000 1/v; a.c. volts ditto at 2,000 1/v; d.c. ma 0-1, 10, 50, 250; 4 resistance ranges reading 0.1 to 15 meg ohm; capacity 0.01 to 10uF tests over 1,000 U.S.A. valves, black crackle case with carrying handle, each instrument tested and guaranteed, £17/10, car. paid. U.S.A. make output meters, 5 ranges, 1.5 to 150v a.c., in small bakelite case, £4/17/6, post free.

**LESTER** RADIOCRRAFT, Ltd., 69-71, Churchgate [2530

**METERS**,—0-1ma, 2 1/2in. m.c. 13/6; 3.5 amp 2in T.C., 5/-; 30ma, 2in. m.c. 6/-; 4 amp 2 1/2in. thermo-coupled, 7/6; double reading, 40-120ma, 2in. m.c. 8/-; 20 amp, 2 1/2in. m.l., 9/6; 5 v. 20v, 2in. m.c., 9/6; 500v, 2 1/2in. m.l., 12/6; 300v, 2 1/2in. 30 amp. dim. m. 12/6; 100v, 6.000v, 3in. m.c. 5/6; 3,500v, 3in. m.c. 20/-; 150-volt, 2 1/2in. m.c. 10/-; 15v/60v, double reading, 2in. m.c. 8/-; 2in meter movements with magnet (500 micro-amp), 2/6; post extra; R.A.F. 2-valve (12-volt) microphone amplifier, used in plane inter-com. m/c, self-contained metal case, can be used to make up a deaf aid outfit, intercommunication system, or with crystal set, complete with valves (also unused), 20/-, post 1/6; wooden box to hold amplifier, 2/- extra; letters only; well illustrated list sent on request with stamp and s.a.e.

**HIGHSTONE UTILITIES**, 58, New Winstead, London, E.11. [2221

**TRANSMITTING EQUIPMENT**

**FOR** sale, Canadian Phoenix 43 mark two, brand new offer.—Box 5577. [2676

**VRH** trans/recrs., sets contained battery operated, require 120v and 2v acc. 5 amp band; internal condition 100%. external soiled only, 9 valves—2158C, 210HL, KT2, etc., £4, carriage 5/-, without valves, £2/10, carriage 5/-.

**GRAMPHONES AND SOUND EQUIPMENT**—Highworth Rd., Brixton, London, S.W.2. [2660

**SIMON SOUND SERVICE** have recorders in stock. [8713

**THREE** crystal P.U.s. senior type, new, unused; 3/2 1/6 each.—Box 3423. [2587

**C** 1/2p. recorder, with modulation meter, complete new; £25 or offer.—Box 3579. [2660

**TRANSFORMERS**, tone control and filter chokes for all "W.W." circuits.—R. Clark, 30, Langland Cres., Stanmore, Mdx. Wor. 5321.

**MARCUS**, Ltd., 75-77, East Rd., N.1, have for disposal number of radiogram cabinets, 6 val. Chassis and Garrard player units with pick-up.—Tel. Cle. 2462. [2660

**SOUND** recording by the Direct Disk Method," by D. O.C. Roe, copies available, 5/-, post paid, from Birmingham Sound Reproducers, Ltd. Old Hill, Staffs. [2334

**ARR** gram. motors, 200-250v a.c. recording unit, fitted speed control, 9/6; Gram CMG25 phocells with precision oscillator, 17/6.—Western, 35, Portland St., Lincoln. [2565

**URICON** 16mm portable sound recorder. A model 20, complete including amplifier, cables, m.c. microphone and cardioid microphone, £285; Attreaves condenser microphone with preamp, £12; Vitavox 6x2 multicell horn, £15; p.m. unit for same, £3; Collorec microgram, £17/10.—Leavers, Rich & Co., Ltd., Cinema House, 80, Wadour St., London, W.1. [2579

**PROFESSIONAL** recording equipment to the trade, M.S.S. recording machines, recording amplifiers, ribbon and M/C microphones, blank discs, etc., etc.; gramophone motors and lightweight pick-ups, radio pre-stage units and quality speakers, all from stock on full trade terms; 16mm talkie projectors for immediate delivery.—Sound Discs (Supplies) Ltd., 37, Houghton St., Southampton, Lancs. [1199

**MORECAMBE SOUND SERVICE** are here to serve you with your needs. The C.D.P. recorder, £32; special model, £40; complete recording unit, size 19in x 16in x 12in, £95. We carry a large stock of Grade 1 recording discs, DS10in 4.6, DS12in 6.7, etc. Cutters, mikes, pick-ups, special mains suppressors for radio (not R.A.F.), 12/6.—Morecambe Sound Service, 1-6, Green St., Morecambe, Tel. 1161. [2725

**MEMBERSHIP** of the British Recording Association ensures the professional and amateur recording engineer, and quality reproduction enthusiast of all the latest information in the form of monthly lectures, publications, demonstrations and the official journal, "Sound Recording," published quarterly. Vol. 7, Nos. 1, 2, 3, 4 available at 2/6 each.—Details of membership and application form from Membership Secretary, Harrie J. King, 48, Mount View Rd., N. Chingford, London, E.4. [2119



**THE  
BRITISH NATIONAL  
RADIO SCHOOL**  
ESTD. 1940

for  
**New World Ideas and Old World  
Ideals!**

**The Urge to Serve and the Know-  
ledge How!**

**Home Study Specialists with the  
Personal Touch.**

**Radio, Radar, Maths., Physics.**

**The B.N.R.S. FOUR YEAR PLAN**

covers the full syllabus of:  
**A.M.I.E.E., A.M.Brit.I.R.E. and  
CITY and GUILDS Radio and  
Telecommunications Exams.**

Six months' trial period without  
obligation to continue.

Send for free booklet to:—

**STUDIES DIRECTOR  
BRITISH NATIONAL RADIO SCHOOL,  
66, ADDISCOMBE ROAD, CROYDON**  
Phone: Addiscombe 3341

**TELEVISION CONSTRUCTION FROM  
EX-GOVT. GEAR** is becoming all the rage. We can supply full constructional details for a TV Receiver using Radar Units costing £6/10/-. The data is 7/6, but if the units are purchased is supplied gratis, or the cost will be allowed if the purchase is made within 14 days. A combined HT and EHT Mains Transformer is £5/10/-. but if bought with the Radar Units the total cost is £11/10/-, showing a saving of 10/-. (Please add 12/6 carriage, plus 10/- deposit, on returnable packing case.) WE CAN ALSO supply the "Radio Constructor" inexpensive Television Data, priced at 1/6.

**1 1/2 METRE SUPERHETS APW4790.** Contains one each valve RL7 and RL16, six of SP61, and one EA50. Has 6 I.F.'s of 12 megs. with 4 meg. bandwidth, and variable tuning. All are BRAND NEW, but some have had coils removed by the makers in preparation for fitting others of a different range. With these we supply three 11 mm. formers with brass core, enabling coils to be wound for ranges required. ONLY 59/6 (carriage, etc., 5/-).

**MODULATOR AND MIXER UNIT W6331.** An ex-Admiralty Unit containing a host of gear, including a 231 V.A. transformer, one valve 5U4G, two of 6J5G, three of P61, one of SP61, and one of EB34. BRAND NEW. ONLY 19/6 (carriage, etc., 5/-).

**INSULATION TESTERS (MEGGERS),** Ex-R.A.F. Brand New Testers by Evershed & Record. Readings up to 20 megs. at 500 v. pressure. Listed at over £12. Our price is ONLY £8/10/-.  
C.W.O. Please S.A.E. for lists

**U.E.I. CORP.,**

**THE RADIO CORNER,**  
138, Gray's Inn Road, London, W.C.1.  
(Telephone TERminus 7937)

We are 2 mins. from High Holborn, 5 mins. from King's Cross. Open until 1 p.m. Saturdays.

**SIMON SOUND SERVICE** can supply your needs. [8712]

**F**OR sale, MSS recording machine with back BSR amplifier, BSR Ampligram, 2 10-watt Vitabx speakers, 3 prs. earphones, 2 lustraphones microphones, 1 microphone stand; considerable stock steel discs, various sizes, used very little.—Box PP 3827, W. H. Smith & Son, Ltd., Manchester, 3. [2632]

**A**.C. gram. motors 200/240v 9in t.t., 75/-; Collaro ditto 110/250v, 12in t.t., variable speed, £5; Collaro ditto with universal auto-stop, £7/6/3; Collaro R/3 combined units motor/pickup/autostop, 447 v.s., 12in t.t., a.c., £9; a.c./d.c. £12/18/9; the new Collaro model R.P.49, rim-drive, 10in t.t., 110/250 a.c., mag. pickup, autostop, £5/14/8; Garrard ditto (model S), £5/18/4; Plessey, as new, super-quick mag. pickup, our price, £18; leaflet on request; terms c.w.o. or c.o.d.; bargain list 21st ed.—N.R.S., 102, Parkhill Rd., London, N.W.3. [2698]

**A** MUST for all music lovers; our 16-page booklet, "Living Music," tells you all about the famous Concerto amplifier and the increasingly popular K1 amplifier; tuning units giving the utmost fidelity from your local stations or by the flick of a switch a superhet of world-wide performance; and, to complete this chamber recently developed. Write at once, enclosing 5d in stamps, for your copy or, better still, visit us and hear for yourself; deferred terms now available. Don't hesitate to write for any advice you need to.—[2698]

**CHARLES AMPLIFIERS, Ltd.,** 1m, Palace Gate, Kensington, London, W.8 [2718]

**COMPONENTS—SECOND-HAND, SURPLUS**  
**12V** o/c vibrators, UX4 base, V.6512; 2/6 each, post paid.—Electron Works, 92, East Ham, London, E.6. [2710]

**F**WATT amplifier kit for p.c.k.-up, etc.; full instructions for assembly and new components; £4/19/6, carr. 2/6; details.—Box 3622.

**F**OR sale; unused 12in Emissioncope, with matched scanning coils, suitable for Type 901 television model; first reasonable offer secures.—Box 3432 [2610]

**TELEVISION** magnifying lenses of famous make, to fit any and every make of receiver, just in; our price from £5/19/6.—Duke & Co., 219, Ilford Lane, Ilford, Essex. [2475]

**BC453** conversion to car radio or a.c. mains receiver, circuit and full constructional notes; send 3/6 and state circuit required.—Radio Engine, 14, Stuart St., Dunstable, Beds. [2610]

**TELEVISION** scanning coils, 30/-; frame output transformers, 17/6; line output transformers, 25/-; also mains transformers, chokes etc.—The Banner Electric Co., Ltd., Hoddeston [2459]

**TELEVISION** chassis and components of the "Electronic Engineering" specification; s.a.e. for list.—Osmor Radio Products, Ltd., Borough Hill, Croydon, Surrey. [2459]

**VCR97;** fit a Magnavista lens; will make your 5in picture 9 or larger at the staggering low price of 4 gns.; trade supplied; orders taken in strict rotation.—Duke & Co., 219, Ilford Lane, Ilford, Essex [2612]

**EHT** transformers, mains transformers and chokes for general purpose oscilloscope, as per W.W. May, 1948, delivery ex stock.—Metropolitan Radio Service Co., 1021, Finchley [2655]

**N.W.11, Tel. Speedwell 3000.**  
**PARCELS** of radio and electrical material, including main components for constructing first-class superhet, 20/-, post free; also service manuals, technical books.—Mawson 11, Salisbury St., Pelaw-on-Tyne. [2456]

**YOU'LL** probably get it at a Smith's, Edgware Rd.!! Every thing for the constructor from a 1/10watt resistor to a radiogram cabinet; lowest prices, biggest variety.—Near Metropolitan Music Hall, Pnd. 5891. [8005]

**E.H.T.** transformers, mains transformers and chokes for cathode ray oscilloscope as per W.W. World, Dec., 1948; delivery ex-stock.—Metropolitan Radio Service Company, 1021, Finchley Rd., N.W.11, Tel. Speedwell 3000.

**OSMOR RADIO PRODUCTS, Ltd.**—All components for the Osmor superhet available at attractive prices, including the famous Q coilpack, etc.; designed for easy assembling and perfect matching; send s.a.e. for free literature to Bridge View Works, Borough Hill, Croydon 1220. [2458]

**MANUFACTURERS**—Enamel, copper wire, all gauges, lamination, all types, huge stocks radio components, s/m, m/m, p.t and block condensers, close tolerance and high stability resistors to 1%; all woods guaranteed.—L. E. Simmonds, 10, Valencia Rd., Stanmore, Middx, Grimsdyke 608

**RAYMAX** are your suppliers for radio television and gramophone equipment, components kits and chassis; all at prices you can afford; all necessary items, including cabinets, for player or auto table radiograms; stamp for general list or state your requirements.—Raymax Elec. Co., Ltd., 126, Norwood Rd., S.E.24.

**LOUDSPEAKER** bass and treble separator, 6 parts consisting of choke 6/-, and 12mf condenser 10/-; crossover at 1,000 c.p.s.; suitable 2 to 15ohm speakers; full instructions; circuit diagram of "Variable Selectivity 5," with constructional hints, 3/-; a high quality receiver with special consideration in the I.F. and for light weight p.c.k.-up, variable selectivity I.F. transformer, 12/-; gramophone scratch filter, 15/-.—B. & H. Radio, Huntley St., Darlington.

**PITMAN**  
*Electrical Books*

★  
**Elementary Vectors**  
for Electrical Engineers  
by G. W. STUBBINGS, B.Sc. (Lond.),  
F.Inst.P., A.M.I.E.E.

A useful guide to the fundamental principles of vector theory. With graphs and diagrams.  
**Third Edition.** 7/6 net  
"Useful, original, stimulating and well-written."  
*Electrical Review*

**Radio Mains Supply Equipment**  
by E. M. SQUIRE  
Surveys the principles of design and operation of the mains supply equipment, and is invaluable in dealing with faults. **Illustrated.** 12/6 net

**Photoelectric Cells in Industry**  
by R. C. WALKER, B.Sc. (Lond.),  
A.M.I.Mech.E., A.M.I.E.E.

A guide to the principal industrial uses of photoelectric cells.  
**Profusely Illustrated.** 517 pages. 40/- net

**Classified Examples in Electrical Engineering**  
by S. GORDON MONK, B.Sc., M.Sc., M.I.E.E.

In two volumes, each containing a selection of examination questions with fully worked out answers. Vol. I (Direct Current) 5th Edition, 5/- net. Vol. II (Alt. Current) 5th Edition, 6/6 net.  
**PITMAN Parker Street, Kingsway, London, W.C.2**

**3 AMPLIFIERS**  
that meet all needs

**3 WATT . . . 11 Gns.**  
P.14.—A highly portable amplifier—it weighs only 10 lbs. and is suitable for outdoor use. Works from a low power supply of 2 amps. at 6 volts. Built into case 13in. x 6 1/2in. x 4in. with controls and sockets at one end.

**15 WATT . . . 66 Gns.**  
P.10.—A quality amplifier in which the HT supply is carefully filtered and all components conservatively rated. No electrolytic condensers are used in any part of the circuit. Switch correction is provided for Decca and HMV recordings. Mounted on polished chromium plated chassis.

**20 WATT . . . 26 Gns.**  
P.16.—Designed for universal mains supply, its output of 20 watts is exceptionally high. Total harmonic distortion at full output is only 4 per cent. and hum level is unusually low. Weight, 17 lbs. Overall size 15 1/2in. x 7 1/2in. x 8 1/2in.

Write for leaflets giving full details.

**McMURDO**  
INSTRUMENT CO. LTD.  
Victoria Works, Ashted, Surrey





GOVT. SURPLUS, UNUSED

# CONDENSERS

of all types . . .

We can offer, FOR IMMEDIATE DELIVERY from very generous stocks, a wide range of ultra-high quality fixed paper Condensers, from .001  $\mu$ F to 8  $\mu$ F. Also STOCKS of small, genuine MICA Condensers from .00001 (10 pf) to .01  $\mu$ F (10,000 pf). Prices are exceedingly moderate.

Enquiries are invited for manufacturers' requirements, wholesale and export only for bulk quantities, and for scheduled deliveries over a period, as required. Most condensers are now available for immediate delivery.

Please request our 4 page bulletin CONSEVEN 01114

**CLAUDE LYONS LTD.**  
180, Tottenham Court Rd., London, W.1  
and 76, Oldhall St., Liverpool 3, Lancs.

first and  
foremost!

# LOWTHER

TUNERS  
AMPLIFIERS  
HIGH FLUX LOUD-  
SPEAKER UNITS  
PICK-UP MOVING COIL  
DIAMOND POINT  
BASS-TREBLE  
CORRECTOR  
WHISTLE SCRATCH  
FILTERS

etc., etc.

either collectively or independent  
units

**THE LOWTHER MANUFACTURING CO.**  
Lowther House, St. Mark's Road  
BROMLEY, KENT

Rev. 5225

**TELEVISION!** Television! Television! Still a few tube 6 indicator units complete with VCR97 tube and all valves, brand new, £3/19/6; please include 10/6 for non metal bound tool box which is refundable if returned (optional); RX TX includes all valves (11) and rotary transformer (suitable for conversion to a.c. mains motor), 39/6; here's a bargain! control panel type IV, contains 2 meters, Yaxley type switches, transformers, rectifiers, many components, resistors, etc., etc., and 2 6K6G and 2 6K7G valves, 29/6, plus 10/6 for metal bound tool box; 4 point 4-way Yaxley type switch, 1/8 each, 18/- doz; Diamond H double pole 10amp switch, 2/- each, 20/- doz; R.A.F. carbon hand microphone, 2/- each, 21/- doz; standard 2 point telephone jack plugs, 1/- each, 8/- doz; P.O. 3 point jack plugs in pairs 1/6 per pair, 15/- doz; 1meg and 1meg volume controls, 2/- each, 21/- doz; heavy brass 2BA terminals, 3d each, 2/6 doz; 3 position wave change switches, 6d each; microphone transformers, 2/6 each, 24/- doz; ask for special condenser list which covers all high and low voltage receiving, transmitting and television condensers, com/1. J.B. slow motion drive with knob and dial to fit standard 1/4 spindle, 2/9; do not include extra for carriage, all is free to any address in the U.K.; send 3 s.a.e. to-day for our latest lists.—Walton's Wireless Stores, 205, Staveley Rd., Wolverhampton.

**SELENIUM** rectifiers, charger kits, etc., new goods, not surplus. S.T.C. Sentercel L.T. metal rectifiers, 12V/17V 1.5amp 9/4, 12/17V 2amp 6/4, postage 6d; 12V/17V 2amp 0r 6V 2amp 9/6, postage 6d; heavy, finned type, 12V/17V 3amp bridge 20/-, 2.5amp 19/-, 4amp bridge 22/6, 5amp 25/-; giant finned type, 6amp 32/6, 6V 10amp 25/-, postage 1/2; 24V 2.5amp, 29/-, 24V 6amp h.t., 24V 5amp 39/6. Small, space selenium h.t. 120V 30m.a. eliminator type 6/-, 350-0-350V 80m.a. 10/6, 450V 40m.a. 6/-, 250V 100m.a. bridge type 12/6, postage 6d. Varied stock of rectifiers for garage charger conversions, and other purposes. Charger kits, all kits guaranteed one year. S.C.G. 12/15V 5amp rectifier with 50watt transformer and ballast bulb for 2V, 6V, 12V charger, no rheostat and ammeter required, 45/- with specially manufactured steel case and terminals, screws, etc., 62/-; 12/15V 2amp rectifier with 45watt transformer and ballast bulb for 2V, 6V, 12V charger, 32/6, or with case, etc., 52/-, post 1/2. Medium duty kit, 75watt trans, 12/15V 4amp rectifier, ballast bulb, 62/-; with case, etc., 77/6, postage 1/6. Heavy duty kit: 140watt, trans, giant 6amp rectifier for 6V, 12V charger, £3 15/-, ditto with slider resistor and high-grade ammeter, £5, post 2/-; chargers, 6V, 12V 2amp max, 57/6; ditto, 12V 3amp, 79/6; 12V 4amp, 92/-, guaranteed one year, post 2/-, 80watt fluorescent chokes, 16/-; 0-6amp ammeters, flush bakelite, 12/6; Rola 5in speakers, 15/-, post 1/2; 350-0-350V trans with h.t. rect., 29/-; 6.3 or 4V heater. CHAMPION, 43, Uplands Way, London, N.21. Tel. Lab. 4457.

**B**ENDIX command receivers BC 454, 3-6megs (1/1s 1415Kc/s) BC 455, 6-9.1megs (1/1s 2830Kc/s), 6 valves, 12SK7 (5), 12SR7 (1), 12A6 (1), and 12K8 (1), ideal for a.c./d.c. receivers or car radios, either set 35/-, plus 1/6 postage, new and boxed; Marconi 600hm headphones, leather headbands, 5/6 each, post 6d; fractional horse power motors, approx. 1/6; 2000 rpm, 4 1/2" x 2 1/2" in dia. black chrome finish, 15/- each, post 1/6; control boxes for Bendix BC 453, 454 and 455 receivers, 6 dials and drives, 5 50,000ohm volume controls and 6 rotary switches, 12/6, post 1/-; drive adaptors and knobs for Bendix 453 series, easily fitted to existing shaft to give full slow motion drive, 2/6 per set, post 3d; receivers type 76, 150-505Kc/s in two bands, 26V operation, valves VR92, VR57 and ARH2, flexible geared drive, Desynn control and other high grade components, new 30/- each, post 1/6 extra; contactor time switches, by Smiths and Venners, 10 hour movement giving two contacts per second, ideal for darkroom work, in soundproof boxes with thermostatic control, brand new, 10/-, post 1/4; Westectors W.X.6 and W.112, brand new 6 1/2 per cent, post 4d; screening cans, screw-on base and spring loaded retainer, 4 1/2" x 1 1/2" dia., 1/6 each; 2 24V motors with smoothing circuit and slow motion gears, brand new, in maker's cartons 10/6 each, post 1/4; transmitter tuning units T.U.9B (7,700-10,000Kc/s), T.U.10B (10,000-25,000Kc/s), T.U.25B (200-500Kc/s) any unit, £1, plus 2/6 carriage, brand new, hide-faced hammers, ideal for panel and chassis work, 2/6 each, post 6d; batteries, M.C.R.1, type 90V h.t., 7 1/2" x 1 1/2", 6/6 each, post 9d; throat microphones, brand new with three foot lead and jack, low impedance, 3/6, post 6d; drive cables for Bendix receivers, 14 feet long, gang 5/-, post 4d, single gang, 2/6, post 4d; Lufbra hole cutters, for use on wood, metal and plastic, adjustable to 3in dia., 5/- each, post 6d; half metre folding dipoles, 3/6 each, post 4d; Navai signalling lanterns in wooden transit cases, 10/- each, post 1/-; Naval Aldis lamps, 6in dia., 110 and 250V supply, complete with 10 feet waterproof cable, spare bulbs and lenses and two switch plugs, brand new in strong transit cases, 40/-, plus 5/- carriage; send 2d stamp for full publication list; no component lists in stock for present.

SOUTHERN RADIO SUPPLY, Ltd., 46, Lisle St., London, W.C.2. Gerrard 6653. [2707

## PORTABLE TESTING INSTRUMENTS



### SENSATIONAL SURPLUS BARGAIN!

A huge purchase of brand new Army general purpose, line-testing instruments, enables us to make another of our amazing "once in a life-time" bargain offers. The instrument illustrated is a necessity for every electrician, general mechanic, handy man and radio repairer, and is a reliable standby for the "ham".

The instrument comprises a moving coil D.C. movement, housed in an attractive carrying case with handle. The dial is calibrated for readings of 0-1.5 volts, 0-3 volts, 0-60 m.a., and 0-5,000 ohms. Additional ranges may be added at will. The basic movement is 6 m.a. 250 ohms resistance.

Each instrument is fully guaranteed perfect, brand new and in the original manufacturer's container. The price is 21/- plus post. Naturally, the cost of manufacture of these fine instruments, which have been made by Aron, Pullin, Sifaou, Weston, etc., must have been double the amount we ask. For the benefit of beginners in electrical and radio work, this meter is the cat's whiskers, and will pay for itself time and time again.

Space for mounting extra shunts, etc., is available within the moulded case.

Terms: C.W.O. Remittances payable to E. and G.

Distributing Corporation Limited.

**M.O.S. MAIL ORDER SUPPLY CO., Dept.**  
Road, London, N.W.1. Stepney Green 2760-3803

CALLERS TO 24, New Road, London, E.1.

## MIDLAND INSTRUMENT Co.

BRAND NEW GOVT. SURPLUS STOCK

**ELECTRIC TIME CLOCKS** run for over 1 year from 3 volt cycle battery, 44-day, 24-hour setting, also sec. hand, jewelled movement, 3 1/2" dia. by 3 1/2", brand new boxed, 25/- post 9d. **ELECTRIC PUMPS**, centrifugal type, self priming, max. head approx. 25ft., delivery 10-g.p.m., ideal for water supply, garden fountains, bilge pumps etc., two models, 12 or 24 v. A.C./D.C., 25/- post 1/4. **TRANSFORMERS**, input 230 v. 50cycs., output 50 v. at 71 amp., or with little alteration, 110 v. at 61 amp., 25/- carriage 5/-. **ALTIMETERS**, sensitive "Kollsman" type, 15/- post 9d. **MAGNETIC COMPASSES** type 0-6A hand bearing type, alcohol fluxgate, fitted prism, takes standard torch battery in the hand grip, complete in carrying case, exceptional value, 25/- post 1/4. **AMERICAN HAND GENERATORS**, generates 8 v., at 3 amp., complete with handles, folding tripod seat, charging leads with battery clips, 25/- carriage 5/-. **VIBRATOR PACKS**, input 6 v., H.T., L.T. and G.B. outputs for 18 and 38 sets, 20/- post 1/4. **BEKESHIRE MOTORS**, 12 v., 4 amp. A.C./D.C., fitted reduction gear box, final drive approx. 1,000 r.p.m., 15/- post 1/4, ditto 24 v., 1.7 amp., 10/- post 1/4. **TOOLS**, "Terry's" B.A. spanner sets, 8 sizes, 1/-. "Eliot Lucas" 6in. flat nose pliers, 1/6. "Apollo" 9in. box spanners, one each 4 b.a. the other 6 b.a., 6d., ditto 4in. 1 b.a. only 4d., one of each, 3/3 post 9d. **TELEPHONE SETS**, consists of two combined microphones and telephones, 25/-, connecting flex, provides perfect two way communication, self-energised no battery required, 7/6 post 9d. **D.R. MASTER COMPASS SETS**, consists of a master compass, pilot's and observer's repeater compasses, variation setting corrector, control switch, all items brand new, cost £250, ideal for boats, operated from 24 v. D.C., 25 centime 10/-, **FILM FOOTAGE INDICATORS**, makes good magnetic counter 0-125, with switch and reel control, dual voltage 12 or 24 v., 2/6 post 9d. **FUSE BOXES**, bakelite, panel orig., 4 way, complete with 4 fuses and 4 spares in cover, 2/6 post 9d.

Hundreds of other interesting items, send for our new enlarged Jan./Feb. lists, 2d, with s.a.e. Orders over 30/- post-paid, carriage orders extra in all cases, our C.O.D. service is cancelled for the time being.

**MOORPOOL CIRCLE, BIRMINGHAM, 17**

Tel. HARborne 1308 or 2644



# YOU can become a first-class RADIO ENGINEER

We are specialists in Home-Study Tuition in Radio, Television and Mathematics. Post coupon now for free booklet and learn how you can qualify for well-paid employment or profitable spare-time work.

## T. & C. RADIO COLLEGE

King Edward Ave., Aylesbury, Bucks.

(Post in unsealed envelope, 1s. stamp)

Please send me free details of your Home-Study Mathematics and Radio courses

NAME .....

ADDRESS .....

w.w.80

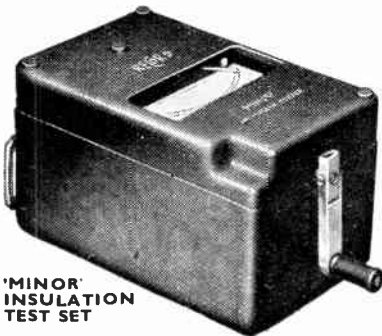

**'MINOR' INSULATION TEST SET**

Compact and inexpensive without sacrificing accuracy and reliability. Weighs only 3lbs. Height allows for full swing of generator handle. Ranges up to 20 megohms 500 volts.



**CONTINUITY TESTER**

This latest addition to the Record Ohmmeter range is enclosed in a moulded bakelite case of pleasing appearance. Equipped with self-contained dry battery. Specially designed test spikes and leads can be supplied also a "test and carry" case in which the instrument may be used without removal. Ranges—0/3—0/30 ohms, 0/30—0/300 ohms, 0/1,000—0/200,000 ohms.

**THE RECORD ELECTRICAL CO. LTD., Broadheath, Altrincham, Cheshire.**  
Tel.: Altrincham 3221-2/3, Grams. "Infusion," Altrincham. LONDON: 28, Victoria St., S.W.1. Tel.: Abbey 5148.

**TELEVISION** constructors! Once again we come to your assistance! E.E. television kits of resistors and condensers, carded and indexed to E.E. Manual, two types, Card A.1 as per E.E. specification; Card B.2, to our specification; total six Cards, as follows: Vision strip, sound strip, sync separator, line time base, frame time base, sound output and power pack, any card supplied separately; other items at the correct price: focus coils, 32/6, finished black crinkle and chrome, scanning yokes, 30/-, all Paxolin construction, a streamline job, weighs only 3/4oz; line transformers, 27/6, finished black crinkle, ratio 5-1, all are thoroughly tested and are fully guaranteed, complete set of coils, wound to E.E. specification, on Polystyrene formers with dust iron cores, 11/9 per set; coil formers with cores, 9d each, cathode ray tubes, Mazda, Mullard, Brimar, £1 per inch, plus tax, p.u.s carriage and packing 3/6; all valves, chokes, transformers, etc., for the E.E. Television in stock; send for list and prices—E. A. Porritt, 13-27, Westdale Rd., Forest Hill, S.E.23. For. 1292.

**FRITH RADIOGRAPH LTD., Leicester.** offers: Mains transformers, 200/220/240v. 325-0-325 70ma, 4v 2a, 4v 5a c.t., drop through type, brand new, 21/-, plus 1/3 post; chokes, 12H 175ma weight 11lb 21/-, plus 1/6 post; ditto 400ma, wt. 2lb 4/-, plus 4/6 post; R.C.A. chokes, 50H, 670ma, wt 200lb, £5.5/-; 8uF 600v paper condensers, metal can type, 4in x 2in x 1/2in high, 5/-, plus 6d post; brand new electrolytics (not surplus), Hunts' miniature tubulars, all one size, 2 1/2in x 1in, 8/450 v.v. 2/6; 16/450v w.v. 8/450v w.v. 6/1 15+16/350v w.v. 7/-; 32+32/250v w.v. 7/6; B.I. waxed carton type, all 500v w.v. 4uF 3/3, 8uF 3/6, 8+8, 4/9, 8+16, 6/1; 16/16 6/11; vertical can, 8+8/500v w.v. 5/-; 16 500v w.v. 5/-; post 3d each or dozen lots assorted post free; U.S.A. field telephones, complete with streamline microphone, handset, 35/-, plus 1/6 post; 2 sets (making complete intercom system) £3/3, plus 3/- post; latest lists free on request; satisfaction guaranteed or cash refunded without question. **FRITH RADIOGRAPH LTD., 69-71, Churchgate, Leicester.** [23]

**W.G.I. Tel. Mus. 9594.**—Type 24 r.f. units, new in makers' cartons, these make excellent s.w. converters, complete with valves, 30 to 40mc/s, price 13/6 each, post paid; mains transformers, 230v a.c., outputs 250v 90ma, 2.7volts 8amp, 5volts 2amps, price 17/6 each, post paid; mains transformers, input 200-250v a.c., outputs 325-0-325v, 20 ma, 6.3v 0.3amps, price 11/- each, post paid; stainless steel wire, 7/0/0.15in, 1.680ft reels, price 22/6 per reel, 100 reels only available, reduction in price for 20 reels or more; condensers, 25mfid, 4,000v d.c. working, 4/- each, or 40/- per doz., post paid; Sangamo synchronous motors, self-starting, 200-250v a.c., 50cycle, consumption 2W, watts size 2 1/2in diam., 2in deep, geared 1 rev 60 mins, can be reset to zero by friction drive from front or back, to run clockwise, ideal movements for making electric clocks, time switches, etc., nickel-plated finish, complete with 12 to 1 dial train, price 25/- each, postage 6d.; Sangamo as above, final speed 1 rev per min., less dial train, ideal for dark room, process timing, etc., price 22/6 each, postage 6d.; hour meters, fitted Sangamo synchronous motor, with gear train 1 rev 1/10 hours to 10,000 hours recording in bakelite cases, ideal for process timing, etc., price 35/- each, postage 1/-; receivers, type 184; modulators, type 67; indicator units, type 184a; receivers, type R3206; performance meters, type No. 2; test sets, type 102; test set, type 76; power units, type 526; indicator units, type 235; a.c. mains waveneters, type W1252; battery waveneters, type 1095; and various other types, s.a.e. for lists. [268]

**TELEVISION** branded components, exact to E.E. designers' specifications; vision chassis fitted valveholders, coil formers, 22/6; sound ditto chassis, 18/6; time base ditto, 18/6; power ditto chassis 25/-; set gantrys, clips, control panel, 10/-; complete chassis assembly with gantrys, etc., 24/14/6; Aden deflector coil assembly, 32/6; line transformer, 32/6; focus coil, 32/6; set 8 coils, fully wound, with h.f. chokes, 15/-; television aerials, Hunts 0.1mfid tubular condenser with clip, 7.000v v.v., 14.000v test, 19/6, rubber mask for 9in tube, 11/-; Magnavista screen enlarger, 6gns; Co-axial 1 1/3 per yard, e.h.t. transformer, 4.000v, 2-0-2v, 60/-; ditto 5.000v, 2-0-2v, 65/-; glass s.m.o. dial, 6x8in, 4/6; pan, 4/6; escutcheon, 5/6; 8in p.m., less trans, 17/6; 6 1/2in p.m., with trans., 22/6; P.P. output heavy duty trans. for 616 valves, tapped output 15 and 7.5, and ditto for 616 valves at 21, each; American throat microphones, boxed, 3/- each; condensers, 8mfid 450v, 2/6; 16mfid 350v, 2/6; 8mfid 350v, 2/-; 8 plus 16mfid 450v, 5/6; choke, 150ma 10hy, 14/-; heavy duty variable resistance, 300 ohms, 1 amp, 15/-; rotary trans., in 6-12v, out 200-490v 50ma, or as motor, d.c. mains, 15/-; Collaro a.c./d.c. gram. motor and p.u. on plate, £12/17/6; 4-pin vibrators, 6v, 6/-; switches, Yaxley type 3-pole 2-way, 2/-; 4-pole 3-way, 3/-; 4-pole 4-way, 3/6; 6-pole 4-way, 4/6; 14-pole 3-way, 7/6; midget switches, 4-pole 3-way, 3/-; 4-pole 2-way, 3/-; enamelled copper wire, various gauges, in 1/4lb reel, tinned, full list at 2 1/2d postage all orders.

**O. GREENLICK, Ltd., 265, Whitechapel Rd., London. F.I. Bils. 5079** [2717]

# —VALVES—1/8

—equivalent charts and comparative tables with quick reference index. A special valve list is enclosed with—  
**Telescreen Design and Construction for a Modern Home-Built Set, 2/6;** Components for above: V1 Vision Chassis, ftd. 6 V/holders, screens, coil formers, etc., £12/6; S1 Sound Chassis, ftd. 3 V/holders, screens, coil formers, etc. 18/6; T1 Time Base Chassis (steel) fitted 6 valves h.t. 17/6; T1 1/2 Time Base Chassis in steel, drilled and cut out to E.E. Spec., 15/9; P1/B Power Unit Chassis, in steel, drilled and cut out to E.E. Spec., 17/3; Gantry, brackets and Front Strip, 6/9; Complete set of Television Chassis, gantry and brackets, comprising units as above, V1, S1, T1 1/2, P1/B. The set set £41/-; Deflector Coil Assembly "Aden" £112/6; Line Output Transformer "Aden" £112/6; Focus Coil Assembly "Aden" £112/6; Ocean Coloured Rubber Television Mask for 9in. tube, 11/-; Ocean Coloured Rubber Television Mask for 12in. tube, £11/6; Varley DP 92 L.P. Choke 5.5 hrs. at 250 m.a., 50 ohms, 18/6; 6 K/B EH Trans. 5,000 v. 2-4-6 v. tappings, £411/6; 2 K/B EH Trans. 2,000 v. 2-4 v. tappings, £2214/9; PT/1 Power Transformers 350-0-350 v. 250 ma., 6.3v 6amp., 4 v. 8amp., 0-2-6 v. 2 amp., 4 v. 3 amp., £25/5-; **CONDENSERS**—Hunts Capacitor 1.mfd. 7K volt with clips, each 18/9; Micromold condensers, 500 pfd., 1,000 v., per doz. 9/-; **RESISTORS**—12 watt 7.5K wire wound, each 2/7; 12 watt 6K wire wound, each 2/7; 12 watt 1.5K wire wound, each 1/10; 6 watt 500 ohms, each 1/6.

**VALVES**—A fully comprehensive stock of all Valves, at B.O.T. prices is carried. Order C.O.D.

**COILS**—Ref. Tel/Ol. Set of 3 permeability tuned coils and 9 RF chokes for E/E panels, 16/6.  
**WIRED CHASSIS**—V2 Chassis and Components, wired and tested, £715/10; S2 Chassis and Components, wired and tested, £55/5; T2 Chassis and Components, wired and tested (less line trans), £814/2.  
**TELE-AERIALS**—Aerialite, DRB and DPM, etc., from stock, also TVA2 Dipole, with wall Bracket and Arm, £110/-; TVA3 Dipole, with chimney Bracket, Lashings, £2; TVA 5 Dipole, as above, with Reflector, £3 2/-; TVA 4 Element Higan Array, 3 Reflectors and Dipole, £410/-.  
**CO-AXIAL CABLE**—Black, White or Brown (standard impud.) per yard, 1/3.  
**TELE-SCREEN ENLARGERS**—For 9in., 10in., 12in., 15in. Tubes: Alba, Bush, Cosor, Ekco, Ferguson, Ferranti, GEC, HMV, Invisita, Marconi, Murphy, Philco, Philips, Pilot, Pye, Sobel, Vidor, Vidor, from £419/6; for 9in., 22 6s, plus 1/3 postage. **COLLARO AC 47** Induction Motor, with 12in. turntable and speed regulator. Ref. M.T.T. £2518/2; **Collaro AC 47** Motor on Unit Plate with Auto stop, turntable, speed regulator. Ref. M.T.S. £76/3; **Collaro RG Unit** type U48, AC/DC Universal Motor, with turntable, speed regulator, auto-stop and magnetic pick-up, £12 18 8; **Collaro RG Unit**, type 48 Unit, AC 47 Motor, etc., Crystal Pick-up, £1017/10; **Collaro Microgram**, combines an AC/3 valve amplifier, induction motor, speed reg., auto-stop and magnetic pick-up, in carrying case, £241/8; **Collaro Microgram De-luxe**, similar to above but fitted with 6in speaker and Crystal Pick-up. Handsome imitation lizard skin carrying case, £28 11 11; **Collaro Record Changer AC only**, Plays mixed 10in. & 12in. Records, £22/4 8. **Richard Allan Auto Record Player** in handsome walnut cabinet, Collaro Auto Unit, plays mixed 10in. and 12in. records. Mag. P/up. A.C. mains, 100-250 volts, £33/18/8.  
**PLESSEY RECORD CHANGERS**—Fully automatic, plays 10in. or 12in. records, mixed. Light-weight Magnetic Pick-up. Rim driven constant-speed motor. AC mains, only £18 6/8. Orders in strict rotation due to shortage of supplies.  
**SPECIAL OFFER**—Portadryne RG95a 5v. Superhet Radio-Gram. Garrard Auto Unit, 50 gns. Radio-Gram Table Cabinet Walnut veneered, beautifully finished, complete with escutcheon. Size 20in. x 15in. x 14in., £13.  
**ELECTROLYTIC CONDENSERS (1948 manufacture)**. B1 Cardboard Blocks: 8 mfd. 550 v. 3/6; 8 mfd. 550 v. 4/9; 16 mfd. 550 v. 6/-; 25 mfd. 25 v. 2/4; **Dubilier Tubular Wire Ends**: 4 mfd. 500 v. 4/3; 16 mfd. 500 v. 6/3; 30 mfd. 500 v. 3/8; B.E.C. Minicams: 2 mfd. 450 v. 3/0; 4 mfd. 450 v. 5/3; 16 mfd. 450 v. 5/3; 16 mfd. 450 v. 6/9; 16 mfd. 450 v. 8/3; 25 mfd. 25 v. 1/6; 50 mfd. 50 v. 3/8.  
**SPECIAL OFFER OF CRYSTALLINE PICK-UPS AND PLAYERS AT GREATLY REDUCED PRICES**. Crystallone Pick-up and Rest £2/5/3. (Listed at 2/- plus P.T.) Crystallone Record Player with Crystal Pick-up, £28/13/6. in cabinet (Listed at 10/- plus P.T.).  
**SPEAKERS**—Richard Allan Baffleite, the modern popular extension speaker, Junior Model, 50/6. Also 5in. Goodman P.M. less transformer 15/- each; 8in. Goodman P.M. less transformer 16/6 each; 9in. Rola P.M. less transformer, 26/3 each; 10in. Goodman P.M., less transformer, 30/- each; 12in. Celestion P. 44 less transformer, 78/9.  
**PARVO AERIAL**—This useful little aerial again in stock, 3/6. *Please write to W.W.*

**RADIO AUTO RECORD PLAYERS**  
246 HIGH ST. HARLESDEN W.M.P.



# TELERADIO

Radiogram Equipment

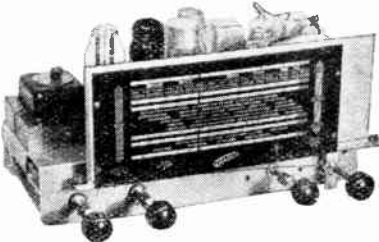

**MODEL A70.** 6 valve all wave modern superhet chassis with tuning indicator, tone control and radiogram switch. The ideal replacement chassis. £14 14 0d. plus £3 3 3d. Purchase Tax.

**MODEL 70 TU.** As above but as 3 valve tuning unit feeding model 77 amplifier £8 0 0d. plus 34/10d. Purchase Tax.

**MODEL 77.** 4 valve push pull amplifier with 2 6V6 fed by phase inverter. Approx. 8 watts output £9 5 0d.

Send for leaflet to:

**THE TELERADIO CO.,**  
 157, Fore St., Edmonton, N.18  
 also at 224, Chingford Mount Rd., E.4  
 and 668, High Road Tottenham, N.17

C. A. RYALL, "Utopia," Mayfield Rd. Herne Bay, Kent, mail order only; postage or carriage extra; c.o.d. £1 or over; full list, large s.a.e. please; U.S.A. tubular metal cased wire ended 0.1m.f. 500v 7/6 doz., 350v 5/6 doz.; U.S.A. tubular metal cased wire ended 0.5m.f. 350 7/6 doz.; Mansbridge 1m.f. 500v wkg. 3-2/-; Mansbridge 4m.f. 400v wkg. 2/3 each; silver mica 100p.f. 40p.f., 200p.f., 300p.f., 400p.f., 500p.f. 3/6 doz.; mica 0.01m.f. 3-1/3; all condensers guaranteed; Amphenol type British 5-pin chassis valve holders, 3/6 doz.; international octal chassis valve holders, paxolin 4/- doz.; bar type 5-gangs 5/-; bar type 4-gangs 5/-; resistors 1/2 watt and 1 watt assorted 100 ohms to 2 meg. level assortment 40-5/-; switches, SB. 2P 6w miniature 1/6, 3B, 2P 6w five poles total 2/3 each; SB. 9w 2/-, 2B SP 6w 1/6, SB. SP. 3w 1/-, 2B. 3P. 3w 2/-, SB. 2P. 4w 1/3; twice-way group boards with 9-1w and 2w resistances, etc. 2/-; all high resistances, phones with sponge earcaps, with good class microphones, all w.r.ed into p-ug type 10H 10991, 10.9 par.; metal boxes, black finish with quarter inch paxolin panel, fixing nuts and corner sockets, size 9 1/2 x 7 1/2 x 3 1/2, 6/9 each new; 10,000 ohm bakelite cased volume controls medium spindle 1/6; metal cased minimum depth 1/2 meg. vols., short spindle 1/6 each; special list for trade. [1613

**JACK PORTER, Ltd. (Radio)**—New components, satisfaction guaranteed; U.S. octal block condensers, 4+4+4+3+3 1mfd, with clips, 7/6; U.S.A. electrolytic can condensers, 2,000 mfd, 15 volts, 2/6; moulded mica condensers, 0.01, 400 volts, wire ends, 3/- doz.; ceramic tub. condensers for C.R. work, 0.001mfd at 9,000 volts, 2/-; Cylindrical type ceramic variable 0.0001 midget condensers with full 1/2 shafts, 1/-; U.S.A. midget Neons, 115 volt, 1/4 x 1/2 in. 1/-; Cossor-Osram type 4-pin 5.13N Neon Stabs, 3/9; boxed RF 0-350 ma meters, 3 9; boxed 0-20 voltmeters, 3 9; Thorndon tropical 1-l. chokes, 70ma 30 ohms 5/-; variable capacitors, 30 ohm bias resistors, 30 watts with clips, 1/-; standard fuseholders, black, plastic tubular type, 1/-; U.S.A. crackle finished metal boxes with sliding clip fastening lids, 6x5x 1/2 in, 2/6; boxed U.S.A. 24 volt ac/dc blowers, 1/2 shafts 5/6; complete with fan, 12/6; British 12-volt small ac/dc motors, 1/2 shafts, 8/-; Pyrex glass ribbed Lo-Loss aerial, sw. insulators, 11d; boxed U.S.A. vibrators, 7-p.n. 6-volt and 4-pin 12-volt, 2/- each; C.R. terminal blocks, 5,000 volts, black plastic, 8-way, with terminals both, 10 pf to 0.1mfd, in silver mica, mica and tubular paper, per box of 50 assorted, 10/-; U.S.A. 35mm direct embossing film for recording and playback, per box of 50ft, 1/6; double wound 230 to 115-volt transformers, 450 watts with terminals, 28/-; P.P.O. type multi key switches, 1/-; McElroy moving coil and Stylus morse assembly, boxed, new, 1/-; Midget transformers, 50 ohms to 5,000 ohms, ideal for mikes or phones, 1/9; R.C.A. boxed 925 photo electric cells, 1/9; orders over £10 post—Jack Porter, Ltd. (Radio), 22-31, College St., Worcester, Tel. 2442. [2516

**NEW S.T.C. selenium rectifiers:** largest range of l.t. metal rectifiers in the country makers' current products, not surplus. From stock: H.2/200 CR. 100 watts with terminals, all p. d.i. half-wave 16v 5a 6/8, 1a 8/-, 2a 9/6, 5a 17/-, 6a 18/-, 5a 21/6, 6a 22/6, 10a 24/6, all p. 10d; 30v 2a 14/-, 5a 35/-, 8a 38/6; 45v 2a 21/-, 5a 48/-; 100v 2a 34/6, all p. 1/-; full-wave bridge-conn, 17v 1.5a 27/-, 2a 15/5, 2.5a 20/6, 3a 21/6, 4a 25/-, 5a 27/-, all p.f.; 33v 1/2a, 18/6, 1a 21/3, 1.5a 28/-, 2a 29/6, 3a 35/-, 4a 42/-, 5a 45/6; 100v 1.5a 72/-, all p. 10d; heavy duty type 7in sq cooling fins, 16v 10a 45/8, 20a 80/-, 17v 6a 34/1; 33v 6a 64/-, 10a 71/-, 54v 6a 64/-, 65v 10a 130/-, all p. 1/4. Industrial rectifiers, funnel cooled: 17v 12a 76/-, 17v 50a 188/-, 33v 6a 114/-; 100v 6a 160/-, all p. 1/6; 100v 10a 192/-, carr. 2/6; valve chargers; conversions to metal rect. from stock; Philips 328 and 367; Tungar 68504, 68530, U600, etc., fitted in 5 mins without alteration to wiring. Please state make, type No. and max. d.c. O/P when ordering. Charger kits: Trans rect. and rheo, 54v 6a, incl. tap, switch, £11/10; 33v 6a, £7/19/6; 16v 10a, £6/12/6; 17v 6a, £4/12/6; 16v 5a, £3/10; vent. steel case 7/6 extra; 16v 4a £3, case 7/6; 16v 2a 35/6, case 7/6. Transformers, 200/250 input, 16v 10a 65/-, p. 1/4; 17v 6a 76/-, p. 1/4; 16v 5a 41/6 p. 1/-; 16v 4a, 35/6, p. 1/-; 16v 2a, 38/6, p. 10d; slider res. from 24/6, all values, p. 1/-; ammeters 0-6a M.I. 12/6 0-5a M.C. 15/-, both p. 6d; 0-14a, 5in dial, 32/6, p. 1/4. We stock the new S.T.C. portable charger as advertised in the "Autocar," etc. fully automatic charging of 6-12v batteries at 3-5a, from 200-250v a.c. guar. 1 year, £10 carr. free. Send for illus leaflet. Another type to charge 6-12v at 5-6a input 200-250 a.c., charger in vent steel case with rheo. and ammeter, £6/19/6, carr. 3/6. See others under "Dynamos," terms, c.o.d. post goods only, others c.w.o. or pro forma; wholesale and retail.—Pearce, 66, Gt. Percy St., London, W.C.1. Nr. Angel and King's Cross. Est. 17 years. [2748

**"INEXPENSIVE TELEVISION" for the Home Constructor.**

The above now famous booklet can be supplied by us, price 1/6. Uses War Surplus equipment. The following major items required are available:

**10D/APN4 LORAN INDICATOR UNIT.** Complete with CR Tube 5CP1 in original mounting, 14 valves, 68N7, 8 6116, 3 68L7, 1 68J7, 100 crystal, and a multitude of condensers, resistors, etc., etc. £3/19/6 (Carriage and Packing 7/6).

**CR TUBE VCR97.** Each tube brand new, suspended in manufacturer's original packing case, guaranteed, complete with printed data sheet. Only 35/- (Reg. carriage and packing 7/6).

**TUBE ENLARGING LENS.** For VCR97, or 5CP1. Double your picture area, without distortion. Easy fixing. Really amazing in performance. Only 29/6 (Plus 1/6 postage and packing).

**R1355 RECEIVER.** Complete with 8 valves VR65, 1 5U4G, 1 VU120, condensers, resistors, etc., etc. Only 30/- (carriage and packing 5/-).

Or this unit can be supplied brand new in original wooden crate at 45/- plus carriage.

**TYPE 25 B.F. UNIT.** Complete ready for use in R1355 Receiver. 12/- (carriage and packing 1/6).

**E.H.T. TRANSFORMERS.** These Transformers have been specially wound for us, for use with this circuit. For VCR97, Input 210-230-250 v. Output 2,500 v. 4 v., 1.1 a., 2-0-2 v. Only 37/6. For 5CP1 Input 210-230-250 v. Output 3,250v., 6.3 v., 0.6 a., 2-0-2 v. Only 39/6.

Both of these above transformers are of first-class manufacture, fully impregnated and guaranteed by us.

**P.M. SPEAKERS WITH TRANSFORMERS.** R. and A. only 15/-, 8in. R. and A. only 21/-. Not repeatable at these prices. Brand New Surplus.

**INDICATOR TYPE 157.** Complete with VCR97 Tube, 16 valves, M161, 2E134, 2 EA50, potentiometers, 75 kcs, crystal, Muirhead dial, etc., etc., at £2/19/6 plus 5/- carriage and packing.

**MAINS TRANSFORMERS.** 250-0-250, 80 m/a., 5 v., 2 a., 6.3 v., 0 a., for Vision Receiver Unit, only 29/6.

For Time Base Unit, 350-0-350, 80 m/a., 5 v., 2 a., 6.3 v., 3 a., 28/6. Both chassis mounting.

In addition to the above, we have a large stock of brand new B.V.A. Valves at current E.O.T. prices for this inexpensive television.

If unable to call please send stamp for our new issue price list. This is probably the most comprehensive component list in the trade.

**TRADE SUPPLIED.**  
**HENRY'S**  
 5, HARROW ROAD, W.2  
 PADdington 1008/9

## THESE ARE IN STOCK

- Television—Home Construction Using War Surplus Equipment. Is. 6d. Postage 2d.
- Television and F-M Receiver Servicing. By Milton S. Kiver. 16s. Postage 9d.
- Radio Communication Transmitters. By J. J. Mupert. 30s. Postage 9d.
- Radio Valve Application Manual. B. B. Babani. 5s. Postage 3d.
- A Textbook of Radar. By Australian Indust. Research. 50s. Postage 9d.
- Wireless Servicing Manual. By W. T. Cocking. 10s. 6d. Postage 4d.
- Newnes Television Manual. By F. J. Camm. 7s. 6d. Postage 6d.
- Radio Engineering. By F. E. Terman. 42s. Postage 9d.
- Electronic Circuits and Tubes. By Cruft Electronics Staff. 45s. Postage 9d.
- Television Simply Explained. By R. W. Hallows. 9s. 6d. Postage 6d.
- Radio Tube Vade-Mecum 1946 Edition. By P. H. Brans. 5s. Postage 6d.
- Short Wave Wireless Communication. By A. W. Ladner and C. R. Stoner. 35s. Postage 9d.
- Radio Receiver Design Part I. By K. R. Sturley. 28s. Postage 9d.

We have the finest selection of British and American radio books. Complete list on application.

**THE MODERN BOOK CO.**  
 (Dept. W.2)  
 19-23, PRAED STREET, LONDON, W.2

**LOOK!**

**Mains Transformers, Screened, Fully Interleaved and Impregnated.**

H.S.63. Input 200/250, Output 250/0/250/60 m/a, 6.3 v. at 3 amp., 5 v. at 2 amp.	15/6 Half
H.S.40. Windings as above, 4 v. at 4 amp., 4 v. at 2 amp.	Shrouded
F.S.2. Input 200/250, Output 250/0/250, 80 m/a.	19/6 Fully Shrouded
F.S.3. Input 200/250, Output 350/0/350, 6.3-4.0 v. at 4 amp., 5.4-0 v. at 2 amp.	Shrouded
H.S.2. Windings as F.S.2, 80 m/a.	17/6 Half
H.S.3. Windings as F.S.3, 80 m/a.	Shrouded

C.W.O. (add 1/3 in the £ for Carriage. Over £2 Carriage Paid).

**H. ASHWORTH, 676 Great Horton Rd., Bradford, Yorks.**

**COVENTRY RADIO**  
 DUNSTABLE ROAD, LUTON, BEDS.  
 Phone: Luton 2677

**NEW 1st GRADE COMPONENTS**

8 mfd. 450 v. Electrolytic Condensers, metal	3/-
16 mfd. 450 volt Electrolytic Condensers, metal	3/9
8—8 mfd. 450 volt Electrolytic Condensers, metal	4/9
25 mfd. 25 volt Electrolytic Condensers, metal	1/6
Mains Transformers, 6.3 volt, 5 volt, 275—0—275 volt, 80 m/a, drop through Chassis	19/6
Mains Transformers, 6.3 volt, 5 volt, 350—0—350 volt, 120 m/a with tapped L.T.'s—Impregnated	25/6
L.F. Chokes, Standard 75 h/a, 6 H.	4/6

**SEND FOR LATEST LIST—6d. POST PAID.**

# GALPINS

ELECTRICAL STORES

408 HIGH STREET, LEWISHAM, LONDON, S.E.13

Telephone: Lee Green 0309. Near Lewisham Hospital.

TERMS: CASH WITH ORDER. NO C.O.D.

(HASSIS, aluminium, 16 swg (receiver type), 10x5 $\frac{1}{2}$ x2in. 3 - ea. 11x6x2 $\frac{1}{2}$ in. 3/9, 12x8x2 $\frac{1}{2}$ in. 4/3, 16x8x2 $\frac{1}{2}$ in. 5/3, 20x8x2 $\frac{1}{2}$ in. 6/6; ma.n. transformers, standard screened primary 200-250v 50 c/y.c.s. output 350-0-350v 80ma 6.3v 3a, 5/2a, half shrouded, drop through type, 18/6; Selenium rectifiers, small size, 600v, 40ma H.W., 2/9 ea. 27/- doz.; 500v 90ma H.W., 5/- ea. 52/- doz. 270v 90ma H.W., 5/- ea. 52/- doz. 120v 40ma F.W. Bridge, 3/9 ea. 50/- doz. 120v F.W. Bridge, 4/9 ea. 33/- doz. 6-12v 1a H.W. C.T., 1/6 ea. 15/- doz.; electrolytic tubulars, 8mf, 250v, 1.9 ea. 15/1 doz., 8mf 500v, 2.6 ea. 27/6 doz.; cans, 8-16mf 450v, 4.6 ea. 47/- doz., 16-32 mf 350v, 3.11 ea. 42/- doz.; tubular condensers, 0.01mf 350v, 3.6 doz. 30/- gross; ex-Govt. lines, 32mf 450v block electrolytics, 1/9 ea. 18/- doz.; R.A.F. test buzzers with Morse key and battery, 5/9 ea. 42/- doz.; 0.1mf 450v tubulars, 4/6 doz.; brand new dry batteries, 22 $\frac{1}{2}$ v, 1/6 ea. 15/- doz.; all new goods; c.w.o. or c.o.d., add 1/- postage on orders under £2; trade supplied; lists 2/6d.—Radio Supply Co., 15, Queen Square, Leeds, 2.

**RODING LABORATORIES** are so proud of the low cost and high quality of their aligned coil packs and accessories they are offering absolutely free the new Giant "Home Constructor's Handbook"—the book for the man who wants to "know how" and "go places"; it contains the latest circuits, hints, formulae, etc., easy-to-read circuits of tuning hearts, superhets, amplifiers, etc., with all components; the circuits alone would cost 2/6 each, this offer is made to all purchasers of the special brand tuning unit, comprising the world-famous 30-coil pack, 2-gang condenser, dial, etc., and I.F. transformers, all aligned and sealed as a matched outfit for only 47/6 (c.o.d. or c.w.o.—we pay postage on c.w.o.); it need cost you nothing to try this unit if you are not absolutely satisfied and return the unit within 7 days in its original condition your money will be refunded in full! But remember, you keep the free book in any case! Be sure to act promptly—this offer is limited.—Roding Laboratories, Mail Order Dept. W., 70, Lord Ave., Ilford. [2754]

**RADIO CLEARANCE Ltd.**, 27, Tottenham Court Rd., London, W.1., Maida Hill, R.F.O. by Wilcox Gay, type M1, 19467A, uses 807 electron coupled osc. very stable, employs 2 circuits, grid 1-5mc/s in 6 bands, plate 2-10mc/s in 5 bands, grid current meter (0-10ma), supplied in original cartons, brand new, with accessories and instruction book, cost 1/4, but personal req., B.C.728C, 7-valve set, using 1.4v valves, super het with 4 push-buttons, covering 2.6mc/s, operates from 2v A.C.C., by 2v vib., with provision for charging 2v A.C.C. from 12v source by means of 12v V.I.B., carried slung on shoulder, supplied brand new, complete with valves, telescopic A.E. access, and inst. book, built-in I.S., 4v 9/9, carr. paid; mains trans., Sec. 460j 200ma, 210v 15ma, 6.3v 5a, primary 23/250v, 50 c/s, 16/6, post 1/6; Sec. 290-0-290v, 80ma, 5v 2a, 6.3v 2.5a primary 200/250v, 50 c/s, 17/6, post 9d; sec. 230-0-230v, 100ma, 5v 2a, primary 200/250v with 110v tap, 50 c/s, 14/11, post 9d; sec. 275-0-275v 120ma, 4v 2a, 4v 3a, primary 200/250v, 50 c/s, 12/6, 9d, post; smoothing chokes, 20H 40ma, 220j, 3/11; 5H 120ma, 140j, 5/-; 2H 150ma, 75j, 4/-; 10H 80ma, 150j, 5/-; 5H, 200ma, 90j, 7/6; 20H, 300ma, 150j, 14/1bs., 18/6, post 1/6; electrolytics, 100mf, 6v 6d.; 50mf 12v 1/-; 25mf 25v 1/6, 25mf 50v 1/9, 50mf 50v, 2/-; 8mf 150v 1/6, 8mf 170v 1/9, 8mf 350v 2/3, 8mf 450v 2/6, 16mf 350v 3/-, 16mf 450v 3/6, 24mf 350v 2/6, 8+8mf 450v 4/-; 8+16 450v 5/-, 16+16 450v 5/-, 16+24 350v 4/6, 8+24 350v 5/6, 32mf 450v 5/-; loudspeakers, P.M. 5in, less trans., 15/11, with trans. 16/11; 6", less trans., 15/11, with trans., 32/6, all brand new, boxed; moving coil meters, metal cased, 2in. round, 0-500 microamps, 7/6, 0-15-800v, 6/6; 0-20a and 0-40a, with shunts, 5/-; 2in. square bakelite cases, 0-500 microamp, 9/6; 0-1ma, 7/6; 0-5ma 6/-; 0-50ma, 7/-; 0-150ma, H.W., 4/6; 2in. circular bakelite cases, 0-500 microamps, 16/6; 0-15v, 7/-; 0-30ma, 10/-; 0-100ma, 9/6; 0-200ma, 9/6; 0-6ma, sealed 1.5v, 3v, 60ma, 5,000 $\Omega$ , 12/6 0-1ma, 2 $\frac{1}{2}$ in desk type, 15/-; 100-0-100v, 2 $\frac{1}{2}$ in (1ma movement), 7/-; 0-3.500v, 3 $\frac{1}{2}$ in, 17/6; 2 $\frac{1}{2}$ in circular, 100 microamp, sealed 0.4W, 5m, 18/6; metal rectifiers, 250ma, 80ma, H.W., 4/6; 50v 80ma, H.W., 1/-; 400v 120ma, H.W., 6/6; 50v 80ma bridge, 2/6; Mansbridge conds., 4mf, 600v, 3/6; 4mf, 1,000v, 2 in a packet, 7/6; 1mf, 1,000v, 1/-; V.C. carbon, No SW, 10K, 20K, 50K, 100K, 2M, 2/-; with SW, 2 $\frac{1}{2}$ in spindle, 25K, 50K, 100K, 250K, 500K, 2M, 5/6; with SW, 1 $\frac{1}{2}$ in, 25K, 50K, 100K, 200K, 500K, 2K, 2.5K, 5K, 10K, 25K, 2/6; rotary trans. power units, input 12 or 24v (state which), output 250v 60ma, 6.5v 2.5a, in metal cases 9in x4in x7in, 7/6, post 1/6. [2746]

**CHARGING UNITS**, Selenium Rectifiers. Input 100/250 volts 50 cys. for charging 24 volts at 10 amps., complete with Meter, resistances, fuses, etc., complete in rack size 27in x24in x16in. to clear £10 each, carriage 10/-.

**MAINS TRANSFORMERS**. Input 230 volts 50 cys., Output 42 to 50 volts at 100 amps., £12/10 each, carriage 10/-, another 200/250 volts in steps of 10 volts, output tapped 6, 12, 18, and 24 volts, at 10/12 amps, 45/- each, carriage 2/-, another 230 volts input, output 12 volts at 8 $\frac{1}{2}$  amps., 25/- each, carriage 2/-, another 220 volts input, output tapped 12 $\frac{1}{2}$ , 25, 37 $\frac{1}{2}$ , 50, 60, 75, 87 $\frac{1}{2}$  100 and 110 volts at 1,100 watts, £4/15/- each, carriage 7/6. (These transformers are all double wound).

**EX-NAVAL (CROMPTON PARKINSON) TONG-TESTERS**, 0 to 100, and 0 to 400 amps., new, in leather carrying case, 90/- each. A.C. V/Meters, 0 to 300 6in. scale, calibrated 50 cys., 37/6 each.

**MAINS TRANSFORMERS**, all 200/250 v. 50 cys., 1 phase, input, output 700/0/700 v., 70 m/a., 4 v., 2 $\frac{1}{2}$  a., 12 v., 1 a., 30/- each. Another 525/525 v. 150 m/a., 6.3 v., 5 a., 5 v., 3 a., 37/- each. Another 2,350 v. at 500 m/a., 85/- each. Mains Smoothing Chokes, 10 Hy. 100 m/a., 6/-; 150 m/a., 8/6; 350 m/a., 25/-; 5 H.C., 250 m/a., 17/6.

**EX-GOVERNMENT (G.E.C.) ELECTRIC FANS**, 12 v., A.C./D.C. laminated field, complete with Sin. impeller. New, boxed, 20/- each, post 1/-.

**EX GOVT. MAINS TRANSFORMERS**. Input 230 volts 50 cys., output 450/0/450 volts 250 m/a., 6.3 v., 8 a., 6.3 v., 8 a., 6.3 v., 5 a., 5 v., 4 a., 5 v., 4 a., 5 v., 3 a., 37/- each. Another, same input, output 350/0/350 volts at 180 m/a., twice 5 volts at 4 amps, twice 6.3 volts at 5 amps three times 47/6 each, carriage 5/-. Another, same input 350/0/350 volts 250 m/a., 50/0/50 volts at 100 m/a., four 6.3 volts at 5 amps, also 5 volts at 4 amps, 42/6 each, carriage 5/-. (Size of these transformers is approx. 7 $\frac{1}{2}$ in. x 7 $\frac{1}{2}$ in. x 6 $\frac{1}{2}$ in. weight 20lbs.).

**MAINS VARIABLE RESISTANCES** (slider type), new, ex-Govt., 14 ohms, carry 1 to 4 amps., graduated, useful as dimmers, etc., 17/6 each; another 0.4 ohms, carry 25 amps., 17/6 each; post 1/6. Ex-Govt. Moving-coil Cell Testers, 3-0-3 v. (new), 15/- each.

**MAINS TRANSFORMERS** (Auto Wound). Voltage Changers tapped 10, 20, 25, 90, 130, 150, 190, 210 and 230 v., all at 1,000 watts, a combination of 34 voltages can be obtained from this transformer, new ex-Government Stock, £5/10/- each, carriage 5/-. Mains Booster Transformer, tapped 0, 6, 10, 19, 175, 200, 220, 225, 240 and 250 v., at 1,500 watts (new, ex-Government), £5/5/- each, carriage 5/-. Another Auto wound, tapped 0, 110, 150, 190, 210 and 230 v., at 1,500 watts, £6/10/- each, carriage 5/-. Ditto, 2,000 watts, £7/5/- each, carriage 5/-.

**EX-R.A.F. MICROPHONE TESTERS** (new). These consist of a Ferranti 0 to 450 mamp, 2 $\frac{1}{2}$ in. scale meter shunted to m/a., incorporated Westinghouse Rectifier, the whole encased in polished teak case, calibrated at present 0 to 10 v. 25/- each.

**EX-R.A.F. CRYSTAL CALIBRATORS UNITS**. Type 18, R.A.F. serial No. 10a/15237. These units contain 100 kcs. xstal, 2-EF 50 valves and numerous other items all new and unused, 35/- each.

**SPECIAL OFFER METERS**, all new, boxed. Moving Coil, first grade instruments, 0 to 20 v., 10/- each, or 3 for 25/-; 0 to 40 v., 12/6 each; 0 to 10 amps., 15/- each, all 2in. scale, 0 to 20 v., A.C., calibrated 50 c/y.s., 25/- each; 0 to 40 amps., thermo-coupled 25/- each.

**EX-NAVAL jin. SPARK COILS**, approximately 3,000 v., from 6 v. supply, 8/6. G.P.O. Galvanometers, reading 300/30, vertical type, 8/6 each. Ex-R.A.F. Impulse Transformer (Magnetron), output believed to be approximately 15,000 v., at 3 kw., for 1 m/a., 7/6 each. Variometers for No. 19 Mk. II Receivers, 6/4 each.

**MAINS TRANSFORMERS**, as new, input 230 v., 50 c/y.s., output 12 v. at 8 $\frac{1}{2}$  amps., A.R.P. shelter transformers, 25/- each, post 2/-.

**CHARGING SWITCHBOARDS**, size 17 $\frac{1}{2}$ in. x 16 $\frac{1}{2}$ in. x 8in., containing 5 circuits, 5 moving coil 0 to 15, Ammeters, 10 to 50 V/meter, 4-1 ohm 12 amp. resistances, 1 14-ohm 1-4 amp Resistance, all variable, also Switches, Fuses, etc., condition as new, £4/10/- each, carriage 10/-.

**SWITCHBOARD METERS**, 6in. scale, 0 to 500 v. A.C., 50 cys., 42/6; 0 to 50 amps., A.C., 50 cys., 37/6 each.

**ELECTRIC LIGHT CHECK METERS** (Watt Hour). A.C. 50 cys., 200/250 v., 5 amp. load, 18/6, post 2/-; 10 amp., 21/-, post 2/-; 20 amps., 25/- post 2/-; also a few only Pre-Payment 1/- slot type, 20 amp. load, less coin box, complete with synchronous Motor, 35/- each, carriage 3/6.

**EX-R.A.F. CRYSTAL MONITORS**, type 2, complete in wooden carrying case, the frequency depending on crystal used, 5/- each. Short Wave Aerial Coupling Units (Wave-meters), 5/- each.

**LARGE TYPE RECTIFIERS**. Output 50 v. at 1 amp.  $\frac{1}{2}$  wave, input voltage 70/75 v., 17/6.

**MAINS TRANSFORMERS** (Auto Wound), input 200/250 volts, output tapped 14 and 17 $\frac{1}{2}$  volts at 30 amps., 45/- each, carriage 5/-. Another same input with two 4 volt at 20 amps. output, 25/- each, carriage 3/-.

**EX R.A.F. R.F. UNITS** (New) containing 6 valves including E.F.50s, 5U4Gs, Grounded Grid Triodes, also a 24 volt Miniature Motor with laminated Field, and approx. 60/75 Resistances and Condensers, 32/6 each, carriage 3/6.

**EX NAVAL CATHODE RAY RECTIFIER UNITS**. New, containing High Voltage Condensers, Resistances, Chokes, Volume Controls, all mounted on brass chassis, 22in. x 11in., to clear 37/6 each, carriage 3/6.

**EX R.A.F. I.F.F. UNITS**. 10 Valve Short Wave complete with valves. E.F.50s, S.P.41s, E.A.50s, fitted with a motor generator, 12 volts input, 450 volts at 50 mamps. output, these units are as new, 30/- each, carriage 3/6.

**FRACTIONAL H.P. MOTORS**, 230 volt. series wound with laminated fields easily convertible to work off A.C. Mains, approx. 16th h.p., 20/- each, post 1/6. Another of a larger type approx 1 $\frac{1}{2}$  h.p., 32/6 each, carriage 2/6.

**EX R.A.F. AMPLIFIERS TYPE 6**. Containing Input and Output Transformers 0 to 150 M/amp. Output Meter, made to use with PX4s in push pull, these are complete less valves and power pack. New, 37/6 each, carriage 3/6. Tests Sets, Type 211, (New) containing 4 E.F.50s, and other useful components, complete in metal box, 25/- each, carriage 2/-.

**LARGE CONDENSERS (NEW)**, 80 M.F.D. at 250 volt A.C. working, 10/- each, carriage 2/6.

**CONVERTERS**, 24 volts D.C., input 230 volts 50 cycles 1 Phase at 100 watts output, 65/- each, carriage 3/6.

**EX NAVAL TELEPHONES**, with self energised headsets, complete with buzzer (24 volts), and calling device, 22/- per pair, carriage 2/6.

**LARGE VARIABLE RESISTANCES** (Stud Switch-arm type), 25 studs, 50 ohms to carry 1.4 to 9 amps., 30/- each. 10 ohms to carry 9 to 14 amps., 32/6 each.

**MAINS TRANSFORMERS**. 200/250 volts 50 cys. input, output 350/0/350 volts at 250 mamps. 4 v. 8 a., 4 v. 4 a., 6 v. 6 a. 6 v. 2 a. tapped at 2 volts, 65/-; Ditto, 500/0/500 volts at 300 mamps. 6.8 a., 4 v. 8 a., 5 v. 4 a., 6.2/6. Ditto, 350/0/350 volts at 180 mamps. 4 v. 4 a., 6.3 v. 6 a., 5 v. 3 a., 38/6, post 1/6. Ditto, 500/0/500 volts at 150 mamps. 4 v. 4 a., 6.3 v. 4 a., 5 v. 3 a., 45/-, post 1/6. Another 100/230 volts input, 12 volts at 15 amps. output, 32/6 each.

**D.C. PRE-PAYMENT 1/- SLOT METERS**, 10 amp. load, 200/250 volts as condition as new, 27/6 each, carriage 3/6.



**L-R-S** FOR **PROMPT & EFFICIENT SERVICE**  
**CASH or EASY TERMS**

Goodman's "Axiom Twelve" Speaker Unit Cash price £8 8 0

Goodman's Standard 12" Speaker " £6 15 0

Barkers Natural Loudspeaker " £15 15 0

Callenders B.I. all-wave Anti-interference aerial " £6 18 0

Avo Model 7 Meter " £19 10 0

Avominor AC/DC Meter " £8 10 0

Avo New Wide Angle Signal Generator " £20 0 0

Avo Valve Tester, Complete " £16 10 0

Collaro Radiogram Units—various models.

Stuart Centrifugal Electric Pumps for all pumping purposes.

*Specifications of all the above on request.*  
*Please write for our EASY TERMS.*

**PERSONAL ATTENTION TO ALL ENQUIRIES**

**The LONDON RADIO SUPPLY CO.**  
 Est. 1925  
**BALCOMBE, SUSSEX**

**SUPREME RADIO.** 746b, Romford Rd., Manor Park, London, E.12. Tel. LI. 1260. Est. 15 years. 1949 and more Supreme radio and television bargains for you to invest in. Television components as follows: E.H.T. 4kv or 5kv. 2v fil, tested at 20kv 55/- ea; also E.H.T. 2kv 4v c.t., 2amp, 26/- ea; scanning coils 25/6 ea; line trans. 21/- ea; focus coils, 30/- ea; h.t. trans. 350-0-350v 6.3v 6amp, 4v 8amp, 4v 3amp, 0-2v 6.3v 2amp, 250ma, with screen, 70/- ea; 5hy choke, 250ma. 18/6 ea; 10hy choke, 80ma, 8/6. The above components have been designed to give maximum efficiency, and are the result of much research. We have experienced all the teething troubles usually met with in television construction, and know the above components will help you to attain success. Valve holders for E.F.50 valves, ceramic type, 6d ea; retaining rings for E.F.50 v holders, 8d ea; valve holders for E.A.50 valves, plastic, 15v only, 3/- ea; anti-Corona caps, 8d ea; co-axial cable or twin balanced 80Ω feeder, 1/- yd. 11/- doz yds only; co-ox plug and socket, 1/- complete; 0.1 mfd 2.5kv metal tubular condensers, 2/6 ea; these components and also all valves of resistances, variable controls and condensers for the E.E. television receiver in stock at the keenest prices; also revised edition E.E. home-built television handbook, 2/6 ea; layout plan and wiring diagram for E.E. television, 3/6 ea; tubular condensers, 25mfd 25v, midket metal tag end condensers, 1/2 ea, 13/- doz; 50mfd 50v can type condensers, 1/- ea, 11/- doz; 50mfd 12v, 3/- ea, 11/- doz; 0.01mfd 10v, 0.02mfd 750v, 0.05 ea, 500v, 5/6 doz; 0.01mfd 50v, 6/6 doz; 0.1mfd 350v, 5/6 doz; 0.001mfd and 0.0005mfd midket mica, 5/6 doz. Just arrived! A new bargain line: Silver mica ppt condensers, 3 ppf, 30 ppf, 60 ppf, 65 ppf, 70 ppf, 180 ppf, 305 ppf, 507 ppf, 500 ppf, 570 ppf, 700 ppf, 590 ppf, 4,550 ppf, 2/6 doz or assorted doz; also 0.005mfd mica condensers, 3/- doz and 0.01mfd mica 3kv, 3/- doz, now for a real snip line: Assorted panels, fitted with handy value resistances and condensers, some with Westectors, 1/- ea, 10/6 doz; trade enquiries invited; terms, c.w.o., no c.o.d. Send 6d extra for postage orders under £5; 2d, s.a.e. all enquiries and list. [2745]

**WANTED, EXCHANGE, ETC.**  
 WANTED—Ashworth, 58, Mumps, Oldham.  
 WANTED for binding, "W.W.," Feb., Mar., Apl., May, 1947.—P. Birkett, 48, Princess Rd., Leicester [2657]  
**A**merican books on radio, s/hand clean, also British.—Post to Bulls, 246, High St., Harlesden, N.W.11 [2680]  
**W**ANTED. Teletype apparatus, parts and accessories of all kinds.—Terry, Strouds, Pangbourne, Berks [2666]  
**G**ood price given for service data for all types receivers.—G. P. McMillan, 13, Cotsburn St., Greenford, W.10 [2604]  
**W**ANTED. VCR 518 cathode ray tubes.—Radio Experimental Products, Ltd., 33, Much Park St., Coventry. [2662]  
**W**ANTED. Telephone and telegraph carrier apparatus of all types in any condition.—Wilson, 93, Wardour St., W.1. [2665]  
**W**ANTED. Low prices for used test equipment, all types.—University Radio, Ltd., 22 Lisle St., London, W.C.2. Tel. Ger. 4447 and Ger. 8582. [19992]  
**W**ANTED two good Rx. HRO. AR89, CR150, etc.; state condition accurately and price; s.a.e. for sale, SX-28, excellent condition, £30, plus carriage.—Box 3518. [2631]  
**A**ll types of radio and television surplus materials for spot cash; large and small quantities considered.—Gee Electric, 15, Little Newport St., London, W.C.2. Ger. 6794. [2673]  
**R**X-GOVT. or surplus equipment required. I can offer or quantities considered; terms, immediate cash; indicators, test equipment, receivers especially.—"Fernbank," Denville, Havant, Hants. [2590]  
**R**EDUNDANT radio components, materials and equipment of all kinds urgently required in large quantities; immediate cash available and fair prices paid.—Radio Agencies, Ltd., 157, Wardour St., W.1. Gerrard 2640. [2208]  
**W**ANTED. Cossor D.B. o scope, 3339A, with 3343 oscill.; exchange Mullard 7629 combined valve tester and 60 range a.c. and d.c. analyser, perfect both ways.—R. J. Reppel, Depot, 37, St. Andrews Rd., South St. Annes, Lancs. [2669]  
**W**ANTED. Small quantities in good condition: Monitor unit type 28 or 27; transmitter TR 3529A; power unit 529; test set TS 34/AP; modulator unit type 158A, test set TS 13/AP; amplifier type 358 or A 3531; signal generator type 52; also 3cm waveguide components.—Box 3527. [2653]  
**W**E buy for cash, new, used, radio, electrical equipment, all types; especially wanted, radios, radiograms, test equipment, motors, chargers, recording gear, etc.—If you want to sell at the maximum price, call, write or phone to University Radio, Ltd., 22, Lisle St., Leicester Sq., W.C.2. Ger. 4447.

**REPAIRS AND SERVICE**  
**J**OUDSPEAKER repairs, prompt and efficient service.—Dodds Radio Service, 131a, Hurst St., Cowley, Oxford. [2681]  
**S**ERVICE with a Smile.—Repairers of all types of British and American receivers, coil rewinds; American valves, spares, line cord.—F.R.I., Ltd., 22, Howland St., W.1. Museum 5675. [1575]

**WESTERN GATEWAY HEADQUARTERS**  
 for Radio Equipment and Components

G6YA G6BAR

**SOUND AMPLIFYING EQUIPMENT**  
**AMPLIFIERS**, 25 watt, suitable for Youth Clubs, Factory installations, Dance Bands, or a first-class Modulator for Amateur Radio Station. The amplifier is housed in a handsome metal black-crackle cabinet. Original use as a Keyer Unit type 7910. Valve line-up: two 6X7's, two 6N7's, two 6Y6's, and one 5Y4. We offer modified with switched "mike" and "gram" inputs, tone and volume controls, ready for use on 200-250 v. A.C. mains. £12 10s. The amplifier, as above, unmodified, useable immediately from phase-splitter, 110 v. A.C. mains. £7 12s. 6d. plus 10s. carriage in each case.

**RADIOGRAM UNITS**  
**"GARRADD" MODEL S.** Automatic Stop, neat and compact. Ideal for mounting in table cabinet gram unit. £5 18s., inc. P.T.  
**"PLESSEY" AUTO-CHANGER.** Will take mixed 10in. and 12in. records, easy and positive operation. £19 18s., inc. P.T.  
**"COLLARO" AUTOMATIC RECORD CHANGERS.** sets an entirely new standard in record changer design and performance, combines the "Collaro" Induction or Universal Motor for power, and the "Collaro" Pick-up for excellent reproduction. £22 4s., inc. P.T.

Carriage extra  
 Agents for "Eddystone," "Denro" "Labgear" and "Raymart." We guarantee satisfaction with all our equipment. Write to us for all your requirements. Export Enquiries Invited.

**ARTHUR H. RADFORD A.M.I.E.E**  
 28, BEDMINSTER PARADE, BRISTOL, 3.  
 Tel.: 64314.  
 Open Saturdays: 9—5.30 p.m.

**EDDYSTONE**  
 '640' .... £27 10s. 9d.  
 H.P. Terms available.  
 Orders now being booked in strict rotation.  
 Full range of components.  
 All C.O.D. orders promptly executed.  
 Send for Catalogue, 1/- post free.

**SPECIAL OFFER**  
 P.M. Speakers  
 Goodman's, Truvox, Rola (as available).  
 5 inch 13/-; 6 inch 14/-; 8 inch 16/-  
 including packing and postage.

**B.T.S.**  
 THE Radio firm of the South.  
 63, London Road, Brighton 1, Sussex.  
 'Phone: Brighton 1555

**MORSE CODE TRAINING**

There are Candler Morse Code Courses for **BEGINNERS AND OPERATORS**  
 Send for this Free **"BOOK OF FACTS"**  
 It gives full details concerning all Courses.

**THE CANDLER SYSTEM CO.**  
 Room 55W, 121 Kingsway, London, W.C.2  
 Candler System Co., Denver, Colorado, U.S.A.

**W.D. TELEVISOR**

This is the title of our latest publication giving 26 pages of photographs, wiring diagrams and construction notes of an excellent little T.V. receiver. You can make this from Government surplus equipment and the total cost should not exceed £18. send 7/6 and start right away. A demonstration receiver can be seen working and all parts are available ex-stock

**WHITE PLASTIC MASK** for 6in tube, 7/6, enlargers from 27/6.

**INFRA RED IMAGE CONVERTER.** Complete with technical data. Price 14/6.

**E.H.T. TRANSFORMER.** 4000 v 2 and 3 v heater winding, 50/- . Television Transformer, 350-0-350, 250 mA, 6.3 v 7 amps, 6.3 v 4 amps, 0-4-5 v, 3 amp., 0-2-6 v, 2 amps., 69/6. E.H.T. Rectifier Hi-vac 5000 v, 4 v, 11/- . 250 ma. Choke, 10 henries, 9/6. Electrolytic, 450-500 volts working 8 mfd., 1.11, 16 mfd., 2/8. 8-16 mfd., 3/4. 15+16 mfd., 3/9. 25 mfd., 25 v., 1/3. 8,000 volts tubular for E.H.T. Smoothing 2/- each.

**BULL'S EX-GOVERNMENT DEPOT**  
 ELECTRON HOUSE, WINDMILL HILL, RUISLIP MANOR, MIDDLESEX.  
 (Open Saturdays until 5 p.m.)

**ROGERS DEVELOPMENTS CO.**

offer the following either from stock or to reasonably quick delivery

Decca model "D" Pick-up, with 12in. arm ..... £7 5 2

The Williamson Amplifier ..... £26 10 0

The Partridge 15-watt Amplifier ..... £31 0 0

Wharfedale W10/CS/B Speaker ..... £7 0 0

Barker model 148A Speaker, improved version of model 148 ..... £15 15 0

"RD" Bass Reflex Cabinets: ...

G1/8 (for Goodman's T2/12) ... £15 15 0

G2/8 (for Goodman's Axiom 12) £16 16 0

B/8 (for Barker 148 or 148A) ... £15 15 0

12in. "RD" Corner Cabinet... £32 10 0

10in. "RD" Corner Cabinet ... £27 10 0

De Luxe "RD" Corner Cabinet, complete with three speakers ..... £78 15 0

Drilled Williamson Amplifier Chassis ..... £1 7 6

Partridge WWFB 0/1-7 ..... £5 0 0

Partridge T425/150/1 ..... £2 17 0

Partridge WWFB/M, as above, but with 200 mA H.T. secondary £4 8 0

Leaflets dealing with the Williamson amplifier, Bass Reflex Cabinets, Corner Cabinets, and Feeder Units are available on request.

**106, HEATH STREET, HAMPSTEAD, LONDON, N.W.3. HAMpstead 6901**



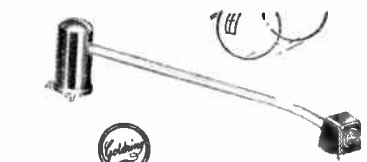

**GOLDRING**  
*Light Weight*  
**PICK-UP**

WITH JEWEL POINT  
SAPPHIRE NEEDLE

The Latest GOLDRING Pick-up No. 121 has many great advantages, including:—

- Full Frequency Reproduction in combination with a standard Wireless Set.
- Will abolish constant needle changing.
- Will safeguard records through reduced wear.

Write for full descriptive leaflet

**ERWIN SCHARF**  
49-51a, De Beauvoir Road,  
London, N.1

Telephone: CL1ssold 3434

**SENSATIONAL OPPORTUNITY—**



**MOVING COIL HEADPHONES.**  
Made to stringent Government specification by **WORLD FAMOUS MAKER.** Low resistance type with earpads and headband.

**10'6** per set

also

**MOVING COIL HEAD & MICROPHONE SETS (Brand new)**

Made by the same famous maker, these units must have cost many pounds.

Our Bargain Price

**13'6**

Send stamped addressed envelope for illustrated list.

**WIRELESS INSTRUMENTS (LEEDS) LTD.**  
54-56, THE HEADROW, LEEDS 1.

Tel. 22762.

**M**AINS transformers rewound, new transformers to any specification. MOTOR rewinds and complete overhauls; first-class workmanship, fully guaranteed.

**F.M. ELECTRIC Co., Ltd.,** Paters Bldgs., Warsler Gate, Nottingham, Est. 1917, Tel. 3855.

**M**AINS transformer rewound and constructed to any specification; prompt delivery.—Brown, 3, Bede Burn Rd., Jarrow. [3460]

**R**EWINDS, vac. drill armatures, etc. 14/6; repetition work a speciality, work guaranteed, good deliveries.—Details Box 3542, [2674]

**L**OUDSPEAKER repairs, British, American, any make, moderate prices.—Sinclair Speakers, 12, Pembroke St., London, N.1. Terminus 4355. [3308]

**L**OUDSPEAKERS repaired; clock coils, chokes rewound; prompt attention; prices quoted.—E. Mason, 5, Balham Grove, Balham, London, S.W. [7667]

**E**LECTRIC gram motors, auto-changers repaired, rewound.—Radio & Transformer Services, Manchester Rd., Hollinwood, Lancs. Est. 257. [2140]

**R**EWINDS and conversions to mains and output transformers, from 4/6; pp equipment a speciality.—N.L. Rewinds, 4, Brecknock Rd., N.7. Tel. Arnold 3390. [6283]

**A**REWIND service which duplicates or modifies as required; transformers, loudspeakers, etc.; prompt returns.—Raidal Services, 49, Lr. Addiscombe Rd., Croydon, Cro. 6537. [2719]

**R**EWINDS, mains transformers, speaker field coil, chokes, high-grade workmanship, 7day delivery; new transformers constructed to customers' specification, singly or in quantities.—Metropolitan Radio Service Co., 1021, Finsley Rd., N.W.11. Speedwell 3000. [3719]

**E**VERY make of electrical measuring instruments repaired and standardised.—The Electrical Instrument Repair Service, 329, Kilmurban Lane, London, W.9. Tel. Lad. 4168. [2527]

**R**ADIO MAINTENANCE SERVICE for guaranteeing rewinds and repairs; armatures; F.H.P. motors vac. units, good deliveries.—139, Goldhurst Terrace, N.W.6. Mal. 6133. [2483]

**"STURDY"** rewinds, mains transformers, chokes and fields, first-class work, prompt deliveries and satisfaction guaranteed.—Sturdy Electric Co., Ltd., Dipton, Newcastle-on-Tyne. [2340]

**R**EWINDS.—Mains transformers, chokes, fields, O/P transformers, etc.; prompt deliveries and satisfaction guaranteed.—Thomas Bolton & Co., 20, Heath Terrace, Leamington Spa. Tel. 18. [2483]

**A**COURATE coil winding; tuning coils, I.F., L.F. and mains transformers rewound and wound to specifications; wave and progressive wave winding.—Rynford, Ltd., 17, Arwenack St., Falmouth. [2497]

**R**EPAIRS to moving coil speakers, cones, coils fitted, field rewound or altered; speaker transformers, clock coils rewound; guaranteed satisfaction, prompt service; we do not rewind mains trans.—Closed Sat.

**L.S. REPAIR SERVICE,** 49, Trinity Rd., Upper Tooting, London, S.W.17. Balham 2359.

**A**SECOND to none rewind service, reliable clean, neat, return of best new transformers, standard or to specification, EHT, 2HT, choke; stamp quotations.—R.E.F., 137A, Ashton Rd., Oldham. [2379]

**T**RANSFORMERS and chokes to specification, single or quantities; finest quality work and finish; all units fully tested and guaranteed.—Millet & Holden, Ltd., Oxford Garage, Mews, Nelson St., Southend-on-Sea, Essex. [2409]

**24**-HOUR service, 6 months' guarantee, any i.f.s. etc.; all types of new transf., etc., supplied to specification; business heading or service card for trade prices.—Magnetic Winding Co., 180, Windham Rd., Bournemouth. [2730]

**L.T.P.** are pleased to announce the reopening of their repairs department, which has been modernised, and offers a 48-hour service on all types of mains transformers, chokes, etc.—Enquiries, London Transformer Products, Ltd., L.T.P. Works, Cobbold Estate, Willesden, N.W.10. Tel. Willesden 6486. [2730]

**R**EWINDING of all types of transformers, chokes, clockcoils, etc.; quick service; new transformers supplied to any spec. "Wireless World," transformers a speciality; bobbin replacements for all makes of trans.—Radio & Transformer Services, Manchester Rd., Hollinwood, Tel. Fai. 2507. [2409]

**R**EWINDS and repairs, mains transformers, O/P trans., clock coils, field coils, pick-ups; vacuum and gram. motors; new transformers to any specification; guaranteed work; competitive prices; delivery 2/3 days.—W. Groves, Manufacturers' Electrical Engineers, 154, Icknield Port Rd., B'ham. 16. [1482]

**A.W.F. TRADE SERVICE** offers you speedy loudspeaker repairs, loudspeaker cone assemblies, mains transformer rewinds from 15/-; new transformers at keenest trade prices; transformers built to your own specifications; lists 1d.—A.W.F. Radio Products, Ltd., Borough Mills, Bradford, Yorks. Tel. 22838. [1164]

**NATIONAL RADIO SERVICE & TELEVISION Co.,** radio and television development engineers; high quality receivers and amplifiers built to specification and modernised, repairs to all makes of receivers, transformers, coils, armatures rewound, loudspeaker cones renewed, television aerial installations, conversion, etc.—63, High St., St. John's Wood, N.W.8. Primrose 6725. [2671]

**LASKY'S RADIO**

FOR TELEVISION CONSTRUCTORS

Full data for building a television set from ex-Government units. Price 1/6, post extra.

**RECEIVER UNIT TYPE 1355.** Brand new and unused in maker's original wood transit case. When used with R.F. Unit type 25 makes the ideal vision receiver with the minimum of modification. Contains 10 valves: 8 VR65, 1 5U4G, 1 VU120, a 7.7 Mc/s I.F. strip and dozens of components. Size 9in. x 8in. x 18in. Weight 35lb. **LASKY'S PRICE 59/6.** carriage 5/- extra.

As above but used **LASKY'S PRICE 30/-**, carriage 5/- extra.

**R.F. UNIT TYPE 25 10/6,** carriage 1/6d. extra. (Used as sound converter.)

**INDICATOR UNIT TYPE 62.** Contains very nearly all the parts and valves, including the cathode ray tube for the time base and associated circuits of a television set.

Containing 20 valves and a 6in. cathode ray tube type VU197 (short persistence). Valve line up: 16 8P61, 2 EA50, 2 ER4, 2 6X5, 2 6X4, 2 6X5, 117 Mc/s, crystal, 16 pot meters, etc. Totally enclosed in metal case, size: 18in. x 8 1/2in. x 11in. Weight 40 lb., Enamel grey or black, with coloured control knobs.

**LASKY'S PRICE 59/6** carriage 7/6 extra.

**HAVE YOU ALREADY BUILT A TELEVISION SET USING THE VCR97 OR A SIMILAR 6in. CATHODE RAY TUBE? IF SO YOU NEED THE VCR87 ENLARGER. LARGER AND SHARPER, BIGGER AND BETTER PICTURES.**

Easy to fit, the very latest in plastic lenses. Satisfaction guaranteed. You will be surprised at the results. **LASKY'S PRICE 29/6,** post 1/6 extra.

**R.D.F.1 RECEIVER.** Contains 14 valves: 2 VR66, 1 5Z4G, 1 VR137, 5 VR65, 3 EA50, 1 VR63, 1 VR64, and 8 x 8 x 8 mfd., 500 v.v., smoothing condenser Hundreds of components. Frequency 1 1/2 meters (can be modified to 2 meters working). Size: 11 1/2in. x 10in. x 6in. Weight 30 lb. **LASKY'S PRICE 37/6.** carriage 3/6 extra.

We still have a few **W1191** frequency meters brand new in maker's wood transit case. 100 Kc/s—20 Mc/s. Supplied complete with calibration chart and instructions. **LASKY'S PRICE 25/19/6,** carriage 10/- extra.

**ARE YOU THINKING OF BUILDING AN OSCILLOSCOPE? THEN THE TEST SET TYPE 74 IS WHAT YOU NEED.**

Specifications: A special purpose oscilloscope, working from 230 volts 50 c.p.s. mains. Containing power pack with two rectifiers HVR2, and 5Z4H; also 9 other valves: 5 VR65, 1 6J5, 1 6Q7, 1 EA50, 1 VR133 and a 2in. cathode ray tube type VCR139A.

Also incorporated in this set is a sender and receiver complete with a chrome plated antenna. The whole unit is totally enclosed in a metal cabinet, grey finish with all controls clearly marked. Size of cabinet: 18in. x 9in. x 12in. Weight of unit 45 lbs. With modification to the time base, this unit will make an excellent general purpose oscilloscope. **LASKY'S PRICE 24 19/6,** plus 10/- carriage.

**BRAND NEW AND UNUSED IN MAKER'S CARTON. EX A.M. RECEIVER TYPE 8108.**

Contains 8 new valves: 4 8P41, 2 CV6, 2 EA50. Dozens of resistances, condenser, switches, valve holders, etc. Also motor generator with 12 volt input and 450 volt output. **LASKY'S PRICE 25/-**, carriage 4/6 extra. The generator can be easily converted to a small motor running off 230 volts mains.

A 2d. stamp will bring you our bulletin by return. Name and address in block capitals please. Why not pay us a visit? Our staff will be only too pleased to help you with your queries.

We carry a comprehensive stock of valves and other components for the experimenter, service man and radio amateur. No order too large, or too small, that we will not give our full attention to.

**LASKY'S RADIO**

370, HARROW RD., PADDINGTON

LONDON, W.9. (Opp. Paddington Hospital)

Telephone: CUNNINGHAM 1879  
Hours. Mon.—Sat. 9.30 am. to 6 p.m.  
Thurs. Half-day.





# Specialists in

## HIGH-POWER AMPLIFIERS from 250W to 1kW

**W. Bryan Savage Ltd**  
WESTMORELAND ROAD, LONDON, N.W.9

Telephone: Colindale 7131

**THE KEMEL RELAY SWITCH** (45 - retail) switches any mains receiver on or off, from any point in the house. You can listen in bed, and switch off or on from your bedside. Lists and showcard stand available on request from **A.W.F. Radio Products Ltd.**

**A.W.F. REPLACEMENT LOUD-SPEAKER CONE ASSEMBLIES** are now available for most types of commercial loudspeakers, in cartons of 3, 6, or 12, complete assemblies. **FULL FITTING INSTRUCTIONS ENCLOSED IN EACH CARTON.**

Enjoy larger profits for less outlay with the aid of these pre-fabricated units.

**BRING YOUR SERVICE DEPARTMENT UP TO DATE. WRITE NOW.**

Send 1d. stamp for the current "Monthly Bulletin" containing full details.

### "BARGAIN OF THE MONTH"

Brand new PAGE standard pentode output transformers, 4/3 each, 48 - dozen.

ENJOY THE SPEEDY "SPECIALIST" SERVICE GIVEN BY

**A.W.F. Radio Products Ltd.**  
Borough Mills, Bradford, Yorks.

**ROYAL NAVY.**—Short service commissions in the electrical branch. SHORT service commissions of five years are offered in the Electrical Branch of the Royal Navy to ex-R.N.V.R. officers under 35 years of age on 1st January, 1949, who served in the Torpedo, Special Electrical or Air Branches and were employed on technical duties connected with radar, wireless, air radio, air electrical or ships' electrical equipments. Candidates will be entered in the substantive rank held on release, with seniority adjusted by the time out of the Service. Promotion will be in accordance with the regulations in force at the time for R.N. officers (e.g., a Lieutenant (L) is at present eligible for promotion to Lieutenant-Commander (L) at eight years' seniority). Officers who complete the full period of five years on the Active List will be eligible for a gratuity of £500 (tax free). Daily rates of pay are as follows: Sub-Lieutenant (L), 13/-; Lieutenant (L), 12/-; Lieutenant (L), 17/-, after two years 19/-, after four years £1/4, after six years £1/6; Lieut.-Cdr. (L) on promotion, £1/12, thence in biennial increments of 2/- per day to a maximum of £2/2. Marriage allowance of £337 per annum if aged 25 or over, or £146 if under 25, is payable, and accommodation and rations are provided free, or allowances in lieu.—Apply to the Director, Naval Electrical Department, Admiralty, Queen Anne's Mansions, London, S.W.1, for fuller details and application forms. [2620]

**TELEVISION engineers** required for central service department of large chain store retail distributors.—ADDY, J. & F. Stone, 53, Worship St., E.C.2. [2617]

**VACANCY exists** for scientifically minded person, preferably with experience, to undertake the processing of quartz crystals.—Write, stating wages required, to Box 3516. [2626]

**PROMINENT engineering firm** in North-West requires senior engineer having experience in development of centimetric radio aerials and waveguide technique.—Reply Box 3515. [2623]

**MANAGER** required for W.C. London retailers specialising in components, etc., for the radio constructor and short wave enthusiast; wage and commission.—Apply, stating experience, etc., to Box 3522. [2644]

**A SENIOR electronic engineer** required for circuit work on industrial equipment in the Midlands; salary range £600-£1,000.—Send details of age, qualifications and experience, quoting ref. 144 to Box 2234. [2151]

**PHYSICIST** required to take charge of circuit design of industrial electronics equipment in large Midlands firm; salary £600-£1,000 depending on qualifications and experience.—Send full details quoting Ref.176 to Box 3428. [2601]

**SENIOR mechanical designer** with experience of electro-mechanisms for work on industrial electronic equipment in the Midlands; salary range £600-£1,000.—Details of age, qualifications and exp. quoting ref. D.O.23, to Box 2235. [2649]

**LEADING firm** of component makers with factories in London, have vacancies for physicists and engineers, preferably with experience in dielectric research or condenser manufacture; write giving full particulars to—Box 3435. [2616]

**FIRST-CLASS mechanical designers** required; men with experience in the design of domestic radio receivers and components preferred.—Applications in writing to Personnel Department, Murphy Radio, Ltd., Welwyn Garden City, Herts. [2481]

**ENGINEERS** required by loudspeaker manufacturer for research and production department; preferably with experience in pressure unit design and development.—Write full particulars of age, experience, qualifications and salary required to Box 3434. [2614]

**EXPERIENCED radio mechanic**, to radiomobile standard, required by reputable firm of automobile engineers; good wages and conditions; please reply, giving fullest details of qualifications.—Smiths of Stockport, Ltd., Wellington Rd., South Stockport, Cheshire. [2649]

**SENIOR research engineer** required with honours degree in electrical engineering or physics, for advanced work on radar, radio and electronics.—Apply, quoting Ref. 187, to Central Personnel Services, English Electric Co., Ltd., Queens House, Kingsway, W.C.2. [2629]

**YOUNG man** with Higher National Certificate in electrical engineering required, preferably with some knowledge of measurements, to carry out electrical and magnetic measurements on all kinds of special alloys and the application thereof.—Full particulars to Box 3524. [2646]

**AN engineer or physicist** with University degree and experience in installation, maintenance or repair of radar or television equipment required by well-known manufacturing company in Essex.—Send full particulars and salary required quoting Ref.177 to Box 3429. [2646]

**PYE, Ltd.**, have vacancies in the Research Division for laboratory assistants to work under supervision of senior engineers on design and development projects.—Write, stating age, qualifications and experience, to the Personnel Manager, Pye, Ltd., Radio Works, Cambridge. [2649]

**DRAFTSMEN** are required by the Research Laboratories of the General Electric Co., Ltd., North Wembley, Middlesex, for work in the field of radio or telecommunications; vacancies exist for scientist for several years' experience as well as for more junior candidates.—Apply to the Director, stating age, academic qualifications and experience. [2651]

# You're SURE to get it at STERN'S ESTABLISHED 25 YEARS

**Resistances—Special Offer.** Parcel containing 100 popular assorted values 1-watt type 8/6 per 100, 1/4-watt type 11/6 per 100 (Trade enquiries invited).  
**M/Coil Speakers.** Well-known firms' surplus: 10in. P.M. with Trf. 27/6; 8in. P.M., 2/3 ohms, 17/8; 6in. P.M., 2/3 ohms, 16/6; 5in. P.M., 2/3 ohms, 12/9; 3in. P.M., 2/3 ohms, 13/9.  
**Rectified M.Coil A.C. Meter.** 0-300 v., 21in. 13/9.  
**Tuning Cond. (Twin gang.)** .0005 mfd. ceramic, 7/6 (with Trm., 8/6). .0003 mfd. with Trm., 8/6.  
**Midget .0001 mfd., 5/-.** Midget .0005 mfd. with Trm., 11/9. Midget .0005 mfd., 1 1/2 x 1 1/2 in. x 2in., 10/6. 4 gang .0005 mfd., 5/9.  
**Coils, T.R.F. Matched pair, M. & L., 6/9.** Wermouth 4110, 9/6 pair. S/Hot. mat.-red, S.M. & L., 8/9. 10/8 and 11/8 pair. All Wearite "P" Coils 3/- each. Defect from the Marx "Q" Coils, complete range available from 3/9 each.  
**Vibrator Transf.** 6V in. 250-0-250 v., 100 mA out (also available in 12 v.), 8/6.  
**I.F. Transf.** 465 k/c. New well-known Mir's Surplus. 8in. x 1 1/2 in. Fern. Tuned, 9/- each.  
**Potentiometers.** Central, 5K, 10K, 25K, 50K, 100K, 1, 1, 1 and 2 Meg. less switch, 4/3. With switch, 6/-. Midget with Switch 1 and 1 Meg., 6/-. Special 75 Meg., with switch, 4/9.  
**Electrolytics.** B.E.C., Midget, 8-8 mfd., 450 v., 1 1/2 in., 5/6, and 32 mfd., 350 v., 1 1/2 in. x 1 1/2 in., 5/-. T.C.C. 10 mfd., 150 v., 2 1/2 in. x 1 1/2 in., 3/3. Bulbifier 8 mfd., 500 v., 2 1/2 in. x 1 1/2 in., 4/-. Apd all makes and types. T.M.C. 8-16 mfd., 450 v., 4/11.  
**Meter Rectifiers.** Westinghouse, 0.5 mA., 3/11; 0-10 mA., 7/6; 0-1 mA., 10/6.  
**Selenium Rectifiers.** 11.7, h/wave; 250 v., 50 mA., 5/9; 200 v., 100 mA., 5/9; 250 v., 100 mA., 7/6; 250 v., 300 mA., 13/9; Bridge Rect.: 6 v., 1 1/2 amp., 6/3; 12 v., 1 1/2 amp., 12/6; 12 v., 3 amp., 24/-; 12 v., 6 a., 37/6; 36 v., 1 1/2 a., 23/6; 70 v., 1 1/2 a., 37/6. Also L.T. 2-4 v., 1 a., h/wave, 3/6.  
**T.C.C. 10 mfd., 150 v., 2 1/2 in. x 1 1/2 in., 3/3.**  
**45/-** 500-0-500 v., 250 mA., 4 v., 5 a., 6.5 v., 8 a., 75/-; 350-0-350 v., 250 mA., 6.3 v., 6 a., 4 v., 8 a., 4 v., 3 a., 6.3 v. (tapped 2 v.), 2 a., 72/6.  
**Charger Transfs.** Each has Input 210-230-250 v. Outputs: 24 v. (tapped 15, 8 and 4 v.), 3 amps.; 27/6; 30 v. (tapped 15 and 9 v.), 3 output, 25/6; 15 v. (tapped 9 v.), 3 amps., 17/6.  
**Filament Transfs.** Input 200-250 v., output 6.3 v., 11 amps., 9/-. Also with output 4 v., 1 1/2 amps., 9/-.  
**Ex-Govt. T.M.C. Reed-type Headphones.** 70 ohms, 75 ohms, with adjustable Headband, 1/6. Midget Output Trans., 32-1, and Parafied Trf., 4-1, both 1 1/2 in. x 1 1/2 in., 3/- each. P/Pulld Intervalve 2.5-1 each half. Output Trf. 60-1, both 1 1/2 in. x 1 1/2 in., 3/- each. Tannoy Transverse Carbon Mike inset, 2/3. Midget Intervalve Transf., 3-1, 5-1 or 10-1, 2/3 each. Multi-tap to Matching Transf., 4 windings (2 C.T.) over 10 ratios between 150 and 100-1, 2in. x 1 1/2 in., 3/9. 12 volt D.C. motor suitable for models, 19/6. Moving Coil Mike with S/R Switch, 2/6. M/Coil Headphone, 2/- each. Carbon Hand Mike, with S/R Switch, 2/11.

★ Send 2d. stamp for very full Stock Lists. When ordering please cover packing and postage.

**STERN RADIO LTD.**  
109 & 115, FLEET STREET, E.C.4.  
Telephone: CENtral 5814 and 2820.

### POWER TRANSFORMERS FOR HOME & EXPORT.

Primaries 200/230/250 v., 10-100 cps. Secondaries 350-0-350 v., 90 mA.; L.T. (1) 5 v., 2 a., L.T. (2) 6.3 v., 3 a., c.t. Electro screen, 6 inch leads. Type: P, Surface mounted, 29/-, S, Drop thro', single shroud, 31/-. SS, Surface twin shroud, 32/6. The SS type, totally enclosed, illustrated. Chokes, output transformers to match. Power units 200-500 volt, secondaries from 60 mA. to 300 mA., are available. Special terms to the trade, factors, and larger users home and overseas.

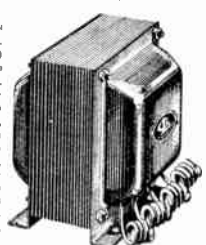

**MERIT TRANSFORMER SUPPLIES,**  
294, BROADWAY, BEXLEYHEATH



## RECEIVERS for WEST COUNTRY AMATEURS. EDDYSTONE 640

FROM STOCK



Cash £27 10 0 or terms.

**G. N. PILL & PARTNERS**  
49, COBOURG STREET, PLYMOUTH  
Telephone: 2239

After years of experimenting Mr. Voigt has designed a P.M. unit of the open, low leakage type, up to the standard of his excited fields.

It is demountable for assembly with pole tips and or magnet blocks of varying dimensions and materials. This provides for future metallurgical and other developments. More expensive than an inflexible design but justified.

THE WISE



Anticipated prices with—  
2mm. gap and twin diaph. ... £36  
1½mm. gap light coil twin and B.B.C. corrector ... £43

Re Horns see Nov. advt.  
**VOIGT PATENTS LTD.**  
LONDON, S.E.26  
P.S. Mr. Voigt is not yet able to give demonstrations.

## TRANSFORMERS & COILS TO SPECIFICATION.

MANUFACTURED OR REWOUND  
Filter Coils + 1% a Speciality.

**JOHN FACTOR LTD.**  
9-11 EAST STREET, TORQUAY DEVON  
Phone: Torquay 2162

## EX-R.A.F. EQUIPMENT for REBUILDING or disassembly for parts and valves.

Type 25 VHF Receiver. Includes two EF36 two EF39, one EK32, and one EB33 or equivalents; and lots of useful parts. 22 6, inc. postage.

Type 6C Indicator Unit. Includes two EF30 and two EB34 valves, and a VCR138 (5CR35 or equivalent), 4in. CR Tube; and lots of useful parts. 42/-, inc. postage.

Type 5A Mine Detector Amplifier. Includes three VP23 valves (or equivalents), pair of high-impedance headphones, and lots of parts. 17/-, inc. postage.  
(As with all ex-Govt. surplus, sold without guarantee, but all in apparent good condition.)

**WIRELESS SUPPLIES UNLIMITED**  
(Props. Unlimitex Radio Ltd.)

264-266, Old Christchurch Road,  
BOURNEMOUTH, Hants.

**E**LECTRICAL component manufacturers in West London require man for assembly and wiring of test equipment; applicants must be experienced and have good knowledge of radio and valve technique; five-day week.—Write stating age, experience and wages required to Box 3426. [2596]

**S**ENIOR Chemist for electronic research required for new chemical laboratory in Essex; applicants must have B.Sc. in Chemistry and less than seven years' research experience; a flat in the country will be available for the successful applicant.—State full particulars to Box 3424. [2592]

**T**ELEVISION and radio service engineers; opportunity occurs to join the permanent staff of a company with branch in Kent area; vacancies for test bench and field service (clean driving licence essential); lodgings available for single men.—Give full particulars, including qualifications, to Box 3425. [2593]

**S**ENIOR and junior experienced development, research engineers and draughtsmen required for radio, television, electronics, radar, speakers; preference B.Sc., H.N.C.; also testers, inspectors, repairers, service engineers, etc.—Technical Employment Agency, 179, Clapham Rd., S.W.9 (Brxton 3487). [2656]

**C**HIEF engineer wanted for company manufacturing electrical measuring instruments and industrial radio and electronic test equipment; excellent position and prospects; salary with suitable experience.—Write, giving full particulars of experience and qualifications and salary required, to Box 2523. [2645]

**E**LECTRONIC circuitry engineer with considerable experience of pulse technique required for development of industrial electronic equipment in expanding organisation; salary according to experience. Working, Surrey area.—Apply, stating experience, academic qualifications and salary required, to Box 3539. [2663]

**A**SSISTANT to sales manager of electronic instrument company; must have sound knowledge of electronics and possess flair for selling and ability to write technical pamphlets; some knowledge of export an advantage; not under 30.—Write in first instance, giving full particulars of experience to Box 3431.

**D**ESIGNER draughtsman required for development of mass-produced electro-mechanical devices and mechanical design of industrial electronic equipment in expanding organisation; salary according to experience; Working, Surrey area.—Apply, stating experience, academic qualifications and salary required, to Box 3540. [2664]

**L**EADING component manufacturers require chief inspector possessing drive and initiative; applicants must be sound technicians with qualifications at least equivalent to inter-B.Sc. and with experience of modern testing technique.—Furnish resumes including dealing with Government inspection departments; West London area.—Write stating experience and salary required to Box 3430. [2603]

**E**LECTRONIC and general development engineer required for development of electronic and associated apparatus for industrial purposes; considerable experience of development or design in radio or industry is essential; sound mechanical knowledge an asset.—Write, stating salary required, qualifications and experience, to Personnel Manager, Edison Swan Electric Co., Ltd., Ponders End, Enfield, Middlesex. [2648]

**L**IMITED numbers of vacancies for mechanical engineers, electronic engineers, vehicle mechanics and tradesmen of all kinds still exist in A.A. Command workshops in various parts of the United Kingdom; if you would like a job near your home write to D.D.M.E., A.A. Command, Stanmore, Middlesex; tell him where you want to work and he will let you know what he has to offer; pay varies from 110/- per week to £750 per year, according to qualifications.

**M**URPHY RADIO, Ltd., invite applications for the following vacancies in the electrical design laboratory: (1) Senior radio engineer, with good honours degree in physics or electrical engineering and several years' industrial experience in television or radio receiver development. (2) Radio engineer, with good academic qualifications in physics or electrical engineering, preferably with some industrial experience.—Apply to Personnel Dept., Murphy Radio, Ltd., Weiwyn Garden City, Herts. [2618]

**T**HE following vacancies exist in a large radio manufacturing company, London area: (1) Radio research engineers for the development of domestic receivers for the home and export markets; (2) television research engineers; (3) specialists in time base and E.H.T. circuit development. Extremely good positions offered to competent men with ideas and ability to develop equipment to the stage of production.—Write in confidence, stating age, qualifications, experience and salary required, Box 3517. [2627]

**A**NGLO-IRANIAN oil company requires an electronic engineer for work at their research station in connection with the development of engine inductors, special amplifiers, control equipment and other apparatus for research on the behaviour of internal combustion engines and their fuels, etc. Applicants, who should have had experience on development of electronic apparatus, should be aged 20-30 and possess Higher National Certificate or a University degree; salary according to age, qualifications and experience.—Write quoting Dept. H.827 to Box 5509, at 191, Gresham House, E.C.2. [2622]

## WE OFFER

A large range of used and new Test Equipment, Converters, Recorders, Amplifiers, Motors, Transformers, etc.  
All guaranteed and at very attractive prices.

We buy good modern used equipment of all types for spot cash.  
**UNIVERSITY RADIO LTD.**  
22 LISLE STREET, LONDON, W.C.2.  
Tel.: GER 4447 & 8582.

## RELAYS



for A.C. and D.C.  
2 VA Coil consumption from 2 to 600 volts and tested to 2000 volts, Aerial Changeover Relays, Measuring Relays and Time Delay Relays.

Midget Relay ML/C Ask for leaflets RE/WW

## LONDEX LTD

Manufacturers of Relays  
207 ANERLEY ROAD, LONDON, S.E.20.  
SYDenham 6258

## AUDIO FILTERS

Field-free, Hi-Q, Toroidal Windings.  
Permalloy Cores — Permanent Accuracy.  
Low, High, Band-pass or Cross-over.  
ADJUSTABLE Whistle and Scratch Extractors.

## LYNCAR LABORATORIES

19, Camborne Road, Morden, Surrey. LIB. 3247

**COPPER WIRE**, Enamelled, Silk, D.C.C., etc., all sizes. **TRANSFORMERS & CHOKES** made to your special requirements. **SMALL MOTORS** 1/200 to 1 H.P. a speciality. **ALL COMPONENTS** for the Radio and Television constructor.

Send S.A.E. for list to:

**STAN. HOLT,**  
349, HIGH ST., SMETHWICK, STAFFS.

## INDIVIDUAL TRANSFORMER REWINDS

SEND YOUR "BURNT OUT" TRANSFORMER TO BE REWOUND. NO TECHNICAL DATA REQUIRED. OUR TRANSFORMER WINDINGS ARE DOUBLE WOUND AND BACKED BY A SPECIALISED SERVICE  
LOUDSPEAKER REPAIRS.  
FIELD COILS.

**SOUTHERN TRADE SERVICES LTD.,**  
297/299, HIGH STREET,  
Telephone: CROYDON 4870.

# THE HEART OF A FIRST-CLASS RADIO-GRAM

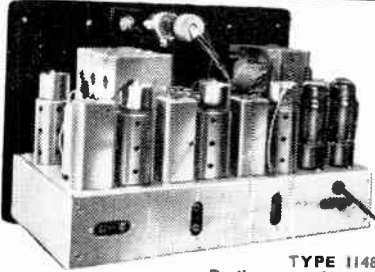

**TYPE 1148**  
Radio-gram Chassis

Developed from the popular type 1047, this receiver will form the basis for a Radio-gram of unsurpassed performance, and at great saving in cost. Principal features include:

- 12 stage superhet circuit
- 11 valves with magic eye indicator
- 4 wavebands (11-2,000 metres)
- R.F. Amplifier
- 2 I.F. stages
- 4 stages AVC
- 10 watts push-pull output
- Separate treble and bass controls
- Tropicalised components.

Other Peerless equipment of interest to the enthusiast includes: 16-valve Communications Receiver Type 1346 • R/F Feeder Unit (comprising R/F portion of Type 1148 Receiver) • A/F Unit and Power Pack Type 1. All details on request.

## PEERLESS RADIO LIMITED

374 KENSINGTON HIGH STREET, LONDON W.14  
Telephone: WE8tern 1221

# ETA PRESET TUNER

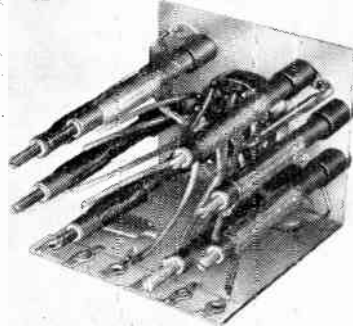

**TYPE TS41 (Patent Applied for)**

- ★ Is a complete pre-set tuning unit for use in superhet circuits.
- ★ Gives a choice of four stations, any three M.W. and any one L.W.
- ★ Requires no tuning condenser, trimmers or other extra components.
- ★ Uses a new type of inductor, giving maximum sensitivity and stability.
- ★ Each permeability trimmed coil tunes over the whole relevant band.

Supplied with full instructions and a complete receiver circuit.

PRICE 33/6, plus 7/2 P.T.

Obtainable from your dealer, or direct from

**ELECTRO TECHNICAL ASSEMBLIES**  
West Hill, St. Leonards-on-Sea, Sussex

**L**ARGE electrical organisation requires an assistant engineer, capable of writing specifications, dealing with tenders and contracts for sound installations; design work on special amplifier and electronic circuits; successful applicant would be required to assist in special surveys of factories, etc.; some general experience of office routine; B.Sc. and/or A.M.I.E.E. qualifications preferred, but not essential.—Write, giving full details as to age, previous experience and salary required, to Box 2251. [2142]

**V**ALVE engineer: a well-known Company in the London area has a vacancy for an engineer to act as technical assistant to manager in their transmitting and special valve section; applicants should be fully conversant with modern manufacturing methods and have had experience in the design and manufacture of radiation-cooled, and external anode type valves; knowledge of valve application, particularly in the R.F. heating field an asset.—Write stating qualifications, experience and salary required to Box 3581. [2622]

**B**ELLING & LEE, Ltd., Cambridge Arterial Road, Enfield, require services of experienced and qualified electronic engineer to investigate problems in connection with broadcast and television receiving aerials, radio interference suppression and radio and electronic components. This type of work presupposes a working knowledge of physics and electronic mathematics, together with an inventive flair; applicant's age should lie between 25 and 35 years, and the scale of salary commensurate with experience and knowledge will not exceed £600 per annum. [2619]

**E**NGINEER required to take charge under supervision of internal and external engineering for relay company with 20,000 subscribers in the North Midlands; a good theoretical knowledge (approx equivalent to C. and G. L.V., telecommunications), together with sound practical experience of light electrical engineering audio amplifiers, transmission lines (both overhead and underground) and radio receivers, is expected of the successful candidate, together with efficient administrative ability.—Write to Box No. 863, Sells, Ltd., Brettenham House Strand, W.C.2. [2624]

**M**ICHAEL RADIO, Ltd., require senior project engineers in their equipment development laboratory at Slough; these appointments are of a stable and progressive nature, satisfying the keenest appetite for the expression of initiative and the acceptance of responsibility; training and experience in the field of applied electronics (including communications) and experience of working with Government departments are the chief qualifications required; salary will be commensurate with ability.—Write stating age and full details of training, qualifications and experience to the Chief Engineer, Equipment Division, McMichael Radio, Ltd., Slough, Bucks. [2683]

**C**ONTINUED expansion of the E.M.I. Electronics College has created further vacancies for lecturers in radio communications; two lecturers whose duties will include some technical writing are required immediately; applicants should possess a good Physics or Electrical Engineering Degree and also experience in radio, television, etc.; age 22-28; commencing salary according to age, qualifications and experience, not less than appropriate Burnham scale; superannuation benefits in addition.—Apply giving fullest possible particulars to Professor H. P. Trewartha, M.A. (Cantab.), M.I.E.E., M.I.Mech.E., M.Brit.I.R.E., E.M.I. Institutes, Ltd., 43, Grove Park Rd., London, W.4, Tel. Chiswick 4417/8. [2712]

**W**OOLWICH Polytechnic, Woolwich, S.E.18. Applications are invited for the following permanent posts: physics and telecommunications department: two laboratory stewards (salary £275-£290-£355); candidates should be able to undertake preparation and maintenance work in the laboratories in connexion with classes for University degrees; in one post it is proposed to appoint a person who will be able to help in the department workshop; experience in workshop practice and instrument making will be a desirable qualification; these posts are permanent and after a satisfactory probationary period, will be established for superannuation scheme; holidays with pay and sick pay regulations apply; further particulars and application forms may be obtained from the Secretary, Woolwich Polytechnic, S.E.18, to whom they should be returned within two weeks of the date of this advertisement. [2608]

**C**ROWN Agents for the Colonies: application from qualified candidates are invited for the following posts: wireless station superintendent agents required by Nigeria Government Posts and Telegraphs Department, for 18-24 months, with prospect of permanency; outfit allowance £60; free passages; salary according to age and war service in scale £600-£850 a year (including expatriation pay); candidates must hold first class radio-telegraph operator's certificate, have had recent experience in wireless operating and direction finding operation, have thorough knowledge of transmitters and receivers and be capable of maintaining (under an engineer's instructions) diesel engine sets, driving small generators.—Apply at once by letter, stating age, whether married or single, and full particulars of qualifications and experience, and mentioning this paper, to the Crown Agents for the Colonies, 4 Milkbank, London, S.W.1, quoting M/N 24044(3B) on both letter and envelope.

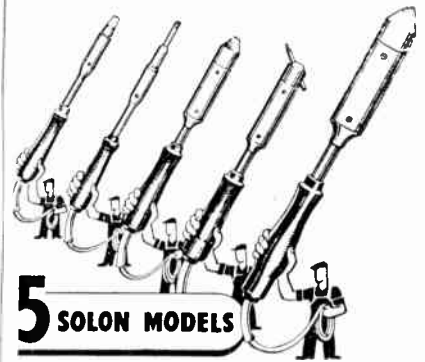

**5 SOLON MODELS**

SOLON electric soldering irons have proved their capacity for continuous service under the most exacting conditions. 5 models: 240 watt oval tapered bit; 125 watt oval tapered and round pencil bits and 65 watt oval tapered and round pencil bits. Each model complete with 6 feet of Henley 3-core flexible. Now available from stock. Write for folder Y 10.



W. T. HENLEY'S TELEGRAPH WORKS CO. LTD.  
51-53 Hatton Garden, London, E.C.1

## MOVING COIL

# AMMETERS & VOLTMETERS

EXGOVT., NEW, UNUSED & BOXED  
Offered at a fraction of original cost



## FINEST QUALITY PRECISION INSTRUMENTS

by famous makers such as Ferranti, Pullin, Metropolitan Vickers, Sangamo Weston, G.E.C.

### AMMETERS

2in. Flush, 50-0-50 amps

### VOLTMETERS

2in. Flush, 0-40 volt      2in. Flush, 0-20 volt

All at 3/11 each. Carriage paid.

Cash with order only.

Secure yours now—limited quantity

## H. H. LINTON & CO., LTD.

34 Osnaurgh St., London, N.W.1

Telephone: EUSton 8406



**"ENGINEERING OPPORTUNITIES"**

This unique handbook shows the easiest way to secure **A.M.I.Mech.E., A.M.Brit.I.R.E., A.M.I.E.E., City and Guilds, etc.**

**We Guarantee —**

**"NO PASS — NO FEE."**

Details are given of over 150 Home-study Diploma courses in all branches of **Civil, Mech., Elec., Motor, Aero, Radio, Television and Production Engineering, Tracing, Building, Govt. Employment, R.A.F. Maths, Matriculation, etc.**

Safeguard your future; send for your copy at once—**FREE.**

**B.I.E.T., 387, SHAKESPEARE HOUSE, 17, STRATFORD PLACE, LONDON, W.1.**

**WARD ROTARY CONVERTERS**

For Radio, Neon Signs, Television, Fluorescent Lighting, X-ray, Cinema Equipment and numerable other applications.

We also manufacture:—

**Petrol Electric Generating Plants, H.T. Generators, D.C. Motors, etc., up to 15 K.V.A.**

**CHAS. F. WARD**

**LORDSCROFT WORKS, HAVERHILL, SUFFOLK**  
Telephone: Haverhill 253 & 4.

**CRYSTALS**

FOR  
**AIRCRAFT  
MARINE  
AND  
AMATEUR  
TRANSMITTERS**

ALL LOW TEMP. CO-EFF. CUTS.

**BROOKES CRYSTALS LTD.**

10, STOCKWELL ST., GREENWICH,  
GRE. 1878. LONDON, S.E.10.

**WAVE WINDINGS**

**TO YOUR OWN SPECIFICATION**

We can also offer you a standard range of adjustable iron dust cored coils of exceptional efficiency and stability, suitable for superhet and T.R.F. receivers.

**MONOCHORD RADIO**

(Established 1929)

17, Streatham Hill, London, S.W.2.  
Phone: Tulse Hill 1061.

**ELECTRICAL** engineer required for design of battery charging and other equipment incorporating metal and valve rectifiers; Higher National Certificate or equivalent, with some general engineering experience, together with electrical and mechanical, estimating and investigation of customer requirements; previous experience with rectifiers desirable but not essential; a good opportunity for a progressive young man.—Write, stating salary required, qualifications and experience, to Personnel Manager, Edison Swan Electric Co., Ltd., Ponders End, Enfield, Middlesex. [2647]

**SITUATIONS WANTED**

**EX-R.A.F.** Cpl., wireless fitter, 26, pre-war boy service trained, keen, anything considered, able drive.—Box 3620. [2722]

**HONOURS** Engineering Graduate (telecom. measurements, power materials, structures) aged 21, seeks opening.—Box 3433. [2613]

**EX-R.A.F.** sigs/radar officer, B.Sc. (Eng.), 24, experienced radar air survey, general telecomms., keen ham, seeks post.—Box 3582. [2684]

**AGENTS WANTED**

**RADIOMEN** required as commission agents to distribute low-priced television and broadcast receivers.—Box 3621. [2732]

**ENQUIRIES** invited from established service engineering shops with interest in high fidelity equipment to act as sole district representatives for London firm; demonstration equipment supplied free on loan, and orders dealt with from London.—Please Write, Box A.C. 35509, Samson Clarks, 57/61, Mortimer St., W.1.

**BUSINESS AND PROPERTY**  
**RADIO**, electrical cycles, principal agencies, premier trading position, Midlands town, living accommodation, long lease; inclusive price approx £3,000.—Sutton & Co., Auctioneers, Ilkeston, Derby. [2598]

**BUSINESS OPPORTUNITIES**

**COUNTY** Borough of Croydon, relay wireless service.—The Council are prepared to consider offers for the privilege of installing a relay wireless service in Croydon; full particulars of the system and of the financial arrangements should be sent to me in sealed envelopes, endorsed "Relay Wireless Service", no later than 15th January, 1949. The Council do not bind themselves to accept any offer.—E. Taberner, Town Clerk, Town Hall, Croydon. [2594]

**PATENTS**

**THE** proprietor of British Patent No. 573313, entitled "Multiple section electronic tube and method of making it" offers same for licence or otherwise to ensure practical working in Great Britain.—Inquiries to Singer, Ehlert, Stern & Carlberg, 28 East Jackson Blvd., Chicago 4, Illinois, U.S.A. [2591]

**TECHNICAL TRAINING**

**A.M.I.E.E., City and Guilds, etc.**, on "No Pass—No Fee" terms; over 95% successes; for full details of modern courses in all branches of electrical technology send for our 112-page handbook, free and post free.—B.I.E.T. (Dept. 382A), 17, Stratford Place, London, W.1. [2670]

**UNRIVALLED** opportunities for training in electronics; a few vacancies remain in 2 and 3 year telecommunications engineering courses commencing early in 1949; in addition to considerable practical work at the Institutes in the 3 year course includes 1 year's training in the extensive E.M.I. factories and laboratories at Hayes (H.M.V., Columbia, Marconi-Phone, etc.).—Full details, including information concerning postal courses, from Dept. W.W., E.M.I. Institutes, Ltd., 43, Grove Park Rd., London, W.4. Tel. Chiswick 4417-9. [2577]

**TUITION**

**THE** British National Radio School

**OFFERS** you a career.

**WRITE** to-day for free booklet describing our wide range of training courses in radio, Radar, telecommunications, principles, mathematics, physics, and mechanics; correspondence and day classes for the new series of C. & G. examinations; we specialise in turning "operator" into "engineers," and for this purpose our "Four Year Plan" (leading to A.M.I.E.E. and A.M.Brit.I.R.E. with C. & G. Certificates as interim rewards) is unsurpassed; our "guarantee has no strings attached."—Studies Director, B.Sc., A.M.I.E.E., M.Brit.I.R.E., 66, Addiscombe Rd., Croydon, Surrey. [6811]

**ENGINEERING careers and qualifications.**

**BOTH** Government and industry have announced and emphasised that young men with technical knowledge and qualifications must receive every chance to rise to the highest positions within their capacity. In post-war engineering and allied industry; write to-day for "The Engineer's Guide to Success"—200 courses free—which shows you how you can become A.M.I.E.E., A.M.I.Mech.E., A.F.R.Ae.S., etc., and covers all branches in radio, automobile, mechanical, electrical, production, aeronautical, etc.

**THE** Technological Institute of Great Britain, 82, Temple Bar House, London, E.C.4. [1776]

**RADIO** training.—P.M.G. exams, and I.E.E. Diplomas; prospectus free.—Technical College, Hull. [1611]

**TELEVISION** postal course for radio trades Examination Board's diploma, also postal courses for P.M.G. 2nd and 1st class Certificates and Amateur Radio Transmitting licence.—Apply British School of Telegraphy, Ltd., 179, Clapham Rd., London, S.W.8. [40 years' experience in coaching students in wireless telegraphy and allied subjects.] [2586]

**LOCKWOOD**

makers of

**Fine Cabinets**

and woodwork of every description for the . . .

Radio and allied trades

**LOCKWOOD & COMPANY**

Lowlands Road, Harrow, Middx.

Phone: BYRon 3704

**TELEVISION**

an essential accessory for

**LONG DISTANCE VIEWING**

A type AC/2 pre-amplifier.

Full particulars from **SPENCER-WEST, North Quay Works, Gt. Yarmouth.**

**PHOTO-ELECTRIC CELLS**

for

**Talking Picture Apparatus.**

Catalogue now available

**RADIO-ELECTRONICS LTD.,**

St. George's Works, South Norwood, London, S.E.25.

**RADIOMENDERS LIMITED**

**FOR SPECIAL TRANSFORMERS AND REWINDS**

We specialise in—

**AMATEURS' WINDINGS, TRANSFORMERS ALL TYPES, CHOSES, PICK-UP COILS, INSTRUMENT COILS, Etc.**

**LOUD SPEAKER SERVICE**

Highest workmanship. Good Delivery

★

**RADIOMENDERS, LTD.**

123-5-7 Parchmore Road,

**THORNTON HEATH, SURREY**

LIV 2261. Trade enquiries invited. Est. 16 years

**ELMSLEIGH WHISTLE FILTERS**

A "ladder" type low-pass filter giving a sharp cut of approx. 30DB at 9 Kc. and less than 4DB at 8 Kc. Unaffected by neg. feed back taken from O.P. Sec. Connected in speech coil leads. In steel case, 21/-. [2670]

**IAN BAILEY REPRODUCER, SERIES 2**

A horn-type speaker which supersedes the original Ian Bailey C.H., but measuring only 3ft. 2in. high by 1ft. 9in. wide, 1ft. 4in. deep, giving an actual range of 20-18,000 c.p.s. Transient response is outstanding. In walnut (other finishes to order), complete with L.S. unit. **PRICE: £33.** Send stamp for details.

**ELMSLEIGH RADIO CO.**

1102 London Rd., Leigh-on-Sea, Essex

Leigh-on-Sea 75168



**RADIO ENGINEERING SCHOOL.** Air Service Training, Hamble, Southampton, provides the best full-time training for responsible positions in industry or aviation; students coached for C. & G. Inter. and Final Certs. in radio-tele-communications; Graduateship of Brit. I.R.E., M.C.A., radio engineer licence, and for air and marine radio officers' licences; full details from the Commandant. [2250]

**THE Institute of Practical Radio Engineers** have available Home Study Courses in every phase of radio and television engineering, specialising in the practical training of apprentices in the retail trade; enrolments limited, fees moderate.—The Syllabus of Instructional Text may be obtained post free from the Secretary, I.P.R.E., Fairfield House, 20 Fairfield Road, Crouch End, London, N.8. [1614]

**ELECTRONICS** in industry.—Free booklet describing postal course prepared by E.M.I. engineers (H.M.V., Marconiphone, Columbia, etc.); course includes circuit details and descriptions of the functioning of industrial electronic devices; booklet also contains details of other postal and attendance courses.—Write to E.M.I. Institutes, Ltd., Dept. WW, 43, Grove Park Rd., Chiswick, London, W.4. Tel. Chiswick 4417-8.

**A.M.I.Mech.E. A.M.I.E.E.,** City and Guilds etc. on "No Pass—No Fee" terms, over 95% successes; for details of exams, and courses in all branches of engineering, building, etc., write for 108-page handbook—free.—B.I.E.T. (Dept. 3873) 17, Stratford Place, London W.1.

**BOOKS, INSTRUCTIONS, ETC.**  
**WEBB'S 1948 radio map of world,** new multi-colour printing, with up-to-date call signs and fresh information, on heavy art paper, 4.6. post 6d; on linen on rollers, 11.6. post 9d.—Webb's Radio, 1-4 Soho St., W.1. Gerrard 2089.

**SOUTHERN RADIO'S** Radio publications:

**RADIOCRAFT** books. "Unusual Patented Circuits, 1944-1946," 3/6; "Radio Test Instruments," 3/6; "Elementary Radio Servicing," 3/6; "Advanced Service Technique," 3/6. British publications: "Radio Valve Equivalents," 2/6; "Radio Repairs Manual," 2/6; "The Walkie-Talkie Construction Manual," 2/6; "Radio Designs Manual," 2/6; "Frequency Modulation Receivers Manual," 2/6; "Modern Battery Receivers Manual," 2/6; "Television Constructors' Manual," 3/6; "Communications Receivers Manual," 2/6; "Amateur Transmitters' Construction Manual," 2/6; "Radio Test Equipment Manual," 2/6; "Ultra Short-wave Handbook," 2/6; "Radio Calculations Manual," 3/6; "Radio Constructors' Manual," 3/-; "Shortwave Radio Handbook," 2/-; "Radio Inductance Manual," 2/6.

**SOUTHERN RADIO SUPPLY Ltd.,** 46, Lisle St., London, W.C.2. Gerrard 6653. [2711]  
**YOURS** for the asking; grand new catalogue of over 100 new publications dealing with every aspect of radio, television and electrical engineering; also 6-page ditto of exceptional bargain lines in radio and gram equipment, and the pick of current Government releases; s.a.e. please, to: Radio Unlimited, 16, Carnarvon Rd., Leyton, E.10. [2251]

**RADIO BATTERY TESTER**

Use "Quixo" method of battery testing.

Reliable results. Guaranteed.

Send for interesting leaflet  
R115 on battery testing.



**RUNBAKEN • MANCHESTER**

**INDUSTRIAL FINISHING  
CRACKLE**

STOVE ENAMEL • ALL COLOURS

Stoving ovens and spray service at your disposal. Prompt return after final inspection. Chassis, Panels, Cabinets, Photographic Equipment, etc. Black 1/-. Colours 1/3 per sq. ft. Carriage extra. Special quantity quotations. We make anything in metal to your requirements.

**Buccleuch Radio Manufacturers**

6 Wheatfield St., Edinburgh, 11

Grams: "Therm" Telephone 64596

**The "ADCOLA" Soldering Instrument**

Reg. Trade Mark.



Designed for Wireless Assembly and Maintenance.

Working temperature reached in 1 1/2 mins., consumption 25 watts, weight 2 1/2 ozs. Supplied in voltage ranges from 67v. to 230 250v. 1/8" diam. Copper Bit (standard model) 22/6. 1/4" diam. Copper Bit 25/-. Replacement Unit Bit Elements available. British and Foreign patents.

Sole Manufacturers:

**ADCOLA PRODUCTS LIMITED**

Alliance House, Caxton Street, London S.W.1  
Write or Phone: WHI. 0030.

**OLDCHURCH LABORATORIE**

And now to follow the famous Test 73:—

**INDICATOR UNIT 73**

Brand new, in original cases. Price complete with Modification Plans

**£3/5/- (plus carriage)**

These units incorporate the V.C.R. 13sa Tube, which is probably the finest 3 1/2in. scope tube now available. Also included are:—4 VR65 valves, 1 VR54 valve, 1 VR32 valve and many useful components. The addition of a Power Supply and Time-Base Unit (as described), renders this a first class oscilloscope. We can supply all the necessary additional components. Still available: Modification Data for T.S.74. Modification Data for T.S.74

Each £1/-

E.H.T. Transformers, 2 Kv. & 4v. C.T., each 30/-  
Send 2/4. stamp for our latest Television and Radio Components List.

**L. P. DISMORE,**  
52c, Oldchurch Road, Chingford, E.4.

**MAGNIFY THE PICTURE  
ON YOUR W.W TELEVISION**

WITH THE **MAXWELL** MAGNIFYING LENS

- CRYSTAL CLEAR ● SIMPLE FIXING
- NO DISTORTION
- IMMEDIATE DELIVERY

**27/6**  
PLUS 10d. POST AND PACKING COST WITH ORDER

OTHER SIZES: 9" UNIVERSAL 79/6: 12" UNIVERSAL

99/6 PLUS 2/6 PACKING & POSTAGE

TRADE ENQUIRIES INVITED

**MAXWELLS, 112 HAMPSTEAD RD., LONDON, N.W.1**

TEL: EUS. 4583

**Technical Excellence—**

combines with beauty and soundness of DESIGN in the

**"OXLEY"**

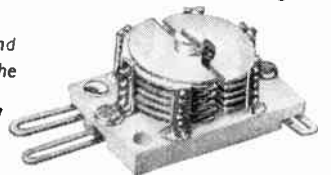

**DIFFERENTIAL AIR DIELECTRIC TRIMMER**  
Type Approved Cat. A. No. 464.

**OXLEY DEVELOPMENTS CO., LTD.,**  
ULVERSTON, N. LANCS. Tel. Ulverston 3306

★ Width: 10.5 m/m Length: 25 m/m  
Height:  
1.5 to 8pF—8m/m  
1.8 to 20pF—10.6 m/m  
2 to 25pF—11.6 m/m  
2 to 32pF—12.5 m/m  
Law: Straight line capacity  
Power Factor: Less than .001  
Insulation: Over 2,000 megohms  
Voltage: 500 D.C.

**MICROPHONE MIXER UNIT**

Permits the controlled mixing and fading of microphone and/or gramophone inputs. Is valveless, and requires no power supply. Elegantly finished in mat. gold and black. Silent in action, and long lasting.

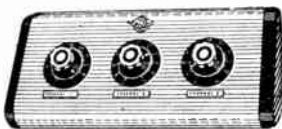

Standard Model—3 Input Channels, 4 and 5 Channel models available. Details on request from the makers

by:—

**LUSTRAPHONE LTD.**

84, BELSIZE LANE, LONDON, N.W.3.



Products of Quality & Reliability

- MAINS TRANSFORMERS
- A. F. TRANSFORMERS
- THERMAL DELAY SWITCHES
- SMOOTHING CHOKES
- POWER RESISTANCES

Made by **OLIVER PELL CONTROL LTD**

Telephone: WOOLWICH 1422-1426  
CAMBRIDGE ROW • WOOLWICH • S.E.18

**THE COIL PICK-UP**  
 Gives harmonics their True Value.  
**WILKINS & WRIGHT LTD.**  
 Holyhead Road, Birmingham 21.

**A.B. OAK**  
**wafer switches**  
 The wave-change switch with silver-plated double contacts.  
**A.B. METAL PRODUCTS LTD.,**  
 Great South-West Road, Feltham, Middx.

**TELEVISION SCANNING COILS**  
  
 Technical Publication No. 29. Post FREE  
**HAYNES RADIO LTD.,** Queensway, Enfield

**VALRADIO**  
 Vibrator Converters can be depended on for  
**TELEVISION FROM D.C.**  
 These British designed and manufactured converters give steady A.C. from 12 volts D.C. upwards. There are heavy duty types to give up to 300 watts output. Valradio Converters are quiet in use and are built for years of unflinching service.

- **MODEL 230/203 110**  
 D.C.—100-110 v. A.C.—230 v.,  
 200 watts, 50 or 75 c.p.s. **£14**
- **MODEL 230/175 21**  
 D.C.—240 v. A.C.—230 v., 150  
 watts, 50 or 75 c.p.s. **£16**

**VALRADIO LTD., 57 Fortress Rd., London, N.W.5**  
 Telephone: GULiver 5165

**WILKINSON'S OF CROYDON**  
**AMPLIFIER UNIT**, type A 3574, employing 2 5U4G, 1 6X5, 1 EF50, 2 807, 1 EA30. All useful valves well worth the price of the Unit which is 45/-.  
**RACKS**, standard 19in. 5ft., fitted with tray, only a few left, 70/- each.  
**POWER UNIT**, employing a 524G and a high voltage rectifier 8U2150A, together with a .1 mf. condenser, 2.5 kV, and other components, 15 6/-, post free.  
**TELEVISION Unit**, 21H stage, 1 detector and 1 video amplifier, complete with 4 valves, adjustable iron core'd coils, etc., brand new, only 45/-.  
**CATHODE RAY tube Unit**, type 97, with 14 valves, C.R. Tube and various condensers, resistors, etc. Our price, only 65/-, carriage paid.  
**CATHODE RAY Receiver Indicator Unit**. Brand new! Ex-U.S. Navy. Employing 40 useful valves, 2 Cathode Ray tubes, power pack, motor blower, Milliammeters, etc. The following are the valves: 13 6SN7GT, 8 6AC7, 2 6L6, 6 6BG6, 3 6VR150-30, 1 2X2, 3 6U4G, 2 6X5, 2 6H6. **SPECIAL PRICE £16/10/0.**  
**MURHEED SLOW MOTION DRIVES**, 7 6 EACH.  
**VOLTMETERS**, 0-300 volts A.C., moving iron, 2 1/2in. dial, flush type, 17/6 EACH.  
**ABKI SPARES KIT**, including 32 valves individually boxed, 18 6SH7, 6 6H6, 87193, also many useful Relays, Resistors, Condensers, and a Dynamotor with extended Spindle which will work as a powerful motor on 200/250 A.C. mains without alteration. 145 items in all, brand new, factory packed, 70/- complete.  
**CRYSTAL MULTIPLIER UNIT**, 2 to 6.67 Mc/s in 3-switch steps, 807 Oscillator and tuning control. Brand new with spare 807 valve, instruction books, etc. 55/- EACH.  
**RF AMPLIFIER**, 100/124 Mc/s for 2VT62 Triodes in push, pull, standard 19in. rack mounting, easily modified for 144 Mc/s. Brand new 75/-  
 List 2/6.  
**L. WILKINSON, 204, Lower Addiscombe Road, CROYDON.**

**Index to Advertisers**

	PAGE		PAGE		PAGE
A.B. Metal Products Ltd.	12	Ferranti, Ltd.	19	Premier Radio Co.	29
Acousticon Mfg. Co., Ltd.	32	Film Industries, Ltd.	75	Radford Crystal Co., Ltd.	66
Acrop Electric Tool Mfg. Co., Ltd.	32	Fluxite, Ltd.	71	Radford, A. H.	64
Adcola Products, Ltd.	41	Fox, P. X., Ltd.	46	Radio-Electronics, Ltd.	70
Aerialite, Ltd.	24	Frith Radiocraft, Ltd.	26	Radiomart (B'ham), Ltd.	18
Airmec Laboratories, Ltd.	2	Furzehill Laboratories, Ltd.	8	Radiomenders, Ltd.	70
All-Power Transformers, Ltd.	24	Galpins	63	Radiospares	66
Allan, Richard, Radio, Ltd.	57	General Electric Co., Ltd.	25	Ransony	66
Antiference, Ltd.	77	Goodmans Industries, Ltd.	35	Record Electrical Co., Ltd., The	61
Armstrong Wireless & Television Co., Ltd.	59	Grampian Reproducers, Ltd.	28	Reliance Mfg Co. (Southwark), Ltd.	54
Ashworth, H.	62	Gray, A., Ltd.	34	Reproducers & Amplifiers, Ltd.	48
Astor Boisselier & Lawrence, Ltd.	50	Hartley, H. A. Co., Ltd.	56	R.M. Electric Ltd.	14
Atkins, H. C., Laboratories	30	Haynes Radio, Ltd.	72	Rogers Developments Co.	64
Automatic Coil Winder & Electrical Equip. Co., Ltd.	3	Hazlehurst Designs, Ltd.	16	Rubber Bonders, Ltd.	15
A.W.F. Radio Products, Ltd.	67	Henley's, W. T., Telegraph Works Co., Ltd.	62	Runbakken	71
Barker, A. C.	54	Henry's	69	Salford Electrical Instruments, Ltd.	42
Belling & Lee, Ltd.	41	Hill & Churchill, Ltd.	66	Sangamo Weston, Ltd.	22
Berger, Lewis & Sons, Ltd.	46	Hivac, Ltd.	22	Savage, W. Bryan, Ltd.	67
Bird, S. S., & Sons, Ltd.	5	Holt, Stan	68	Scharf, Erwin	65
Birmingham Sound Reproducers, Ltd.	53	H.P. Radio Services, Ltd.	50	Simon Sound Service	49
Brierley, J. H. (Gramophones & Recordings), Ltd.	54	Hunt, A. H., Ltd.	2	Sobell Industries, Ltd.	42
Brighton Tele-Services	61	Industrial Electronics	16	Sound Sales Ltd.	6
Britain, Chas. (Radio), Ltd.	52	International Correspondence School, Ltd.	39	Southern Trade Services, Ltd.	38
British Institute of Engineering Technology	56	Johnson, Matthey & Co., Ltd.	9	Spears Radio, Ltd.	62
British Insulated Callender's Cables, Ltd.	70	Kolectic, Ltd.	4	Stability Radio Components, Ltd.	14
British National Radio School	58	Lasky's Radio	65	Standard Telephones & Cables, Ltd.	39
British N.S.F. Co., Ltd.	22	Leak, H. J. & Co., Ltd.	5	Steatite & Porcelain Products, Ltd.	67
British Physical Laboratories	23	Linton, H. H., & Co., Ltd.	69	Stern Radio, Ltd.	71
British Rola, Ltd.	28	Lockwood & Co.	70	Sugden, A. R. & Co. (Engineers), Ltd.	51
Brookes Crystals, Ltd.	70	Londex, Ltd.	68	Taylor Electrical Instruments, Ltd.	6
Brown, S. G., Ltd.	18	London Central Radio Stores	31	Taylor Tanniciff (Refractories), Ltd.	10
Buccleuch Radio Manufacturers	71	London Radio Supply Co.	6	Telegraph Condenser Co., Ltd.	Cover iii
Bulgin, A. F. & Co., Ltd.	79	Lowther Mfg. Co.	60	Telegraph Construction & Maintenance Co., Ltd., The	35
Bull, J. & Sons	64	Maxwells	67	Telegraph Co.	62
Bull's Ex-Govt. Depot	24	Merit Transformer Supplies	60	Thermionic Products, Ltd.	27
Bullers, Ltd.	68	McMurdo Instrument Co., Ltd.	58	Transradio, Ltd.	73
Burgoyne Eng. Co., Ltd.	47	Metro Fax, Ltd.	4	Trix Electric Co., Ltd.	Edit. 73
Candler System Co.	55	Midland Instrument Co.	60	Truxov Eng. Co., Ltd.	13
Celestion, Ltd.	36	Modern Book Co.	62	T. & C. Radio College	61
Collaro, Ltd.	20	Monochord Radio	32	United Insulator Co., Ltd.	53
Cosmocord, Ltd.	32	M.R. Supplies, Ltd.	23	Universal Electrical Instruments Corpn.	58
Couplhone Radio	62	Mullard Electronic Products, Ltd.	12	University Radio, Ltd.	68
Coventry Radio	32	Multicoore Solders, Ltd.	11	Valradio	72
Davis Supplies, Ltd., Alec	48	Murphy Radio, Ltd.	11	Vitavox, Ltd.	51
Desoutter Bros., Ltd.	21	Oliver Pell Control, Ltd.	71	Voigt Patents, Ltd.	68
Dismore, L. P.	73	Osamor Radio Products, Ltd.	50	Vortexion, Ltd.	40
Dubiller Condenser Co. (1925), Ltd.	25	Oxley Developments Co., Ltd.	71	Ward, Chas. F.	70
Duple Electronics, Ltd.	66	Painton & Co., Ltd.	18	Wayne Kerr Labs., Ltd., The	30
Edison Swan Electric Co., Ltd.	17	Parker Radio Corpn., Ltd.	52	Webb's Radio	16
Electradix Radios	57	Partridge Transformers, Ltd.	35	Westinghouse Brake & Signal Co., Ltd.	10
Electric & Musical Industries, Ltd.	26	Peerless Radio, Ltd.	69	West, Spencer	70
Electrical Sound & Television Patents, Ltd.	44	Pennine Amplifiers	56	Wharfedale Wireless Works	33
Electro Technical Assemblies	69	Phillips Electrical, Ltd.	56	Whiteley Electrical Radio Co., Ltd.	30
Electronic Instruments, Ltd.	20	Pilco, Ltd.	52	Wilkins & Wright, Ltd.	72
Elmsleigh Radio Co.	14	Pitman, Sir Isaac & Sons, Ltd.	54	Wilkinson, L.	72
Enthoven, H. J., & Sons, Ltd.	43	Pill, G. N. & Partners	68	Wimbleton Eng. Co., Ltd.	47
Erle Factor, Ltd.	43			Wireless Instruments (Leeds), Ltd.	65
Erle, J., Ltd.	68			Wireless Supplies Unlimited	68
				Woden Transformer Co., Ltd.	25
				Wright & Weaire, Ltd.	47

Printed in Great Britain for the Publishers, HILFE and SONS LTD., Dorset House, Stamford Street, London, S.E.1, by THE CROWN WALL PRESS LTD., Paris Garden, Stamford Street, London, S.E.1. "Wireless World" can be obtained abroad from the following—AUSTRALIA and NEW ZEALAND: Gordon & Gotch, Ltd. INDIA: A. H. Wheeler & Co. CANADA: Imperial News Co., Gordon & Gotch, Ltd. SOUTH AFRICA: Central News Agency, Ltd.; WILLIAM DREWSON & SONS (S.A.), Ltd. UNITED STATES: The International News Co.

As a  
SERVICE ENGINEER

**I don't take risks . . .**

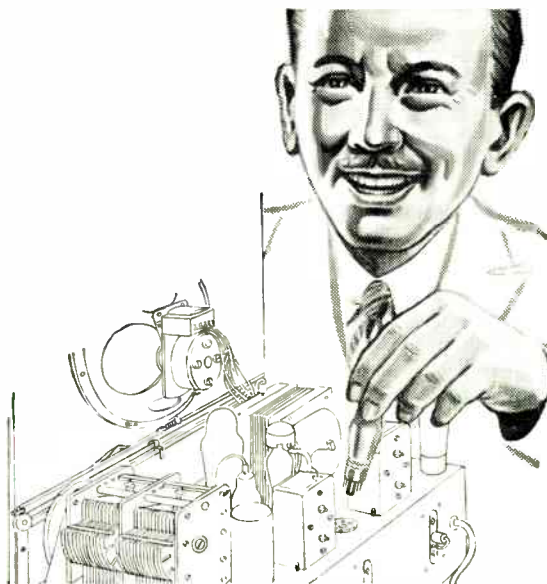

I know what the customer wants . . . not only a rejuvenation of his set's original quality and "punch", but he wants the certainty that it will be maintained for a good long time. In other words, he wants reliability in addition to a good job.

Reliability is a question largely of dependable components. That's why I pin my faith to T.C.C. where condensers are concerned. Their range is so wide that I can find a T.C.C. for every conceivable need. Their catalogue is so clearly set out that I can find the right condenser for the job without loss of time.

Moreover, I know from long experience that I can depend unquestionably on T.C.C. condensers to live up to their rated standards for a good long life free from trouble and uncertainties.

**I don't take risks**

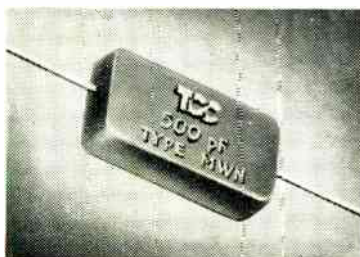

*A TYPICAL EXAMPLE FROM THE T.C.C. RANGE*

*T.C.C. Moulded Mica Condensers have been familiar to Service men since the early days of radio. They are practically indestructible and outlast the life of most apparatus. Send for literature giving details of these and other types of T.C.C. Condensers.*

IN THE BEST SETS YOU'LL SEE



**THE TELEGRAPH CONDENSER CO. LTD.**

RADIO DIVISION

NORTH ACTON · LONDON · W. 3

Telephone. ACORN 0061



WHY ERSIN MULTICORE SOLDER IS USED IN THE MANUFACTURE OF

# Television Receivers

THERE ARE AT LEAST TEN TIMES AS MANY OPPORTUNITIES FOR

*bad*

JOINTS IN TELEVISION ASSEMBLIES AS THERE ARE IN RADIO SETS. AVOID H.R. TROUBLE AND GET CONSISTENTLY

*good*

SOLDERING JOINTS WITH

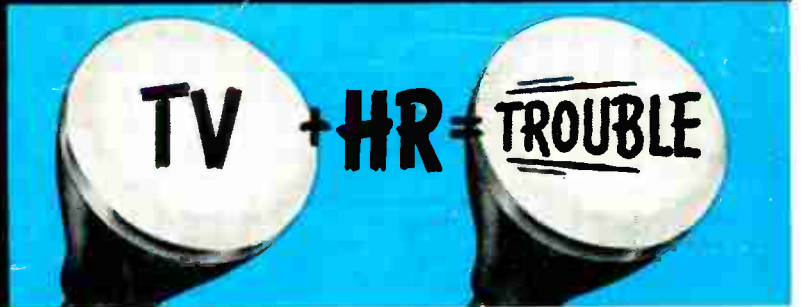

Television receivers contain from ten to fifteen times as many connections as ordinary radio sets. That means that there are at least ten times as many places where H.R. connections may occur through dry joints. H.R. joints can only be avoided by the use of Ersin Multicore Solder and correct soldering technique—that is why it is used by *all* the manufacturers of television receivers.

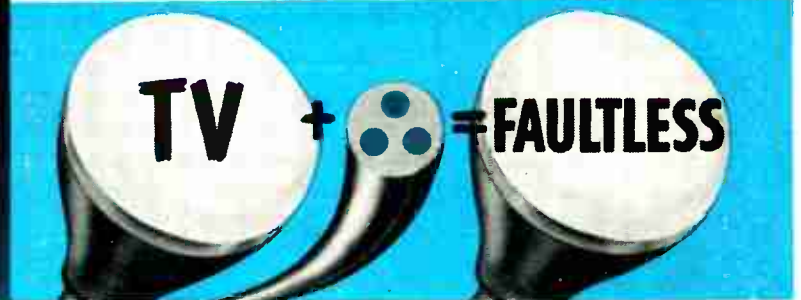

For servicing television and radio it must pay you to use only Ersin Multicore Solder—The Finest Cored Solder in the World. Size I cartons are available in the specifications shown below. Ersin Multicore Solder is supplied to manufacturers on 7-lb. reels. Quantity rates on application.



**ERSIN**  
*Multicore*  
**THREE CORE SOLDER WIRE**

MADE WITH NON-CORROSIVE EXTRA-ACTIVE ERSIN FLUX

**MULTICORE SOLDERS LTD.**  
MILLER HOUSE, ALBEMARLE STREET  
LONDON, W.1 Tel: REgent 1411

Catalogue Ref. No.	Alloy Tin/Lead	S.W.G.	Approx. length per carton	List price per carton (subject)
C 16014	60/40	14	32 feet	6 0
C 16018	60/40	18	84 feet	6 9
C 14013	40/60	13	20 feet	4 10
C 14016	40/60	16	44 feet	5 3