

Wireless World

RADIO AND ELECTRONICS



MAY 1948

1/6

Vol. LIV. No. 5

IN THIS
ISSUE:

BUILDING AN OSCILLOSCOPE



Interference?

*never heard
of it!*

Never had your favourite programmes spoilt by a background of hissing, crackling and spluttering noises? No? Lucky you! But for thousands living in towns and cities near industrial electrical apparatus, near trolley-bus routes or in the vicinity of high-frequency equipment such interference is only too common.



B.I. Callender's Anti-Interference Aerial when properly erected, will give you better listening and reveal many stations you never heard before.

The aerial is a 60ft. polyethylene insulated dipole type with suspension insulator and matching transformer. The 80ft. down lead is a fully screened coaxial cable with polyethylene plugs moulded to each end; it is matched to the receiver by a transformer with easily fixed suction mounting.

It acts as a "T" type aerial on long and medium waves and as a true dipole on short waves.

Write to-day for descriptive folder No. 221S on "Anti-Interference Aerial."

Licensed under Amy Aceves & King, Inc. Patents Nos. 413917, 424239, and 491220.



All-Wave
ANTI-INTERFERENCE

AERIAL

BRITISH INSULATED CALLENDER'S CABLES LIMITED
NORFOLK HOUSE, NORFOLK STREET, LONDON, W.C.2

Fine Limits of Accuracy



VALVE CHARACTERISTIC METER

A comprehensive instrument built into one compact and convenient case, which will test any standard receiving or small power transmitting valve on any of its normal characteristics under conditions corresponding to any desired set of D.C. electrode voltages. A patented method enables A.C. voltages of suitable magnitude to be used throughout the Tester, thus eliminating the costly regulation problems associated with D.C. testing methods.

A specially developed polarised relay protects the instrument against misuse or incorrect adjustment. This relay also affords a high measure of protection to the valve under test. Successive settings of the Main Selector Switch enable the following to be determined:—

Complete Valve Characteristics including I_a/V_g , I_a/V_a , I_s/V_g , I_s/V_a , Amplification Factor, Anode A.C. Resistance, 4 ranges of Mutual Conductance covering mA/V figures up to 25 mA/V at bias values up to -50V., together with "Good/Bad" comparison test on coloured scale against rated figures.

"Gas" test for indicating presence and magnitude of grid current, inter-electrode insulation hot and cold directly indicated in megohms, separate cathode-to-heater insulation with valve hot. Tests Rectifying and Signal Diode Valves under reservoir load conditions, and covers all the heater voltages up to 126 volts.

The AUTOMATIC COIL WINDER & ELECTRICAL EQUIPMENT CO., LTD.
WINDER HOUSE, DOUGLAS STREET, LONDON, S.W.1. Phone: VICTORIA 3404-9

Avo Precision Electrical Testing Instruments

**10 to
310
mcs.**

Light Weight
36 lbs.

Negligible
Stray Field.

Frequency
Calibration 1%

Modulation
30% sine wave
1,000~ and
pulsed 50/50
square wave
at 1,000~.

Attenuation
Max. error at
300 mcs. ± 2 dB

Precision
Slow-Motion
Dial.

Wide Range,
10-310 mcs.

Compact
12½ in. x 13½ in.
x 7½ in.

Dual-Power
Supply
200-250v., 40-100
80-v., 40-2000~

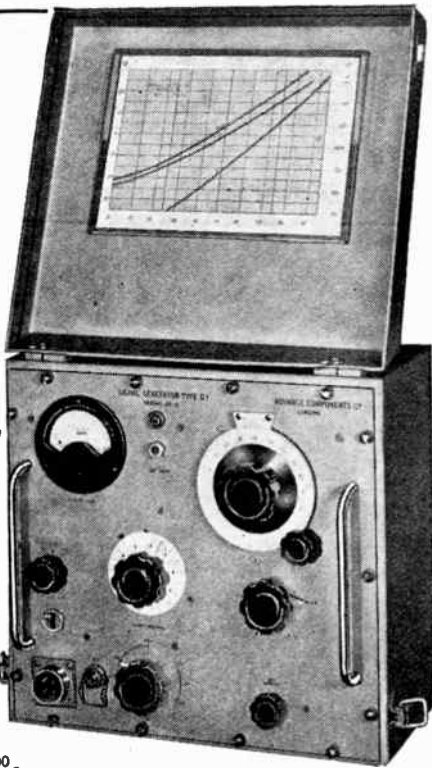

"Advance" Signal Generator type D.1.

This "ADVANCE" Signal Generator is of entirely new design and embodies many novel constructional features. It is compact in size, light in weight, and can be operated either from A.C. Power Supply or low-voltage high-frequency supplies.

An RL18 valve is employed as a colpitts oscillator, which may be Plate modulated by a 1,000-cycle sine wave oscillator, or grid modulated by a 50/50 square wave. Both types of modulation are internal, and selected by a switch. The oscillator section is triple shielded and external stray magnetic and electrostatic fields are negligible. Six coils are used to cover the range, and they are mounted in a coil turret of special design. The output from the R.F. oscillator is fed to an inductive slide wire, where it is monitored by an EA50 diode. The slide wire feeds a 75-ohm 5-step decade attenuator of new design. The output voltage is taken from the end of a 75-ohm matched transmission line.

The instrument is totally enclosed in a grey enamelled steel case with a detachable hinged lid for use during transport.

Price £80

Delivery ex Stock.

Write for descriptive Leaflet.

ADVANCE COMPONENTS, LTD.
BACK ROAD, SHERNHALL STREET,
WALTHAMSTOW, LONDON, E.17.

Telephone: Larkwood 4366-7.

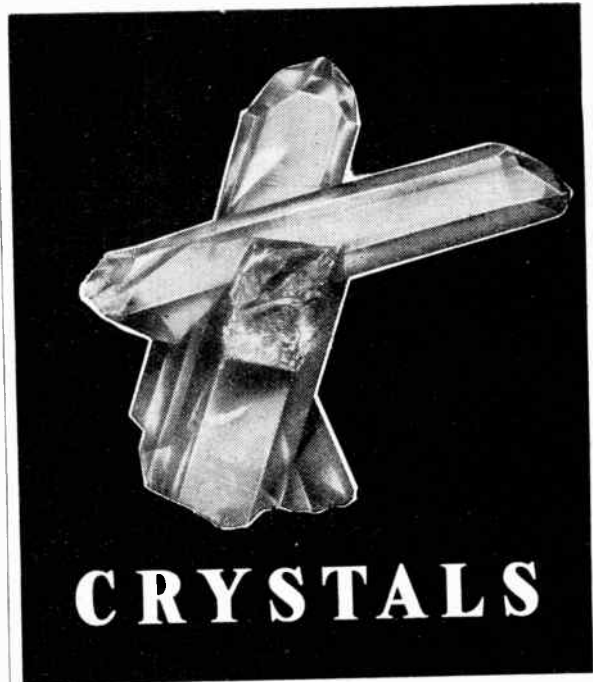

MARCONI QUARTZ CRYSTALS are made to satisfy the highest possible standards because nothing but the highest standards satisfy the designers of Marconi equipment.

Mounted in an evacuated glass envelope, with a Type B7G base, Marconi Crystals can now be supplied to all Manufacturers in the following ranges:—

75-150 kc/s

200-500 kc/s

2-15 Mc/s

12-35 Mc/s (overtone plates)

Frequency Tolerance . . .01% normal

.005% maximum

Temperature Coefficient . . . 2 parts in 10^8 per degree C.

Enquiries are also invited for other types to suit specific requirements.

Marconi

MARCONI'S WIRELESS TELEGRAPH COMPANY LIMITED
(DEPT. B.), MARCONI HOUSE, CHELMSFORD, ESSEX

MAZDA for Dependability

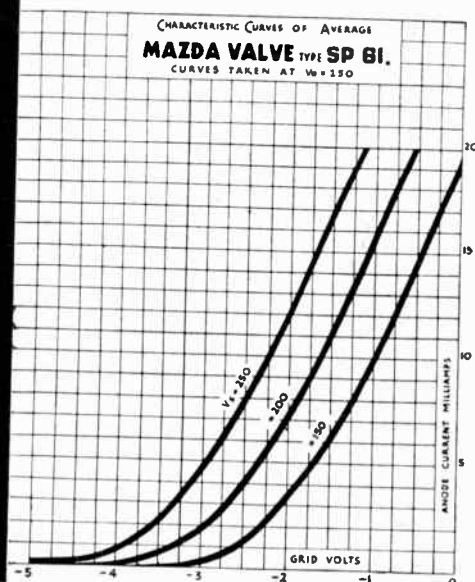
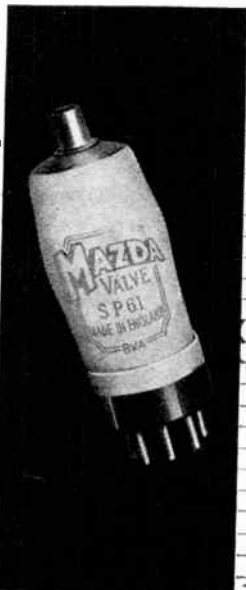
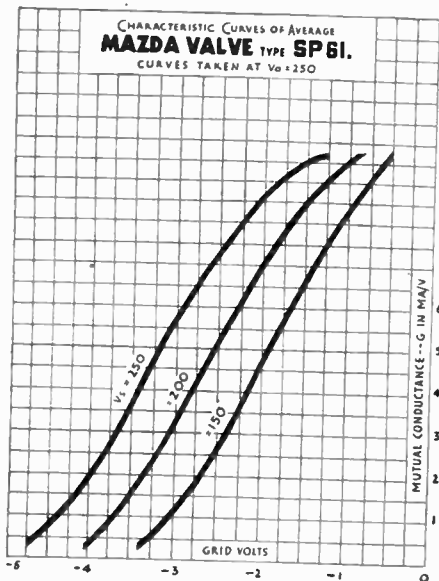

SP.61

A.C. MAINS H.F. PENTODE

BASINGS

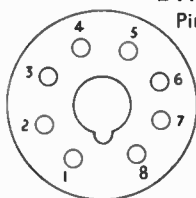

- Pin No. 1. Heater.
- 2. Cathode.
- 3. Anode.
- 4. Screen.
- 5. Suppressor Grid.
- 6. Metallising.
- 7. Omitted.
- 8. Heater.

Top Cap. Control Grid.
Viewed from the free end of the base.

RATING

Heater Voltage	6.3
Heater Current (Amps.)	0.6
Maximum Anode Voltage	250
Maximum Screen Voltage	250
*Mutual Conductance (mμV)	8.5

* Taken at $V_a=200v$; $V_g 2=200v$; $V_g 1=-1.5$

TYPICAL OPERATION

Anode Voltage	200	200	250
Screen Voltage	250†	200	200
Grid Voltage	1.0	1.8	1.5
Anode Current (mA)	22†	8.5	10.9
Screen Current (mA)	5.5†	2.1	2.7
Mutual Conductance (mμV)	—	7.6	8.5
Input Capacity Working (μμF.)	—	15	15.25
Change in Input Capacity produced by biasing valve to cut-off ΔC (μμF.)	—	3.75	4.0
Self Bias Resistance (ohms)	37	170	110
Input Loss at 45 Mc. (ohms)	—	2,500	2,200

†Maximum permissible rating as Video Output valve, anode volts must not exceed 200 volts. Grid cathode circuit resistance should not appreciably exceed 5,000 ohms.

INTER-ELECTRODE CAPACITIES

*Anode to Earth	5.25 μμF.
*Grid to Earth	10.75 μμF.
Anode to Grid	0.005 μμF.

* "Earth" denotes the remaining earthy potential electrodes and metallising joined to cathode.

Price: 10/6 plus 3/5 purchase tax

MAZDA

RADIO VALVES AND CATHODE RAY TUBES

THE EDISON SWAN ELECTRIC CO. LTD., 155 CHARING CROSS ROAD, LONDON, W.C.2

R.M.58

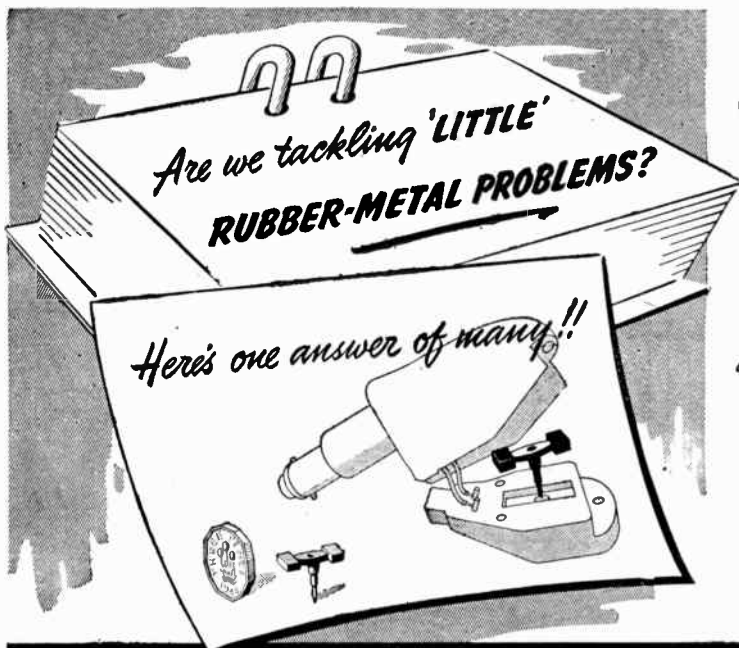

The
STYLUS UNIT
of the
NEW DECCA
firr pick-up
incorporated in the
"DECOLA"
de luxe
ELECTRIC RECORD
REPRODUCER

RUBBER BONDBERS LIMITED
FLEXILANT WORKS · DUNSTABLE · BEDS
ENGINEERS IN RUBBER BONDED TO METAL
TELEPHONE: DUNSTABLE 803-4-5

RB 50

E.M.I. TRAINING
FOR CAREERS IN ELECTRONICS

An E.M.I. correspondence course, brings students into direct contact with scientists of Britain's Largest Electronic organisation.

BASIC RADIO or } for { City and Guilds
BASIC TELEVISION } for { Telecom. Finals.
A.M. Brit. I.R.E.

(Ready this Autumn)

Intermediate Maths. } for { City and Guilds
Higher Maths. } for { Telecom. Finals.
Advanced Maths. }

Industrial Electronics

Also FULL TIME COURSES

Whatever course is chosen, the E.M.I. staff give first hand up-to-the-minute knowledge of the application of electronics to industry. Write for full details to:—



The Principal: PROFESSOR H. F. TREWMAN, M.A. (Cantab)
M.I.E.E., M.I.Mech.E., M.Brit.I.R.E.

E.M.I. INSTITUTES LTD
Dept. 16, 43, Grove Park Rd., London, W.4

E.58a

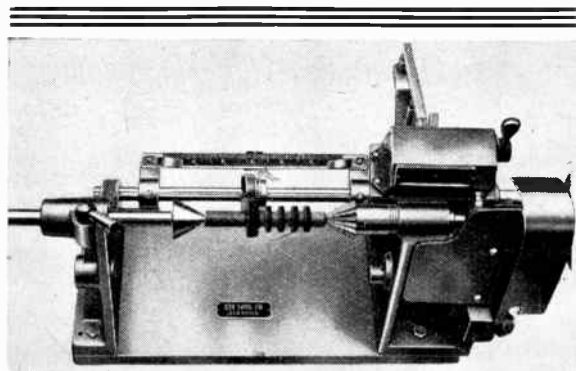

MODEL WX

**AUTOMATIC
COIL WINDING
MACHINES**

FOR PILE OR WEAVE WOUND COILS

Particulars of this new improved model and other machines on application.

ETA TOOL CO
(LEICESTER) LTD.

16½ METCALF STREET, LEICESTER.

'Phone—5386.

Condenser sealing—

*a
New technique*

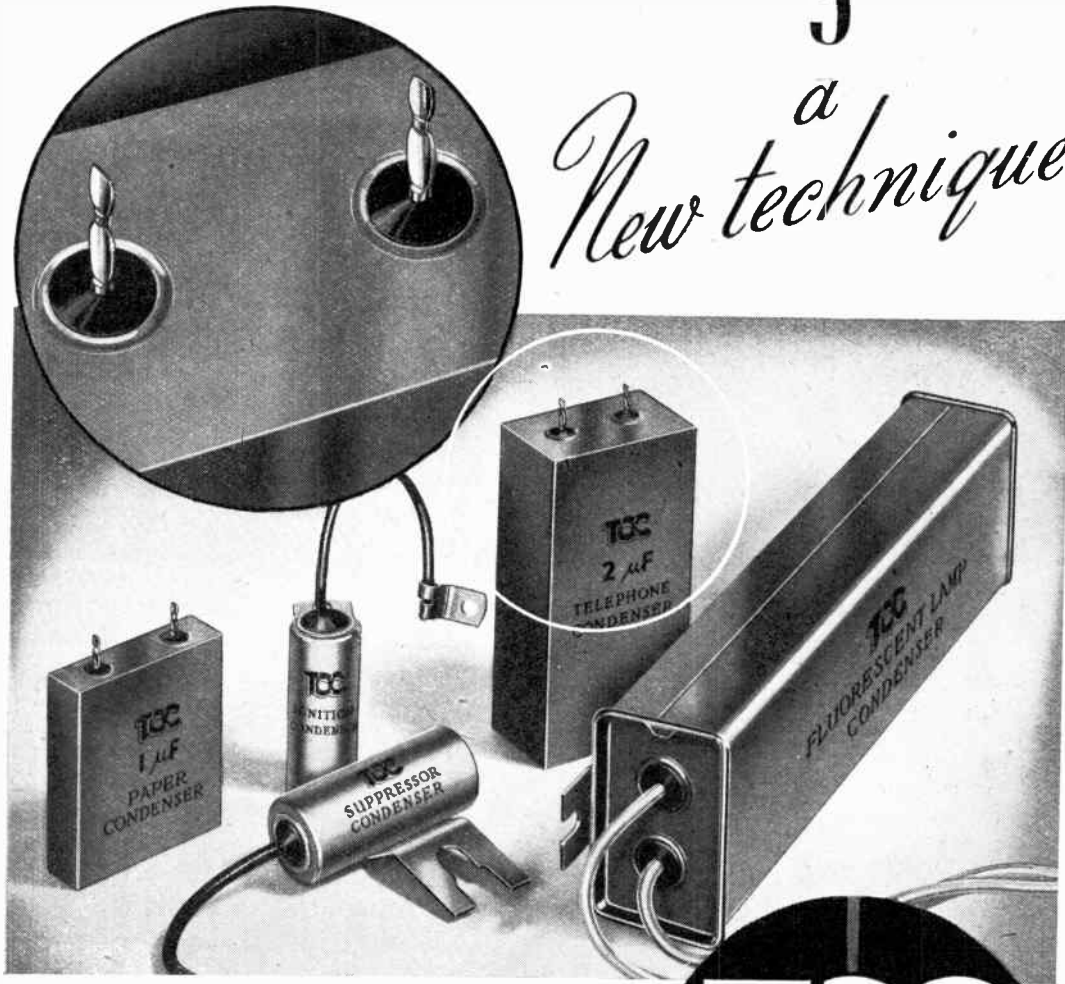

Pioneers of the familiar bakelite terminal method of sealing condensers, T.C.C. have now developed a new method of complete hermetic sealing by means of Neoprene bungs through which are brought soldering wires tags or insulated flexible leads. Typical types of condensers to which this construction is applicable are illustrated above. Obvious applications are paper condensers for telephones, fluorescent lighting, ignition, interference suppression, flash photo-graphy, etc., etc. Considerable economies are made possible by the use of this technique, and we shall be pleased to put forward designs and prices against enquiries where quantity production is warranted.

PATENTS AND REGISTERED DESIGNS PENDING



THE TELEGRAPH CONDENSER CO., LTD.

INDUSTRIAL DIVISION

NORTH ACTON · LONDON · W·3

Telephone ACORN 0061



The Type 1684 series of Oscilloscopes is already well known. The new Model retains the desirable features of this series—d.c. shift controls, response flat to video frequencies, d.c. coupled symmetrical amplifiers on both axes, fully-automatic synchronisation of the time base, etc. but incorporates many new features of design, both electrical and mechanical. 1648 D has, in fact, been accorded an enthusiastic reception and despite steadily mounting orders, a three-fold increase in production is enabling reasonable deliveries to be maintained.

PRINCIPAL FEATURES

- ★ TUBE 3½ in. diam. Blue, green or delay screen.
- ★ AMPLIFIERS. D.C. to 3 Mc/s., 18 mV. r.m.s. per cm. or D.C. to 1 Mc/s., 6 mV per cm. Symmetrical or asymmetrical input. X and Y amplifiers are similar.
- ★ TIME BASE. 0.2 c/s to 150 kc/s. Variable through X amplifier 0.2 to 5 screen diameters.
- ★ ACCESSORIES. Camera, telescopic light shield, ruled graticule.



Fitzhugh LABORATORIES LTD
 BOREHAM WOOD, HERTS
 Telephone: ELSTREE 1137

Ahead of all others!



TYPE "K."

S. G. BROWN, Type 'K' Moving Coil Headphones, with the following outstanding characteristics, supply that High Fidelity Reproduction demanded for DX work, monitoring and laboratory purposes, etc.

NOTE THESE CHARACTERISTICS.
D.O. RESISTANCE, 47 Ohms.
IMPEDANCE, 52 Ohms at 1,000 c.p.s.
SENSITIVITY, 1.2 x 10⁻¹³ Watts at 1 kc.—.0002 Dyne/cm².

Descriptive Literature on request.

PRICE £5.5.0 PER PAIR.

Supplies now available.

Order from your Local Dealer.

For details of other S. G. Brown Headphones (prices from 30/- to 63/-) ask for illustrated Brochure "W.W."

HEADPHONES WHICH UPHOLD BRITISH PRESTIGE.

Phone ACOrn 5021.

S. G. Brown, Ltd.

VICTORIA RD., NORTH ACTON, LONDON, W.3

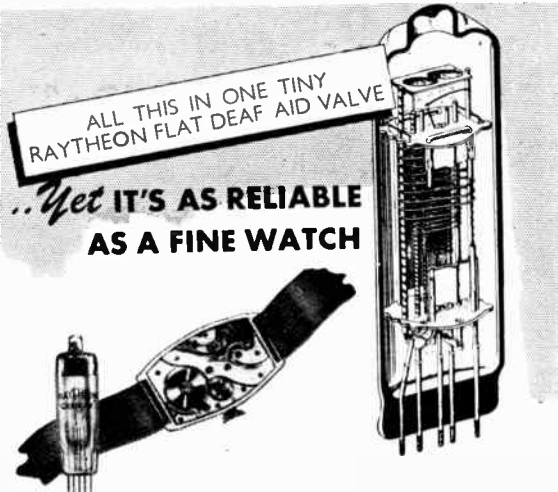

Here is the Raytheon valve that is the heart of almost every Deaf Aid in use today. . . . In spite of the complex construction within this tiny tube, Raytheon's unique precision-electronic assembly methods have resulted in

valves so uniform and dependable that the Deaf Aid user no longer gives them a thought. . . . Is it any wonder that Deaf Aid makers and users rely so universally on valves bearing the name RAYTHEON?

For detailed information on Raytheon Deaf Aid Valves write to Submarine Signal Company (London) Ltd., Artillery House, Artillery Row, London, S.W.1, England, or to:



RAYTHEON MANUFACTURING COMPANY
 INTERNATIONAL DIVISION
 60 EAST 42nd STREET
 NEW YORK 17, N. Y., U. S. A.

Excellence in Electronics



FORTHCOMING PRODUCTIONS

"Monobolt" speakers, the first of the new Truvox radio range, are now available from all radio dealers. Quality enthusiasts, and all those who want "the best," will welcome this news. If you require fuller details than are given below—a postcard will bring them.

Model BX 50	5in.	8,500 lines	£1 1 0
Model BX 52	5in.	10,000 lines	£1 4 6
Model BX 60	6½in.	8,500 lines	£1 2 6
Model BX 62	6½in.	10,000 lines	£1 6 0
Model BX 80	8in.	8,000 lines	£1 4 0
Model BX 82	8in.	10,500 lines	£1 10 0
Model BX 100	10in.	8,000 lines	£1 10 0
Model BX 102	10in.	10,500 lines	£1 17 6

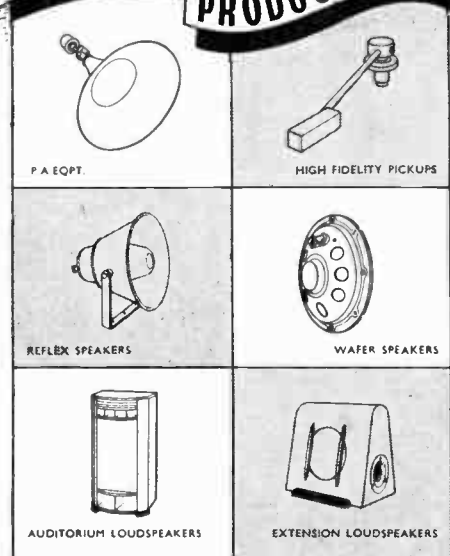

New products, as illustrated above, are well under way. Full details will be announced as they become available.

TRUVOX

TRUVOX ENGINEERING CO., LTD., EXHIBITION GROUNDS, WEMBLEY, MIDDLESEX.



THE COMPLETE SERVICE FOR SOUND RECORDING AND REPRODUCTION

- ★ Mobile, static and specialised recording units.
- ★ Complete Wire Recorders, Recording and Wipe-off Units.
- ★ Recording Amplifiers.
- ★ Moving Coil and Crystal Microphones.
- ★ Sapphire cutting and reproducing stylii.
- ★ Blank recording discs from 5in. to 17in. Single or Double sided.
- ★ Lightweight, moving iron, permanent sapphire and moving coil pick-ups.
- ★ A comprehensive range of accessories to meet every requirement of the sound recording engineer.
- ★★ And our latest development (of special interest to users of sapphire and delicate pick-ups)—THE SIMTROL. This is a controlled micro-movement easily fitted for use with any type of pick-up.



Portable Dual Channel
Recording and Replay Outfit.

OUR WELL-EQUIPPED WORKSHOPS ARE AVAILABLE FOR
THE DEVELOPMENT OF EQUIPMENT TO MEET SPECIAL NEEDS.

SIMON SOUND SERVICE, Recorder House, 48/50, George St., Portman Square, London, W.1.

CABLES: Simsale, London.

TELEGRAMS: Simsale, Wesdo, London.

TELEPHONE: Welbeck 2371/2.

B. I. F.
See our Stand
H 57
OLYMPIA

M. R. SUPPLIES Ltd.

offer only selected and brand new material which is sure to give complete satisfaction. All orders handled with the utmost diligence and despatch. All prices nett.

ROTHERMEL AMPLIFIERS. Very special exclusive offer of two currently listed models at attractive prices. Operation 220/240 v. A.C. Model VR/2, output 5 watts (two 42 valves in p.p.) inputs for crystal mic. and any pickup, with switch-over. Output matched to 2/4 ohms. Open chassis style, size 12in. by 7in. by 6in. Complete with 5 valves, ready for use. (List £25), limited number at £12/15/- (despatch 5/-). Also Model HG/304, output 9 watts (two EL33 in push-pull). Inputs for crystal mic. and any pickup with electronic mixing and tone controls. Output matched to 24, 5, 7 1/2, 15 and 500 ohms. Overall gain 113 db. Response within 2 db from 50 to 10,000 c/s. In crystalline finished steel cabinet 11 1/2in. by 7 1/2in. by 6 1/2in. Complete with 5 valves, ready for use. (List £35), limited number at £21 (des. 5/-).

D.C./A.C. CONVERTERS, the new efficient Vibrator type, fully smoothed and filtered for all wave-lengths. 200/240 v. D.C. to 200/240 v. 50 c., 100 watts, £9 (des. 2/-) 200 watt, £14 (des. p. tram 3/6) NOTE:—For television we recommend the 200 watt 75 cycle model at £14, many already in use. **ROTARY CONVERTERS** (ex Admiralty) input 100/110 v. D.C. Output 230 v. 50 c., rated at 200 watts but capable of 750 watts duty. Fully enclosed, 19in. by 11 1/2in. by 9in. Weight approx. 100 lbs., £10 carr. pd.

ANODE CONVERTERS (Rotary Transformers). This is the really useful one. Input 12 v. D.C., output 250 v. 125 m.a. D.C. Ideal for mobile radio and small amplifiers, etc. In makers' cartons, 19/6.

PIEZO-ELECTRIC HEADPHONES. (Rothermel) Exceptional limited offer. With adjustable headbands. Response 60/10,000 c/s. Weight 8 oz. Used in normal way. Each complete is a perfect piezo-crystal microphone without alteration. (List £3/10/-) A few brand new pairs at 32/6.

BATTERY CHARGERS. (Ex Air Ministry). Operation 200/250 v. A.C. Output 5 amps. at 15 v. D.C. Metal (STO) Rectified, fitted sliding resistance, 0/6 ammeter, fuse, lead, etc., ready for use. For charging all batteries 2 to 12 volts and ideal for garage. In steel housing 15in. by 13in. by 7in., with wall mounting lugs, £7/15/- (des. 5/-).

P.A. SPEAKERS. Exceptional offer of 8 watt Pressure Units, P.M. M/Coil, with standard P.A. thread to suit all types of horn. 15 ohms imp. Best makers, 57/6. (These can also be used as "tweeters.") Reflected Horn Speakers complete with 10 watt P.M. M/Coil Pressure Unit (15 ohms), Flare 12in. long, 1 1/2in. dia. On swivel mount with pillar, £7/12/6. Steel Tripods for these and all other P.A. Speakers, extending to 12ft., substantially made and rigid under all conditions, 55/- (des. 2/6).

HIGH-FIDELITY SPEAKERS. We confidently recommend these two very satisfactory speakers. Dia. 12in. imp. 15 ohms. The new B.T.H. "R.K." P.M. m/coil with paracourve cone, £6/15/- (des. 2/6). The new Gramspan model 3612/15, £6/10/- (des. 2/6). Of the smaller models we consider the Gramspan G.12 the best proposition. Dia. 9in., handling 7 watts, imp. 9 ohms or 15 ohms (please state which). Response 50/10,000 c/s, 40/-.

SMALL UNIVERSAL L.V. MOTORS. 12/24 v. A.C./D.C. Length 2 1/2in., d.s. 2 1/2in., 1/2in. shaft. Many uses in lab. and home, 15/-, Suitable step-down mains Transformers, pair: 200/240 v. Sec. 22 v. 2 amps, £2/6.

SYNCHRONOUS ELECTRIC CLOCK MOVEMENTS. 200/250 v. 50 c. Fitted spindles for hours, min. and sec. Centre-brush fitting. With dust cover and hex, the perfect movement for the home constructor, 37/6.

POWERFUL SOLENOIDS. Operation 24v. D.C., fitted Bowden lead arranged for approx. 1in. pull of about 20 lbs., 15/-.

V.H.F. SIGNAL GENERATORS, (Marconi and others) Model TF390 (various). A selection for sellers only. Range 1.5 to 300 mc/s. Tested, perfect. Prices from £25 to £55. (Please include sufficient for despatch).

M. R. SUPPLIES Ltd., 68, New Oxford Street, London, W.C.1

Telephone: MUSUeum 2958

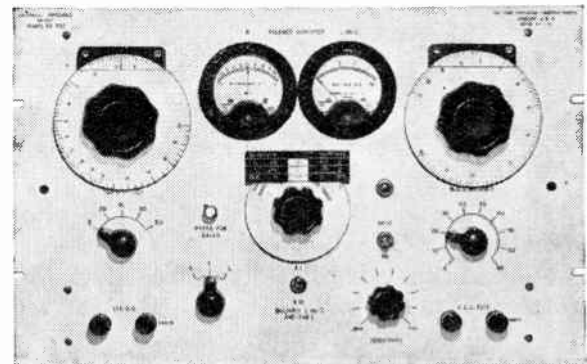

UNIVERSAL IMPEDANCE BRIDGE

MODEL UB 202

This is a self contained universal bridge which measures resistance at DC, Capacity and Inductance at 1000 Cycles. The necessary bridge voltage and null detectors are incorporated in the instrument. Measurements in condensers can be carried out with applied polarising voltage and inductances can be measured with superimposed DC.

Resistance Range .01 ohm to 1 megohm
Capacity Range 10 pf. to 1000 mFds.
Inductance Range 10 μ H. to 1000 Henries

For particulars of this and our full range
of measuring instruments write to:—

BRITISH PHYSICAL LABORATORIES
HOUSEBOAT WORKS, RADLETT, HERTS

Telephone: Radlett 5674-5-6

NITROGOL *Capacitors*

THE STANDARD OF TECHNICAL EXCELLENCE, QUALITY AND RELIABILITY

The most modern development in Paper Dielectric Capacitors. Subjected to a new and highly specialised process, with extended foil construction and a mineral base impregnant, they have low power factor, low inductance, uniformity of dielectric and small temperature gradient.

They withstand diversity of temperature, humidity and vibration, making them suitable for use in the most arduous conditions

Manufactured in rectangular metal containers for all normal purposes and in shallow containers for under-chassis mounting, they are fitted with ceramic terminals.

Special cylindrical and rectangular designs are available for Television and other small-ripple high-tension applications.

MAKERS OF THE WORLD'S FINEST CAPACITORS



DUBILIER

CONDENSER CO. (1925) LTD.

B. I. F. STAND No. H.45.

EMPIRE HALL, OLYMPIA.

DUBILIER CONDENSER CO. (1925) LTD., DUCON WORKS, VICTORIA ROAD, NORTH ACTON, W.3
 Phone : Acorn 2241. Grams : Hivoltcon, Phone, London. Cables : Hivoltcon, London. Marconi International Code. D6.

Measuring Instruments by PULLIN



For every need of consistently accurate electrical measurement, there is a Pullin Instrument.

- Miniature ● Industrial ● Portable
- Laboratory Pattern ● Single or Multi-range

Send your instrumentation problems to us.



MEASURING INSTRUMENTS (PULLIN) LTD

Address all enquiries to Dept. J, Electric Works,
Winchester Street, Acton, London, W.3. Telephone: Acorn 4651-4

"Cyldon"

MICA DIELECTRIC TRIMMER Capacitors



Type No. 16



Type No. 14



Type No. 16G

SYDNEY S. BIRD & Sons, Ltd.

CAMBRIDGE ARTERIAL ROAD, ENFIELD, MIDDX.
Phone: Enfield 2071-2 Grams: Capacity, Enfield.

Wharfedale

W10/CS LOUDSPEAKER



An outstanding Speaker. Level Response—Cloth Suspension—10" Die Cast Chassis—14,000 lines Magnet. Speech Coil 3 or 15 ohms.

Each Speaker with Calibrated Resonance

PRICE 140/-



RESPONSE CURVE OF W10/CS UNIT
INFINITE Baffle 20,000 C/LS UNIT CONSTANT VOLTS
LEVEL = 1 VA AT 400 MIC 1 FT ON AXIS

Made and Guaranteed by

WHARFEDALE WIRELESS WORKS

BRADFORD ROAD, IDLE, BRADFORD

Telephone: Idle 461 Telegrams: Wharfedel, Idle, Bradford

THIS LITTLE UNIT BEATS THEM ALL!



The Hadley **MULTICOM** *for* COMPLETE INTERNAL COMMUNICATION

HADLEY engineers "scoop" the trade with this new intercom, the first of its kind to provide complete intercommunication between all points.

Secret is the new design auto-control unit, housed out of sight, which cuts the size of the desk unit down to a 6" x 4" cabinet—a marvel in miniature.

Every desk unit has direct contact with all other units while executives can have priority.

THE HADLEY INTERCOMMUNICATOR provides for two way calling and communication between master unit and any or all of the sub-stations and also incorporates the novel feature of a desk radio which can be relayed to the sub-stations.

THE HADLEY INDUSTRIAL UNIT proved to be well in advance of any similar equipment. Provides all facilities for 'Staff Location,' 'Music for the Workers,' 'Time Signals,' etc.

All Hadley Equipments are available on Cash Purchase or Rental Maintenance terms.

Trade and overseas enquiries invited. Literature on request.

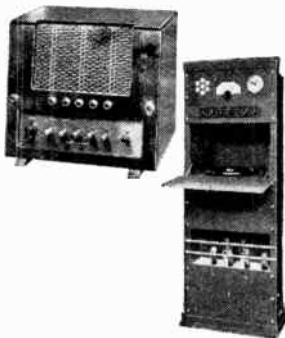

Hadley

Sound

Equipments

Phone: BEArwood 2575/6

BEARWOOD ROAD, SMETHWICK, STAFFS.

Stabilised Insulation BY MODERN IMPREGNATION METHODS

HYMEG

HIGH-SPEED PRODUCTION

Now, special methods of continuous conveyor impregnation and baking developed with the use of HYMEG have still further reduced processing times to a fraction of those previously believed necessary. Often faster than infra-red baking with none of the defects, reduced handling, absence of special jigs, with complete freedom from blistering, bubbling and porosity, are some of the advantages claimed and substantiated for HYMEG High Speed Production methods.

HYMEG Synthetic Insulating Varnishes are recognised and widely used for their mechanical rigidity, improvement of electrical properties of windings; heat, moisture, oil, acid and alkali resistance as well as for the considerably reduced stoving time necessary.

HYMEGLAS (REGD.)

GLASS FIBRE INSULATION SYSTEM

This integrated system of development is successful in enabling machines to be designed and operated without weak links in the chain of insulation below 200°C. Thus the fullest advantage is taken of modern glass fibre insulation by providing a degree of bonding and insulation at every point in which the uniting of Hymeglas impregnation with the Hymeg as used for subsidiary insulations gives a solid homogeneous winding of equally efficient characteristics and heat resistance throughout.

After much research in our laboratories and in conjunction with many well-known specialist manufacturers, we have now evolved the Hymeglas system of Insulation which comprises modifications of Hymeg as used for coil impregnation to meet the varying conditions applying to each field of manufacture.

Hymeglas therefore virtually eliminates any risk of insulation failure and enables motors and the like to operate under abnormal conditions for long periods without risk of electrical breakdown.

Due to the excellent space factor of glass fibre as compared with the more usual asbestos and mica Class B insulations, it is often possible in redesigning with the Hymeglas system to employ larger copper sections with well-known advantages.

The Berger Technical Service—the research work of which produced "HYMEG" and "HYMEGLAS" is available to advise manufacturers on all problems of insulation. Get in touch now with—

LEWIS BERGER & SONS LTD. (Est. 1760)
35, BERKELEY SQUARE, LONDON. W.1.

Telephone: MAYfair 9171.

MANUFACTURERS OF HIGH-PERFORMANCE INSULATING VARNISHES AND ENAMELS

Miniature or Midget

ACTUAL SIZE ACTUAL SIZE

30% 24%

10% 10%

XY 1.4A XW 0.75A

NEW TYPES FOR
MIDGET RECEIVERS
HEARING AIDS
METEOROLOGICAL
INSTRUMENTS
ETC.



HIVAC LIMITED Greenhill Crescent, Phone HARROW
Harrow on the Hill, Middx. O895

Radiomart 'Special Offers'

BRAND NEW HEAVY DUTY L.F. CHOKES.

Fully shrouded in cast aluminium rectangular "Pots."

	PRICE
30 Hy. 100 m/A 150 ohms (wt. 14 lbs.)... ..	20/-
20 Hy. 126 m/A 100 ohms (wt. 14 lbs.)... ..	22/6
30 Hy. 150 m/A 150 ohms (wt. 18 lbs.)... ..	25/-

(The rating on these can be increased 100 per cent. on "Ham" service.)

BRAND NEW H.V. TRANSFORMERS

Primary 115 volt, sec. 1250-0-1250 v. 200 m/A. Connect two of these in series with secondaries in parallel for 1250-0-1250 v. 400 m/A or secondaries in series for 2500-0-2500 v. 200 m/A 30/-

(INCLUDE 5/- FOR CARRIAGE ON ORDERS FOR ALL THE ABOVE.)

H.F. CHOKES, Pie wound. 250 m/A Tx. type, 1/9 each, 18/- dozen
100 m/A Rx., type 1/6 each, 15/- dozen.

Screened Valve Caps (English type), 6d. each, 4/6 dozen.

Yaxley Switches (small type), 2-pole 6-way, 2/6 each.

Tuning Condensers, small, 20 pf. double spaced, ceramic insulation, double end frames, 3/6 each.

CO-AX CABLE. Genuine 72 ohms, now reduced to: 1/2 in. dia., 1/- per yard; 1/4 in. dia., 9d. per yard.

CO-AX PLUGS for 1/2 in. dia. cable, 2/- each. Sockets for 1/2 in. plugs, 1/6 each.

CO-AX PYE PLUGS for 1/2 in. dia. cable, 9d. each. Sockets for 1/2 in. Pye Plugs, 6d. each.

RADIATOR THERMOMETERS. These make excellent backwards reading meters for "R" Meters connected in cathode or plate of L.F. Approx. 750 micro-amp movement. Price 3/- each, 30/- dozen.

Best quality Flexible Couplers, 1 1/2 in. dia. Price 1/3 each. **New G.P.O. type Relays**, 500 ohm coil 4-pole make. Price 2/6 each. **0-1 m/A Meters**, 2 1/2 in. dia. flush mounting, in desk stand, 21/- each.

15 WATT MOBILE AMPLIFIERS. 6N7, 6N7, 2 6L6's, with built-in rotary converter. For operation off 12 v. D.C. £12
Folded Horn Speakers for above £3
Carriage and packing on Amplifier or Speaker, 10/- each.

RADIOMART 48, HOLLOWAY HEAD,
BIRMINGHAM, 1
G.S.M. (HAM) LTD.

TECHNICAL TOPICS

for Amplifier designers



● **Pentode (or beam Tetrode) or Triode output.**
 With the demand for high sensitivity the popularity of an output Pentode (or beam Tetrode) has grown. OSRAM output tetrodes, in particular type KT61, are therefore widely used where the maximum sensitivity is required. Type KT66 — a larger tetrode with aligned grids — is unsurpassed in combining high sensitivity with large power output and a long reliable life performance at maximum rating. For those who demand high quality, triode output is often preferred because of its lower impedance, and not only are directly heated triodes such as types PX4 and PX25 in wide demand, but the tetrode KT66 is also eminently suitable for wiring as a triode, giving similar characteristics to those of the PX25, but with a 6.3 volt indirectly heated cathode.

TYPE	FILAMENT OR HEATER		AS TETRODE					AS TRIODES PUSH PULL PAIR		
			V _a	V _{g2}	I _a	OUTPUT POWER*		V _a	I _a	OUTPUT POWER
						SINGLE	PUSH PULL			
KT61	6.3	0.95	250	250	40	4.3	—	not recommended		
			250	250	72	—	11.5			
KT66	6.3	1.27	400	300	85	7.25	—	400	125	14.5
			400	300	136	—	35			
KT33C	26	0.3	200	200	60	5.0	—	not recommended		
			200	200	113	—	15.5	300	100	13.5
PX4	4	1.0	—	—	—	—	—	500	100	20
PX25	4	2.0	—	—	—	—	—			

* With auto-bias in every case.



The General Electric Co., Ltd., Magnet House, Kingsway, W.C.2.

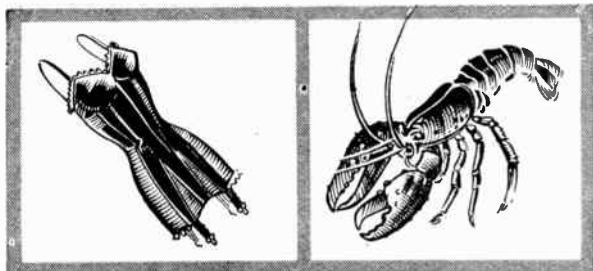

ON CONTAINERS. . .

Ever considered how important containers are to so many Industries ? Just look at these containers and imagine what would happen if there were no such things.

Dwell upon madam's temper if she was denied the exquisite pleasure of encasing her figure in armour; what indeed would be lost to the world of gourmets if lobster a la what you please vanished from the a la carte; think of all the funny tales which never would have been if bangers were just a shapeless mass and not their customary disciplined, delectable selves. Above all, think how the further progress of Electronics would have been halted if the new Parmeko Mercury series in their seamless containers had never been developed to operate under any abnormal conditions . . .

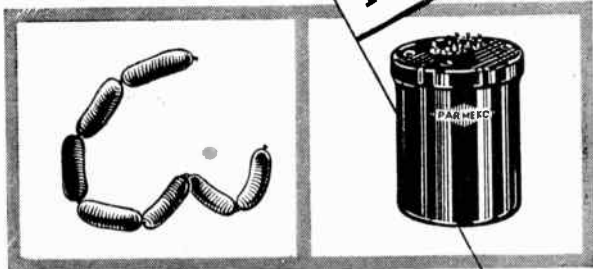
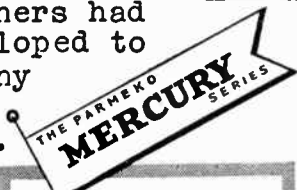

PARMEKO OF LEICESTER
Makers of Transformers.



FOR THE RADIO SERVICEMAN DEALER AND OWNER

The man who enrolls for an I.C.S. Radio Course learns radio thoroughly, completely, practically. When he earns his Diploma, he will KNOW radio. We are not content merely to teach the principles of radio, we want to show our students how to apply that training in practical, every-day radio service work. We train them to be successful.

Write to the I.C.S. Advisory Dept. stating your requirements. Our advice is free.

.....You may use this coupon.....

INTERNATIONAL CORRESPONDENCE SCHOOL Ltd.
DEPT. 38, INTERNATIONAL BUILDINGS, KINGSWAY, LONDON, W.C.2

Please explain fully about your instruction in the subject marked X.
Complete Radio Engineering Radio Service Engineers
Radio Service and Sales Advanced Short-Wave Radio
Elementary Electronics, Radar, and Radio

And the following Radio Examinations:—
British Institution of Radio Engineers
P.M.G. Certificates for Wireless Operators
City and Guilds Telecommunications
Wireless Operators and Wireless Mechanics, R.A.F.
I.C.S. students for Examinations are coached till successful.

Name..... Age.....
Address.....



"You're CERTAIN to get it at ARTHURS!"

★ **VALVES** : We have probably the largest Stock of valves in the Country.

Let us know your requirements.

AVOMETERS. NOW IN STOCK.

AVOMETER, Model 7	£19 10 0
AVOMETER, Model 40	£17 10 0
VALVE TESTER (Complete).....	£16 10 0
TEST BRIDGE	£11 0 0
AVOMINOR, Universal Model.....	£8 10 0
AVOMINOR, D.C. Model.....	£4 4 0
SIGNAL GENERATORS, A.C.....	£13 0 0

TAYLORS' METERS. COMPLETE RANGE NOW IN STOCK.

All orders sent **STAGE EQUIPMENT** Terms C.O.D.
by return of Post. **PROJECTOR LAMPS** or cash with order.

London's Oldest Leading Radio Dealers.

Arthurs EST. 1919
PROPS: ARTHUR GRAY, LTD.

Our Only Address: **Gray House, 150, Charing Cross Rd., London, W.C.2** Telephone Bar 5833/4.

ELECTRICAL, TELEVISION & RADIO ENGINEERS.

...“and you shall have music”...

Classics, Ballads, Swing or Jive—whatever your music tastes—you'll get more . . . *infinitely* more enjoyment from your records if you play them on the new Collaro “De Luxe” Microgram!

Hear your records as they were *meant* to be heard . . . enjoy the pure, mellow tone . . . the faithful, sparkling reproduction . . . as sharply defined, and as clearly recorded as your reflection in a new cut mirror! Without a doubt, the new Collaro “De Luxe” Microgram is one of the world's finest electric gramophones—and *it's portable!*

Outstanding design, first class workmanship . . . the new Collaro light-weight Crystal Pick-up . . . automatic stop . . . 6½” Speaker and handsome imitation lizard-skin case with finest chromium fittings—see it . . . admire it, but above all, ask to HEAR the Microgram at your dealer's showroom today!

Should your usual dealer not have a “DE LUXE” Microgram in stock when you call . . . just drop a line to Collaro, Ltd. for illustrated literature which describes the Microgram in detail.



RETAIL PRICES

“DE LUXE” MODEL £19 19 0
Plus Purchase Tax, £6 9 8

STANDARD MODEL £16 16 0
Plus Purchase Tax, £5 9 3

Both the “DE LUXE” and Standard Models are suitably connected for A.C. mains supply of 200-250 volts at 50/60 cycles.

The **COLLARO**
“DE LUXE”
Microgram
Portable Electric Gramophone

Trade enquiries to
COLLARO LTD., Ripple Works, By-Pass Road, Barking, Essex.

Telephone : Rippleway 3333

EDDYSTONE AND THE AMATEUR

NEW EDDYSTONE TRANSMITTING CONDENSERS

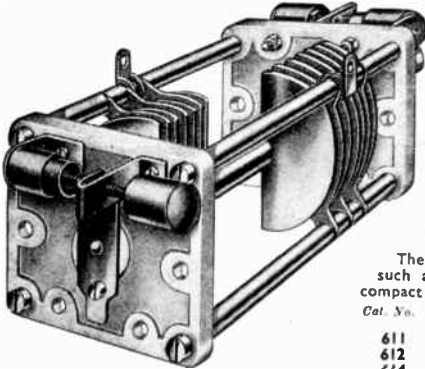

A new range of Eddystone transmitting condensers is now available for immediate delivery. A standard type of construction is employed in all three, the ceramic end plates being 2½ in. square. Losses are extremely small.

The metal mounting plates supplied provide alternative methods of fitting—either directly to a metal chassis or on small stand-off insulators. The former method is satisfactory for C.W. operation with up 1,000 D.C. anode volts or for telephony with somewhat lower anode volts. If higher voltages are employed, the second method is preferable, since the condenser is then subject to the R.F. voltages only. The rotor plates should be connected to the chassis via a .001 voltage fixed condenser.

All three are of split stator type, and are therefore suitable for balanced and push-pull circuits. By strapping the stator plates together, additional capacity values are available for use in single ended or aerial tuning circuits.

The Cat. No. 611 is particularly suitable for use with modern low capacity triodes such as the T20, 4304, and 35T. The built-in neutralising condensers enable a very compact and efficient push-pull amplifier to be constructed.

Cat. No.	Cap. per Section.	Effective Capacity as Split Stator.	As Single ended.	
611	25 pF	12.5 pF	50 pF	39/6
612	50 pF	25 pF	100 pF	32/6
614	100 pF	50 pF	200 pF	36/-

Please order from your Registered "EDDYSTONE" Retailer, as we do not supply direct.

STRATTON & Co., LTD

EDDYSTONE WORKS

WEST HEATH

BIRMINGHAM 31



DAWE

INSULATION TESTER

TYPE 402 B

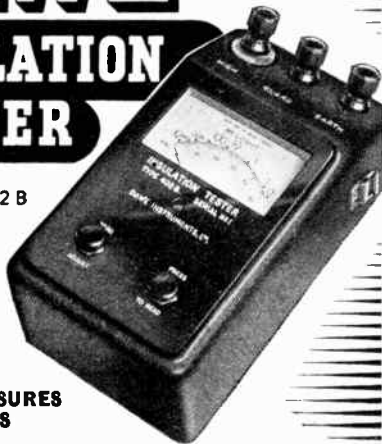

**DIRECTLY MEASURES
10,000 MEGOHMS
at low voltage.**

A compact, highly sensitive instrument for measuring Insulation Properties and Leakage Resistance without destructive breakdown; also suitable for Moisture Determinations. A guard circuit is provided for proper elimination of surface leakages.

Range: 0.1 MΩ to 10,000 MΩ :: Test Potential: Less than 50 volts.
Power supply: Self-contained dry batteries :: Size: 4½" x 7½" x 4" deep.
Technical data sent on request to: DAWE INSTRUMENTS LTD.
130, UXBRIDGE ROAD, HANWELL, LONDON, W.7 :: EALING 6215
Visit our Stand at the B.I.F. (S.I.M.A. section)

Denco - Chassis

DR 21. For A.C. mains, incorporating the well-known CT 6 Turret (see April W.W.), 5 bands, complete coverage, permeability tuned IF's.

4 valves, plus rectifier and magic eye, completely aligned and ready to switch on

(less loudspeaker) **£15 0 0**
P.T. £5 3 5

Ask your stockist for details of the Denco range of receivers or components (or write us in case of difficulty).

DENCO (CLACTON) LTD.,
OLD ROAD, CLACTON, ESSEX

LONDON CENTRAL RADIO STORES

Government Surplus—Immediate Delivery from Stock

EX-R.A.F.

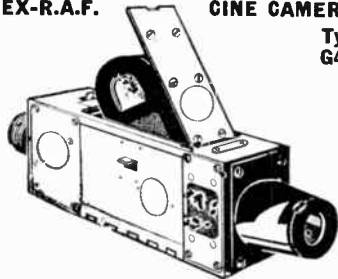

CINE CAMERA
Type
G45B

To take 16 mm. film. Fixed focus lens approx. 5 cm., $1/3.5$. The illustration shows loading chamber partly open. In metal case. Dimensions $12 \times 3\frac{1}{2} \times 2\frac{1}{2}$ ins. With 24 v. motor drive With 12 v. drive, £3. **57/6**

NEW MILNES H.T. UNITS (Everlasting)
120 v. 60 ma. Will charge from 6 v. accumulator. For Callers Only. **67/6**

WAVEMETER W1191. With frequency chart **£7**

PIVOTED FLUXMETER

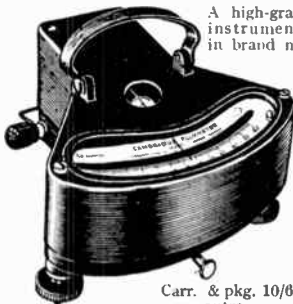

A high-grade laboratory instrument unused and in brand new condition, made by Cambridge Instrument Co. Dial reading 60-0-60. Each division equals 10,000 Maxwell Turns.

Limited Number Only.

Carr. & pkg. 10/6 extra. **£17.10.0**

7-VALVE U.H.F. RECEIVER
Type R1147A (with 4 Acorn Valves)
Range approx. 200 megacycles



A Real Opportunity!

Beautifully constructed and fitted with micro condenser drive. Valve types: two EF30, one EBC33, three 954, one 955. In black metal case, $8 \times 7 \times 6\frac{1}{2}$ in. Set complete with valves. **£27.6**
Carr. paid.

THE FAMOUS EDDYSTONE 358 COMMUNICATIONS RECEIVER

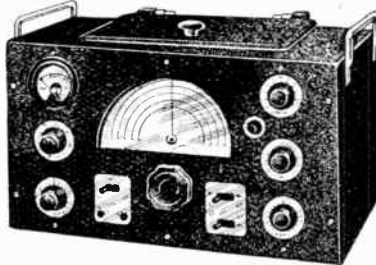

Range 31 Mc/s to 90 Kc/s, 9 Plug-in coils, 7 valves and rectifier, variable selectivity, B.F.O. stand-by switch, A.V.C. switch, band-spread dial, valve check meter. In heavy black crackle finished steel cabinet with chrome fittings. Complete with 200-250 v. A.C. Power Supply Unit. **£25**
Carriage and packing 17/6 extra.

10-VALVE COMMUNICATION RECEIVER—Type R1155

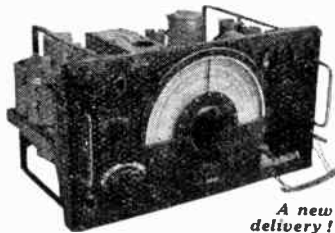

A new delivery!

These sets are as new. Need only a power pack for immediate use (see "W.W." July, 1946). Freq. range 7.5 mc/s to 75 kc/s in five wavebands. Complete with 10 valves including magic eye. Enclosed in metal case. Every receiver is aerial tested. Set only... **£12.10.0**

Complete with Power Pack and Loudspeaker, for A.C. mains, 200-250 v. **£20**
(Carr. and pkg. 10/6 extra).

FREE with each receiver! Complete circuit, description and modifications for civil use, reprinted from "W.W." July, 1946.

VISUAL UNITS

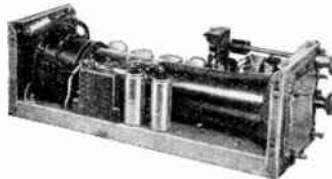

With 4in Cathode Ray Tube, two EF50 and two VR54 valves, potentiometers, etc. Complete on chassis $15 \times 5\frac{1}{2} \times 5\frac{1}{2}$ in. Carr. and pkg. 13/- extra **42/6**
10 - refunded on return of empty case.

2-VOLT POWER PACKS



Complete with Vibrator

Output approx. 200 v., 60 ma. Size $9 \times 5 \times 3\frac{1}{2}$ in.

A first-class job, complete with accumulator in carrying case **£3.7.6**

Plus 5/- carr. and pkg.

VIBRATORS. 2-v. input. Self rectifying type. Output approx. 200 v. 600 ma. **7/6**

3-VALVE R.F. AMPLIFIERS V.H.F.

Types 24 and 25

110/125Mc/s.

Complete

with valves.

In metal case

Illustration

shows unit

with case

removed.

16/6

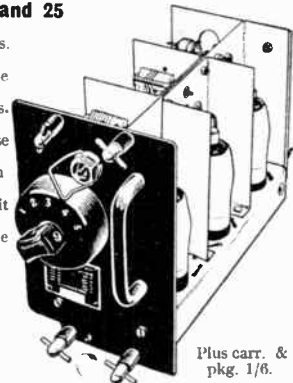

Plus carr. & pkg. 1/6.

2-VALVE BATTERY AMPLIFIERS

Type A1134



Q.P.P. output. Complete with 2-volt valves. In strong wood transit case $10\frac{1}{2} \times 8 \times 7\frac{1}{2}$ in. New bargain offer. Carr. and pkg. 2/6 extra. **21/6**

9-PIN VALVE HOLDERS. Mullard type for EF50, etc. With ceramic base. Per doz. **5/6**
Quantities supplied to Trade.

Please Note: All carriage charges relate to the British Isles only • We do not issue lists or catalogues

LONDON CENTRAL RADIO STORES, 23, LISLE ST. (GERard 2969) LONDON, W.C.2

Closed Thursday 1 p.m. Open all day Saturday and weekdays 9 a.m.—6 p.m.

Forty-Niner!



A hundred years ago communication between prospecting parties and civilization was slow, uncertain and often hazardous. Today a radio telephony link eliminates the difficulties imposed by distance, terrain and climate. Geological, seismic and other prospecting parties all over the world are specifying the 50 watts Redifon GR.49 as essential equipment. This efficient new short-wave radio telephone is very simple to operate, sturdily built and finished to withstand tropical conditions.

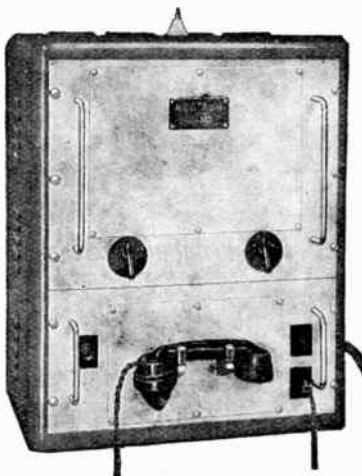

Redifon GR.49
Radio Telephone

Redifon Radio

Radio Communications Division
REDIFFUSION LTD., BROOMHILL ROAD, WANDSWORTH, S.W.18
 Designers and Manufacturers of Radio Communication and Industrial Electronic Equipment

Scientific RC 105

Fine tone RADIOGRAM from present GRAMOPHONE

easily and quickly made
IN THE HOME
 with the

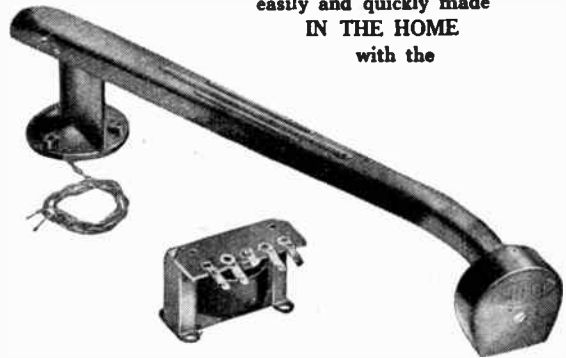

S.H.E.F.I. MOVING COIL PICK-UP

Voigt Patent No. 538058.

High fidelity without shielded transformer. No hum problem. Extreme lightness gives long record life. Complete with Transformer and full instructions. £2 plus Purchase Tax. De Luxe model now available with ball bearing suspension and spring counter-balance. £2.11.0 plus P.T.

EXPORT ENQUIRIES INVITED.

BROOKS & BOHM LTD.

90, Victoria St, London, S.W.1. Telephone: VICtoria 9550/1441

You
 get
 years of
 faultless
 service
 from...

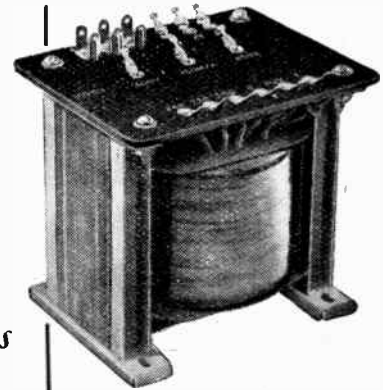

because they are :-
INDIVIDUALLY DESIGNED
RIGOROUSLY TESTED
MECHANICALLY SOUND
ELECTRICALLY PERFECT



"PURPOSE-BUILT" Savage TRANSFORMERS LTD.

51, NORTHGATE STREET, DEVIZES. Phone 536

12113A

Webb's

FOR DIVERSITY OF STOCK

EDDYSTONE MINIATURE SPEAKER No. 652.



An efficient little unit in an attractive diecast housing approximately 5 1/2 in. diameter. Particularly suitable for use with Communication Receivers and as a small extension speaker, impedance 3 ohms. Finished either ripple grey to match "640" or ripple black, both with chromium relief. PRICE £3.7.6

WEBB'S HEAVY DUTY OPERATING KEY.

The experienced operator will appreciate the perfect balance of this well made "G.P.O. pattern" key. Heavy lacquered brass movement with back and front contacts.

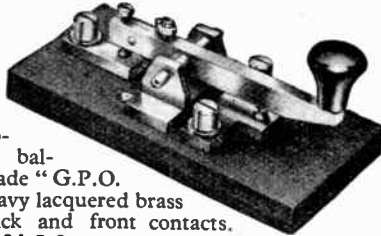

PRICE £1.8.6

EDDYSTONE SEMI-AUTOMATIC MORSE KEY.



PRICE £3.17.6

At long last we have a British made "bug" key, capable of high speed and easy adjustment. It is totally enclosed in a streamlined diecast housing, with rubber feet on rubber base. No. 689.



EDDYSTONE '640'

COMMUNICATIONS RECEIVER

An efficient general purpose short-wave receiver, designed to meet the exacting requirements of Amateur-Band Communications.

- Coverage 31 to 1.7 Mc/s.
- Electrical Band-spread throughout range.
- Eight Valves (plus rectifier).
- One R.F. and Two I.F. Stages.
- Efficient Noise-limiter.
- 10, 20, 40, 80 and 160 metre Amateur Bands calibrated.
- Beat Frequency Oscillator.
- Fly-wheel Control on Band-spread.
- Vacuum mounted Crystal filter.
- Adaptor for Battery Operation.

The "640" has outstanding signal/noise ratio and extremely good image rejection.

PRICE £39.10.0 (NO PURCHASE TAX).
AVAILABLE FROM STOCK AT WEBB'S.

EDDYSTONE "S" METER No. 699 is also now available, complete with cable for plugging into Receiver.

PRICE £5.5.0

EX-SERVICE MATERIAL

We are not "Surplus Dealers" and we are not normally very enthusiastic about surplus service equipment. The Crystal Calibrated Wavemeter detailed below and the Panel Mounting Meters constitute something of special interest.

WEBB'S TYPE "D2" CALIBRATED WAVEMETER.
This is essentially a Crystal Calibrator giving markers at every 100 kc/s and also discriminating markers at 1,000 Kc/s, combined with continuous calibration on dial-scale reading single kilocycles between each 100 Kc/s. It is applicable for both Receiver calibration or Transmitting monitoring and for the latter purpose a telephone jack is incorporated. It is exceptionally well made with such details as temperature compensating Condensers, and separate 100 Kc/s and 1,000 Kc/s Crystals, which feature gives a greater accuracy and reliability than the dual type Crystal. Incidentally the Crystals alone would cost more than our price. Contained in neat metal case with hinged top lid, overall size 7 1/2 in. x 7 1/2 in. x 6 1/2 in. high, and with stout outer wooden case for rough transport use. Each instrument has been tested and adapted by Webb's for either operation of 6.2 volts A.C. or 6 volts battery. The Wavemeter comes to you ready for immediate operation from 6.2 volts A.C. with easy internal provision for changeover to 6 volts D.C. The original Army Service Manual of 26 pages, with full circuit diagram is included, also a copy of Webb's "Simplified Instructions."

PRICE £6.17.6

WEBB'S "D2T" TRANSFORMER for external connection from 210, 230, 250 volts A.C. PRICE 14/-

METERS New and Individually Cartoned in makers boxes. Ex-Government stock at a fraction of to-day's prices.

FLUSH-MOUNTING External Flange 2 1/2 in. SQUARE Fixing Hole Round 2 1/2 in. diameter :-

- 0/5 milliamps 5/9 each
- 0/5 amp. R.F. with self-contained thermo-couple... 5/9 each
- The internal thermo-couple can be disconnected, when the fundamental movement is a sensitive milliammeter, full-scale deflection between 1.5 and 3 mA.
- Four of the above meters (2 of 0/5 mA and 2 of 0/5 amp. R.F.) at special rates. Four for 21/- (Post free 22/-)
- 0/150 milliamps 6/6 each
- 0/1 milliamp 10/- each

FLUSH-MOUNTING 2 1/2 in. ROUND Type Meters. External Flange 3 1/2 in. dia. Fixing Hole 2 1/2 in. diameter :-

- One-milliamp Meters, scaled c/100—ideal as foundation instruments. Internal resistance 75 ohms marked on each meter 16/- each
- 0/1 amp. R.F. with self-contained thermo-couple... 7/6 each
- 0/20 volts A.C. (moving iron) 8/6 each
- 0/15 volts A.C. (moving iron) 8/6 each

Post Customers—Please add 1/- extra on orders for meters (except special 22/- offer of four specified meters).



E.H.T. DEVELOPMENTS

Come to the B.I.F. and see something that has never been done before—5kV D.C from a 350-0-350 volt A.C. input. Simply connect three wires to the standard mains transformer in a television receiver. No E.H.T. transformer required. Also, a complete new range of high voltage metal rectifiers giving up to 15,700 volts from a pulse input.



"Westeht" unit, which gives 5kV output from a 350 volt input.

WESTINGHOUSE WESTALITE METAL RECTIFIERS

B STAND
I H.21
F OLYMPIA

WESTINGHOUSE BRAKE & SIGNAL CO. LTD.

82, YORK WAY, KING'S CROSS, LONDON, N.1

*Which Switch
is the right switch?*

... is it Rotary or Pushbutton or Slider? Is it wanted for circuit selection, band selection, tap switching? Is it for a new design or in quantities for a well proved circuit?

Whatever it is — the answer is always OAK!

The basic design of all Oak switches is one of strength and efficient functioning, including such exclusive features as the double-contact clip and the floating rotor, ensuring self-alignment of each section.

N.S.F. AND **A.B.**
OAK SWITCHES

BRITISH N.S.F. CO. LTD., Keighley, Yorkshire
(Sole Licensees of OAK Manufacturing Co., Chicago)

A.B. METAL PRODUCTS LTD., Feltham, Middx.
(Sub-Licensees of N.S.F.)

The only Manufacturers of OAK Switches under Patent
Nos. 478391 & 478392

- ★ DYNAMIC RADIO FREQUENCY RESPONSE CURVES
- ★ DYNAMIC AUDIO FREQUENCY RESPONSE CURVES
- ★ DYNAMIC MECHANICAL RESONANCE CURVES
- ★ DYNAMIC THERMIONIC VALVE CHARACTERISTIC CURVES

can be AUTOMATICALLY TRACED on the screen of the Model 1200 OSCILLOSCOPE with the aid of the appropriate unit.

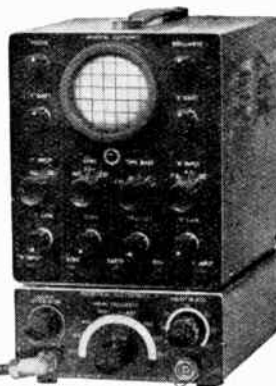

Model 1200 Oscilloscope. Price £32
Model 1400 Unit. Price £8 10 0

The model 1200 Oscilloscope is a basic unit which is complete in itself. It is a first-class general purpose oscilloscope with a wide field of application. Its special features include high gain D.C. amplifiers, symmetrical deflection, and excellent trace definition. It is compact enough to be truly portable. For any of the above special applications we can supply a unit which will plug into the oscilloscope forming one compact instrument.

Illustrated is the Model 1200 Oscilloscope and the Model 1400 Visual Alignment Generator Unit for R.F. response curves. With these instruments one can show the response curve of an I.F. or R.F. amplifier on the oscilloscope screen. General shape, band width, and attenuation off resonance can be seen, and perfect alignment is easily accomplished. Overall size of combined instruments, 7in. wide, 11in. high, 9in. long.

• We also make special test equipment for production of radio receivers. We welcome any enquiries in this and allied fields.

Enquiries to:

INDUSTRIAL ELECTRONICS

229, Hale Lane, Edgware, Middx.

Tel.: EDG. 7312

Makers of Industrial Controls and Precision Instruments.

Designed to suit the circuit

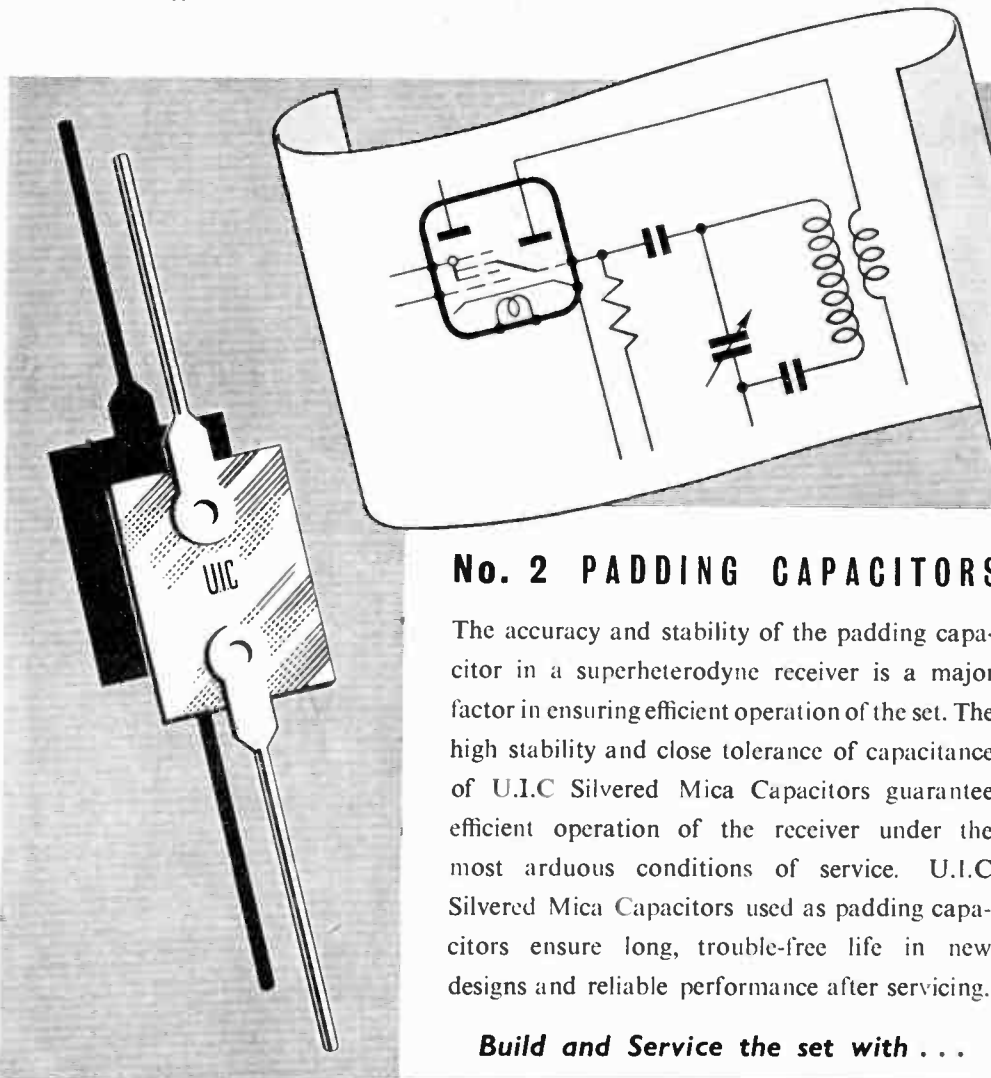

No. 2 PADDING CAPACITORS

The accuracy and stability of the padding capacitor in a superheterodyne receiver is a major factor in ensuring efficient operation of the set. The high stability and close tolerance of capacitance of U.I.C. Silvered Mica Capacitors guarantee efficient operation of the receiver under the most arduous conditions of service. U.I.C. Silvered Mica Capacitors used as padding capacitors ensure long, trouble-free life in new designs and reliable performance after servicing.

Build and Service the set with . . .

U.I.C. HIGH STABILITY CAPACITORS

UNITED INSULATOR CO. LTD. OAKCROFT RD. TOLWORTH SURBITON SURREY



A Growing Audience

MORE AND MORE people are enjoying good radio entertainment through the smooth power provided by Pertrix accumulators. Every Pertrix product gives a consistently high performance—just a little more than the promise. For trouble-free listening choose the accumulator in the red and yellow pack. Most good dealers stock them.

HOLSUN BATTERIES LTD.
137 Victoria Street, London, S.W.1



AMBASSADOR Radiograms

The best British Radiograms are Ambassador! Overseas buyers will be particularly impressed at our new range and attractive prices. Limited supplies for home Sales. Write for details.

AMBASSADOR RADIO WORKS
HUTCHINSON LANE, BRIGHOUSE, YORKS.



Products of Quality & Reliability

MAINS TRANSFORMERS
A. F. TRANSFORMERS
SMOOTHING CHOKES
THERMAL DELAY SWITCHES
POWER RESISTANCES

Made by

OLIVER PELL CONTROL LTD

Telephone - WOOLWICH 1422
CAMBRIDGE ROW · WOOLWICH S·E·10

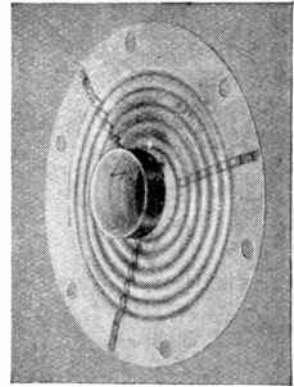

•Co-axial Construction . . . •

The voice coil and centring member assembly of the "Series 700" Reproducers is a further example of the advanced design of these models. The voice coil is wound with wire especially enamelled to give perfect adhesion between the wire and former and between layers and is of the optimum number of turns and weight for maximum efficiency; all models have an impedance of 3.0Ω at $400\sim$. The centring member is made of two layers of Bakelised linen, moulded under heat and pressure with beryllium-copper strips inserted between them; two of these strips form the connections to the voice coil and a third is a balancing member to ensure truly axial movement.

The removal of voice coil leads from the diaphragm itself, hitherto inseparable from the design of the loudspeakers employing corrugated centring members, prevents the inevitable distortion of the cone in assembly by the insertion of eyelets or soldering tags and the asymmetrical loading due to the inertia of the leads and attachments. The two layers of material with fibres disposed at 45° provide a centring member of exceptional radial rigidity, at the same time giving the maximum flexibility in the direction of motion. Lastly, as are all other component parts, this assembly is non-hygroscopic and fully tropicalised.

Reproducers & Amplifiers Ltd., Wolverhampton

The LOWEST EVER
attenuation & capacitance

CO-AX
air insulated articulated
CABLES for R.F.

TRANSRADIO LTD - 138A CROMWELL ROAD - LONDON, S.W. 7

CO-AX

LOW WATTEN. TYPES	IMPEDANCE OHMS	ATTEN. db/100ft. at 100 Mc/s	LOADING kW	O.D.
A 1	74	1.7	0.11	0.36"
† A34	73	0.6	1.5	0.85"

LOW CAPAC. TYPES	IMPEDANCE OHMS	CAPAC. mmf/ft	BREAKDOWN Volt	O.D.
C 1	150	7.3	1100	0.36"
XPC 1	132	10.2	950	0.36"
C 11	173	6.3	800	0.36"
C 22	184	5.5	900	0.44"
C 33	220	4.8	1000	0.64"
C 44	252	4.1	1150	1.03"

† Bending radius 5°
* Photocell cable.

Write for Characteristics of further types.



Your designs

LET US BRING THEM TO

LIFE!

Made in Three Principal Materials

FREQUELEX

An insulating material of Low Di-electric Loss, for Coil Formers, Aerial Insulators, Valve Holders, etc.

PERMALEX

A High Permittivity Material. For the construction of Condensers of the smallest possible dimensions.

TEMPLEX

A Condenser material of medium permittivity. For the construction of Condensers having a constant capacity at all temperatures.

the most difficult problems solved by . . .



Bullers

BULLERS LOW LOSS CERAMICS

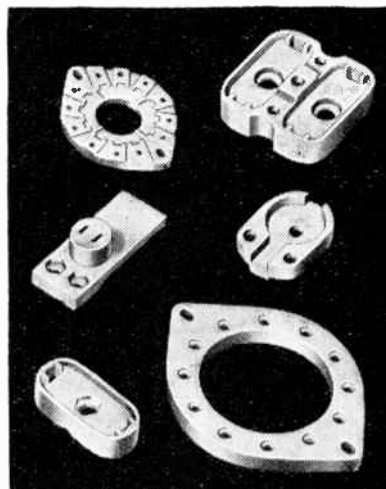

BULLERS LTD., 6, LAURENCE POUNTNEY HILL, LONDON, E.C.4
 Telephone: Mansion House 9971 (3 lines) Telegrams: "Bullers, Cannon, London"

Small Geared **MOTOR UNITS**



for
 OPERATING VALVES,
 DAMPERS OR RHEDSTATS,
 CINEMA PROJECTORS,
 ROTATING SCREENS,
 ILLUMINATED SIGNS,
 SMALL WORKING SIGNS,
 GENEVA MOVEMENTS FOR
 DRUM-TYPE SWITCHES,
 ROCKING BATHS, WORK
 MOVEMENT, SOLDERING
 AND WELDING FIXTURES,
 CONTINUOUS TURNING,
 FEED OF LIGHT STRIP
 UNDER PROCESS, etc.

(R.Q.6)

Drayton "R.Q." Motors are supplied reversing or continuous running, with or without self-switching for 100/110 or 200/250 volts A.C.
Final Shaft Speeds: 600 r.p.m./27 min. per rev.
Torque: 60 in. lbs. **Consumption:** 25 W.
 Send for List 302-1/

The DRAYTON 'R.Q.'

Drayton Regulator and Instrument Co. Ltd.,
 West Drayton (West Drayton 2611) Middx

Compact-Efficient

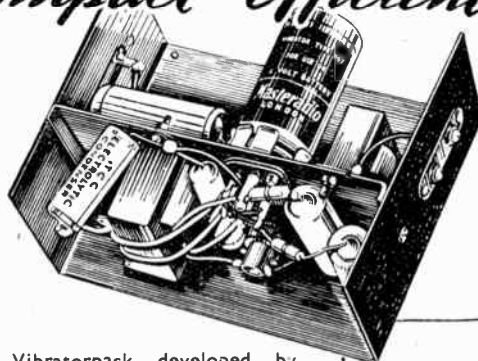

This Vibratorpack developed by Specialists will enable users of battery sets to operate from a 6-volt car accumulator, thus eliminating expensive H.T. battery replacements. Careful design has eliminated all interference. Consumption is less than 3/4 amp.

SMALLER
 than a H.T.
 Battery.
 Size: 7 x 5 1/2 x 3



Masteradio VIBRATORPACK

MASTERADIO LTD., Sales Dept., 319/321, Euston Road, London, N.W.1

*It's easy to make Pick-ups
— if you know how.*

The know-how in the manufacture of
Lexington
MOVING COIL PICK-UPS

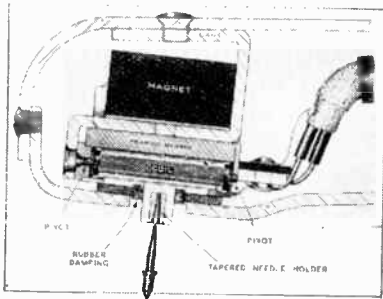

is the result of long experience and precision watch-making standards which give a finely constructed instrument the details of which are shown in the sectional diagram.

DE LUXE MODEL ● Robust design. Ascidental dropping on record will not damage Pick-up ● Extremely low moment of inertia (80 milligrams total weight of movement) ● Pure sine wave with no harmonic distortion ● Automatic needle or sapphire changing opens new fidelity field to the amateur ● Can be used with normal record changer without fear of damage. Price (without sapphire) £5.10.0, plus 24/6 P.T.

PLUG-IN HEADS

Available in both junior and De Luxe types to fit Collaro and Garrard arms, thus providing easy change-over from Magnetic types. Input conversion may be required. (See our Technical Brochure.) Price 49/6, plus 11/- P.T. Separate Ejector for De Luxe type, 30/10, plus 6/10 P.T.



Sapphire Needle with specially tapered shank, 15/3 (incl. P.T.).

PRE-AMPLIFIERS having an inverse of the recording characteristic incorporated are available for use with pick-ups. These are necessary with some amplifiers. Price complete with valve and input Transformer, £6.1.0.

**Announcing The NEW LEXINGTON
15-WATT HIGH FIDELITY**

AMPLIFIER

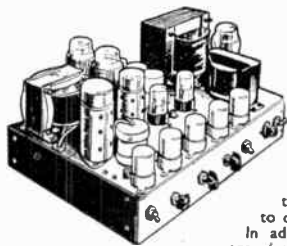

Designed in our laboratories for use with our own Pick-ups, also as an Audio-channel for high quality local station radio feeder units.

The amplifier is available completely constructed or the necessary circuit diagrams and technical details can be supplied to technical amateurs who prefer to do their own construction.

In addition technical details and circuit are also available showing the construction of a high quality **RADIO FEEDER UNIT**

incorporating local stations and television sound bands for use with the above amplifier, making a perfect combination for the connoisseur.

Prices and details of the above will be sent upon request. This service is introduced at the request of the many satisfied users of our Pick-ups.

*Illustrated Technical Brochure upon request.
Export and Trade Enquiries invited.*

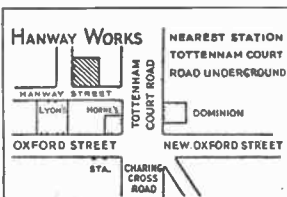

COOPER
MANUFACTURING CO

**HANWAY WORKS,
HANWAY ST., LONDON, W.1**
Telephone: MUSEum 9779
SALES OFFICES—Top Floor



**Plans for a
neighbourly world**

Marconi's first wireless messages did more than enable nation to speak to nation. They drew closer the world's boundaries, quickened the tempo of existence and turned distant acquaintances into next-door neighbours. Broadcasting has helped still further to increase our knowledge of our neighbours; wireless navigational aids and radar have brought greater safety and faster travel between Continents. And so Marconi's will continue to pioneer. Their engineers are busy today on developments which will make the world a closer community tomorrow.

Marconi

the greatest name in wireless

MARCONI'S WIRELESS TELEGRAPH COMPANY LTD.,
MARCONI HOUSE, CHELMSFORD, ESSEX.

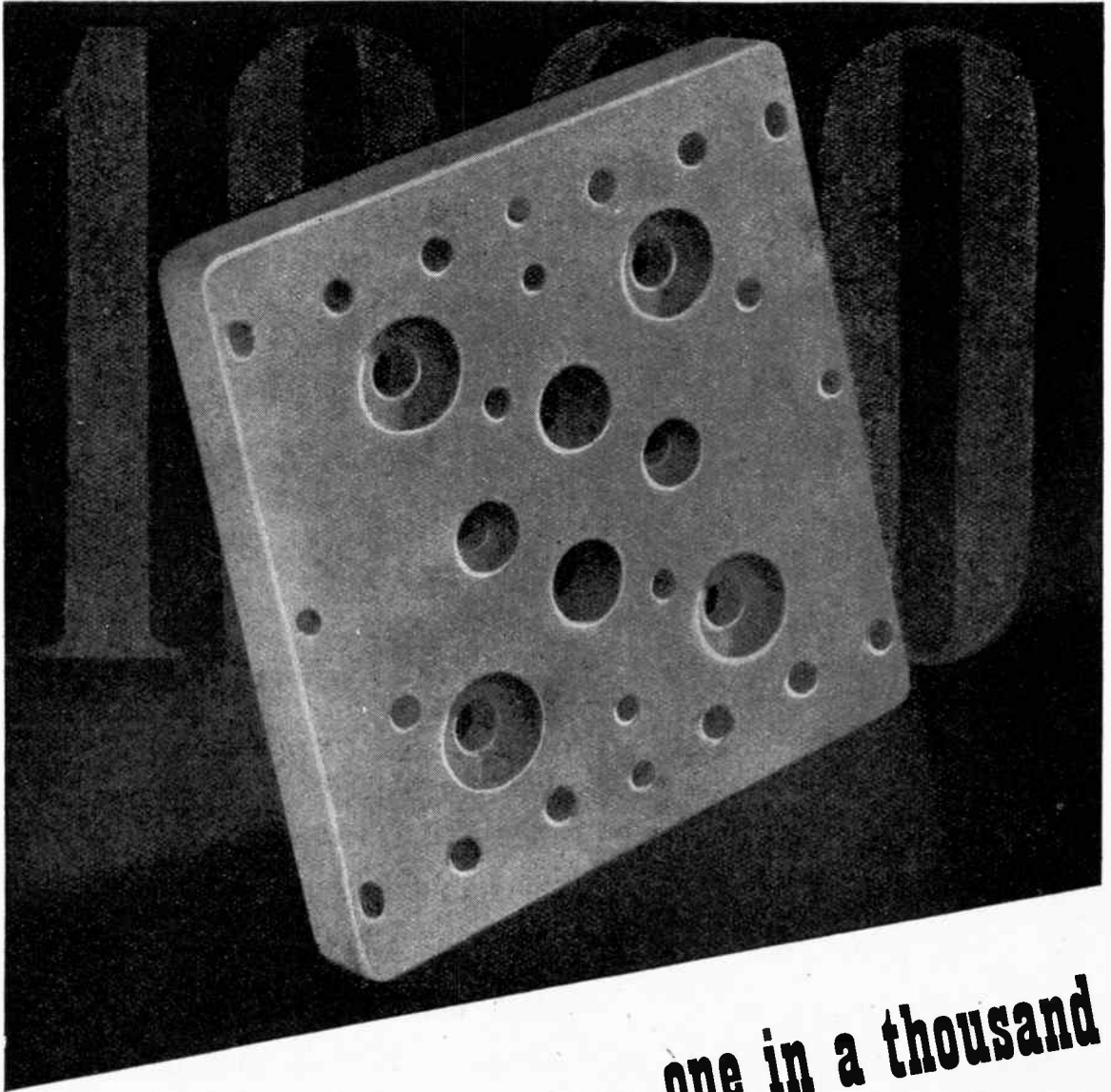

one in a thousand

Fifteen years ago we introduced the first British-made low-loss ceramic. To-day the range of **Frequentite** components covers more than a thousand pieces of every shape and size.

With such a store of manufacturing experience we are able to offer advice backed by practical knowledge on your insulation problem. Please consult us before you finalize your design.



STEATITE & PORCELAIN PRODUCTS LTD.

Head Office: Stourport-on-Severn, Worcs.

Telephone: Stourport 111.

Telegrams: Steatoin, Stourport.

S.P.27

Wireless World

RADIO AND ELECTRONICS

MAY
1948

38th YEAR OF PUBLICATION

Proprietors : ILIFFE & SONS LTD
 Managing Editor : HUGH S. POCKOCK, M.I.E.E.
 Editor : H. F. SMITH

Editorial, Advertising and Publishing Offices :
 DORSET HOUSE, STAMFORD STREET,
 LONDON, S.E.1.

Telephone : Waterloo 3333 (60 lines).
 Telegrams : "Ethaworld, Sedist. London."

PUBLISHED MONTHLY
 Price : 1/6

(Publication date 26th of preceding month)
 Subscription Rate : 20/- per annum. Home and
 Abroad

Branch Offices :
 Birmingham : King Edward House, New Street, 2.
 Coventry : 8-10, Corporation Street.
 Glasgow : 26B, Renfield Street, C.2.
 Manchester : 260, Deansgate, 3.

In this Issue

EDITORIAL COMMENT	159
GENERAL-PURPOSE OSCILLOSCOPE By J. F. O. Vaughan	160
DRY BATTERY DEVELOPMENTS By R. W. Hallows ..	166
TELEVISION E.H.T. SUPPLY—2 By A. H. B. Walker ..	169
PHYSICAL SOCIETY'S EXHIBITION	174
WORLD OF WIRELESS	180
PUSH-PULL INPUT CIRCUITS—5 By W. T. Cocking ..	183
PHASE By "Cathode Ray"	187
SHORT-WAVE CONDITIONS	191
UNBIASED By "Free Grid"	192
LETTERS TO THE EDITOR	193
RANDOM RADIATIONS By "Diallist"	196
RECENT INVENTIONS	198

WEARITE Components of undoubted **MERIT**

The range of "WEARITE" time-proven products embodies all your needs in Mains Transformers, I.F. and Miniature I.F. Transformers, "HYPERLOY" Chokes, Vibrators, Coils and Ceramic Switches. Your dealer should be able to supply from stock.

If any difficulty, write to us giving his name. If you haven't yet had our Catalogue giving full information on "WEARITE" Components, write to-day.

Wright and Weaire Limited
 2 LORD NORTH ST., LONDON, S.W.1. TELEPHONE ABBEY 2126. FACTORY: SOUTH SHIELDS, CO. DURHAM



VALVES AND THEIR APPLICATIONS

By M. G. SCROGGIE, B.Sc., M.I.E.E.

No. 17: MULLARD HEPTODE FREQUENCY CHANGER DK91

THIS is a miniature all-glass single-ended heptode with a filament consumption one twelfth that of a pen-torch bulb. An obvious role for it is in portable receivers, especially of the "personal" calibre.

In this country the triode-hexode is so popular that not everybody may be sure about how to use the heptode, or pentagrid, particularly as there are several different kinds. So here are a few notes on the DK91.

The prescribed range of H.T. voltage is 45 to 90, but $g_2 + g_4$ (used as the oscillator anode) must be limited to $67\frac{1}{2}$, by a dropping resistor if necessary.

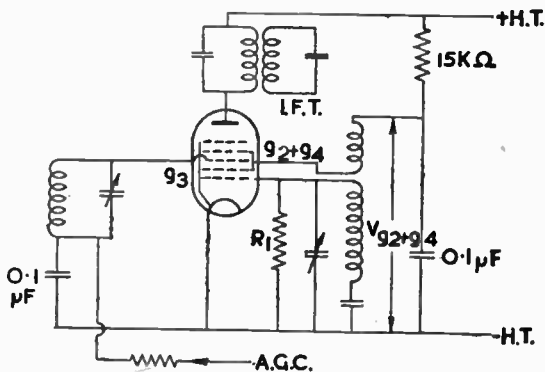

This skeleton circuit diagram is merely to show how the valve should be connected; the details of tuning arrangements can follow conventional lines. An alternative scheme, for making the whole mutual conductance of the valve effective in the oscillator, is to take the +H.T. lead from the I.F. transformer via the oscillator reaction coil instead of direct. Any voltage-dropping resistor must be inserted on the $g_2 + g_4$ side of the reaction coil and shunted by the by-pass capacitor. It is then not available for sharing with the screen of the I.F. valve.

Normally, however, the oscillator section is quite capable of providing sufficient amplitude without help

from the I.F. anode. Such help, too, is liable to be varied by A.G.C. bias on g_3 .

The amplitude of oscillation is not at all critical, and there is little to be gained by striving earnestly to keep it at optimum all the time; it is generally more important to economise in H.T. current. The amplitude is measured by a micro-ammeter in series with R_1 . Although $200\mu A$ is recommended, the effective optimum, with $V_{g_2 + g_4} = 45$ or so, is nearer $100\mu A$, and there is not much loss of signal even at $50\mu A$. Fortunately the optimum increases with $V_{g_2 + g_4}$. The less oscillator voltage on $g_2 + g_4$ the better; the reaction coil should be comparatively small.

A.G.C. may be applied to the DK91; the grid base is roughly one fifth of $V_{g_2 + g_4}$. It is important that the g_3 -to-cathode impedance at oscillator frequency should be low, otherwise the action of g_3 may be upset by oscillator voltage from $g_2 + g_4$. It is true that it can be neutralized out by a few pF from g_1 to g_3 , but there is no need for this complication if the previous condition is fulfilled.



This is the seventeenth of a series written by M. G. Scroggie, B.Sc., M.I.E.E., the well-known Consulting Radio Engineer. Reprints for schools and technical colleges may be obtained free of charge from the address below. Technical Data Sheets on the DK91 and other valves are also available.

**THE MULLARD WIRELESS SERVICE CO. LTD.,
TECHNICAL PUBLICATIONS DEPARTMENT,
CENTURY HOUSE, SHAFTESBURY AVE., W.C.2**

Wireless World

RADIO AND ELECTRONICS

Vol. LIV. No. 5

May 1948

Business Radio

AS we told our readers last month, "business radio" is the term that has now been officially chosen to describe low-power radio-telephone communication systems as used by public utility vehicle and car-hire services, newspapers, towage companies, doctors, etc. The term seems to be an unhappy one—just another example of our seeming inability in the world of wireless to coin the apt name for the new thing. Perhaps our readers can think of something better before it is too late to prevent the title from passing into the language.

But enough of terminology; though the name may be bad, the thing itself is good. More precisely, it is all to the good that radio communication is being extended into fields where it can add to the comforts, amenities and efficiency of life, though perhaps on a rather more humble and less spectacular plane than in some of its older applications. So far as this country is concerned, the kind of radio communication that we are now considering is virtually new: the Post Office, as the supreme licensing authority, has hitherto tended to regard the less serious uses of radio with some disfavour. We are glad that the official attitude has now changed, and that the G.P.O. is now giving sympathetic consideration to applications from all kinds of potential users. The task of allotting licences must be an unenviable one, as many of the applications are apparently of the type that can only be described as frivolous. It is certainly not the intention of *Wireless World* to advocate the granting of licences for anything approaching such purposes; radio channels are too precious for that, and a "free for all" in the part of the spectrum allocated to low-power telephone services would in the long run be disastrous.

While the whole matter is admittedly in the experimental stage it would perhaps be unwise to enquire too closely into the principles under which licences are, or should be, allotted. On the broadest issue, the good of the community as a whole must clearly come first. Also, no wireless

man nowadays will quarrel with the principle that radio licences should be withheld when other means of communication are adequate.

The position at present seems to be that channels are allotted in relation to the nature of the intended communication and its estimated importance. Thus, a service of the highest importance is granted, so far as possible, an exclusive channel, while those with less substantial claims must share with a large number of other users. This should provide a workable basis for the scheme as a start; indeed, it would be almost impossible to devise any other system with so many points in its favour. By balancing importance of the proposed service against exclusiveness of the channel allocated the dispensation of a rough-and-ready kind of justice between applicants should be made fairly easy. The alternative—summary refusal of a licence for purposes judged to be unimportant—would be likely to lead to greater injustice, and would restrict the natural growth of the service.

Problems of Control

Nobody wishes to see "business radio" entangled in a maze of red tape, especially at this early stage, but fairly close control is clearly essential. The problem, as usual in communications, is to pack as much interchange of useful information as possible into the minimum number of channels. The less important users of the service can rarely expect anything approaching exclusive channels: there must be a good deal of sharing and "waiting turns." This implies some knowledge of, and experience in, the niceties of operating procedure. There must also be a strict ban on "chatter."

Maintenance of the apparatus is likely to present a problem, and we suggest that in this matter something may be learned from the early days of wireless. It would probably suit many users—especially the smaller ones—to obtain their gear on a hire and maintenance contract rather than by outright purchase.

General-

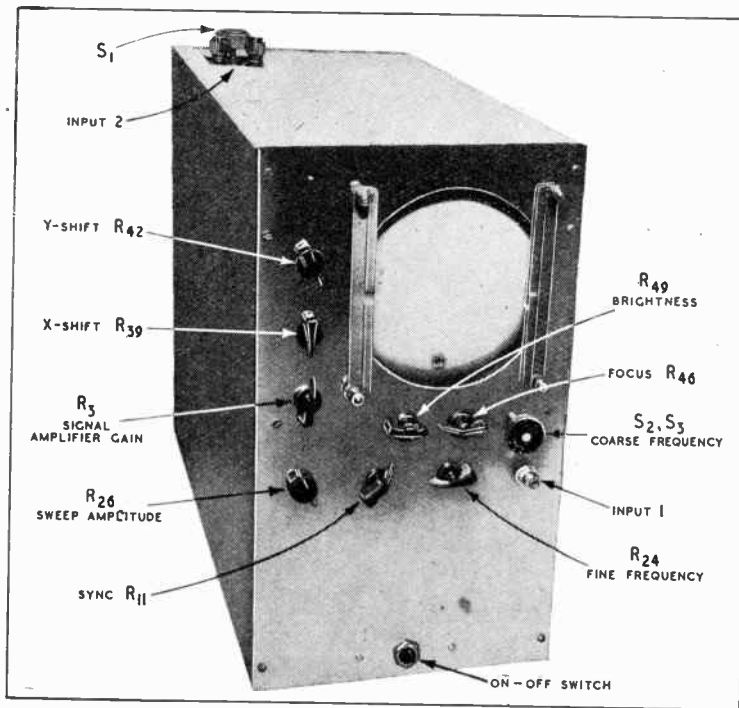

signal amplifier through an EF50 buffer stage.

Signal Amplifier.—The first valve V_1 is a straightforward amplifier having a variable resistor R_3 in its cathode lead which functions as a gain control. It provides a range of control of approximately 70 : 1. The coupling resistor R_4 is given a fairly low value (3.5 k Ω) in order to secure a good high-frequency response.

The output of this stage is taken to V_2 which forms the input valve of a paraphase pair. The input to the second is secured from the resistance network R_8, R_9, R_{10} and R_{11} joining the two anodes. Because of the low value coupling

SOME of the Government-surplus radar units now on the market lend themselves admirably to conversion to an oscilloscope. In particular, the Admiralty Type 6A or 6B and the R.A.F. Type 10Q13/24 are suitable for this, and these three units are essentially identical.

The cathode-ray tube is of the electrostatic type with a 6½-in green screen of short persistence; its type number is VCR97 (=CV 1097). The unit includes four VR91 (=CV1091=Mullard EF50) valves and three VR54 (=CV1054=Mullard EB34) valves, as well as a large number of capacitors, resistors, and potentiometers, and most of the parts in it find application in a conversion.

There are many ways in which such a conversion can be performed and the type of oscilloscope circuit adopted must depend on two factors—the main purpose for which the oscilloscope is required and the material available. It was decided in this case to make the oscilloscope of the general-purpose type, but to bear in mind the particular requirements of television. These last demand an especially good frequency response at low and high frequencies and the ability to

This front view shows the controls.

Fig. 1. The complete circuit diagram of the oscilloscope together with the base connections (looking at the rear of the tube) of the C.R. tube, type VCR97. The power supply is on a separate chassis and the components mounted on it are enclosed within dotted lines.

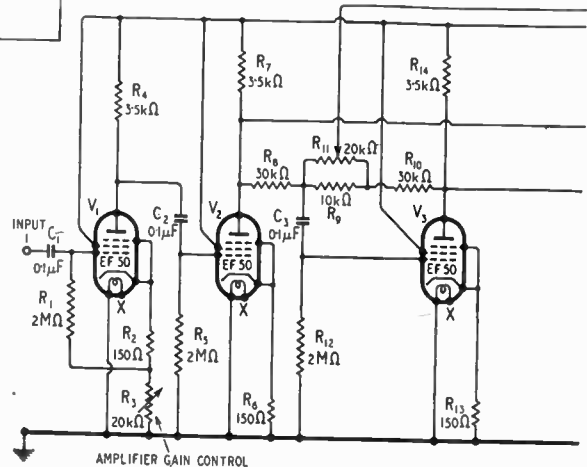

handle a wide range of input voltages. In addition, means must be provided for supplying the time-base generator with a synchronizing input of suitable phase, since with the pulse waveforms of television a particular phase of input is desirable for a good lock.

The complete circuit diagram of the oscilloscope is shown in Fig. 1. Everything, apart from the power supply, is included on the original radar chassis and the power supply is built on a new chassis beneath it. It will be seen that the signal amplifier comprises three EF50 valves and provides a push-pull output. The synchronizing signal is taken from the output of the

resistors R_7 and R_{14} and the un-bypassed cathode resistors R_6 and R_{13} the inherent stage gains are not high. A balanced output from the stage is not obtained, therefore, by feeding the grid of V_2 from the junction of equal value resistors between the valve anodes. Accordingly, while on one side the resistance is 30 k Ω (R_8) on the other it is 37 k Ω and comprises R_{10} of 30 k Ω in series with the parallel combination of R_9 and R_{11} of 10 k Ω and 20 k Ω respectively.

An output is taken from the slider of R_{11} through a buffer stage V_4 to the saw-tooth oscillator for synchronizing. The voltages to earth at the two ends

Purpose Oscilloscope

of R_{11} are approximately equal but of opposite phase and the centre is at earth potential. Consequently zero sync signal is obtained with the slider at the centre. Turning the control one way gives a sync signal of one phase, turning it the other way gives one of opposite phase.

The anodes of V_2 and V_3 are coupled to the horizontal deflector plates of the tube through C_4 and C_5 via the switch S_1 . This enables the deflector plates to be disconnected from the amplifier and joined instead to an alternative input, "Input 2." This is desirable when the oscilloscope is used for the examination of large voltages. With the amplifier in circuit a range of input voltages

Modifying an Ex-Government Radar Unit

By J. F. O. VAUGHAN

10:1 change of picture size. Without the amplifier the range is extended up to 120 V p-p, since the deflection sensitivity for the voltage used is 12 V per cm. Input 2 is not, of course, push-pull.

When the amplifier is in circuit the response is limited by the interval couplings, but is adequate down to 50 c/s. At the high-frequency end it is -3 db at 550 kc/s, 6 db at 950 c/s and -20 db at 3 Mc/s. It is adequate for all normal purposes in investigating the pulse waveforms

is a Transiron-Miller integrator. The frequency coverage is from 12.5 c/s to 10 kc/s obtained in three ranges by means of S_2 and S_3 , the fine control being by R_{24} . The series resistor R_{25} limits the frequency range provided by R_{24} . Sufficient overlap between ranges is still obtained, however, and its inclusion prevents the very rapid change in frequency which would otherwise occur at low values of R_{24} . It is also necessary as a safety measure, for if it were omitted it would be possible to connect the grid of V_5 direct to

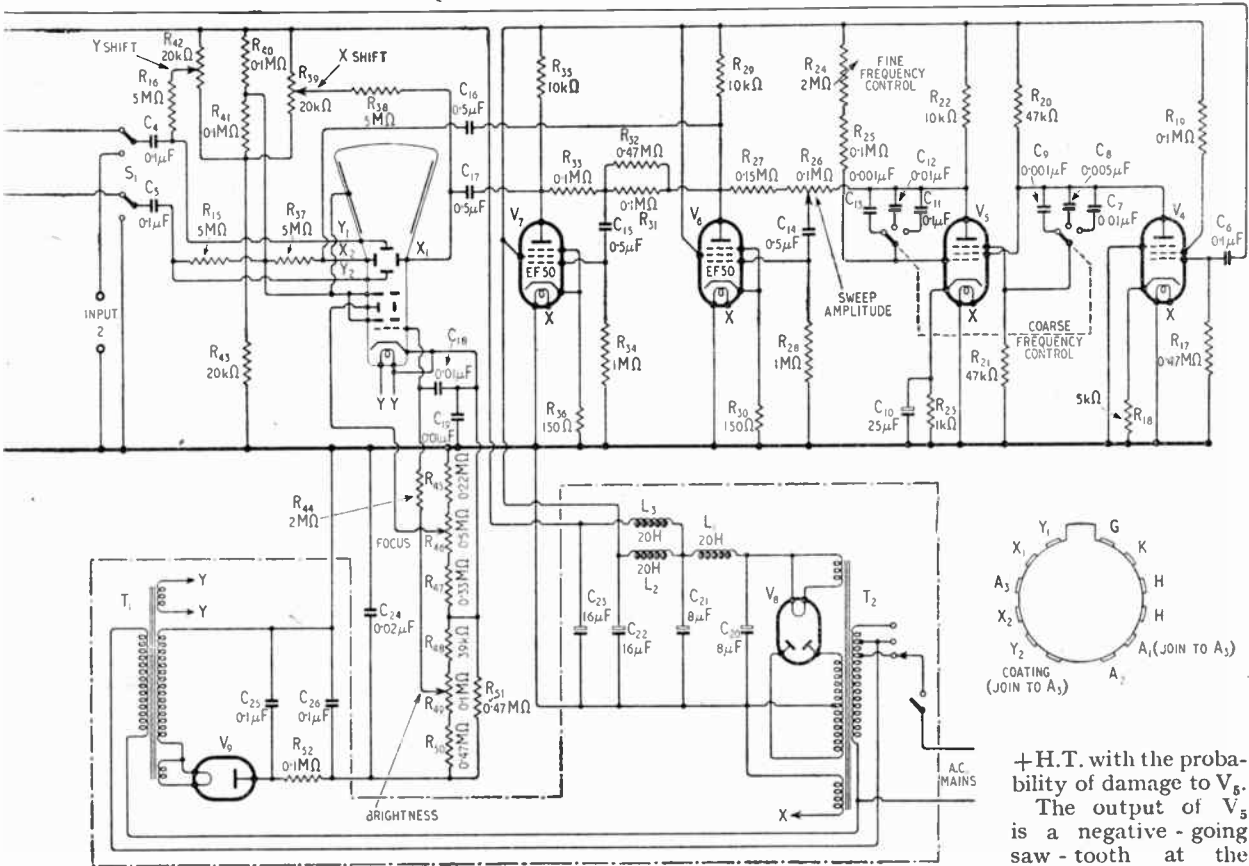

of approximately 0.05-35 V p-p is catered for, by means of the gain control ratio of 70:1 and a

Time-Base. The oscillator V_6 ,

+ H.T. with the probability of damage to V_5 . The output of V_5 is a negative-going saw-tooth at the anode and feeds the first valve V_6 of the paraphase pair V_6 and V_7 . The input circuit to V_6 is somewhat

avoided by omitting C_{16} , C_{17} , R_{37} and R_{38} and joining the X-plates of the tube directly to the anodes of V_6 and V_7 . However, horizontal shift is not then obtainable, so that in most cases it is desirable to retain the coupling components.

The saw-tooth generator V_5 is synchronized by a signal applied to its screen-grid from the buffer valve V_4 . This is necessary to

and it is biased by R_{18} of 5 kΩ in its cathode. This value of resistor is necessary in order to limit the anode current of V_4 to a value which does not interfere with the operation of V_5 . If a lower value is used, V_5 will not oscillate unless there is a synchronizing signal of some sort. R_{18} is not bypassed, as there is no need to obtain maximum gain from the valve.

shifts are obtained from R_{39} and R_{42} respectively. These are connected to the H.T. supply of the signal amplifier and there is about 100 volts across them. This is sufficient to move the trace in the vertical direction from top to bottom edge of the screen, but owing to the lower sensitivity of the tube in the X-direction, it can shift the time base sideways by

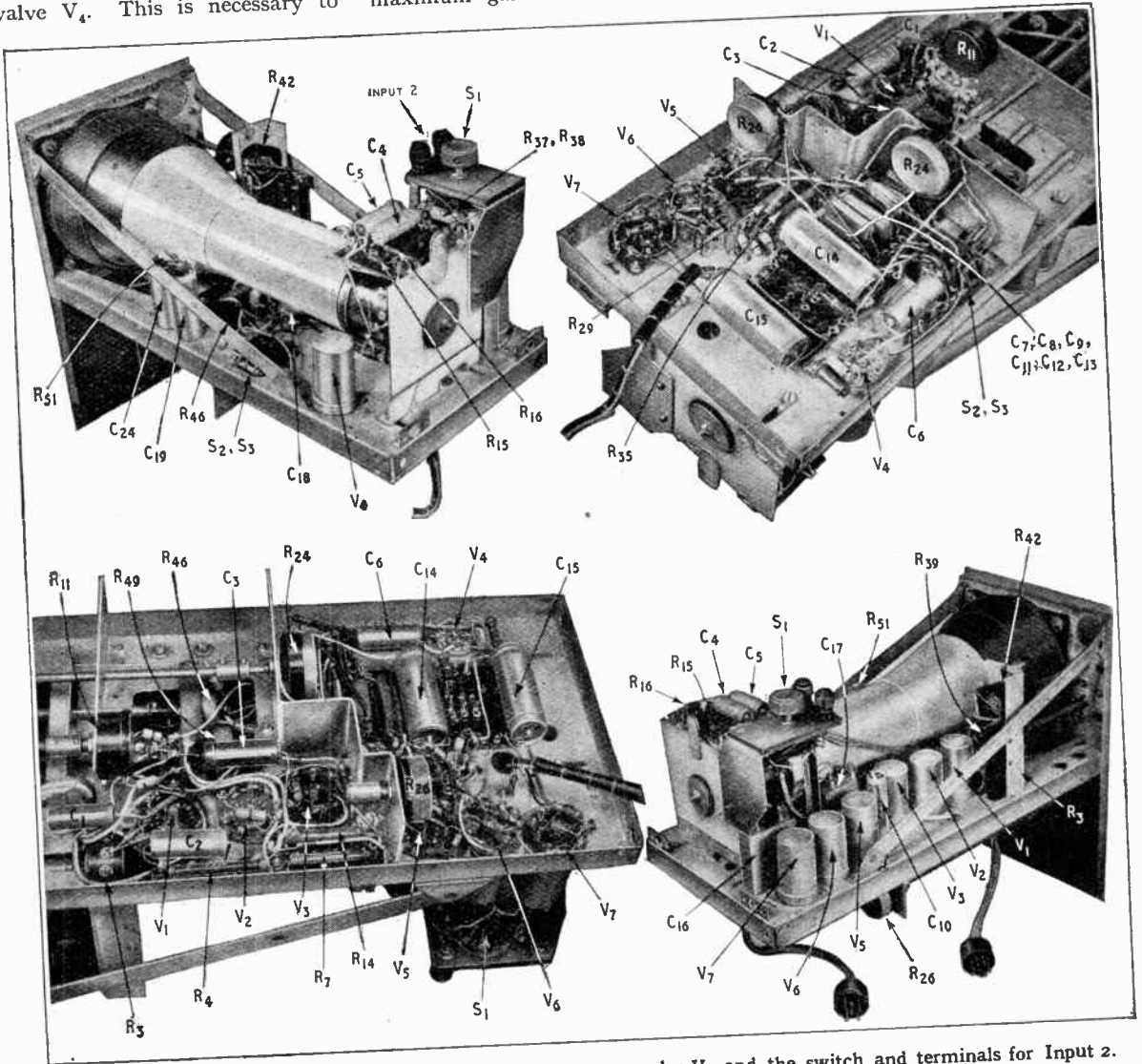

(Top left) This view of the modified chassis shows the sync valve V_4 and the switch and terminals for Input 2. (Bottom left) In this view the parts of the signal amplifier can be seen. The control shaft of R_{26} has been removed for clarity. (Bottom right) Here the general arrangement of the parts above the chassis is clearly shown.

prevent any feedback from the oscillator into the signal amplifier. Such feedback would produce a distorted trace. V_4 has its anode tied directly to the screen of V_5 ,

R_{19} (100 kΩ) in the screen is inserted merely to limit the screen current. No bypass capacitor is used here, either.

C.R. Tube. The X- and Y-

only about half the screen diameter. This is usually sufficient, however, to enable any part of the waveform under examination to be brought to the

General Purposes Oscilloscope—

centre of the tube. Owing to the very long time constants ($2\frac{1}{2}$ seconds) of the couplings to the X-plates, it takes several seconds for the trace to come to rest after the X-shift control has been moved.

The potentiometer which supplies the tube voltages is the same as in the original circuit, except

that the value of the brightness control, R_{49} , has been changed from 500 k Ω to 100 k Ω . The former value gives too critical a control. To avoid further changes the value of 500 k Ω is maintained by inserting a 470-k Ω resistor in series with R_{49} . This means that a small proportion of the available E.H.T. voltage is wasted, but this is unimportant as the trace is

adequately bright and the focus is quite good. The purpose of R_{48} of 39 k Ω is to provide a minimum bias. The two ends of R_{51} (across the brightness control resistors) are bypassed to earth by C_{19} and C_{24} . These two capacitors have to withstand the full E.H.T. voltage. The grid is decoupled to the cathode by C_{18} . This capacitor has only a few volts across it, but its case must be insulated to withstand the full voltage to chassis. It is most conveniently suspended in the wiring. The resistor R_{44} , in series with the C.R. tube grid is part of the original wiring. It has been left in so that, by disconnecting C_{18} , modulation can be applied to the grid if required.

Power Supplies. The E.H.T. supply is provided by T_1 which has an H.T. winding of 1,000 V R.M.S., a rectifier L.T. winding of 4 volts tapped at 2 volts, and a tube heating winding of 4 volts. The tapping on the rectifier L.T. winding is to enable either 2- or 4-volt rectifiers to be used as desired; the unused lead should be taped or otherwise safely insulated. Smoothing is provided by C_{25} and C_{26} separated by R_{52} . From the circuit diagram it can be seen that C_{24} and C_{25} are in parallel. More of this later.

T_2 supplies H.T. and L.T. to the signal amplifier and time base. The H.T. winding is 350-0-350 V R.M.S. The rectifier L.T. winding is 5 volts tapped at 4 volts to enable 4- or 5-volt rectifiers to be used (again the unused lead should be taped) and the valve-heater winding is 6.3 volts. Owing to the very low frequency at which it is sometimes necessary to run the time-base it has been found that separate smoothing for the H.T. feeds to the time-base and signal amplifiers is essential as otherwise the consequent cross-talk results in a curved trace. C_{20} and C_{21} are two sections of an 8-8- μ F electrolytic capacitor. C_{22} and C_{23} are each similar 8-8- μ F capacitors having the two sections joined together to form 16- μ F capacitors. L_2 and L_3 are the separate smoothing chokes for the time-base and signal amplifier respectively; L_1 is the common first filter choke.

The three output leads from the E.H.T. supply are all at high voltage to chassis but have only

LIST OF COMPONENTS**Resistors**

* R_1, R_5, R_{12}, R_{44}	2 M Ω , $\frac{1}{2}$ W.
$R_2, R_6, R_{13}, R_{30}, R_{36}$	150 Ω , $\frac{1}{2}$ W.
* $R_3, *R_{11}, *R_{39}, *R_{42}$	20 k Ω , variable.
R_4, R_7, R_{14}	3.5 k Ω , 6 W, wirewound.
R_8, R_{10}	30 k Ω , $\frac{1}{2}$ W.
$R_{15}, R_{16}, R_{37}, R_{28}$	5 M Ω , $\frac{1}{2}$ W.
$R_{17}, R_{32} *R_{50} *R_{51}$	470 k Ω , $\frac{1}{2}$ W.
R_{18}	5 k Ω , $\frac{1}{2}$ W.
* $R_{19}, *R_{25}, R_{31}, R_{33}, R_{10}, R_{11}$	100 k Ω , $\frac{1}{2}$ W.
R_{20}, R_{21}	47 k Ω , $\frac{1}{2}$ W.
* R_{22}	10 k Ω , $\frac{1}{2}$ W.
* R_{23}	1 k Ω , $\frac{1}{2}$ W.
R_{24}	2 M Ω , variable.
R_{26}, R_{49}	100 k Ω , variable.
R_{27}	150 k Ω , $\frac{1}{2}$ W.
R_{28}, R_{34}	1 M Ω , $\frac{1}{2}$ W.
R_{29}, R_{36}	10 k Ω , 6 W, wirewound.
R_{43}	20 k Ω , 2 W.
* R_{45}	220 k Ω , $\frac{1}{2}$ W.
* R_{46}	500 k Ω , variable.
* R_{47}	330 k Ω , $\frac{1}{2}$ W.
* R_{48}	39 k Ω , $\frac{1}{2}$ W.
R_{52}	100 k Ω , 1 W.

Capacitors

* $C_1, *C_2, *C_3, *C_4, *C_5, C_6, C_{11}$	0.1 μ F, 500 V, paper, tubular.
C_7, C_{12}, C_{18}	0.01 μ F, mica.
C_8	0.005 μ F, mica.
C_9, C_{13}	0.001 μ F, mica.
C_{10}	25 μ F, 12V, electrolytic.
C_{14}, C_{15}	0.5 μ F, 450 V, paper, tubular.
C_{16}, C_{17}	0.5 μ F, 450 V, paper, rectangular, metal case type.
* C_{19}	0.01 μ F, 2,500 V, paper.
$C_{20-24}, C_{22}, C_{23}$	8-8 μ F, 500 V, electrolytic.
* C_{24}	0.02 μ F, 2,500 V, paper.
C_{25}, C_{26}	0.1 μ F, 2,500 V, paper, tubular.

Valves

V_1-V_7	Mullard EF50.
V_8	Any 120 mA, 350 V rectifier.
V_9	Mullard HVR2 (or 2a).

Transformers and Chokes

T_1	Primary, 230 V; Secondaries, 1,000 V, 20 mA; 4 V, 2 A; 4 V, 2 A, tapped at 2 V	Vortexion.
T_2	Primary, 200-250 V; Secondaries, 350-0-350 V, 60 mA; 6.3 V, 4 A; 5 V, 2 A, tapped at 4 V... ..	Vortexion
L_1, L_2, L_3	20 H, 60 mA, 300 Ω	Vortexion.

Valveholders and Plugs ... B9G wafer-type for V_1-V_7 (four in original chassis).
5-pin high-voltage type for V_9 and E.H.T. cable... ..

5-pin or octal for V_8 (to suit valve).

Octal for H.T. cable.

5-pin plug for E.H.T. cable Bulgin. |

Octal plug for H.T. cable Bulgin. |

Components against which an asterisk (*) has been placed are part of the original radar unit, but may or may not occupy their original positions.

a small p.d. between them; they are taken to a 5-pin high-voltage socket on the chassis and carried by a cable to the oscilloscope chassis. The output leads from

General view of the power unit.

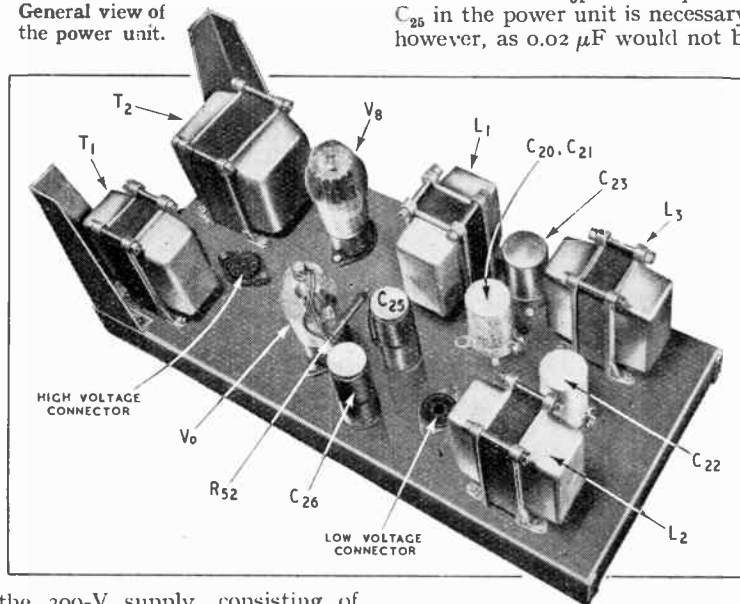

the 300-V supply consisting of two \pm H.T., two heater and one earth lead are connected to an octal socket and thence through a second cable. By this means the leads within each cable do not require very high insulation and the equipment can be easily taken apart and re-connected with the two units side by side for testing purposes.

Mechanical Arrangement. As can be seen from the photographs the original chassis is mounted over the power supply chassis. Valves V_1 , V_3 , V_5 and V_7 occupy the sockets already in position; V_2 , V_4 and V_6 are accommodated by replacing the existing octal sockets with the B9G type. This necessitates enlarging the existing chassis holes. The other components which remain in situ are C_{25} and C_{26} , R_{39} and R_{42} , the focus control R_{46} and the remaining resistors of the C.R.T. chain apart from the brightness control. The coarse-frequency control switches S_1 , S_2 and the gain control R_3 are also in their original positions. All remaining components should be removed, including the brackets for the potentiometers, together with all wiring except that associated with the C.R.T. chain. As mentioned earlier, C_{24} and C_{25}

are in parallel, the latter on the power supply chassis, and the former on the oscilloscope chassis. This component was left in place as it acts as a useful anchorage for one end of R_{51} . The capacitor C_{25} in the power unit is necessary, however, as $0.02 \mu\text{F}$ would not be

5-M Ω resistors are used and, in particular, of R_{51} and associated components. Excessive surface leakage in the case of the 5-M Ω resistors will affect the low-frequency response adversely, while leakage across R_{51} will make it impossible to black out the trace.

No provision has been made in this model to enable direct connections to be made to the X- and Y-plates, since it is not often needed in ordinary work. If it is needed for any special purpose the modifications are obvious.

No arrangements for blacking out the trace during flyback are included because simple methods have a certain drawback. If it is desired, it can be fitted by including a 5-k Ω resistor in the grid lead of the tube and connecting a 50-pF, 1,500 V capacitor from the tube grid to the anode of V_6 . The saw-tooth is positive-going on the anode of V_6 and the capacitor and resistor differentiate it and produce a pulse waveform on the tube grid which is negative-going on the flyback.

This simple scheme works excellently, but has the defect that the brightness of the trace varies considerably with the setting of the Fine Frequency Control. This is because the flyback time tends to be independent of frequency, so the scan/flyback ratio decreases with frequency, and in the derived pulse wave the mean level alters. The effect could doubtless be overcome by using a D.C. restoring diode at the tube grid, but this seems a complication which is hardly worth while.

Anti-Interference

TWO reports dealing with the subject of electrical interference with radio reception have recently been issued by the Electrical Research Association (15, Savoy Street, London, W.C.2).

"The Measurement of Radio Interference by the Modified Reception Set R206, Mark I," describes the conversion into an interference measuring set of an ex-Army receiver. A limited number of these receivers will be made available for industry. The report costs 13s 6d.

"Radio Interference Tests on an Electrified Railway" (price 1s 6d), details measurements of interference in the frequency range 0.6–5 Mc/s at various points and at varying distances from the track.

enough for smoothing purposes.

The photographs show that the C.R.T. chassis is supported by the front panel, and by two strong brackets at the rear. Aluminium has been used for these parts, as well as for the power-pack chassis, as it is easy to work, and strong enough to carry the weight. The clearance between the two decks is just enough to accommodate the chokes and the transformers. The capacitors C_{16} and C_{17} are mounted above the chassis, and as the upper frequency limit is only 10 kc/s the capacitance to chassis of these components does not have any detrimental effect. The arrangement relieves congestion below the chassis. The other capacitors C_{14} and C_{15} are metal-cased tubular types mounted beneath the chassis.

Great care must be taken to maintain good insulation of the leads connected to the grid of the oscillator. If there is a leak to chassis oscillations may cease when R_{24} exceeds a certain value, as the operation of the circuit depends upon the tendency of the grid potential to rise to the \pm H.T. level.

Care must also be taken over insulation in all circuits where

Dry Battery Developments

The R.M. Mercury Cell

By R. W. HALLOWS, M.A.Cantab, M.I.E.E.

THERE can be no doubt that there is a real demand today for a primary dry cell of greater efficiency than those which are passed over the counter in response to our demands for "refills" for our pocket flash-lamps, or to replace the run-down H.T.B.'s (and it may be the filament-heating batteries) of portable wireless receivers, or those of the stationary type, which must be used when and where no suitable mains supplies of current are available. Nor is it only the consumer who has this feeling. Designers of a multitude of different kinds of valve-operated devices, intended to be independent of mains supplies, have long held that they were being let down by those whose advances in the realm of primary cells might have been expected to keep pace with progress in electronics.

The cold, hard facts are: (1) that the only type of dry primary cell now generally available is identical, save for minor improvements, with that used by our grandfathers; and (2) that, apart from air-depolarizer types (whose size and weight rule them out for use in portable apparatus) Leclanché cells suffer from the defect that the depolarizer never, so to speak, catches up with its job. In other words, the internal resistance of the cell rises steadily under discharge, with a consequent drop in E.M.F. To fall into line with the vicious circles and vicious spirals of which so much is heard nowadays, we may describe the discharge curve of such a cell, under intermittent load, as a vicious saw-tooth! The tip of no tooth is quite as high as that of the one immediately before it; the valleys between the teeth reach continually lower levels as the discharge periods follow one another.

The dry Leclanché cell has its good points. It is reasonably cheap to produce and fairly light; in use it is as nearly trouble-free

as makes no matter; its shelf-life is reasonably good in its usual form, and, if made up in inert form, it can be stored for years with little deterioration. But, though valve designers have done wonders in producing battery-operated valves which continue to perform remarkably well despite a falling off in both filament and anode voltages, that vicious saw-tooth discharge curve is a very big, bad wolf.

I am far from saying that the Ruben mercury cell, developed by the P. R. Mallory Company of Indianapolis, U.S.A., gives all the answers to our prayers. It doesn't.

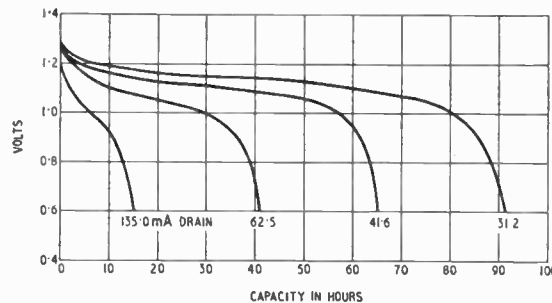

Fig. 1. Discharge curves of a mercury cell 1.19in dia. and 0.46in deep, weighing 1.1 oz.

To begin with it costs more than the dry Leclanché cell. Again, its open-circuit E.M.F. is only 1.34V compared with the rather over 1.5V of the Leclanché. But it represents an entirely new cell, constructed on lines different from those of any other; and a cell roughly $\frac{3}{8}$ in in diameter by $\frac{1}{2}$ in deep, weighing just over $\frac{1}{2}$ oz, will supply 31 mA continuously for 37 hours with a closed-circuit voltage of 1.0-1.2V. A smaller cell of half the weight will furnish 18 mA within the same voltage limits for a similar period. A larger type, with a weight still well under the ounce, has a life (to a cut-off of 1V) of 60 hours under a load of 31 mA, 76 hours at 25 mA and 91 hours at 20 mA. Fig. 1 shows discharge curves for the largest type

of mercury cell. This is 1.19in in diameter by 0.46in in depth and weighs 1.1 oz.

Figs. 2 and 3 show two different methods of cell construction. In the rolled-anode cell (Fig. 2) the negative element is a strip of zinc foil, placed between two strips of alkali-resistant absorbent paper and rolled up. The paper serves to hold the electrolyte, a solution of caustic potash (KOH). The zinc roll is separated by a barrier of dense, alkali-resistant dialysis paper from the depolarizing anode, which consists of a pellet of mercuric oxide (HgO). The copper cover of the cell makes direct contact with the zinc anode and so forms the negative terminal. It is insulated by a sealing gasket of synthetic rubber from the steel can, which is in direct contact with the cathode and forms the

positive connection.

The pressed-powder - anode cell (Fig. 3) is basically similar, save that its anode consists of a pellet of powdered zinc.

It will be noticed that the cell is the exact opposite of the dry Leclanché in that its can is positive.

Another constructional difference which makes for increased compactness, is this. In the Leclanché cell the bulkiest component is the sac of depolarizer surrounding the cathode. This is eliminated, since the mercuric oxide cathode helps to produce an automatic depolarization within the cell.

The chemical reactions in the cell are of a very complex nature and they have not yet been fully worked out. The authors of a paper read before the Electrochemical Society of America last year admit this.¹ They give, at the same time, some exceedingly

¹M. Friedman and C. E. McCauley: "The Ruben Cell: A New Alkaline Primary Dry Cell Battery." *Trans. of the Electrochemical Society of America*, Vol. 92, 1947.

interesting facts about the working of the cell. They show, for example, that from 80% to 90% of the active materials of the cell are used up during discharge. Compare this with the Leclanché

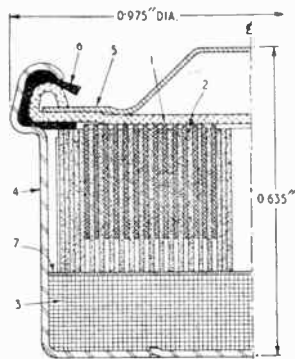
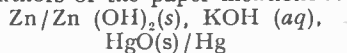

Fig. 2. Half-section drawing showing construction of the mercury cell in rolled anode form. 1. zinc foil; 2. absorbent material; 3. mercuric oxide pellet; 4. steel can; 5. copper top of cell; 6. synthetic rubber gasket; 7. insulating barrier.

dry cell, which always "dies" with much of its zinc unconsumed.

The Ruben-Mallory (R.M.) cell is symbolized as follows by the authors of the paper mentioned:



where *s* = solid and *aq* = aqueous.

The overall reaction is:

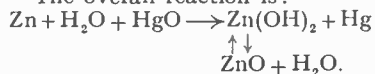

No ingredients will suffice for the making of a dry cell of practical value unless they are such that a condition of chemical equilibrium is reached and maintained when the cell is on open circuit. To put it in another way, the electrolyte must, on open circuit, quickly reach a condition in which it is unable to attack the zinc. This happens in the Leclanché cell because very shortly after the introduction of the electrolyte of sal ammoniac (NH_4Cl) and water, the solution becomes saturated with positive ions of zinc chloride; mutual repulsion, therefore, prevents the entry of further such ions into the electrolyte—until the cell is put on closed circuit.

In the mercury cell equilibrium is reached rather slowly after a complicated series of reactions. Immediately after it has been made the O.C. voltage is about 1.36. This falls sharply to a little

above 1.35 within 24 hours. There is then a further slower fall to the normal O.C. voltage of 1.34. It is known that zinc oxide and potassium zincate are formed during this "settling down" period.

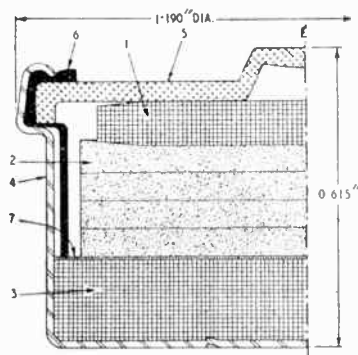

Fig. 3. Pressed-powder-anode version of the mercury cell. 1. powdered zinc anode; 2. electrolyte absorbent; 3. mercuric oxide; 4. steel can; 5. copper top; 6. synthetic rubber gasket; 7. barrier.

When the cell is placed under load sufficient zincate ions are available to make the oxidation products almost entirely ZnO and Zn(OH)_2 ; there is hardly any possibility of the formation of gaseous hydrogen.

The internal resistance of the cell is not stated, but from the flash currents (that is the peak currents registered on momentary connection to an ammeter) as given by the makers it would appear to be higher than that of a small Leclanché cell. Flash currents range from 0.5-0.8A for the smallest R.M. cells to 1.1-1.8A for

portant point, however, is that the internal resistance of the R.M. cell remains substantially constant under loads of approximately 100 mA per square inch of cathode surface area.

The shelf-life of the cell is good. Tests made on cells stored for two years and three years show results little inferior to those given by cells of the same batches shortly after manufacture.

To sum up: the R.M. cell is revolutionary in its design (no other cell has electrodes and electrolyte completely sealed in a metal case) and in its performance (no dry cell now in use can match the constancy of its E.M.F. under heavy loads); but is it going to revolutionize methods of L.T. and H.T. supply in portable apparatus? It was so used very satisfactorily by the American fighting services during the war; but in wartime expense is not often a primary consideration. I welcome the R.M. cell because it represents a breakaway from accepted methods and accepted standards of far too long standing. I do not believe that in its present form and at its present price it is likely to oust the dry Leclanché cell. But the new ideas which it incorporates are capable of interesting developments and it may well point the way to the really efficient dry cell for which we have for so long been waiting.

Addendum

By D. W. Thomasson

Mercury cells are now being made by Mallory Batteries, Ltd., of Belfast: the only British-made

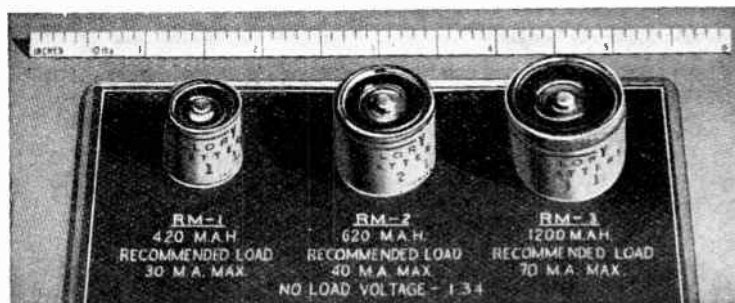

Various sizes of R.M. cells.

the largest. From good-quality Leclanché cells of the sizes used in H.T.B.'s of various capacities one usually obtains flash currents of from about 2A to 5A. The im-

cell commercially available at the present time is the RMB-3. This single-cell unit measures 1in in diameter and 3/4in in height, and is stated to have an average

Dry Battery Developments—

capacity of 1.45 ampere-hours. The maximum continuous drain is 65 mA, but much heavier currents may be drawn intermittently. Internal resistance is of the order of 2.5 Ω .

This cell has been used to some extent for hearing aids, and is especially suitable for use with the new sub-miniature valves being produced by Mullard and Hivac. One cell suffices for four amplifier valves of this type, or two amplifiers and one output.

It has also been used to provide a comparison standard in a pocket

No HT batteries made up from these cells are available, but pro-



The British-made cell is shown here actual size.

duction to special order would be considered.

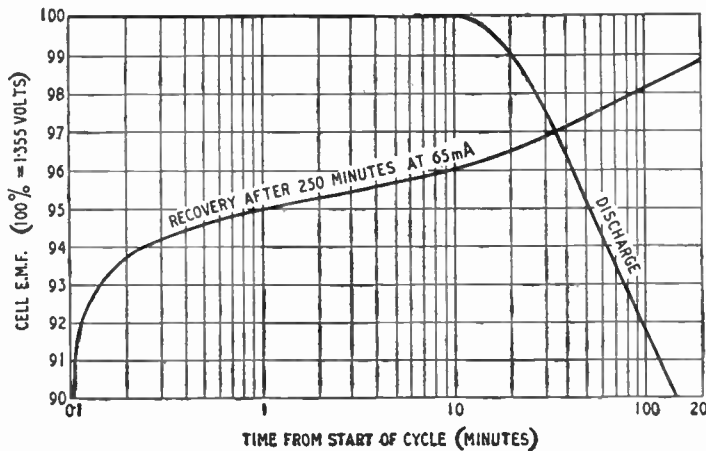

Discharge curves for British-made Mallory cell. Discharge rate, 65mA; recovery discharge 1mA.

instrument for the measurement of light transmission. The high voltage stability is of considerable value here.

The photograph shows the general appearance of the cell and the graph indicates the high voltage stability.

The "Phasitron"

Application in Sound Amplification

AS a result of investigations into the causes of parasitic oscillations in frequency changers (see *Wireless World*, August 10th, 1939) J. A. Sargrove has evolved a sensitive method of detecting small phase differences. When an R.F. voltage is applied to the suppressor grid (G_3) of a pentode under certain conditions, a voltage of similar frequency is induced at the working grid G_1 due to electrons which, by virtue of their velocity, are able to penetrate the positive screen grid (G_2) and impinge on G_1 .

If a tuned circuit is connected between G_1 and earth, the phase of the induced voltage varies as the

circuit is tuned through resonance, and the anode current of the valve which depends upon the relative phase of the voltages on G_1 and G_3 fluctuates first above and then below its mean value. The anode-current/phase characteristic includes a steep straight portion which is chosen for the operating point, and it is then possible to record minute changes of capacitance in the tuned circuit. The efficiency of indication is proportional to the square of the mean frequency and at 40Mc/s the full length of the anode-current/phase characteristic is swept for a change of 0.1 pF.

The system responds to step

changes of capacitance and can be used as an ultra-micrometer. When used in association with a condenser microphone the frequency response could be flat from zero to 1Mc/s (sub-sonic as well as super-sonic) depending on the mechanical characteristics of the diaphragm. The upper limit is set by the filter circuits necessary to eliminate the R.F. component of the output.

At a meeting of the British Kinematograph Society on March 10th, J. A. Sargrove, in collaboration with D. A. Ball and N. Leever, read a Paper on "Phase Modulation Principles Applied to Sound Recording" in which a new condenser microphone for film recording studios incorporating the "Phasitron" system of amplification was described. The condenser diaphragm is only $\frac{1}{16}$ in diameter and causes the minimum disturbance of the sound field. It was pointed out that as the excitation is at 40Mc/s it might be possible to radiate the microphone output from a small folded dipole and so have a number of microphones, working on slightly different frequencies, hidden on the film "set," with a remote pickup and mixing control unit behind the cameras, thus obviating the complication of overhead booms and trailing cables.

A.R.R.I. 1948 Handbook

THIS, the 25th edition of the amateur Radio Relay League of America's Handbook, has been completely revised and now contains 25 chapters of theoretical and practical matter.

It reflects the growing interest of American amateurs in V.H.F. and microwaves, containing as it does practical descriptions of apparatus for use on frequencies up to 21,000 Mc/s.

V.H.F. is dealt with far more comprehensively than hitherto but not at the expense of the still ever popular H.F. bands. Transmitters and receivers to suit all needs are to be found in chapters 5 to 10 inclusive.

The data on American type valves is as comprehensive as ever and this year a table of klystrons has been added. There are two pages of tabular matter on cathode-ray tubes and several of the types listed were used in American Service equipment.

The Handbook is obtainable in this country from A. F. Bird, 66, Chandos Place, London, W.C.2, at 17s 3d including postage, or it can be ordered through the Radio Society of Great Britain (for delivery direct from the U.S.A.) at 12s 6d including postage.

Rectifiers it's plain to see - can be BRIMARIZED with an **★SB3**

THE Brimar metal rectifier type SB3 is a big brother to the popular SB2 and is rated at 250 volts, 65mA. It is fitted with an insulated bracket and may be mounted horizontally on chassis or cabinet as required.

The SB3 will replace the 117Z6GT in the usual American AC/DC/Battery receiver and will substitute for the rectifier sections of types 117N7GT, 117P7GT and 117L/M7GT. In such receivers, the filament supply for the battery valves is taken from the rectified H.T. via a suitable dropping resistor.

After Brimarizing, the H.T. should be between 80 and 100 volts and this must give 1.4 volts across each filament section. To obtain these readings the line cord may need adjustment, an average value being 800 ohms for a mains input of 230 volts.

If modulation hum is present, it may often be eliminated by fitting an 8 mF. condenser between the screen grid (Pin 4) of 1A7G and chassis.

PUNCH HOLES HERE

<p>TYPE 117Z6GT</p>	<p>CHARACTERISTICS</p> <table border="1"> <tr> <td>Type 117Z6GT</td> <td>Type SB3</td> </tr> <tr> <td>Heater Voltage 117 v.</td> <td>—</td> </tr> <tr> <td>Heater Current 0.075 amp.</td> <td>—</td> </tr> <tr> <td>R.M.S. Input 235</td> <td>250 v.</td> </tr> <tr> <td>D.C. Output 60</td> <td>65 mA.</td> </tr> </table>	Type 117Z6GT	Type SB3	Heater Voltage 117 v.	—	Heater Current 0.075 amp.	—	R.M.S. Input 235	250 v.	D.C. Output 60	65 mA.	<p>TYPE SB3</p>
Type 117Z6GT	Type SB3											
Heater Voltage 117 v.	—											
Heater Current 0.075 amp.	—											
R.M.S. Input 235	250 v.											
D.C. Output 60	65 mA.											

TYPE	CHANGE SOCKET		OTHER WORK NECESSARY	PERFORMANCE CHANGE
	FROM	TO		
117Z6GT	International Octal	NO CHANGE	<ol style="list-style-type: none"> Fit rectifier Type SB3. Connect + ve (Red) tag to Pins 4 and 8 of Valve Socket. Connect - ve (Black) tag to Pins 3 and 5 of Valve Socket. 	Receiver will function almost immediately on switching "on," no warm-up time being necessary.

IMPORTANT. The SB3 is a direct replacement for the rectifier type RD18/9/1 used in the new "Double Decca" and Collaro "Microgram."

★ Supplies of Type SB3 may be obtained via your wholesaler from: Standard Telephones and Cables Limited, Valve Works, Footscray. Retail price - 10/6 each.

BRIMAR RADIO VALVES

STANDARD TELEPHONES AND CABLES LIMITED, FOOTSCRAY, SIDCUP, KENT.

The next issue will BRIMARIZE Types 117L/M7GT, 117N7GT & 117P7GT

117Z6GT

INSTRUCTIONS: Punch holes where indicated, cut away this portion and file for reference guide.

14

*Virtually
Distortionless*

MODEL A.D./47 10-VALVE TRIODE CATHODE FOLLOWER AMPLIFIER

This is a 10-valve amplifier for recording and play-back purposes for which we claim an overall distortion of only 0.01 per cent., as measured on a distortion factor meter at middle frequencies for a 10-watt output. The internal noise and amplitude distortion are thus negligible and the response is flat plus or minus nothing from 50 to 20,000 c/s and a maximum of .5 db down at 20 c/s.

A triple-screened input transformer for $7\frac{1}{2}$ to 15 ohms is provided and the amplifier is push-pull throughout, terminating in cathode-follower triodes with additional feedback. The input needed for 15 watts output is only 0.7 millivolt on microphone and 7 millivolts on gramophone. The output transformer can be switched from 15 ohms to 2,000 ohms, for recording purposes, the measured damping factor being 40 times in each case.

Built-in switched record compensation networks are provided for each listening level on the front panel, together with overload indicator switch, scratch compensation control and fuse. All inputs and outputs are at the rear of the chassis.



Send for full details of Amplifier type AD/47

C.P.20A. 15 WATT AMPLIFIER

for 12 volt battery and A.C. Mains operation. This improved version has switch change-over from A.C. to D.C. and "stand by" positions and only consumes $5\frac{1}{2}$ amperes from 12 volt battery. Fitted mu-metal shielded microphone transformer for 15 ohm microphone, and provision for crystal or moving iron pick-up with tone control for bass and top and outputs for 7.5 and 15 ohms. Complete in steel case with valves.

As illustrated. Price £28 0 0



RECORD REPRODUCER

This is a development of the A.C.20 amplifier with special attention to low noise level, good response (30-18,000 cps.) and low harmonic distortion (1 per cent. at 10 watts). Suitable for any type of pick-up with switch for record compensation, double negative feedback circuit to minimise distortion generated by speaker. Has fitted plug to supply 6.3 v. 3 amp. L.T. and 300 v. 30 m/a H.T. to a mixer or feeder unit.

Complete in metal cabinet and extra microphone stage. As illustrated. Price 25½ Gns. CHASSIS, without extra microphone stage. Price £21.



EXPORT

Enquiries from Overseas will receive prompt attention. CONTINENTAL BUYERS are invited to get into touch with our Belgian Agents:

Ms. Constant L. Bisman,
129 Avenue de la Reine,
Bruxelles
Téléph. 16.10.31.

Vortexion
LIMITED

257-261 THE BROADWAY, WIMBLEDON, LONDON, S.W.19

TELEPHONES: LIBerty 2814 and 6242-3.

TELEGRAMS: "VORTEXION, WIMBLE; LONDON."

Television E.H.T. Supply

2.—Voltage Multipliers: New Low-voltage Input Circuit

IN the first article¹ the performance requirements of a good E.H.T. supply were considered and three alternative systems were discussed. These were (a) E.H.T. mains transformer and rectifier, (b) R.F. power oscillator and rectifier and (c) Pulse-driven voltage-multiplier fed from the line output transformer. In ad-

dition to the last two methods of dispensing with the E.H.T. mains transformer, the writer has recently proposed a multiplier-circuit which achieves the same object by producing E.H.T. from

the normal centre-tapped H.T. transformer without using an excessive number of multiplying stages.

Almost all present-day television receivers include a mains transformer having a centre-tapped H.T. winding for the provision of the anode supply to the receiver and time-base valves. This transformer is usually wound for 350-0-350 volts. Consequent-

¹ Wireless World, April 1948.

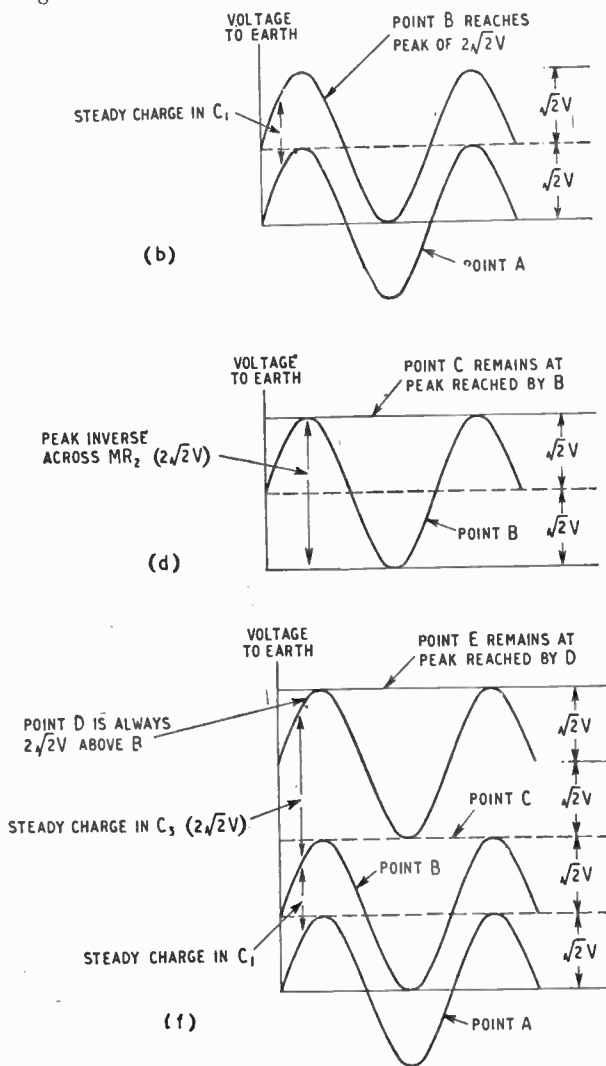
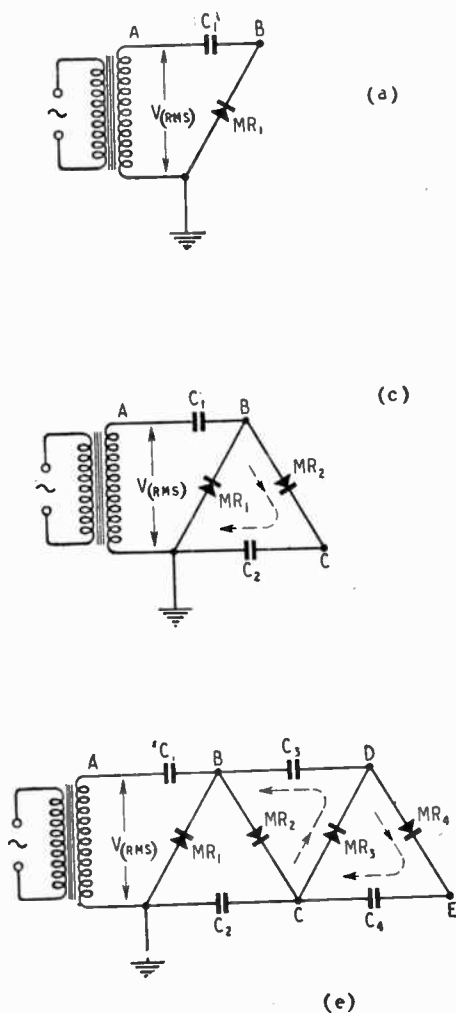

Fig. 6. Principle of operation of the Cockcroft-Walton voltage multiplier.

Television E.H.T. Supply—

ly most sets have available a 700-volt A.C. supply with an earthed centre tap, and it would be very useful if this could be used to produce an E.H.T. supply by some form of voltage multiplier. This cannot be achieved economically with conventional multiplier circuits, but in order to follow the development of the proposed system it is useful first to consider a normal Cockcroft multiplier and to analyse its operation.

Cockcroft Multiplier. A single half-wave section is shown in Fig. 6 (a), and in (b) the various potentials with respect to earth are illustrated as waveforms. The voltage to earth at point A is the transformer voltage as shown in Fig. 6 (b), but since capacitor C_1 soon becomes charged to the peak of the supply voltage, the voltage to earth at B is the same input voltage as at A, but with the addition of the steady charge on C_1 , so that the positive peak reached at B is the original peak at A ($=\sqrt{2} V$) plus the charge on C_1 ; that is, a total of $2\sqrt{2} V$. This peak voltage at B can easily be

easy going, but it is usually found more difficult to visualize the operation of the later stages. However, looking again at (d), it can be seen that, while point C remains at a steady positive potential, point B reaches earth potential once every cycle. Now, forgetting absolute voltages to earth for a moment, and thinking only of relative voltages, this means that once in every cycle, C becomes *positive* with respect to B to the extent of the full double-peak voltage of the input wave. When this happens there is no reason why a half-wave rectifier and capacitor should not be joined between C and B to take advantage of this fact, as it is a purely "local" matter concerning only the points B and C, and the relative potential between them. This has been done in Fig. 6 (e) with MR_3 and C_3 , and just as in a normal half-wave circuit, forward current will flow through MR_3 as indicated, and C_3 will charge up to the peak of the voltage between C and B. The result is that the point D will remain *permanently* above point B at the maximum

B, but that B sinks below C. We have now a steady charge in C_3 equal to $2\sqrt{2} V$, and therefore the potential to earth of point D is easily obtained by adding this to the potential of point B. This is seen in Fig. 6 (f), and clearly, a peak of $4\sqrt{2} V$ to earth is reached by D every cycle. This peak voltage to earth can be rectified and stored by MR_4 and C_4 (just as the high peak voltage to earth of point B was rectified and stored by MR_2 and C_2), so that point E remains permanently at the peak reached by D once per cycle; i.e., $4\sqrt{2} V$.

To recapitulate briefly, when the earthed end of the transformer is positive with respect to A, MR_1 charges C_1 to the *relative* peak between A and earth, and MR_3 charges C_3 to the *relative* peak between C and B; in the next half-cycle, when A is positive with respect to earth, MR_2 charges C_2 to the peak voltage reached by B, and MR_4 charges C_4 to the peak voltage reached

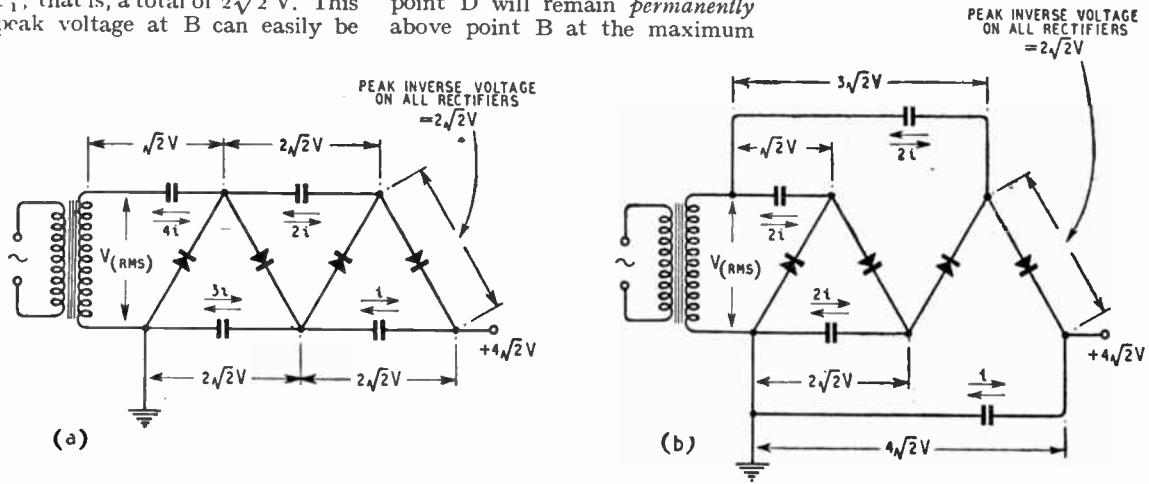

Fig. 7. (a) Series-fed multiplier; all capacitors, except the first, charge to equal voltages, but must carry different currents. (b) Parallel-fed multiplier; all capacitors, except the last, carry equal currents, but must withstand different voltages

rectified and stored by adding a further rectifier and capacitor as shown in Fig. 6 (c). At each cycle when point B reaches the peak, a current will flow into C_2 through MR_2 as shown, and will soon charge C_2 up to the peak voltage reached by point B (i.e., $2\sqrt{2} V$). There will then be this steady voltage available at C without any superimposed alternating voltage [Fig. 6 (d)]. Thus far it has been

potential which C ever reaches above B or, in other words, C_3 becomes charged to a steady potential of $2\sqrt{2} V$.

By considering relative voltages only, and realizing that C becomes *positive* relatively to B, and therefore carries D with it, we avoid the difficulty which results from trying to visualize the absolute conditions, which are of course that C does not rise above

by D. Naturally, any number of stages can be added, the only limitation being the voltage drop in the feed capacitors along the chain.

Series or Parallel Feed. Since in Fig. 6 (e) the alternating feed current to all the rectifiers has to be conveyed along the chain of series-connected capacitors, this current is greatest near the transformer, and decreases along

the cascade. It is, therefore, clearly desirable (particularly with a large number of stages) to use larger capacitors at the feed end, and to decrease the values progressively along the cascade.

This arrangement is known as a "series fed" multiplier, and although it ideally requires graded capacitance values, it has the advantage that all the capacitors (except C_1) can be rated for equal voltages. In Fig. 7 (a) this circuit is redrawn, but with the voltage and current distribution indicated, in order to bring out the points of difference from Fig. 7 (b) which shows the "parallel-fed" arrangement. In the parallel-fed circuit, all the feed capacitors are returned directly to the transformer, and have to carry equal currents (except the last); they can therefore be made equal in capacitance, but have to withstand progressively increasing voltages along the cascade as indicated in Fig. 7 (b).

Ripple and Regulation. From what has been said it will be apparent that the cascade multiplier is virtually a series of half-wave rectifier circuits, so contrived that each succeeding section rectifies and stores the peak-inverse voltage developed across the rectifier of the previous section. In a simple half-wave circuit the forward pulse of current through the rectifier which occurs once in each cycle, has to replace the charge given up by the capacitor to the load during the remainder of the cycle. The ripple voltage is, of course, due to the fact that the capacitor voltage must drop while it is being discharged, and must rise again during the recharging period. The extent of this voltage drop depends on the discharge current I , the time of discharge t , and the capacitance C . If V_R is the ripple voltage, Q is the capacitor charge in coulombs and q is the change in charge, then

$$q = It$$

$$\text{but } Q = CV$$

$$\therefore V_R = \frac{q}{C} = \frac{It}{C}$$

If f is the operating frequency, we may write $t = 1/f$ hence

$$V_R = I/fC$$

Now, in the series-fed multiplier of Fig 6 (e), the total ripple voltage is the sum of the in-

dividual ripple voltages on C_2 and C_4 , so that

$$V_R = \frac{I}{f} \left(\frac{1}{C_2} + \frac{1}{C_4} + \dots + \frac{1}{C_n} \right)$$

and it can be shown that for a

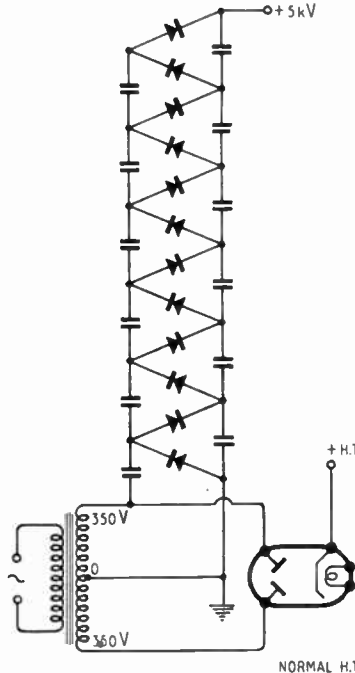

Fig. 8. A series-fed multiplier coupled to half of the H.T. transformer winding. At least 12 stages are needed to develop 5 kV on load and the voltage regulation is much too poor for television purposes unless the capacitors are made uneconomically large.

total of n full stages (i.e., $2n$ capacitors and $2n$ rectifiers)

$$V_R = \frac{I}{fC} \cdot n \left(\frac{n+1}{2} \right) \dots (1)$$

This relationship shows that the ripple voltage can be reduced by reducing the load current or increasing either the frequency or the capacitance values, but that the ripple increases with an increasing number of stages.

By a similar analysis it can also be shown² that the voltage regulation V_d (or steady voltage drop from the theoretical output voltage), assuming perfect rectifiers, approximates to

$$V_d = \frac{I}{fC} \cdot \frac{2n^3}{3} \dots (2)$$

By comparing equations (1) and (2) it is interesting to note that the

² Cockroft & Walton, *Proc. Roy. Soc.*, 1932, Vol. 136, p. 619.

ripple voltage is roughly equal to the regulation voltage drop divided by the number of full stages n .

E.H.T. from the Normal H.T. Transformer. When applying a multiplier to a normal 350-0-350 volt transformer, the first natural step is to connect the series-fed multiplier of Fig. 7 (a) to one-half of the normal transformer, as shown in Fig. 8, so that the earth side of the multiplier is joined to the transformer centre tap. This will produce E.H.T., but since only half the transformer winding is used, the number of stages required is excessive. For example, if a 350-0-350 volt transformer is used, the theoretical output stage on no-load will be only $\sqrt{2} \times 350 = 500$ volts, while the average stage output when loaded will be about 20 per cent lower, so that 12 or 14 stages will have to be used. Apart from this complication, the performance will be very poor, since, as we have seen above, the regulation increases as the square³ of the number of stages, and it would be quite impracticable to achieve the figure of 10 per cent per 100 micro-amperes change which we have seen is the worst regulation which can be tolerated (see Part 1).

In an attempt to improve

³ Equation (2) shows that the absolute value of the regulation voltage drop is proportional to n^3 , but since the output voltage is proportional to n , the percentage regulation varies approximately as n^2 .

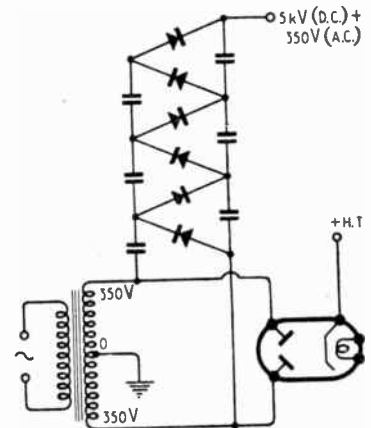

Fig. 9. A series-fed multiplier connected across the whole centre-tapped transformer winding is also unusable for television, as 350 volts A.C. is added to the E.H.T. generated by the multiplier.

Television E.H.T. Supply—

matters the multiplier might be connected across the whole transformer winding as in Fig. 9. This immediately halves the number of stages required, and improves the regulation by a factor of 4, but unfortunately half the transformer voltage (350 volts A.C.) becomes added to the steady voltage produced by the multiplier, so that the E.H.T. output is unusable for television purposes.

These difficulties can be overcome by the new circuit⁴ shown in Fig. 10. Here two half-voltage rectifier sections MR_1 and MR_5 are used at either end of the cascade, thus enabling A.C. symmetry to be preserved, and preventing any alternating voltage from being injected into the high-voltage output. Moreover, the unwanted alternating voltages at both ends of the multiplier now become rectified by MR_1 and

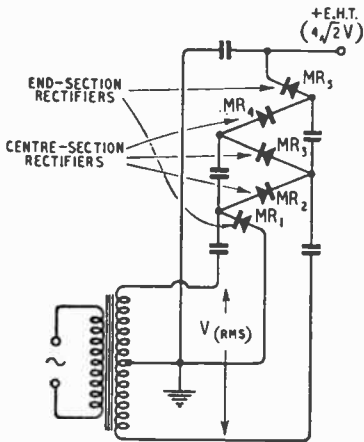

Fig. 10. New multiplier arrangement suitable for operation from a transformer with an earthed centre tap. The circuit is symmetrical, provides full-wave rectification, and does not inject A.C. into the E.H.T. output. Additional stages may be added at the centre without disturbing the symmetry. Negative E.H.T. can be obtained by reversing the rectifiers.

MR_5 and contribute to the E.H.T. output, while the central rectifiers MR_2 , MR_3 , and MR_4 still continue to multiply the peak of the total transformer voltage. In Fig. 10, only three full sections are shown

for simplicity, together with two half sections, but since these half sections contribute to the output, the total E.H.T. voltage is exactly the same as if four full sections had been used; i.e., $4\sqrt{2}V$. This circuit can be fed, as it stands, from an existing centre-tapped transformer which is already feeding a conventional centre-tapped rectifier for normal H.T. purposes. Thus, both H.T. and E.H.T. supplies can be satisfactorily derived from the same winding, and they will have a common earthed negative pole, as shown in Fig. 11.

However, there is a further modification which can be made to the basic circuit of Fig. 10 which will enable a somewhat higher output voltage to be obtained without using any more multiplier sections, and this is shown in Fig. 12. Here the feed-end half-section rectifier, MR_1 (which, in Figs. 10 and 11, was returned to the rectifier valve cathode. Owing to the presence of the large reservoir capacitor C_R , this point is virtually at earth potential as far as alternating voltages are concerned, so that the operation of the multiplier is not affected. The mean potential of the cathode, however, is about 400 volts positive to earth, so that this additional voltage will be passed along the rectifier cascade and will increase the E.H.T. output voltage by the same amount. It almost appears that this advantage has been gained without any corresponding cost, and this is almost true, but in fact the voltages on C_1 and C_2 are both increased, as well as the desired increase in voltage on C_3 . In general, if the total transformer voltage is V_{RMS} and the number of full section rectifiers is $2n$, as before, the theoretical open circuit output voltage will be $\sqrt{2}V(2n + 1.5)$, and the earlier calculations on ripple voltage and regulation will still apply to a first approximation. Capacitor voltage ratings should be as follows,

$C_1, \sqrt{2}V; C_2, \sqrt{2}V(2n + 1.5);$ all others $2\sqrt{2}V$. For the arrangement of Fig. 12, therefore, and assuming a 350-0-350 volt sinusoidal input, the theoretical maximum output would be 6.5 kV. C_1 would be rated at 1 kV and all

other capacitors at 2kV. These voltages, however, are open circuit figures, and assume no leakage

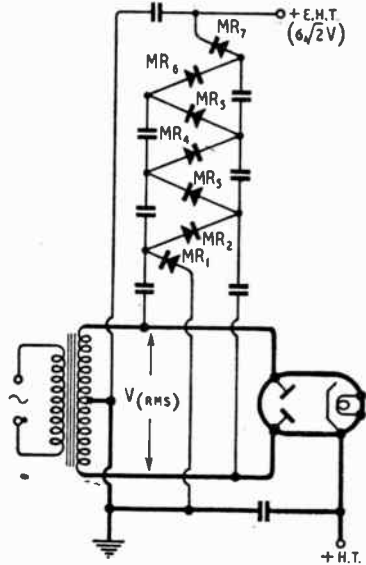

Fig. 11. The multiplier of Fig. 10 may be directly connected to a transformer which is already supplying H.T. through a normal rectifier (shown in heavy lines). Both E.H.T. and H.T. supplies then have a common earthed negative pole.

current in the rectifiers. In practice, both the forward resistance and reverse leakage of the rectifiers limit the output voltage reached on open circuit, and by good design this limiting effect can be used to obtain better regulation than would be possible with rectifiers having no reverse leakage at all.

The "Westekt" Unit. We have seen that by using the circuits of Figs. 10, 11 or 12, it is possible to derive E.H.T. voltage efficiently from the existing transformer without making any alteration whatever to the normal H.T. rectifier circuit. This means that, quite apart from the possibility of incorporating the circuit in new receivers it would be particularly useful to have it available as a complete "add-on" unit which could be used to provide E.H.T. from the ordinary transformer in receivers which have been put out of action through failure of the E.H.T. transformer. The recently introduced "Westekt" E.H.T. supply

⁴ Patents pending.

unit, which incorporates this circuit, has been designed with this in view. The complete circuit is shown in Fig. 13, together with the approximate distribution of potentials up the cascade when operating under load, and fed from a 350-0-350 volt transformer. In its mechanical form the rectifiers are mounted horizontally on one side of an insulating panel, while the feed capacitors are arranged vertically on the opposite side.

To protect the components from damage, and from electrostatically attracted dust, and also to reduce the risk of shock, the assembly is normally mounted in a housing consisting of a vertical tube of insulating material to which the moulded end plates are cemented, the E.H.T. terminal being brought

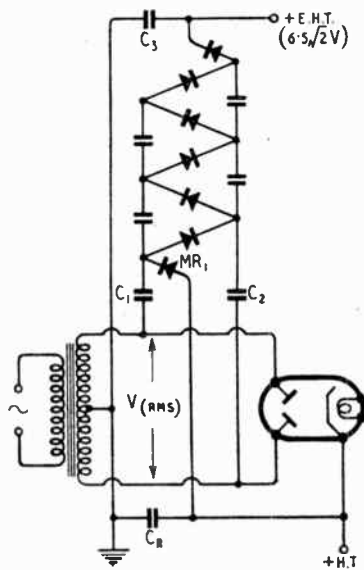

Fig. 12. By connecting the negative end of the half-section feed-end rectifier (MR1) to the rectifier valve cathode, the normal H.T. voltage becomes added to the multiplier output voltage without disturbing its operation. In practice this adds about 400 volts to the E.H.T. output.

out at the top. The base is designed for single hole fixing to the chassis, and three clearance holes are also required to accept the projecting bosses which carry the colour-coded input tags through the chassis. The chassis area required is less than that which would be occupied by an E.H.T. transformer with its asso-

ciated rectifier, while advantage has been taken of the great headroom which is normally available in a television receiver on account of the large cathode-ray tube. The total weight is much less than the weight of an E.H.T. transformer, and apart from any other advantages, it is worth noting that no scarce materials, such as silicon steel or fine-gauge copper wire, are needed.

The regulation is shown in Fig. 14 and it can be seen that it is only approximately 7 per cent by our earlier definition, and this is well within the allowable limit of 10 per cent. The output ripple is very small, since rectification is full-wave instead of the usual half-wave, and no smoothing is necessary beyond the single reservoir capacitor, which should be 0.05 to 0.1 μ F; no series smoothing resistor is needed. In fact, since the reservoir capacitor also acts as the feed capacitor to the final half-section rectifier, it is important to note that no resistor should be connected between it and the output terminal of the Westeht, or the E.H.T. voltage will be reduced, and the regulation will be impaired. Some reduction of output voltage is possible without affecting the regulation or reducing the input voltage by connecting the lead marked "yellow" in Fig. 13 to earth instead of to the rectifier-valve cathode; the circuit then becomes that of Fig. 11, and the E.H.T. voltage will be reduced by about 400 volts.

Summary — Future Trends. — Although it is perhaps unwise to attempt to forecast future developments in such a rapidly advancing subject, it is probably true to say that the recent development of miniature high-voltage metal rectifiers will result in the wider use of multiplier circuits in many varied forms. For low-priced receivers which do not include a mains transformer, the pulse multiplier operating from the line fly-back (Part 1) now appears very attractive; while for medium-priced

receivers, and for the rapid servicing of sets with faulty E.H.T. transformers, the

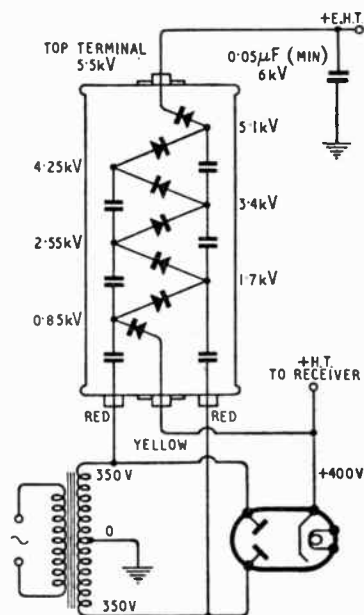

Fig. 13. Complete Westeht (Model 1) circuit showing how the unit is fed from a conventional centre-tapped transformer and rectifier. The approximate distribution of potential on load is shown.

"Westeht" unit offers advantages. For future requirements of 25 to 50 kV in projection receivers, the E.H.T. mains transformer and valve rectifier system becomes very bulky and heavy if adequately insulated, and it now seems very probable that it will be replaced

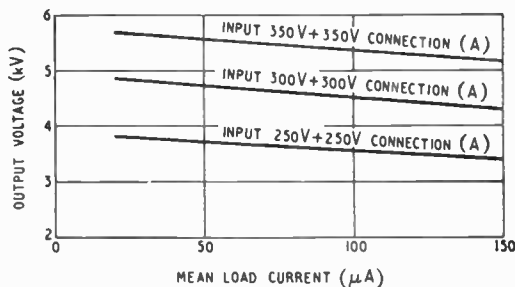

Fig. 14. Output voltage curves of typical Westeht unit for various input voltages.

by multiplier circuits using high-voltage metal rectifiers, or by specially developed high-frequency E.H.T. power packs.

Physical Society's Exhibition

New Testing and Measuring Equipment

AT the third post-war Exhibition of the Physical Society, held in London from 6th - 9th April, the application of radio technique to non-communication purposes was prominent, as was the use of radar methods in other branches of physics. Generally, there was more emphasis on research and development than on production techniques

Research Section

Examples of the travelling wave tube, which provides a new method of obtaining high amplification over a wide band at extra-high frequencies, were shown by G.E.C. and Standard Telephones. The S.T.C. tube was demonstrated under working conditions giving a 20 db gain at centimetre wavelengths.

Component parts of a miniature magnetron for the so-called Q band were displayed by Admiralty Experimental Establishments. With an external diameter of the same order as a standard receiving valve, this magnetron has a peak power output of 15 kW at a wavelength of 8 mm. An interesting demonstra-

tion of the optical properties of millimetre waves was given, using as a detecting screen a copper plate with a pattern of $\frac{1}{2}\lambda$ slots in an atmosphere of neon at 150 mm/Hg.

Energy falling on the plate causes the slots to fill with the characteristic neon glow in the region of excitation. The demonstration included diffraction, change of polarization at reflection and focusing by metal lenses.

A sensitive D.C. amplifier making use of a magnetic transductor to modulate an A.C. source was shown by Ferranti. The sensitivity is greater than that obtainable from a moving-coil galvanometer and the instrument can be used under conditions of vibration which would rule out the use of a galvanometer. The principle can also be used for power control and examples of its application in this connection, with the gain increased by positive feedback, were demonstrated by Elliott Bros.

Methods of measurement formed a large proportion of the exhibits in the research section. The N.P.L. demonstrated the measurement of the velocity of propagation of electromagnetic waves by the frequency of resonance in a cylindrical cavity, and B.T.-H were showing a resonant cavity method of determining dielectric loss and permittivity at frequencies in the range of 8,000-10,000 Mc/s.

Ferranti magnetic amplifier.

A disc specimen of material under test is placed on the tuning piston of the cavity. The permittivity is obtained in terms of the change of resonant length of the cavity and

the dielectric loss by the change in Q at resonance.

A simple method of impedance measurement giving results better than ± 5 per cent in the frequency range 30-500 Mc/s was demonstrated by G.E.C. Research Laboratories. By using exponential capacitances in the ratio arms of the bridge a range of 1 to 100,000 ohms can be covered by a single scale. The impedance is compared with a standard 100-ohm resistor and a

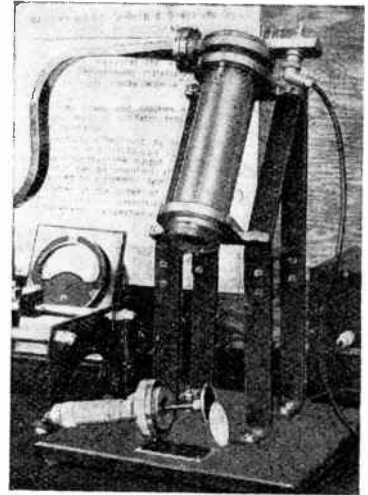

Cavity resonator for measurement of dielectric loss and permittivity (British Thomson-Houston).

tuning head is provided so that the susceptance of the impedance to be measured can be tuned out, if desired.

The Post Office Engineering Dept. exhibited a speech transmission system used in determining the optimum characteristics of hearing aids, and also a probe microphone for use in conjunction with an artificial ear. They were also showing a speech spectrum integrator for measuring the total energy in a series of half-octave bands over a timed period. The method is used to determine the characteristics of

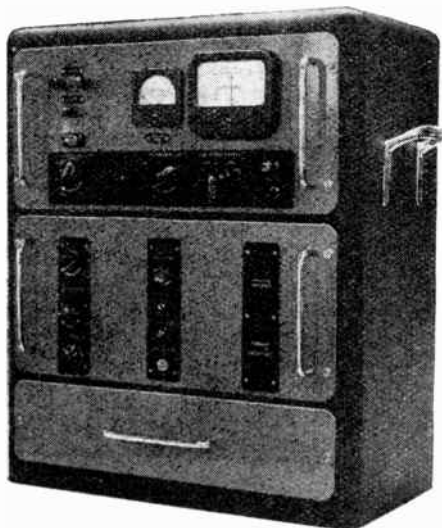

microphones when held close to the mouth.

Apparatus for the investigation of architectural acoustics by the analysis of C.R.-tube traces of reflected sound pulses was demonstrated by Standard Telephones and Cables.

Marconi's W.T. Co. were showing equipment demonstrating a method of frequency-modulating a quartz crystal. The crystal itself is of special type and consists of a rectangular plate which is much larger than the electrodes and which is supported around its edges in a manner imposing a damping load. The active part of the crystal corresponds to the area covered by the electrodes and the surround bare quartz acts as a filter. By using the crystal in a special circuit a deviation of 1 part in 1,000 is possible.

Two pieces of apparatus designed to reduce the labour of routine measurements and applied to widely different subjects were noted. One was the polar diagram equipment for measuring centimetre aerials shown by Cossor, and the other a B/H curve tracer for magnetic materials by B.T.-H. Both depend upon the application of servo mechanisms and produce large-scale pen tracings on paper.

Many adaptations of radio and radar methods to other branches of

physical science were noted. G.E.C. in conjunction with the Radio Therapeutic Research Unit of the

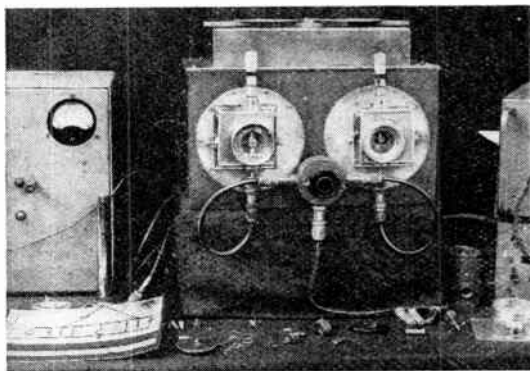

Impedance bridge giving, on a single scale, constant accuracy over the range 1 to 100,000 ohms at frequencies from 30 to 500 Mc/s (G.E.C. Research Labs).

Medical Research Council had in operation a linear accelerator employing a pulsed magnetron in conjunction with a wave guide and iris-loaded cylindrical resonator. The latter is virtually a succession of resonant cavities in which adjacent cells are designed to oscillate with a 180° phase difference when excited at the correct frequency. Electrons injected at one end of the resonator at a critical velocity are

further accelerated to speeds approaching the velocity of light and energies of the order of 5 to 20 Mev. The difficulty of obtaining stable operation of the magnetron under the varying load (during the build-up period of the pulse) presented by the high Q of the resonator elements has been solved by careful design of the wave guide coupling system, which includes a stabilizing water load.

Radar technique has been applied by the Post Office to the location of faults in overhead lines by the examination of pulse reflections displayed on a C.R. tube. The equipment was shown in operation on an artificial line and photographs of characteristic responses demonstrated the effect of various faults.

B.T.-H demonstrated a relative velocity indicator operating on the radio Doppler principle which was employed in the proximity fuse. Indication was given on a meter calibrated directly in m.p.h.

Electronic counting methods have come into prominence recently in connection with nuclear research and an elaborate pulse amplitude analyser and counter for sorting the various responses of an ionisation chamber was shown in operation by the Atomic Energy Research Establishment Electronics Group.

Trade Section

Valve - Voltmeters. — The valve-voltmeter originally designed for A.F. and R.F. measurements is now being used as the nucleus of multi-range measuring instruments and other comprehensive test sets. Its high input impedance is particularly valuable for many D.C. voltage

measurements for often a fraction of a milliamp load will lead to an ambiguous voltage reading.

Avo use a valve-millivoltmeter as the basis for their multi-range Electronic Tester and by so doing achieve a D.C. voltmeter resistance of $11\text{ M}\Omega$ on all ranges up to 1,000 volts. A multiplier raises this to $110\text{ M}\Omega$ and increases all ranges ten times. This instrument provides no fewer than 49 ranges of volts, current, power, resistance, capacitance, and R.F. voltage up to 200 Mc/s.

A valve-voltmeter is again the nucleus of the Micovac multi-range tester made by Electronic Instruments. As a D.C. or A.C. voltmeter the resistance is $1\text{ M}\Omega$ per volt. This meter embodies a V.H.F. probe and R.F. voltage measurements can be made up to 200 Mc/s.

Metropolitan-Vickers adopt a similar principle in their multi-range test set, the valve-voltmeter being usable for R.F. measurements, while on the A.C. and D.C.

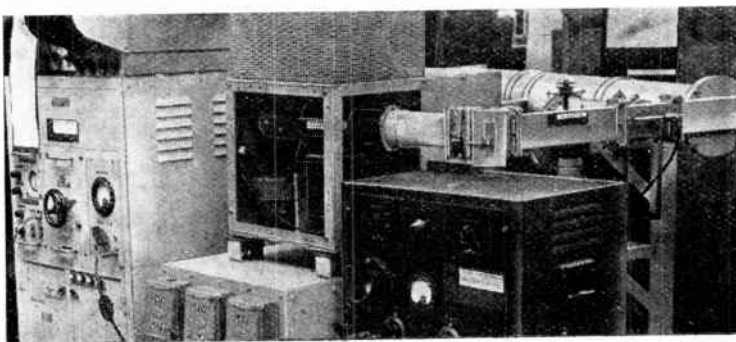

Pulsed magnetron (left) and wave-guide system energizing multi-cell cylindrical resonator for accelerating electrons in the range 5 to 20 Mev (G.E.C. Research Labs).

Physical Society's Exhibition— ranges the resistance is $4\text{ k}\Omega$ per volt. A wide-range volt-ohmmeter of the same basic style having an A.F.-R.F. range of 50 c/s to



Rediffusion valve kilo-voltmeter Type M36 for measuring R.F. up to 15 kV and to 30 Mc/s .

50 Mc/s , and using a detachable probe unit, was shown by Sifam.

A valve kilo-voltmeter has been designed by Rediffusion for use in research and development laboratories and for R.F. measurements on industrial electronic apparatus. By means of three auxiliary units, each covering two voltage ranges, provision is made for R.F. voltage measurements up to 15 kV and to 30 Mc/s .

A departure from customary practice was noticed in the Marconi Instruments Type TF899 valve



Valve milli-voltmeter Type TF899 made by Marconi Instruments.

milli-voltmeter where a triode mounted in a probe is used in place of the more usual diode. It is usable up to 100 Mc/s and in three ranges gives R.F. voltage measurements up to 200 mV .

Signal Generators.—The familiar standard signal generator, which at one time occupied a very pro-

minent place among test equipment, appears to have retreated into the background this year and to have given way for more specialized types of R.F. and A.F. generators.

Furzehill Laboratories showed a portable frequency standard using a quartz crystal oscillator on 1 Mc/s with which is synchronized a series of multi-vibrators giving outputs of 1 kc/s , 10 kc/s and 100 kc/s respectively. All these generators are very rich in harmonics and together provide a wide range of check frequencies of high accuracy extending up to and beyond 50 Mc/s .

Several interesting A.F. generators have made their appearance, one by Elliott Bros. being a high-power precision generator covering a range of 40 to $2,500\text{ c/s}$ with a short-period stability of one part in $20,000$. A voltage or current output up to a maximum of 75 VA is available, according to the nature of the test work to be undertaken.

For general A.F. testing Dawe Instruments have developed a range of resistance-tuned oscillators covering 0.1 c/s to 5 Mc/s . The lowest range is covered by the Type 400C which extends from 0.1 c/s to $1,000\text{ c/s}$ in four bands. It gives 100 mW output into $10,000\text{ ohms}$, or 50 mW into $5,000\text{ ohms}$ and is balanced to earth.

An A.F. oscillator, described as Type F, for modulating R.F. signal generators was shown by Advance Components. It covers 50 to $10,000\text{ c/s}$ and gives 1 watt output which is maintained at $\pm 2\text{ db}$. The total harmonic and noise content

Sullivan direct-reading Universal Inductance Bridge covering 1 pF to 100 H . Attachments are available for the measurement of capacitance and inductance with superimposed D.C.

is less than 3 per cent of the full output when measured at $1,000\text{ c/s}$.

Another variable frequency generator, in this case covering 25 c/s to 100 kc/s and using an R-C oscillator circuit, was shown by Pye. The output can be monitored and it provides 20 volts into a $6,000\text{ ohms}$ line or 1.0 volt into 600 ohms as required. The total harmonic content is less than 1 per cent of the maximum output. All these oscillators are mains operated and the majority are self-contained, being reasonably compact and portable.

Bridges.—A compact and portable bridge for carrying out a wide range of measurements on components of various kinds was shown by Wayne-Kerr. Described as the Model B101 Components Bridges it has the advantage that in most cases components can be measured



Type 400C A.F. generator covering 0.1 to $1,000\text{ c/s}$ made by Dawe. This is one of a range extending to 5 Mc/s .

in situ. It covers resistance from $2\text{ }\Omega$ to $500\text{ M}\Omega$, capacitance from 2 pF to $500\text{ }\mu\text{F}$, inductance from $0.1\text{ }\mu\text{H}$ to $5,000\text{ H}$, all with an accuracy of less than ± 2 per cent. It also covers leakage measurements on electrolytics, power factor and Q values.

Another very versatile bridge for

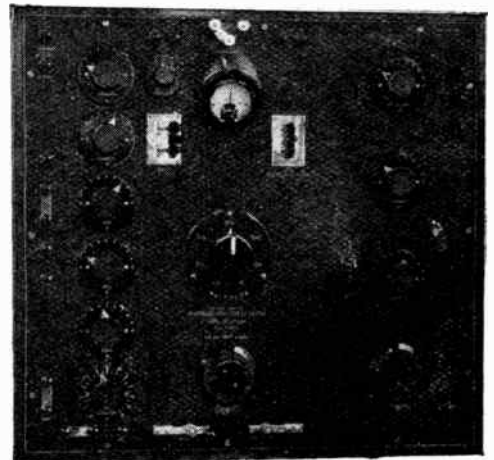

measurements at radio frequency is the General Purpose Bridge, Type 940162, shown by Pye. Made in three complementary units it provides inductance measurements from 10 to 20,000 μ H, capacitance from 10 to 950 pF and resistance from 10 to 20,000 Ω . Components can be measured whose reactance changes from capacitive to inductance reactance according to the applied frequency and the critical frequency determined if within the range of the bridge oscillator. This covers 100 kc/s to 5 Mc/s with an accuracy of ± 1 per cent.

For laboratory use Sullivan were showing an improved version of their direct-reading Universal Precision Inductance Bridge having an overall accuracy better than ± 0.1 per cent and covering capacitance from 1 μ H to 100 H and with attachments provides for the measurement of capacitance and inductance with superimposed D.C. at the same high order of accuracy.

A new item of measuring equipment shown also by Sullivan was a bridge for resistance measurements in either absolute or international units.

There were several self-contained



Sullivan A.F. power oscillator for energizing a bridge.

wheatstone bridges incorporating the galvo and the battery, Pye in particular showing this style of apparatus.

A tendency towards the production of special power sources for energizing bridges is exemplified by the Sullivan Fixed-Frequency Oscillator. With an output of 1 W at three different impedance values, it can be supplied for frequencies of 800, 1,000 or 1,600 c/s.

Miscellaneous Measuring Apparatus.—A heterodyne wavemeter covering 100 kc/s to 20 Mc/s in

eight switched ranges was seen on the Plessey stand. The output

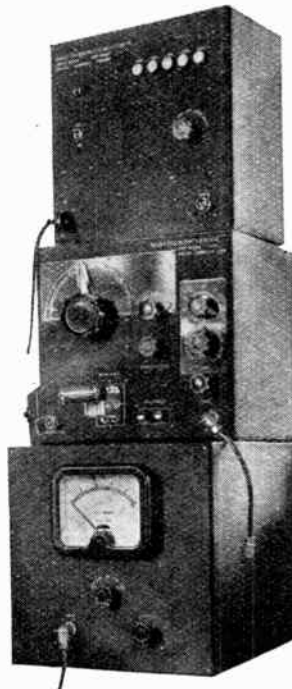

Pye General Purpose R.F. Bridge, including oscillator, bridge and detector units. Normally they would be assembled side-by-side.

from the R.F. oscillator is substantially pure in order to avoid ambiguity. Measurements are made by injecting the signal into the wavemeter and setting the internal circuits to resonance by the zero-beat method using headphones. It is essentially a precision instrument and the accuracy is better than ± 0.2 per cent throughout. A crystal-controlled oscillator giving an output at either 10 kc/s or 100 kc/s and rich in harmonics is included for checking the calibration. Further examples of laboratory-type heterodyne wavemeters were included in Sullivan's exhibit.

Another new piece of apparatus introduced only recently by Plessey is an Impedance Meter for measurements on A.F. transformers and chokes. It operates on the prin-

ciple of equalizing the voltage drop across a known resistance and the unknown, both being supplied from a source of A.C. at 400 c/s. Apart from a phase angle control only one other control is used and this is attached to a scale giving direct readings of impedance in ohms. The impedance range is 2-124 k Ω .

Some H.F. and V.H.F. bridges designed especially for impedance measurements on lines and aerials were shown by Wayne-Kerr. The former covered a range of 15 kc/s to 5 Mc/s, while the latter extended from 1 Mc/s to 100 Mc/s.

The pointer-type instruments which form the basis of so much test gear follow established lines in the main. There is a tendency towards the adoption of hermetic sealing and Ferranti exhibited a number in operation while immersed in boiling water.

Sifam have a model with a nominally logarithmic scale obtained through the use of a non-linear shunt, which acts also as an overload protector. An unusual instrument was shown by Nalder-Lipman; this is a meter with a 220° pointer movement. It is available in various sizes from 2½ in to 12 in.

Components.—The Berco range of vitreous resistors has been extended by the addition of the Z type. These are of 42-375 W at 380°C rating and are in values of 0.15-32.2 Ω ; they consist of a corrugated resistance strip wound on a ceramic tube. The standard type is now made with a blade-type fitting and the resistors are all of the same diameter but vary in length according to the value.

A power variable resistor in values up to 15 k Ω is available in ratings



Transformer and choke impedance measuring meter, shown by Plessey.

of 25-300 W. It has a detachable ¼-in shaft so that the units can readily be ganged.

Wire-wound attenuators with an L.F. accuracy of ± 0.1 db were

Physical Society's Exhibition—

shown by Langham Thompson and carbon types accurate within ± 0.25 db. At 15 Mc/s and 30 Mc/s, the changes of accuracy are respectively claimed to be 0.25 db and 0.2 db. Sullivan were also showing attenuators of the T and H types, while Ferranti had miniature enclosed wire-wound variable resistors of precision design.

Special high-value resistors were shown by the G.E.C. Research

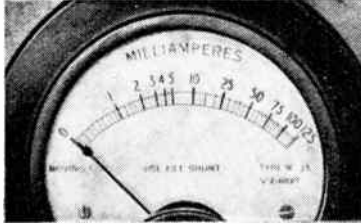

Sifam log-scale milliammeter; 125 mA full-scale; 10 mA half-scale.

Laboratories. Using as a conducting medium a toluene/alcohol/pigric acid mixture resistors of low-temperature coefficient and a value of 10^{10} – 10^{13} Ω have been developed.

Relatively few new capacitor types were on view, but T.C.C. had a range of large-capacitance models intended for photo-flash equipment. Values of $14 \mu\text{F}$ at 2.5 kV intermittent rating are typical. This firm had also a range of components with plastic film dielectric for which exceptionally low leakage is claimed as well as a stable capacitance with time, low-power factor and low-dielectric hysteresis.

An unusual variable capacitor was shown by Labgear. A range of 5–25 pF is obtained by varying the separation of two circular discs by means of a micrometer—the capacitance change being 1 pF per 30 graduations of the barrel.

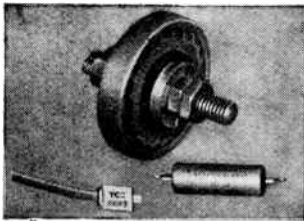

T.C.C. Micadisc lead-through capacitor for radio-heaters, CE70B 30- μF , 15-V electrolytic, and midget silvered-mica by-pass capacitors.

A range of thermally compensated mutual-inductance standards covering $10 \mu\text{H}$ to 0.01 H was shown by Sullivan.

Relays were shown by many firms and miniature types included the Electro Methods Type MIN which measures only $\frac{5}{8}$ in \times $\frac{3}{4}$ in \times $\frac{7}{8}$ in and weighs $1\frac{1}{4}$ oz. There are two coils for series-parallel connection, and two models are available having coils of 100 or 350 Ω . With the latter in series connection the operating current is only 75 μA .

A wide range of centimetre-wave components was exhibited on the Plessey stand. They included piston attenuators and wavemeters for cm-wave operation as well as crystal units, adjustable probes and connectors.

Valves.—A number of special-purpose valves shown by Ediswan included the 6F32 and 6F33. They are screened pentodes with sharp cut-off suppressor-grid characteristics intended for use in modulator, reactance and timing circuits. Cut-off is at about -8V for the suppressor grid. In the case of the 6F33 positive drive on the suppressor grid is permissible, since a built-in diode is tied to it to prevent the grid from locking positive.

For use in stabilizer circuits there are the 29C1, a diode with a directly-heated tungsten filament, and the 12E1. The latter is a tetrode for series or shunt control

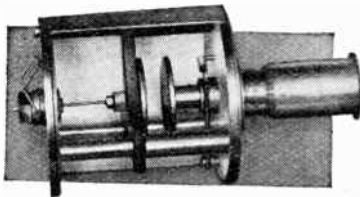

Labgear sub-standard variable capacitor with part of the screening removed.

in stabilized power units. With a maximum rating of 35 W dissipation, the operating limits are 700 V anode potential or 300 mA cathode current, while it will withstand 300 V between heater and cathode.

A neon tube designed for use as a voltage reference-level tube was shown by Mullard. It is the 85Ar with a burning voltage of 85.5 V and a short-term stability of 0.2 per cent; the variation between tubes is limited to 0.5 V. The well-known EF40 range of valves was shown, as

well as the sub-miniature hearing-aid types.

Standard Telephones exhibited a

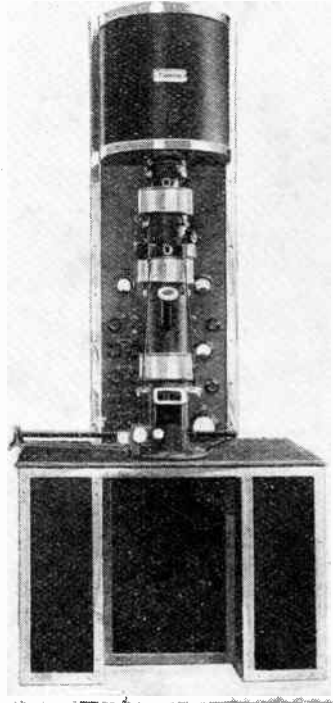

Plessey electron microscope.

number of gas-filled voltage-regulator valves which included sub-miniature types. This firm had on view a new selenium metal rectifier which is designed for use at radio frequencies up to 5 Mc/s, as well as their well-known range of power frequency types. Westinghouse featured the 36EHT copper-oxide rectifiers for low-current high-voltage rectification.

The M.-O. Valve Company was showing a large number of types of all-glass construction, among which the 101-series is interesting in having heaters consuming only 0.1 A. The range includes a triode-hexode, X101, which is claimed to be useful up to 100 Mc/s. Sub-miniature pentodes with 25-mA filaments for hearing aids were shown.

Ferranti showed miniature high-voltage rectifiers as well as cold-cathode tubes and electrometer valves.

Cathode-ray tubes for oscilloscope and radar applications were shown by Ediswan and Cinema Television. Among the former were flat-ended types and some specimens that had

special scales marked directly on the glass.

Metropolitan-Vickers had a new electron microscope giving a magnification continuously variable from 1,000 to 100,000 times, and Plessey were showing an experimental model with a magnification of 20,000 diameters and a resolving power of 100Å. It operates at 50 kV.

Materials.—A series of non-metallic ferrite core materials under the trade name of "Ferroxcube" was shown in various applications by Mullard Wireless Service Company. This material, which has high resistivity and low eddy-current loss, is particularly useful for filter inductances used in the range between audio and radio frequencies. A carrier filter coil in a circuit resonant at 60 kc/s was demonstrated to have the remarkably high Q of 600.

The alloy known as "Permen-dur," made by Telegraph Construc-

tion and Maintenance, has a saturation induction of over 20,000 gauss and is used for the pole pieces of high-grade permanent-magnet loudspeakers. T.C.M. were also showing a comprehensive range of cables including types with expanded Telcothene insulation (capacitance 6 to 8 pF/ft) and anti-microphonic cables in which spurious voltages generated by flexing are dissipated by a conducting surface applied to the insulation where it makes contact with the outer metal braiding.

A new glass, suitable for a jointing technique analogous to soldering, was shown by B.T.-H. and should solve many awkward glass-blowing problems.

Synthetic sapphire, formerly produced in the wastefully shaped "boules," is now being extruded in rod form from a special furnace developed by G.E.C. Research Laboratories.

Microwave Equipment

New Plessey Multi-Channel System

DEVELOPED for use where land-lines are impracticable, the Plessey microwave multi-channel radio communication system provides eight duplex speech channels. The equipment operates on the same basic principles as the Army No. 10 set¹ and similarly uses pulse-width modulation² and a paraboloid mirror at a wavelength of some 6cm. The circuits used, however, differ considerably and of particular interest is the adoption of a common aerial system for transmission and reception.

guide mouth with its convex side facing it. The wave emerging from the guide is reflected back to the mirror by this plate and is then again reflected forwards to form the main radiated beam of some 4° in width. On reception the reverse action takes place.

The radiating system is con-

nected to the equipment proper through a circular waveguide which can be of the flexible type. Separation of the transmitted and received waves is effected at the waveguide termination.

The principle depends on the use of polarization at 90° for send and receive; thus, if one wave is vertically polarized the other is horizontal. The waveguide, which carries both waves, terminates in a Y-branch in the two arms of which are included polarization filters. Within narrow limits these pass only waves of particular polarization. Beyond the filters the guides are terminated in resonant sections and coupled by probes to short lengths of coaxial lines for the connections to the equipment.

Velocity-modulated valves are used both for the transmitter and the receiver oscillators. The former develops some 400 mW peak power and is pulse modulated. The latter is operating continuously and kept to its correct frequency by an A.F.C. system operating on the received signal. A crystal mixer is used with a 6-stage wideband I.F. amplifier.

The pulse system comprises a 9-kc/s oscillator arranged to produce an 8-phase output which, in turn, controls a set of eight multi-vibrator pulse generators.

At a recent trial the equipment was installed, one on the roof of the telephone exchange at Hainault, Essex, and the other on the top floor of the Grandstand, at Epsom, Surrey, the distance being 25 miles. Eight duplex speech channels of excellent quality were obtained and cross-talk appeared to be quite absent. Some background hiss was evident but not to a degree which, in any way, impaired the intelligibility of speech.

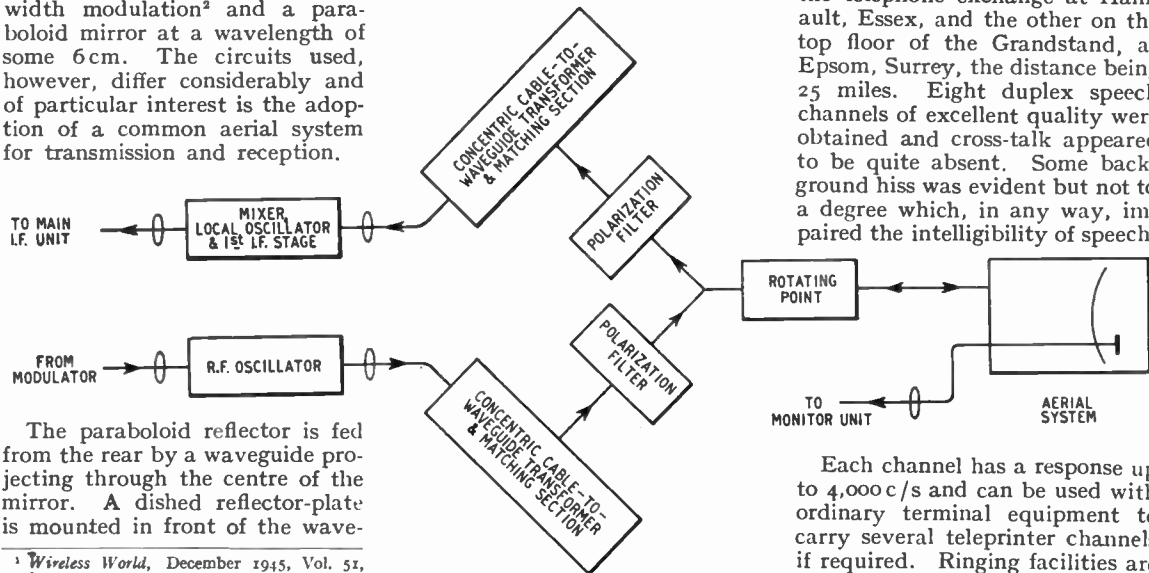

Block diagram of the signal-frequency and aerial systems.

Each channel has a response up to 4,000 c/s and can be used with ordinary terminal equipment to carry several teleprinter channels if required. Ringing facilities are included. The system allows for intermediate relay stations.

¹ *Wireless World*, December 1945, Vol. 51, p. 383.

² *Wireless World*, December 1945, Vol. 51, p. 361.

WORLD OF WIRELESS

P.T. Increases ♦ Extending Television ♦ B.S.R.A. Conference ♦ "Gee" Mechanics Wanted

PURCHASE TAX

CHANGES in the purchase tax chargeable on radio equipment were announced by the Chancellor of the Exchequer in his budget speech.

Radio receivers—whether of the domestic type, or for use in cars—radio-gramophones, television sets, kits of parts and valves are now chargeable at 66½ per cent on the wholesale price instead of 50 per cent. Batteries and accumulators, other than dry batteries of not more than 6 volts, are still chargeable at 33½ per cent. Hearing-aid batteries are exempt.

Loudspeakers, cabinets, transformers, resistances, etc., "when not sold as part of a transaction involving a chargeable receiver," remain untaxed, as do amplifiers, transmitters and hearing-aid valves.

The proposed increases will be the second in a few months. In the 1947 Emergency Budget the tax was increased from 33½ per cent to 50 per cent. The industry rightly complains that the increases will have an adverse effect on it, especially as radio is a rapidly developing industry in which, when once ground is lost it is difficult to regain. Moreover, success in the export market depends on an adequate home market from the point of view of both research and production.

MIDLAND TELEVISION

WORK on the construction of the first Midland television station was begun recently at Sutton Coldfield, near Birmingham, but no date can yet be given as to when it will be brought into service, neither has it been decided on what frequencies the sound and vision transmitters will operate. The 35-kW vision transmitter is being manufactured by E.M.I. and the 12-kW sound transmitter by Marconi's.

The station will transmit the same programme as that radiated from Alexandra Palace and it is the responsibility of the G.P.O. to provide the link between the two stations. In order that both cable and radio can be used experimentally in the initial stages a co-axial cable has been laid and, as already announced, the G.E.C. is erecting radio relay stations.

The radio link includes four relay stations situated at Harrow Weald,

Dunstable, Blackdown Hill near Charwelton, and Rowley Regis, and terminal stations at the Museum Telephone Exchange, London, W.1, and at Telephone House, Birmingham. The programmes will be piped between the terminal stations and the main transmitters.

AERIALS

THE importance of an efficient aerial has often been stressed in *Wireless World* and it is gratifying to find that the industry is recognizing this. The Radio Component Manufacturers' Federation has formed a Panel to consider the classification of broadcast receiving aerials. It is not proposed to produce rigid specifications for standardization but merely a classification by types specifying technical requirements.

The results of tests undertaken by manufacturers in various parts of the country are being collated and will form the basis of a report to be circulated to the B.B.C., G.P.O., and the industry.

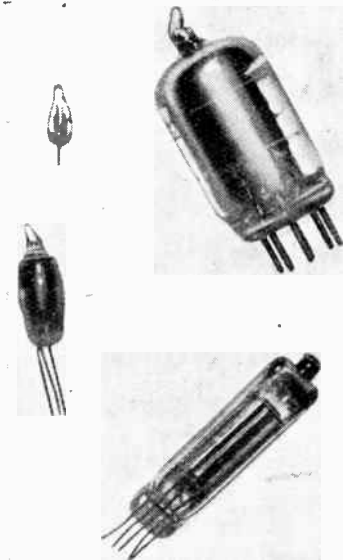

"RICE-GRAIN" VALVES are being developed in the laboratory of the U.S. Bureau of Standards. One is shown here in comparison with a miniature valve, a hearing-aid valve and an earlier "sub-miniature" type.

TELEVISION AT B.I.F.

EXHIBITORS of television sets at the British Industries Fair, at Olympia, will be the first to use the special receiving aerial which is being erected by the Radio Industry Council on the roof of the exhibition building.

Some sixty or seventy manufacturers of radio equipment and accessories are exhibiting in the radio and scientific sections of the Fair at Olympia. In addition a number have taken stands in the engineering section at Birmingham.

The B.I.F. will be held simultaneously in London and Birmingham from May 3rd to 14th. Admission is by Trade Buyers' badge obtainable at the entrance price 2s 6d. The public will be admitted to Olympia on May 5th, 8th and 12th only.

RECORDING CONFERENCE

DISC, film and magnetic-tape recording and reproducing will be discussed and demonstrated at a conference being organized by the British Sound Recording Association. The conference, which will be preceded by the annual general meeting, will be held at the St. Ermin's Hotel, Caxton Street, London, S.W.1, on May 29th and 30th.

The A.G.M. begins at 2.15, and the conference opens at 4.30 with a paper on disc recording and reproduction. The annual dinner will be held at 7.15. The conference will continue on the second day with sessions at 11.0, and 2.30 on magnetic recording and sound on film, respectively. Demonstrations will be given at each session and throughout the conference recording and reproducing equipment will be on show. Admission is by ticket only.

Particulars are available from the hon. secretary, R. W. Lowden, "Wayford," Napoleon Avenue, Farnborough, Hants.

"BUSINESS RADIO"

THE fifteen frequencies in the band between 67 and 87 Mc/s which, as stated last month, were to be made available for the use of the Press in the G.P.O.'s "Business Radio" scheme, have now been allocated.

The allocations have been made by the Joint Telecommunications

Committee of the Newspaper Society and the Newspaper Proprietors' Association and it now remains for the individual publishers to apply to the P.M.G. for licences. The allocations cover eighty provincial papers, eight nationals and two news agencies.

Owing to the limited range of the equipment permitted to be employed it has been possible to allocate the same frequency for use in different parts of the country.

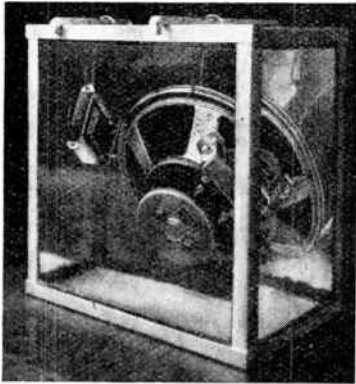

Courtesy "La Télévision Française."

PUT TO THE TEST.—A tropicalized loudspeaker was suspended in a tank of water during the recent Paris radio components exhibition.

MECHANICS WANTED

WITH the completion of the Scottish "Gee" chain, which is expected to come into operational use during this summer, the Ministry of Civil Aviation will require additional radio mechanics to maintain the equipment. The stations are being erected at Great Dunn Fell, Lowther Hill, Craigowl Hill and Ru Stafnish.

Applications are invited from men who have had practical experience in the maintenance of radio and/or radar equipment. Successful applicants are given four weeks training at the M.C.A. Signals Training Establishment at Bletchley, Bucks, and start as Radio Mechanics, Grade II, at £5 15s a week.

Radio Mechanics are also required for the maintenance of radio and radar equipment in other parts of the country.

INVESTIGATING PROPAGATION

ANOMALOUS propagation, or "super-refraction," of radio waves is being investigated by physicists from the Telecommunications Research Establishment, who have gone to Malta where the necessary atmospheric conditions exist from about May to September.

Test flights will be made by two R.A.F. aircraft in order to measure the strength of signals at various ranges and heights. Meteorological observations will also be made as a result of which it is hoped to ascertain the relationship between the meteorological and propagational properties.

PERSONALITIES

E. F. Guest, technical development officer of H. J. Enthoven and Sons, manufacturers of "Superspeed" solder, has been appointed to represent the company on the Inter-Service Radio Components Standardization Committee of the Ministry of Supply.

E. L. A. Mathias, O.B.E., who has been chief engineer and general manager of the Marconi Radio Telegraph Company of Egypt since its formation twenty-one years ago, has been appointed managing director. Prior to going to Egypt he was with Marconi's at Chelmsford for fourteen years. He is succeeded as general manager by **P. T. Simpson**.

J. W. Ryde, a senior physicist at the G.E.C. Research Laboratories, Wembley, has been elected a Fellow of the Royal Society. He has been a member of the scientific staff of the Laboratories since their formation twenty-nine years ago. His researches during the recent war were concerned with the attenuation and scattering of centimetric radar waves in various meteorological conditions.

A. Shore, A.M.I.E.E., has retired from Marconi's after 36 years' service. He joined the company's test department in 1912, was at one time assistant to the principal of the Marconi School and has lately been in charge of the section producing technical literature.

Dr. R. C. G. Williams, who was recently appointed chief engineer of Philips Electrical, has been elected a Fellow of the American Institute of Electrical Engineers. He was for two years executive engineer to the North American Philips Company.

OBITUARY

We regret to record the death of **Frank E. Butler**, the American radio pioneer and associate of Dr. Lee de Forest, who died recently at his home in Toledo, Ohio, at the age of 70.

Piotr Nikolayevich Rybkin, who was an assistant of Popov, the Russian radio scientist, died in Kronstadt in January. For his services to the U.S.S.R. he was awarded the Order of Lenin and the Order of the Red Star.

IN BRIEF

Receiving Licences.—The number of licences in force in Great Britain and Northern Ireland at the end of February was approximately 11,233,500, including 43,500 television licences.

Exporting Television.—The Radio Industry Council is taking active steps to promote the export of television equipment and to this end transmitting gear is being installed in Copenhagen

in order to demonstrate receivers during the British Exhibition to be held there in September.

U.S. Television.—The F.C.C. announces that at the end of 1947 there were seventeen television stations operating in the United States. Permission had been granted for a further 55 to be constructed and applications for another 84 were pending. The industry produced 178,571 television receivers last year, which was about one per cent of its total output of sets.

F.M. in U.S.—According to figures recently published in the U.S.A. there were, at the end of the year, 356 F.M. stations in operation. The production of F.M. receivers last year accounted for seven per cent of the industry's set output. The figures were: A.M. sets, 16,342,002; F.M., 1,175,104; television, 178,571.

Teaching by Example.—All the vehicles used by our Publishers, the Associated Iliffe Press, and our Printers, the Cornwall Press, which, with staff cars, number seventy, have been fitted with interference suppressors, in conformity with the campaign launched by the Radio Industry Council to impress upon motor users the need for suppressing television interference.

German Amateurs.—Although German amateurs are not yet licensed to operate, the Deutscher Amateur Radio Club has restarted publishing its journal *CQ*. The first number contains a message from R. G. Shears, organizing secretary of amateur radio in the British Zone. The secretary of D.A.R.C. is Hans Haberl, Holbeinstrasse, 27, Munich.



J. W. Ryde, of G.E.C. Research Laboratories becomes a F.R.S.

Radio Courses.—Among the courses available at the Cardiff Wireless College (3, Park Grove, Cardiff) is one for the City and Guilds amateur transmitters' examination. In addition to this evening course the College conducts full-time and postal courses for the P.M.G.'s certificates in wireless telegraphy, civil aircraft radio officers' certificate, radio servicing and City and Guilds examinations.

Aircraft Radio.—For the purpose of assisting aircraft owners, manufacturers and maintenance organizations in obtaining approval of radio installations the Ministry of Civil Aviation has appointed Aircraft Radio Surveyors at

World of Wireless—

Croydon, Liverpool (Speke) and Prestwick airports, and also in Cairo. Applications for approval should be sent to the Director of Telecommunications (Tels.: 7 (b)), M.C.A., Cornwall House, Stamford Street, London, S.E.1.

European Broadcasting Stations.—According to figures issued by the International Broadcasting Organization there were 344 medium- and long-wave broadcasting stations operating in Europe at the end of last year.

India's New Stations.—Four new broadcasting stations have been opened in India during the past few months, bringing the number of medium-wave stations operated by All-India Radio to nine. The new stations are: Jullunder (1,333 kc/s), Cuttack (1,355 kc/s), Patna (1,131 kc/s) and Amritsar (1,305 kc/s). There is also one medium-wave station in each of the following four Indian States: Baroda, Mysore, Travancore and Hyderabad.

"Trader Year Book."—The 1948 edition of this year book for the radio and electrical trades includes approximately 10,000 entries in its three directory sections giving trade addresses of manufacturers, proprietary names of products and a buyers' guide to makers of equipment grouped under some 200 headings. In addition, such information as the mains voltages throughout this country and in many towns overseas, condensed specifications of receivers introduced for the 1947-48 season, and a directory of trade associations is given. The year book is obtainable from the Trader Publishing Company, Dorset House, Stamford Street, London, S.E.1, price 10s 6d post free.

Meteorology and Radio.—Under the title "Meteorological Factors in Radio-Wave Propagation," the Physical Society has issued a report on the conference held by the Physical and the Royal Meteorological Societies in April, 1946. The volume is obtainable from the Physical Society, Lower Gardens, London, S.W.7, price 2s.

British Standards.—A synopsis of the 1,400 British Standards now current is contained in the 1947 Year Book of the British Standards Institution which has just been published. The 324-page volume, which includes a subject index and lists of members of the councils and industrial committees, is obtainable from the B.S.I., 24, Victoria Street, London, S.W.1, price 3s 6d.

A Guide to the new electricity organization has been produced by our associated journal *Electrical Review*. This directory of the British Electricity Authority gives brief biographies of the officials. "Electricity Supply," as it is called, is obtainable, price 2s (postage 2d), from *Electrical Review*, Ltd., Dorset House, Stamford Street, London, S.E.1.

F.B.I. Register.—We are informed that further supplies of the F.B.I. Register of British Manufacturers, the first post-war edition of which was recently issued, are available for the home and overseas markets. It is published jointly, for the Federation of British Industries, by Kelly's Directories and Iliffe and Sons, price 2 gns.

OUR COVER

The subject for this month's cover illustration is the V.H.F. frequency-modulated communication equipment recently installed by G.E.C. for the Madras City Police. The transmitter has a power of 100 watts.

INDUSTRIAL NEWS

Philips sound-reproducing equipment is to be made available on a rental/maintenance basis in addition to the normal outright sale method. The distribution of the equipment will be undertaken by the Modern Telephone Co., of 139, Tottenham Court Road, London, W.1, through appointed S.R.E. (sound-reproducing equipment) dealers, who will receive a share of the rental and may assist in the installation and maintenance.

Pye.—To mark the 50th anniversary of the founding of the Pye Company the directors are presenting £5,000 worth of television receivers to its workers. Two television sets are also being presented to each of the colleges at Cambridge University.

Taylor Electrical Instruments announce that their test equipment will in future be sold under the trade name of Windsor instead of Taylor in order to enable it to be exported to markets hitherto closed because of the name conflicting with that of the Taylor Instrument Company of America.

Raw Materials.—Details of all raw materials controlled by the Board of Trade and the Ministry of Supply, together with the types of control at present operating and the addresses at which enquiries may be made, are given in the revised edition of "Raw Materials Guide," published by H.M. Stationery Office, price 1s 6d.

Marconi V.H.F. radiotelephone equipment has been installed at Douglas, Isle of Man, and on Merseyside for use in conjunction with radar for the control of shipping.

R.C.A. in Britain.—Arrangements have been made for enquiries regarding the engineering activities and products of the Radio Corporation of America to be dealt with in Great Britain by the Engineering Division of R.C.A. Photophone, Ltd. The address is 43, Berkeley Square, London, W.1.

E.M.A.—The first of a series of dinner meetings arranged by the Electronic Manufacturers' Association was held on April 20th. The address of E.M.A. is now 83, Pall Mall, London, S.W.1.

Partridge Transformers, Ltd., of 70-78, Petty France, London, S.W.1, has moved to Peckford Place, Brixton Road, London, S.W.9. (Tel.: Brixton 6506.)

United Insulator Company no longer has a factory at Laystall Street, London, E.C.1. All communications should now be sent to Oakcroft Road, Tolworth, Surbiton, Surrey. (Tel. Elmbridge 5241.)

British Electronic Products.—The development and engineering sections of British Electronic Products, Ltd., of Moxley Road, Bilston, Staffs, have been transferred to Brereton Road, Rugeley, Staffs. (Tel.: Rugeley 130.)

MEETINGS**Institution of Electrical Engineers**

Radio Section.—"Carrier Frequency Shift Telegraphy," by R. Ruddledsen, M.Eng., E. Forster and Z. Jelonek, and "Some Developments in Communication Point-to-Point Radiotelegraphy," by J. A. Smale, B.Sc., on May 11th, at the I.E.E., Savoy Place, London, W.C.2, at 5.30.

Cambridge Radio Group.—"Tropospheric Propagation," by H. G. Booker, M.A., Ph.D., on April 27th, at the Cavendish Laboratory, at 8.15

"Some Aspects of Gramophone Reproduction," by K. N. Hawke, B.Sc., on May 18th, at the Cambridgeshire Technical College, at 6.

Scottish Centre.—Faraday Lecture on "Electricity and Everymen," by P. Dunsheath, C.B.E., M.A., D.Sc. (Eng.), on May 21st, at the Training College Hall, Park Place, Dundee.

British Institution of Radio Engineers

London Section.—"The Calculation of Electrode Temperatures in the Radio Valve," by I. A. Harris, on May 13th, at the London School of Hygiene and Tropical Medicine, Keppel Street (Gower Street), London, W.C.1, at 6.

Merseyside Section.—"Factors Governing the Performance of I.F. Amplifiers," by H. Stibbe and K. G. Lockyer, on May 12th, in the Lecture Room, Liverpool Engineering Society, 9, The Temple, 24, Dale Street, Liverpool, 2, at 6.45.

North-Western Section.—"The Wave Analysis of the Low Frequency Potentials of the Human Body," by W. E. Boyd, M.A., M.D., on May 13th, at the College of Technology (Reynolds Hall), Sackville Street, Manchester, at 6.45.

Midland Section.—"The Acoustic Aspects of High Quality Reproduction," by J. Moir, on April 30th, at the Technical College, The Butts, Coventry, at 6.30.

North-Eastern Section.—"Supervisory Control," by L. G. Brough, on May 12th, at the Neville Hall, Westgate Road, Newcastle-on-Tyne, at 6.

Institution of Electronics

North-West Branch.—"The Application of Electronics to Vibration Research," by D. M. Corke, on April 30th, at the Reynolds Hall, College of Technology, Manchester, at 6.30.

Radio Society of Great Britain

London Meeting.—"Aspects of High Quality Sound Recording," by W. S. Barrell, on May 14th, at the I.E.E., Savoy Place, Victoria Embankment, London, W.C.2, at 6.30.

Electrical Trades Union

London Meeting.—An open discussion on "Short-Wave Tuning Problems," on May 21st, in Room 11, The Friends' House, Euston Road, London, N.W.1, at 7.

CLUB NEWS is unavoidably held over.

THE "BELLING-LEE PAGE"

Providing technical information, service and advice in relation to our products and the suppression of electrical interference

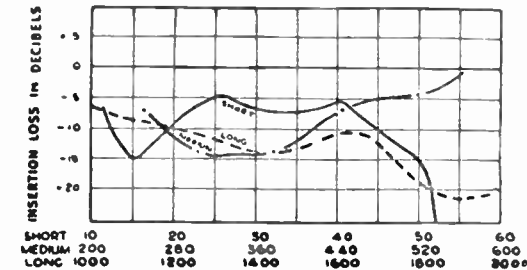
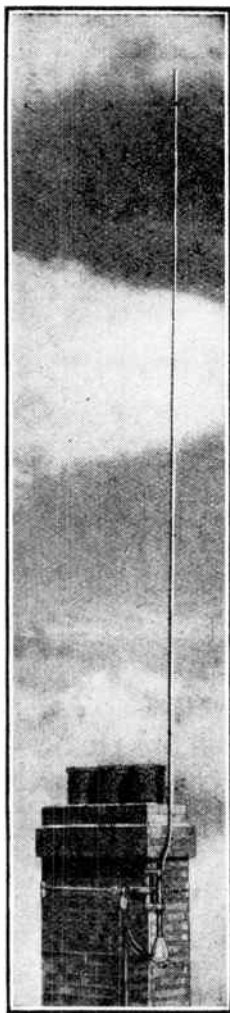

WAVELENGTH IN METRES

The above curves are reproductions of those obtained by the National Physical Laboratories for the "Eliminoise" Aerial.

This illustration shows the "Belling-Lee" "Skyrod" List No. L.638 K (see prices in column 3).

of the aerial is cranked to avoid chimney compings.

It sounds self-satisfied to say that we are proud of the results achieved with this new version but the fact remains that it has to be extremely good to improve on the old design. We are satisfied that it does this. The collector is a little more "whippy" but its tensile strength is greater.

"Eliminoise" Aerials.

The anti-interference "Eliminoise"† incorporates the original electrical design (characteristic curves are given below the illustration) but both aerial and receiver transformers have been modernised, the first mentioned being weather-proof sealed and the receiver transformer embodying a co-axial socket outlet and detachable co-axial lead, 5 feet long which can be removed for domestic cleaning without inconvenience. The new die-cast housings provide complete screening and are finished to harmonise with most interior decorations.

It is probably not appreciated generally that the "Eliminoise" system is not simply a domestic aerial. For many years it has been used and standardised for marine use and some of the world's most famous shipping carries it as standard equipment. It is in fact, part of the "Belling-Lee" complete suppression service which covers the simplest ignition suppressor for motor vehicle interference with television to the complete screened room for laboratory installations, diathermy suppression, and the intermediate devices for domestic mains filtering, appliance suppressors, and complete industrial equipments. Our facilities extend to installation service and our teams of skilled riggers are qualified to attend equally to the fitting of a domestic aerial or the complete suppression of a steamship, railway train, a block of flats with lifts and hotel services or a complete factory.

British Industries Fair.

The opportunity to see new designs and old trusted friends will be given at the B.I.F. when in addition to suppression matters we shall show our range of components and accessories and the latest of our new developments including miniature quick action thermostats, a television outlet box (also suitable for radio) for fitting to the skirting board, a new car ignition interference suppressor which screws into the distribution cap of the ignition system and additions to our new range of co-axial plugs and sockets in the form of single and twin right angle plugs and line and chassis connectors.

We hope that the authorities will have made a statement on the wavelength of the new Birmingham Television service in time for us to show models of the new aerials for that area.



Showing the "Eliminoise" Kit L.308 K.

* "Skyrod" (Regd. Trade name).
L.638/K as shown complete £10/0/0.
L.638 Collector and lashings only £4/4/0.

† "Eliminoise" (Regd. Trade name).
L.308/K as shown complete £6/6/0.
We should be pleased to quote for your aerial installation upon request.

BELLING & LEE LTD
CAMBRIDGE ARTERIAL ROAD, ENFIELD, MIDD.

MARCONIPHONE

Radio for all occasions

World Radio — Personal Radio



FIVE VALVE, FIVE WAVEBAND
A.C. TABLE MODEL T14A
25 GNS. (plus Purchase Tax).

Overall bandspread tuning throughout the complete short waveband range from 13.5 to 52 metres is one of the innovations incorporated in the world receiving circuit on this model. The use of all-glass valves in the high frequency stages reduces oscillator drift and "pulling." This feature combined with the rubber mounting of the chassis to eliminate vibration, ensures high efficiency reception on all wavebands. Station selection is made rapid by the use of flywheel tuning. In addition to a socket for an extra loudspeaker, a separate socket and switch are provided for connecting a record player. The radio circuits are automatically isolated when the set is used for record playing.

FIVE VALVE, TWO WAVEBAND
DC/AC "COMPANION" RECEIVER
T15DA 14½ GNS. (plus Purchase Tax)

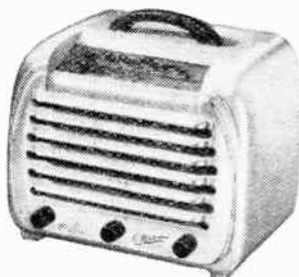

Weighing only 7½ lbs. and small enough to stand on the smallest "occasional" or bedside table, the T15DA incorporates an in-built aerial and needs only connection to the mains to become fully operational. Its excellent performance is enhanced by the use of all-glass valves throughout. The consumption figure is low — a mere 35 watts. An internal dropping resistance besides eliminating the resistance type of mains lead has three voltage tappings which enable the optimum performance to be obtained on any voltage supply between 195—255 volts DC or AC.

SEE THE SIGNATURE

G. Marconi

ON EVERY SET

*Radio in the palm of
your hand*



THE "PERSONAL" SET-4-VALVE
BATTERY MODEL P17B
12½ GNS. (plus Purchase Tax).

The "Personal" set is a triumph for Marconiphone engineers in fitting a complete 4-valve battery superhet in a case only 9" x 5" x 2½". Weight, including batteries is 3 lbs. 10 ozs.

Pressure on two small catches releases the lid and the P.17B springs into immediate operation. Closing the lid automatically switches the set off.

Tuning is simple with two thumb-operated wheels — one for range and one for volume. A sensitive frame aerial incorporated in the lid contributes to the surprisingly high standard of reception.

One dry battery fulfils the function of both accumulator and H.T. and is easily replaced when a renewal is necessary. A special self locating plug ensures that it can only be connected the right way.

Like all Marconiphone products, the "Personal" bears the most famous signature in radio—a safe guarantee of satisfaction. A plaque is incorporated on top of the lid on which the owner's name may be engraved to give the set an additional "personal" touch.

MARCONIPHONE — the REAL thing

THE MARCONIPHONE COMPANY LIMITED, HAYES, MIDDLESEX
M39

Push-Pull Input Circuits

Part 5.—Cathode-coupled Stage

A SYSTEM of rather different character from the phase-splitters and phase-reversers must now be discussed.¹ Two valves are used instead of one, but the pair does provide amplification. One valve is rather like a cathode-follower phase splitter. The input is applied to its grid and one output of opposite phase is taken from its anode. The cathode circuit provides a voltage of the same phase as the input which is used, not to provide the second output directly, but to drive a cathode-input amplifier stage. This cathode-input stage provides at its anode the second output in the same phase as its input.

The basic circuit is shown in Fig. 23, which is complete except for grid bias arrangements. The mode of operation is quite simple and is most easily understood by considering a steady change of input voltage. Let terminal A become more positive than terminal B. The anode current of V_1 increases and so the voltage drops across R_c and R_{a1} increase. Because of the latter the anode potential of V_1 becomes less positive and there is a negative-going output at the anode of V_1 .

The increased drop across R_c makes the cathode potential become more positive than before. As the cathodes of both valves are joined together the cathode of V_2 also becomes more positive. Now the grid of V_2 is returned to the earth line, so that making its cathode potential change positively is the same thing as making its grid change negatively. Consequently the anode current of V_2 falls and its anode potential rises to provide the second output in the same phase as the input to V_1 and in opposite phase to the output of V_1 .

The alternating current through R_c is the difference between the

By W. T. COCKING, M.I.E.E.

alternating anode currents of the two valves. If there is to be a voltage drop across R_c to provide an input to V_2 , therefore, the currents cannot be equal. Con-

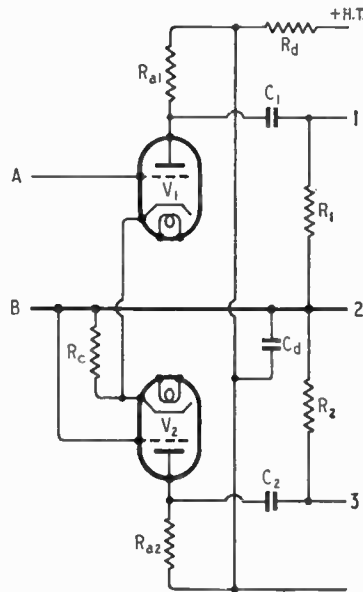

Fig. 23. Typical cathode-coupled circuit without bias details.

sequently, if $R_{a1} = R_{a2}$, and $R_1 = R_2$, the outputs E_{12} and E_{32} cannot be equal in magnitude. Equal output voltages demand unequal values of R_{a1} and R_{a2} .

If R_{a1} and R_{a2} are nearly equal, and the currents are nearly equal also, their difference is small. Consequently the value of R_c must be large. When the currents are nearly equal the grid-cathode voltages of the two valves will be nearly equal also, assuming similar valves. Therefore, the cathode-earth voltage will be nearly the same as the grid-cathode voltage of V_1 and each will be nearly one-half of the input voltage E_{AB} .

Now it will be clear that although the alternating anode currents are in opposite phase in

R_c the direct anode currents are additive. The first necessitates a high value for R_c and the second means that this high value results in a large mean cathode potential relative to earth. If the heaters are earthed, and it is usually necessary to earth them to avoid hum, there is a large voltage (100-200 V) between heater and cathode. It is necessary, therefore, to choose valves which will safely withstand it.

Because of this drawback, and because the amplification obtainable is about one-half of that given by other arrangements the circuit is not much used in A.F. amplifiers. All other forms of push-pull input circuit, except some of the simplest types described in Part 1 and of very limited application, demand the use of A.C. couplings; that is, either a transformer or coupling capacitors are needed to remove unequal steady potentials produced by the H.T. supply.

These A.C. couplings, and also decoupling circuits, make it difficult to secure balance at very low frequencies. However, conditions are such that it is not difficult to secure adequate balance down to the lowest frequencies needed for the reproduction of music. Much lower frequencies are sometimes involved in the case of an amplifier for an oscilloscope, however, and it is here that the cathode-coupled circuit offers definite advantages. Coupling capacitors are not essential and,

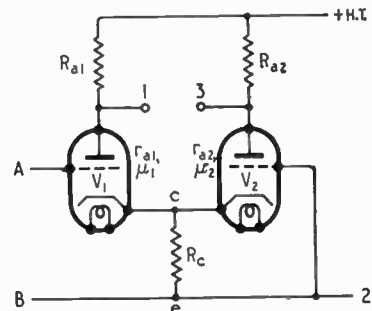

Fig. 24. Cathode-coupled circuit reduced to its simplest form.

¹ "Cathode Phase Inversion," by O. H. Schmitt, *J. Sci. Instrum.*, March 1938, Vol. 15, p. 100.

"Phase-Splitting in Push-Pull Amplifiers," by W. T. Cocking, *Wireless World*, April 13, 1939, Vol. 44, p. 340.

Push-pull Input Circuits—

as a result, the response and balance can be maintained down to zero frequency.

The circuit is shown in Fig. 24 devoid of coupling capacitors and in Fig. 25 split into its component parts. In Fig. 25 (a) V_1 is shown and is evidently a similar stage to a cathode-follower phase splitter, the cathode load comprising R_c in shunt with the input impedance of V_2 . Fig. 25 (c) shows the V_2 -stage and is a simple cathode-input amplifier (grounded-grid stage). Figs. 25 (b) and (d) show the equivalent circuits.

The circuit is analysed in Appendix V. The input impedance of V_2 [Equ. (3)] is very low and in the limit tends to a minimum value of $1/g_{m2}$. The unbalance is given by Equ. (10) and the condition for zero unbalance by (11). It is expressed in different and more useful form in (13) and this simple equation will repay some study. The term x ($=R_{a2}/r_{a2}$) represents the ratio of the coupling resistance to the anode A.C. resistance of V_2 , and y ($=R_c/r_{a2}$) represents the ratio of the cathode-coupling resistance to the anode A.C. resistance.

With triode valves the value of

x is usually around 2 to 3, but with pentodes it will usually be much less than 1. Again with triodes μ_2 will generally be about

$g_{m2}R_c = 99$. If $g_{m2} = 1$ mA/V, R_c must be 100 k Ω and the mean anode current will be about 1 mA per valve, so that the cathodes will be 200 V above earth. If $g_{m2} = 6$ mA/V, R_c need not be more than 16 k Ω or so, but the current per valve is not likely to be less

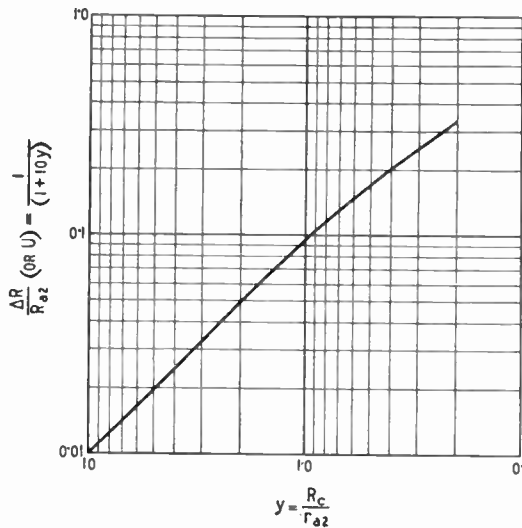

Fig. 26. This curve shows the relation between unbalance for equal values of R_{a1} and R_{a2} or the fraction by which R_{a1} must be less than R_{a2} for balance as a function of $y=R_c/r_{a2}$ for the condition $\mu_2=29$ and $R_{a2}/r_{a2}=2$.

20-40, but with pentodes it will be very large compared with 1. With the latter valves, therefore, Equ. (13) can be reduced to

$$\Delta R/R_{a2} \approx 1/(1 + \mu_2 y) = 1/(1 + g_{m2} R_c)$$

If $R_{a1} = R_{a2}$ (i.e., $\Delta R = 0$), the unbalance from Equ. (10) becomes $1 - 1/(1 + 1/g_{m2} R_c)$. For 1 per cent unbalance we get

than 7 mA, so that the cathodes will still be over 200 V above earth.

It is possible to reduce this cathode-earth voltage by replacing R_c by a pentode valve.³ The A.C. resistance of such a valve is much higher than its D.C. resistance, and the mean cathode potential can then be kept down to some 50-100 V, while the effective value of R_c can be kept as high as 0.1-1 M Ω .

Pentodes, however, are less generally desirable than triodes at low frequencies because of their need for a screen supply of constant voltage relative to cathode. With triodes it is clearly desirable to make $y(1 + \mu_2)/(1 + x)$ as large as possible, and this means y and μ_2 should be large and x small.

In order to secure good linearity R_{a2} should normally be several times r_{a2} , and the practical minimum for $x = R_{a2}/r_{a2}$ is about 2. If the frequency response must be well maintained at high frequencies a large value of r_{a2} is undesirable when R_{a2} is still larger. A value of around 10-15 k Ω is usually as high as is desirable. With such a value μ_2 will be around 30 in most cases. With $x = 2$, and $\mu_2 = 29$, Equ. (13)

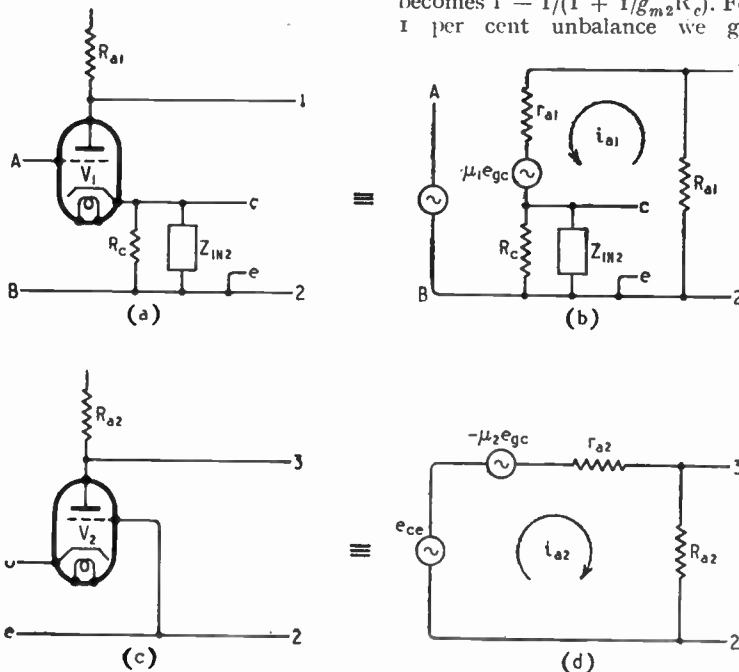

Fig. 25. The first half of the circuit is shown at (a) with its equivalent at (b) while the second part, which has the form of a grounded-grid stage, appears at (c) with its equivalent at (d).

³ "Electro-Encephalograph Amplifier," by Denis L. Johnston. *Wireless Engineer*, August, September and October 1947, Vol. 24, pp. 231, 271 and 292.

becomes $\Delta R/R_{a2} = I/[I + 10y]$ and (10) becomes

$$U = 1 - \frac{R_{a2}}{R_{a1}} / [I + I/10y].$$

If $R_{a1} = R_{a2}$, $U = I/[I + 10y]$. The fractional change of resistance for balance and the unbalance for equal resistances are numerically the same. The curve of Fig. 26 shows how U and $\Delta R/R_{a2}$ vary with $y = R_c/r_{a2}$. For 1 per cent unbalance it is necessary to have $y = 9.9$, and this usually means R_c is of the order of 100-150 kΩ. The voltage drop with this is excessive in most cases, and it is more usual to choose y around unity. The unbalance for equal values of R_{a1} and R_{a2} is then 12.5 per cent. This is large for A.F. amplifier applications, but may not be too great for an oscilloscope amplifier. Push-pull is here adopted more to avoid

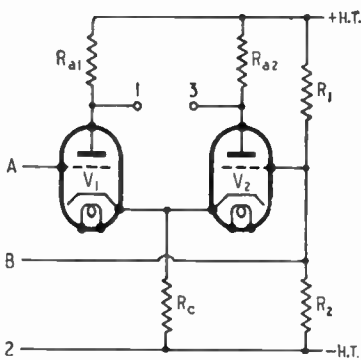

Fig. 27. Bias can be obtained from a voltage divider R_1, R_2 across the H.T. supply.

trapezium distortion than to obtain maximum undistorted output from the valves, although the increased output is naturally welcome.

With $y = 1$, R_c is some 10-15 kΩ in most cases, and the mean voltage drop across it can often be kept down to 100 V or so. It is important to keep the voltage drop across R_c small, even apart from heater-cathode insulation difficulties, because it is subtracted from the H.T. supply, and when this is fixed it reduces the undistorted output.

The problem of grid bias must now be considered. A suitable arrangement for D.C. conditions is shown in Fig. 27. The grids are returned to a voltage-divider R_1, R_2 across the H.T. supply, the values being so chosen that the

voltage drop across R_2 is less than that across R_c by the amount of the bias needed. The earthy-input terminal B is no longer - H.T. but the junction of R_1 and R_2 .

When the amplifier has to deal only with alternating voltages a capacitance can be included between A and the grid of V_1 with a grid leak from the grid to the junction of R_1 and R_2 . The input can then be terminals A and 2. It is usual to shunt R_2 by a large capacitance to prevent any hum on the H.T. line from being applied to the grids.

An alternative bias circuit is shown in Fig. 28. Here grid leaks are returned to a tapping on the cathode resistor and the bias is the voltage drop across R_3 . As long as C_2 is large enough in relation to R_2 at the frequency concerned the effective value of

$$R_c \text{ is } R_3 + \frac{R_2 R_4}{R_2 + R_4}.$$

However, if the frequency is low enough C_2 introduces phase unbalance for, in effect, the grid of V_2 is returned, not to earth, but to the tapping on the potential divider formed by R_2 and C_2 across R_4 .

There is additional unbalance at all frequencies brought about by the presence of R_1 and it is similar to that found with the cathode-follower phase splitter (Part 2). If R_1 is kept large, however, it is unlikely to be serious.

At high frequencies stray capacitances greatly complicate the action of the circuit. The valve capacitances are shown in Fig. 29. Currents from the input flow through C_{ga1} and C_{ge1} . The former tends to reduce the output E_{12} and cause a phase error. The latter flows through R_c and tends to increase the cathode-earth voltage but again causes a phase error. The effective input capacitance resulting from these currents is C_{in} and composed of two parts. Since the cathode-earth voltage is nearly equal to $E_{AB}/2$ the component due to C_{ge1} is nearly $C_{ge1}/2$. The

component due to C_{ga1} is nearly $C_{ga1} (1 + A_1)$ where $A_1 = E_{21}/E_{AB}$

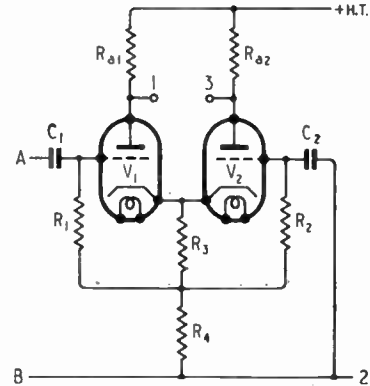

Fig. 28. When A.C. couplings are used bias can be obtained from a tapping on the cathode-coupling resistance.

as in Equ. (6), Appendix V. Therefore, $C_{in} \approx C_{ge1}/2 + C_{ga1} (1 + A_1)$.

In V_2 , C_{ga2} comes as a shunt on R_{a2} and is additive to other stray capacitance shunting this resistor. C_{ve2} comes as a shunt on R_c and is additive to the heater-cathode capacitances, not shown. The anode-cathode capacitances have similar effects on the two sides; their effect on the balance is therefore small.

The effect of C_{ga1} and C_{ga2} on the balance is analogous to that obtained in the case of the cathode-follower phase splitter, and it may be expected that the order of unbalance obtained will not be dissimilar and so will be negligible at audio frequencies. Ignoring

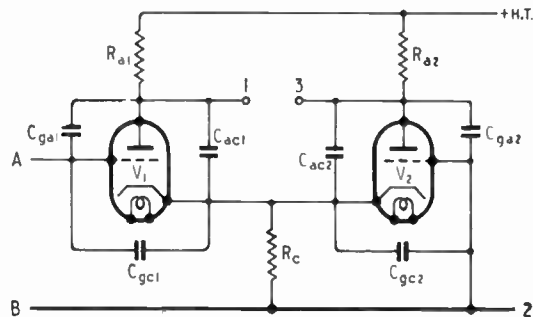

Fig. 29. This diagram shows the various inter-electrode capacitances of the valves, which influence the performance at high frequencies.

this, the main effect of capacitance on the balance will be that shunting R_c , for the capacitances in

Push-pull Input Circuits—

parallel with R_{a1} and R_{a2} are likely to be nearly equal and so to have little effect on the balance.

In view of the fact that R_c is shunted by the input impedance Z_{in2} of V_2 , which is small, small values of C_c are unlikely to cause serious unbalance. It can be estimated from Equ. (10) by writing $R_c/(1 + j\omega C_c R_c)$ in place of R_c .

Working out the phase unbalance on the lines of the preceding articles we find it is, approximately

$$\omega C_c R_c \left/ \left[1 + \frac{y(1 + \mu_2)}{1 + x} \right] \right.$$

Taking $y = 1$, $x = 2$, $\mu_2 = 29$, the unbalance is $\omega C_c R_c / 11$. If $R_c = 10 \text{ k}\Omega$, $C_c = 50 \text{ pF}$ and $f = 10 \text{ kc/s}$, the unbalance is $6.28 \times 10^4 \times 5 \times 10^{-11} \times 10^4 / 11 = 0.00285$ and is negligibly small.

APPENDIX V

Referring to Fig. (b) the second valve can be regarded as a cathode-input stage in which

$$e_{gc} = -e_{cc}$$

Therefore,

$$i_{a2} = \frac{e_{cc}(1 + \mu_2)}{r_{a2} + R_{a2}} \dots \dots (1)$$

$$\frac{E_{32}}{e_{cc}} = \frac{(1 + \mu_2)R_{a2}}{r_{a2} + R_{a2}} \dots \dots (2)$$

$$Z_{in2} = \frac{e_{cc}}{i_{a2}} = \frac{r_{a2} + R_{a2}}{1 + \mu_2} \dots (3)$$

The first stage is a normal amplifier with a cathode impedance

$$Z_c = \frac{R_c Z_{in2}}{R_c + Z_{in2}} \dots (4)$$

and

$$E_{ab} = e_{gc} + i_{a1} Z_c$$

$$\mu_1 e_{gc} = i_{a1}(r_{a1} + R_{a1} + Z_c)$$

$$\therefore i_{a1} = \frac{\mu_1 E_{AB}}{r_{a1} + R_{a1} + Z_c(1 + \mu_1)} (5)$$

$$\frac{E_{21}}{E_{AB}} = \frac{\mu_1 R_{a1}}{r_{a1} + R_{a1} + Z_c(1 + \mu_1)} (6)$$

$$\frac{E_{cc}}{E_{AB}} = \frac{\mu_1 Z_c}{r_{a1} + R_{a1} + Z_c(1 + \mu_1)} (7)$$

$$\therefore \frac{E_{32}}{E_{AB}} = \frac{\mu_1 Z_c}{r_{a1} + R_{a1} + Z_c(1 + \mu_1)} \cdot \frac{(1 + \mu_2)R_{a2}}{r_{a2} + R_{a2}} \dots 8)$$

$$\text{The unbalance is } U = 1 + \frac{E_{32}}{E_{12}} = 1 - \frac{R_{a2}}{R_{a1}} \cdot \frac{(1 + \mu_2)Z_c}{r_{a2} + R_{a2}} \dots \dots (9)$$

$$= 1 - \frac{R_{a2}/R_{a1}}{1 + \frac{r_{a2} + R_{a2}}{R_c(1 + \mu_2)}} \dots \dots (10)$$

For $U = 0$

$$R_{a1} = \frac{R_{a2}}{1 + \frac{r_{a2} + R_{a2}}{R_c(1 + \mu_2)}} \dots (11)$$

If $R_{a2} = x r_{a2}$ and $R_c = y r_{a2}$, this can be written

$$R_{a1} = \frac{R_{a2}}{1 + \frac{1 + x}{y(1 + \mu_2)}}$$

With triode valves the values of x and y are likely to be independent of R_{a2} , and so a valve with a high value of μ_2 is advantageous in reducing the difference needed between R_{a1} and R_{a2} for balance. A high value of $y = R_c/r_{a2}$ is also desirable.

With pentode valves $r_{a2} \gg R_{a2}$

and $\mu_2 \gg 1$, therefore,

$$R_{a1} \approx \frac{R_{a2}}{1 + \frac{1}{g_{m2} R_c}} \dots (12)$$

where $g_{m2} = \mu_2/r_{a2}$.

High values of g_{m2} and R_c are obviously desirable.

Writing $R_{a1} = R_{a2} - \Delta R$, we get

$$\frac{\Delta R}{R_{a2}} = \frac{1}{1 + \frac{y(1 + \mu_2)}{1 + x}} \dots (13)$$

Monitoring Loudspeakers

Requirements for Balance and Quality Control in Broadcasting and Recording Studios

AN interesting discussion of this subject, at a joint meeting of the British Sound Recording Association and the Acoustics Group of the Physical Society at the Royal Society of Arts on March 11th, was opened by D. E. L. Shorter of the B.B.C. Research Dept. Mr. Shorter reviewed the methods by which the merit of a loudspeaker might be assessed. Measurements of loudspeaker response were easy to make, but difficult to interpret. What we needed was an instrument which would do the interpretation. Meanwhile, subjective listening tests, although not very scientific, provided the most reliable guide. For judging the highest quality of reproduction direct comparison with the original sound over a long period was necessary, but for somewhat lower standards a reduction in listening time could be effected by the use of successive recordings, and also by the use of a source of random noise. By re-recording a piece five or six times through the medium of a mediocre loudspeaker, its salient errors could be readily distinguished. Similarly, with the random noise source, the characteristic hiss would be coloured by what might be termed the formants of the loudspeaker tone.

Mr. Shorter did not subscribe to the "complacent mysticism" which surrounded the ear as a unique arbiter of quality of reproduction.

tions (Q), phases and "dilutions" was proposed.

Although commendable in principle the use of box or infinite baffles did not always result in an improvement and something was lost by the suppression of the back radiation. Attempts to fit the room acoustics with those of the loudspeaker were not often successful as the ear was capable of separating the two characteristics.

In the discussion which followed several speakers underlined the importance of balance between bass and treble. Extension of frequency range should be symmetrical about a mid-frequency, say 800c/s, and it was better not to avail oneself of possible extra frequencies at one end of the scale if complementary octaves at the other end were unattainable. When using two loudspeakers to cover the frequency range, great care was necessary to avoid phase distortion near the cross-over frequency.

One speaker drew attention to the possibility of intermodulation effects due to vibration in the fabric grille coverings which were commonly used; he favoured a rigid metal grille when some form of covering was desirable.

The possibility of using radically different physical effects, e.g., phonic arc flames, for electro-acoustic energy conversion was discussed, but it was thought that there was little prospect of the conventional forms of loudspeaker being superseded. No single source of sound could be small enough to avoid interference effects at high frequencies, and at the same time produce comparable sound intensities at low frequencies without creating pressures which would give rise to distortion in the transition from adiabatic to isothermal conditions.

Correlation between the results of listening tests and the shape of response curves was possible, and a method of interpreting response curves as a combination of resonant mechanical circuits each with characteristic frequencies, magnifica-



PHILIPS

SOUND AMPLIFYING EQUIPMENT

for every purpose

British made to an exacting tropical specification. Most standard items available from stock. Enquiries invited

from Dealers and Wholesalers. If you need sound equipment, write or 'phone the Amplifier Sales Manager,



PHILIPS ELECTRICAL

LIMITED

AMPLIFIER DEPARTMENT, CENTURY HOUSE, SHAFTESBURY AVENUE, W.C.2
Telephone: GERrard 7777

PREMIER RADIO COMPANY

MORRIS & CO. (RADIO) LTD.

ALL POST ORDERS to 167 LOWER CLAPTON RD., LONDON, E.5. 'Phone: Amherst 4723.

ALL CALLERS to 168 FLEET STREET, LONDON, E.C.4.

'Phone: Central 2833.

Terms of Business: Cash with order or C.O.D. over £1.

Send 2½d. stamp for latest list.

GOVERNMENT SURPLUS

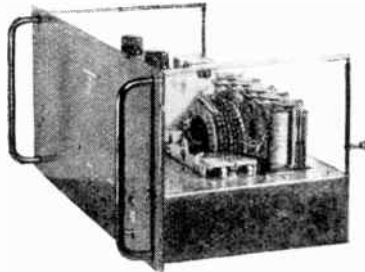

RELAY UNIT TYPE 9 consists of a 24v. operated relay unit incorporating 3 KT330 valves, a telephone line (Uniselect) switch with 6 poles, 26 contacts, 5 P.O. type relays, 2 high-speed relays, and a quantity of other material. Contained in an attractive relay rack type metal case 19 x 19 x 9 1/2 in. deep. Price 60/-, or without valves, 30/-, Carriage and packing 5/-.

TEST UNIT AP58874 consists of Test Unit for a U.H.F. Tx., incorporates a 230 v. 50 c/s Power Pack, with a smoothed output of 240 v., up to 50 ma and 6.3 v. 2 a., 2 EP50, 1 EC52, 1 EA50, 1 5Z3G, 1 Y63 Magic Eye, and a large quantity of condensers, resistors, and tuning gear. Contained in an attractive steel case. Size 10 1/2 x 9 x 8 1/2 in. Price 45/-, Carriage and packing 5/-.

METAL RECTIFIERS.

Output 300 v. 50 ma., 5/-, 275 v. 30 ma., 4/6, 250 v. 30 ma., 4/-, 4 v. 1 a., 5/-, 36 v. 75 ma., 1/6, 16 v. 1 a., 12/6, 48 v. 1 a., 25/-, 16 v. 4 a., 30/-, 16 v. 8 a., 37/6, 30 v. 5 a., 37/6.

Mains Transformers at exceptional prices. All are heavy duty and robust. All 230 v. 50 cycles input.

Type	Price
3 500-0-500 v. 150 ma., 4v. 2 1/2 a., 4v. 5 a., 4 v. 1 a	35/-
4 865-0-865 v. 500 ma., Tapped at 690 v. and 780 v. 4 v. 3a.	75/-
35 300-0-300 v. 250 ma., 4 v. 3-5 a., 6.3v. 5-7 a., 6.3 v. 1-2a.	35/-
30 30 v. 4 a.	20/-
31 40 v. 3a. and 104 v. 1.5a. (autowound)	21/-
32 700-0-700 v. 150 ma., and 1000 v. 30ma., 4 v. 1a., 4 v. 4a.	40/-
33 38 v. at 2a., tapped at 36 v., 34 v., 32 v.	15/-
34 1500-0-1500 v. 120 ma., 4 v. 2-3a., 4 v. 2-3a	55/-
34A 1500 v. 5 ma., and 1500 v. 5 ma., 4 v. 2 a., 2 v. 2 a., 2 v. 2 a	25/-
41 550-0-550 v. 120 ma., 4 v. 2 a., 6.3 v. 2.5 a., 6.3 v. 3a.	40/-
42 500-0-500 v. 170 ma., 4 v. 4 a.	35/-
43 4 v. 20 a.	25/-
46 100 watt auto 230 v., 150 v., 100 v., 50 v.	12/6

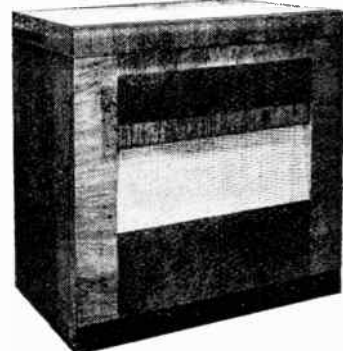

RADIOGRAM CABINETS. Dignified appearance and good workmanship. Size 3 1/2 in. high, 18 1/2 in. deep, 33 in. wide. French polished, veneered walnut. Price £29. Also available complete with electric motor, auto stop and magnetic pick-up, £37 18/11. Ditto, with Rothenel Crystal Pick-up, £39/12/8.

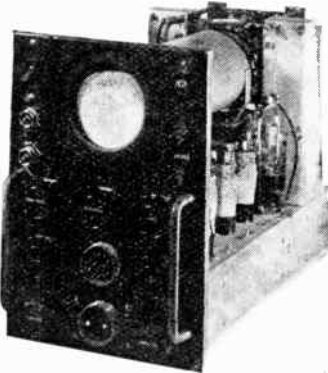

TEST UNIT TYPE 73 consists of a special purpose Oscilloscope that requires only rewiring and the addition of a few condensers and resistors to convert into a standard Oscilloscope, input 230 v. 50 c. A 3 1/2 in. C.R. tube and 1 8U220A, 1 EB34, 1 6Z4, 3 SP41, 2 EA50, are included. Controls are "Brightness," "Velocity," "X Shift," "Y Shift," Focus Amplifier, "In/out," "Calibrate," "on/off/TX." Price £8/8/-. Carriage and packing 20/-.

METERS. All meters are by the best makers and are contained in bakelite cases. Prices are about one-quarter the original cost.

Range	Diam.	Fitting	Type	Price
500 ma. 3 1/2 in.		Proj.	M.C.D.C.	7/6
40 v. 2 1/2 in.		Flush	M.C.D.C.	5/9
2 1/2 a. 2 1/2 in.		Flush	Thermos H.F.	5/-
20 a. 2 1/2 in.		Flush	M.C.D.C.	7/6
40 a. 2 1/2 in.		Flush	M.C.D.C.	7/6
25 a. 3 1/2 in.		Flush	M.C.D.C.	7/6
25 a. 3 1/2 in.		Proj.	M.C.D.C.	7/6
25 a. 3 1/2 in.		Flush	M.I.D.C.	2/11
500 ma. 2 1/2 in.		Flush	M.C.D.C.	7/6
3 ma. 2 1/2 in.		Flush	M.C.D.C.	5/-
1 ma. 2 1/2 in.		Flush	M.C.D.C.	15/11
20 v. 2 1/2 in.		Flush	M.C.D.C.	19/6
15 v. 3 1/2 in.		Flush	M.I.A.C.D.C.	7/6
150 ma. 2 1/2 in.		Flush	M.C.D.C.	6/-
200 ma. 3 1/2 in.		Flush	M.C.D.C.	8/6
5,000 v. 4 1/2 in.		Flush	Electrostatic	50/-
1 ma. 2 1/2 in.		Flush	M.C.D.C.	8/6

FERRANTI 1 MILLIAMPER METERS. 3 1/2 in. external diameter, flush mounting, with self-contained Westinghouse bridge rectifier. Scale marked 0-10 volts with fifty divisions, fitted in well-made wooden box 6 x 5 x 5 1/2 in., 35/-.

ALUMINIUM CHASSIS. Substantially made of bright aluminium, with four sides.

7 x 3 1/2 x 2 1/2 in.	4/6	9 1/2 x 4 1/2 x 2 1/2 in.	5/6
10 x 8 x 2 1/2 in.	7/-	12 x 9 x 2 1/2 in.	7/9
14 x 9 x 2 1/2 in.	8/3	16 x 8 x 2 1/2 in.	8/6
20 x 8 x 2 1/2 in.	10/6	22 x 10 x 2 1/2 in.	13/6

SUPERHET TUNING PACKS. Completely wired and aligned. 13-40, 40-150, 150-570 metres. R.F. Staze, 455 k.c.; 9 connections only. Complete with 3-gram condenser, calibrated, engraved Perspex dial, and S/M drive. Litz wound polystyrene insulation, permeability tuned I.F.'s, 7 k/c. bandwidth. Price complete £3/17/6.

8 WATT A.C. AMPLIFIER. For 200/250 v. 50 c. mains. 2 to 16 ohms output. Mike, Gram, and Radio switched inputs. 2 SP41, one HL41, 2 Pen45, one UC3. Screened Input Mike Transformer, Tone Control. In attractive metal case. With Rola Q12 P.M. Speaker. £15 15/-.

LOUDSPEAKERS BY FAMOUS MAKER.

5in. P.M. 2-3 ohms.	10 11
6in. " 2-8 " "	18/6
8in. " 2-3 " "	17/6
10in. " 2-3 " "	23/6
12in. " 15 " "	85/-
10in. Energised, 2,000 ohm field	25/-

SPECIAL OFFER OF ELECTRIC GRAMPHONE MOTOR. British-made, Rim driven, with 8 in. turntable. Fixed speed (78 R.P.M.) for 200-250 volts A.C. only. £4 19/6.

OSCILLOGRAPH FOUNDATION KITS. Comprise a transformer giving an output of 800 v., condensers, metal rectifiers, 3 1/2 in. Cathode Ray Tube and Base and L.T. Transformer. 55/-.

GOVERNMENT SURPLUS

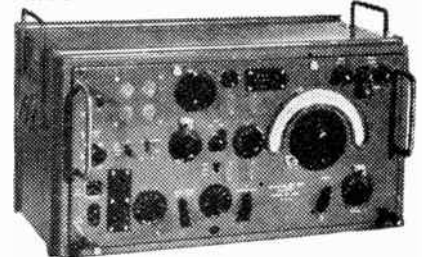

R107. ONE OF THE ARMY'S FINEST COMMUNICATIONS RECEIVERS. (See "W.W.," Aug., 1945.) 9 Valves, R.F. amp. osc. Frequency Changer, 2 I.F.'s. (405 kc.) 2nd Detector, A.V.C. Af. amp. A.C. mains, 100-250 v. or 12 v. accum. Frequency range 17.5 to 7 m/c/s., 7.25 m/c/s. to 2.8 m/c/s., 3.06 to 1.2 m/c/s. Monitor L.S. built in Complete. Write for full details. £16 16/- complete.

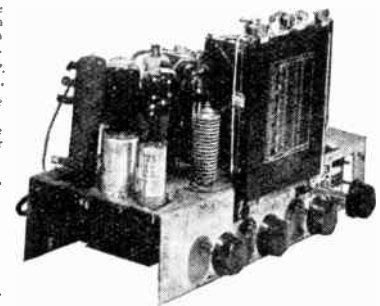

ALL-WAVE SUPERHET KIT. A Kit of Parts to build a 6-valve (plus rectifier) receiver, covering 16-50 metres. Medium and Long wave-bands. Valve line-up 6K5, 6K7, 6Q7, 6J7, two 25A6 in pushpull. Metal Rectifiers are incorporated for H.T. supply. Output impedance is for 3 and 15 ohms. The latest Wearite Coil Pack incorporating Iron Dust Cells is used, making construction and alignment extremely simple. A pick-up position on the wavechange switch and pick-up terminals is provided. A complete kit including valves but without speaker or cabinet. Chassis size 14 x 6 in. Overall height, 9 in. Price £21/16/3. Includes P.T. Suitable loudspeakers are the GOODMAN 8 10in. 6-watt P.M. at 47/6, or for superlative reproduction, the Goodman 12in. P.M. at £6 15/-.

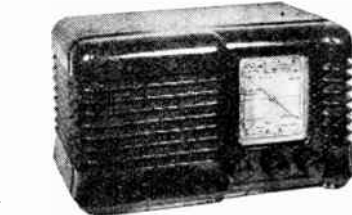

NEW 1948 MIDGET T.T. R.F. RADIO KITS with illuminated Glass Dial. All parts including Valves, M/C Speaker and instructions. 3 valves plus Metal Rectifier. 200-657 metres and 700-2,000 metres. 200 to 250 v. A.C. or A.C./D.C. mains. State which is required. Size, 10 in. x 6 in. £8 0/11, including Purchase Tax.

NEW 1948 MIDGET SUPERHET RADIO KIT with illuminated Glass Dial. All parts including Valves, M/C speaker and instructions. 4 valves plus Metal Rectifier. 16-50 metres and 200-257 metres. 200 to 250 v. A.C. or A.C./D.C. mains. State which is required. Size, 10 in. x 6 in. x 0 in. £9, including Purchase Tax. An attractive Brown Bakelite Cabinet can be supplied for either kit, at 27/3, including Purchase Tax.

Phase

By
"CATHODE RAY"

What Does It Really Mean ?

THIS is a term I have more than once been asked to clarify, on the ground that beginners find it confusing. It is not at all surprising if they do, seeing that the highest authorities give quite a variety of different meanings to the word. The famous Dutch professor, Van der Pol, called attention to this in a lecture he gave before the I.E.E.¹ After quoting a selection of the meanings which he had culled from about fifty books, he defined his own choice. As it is in mathematical form I will keep it till later, and start off with the British Standard definition,² which is quite consistent with it, but expressed in words, and rather more general in its scope.

The root of most difficulties with phase, I think, is vagueness about what it consists of. Is it time? Or is it an angle? Or is it something else? The British Standard has two alternative

definitions. The second is rather more scientific—"The fraction of the whole period which has elapsed, measured from some fixed origin."

Let us consider the first. The "operation" might be the mass production of a radio receiver. Any particular "stage or state" could be named; say, the soldering of the output valveholder cathode contact. If all the sets were manufactured at exactly the same speed at every stage, then any phase in the whole operation could be specified by the *time* in hours and minutes from the start. In practice, however, the wiring operative's dinner hour might have upset the timing, so that at the same time after starting the next set she might be connecting the first I.F. transformer, which would obviously be a different stage or state. So although time

things such as this by drawing graphs connecting voltage, current, power output, or what you will, with time. Fig. 1(a) is such a graph for the radar output. Any point on the graph marks a stage (and hence a phase) in the operation of radiating a pulse. Take A, for example. The same phase in the next pulse would readily be identified as point B. This is a better and clearer way of indicating phase than trying to describe it in words as "the stage at which the peak power of the pulse has decreased by nearly half," or some such story.

Now suppose there is another radar transmitter, identical with the first except for a higher pulse recurrence frequency, as shown by its graph, Fig. 1(b). The first pulses shown for both transmitters coincide in time, so it seems reasonable enough to choose point C to mark the same phase as A. Measuring off from C a time interval equal to AB gives point D. There is no doubt about this being an entirely different phase. The point corresponding to B on the second pulse is E, surely. Again time enters into the matter, but phase is not just time, nor even directly proportional to time.

So far, the first B.S. definition seems to have been quite clear, enabling anyone to identify similar phases. But the second one puts it a little more specifically: "The fraction of the whole period which has elapsed, measured from some fixed origin." A period is, normally, a time. Scientifically, it is the time of one complete operation in a recurring series. It is marked "T" in Fig. 1(a) and (b). Phase being defined as a *fraction* of the whole period certainly rules out any such silly mistake as D in Fig. 1(b). Evidently one starts reckoning phase afresh from the beginning of each period. A convenient "fixed origin" from which to start is the point O at

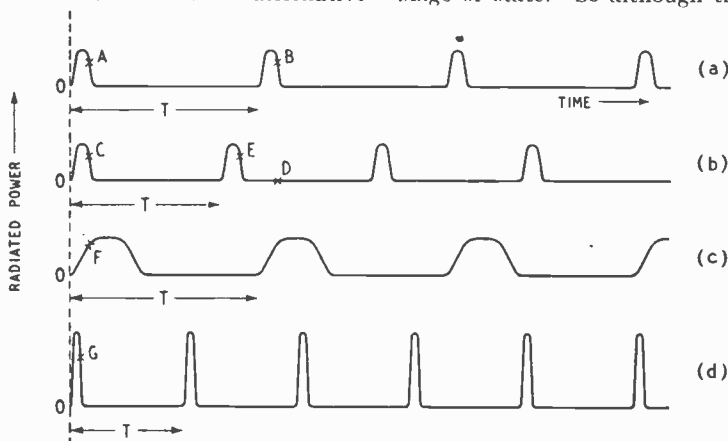

Fig. 1. What phase is and what it is not are discussed with the aid of these pulse waveforms.

definitions of phase, as it exists "in an operation which recurs periodically." The first is very broad—"The stage or state to which the operation has pro-

ceeded." The second is rather more scientific—"The fraction of the whole period which has elapsed, measured from some fixed origin."

Next consider another operation which recurs periodically—the pulses radiated by a radar transmitter. It is a pleasant custom to elucidate periodical opera-

¹ Journal I.E.E., Part III, May, 1946, p. 153.
² B.S. 205: Part I: 1943, definition 1511.

Phase—

which the pulse commences.

At this juncture one might hastily suppose that a phase, being defined as a fraction of a time period, is itself a time. A little thought will show that this is not so. The fraction of a period, measured from its start, is

$$\frac{\text{Time between start of period and selected phase}}{\text{Time of whole period}}$$

Time divided by time is just a number, a ratio. Phase A, for example, could be precisely specified as 0.1; that is to say, if the whole period T were divided into 10 units, it would occur after 1 of these units had elapsed, starting from O.

Applying this to Fig. 1(b) we immediately get into difficulties. T is a shorter period here, so phase 0.1 would be nearer O than A and C are. It would be a little higher up the pulse. To take a more extreme case, consider Fig. 1(c). Here the period is the same as in (a) but the pulse is fatter. Phase 0.1 brings us to F, which no one would recognize as the same stage or state of the operation as A. Apparently the two definitions disagree. F is the same "fraction of the whole period," but certainly not the same state.

Where we have gone wrong is in trying to identify the same phase in two *different* operations. After all, the definition referred to an *operation*, not to two or more sets of different operations. It would be difficult to identify the stage of wiring the first I.F. transformer in the manufacture of a T.R.F. set! So long as we stick to Fig. 1(a), or (b), or (c), then the phase reckoned according to the second definition agrees with the first definition. Measuring 10 per cent of T from the start of the second pulse in Fig. 1(a) brings us to point B, which is the same state as A in the first pulse. And so on.

Comparing phases in two or more sets of operations need not be forbidden in every case; it is allowable so long as they are identical operations. That is obvious, of course. What is not so obvious—in fact some people would disagree with it, though it does satisfy both B.S. definitions—is that corresponding phases can be picked out in operations having

different periods and amplitudes, so long as the *shapes* of the graphs are the same, and only the scales are changed. For instance, in Fig. 1 (d) the recurrence frequency is higher than in Fig. 1 (a), so that the period is shorter; also the peak output is greater. But if 1 (d) were replotted to suitably

altered time and power scales it could be made to coincide exactly with 1(a). This being so, 0.1 of T brings us to G, which will generally be agreed to be the same phase as A in 1 (a).

So far so good. Accepting the B.S. two-fold definition, we have a method of specifying any particular point in a recurring waveform (or other operation or pheno-

"The difference of phase (usually expressed as a time or an angle) between two periodic quantities which vary sinusoidally and have the same frequency. Symbol: ϕ ." Whew! To anyone who has been carefully studying the B.S. definition of phase, as we have, this raises a whole crop of questions. Why "usually expressed as a time" when we have just decided that it is not a time, ". . . or an angle" (what on earth has an angle to do with it?); and why should the periodic quantities have to vary sinusoidally (we have been blithely comparing the phases of aggressively non-sinusoidal waveforms!), or have the same frequency, just as we have decided that there is no need for this? As regards the last point, Van der Pol particularly stresses as an advantage of his conception

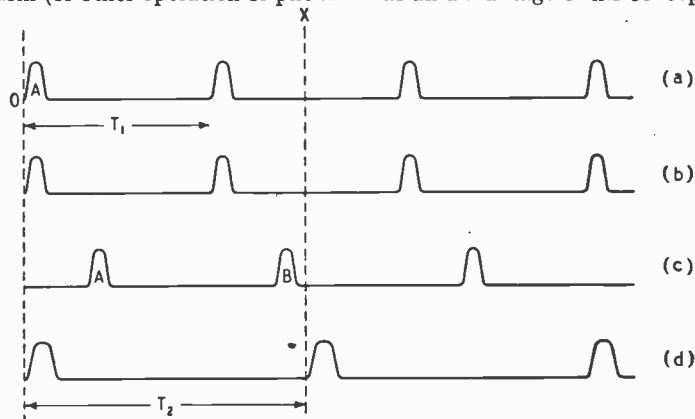

Fig. 2. This set of waveforms illustrates phase difference.

menon) by means of a fractional number. It is not a time or a distance or any other physical dimension, although in most of the cases in which we are likely to be interested it is related to time and can be represented (on a graph) as a distance.

The chief usefulness of the phase idea, however, is not just in marking or identifying stages or states or points. Nearly always it is a phase *difference* that is involved, even when the word "difference" is left out. That is why it is important to be quite clear about what sorts of different waveforms, etc., can be compared as regards phase. The B.S. definition of phase *difference* is not really a definition, for it starts off by saying it is "The difference of phase . . ." What it does do is to lay down certain limitations—

of phase that it does enable one to speak of a phase difference between oscillations of different frequencies.

To avoid any abrupt break in the line of thought, let us postpone for a few minutes all these new complications, and go on calmly with our radar pulses. Fig. 2 (a) is just a repetition of the Fig. 1 (a) waveform, but we are going to use it for considering phase *difference*. Fig. 2 (b) is yet another repetition of the same graph, but it is to be supposed to relate to another radar transmitter. No one is likely to dispute the statement that the two transmitters are pulsing "in phase." That is to say, at every instant their phases are the same; in other words, the phase difference is nil.

Fig. 2 (c) is the graph of a third

transmitter, still with the same recurrence frequency. Consider the phase at the starting line. Taking the commencement of the pulse as the fixed origin in all cases, the phase of the first two is zero, while that of the second is, at a guess, $+\frac{2}{3}$ or $-\frac{1}{3}$, depending on whether one reckons from the last prehistoric pulse or the first one to be recorded here. The phase difference of (c) relative to (a) and (b) is $+\frac{2}{3}$ or $-\frac{1}{3}$, or in other words (c) leads (a) and (b) by $\frac{2}{3}$ of a period, or lags by $\frac{1}{3}$. That is because a (c) pulse started $\frac{2}{3}$ of a period before the start of a pulse in (a) and (b), and another pulse is going to start $\frac{1}{3}$ of a period later. If, instead, you take (c) as the standard, and note the phase difference of (a) and (b) relative to it, you will find that the signs are reversed; the phase difference is $-\frac{2}{3}$ or $+\frac{1}{3}$. Make quite sure of this before passing on! The same phase difference can be either positive or negative, just as the potential difference between two terminals of a battery is either positive or negative according to which terminal is taken as zero.

You may say there are more than two alternative phase differences; the (c) pulse can be said to be $1\frac{1}{3}$ or $2\frac{2}{3}$ or even $3\frac{2}{3}$ periods behind (a). True, but seeing that phase has been defined as a *fraction* of a period, it is surely just being awkward to bring in an indefinite number of other values containing whole numbers. The only justification might be if particular cycles in one of the sets of waves were connected in some way with particular cycles in the other set. Suppose that Fig. 1 (c), instead of representing transmitter pulses, represented the received echoes (not to the same power scale!). Then it would seem rather absurd to say (c) led (a) in phase; it would suggest that an echo arrived before the pulse which caused it had been radiated! If echo A were caused by pulse A, the natural thing would be to say that its phase difference was $-\frac{1}{3}$. But if pulse A produced echo B, this fact could be brought out by saying the lag was not $\frac{1}{3}$ but $1\frac{2}{3}$.

It is necessary to be rather careful about this, though. It is likely to lead to entirely wrong ideas about phase. The lag between radar pulses and echoes is really and truly a *time* lag. It

is not, in its nature, a phase lag at all. A single pulse with its single echo would display the same time lag, but as it wouldn't be a periodical operation, phase wouldn't exist at all. To avoid confusion it is better to call a time lag a time lag, and if for any reason it may be possible and desirable to treat it as a phase difference, never to forget that it is only indirectly so, and that the agreement would be upset, for example, by a change in frequency.

Current "Leading" Voltage

Another example of the confusion of thought caused by thinking of phase as time is probably more familiar to most readers. When we study simple A.C. circuits we learn that the current in a purely capacitive circuit leads the voltage by a quarter of a cycle (or period). Since there is no doubt that the current is a result of the voltage, it seems queer, to say the least, that the result should come before the cause!

As this is a common stumbling-block we might digress from pulses to consider it. The fallacy, of course, is in assuming that each voltage peak from the supply is the cause of a current peak. That is so in a resistive circuit, but not in a reactive one. You can have as many volts as you like across a condenser, but so long as the voltage is steady there will be no current (if it is a good condenser). When current flows in or out of a condenser, it charges or discharges it; that is to say, the voltage across the condenser rises or falls. Conversely, if the voltage across it is made to rise or fall, current flows in or out. The more rapidly the voltage changes the greater the current. If the supply voltage is sinusoidal, its most rapid increase is when it is zero, at point 0 in Fig. 3. So it is that zero (but rapidly increasing) voltage which causes the peak current. At point 1 the voltage is momentarily not changing at all, so the current must be zero. At point 2 the voltage is decreasing at its fastest, so the current is at its negative peak. And so on. The cause of the peak current at the start of Fig. 3 is the rapid increase of voltage at 0, not the voltage peak at 1.



SOUND INSTALLATIONS
in
Sports Arenas
CALL FOR THE
CLARITY
of
TRIX
Quality
SOUND EQUIPMENT

Clear, undistorted output, efficiency in operation, robust construction and complete reliability are features of TRIX Sound Equipment which have led to its installation in Sports Arenas, Rinks, Dance Halls etc. all over the country.

In the entire range there is Sound Equipment not only for Sports Arenas but for every purpose and every type of installation from a 500 watt rack outfit to a portable battery model. A list giving full details will be gladly sent on request.

SOME TRIX INSTALLATIONS

Queen's Ice Rink, London.
Richmond Ice Rink.
Gateshead Greyhound Stadium.
Mayfair Hotel, London.
Cricklewood Dance Hall.
Sportsdrome, Twickenham.
Victoria Ballroom, Nottingham.
State Opera House, Ankara, Turkey.
and many Theatres, Restaurants, Clubs, etc

See our exhibit at the

B.I.F. Olympia, Stand No. H.42

THE TRIX ELECTRICAL CO. LTD.
1-5 Maple Place, Tottenham Court Road,
London, W.1. Phone: MUSEum 5817.
Grams & Cables: "Trixdia, Wesdo, London."



Typical Chassis Type Amplifier.

AMPLIFIERS · MICROPHONES · LOUDSPEAKERS

Phase—

Still another wrong idea of phase sometimes mystifies students of wave guides who have previously learned that nothing

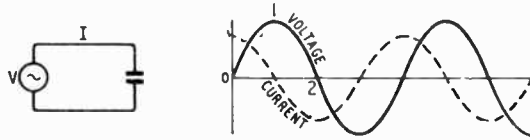

Fig. 3. The well-known case of "current leading voltage" sometimes causes perplexity, owing to a wrong idea of phase.

can travel faster than light. The mystification occurs when they are told that "phase velocity" in wave guides is always faster than light. It is true that no material or energy or radiation or signal of any kind can travel faster than light, but phase is none of these things; in a wave guide it is a mere pattern formed by relatively slowly moving fields. It is like the cutting intersection of the blades of a pair of scissors. The intersection is just a point in a geometrical pattern, like phase, so has no restriction on its velocity.

Now let us get back to our pulses. One thing I omitted to point out about Fig. 2 (a) and (c) is that the phase difference which we observed on the starting line is the same everywhere else. If that is not obvious you had better try a few places to see; for example, the second dotted line marked X. Here the phase of (a)

is $+\frac{1}{2}$, and of (c) $+\frac{1}{6}$. Subtracting $+\frac{1}{2}$ from $+\frac{1}{6}$ to get the difference, we have $-\frac{1}{3}$ as before.

But now consider Fig. 2(d), which has a lower frequency. At the start it is in phase with (a). But as time rolls on, (d) lags behind. At line X it is half a period behind. At the fourth pulse in the (a) series it is a whole period behind. Or in

phase, if you prefer it. The phase difference varies with time. That is a feature of the phase differ-

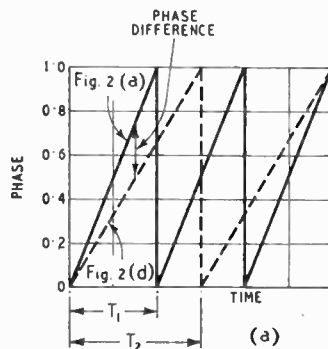

clearly by drawing a phase/time graph, as in Fig. 4(a). Adhering to the strictly fractional idea of phase, which is what the British Standard seems to have had in mind, the phase jumps back to zero at the completion of each cycle, as shown. The phase difference is represented by the vertical distance between the two graphs. As you see, (a) gains a steadily increasing lead up to the end of its first period; then after its jump back it finds itself lagging, but it gradually reduces this lag,

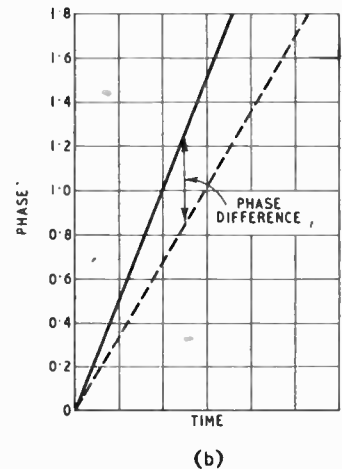

Fig. 4. Graph of progressive phase difference between two similar waves of different frequency, Fig. 2(a) and (d), according to two different definitions of phase difference.

ence between wave trains of unequal frequency.

This process can be seen more

until (d) jumps back and gives it a big lead. Finally the two come momentarily into phase again, after three (a) periods, which is the same time as two (d) periods.

If, on the other hand, you prefer to let your phase accumulate, as I understand Van der Pol and others do, the diagram is as in Fig. 4(b), in which the (a) series gains an ever-increasing lead at a steady rate. The difference between these two diagrams shows one of the differences in the minds of the authorities, which one has to know if not to be caught. Of course the British Standard wouldn't own Fig. 4(a), because the B.S. rules out phase differences between quantities of unequal frequency. Don't ask me why; we seem to have been getting along quite happily with different frequencies on the basis of the British Standards definition of phase.

(To be concluded.)

Books issued in conjunction with "Wireless World"

	Net Price	By post
TELEVISION RECEIVER CONSTRUCTION. A reprint of 10 articles from "Wireless World"	2/6	2/9
FOUNDATIONS OF WIRELESS. Fourth revised Edition, by M. G. Scroggie, B.Sc., M.I.E.E.	7/6	7/10
WIRELESS DIRECTION FINDING. By R. Keen, M.B.E., B.Eng. (Hons.), Fourth Edition	45/-	45/9
TELEVISION RECEIVING EQUIPMENT, by W. T. Cocking, M.I.E.E., Second Edition	12/6	12/11
WIRELESS SERVICING MANUAL, by W. T. Cocking, M.I.E.E., Seventh Edition	10/6	10/10
HANDBOOK OF TECHNICAL INSTRUCTION FOR WIRELESS TELEGRAPHISTS, by H. M. Dowsett, M.I.E.E., F.Inst.P., and L. E. O. Walker, A.R.C.S., Eighth Edition	30/-	30/8
BASIC MATHEMATICS FOR RADIO STUDENTS, by F. M. Colebrook, B.Sc., D.I.C., A.C.G.I.	10/6	10/10
GUIDE TO BROADCASTING STATIONS, Third Edition	1/-	1/1
RADIO DATA CHARTS, by R. T. Beatty, M.A., B.E., D.Sc., Fourth Edition—revised by J. McG. Sowerby, B.A., Grad.I.E.E.	7/6	7/11

Obtainable from all leading booksellers or from

ILIFFE & SONS LTD., Dorset House, Stamford Street, London, S.E.1.

Short-wave Conditions

March in Retrospect : Forecast for May

By T. W. Bennington and L. J. Prechner (Engineering Division, B.B.C.)

DURING March the average maximum usable frequencies for these latitudes decreased during the day and increased considerably during the night. Communications on frequencies higher than 35 Mc/s were very infrequent. There was in March more ionosphere storminess than in February, much of it very probably connected with two large sunspot groups, one of which crossed the central meridian of the sun on March 3rd and the other on March 14th. Ionosphere storms occurred on 2nd, 13th-16th and 21st, the conditions on 15th being particularly disturbed.

Of the several "Dellinger" fade-outs which occurred, that at 1240 G.M.T. on the 20th appears to have been most severe.

Forecast.—It is expected that during May daytime M.U.F.s in the Northern Hemisphere will undergo a considerable decrease, though, because of the longer duration of daylight at this end of the circuits, moderately high frequencies will remain of use for longer periods than during April. Night-time M.U.F.s should continue to increase and thus, during May, there will be less change in working frequencies from day to night than during the previous months.

Daytime communication on very high frequencies (like the 28-Mc/s band) should be relatively infrequent except on southerly transmission paths, but over many circuits frequencies as high as 15 Mc/s will remain usable till well after midnight. During the night frequencies lower than 11 Mc/s should not really be necessary at any time.

For distances up to about 1,800 miles transmission will be controlled largely by the E and F₁ layers, and for these distances both daytime and night-time working frequencies should be higher than in April.

Sporadic E usually increases sharply in its rate of incidence during May. Medium-distance communication (up to 1,400 miles) by way of the Sporadic E layer may be possible for about 15 per cent to 25 per cent of the time on frequencies exceeding 21 Mc/s. Frequencies as high as 50 to 60 Mc/s may be occasionally reached for a very short time.

Below are given, in terms of the broadcast bands, the working frequencies which should be regularly usable during May for four long-distance circuits running in different

directions from this country. In addition, a figure in brackets is given for the use of those whose primary interest is the exploitation of certain frequency bands, and this indicates the highest frequency likely to be usable for about 25 per cent of the time during the month for communication by way of the regular layers. Times in G.M.T.

Montreal :	0000	15 Mc/s	(20 Mc/s)
	0200	11 "	(17 ")
	1000	15 "	(21 ")
	1300	17 "	(23 ")
	2300	15 "	(20 ")
Buenos Aires :	0000	17 Mc/s	(23 Mc/s)
	0200	15 "	(21 ")
	0900	17 "	(23 ")
	1000	21 "	(29 ")
	2200	17 "	(23 ")
Cape Town :	0000	17 Mc/s	(24 Mc/s)
	0600	21 "	(30 ")
	0900	26 "	(37 ")
	1800	21 "	(29 ")
	2300	17 "	(23 ")
Chungking :	0000	11 Mc/s	(17 Mc/s)
	0200	15 "	(21 ")
	0400	17 "	(24 ")
	0700	21 "	(29 ")
	1700	17 "	(23 ")
	2100	15 "	(20 ")

During May ionosphere storms are not as a rule very prevalent, nor are the effects of those which do occur usually particularly disastrous to radio communication. At the time of writing it would appear that storms are more likely to occur during the periods 5th-10th, 15th and 22nd-24th than on the other days of the month.

SOUND REPRODUCTION MANUAL

THE new "Partridge Manual" replaces "The P.A. Manual" and "The Partridge Amplifier Circuits" previously issued by Partridge Transformers, 76-78, Petty France, London, S.W.1. It deals broadly with sound reproduction and in addition to practical data on amplifier design contains useful information on sound and hearing, and acoustical problems such as the location of microphones and loudspeakers.

The manual which costs 5s runs to 60 pages and contains about 30 figures and charts.

Bi-colour Wire

Two-colour P.V.C.-insulated connecting wire is now being produced by a new process by Associated Technical Manufacturers, Vincent Works, New Islington, Manchester, 4. It is especially intended for use in elaborate colour-coding schemes.

And now the STANDARD RACK

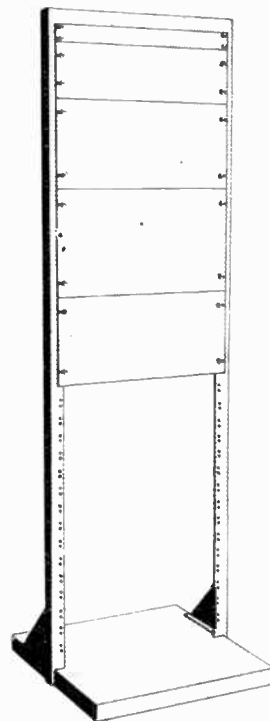

Latest edition to the Imhof range of cases is the new Standard Rack and Panel assembly. Of heavy gauge mild steel angle, it is strongly constructed with welded corners, and finished in grey stove enamel. Standard 19" Rack panels of $\frac{1}{8}$ " thick mild steel plate are available in four sizes:—1 $\frac{1}{2}$ ", 5 $\frac{1}{2}$ ", 8 $\frac{1}{2}$ " and 10 $\frac{1}{2}$ " deep finished in grey stove enamel.

Prices:—
Standard Rack frame 5' 6" high £4 15s. 0d. each
Panels 19" x 10 $\frac{1}{2}$ " ... 11s. 3d. "
" 19" x 8 $\frac{1}{2}$ " ... 8s. 9d. "
" 19" x 5 $\frac{1}{2}$ " ... 5s. 7d. "
" 19" x 1 $\frac{1}{2}$ " ... 3s. 2d. "
Plated chassis with associated mounting brackets 15s. per set.



PRECISION BUILT INSTRUMENT CASES
112-116, NEW OXFORD STREET,
LONDON, W.C.1
Telephone: MUSEum 5944

Unbiased

Ten Per Cent More

THOSE of us who are striving with might and main to achieve the extra ten per cent for which the Prime Minister has appealed cannot help feeling sorry that more scientific and subtle methods are not used to achieve this desirable target. The sandwiching of these calls on our patriotism between the more alluring appeals made by the seductive sirens of Wardour Street is of little value.

The gist of the whole problem so far as I can see it is that we should all put in longer hours of work and so increase production. I cannot help feeling that however willing we may be, the flesh is weak and to some of us, myself included, these appeals to our better nature have about as much effect as the leaflets, which we dropped from the skies, did on the Germans. Experience taught us then that sterner and more scientific measures were necessary and such I feel will be necessary now to extract the extra hour out of us painlessly and without protest.

The method of doing it must be fairly plain to all of you who live in districts served by A.C. mains. It will be recalled that in the days immediately preceding the great freeze-up in February, 1947, when there were frequent and, at times, lengthy periods of frequency "slow down," the B.B.C. used to bid us



Seductive sirens.

not to put forward the hands of our synchronous clocks as the lost time would be made up at the generating station.

It is obvious from the foregoing that if the Government, who now own all electricity supplies, cared to do it, they could quite easily issue a ukase to the engineers to speed up the frequency at night so that we lost an hour's sleep unbeknown

By FREE GRID

to us and slow it down during the daytime so that we did an hour's extra work, also unbeknown.

There are, of course, several practical difficulties in the way which might be likened to the nasty little fact which sometimes destroys a beautiful theory. But all these difficulties can be overcome with a little ingenuity. The first of these is, of course, that some people are served by D.C., while others have no mains at all. This can easily be remedied by quickly supplying A.C. to everybody. Labour and materials thus expended would be recouped a thousandfold when once the scheme got going. After that it would, of course, have to be made a penal offence to use or own ordinary clocks, but this would be well within the scope of a ministerial regulation. Watches would, of course, be a bit of a snag but I feel sure that everybody could be induced to surrender them for export to the Andaman islands or somewhere like that. The real snag is, of course, the shift workers, but even here it must be remembered that most factories use individual master-and-slave clock systems which could easily be slowed down and speeded up at the master clock.

Babel Up to date

THE Oxford accent, like Cambridge sausage, has no connection with the ancient seat of learning after which it appears to be named. Unfortunately, however, some people seem convinced that this ghastly sort of pseudo-English is both used and encouraged at Oxford, rather in the manner that some people imagine that people in Australia spend their time in throwing boomerangs and crying coo-ee. I'm sure I don't know where this particular accent is used. The B.B.C. announcers are not guilty.

Although they are not guilty of using this atrocious travesty of good English, the B.B.C. announcers are, I am sorry to say, very guilty of causing bewilderment and chaos among those of us who are not *alumni* of places where the niceties of English pronunciation are taught. I am no supporter of a dull, rigid and monotonous sort of standard



No alumni.

English, and rejoice to hear the sing-song accents of the Rhondda Valley or the still surviving Cromwellian accent in Sele Suffolk.

But from the lips of B.B.C. announcers when they read the news or bid us be ready to hear some sentimental slush from the lips of an inane crooner, I certainly think that we ought to hear some form of standard pronunciation as indeed I think we used to do at one time. To mention but two of the many words upon which the B.B.C. announcers do not seem to be agreed; when we talk of "finance" must we call it "fine-ants" or "finnants," and is it "civil-eyes-ation" or "civil-liz-ation"?

Perchance there is no hard and fast rule on this matter, and one method of pronunciation is as good as the other, but surely the announcers can all use the *same* pronunciation even if it is the wrong one. We have in this country no equivalent to the "Académie Française" to guide us in this matter, but surely the B.B.C. can find somebody as painstaking as the late Professor Lloyd James to guide them in this matter. Maybe I shall be told that there is an authority at the B.B.C. to see to these matters and probably the B.B.C. will send me some little "Announcers' Vade-mecum" which, like the Highway Code, is supposed to be studied by all and so seldom is—by pedestrians at any rate. Don't think that I am trying to set myself up as an authority on good English. I am not, for I am, relatively speaking, a newcomer, an alien whose ancestors came over from Normandy not yet 900 years ago. I make no pretence to be a real dyed-in-the-wool Englishman who came over with Hengist and Horsa some six hundred years earlier—449 was the year if my memory serves me right.

LETTERS TO THE EDITOR

**Midget Valves ♦ F.M. and Interference ♦
No-A.F. Receiver ♦ Contact Resistance**

British Sub-miniature Valves

I WAS glad to see the article in the March, 1948, issue of your journal, and to learn that a serious attempt is being made by British manufacturers to supply these tiny valves, which have hitherto come principally from the United States.

I fear that some of your readers may be misled by the comparison made between the British valves and their American counterparts. The figures given for the English valves relate to a product which is not yet commercially available, whereas the figures for the American counterparts relate to valves which have been freely available for the past two years, and which are now obsolescent.

Taking first the statement that "These (English) valves compare favourably in size with corresponding sub-miniature valves of American manufacture." While the English valves are 0.4in in diameter, the American valves approximate to a rectangular cross-section 0.385in by 0.285in. The significant factor here is the flatness of the American valve, of which full advantage is taken by some English and most American manufacturers of miniature hearing aids. British-made hearing aids are in current production which are too slim to accommodate the new English valves. To increase the dimensions of these aids would be to put this country at a disadvantage in important export markets.

Again, while it is appreciated that the reduction of the total filament current of a three-valve hearing aid to 1.25V, 50mA represents a very considerable technical feat, the present American hearing aids have reduced the current drain to 40mA. The voltage amplifier valve used, Raytheon CK-512AX, has a filament rated at 0.625V, 20mA. The voltage gain obtainable is slightly above the figure quoted for the equivalent new English valve. These valves have been produced and are in use in very large quantities and have

proved extremely reliable; indeed, the service obtained is better than that which we have come to expect from full-sized battery valves. The figure quoted in the article of 75mA filament current for a similar circuit employing valves of American manufacture is seriously out of line with current practice.

It seems appropriate to point out here that initial leadership in the design and manufacture of sub-miniature valves came from this country, and in the late 1930s such valves were exported to the United States.¹ Immediately after the war, a satisfactory sub-miniature output valve with a filament current of 30mA was available in this country, and at that time was superior to equivalent American valves in that respect. Such valves have been used by the company with which the writer is associated for nearly two years with satisfactory results. It may be of general interest to readers to learn that a complete range of these sub-miniature valves comprising more than twenty different types, is now available in the United States, and that as well as valves specially designed for hearing aids, there are also types for portable radios, U.H.F. oscillators, gas triodes and electrometers.

I have every reason to believe that the new English developments will lead to the production of miniature valves of the highest performance and reliability, but it does seem important to take this opportunity of reviewing these developments in their correct perspective in order to avoid any suggestion of complacency.

J. P. ASSENHEIM,
Chief Research Engineer,
Amplivox, Ltd.,
London, W. I.

"F.M. Reception"

REFERRING to the description in your March issue of comparison tests on F.M. phase dis-

¹ This presumably refers to Hivac valves—Ed.



**SPECIAL
ADVANCE NOTICE**

**AN UNUSUAL CIRCUIT
WITH
AN UNUSUAL LAYOUT**

which may set the fashion for future design. The most advanced design for Radio Reception ever offered to home constructors, covering V.H.F. from 2½ to 2,000 metres. It includes Frequency Modulation, Television Sound, Short-Wave and Broadcast Bands with separate tuning for V.H.F. which also functions as bandspread on all other short-wave bands.

Brief Description of Circuit

A double frequency changing circuit is used. The aerial input is fed into the first R.F. tuned transformer stage, the output being taken to another H.F. transformer coupled to a second R.F. stage using short wave R.F. pentodes, the sensitivity of which is controlled by suppressor and control grid bias. The second R.F. stage is again coupled to a H.F. transformer feeding into the grid section of the first frequency changer. Tuning is effected by a four-gang ceramic insulated tuning condenser mounted on rubber. A separate low capacity four gang V.H.F. tuning condenser is wired into the coil unit to a double wafer switch unit (four-bank) mounted in each coil section. 24 coils are used, iron-cored, litz wound on all bands except the Television and F.M. coil, which is wound on a ceramic former.

A separate oscillator is used of the "Transitron" type, another R.F. pentode. The output from the mixer is fed into a wide band HIGH intermediate frequency amplifier, two stages are used, the last I.F. transformer feeding into the second frequency changer stage (a triode-hexode valve) with a fixed frequency oscillator stage. The output from the second frequency changer is taken to a LOWER, intermediate frequency amplifier, the output of which is taken to a double triode (6C8), the 1st triode section of which is used as an infinite impedance detector, then to special filter circuit feeding into the output stage a pentode (EL33), alternatively an octal plug can be fitted into the output valve socket and connected to any L.F. amplifier. The second triode section of the 6C8 is used for AVC control only.

All the necessary smoothed I.T and HT is taken from a mains transformer 200-250 volts. Theoretical and full size practical blue prints for this UNIQUE receiver available on and after the

RELEASE DATE—MAY 27th.

Price 10/-. **ORDER NOW!**

Registered design. This will be illustrated when advertisement space permits.

**6-VALVE SUPERHET CIRCUIT
3 Wavebands. A.O. only.**

A circuit that will please the most critical. This circuit has been designed to receive all worthwhile stations on the medium wave band (200-540 metres) with a high fidelity output. Short Waves (16-47 metres) are as good as obtained on some purely short-wave receivers. Australia and America have been received regularly by many of our customers at loudspeaker strength. Long Wave: The few stations now operating are well received.

Blue Prints. 2 Practical and 1 theoretical with detailed priced list of components, 3/6 per set.

**307, HIGH HOLBORN,
LONDON W.C.1. Phone: HOLborn 4631**

Letters to the Editor—

criminator and ratio detectors, I am not quite satisfied with the legitimacy of making the impulsive interference tests in the absence of a frequency modulated signal.

In the case of the phase discriminator this is probably justifiable, but in the ratio detector it would appear that when the impulsive interference has a peak value greater than twice the peak value of the signal, the capacitor C3 would charge up rapidly to almost the peak value of the interference, and not to the peak value of the signal.

The diodes will then be rendered non-conducting except during interference pulses, and the signal will either disappear or at least become seriously distorted.

I should be interested to know whether the authors have made any tests under these conditions, and whether they have any evidence of distortion occurring during impulsive interference.

J. E. PATEMAN.

Enfield, Middlesex.

[The authors of the original article comment as follows.—
ED.]

THE biasing-back effect which Mr. Pateman suggests has not, in fact, been observed until the strength of the impulsive interference is so great that the programme is virtually drowned in it. In this case, it is hard to say whether the programme is being aurally masked by the interference or whether it is being electrically biased back by this. It would seem that the probable reason why this biasing-back effect is not serious is because the condenser C3 would not charge up rapidly to almost the peak value of the interference because the charge time of the network, including C3, is probably a little longer than the discharge time. This being the case, the voltage across C3 would tend to something a little lower than the mean value of the impulsive interference which, for normal repetition rates, would be far below the peak value and, therefore, probably insignificant.

We have made some tests in the conditions specified by Mr. Pateman and we have not noticed any evidence of distortion occurring

during impulsive interference, at least, until it becomes so disturbing that the programme coming through it is not worth listening to at all.

High-level Detection

IN the last two years you have published details of a number of high-quality amplifiers and receivers but all of them have had one or more A.F. stages before the output. There has been no mention of my own particular pet—the high-voltage diode feeding a push-pull output stage without any intermediate amplification. This strikes me as being capable of permitting the best quality reproduction on radio; you allowed me to describe it in *Wireless World* as long ago as November, 1934

I contend that the diode provides the most linear detection when used as high on its slope as possible and that it permits the use of a most convenient method of paraphrasing. The use of only the one A.F. coupling has advantages in a decrease of phase-shift, in stability and in diminution of hum.

It may interest you to know that, thanks to improvements in valves, my present set represents a further stage in my search for quality. The D63 diode I use is capable of handling up to 2mA per diode (mine are strapped in parallel) allowing a low D.C. load to be used and therefore a better relationship between the D.C. and A.C. loads (*vide* Langford Smith's "Radio Designer's Handbook"). The D63 is capable of giving a sufficient reserve of output to permit a fair amount of negative feed-back being employed in the PX25 output circuits, a further precaution which increases quality. I found little difficulty in feeding an adequate R.F. voltage to the diode, thanks to the use of an output tetrode in the third R.F. stage; nor had I much trouble with instability as the gain per stage is low and totally screened pre-set tuning as well as staggering of the tuning allowed me to get the three stations I require with the widest possible band of frequencies.

While such a set is admittedly extravagant, to me it represents the nearest approach to an ideal

both regarding quality of reproduction and simplicity of design. It has two disadvantages, however; it cannot very well be used for gramophone reproduction, and, most serious, it shows up many of the B.B.C. transmissions, particularly recordings, long land-line and short temporary land-line transmissions. On the other hand it provides me with a supreme enjoyment of the really high quality transmissions and programmes that are frequently broadcast by the B.B.C. This alone makes the labour and expense well worth while.

W. MACLANACHAN.

London, W.8.

"Cleaning Switch Contacts"

IN his article in your February, 1948 issue J. J. Payne does not mention the more complex problems of contact non-linearity. These might not cause any great difficulties when dealing with circuits where small changes in contact resistance can be neglected. But such changes undoubtedly occur and Mr. Payne's statement that high spots "will still make electrical contact" because "the contact pressure will force the high spots through this layer" (of grease) must be read with caution. There is no reason to believe that there will not be a very fine layer of grease between the contacts even with comparatively high pressures. This layer will cause a small change of contact resistance. Also, this resistance is affected by the substance or gas with which the gaps between any two contacts are filled, whether air or grease or impurities or any combination of these. Thus, even if the area of direct contact is not altered, whether grease is applied or not, as Mr. Payne states, the contact resistance will be altered in cases where the gaps do not act as a perfect insulator, as they seldom do. Contact resistance problems will then become considerably more complex.

G. L. WALLACH.

London, S.W.15.

WITH reference to the interesting article in the February *Wireless World*, I have found carbon tetrachloride in which a quantity of "Vaseline" has been dissolved—enough to give the

mixture a rich amber colour—to be very satisfactory. It would appear that this meets the require-

ments referred to in the article.

R. V. GOODE.

Totland Bay, I.o.W.

New Domestic Receivers

A table model battery receiver (Model A801) designed to run off a 1½-volt dry cell or 2-volt accumulator has been introduced by Allander Industries, Bridgeton, Glasgow.



Ekco "Princess" portable.

Loctal base valves are used in the four-valve circuit which covers short, medium and long waves. The price is £16 16s plus purchase tax.

In the "Princess" portable, made

by E. K. Cole, Southend-on-Sea, miniature valves are used in the 4-valve superhet circuit which operates on medium and long waves. The battery consumption is 0.25A at 1½V and 9mA and 69V. The dimensions are 8½in. x 7½in. x 2½in and the weight approximately 4½lb. Provisionally the price has been fixed at £13 13s plus purchase tax.

A four-valve, four-waveband A.C. superhet (Model 31) has been added to the range of receivers made by Invicta Radio, Parkhurst Road, London, N.7. The price is £18 18s. plus purchase tax.

Those who saw the 128 series of export receivers made by Murphy Radio, Welwyn Garden City, Herts, at Radiolympia, will be interested to know that equivalent models for sale in this country are now available. In addition to the usual medium and long-wave ranges the sets cover 75-200 metres and have bandspread tuning on the 16, 19, 25, 31 and 41-49 metre bands. An SP41 R.F. amplifier is added to the 4-valve superhet circuit for the bandspread ranges. The price is £31 plus purchase tax and alternative models are available for A.C. or A.C./D.C. supplies.

Manufacturers' Literature

Leaflet giving particulars of television aerial installation service from Wolsey Television, 87, Brixton Hill, London, S.W.2.

Leaflet describing the new "Acru 24" soldering iron from the Acru Electric Tool Manufacturing Co., 123, Hyde Road, Ardwick, Manchester, 12.

Descriptive leaflet and specification of the Barker Model 148 loudspeaker, from Barker Natural Sound Reproducers, BCM/AADU, London, W.C.1.

Catalogue of radio components, receiver kits, etc., from Coulphong Radio, 58, Derby Street, Ormskirk, Lancs.

Descriptive leaflet dealing with the "Aldryunit" battery eliminator from the Dulci Company, 95-99, Villiers Road, Willesden, London, N.W.2.

Leaflet No. 1303, "Metal-to-Glass Terminal Seals," from the Edison Swan Electric Co., 155, Charing Cross Road, London, W.C.2.

Illustrated folder describing 15in and 18in heavy-duty loudspeakers from Goodmans Industries, Lancelot Road, Wembley, Middlesex.

Catalogue of silvered mica capacitors from Stability Radio Components, 14, Normans Buildings, Central Street, London, E.C.1.

Booklet giving dimensions of transformer and choke laminations in Mumetal, Radiometal and Rhometal from Telegraph Construction and Maintenance Co., 22, Old Broad Street, London, E.C.2.

Catalogue and price list of microphones, loudspeakers and accessories from Vitavox, Westmorland Road, London, N.W.9.

Illustrated folder on Carbon Pile Resistors from the Morgan Crucible Co., Battersea Church Road, London, S.W.11.

Catalogue of Single Phase Medium Current Rectifiers (Bulletin SRT6, issue 2) from Standard Telephones and Cables, Rectifier Division, Oakleigh Road, New Southgate, London, N.11.

A.F. Measurement Service

A series of twenty-four tests of performance of audio-frequency amplifiers is undertaken by A. E. Cawkell, 7, Victoria Arcade, The Broadway, Southall. These include distortion, phase shift, etc., and trace photographs of oscillograms. The charge for the comprehensive tests is 6 gns and a selection of four "minimum essential" tests can be made for 2½ gns. It is hoped later to extend the service to microphones, loudspeakers and pickups.

The following figures are the pass figures on final test for Model QA12/P AMPLIFIER



FREQUENCY RANGE
± 0.3 db 20 - 20,000 c.p.

SENSITIVITY
1.5 millivolts for full output
(without boosts)
15 millivolts for full output
(with boosts.)

BASS CONTROL RANGE
- 12 db to + 16 db at 30 c.p.s.
relative to 600 c.p.s.

TREBLE CONTROL RANGE
- 30 db to + 18 db at 15,000
c.p.s. relative to 600 c.p.s.

DISTORTION CONTENT
(up to 12 watts output)
2nd Harmonic < 0.2%
3rd Harmonic < 0.3%
Higher order < 0.4%
Total

BACKGROUND NOISE
better than - 66 db at full gain

DAMPING FACTOR 12

INPUT IMPEDANCE
1.5 megohms

SOURCE IMPEDANCE
Up to 50,000 ohms

OUTPUT IMPEDANCE
7 and 15 ohms

2267

ACOUSTICAL

ACOUSTICAL MANUFACTURING
CO., LTD., HUNTINGDON

TEL: 361

Random Radiations

By "DIALLIST"

F.M. Receivers

THOUGH V.H.F. F.M. transmissions have been made regularly by the B.B.C. for some time now, and though the corporation's policy is to develop this kind of high-fidelity broadcasting in addition to its medium-wave, medium-fidelity system, our radio manufacturers don't yet seem to be offering the man in the street apparatus that will receive the transmissions. I expect that they'll be doing so before the autumn. If they take the right steps to interest the public, they are sure to reap a rich reward. There must be a demand for high-fidelity reproduction, for the success of the Third Programme has proved the unexpectedly wide interest of listeners in good music—and good music cannot be reproduced properly by other than high-fidelity apparatus. Not the least of the other advantages of F.M. are freedom from most forms of interference and the fact that there is no need for "contrast compression" to be anything like so severe as it must be in A.M. broadcasting.

New Primary Cells

PARTICULARS OF TWO new primary cells, both using magnesium instead of zinc for the negative electrode, have reached me from the United States. The possibilities of magnesium have been realized for sometime, but there were until recently difficulties about producing at the right price adequate supplies of a sufficient degree of purity. Unless the metal is well over 99% pure the shelf-life of cells is apt to be unsatisfactory. One type developed for special war purposes by the Burgess Battery Company has a spirally wound positive electrode of silver foil. The depolarizer of silver chloride is applied to the strip in the form of a paste. The electrolyte is simply—water! Such cells are capable of quite remarkable discharge rates at relatively high voltages. One battery, for example, which weighs 10 oz consists of two cells in series. It will supply a substantially constant current of 53.5 amperes at 2.8 volts for 6 minutes. A single cell of another type, cylindrical in shape and measuring $1\frac{1}{2}$ in.

$\times 2\frac{1}{2}$ in., gave under test 100 amps at 1.4 volts for $1\frac{1}{2}$ minutes. The zinc-carbon dry cell averages 1.55 ampere-hours per pound of weight, the lead-acid accumulator 5.6 Ah, the nickel-iron accumulator 9.6 Ah and the magnesium-silver chloride cell 12.9 Ah. The magnesium cell also behaves well under small loads such as those imposed on the H.T. batteries of wireless receiving sets. In such cases the discharge curve, whether the load is continuous or intermittent, remains almost flat, the voltage being 1.55 V per cell until a short time before the battery is run down. At that point there is a sharp downward bend. The discharge curve is, in fact, shaped almost exactly like that of a secondary battery or cell. We seem at last to be progressing in the matter of primary cells. If only someone would invent that A.C. battery demanded years ago by "Free Grid"!

Television in America

ACCORDING TO THE LATEST statistics prepared by the American Radio Manufacturers' Association 170,000 televisors (they spell it televisers) were sold in the States during 1947. The average price paid by viewers for their apparatus is rather surprising, working out as it does at \$759, or £189 15s. I think I mentioned some time ago in these notes that American television receivers were a good deal more expensive than ours; but I hadn't realized that the difference was so great. The figures are official, so there's no mistake about them. It is a curious fact that though American manufacturers can and do beat us hollow in the matter of broadcast radio receiver prices (you can buy 4-valve plus rectifier models from \$29, or £7 5s apiece, or even less), we are producing good and reliable television receivers at about one-third of the average price over there. Probably American televisor prices will come down with a run when production really gets into its stride. It seems to be doing so fairly rapidly. In January, 1947 (a month of five working weeks) 5,437 televisors were manufactured. In the five working weeks of October the total had risen to 23,693; and in the same number

of weeks in December it reached 29,345. The industry's forecast of the number of vision receivers in use by the end of this year is a round million; you can see, then, that the new sets produced are going to average about 70,000 a month this year.

Transmissions in the States

At present the best-served cities in America, so far as television is concerned, are New York, Philadelphia, Chicago, Los Angeles, Washington, Detroit, Baltimore and St. Louis. The present scheme (already partly carried out) is for a chain of television transmitters down the east coast, a similar chain down the west coast and a connecting chain right across the country from New York to Los Angeles, with branches into the more thickly populated parts of the country such as Illinois and the Middle West in general. The links of the chain consist partly of runs of coaxial cable (some very long) and partly of radio relays. The system now in operation is extensive; it should cover a very considerable part of that large country within two or three years, at the present rate of progress.

Reflections from the Moon

A REPORT IN THE MARCH number of the *O.I.R. Bulletin* gives some interesting particulars of work done last year by the Australian Council for Scientific and Industrial Research on radio echoes from the moon. Transmissions were made, by means of a rhombic aerial system, from the short-wave station at Shepparton (about 100 miles almost due north of Melbourne) reception taking place at Hornsby, some 350 miles away in New South Wales. The frequencies employed were 17.84 and 21.54 Mc/s and the transmissions were in the form of pulses. On some occasions sets of three 0.1-second pulses were sent out; on others single 2.2-second pulses were used. As the aerial system was fixed, transmissions could be made only when the moon was in the right position. They were further limited to times when the F₂ layer was in a suitable condition to allow the radiation to penetrate it. And overriding both these considerations was the fact that the Shepparton station was available for experimental purposes only at times when it was not required for broadcasting. All conditions, however, were ful-

filled on the nights of November 7th, 8th, 9th and 10th, when most successful results were obtained. The echoes were received with a delay of 2.66 seconds, which, taking the velocity of electromagnetic waves in round figures at 186,200 miles a second, makes the distance of the moon from us at that time some 247,640 miles. One very interesting phenomenon was observed: the received signals were tuned in on a frequency about 50 c/s above that of the transmissions, due to the Doppler Effect.

Television Test Pattern

THE NEW TELEVISION test pattern seems to me to be quite first rate from everyone's point of view except possibly that of the fellow who is trying to dispose of a dud television. It must be of great value to designers and back-room boys servicemen can spot a large variety of faults and wrong adjustments in the twinkling of an eye; the would-be televiewer can check the performances of the set he thinks of buying. It says a great deal for the high standard of British television that our manufacturers should not only have co-operated with the B.B.C. in designing this very exacting test pattern, but should also be anxious to have it broadcast for anyone to receive. One effect rather unexpected in a modern television is shown up, by the way, in no uncertain manner if it is there. This is "pin-cushion" distortion (concavity of the edges of the raster) which leapt to the eye when a friend and I tried his home-made set, incorporating a "disposals" C.R.T., on the pattern a few mornings ago.

Sound Recording Manual

Hints and Tips for Beginners

NEWCOMERS to the art of disc recording will find interest and instruction in a handbook "Sound Recording by the Direct Disc Method," by D. O'C. Roe, issued by Birmingham Sound Reproducers, Claremont Street, Old Hill, Staffs. In addition to operating instructions for the B.S.R. Type DR33 recorder and AR15 amplifier there is much useful general information including hints and tips on recording practice, studio acoustics and the arrangement of performers and microphones and the addresses of societies concerned with questions of copyright.

The booklet is well printed and illustrated and costs 5s.

INDICATORS -

BULGIN

REGISTERED TRADE MARK

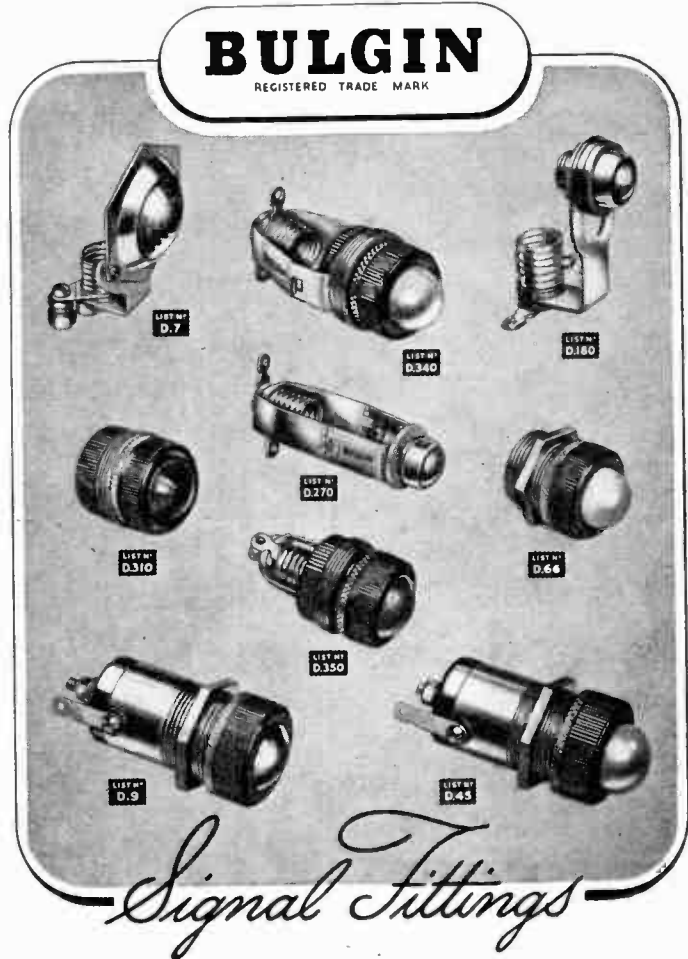

Signal Fittings

IN ALL COLOURS

Universally used by reason of their complete reliability, these signal fittings are found on all types of electronic and domestic electrical apparatus. The types illustrated are for low-voltage use, and are designed for M.E.S.-cap and similar lamp bulbs. Models are available with one pole "live" to frame, or with frame "dead" (when max. [peak] wkg. V. to E. = 250, 500 V. peak test). Internal lamp-holding arrangements ensure permanent trouble-free contacting. Types also manufactured suitable for M.B.C. and S.E.S. lamps.

Enquiries for direct—and indirect—export are particularly invited.

"The Choice

BULGIN

of Critics"

REGISTERED TRADE MARK

A. F. BULGIN & CO. LTD. · BYE-PASS RD. · BARKING

Telephone: RIPpleway 3474 (5 lines)

RECENT INVENTIONS

A Selection of the More Interesting Radio Developments

CATHODE-RAY INDICATORS

WHEN rectified, as distinct from alternating, voltages are applied to the deflecting plates of a cathode-ray tube, as, for instance, in automatic direction finding, the indicating spot is moved to some fixed point on the screen, and the direction is then given by the imaginary line joining the spot to its normal or zero position, which is often difficult to identify accurately.

According to the invention, the charging voltages are applied to each of the deflecting plates through equal resistances of high value, and the plates are coupled to a common earthing point through separate condensers which are periodically shorted, say, at 50 c/s, by electronic switching. The fixed-spot indication is thus converted into a permanently visible straight-line trace, the length and orientation of which is determined by the steady value of the original deflecting voltages.

Standard Telephones & Cables, Ltd. and R. F. Cleaver. Application date, April 14th, 1945. No. 590260.

RECORD REPRODUCTION

THE movements of the stylus are applied to de-tune the circuits of a pair of diode rectifiers which are coupled to a radio-frequency oscillator. The arrangement develops an audio-frequency output voltage that is directly proportional to the mechanical drive; it also automatically suppresses any parasitic noises or disturbances that may arise in the R.F. circuits.

A crystal-controlled valve V supplies R.F. oscillations to the two input circuits of a pair of diodes D₁, D₂, which are connected to a common load resistance R. Both circuits are tuned by a split condenser C. This has a flexible electrode which is directly

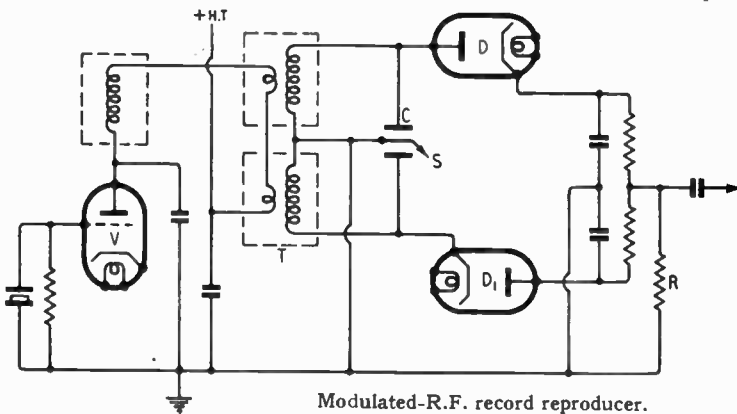

Modulated-R.F. record reproducer.

driven or vibrated by the stylus S. The circuits are therefore simultaneously de-tuned, in push-pull fashion, and a corresponding summation voltage appears across the load resistance,

and is fed to an audio-frequency amplifier (not shown). Any fluctuations originating on the R.F. side of the transformer T are opposed after rectification, and mutually cancel out.

Radio Corporation of America. Convention date (U.S.A.) March 29th, 1944. No. 589834.

WAVE GUIDE FILTERS

ELECTROMAGNETIC energy can flow through a wave guide either as a TM wave having a transverse magnetic and a longitudinal electric field, or as a TE wave with a transverse electric and a longitudinal magnetic field the former induces longitudinal, and the latter transverse currents in the walls of the tube. Both types of wave are usually present initially in the guide, and the inven-

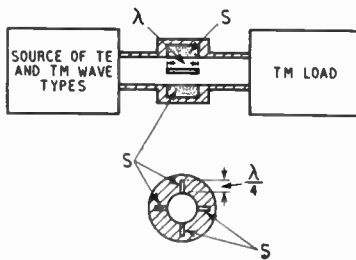

Filter designed to pass transverse magnetic waves.

tion describes means for filtering out one from the other.

As shown, a series of radial quarter-wave slots S are cut in the thickness of the walls, extending for a full wavelength, so as to present a substantially infinite impedance to the flow of transverse current. This blocks the passage

of the TE wave. In width, the slots are too narrow to have any noticeable effect on the flow of axial currents, so that the TM wave is not attenuated. The slots may be filled with powdered

The British abstracts published here are prepared with the permission of the Controller of H.M. Stationery Office, from specifications obtainable at the Patent Office, 25, Southampton Buildings, London, W.C.2, price 1/- each.

graphite to dissipate the energy of the standing wave.

A single circular slot, a quarter wave in depth, and carried peripherally around the guide, will pass the TE type.

Western Electric Co., Inc. Convention date (U.S.A.), April 28th, 1944. No. 590302.

PIEZO-ELECTRIC REACTANCES

A PIEZO-ELECTRIC capacitor is held, by thermostatic control, at its critical or Curie-point temperature, where the dielectric is found to show maximum change in capacitance for a given variation in the applied voltage. The arrangement can be used as a fast-acting reactance for frequency modulation, when shunted across the inner and outer conductors of a tuned coaxial-line element coupled to the output circuit of a U.H.F. triode oscillator.

A convenient dielectric is standard Rochelle salt, which has a Curie-point temperature of 24° C. Another alternative is the same salt crystallized from heavy water (deuterium oxide) this crystal has a critical temperature of 35° C., which can be held by a very simple form of thermostatic control.

Western Electric Co., Inc. Convention date (U.S.A.) October 21st, 1943. No. 589659.

LARGE-SCALE TELEVISION

THE screen of a cathode-ray tube is coated with caesium, which is maintained at such a temperature that the extra heat produced by the impact of the scanning beam is sufficient to produce a momentary evaporation of the metal from point to point along the line of scan. The extent of evaporation increases with the power of the beam as modulated by the received signals, thus varying the transparency of the screen to an external source of light and allowing the picture to be projected outside the bulb of the cathode-ray tube, where it is not restricted in size.

Local cooling is applied to ensure that the volatile metal is deposited back on the screen, in the rear of the scanning beam. In addition, the whole of the cathode-ray tube, except the screen, is enclosed in an electric oven, which is maintained at a sufficiently high temperature to prevent undesirable condensation.

Compania para la Fabricacion de Contadores y Material Industrial S.A. and P. Vileau. Application date June 22nd, 1944. No. 587125.

1998

Quality

**ACKNOWLEDGED
THROUGHOUT
THE WORLD**



ERIE

Radio & Electronic Components

**RESISTORS · CERAMICONS · Hi-K CERAMICONS · POTENTIOMETERS
SUPPRESSORS · VITREOUS ENAMELLED WIRE-WOUND RESISTORS**

Erle Resistor Ltd., The Hyde, London, N.W.9, England

Telephone: COLindale 8011-4.

Cables: RESISTOR, LONDON.

Factories: London & Gt. Yarmouth, England · Toronto, Canada · Erie, Pa., U.S.A.

THE LARGEST PRODUCERS of FLEXIBLE SHAFTING

offer you

TORSIONAL REMOTE CONTROL and FLEXIBLE SHAFT ASSEMBLIES

DEFLECTIONLESS SLOW SPEED OPERATION
 POWER SHAFTS FOR HIGH SPEED OPERATION
 PUSH-PULL OPERATION
 TENSION OPERATION

for
 car radio etc.
 tachometer
 starters
 brakes

The S.S. White Company of Great Britain Ltd

BRITANNIA WORKS · SAINT PANCRAS WAY · CAMDEN TOWN · LONDON · N · W · 1

TELEPHONE : EUSTON 5393

W.T. 58

The

MICOVAC

ELECTRONIC TESTMETER

22 Ranges.
 Long-life batteries.
 VHF probe and 5000v. D.C. multiplier optional.

The multi-range meter that will measure A.F. & R.F. signal voltages!

PRICE £24 . 10s.

ELECTRONIC INSTRUMENTS LTD

17 Paradise Road, Richmond, Surrey

STABLE

to

Resistors produced by the cracked carbon process remain stable to $\pm 1\%$ of initial value.

★ Tolerance $\pm 1\%$
 $\pm 2\%$ $\pm 5\%$

Low temperature co-efficient.

Welwyn carbon resistor

WELWYN ELECTRICAL LABORATORIES LTD.
 Welwyn Garden City, Herts. Telephone · Welwyn Garden 38168

TWO AMPLIFIERS covering all normal requirements for the highest quality record reproduction.

THE CONCERTO 12 watts—8 triodes plus rectifier. Separate treble and bass controls with two steps of bass boost. £27.10s.

THE KI 5 watts—7 valves. Compare this specification with any other 5 watt amplifier in this price region. Push-pull with negative feed-back, distortion less than 1 per cent. Separate treble and bass controls. 17 gns. Available as a kit 13 gns. Blueprint separately 2/6.

Both Amplifiers are designed to take any type of Pick-up, Moving Coil, Moving Iron, or Crystal, without additional pre-Amplifiers or Tone corrections. Radio input sockets are provided and tapped output transformer provides 15, 7 and 3 ohm impedances.

Send stamps for fully illustrated catalogue of Amplifiers, Pick-ups and Speakers.

CHARLES AMPLIFIERS LTD., 1e, Palace Gate Kensington, W.8. (WESTern 3350)



**CONSOLE
REPRODUCER MODEL KC10**

Designed for better listening in the home, the KC10 Console Reproducer incorporates the K12/10 12 in. moving coil loudspeaker in an acoustically damped, totally enclosed, cabinet of optimum dimensions. The walnut veneered cabinet is hand polished and fitted with an anodised aluminium grille. PRICE 20 Gns.

ELIMINATE SOUND DISTORTION

Can distortion be eliminated? Not quite, of course, but it can be reduced to a minimum by the use of loudspeakers which will introduce as little discoloration as possible—well designed loudspeakers—Vitavox loudspeakers in fact.

VITAVOX

MANUFACTURERS OF SOUND EQUIPMENT

VITAVOX LIMITED

Westmorland Road, London, N.W.9, England

Grams : Vitavox, London, England

PRECISION COMPONENTS



CORD DRIVES

Now available in five types as illustrated (left to right) Standard, R/V, Reverse, "D" type and "A" type. All one hole fixing.

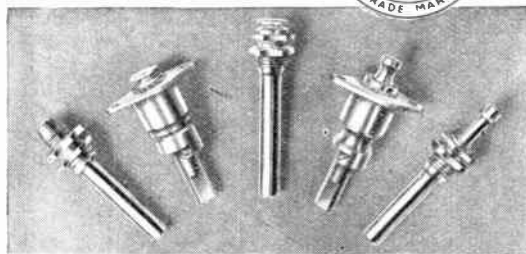

GANG CONDENSERS

A wide range is now available in 1, 2, 3 or 4 gang types of various capacities.

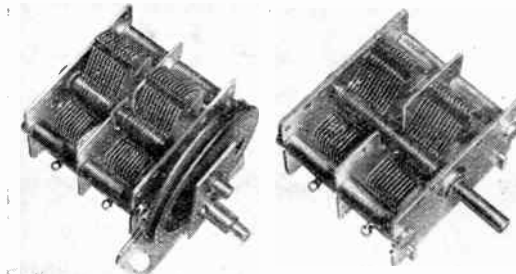

Write for Catalogue No. (W.W.1.)

JACKSON

BROS (LONDON) LIMITED

KINGSWAY · WADDON · SURREY

TELEPHONE: CROYDON 2754-5 TELEGRAMS: WALFILCO. PHONE, LONDON



Coils & Packs.

OUR packs have been designed for the more advanced type of Radio Receiver, covering wave bands from 5 to 2,000 metres up to 6 Bands. High frequency stages are included together with the necessary padding and trimmer condensers, the whole being carefully aligned and receiver tested. Full details of these packs and other combinations are available on application.

LABORATORY



TESTED

H. C. ATKINS Laboratories, 32 Cumberland Road, Kew, Surrey, Richmond 2950

AT 103

S-T

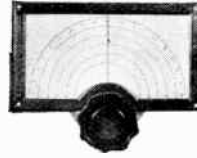

"Q-MAX" SLOW MOTION DIAL FOR SELF CALIBRATION

Dial 6½" x 3½", engraved five blank scales and one 0-180. 8-1 drive; metal escutcheon, glass and knob **15/6**

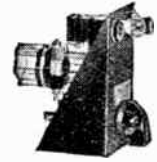

"Q-MAX" ABSORPTION WAVEMETER AND PHONE MONITOR

All amateur bands covered. Plug-in coils, 3/9 each (1.8 mc/s, 3.5 mc/s, 7 mc/s, 14 mc/s, 28 mc/s). Price with one coil **35/-**

IF YOU WANT QUALITY PRODUCTS

WE HAVE THEM.

NO

EX. GOVT. SURPLUS.

NEW HIGH QUALITY CIRCUITS

10 valve semi-com., 13-557 m., 1 R.F., 2 I.F., A.V.C., B.F.O., 2 6F.6 in P/P. Circuit 8/-.
8 valve semi-com., 13-557 m., 1 R.F., 2 I.F., B.F.O., S. Meter. Circuit 6/-.
5 valve A.C. S'Het., 12-550 m., A.V.C., 4 watts. Circuit 5/6.
5 valve Amplifier 6S.N.7, 6I.5, 2 6F.6, 5Z.4. Circuit 3/6.
AND MANY OTHERS.

OUR 1948 CATALOGUE IS NOW AVAILABLE PRICE 3D.

BERRY'S (SHORT WAVE) LTD.

25, HIGH HOLBORN, LONDON, W.C.1

(Opp. CHANCERY LANE)

Tel. : HOL. 6231

We have produced a

CORNER HORN REPRODUCER

which will be of interest to those who like to listen to as near the real thing as possible . . .

May we send you details?

—ALSO—

FEEDER UNITS, TONE CONTROL UNITS, TUNERS and the WILLIAMSON AMPLIFIER.

Trade and Export Enquiries invited.

THE ELMSLEIGH RADIO COMPANY,

1102, London Road, Leigh-on-Sea, Essex.

Telephone : Leigh-on-Sea 75163

TELE RADIO (1943) LTD.

OFFER THE FOLLOWING EX-STOCK

AERIAL WIRE HARD DRAWN ENAMELLED COPPER.	
12 S.W.G. 75 feet	7/-
14 S.W.G. 75ft.	4/6
12 S.W.G. 100ft.	9/3
12 S.W.G. 100ft.	5/6
COAXIAL CABLE ½ in. dia., 22ft. lengths with plugs	5/-

DURAL PANELS.

Lighter and easier to work than steel. Finished fine black crinkle.

10 S.W.G.		14 S.W.G.	
19in. x 10½ in.	13/6 each	19in. x 10½ in.	9/6 each
19in. x 8½ in.	12/6 "	19in. x 8½ in.	8/6 "
19in. x 7in.	10/3 "	19in. x 7in.	7/6 "
19in. x 5½ in.	8/3 "	19in. x 5½ in.	6/6 "
19in. x 3½ in.	6/6 "	19in. x 3½ in.	5/6 "

177, EDGWARE ROAD - LONDON, W.2.

Phone : AMB. 5393.

PAD. 6116/5606.

Rate 6/- for 2 lines or less and 3/- for every additional line or part thereof, average lines 6 words. Box Numbers, 2 words plus 1/- Press Day. This 1948 issue, first post Wednesday, May 5th. No responsibility accepted for errors.

WARNING

Readers are warned that Government surplus components which may be offered for sale through our columns carry no manufacturer's guarantee. Many of these components will have been designed for special purposes making them unsuitable for civilian use, or may have deteriorated as a result of the conditions under which they have been stored. We cannot undertake to deal with any complaints regarding any such components purchased.

NEW RECEIVERS AND AMPLIFIERS

WAKE the Easy Way" with the Revell clock radio, only 12gn. stamp for leaflet.—Thames Valley Products, 28, Camden Ave., Feltham, Middx. 19544

WAVELENGTH receivers with bandspread ranging or chassis complete for gram mounting, gram units, grams, amplifiers, 5-500 watts; why not try us? We always try to help; s.a.e. for list to Mason's (W.W.), Wivenhoe, nr. Colchester.

HIGH quality amplifier and radio tuner units. 15 valve, 30 watts, 30 D.B. bass and treble lift; send for specification.—Broadcast & Acoustic Equipment Co., Ltd., Broadcast House, Tombard, Norwich 26970. 19392

H.R.O./Seniors, AR88s, brand new; send 2/4d stamp for list of these and similar items; superb stocks of gramophone requirements at Johnsons (Radio), Macclesfield, Cheshire. Tel. 4080. Grams: Jonrad, Macclesfield. 19678

SHORT-WAVE Denco communications receiver shortly available, a real step forward in short-wave technique, you simply must have the data sheet of this instrument. Denco Components always available; illustrated catalogue price 9d.—S.a.e. now to Mason's (W.W.), Wivenhoe, nr. Colchester. 19649

SPECIAL offer this month only of 15watt a.c. mains amplifier, 6-valve, 16.45 in. push-pull input for mic, gram, and radio, switching for same, housed in black crackle case with chrom. handles, these are new stock, not ex-Govt., 12gns.; or complete with 12in speaker, £17/10; less than wholesale.—Radio Unlimited, 16, Carnarvon Rd., Leyton D.B. 9508

BRIERLEY ribbon and armature pick-ups, B filters, amplifiers and pre-amplifiers. Arrangements are being made for the demonstration of these products by agents throughout the British Isles. Where arrangements for this have not so far been effected, it is possible for our sales representative to demonstrate in your own home when next in your district.—J. H. Brierley, Ltd., 46, Tithebarn St., Liverpool, 2. 19266

AMPLIFIERS, radio-feeder units and high quality electronic equipment for all purposes. Many we send you details of our range of quality amplifiers, incorporating built-in pre-amplifier and independent bass and treble controls, also our range of radio-feeder units for use with high grade amplifiers?; complete installations undertaken.—Write or call Martin Slater Radio, 96, Wardour St., London, W.1. Tel. Gerrard 4681. 19660

R.A.F. I.F.F. responder units, complete with 4 mains H.F. pentode valves, 3 Mazda television diodes, 2 twin triode mains valves and 1 EF50 Mullard; also includes 24v motor generator, suitable for modification to universal motor, 2 magnetic relays, several mechanical multi-contact relays; includes resistances, condensers, variable and fixed, and other useful components; 35/- each, carriage paid.—Uncle Tom's Radio Cabin, 5, Seven Stars Court, Manchester, 4. 19623

UNIVERSAL ELECTRONIC PRODUCTS, 36, Maryibone High St., London, W.1. Specialists in the design and manufacture of high grade fidelity gramophone reproducers and radio units. If you are interested in obtaining the finest possible reproduction from recorded music we invite you to hear our equipment demonstrated in conjunction with the Wilkins and Wright coil set-up, and the Wharfedale corner cabinet speaker. We will gladly give you a quotation for the conversion of your existing radio gramophone into a first-class reproducing instrument, or for the design and construction of equipment to your own special requirements. Write for descriptive leaflets of our range of fidelity amplifiers and radio tuning units. 19608

RADIO TRADES MANUFACTURING CO (FALING), Ltd., 141, Little Ealing Lane W.5 (Ealing 6962), pioneers in the manufacture of the Williamson amplifier and now the basic circuit in G.E.C. book, are producing a super edition of this famous amplifier which is without doubt the finest reproducer yet evolved. Using Partridge transformers and other parts throughout of the finest quality built on heavy gauge chassis, there is no other amplifier offered at such a reasonable price, tested and aligned. £25/10. 3-valve pre-amplifier of new design giving perfect control of bass treble, £10, complete. Kit of parts with Partridge transformers, £20. 10in speakers, £2. 12in speakers and gram motors with pick-up also supplied. Full details (stamp) R.T.M.C. Ltd. as above. 19038

Partridge News

REMOVAL

Our offices at Petty France are now closed and we wish to bring to your notice our new address at Brixton as shown below. Pending the completion of our new modern transformer factory, our offices, stores and works will now be located at this address.

★ ★ ★ ★

LONDON SALES OFFICE

For the benefit of our many friends we have made arrangements for the immediate supply from stock of small quantities of our standard components (see paragraph below). These can be collected from our address at King's Buildings, Dean Stanley Street, Millbank, Westminster, S.W.1 (250 yards from Big Ben). Hours: 10 a.m.-1.0 p.m. and 2.5-3.0 p.m. (Mondays to Fridays only). Kindly note this address is for stock sales only, and all correspondence and other enquiries should be sent to Peckford Place.

★ ★ ★ ★

AVAILABLE STOCK

A comprehensive range of mains and audio components is now available from stock, and we can despatch small quantities of these per return. We would stress that before ordering you send for our list detailing these components. Our stock range now covers almost all normal requirements, and by availing yourself of this service you will save the inevitable delay in the production of a special component. We shall be pleased to send you our stock list upon receipt of your address.

★ ★ ★ ★

THE NEW PARTRIDGE MANUAL

The completely revised post-war edition of this new Manual, now available, contains:—

Many useful circuits including New 15 watt high quality amplifier with 40 db of negative feedback over three stages. Also articles on Sound Reinforcing and Public Address, Acoustical Problems, Cross-over networks, etc. A useful appendix is included consisting of six selected design charts.

Price 5/- Post Free.

★ ★ ★ ★

Telephone:  Brixton 6506

PARTRIDGE TRANSFORMERS LTD

PECKFORD PLACE, LONDON, S.W.9

1948 feeder units.—Complete range of aligned and calibrated feeder units with accurately printed station named scales; model A3, s.m.l. wave frequency changer and i.f. stage; model B3, s.m.l. wave, r.f. stage, f.c., i.f., and double diode triode; model B5 de luxe, 3 short-wave bands, m.l., 15in x 4in scale, Magic Eye.—Send 2/4d. stamp for illustrated brochure to sole distributors, Coulphone Radio, 58, Derby St., Ormskirk, Lancs. 19313

CONNOISSEUR'S receiver. Combination 10-valve communication receiver and T.R.F. quality set fully converted R1155, switched super-het or T.R.F., 9-1,500 metres, with 1/4 push-pull quality amplifier. Bass and treble boost (separate controls), gram input and other refinements, £35. Makes ideal radiogram. Write for full details or call for demonstration. We can modify your R1155 similarly or to your requirements. R1155 circuit and valves, 2/- post free. Repairs, etc., to all communication and quality receivers.—R.T.S. Ltd., 8, Gladstone Rd., Wimbledon, S.W.19, Lib. 3305.

J.F.R. ELECTRIC & ELECTRONIC DEVELOPMENT LTD., Hubert St., Birmingham, 6 (Tel. Aston Cross 2440). The Midland, high fidelity specialists, manufacture W.W. Williamson and other quality amplifiers strictly to specification; our own Electrona super a.c. and a.c./d.c. types; tone control stages, loudspeaker crossover units, contrast expanders and high quality t.r.f. radio feeders for all amplifiers; we can also adapt them for use with existing equipment according to customers' own requirements; call for a demonstration; give us a ring, or send 2/4d. stamp for details and prices.

RADIO UNLIMITED, 16, Carnarvon Rd., Leyton, offer this month: Varied selection of r gram chassis, from 3 to 10 waveband, single or p.p. output. Example: 3-wave 6-valve universal mains chassis, 6watts, tapped output, attractive glass dial, gram switching, complete with 10in speaker, 16gns; 5-wave chassis, Magic Eye tuning, etc., complete with 10in spkr., £23/10; 3-wave chassis, a.c. or universal, 3watts output, complete with 8in spkr., £15/10; special offer of 3-wave universal mains superhet receiver, in handsome veneered cabinet, illuminated dial, 12gns.; limited numbers available. 19507

GOODSELL, Ltd., 40, Gardner St., Brighton, 1, Sussex.—B.6735. A new amplifier identical to Williamson's but using P.X.25's in the output, giving 20 watts. Gardner mains transformer, two separate rectifiers, one at 500 volts and the other at 350 volts, with 50 miles for pre-amp and tuner, on two chassis, 27gns; for use with Williamson's or the W.W. using Partridge mains transformers and a choice of valves; for complete stability with high gain pre-amps, using 6L6, 6SJ7 and VR150/30, 26gns; pre-amp and E.F.37 as pentode, giving 10 cuts and two boosts of treble and bass, and "straight" £4/6/6; with built-in Quality tuner for local stations only, complete with tuning eye, £9/9, 19669

RECEIVERS, AMPLIFIERS—SECOND-HAND
3-VALVE Burndept Attache portable, £4.—Box 5937. 19445

FOR sale, AR 88 radio receiver.—Tel. Wan 6754. 1929

BC348 built-in a.c. power pack; £20.—Box 6996. 19788

CLYDESDALE for ex-Services electronic bargains.

THE BC348 ex-U.S.A.A.F. communications receiver, 6 bands, 200-600 kc/s, 1.5-18.0 mc/s, 9 valves, crystal filter, etc., for 200-250v a.c. at £27/10 each, carriage paid; price of unmodified BC348 on application.

THIS R.1155 ex-R.A.F. communications, R.X. 5 bands, 1,500-75 kc/s, 18.0-3.0 mc/s, 10 valves, power unit required; at £12/12 each, carriage paid.

CLYDESDALE SUPPLY Co., Ltd., 2, Bridge St., Glasgow, C.5. Tel. South 2706-9. 19828

Harvard Rd., Isleworth, Middx., 19732

R1155 model conversion, complete power pack, cabinet speaker; £25.—Park 7401. 19574

HALLICRAFTER SX-28 (Super Skyriдер), perfect; £50 or best offer.—Box 6872. 19712

As new, p.p. DA30, power-pack, Bl-Tone speaker, 550 filter; offers.—Box 6275.

HALLICRAFTER 827, recently overhauled, 28 to 150m/c/s; nearest £45.—Box 6271. 19583

NATIONAL H.R.O., incl. power unit, 9 coils, phones, excellent condition; £42.—Box 6412.

NATIONAL H.R.O., 9 coils, bandspread facilities on amateur bands; £55.—Box 6394.

FOR sale, AR88 communication receiver.—Offer over £45 to R. & S. Services (Abingdon), Berkshire. 19554

NATIONAL H.R.O. comm. rec., crystal gate, S meter, complete with speaker; offers; would exchange wire recorder.—Box 6803.

HEDDYBUNKEN 7-valve portable, comm. R.X. T.110-230 a.c. or 6v d.c., 2.5-25megs., built-in spkr., B.F.O.; £18.—Box 6280. 19583

R.C.A. AR 88 communications receiver, crystal gate, noise limiter, 14 valves, 10-550 metres, new cond. manual; offers.—Box 6864.

INSPECTION All-World two battery communication receiver, eliminator, charger; £5.—Inspection 8, Midholm, Wembley Plk., Arn. 3678.

REC. R1471, 3-30mc/s, 2 r.f., f.c., osc. 3 valves, b/s p pack; £38.—104, Montagu Rd., Walton, Peterborough. 19759

POTENTIOMETERS

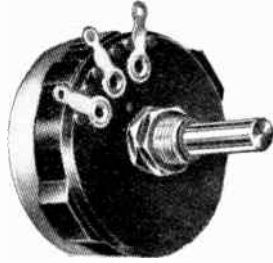

by

RELIANCE

Type T.W. Wire Wound	
Rating	RANGES
5 Watts Max. (linear)	10-100,000 (2) Max. (linear)
3 Watts Max. (graded)	100-50,000 (2) Max. (graded)
	100-10,000 (2) Non-inductive
Type S.G. Composition	
1 Watt Max.	2,000 ohms to 2 megohms

CHARACTERISTICS : (both types) linear, log., semi-log., inverse log., non-inductive, etc.

FULL DATA FROM :

RELIANCE

Manufacturing Co. (Southwark) Ltd. Sutherland Rd., Higham Hill, London, E.17 Telephone : Larkwood 3245

HARTLEY-TURNER

HIGHEST FIDELITY SERVICE

Having overcome the trials and tribulations inseparable from present-day production we can now offer the complete answer to all your high-fidelity problems.

We can supply limited numbers of amplifiers and our unique T.R.F. local-distant radio unit, and, of course, the Hartley-Turner 21S Speaker. In the opinion of those who use our equipment and have tried it out in direct comparison with other outfits costing up to hundreds of pounds, we are, where we always were—at the top of the high-fidelity league table.

If you want this unequalled performance ready-made, the vital prices are : Speaker £9 ; Pick-up £4/7/2 ; 25-watt Amplifier £40/10/- ; T.R.F. Radio Unit £19/10/- + P.T.

But if you want to save money without sacrificing anything except a little leisure time in building it, we can supply you with all the information with or without the components so that you can make it yourself, always excepting the speaker. Thus a complete kit of parts down to the last screw, to make the amplifier costs £24, and the results will be precisely the same as we guarantee with one we produced.

How this is done is given in the Hartley-Turner Technical Bulletins, price 10/- each, with full text and photo-prints.

The following are ready :

T.B. No. 1 25-watt Amplifier and Power Unit.

T.B. No. 2 T.R.F. Radio Unit.

Others are being prepared.

"New Notes in Radio," at 3/8 post free, is the indispensable guide to the whole subject, and has already earned hundreds of testimonials for the accuracy of its information and the logic of its arguments. Send for your copy today.

H. A. HARTLEY CO. LTD.
152, HAMMERSMITH RD., LONDON, W.6
R/Verside 7387.

R1155 receiver, excellent condition, £10; 3v battery rec. (incomplete), £1.—Box 6395.
HR.O. Senior, little used, mains power pack and 9 coils, set unused spare valves; £50.—Box 6879. [9749]

HOMELAND radiogram, 12vs, 6m to 2,000 in 5 bands, 15 watt U.D.O., fig. walnut cabinet; £30.—H. R. Harvey, 29, Fairholme Rd., West Kensington, W.14. [9629]

SECOND-HAND 200-watt amplifier for sale, manufactured E.M.I., in excellent condition.—Available for inspection by telephone call at Beckenham 5014. [9521]

W.W. QA 8w PX4S and tone stage, also 20 W.W. 2RF tuner with AVC professionally built, no speaker; £16 10.—9, Southfield Pk., North Harrow. [9634]

R1155 communications receiver, perfect, including power pack and output stage, £17/10; also T.1154 transmitter, perfect, £6/10. Speedwell 2336. [9465]

RC.A. 877E, 540c/s to 32mc/s, 10 valves. R meter, bandspread, Xtal, must sell; first reasonable offer.—Harman, Pentlands, Pentland Rise, Portchester, Hants. [9772]

NATIONAL H.R.O. receiver, latest model, complete with 7 coils, power pack, listed at £390, with Ericsson phones and spare valves, as new; any offers?—Box 5934. [9431]

EDDYSTONE 504 communication receiver, 600k/c to 30m/c, practically new, in perfect condition; £45.—Seeker, 21, Queens Gate Terrace, S.W.7, Western 0755. [9501]

R1155 com. rec., good condition, d.f. parts removed, pane partially reconstructed in black crackle, ready for use 'phones; offers over £9.—Hamilton, Muirbank, Strathaven. [9728]

HALLICRAFTER'S SX24, S meter, crystal, etc., manual, £36; RAF116A Rx, perfect. £7; TX RX HB11A Hallicrafter stamp list.—Wheatcroft, 39, Leabridge Rd., Exeter. [9767]

HOWARD 450A communication receiver, with matched speaker, 65mc to 540kc, complete with Xtal gate, recently aligned, excellent condition; £50, or offers.—Box 6261. [9479]

HALLICRAFTER'S SX28, with handbook and spare set of valves, offers over £50; HRO complete coils 50c/s to 30mc/s with band spread 1.7 to 30m, cs, both in perf. cond.—Box 6408. [9468]

TROPHY 8 communication receiver, £13; Mullard master test board, with cards, £20; Genalex p.a. 4ft horn speaker, £5.—Shottermill Radio, Wey Hill, Haslemere, Surrey. [9483]

SENIOR HRO complete with coils, power pack, manual, pre-war model, guaranteed new condition in original shipping case; offers over £60; BC-312N, brand new with speaker, manual, £20.—Box 6405. [9468]

DETROLA 6v car radio, perfect, £10; 2-wanted Marconi 707 television set; unused Partridge oscilloscope transformer, 45/-; multi tapped vibrator transformer, 100 m.a. output, 12v in.—Box 6368. [9585]

WHAF offers 1947 35mm G.B. 5-valve amplifier, as new, takes pick-up, mike and sound track, very high output, fine selective control panel.—J. Peters, 118, High St., Brimley, Kent, Rav. 1687. [9541]

HRO Senior, grey enamel, fitted into enclosed sloping front, professional rack with loud speaker, 3 spare tubes, 2 spare coils, spare S meter, 230 volt pack; £55.—G5FH, 17, Knottsall Lane, Langley, Birmingham. [9602]

RC.A. com. rec. for sale (10 valves), in perfect condition, 54 to 31 mc/s in 6 wavebands with band spread; set of spare valves available if required, £50; also fully converted R1155 in new cabinet, £20.—Box 6366. [9581]

HR.O. sen., 7 coils (3 bandspread), a.c. and 6UDL power packs, £42/10; BC 348, new for a.c. operation, £22/10; Eddystone 400X coils and a.c. pack, £12/10; enquiries invited.—Parfitt, Swinland Lane, Rothley, Leics. [9849]

EDDYSTONE communications receiver, type 358X, 40kc/s to 31mc/s, a.v.c., b.f.o., noise limiter, etc., complete 10 coils, coil tray, power pack, matched speaker; buyer collects Stockport.—Best offer: Gt. Moor 4002 or Box 6977. [9670]

W£8/15 complete; Couploune B3 feeder unit, small wave, r.f., i.c., i.f., ddt stages, £5/15 (suitable valves, £1/10); basic kit for 4-valve a.c. T.R.F. receiver, £4/15.—Box 6369. [9581]

HR.O., excellent condition, 9 coils covering 50kc-30mc, 4 bandspread, power pack, speaker, phones, instruction, £55 or nearest; also a lot of amateur equipment such as transmitting valves, high voltage rat. condensers, etc.—Box 6858. [9670]

AMERICAN amateur radio gear receivers, A transmitters code equipment, test gear, aerial systems and masts, telephone apparatus, transformers, chokes, rectifiers, etc., etc.; full list available, stamp will oblige.—Harris, Strouds, Pangbourne, Berks. [9489]

10-WATT quality amplifier, trimmers, output meter, 3.5, 7.5, 15, 30 ohms output, two 4ft horn loudspeakers, fitted 8in P.M. units, 15 ohm, 15 watt, tropical finish, all practically unused; £80 the lot, or would separate.—McNabb, 65, Linden Ave., Wembley. [9644]

90lb weight of wireless for £15; type 19 Canadian sw transmitter receivers for sale, comprising set with 16 valves, etc., power unit, with vibrator and rotary transformer, etc., and aerial variometer, made by R.C.A. Canadian Victor; carriage extra, packing returnable for credit, or would dispose of the lot if collected.—Hampshire Ignition, Ltd., Cheesehill St., Winchester. Tel. 2366. [9459]

COMMUNICATIONS RECEIVER R.1155

This famous 10 valve receiver is known too well for us to repeat all its outstanding features. Covers 7.5 mcs.-75 kcs. in 5 switchable bands. Slow and fast ratio tuning with Magic Eye. Complete with 10 valves and BOOKLET GIVING CIRCUIT DIAGRAMS, ETC. All sets have been used, but ARE IN SUPERB ORDER, and only require power pack. ONLY £12/10/- (carriage, etc., 10/-).
INDICATOR UNITS. A large selection of ex R.A.F. CR Units which are suitable for conversion to oscilloscopes or television work, etc. The main items are listed below, but every unit contains a host of components.
UNIT TYPE 48A contains 2 tubes VCR138 (4in.) and 2 valves SP 41. ONLY 50/-.
UNIT TYPE 184A contains 1 tube VCR S17 (6in.), and 1 3in. tube, 5 valves EF50, 3 type EB34, 3 type SP41, and 5 diodes. ONLY 85/-.
UNIT TYPE 182 contains 1 tube VCRS17, 3 valves EF50, 4 type SP61, and 1 type US2. ONLY 85/-.
UNIT TYPE 162B contains 1 tube VCRS17, 1 tube VCR139 (3in.), 3 valves SP41 (6 volt), 1 VR17, 1 CV67, and 12 v. cooling blower. ONLY 100/-.

Customers are requested to call if possible for these CR Units, owing to risk of damage in transit, but if unable to do so please add 10/- for packing and carriage on No. 48, and 15/- on all others.

TEST SET TYPE 74 contains VCR139, 1 valve SU2150A, 1 type 6Q7, 1 type 6J5G, 3 type SP41 (6 v.), 1 type E1148, 1 type S24. Internal power pack for normal A.C. mains input. ONLY £7/10/-. Requires little modification for use as a normal oscilloscope.

C.W.O. please. S.A.E. for lists.

U.E.I. Corp. THE RADIO CORNER

138, GRAY'S INN ROAD, LONDON, W.C.1

*Phone : TERminus 7837.

Open until 1 p.m. Saturdays, we are 2 mins from High Holborn, 5 mins. from King's Cross.

AT ALL GOOD RADIO SHOPS

TECHNI-GEN

No. 8 Now Ready!

HOW TO MAKE an AC/DC ALL-WAVE T.R.F. 3 Valve & Rectifier RECEIVER

THIS latest addition to the

Famous Techni-Gen Series

describes, with large-size Blue-

prints, layout Diagrams and

complete instructions a very

efficient Receiver covering

wavelengths of 12-30, 30-75

and 200-540 metres. There

is provision for a Gramophone

Pick-Up and use of Headphones

**LEWIS GEORGE
LABORATORIES LTD.**
227-229, Hammersmith Rd., London, W.6.

Sole Agents

Gordon Lawrie & Co. Ltd.,
36, Dorset Street, London, W.1.

LASKY'S RADIO

VALVE MONTH.

A FEW EXAMPLES OF OUR TREMENDOUS STOCK OF RADIO VALVES. BRITISH, AMERICAN, AND CONTINENTAL TYPES, ALL AT B.O.T. PRICES. WE HAVE THE VALVE YOU WANT

MULLARD. DK32, DAC32, CL33, CL4, 1W4 500, CBL1, UBL21, UCH21, UY21, EZ25, PEN36C, PEN40DD, AC044, PEN4DD, PEN4A, CBL31, FC13C, SP13, CY1, SP2, VP2, EBL21, ECH21, AZ1, AZ31, URIC, EF36, EP37, EF38, EF39, EMI, EM4, EM34, EL33, EL38, HVR2, HVR2A, EL38, EF9, EK32, OCH45, VP4B, DF91, DAF91, JL32, DK91, 1024, D030, QP2B, TH30C, 1D2, PC2A, EF22, DF33, DL35, VP13C, VP13A, UR3C, VP2B, EF54, AMERICAN TYPES. 35L6rt, 35Z6rt, 35Z7rt, 3Q5, 1A5, 12N47, 574, 6F6, 6V6, 6L6, 26A6G, 26Z6, 43, 42, 41, 80, 84, 77, 38, 616, 6C6, 6C8, 37, 6A7, 6X5, 6Z4, 6SN7, 6Q7, 6L7, 6U7, 12SK7, 78, 6J7, 6A8, 50L8, 12C8, 6J5, 6C5, 25Y5, 1196, 12K8, 12K7, 6AG7, 6AC7, 6K6, 5U4G, 5Z3, 7B5, 7A4, 7A7, 7B7, 7196, 7C3, 14H7, 68H7, 6A16, 1A4, 39/44, 68F7, 6R7, 11776, 83, 12A5, 6N7, 68N7, 68A7.

OSRAM. MX40, KT30C, U31, Y63, W76, U52, D63, HM14, Z14, MHD4, KT66, D6119, X76M, D163, VM14G, VM81B, PX25, U17, U18/20, M14, Z21, KT61, KT71, KT2, MKT4 5-pin, MKT4 7-pin, Z22, H30, D63, MHP4, Z14, GT1C, GU30, KT41, H12.

BRIMAR. 812, 9D2, 1D5, 1D6, 2Z4R, 6A6B, 1512, 1D11, R1, R2, R3, 574, 5V4, 6U4G, 12K8, 5Y3, 80, 83, 84, 024, 617.

MAZDA. AC2P2ND, PEN43DD, UUG, VP133, TP22, SP41, VP41, H1A1DD, H123DD, PEN25, 10C1, 10P14, 10F9, 10L1D11, H1320.

OSBOR. 2023TH, 418TH, 2P, MV8PENB, D1T, 41XP, 41Y, 2023P1, 2023P, 210HP, 4311, 18SPA, 13VPA, OM4, OM10, OM6, 41MHL, 41MTL, 405BU, M8/PEN, 202D2T, 230XP, 2158G, 4THA.

TUNGSRAM. PF36, EF8, VP4B, PP13A, 25A6c, 18, 42, 43, 6A8, 6A7, 6H7, 6P7, HP4116, AS1125, AS1420, HP211C, H4201, H41, H12, APV4.

WE HAVE THE VALVE YOU WANT. ALL EQUIPMENTS DEALT WITH IMMEDIATELY. TERMS: C.O.D. CASH WITH ORDER, OR PRO FORMA INVOICE. SEND 1d. STAMP FOR OUR CURRENT LIST OF RADIO COMPONENTS AND BULLETIN OF EX-GOVERNMENT BARGAINS.

LASKY'S RADIO

370 Harrow Road, Paddington, London, W.9. (opposite Paddington Hospital)
Telephone: Cuninghnam 1979.
Hours: Mon. to Sat. 9.30 a.m. to 6 p.m. Thurs. half day.



NEW G.P.12 CRYSTAL PICK-UP
with permanent sapphire stylus

—was fully described in *The Wireless World's* recent article "Crystal Pick-ups—Basis of Design for Fidelity Reproduction."

This remarkable pick-up, which represents the ultimate in high-fidelity reproduction, is now available in limited quantities through your radio dealer, price 96/- incl. P.T.

FREE ILLUSTRATED FOLDER describing this new pick-up may be obtained by returning the coupon below.

TO COSMOCORD LTD. ENFIELD, MIDDXX.

Please send folder of ACOS Pick-ups.

NAME _____

ADDRESS _____

W.W.

COMPONENTS—SECOND-HAND, SURPLUS CHARLES BRITAIN (RADIO), Ltd.

BRAND new mains transformers, semi-shrouded drop-through type, 350-0-350 80 mVts 5volts 2amps, 6.3volts 3amps, price 21/- plus 1/6 post; brand new Rola G12 12in P.M., £5/17/6, plus 5/- carriage and packing; brand new Rola 10in P.M., 30/-, 4-range 0003 condensers, ceramic insulation, long spine, 4/6 ea. 2-range 0001 midget ceramic, 3/6 ea. 4mf 1.000V wkg. mainsbridge, 5/- ea. 72 asstd. resistors, all brand new, wire end, 12/6. MOVING coil microammeter, made by Weston, 2 1/2in scale, 0-250 microamps, internal resistance, 330ohms, brand new and boxed, 25/- ea. —Send for component list, 2d. stamp please.

CHARLES BRITAIN (RADIO), Ltd., Radio House, 2, Wilson St., E.C.2. Tel. Bis. 2966.

SOUTHERN RADIO'S wireless bargains.

RADIO publications.—"Radio Valve Manual," British and American alternatives and equivalents, 3/6; "Frequency Modulation Manual," 3/6; "Amplifier Manual," 2/-; publications previously advertised still available, full list 2d. postage on books 3d. A.C. motors, 200-250 volts, 1/2hp 2,000r/m. consumption, ideal for light work, brand new, 55/- plus 5/- carriage. R.A.F. bombsight computers, brand new with Sperry gyroscope, 2-28vot motors, gearing, counters and hundreds of other components, £3 carriage paid. R.A.F. RT testers, 2,500-6,700cps-45-120 metres, two valves, metal carrying case, 16in x 10in x 6in. 20/- Telephone line units with rectifiers, relays, etc., in wooden box, 5/-; ex-Army headsets (mike and m'vng coil phones), 12/6; input transformers, 1/50 or 1/7 mu metal, 5/- each; dipole aerials (folding), R.A.F. Morse keys, 2/6, post 4d; special offer double-sided recording discs, 5 1/4in, 1/- each, 10/6 doz; ex-Govt. inspection lamps, with cord and Lucas plug, 3/6; ex-Army geared dial drives, 4/1 ratio, 3/6; hundreds of other bargains for callers. Lisle SOUTHERN RADIO SUPPLY Ltd., 46, Lisle St., London, W.C.2. Gerrard 6653. 19824

H. RADFORD, 28, Bedford Parade, Bristol, 3.

CRYSTAL diodes; genuine Sylvania 1N22s, ideal for crystal sets (see W.W., April 1948); monitors, noise limiters, grid strength meters, etc.; 2/6 each, 10 for £1, post free; vibrator units, 12v input, output 120/150v, 50/30ma, including G.B. and L.T. for battery valves, U.S. made by Jefferson and Travis to AM specification; 19/6 each, plus postage. R.C.A. H.T. transformer, 1,750-0-1,750-2,300v (for nominal outputs of 2,000 and 1,500v at 800ma), weight 97lb net, size 9in x 9in x 7 1/2in; £8/10 each; R.C.A. modulation or output transformer, primary 10,400 ohms (suitable P.P. 810, 805, TZ40, 813, ec.), sec. 4,300 ohms, suit any P.A. up to 1kw, weight 67lb net, size 9in x 9in x 7 1/2in; £6/10 each; R.C.A. modulator unit, comprised mod. trans. as above, driver trans., filament trans., valveholders and balancing controls for PP805 valves on chassis, wired ready for use, input 190/250v 50cps; £9 each; R.C.A. speech amplifier, input 190/250v 50cps; valve line up 4-6g7s, 2-6L6s, 1-5U4G, resistance coupled P.P. 25 watts, output, standard input and output impedances, will feed modulator unit above, in brown crackle case with valves; £13/10; L.F. chokes, 250ma, 10-15t, 100ohms, 6g4b; 250ma, 15/20h, 200chms, 6g4b, 10/6 each; 300ma, 100h, 400ohms, C.T. 2 1/2in, 6/6 each; 500ma, 15/20h, 800ohms, 20lb, 35/- each, plus carr.; 2 1/2in electrolytic cond., standard input and output impedances, will feed modulator unit above, in brown crackle case with valves; 5/6 ea. 0/- per doz, plus postage; silver-plated 1.5mm Lee type plug and socket, 5/- pin, complete, 2/- per pair, 30/- per doz, plus postage. 1957

WILSON'S 6 waveband coil unit, completely wired; £4.—Box 6278. 19537

W & W. coil pick-up, new, with equalizer; £5.—McKean, 150, Dorchester Av., Glasgow, W.2. 19481

COIL formers.—All types to meet your requirements; good deliveries.—Tavak Products, 19, Belsize Lane, N.W.3. 19714

NEWTONS 4-circuit rectifier, 72v, 10a, 300v, 3A, first-class condition; £25.—N. Heit, 29, Silver St., Ilminster, Som. 19761

EXPERIMENTER proceeding overseas selling off surplus equipment, s.a.e. for list.—26, Uxendon Cres., Wembley, M'dxx. 19546

AMERICAN and British surplus service radio gear; receivers, I.F.S., amplifiers and components; s.a.e. for list to G3DRZ, 289, Humberstone Rd., Leicester. 19616

B & H. RADIO. Only good components of well-known makes supplied, everything guaranteed, newcomers welcomed, trade only; stamp for list.—Huntley St., Darlington 2198.

COMPONENTS and valves for constructors and amateurs; special terms to radio clubs.—Trade Radio Service Co., 45a, Wood St., Deansgate, Manchester, 3. Send for list. 19597

HIGH stability resistances, 1watt ±1%, 21,000ohms, .375, .366, .5, .125, .25, .2, .9, 1.0, 1.1 and .6meg; up to 800 of each; pure silk-covered wire, 46s.w.g., 284lb. Tel. Dartford 2960. 19758

EX-STOCK, output transformers, mains transformers and chokes for D.T.N. Williamson amplifier, as per "W. World," May, 1947.—Metropolitan Radio Service Co., 1021, Finchley Rd., N.W.11. Tel. Speedwell 3000. 19441

BAKERS 'Selhurst' RADIO HIGH FIDELITY SPEAKERS

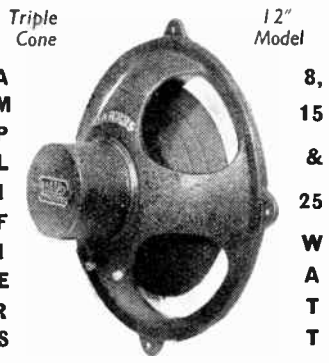

Triple Cone 12" Model

A M P L I F I E R S

8, 15 & 25 W A T T

Est. 25 years
The Pioneers of Moving Coil Speakers

GINEMA Model, 18 inch - £9 19 6
AUDITORIUM Model, 12 inch - £8 10 0
SINGLE CONE, 12 inch - £5 18 6

Send 2d. stamp for illustrated list to:
BAKERS 'SELURST' RADIO
75-77, Sussex Road, South Croydon, Surrey
Telephone: CROYdon 4226.

ALEC DAVIS Supplies LTD.

18, Tottenham Court Road, LONDON, W.1.
SURPLUS

METERS:
0.5 amp. Sangamo Weston Thermocouple meters, 2in. square face type. New and boxed, 7/6 (postage 6d.).
5mA Metropolitan Vickers moving coil meter, 2in. square face type. New and boxed, 7/6 (postage 6d.).

CONDENSERS:
Bakelite cased high voltage condensers. Postage 3d. extra.

.2 mfd. 200 v. d.c. wkg., size 1 1/2in. diam. x 3 1/2in. long 1/-
1 mfd. 2,500 v. d.c. wkg., size 1 1/2in. diam. x 3 1/2in. long 8d.
1 mfd. 1,500 v. d.c. wkg., size 1in. diam. x 2 1/2in. long 6d.
13 mfd. 600 v. d.c. wkg., size 1 1/2in. diam. x 2 1/2in. long 6d.
.03 mfd. 2,500 v. d.c. wkg., size 1in. diam. x 2 1/2in. long 6d.
.01 mfd. 5,000 v. d.c. wkg., size 1in. diam. x 2 1/2in. long 6d.
.01 mfd. 3,000 v. d.c. wkg., size 1in. diam. x 2 1/2in. long 6d.

MISCELLANEOUS:
Exide new and unused accumulators in moulded case. Size 2 1/2in. square by 6 1/2in. high—2-volt type, 7/6 (postage 1/-).

Inert cells, 15-volt type. Size 9in. by 1in by 3 in. 1/6 (postage 6d.). Set of four 15-volt cells in sealed can, 5/- (postage 1/-).

Plessey 5 in. electrodynamic speaker with 4 ohm. speech coil. Complete with transformer for 4,600 ohm. load. All brand new, a real bargain for those in need of an extension speaker. 10/6 (postage 1/-).

Santon 30 amp. rotary double pole on/off switch—new and boxed. Price 7/6 (postage 3d.).
Stockists of Valves, Batteries, Components and Test Equipment.

Business Hours—9 a.m.—5.30 p.m. Mon./Fri. 9 a.m.—1 p.m. Sat.
Telephone: MUScum 4539.

CONDENSERS, 350v., 1.05mfd, tubular, 3/9 per doz, 43/- per gross; cash with order. —Allen & Gibson, Ltd., Worcester, Northants.

AERIAL rods, with aerials, covered molybdenum steel, 1/4in diam., 4ft long, with 3/16in x 2in brass spigot one end, 12/- doz. —Below.

AERIAL screened lead-in, 3/4in cable, 18ft long, all connec. soldered with spade terminals; 7/6. —Below.

AERIAL guyropes, compris. 4 25ft lengths 3/4in rope each fitted chain insulators and stay-plates; 5/- —Below.

CONDENSERS, paper tubul., .5mfd 350v., 25-mfd 350v., 1mfd 1,000v.; all 6/- doz. —Below.

CONTROL units, type 280, 7in x 5in x 3in metal box contains 3 relays, 3 jacks, 2 switches, etc.; 7/6. —Below.

DIMMER switches, 12/- doz; terminal blocks, 2-way, small, 6/- doz; 3-way, larger, 12/- doz; fuses, 5 or 10amp, 10/- per 100. —Below.

HEADPHONES bargain! Double, balanced armature units, reed-driven corrugated aluminium diaphragms, double headbands, 8ft cords and jack-plug, dc resistance instruments brand new, boxed, super sensitive instruments (not cheap light goods), purchases, ex-Army Ordnance air-conditioned stores; per pair 5/6, 2 prs. 10/-; trade, case of 10 prs., 35/- or 100 prs. £15 (carr. 2/6 per case); export enquiries invited; these headphones are worth about 42/- pr. —Below.

MOTORS elec. approx. 1/4hp, 200-250v ac, 2,000 p.m., size 1 1/2in x 5 1/2in x 5 1/2in, weight 18lb, brand new; only 45/-; converted from (below).

ROTARY transformers in 24v 16amps, out 1.250v 200ma, brand new, unused, ex-R.A.F. Hoover made (see above, motors), 40/- (below); power unit, Murh'y, in 24v, out 250v 50ma and 6.5v 2.5a, new, 25/- —Below.

RECTIFIERS, metal Westinghouse, 12v lamp, new; 6/6, 10 for 52, 6/- —Below.

TRANSFORMERS, in 230v, out 6.75-0-6.75v 15ams, new, 50/- type 283, in 230v, out 4 taps 15v to 15v 60amps, new, £3. —Auto Collections Ltd., 15 Lawrence St., Northampton.

TELEVISION aerial equipment, 5 types fully waterproofed aerials available, pole and lashing, all types of feeder in stock; send for brochures. —Aerials installed—Wolsey Television, Ltd., 87, Britton Hill, S.W.2, Tulse Hill 1240.

MONO-PLANAR horn, £3, take 12in; Vitavox 20 watt, 8gns; 32 mfd can, 5/7; 1/2in copper per rod, 1/- ft; 25 and 15 watt lamps, 250v, T.R.S. cable, flex, and a.c., Nife cells, twin T. Watson's Peak Buildings, Buxton. [9454]

THREE-STAGE resistance capacity miniature amplifiers with three tested 174 midret valves, 20/- each, post free; in aluminium case, 22/-; spare 174 valves, guaranteed, 6/- each; holder, 6/- each. —Littler, 24, Stanley Rd., Whalley Range, Manchester, 16.

COPPER wires, enamelled, tinned, Litz, cotton, silk covered, all gauges; B.A. screws, nuts, washers, soldering tags, ebonite and laminated bakelite panels, tubes, coil forms; tuning coils, headphones, flexes, etc.; list s.a.e.; trade supplied. —Post Radio Supplies, 33 Bourne Gardens, London, E.4.

PROSPECTIVE buyers of radio components are invited to submit tenders for the following: Silvered mica condensers, Systoflex metal, rectifiers, variable rheostats, potentiometers, transformer laminations, etc., all in small lots, suit radio dealer or small factory. —For further details apply Box 6868. [9702]

MANUFACTURERS; huge stocks all components, S.P. and block condensers, close tolerance resistors and all types resistances, potentiometer, laminations, valve holders, glass cartridge fuses, 1/4in; suppliers to leading manufacturers; all goods guaranteed. —L. E. Simmonds, 10, Valencia Rd., Stanmore, Mx. Grimsdyke 608.

KITS of radio receivers from £7/8; 4- and 5-valve, new materials, table models, semi-midget; our latest kit.—Wylwyn Star 1948 has connections for gramophone pick-up, extensions to loudspeaker, A.V.C. 6 hours average time for constructing; full details, diagrams with each kit; c.w.o. or c.o.d.—Isherwoods, Reme House, 81, Plungington Rd., Preston, Tel. 3348, Estd. 1936.

FRITH RADIOCRAFT Ltd., the Leicester specialists, offer from their comprehensive stocks: Rotary converters input 24v d.c., output 230v a.c. 50 cycles, 100-200 watts, in steel cases with carrying handle, ideal for mobile amplifiers, etc.; further supplies of these are now available at £3/15. Battery communications receiver, 5v s'het, r.f. stage, 1 to 9 mc, in 3 bands, complete, tested and guaranteed OK, with 5 Mazda Octal valves, £4/19/6.

BENDIX radio compass receivers, model, MN26C, 3 bands covering 150-325, 325-695, 695-1500 kc/s, 2 r.f. stages, with 12 new metal valves (5CK7, 2-6J5, 2-6GN, 1-6BE, 1-6R6, 1-6L7); rotary converter for 24/28v operation; complete with full instructions for converting to a.c. operation, £10; standard U channel steel racks (for 19in panels), 4ft 10in high with base plates, £2.

BARGAIN parcels, over 50 useful ex-Govt. components, 5 or 6 valves, 12 valves, Systoflex, 72 yds assid., 5/6; 50 assid., 10/6; 100 assid., £1. Satisfaction guaranteed on money refunded without question. Latest lists free on request. Trade supplied.

FRITH RADIOCRAFT Ltd., 69-71, Church Gate, Leicester, Tel. 58927.

GALPINS

ELECTRICAL STORES,
408, HIGH STREET, LEWISHAM,
LONDON, S.E.13

Telephone: LEE GREEN 0309.
(Near Lewisham Hospital.)

TERMS: CASH WITH ORDER.
NO C.O.D.

MAINS TRANSFORMERS (AUTO WOUND). Voltage Changers tapped 10, 20, 25, 90, 130, 150, 190, 210 and 230 volts, all at 1,000 watts, a combination of 34 voltages can be obtained from this Transformer, new ex-Govt. stock, £5/10/- each, carriage 5/-. Mains Booster Transformer, tapped 0, 6, 10, 19, 175, 200, 220, 225, 240, and 250 volts at 1,500 watts (new ex-Govt.), £5/5/- each, carriage 5/-. Another, 200 volts input, 240 volts output at 2,500 watts, £7/10/-, carriage 7/6. Another, 2 to 1 ratio, 110 volts input, 220 volts output, or vice versa, at 4,000 watts, £12/10/-, carriage 10/-. Another, 230 volts input, tapped output 40, 41, 42, 44, 46, 47, 49 and 52 volts at 100 amps., £15 each, carriage 10/-. The latter two are double wound. Another auto wound, tapped 0, 110, 150, 190 and 230 volts at 1,500 watts, £6/10/- each, carriage 5/-. Ditto, 2,000 watts, £7/5/-, carriage 5/-.

EX-GOVT. (G.E.C.) ELECTRIC FANS, 12 volts AC/DC laminated field, complete with 5in. impeller. New boxed, 20/- each, 1/- post. Transformer to suit 230 volts input, 10/16 volts at 4 amps. output, 32/6 each.

EX-GOVT. (NEW) MAINS TRANSFORMERS, 200/250 volts 50 cys. 1 ph. input, 525/0/525 volts 150 M/amps., 6.3 v. 5 a., 5 v. 3 a. output standard rating, 35/-, post 2/-. Mains Smoothing Chokes, 10 Hy. 150 M/amps. 180 ohms DC Resistance, 8/6 each. Ditto, 100 M/amps., 5/6 each, post 9d.

EX-R.A.F. MICROPHONE TESTERS (new). These consist of a FERRANTI 0 to 450 Microamp. 2 1/2in. scale meter shunted to 1 M/A incorporated Westinghouse Rectifier, the whole encased in polished teak case calibrated at present 0 to 10 volts, 32/6 each.

SPECIAL OFFER METERS, ALL NEW BOXED. Moving Coil First-Grade Instruments, 0 to 20 volts, 10/- each, or 3 for 25/-; 0 to 40 volts, 12/6 each; 0 to 100 amps., 15/- each; all 2in. scale. 0 to 20 volts AC calibrated 50 cys., 25/- each.

EX-R.A.F. IFF UNITS. As new, these units contain 10 valves S.P. 41s, Ef 50s, EA 50s, etc., also approx. 100 resistances and condensers, also complete with motor generator, 12 or 24 volts input, 450 volts at 50 M/amps. output. To clear, 24-volt type, 35/-; 12-volt type, 42/6, carriage 3/6.

MAINS TRANSFORMERS (NEW). Input 200/250 volts 50 cys. 1 ph., output 350/0/350 volt at 180 M/amps. 4 v. 4 a. C.T. 6.3 v. 4 a. C.T. 5 v. 3 a., 37/6 each, post 1/6; ditto, 500/0/500 v. 150 M/amps. 4 v. 4 a. C.T. 6.3 v. 4 a. C.T. 5 v. 3 a., 47/6 each, post 1/6; another, tapped 6, 12 and 24 volts at 10/12 amps., 45/- each, post 1/6. Auto wound Voltage Charger Transformers, tapped 0, 110, 200, 220 and 240 volts 250 watts, 45/-; 350 watts, 55/-; 500 watts, 70/- each, carriage 1/6. (Please note, these Transformers can be delivered 10 days from receipt of order.)

MAINS VARIABLE RESISTANCES (New ex-Govt. Stock) Slider type 14 ohms carry 1 to 4 amps., graduated, useful as dimmers, etc., 25/- each, post 1/-. Another, 0.4 ohm, carry 25 amps., 22/6 each, post 1/6. Ditto, 450 ohms 0.7 amps., 27/6 each. Ditto, 5.7 ohms 8 amps., 27/6. Ditto, 4,000 ohms 0.25 amps., 32/6 each. Ditto, 60 ohms 1 1/2 amps., 25/-.

ELECTRIC LIGHT CHECK METERS (for garages, sub-letting, etc.), 200/250 volts 50 cys. 1 phase, 20 amp. load, 25/- each, post 2/-. Ditto, 1/- slot type, 42/6 each, post 2/-. Ditto, 2 1/2 amp. 1/- slots, 30/- each, post 2/6. All fully guaranteed.

MAINS TRANSFORMERS, EX-A.R.P. Input 230 volts 50 cys., output 12 volts 8 1/2 amps., as new, 25/- each, post 2/-.

SELF-ENERGISING TELEPHONE HANDSETS with wall bracket (new), 12/6 each, or 21/- per pair.

TEST SETS, Type 211, complete with 4 Ef 50s (new), 35/- each. Cell Testing V/Meters, reading 3-0-3 volts, moving coil, 21/- each. AC V/Meters, 6in. scale, 0 to 300 volts, 37/6 each. Spark Coils, 1/2in. spark, or approx. 3,000 volts, from 6 volts, 10/- each.

ABOUT 2,000 radio enthusiasts are on our mailing list, are you? Hundreds of brand-new ex-Govt. and manufacturers' surplus bargains each month. Example: 38 sets, complete with power pack, all spares, aerials and 1.1 amplifier at £5/10; get in the know now.—2/6 stamp to Radio Constructors, 28, The Hill, Sheffield, 4. [9497]

MIDGET coils, as described in last month's issue, available in all standard ranges; also available, coils type I.B.2S., which are 2-wave (M. and L.) superhet, especially designed for use with the I.B.3 frequency changer and require only a 2-pole 2-position switch for wave-changing; remember the name.—Meteor Electronics, Gloucester Row, Weymouth. The coil specialists. [9586]

RADIO-SERVICE, East Cliff, Lyme Regis, Dorset. New Goods only! Electrolytics, 450v. w. can, 8uf 3/6, 8-8uf 6/3, 16+16 6/6, 16+8uf 6/3; bias types, 50v. w., 25uf 2/3, 50uf 2/6; speaker transformers, 40ma, multi-ratio, 40ma, 40/6; standard 80ma, 6/-; vol. controls, all values, ws. p. switch 5/-; 1 switch 4/-; prompt c.o.d. or c.w.o. service. [9543]

BRAND new components, 60ma smoothing chokes, 39/- doz; 2 gangs, 72/- doz; 16x8 500v electrolytics, 60/- doz; 16x8 250v 100/- doz; 4-pole 3-position w.c. switches, 22-4-40 pf 3-bank trimmers, 15/-; output transformers, 60ma, 54/-; .5amp 3-way line cord, 16 yd; 2-pole 2-position switches 21/- dz; resistors for 20/- doz; 1in x 5BA and nuts, 5/- 2 doz; 1in x 4BA and nuts, 5/- 2 doz; 1in x 4BA screws and nuts, 4/-; terms c.o.d. or cash with order.—J. L. Baker, Berystede, St. Helens Rd., Leamington Spa, War. wicks. [9571]

KYNRAD SUPPLIES, Ltd., the premier house for the radio amateur. Meters 0.5ma, 6 each; 100v, 100/6; 500v, 100/6; transformer, 17/6; Truxov 6in. lens transformer, 15/-; multi-ratio output transformers, 7/6; 60ma chokes, 7/6; valve holders, octals or button base 6d; condensers, split stators, 5pf and 10 pf, 1- each; 100pf, 1/-; 0.1mfd, 1/6; 100v, 1/6; 500v, 1/6; 500v, 4d each; 0.5mfd, 500v, 4d each; soldering irons, 60watt, 10/6. This is only a small selection of our varied stock, write for list, s.a.e. to—Kynrad Supplies, Ltd., 10 and 12, Spring Hill, Birmingham, 10. [9491]

SPECIAL this month!—Europa superhet 8V chassis, 5-valve ac/dc, medium and long or medium and short, fully wired, aligned and tested, ready to switch on, overall 11in x 6in x 5in. p.m. speaker, dial, drive on chassis, ready to slide into cabinet, inductances iron-cored, splendid performance, brand new, guaranteed, £6/5, carr. 2/6, set of valves £3/7; also Overseas 5 superhet assemblies, L.M. & S. ac model, £6/17/6, ac/dc, £6, speakers and cabinets available; send postage now for full details of these bumper W.W. offers. —W.W. Whalley Range, N.E.3, 66 & 102, Parkhill Rd., London, N.W.3. Gulliver 1453. [9663]

TELEVISION hams!—We have the following in stock: CRM91 9in, CRM121 12in tubes, rubber masks, h.v. condensers, Micadisc, CM30 and Ceramic through 300PF, 500PF, 1,000 valves, inc. EL33, EL38, T41, SU2150, HVR2, HVR2A, AC/6 pen, Pen 45, etc., STC/H4/200 rect. coilformers, 3/4in and 1/2in with adj. dust iron cores, Coaxial plugs and sockets, 80 ohms, 75 ohms, 1in feeder, resistors, chokes and condensers, etc.; coming shortly, 1000 valves, trans., Focus and Scanning coils; send for lists; s.a.e. please; all goods at manufacturers retail prices.—E. A. Porritt, 13 and 27, Wastdale Rd., Forest Hill, S.E.25. [9659]

HAWK JAMES PRODUCTIONS, 270, with H. Walk, Edinburgh, 6.—Mail order specialists, c.o.d. or cash with order, electrolytics, new not W.D. surplus; B.I., Hunts., etc., 8mdfs, 3/6; 16+8mdfs, 6/6; 8+8mdfs, 6/3; 16mdfs, 5/6; 0.25mfd 25-volt, 2/2; t.r.f. chassis, 4/6; t.r.f. coils, M. & L., 8/5 pair; condensers, 0.1, 0.01, 0.05, 500v., 8d each; variable 2-gang, 0.0005, 12/-; with trimmers, 15/6; loudspeakers, 5in P.M., 19/6; 6 1/2in energised 1,000 ohms, 29/6 8in P.M., 25/-; volume controls, W/S long spindle, 5/6, less switch 3/6; mains transformers, 350-0-350 6.3v and 5v or 4v heater, 30/-; output multi-ratio, 9/-; valve holders, 5-pin 7 and Octals, 7d. each; Amphenol type, 9d. each; voltage droppers, 0.2amp 1,000 ohms, 3/9; 0.3 amps, 4/9 1,000 ohms; line cord, best quality, 0.3amp 3-core, 9d. per ft; special offer, 0.1 milliamper metres, suitable for multi-meters, price 12/6; valves, etc.; large stocks of British and American types; enquire for anything radio; s.a.e. for lists.

RUCO tuning heart S.M.L. on chassis with all coils, I.F.s, and padders, etc., factory wired, tested, and aligned, ready for use, with circuit, 25/-; Rucoc conversion chassis fitted with S.M.S. dial, 2-gang condenser, padders, etc., for the 5v S.M.L. super a.c. type 84/- a.c.-d.c. type 94/- with circuit; our mains noise suppressor for all kinds electrical interference, simple to fit, 16/6; Goodmans 12in speaker, 150hm, 66/0; ditto, double cone, £9/8; 4vo test bridge, £11; amplifier case, undrilled chassis 17 1/2 x 8 1/2 x 3 1/2; with detachable perforated cover, 30/-; P.P. output transformer (616 a.a. load 6,600ohms), tapped 7.5, 15ohm, ditto (6V6 a.a. load, 10,000-ohms), tapped 2.5, 7.5, 15ohms, 20 watts, modulated P.P. trans for 807 valves, 51/6; 12/6 chokes, 80ma, 8/6; heavy duty 200ma 20 henries, 100ma 28 henries, 120ohms, 25/-; Weymouth S.M.L. coil pack, circuit, 36/6. O. GREENLEK, Ltd., 265, Whitechapel Rd., London, E.1. Tel. 515, 5079. [9899]

G. A. RYALL, 65, Nightingale Lane, London, S.W.12.—Mail order only, postages extra, c.o.d. £1 or over; special sale list now ready, enclosure stamp, please. U.S.A. make metal cased 500c tubular 0.1mf. 7/6 dozen; silver m.ca. 200pf. 300pf. 400pf. 500pf. 4/6 dozen; 500v w.g. mica-moulded 0.004mf. 4/- dozen; m.ca. 0.01mf. 3-2/-; Mansbridge 1mf 500v w.g. 3-2/-; all condensers guaranteed; Amphenol type British 5-pin valve holders, 4/6 dozen; U.S.A. paxlin 4-5-6-pin, 3/6 dozen; valve controls, 10,000 medium spindle, 1/6; 250,000ohm short spindle, 1/6; bar type 3-gang, 0.0004mf short spindle, 5/-; bar type 4-gang 0.0004mf. 5/-; resistors, (wart. 1/6); 100ohms to 2meg, level assortment, 40-5/-; plastic group boards, drilled, less tags, 9w types, 3-1/6; switches, 2B, 2p 6w; nunature circular switches, 2/-; 3B 2p 6w 5p 10p, 2/6; 2B 3p 3w, 2/3; res. panels, 5w with 25mf 12v and 3 res., 1/3; 12-way group boards with 9-watt and 1-watt resistors, all new; 20 types in stock; ctal plugs, cap and socket, 3-2/6, with tags 3-3/-; high resistance phones with sponge earpads, with 6cd class microphone, all wired into plug, rubber padded, plug type 10H 10991, 10/9 pair; metal boxes, black finish with 1-in paxolin panels, fixing lugs; and corner sockets, size 8 1/4 x 7 1/4 x 3 1/4 in deep, 6/9 each complete; international octal valve holders, paxolin chassis type, 4/6 dozen; meta-cased tubulars, 0.5mf, 350v, at 7ld C, wire ends, 8/6 per dozen; Paxolin panels, not drilled, new, 8x8, 2/6; 12x8 3/8, 2x12 5/8, 12x12 5/8, 12x12 5/8, 12x12 5/8, 3w 33,000ohm carbon res. 6d ea; 1,800 W.W. lw, 2/- doz; five lw carbon, 330,000 and 1meg, on panel, 1/6; ten lw and 1/4w res. and 0.1mf condenser, on panel, 1/-; six 0.01 condensers and three 0.1mf 500v, slight soiled, 5/6 doz; metal cased, 0.5mf 350v tubulars, wire ends, 7/- doz; 5mf mica, 10 pf., 25 pf., 40 pf., 200 pf., 300 pf., 350 pf., 400 pf., 500 pf., 3/- doz; mica moulded, .0005, .001, .002, type valve holders, 3/6 doz; international octal Paxolin v.h., 3/6 doz; or dozen of each, 6/-; mica 0.01mf, 4/6 dozen; mica 0.015mf, 6d ea; 4 meters 2 1/2 in, moving coil 0-30ma, 7/6 ea; all above new.—Tropia, Mayfield Rd., Herne Bay.

CASTLE RADIO offers the following complete turn-table units (a.c. only) complete with p.c.s.—including P.T.; adjustable iron core, "P" type coils at 3/6 each; Summersby high gain midget coils, 3/3 each; variable selective I.F.s. permeability tuned, high gain, set of three, 28/6; standard I.F.s. 15/- pair; I.F. filter 465kc/cs, 3/6; 9-coils packs, 36/6; Osamor coils packs, 36/6; valve a.c. d.c. superhet chassis, 8-watt output, complete, 24-0-0 including P.T.; Ceramic voltage droppers, 3amp 4 taps, 5/-; 25mf x 25v (T.C.C.), 2/-; 8mf x 450v, 6/-; 2-speed condenser drives, 2/6; dials, speakers, chassis, complete, 10-0-0 including P.T.; cabinet (midget, plate chassis (from 8-0-0), cabinet (midget, Marconis),—Castle Radio, 11, Mill Lane, Margate, Kent. [9584]

NEW S.T.C. sel. rectifiers, bridge conn. damp-proof finish, 17v 1.5a 1f.1, 2a 1.5a 2/-, 3a 21/6, 4a 25/-, 5a 27/-, all p.f.; 33v 1.5a 28/-, 2a 29/6 3a 35/-, 4a 42/-, 5a 43/6, 50v 4a 54/-, 1a p. 10d; H.D. type, 7im 80 cooling fins, 13v 6a 34/1, p. 10d; 10a, 43/6, p. 1/-; 13v 6a 34/-, 10v 71/-, 25v 20a 140/-, 28v 30a, 207/6; 50v 6a 90/-, 90v 6a, 142/-; 110v 6a 166/-, all p. 1/4; funnel cooled industrial types, 35/6; 69/-, 10a 80/-, carr. 1/6; other to *w. Church St. rect. equipments in steel case, input 115-230v, conversions for valve-type chargers, Philips 367 and Tungas 68504 and 68530 and U600 from stock; chargers for 12 cells at 4a, two M.c. meters in steel case, 200-250 a.c., £9/10, carr. extra; rect. equipments in steel case, input 115-230v, O/P 100-120v 2.5a, £10, carr. extra; p. 10d; sets, 1hp J.A.P., 288w, 12/3; 2v var. field, £19/10, carr. extra; with control box cable and spares, £19/10, carr. extra; terms, c.o.d. post goods only, otherwise c.w.o. or pro forma; wholesale and retail.—Pearce, 66, Gt. Percy St., London, W.C.1., Nr. "Angel." Est. 16 years. [9301]

SELENIUM h.t. and l.t. rectifiers, foolproof charger kits, speakers, mikes, etc. Add 7d postage up to 15/- 1/3 above. Informative data sheet with all rectifiers and charger kits. S.T.C. selenium rectifiers, 12v 3amp, 22/-; 12v 4amp, 25/-; 12v 5amp, 27/6; also giant finned 12v 6amp type, 33/- smaller types, 12v 2amp, 12/6; 12v 1amp, 10/6; 6v 2amp, 9/6; 6v 1amp, 5/6; 12v 1amp, 7/6; higher voltage types in stock, including 24v 2.5amp, 36/6; 24v 5amp, 44/6; many others. New small space type selenium h.t. rectifiers for converting a.c./d.c. sets to metal rectifier, 250v 60ma or 110v 60ma, 9/6; 350-0-350v, 80ma, 13/6; eliminator type, 120v 20ma, 7/6; or 15/6; eliminator transformer, 2v trickle charge with mains transformer, sets rebuilt, reconditioned and modified to specification, prompt delivery.—Fildred Radio & Television, Ltd., 27, Lyddford Rd., N.W.2. [9578]

Charger kits, no rheostat or ammeter required, S.T.C. 12v 5amp rectifier with 60watt transformer and ballast bulb for 2v to 12v charger, 45/-; ditto but with 2amp rectifier, 36/6; ditto but 6v 2amp rectifier for 2v, 6v charger, 35/-; ditto with 6v 3amp rectifier, 42/6. Mains transformer, 75watt with 12v 4amp rectifier and ballast bulb for 2v to 12v charger, 62/-; ditto but with 3amp rectifier and 140watt transformer for 6v, 12v charger, £5; 2v, 4amp trickle charge rectifier with transformer, 13/6; 6v 1.5amp rectifier with 25watt transformer, 26/-; CHAMPION 33, Uplands Way London, N.21, Tel. Lab. 4457. [9410]

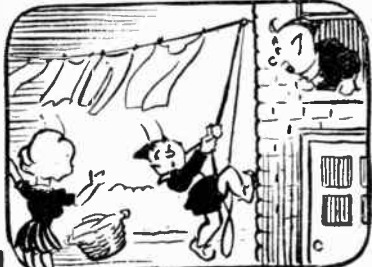

THE "FLUXITE QUINS" AT WORK

"Your clothes line won't budge," panted EE
 "It's fixed tight with FLUXITE strikes me"
 Bawled OI "Yes, you're right
 You can pull all your might
 That clothes line's our aerial, See! "

See that FLUXITE is always by you—in the house—garage—workshop—wherever speedy soldering is needed. Used for over 40 years in Government works and by leading engineers and manufacturers. Of all Ironmongers—in tins, 10d., 1/6 & 3/-.

TO CYCLISTS! Your wheels will NOT keep round and true unless the spokes are tied with fine wire at the crossings AND SOLDERED. This makes a much stronger wheel. It's simple—u-ith FLUXITE—BUT IMPORTANT.

The FLUXITE GUN puts FLUXITE where you want it by a simple pressure. Price 1/6, or filled, 2/6.



ALL MECHANICS WILL HAVE
FLUXITE
 IT SIMPLIFIES ALL SOLDERING

Write for Book on the ART OF "SOFT" SOLDERING and for Leaflets on CASE-HARDENING STEEL and TEMPERING TOOLS with FLUXITE. Price 1d. each.
FLUXITE LTD.
 (Dept. W.W.), Bermondsey Street, S.E.1

CRYSTAL multiplier unit.—Brand new American equipment containing 807 crystal oscillator and tuning controls for selecting crystal harmonics, spare valve accessories, instruction book, etc., £3/15; cathode ray tube unit, type 97, complete with tube, 14 valves, suitable for conversion, £4/10, cge 5/-; kit of spares for the American receiver ABK1, 145 items, including 32 valves, resistors, condensers, a dynamotor with extended spindle which can be connected for use on 200/250v a.c., makes a fine grinding motor; do not miss this bargain, only £5/15, cge. paid; receiver R3003 (I.F.F. unit), including 10 valves, geared motor, many useful components, 37/6, cge. 3/6; Muirhead drives, 10/-; instrument rectifiers, 5 ma., 7/6; milliameters, 0-1, 15/4; for other bargains see our latest lists, sent on receipt of 2/-d. stamp.—Wilkinson's, 204, Lower Addiscombe Rd., Croydon.

WANTED, EXCHANGE, ETC.
 ADVANCE, sig. gen., Type E.—71, Lynton Ave., N.22, Bow 2701. [9626]
 WANTED, Mullard MAS15 cabinet, perfect condition; price.—Box 6406. [9635]
 WANTED, 1 ton 23 swg enamelled copper wire; state price.—Box 6255. [9475]
 WANTED, "Trader" service diagram.—SERVICE sheets for Ekco A.R.G.399.—Plant, 286, High St., Sandford, Stoke-on-Trent. [9599]
 358X Eddystone (Naval B.34) coil and power packs, state range.—Smeeton, 85, South St., Greenock.
 V.G. 76/53rpm recording motor with tracking gear, state price and condition.—Brewer, Bethcar St., Ebbw Vale. [9568]
 ELECTRIC gramophone motors, 200-230 a.c., second-hand (r new, state make and price.—Rivoboro, Oxford P.ace, Leeds. [9550]
 VIBRATOR converter, rcqu red, 230 d.c., 15 Philips type preferred.—Haggart, 80, Sunningfields Rd., Hendon, N.W.4. [9599]
 WANTED, data books or circuit diagrams for the following ex-U.S. Army radio sets and amplifiers; EC499, BC500, BC659, BC340.—Box 6880. [9751]
 ENAMELLED copper wire, all gauges wanted in quantity, no quantity too large.—Simmonds, 10, Valencia Rd., Stanmore, Middx. Grimseyde 608. [9482]
 URGENTLY needed for export, M.E.A. pattern 72, 74 and 4a laminations; Scott's set 60, Philips type preferred, or equivalent to A.W.P. Radio Products, Ltd., Borough Mills, Bradford. [8526]
 WE buy for cash, new, used, radio, electrical equipment, all types; especially wanted, radios, radiograms, test equipment, motors chargers, recording gear, etc.—If you want to set at the maximum price call, write or phone to University Radio, Ltd., 22, Lisle St., Leicester Sq., W.C.2. Ger. 4447. [9647]

REPAIRS AND SERVICE
 MAINS transformer rewound and constructed to any specification; prompt delivery.—Brown, 3, Bede Burn Rd., Jarc, N.13460
 LOUDSPEAKER repairs, British, American, any make, moderate prices.—Sinclair Speakers, 12, Pembroke St., London, N.1. Terminus 4355. [5308]
 LOUDSPEAKERS repaired; clock cases, chokes rewound; prompt attention; prices quoted.—Mason, 5 Balham Grove, Balham, London S.W. [7667]

WINDING, rewinding, transformers constructed to specification; send your problem for quotation.—Sing and Radio, 93, Church St., Blackpool. [9647]
 Rewinds and conversions to mains and output transformers, from 4.6; p.p. equipment a speciality.—N.L. Rewinds, 4, Brecknock Rd., N.7. Tel. Arnold 3390. [6283]

ALL makes of electrical measuring instruments repaired and calibrated accurately and quickly.—L. Gaser, 341, City Rd., E.C.1 (Dept. A). Tel. Terminus 2489. [9743]
 ELECTRICAL measuring instruments skilfully repaired and recalibrated.—Electrical Instrument Repair Service, 329, Kilburn Lane, London, W.9. Tel. Lad. 4168. [6955]

REWIND service which duplicates or modifies as required; transformers, loudspeakers, etc.; prompt returns.—Radio Services, 49, Lr. Addiscombe Rd., Croydon, Cro. 6537. [9743]
 7-DAY armature rewinding service; 1 year's guarantee; complete overhauls to all types of fractional hp motors.—H. G. Millet & Co., 54, Arnewood Rd., Southbourne, Bournemouth. [9743]
 TEST instruments repaired and recalibrated; meters a speciality; speaker repairs, mains transformer rewinds; E.H.T.s a speciality; quick service; guaranteed work.—Electrico, 99, George St., Croydon. [9762]

RADIO and television repairs for the trade at reasonable charges, sets rebuilt, reconditioned and modified to specification, prompt delivery.—Fildred Radio & Television, Ltd., 27, Lyddford Rd., N.W.2. [9578]
 STURDY rewinds, mains transformers, chokes and fields; we give prompt delivery and guarantee satisfaction.—Sturdy Electric Co., Ltd., prices on request.—Sturdy Electric Co., Ltd., Dipon, Newcastle-on-Tyne. [4316]
 REWINDING of all types of transformers, chokes, etc.; quick service; motor rewinding of all types; replacement bobbins supplied; new transformers to any specification.—Radio & Transformer Services, 570, Manchester Rd., Hollinwood, Lancs. [8658]

**Specialists
in**

HIGH POWER - HIGH QUALITY

**PUBLIC ADDRESS
SYSTEMS**

★

AMPLIFIERS

from 150 W to 1kW

W. Bryan Savage Ltd

WESTMORELAND ROAD, LONDON, N.W.9

Telephone : Colindale 7131

COVENTRY RADIO

COMPONENT SPECIALISTS SINCE 1925

ELECTROLYTIC CONDENSERS

New delivery of 1st grade well-known makes.
Note our Low Prices.

Tubular Metal, 2 or 4 mfd., 350 volt	25
" " 8 mfd., 450 volt	211
" " 16 mfd., 300 350 volt	36
" " 8-8 mfd., 450 volt	49
Tubular Cardboard, 50 mfd., 50 volt	111
" " 25 mfd., 25 volt	18
" " 2 mfd., 350 volt	18

Prompt Service, Complete Satisfaction.

COVENTRY RADIO

191 DUNSTABLE RD., LUTON, BEDS.

Phone : LUTON 2677

**MOVING COIL
HAND MICROPHONES (No. 13)**



Blackite case 2 1/2" diam. Press-to-talk switch. Soft rubber mouth-piece. Coil 40 ohms d.c. res. Excellent performance. Brand new, in original packing. Including postage, 5/- each, or case of ten for 40/-. Despatched same day.

Miniature 30:1 Hyper-loy matching Transformers for above, 7/6d. Packing and postage, if ordered separately, 9d. extra.

WIRELESS SUPPLIES UNLIMITED

(Props. Unimitex Radio Ltd.)
264-266, Old Christchurch Road,
BOURNEMOUTH, Hants

REWINDS, mains transformers layer wound, wax impregnated field coils, pick-ups, chokes, clock coils, gram and vac. motors; prompt service and competitive prices.—W. Groves, 154, Icknield Port Rd., Birmingham, 16. [1972]

ELECTRICAL measuring instruments, commercial radio frequency oscillators and signal generators skilfully repaired and recalibrated.—Electrical Instrument Repair Service, 329, Kilburn Lane, London, W.9. Tel. Lad. 4168. [19724]

ISTRUMENT repairs: Moving coil meters, multi-meters, electrical test equipment of all descriptions, etc.; skilled workman ship; special terms to the trade.—Metr Politan Instrumen: Repair Co., 5, Friern Barnet Rd., N.11. [19552]

TRANSFORMERS, chokes, coils, etc., rewound and manufactured to order, single or quantity; qualified consulting engineers available to help solve your problems.—Millett & Holden, Ltd., 2, Pembury Rd., Westcliff-on-Sea, Essex. [1977]

LOUDSPEAKER repairs, any make, reasonable prices, prompt delivery, to the trade and quality fans; 25 years' combined experience with HOLA, Magnavox, Goodmans, Celestion.—Sound Service Radio, 80, Richmond Rd., Kingston-on-Thames, Kin. 8008. [19774]

REWINDS, mains transformers, speaker field coil, chokes, high-grade workmanship, 7day delivery; new transformers constructed to customers specification, singly or in quantities.—Metropolitan Radio Service Co., 1021, Finchley Rd., N.W.11, Speedwell 3000. [19719]

24-HOUR service, 6 months' guarantee, any transformer rewind, mains outputs and i.f.s., etc.; all types of new transf., etc., supplied to specification; business heading or service card for trade prices.—Majestic Winding Co., 180, Windham Rd., Bournemouth. [19719]

REWINDS, "Send your 'burn out' to be re-wound, no technical data wanted; post transformer, etc., labelled with your name, address and marked "for re-wind"; our windings are double wound, interleaved and impregnated.—Southern Trade Services, Ltd., 237-239, High St., Croydon, Tel. 4870. [19883]

MISCELLANEOUS

RELAY concession (Scotland), 10,000 population.—Offers to Box 6873. [19725]

WINDING machines, Douglas No. 1, perfect condition; £25.—Speedwell 2396. [19708]

5-538 lbs of 26 gauge copper cotton covered wire for disposal, can be split into small lots.—Box 6874. [19727]

KRAFT interleaving paper, 1 mil, 1/6 lb; also P.V.C. coloured wires, 1/28 to 25/36, cheap.—Speedwell 2396. [19662]

FURTHER copies of our advanced radio servicing course again available.—Details, BCM/Circuit, London, W.C.1. [19426]

WALNUT radiogram cabinet, manfs. samples, few only, 33x32x18, stamp details.—Walters, 501, Hale End Rd., E.4. [19773]

STALLOY 0.014 blanks, 1 1/2 in x 2 1/4 in, clean, about 2 tons, £35; also strips 1 1/2 in x 10 in, about 1 ton, £15.—Speedwell 2396. [19693]

ENAM, copper wire on circular hollow bobbins, 1 1/2 in x 1 1/2 in wide, 47 and 45 s.w.g., approx. one ounce @ 3/6 per lb.—Speedwell 2396. [19693]

DOUGLAS wave winder, like new, complete with motor, many extras, £60, or exchange portable typewriter, screw-cutting bench in the.—Box 6370. [19588]

TIMESWITCHES, partly used, 14-day, 5-10-amp, guaranteed, watertight case, key, etc.; post free, cash with order, 30/.—Donohoe, 2, Upper Norfolk St., North Shields. [19542]

AMATEUR would like to contact experienced wireless engineer in London for obtaining advice for lay-out, components, etc., for building radio-gram-television set.—Box 6878. [19744]

TUNGSTEN, molybdenum and magnesium wire for disposal, also large quantities of rubber grummetts, 8BA screws and washers.—List from Wolsey Television, Ltd., 87, Brixton Hill, S.W.2. [19744]

CIRCUIT diagrams (individual designs) to order; chassis layouts suggested, data and technical advice for radio enthusiasts; special tuition by correspondence.—Write, R. G. Young, 3a, Bridges Rd., Wimbledon. [19744]

SPARKS' data sheets provide complete constructional details and full-size draughtsman-prepared prints showing drilling, assembly and wiring plans of tested and guaranteed designs by L. Ormond Sparks. [19744]

LAATEST release.—The Challenger portable, an ac/dc 3-valve (plus rect.) T.R.F. circuit having an exceptional performance on med. and long waves, the ideal set for radio in any room, no aerial or earth; 6in Senterian speaker gives amazing power and quality; no complicated switching or adjustments; data sheet 2/9. [19744]

COMPONENTS can now be supplied; send a stamp for list giving full details of the 34 designs available. [19744]

SPARKS' DATA SHEETS (W). 9, Fhoebeth Rd., Brockley, S.E.4. Tel. Lee Green 0220. [19744]

FLUORESCENT lighting, huge purchase 80-watt 5ft choke-capacitor unit, 220-235v a.c. holders, starter button, ready wired, installed in 5 minutes, less tube, 47/6, carr. free; buy tube locally for £3; tubes for callers, Saturdays. M.T.S.—E. J. Williams, 39, Malden Rd., New Malden, Surrey. [19631]

JUNCTION electric irons, complete with stand, switch connector and flex, again available; very prompt deliveries; beautifully chromiun-plated; the finest electric iron of its kind in the world; a.c. d.c., in all voltages; with rich range of other household electrical appliances.—Distributors, Brooks & Bohm, Ltd., 90, Victoria St., London, S.W.1. [19023]

**OPPORTUNITIES
IN RADIO**



Get this FREE Book!

"ENGINEERING OPPORTUNITIES"

reveals how you can become technically-qualified at home for a highly-paid key-appointment in the vast Radio and Television Industry. In 108 pages of intensely interesting matter, it includes full details of our up-to-the-minute home study courses in all branches of **TELEVISION and RADIO, A.M. Brit. I.R.E., A.M.I.E.E., City & Guilds, Special Television, Servicing, Sound Film Projection, Short Wave, High Frequency, and General Wireless Courses.**

**We Definitely Guarantee
"NO PASS—NO FEE"**

If you're earning less than £10 a week, this enlightening book is for you. Write for your copy today. It will be sent FREE and without obligation.

**BRITISH INSTITUTE OF
ENGINEERING TECHNOLOGY**

388b, Shakespeare House,
17/19, Stratford Place, London, W.1.

**WARD ROTARY
CONVERTERS**

For Radio, Neon Signs, Television, Fluorescent Lighting, X-ray, Cinema Equipment and numerable other applications.

We also manufacture:—
Petrol Electric Generating Plants, H.T. Generators, D.C. Motors, etc., up to 25 K.V.A.

CHAS. F. WARD

LOROSGROFT WORKS, HAVERHILL, SUFFOLK

Telephone : Haverhill 253 & 4.

Mr. A. C. BARKER

Thanks the many owners of his **MODEL 148 CONCERT SPEAKER** who have written in its praise. To those who have had to wait for theirs he tenders regrets, with tidings of early delivery and further supplies for their friends who own first class amplifiers and seek **NATURAL REPRODUCTION.** Details obtainable from

BCM ADU, LONDON, W.C. 1

A LUMINIUM chassis, panels and screens to your requirements, plain or punched for valve-holders, etc.; sample prices, 18swg. 6x4 X 2. 3/9; 10X6x2. 4/6.—Mead, 13, Bence Lane, Darton, Barnsley. 1955

21 s.w.g. annealed glass fibre covered copper wire, 3 tons, new unopened reels better than cotton covered, offered cheaper, 2/3 per lb, or offer for lot.—Victor Laurence & Co., 10, D'Arbly St., W.1. 19645

WORK WANTED

VAC. armatures, etc., rewound, 13/-; quality work.—Kernick, 32, Waller Rd., S.E.14.

FACTORY has technical staff and capacity available for manufacturing scientific or other articles in glass.—Box 4462. 18653

VITREOUS enamelling of iron for all radio and electrical purposes; enquiries invited.—Folick & Son, 36-38, Western Rd., E.15. Gra. 4524. 19774

RADIO apparatus can be designed or built to your special needs by a competent engineer, technical queries answered, min. fee 5/—.—B.C.M. FIDEL, London, W.C.1. 19601

We make wireless and radiogram cabinets in home and export; immediate deliveries.—Radiac, Ltd., 26, Brondesbury Rd., London, N.W.6. Maida Vale 8792. 18025

AGENTS WANTED

COMPETENT and active distributors required to distribute keenly priced resistors/capacitors in home and export markets; an important test instrument of excellent performance and appearance.—Letters only, immediately to Television & Radio (Re-builders), Ltd., 42, West End Lane, London, N.W.2. 19645

BUSINESSES FOR SALE OR WANTED

COMPONENTS works (London), suitable live engineer; turnover £25,000; price £6,500 incl. stocks and adequate premises; genuine offer; principals only.—Box 561, c/o Dawsons, 28, Craven St., W.C.2. 19645

RADIO-ELECTRICAL (Birmingham).—Skillfully managed, outstandingly successful long up store; sales £70,000; profits proportionately large; £10,000; book debts and s.a.v.—Havilands, 1, Rutland Rd., Bearwood, Birmingham, 17, 19510

N. LONDON.—Successful radio electrical business, excellent profits, manager if required, £5,000 plus s.a.v., good lease, owner leaving country necessitating immediate sale; accountant's figures; principals only.—Box 6875.

RADIO and cycles, busy mining town in Derbyshire, good living accommodation including 3 bedrooms and bathroom, large workshop, good sales shop in busy shopping centre (opp. Woolworths), rent and rates £150 per annum; takings £4,000, £5,000 and increasing; good lease; audited accounts; 1946 van available; £1,000. s.a.v.—Box 6869. 19705

PATENTS.

THE proprietor of British Patent No. 531963, entitled "Device for producing vibrato in s and amplifying systems and the like," offers same for license or otherwise to ensure practical working in Great Britain.—Inquiries to Singer, Ehler, Stern & Carlberg, 28, East Jackson Boulevard, Chicago 4, Illinois, U.S.A. 19449

PUBLIC NOTICE

THE trade mark "Dynamina," registered in class 9, schedule IV, under No. 648931, in respect of rotary electric converters, was assigned on January 29, 1948, by Hoover, Ltd. of Liverpool, Greenford, Middlesex, to Newton Bros (Derby), Ltd., of Alfreton Rd., Derby, without the goodwill of the business in which it was then in use. 19746

SITUATIONS VACANT

Vacancies advertised are restricted to persons or employments excepted from the provisions of the Control of Engagement Order, 1947

NORTHERN POLYTECHNIC, Holloway, N.7.

THE Governing Body invite immediate application for appointment as full-time lecturer in radio engineering to commence in September, 1948. Burnham scale salary; forms of application, together with full particulars, will be forwarded on receipt of a stamped addressed foolscap envelope.—R. H. Currell, Clerk. 19698

BRIGHTON Education Committee.—Brighton Junior Technical Institute. Principal, L. W. Palmer, B.A., B.Sc. APPLICATIONS are invited for the following full-time teaching post:—

INSTRUCTOR for part-time Day and Evening classes in the theory and practice of Radio Mechanics Work, with ability to assist in the training of Electrical Installation Apprentices. Salary in accordance with Burnham Technical Scale. Duties will commence in September next. Forms of application obtainable from the undersigned on receipt of a stamped addressed foolscap envelope. Completed forms to be returned to the Principal, Brighton Junior Technical Institute, Coombe Rd., Brighton, within two weeks of the appearance of this notice.—W. G. Stone, M.A., Education Officer, 54, Old Steine, Brighton.

ARMATURE winder and stator winder. A small firm with good contacts; exceptionally good prospects for young man with ambition.—Box 5551. 19255

SENIOR Draughtsman, to take charge of small S.D.O.; electrical, radio components, mouldings, etc.—Full details of exp. qualifications, age, salary (present, expected) to Box 6881.

RADIO and television engineer, must be experienced with Murphy and E.M.I. certificate, for old established firm.—Write, with refs., Roberts & Co., 145, North End, Croydon.

RADIO BULLS VALVES
246, HIGH ST., HARLESDEN, N.W.10

BRIMAR.—R2, 5Y3, 5U4, 80, 5Z3, 5Z4, 6X5, 5Y4, 1D5, 25Z4, 1D6, 0Z4, 35Z4, 1D5D, 9J2, 8D2, 10D1, 11D5, 11D3, 7D5, 6A8, 6K8, 617, 6K7, 6J7, 616, 6C5, 6J5, 6Q7, 6R7, 6P6, 616, 6N7, 6B8, 6V8, 68P7, 616, 678, 677, 617, 25A6, 129Q7, 128K7, 128A7, 12K7, 12Q7, 12K6, 12A6.

COSSCR.—4T1A, 418TH, 41MPG, MVS/PEN, MS/PEN, 5- and 7-pin, DD14, DDT, 41MTL, 41MH1, 41MP, PT41, 2P, 202ST11, 13VPA, 138PA, 210HF, 210D1T, 215P, 2200T, 240Q, 210LP, 478P, 478A, 202VP, 202VP, 130, 807.

MARCONI/GRAM.—U10, U14, U16, U17, U18P20, U50, U52, U31, U74, U76, VMP46, MS48, MSP4, 5- and 7-pin, D11, MH14, M11, MKT4, 5- and 7-pin, KT11, D4, VMS4B, H30, X65, KTW63, KTW65, KTW61, H63, L63, D163, KT44, KT66, KT61, Y63, KT71, X61M, KT74, KT76, KT83C, Z11, Z21, HP24, LP2, KT2, L2, QP21, Z22, Z02, Z66, GT1C, GU50.

MAZDA.—U6, V91, AC, PCPEN, 5- and 7-pin, H41DD, SP41, VP41, P41, DD41, H42DD, TH221, Pen3520, VP132, Pen383, Pen4531D, H11331D, H1211D, QP280, T122, QP25, TP20, Pen23, QP25, D1D207, H123, H123D, VP23, D1, C18PA, 1A4P1, DF51, DF91, DK91, EA50, EB34, EC33, EC33C, EC331, EC332, EC33A, EC333, EC335, EF9, EF36, EF39, EK32, EL2, EL32, EL33, EL35, EL37.

MULLARD.—DW2, DW4350, FW4500, AZ1, AZ31, EL38, EM1, EM4, EM34, 1W4, 3C0, UR3C, T14B, VY4, VY4A, SF4, 5- and 7-pin, 219A4, 354Y, T14, PM24M, Pen4DD, D024, D026, D030, R4428, TH21C, TH30C, PC13, TH31C, GP13C, 2013C, H113C, VP13A, SF13, Pen30C, G14, V12B, P2, PM2A, PM12M, FC2, FL30, QP22B, DF22, KK32, KF35, KBC32, K135, EB211, ECH21, VCH21, HVR2, KVR2A, EF50, EF6, EL50, AC06pen, CL33, UY21, EF22.

PHILIPS.—1821, CY31, CIC, CI, CY1.

AMERICAN.—0Z4, 1A4, 1A5, 1H5, 11N5, 11A6, 1B5, 1T6, 1V, 2A6, 2A7, 2B7, 3A4, 3Q5, 5U4, 5V4, 6X3, 6Z3, 6Z4, 6A3, 6A7, 6A8, 6A7, 6A7C, 6A25, 6A26, 6B7, 6H8, 6C4, 6C5, 6C6, 6C8, 6D5, 6D6, 6D8, 6E6, 6F6, 6F7, 6F8, 6G6, 6H1, 6J5, 6J7, 6K3, 6K6, 6K7, 6K8, 6L5, 6L6, 6L7, 6Q7, 6R7, 68A7, 68P7, 68Q7, 68H7, 68J7, 68K7, 68L7, 68N7, 68Q7, 68R7, 68S7, 6V6, 6X3, 7A7, 7H7, 10, 12A5, 12A6, 12C8, 12J5, 12K7, 12K8, 12Q7, 12S47, 12SF5, 12SF7, 12SL7, 12S47, 12SR7, 1A47, 12B7, 14B6, 14Q7, 15, 17, 18, 20, 22, 25Z4, 26, 27, 32, 34, 35A5, 35L6, 35Z4, 35Z5, 37, 38, 42, 43, 46, 45, 49, 50, 53, 55, 56, 59, 71A, 76, 77, 78, 79, 80, 83, 84, 89, 90A, 955, 956, 9001, 9002, 9003, 9004, 9005, 9006, and 101 more types. Order C.O.D., above listed or equivalents (subject to stock). Please enclose for any valve you require. Old and new types arriving daily. Old stock at pre-increased and pre-Bidding prices.

Just in:
PT41, Pen4DD, X41, MX40, 41MPG, VP1B, KT38C, 35L6, Pen 36C, SF2, Pen383, PM24M, MH4105.

EXPORT. We are fully equipped for safe packing and despatch from the smallest item to bulk. All orders immediately despatched and fully insured.

"GOLDRING" PICK-UP HEAD gives your old Gramophone Radiogram quality reproduction, 28/-.

MIDGET SOLDERING "IRON" BRON works off 6V car battery, 9/-.

SERVICE SHEETS British and American assorted, 2 doz. (each lot), 21/-.

TWO-INCH MIDGET EXTENSION FOR SPEAKERS, also suitable as mikes, 7/6.

EX-R.A.F. TELESCOPIC ALUMINIUM MASTS, 9ft., 10-. Same in Steel, 16/-.

"RADIO-CRAFT" American library of 10 books (last consignment to come in from U.S.A.), 36/-.

SPEAKERS, 6in., brand new and boxed, 15/-.

TELEVISION—Baird's "GARRICK" Model (Radio-combined) 12in. tube giving brilliant picture.

EASY TERMS on all TAYLOR Instruments.

Ex-A.M. Batteries, inert, 120 volts, 10/9.

"PETER PAN" Kit 474U, Universal 4-valve, £13 17s. 9d.

"PETER PAN" Kit 486B, Battery 3-valve, £10 14s. 2d.

BATTERY Superhet Kit, 3-wave, £15 17s. 3d.

FLIERS and **CUTTERS**, 6in., insulated, 5/-.

TRIMMER Tool Kits, improved, 10 tools, £1 10s. 0d.

COUPON FREE Speaker Fabric, 1 sq. ft., 3/6.

ALARM Clocks, Electric, £3 19s. 6d.

ELECTRIC Wall or Mantel Clocks, £1 19s. 6d.

VARLEY 6 v. Accumulator, to suit Valvo-Arc Tun., £1 15s. post free.

HOBBIES Fretwork Outfits, from 9/6.

STOP PRESS

MODEL Maker's Press Outfits, 55/- and 84/-.

MOTOR, electric miniature, 12/6.

WONDER Crystal Set with pair of Headphones, 25/-.

Please write immediately to BULLS (W.W.)

RADIO BULLS VALVES
246, HIGH ST., HARLESDEN, N.W.10

EXPERIENCED service engineer required. Must have up-to-date knowledge and good practical pre-war experience with all types of receivers.—Tel. or call, R.S.S., Ltd., 68a, Park Rd., N.8. Mou. 5533. 19713

TECHNICAL sales assistant required, experienced in preparing literature, publicity and advertising copy.—Write full details of experience to Taylor Electrical Instruments, Ltd., Montrose Ave., Slough. 19677

TECHNICAL-REPRESENTATIVE Executive, with own car; electrical and radio components S.W. of London; experience, age, qualifications, salary (present, expected), (travelling expenses are met) to Box 6882. 19753

DESIGNER - DRAUGHTSMAN required for factory, Northern area, must be conversant with Radar and radio equipment construction.—Reply stating age, full details of experience, training and salary required to Box 5548. 19279

SALES engineer for well known radio and electrical component manufacturers in North-West London; post calls for initiative, adaptability and energy.—Give full details, age, experience, qualifications, salary reqd. to Box 6867

TELEVISION engineer, required by R.F. Equipment (Sobell Industries) for laboratories situated at Hirwaun, nr. Aberdare, Glamorgan. Write in first instance to Personnel Manager, stating qualifications, exp. and salary expected.

DRAUGHTSMEN required for big and tool drawing office; must be familiar with electronic equipment construction, Manchester area.—Apply, giving full particulars of experience, qualifications and salary required, to Box 5547.

HADLEY SOUND EQUIPMENTS require outside radio service engineer, B'ham area in district S.W. of London; good technical knowledge and good address essential.—Apply Works Manager, Hadley Sound Equipments, 587, Bearwood Rd., Smethwick. 19691

RADIO Service Engineer required; first-class experience of advanced radio and test receiving ability to drive car; excellent prospects.—Apply personally or by letter to Personnel Manager, Dynatron Radio, Ltd., Ray Lea Rd., Maidenhead, Berks. 19750

EXPERIENCED designer of domestic radio receivers required by manufacturers in district S.W. of London; knowledge of television technique an advantage.—Write, stating details of qualifications and salary required, to Box No. D 718, c/o Streets, 110, Old Broad St., E.C.2.

ELECTRICAL component manufacturers require young man with good electrical training, preferably with Higher National certificate or equivalent for development work on television components.—Write, giving full details and stating remuneration required, to Box 6865.

R. M. ELECTRIC, Ltd., Team Valley, Gateshead, 11, have vacancy for works manager; applicant must be conversant with time study, network and modern radio production methods.—Apply, stating age, exp. and salary required.

ASSISTANT engineer for laboratory development of radio communication receivers. University degree or equivalent and industrial experience of receiver measurements essential; applicants should state salary required.—Apply Ref. 715 Siemens Brothers & Co., Ltd., Woolwich, S.E.18. 19703

RADIO engineers required for design and test of latest type radio transmitters and receivers. Technical standard preferably up to City and Guilds final, or equivalent; essential offers good prospects; London area.—Apply, in confidence, giving age, details of education, experience and salary required, to Box 6870. 19706

CHIEF engineer and physicist required by large manufacturer in the South to take charge of important department engaged on production of microwave development. Essential qualifications are adequate technical education and practical experience in this field of radio; applicants should state qualifications, experience, and age, to: Box 7050. 19830

JUNIOR Development Engineer required to work on the development and engineering of large screen television equipment; degree not necessary, but commercial experience in work of a similar nature essential.—Write, stating age, qualifications and salary required, to Cinema-Television, Ltd., Worsley Bridge Rd., 10, Worsley, S.Ydenham, S.E.26. 19747

UNIVERSITY COLLEGE, Southampton, invites applications for the post of Lecturer in the Technical Department, University College, Southampton, for City and Guilds Telecommunications up to Grade 5; salary Burnham scale.—Further particulars may be obtained from the Technical Officer, with whom application should be lodged by 12th June. 19730

TECHNICAL assistant required for radio and lines project section, age 21-26 years, experience in communication and radio engineering essential, together with ability to write descriptions of such equipment, minimum qualification City and Guilds Radio Part 3.—Apply in writing to E.T.E., Ltd., Brathway Rd., Wandsworth, London, S.W.18 (Radio Laboratory), stating experience, age and salary required. 19687

RADIO service engineers for works and field, primarily in London area; well known company, excellent prospects; applicants should have comprehensive knowledge radio servicing and minimum of 2-3 years' retail or industrial experience in repair work; 5-day, 44-hour week; wages according to experience and at prevailing levels.—Apply, stating age, full details experience, wages required, Box 6866. 19690

L-R-S IN STOCK

AVOMETERS	
Model 7	Cash price £19 10 0
Avominor AC/DC Universal Meter...	£8 10 0
Valve Tester, complete	£16 10 0
Avominor DC Meter	£4 4 0
Oscillator, Mains	£13 0 0
New Signal Generator available shortly	
Enquiries for other models are invited.	
Goodman's 12in. Loudspeaker Unit	£6 15 0
Stuart Centrifugal Electric Pumps for all pumping purposes. Compact and Efficient. All sizes again available. Please write for specification.	
Morphy Richards Auto Electric Irons. Chrono, superb quality 39/6, post 1/-.	
All the above available on convenient terms.	
Illustrated list of any of the above items 1d.	
The LONDON RADIO SUPPLY Co. (The L.R. Supply Co. Ltd.) Est. 1925 BALCOMBE SUSSEX	

HIGH FIDELITY

A much improved version of our Corner Cabinet is now available, in either whitewood or walnut veneer. Full details on request. Our Feeder Units and Amplifiers are now available from stock. A prototype miniature Hi. Fl. receiver and amplifier using button base valves is in course of development and will soon be demonstrated in our showrooms. Components for the Partridge 15 Watt Quality Amplifier are available from stock. Our Price List covering components for High Fidelity equipment will be forwarded on request.

ROGERS DEVELOPMENTS Co.
106 HEATH STREET, HAMPSTEAD,
LONDON, N.W.3.
Telephone: HAMPstead 6901

100 kcs.
QUARTZ
CRYSTAL
UNIT
Type
Q5/100



for Secondary Frequency Standards

★ Accuracy better than 0.01%. ★ New angles of cut give a temperature coefficient of 2 parts in a million per degree Centigrade temperature change. ★ Vitreous silver electrodes fired direct on to the faces of the crystal itself, giving permanence of calibration. ★ Simple single valve circuit gives strong harmonics at 100 kcs. intervals up to 20 Mcs. ★ Octal based mount of compact dimensions. PRICE 45/- Post Free

Full details of the Q5/100, including circuit are contained in our leaflet Q1. Send stamp to-day for your copy

THE QUARTZ CRYSTAL Co., Ltd.
63-71 Kingston Road,
NEW MALDEN, SURREY
Telephone: MALden 0334

ASSISTANT laboratory engineer required by capacitor manufacturers, applicants should hold Higher National Certificate in electrical or radio engineering or have similar qualifications and must have experience of industrial laboratory work, knowledge of capacitors preferable but not essential.—Write, giving details of experience and salary required, to A. H. Hunt, Ltd., Bendon Valley, Wandsworth, S.W.18. (9715)

PRESS Officer.—The General Electric Co., Ltd., requires an experienced journalist for the Press Relations Section of the Publicity Department. Applicants should be under 40 years of age and must have previously been engaged on work of this nature; knowledge of electronic techniques needed.—Apply, giving age, details of exp. and salary reqd. to Staff Manager, G.E. TECHNICAL, Magnet House, Kingsway, W.C.2.

TECHNICAL sales representatives required in the following areas: London, Manchester, Newcastle-on-Tyne, Glasgow, Cardiff, by leading sound equipment manufacturers, to deal with enquiries and supervise the installation of "Music While You Work" and Staff Location Equipment; previous trade experience and possession of a car essential; salary, commission, car expenses; write, stating previous experience and qualifications.—Box 6876. (9737)

DRAUGHTSMEN: North London firm requires good draughtsmen (a) designer with sound training and wide experience including instrument and tool work for preference, commencing salary up to £475 p.a.; (b) young man with initiative and preferably some knowledge of electrical layout and circuit diagrams (A.E.S.D. rate); much interesting development work for the right men.—Write, stating qualifications, experience, age and salary required, to Box 6860. (9652)

RADIO engineering firm in Essex (30 miles London) requires a writer to originate technical sales literature, to deal with printing production and assist in administration; experience would range over whole of company's many products and would be valuable to young wireless or electrical engineer; degree in electrical engineering or equivalent desirable; keenness and ability for writing of this special kind essential.—Apply, quoting Ref. 102, to Box 6860. (9679)

PHILIPS ELECTRICAL, Ltd., require engineers in the Birmingham and Manchester area to deal with public address equipment and installations; a good standard of technical knowledge and commercial experience in public address or other allied trade is essential; successful applicants must be prepared to reside in London for several months for preliminary training, and possession of a car is essential; write, giving full details as to age, previous experience and salary required, to: Box 5522. (9213)

ELECTRONIC development engineer; well-known North London firm requires good engineers interested in electronic design and instrument work, sound theoretical knowledge and wide experience of low frequency circuits in particular is essential; vacancies for senior assistants with academic qualifications commencing salary up to £500 p.a., an junior with Nat. Cert., Inter. or C. & G., commencing salary up to £350 p.a.—Write, stating qualifications, experience, age and salary required, to Box 6861.

SENIOR radio engineer required for large industrial concern operating in the Middle East; applicants should have had at least 7 years' experience in technical installation, operation and maintenance of M.F. H.F. and V.H.F. communication transmitters, superhet receivers and high speed W.T. systems; a knowledge of carrier current technique advantageous; age not over 35, secondary school education; salary plus generous allowance in local currency; free passage out and home, medical attention, kit allowance and furnished bachelor accommodation.—Write, giving age and full particulars of qualifications and experience, quoting Department F.96, to Box 1075 at 191, Gresham House, F.C.2. (9525)

PHILIPS' Mitcham works have vacancies in their domestic receiver development laboratories for technical assistants; applicants should be between the ages of 20-30, and be graduates (engineering with radio or telecommunications) of a recognised university or hold qualifications exempting from I.E.E. examination; the work will involve a study of the problems of mass production of components and complete receivers, and successful candidates will be expected to work with a minimum of supervision, and to take responsibility for the preparation of receivers and associated components for production; some experience of production is an advantage; salary according to qualifications.—Write for application form to the Personnel Manager, Mitcham Works, Ltd., New Rd., Mitcham Junction, Surrey, quoting reference "G.I." (9674)

B.B.C. invites applications from men (British) for the post of radio engineer in the Planning and Installation Department in London. Applicants, who should not be less than 30 years of age, should possess a University degree in electrical engineering or equivalent qualifications, coupled with radio transmitter theory and practice. A knowledge of F.M. and Television would be advantageous. The successful candidate must be able to conduct correspondence generally and in particular must have a knowledge of Specification writing and the management of Tenders and Contracts. The salary is on a grade rising by annual increments of £35 to a maximum of £785 per annum.—Applications, stating age, qualifications and experience, should reach the Engineering Establishment Officer, Broadcasting House, London, W.1, within 7 days of the appearance of this advertisement. (9734)

**For Export
And Home**

**LOWTHER
VOICET**

Designed & Manufactured by:
THE LOWTHER MANUFACTURING CO.
Lowther House, St. Mark's Road,
BROMLEY, KENT.
Rev. 5225.

TELEVISION

The advance in Radio Technique offers unlimited opportunities of high pay and secure posts for those Radio Engineers who have had the foresight to become technically qualified. How you can do this quickly and easily in your spare time is fully explained in our unique handbook "Engineering Opportunities." Full details are given of A.M.I.E.E., A.M.Brit.I.R.E., City & Guilds Exams., and particulars of up-to-date courses in Wireless Engineering, Radio Servicing, Short Waves, Television, Mathematics, etc., etc.

We Guarantee "NO PASS—NO FEE"

Prepare for to-morrow's opportunities and future competition by sending for your copy of this very informative 112-page guide NOW—FREE.

BRITISH INSTITUTE OF ENGINEERING TECHNOLOGY (Dept. 388)
17, Stratford Place, London, W.1

QUARTZ CRYSTAL UNITS

FOR AMATEURS

For your
TRANSMITTER

HIGHER ACCURACY

COMPETITIVE PRICES

Delivery FROM STOCK

For your
FREQUENCY STANDARD

SALFORD ELECTRICAL INSTRUMENTS LTD.
PEEL WORKS, SALFORD 1,
Proprietors: THE GENERAL ELECTRIC Co. Ltd., of England

VALLANCE'S OFFER

THE FAMOUS B2 RECEIVER, COMPLETE WITH POWER SUPPLY.

This receiver is a 4-valve superhet covering 3 frequency bands, 3.0/5.0 mc/s, 5.0/9.0 mc/s, 8.0/15.0 mc/s. Valve line-up: 7R7 mixer-oscillator, 7R7 1st I.F.-A.V.C., 7Q7 2nd I.F. and 1st L.F., 7R7 Det. and audio output. Provision is made for phone or C.W. reception, output being taken through a matching transformer, for headphone operation, but can be easily converted for loudspeaker operation.

Controls are:—bandswitch, volume, B.F.O. control and 5.M. tuning; a dial magnifier is fitted for easy readability.

The receiver is built in a substantial metal cabinet finished in black crackle. Size 9½ in. x 4½ in. x 4 in.

POWER SUPPLY is self-contained in black metal cabinet, size 9½ in. x 4½ in. x 4 in.

Suitable for operation on any voltage between 97 and 250 volts AC or DC; or alternatively direct from a 6-volt source. Additional output of 500 volt and 6.3 volt.

Both units are supplied complete in a black metal container with lid, and fixing clamps, measuring 11½ in. x 10½ in. x 6½ in.

Complete with the following accessories:—Mains cord with 5 amp. 2 pin plug, plug to B.D. adaptor, B.C. adaptor to Edison screw; Pair of Headphones, spare fuses, two screwdrivers, Battery leads with clips.

Absolutely Brand New and Unused. Very limited quantity. Price: £9. Plus 5/- post and packing.

Goods can be sent C.W.O. or C.O.D.

VALLANCE & DAVIDSON, LTD.

144 BRIGGATE, LEEDS, 1. Phone 29428/9. Staff call signs: 02HHV, 088X, 03ABD, 03AHV.

Audix

B.B. LTD.

Electro-Mechanical Engineers

- Disc Recording Equipment Studio and Mobile.
- Gramophone Reproducer Turntables, Synchronous and Non-Synchronous Types.
- Ribbon Microphones.
- Specialised Receivers and Amplifiers for Schools Installations.

EXPORT ENQUIRIES INVITED

39/43 WEST HILL,
LONDON, S.W.18
Telephone: BERmondsey 1220

SERVICE mechanic with previous experience in radio repair, or London, West End.—Write, giving full particulars, to Box No. W.774, Haddons, Salisbury Sq., London, E.C.4.

REQUIRED as technical assistant to Chartered Patent Agent in Patent Department of the General Electric Co., Ltd., at Research Laboratories, Wembley, Middlesex, a young man with a honours degree or similar qualifications and preferably with some experience or knowledge of radio engineering and electronics; the assistant would receive training for qualification as a Chartered Patent Agent.—Apply by letter only to the Director, stating age, academic qualifications and experience. [9723]

MANUFACTURERS and distributors of well-known 16mm sound on film projectors require additional personnel for test and service departments; excellent opportunity for applicants with first-class knowledge and experience in all branches of this equipment, who will be required to devote part time London and part N. of England; write, stating age, experience and salary required, to: Box 229, Phillips Advertising, Thanet House, Craven Rd., London, W.2.

B.B.C. invites applications from men (British) for three Senior Technical Posts in the Engineering Training Department at Evesham; candidates must be graduates in Electrical Engineering or Physics with a sound knowledge of radio fundamentals and a good mathematical background; teaching, research or manufacturing experience and ability to write technical articles or manuals are required. Candidates must, in addition, possess either (1) Fundamental knowledge and practical experience in UHF techniques (up to 5,000 Mc/s); or (2) Research or development experience in radio frequency problems involving lines, and/or recording and acoustics; or (3) Research or development experience in radio frequency measurements and in the application of electronics to remote control mechanisms. The salaries are on a grade rising by annual increments of £40 to a maximum of £840 per annum. Applications, stating age, qualifications and experience, should reach the Engineering Establishment Officer, Broadcasting House, London, W.1, within 7 days of the appearance of this advertisement. [9735]

SITUATIONS WANTED

RADIO and television service eng., experienced all makes, seeks post anywhere; clean driving licence; able to take charge.—Box 6871.

ENGINEER, experienced design and development, seeks position; City and Guilds Final grade in radio communication and technical electricity.—Box 7056. [9691]

R.A.F. Signals officer, 30, invalided, 12 yrs. experience service telecomms. and administration, seeks position with opportunity for advancement.—Box 7004. [9820]

WIRELESS fitter, ex-R.A.F., age 26, 6 years' experience in civilian radio, studying for A.M.I.E.E., seeks progressive employment in radio.—Write BM/APHI, London, W.C.1. [9739]

EX-F/Lt. Transport Command wireless op., 5 yrs. India-Ceylon, 14 yrs. practical exp. Tx. D/F. Lorán, qual. equ. P.M.G., seeks position overseas; pref. East Far East.—B-x 7055.

EX-CAPTAIN R. Signals seeks responsible post, preferably overseas; 25, single, Inter. B.Sc., service, theoretical qualifications and wide experience all branches of radio communication.—Box 7035. [9342]

EX-OFFICER, A.M.BRIT.I.R.E., with total of 10 years' experience in various branches of radio engineering, seeks post with scope for initiative; would prefer to be stationed abroad; age 29.—Write Box 6885. [9760]

EX-R.A.F. Cpl., wireless fitter, seeks opening in either sales or business side of radio; London or Southern Counties; willing to work for nominal salary for six months; must receive every job with prospects is offered.—Box 6885.

TELECOMMUNICATIONS engineer (32), Assoc. Brit.I.R.E., 10 C. & G. certs., Final radio comm., ex foreman of signals, 12 years' exp. telephony, telegraphy, H.P., H.F., V.H.F. transmitters, receivers, seeks responsible position.—Box No. 7, Smith's Library, Bexhill. [9660]

I.M.Sc. Physics degrees and 3 years' radio research experience, seeks suitable employment in industry; now doing a post graduate course in Electronics at University College, Southampton; ready to join in September.—Please reply to M. Krishnamurthi, Sonnaraj Hall, Westgate Lane, Swaythling, Southampton. [9764]

TUTORIAL

ENGINEERING careers and qualifications. BOTH Government and industry have announced and emphasised that young men with technical knowledge and qualifications must receive every chance to rise to the highest positions within their capacity, in post-war engineering and allied industry, write to-day for "The Engineer's Guide to Success"—200 courses free—which shows you how you can become A.M.I.E.E., A.M.I.Mech.E., A.F.R.A.E.S., etc., and covers all branches in radio, automobile, mechanical, electrical, production, aeronautical, etc. THE Technological Institute of Great Britain, 82, Temple Bar House, London, E.C.4. [4918]

100 worked examples, advice and notes in valuable examination practice, set A for City and Guilds, year one, telecommunications, principles and practice, or similar examination.—From Box 6382. [9643]

THESE ARE IN STOCK

Television Receiver Construction. 2s. 6d. Postage 2d.

Radio Valve Data Pocket Book. By F. J. Camm. 5s. Postage 3d.

Television Receiving Equipment. By W. T. Cocking. 12s. 6d. Postage 5d.

The Cathode Ray Oscilloscope in Industry 3rd Ed. By W. Wilson. 18s. Postage 6d.

A Practical Course in Magnetism, Electricity and Radio. By W. T. Perkins and A. Charlesby. 10s. 6d. Postage 6d.

Foundations of Wireless. By M. G. Scroggie. 7s. 6d. Postage 4d.

Classified Radio Receiver Diagrams. By E. M. Squire. 10s. 6d. Postage 4d.

Radio Aids to Navigation. By R. A. Smith. 9s. Postage 5d.

Radio Data Charts. By R. T. Beatty. 7s. 6d. Postage 6d.

The Principles and Practice of Wave Guides. By L. G. H. Huxley. 21s. Postage 6d.

Radio Engineering Handbook. By Henney. 42s. Postage 9d.

Elements of Radio Servicing. By Marcus and Levy. 27s. Postage 7d.

Frequency Modulation Engineering. By C. E. Tibbs. 28s. Postage 6d.

The Wireless World Valve Data. 2s. Postage 2d.

Cathode-Ray Oscilloscopes. By Reyner. 8s. 6d. Postage 4d.

We have the finest selection of British and American radio books. Complete list on application.

THE MODERN BOOK CO.

(Dept. W.4)

19-23, PRAED STREET, LONDON, W.2.

A NEW TELERADIO CHASSIS

Model A70

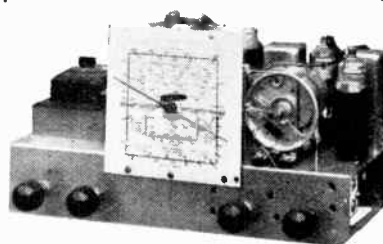

6-Valve A/C MAINS R/G CHASSIS, 15-50, 200-600, 540-2,000 Metres with TUNING INDICATOR, TONE CONTROL.

14 Gns. plus P. Tax.

Also available as tuning unit feeding push-pull amplifier. Blueprints can be supplied for home construction if desired.

Export enquiries invited

Send 2½d. stamp for full illustrated lists to

THE TELERADIO CO.,
157, FORE STREET, LONDON, N.13

Tott.: 3386

MORSE CODE TRAINING



There are Candler Morse Code Courses for **BEGINNERS AND OPERATORS.**

Send for this Free "BOOK OF FACTS" It gives full details concerning all Courses.

THE CANDLER SYSTEM CO.,
Room 55W, 121 Kingsway, London, W.C.2
Candler System Co., Denver, Colorado, U.S.A.

IN SPITE OF DIFFICULTIES



SERVICE ON LOUDSPEAKERS IS BEING MAINTAINED. We regret service on PU's must await an improvement in Mr. Voigt's health.

VOIGT Patents Ltd.

NON-MAGNETIC TURNTABLES

with **STROBOSCOPIC MARKING**
An essential accessory for serious **PICK-UP DESIGN RESEARCH**

SOUND SALES LIMITED

57 St. Martin's Lane, London, W.C.2
Temple Bar 4284
Works: Farnham, Surrey

VIBRO-ARC ELECTRIC METAL ENGRAVING TOOL

Engraves, etches, marks, writes... on
BRASS, COPPER, SILVER, NICKEL, ALUMINIUM, CHROMIUM, Hardened Steel

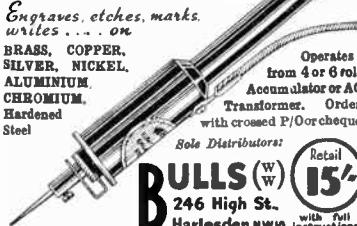

Operates from 4 or 6 volt Accumulator or AC Transformer. Order with crossed P/O or cheque

Sole Distributors: **BULLS (W)** Retail 15/-
246 High St., Harlesden N.W.10. with full instructions post free.

WE OFFER

A large range of used and new Test Equipment, Converters, Recorders, Amplifiers, Motors, Transformers, etc.

All guaranteed and at very attractive prices.

We buy good modern used equipment of all types for spot cash.

UNIVERSITY RADIO LTD.
22 LISLE STREET, LONDON, W.G.2.
Tel.: GER 4447 & 8582.

RADIO training.—P.M.G. exams. and I.E.E. Diploma; prospectus free.—Technical College, Hull. 19611

COMplete correspondence course covering amateur and C. & G.I exams, consisting of 12 lessons, send for particulars.—Everyman's Correspondence College, 72, St. Stephens House, Westminster, S.W.1. 18839

POSTAL courses of instruction for amateur radio transmitting licence, P.M.G. Certificates in wireless telegraphy, Ministry of Civil Aviation Certificate, radio engineering and television; also instruction at school.—Apply British School of Telegraphy, Ltd., 179, Capham Rd., London, S.W.9 (Estd. 40 years). 19639

ENGINEERING opportunities.—Have you had your copy of this free guide to A.M.I.Mech.E., A.M.I.E.E., and all branches of engineering, building and plastics? Become technically trained on "no pass—no fee" terms for higher pay and security.—For free copy write B.I.E.T. (Dept. 387B), 17, Stratford Place, London, W.1. 19255

THE RADIO ENGINEERING SCHOOL, air service training, Hamble, Southampton offers full-time residential training for radio engineers seeking responsible positions in industry or civil aviation; students are coached for C and G telecommunications or Brit. I.R.E. exams as preferred; tuition also available to M.C.A. requirements in radio and radar.—For full details apply to the Commandant. 19265

THE Institute of Practical Radio Engineers have available Home Study Courses covering elementary, theoretical, mathematical, practical and laboratory tuition in radio and television engineering; the text is suitable coaching matter for I.P.R.E. Service entry and progressive exams; tuition fees at pre-war rates are moderate.—The Syllabus of Instructional Text may be obtained, post free, from the Secretary, 20, Fairfield Rd. Crouch End, N.8. 16722

TECHNICAL TRAINING

A.M.I.E.E., City and Guilds, etc. on "No Pass—No Fee" terms; over 95% successes; for full details of modern courses in all branches of electrical technology send for our 112-page handbook, free and post free.—B.I.E.T. (Dept. 382A), 17, Stratford Place, London, W.1. 16270

BOOKS, INSTRUCTIONS, ETC.

WEBB'S radio map of the world locates any station heard, size 40X30in, 4/6, post 6d.; on linen, 10/6, post free.—Webb's Radio, 1-4, Soho St., W.1. Gerrard 2089. 19947

R.S.G.B. technical publications.—The following are of special interest to transmitting amateurs and short-wave enthusiasts:—"MICROWAVE Technique."—An up-to-date treatise on a subject of vital interest, 68 pages, 2/3, post free.

"SERVICE Valve Equivalents."—Lists commercial equivalents of many hundreds of Service and CV types, 28 pages, 1/-, post free.

"THE Transmitting Licence."—How to obtain an amateur licence, 32 pages, 1/-, post free.

"RADIO Handbook Supplement," 4th edition, Radio mathematics, D.F.C.R. tubes, etc., etc. 168 pages, 2/9, post free.

"R.S.G.B. Bulletin"—Monthly pub. of the R.S.G.B. 1/6 post free. (Free to members.)

RADIO Society of Great Britain, 25, Little Russell St., London, W.C.1. 19225

TRANSFORMERS & CHOKES

High Quality Vacuum Impregnated

AUSTIN MILLS LTD.

LOWER CARRS STOCKPORT

Telephone: STO. 3791 Established 20 years.

THIS Does these



ACCURATELY and QUICKLY Chassis, Brackets, Shrouds, Condenser and Transformer clips—TREPANNING Steel or Aluminium. Five sizes—12" to 36"

Full particulars from **A. A. TOOLS, (W),** 197A, WHITEACRE ROAD, ASHTON-UNDER-LYNE

FORREST

(EST. 1922)

FOR **QUALITY**

- TRANSFORMERS
- CHOKES, ETC.
- REWINDS (all makes)

SHIRLEY, BIRMINGHAM . . . SHI. 2483

A.B. OAK wafer switches

The wave-change switch with silver-plated double contacts.
A.B. METAL PRODUCTS LTD.,
Great South-West Road, Feltham, Middx.



TRANSFORMERS & COILS TO SPECIFICATION.

MANUFACTURED OR REWOUND
Filter Coils + 1% a Speciality.

JOHN FACTOR LTD.
9-11 EAST STREET, TORQUAY, DEVON.
Phone: Torquay 2162

"PERIMET" ELECTRODE Soldering and Brazing Tool



Operates from 4 or 6 Volt Accumulator or Transformer. 15s. Post free

MAINS TRANSFORMER, 3 Heats. 35s. Post free.
HOLBOROW & CO.,
71, Weymouth Bay Avenue, Weymouth.

A.C.S. RADIO

SPECIALISTS IN AMATEUR AND EXPERIMENTAL SHORT-WAVE EQUIPMENT.
Communications Receivers, Televisions High Quality Amplifiers, Speakers, Aerials, Receiving and Transmitting Valves and Meters, etc.

List "W" free on request to:—
A.C.S. RADIO, 44 Widmore Rd., BROMLEY Kent.
Phone: RAV 0156

RADIO BATTERY TESTER

Use "Quixo" method of battery testing.
Reliable results. Guaranteed.
Send for interesting leaflet R115 on battery testing.

RUNBAKEN • MANCHESTER

PHOTO-ELECTRIC CELLS

for Talking Picture Apparatus.
Catalogue now available

RADIO - ELECTRONICS LTD.,
St. George's Works, South Norwood, London, S.E.25.



... the invisible export

BRITISH goods enjoy a world-wide reputation for a reliability which is the one supreme quality which will win for us the battle of the gap between imports and exports. But reliability does not come from hit or miss methods — all things being equal, every unit of a product must be carefully considered and chosen in relation to its effect on the whole. When it comes to electrical apparatus, utmost care in design and manufacture can be wasted if the capacitors fail.

Because of the importance of the capacitor, Hunts make sure that the Hunt trade mark on a capacitor is a sufficient guarantee of its reasonable reliability. Quite apart

from specialisation in capacitor design and manufacture, elaborate measures are taken by Hunts for quality control and inspection at every stage of production, and are constantly extended in the light of concentrated experience in the requirements of markets at home and overseas.

To users of capacitors—of every type and for every purpose—an invitation is extended to call on Hunts assistance in technical advice and manufacturing resources. Hunts are playing a proper part in the export drive, in partnership with manufacturers of radio and electronic apparatus much can be done to further the British market-winning tradition for complete reliability.



- DRY ELECTROLYTIC • FOIL AND PAPER • METALLISED PAPER • MOULDED STACKED MICA
- PROTECTED SILVER MICA • TRIMMERS AND PADDERS • ETC.

A · H · HUNT LTD · LONDON · S.W.18 · ESTABLISHED 1901

This operative makes more than 1,000 perfect soldered joints per hour, with ease



THANKS TO THE THREE-CORE CONSTRUCTION OF ERSIN MULTICORE SOLDER



Ersin Multicore Solder is supplied in nominal 7 lb. reels for use by manufacturers. Prices on application. The prices for the Size 1 Carton illustrated are detailed below:

7 lb. REEL for Factory use.

SIZE 1 CARTON for Service Engineers and Workshops.

No matter how many joints are soldered with Ersin Multicore Solder, its three cores (filled with extra active non-corrosive Ersin Flux) ensure that the correct proportion of flux is always present. Ersin Multicore gives a consistently high standard of precision soldered joints, at high speed, without waste, with freedom from H.R. or 'dry' joints. Comparative tests have shown conclusively that it is *more economical* to use Ersin Multicore Solder. Manufacturers and Service Engineers are invited to write for technical information and free samples.

Catalogue Ref. No.	Alloy Tin/Lead	S.W.G.	Approx. length per carton	List price per carton (subject)	
				s.	d.
C16014	60/40	14	38 feet	6	0
C16018	60/40	18	102 feet	6	9
C14013	40/60	13	25 feet	4	10
C14016	40/60	16	53 feet	5	3

The Finest Cored Solder in the World

MULTICORE SOLDERS LIMITED

MELLIER HOUSE, ALBEMARLE STREET, LONDON, W.1.

REGent 1411