

# Wireless World

RADIO AND ELECTRONICS

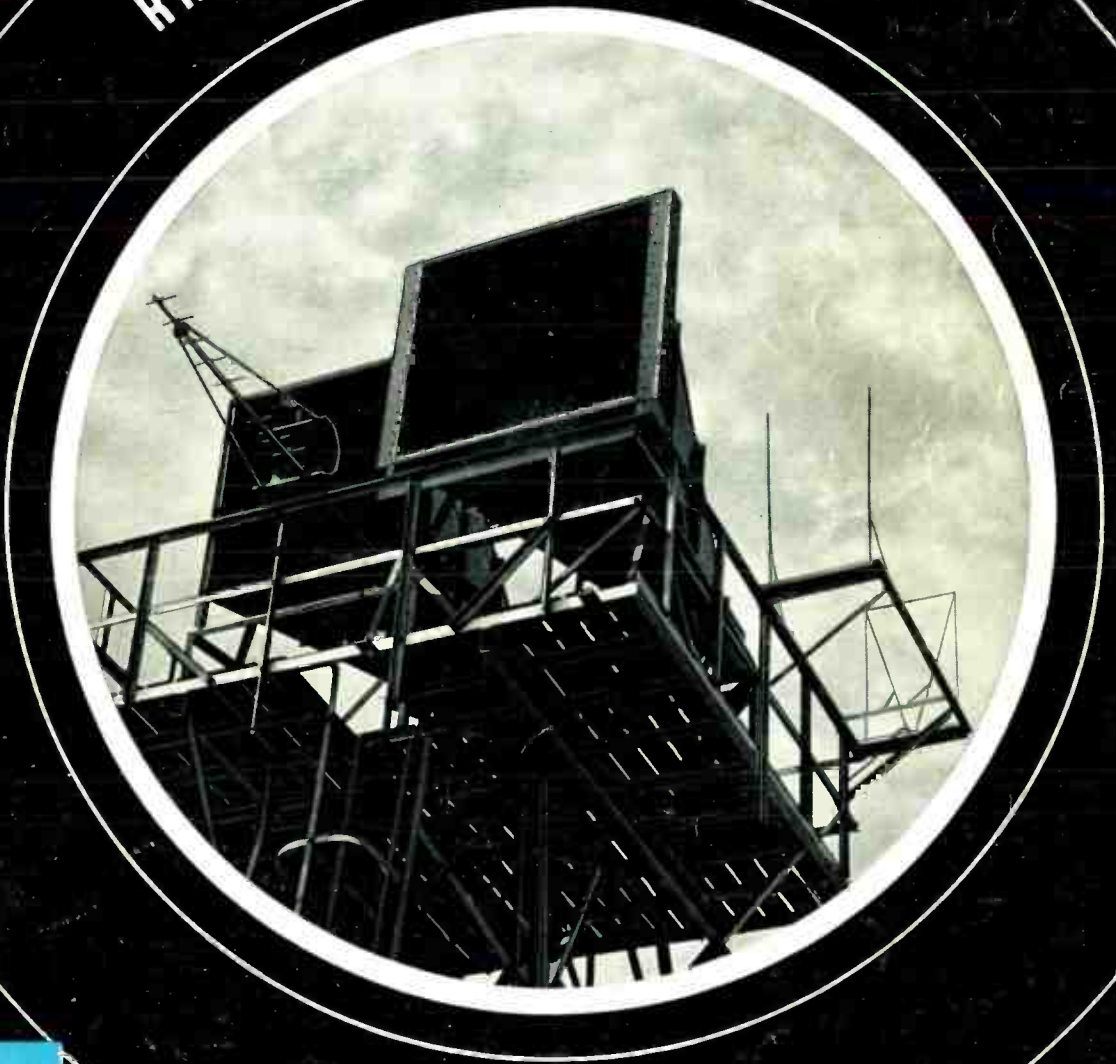

AUG. 1947

1/6

Vol. LIII. No. 8

IN THIS  
ISSUE :

TELEVISION AERIALS



The Research Engineer knows that the best speaker for any set is one that offers complete reliability plus true tonal fidelity. After exhaustive tests his advice is always the same—fit Rola and relax!

**ROLA SPEAKERS**  
THEIR QUALITY SPEAKS FOR ITSELF

BRITISH ROLA LTD · 8, UPPER GROSVENOR STREET · LONDON, W.1



MODEL 7 UNIVERSAL Avometer

MODEL 40 UNIVERSAL Avometer

THE AVO TEST BRIDGE

THE AVO VALVE TESTER

THE ALL WAVE AVO OSCILLATOR

**R**AUDIO manufacturers, service engineers, workshop and laboratory technicians are familiar with the precision and dependability of "AVO" Electrical Testing Instruments. Long years of successful experience in the design and manufacture of first-grade instruments have produced a consistently high standard of accuracy which has become a tradition as well as a standard by which other instruments are frequently judged

**THE AUTOMATIC COIL WINDER & ELECTRICAL EQUIPMENT CO., LTD.**  
 WINDER HOUSE · DOUGLAS STREET · LONDON · S.W.1 TELEPHONE: VICTORIA 3404/7

1218



# THE GREEKS HAD A WORD FOR IT

but we prefer to call it "AUDIOSCOPE"

"Audioscope"—maybe we have invented a new word, but the meaning, when applied to WODEN AMPLIFIERS, is that their "audioscope" embraces not only perfected reproduction of any sound but such excellent amplification that it will reach the widest audience in hall or open space without the loss of the slightest undertone or the distortion of music's highest C. Designed for a long life of trouble-free service and built in the WODEN belief that Finest Materials + Expert Craftsmanship must = Quality. Now it's up to you to send us your name and address for further particulars . . . why not do so TO-DAY ?

## WODEN AMPLIFIERS

BUILT FOR THOSE WHO KNOW



**60 WATT "CLASSIC" AMPLIFIER**  
Mains supply 200-250 v. A.C. 50 cps. Transformer tapped at 0, 8, 15 and 200 ohms. Response 50-10,000 cycles  $\pm$  2 db. Undistorted output of 60 watts. Finished in Light Grey Stove Enamel and Chromium. Retail Price £47.10.0.



**20 WATT "JUNIOR" AMPLIFIER**  
Undistorted output of 20 watts. Transformer tapped at 0, 8 and 15 ohms. Flat from 50-10,000 cycles  $\pm$  1 db. Controls consist of Mic. and Gram. Feeders and Tone. Finished in Light Grey Stove Enamel and Chromium. Retail Price £27.10.0.

WODEN TRANSFORMER COMPANY LIMITED

MOXLEY ROAD, BILSTON, STAFFS.

TELEPHONE BILSTON 41959

## THE ROMAC MODEL 126 "Personal" RECEIVER

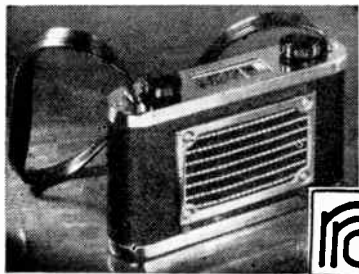

The Romac Personal Receiver is an entirely new departure in portable radio. The shoulder strap method of carrying has ingeniously been used to provide an "invisible" aerial. This convenient feature is exclusive to Romac Models.

Price £17 3s. 8d. Plus £3 16s. 4d. Purchase Tax.  
Complete with 1 H.T. and 2 L.T. Batteries.

Home and Export Enquiries should be directed to  
**ROMAC RADIO CORPN. LTD.**  
THE HYDE · HENDON · LONDON, N.W.9.

Tel. No.: COLindale 5401 (Three lines).

**... DEPENDABILITY**  
*is Essential*

Reception conditions range from excellent to very poor; signal strength from strong to very weak, and to cope successfully with all such conditions, you need a pair of highly sensitive and dependable headphones.

If you want maximum reception results you should insist that your local dealer supplies you with a pair of the rightly famous S. G. BROWN Type 'F' headphones. Sea, land and air W/T operators, servicemen, experimenters and radio amateurs all vouch for their dependability.

**TYPE 'F' (Featherweight)**  
Price **25/-** per pair.

YOUR LOCAL DEALER CAN SUPPLY.

Type 'F'

Descriptive Brochure "W.W." gives details of full range. Prices from 25/- up to 105/- for Moving Coil Type 'K'. Brochure "W.W." sent on request.

Phone:  
ACOrn  
5021

**S.G. Brown, Ltd.**  
VICTORIA ROAD, NORTH ACTON, LONDON, W.3

**HIGH**  
**STABILITY RESISTORS**

**DUBILIER**  
CONDENSER CO. (1925) LTD.

## WHERE HIGH STABILITY IS ESSENTIAL

For operation in certain special conditions, a high degree of stability is the chief characteristic required of fixed resistors. For example, in television, electronic and instrument applications where maintenance of maximum stability is desired over long periods of continuous use, high stability in resistors must be the primary qualification. The particular process of manufacture to which Dubilier High Stability Resistors are subjected ensures this great stability of resistance value, coupled with a low temperature coefficient of resistance, a negligible voltage-coefficient and a low "noise level".

In all conditions where high stability is vital, a selection from this specially designed range of Dubilier High Stability Resistors type R should be made. Full technical details and prices will be sent upon receipt of your enquiry.

DUBILIER CONDENSER CO. (1925) LTD., DUCON WORKS, VICTORIA ROAD, NORTH ACTON, W.3  
 Phone : Acorn 2241. Grams : Hivoltcon, Phone, London. Cables : Hivoltcon, London. Marconi International Code.

D11

# Webb's RADIO

**Interested in really good reproduction ?**

**IF SO . . . . hear the new loudspeakers in our Demonstration room.**

## WHARFEDALE "CORNER" CABINET

Triangular cabinet construction in solid mahogany of pleasing finish. (Available in solid oak—any shade to order.) Uses separate speakers for bass and treble, with new cross-over system at 1,000 c/s. Very pleasing balance between bass and treble. All bass resonance above 50 c/s eliminated. Size of cabinet 25½" x 18½" deep x 44" high. PRICE £47.10.0.

## ACOUSTICAL "LABYRINTH S.L.15"

Solidly constructed cabinet of ingenious internal design giving equivalent of a five-foot, folded pipe, the anti-resonances of pipe being cancelled by cabinet acoustic resonance. Wide-response bass down to 35 c/s with good middle and top definition. Size 21" x 15" deep x 32" high. (Cabinet is in plain wood, WEBB'S can finish to your requirements.) PRICE £19.10.0.

## SOUND SALES "PHASE INVERTER SPEAKER"

Cabinet design gives 180° phase-inversion and general effects are better than results obtained with a 4-foot baffle. Uses Sound-Sales Dual-Suspension Unit that remains centralized during a parallel excursion of ⅜" in the magnetic field. Very good diffusion of sound. Cabinet size 14" x 14" x 29" high. PRICE £12.10.0.

WEBB'S are world known as Short-Wave Specialists—in addition we have for years joined in the quest for that elusive quality—really high-fidelity reproduction. The specialised speakers shown above are all good—we have our own ideas of relative merit but you may not agree—that last elusive "touch" is largely a matter of personal preference (or aural idiosyncrasy!).

**. . . . hear them playing from:  
WILKINS & WRIGHT MOVING COIL PICK-UP**

Lexington Moving Coil Pick-up.  
Connoisseur Moving Iron Pick-up.  
Sound Sales Radio Feeder and Amplifier.  
Webb's "Quality" Amplifier.  
Acoustical "QA/12/P" Amplifier, etc.

**. . . . We are also stockists for Broadcast Receivers and Televisors by MURPHY, BUSH, COSSOR, etc.**

Write, phone or call

**14 SOHO ST., OXFORD ST., LONDON, W.1**

Phone: GERrard 2039. Shop hours: 9 a.m.—5.30 p.m. Sats. 9 a.m.—1 p.m.



## GOOD NEWS

for the Deafened!

# RAYTHEON

## Hearing-Aid Valves

Now Available in Quantity

YES—good news for all who use hearing-aids, and for all who manufacture or sell them. Raytheon valves . . . especially designed for hearing-aids, and noted the world over for their sturdy long life and rugged construction . . . are available for immediate shipment.

These are the world's most widely-used valves for hearing-aids. They give maximum performance for minimum battery drain. They are proven favorites with engineers, manufacturers and users alike.

Ask for complete information. Address your inquiry to Submarine Signal Company (London) Ltd., Artillery House, Artillery Row, London S.W.1, England or to:

**RAYTHEON MANUFACTURING COMPANY**

International Division,

60 East 42nd Street, New York 17, N. Y., U. S. A.

**RAYTHEON**

*Excellence in Electronics*

# from WHISPERING to SHOUTING . . . .

## The R.S. TYPE 12 ABLY AND FAITHFULLY REPRODUCES

. . . what do you care whether he whispers with nervousness, or shouts with excitement into your Microphone, when you know that your R.S. Amplifier Type 12 will ably and faithfully 'put over' even the squeak of the mouse or the trumpet of the elephant, without loss of timbre or intonation. No more fearful moments for you with 'mike-unconscious' people or music which will 'blare' . . . the R.S. Type 12 takes care of all that. This amplifier is only a part of the R.S. completely new series of advanced Sound Equipment which you should know about . . . write to-day for full information.



**MICROPHONES RADIO**      **RADIOGRAMS LOUDSPEAKERS**  
**AMPLIFIERS**  
**PORTABLE EQUIPMENT**

R.S. Amplifiers Ltd., Reynolds Road, Acton Lane, London, W.4.  
Telephone: CHISWICK 1011-3

# Taylor made - to fit your needs

The **UNIVERSAL TAYLORMETER**

Model 70A

**50 Ranges. Only Two Terminals. Steel Case.**



**Sensitivity**

**1000 ohms per volt.**

**BUZZER CONTINUITY TEST**

**Meter**

**Overload Protection**

LIST PRICE

**£10 10 0**

**2 mV to 1000 V** Volts

**20 mV to 1000 V** Volts

**20  $\mu$ A to 5 Amps** Amps

**20  $\mu$ A to 5 Amps** Amps

**D.C. + A.C.**

**Resistance**

**1 ohm to 1 Megohm or 10 Megohms with external battery.**

**Decibels**

**- 34 to + 55 or + 69 with external adaptor.**

*Immediate Delivery*

*Leaflet sent on Request.*

This new Universal Taylormeter is a robust instrument of great scope and high accuracy. Accuracy : .2% f. s. on D.C. ranges and 4% f. s. on A.C. From your usual supplier, or direct from the manufacturer.

**HIRE PURCHASE TERMS AVAILABLE.**

# TAYLOR

TAYLOR ELECTRICAL INSTRUMENTS LTD., 419-424 MONTROSE AVENUE, SLOUGH, BUCKS.  
Grams. and Cables : " Taylins " Slough. Telephone : SLOUGH 21381 (4 lines)

# MARCONI Mastery of Measurement

is the outcome of unique experience in the design of Communications Test Gear

FOR IMMEDIATE DELIVERY

## UNIVERSAL WAVEMETER

TYPE TF 370F

*Brief Specification:*

**Frequency Range:** 100 kc/s - 20 Mc/s by means of Calibration Charts.

**Accuracy** - - - - 1 in 10<sup>3</sup>

*Full Specification supplied on request*

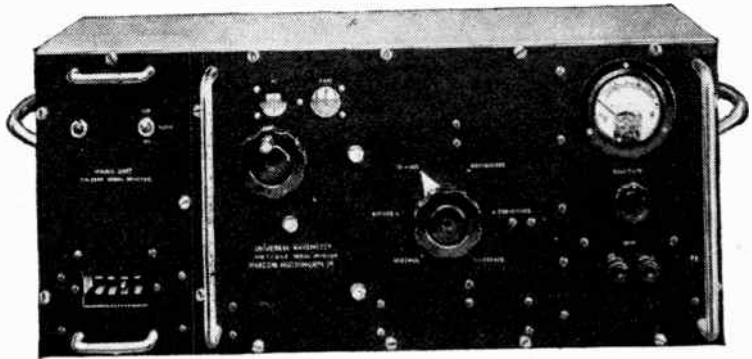

The Wavemeter is of the resonance type and consists of an adjustable tuned circuit shunted by a high impedance valve voltmeter, the input to the tuned circuit being taken via a two-stage amplifier of variable gain. The power supply may be taken either from A.C. mains or from external batteries. Workmanship is in the highest Marconi tradition.

# MARCONI INSTRUMENTS LTD

ST. ALBANS, HERTFORDSHIRE

Phone: St. Albans 6161/5

See us at  
**RADIOLYMPIA**  
STAND No. 226

Northern Office: 30 ALBION STREET, HULL. Hull 16144  
Southern Office: 109 EATON SQUARE, LONDON, S.W.1 Sloane 8615

Western Office: 10 PORTVIEW ROAD, AVONMOUTH, BRISTOL. Avonmouth 438



## FOR THE RADIO SERVICEMAN DEALER AND OWNER

The man who enrolls for an I.C.S. Radio Course learns radio thoroughly, completely, practically. When he earns his Diploma, he will KNOW radio. We are not content merely to teach the principles of radio, we want to show our students how to apply that training in practical, every-day radio service work. We train them to be successful!

Write to the I.C.S. Advisory Dept. stating your requirements. Our advice is free and places you under no obligation.

-----You may use this coupon-----

### INTERNATIONAL CORRESPONDENCE SCHOOLS Ltd.

DEPT. 38, INTERNATIONAL BUILDINGS, KINGSWAY, LONDON, W.C.2  
Please explain fully about your instruction in the subject marked X

Complete Radio Engineering      Radio Service Engineering  
Elementary Radio

And the following Radio Examinations:—

British Institution of Radio Engineers  
P.M.G. Certificates for Wireless Operators  
City and Guilds Telecommunications  
Wireless Operators and Wireless Mechanics, R.A.F.

Name ----- Age -----

Address -----



## WITH THIS SENSITIVE GRAMPIAN MIKE

The Grampian M.C.R. Type Microphone reproduces voices with that crystal clearness which gives full value to every word and accentuates the "personality" of the speaker. Those who still have "make do" microphones on their P.A. Systems should take advantage of this up-to-date, highly sensitive model which Grampian are now in a position to supply. The M.C.R. is mounted in a spring suspension frame with the Unit Assembly housed in cast metal case. In crinkled black and nickel standard finish. Write for details now.



Type M. C. R. Frequency Range 80-7,500 cycles. Sensitivity Minus 45 d.b. Impedance 20 ohms. Size 2½ ins. by 3½ ins. frame. 6 ins. square with Base Adaptor threaded ¼ ins. B.S.F. weight 3½ lbs. List £5 - 0 - 0

# GRAMPIAN LOUDSPEAKERS

GRAMPIAN REPRODUCERS LTD. Hanworth Trading Estate, Feltham, Middlesex  
Phone: Feltham 2657      Telegrams: Reamp, Feltham.

See 6011/16 G21



# See 'em off, boy!

Spire fixings replace nuts and washers. But they do far more than that. For any assembly problem there's probably a Spire solution that will be speedier and surer than any other. There are Spire nuts, clips and gadgets of all imaginable shapes. Over 350 of them and fresh ones being devised every day to meet somebody's special need. Shall we have a shot at a Spire fixing for you?

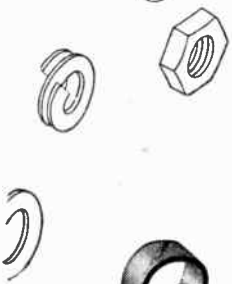
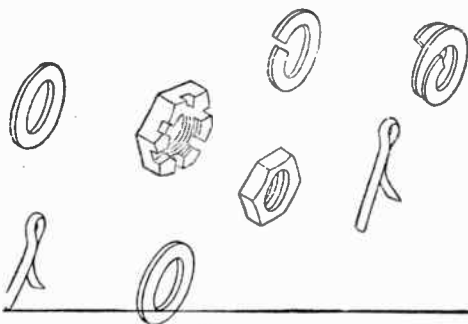
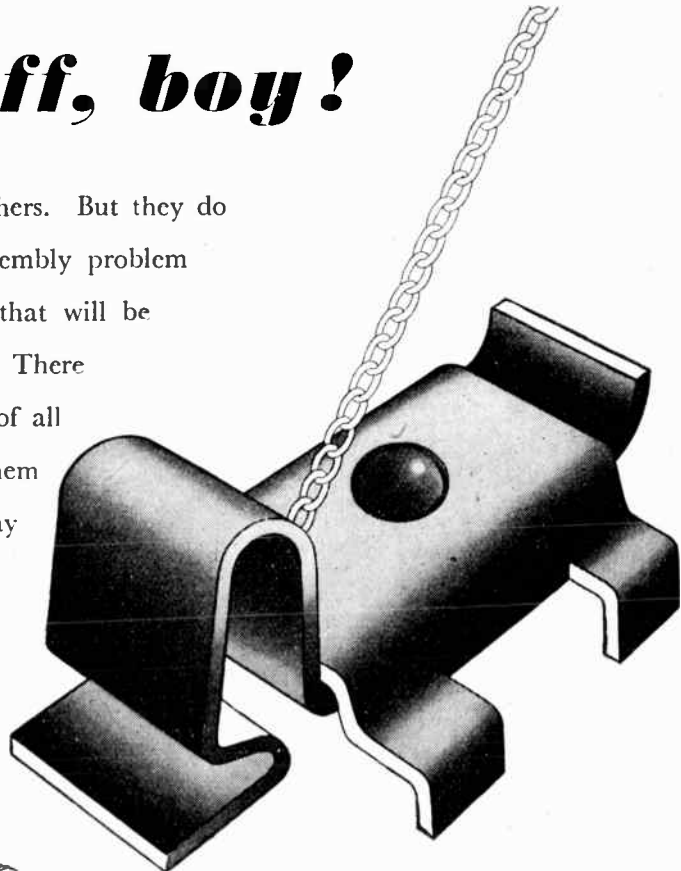

**THAT'S Fixed THAT!** The "doggie" looking Spire fixing illustrated above is actually made for a motor-car manufacturer to hold door trim in position. The Electrical Industry thinks highly of the Coil Former support — Spire Fix No. SO1652 — shown in the small picture. It provides the simplest and quickest assembly, the firmest support. The core-adjustment is a matter of a turn of the screw, and when made is securely held by the Spire impression on the bottom of the support. Available in various sizes. (To make its operation quite clear, we have shown this Spire fixed to a transparent plate.)

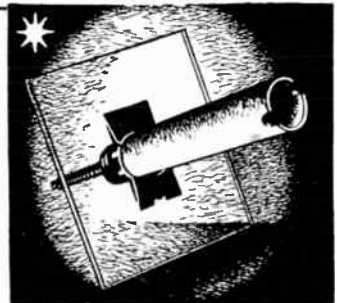

# Spire

Regd.

★ A BETTER way of fixing

SIMMONDS AEROCESSORIES LIMITED TREForest GLAMORGAN

# WESTINGHOUSE WESTALITE RECTIFIERS for all radio applications

H.T. SUPPLIES

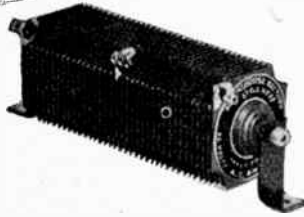

Units available for A.C., A.C./D.C. receivers, battery eliminators. Outputs up to 600 volts at 120 mA.

L.T. CHARGERS



These rectifiers enable chargers to be built capable of dealing with from 1-6 2-volt cells at currents up to 4 amps.

H.F. APPLICATIONS



"Westectors" operate at frequencies up to 1,500 kC and are suitable for use as detectors, as well as for the provision of A.V.C.

MEASURING INSTRUMENTS

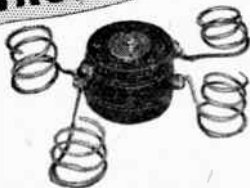

These small rectifiers enable a D.C. instrument movement to be adapted to read A.C. and yet retain all its advantages.

Write for descriptive literature to Dept. W.W.  
**WESTINGHOUSE BRAKE & SIGNAL CO., LTD.,**  
82, York Way, King's Cross, London, N.1

## M. R. SUPPLIES Ltd.

Some first-class new offers by this old-established house. Our discriminate buying is your guarantee of satisfaction. Immediate despatch. All prices nett.

**VENNER TIME SWITCHES** (Process Timers). All-brass cut-gear spring-driven movement automatically rewound every eight hours by mains. Pulsing in 4-second closed circuit every one (or two) minutes. Precision made for Admiralty use. In weather-proof die-cast housing, 9 by 6 by 4ins. The re-wind motor is for 100 v. D.C. but we supply (16 6 extra) suitable rectifier gear for any A.C. mains operation. A very limited supply of the Timers, brand new, at £5 each (desp. 2/-).

**RESISTANCE BOXES.** Decade type. Units 0/10 ohms. Tens 0/100 ohms, with additional 100 ohms. Fitted m/coll Galvo. Switching for Wheatstone Bridge and other tests. Very fine instruments in teak case, 18 by 7 1/2 by 6ins. Brand new, 65/- (desp. 2/6).

**SMALL ELECTRIC BLOWERS.** 12 v. AC/DC motor with filtered intake and outlet at one end. Outlet aperture 1 1/2 in. sq. Total length 5in., width 4 1/2 in. Powerful blast 29 6.

**MINIATURE GOVERNED MOTORS** with constant speed slip-ring device. 24 v. D.C. Speed 2,750 r.p.m. With rectifier quenching system. In metal case 3 1/2 in. sq., by 2in. (These precision instruments cost Govt. £19/10/- each). Brand new, 25/-.

**SMALL UNIVERSAL L.V. MOTORS,** 24 v. AC/DC (operating very well on 12 v. D.C.) Length 5in., width 2 1/2 in. Series w/d., ball bearing, 3 1/2 in. spindle. Ideal for cine, laboratory stirrers, fans, etc., exceptional offer, only 17/6 each.

**INTERFERENCE SUPPRESSORS,** for inserting between "source" and mains. Will take the load of com. motors up to 1/2 h.p. Completely suppress radio interference from any gear employing commutator motors, 21/-.

**DC/AC CONVERTERS,** newest Vibrator type, for radio and television, amplifiers, etc. Silent and utterly reliable. 200/240 v. D.C. to 200/240 v. A.C. 50 c., 200-watt £12 (desp. 3/-); 100-watt, £9 (desp. 2/-).

**NOTE:**—If for television we recommend the 75 cycle model, 200-watt, same price. **LOCAL VOL. CONTROL UNITS,** wire-wound 100-ohms potentiometer with separate on-off switch, in metal housing 3 1/2 by 2 by 3ins. These well-made units are ideal for vol. control of extension speakers, 6/6.

**H.V. CONDENSERS,** 1 1/2 mid. 4,000 v. wkg. Insulated terminals, 12/6.

**G.E.C. INDUSTRIAL LOUDSPEAKERS,** in metal drum 1 1/2 in. dia., with front and rear opening (for two-way diffusion). Fitted P.M. m/coll unit, with multi-transformer, handling 8-watts, 65/- (desp. 2/-).

**REFLECTED HORN SPEAKERS** (Reslo). With 10-watt P.M. m/coll Pressure Unit, 15-ohms imp. Flare 12in. long and 14in. dia. On swivel bracket with wheel bolts for clamping at any angle. Stormproof and highly efficient, £5/17/6 (desp. 5/-).

**STEEL TRIPODS** to suit these and all other P.A. Speakers, collapsing to about 5ft. and ext. to 12ft. Perfectly rigid in use, 55/- (desp. 3/6).

**PANEL METERS** (AC/DC) Good quality M/Iron, 3 1/2 in. proj. mtg. with back terminals. Following range:—Amps, 0/5, 0/10 and 0/25. Volts, 0/20 and 0/40. Any one, 29/6.

**HAND BEARING COMPASSES,** type 06A. Prismatic, alcohol floated. Dia. 3 1/2 in. Torch illuminated (battery not supplied). Overall length 8 1/2 in. In wooden transit case. Fine condition, as new, £3/17/8 (desp. 2/-).

**S.T.C. TOGGLE PRESSES** (We are London Stockists). Double-acting, space-saving, precise tool suitable for pressing operations in many trades. Senior, pressure 1 1/2 tons, £31/10/-; Minor, pressure 0.75 ton, £24/15/- ex this address.

We hold large stocks of Transformers, Rheostats, Rectifiers, Measuring Instruments, Electric Pumps, Extractor Fans, Amplifiers, etc. Please include sufficient for packing and despatch.

**M. R. SUPPLIES LTD., 68, New Oxford Street, London, W.C.1**

Telephone: MUSeum 2958



**MAXIMUM EFFICIENCY MINIMUM SIZE**  
(3 1/2" x 2" x 2")

A 3-waveband coil assembly, employing six separate high "Q" coils, wound on ultra low loss formers, giving a remarkably high performance. The "KEW" superbolt coil pack is easily fitted to any standard or midget circuit. One-hole fixing and only three connections to make, no alterations to the receiver chassis being necessary. Adjustable cores and trimmers are conveniently accessible. Wavebands available: Type HO. Short, medium and long. Type EX. Medium and two shorts. Type TB. Long medium and shipping. Trade Enquiries invited

RETAIL  
**33/-**  
PRICE

Sole Manufacturers:-  
**MORGAN, OSBORNE & CO. LTD**  
Warlingham SURREY Upper Warlingham  
2560

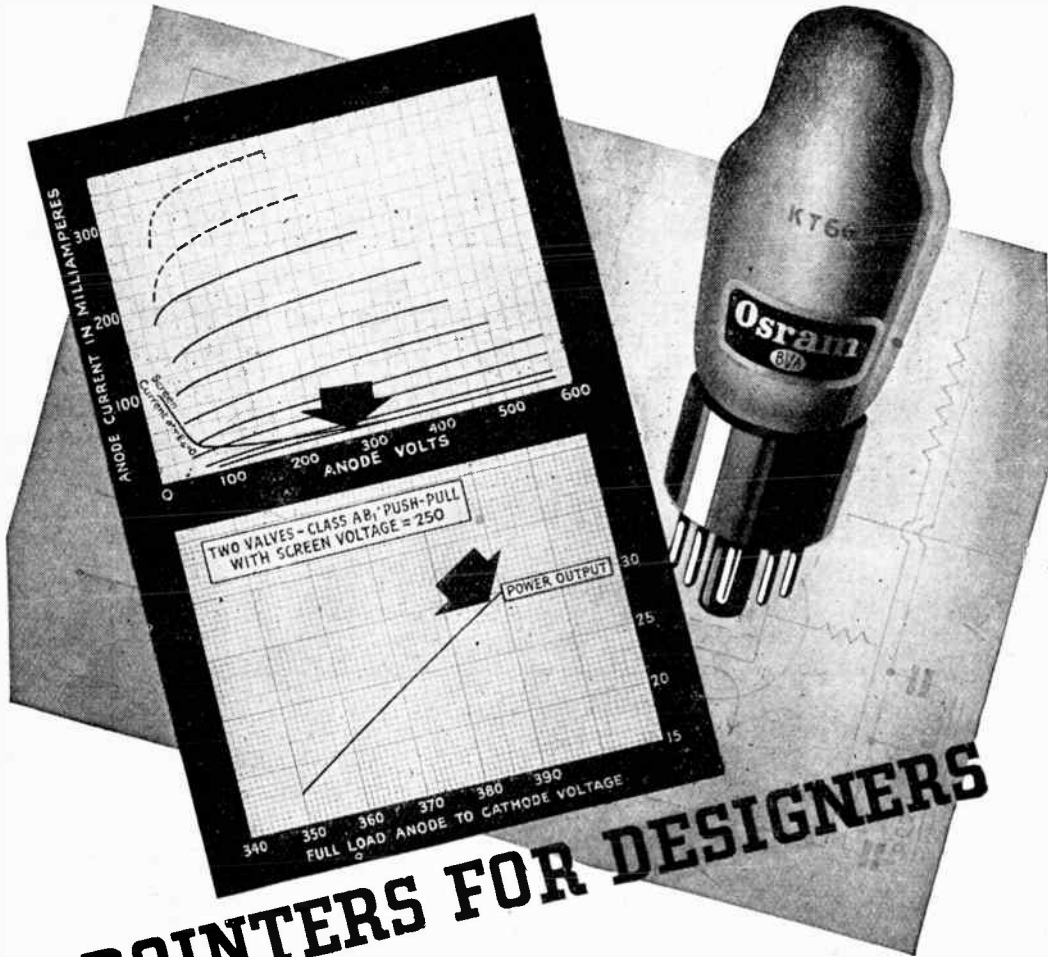

# POINTERS FOR DESIGNERS

## THE KT66

A beam power tetrode for use principally in the output stage of an audio frequency amplifier, or as a low-power transmitter. Indirectly heated cathode 6.3v. 1.27 amps.

- ▶ "Aligned" control and screen grids resulting in a low screen current and improved efficiency.
- ▶ Up to 35 watts in a push-pull Class AB1 stage, or 7.5 watts per valve Class A.
- ▶ Suitable for use in a parallel-push-pull circuit (4 valves) for outputs up to 60 watts, requiring an input only of 1.75 volts peak.
- ▶ Very suitable for use as Triodes in a push-pull circuit, for high quality power amplification up to 15 watts audio output, with less than 1% distortion.
- ▶ Suitable for use as an R.F. Transmitter for an output of up to 21 watts. R.F. at frequencies up to 10.5 megacycles per sec. at anode efficiency 66%.

A detailed technical data sheet is available on request.

**Osram**  
PHOTO CELLS

**G.E.C.**  
CATHODE RAY TUBES

**Osram**  
VALVES

Advt. of The General Electric Co. Ltd., Magnet House, Kingsway, London, W.C.2.

# IT CAN SEEM LIKE CHILD'S PLAY



With a good testing instrument you can make fault finding on a defective wireless set seem like child's play. The Weston Model E772 Analyser will meet all your normal radio servicing requirements and will save you time, trouble and money. This instrument is simple to use and is both accurate and reliable. It has a wide range coverage with a sensitivity of 20,000 ohms per volt on all D.C. ranges. Please write for full details.

SYSTEMATIC  
SERVICING  
STARTS WITH A  
**WESTON**

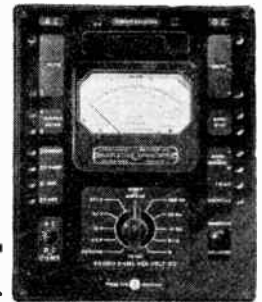

SANGAMO WESTON LTD., ENFIELD, MIDDX.

Telephone: Enfield 3434 & 1242.



## UNIVERSAL COUPLING

CONSTANT VELOCITY ★  
TROPICAL BAKELITE INSULATION  
FINEST QUALITY MATERIAL

★ Compensates for both axial and angular misalignment and provides accurate "ganging."

PRICE 2/9 RETAIL



**JACKSON**  
BROS (LONDON) LIMITED  
KINGSWAY · WADDON · SURREY  
TELEPHONE: CROYDON 2754-5 TELEGRAMS: WALFILCO, PHONE, LONDON



★  
FOR

**MEN ONLY** *interested in*

Seamless, one-piece, metal bellows... formed in one continuous operation by a process unique in this country, with a uniformity of wall-thickness unobtainable by any other method... No annealing, no spinning, no localised strain or thinning; none of the limitations of metallic diaphragms.

These bellows, though no thicker than paper—the walls range from 4/1000" to 7/1000"—are tough, resilient, and combine the characteristics of a coiled compression spring, a packless gland, and a non-ferrous hermetically sealed container. Every bellows is pretested during forming and has a high degree of uniformity of life, performance and reliability in operation. Available in root diameters of 1" to 3", outside diameters 1 1/2" to 4 1/2".

Write for the Hydroflex Brochure Y



- Refrigeration
- Temperature Control
- Air compressors
- Water pumps
- Paper machines
- Gland seals
- Thermostatic & pressure operated appliances

## Drayton Hydroflex METAL BELLOWS

Drayton Regulator & Instrument Co. Ltd., West Drayton, Mdx.

# METALLISED CERAMICS

There's a size for every job  
in the S.P. range of  
metallised  
bushes

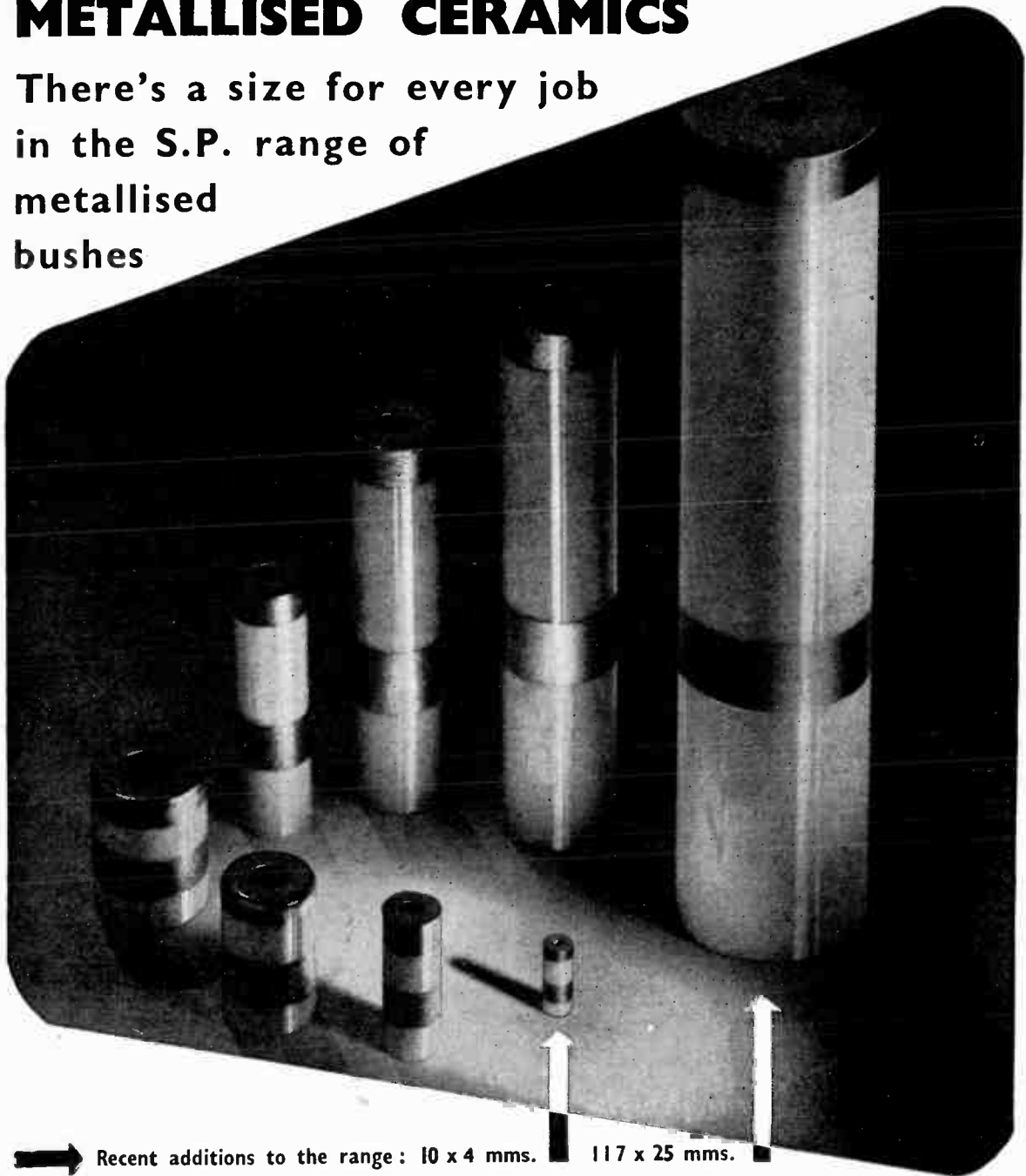

➔ Recent additions to the range : 10 x 4 mms. 117 x 25 mms.

For full information and prices please write to :

## STEATITE & PORCELAIN PRODUCTS LTD.

STOURPORT-ON-SEVERN, WORCS. Telephone: Stourport III. Telegrams: Steatoin, Stourport.



S.P.44

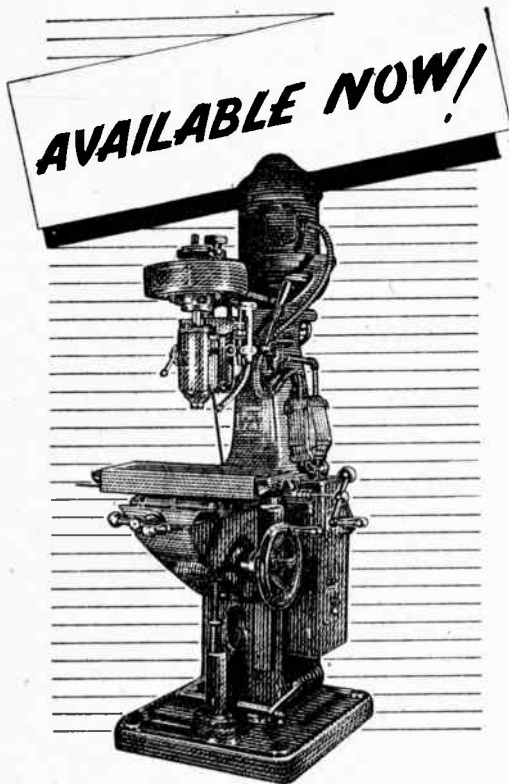

# machine tools

## OF NUMEROUS TYPES

Government Surplus machine tools available NOW at attractive prices. YOUR opportunity to get better equipment and increase production.

DISPOSAL CENTRES, where records of all machines available may be inspected, are open to the public for enquiries from 10 a.m. to 4 p.m. Monday to Friday inclusive:—

**BIRMINGHAM** C.M.L. Buildings, Great Charles Street.

**BRISTOL** 8/9 Elmdale Road, Bristol 8.

**CARDIFF** Imperial Buildings, Mount Stuart Square.

**GLASGOW** 21 Glassford Street.

**LEEDS** 10 Bank Street, off Boar Lane.

**LONDON** Room 0088, Ground Floor, Thames House North, Millbank, S.W.1.

**MANCHESTER** Britannia House, Fountain Street.

ISSUED BY THE MINISTRY OF SUPPLY

K

## H. T. UNITS . METERS . TRANSFORMERS ETC.

### Another Selection of Fine Bargains

No. 1 M.K. II H.T. UNITS. Rotary Transformer with all smoothing and filters, 11 volts input, 230 v. 30 m/A output, in metal case  $4\frac{1}{2} \times 7 \times 10\frac{1}{2}$ ". Brand new and unused. £1 10s., plus carr. 5/-.

TRIPLETT Model 644H Pocket AC/DC Volt-ohm-Milliammeter. 0-5,000 volts AC/DC at 1,000 ohms per volt. 0-500 Milliamperes at 100 millivolts. 0-300 ohm and 0-250,000 ohms with internal  $1\frac{1}{2}$  v. battery. Complete with test prods and attractive black leather carrying case with strap handle. Brand new £9 9s.

METERS, 0-500 Micro-Amperes Moving Coil, 2" dia. flush mounting, 21" dia. overall. Res. 500 ohm. Brand new £2.

METERS, 0-500 Micro-Amperes Moving Coil, 2" dia. flush mounting, 21" dia. overall. Scale reads 0-15 and 0-600 v. For use with external resistors. Made by Simpson Electrical Co., U.S.A. Brand new £2 10s.

METERS, 0-5 m.A. Moving Coil, 2" dia. projecting mounting. Res. 15 ohm. Originally made for tuning meters. Brand new 17/6.

DIALS, 3 1/2" dia. Black and Chrome. Engraved 180-0° with 1 1/2" dia. fluted knob for 1/2" spindles. Brand new 4/6.

INTERVALVE Transformers (3 windings). Primaries 300 ohm and 7.5 ohm. Secondary 3,500 ohm D.C. resistance. Useful for transceivers. Brand new. Core size, 1" x 2" x 3 1/2". 3/6.

MICROPHONE Transformer, No. 2, D.C. resistance primary, 1 1/2 ohm. Secondary, 60 ohm. 2/6.

TELEPHONE Transformer No. 3, D.C. resistance. Primary, 7 1/2 ohm. Sec., 1,750 ohm., 2/6. Ditto, MK IV. D.C. Resistance: Pri., 6 ohm. Sec., 150 ohm., 2/6. Size of 3 above Transformers: 1 1/2" x 2 1/2" x 2 1/2".

HEADPHONES, 100 ohm Magnetic. (See above for suitable transformer.) Brand new, 10/6. Brown's type A adjustable, 19/6.

MORSE KEYS. No. 2 MKII 8 amp. rating. 1/2 sq. x 4 1/2 Beam silver contacts. Black moulded knob mounted on 1 1/2 x 3 1/2" moulded base. Brand new, 3/6. Miniature Morse Keys (see our previous advertisement) now reduced to 9d.

P.A. or Ant. Coupling Coils. Constantly variable tapping 0-48 turns by means of roller bearing on turns as whole. Former is rotated within the end frames. All ceramic construction and dimensions of coil are 48 turns of 16 SWG tinned copper on ceramic ribbed former 2 1/2" dia. x 7 1/2" spacing between turns 1/4". A really fine job. Brand new, 30/-.

**RADIOMART**  
C.S.N.I. (SHAM) LTD.

SEND FOR LATEST LIST 'W.W.'

Telephone: Midland 3254

48 HOLLOWAY HEAD, BIRMINGHAM, 1

## THE ROBERTS PORTABLE

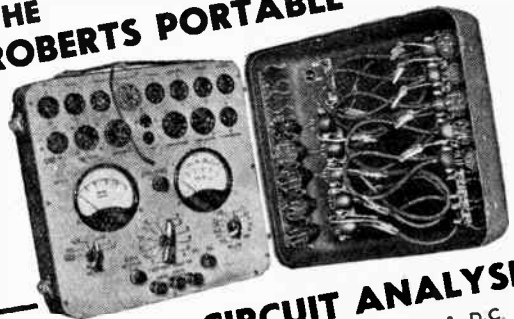

## VALVE & CIRCUIT ANALYSER

- Tests Valves for Current, any Electrode, A/C & D.C. 11 Ranges 0—2.5 Amps.
- Tests Electrodes for Volts, any Electrode, A/C & D.C. 17 Ranges 0—1000 Volts.
- Checks Resistance any Electrode. Valve to Valve or Chassis 3 Ranges 0—1 meg.
- Can be used as Universal Meter 2000 Ohms. per volt. Invaluable for testing A/C—D.C. Radio Receivers.

**NO NEED TO REMOVE CHASSIS FROM CABINET FOR TESTING**

Best materials and workmanship. Guaranteed for 12 months.  
Dimens.: 12 x 12 x 6 ins., weight 11 lbs. Manufactured by:—  
**LONDON SOUND LABORATORIES LTD.,**  
40, South Molton Lane, Bond Street, London, W.1.

Sole Distributors:

**Kerry's**  
GREAT BRITAIN

WARTON RD., STRATFORD,  
LONDON — E.15  
And all Branches

# PREMIER RADIO COMPANY

MORRIS & CO. (RADIO) LTD.

ALL POST ORDERS to 167 LOWER CLAPTON RD., LONDON, E.5. 'Phone: Amherst 4723  
ALL CALLERS to 169 FLEET STREET, LONDON, E.C.4. 'Phone: Central 2833

Terms of Business: Cash with order or C.O.D. over £1. Send 2½d. stamp for list

Due to improving supplies all the following goods can be supplied to the trade, please specify actual items and quantities required when requesting quotation.

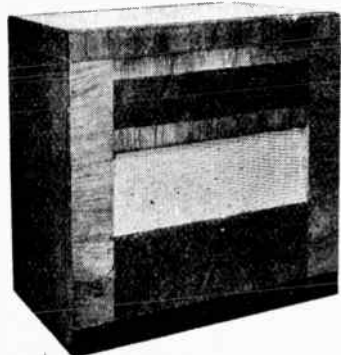

**RADIOGRAM CABINETS.** Dignified appearance and good workmanship. Size: 31 1/2 in. high, 18 1/2 deep, 33 wide. French polished, veneered walnut. Price £28. Also available complete with electric motor with auto stop, £30 3s. 6d., or with electric motor, auto stop and magnetic pick-up, £32 13s. 6d.  
Ditto with Rothermel Crystal Pick-up, £35 2s. 1d., or with 8 record-mixer changer, £45 7s. 6d.

**METERS.** A huge purchase of military surplus meters allows us to offer the following bargains. All meters are by the best makers and are contained in bakelite cases. Prices are about one-quarter of original cost.

Range	Diagm.	Res.	Fitting	Type	Price
300 v.	3 1/4"	15K	Flush	M.I. A.C.	7/6
500 mA.	3"	—	Proj.	M.C. D.C.	12/6
250/250 mic/A.	2"	100	Flush	M.C. D.C.	7/6
40 v.	2"	8K	Flush	M.C. D.C.	7/6
2 1/2 a.	2 1/2"	—	Flush	Thermo. H.F.	7/6
4 a.	2 1/2"	—	Proj.	H.W. H.F.	3/6
3 KV.	3 1/4"	1 meg.	Flush	M.C. D.C.	20/-
20 a.	2"	—	Flush	M.C. D.C.	7/6
40 a.	2"	—	Flush	M.C. D.C.	7/6
25 a.	3"	—	Flush	M.C. D.C.	7/6
25 a.	3 1/2"	—	Proj.	M.C. D.C.	7/6
25 a.	3 1/2"	—	Flush	M.I. D.C.	7/6

**FERRANTI 1 MILLIAMPER METERS.** 3 1/2 in. external diameter, flush mounting, with self-contained Westinghouse bridge rectifier. Scale marked 0-10 volts with fifty divisions, fitted in well-made wooden box 6 x 5 x 5 in. 35/-

**PARMEKO SUPER QUALITY DRIVER TRANSFORMERS.** 6-1 ratio. C.T. primary and split secondary. Weight, 3 lb., handle 15 ma primary current, 15/-

**D/C TO A/C CONVERTERS.** Input, 18/24 v. D/C. Output, 230 v. 50 cycles 100 watts, £5. Similar model, output 200 watts, in silence cabinet, £10.

**POWER PACKS.** Input, 210-240 v. 50 cycles. Output 250 v. 80 m/a, 6.3 v. 3-5 a. Fully smoothed. Contained in substantial screening box, with full wave valve, £2 10s.

**MAINS TRANSFORMERS.** All 230 v. 50 cycles input  
Type 2.—40 v. 2 amps. (Excellent for rewinding.) 15/-  
Type 4.—865-0-865, tapped at 760 and 690 v., 500 milliamps with L.T. trans. 4 v. 3 a. twice. £3 15s.  
Type 36.—1750-0-1750 v. 330 m/a, £3  
Type 8.—6 v. 10 a. and 4 v. 10 a. 15/-  
Type 3.—500-0-500 v. 150 m/a 4 v. 2 1/2 a., 4 v. 1a. 4 v. 5 a. 35/-  
Type 5.—450-0-450 v. tapped at 300 v. 150 m/a, 4 v. 3-5 a. 4 v. 3-5 a. 30/-  
Type 35.—350-0-350 v. 250 m/a 4 v. 3-5 a. 6.3 v. 5-7 a. 6.3 v. 1-2 a., 35/-

**OSCILLOGRAPH POWER UNITS.**—Input, 230 volts  
Consist of kit of parts incorporating mains transformer, metal rectifiers, voltage doubling condenser.  
Type 406.—Output, 1000 v. and 6.3 v. 20/-  
Type 407.—Output, 2000 v. and 4 v. 25/-

**P.M. HORN LOUDSPEAKERS.** Handle 8 watts, weather proof horn mouth, 33 x 13 1/2 in. deep, sealed but unused, 3 ohm V.C. £3 10s.  
Similar model, but with 15 ohm 10 watt unit, £4 10s.

**RECTIFIERS.** 2 v. heater, half wave, 2,000 volts, 12.6 V. R.A.F., 1185 RECEIVERS. Brand new, complete £17 10s.  
A/C POWER PACK (230 v. Input) for above, £2 10s.

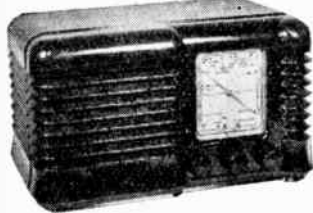

**MIDGET RADIO KIT.** Build your own midget radio. A complete set of parts, including valves, loudspeaker and instructions. In fact, everything except cabinet necessary to build 4-valve Medium and Long Wave T.R.F. radio operating on 200-250 v. mains, A/C or D/C. Valve line-up, 6K7, 6J7, 25A6, 25Y5. Wavelengths covered 200-557 and 700-2,000. Size 10 x 6 x 6 in. Completely drilled chassis. Price, including tax, £7 7s. 6d.  
**SUPERHET MIDGET RADIO KIT.** A complete kit of parts for 6-valve superhet. Covers 16-50 and 200-557 metres, A/C/D/C 200-250 v. 6K8, 6K7, 6Q7, 25A6, 25Y5. Size, 10 x 6 x 6 in. Completely drilled chassis. Price including tax, £8 5s.

An attractive brown bakelite cabinet as illustrated above can be supplied for either kit at a cost of 25/-  
**SHORT-WAVE CONDENSERS.** High-grade ceramic insulation, super midget type, single gangs available in 10, 20, 50, 75 (75 pf. has double spindle for ganging) Price 2/6.

**2-GANG.** in 4.8, 9.6, 27.1, 50, 75 pf. Price 5/-.  
**2-GANG.** Full size, 160 pf. Price 5/-.

**AIR-DIELECTRIC CERAMIC TRIMMERS.** 25, 50, 75 pf. Price 1/-

**WAVE CHANGE SWITCHES.** Available with any of following wafers: 2-pole 3-way, 3-pole 3-way, 4-pole 2-way, 2-pole 4-way, 1-pole 4-way, with shorting bar; 2-pole 5-way: 1-gang, 4/-; 2-gang, 5/6; 3-gang, 7/-; TYPE 100.—A rotary transformer with completely smoothed output, contained in a soundproof metal screening box. Input 6 v. D/C; output 220 v. 50 m/a D/C, £3 10s.

**TYPE 113.** A rotary transformer input 6 or 12 volts With 12 v. input, output is 600 v. 250 m/a. with 6 v. input, output is 300 v. 200 m/a, 30/-

**TYPE 114.** Input 12 v. D/C, output 230 v. 50 cycles A/C 30 w. 45/-

**TYPE NO. 111.** A rotary transformer designed for an input of 6 or 12 volts D/C. With 6 volts input the output is 200 v. 50 m/a. With 12 v. input the output is 480 v. 40 m/a. These ratings are continuous. This unit may be run for up to 3 hours with 12 v. input when 80 m/a may be drawn at 400 v. 20/-

**SPECIAL OFFER. P.M. SPEAKERS AT HALF USUAL PRICES.** 4in., 17/6; 5in., 15/-; 6in., 17/6; 8in., 20/- Output trans. for same, 6/-

**500 MICROAMP METERS.** Moving coil, 2 in. diameter flush mounting. Available by the following manufacturers: Met-Vick 500 ohms; Ferranti 79 ohms. Weston 118 ohms. Either type 21/-

Special quotations for quantities. The following accessories are available to convert the above meter into a multimeter. Set five multipliers plus, minus 2½ per cent. to read 10 v., 50 v. 100 v., 250 v., 1,000 v., 7/6 the set. Bridge type meter rectifier, 10/- Separate 0-10,000 ohms scale chart, 1,000 ohms. Present resistance, and fixed resistor to convert meter into ohm-meter with 1½ v. battery, 3/6

**VIBRATOR POWER PACKS.** Type 301. Input 12 v. D.C., output 230 v. 50 cycles 30 watts. In steel case with complete noise suppression. Price 45/-

**TYPE 302.**—Input 6 volts, output 150 v. 25 m/a. In steel cases, with complete smoothing, 40/-  
**TYPE 303.** Input 12 volts, output 300 v. 100 m/a. In steel case, with noise suppression, no smoothing. Price 42/6

**TYPE 304.** 12 v. input, output 150 v. 40 m/a. In steel case, combined with single valve amplifier (no valve supplied). Price 35/-

**METAL RECTIFIERS.**

Output Volts	Current	Type	Price
600	40 m/a.	H.W.	5/-
280	40 m/a.	H.W. or V.D.	5/-
325	65 m/a.	H.W. or V.D.	5/-
38	75 m/a.	Bridge	1/6
18	1 amp.	Bridge	12/6
48	1 1/2 amp.	Bridge	25/-
18	5 amp.	Bridge	30/-
18	8 amp.	Bridge	37/6
4	1 amp.	H.W.	5/-

**VITAVOX SPEAKERS.**  
A few only Type K12/20 at £8.



**PREMIER PEDESTAL PLAYING DESK.** A well made mahogany finished pedestal cabinet, containing a quality electric gramophone motor and pick-up in upper compartment, and record space in lower. Price £18 18s.

**ALUMINIUM CHASSIS.** Substantially made of bright aluminium, with four sides.

7 x 8 1/2 in.	4/6	9 1/4 x 4 1/2 in.	5/6
10 x 8 x 2 1/2 in.	7/-	12 x 9 x 2 1/2 in.	7/9
20 x 8 x 2 1/2 in.	8/3	16 x 8 x 2 1/2 in.	8/6
20 x 8 x 2 1/2 in.	10/6	22 x 10 x 2 1/2 in.	13/6

**MANSBRIDGE TYPE CONDENSERS.** Huge purchase of military surplus paper condensers. Super quality oil filled.

Capacity	Working Voltage	Size	Price Per Each Doz.
2mf.	1,000	4 1/2 x 1 1/2	2/6
2mf.	600	3 1/2 x 1 1/2	1/9

**TYPE 103 ROTARY TRANSFORMER.** Normal rating is 19 v. D/C input. Output, 300 volts 30 m/a and 6.5 volts 3 a. D/C. By applying between 200 and 250 volt D/C to the H.T. output side, the two low-tension windings may be used to charge accumulators. The 19-volt side will charge a 6-volt accumulator at 2-3 amps, the 6.5 side a 2-volt accumulator at 1-2 a. With a 12-volt input to the 19-volt side, 180 v. at 30 m/a and 4 v. at 3 a. may be obtained. With a 6-volt input to the 6.5 side, 160 v. at 30 m/a may be obtained. By extending the spindle which is flush with the frame and applying 200 to 250 v. D/C mains to the 300 v. side, the unit becomes a powerful high-speed electric motor, suitable for small drill machines, etc. Similarly, it may be used with 6 or 12 v. input to the 6.5 v. or 19 v. side. It employs a powerful ring magnet and is of substantial construction, costing originally over £5. A fortunate purchase enables us to offer these fine units at 10/-

**VALVES.** Hard-to-get types, metal, 6K7, 6L6, 6H6, 5Z4, 6J7, 6BR7, 6L7, 12SJ7, 6C5, 6BK7.

**MAGNETIC PICK-UP HEADS.** Fit gramophone tone arm, 17/6.

**ROTARY TRANSFORMERS.** May be used as 230 v. A/C motors.

**Type 605.**—5,000 revs. 1/40 h.p., 15/-  
**Type 606.** 5,000 revs., 1/20 h.p., 30/-

Philips Amplifiers. Military surplus, soiled condition. Periscope working order, 6- or 12-volt battery operated, speech only, output 8 watts, push/pull output incorporated 220 v. 80 m/a vibrator pack, 35/-

3 Valves for same (OZ4 and two EL35), 35/- High output carbon hand mike for same, 5/-

**2-VALVE SHORT-WAVE BATTERY KIT.** A complete kit of parts for a 2-valve receiver, covering 15-800 metres including valves, coils, drilled chassis, H.T. and L.T. dry batteries to last approximately 6 to 12 months. A pair of double headphones and full instructions. Price £3 10s. An extra coil can be supplied covering 600-1,900 metres, at 4/-

**SUPERHET TUNING PACKS.** Completely wired and aligned, 13-40, 140-120, 190-570 metres. R.F. stage 465 kc.; 9 connections only. Complete with 3-gang condenser, calibrated, engraved Perspex dial, and 8 M drive. Litz wound polystyrene insulation permeability tuned I.F.'s, 7 kc bandwidth. Price complete £3/17/6.

**ENAMELLED COPPER WIRE** from 16 to 22 gauge, available in one pound reels or bulk. Write for quotations.

# Wharfedale

## LOUDSPEAKER SEPARATOR

A new device for dividing the Bass and Treble between two Loudspeakers at low impedance, thus eliminating modulation distortion imposed on the treble by large coil movement in the bass.

It is recommended for use with two speakers of equal sensitivity and similar size. Not suitable for Horn type speakers.

The Separator results in greater efficiency, stronger top note response and improved clarity of reproduction and extends the range and intelligibility of P.A. speakers.

The impedance of two 3 ohm speakers connected to the Unit becomes 6 ohms, but when two 15 ohm Speakers are used the total impedance remains 15 ohms.

*Made and Guaranteed by*

## WHARFEDALE WIRELESS WORKS

**BRADFORD ROAD, IDLE, BRADFORD**

Telephone : IDLE 461.

Telegrams : Wharfdel, Idle, Bradford



Size : 8" x 5" x 4"

*Cross-over at 1,000 c.p.s.  
Maximum Input 30 watts  
at 3 to 15 ohms impedance.*

**PRICE 75/-**

*Delivery 2/3 weeks.*

# Remember-



**RADIO  
STAMPINGS**

**RADIO  
CHASSIS**

**RADIO  
PRESSINGS**

FARM LANE, FULHAM S.W.6. TELEPHONE: FULHAM 5234

# DENCO

## TECHNICAL BULLETIN No. 1

**OBTAIN YOUR COPY, NOW, FROM OUR NEAREST APPROVED STOCKIST (or direct in case of difficulty)**

CONTAINS TWELVE LARGE PAGES ON :-

- (1) COMPLETE TECHNICAL DATA ON THE MAXI-Q RANGE OF COILS.
- (2) DETAILED DESIGNS AND CIRCUITS FOR HIGH PERFORMANCE SUPERHET, T.R.F., AND VHF CONVERTOR.
- (3) OTHER USEFUL INFORMATION ON THE APPLICATION OF MAXI-Q COILS. PRICE 3/-

It is our intention to publish, from time to time, similar bulletins on our other products.

You can now obtain good delivery of all DENCO components from our stockists.

**OLD ROAD, CLACTON-ON-SEA, ESSEX**



# **B.I.** *Callender's* Extensible Copper **EARTH ROD**

Strata of low resistivity are often deep below ground level, but whatever the depth, the simplest method of reaching them is to use B.I.Callender's Extensible Earth Rods. Made in 4 feet lengths from  $\frac{3}{8}$ " diameter corrosion resisting hard drawn Copper, fitted with hardened steel tips and driving caps and joined on site by phosphor bronze screws, these rods can be driven deep into undisturbed soil. Installation costs are low, no excavation being necessary. Deepest penetration is possible by the use of a light mechanical hammer; a 4 lb. hammer will drive the rods to moderate depths in any soil reasonably free from rock or stone. The rod head is sunk below ground level and there protected in a concrete housing, making regular inspection possible and minimising surface potential gradients. Write to-day for B.I.Callender's free publication No. 213Y, "Earthing."



**BRITISH INSULATED CALLENDER'S CABLES LIMITED**  
NORFOLK HOUSE, NORFOLK STREET, LONDON W.C.2

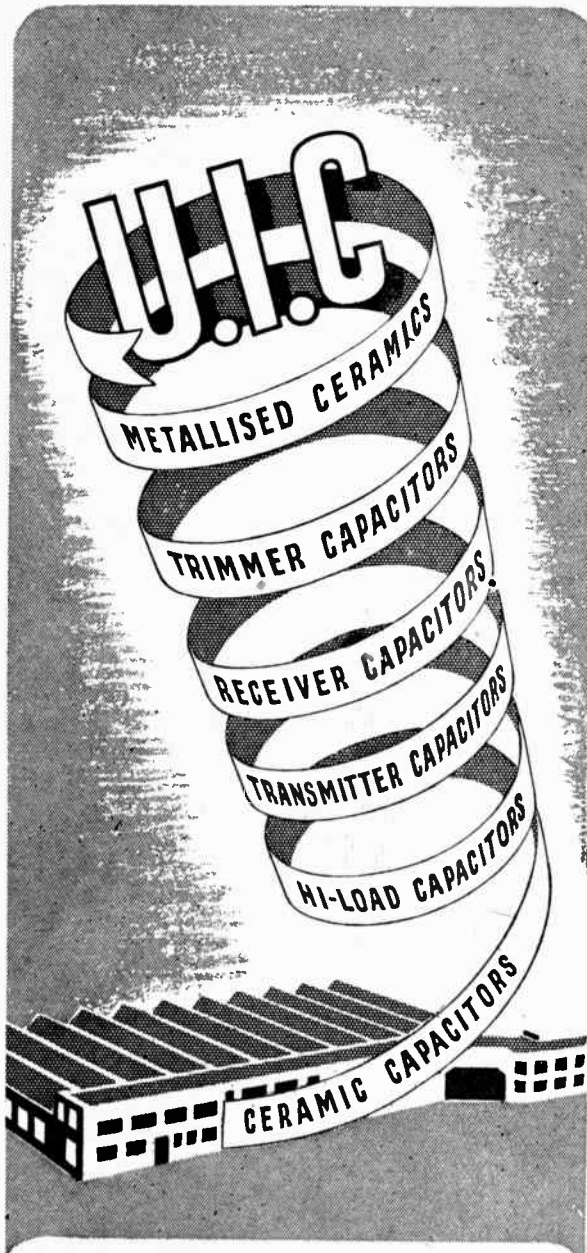

**UNITED INSULATOR CO. LTD.**

OAKCROFT RD., TOLWORTH, SURBITON, SURREY

Telephone: Elmbridge 5241

Telegrams: Calanel, Surbiton

Unsurpassed  
in  
Ceramics

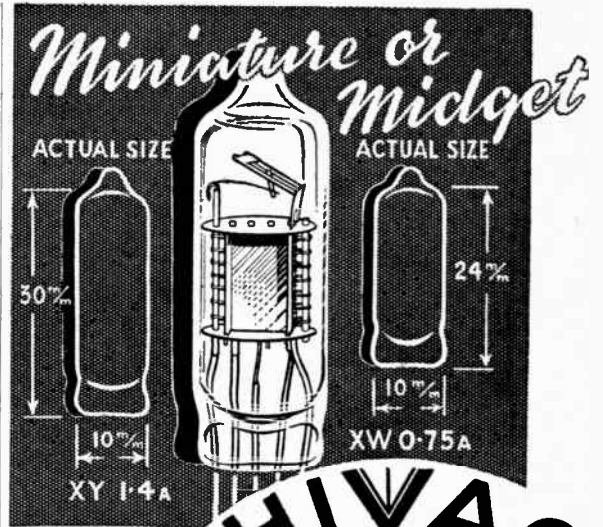

NEW TYPES FOR  
MIDGET RECEIVERS  
HEARING AIDS  
METEOROLOGICAL  
INSTRUMENTS  
ETC.

**HIVAC**  
THE SCIENTIFIC  
VALVE  
BRITISH MADE

**HIVAC LIMITED** Greenhill Crescent, Phone HARROW  
Harrow on the Hill, Middx. 0895



**THE COMPLETE SERVICE  
FOR SOUND RECORDING  
AND REPRODUCTION**

- ★ Mobile and Static Continuous Recording Outfits.
- ★ Recording Amplifiers.
- ★ Moving Coil and Crystal Microphones.
- ★ Sapphire Cutting and Reproducing Styli
- ★ Blank Recording Discs from 5in. to 17in. Single or Double sided.
- ★ Light-weight moving iron, permanent sapphire and "Lexington" moving coil pick-ups.
- ★ Label and Envelope Service.
- ★ A comprehensive range of accessories to meet every requirement of the sound recording engineer.
- ★★ And our latest development (of special interest to users of sapphire or delicate pick-ups)—The Simtrol.  
This is a controlled micro-movement easily fitted for use with any type of pick-up to eliminate the danger of damage to the record or pick-up. This is achieved by a vernier lowering action of the pick-up head to the record.

Write for comprehensive lists or call at Recorder House for demonstration.

**RECORDER HOUSE, 48/50 GEORGE ST.,  
PORTMAN SQUARE, LONDON, W.1.**

Telephone: WEL 2371/2 Telegrams: Simsale, Wesdo, London

# LONDON CENTRAL RADIO STORES

## Special Offer of Ex-Govt. Receivers, etc.

### Type Demolition Mk.1. Ex-ARMY TEST SET—NEW



For circuit continuity and general testing. In hardwood carrying case. Carriage paid **£3.10.0**

### Super Quality Heavy Duty TWIN-ELEMENT SLIDING RESISTANCES

6.4 ohm at 20 amp. ....	47/6
12 ohm at 10 amp. ....	39/6
70 ohm at 5 amp. ....	35/-
Single Element 14 ohm at 5 amp. ....	13/6

### TELEPHONE LINE or UNISELECTOR SWITCHES

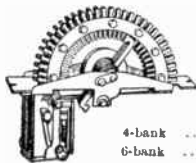

4- or 6-bank, 26 constants. Have various applications including automatic tuning, circuit selection, etc. Operates on 25-50v.

4-bank .....	28/6
6-bank .....	30/-

### Type R1155 10-VALVE COMMUNICATION RECEIVER

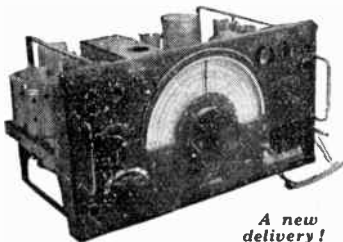

*A new delivery!*

These sets are equal to new, need only a power pack for immediate use (see "W.W." July, 1946). Freq. range, 7.5 mc/s. or 1,500 kc/s., complete with 10 valves, including magic eye. Enclosed in strong metal box **£15.15.0** Each receiver is aerial tested. Carriage and packing 7/6 extra. No C.O.D.

**POWER PACK 220-250 v. A.C. for above is available to CALLERS ONLY.**

### RADAR VIEWING UNITS

Consisting of 6in. diameter Electrostatic C.R. tube, 7 valves including four EF50, potentiometers, resistances and other associated components. In metal cabinet 18 x 8 x 7 1/2in. Bargain price **£3.7.6**

### Type R208 6-VALVE SHORT-WAVE RECEIVER Precision-built Communication Type Range 10—60 megacycles

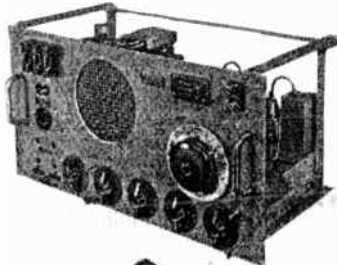

Suitable for AC 100-250v. or 6-v. battery operation. Metal rectifiers, B.F.O., Built-in speaker, Super Slow motion dial. Provision for phono. A real super job in grey metal cabinet. Complete with Valves and Vibrator ready to use **£18.0.0** Carriage and packing 12/6 extra.

### EX-GOVT. TELEPHONE HANDSETS

Self-Energising. Needs no battery or current. 15/- Less Wall bracket. Each .....

### ELECTRO MAGNETIC COUNTERS

Ex-U.P.O., every one perfect, electro-magnetic, 500 ohm, coil, counting to 9,999, operated from 25v.-50v. D.C., many industrial and domestic applications **5/6**

### Type R1147B 7-VALVE U.H.F. RECEIVER Range approx. 200 megacycles

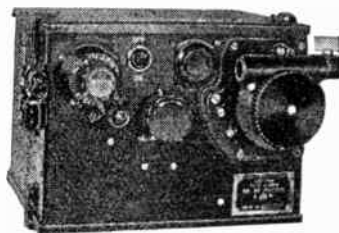

### A Real Opportunity!

Beautifully constructed and fitted with micro-condenser drive. Valve type two EF50, two EF36, one each EBC33, RL7, RL16. In black metal case 8 x 7 x 6in. Set, complete with valves..... **£2.7.6**

**TUNING CONDENSERS** single .0005, best-quality Air Spaced, 1/2" Spindle. Each ..... **3/6**

**EX-GOVT. HIGH-SPEED RELAYS.** Each **6/6**

*For details see March issue.*

### Model \*AN/APA-1 AMERICAN Aircraft RADAR UNIT



Brand new. Complete as shown, incorporating Power Pack, Cathode Ray Tube etc. Book of Instructions with each unit. Carriage paid **£5.10.6**

### EX-U.S. ARMY ULTRA LIGHTWEIGHT HEADSETS

Deaf-aid type earpieces 3/4in. dia. with soft rubber ear fittings, 100 ohms. Brand new and packed **23/6**



### Type 1154 AIRBORNE G.P. TRANSMITTERS

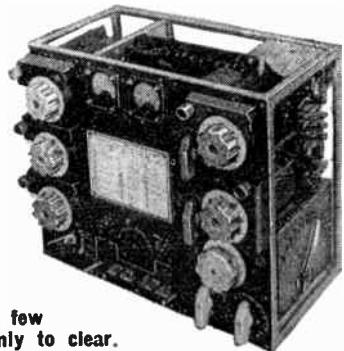

**A few only to clear.**

Complete with 4 valves. Frequency coverage: 500 kc/s., 200 kc/s., 10 mc/s., 3 mc/s., 2.35 mc/s., 8 mc/s., 2.5 mc/s. Power input 1,200 v., 200 m/a. H.T. 6 v. 4 amp. L.T. Chassis size, 16in. x 13 in. x 8 1/2in. In metal cabinet. Supplied in strong wood case, with metal bound corners and carrying handles, easily adapted for Amateur use. Less Power Pack..... **£5.17.6** Carriage and Packing 10/- extra.

**LONDON CENTRAL RADIO STORES, 23, LISLE ST. (GERrard 2969) LONDON, W.C.2**  
Closed Thursday 1 p.m. Open all day Saturday.

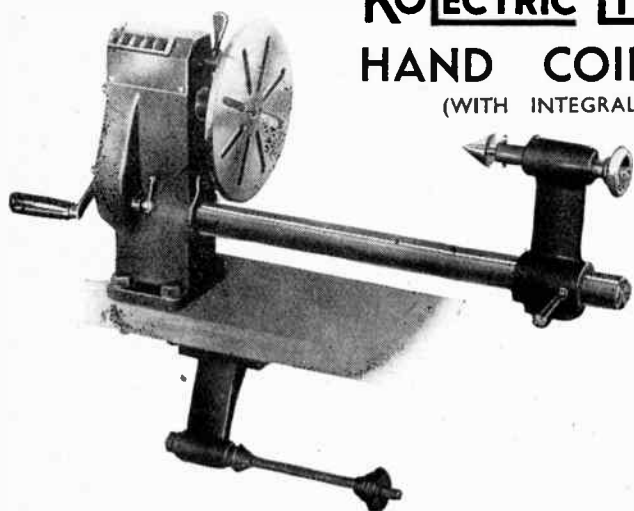

**KOLECTRIC LTD** OFFER A PRECISION BUILT  
**HAND COIL WINDING MACHINE**  
 (WITH INTEGRAL CLUTCH MOTOR DRIVE IF DESIRED)

For Solenoid and Choke Coils, etc.,  
 up to 6" dia.  $\times$  7½" long.  
 Field Coils, etc., up to 12" A/C corners.  
 Armature Rewinding, etc.  
 (16 SWG to 45 SWG)

ATTRACTIVE FEATURES INCLUDE:—

1. TWO SPINDLE SPEEDS 1—1 AND 3½—1
2. TURNS COUNTER WITH INSTANT RESET, ADDS AND SUBTRACTS LARGE EASILY READ FIGURES, RECORDS UP TO 100,000 TURNS
3. ALUMINIUM HEADSTOCK FITTED WITH PRECISION BRONZE BEARINGS, ALL GEARING TOTALLY ENCLOSED, OUTSIDE OILING TO ALL BEARINGS
4. QUICK RELEASE TAILSTOCK WITH BALL THRUST LIVE CENTRE
5. NON-REVERSING TOGGLE CLUTCH WITH INSTANT RELEASE
6. SMOOTH AND EFFORTLESS IN OPERATION

MACHINES AVAILABLE FOR EARLY DELIVERY

**KOLECTRIC LTD., 49 BEDFORD ROW, LONDON, W.C.1**

# AERIALS

**"EXSTAT"**  
**SHORT-WAVE**  
**TELEVISION**  
**CAR RADIO**

STOCKED BY ALL THE  
 LEADING DEALERS

## ANTIFERRENCE LIMITED

SALES DIVISION:  
 67, Bryanston St., Marble Arch, London, W.1  
 Telephone: Paddington 7253/4.

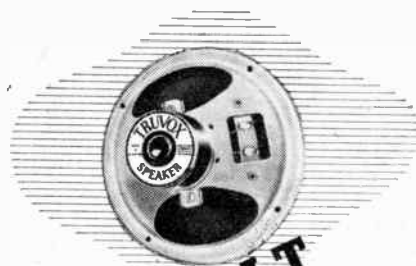

**MONOBOLT**

without transformers wound to specified requirements.

Truvox "Monobolt" permanent magnet speakers embody an entirely new method of construction which greatly increases reliability in transit and use. The 18 years' research and experience which produced this construction enable us to meet with accuracy designer's individual requirements of resonance and sensitivity. If you are interested in quantity production, let us "hand-tailor" a speaker to your specification.

Chassis and complete magnet assembly concentrically located by brass centring ring, and secured by a single fixing bolt effectively preventing any possibility of misalignment in transit or use. Pressed steel chassis gives great rigidity and low weight. Alcomax magnets. Impregnated speech coil and former to prevent former distortion or speech coil turns loosening. Supplied in four sizes—5 ins., 6½ ins., 8 ins. and 10 ins. with or

**TRUVOX**  
 ENGINEERING CO. LTD.

TRUVOX HOUSE · EXHIBITION GROUNDS · WEMBLEY · MIDDX.



THE S. S. WHITE COMPANY BRITANNIA WORKS  
 ST. PANCRAS WAY · CAMDEN TOWN · LONDON N.W.1.  
 Cable Address: WHICODENTA, WESDO, PHONE, LONDON  
 Telephone: EUSTON 4758-4759

Robert Sharp & Partners

WT 35

# A NEW OSCILLOSCOPE

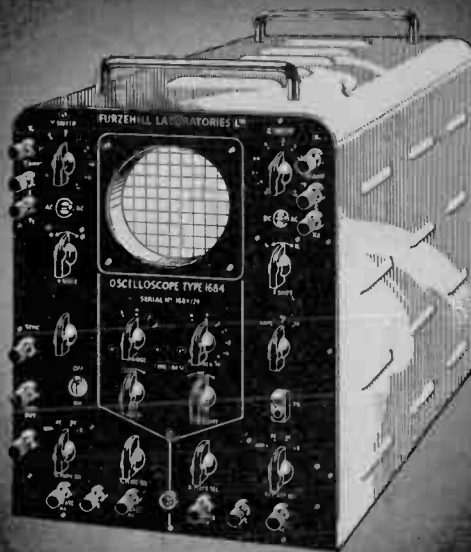

TYPE 1684B

## PRINCIPAL FEATURES

★ TUBE 3½ ins. diam. Blue or green screen.

★ SHIFTS D.C. thus instantaneous on both axes.

★ AMPLIFIERS X and Y amplifiers are similar. D.C. to 3 Mc/s 24 mV. r.m.s. per c.m. or D.C. to 1 Mc/s 8 mV. r.m.s. per c.m.

★ TIME BASE 0.2 c/s to 150 Kc/s. Variable through X amplifier 0.2 to 5 screen diameters. Single sweep available

The Oscilloscope Type 1684B has proved an invaluable instrument for applications ranging from Servo Development, where signal frequencies may be as low as 0.1 c/s, to Television Research. The Oscilloscope is equipped with high gain d.c. coupled amplifiers having a frequency response from d.c. to 3 Mc/s. These amplifiers will handle symmetrical and asymmetrical input. In general the instantaneous shifts, semi-automatic synch, steadiness of image and general ease of operation are features which appeal to all engineers.

Price £100



FURZE HILL LABORATORIES LTD.

TELEPHONE  
 ELSTREE  
 1137

BOREHAM WOOD  
 HERTS

*Fidelity*  
*True TO LIFE - Faithful TO TRADITION*  
**GOODMANS**  
*Loudspeakers*  
 ★ A TRADITION OF EXCELLENCE ★

Goodmans 12" medium heavy-duty reproducer. Ideal for small cinemas, P.A. systems and high power radiograms. Available in Chassis or Cabinet form.

FIDELITY  
EFFICIENCY



GOODMANS INDUSTRIES LTD.  
 LANCELOT ROAD, WEMBLEY, MIDD.

*Which Switch  
 is the right switch?*

... is it Rotary or Pushbutton or Slider? Is it wanted for circuit selection, band selection, tap switching? Is it for a new design or in quantities for a well proved circuit?

Whatever it is—the answer is always OAK!

The basic design of all Oak switches is one of strength and efficient functioning, including such exclusive features as the double-contact clip and the floating rotor, ensuring self-alignment of each section.

 AND   
**OAK SWITCHES**

BRITISH N.S.F. CO. LTD., Keighley, Yorkshire  
 (Sole Licensees of OAK Manufacturing Co., Chicago)  
 A.B. METAL PRODUCTS LTD., Feltham, Middx.  
 (Sub-Licensees of N.S.F.)  
 The only Manufacturers of OAK Switches under Patent  
 Nos. 478391 & 478392

**“You’re CERTAIN to get it at ARTHURS!”**

★ **VALVES** : We have probably the largest stock of valves in the Country.

*Let us know your requirements.*

**AVOMETERS. NOW IN STOCK.**

AVOMETER, Model 7 .....	£19 10 0
AVOMETER, Model 40 .....	£17 10 0
VALVE TESTER (Complete) .....	£16 10 0
TEST BRIDGE .....	£11 0 0
AVOMINOR, Universal Model ....	£8 10 0
AVOMINOR, D.C. Model .....	£4 4 0
SIGNAL GENERATORS .....	£13 0 0

We stock: **TAYLORS' METERS**

15 AMP, 3 pin "CLIX" Foot Switch Plugs £1 0 0

All orders sent by return of Post. Terms C.O.D. or cash with order.

London's Oldest Leading Radio Dealers.

*Arthur's* EST. 1919  
 PROPS: ARTHUR GRAY, LTD.

Our Only Address: **ELECTRICAL, TELEVISION & RADIO ENGINEERS.**

Gray House, 150, Charing Cross Rd., London, W.C.2

Telephone: TEMple Bar 5833 4.



*The*  
**PIECO**  
 ALL-IN-ONE  
**RADIOMETER**

*tests everything electrical*  
**RADIO, HOUSEHOLD APPLIANCES  
 & MOTOR CAR LIGHTING ETC!**

**25/-**

Ask your local Factor to show you one of these remarkable instruments and to put your name down on his waiting list.

*Difficult Problems?*

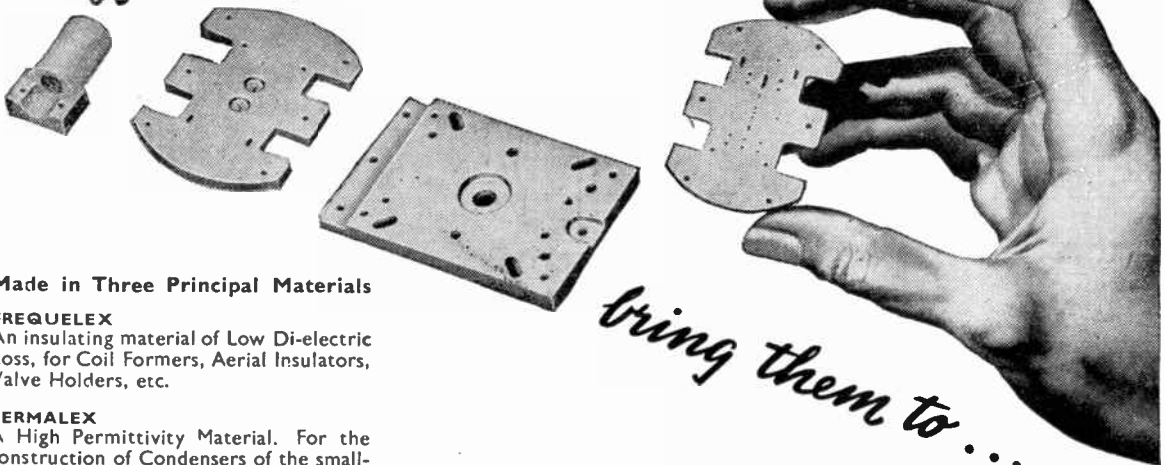

*bring them to...*

**Made in Three Principal Materials**

**FREQUELEX**

An insulating material of Low Di-electric Loss, for Coil Formers, Aerial Insulators, Valve Holders, etc.

**PERMALEX**

A High Permittivity Material. For the construction of Condensers of the smallest possible dimensions.

**TEMPLEX**

A Condenser material of medium permittivity. For the construction of Condensers having a constant capacity at all temperatures.



**Bullers**

**BULLERS LOW LOSS CERAMICS**

BULLERS LTD., 6, LAURENCE POUNTNEY HILL, LONDON, E.C.4

Telephone: Mansion House 9971 (3 lines)

Telegrams: "Bullers, Cannon, London"

The result of long experience and precision watch-making standards which give a finely constructed instrument.

# Lexington

## MOVING COIL PICK-UPS

**DE LUXE MODEL.** Robust design. Accidental dropping on record will not damage Pick-up. Extremely low moment of inertia (80 milligrams total weight of movement). Pure sine wave with no harmonic distortion. Automatic needle or sapphire changing opens new fidelity field to the amateur. Can be used with normal record changer without fear of damage. Price (without sapphire) £5. 10. 0 plus 2/6 P.T.

**JUNIOR MODEL.** Identical in design and workmanship to the De Luxe, the only difference being that it is not equipped with the Automatic Sapphire needle inserter and Extractor device and metal sole plate. Made to take standard steel and fibre needles this model enables every music lover to enjoy the fine reproduction which only a moving coil pick-up can give. £3. 9. 3 plus 15/5 P.T.

**PLUG-IN HEADS.** Available in both Junior and De Luxe types to fit Collaro and Garrard arms, thus providing easy change-over from Magnetic types. Input conversion may be required. (See our Technical Brochure.)

Price 49/6, plus H/-P.T. Separate Ejector for De Luxe type 30/10 plus 6/10 P.T. **PRE-AMPLIFIERS** having an inverse of the recording characteristic incorporated are available for use with pick-ups. These are necessary with some amplifiers.

Price, Complete with Valve and Input Transformer £6. 1. 0  
**Illustrated Technical Brochure upon request.**  
Export and Trade Enquiries invited.

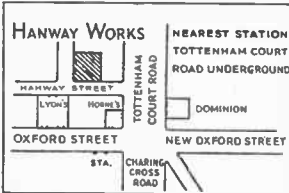

## COOPER

MANUFACTURING CO.

HANWAY WORKS,  
HANWAY ST., LONDON, W.1

Telephone: MUSeum 9779

SALES OFFICES—Top Floor

Modern Assembly Methods Demand the

## "PYROBRAZE"

SOLDERING & BRAZING MACHINE

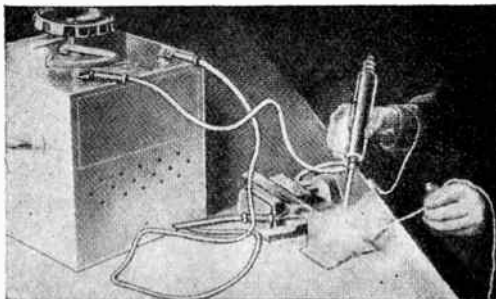

Save time, speed up production, ensure sound joints with the "PYROBRAZE" No. 2" Portable Contact Heater. Solders fine and heavy metals, even big castings—Solders Aluminium—Silver Solders and Brazes up to 16 s.w.g.

Write for full descriptive Booklet and ask for FREE advice on Soldering and Brazing Problems.

**THE ACRU ELECTRIC TOOL MFG. CO. LTD.**

123, HYDE RD., MANCHESTER, 12. Tel.: ARDwick 4284

## ISOLATION FROM VIBRATION

### NEW VIBRATION ELIMINATORS

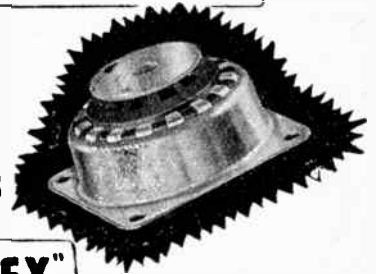

### "EQUIFLEX" MOUNTINGS

AN **AN** PRODUCT

electrical apparatus, motors, etc., and wherever elimination of vibration and shock is required.

"Equipflex" Mountings are invaluable for the mounting and suspension of machines, equipment, instruments,

### SPECIAL FEATURES

Flexible in all directions at an equal deflection. Can be loaded on any side, thus eliminating vibration in Vertical, Horizontal and Longitudinal planes employing best quality natural rubber spring elements and complete with snubbing device. Special Fittings made to suit customers' requirements.

Also available as previously advertised, the ALL-METAL construction comprising an ingenious Damped Spring System.

Write for illustrated brochure, and send us details of your requirements.

A. WELLS & CO. LTD. (Dept. W.W.),

STIRLING ROAD, WALTHAMSTOW, LONDON, E.17

Phone: Larkwood 2691

# DOD

SOUND SYSTEMS USED

# BST

THROUGHOUT THE WORLD

# BOW

**BIRMINGHAM SOUND REPRODUCERS LTD**

CLAREMONT WORKS, OLD HILL, STAFFS.

TEL: CRADLEY HEATH 6212/3

LONDON OFFICE: 115 GOWER ST., W.C.1

TEL: EUSTON 7515

Meet us at  
**RADIOLYMPIA**  
OCT 1-11



# DID YOU READ

Wireless World July, 1946

## Test Report

### SOBELL Type 615

A.C. Table Model Superhet  
(Five Valves + Rectifier)

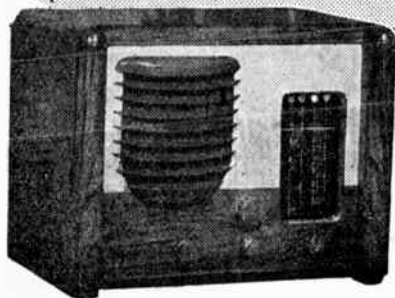

The following are brief extracts from a report which appeared in the July 1946 issue of "Wireless World" on the Sobell 615 6-valve A.C. Table Model Superhet :-

"The quality of reproduction is decidedly above the average for a table model . . . The lower register has breadth and an extended top response gives clarity and brightness without being shrill . . . With two I.F. stages there is no lack of sensitivity and the selectivity is exceptionally good. The division of the short-wave range into two parts gives a degree of band spread which makes for ease of tuning and both ranges provide a wide choice of stations. The sensitivity is well maintained at the high-frequency end . . . The chassis is of ample size and components are well spaced . . . The finish of the cabinet work is of a high order . . . The set is backed by a comprehensive free maintenance scheme for two years. In the event of breakdown the fault will be remedied or the chassis changed on the spot by one of the maker's servicemen"

Price 24 Gns., plus £5. 8. 4d. purchase tax.



TWO YEARS' FREE ALL-IN SERVICE IN THE HOME

SOBELL INDUSTRIES LTD., LANGLEY PARK, NR. SLOUGH, BUCKS.



## SERIES 100 MULTI-RANGE TEST SET by

# PULLIN

A Service Engineers' Universal Testing Set with a sensitivity of 10,000 Ohms per Volt. The instrument is housed in a strong metal case with carrying handle, and is complete with one pair of leads having detachable bull-dog clips and test prods.

- Ranges : AC/DC Volts : 10, 25, 100, 250, 500, 1000.  
D.C. Milliamps : 2.5, 10, 25, 100, 500.  
AC/DC Microamps : 100 Microamps on the 10V range.  
Resistance ranges : 0-1 Meg. (13,500 Ohms mid scale). 0/10,000 Ohms (135 Ohms mid scale).
- Frequency Range : 15 to 20,000 Cycles per second.
- Accuracy : 3% on D.C. Ranges.  
4 1/2% on A.C. Ranges (for sinusoidal waveforms).  
5% on Resistance Ranges (Compensated for normal variation of cell voltage).
- Size : 9" x 5 1/2" x 4".
- Terminals : Socket head type.



Address all enquiries to Dept. J, Electric Works, Winchester Street, Acton, London, W.3. Telephone: Acorn 4651-4

## • ALL-POWER •

### Constant Voltage Power Supplies

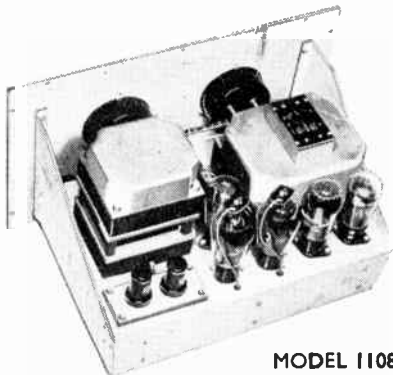

MODEL 1108-S  
One of our low-priced  
industrial units.

LET ELECTRONIC STABILIZATION SOLVE  
YOUR POWER SUPPLY PROBLEMS

ALL-POWER TRANSFORMERS LTD.

8a Gladstone Rd., Wimbledon, S.W.19  
Telephone: LIBerty 3303

## A "Laboratory" INSTRUMENT... but NOT "Laboratory" Price!

The newest addition to the "Advance" range of Signal Generators places an instrument of laboratory class within the financial scope of every radio service engineer and experimenter.

The discerning engineer will appreciate its accuracy and stability, its exceptionally wide range which covers all frequencies required for radio and television receivers, and its accurate attenuating system which enables sensitivity measurements to be made on highly sensitive receivers up to 60 Mc/s. Send for fully descriptive pamphlet.



Price 19 Gns

Range: 100 Kc/s—60 Mc/s  
on fundamentals (up to 120  
Mc/s on Second Harmonic).

Accuracy:

Guaranteed within  $\pm 1\%$

Attenuation: Constant impedance system embodying a matched 75 ohms transmission line.

Stray Field: Less than 5 microvolts at 60 megacycles.  
Illuminated Dial:

Total scale length 30"

Power Supply:  
110-210-230-250 volts.

Dimensions:  
13" x 10 1/2" x 7 1/2" deep.  
Weight: 15 lbs.

The New

**Advance** TYPE E  
Signal Generator

ADVANCE COMPONENTS, LTD., Back Road, Shernhall Street,  
Walthamstow, London, E.17. Telephone: LARKSwood 4366/7

# M. ALLEN (Radio) Ltd

113, CHARING CROSS ROAD,  
LONDON, W.C.2



The  
**TAYLOR  
JUNIOR**  
MODEL 120A  
A REAL  
UNIVERSAL  
METER

#### SPECIFICATION

- 21 Ranges
- Sensitivity: 1,000 ohms per volt D.C. and A.C.
- Measures from 5 mV to 5,000 volts D.C.; 0.2V to 5,000 volts A.C.; 20 $\mu$  A to 500 mA. D.C.; 0.5 to 200,000 ohms with internal battery.
- Size only 4 1/2" x 3 1/2" x 1 15/16".

PRICE  
**£7-10-0**

Write for particulars of full range of  
Radio, Television, Electronic, Electrical instruments and components  
M. ALLEN (Radio), Ltd., 113, Charing Cross Road,  
London, W.C.2. Tel.: Gerrard 8734

## Specialists in 'SPECIAL' Waxes

Most applications of wax in the manufacture of electrical components demand special characteristics which can be met from the regular range of

## OKERIN WAXES & COMPOUNDS

or designed to specification. Grades are available for arctic or tropical service—stable, moisture-proof—fungi-resisting.

For expert advice, samples, etc., please  
Telephone TEMple Bar 5927

**ASTOR BOISSELIER  
& LAWRENCE LTD.**

(Sales Dept.)

Norfolk House, Norfolk St., Strand, London, W.C.2

# Distinctive Speakers

The comprehensive range of TANNOY Sound Equipment now available embodies the latest technical developments in design and performance.

Here are two distinctive loudspeakers. The one above is type LSH/200/H, a weatherproof Re-entrant Horn model giving first-class quality reproduction of speech and music over large areas.

The model shown at left is type LS/CIR/5, a bowl loud-speaker suitable for ceiling or wall mounting and combining the latest development in speaker design with distinctive and artistic appearance. Sound is distributed evenly in all directions.

For full details of these loudspeakers, and all Sound Equipment (microphones, amplifiers and loudspeakers) write to Dept. 'D.'

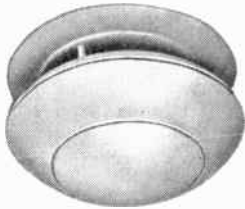
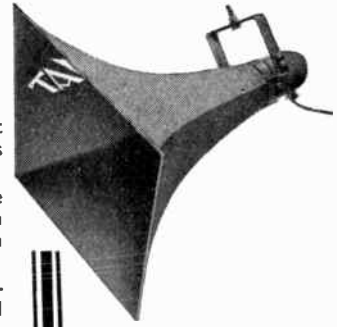

'TANNOY' is the Registered Trade Mark of Equipment manufactured by GUY R. FOUNTAIN LTD. The Largest organisation in Great Britain specialising SOLELY in Sound Equipment.

# TANNOY

SOUND EQUIPMENT

GUY R. FOUNTAIN LTD.

"The Sound People"

WEST NORWOOD, LONDON, S.E.27

(Phone: GIPsy Hill 1131)

Branches at BIRMINGHAM, MANCHESTER, BRISTOL, NEWCASTLE-ON-TYNE, BELFAST, etc.

No. 2

## POINTS OF LOW CONTACT RESISTANCE IN CIRCUIT DESIGN OF MINIATURE RECEIVERS

# CLIX

RADIO & TELEVISION COMPONENTS . . .

. . . ARE USED BY ALL THE LEADING SET MANUFACTURERS

BRITISH MECHANICAL PRODUCTIONS LTD.  
21 BRUTON ST., LONDON, W.1

Telephone: MAYfair 5543

Foremost in Valveholder design

### B7G MINIATURE LAMINATED VALVEHOLDER

For use with 1T4, 1R5, etc.,

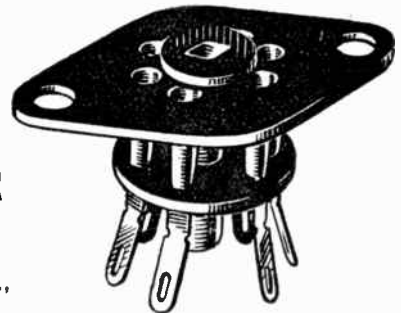

Designed with 7 special sockets giving extremely low contact resistance and ensuring positive location of pins. Tags and centre screen pre-tinned. Fixing centres .875, Hole Dia. .100.

PLATE DIMENSIONS  
Major axis 1.093  
Minor axis .680

for mounting either above or below chassis.

# SPHERE INSTRUMENTS



## Introducing the ALL WAVE SIGNAL GENERATOR TYPE 606

A portable Signal Generator for AC, Mains operation. Specially developed by SPHERE as a high class instrument, for general Laboratory and Workshop use, it is the ideal instrument for the aligning and testing of radio receivers and amplifiers.

This is a specially designed Generator embodying several new and unique features and improvements, which radio engineers will find invaluable.

All "SPHERE" Test-instruments are entirely British made with highest quality materials and workmanship and carry a SIX Months' guarantee.

- Continuous Frequency coverage from 110 Kilocycles to 56 Megacycles, in six bands.
- Exclusive "SPHERE" "SEE AT A GLANCE" Band and Attenuator indicators.
- Built in ladder attenuator, with fine control, giving 1 Volt maximum, in five steps, in multiples of 10 Microvolts.
- Radio and Audio Frequency Voltages can be switched via single Test-lead.
- Variable control of 400 C.P.S. audio, from 0 to 1 Volt.

FOR RADIO SERVICE, RADIO ENGINEERING AND LABORATORY USE.

Write for List No. 505 S.G.

## SPHERE RADIO LIMITED

Radio Instrument Manufacturers

HEATH LANE, WEST BROMWICH

# H.P. RADIO SERVICES LTD.

## Offer

Ex. Govt. Combined Double Moving Coil Headphones and Moving Coil Hand Microphone. Guaranteed Perfect, 9/6. Postage 8d.

Brand New Canadian No. 58 Mark I ★ Transmitter Receivers. Complete in every detail with 8 valves, 2 sets of headphones and microphones 3 types of aerial, battery, etc., full operating details. Ready to switch on. 10 gns. (Carr. 5/-).

Peter Pan Midget Radio Kit. Beautiful Black and Cream Plastic Cabinet, 4-valve circuit, 2 wavebands. Complete in every detail. When completed equals the best commercial product of its class. Illustrated brochure free on request. Price £11/9/7 (including tax).

Airmaster 5 Valve 4 Waveband AC Superhet Chassis, with valves and Moving Coil Speaker. PU and extra LS sockets. De Luxe finish in Cream Cellulose. Magnificent performance. Ideal for incorporating in Radiogram. Latest 1947 product, a few only £17/12/- (Carr. 4/-). Art photos of this item available to genuine enquirers

10 Watt Amplifier Chassis, with valves, KT66 output, Mixing input circuits for mike or gram. Black crackle de luxe finish. Amazing value. 8 gns. (Carr. 3/-). Illustrated leaflet on request.

Car Radio. Ekco, Masteradio, Philco, Pye, etc. 6 or 12 v. Current prices. No Purchase Tax.

Transmitting Valves. Huge stock. "Hams" should get our valve list.

We guarantee satisfaction and safe delivery of all goods. Order with confidence from the old established retailers.

## H. P. RADIO SERVICES LTD.

55, County Rd., Walton, Liverpool, 4

Tel.: Aintree 1445.



Ardente have the most modern Public Address systems—fixed or mobile—for EVERY purpose, indoor or out. Combining technical quality with attractive appearance, the wide range available represents the very finest PA equipment obtainable to-day. Simple to operate; easy to instal.



by **Ardente**

● Write for trade terms direct to Sales Dept. T.W.

## ARDENTE ACOUSTIC LABORATORIES LTD.

London Office: 309, Oxford St., W.1. Mayfair 7917-8.

Works: GUILDFORD, SURREY. Guildford 3278-9.

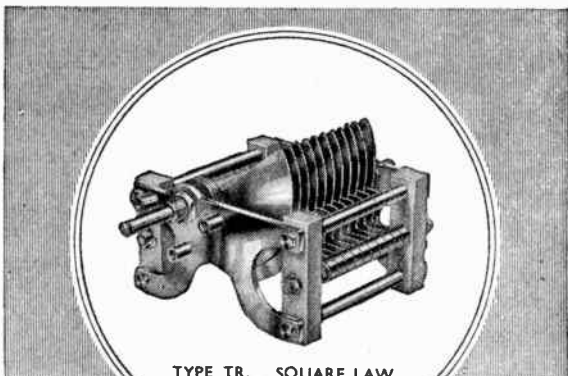

TYPE TR. SQUARE LAW TRANSMITTING

## "Cyldon" TRANSMITTING Capacitors

SYDNEY S. BIRD & SONS, LTD.

CAMBRIDGE ARTERIAL ROAD, ENFIELD, MIDDX.

'Phone: Enfield 20712. 'Grams: "Capacity, Enfield."

*KNOBBS DIALS & POINTERS* by **PAINTON of NORTHAMPTON**

**PAINTON & CO LTD · KINGSTHORPE · NORTHAMPTON**  
 Telephone: Northampton 2820  
 Telegrams: Ceil Northampton

*Make full use of your radio!*

You, too, can enjoy the added pleasure and convenience of radio in every room by making full use of your receiver with a Stentorian Extension Speaker.

These moderately priced Stentorian Extension Speakers with their handsome acoustically designed wooden cabinets, give such superb quality of reproduction that you will be amazed at the difference a Stentorian makes to your receiver. Ask your dealer for a demonstration.



**SENIOR MODEL**  
 Type 8C with Universal Transformer £5. 15. 6  
 .. 8X minus .. £5. 2. 6  
 Walnut Veneered wooden Cabinet. P.M. Unit  
 9in. diameter. Handling Capacity 7 watts. Magnet  
 Flux density 12,000 lines/sq.cm.

**JUNIOR MODEL**  
 Type JC with Universal Transformer £5. 0. 0  
 .. JX minus .. £4. 10. 6  
 Walnut Veneered wooden Cabinet. P.M. Unit  
 8in. diameter. Handling capacity 6 watts. Magnet  
 Flux density 10,000 lines/sq.cm.

Other Cabinet Models available from 39/6



**Stentorian**

THE FINEST EXTRA SPEAKER FOR ANY SET

WHITELEY ELECTRICAL RADIO CO. LTD., MANSFIELD, NOTTS.



**IT COSTS LESS TO USE**

*The Finest Cored Solder  
in the World*

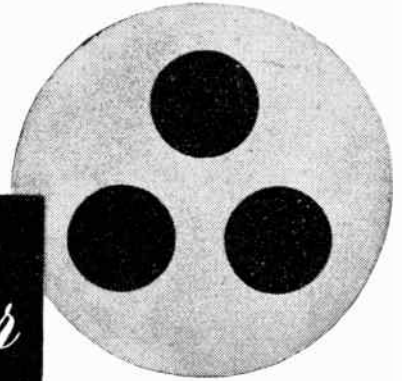

**because**

**YOU AVOID WASTE.** The three cores of flux in Ersin Multicore Solder ensure flux continuity, and eliminate solder lengths without flux.

**because**

**YOU SAVE TIME.** The three core construction of Multicore provides thinner solder walls and gives more rapid melting of the solder, thus speeding up soldering operations.

**because**

**YOU ENSURE SOUND JOINTS.** With correct soldering technique, Ersin Multicore Solder gives precision joints at high speed and avoids 'dry' or H.R. joints.

**because**

**MULTICORE CONTAINS ERSIN.** Multicore is the only solder in the world containing extra-active non-corrosive Ersin Flux—a high grade rosin subjected to a complex chemical process, enabling joints to be made on heavily oxidised surfaces. No extra flux is required.

SIZE 7 REEL for Factory use. SIZE 1 CARTON for Service Engineers and Workshops.  
PRICES SIZE 1 CARTONS.

Catalogue Ref. No.	Alloy Tin/Lead	S.W.G.	Approx. length per carton	List price per carton (subject)	
				s.	d.
C 16014	60/40	14	44 feet	6	0
C 16018	60/40	18	114 feet	6	9
C 14013	40/60	13	27 feet	4	10
C 14016	40/60	16	60 feet	5	3

Manufacturers and service engineers are invited to write for information and samples.  
Available from leading radio shops. In case of difficulty write to:

**MULTICORE SOLDERS LIMITED**  
MELLIER HOUSE, ALBEMARLE STREET, LONDON, W.1. Tel.: REGent 1411

# Wireless World

Radio and Electronics

37th YEAR OF PUBLICATION

## AUGUST 1947

Proprietors:  
ILIFFE & SONS LTD.

Managing Editor:  
HUGH S. POCOCK,  
M.I.E.E.

Editor:  
H. F. SMITH

Editorial, Advertising  
and Publishing Offices:  
DORSET HOUSE,  
STAMFORD STREET,  
LONDON, S.E.1.

Telephone:  
Waterloo 3333 (50 lines).

Telegrams:  
"Ethaworld, Sedist, London."

△

**PUBLISHED  
MONTHLY**

Price: 1/6

(Publication date 26th  
of preceding month)

Subscription Rate:  
Home and Abroad  
20/- per annum.

MONTHLY COMMENTARY .. .. .	273
PUSH-PULL PHASE-SPLITTER. By E. Jeffery ..	274
SHORT-WAVE CONDITIONS. By T. W. Bennington	277
TELEVISION RECEIVER CONSTRUCTION—6 ..	278
TUNED A.F. FILTERS—2. By H. E. Styles ..	282
MOVING-IRON PICKUPS. By E. H. Francis ..	285
RADIAL TIME BASES. By G. W. A. Dummer and E. Franklin .. .. .	287
DESIGN DATA (15) : Link Coupling .. .. .	291
TELEVISION AERIALS. By N. M. Best and R. D. Beebe .. .. .	293
WORLD OF WIRELESS .. .. .	296
UNBIASED. By Free Grid .. .. .	299
PERMANENT MAGNETS. By "Cathode Ray" ..	300
V.H.F. AIRCRAFT EQUIPMENT .. .. .	306
LETTERS TO THE EDITOR .. .. .	308
RANDOM RADIATIONS. By "Diallist" .. .. .	310
RECENT INVENTIONS .. .. .	312

Branch Offices:

COVENTRY:  
8-10, Corporation Street.  
Telephone: Coventry 5210.  
Telegrams:  
"Autocar, Coventry."

BIRMINGHAM:  
King Edward House,  
New Street, 2.  
Telephone:  
Midland 7191 (7 lines).  
Telegrams:  
"Autopress, Birmingham."

MANCHESTER:  
260, Deansgate, 3.  
Telephone:  
Blackfriars 4412 (4 lines).  
Telegrams:  
"Iliffe, Manchester."

GLASGOW:  
26B, Renfield Street, C.2.  
Telephone: Central 4857.  
Telegrams: "Iliffe, Glasgow."

△

*As many of the circuits and  
apparatus described in these  
pages are covered by patents,  
readers are advised, before  
making use of them, to satisfy  
themselves that they would  
not be infringing patents.*



## REPLACEMENT VIBRATORS FOR CAR RADIO

Send new life coursing through your car  
radio. Put a STRATOSIL Vibrator into circuit  
... it defies all climatic conditions  
and operates efficiently—anywhere.  
Your dealer can supply—in case of difficulty  
write direct to us

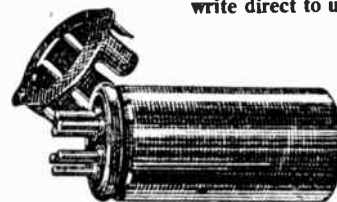



# VALVES AND THEIR APPLICATIONS

By M. G. SCROGGIE, B.Sc., M.I.E.E.

## No. 8: Mullard TWIN-TRIODE ECC34

**T**HE ECC34 is an alternative to the ECC32 where a lower resistance pair is wanted ( $r_a = 5200\Omega$ ;  $\mu = 11.5$ ); for example, in a multivibrator for a rather higher top frequency. But its primary purpose is economical frame time-base generation in television receivers. An example of this was described in "Wireless World," Dec. 1946, p. 403-407 (Pye Model B16T). One valve in the pair is used to generate the saw-teeth by the blocking oscillator method; the other is a current amplifier for energizing the frame deflector coil.

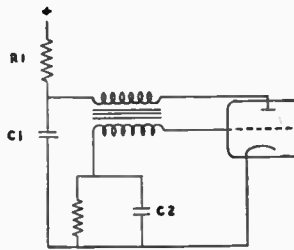

FIG. 1

Fig. 1 shows the blocking oscillator part in its simplest terms. C1 charges through R1 until its voltage is enough to cause current to flow in the valve, which immediately starts into violent oscillation. The first half-cycle discharges C1, and charges C2 so negatively that the second half-cycle cuts the valve off and allows C1 to charge again. And so on.

Obviously the voltage across C1 is exponential, so the amplifier not only has to provide the necessary deflecting current but must also straighten out the waveform. This is done, in the set mentioned, by a negative feedback network, the circuit of which, and the other details of the time base, are given in the article referred to.

Experimenters <sup>+250V</sup> may be interested in a linear voltage sweep that is rather less tricky to design. Fig. 2 shows that it is unusually simple and econ-

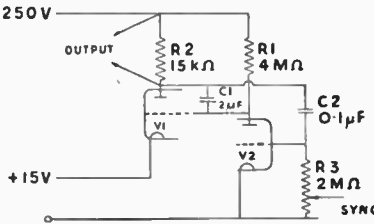

FIG. 2

omical. It is particularly suitable for very low frequencies—the values shown are for 0.2 c/s—but will cover up to thousands of c/s by reducing C1, C2, R1 and R3. With the Fig. 2 specification it gives a 100-volt sweep across a low-impedance output, for a consumption of only 8 mA at 250 V, while its linearity is equivalent to a charging amplitude of only 12½ volts in 250. This is thanks to V1 being a so-called Miller time base, the working stroke being formed by C1 discharging through R1 (and R2). The output is coupled through C2 to V2, which periodically recharges C1 through itself and R2. The only disadvantage is a not-very-fast flyback; with the optimum C2 it is of the order of 6%. Increasing C2 causes a delay at the end of each sweep; if necessary this delay can be made many times longer than the sweep itself.

The frequency can be varied in steps by C1 and C2, and continuously by R1. Supply voltages ought to be reasonably steady at the working frequency.



*This is the eighth of a series written by M. G. Scroggie, B.Sc., M.I.E.E., the well-known Consulting Radio Engineer. Reprints for schools and technical colleges may be obtained free of charge from the address below. Technical Data Sheets on the ECC34 and other valves are also available.*

**THE MULLARD WIRELESS SERVICE CO. LTD.,  
TECHNICAL PUBLICATIONS DEPARTMENT,  
CENTURY HOUSE, SHAFTESBURY AVE., W.C.2**



# Wireless World

Radio and Electronics

Vol. LIII. No. 8

AUGUST, 1947

Price 1s. 6d.

## MONTHLY COMMENTARY

### *What is a Broadcasting Station?*

A FEW readers of the *Wireless World* booklet "Guide to Broadcasting Stations" have expressed regret that it does not give data on meteorological and standard-frequency stations. The short answer seems to be that these are not strictly broadcasting stations, but, if there is any widespread demand for such data, they will be included in subsequent editions. Having said that, one is left with an uneasy feeling of uncertainty as to the exact definition of the term "broadcasting station."

The Post Office has officially defined "authorized broadcast station," an expression which appears in the broadcasting receiving licence, as

**a station in any part of the world which is operated under the authority of any Administration in accordance with the International Radio-communication Regulations.**

That disposes of the word "authorized" but leaves us still in doubt as to the precise legal and technical significance of "broadcasting station," which, so far as we know, has not been officially defined by the Post Office. The British Standards Glossary (B.S.204:1943) does not give the term, but defines "radio broadcasting" as

**the transmission by means of electro-magnetic waves of a programme of sound, vision or facsimile for general reception.**

That definition is helpful, but perhaps rather lacking in completeness. The Postmaster-General's Licence to the B.B.C. does not get us much farther; the nearest definition given there is that of "broadcast matter" which means

**music, lectures, speeches . . . weather reports, news, information, entertainments . . . images . . . spectacles or objects in movement or at rest . . .**

in fact, "any other matter transmissible by wireless telegraphy" (*sic*).

But, after all, it should not be too difficult to find a definition that ought to be acceptable to all law-abiding nationals of countries signatory to the International Telecommunications Convention.

Turning to the International Radio-communication Regulations (Revision of Cairo, 1938) we find "Broadcasting Service" means

**a service of broadcasting of emissions intended to be received by the general public. . . .**

This definition then goes on to embrace sound, television and facsimile broadcasting, and so agrees closely with B.S.204. What is important is that the Regulations make it clear that many other transmissions addressed to a general or limited public are in a different category. This is called "Special Service" and includes

**radio beacons, direction-finders, time signals, meteorological reports, notices to mariners, press messages for general reception, medical advice . . . calibrated frequencies, emissions for scientific purposes, etc.**

Thus, by international agreement, stations performing such services are not classed as broadcasting stations.

All this is of much more than mere academic interest. The legal aspect alone is important. For example, does the ordinary broadcast receiving licence confer authority to listen to the "Airmet" weather bulletins from Borough Hill and to the standard-frequency transmissions from the U.S. Bureau of Standards station WWV? If we are to accept the ruling given in the Regulations, and also to take the licence at its face value, the answer seems to be an unequivocal "no." But, equally definitely, it will be agreed that the public should have facilities for using, without cumbrous formalities, these and many other wireless services that are provided for general use.

Some months ago we protested against the restrictive—even dictatorial—terms of the broadcast receiving licence, and, as a result, some rather trivial changes in wording were introduced. That was not enough; we think that the position should be finally regularized by the issue of a simple form of licence covering reception of all transmissions addressed to CQ and intended for public use.

# Push-Pull Phase-Splitter

## New High-Gain Circuit

By E. JEFFERY

THE advantages of resistance-capacitance circuits for phase-splitting in push-pull amplifiers are now well recognized, a wide variety of circuits for this purpose having been evolved in the last decade or so. If these circuits are investigated it is found that they possess varying degrees of merit in producing symmetrical output voltages, but share the common disadvantage of inherently low gain. In fact, low gain would appear to be almost inherent in any phase-splitting arrangement. The circuit to be described in this article, however, will be shown to possess a very high degree of symmetry with, at the same time, a large amplification from only two valves. An overall amplification of more than 1,000 times can very easily be achieved with standard low- $g_m$  valves.

In order to facilitate analysis and to effect a just comparison with other types, the circuit will be compared with, and developed from, a normal cathode-follower phase-splitter preceded by a pentode A.F. stage.

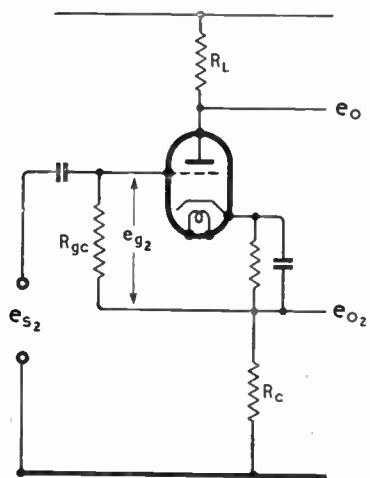

Fig. 1. The basic cathode-follower type of phase-splitter.

For the purposes of this article the amplification of a phase-splitting system will be regarded as the ratio of either output voltage (assuming the two to be sensibly equal) to the signal input

which limit the gain of the circuit of Fig. 2. It is well-known that the input impedance of a cathode-follower is extremely high, approximately  $10 \times$  (impedance between grid and cathode); consequently if the grid-cathode impedance is made  $250 \text{ k}\Omega$  the impedance to the right of "LM" in Fig. 2 is  $2.5 \text{ M}\Omega$ . In other words, the input circuit of  $V_2$

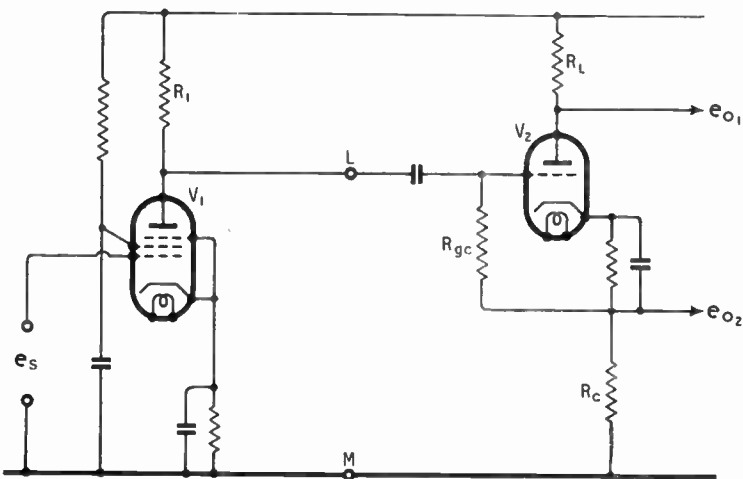

Fig. 2. The combination of a phase-splitter with a preceding A.F. stage is shown here.

voltage (i.e., amplification =  $\frac{e_{o1}}{e_s}$

or  $\frac{e_{o2}}{e_s}$  in Fig. 2). In other words, the gain of the system as a whole is twice that given. The cathode follower, Fig. 1, is perhaps the most generally used circuit because of its simplicity and the high degree of balance obtainable between  $e_{o1}$  and  $e_{o2}$ , at normal frequencies, being dependent, only on the accuracy of  $R_L$  and  $R_C$ . It possesses, of course, the inherent disadvantage of a cathode follower in that its gain is slightly less than unity (Appendix Equation (2)).

If we now consider such an arrangement to be preceded by a pentode stage the circuit becomes that of Fig. 2 and the overall gain is nearly that of the pentode alone, about 100 times.

Let us now consider the factors

does not appreciably shunt  $R_1$  and the gain obtainable from  $V_1$  is determined almost entirely by  $R_1$ . The value of this resistance cannot, however, be increased indefinitely, owing to the fall in steady anode voltage of  $V_1$  and a practical maximum is about  $250 \text{ k}\Omega - 500 \text{ k}\Omega$ . Since the A.C. resistance of the pentode is very high (say  $2.5 \text{ M}\Omega$ ) it follows that only a small fraction of the amplification factor can be realized as gain (since gain =  $\frac{\mu_1 R_1}{R_{a1} + R_1}$ ). This is unfortunate, because the amplification factor is extremely high, about 4,500 being quite a normal value for a pentode.

Suppose, however, it were possible to use the very high input impedance of a cathode-follower as the actual load on  $V_1$ . Then, since this impedance

is comparable with the A.C. resistance of the pentode, the amplification obtained would be greatly increased.

$\mu_2 = 28$ ; with the component values of Fig. 4 Equation (1) gives the input impedance  $R_{in}$  as  $2.05 \text{ M}\Omega$ . It will be noted that

$$R_{gc} = \frac{R_1 R_3}{R_1 + R_3} = 168 \text{ k}\Omega.$$

Then the amplification of  $V_1$  is given by:  $\mu_1 \frac{R_{in}}{R_{a1} + R_1} = 2030$  (where  $\mu_1 = 4.500$  and  $R_{a1} = 2.5 \text{ M}\Omega$ ).

The gain of  $V_2$  as given by Equation (2) is 0.9; therefore the

The inherent unbalance is less than 1.2 per cent. and therefore completely negligible. It may be wondered why any asymmetry should exist in the system; however, a consideration of the equivalent circuit of Fig. 6(b), shows that the sum of the alternating anode currents flows in the cathode load whereas the anode current of  $V_2$  alone flows in the anode load. The ratio of the alternating components of the anode currents of  $V_2$  and  $V_1$  is, however, very large.

### Design Considerations

The circuit was specifically developed to drive valves of the PX 25 class, and the values are therefore chosen to give a large peak output rather than maximum gain. If it is required to drive valves requiring a smaller grid swing no doubt much higher values of gain can be achieved. It should be pointed out to those evolving their own designs that the dynamic load on  $V_1$  is very much greater than the D.C. load, while the A.C. load on  $V_2$  is less than the D.C. load.

For smaller output voltages, say up to 25V R.M.S. at each output point, the component values are not critical while other

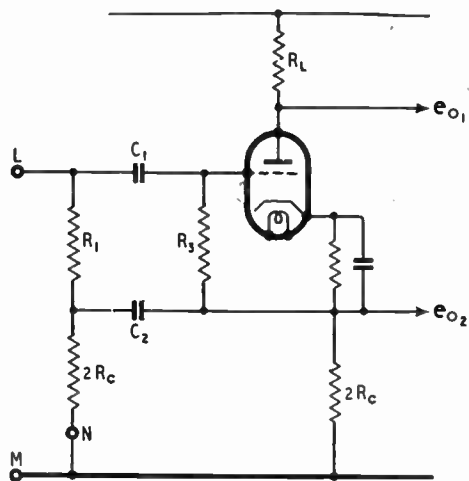

Fig. 3. A modified phase-splitter in which the coupling resistor  $R_1$  becomes part of the grid-cathode impedance of the cathode-follower.

If the circuit to the right of LM in Fig. 2 is rearranged as shown in Fig. 3, the parallel impedance of  $R_1$  and  $R_3$  replaces the grid-cathode impedance  $R_{gc}$  while the effective cathode load is still  $R_c$ . Consequently the A.C. conditions have not been changed by the rearrangement and the input impedance is still approximately  $10 \times R_{gc}$  (where  $R_{gc} = \frac{R_1 R_3}{R_1 + R_3}$ ). It is assumed that the reactances of  $C_1$  and  $C_2$  are negligible at the lowest working frequency.

We cannot, as the circuit stands at present, connect the point L directly to the anode of  $V_1$  since there is no means of supplying anode current to  $V_1$ . It will be seen, however, that N is at earth potential and there is no reason why we should not return this end of the resistor to + H.T., which is also at earth potential, so far as A.C. is concerned. In this way we can provide a D.C. path to the anode of  $V_1$  without disturbing the A.C. conditions on  $V_2$ , while  $V_1$  still sees the input impedance of  $V_2$ , acting as a cathode follower, as its dynamic load.

The final phase-splitting circuit becomes that of Fig. 4, in which the component values are those used in the experimental model.

Using an EF 36 strapped as a triode for  $V_2$ ,  $R_{a2} = 10 \text{ k}\Omega$  and

overall gain of the system  $\frac{e_{o2}}{e_s} = 2030 \times 0.9 = 1860$ . It is of interest to note that Equation (3) in the Appendix, which was derived directly from the equivalent circuit of Fig. 6(b), gives the same value as that obtained by the foregoing physical argument.

The degree of asymmetry between  $e_{o1}$  and  $e_{o2}$  must be regarded

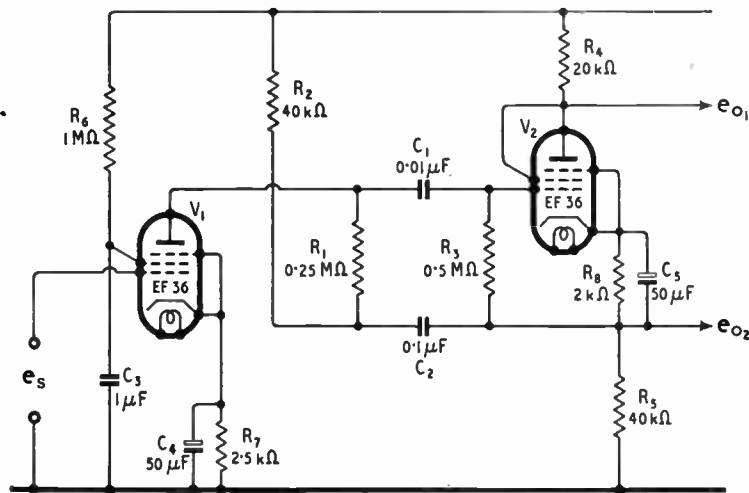

Fig. 4. The practical form of the high-gain phase-splitter and preceding stage.

as of even greater importance than mere gain. Inserting numerical values in Expression (4) of the Appendix we obtain  $\frac{e_{o1}}{e_{o2}} = 0.989$ .

types of valve have been substituted with only minor circuit changes; e.g., bias and screen resistors. It is of interest to note that the EF.36 strapped as a

**Push-pull Phase-splitter—**

triode gave better results from a linearity point of view than any of the triodes investigated.

As with most cathode-follower systems, it is advisable to reduce the heater-cathode voltage of  $V_2$  by using a separate heater supply for the stage, connected to an appropriately decoupled point on the H.T. supply.

In order to avoid loss of gain it is desirable to by-pass the cathode bias resistors of each stage.

Table I gives the results obtained with the circuit of Fig. 4.

TABLE I

H.T. Supply Voltage	Max. output Voltage $e_{o1}$ (or $e_{o2}$ )		Input Voltage for max. output (R.M.S.)	Gain
	R.M.S.	Peak		
400	37.5	53	0.031	1210
290	25.6	36	0.023	1110

It will be noted that the measured gain is somewhat less than the calculated value, the discrepancy is not however more than can be accounted for by variations in the actual values of components from those assumed.

**Application of Circuit**

The circuit has been used over a number of years in a wide

Fig. 5. The circuit of a complete amplifier including the output stage. Overall negative feedback is used.

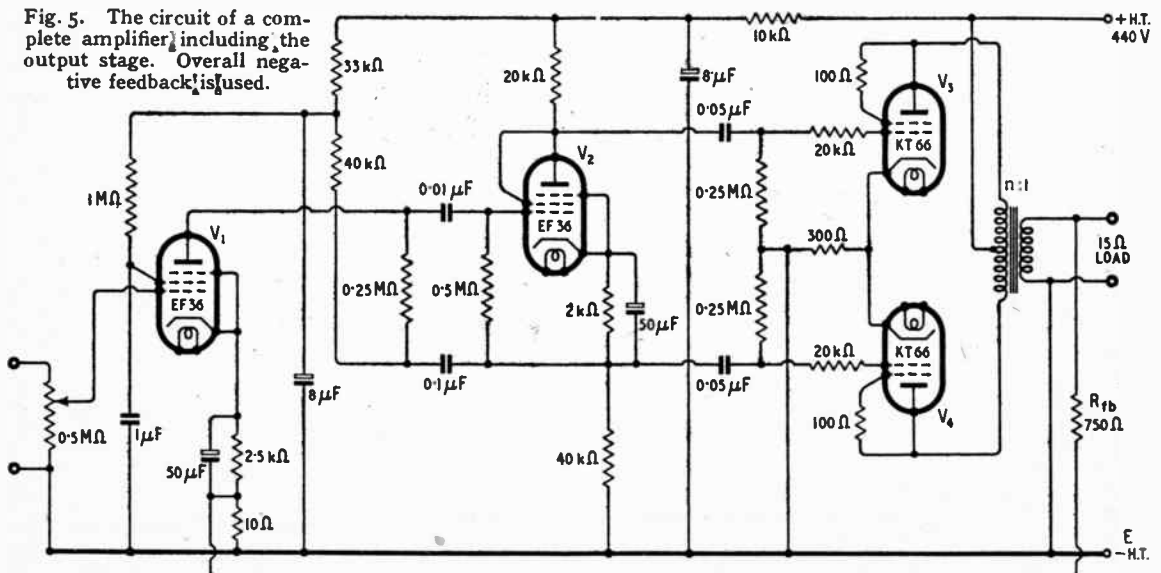

variety of amplifiers and has proved to be remarkably stable and free from undesirable traits.

A complete design is given in Fig. 5. KT 66 valves strapped as triodes have been used in the

$120/n^2$  ohms. It is illuminating to note that this latter value is less than that obtained by opera-

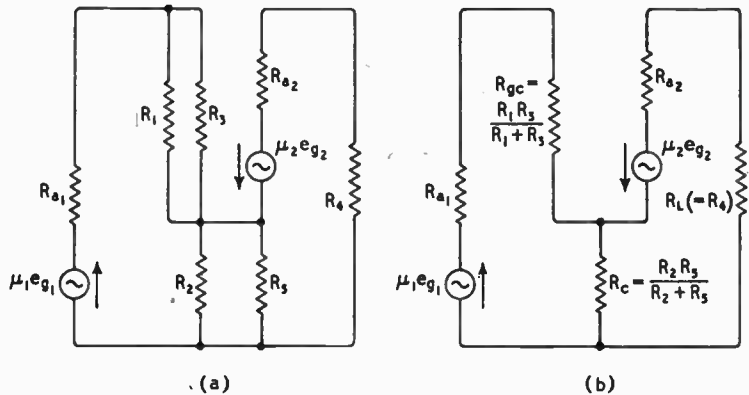

Fig. 6. The equivalent circuit of Fig. 4 can be drawn in the forms shown at (a) and (b).

output stage, this method of connection giving a performance roughly equivalent to that of the PX25 type with the added advantages of shorter grid swing, indirectly-heated cathodes and octal base.

Without negative feedback an output of 14.5W is obtained with less than 0.025V (R.M.S.) input. If negative feedback is applied as shown in Fig. 5 the required input voltage for maximum output is raised to 0.25V (R.M.S.). The negative feedback reduces

the same valves as a cathode-follower stage. Using a good quality output transformer the response, with overall negative feedback, was measured to be within  $\pm 1$  db from 25–20,000 c/s. If an output transformer of poorer quality is used the degree of feedback may have to be slightly reduced in order to satisfy the Nyquist stability criterion.

Where a greater output is required the KT 66 valves can be operated as tetrodes in the normal manner and 35 W can

the distortion content to 0.5 per cent at maximum output, while the output impedance becomes

then be obtained. The author favours however the use of four valves operating as triodes in

parallel push-pull where a large output is desired.

No originality is claimed for the circuit, as a search of the literature has shown that it appeared in the U.S.A. some years ago; however, so far as the author is aware no analysis of the circuit has previously been published.

**APPENDIX**

The input impedance of the cathode-follower phase-splitter of Fig. 1 is well known to be:

$$R_{in} = \frac{R_{a2} + (\mu_2 + 2)R_L}{R_{a2} + 2R_L} \times R_{gc} \dots (1)$$

when  $R_L = R_G$

If, as is frequently the case,  $R_L = R_{a2}$  then  $R_{in} \approx \frac{\mu_2 + 3}{3} \times R_{gc}$ .  
For a triode, with  $\mu_2$  between 20 and 30,  $R_{in} \approx 10 R_{gc}$ .

The amplification is given by:

$$\frac{e_{o1}}{e_{s2}} = \frac{e_{o2}}{e_{s2}} = \frac{\mu_2 R_L}{R_{a2} + (\mu_2 + 2)R_L} \dots (2)$$

If again  $R_{a2} = R_L$  this becomes

$$\frac{\mu_2}{\mu_2 + 3}$$

Then if  $\mu_2 = 20$ , gain  $\approx 0.9$ .

*Amplification of Pre-amplifier and Phase-splitter Together.*

The equivalent circuit of Fig. 4 is shown in Fig. 6(a) and 6(b).  $e_{p2}$  is the voltage developed across  $R_{gc}$ . Taking into account the sign of this voltage  $e_{o1}$  and  $e_{o2}$  can be found in terms of  $e_{p1}$  ( $= e_s$ ) and  $e_{o1}/e_{o2}$  represents the degree of unbalance of the system.

By writing the basic circuit equations from Fig. 6(b) expressions for amplification and unbalance are readily obtained. Thus if  $R_L = R_G$ :

$$\frac{e_{o2}}{e_s} = \frac{\mu_1^2(\mu_2 R_{gc} - R_c)}{(R_{a1} + R_{gc} + R_c) \left( \frac{R_{a2}}{R_{gc}} + 2 \right) + (\mu_2 R_{gc} - R_c)} \dots (3)$$

$$\text{and } \frac{e_{o1}}{e_{o2}} = \frac{\mu_2 R_{gc} - R_c}{\mu_2 R_{gc} + R_{a2} + R_c} \dots (4)$$

**Manufacturers' Literature**

The following lists have been received from Standard Telephones and Cables, Connaught House, Aldwych, London, W.C.2:—

- "Beam Approach Receiving Equipment Type KR/2."
- "Quartz Crystals in Evacuated Glass Envelopes."
- "Valves for Communications and Industry."

"The Royal Train"—a souvenir booklet, giving an account of the part played by Exide batteries, from The Chloride Electrical Storage Co., Grovenor Gardens House, London, S.W.1.

# Short-wave Conditions

## Expectations for August

By T. W. BENNINGTON

(Engineering Division B.B.C.)

**DURING** June the average daytime maximum usable frequencies were slightly lower than those for May, whilst due to the longer duration of daylight, the night-time M.U.F.s were about 1½ Mc/s higher than during that month. Communication on frequencies higher than 21 Mc/s was infrequent, particularly in east/west directions, and would, on an average, only have been possible over long distance routes to places in the high latitudes of the Southern Hemisphere. Medium frequencies—like 17 Mc/s—remained usable for very long periods, and 15 Mc/s could be used throughout the night on many circuits. Some medium distance communications on very high frequencies by way of Sporadic E occurred during the month.

There was less ionosphere storminess than during the previous three months, but June was on the whole more disturbed than is usual during this period of the year. The storms were mostly of short duration, and the most disturbed periods were the 1st, 5th-6th, 14th, 17th-18th, 20th-22nd, and 25th. Several "Delinger" fadeouts occurred, the most severe being at 1035 on the 5th, and 1036 on the 14th.

**Forecast.**—During August the

main of use throughout the night on many circuits.

The E and F1 layers will continue to control transmission over medium distances—between 600 to 1800 miles—for several hours during the day.

Sporadic E is likely to be somewhat less prevalent than during July, but communication by way of this medium may still be possible at times on very high frequencies up to a distance of about 1,400 miles.

Below are given, in terms of the Broadcast bands, the working frequencies which should be regularly usable during August for four long-distance circuits running in different directions from this country. All times in these reports are in G.M.T. In addition, a figure in brackets is given for the use of those whose primary interest is the exploitation of certain frequency bands, and this indicates the highest frequency likely to be usable for about 25 per cent of the time during the month for communication by way of the regular layers:—

<b>Montreal :</b>	0000	15 Mc/s	(22 Mc/s)
	0300	11 "	(10 "
	0900	15 "	(22 "
	1000	17 "	(24 "
	1900	21 "	(20 "
	2100	17 "	(24 "
<b>Buenos Aires :</b>	0000	17 "	(24 "
	0200	15 "	(22 "
	0700	11 "	(20 "
	0900	15 "	(23 "
	1000	17 "	(26 "
	1100	21 "	(20 "
	1500	26 "	(34 "
	2000	21 "	(20 "
2200	17 "	(26 "	
<b>Cape Town :</b>	0000	17 "	(24 "
	0200	15 "	(21 "
	0300	11 "	(18 "
	0500	15 "	(23 "
	0600	21 "	(30 "
	0800	26 "	(34 "
	1900	21 "	(30 "
	2200	17 "	(26 "
<b>Chungking :</b>	0000	15 "	(20 "
	0100	11 "	(19 "
	0300	15 "	(21 "
	0400	17 "	(24 "
	1300	21 "	(29 "
	1700	17 "	(24 "
	2100	15 "	(20 "

working frequencies for long-distance transmission should, generally speaking, be much the same as during July, although there will be a tendency for the daytime usable frequencies to be a little higher, and the night-time usable frequencies a little lower.

Working frequencies for long distance transmission should therefore continue to be relatively low by day and high by night, although towards the end of the month the higher short-wave frequencies—like 28 Mc/s—may begin to become more useful during the day, particularly to the southward of this country. Medium frequencies—like 17 Mc/s—should be usable for very long periods, and 15 Mc/s may re-

Ionosphere storms are not usually prevalent during August, and those that do occur do not, as a rule, cause any major interruption to radio communications.

At the time of writing it would appear that the most likely periods during which disturbances may occur are 1st-3rd, 7th-8th, 11th, 16th-18th, 22nd, 26th, 28th-30th.

# Television Receiver Construction

## 6—Cathode-Ray Tube Mounting

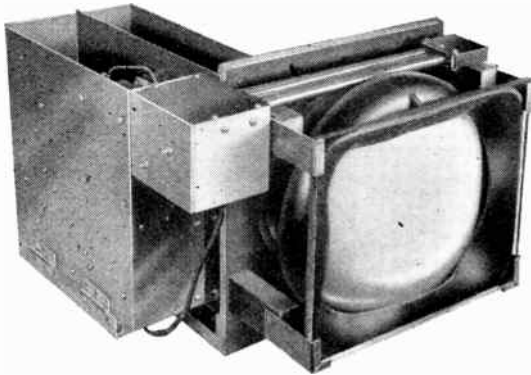

THE equipment is built in three units, apart from the power pack, which are carried by a framework providing also the mounting of the cathode-ray tube. Two of the units—the line and frame time-

The general framework not only holds the units and tube together, but it carries a few components and all the inter-unit wiring. This is shown in Fig. 1. The power input is brought to a tag-board by a 5-way cable and from there

distributed to the three units—6.3 V, - H.T. and + H.T.<sub>1</sub> directly, and + H.T.<sub>3</sub> through the focus coil after which it becomes + H.T.<sub>2</sub>.

As one heater lead is earthed in each unit it is necessary in making the interconnections to take particular care to see that all the earthy leads on the one hand and all the non-earthly ones on the other hand are joined together. If they are mixed up the 6.3-V supply will be short-circuited.

The focus coil is shunted by C<sub>2</sub> of 50 μF capacitance and by R<sub>2</sub> and R<sub>3</sub> in series; the latter forms the Focus Control. The grid of the tube is taken to the slider of the potentiometer R<sub>4</sub> across the H.T. supply and is bypassed to earth by C<sub>5</sub>; this potentiometer forms the Brightness

Control. Neither R<sub>3</sub> nor R<sub>4</sub> is mounted on the framework. They form the only panel controls of the set on the vision side and they are connected by a 4-way cable. They can thus

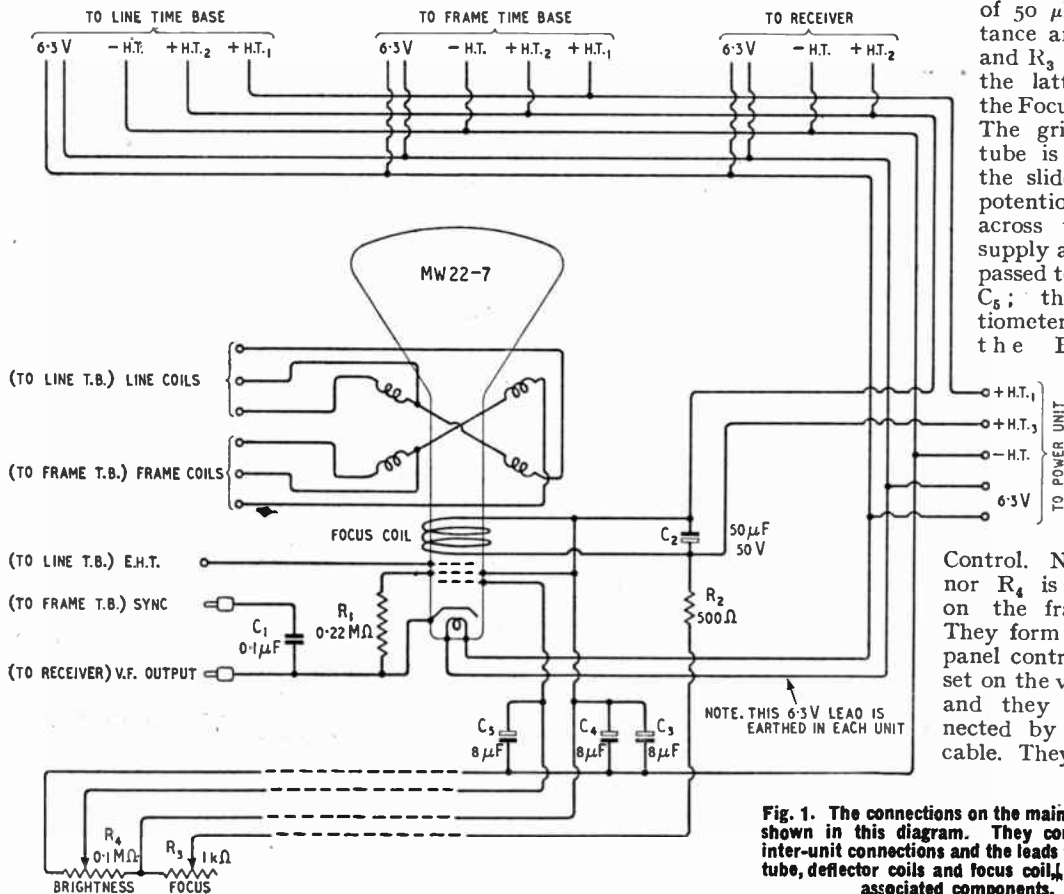
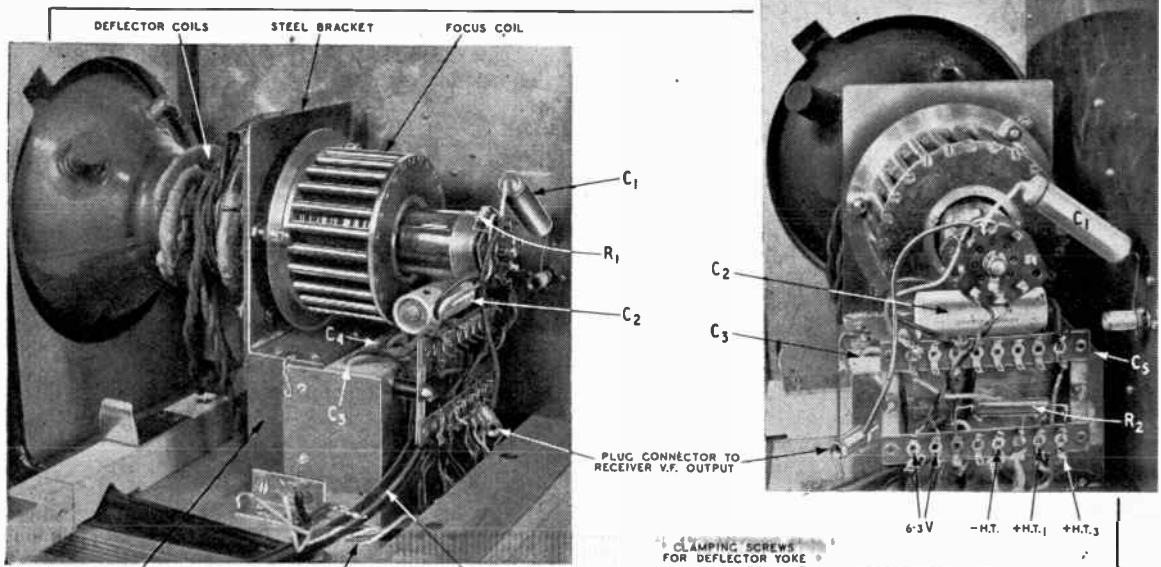

Fig. 1. The connections on the main frame are shown in this diagram. They comprise the inter-unit connections and the leads to the C.R. tube, deflector coils and focus coil, and a few associated components.



WOOD BLOCK  
 $4\frac{1}{2}$ " LONG, 3" HIGH,  
 $1\frac{1}{4}$ " THICK

POWER LEADS FOR RECEIVER UNIT

4-WAY CABLE TO BRIGHTNESS & FOCUS CONTROLS

CLAMPING SCREWS FOR DEFLECTOR YOKE

6-3V -H.T. +H.T.1 +H.T.3

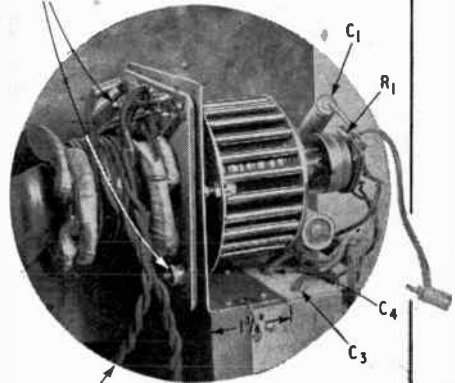

DEFLECTOR COIL LEADS TO LINE & FRAME TIME BASES

A view of the complete receiver assembly, except for the receiver unit, is shown below and the picture above shows the general arrangement of components around the C.R. tube. Other photographs depict the C.R. tube mounting, the focus and deflector coil assembly, and the tube base and tag board.

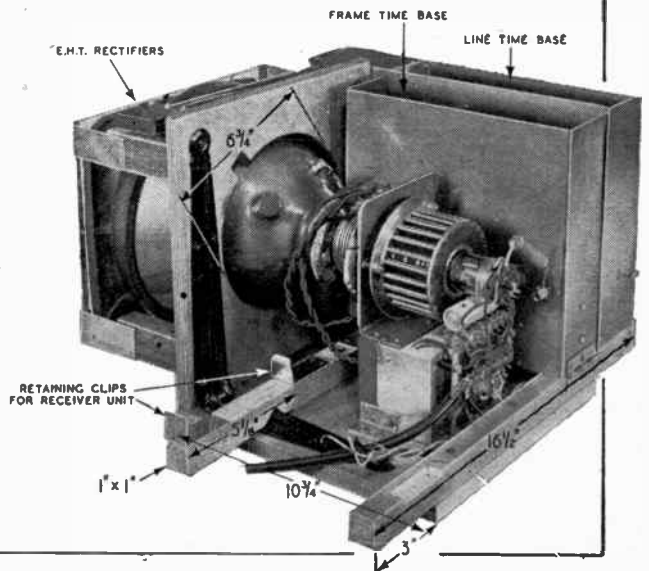
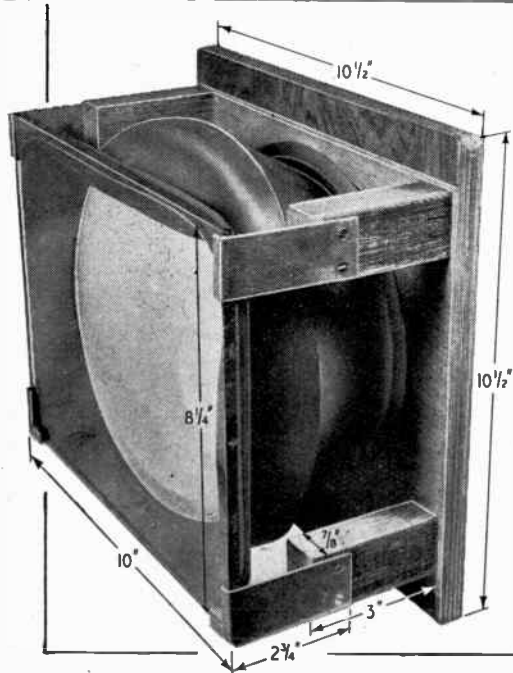

**Television Receiver Construction—** be mounted in any convenient position on the containing cabinet. They will vary according to individual requirements.

The cathode of the tube is connected by a short lead terminating in a wander-plug to a socket on the Receiver Unit and also through a 0.1- $\mu$ F capacitor  $C_1$  and another wander-plug to the Sync socket on the Frame Time-Base Unit. The capacitor must have a low capacitance to earth and so is inserted in the lead and supported by its connections. The resistor  $R_1$  of 0.22 M $\Omega$  is merely to prevent the tube cathode circuit from becoming open if the wander-plug is inadvertently removed with the set switched on.

The tube used is the 9-in Mullard MW 22-7 and it has a tetrode gun. The first anode requires about 200-250 V and is connected directly to + H.T.<sub>2</sub>; the second anode needs about 5 kV and is joined to the E.H.T. supply in the Line Time-Base.

Other tubes can be used with the obvious alterations dictated by physical size, provided that the electrical requirements are similar. It is necessary that the tube neck should not exceed 35.5 mm, since the focus and deflector coils are

possible to obtain a picture of the full width.

Larger tubes than the 9-in can be used with obvious alterations to the mounting. The deflection angle is usually about the same so that no scanning difficulties arise. The brightness will be less with a larger tube, however, but should be adequate for most purposes up to the 12-in type. Ideally one would increase E.H.T. with a larger tube, but this would entail an increase of scan power which is difficult to obtain without using more valves and increasing the demands on the H.T. supply.

Tubes with different heater voltage ratings are easily accommodated by providing an extra suitable winding on the mains transformer. One word of warning is needed, however; before the war some tubes had the cathode internally connected to one side of the heater and this practice may still be adopted in some. A tube of this type is unsuitable for this set, since it must have the V.F. signal fed to the cathode, which demands a tube with an adequate heater-cathode insulation.

In order to make use of a tube with heater and cathode joined it is necessary to fit an extra

It is not necessary that the tube used should have a tetrode gun. The more usual triode gun is quite satisfactory. The writer has used in this equipment a pre-war tube with a 2-V heater and a triode gun with very good results. With this type of tube some increase in the values of  $R_2$  and  $R_3$  may be found necessary since the focus-coil current needed is usually greater with the triode gun than with the tetrode. Because of this there is likely to be rather more change of focus with temperature.

As the photographs show, the framework consists of a plywood base carrying a plywood front by two stout brackets. The front has a hole of 6 $\frac{1}{2}$ in diameter which is bevelled out to 7 $\frac{1}{4}$ in at the front. A length of rubber draft-excluder is tacked around the edge to form a resilient support for the tube. A notch is cut out of the hole opposite the join in the rubber seating to give clearance to the sealing-off cover on the tube.

A moulded rubber mask is fitted to the tube and is faced by a sheet of  $\frac{1}{4}$ -in plate glass roin by 8 $\frac{1}{4}$ in, held in place by brass corner supports screwed to wooden stand-off pieces.

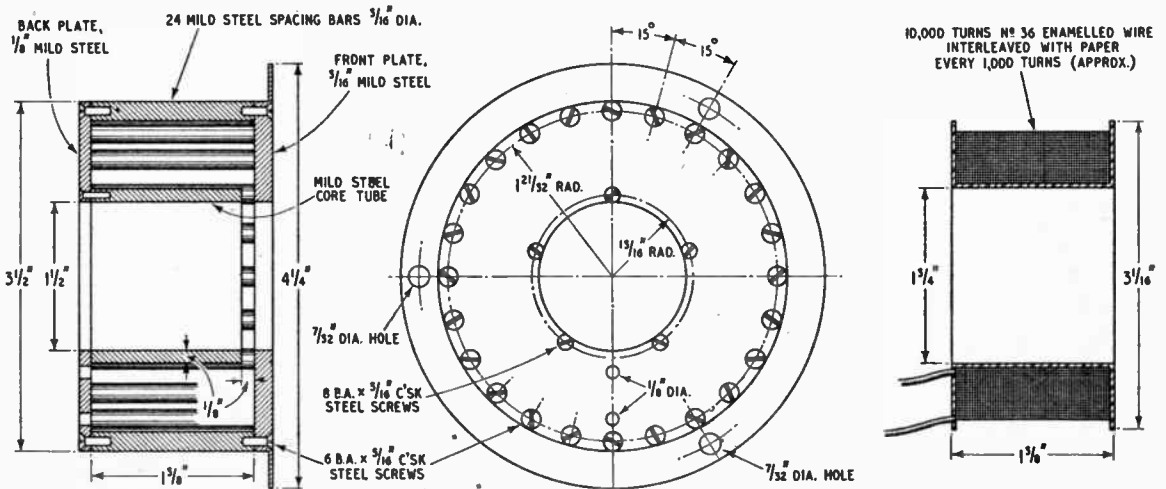

Full details are given here of the focus coil. As explained in the text the 24 spacing-bars are used only because of the difficulty of obtaining large diameter steel tubing.

designed for this. This diameter is more or less standard, however. The angle subtended by the picture width at the centre of the deflection yoke should not exceed 48° otherwise it may not be

stage of unity gain to reverse the phase of the signal. A D.C. restoring diode is also needed, since it is inadvisable to connect the tube grid directly to the anode of a V.F. stage.]

The focus coil and deflector coil assembly are carried by a steel bracket supported in its turn by a block of wood, which carries the various capacitors and a tag strip. A sketch giving



details for making the mounting bracket will be found on page 284. Two 1-in strips of wood, one of which has cut-outs to clear the brackets, are screwed across the base to carry the units. Hinges on the rear of the Receiver and Frame Time-Base units are screwed directly to the rear strip. The Line Time-Base hinges are screwed to a cross piece joining the ends of the two strips. A metal sheet is erected between the two time-base units to provide inter-unit screening. It is, of course, earthed to - H.T.

Details of the deflector coils have already been given and the assembly is held to the bracket by two screws fixed to the latter. Milled nuts permit the assembly to be slackened easily so that it can be rotated slightly about the neck of the tube, and so bring the picture square with the mask.

The focus coil is held to the rear of the bracket on three short lengths of 2 B.A. studing. On one of these a short, strong spring is placed between the coil and the bracket with lock-nuts to hold the coil on. On the other two half-nuts are used, one each side of the coil flange. By slacking these nuts the focus coil can be tilted for centring the picture in the mask. The use of a spring for the third avoids the need for access to a rather awkwardly placed nut.

Details of the focus coil itself are given in one of the drawings. It comprises front and back-end plates of mild steel held apart by 24 mild-steel spacers around the outer edges. Inside there is a core tube, which is  $\frac{1}{8}$  in shorter than the spacers so that there is a  $\frac{1}{8}$ -in gap between the end of the core tube and the front-end plate. It is in this gap that the magnetic field for focusing is developed.

The 24 spacers complete the

magnetic circuit and are adequate for this purpose. It is more usual to employ a piece of large-diameter tubing of  $\frac{1}{8}$ -in to  $\frac{3}{16}$ -in wall, in place of them. With such a piece of tubing the construction would be

to use steel screws than brass for holding the parts together.

The winding consists of 10,000 turns of No. 36 enamelled wire. The coil resistance is 1,000  $\Omega$  and it requires a current of about

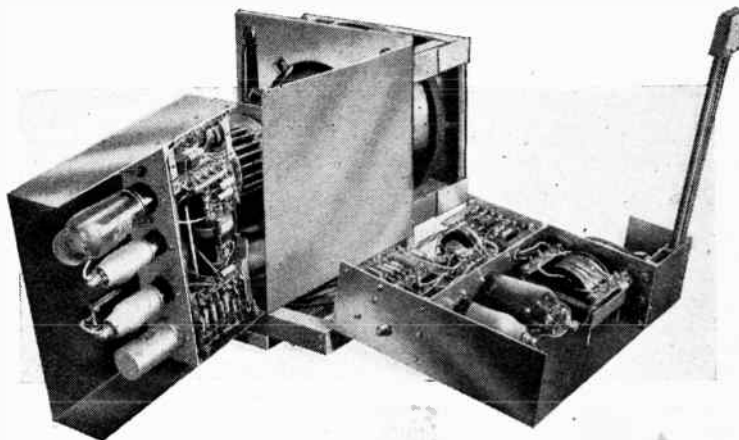

A rear view of the assembly showing the frame and line time-base units opened out for access to the interior. The only connection that need be broken is the plug-connector to the "Sync Input" socket on the frame unit.

easier since only six fixing screws would be needed at each end instead of twenty-four, so that thirty-six fewer holes would have to be drilled and tapped.

However, steel tubing of the requisite diameter is extremely hard to obtain in short lengths and the construction with separate spacers was adopted as a practicable alternative. Incidentally ordinary 5-in wire nails represent the most easily obtainable material for the spacers! Tubing is necessary for the core piece, but because of its smaller diameter it is not unduly difficult to obtain.

A lathe is almost essential for making the focus coil, since it is necessary for the ends of the core tube to be true. It is advisable, although not essential, to true up the ends of the spacers in a lathe and it is also better

45 mA for focusing. The coil is inserted at a point where the current is about 90 mA, and is shunted by resistance to by-pass 45 mA. The resistor is variable as a focus control and has a 500- $\Omega$  fixed resistor in series to limit the range as already explained.

#### Corrections and Additions

In Part 4, the frame scan output valve was given as type CL33 instead of EL33 in the parts list.

In Part 5, the line scan output valve was incorrectly shown in the circuit and in the list of parts as type EF38. It should, of course, be type EL38, and was correctly referred to in the text.

The rectifiers  $W_1$  and  $W_2$  were also listed as Siemens Type H4/200 instead of Standard Telephones & Cables, Selenium Rectifiers, Type H4/200.

Details of the laminations used in the line-scan output transformer were inadvertently omitted from Part 5. The ones used are Joseph Sankey & Sons, No. 4 or 4A, Richard Thomas & Baldwins' Type C.10 or Magnetic & Electric Alloys No. 4 or 4A, silicon steel and a  $\frac{1}{2}$ -in. stack is needed. The No. 4 differs from the No. 4A and C.10 in not having clamping holes in the corners and so with it the clamping screws must pass outside the laminations instead of through them.

#### LIST OF COMPONENTS.

##### Capacitors

$C_1$ .. ..	0.1 $\mu$ F, 500 V working .. ..	T.C.C. type CP435
$C_2$ .. ..	50 $\mu$ F, 50 V electrolytic .. ..	Dubilier Drilitic BR505
$C_3, C_4, C_5$ ..	8 $\mu$ F, 500 V working, electrolytic	B.I.

##### Resistors

$R_1$ .. ..	0.22 M $\Omega$ $\frac{1}{2}$ W .. ..	Erie
$R_2$ .. ..	500 $\Omega$ 3 W .. ..	Welwyn
$R_3$ .. ..	1,000 $\Omega$ 5 W variable .. ..	Reliance Type TW
$R_4$ .. ..	100 k $\Omega$ variable .. ..	Reliance Type SG

##### Miscellaneous

Cathode-ray tube, 9-in .. ..	.. ..	Mullard MW22-7
Cathode-ray tube mask (for Mullard MW22-7 tube)	.. ..	Long & Hamblin

# Tuned A.F. Filters

THE frequency response curve of a crystal pickup is well known to depend largely upon the load resistance employed, due to the capacitive nature of the pickup, and control of low-frequency response by variation of load resistance is often advocated. The solid curve of Fig. 1 (a) shows an average response curve for a load of 500,000 ohms whilst an ideal pickup response is indicated by curve (b). The rise in the bass, of course, required to compensate for the deliberate recording attenuation of 6 decibels per octave of frequencies below 250 c/s.

It will be seen that the output from the pickup is correct at 50 c/s and at 1,500 c/s, but between these limits the output level is too high.

Reducing the load resistance merely attenuates the lowest frequencies which are in any case only just of adequate intensity.

Table I shows the attenuation required to correct the pickup response at frequencies between 50 and 1000 c/s, and it will be seen that the required attenuation reaches a maximum of 10 db at 250 c/s, falling off in a regular manner on each side of this frequency.

TABLE I

Attenuation Required to Correct Pickup Response

Frequency (c/s)	Attenuation (db)	Frequency (c/s)	Attenuation (db)
50	-0.7	300	8.9
60	0.7	400	6.9
70	1.7	500	5.1
80	2.9	600	3.9
90	3.6	700	2.8
100	4.4	800	2.0
200	8.5	900	1.5
250	9.8	1000	1.0

It is apparent that at 75 c/s and at 800 c/s the required attenuation falls to the negligible value of 2 db and for these two frequencies the values of  $(\frac{f_0}{f} - \frac{f}{f_0})$ , where  $f_0 = 250$ , are -3.0 and +2.9 respectively. Thus the required attenuation is at least approximately symmetrical about

## 2—Designing a Correction Filter for a Crystal Pick-up

By  
H. E.  
STYLES  
B.Sc.

a frequency  $f_0 = 250$  on an  $(\frac{f_0}{f} - \frac{f}{f_0})$  basis, which suggests that the required correction might be obtained by means of a flatly tuned rejector or acceptor filter as described in the previous part of this article.

For reasons given in the article referred to above, an acceptor circuit is preferable for the correction of pickup response, and in any case will require more convenient component values.

From the design data already given\* we find that if an effective

attenuation of 10 decibels is required at a frequency  $f_0 = 250$ , the value of  $Q (\frac{f_0}{f} - \frac{f}{f_0})$  at which the attenuation falls to 2 db amounts to 3.8. Since  $(\frac{f_0}{f} - \frac{f}{f_0})$  approximates to 3.0 it follows that the required value of  $Q$  must be 1.3.

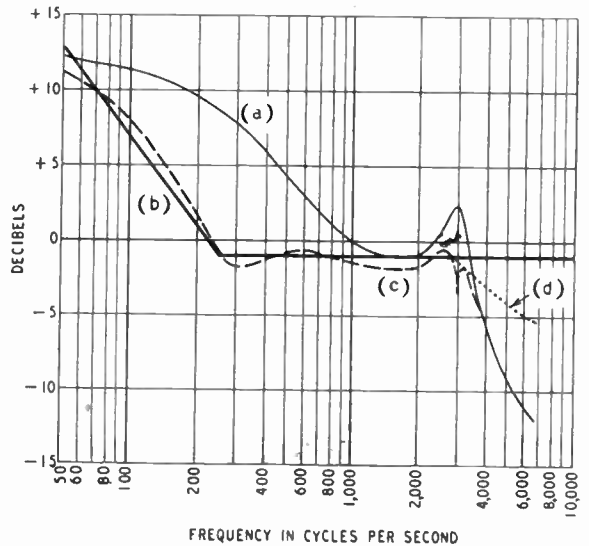

Fig. 1. (a) Response curve of a crystal pickup with 0.5MΩ load. (b) Ideal pickup response. (c) Pickup with filter. (d) Effect of 0.0002μF shunt across resistance S in Fig. 3.

Thus for the correction filter circuit given in Fig. 2, we have the following design data.

$$Q = 1.3$$

$$f_0 = 250$$

$$F_0 = 0.32 \text{ (i.e., -10 db)}$$

$$r = \frac{F_0 SR}{(1 - F_0)(R + S)}$$

$$L = \frac{Qr}{2\pi f_0}$$

$$C = \frac{1}{2\pi f_0 Qr}$$

As already stated, the response curve of the pickup varies considerably with variation in load resistance and the data given in Table I are based upon a fixed load of 500,000 ohms.

\* Incidentally, the title of Table I in the previous instalment should read "when maximum attenuation at  $f_0$  is as indicated".

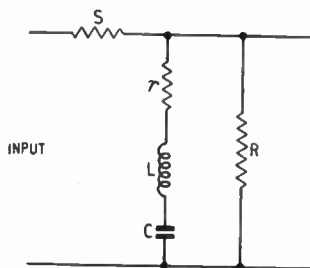

Fig. 2. Basic low-frequency correction circuit.

In order, therefore, to ensure reasonable compliance with this requirement it is necessary to limit the variation of the filter input impedance to say 600,000 ohms maximum and 400,000 ohms minimum.

needle and movement, and whilst this is not of very great magnitude it does produce a certain degree of needle scratch due to shock excitation of the movement. The precise frequency and amplitude of the peak may vary somewhat

TABLE II  
Attenuation Produced by Filter of Fig. 2

Frequency (c/s)	Absolute Attenuation (db)	Effective Attenuation (db)	Frequency (c/s)	Absolute Attenuation (db)	Effective Attenuation (db)
50	8.5	0.9	500	12.2	4.6
70	9.2	1.6	600	11.0	3.4
100	10.9	3.3	700	10.3	2.7
150	13.7	6.1	800	9.7	2.1
200	15.2	7.6	900	9.2	1.6
250	17.6	10.0	1000	9.0	1.4
300	17.2	9.6	1500	8.5	0.9
400	13.7	6.1	—	—	—

Hence  $R + S = 600,000$  and since  $R$  will normally be a volume control its value can be made 250,000 ohms, in which case  $S$  will have to be made 350,000 ohms, a value which will obviously give a minimum input impedance of about the desired amount.

Thus  $r = 68,500 \Omega$ ,  $L = 57 \text{ H}$ .  $C = 0.0072 \mu\text{F}$ . Using these values, the circuit of Fig. 2 will produce a constant attenuation of  $\frac{R}{R + S}$  or 7.6 db at frequencies far from resonance, the attenuation at frequencies between 50 and 1500 c/s being as given in Table II.

It will be seen that the effective attenuation produced by the filter corresponds well with the attenuation required to correct the pickup response, curve (c) in Fig. 1 showing that the corrected response curve nowhere departs from the ideal curve by more than 2 db between 50 and 2,000 c/s.

The output from the pickup and filter combination will, of course, be 8.6 db below the normal output at 1,000 c/s. And since the latter is usually about 1.6 volts, the mean output from the combination will approximate to 0.6 V.

There remains the peak in the response curve at 3,000 c/s resulting from resonance of the pickup

and it is therefore desirable to provide a tunable correction filter with a fairly sharp cut-off. With such a filter a certain degree of over correction will produce no noticeable attenuation, whilst at the same time it will provide a means of ensuring elimination of needle scratch reproduction. It will be observed, that owing to the general fall in response level at high frequencies the resonance peak is sharper on the high-frequency side, and in order to avoid further attenuation of the higher frequencies it is desirable to ensure that the correction filter should produce an attenuation of not more than 2 db at say 3,300 c/s corresponding to a value of  $\left(\frac{f_0}{f} - \frac{f}{f_0}\right)$  equal to 0.19.

If the filter is designed to produce a maximum attenuation of 6 db (i.e.,  $F_0 = 0.5$ ) at the resonant frequency  $f_0 = 3,000$  c/s, the value of  $Q \left(\frac{f_0}{f} - \frac{f}{f_0}\right)$  corresponding to -2 decibels will be 2.0 from which it is evident that  $Q$  must be 10.

Now at frequencies around 3,000 c/s the pickup output does not vary much with variation in load resistance and it is therefore permissible to introduce a retractor circuit as shown in Fig. 3.

At frequencies around 3,000 c/s the effect of the shunt circuit  $L, C, r$ , may be ignored and hence the circuit of Fig. 3 becomes in effect a retractor circuit in which  $L_1, C_1$  and  $r_1$  form the tuned circuit and  $R + S$  the total series resistance, the output being in effect tapped down to a fraction  $\frac{R}{R + S}$  of the voltage developed across  $R + S$ .

Thus we have for this retractor circuit.

$$f_0 = 3,000$$

$$F_0 = 0.5$$

$$Q = 10$$

$$R = 600,000$$

$$\text{Hence } r_1 = \frac{R(1 - F_0)}{Q^2 F_0} = 6,000 \Omega$$

$$L_1 = \frac{Q r_1}{2 \pi f_0} = 3.2 \text{ H}$$

$$C_1 = \frac{1}{2 \pi f_0 Q r_1} = 0.00088 \mu\text{F}$$

The attenuation produced by this filter is given in Table III.

TABLE III  
Attenuation Produced by Retractor Circuit

Frequency (c/s)	Attenuation (db)	Frequency (c/s)	Attenuation (db)
2,600	1.3	3,200	3.2
2,800	3.1	3,400	1.5
3,000	6.0	3,600	0.8

Curve (c) in Fig. 1 also includes the correction produced by this filter, which should be carefully tuned to eliminate scratch, and it will be seen that the overall corrected response nowhere differs by more than 2 (db) from the ideal curve between 50 and 3,500 c/s.

Frequencies above 4,000 c/s are considerably attenuated, but for

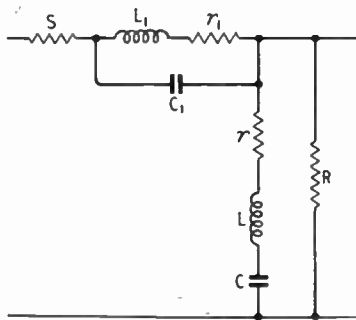

Fig. 3. Circuit with the addition of a retractor for the 3,000 c/s needle resonance.

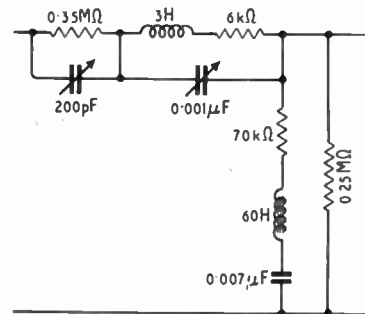

Fig. 4. Final circuit with component values.

most recordings this is not of any great consequence. Nevertheless, if desired, a certain degree of high-frequency lift can be obtained by shunting resistance *S* with a variable condenser of about 0.0002  $\mu$ F capacity, the most suitable value being obtained experimentally. In this manner the

response at 6,000 c/s can be lifted by 5-6 db, as indicated by curve (d) in Fig. 1, without appreciably affecting the level at frequencies of 3,000 c/s or less.

The final correction circuit is shown in Fig. 4 in which the approximate component values are given.

will then be possible to have C.R. tubes side by side, one showing the picture received directly from Alexandra Palace and the other a picture relayed to Bromley and then back to Danbury. By comparing the two pictures the effect of a two-step relay will be immediately obvious.

Our cover picture shows the horn aerial used on the vision transmitter together with a second experimental horn and the Yagi aerial of the sound transmitter.

## Marconi Television Link

**A** DEMONSTRATION was given on June 17 of an experimental television relay link by Marconi's W.T. Co. The Alexandra Palace transmission was received at Danbury, near Chelmsford, and re-transmitted to a receiving site at Great Bromley, close to Colchester, the distance of the relay being about 24 miles.

also and a power of 100 milliwatts.

The programme for the demonstration originated in Ascot, so that as seen at Bromley, it travelled by the B.B.C. outside-broadcast link to Alexandra Palace, from there to Danbury by the normal television transmission, and from Danbury to Bromley by the Marconi link. In spite of its many transformations the received picture was extremely good and appeared to have suffered little, if at all, in the last stage of its journey.

In order to judge the precise effect of the link on picture quality it would be necessary to compare relayed and unrelayed pictures side by side. It is understood that the Marconi Co. hope to carry out such a trial by erecting a further link back from Bromley to Danbury. It

## BOOKS RECEIVED

**The Cathode-Ray Tube Handbook** (Second Edition).—By S. K. Lewer, B.Sc. Other than the sections which have been added to the chapter covering the application of the cathode-ray oscillograph, the material is unchanged. 103 pages with 36 figures. Sir Isaac Pitman and Sons, Ltd., Parker Street, Kingsway, London, W.C.2. Price 6s.

**Capacitors—Their Use in Electronic Circuits.**—By M. Brotherton, Ph.D. (Bell Telephone Laboratories, Inc.). In this book the author has attempted to bring together in a form suitable for quick reading the material needed by a circuit designer to enable him to evaluate his requirements 107+vii pages with 33 diagrams. D. Van Nostrand Co., Inc., New York. English publishers, Macmillan and Co., St. Martin's Street, London, W.C.2. Price 16s 6d.

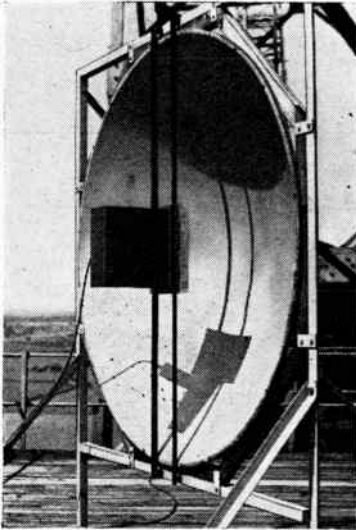

The receiving paraboloid with the input stages of the receiver.

The vision channel was 510 Mc/s (60 cm) and employed a carrier power of some 5 watts. Frequency modulation was used, largely because of the constancy of the receiver output obtained through the use of limiters. The transmitting aerial took the form of a horn radiator mounted on a mast 40 ft above ground and energized by a probe.

At the receiving end a paraboloid reflector was used and carried at the 200-ft level on a mast. For the sound channel the transmitting aerial was a Yagi with a cylindrical reflector and eight directors. Frequency modulation was used here

## Television Receiver Construction

(See page 278-281)

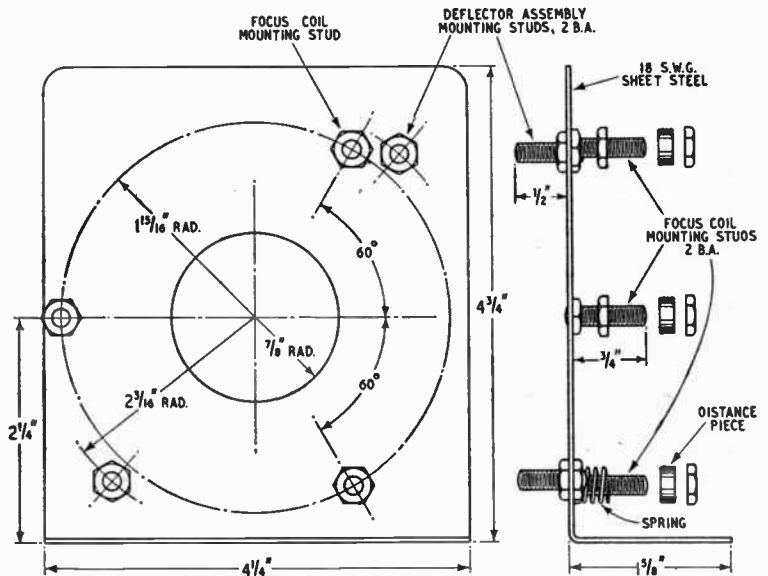

Constructional details for making the steel bracket that carries the focus and deflector coil assemblies.

# WHEN 15D1 NEEDS ARISE — KNOWING DEALERS ★ BRIMARIZE

Types 15D1 and 15D2 are identical except that the heater current of the former is 0.2 amp. whilst that of the latter is only 0.15 amp. In AC/DC receivers where the heaters are wired in series, it will therefore be necessary to wire a resistor in parallel with the 15D2 heater to carry the extra 0.05 amp. This resistor will, of course, not be needed in A.C. receivers where heaters are in parallel.

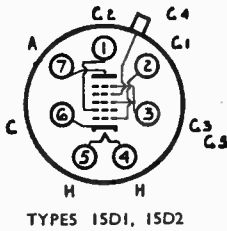

### RATED CHARACTERISTICS

	15D1	15D2
Heater Volts	13.0	13.0V
Heater Current	0.2	0.15A
Anode Volts	250V	250V
Anode Current	3.5mA	3.5mA
Screen Volts	100V	100V
Screen Current	2.2mA	2.2mA
Grid Bias	-3V	-3V
Conversion	0.55mA/v	0.55mA/v

PUNCH HOLES HERE

15D1  
INSTRUCTIONS: Punch holes where indicated and cut away this portion. Cut out and file them in the order in which they appear. This column will then give you a quick reference index.  
5

TYPE	CHANGE SOCKET		CHANGE CONNECTIONS		OTHER WORK NECESSARY	PERFORMANCE CHANGE
	FROM	TO	FROM OLD SOCKET	TO NEW SOCKET		
15D2	ENGLISH 7-pin	NO CHANGE	NO CHANGE	NO CHANGE	In AC/DC receivers a 250-ohm resistor must be connected in parallel with the heater (between pins 4 and 5)	NONE

## BRIMAR

RADIO VALVES

★ OPERATION BRIMARIZE  
—a manoeuvre executed by qualified radio engineers in order to effect the widest possible use of available BRIMAR VALVES.

STANDARD TELEPHONES AND CABLES LIMITED, FOOTSCRAY, SIDCUP, KENT.

WATCH THIS SERIES FOR THE BEST ADVICE

# Judge your success by an **ffrr** test

Whether you build a high fidelity radiogram or just a straight record reproducer, give it a fair test with an ffrr record. Don't ask it to reproduce frequencies that aren't there. Decca ffrr recordings cover from 30 to 14,000 cycles per second. Any of the following records made the Decca ffrr way will instantly tell you how far you have reached that high degree of fidelity which was your aim. If your local dealer cannot supply you with these ffrr records please write direct to us.

*Full Symphony Orchestra*

**Fire Bird Suite** (*Stravinsky*)  
London Philharmonic Orchestra  
Conductor : Ernest Ansermet **AK 1574-6**

*Full Symphony Orchestra*

**March Slav. Op. 31** (*Tchaikovsky*) Parts 1 and 2  
National Symphony Orchestra  
Conductor : Anatole Fistoulari **K 1282**

*Choir, Soprano and Contralto soloists, and String Orchestra*

**Stabat Mater** (*Pergolesi*) Parts 1-10  
Nottingham Oriana Choir with Joan Taylor (*Soprano*)  
Kathleen Ferrier (*Contralto*)  
and the Boyd Neel String Orchestra **AK 1517-21**

*String Orchestra, with flute, oboe, violin and trumpet soloists*

**Brandenburg Concerto No. 2 in F major** (*Bach*)  
Parts 1-4  
Boyd Neel Orchestra with Arthur  
Gleghorn (*flute*) Evelyn Rothwell (*oboe*)  
Frederick Grinke (*violin*) and  
George Eskdale (*trumpet*) **AK 1550-1**

*Solo Soprano (boy), male voice Choir, and Organ*

**Hear my prayer** (*Mendelssohn*)  
**O for the wings of a dove** (*Mendelssohn*)  
Derek Barsham (*Boy Soprano*) with the High  
Wycombe Orpheus Male Voice Choir Conductor .  
W. Bromage Smith Organist : J. B. Harris **K 1111**

*Violin and piano*

**Sonata in G minor** (*Tartini*) Campoli (*violin*)  
with Eric Gritton (*piano*) **K 1531-2**

*Solo piano*

**Sonata in E major** (*Schubert*)  
Kathleen Long (*piano*) **AK 1180-2**

*Rumba band*

**Maracas,**  
**Another night like this**  
Edmundo Ros and his Rumba Band **F 8777**

*Swing band*

**The best years of our lives**  
**Try a little tenderness.** Ted Heath and his  
Music Vocalist Paul Carpenter **F 8776**

# Decca *living music*

The Decca Record Company Limited, 1-3 Brixton Road, London, S.W.9

# Moving Iron Pickups

## Effect of Inductance on Frequency Response

By E. H. FRANCIS

IT is the purpose of this article to underline certain features of miniature moving-iron pickups which should be appreciated to obtain most satisfactory results. These important features are: (1) The frequency response of the pickup; (2) the impedance/frequency characteristic in association with the input transformer; (3) the frequency correction necessary for playing ordinary recordings.

Some experiments with the E.M.I. Type 12 ("Hypersensi-

pickup winding, and the necessity for care in choice of coupling component values.

Dealing first with the H.F. end (i.e., frequencies above 1,000 c/s), curve 1 of Fig. 1 shows the output with the secondary of the step-up transformer (as supplied with the Type 12 pickup; ratio approximately 1:100) connected directly to a medium-slope triode amplifier. The curves of Fig. 1 were taken using H.M.V. test records DB4034 to 4037 and with the transformer feeding into

put of the amplifier was measured with a meter accurately calibrated in decibels. The zero level is an arbitrary one, and small fluctuations of the order of  $\pm 1$  db have been smoothed out as they were not likely to be due to the pickup.

The point to note is that the output increases considerably above 4,000 c/s due mainly to the needle resonance which occurs at 9 to 10 kc/s, and due also to some extent to resonance in the transformer secondary circuit. The reason for the transformer resonance will be seen in a moment.

Turning now to the impedance of the pickup; its winding resistance is approximately 6 ohms, but there is also inductance of the order of one millihenry. Fig. 2 shows the impedance, and also the reactive component, over the frequency range at the pickup terminals, and also on the secondary of the 1:100 transformer. Taking 8,000 c/s by way of example, the secondary impedance contains 500,000 ohms (approximately) of inductive reactance, and thus a circuit stray capacitance (i.e., total of winding capacitance and valve input capacitance) of only 40 pF approximately is required to give resonance at this frequency. The equivalent circuit at the transformer secondary is shown in Fig. 3; the increased gain at the resonant frequency is due to the resonant rise in voltage across the

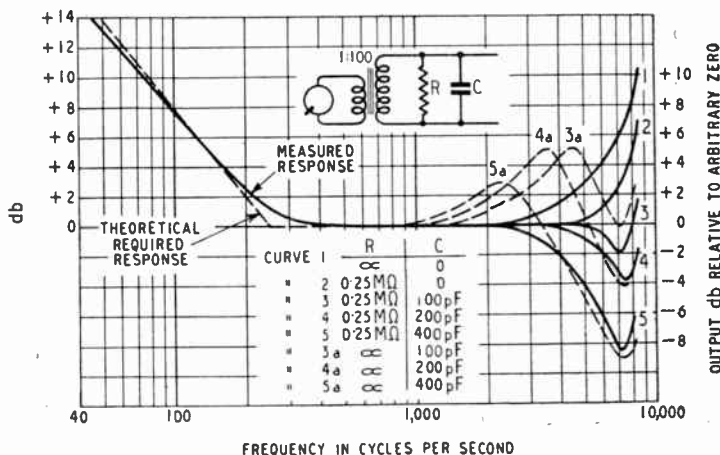

Fig. 1. Frequency response of pickup (including bass compensation) for various loads on secondary of coupling transformer.

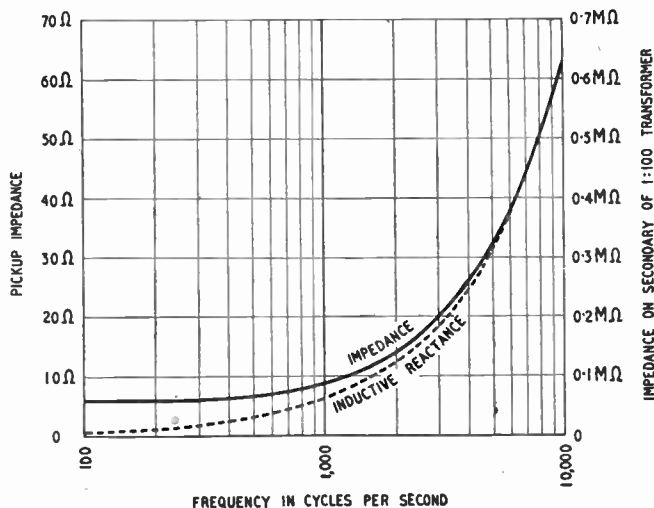

Fig. 2. Impedance and inductive reactance curves above 100 c/s.

tive") pickup may serve to draw attention to the importance of the inductive reactance of the

an amplifier whose gain/frequency response was flat between 1,000 and 10,000 c/s. The out-

**Moving Iron Pickups—**

circuit capacity  $C_s$  being applied to the valve grid. Curves 3a, 4a and 5a of Fig. 1 show the effect more clearly when the capacity  $C_s$  is increased by the addition of 100, 200 and 400 pF condensers respectively.

**Top Cut**

Allowing for the deficiency of the average speaker above 5 kc/s, the rising response of the pickup aided by the secondary circuit resonance might appear to be an advantage. In practice this is not so, and surface noise and higher frequencies are unduly prominent. It is necessary therefore to take steps to attenuate the higher frequencies, in fact to avoid the distortion which occurs on the louder passages of almost all recordings it is necessary to aim at the sharpest possible cut-off. The makers of the pickup recommend the use of filters to give the following characteristics:—

Frequency (kc/s)		Attenuation (db)
New Records	Old Records	
6	4	6
7	5	15
10	7	30

Only a proper low-pass filter comprising coil and condenser networks (difficult to construct and test for the amateur) could give such a sharp cut-off, but if one assumes some discrimination will be used in rejecting inferior quality or worn recordings, a less sharp cut-off can be allowed with corresponding improvement in reproduction.

Fortunately, for this purpose the resonance referred to above comes in useful, as referring to Fig. 3 it will be seen that the circuit is similar to that of a half-section low-pass filter. Referring again to Fig. 1, curves 2 to 5 show the effect of a 0.25 MΩ shunt resistance and various capacities connected in parallel across the secondary terminals of the transformer. A capacity of 200 pF with 0.25 MΩ shunt in parallel gives a curve which is very satis-

factory in practice, but as will be seen from the curve, the output begins to rise again above 7 kc/s. If desired a filter circuit in the amplifier (tuned to 9 kc/s) may be used to ensure further attenuation of frequencies above 7 kc/s. Suitable circuits are described later.

The final circuit of a gramophone pre-amplifier stage used by the author is shown in Fig. 4. Points to note are that the top cut-off condenser  $C_1$  has been made 300 pF variable, further top-cut is given by  $C_2$ , a value of 0.002 μF being suitable. A tone control of the variable resistance-capacity type has been included ( $R_6$ ,  $C_3$ ). This latter control operates lower in the scale than  $C_1$  and  $C_2$  and forms a useful control of tonal balance, as some recordings, notably American, appear to have pre-emphasis of the higher frequencies. The components  $R_1$ ,  $R_4$ ,  $R_5$  and  $C_5$  comprise the main correction circuit for the L.F. recording characteristic giving about 10 db lift at 50 c/s. Additional lift of about 4 db at 50 c/s is given by  $R_1$ ,  $R_2$  and  $C_4$ .  $R_1$  and  $R_2$  also provide the 0.25 MΩ closing resistance for the transformer. The measured L.F. curve including this correction is shown

arm mechanical resonance at about 20 c/s.

$V_1$  is a triode of about 10,000Ω impedance. Should a higher impedance triode be used  $R_3$  should be omitted. If higher gain is required from this stage a pentode may be used. In this case  $R_3$  and  $R_4$  should be omitted, and the anode load resistance made 100 kΩ; suitable other components are, cathode resistor and condenser 1,500Ω and 25 μF, screen resistor and condenser 470 kΩ and 0.5 μF.

One final word on the operation of the control in the pre-amplifier (Fig. 4). On most new English recordings  $R_6$  needs adjustment for maximum top and on good recordings  $C_1$  may be adjusted to allow the full frequency range. On worn records or records with pre-emphasis  $R_6$  is used to reduce surface noise and high frequencies and  $C_1$  will help in these respects and also to eliminate the higher frequency products of distortion. If the bass appears to be too heavy, the components  $R_1$ ,  $R_2$  and  $C_4$  may be replaced by a 0.25 MΩ resistor connected directly across

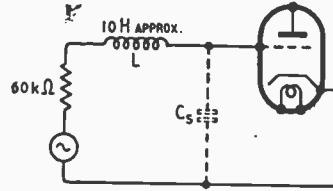

Fig. 3. Equivalent circuit at secondary of coupling transformer (ratio 1:100).

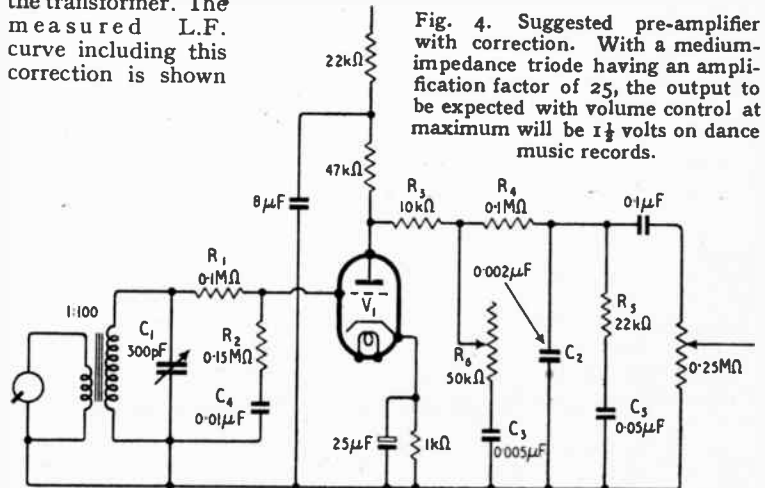

Fig. 4. Suggested pre-amplifier with correction. With a medium-impedance triode having an amplification factor of 25, the output to be expected with volume control at maximum will be 1½ volts on dance music records.

in Fig. 1. This shows more than the calculated lift, due to the effect of the fundamental tone

the transformer, or  $C_4$  may be short-circuited with a switch to form a bass control.



# Radial Time Bases

## How They Were Developed for Radar

By G. W. A. DUMMER, M.B.E., M.I.E.E., and E. FRANKLIN, Ph.D.

(Telecommunications Research Establishment)

**T**HE first radar P.P.I. (Plan Position Indicator) to be used by the R.A.F. was designed by the authors in 1940, and in view of the use since made of this device it may be of interest to recall early experimental work on radial time bases.

The possibility of the desirable P.P.I. presentation of radar echoes had been realized by the pioneers in the early days of radar. It was not, however, until 1939/40 that the two developments of a radar station using a sufficiently narrow beam and the cathode ray screen with bright and lasting afterglow led to the development of a satisfactory P.P.I.

In 1939/40 work was proceeding on the design of a "radio lighthouse" on a wavelength of 50 cm. It was envisaged that with the narrow beams then obtained on this wavelength it should be possible to rotate a time base in synchronism with the aerial rotation to give a radar "map" of all surrounding aircraft. It was decided that the time base should take one of two forms:—

1. An inductive or capacitive voltage split of X and Y vectors and recombination on an electrostatically deflected tube.

2. A mechanically rotated current time base on a magnetically deflected tube.

At that time 12-inch electrostatic tubes were in use on CH and CHL sets and magnetic afterglow tubes were not fully developed; it was therefore decided to adopt the first scheme. A schematic diagram of the arrangement is given in Fig. 1. A resistance-capacity phase shift oscillator (600/800 c/s) was used as a master sine wave generator (see circuit diagram Fig. 2). The output was squared and then integrated by an R-C combination and the result-

ant triangular wave was amplified and fed to the search coil of an inductive type of phase splitter wound to an accuracy of half a degree. By using a triangular wave, all unwanted inductive effects due to flybacks were eliminated.

As the induced voltage on the stators was proportional to the rate of change of rotor current, the voltage on the stators was the differential of the triangular wave and a small square wave was induced in each of the stators. The amplitude of these waves rose and fell according to the position of the rotor coil.

Two similar amplifiers "X"

triangular voltage wave across the condenser and also produced a square voltage wave across the resistance. As both were inserted into the grid circuit of a valve the required mix was obtained.

The resultant waveform was then amplified and passed to two paraphase valves to feed the X and Y deflector plates of the tube. The signals from the receiver were D.C.-restored before feeding to the tube cathode and a diode limiter was also used to prevent defocusing of the tube by large signals. It is interesting to recall that the first model of the rotating time base with tube, time base, power packs, etc., filled the whole of a 6ft Post Office Rack.

By the time the radial time base was completed (May, 1940) the remainder of the 50-cm "Radio

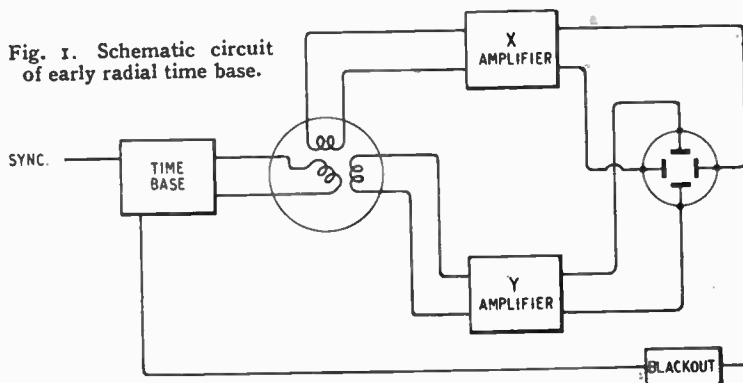

Fig. 1. Schematic circuit of early radial time base.

and "Y" were provided. Taking one amplifier, the incoming square wave was amplified and integrated to a triangular waveform and then mixed with a square wave to give a sawtooth waveform which was equal in positive and negative directions. One of these halves was blacked out on the CR tube so that a single time base trace was left commencing at the centre of the tube. The mixing of triangular and square waves was effected simply by inserting a resistance in series with the integrating condenser. The square-topped current wave produced a

"Lighthouse" was not ready, and it was therefore decided to try out the system on the C.H.L. receiver. The C.H.L. set operated on  $1\frac{1}{2}$  metres and was provided with two display tubes, one for range and one with a "split" device which provided accurate azimuth. It was necessary to stop and "inch" the aerial system to take an accurate azimuth reading on one aircraft and other aircraft on different azimuths might be missed. A radial time base would provide constant 360° cover if a tube with a long afterglow was used. Accordingly, the whole

**Radial Time Bases—**

equipment was fitted to a standard C.H.L. receiver at Worth Matravers, Dorset, and after initial teething troubles and one or two false "invasion" alarms the equipment operated satisfactorily. A map of the Dorset coast was drawn on the tube face with a chinagraph pencil by the authors, and the first demonstration of the equipment was given to A. M. Sir Phillip Joubert. It was remarkable that during his visit a convoy was sailing down the Channel and twelve Spitfires were flying overhead making an excellent "picture" on the C.R.T. face.

decided that, for full production, mechanically rotated time base coils would be simpler to produce, and a P.P.I. of this type was, therefore, designed. A triangular

back; it was not automatically self-centring. In order that the time base should rotate about its one end, it was obviously necessary for there to be zero current

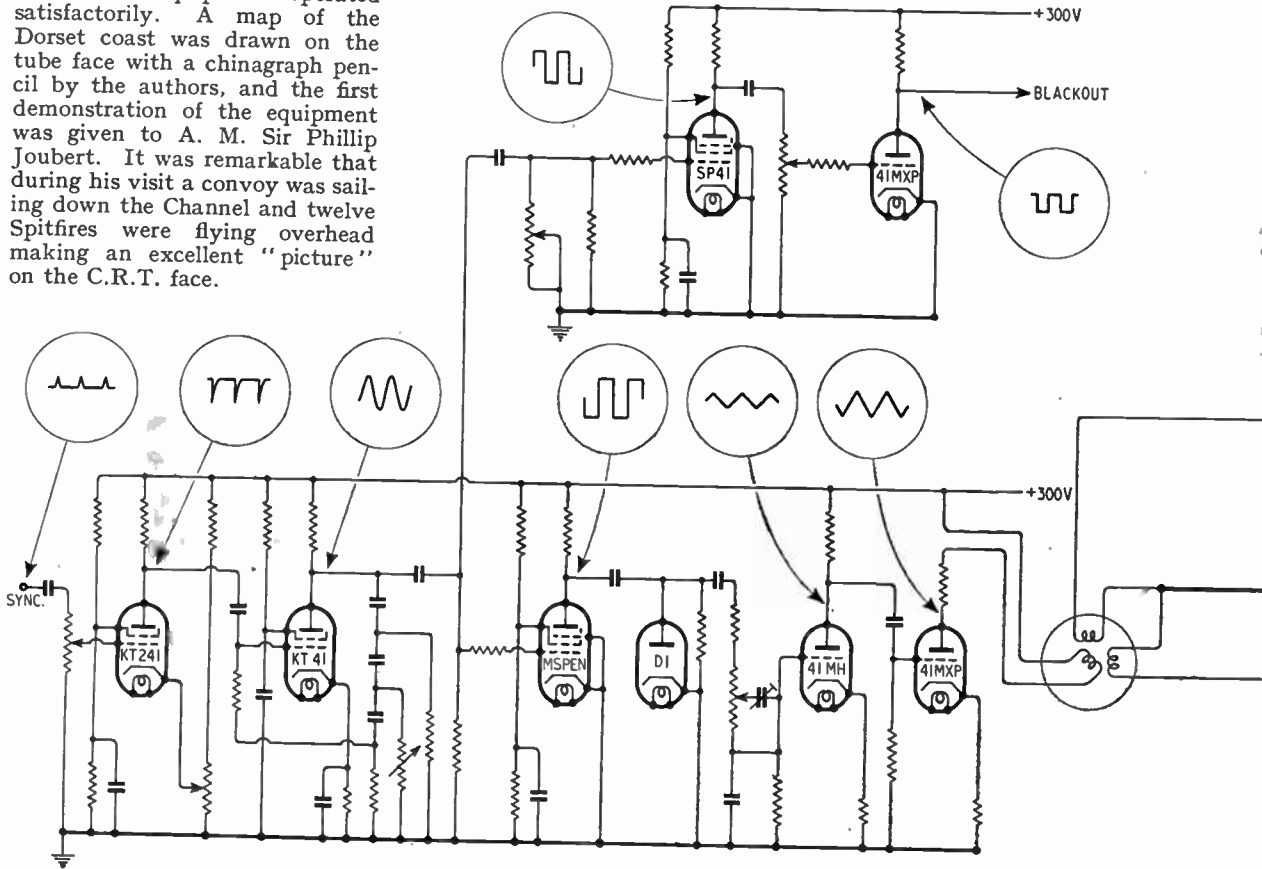

Fig. 2. Complete circuit diagram of radial time base.

Operational results on this equipment provided the ground work for G.C.I. (Ground Controlled Interception) and the radial time base was re-named P.P.I. (Plan Position Indicator). Interception techniques were studied as the enemy night bombing raids were then just starting. As the width of the aerial lobe was approximately 15°, the echoes were seen as arcs, the aircraft position being the centre of the inner edge.

At this period magnetic tubes with increased beam currents were becoming available and it was

waveform was again used to reduce flyback effects and to simplify scanning transformer design. P.P.I.s of this type were modified for production by the manufacturers.

This type had one main draw-

in the deflector coils at that point. But, as the triangular waveform was fed to the coils through a transformer, the zero current point occurred in the middle of the sweep, and the time base rotated around its mid-point.

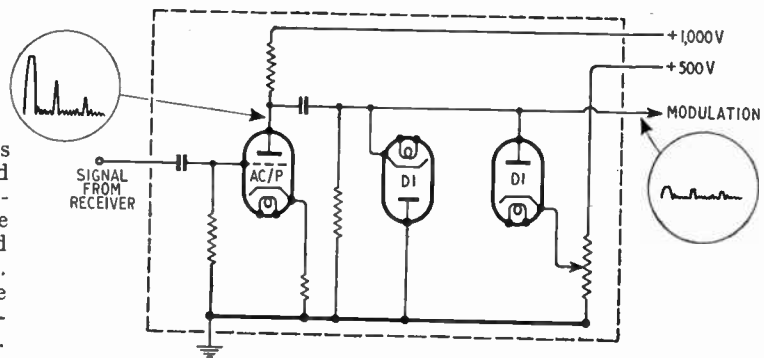

To make it rotate around one end, a "shift" current had to be passed through the coils equal in value to the peak alternating current. This involved a large

highly mobile Light Warning Equipment and in several ground equipments.

A square wave was applied to the grid of the valve

cathode follower, maintained constant voltage across the coils. Constant voltage across an inductance required constant rate of change of current through the inductance, therefore the cathode beam traced out a linear time base starting from the no-current point on the tube.

The valve was cut off during the periods between time base, and therefore the mean current was very much less than that of the previous circuit.

The simple circuit of Fig. 3(a) did not give a perfectly linear trace, due to the fact that the deflector coils had resistance  $R_L$ , and the valve had a finite output impedance. The latter was equal to  $1/g$  where  $g$  was the mutual conductance of the valve, and this was about 150 to 200 ohms for the type of valve used. The effect of this impedance was, at any instant, to decrease the voltage across the inductive part of the coil impedance by an amount equal to the current at that instant multiplied by the resistance  $(R_L + 1/g)$ , this reduced the rate of rise of current in the coil by an equivalent amount.

In order to overcome this effect it was necessary to raise the grid voltage by an equal amount, and this was done automatically in the circuit of Fig. 3(b). A square wave was applied to  $V_1$  grid and this appeared inverted on the

anode of  $V_1$ , and finally on the grid of  $V_2$ , which had the deflector coils in its cathode circuit. These coils had in series with them a total resistance  $(R_L + R_3 + 1/g)$ . Therefore, for a linear time base, it was necessary to add to  $V_2$  grid voltage, at any instant, a voltage equal to the current,  $i$ , through the coil multiplied by  $(R_L + R_3 + 1/g)$ . This was done by feeding back the voltage  $iR_3$  which appeared across  $R_3$  into the cathode circuit of  $V_1$ , and choosing the values of  $R_2$ ,  $R_1$ , and  $R_4$ ,  $R_5$  so that total gain round the circuit from the junction of  $R_2$  and  $R_3$ , through  $V_1$  to the junction of  $R_1$  and  $R_5$  was equal to  $(R_2 + R_3 + 1/g)/R_3$ . To a high degree of ap-

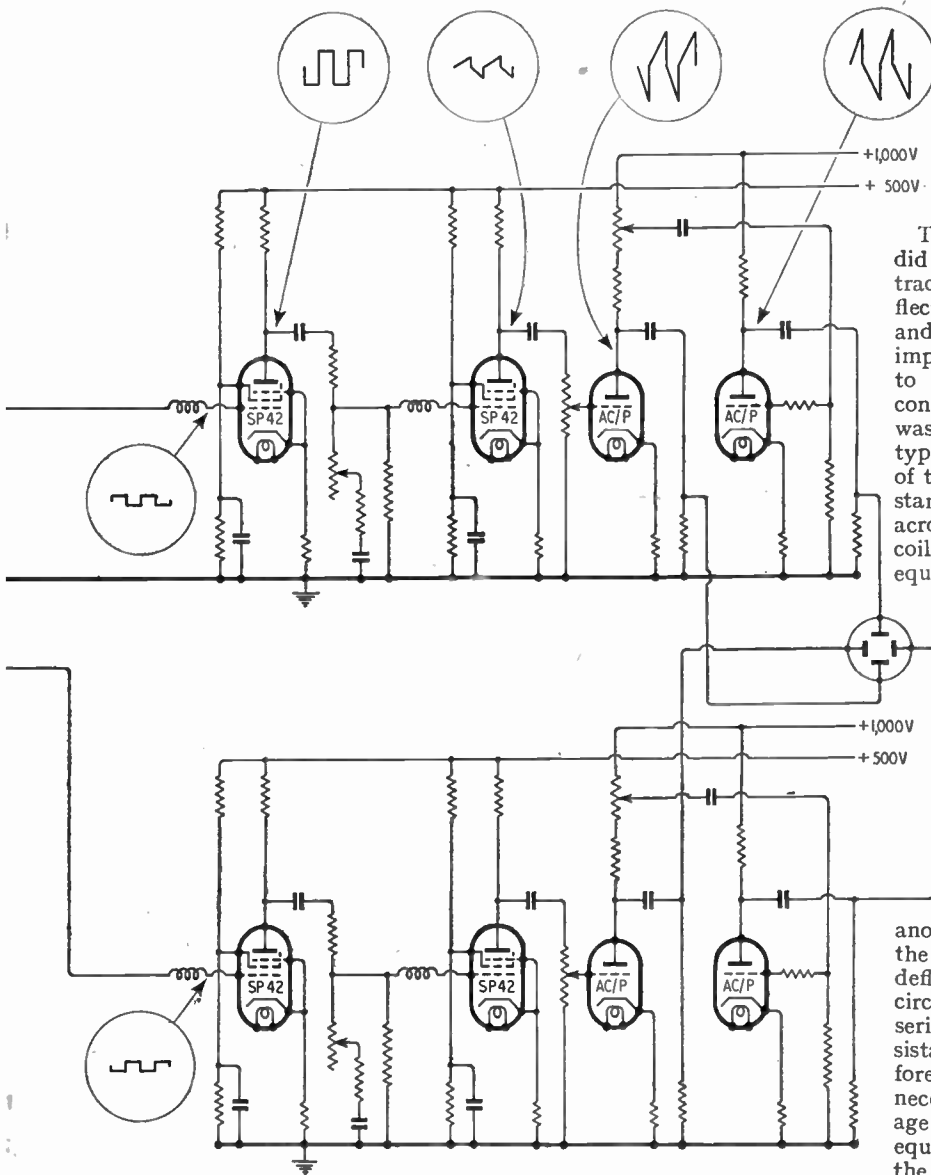

D.C. power supply and high-wattage potentiometers for adjusting the shift current; also, it was found that fairly frequent readjustment of shift current was necessary, due to power supply voltage variations, etc. The automatically self-centring circuit of Fig. 3(a) was therefore developed, and was used in the

$V_1$ , which had the deflector coils in its cathode circuit. During the negative half-wave the valve was cut off, therefore no current flowed through the coils and the cathode beam took up its no-current position in the middle of the tube face. During the positive half-wave the valve took current, and, acting as a

**Radial Time Bases—**

proximation, this occurred when  $R_1 R_3 / R_2 (R_4 + R_5) = (R_L + R_3 + 1/g) R_3$ .

This improvement in the circuit came too late to be adopted in the production models of Mark VA or Mark VI G.C.I. or C.H.L. or in the Light Warning Set, and was,

blackout to identify the area which was being enlarged and this area appeared as full size on the other tube. Owing to the  $15^\circ$  beamwidth of the polar diagram the system was not used, but it is interesting to record that a system of this type was operating in this country in 1941.

The three wavebands provide for reception on the short and the medium waves, their respective coverages being 23 to 7 Mc/s, 7 to 2.3 Mc/s and 190 to 560 metres. These three scales are actually engraved on the transparent dial plate, which also has markings for the wavechange switch and a two-position tone switch.

The coil-unit is well finished and contains high grade parts, air-dielectric trimmers being used where desirable for the short-wave ranges. Adequate screening of the three coil sections is provided, the oscillator section being almost completely enclosed.

Accompanying each kit is a circuit diagram giving all component values for a superhet receiver, but constructors can always modify it to incorporate any preferred feature.

This foundation kit is obtainable from Premier Radio Co., Jubilee Works, 167, Lower Clapton Road, London, E.5, and the price is £3 17s 6d.

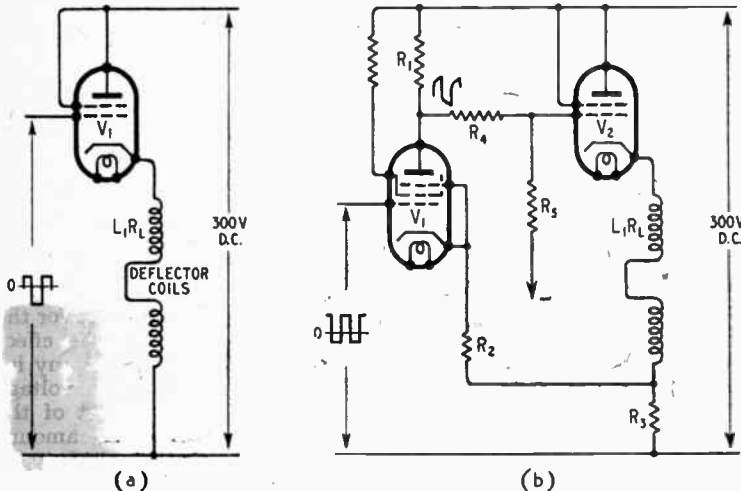

Fig. 3. (a) Automatic self-centring circuit, (b) modified circuit to correct non-linearity in the trace.

therefore, never used in the field.

Experimental work was also carried out on "strobing" a portion of the time base shown in Fig. 1, amplifying it and feeding it to another tube. By this means an enlarged P.P.I. was developed. A "dim square" (approximately 1in side on a 12in tube) was produced on the first tube by partial

The P.P.I. was next adapted for use in the first centimetre A1 equipment and afterwards for H<sub>2</sub>S and ASV. It has become one of the most widely used presentation systems for radar both in this country and U.S.A. and it seems a far cry from the original 6ft rack to the compact, efficient airborne P.P.I.'s in use today.

**Soldering Technique**

A PARTICULARLY informative and well illustrated booklet, "The Evolution of Activated Rosin Cored Solder," has been produced by H. J. Enthoven and Sons (230, Thornton Road, West Croydon, Surrey) who are the makers of "Superspeed" cored solder. Much useful technical information on the properties of solders and fluxes is given, and an especially interesting section is that explaining the transition from the solid to the liquid state of solder. In some kinds of work it is desirable to avoid the intermediate plastic or "pasty" stage in order to prevent waste of time in waiting for the joint to set. This can be done by choosing solder alloy of the right composition.

**Superhet Foundation Kit**

THIS is a selection of parts for the construction of a superheterodyne receiver and consists of a three-band coil unit, complete with switching, padding and trimming condensers; a three-gang tuning condenser; two 465-kc/s permeability tuned I.F. transformers; an air-dielectric trimmer for the oscillator circuit and slow motion drive mechanism and engraved scales. It provides the essential items for either a domestic-type broadcast set or a small communication receiver, the R.F. stage providing that additional sensitivity so desirable in a set of the last-mentioned kind.

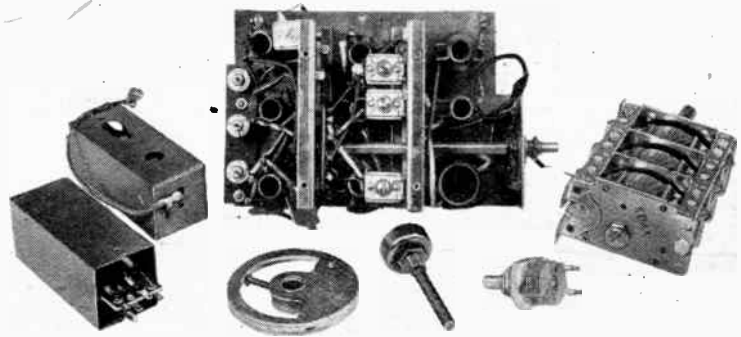

The various items, with the exception of the transparent dial plate, that comprise the Premier three-band superhet kit.

Design Data (15)

# Link Coupling

WHEN it is necessary to use a coupled pair of resonance circuits it is not always convenient to couple them together in any of the conventional ways. It is sometimes mechanically desirable to have the two circuits some considerable distance apart. In a rack-built transmitter, for instance, one circuit may fit best on one deck and the other on a different one; again, in a superheterodyne receiver it is sometimes convenient to build the frequency-changer and I.F. amplifiers as separate units. One circuit of the first I.F. coupling then fits best with the frequency changer and the other with the I.F. amplifier.

In such cases it is customary to use link coupling

two link coils are connected by some form of screened cable, such as a length of coaxial feeder.

If the length of this connecting cable is short compared with a quarter-wavelength the effect of the cable is mainly that of its capacitance. This can usually be made negligible by using sufficiently great step-down and step-up ratios in the transformers at each end.

In most practical applications of link coupling the connecting cable does not exceed a yard in length and is often no more than a foot. Intermediate frequencies do not usually exceed 15 Mc/s or 20 metres, so that the cable is nearly always very short compared with a wavelength.

The case where the cable is comparable in length with a wavelength is comparatively rare. It is usually only met with in a transmitter. It might, for instance, be desired to couple two stages with a link circuit at a frequency of 60 Mc/s or 5 metres. More than a very short cable is likely to approach or exceed a quarter-wavelength, especially as the electrical length of cable is near one-half its physical length.

In such usage it is necessary to exercise very great care in design and the matter will not be dealt with here. In this note only the case of a cable very short compared with a wavelength will be considered, and the effect of the cable will be taken as negligible.

By various well-known transformation theorems, the circuit of Fig. 1 (a) can be reduced to the exact equivalent (d) through the intermediate steps (b) and (c). All the circuits of Fig. 1 are equivalent, and so it can be seen that the link-coupled circuit is no different in its performance from a pair of tuned circuits coupled by mutual inductance between the coils themselves.

When working out the coupling required between two circuits it is usually more convenient to think in terms of the coupling coefficient  $k$  than in mutual inductance. If the two circuits have  $Q$ -values  $Q_1$  and  $Q_2$  optimum coupling is obtained when

$$k = 1/\sqrt{Q_1 Q_2} \dots \dots \dots (1)$$

In the circuit of Fig. 1 (d) the coupling is

$$k = \frac{M_1 M_2}{L_3 + L_4} \dots \dots \dots (2)$$

$$\sqrt{\left[ \left( L_1 - \frac{M_1^2}{L_3 + L_4} \right) \left( L_2 - \frac{M_2^2}{L_3 + L_4} \right) \right]} \dots \dots \dots (2)$$

In Fig. 1 (a) there are two coupling coefficients for the two halves of the circuit,

$$k_1 = \frac{M_1}{\sqrt{L_1 L_3}} \text{ and } k_2 = \frac{M_2}{\sqrt{L_2 L_4}} \dots \dots \dots (3)$$

Rewriting (2) in terms of  $k_1$  and  $k_2$  we have

$$k = \frac{1}{\sqrt{\left[ \left( \frac{L_3 + L_4}{k_1^2 L_3} - 1 \right) \left( \frac{L_3 + L_4}{k_2^2 L_4} - 1 \right) \right]}} \dots \dots \dots (4)$$

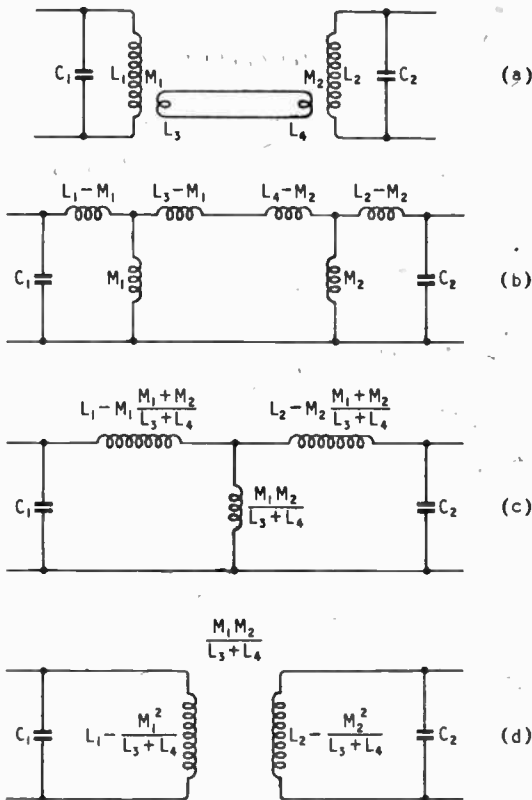

Fig. 1.

between the tuned circuits as shown in Fig. 1 (a). The two tuned circuits are  $L_1 C_1$  and  $L_2 C_2$  and they are coupled by the link circuit which comprises  $L_3$  coupled to  $L_1$  by the mutual inductance  $M_1$  and  $L_4$  coupled to  $L_2$  by the mutual inductance  $M_2$ . The

**Design Data (15)—**

When  $L_3 = L_4$ , as it will do in many practical applications, (4) reduces to

$$k = \frac{1}{\sqrt{\left[\left(\frac{2}{k_1^2} - 1\right)\left(\frac{2}{k_2^2} - 1\right)\right]}} \dots \dots (5)$$

and when  $k_1 = k_2$  it becomes

$$k = \frac{1}{2/k_1^2 - 1} \dots \dots \dots (6)$$

It is important to note that, when the individual couplings are loose so that  $2/k_1^2 \gg 1$ ,  $k \approx k_1^2/2$ . Consequently, the overall coupling is much smaller than the individual couplings; thus, if  $k_1 = 0.01$ ,  $k \approx 0.0005$ .

It is to be noted also that the performance is dependent on  $k$ , which is dependent in the symmetrical case, only on  $k_1$  and  $k_2$ . The actual magnitudes of  $L_3$  and  $L_4$  are thus unimportant.

In practice, one commonly finds that attempts are made to adjust the coupling by altering the number of turns on  $L_3$  and  $L_4$ . The equations show that such attempts will not be successful. Varying the number of turns on these coupling coils simultaneously alters their inductance and their mutual inductance with the tuned coils, so that the coupling coefficients stay unchanged. Of course, in practice, there is usually some change of coupling coefficients as well as inductances because the physical sizes of the coupling coils are altered. Nevertheless, it is true that altering the turns has only a minor effect on the coupling coefficient.

The correct way of adjusting the coupling is by altering the physical separation of  $L_1$  and  $L_3$  on the one hand and of  $L_2$  and  $L_4$  on the other. It is not essential that the two coupling coils should be identical nor that the two couplings should be alike. As  $L_1$  and  $L_2$  are usually approximately the same it is generally convenient to make  $L_3$  and  $L_4$  alike and, in the first instance, to couple them to the same degrees to  $L_1$  and  $L_2$ . Subsequent alterations to achieve optimum coupling need be made only to one circuit, however.

For design purposes, it is desirable to rewrite

Equations (5) and (6) to give the value of  $k_1$  needed. We get, when  $k_1 = k_2$ ,

$$k_1 = \sqrt{\frac{2}{1 + 1/k}} \dots \dots \dots (7)$$

and when  $k_1 \neq k_2$

$$k_1 = \sqrt{\frac{2}{1 + \frac{1/k^2}{2/k_2^2 - 1}}} \dots \dots \dots (8)$$

As an example, suppose that it is required to couple two circuits of  $Q_1 = Q_2 = 100$  with optimum coupling. From (1),  $k = 0.01$  and from (7)

$$k_1 = k_2 = \sqrt{\frac{2}{101}} = 0.141. \text{ If it turns out when the}$$

circuit is put into practical form that the couplings are too large, say  $k_1 = k_2 = 0.2$ , it is not necessary to reduce both. One, say  $k_1$ , can be reduced to the value given by (8); that is, to

$$k_1 = \sqrt{\left[ \frac{2}{1 + \frac{10^4}{\frac{2}{0.04} - 1}} \right]} = 0.099$$

The design of the coils themselves is outside the scope of this note, and the turns needed on the coupling coils and their physical relation to the tuned coils will depend on the turns and shape of the latter. With air-core single-layer coils having a length/diameter ratio of more than unity one will not be far wrong if  $L_3$  and  $L_4$  consist of about one-tenth the number of turns of  $L_1$  and  $L_2$  overwound on the earthy ends. Provision should be made for one of the coils to slide over the main winding as a coupling adjustment.

In the case of wideband amplifiers some difficulty may be found in obtaining sufficient coupling. In such a case  $Q$  may be 2.5 only, so that  $k$  must be 0.4 and  $k_1$  and  $k_2$  become 0.755. Such tight coupling may not be easy to secure with air-core coils, but should not be unduly difficult if iron-dust cores are employed.

**A** REPORT of some importance to both the radio industry and to the would-be radio engineer has just been issued. Entitled "The Practical Training of Professional Electrical Engineers," it is produced by a committee on which the Radio Industry Council is strongly represented.

Two types of apprenticeships are recommended for giving practical training as a supplement to academic instruction. Graduate Apprenticeships (lasting two years) are for those who obtain their technical education by full-time university courses, and

## Practical Training

Student Apprenticeships (four years) for those attending part-time courses at technical colleges.

Some stress is laid on the recommendation that those intending to take university courses should serve the first year of their apprenticeship before entering the university. By doing so the student would be in a better position to profit from formal instruction and, perhaps equally important, would

be able to decide if he has a real inclination towards an engineering career.

The success of this scheme naturally depends on the support given by industry. A number of large firms have already entered but more are wanted to participate. From many students' point of view it is important that the Ministry of Labour have decided to grant deferment of military service for those taking this training.

The report is obtainable from the Institution of Electrical Engineers, Savoy Place, London, W.C.2; price 1s.

# BELLING-LEE QUIZ (No. 14)

Answers to questions we are often asked by letter and telephone

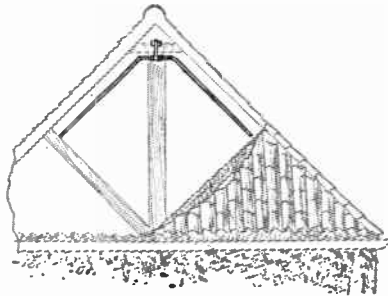

\*1 Shows the Belling-Lee inverted "V" television aerial mounted in the attic.

**Question 43.** (Requested many times.) Can we have further technical information regarding your inverted "V" Television Aerial.

**Answer 43.** This inverted "V" aerial was designed, in the first place, for indoor use in vicinities where the field strength was sufficiently intense to dispense with outdoor aerials. Apart from the symmetrical manner in which this aerial fits in with the roof shape, the bending of each element to an angle of 45° introduces a valuable technical feature, namely the independence of the aerial upon the

angle of polarisation of the incident signal wave.

Although the signal wave is vertically polarised in the first place, the presence of metallic conductors such as conduit, water pipings, etc., can by re-radiation, cause a major change in the polarisation of the signal wave at the receiving aerial. These changes are looked after, automatically, by the inverted "V" construction of our aerial.

There is naturally some loss of signal, the terminal voltage at the mid-point being 6 db less than that from a single vertical half wave dipole. Since the aerial is only intended for use under conditions of high field strength this loss is quite unimportant.

In addition to this non-polarising feature, the aerial is directional, possessing sharp minima at right angles to its plane. This property is of very great use in removing a "ghost" due to the multipath transmission, or for eliminating interference from electronic heating or diathermy apparatus.

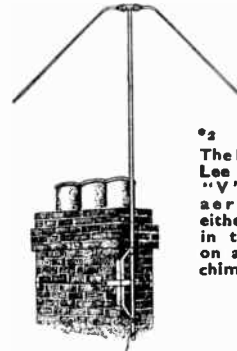

\*2 The New Belling-Lee inverted "V" television aerial may either be fitted in the attic or on a convenient chimney.

As regards the limits of distance (from the transmitter) at which the inverted "V" aerial can be expected to work satisfactorily, a great deal obviously depends upon the amount of local screening.

Experience indicates that, in suburban districts, a distance up to five miles can usually be relied upon.

If the aerial is mounted out of doors at a height of about 40ft. the above distance can be doubled.

The aerial is designed to be connected to a twin balanced feeder of 75 ohms nominal characteristic impedance (our L.336)\*3 but co-axial feeder (our L.600)\*4 may be used with negligible difference in results.

Due to the partial folding of the elements, the bandwidth of the aerial is somewhat greater than that of the conventional dipole using elements of the same diameters, and is more than adequate for both the sound and vision channels as at present transmitted.

As a matter of interest the relative polar diagrams of our three aerial systems are depicted in the May issue of the "Wireless World."

**Inverted "V" TV Aerial.**  
Patent applied for

- \*1 L.605 For Attic Mounting £2/7/6.
- \*2 L.606 For Chimney Mounting £4/10/-.
- \*3 L.336 Balanced twin feeder, per yard, 7½d.
- \*4 L.600 Co-axial feeder, per yard, 1/3d.

**BELLING & LEE LTD**  
CAMBRIDGE ARTERIAL ROAD, ENFIELD, MIDD.

## UNIQUE FEATURES OF THE BELLING-LEE

# "VIEWROD"

## TELEVISION AERIAL

REGD. TRADE MARK

The Belling-Lee Television dipole is neat and easy to erect. It was the first mass produced dipole of improved technical design and embodies many features.

Some of these features are shown below together with various Registered Design and Patent numbers which protect their design and construction.



Regd. Design No. 836593. This registers the design of the moulded dipole insulator (Fig. 1).

U.K. PATENT No. 526587. This Patent is concerned with the cap shaped mast head fixing (Fig. 3).

U.K. Patent No. 520628. This patent covers the use of a combined supporting arm and reflector as a capacity aerial for attachment to the "ELIMINOISE" (Regd. Trade Mark) ANTI-INTERFERENCE AERIAL SYSTEM.

U.K. PATENTS 477218, 479118 (Fig. 5).



Regd. Design No. 836591. This registers the design of the arm and mast cap which support the dipole and reflector elements (Fig. 2).

U.K. Patent No. 519883. This patent covers the attachment of the reflector by direct electrical connection to the metallic supporting arm (Fig. 4).

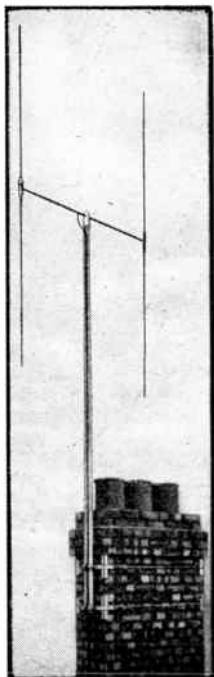
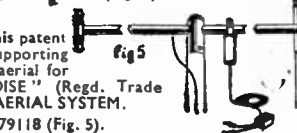

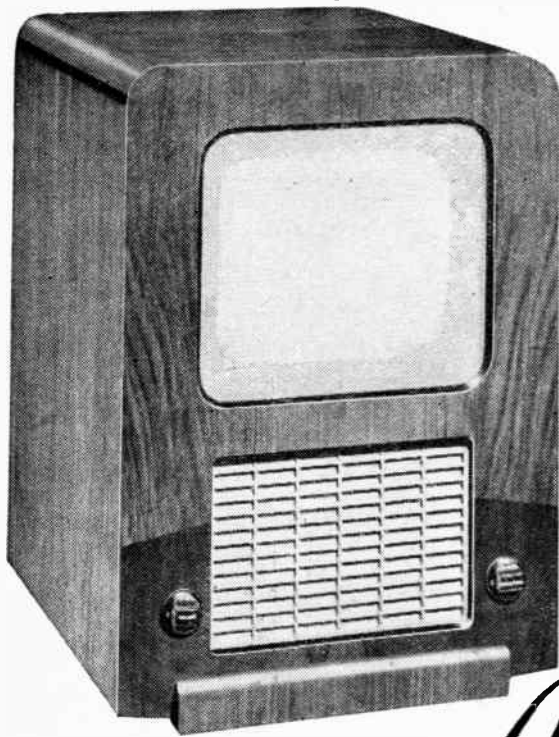

NOW BEING  
DISTRIBUTED...

THE FIRST  
**MARCONIPHONE**  
POST-WAR  
TELEVISION

★ This magic selling feature—the signature of Radio's greatest genius is on every set.

*GMarconi*

THE NEW MARCONIPHONE TELEVISION V.T. 50A

This is a sound and vision Table Grand Receiver, for A.C. mains, using a 10" Emiscope giving a picture 6 $\frac{3}{8}$ " x 8 $\frac{1}{8}$ " with a brilliance permitting enjoyable viewing even with the lights on! The cabinet is of typical Marconiphone quality finished in dark and light walnut panels with the popular Marconi bronze metal speaker grille.

PRICE 59 GNS. (Plus £14.1.11 Purchase Tax)

**MARCONIPHONE**

THE *Real* THING IN RADIO

M.3



# Television Aerials

## Close-Spaced Arrays

By N. M. BEST  
and R. D. BEEBE,  
B.Sc. (Eng.), A.C.G.I.  
(Antiference Ltd.)

IN considering the design of a television aerial array for domestic receivers a number of conflicting factors arise. The electrical requirements are maximum discrimination against interference, good forward gain, and wide bandwidth acceptance. Mechanically, the aerial needs to be of light and rigid construction and as compact as possible. In view of the fact that the spacings and reflector lengths giving maximum forward gain are not the same as those giving maximum discrimination, and that in general the high-gain arrays have considerably narrower bandwidths, a

compromise has to be arrived at in designing an aerial for universal use. In most practical cases these requirements are met by using a dipole and parasitic reflector, and it has been common practice to use a reflector element spaced at approximately a quarter-wavelength from the dipole. Experience showed, however, that closer-spaced reflectors appeared to give equal results, and in view of the mechanical advantage obtained it was decided to investigate the performance of this type of array over the bandwidth required for television reception, and to ascertain the optimum spacing and element lengths. To overcome interference the aerial needs a directional reception pattern so that by rotating the aerial to a suitable position the direction of minimum reception may correspond with that of the interference. As this inter-

ference usually comes from a distributed source, such as motor vehicles passing along the road, rather than from a single point, an array having a sharply defined minimum reception position is not as generally useful as one which has reduced signal pick-up over a wide angle. Good forward gain also helps in improving the signal-to-noise ratio. These considerations do not apply, of course, in cases where both the interference and signal are coming from the same direction, for advantage cannot then be taken of the directional properties of an aerial. An ideal polar diagram is shown in Fig. 1, but such patterns are only obtainable with multi-element arrays which are not practicable for domestic installation. The patterns usually obtained with a single reflector approximate to the general shapes shown in Fig. 2. It is difficult to express the performance of an aerial in

terms of its polar diagram, and it is usually more convenient to specify the ratio of the signal received from the front to that received from the rear. This front-to-back ratio, while not giving a complete picture, is a fair guide to the discriminating efficiency of the aerial. Fig. 3 shows the gain of a reflector array over that of a simple dipole plotted against reflector spacing when the reflector lengths are adjusted in each case for optimum front-to-back ratio. It will be seen that for reflector lengths of between 0.49 wavelength and 0.57 wavelength the front-to-back ratio is greater for the eighth-wave array than the quarter-wave. Below 0.49 wavelength the ratio falls away

very sharply, but the slope is more gradual for increasing reflector lengths. It would appear, however, that spacings of less than  $\frac{1}{8}$  wavelength are not desirable owing to the steep drop in forward gain. The effect on the front-to-back ratio of varying the reflector length is shown in Fig. 4 for  $\frac{1}{8}$ -wavelength and  $\frac{1}{4}$ -wavelength spacing. Reflector spacings between these two values give curves lying between the two shown. It will be seen that for reflector lengths of between 0.49 wavelength and 0.57 wavelength the front-to-back ratio is greater for the eighth-wave array than the quarter-wave. Below 0.49 wavelength the ratio falls away

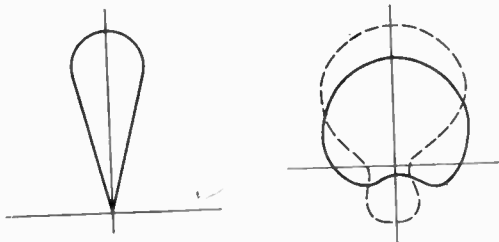

Fig. 1 (left). Ideal directional pattern obtainable only with multi-element array. Fig. 2 (right). Specimen patterns obtainable with single reflector.

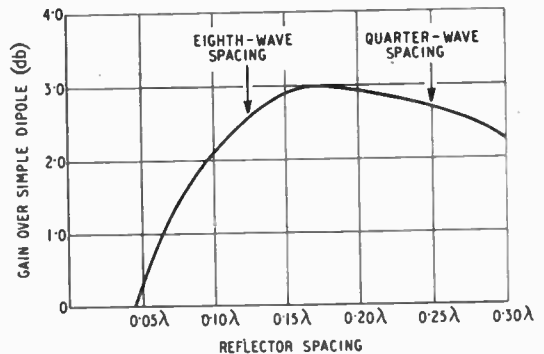

Fig. 3. Variation of gain of dipole and reflector over dipole alone with reflector spacing when the reflector length is adjusted for the optimum front-to-back ratio.

<sup>1</sup> "Some experiments on linear aerials." McPetrie and Saxton, *Wireless Engineer*, April 1946.

**Television Aerials—**

therefore, that for good signal-to-noise ratio using the closer spacing the reflector length should be at least 0.49 wavelength at the

0.47 wavelength at 41.5 Mc/s, and should result in a considerable drop in signal-to-noise ratio on the sound frequency. Table I shows the approximate front-to-

erected at a height greater than 1.25 wavelength at the lowest frequency to be used. The dipole elements were constructed of  $\frac{3}{8}$ -in diameter aluminium tubing. One hundred yards of coaxial cable of 75-ohm impedance joined the oscillator to the dipole, enabling the operator to stand well outside the field of the dipole. About three wavelengths away at the lowest frequency used, a similar dipole was erected connected by a similar cable to a field strength meter calibrated directly in db with a reference level of 1 millivolt. The calibration was checked against a high-grade signal generator through an equal length of cable to that used in the tests and found to be accurate within plus or minus 0.5 db, enabling direct readings to be taken. The frequency of the oscillator was varied in 0.5 Mc/s steps from 41.5 Mc/s to 48 Mc/s, the aerial current being kept constant. The field-strength meter was tuned to the oscillator frequency at each step, the db readings being recorded against frequency. The resulting curve showed slight cyclical variations over the band,

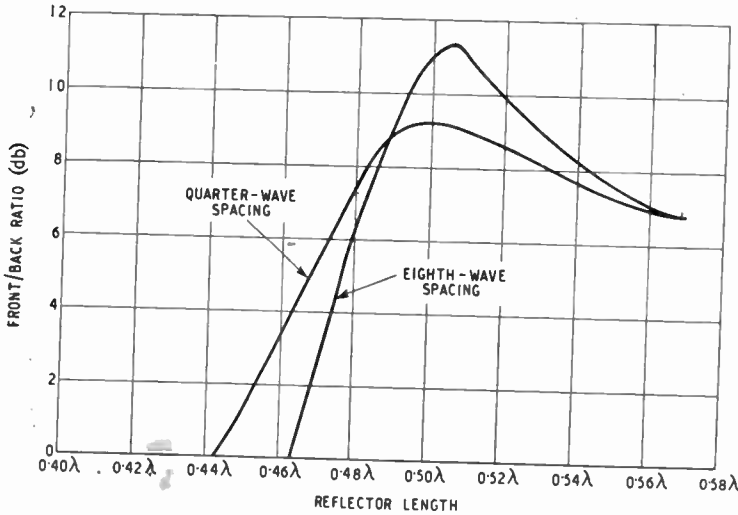

Fig. 4. The effect of the reflector length on the front-to-back ratio is shown here for reflector-aerial spacings of  $\lambda/8$  and  $\lambda/4$ .

lowest frequency to be received. The bandwidth required for television reception is from 41.5 to 48 Mc/s, and if advantage is to be taken of the higher front-to-back ratio possible with  $\frac{1}{4}$ -wavelength spacing, the reflector length should be at least 0.49 wavelength at 41.5 Mc/s. This length is equivalent to 0.57 wavelength at 48 Mc/s, giving a front-to-back ratio over the band of from 9 db at 41.5 to 6.8 db at 48 Mc/s. It has been common practice to make the reflector length about 0.51 wavelength at the vision frequency of 45 Mc/s. This corresponds to a length of

back ratios corresponding to these lengths and spacings. Comparing the arrays, the  $\frac{1}{4}$  wave-

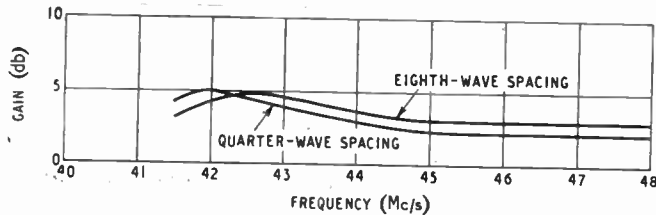

Fig. 5. Measured forward-gain curves of  $\lambda/8$  and  $\lambda/4$  spaced reflectors.

length spaced aerial appears to give a maximum front-to-back ratio between 41.5 and 45 Mc/s, which falls slightly at 48 Mc/s. The  $\frac{1}{4}$ -wavelength array has its maximum at about 44-45 Mc/s, falling away at each end of the band.

To verify the above conclusions an experimental confirmation was planned. A low-power oscillator was connected to a vertical half-wave dipole

but a mean curve could be drawn with a fair degree of accuracy.

A quarter-wave spaced reflector of 0.51 wavelength was then added to the receiving dipole and a similar set of readings obtained, and this was repeated for various element spacings and reflector lengths. At spot frequencies of 41.5, 43.5, 45, 46.5 and 48 Mc/s, polar diagrams were taken by rotating the receiving array in angular steps of 30°. For each array a mean curve of signal against frequency was drawn, and by subtracting from these the mean curve obtained with the dipole alone the forward gains for each array were calculated. The front-to-back ratios were obtained from the polar diagrams.

TABLE I

Array	Freq. (Mc/s)	Length	Spacing	Front/Back (db) (Approx.)
Typical commercial quarter-wave with 133-inch reflector.	41.5	0.47λ	0.23λ	5.4
	45.0	0.51λ	0.25λ	9.0
	48.0	0.54λ	0.27λ	7.6
Eighth-wave with 139-inch reflector ...	41.5	0.49λ	0.115λ	9.0
	45.0	0.53λ	0.125λ	9.0
	48.0	0.57λ	0.133λ	6.8

The forward-gain curves obtained by this method for  $\frac{1}{8}$ -wavelength and  $\frac{1}{4}$ -wavelength spaced arrays are shown in Fig. 5. It was found that spacings between these values gave curves

in Fig. 7, from which it would appear that there is little to choose between the two arrays on the score of discrimination. The familiar cardioid pattern only appears in Fig. 7 (c), and the asym-

of ghost images due to reflections up and down the feeder cable have been encountered, and tests made by introducing a large mismatch at the connection of aerial to cable show no adverse visual effects.

In general, it can be concluded that the advantages of the more sturdy and lighter construction of the close spaced array may be utilized for television-receiving aerials with the additional benefit, in so far as the  $\frac{1}{8}$ -wavelength spacing is concerned, of more even gain over the bandwidth, and better signal-to-noise ratio on the sound channel.

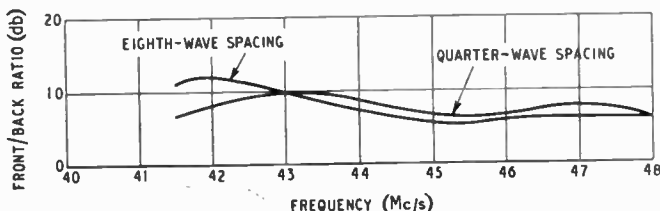

Fig. 6. Measured front-to-back ratios for  $\lambda/8$  and  $\lambda/4$  spaced reflectors.

lying approximately between those shown and that no greater overall gain was obtained. The optimum length of reflector for the  $\frac{1}{8}$ -wavelength spaced array was 0.49 wavelength at the lowest frequency; shorter lengths giving considerable loss at 41.5 Mc/s. The reflector length for the  $\frac{1}{4}$ -wavelength spaced array was less critical, and a value of 0.51 wavelength at 45 Mc/s appeared a good compromise. The curves of Fig. 5 appear very satisfactory, and, assuming that the dipole alone gives a symmetrical bandwidth, the  $\frac{1}{8}$ -wavelength spaced array gives a response curve flat within approximately 1 db over the television band.

Fig. 6 shows the front-to-back ratios of the same arrays. These agree with the figures expected except that the maxima for both curves occur at rather lower frequencies. The polar diagrams for 41.5, 45 and 48 Mc/s are plotted

metrical shape of this is probably due to the use of coaxial-feeder cable.<sup>2</sup> Arrays having spacing between  $\frac{1}{4}$  wavelength and  $\frac{1}{8}$  wavelength gave similar diagrams when the reflector lengths were suitably adjusted.

No adverse effects were produced in practice through the lack of an impedance-matching device between the cable and aerial when using the close-spaced arrays. The figures given include any losses due to mismatch at this point. Eighth-wave spaced arrays have given satisfactory reception with all types of commercial television receivers, and the test results have been confirmed in a large number of practical installations, including many on the fringes of, and beyond, the generally recognized television service area. No cases

<sup>2</sup> "Dipole with unbalanced feeder." D. A. Bell. *Wireless Engineer*, January 1947.

### BOOKS RECEIVED

(see also p. 284)

**Communication Through the Ages.**—By Alfred Still. The first of this book's eleven chapters is headed "The Writer's Aim," in which the author states that his intention is not merely to tell the story of how men, through the ages, have conveyed information over distances but to consider what it is that the mind of one man communicates to the mind of another. 201 pages. Murray Hill Books, Inc., 232, Madison Avenue, New York, 16, U.S.A. Price \$2.75.

**Radio Operating Questions and Answers (Eighth Edition).**—By Arthur R. Nilson and J. L. Hornung. As its title implies, this American book uses the question and answer principle to instruct prospective radio operators in preparation for the U.S. Government's licence examinations for commercial operators. The publication of this edition marks the twenty-fifth year since the book was first issued. A new feature of this edition is the appendix giving the American Standards Association's graphical symbols. 434+xi pages. McGraw-Hill Publishing Co., Ltd., Aldwych House, London, W.C.2. Price 17s 6d.

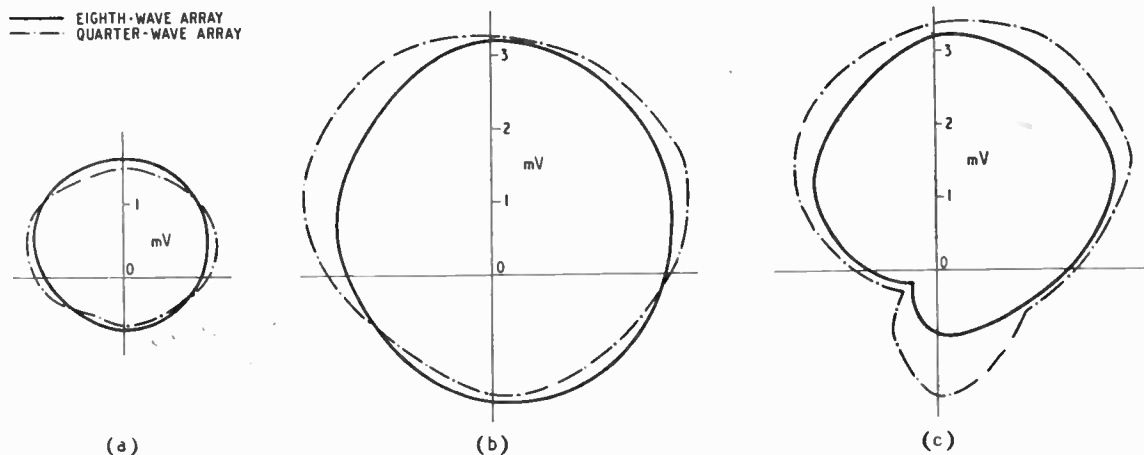

Fig. 7. Polar diagrams of  $\lambda/8$  and  $\lambda/4$  spaced reflector systems at 48 Mc/s (a), 45 Mc/s (b) and 41.5 Mc/s (c).

# World of Wireless

## SERVICE-MEN'S REGISTER

A REGISTER of radio service technicians is to be compiled jointly by the Guild of Radio Service Engineers and the Radio and Television Retailers' Association in the interests of a higher standard of servicing.

The general requirements upon which applications to be included on the Register will be considered are as follows:—

That the applicant is over 21 years of age, and has either

- (a) completed an approved apprenticeship or
- (b) has secured the R.T.E.B. Certificate or other approved certificate, or
- (c) has been in approved employment as a radio service technician for five consecutive years.

Applicants who have served in the Forces on work comparable, in the opinion of the Joint Committee, with service work, and were in the trade prior to being called up will be eligible for registration. Only one-third of their time in the Services will be counted as civilian employment in the case of men who were in the trade prior to their call-up and were not engaged on radio work in the Forces.

## CAR RADIO

CONSIDERABLE confusion has existed regarding the liability of car radio sets to purchase tax. Although manufacturers have been charging purchase tax on these sets for some time the Treasury has announced that the existing law does not provide for purchase tax to be charged on receivers specially designed for use in cars and unsuitable for use otherwise. Manufacturers have, therefore, made arrangements to refund the tax collected on sets recently sold.

The present position is, however, unlikely to last for long as the Board of Trade states that it proposes to make an order charging with purchase tax car-radio sets.

## F.M. OUSTS S.W. ?

ACCORDING to a survey undertaken by our New York contemporary, *Electronics*, most of the new broadcast receivers now being designed will not include coverage of the short-wave bands.

The reasons given are:—

- (1) F.M. is a better selling feature;
- (2) Foreign reception is of last-

ing interest to very few customers;

- (3) The cost of its inclusion (\$2-\$6) "bulks large at a time when consumer resistance to higher list prices is feared."

The fact that short-wave reception is essential for certain regions has not been overlooked, and it is suggested that this demand could be met by the production by each manufacturer of one model with short-wave coverage.

## RADIO TELEPHONY FOR TUGS

DIFFICULTIES of controlling tugs when operating at a distance from their base have been overcome by the installation of radio-telephones on board the France Fenwick's Anchor Tugs operating in the Tyne and Wear.

The Pye system installed consists of four control stations—two on the Tyne and two on the Wear—twenty-five transmitter-receivers on tugs and two portable control stations. The latter are for use in liners being towed, thereby keeping the ship in constant touch with the tugs.

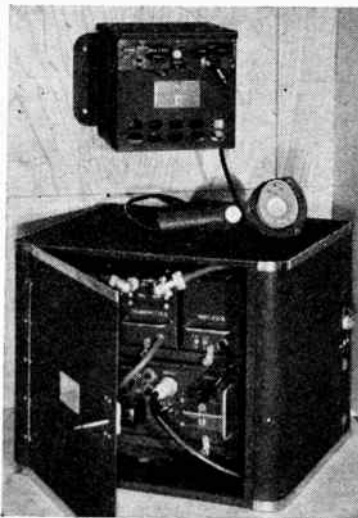

MARINE VERSION of the Pye radio-telephone equipment, described in our November, 1946, issue.

The installations work on two fixed frequencies in the 80-100 Mc/s band, one being used for Tyne traffic and one for Wear traffic. The coverage of the stations is such that tugs based on one river can be controlled when operating in the other river or well out at sea.

## 18,850 TELEVIEWERS

ALL the old 10s licences for both sound and vision reception have now expired, and so it is at last possible to ascertain the number of television viewers from the licence figures. Post Office returns from May 31st show that holders of the new £2 combined sound-and-vision licences number 18,850. Broadcast licence figures are given in "In Brief."

## INTERNATIONAL STANDARDIZATION

THE national standards organizations of eleven countries were represented on the council of the International Organization for Standardization (known as the I.S.O.) at its first meeting since the ratification of its constitution drafted last October. The countries represented at the Zurich meeting were Australia, Belgium, Brazil, China, France, India, Norway, Switzerland, U.K., U.S.A. and U.S.S.R.

The office of the I.S.O. is in Geneva.

As a result of a joint meeting of the I.S.O. and the International Electrotechnical Commission, which was formed over 40 years ago, it has been recommended that the I.E.C. should affiliate with the I.S.O.

## RAILWAY RADIO

REPLYING to a question in the House of Commons, the Postmaster-General announced that wavelengths had been allocated to the railway companies "to cover their immediate radio-communication needs."

It is understood from the Railway Signals and Engineers' Committee, which is the co-ordinating body in this matter for the four main-line railways, that the work to be undertaken is entirely experimental and will, in the first instance, be confined mainly to communication between signal boxes and shunting engines in marshalling yards.

## NO ALL-INDIA RADIO ?

WITH the partition of India the title All-India Radio will presumably no longer be used by the broadcasting organization of either India or Pakistan.

Broadcasting is one of the many "assets" being considered by special committees for division between the two States.

In 1927 the Indian Broadcasting Co. opened its first station—a 1.5 kW M.W. transmitter in Bombay. In 1930 broadcasting was placed under the direct control of

the Government of India and was called the Indian State Broadcasting Service. The service, which by 1936 was provided by three transmitters, was reorganized in accordance with a report presented by H. L. Kirke (B.B.C.) and renamed All-India Radio. At the end of 1939 fourteen transmitters—9 M.W. and 5 S.W.—were in use in Dacca, Delhi, Bombay, Calcutta, Lahore, Lucknow, Madras, Peshawar and Trichinopoly. During the war additional S.W. transmitters were installed at Delhi for the overseas service.

### F.M. ALLOCATIONS

**N**EW frequency allocations for America's F.M. stations were adopted by the F.C.C. in June. Nearly 650 stations, including 35 non-commercial educational stations, are included in the allocations. This list covers all stations for which operating licences have been granted although they are not all operating at the moment. The change-over to the new frequencies in the 89-108 Mc/s band will take place by October 1st.

For allocation purposes the band is divided into 200-kc/s channels, arbitrarily numbered 208-300. A minimum separation of four channels between stations operating in the same city is employed.

A complete list of stations is given in the June 23rd issue of our Washington contemporary, *Broadcasting*.

### E.M.I. INSTITUTES

**A**MONG the postal courses provided by E.M.I. Institutes, which is controlled by Electric and Musical Industries, is one covering the syllabus of the P.M.G.'s Amateur Radio Licence Examination. There are fifteen lessons in the course which provides an elementary knowledge of the principles of design and operation of simple transmitters and receivers. There are also postal courses in basic radio, mathematics and physics and basic television.

An intensive three-week laboratory/workshop course designed primarily as a follow-up to the postal television and radio courses is also provided. There are also full-time courses.

Details are available from the Principal, Prof. H. F. Trewman, 43, Grove Park Road, London, W.4.

### PERSONALITIES

**H.M. Queen Mary** has consented to be Patron of the National Radio Exhibition, Olympia (October 1st to 11th).

**Sir Edward Appleton**, F.R.S., has been elected an honorary life member of the Australian Institution of Radio Engineers.

**Sir Clifford Paterson**, F.R.S., has been elected chairman of the general council of the British Standards Institution in succession to Sir William Larke.

**Sir Stanley Angwin**, who is leading the British delegation to the Atlantic City telecommunications conference, has been appointed chairman of the all-important frequency allocations committee.

**Charles R. Denny**, chairman of the U.S. Federal Communications Commission, is chairman of the Atlantic City conference.

### IN BRIEF

**Receiving Licences.**—A decrease of 28,550 in the number of broadcast receiving licences in force in Great Britain and Northern Ireland was recorded at the end of May. The total was 10,782,000 compared with 10,810,550 in April. The March figure was 10,780,400. The May figure includes 18,850 television licences. During May 525 set owners were prosecuted for operating unlicensed receivers.

### SOVIET RECEIVERS.

This set, the fifty-thousandth, produced in the Elektrosila factory in Voronezh, covers the 25-75, 200-550 and 750-2,000 metre bands. Production of receivers in the U.S.S.R. is considerably in advance of the pre-war output.

**Canadian Licences.**—During the past year (1946-47) 1,807,824 broadcast receiving licences were issued in Canada compared with 1,754,351 in 1945-46. Licensed car-radio receivers totalled 53,479 compared with 51,162 the previous year. The Province with the largest number of licence holders is Ontario with 628,075.

**Ship's Newspapers.**—With the sailing of the *Queen Mary* on July 31st *Ocean Times* will be published daily at sea on board three Cunard-White Star transatlantic liners. *The Empress News* recommences daily publication at sea when the C.P.S. *Empress of Canada* makes her first transatlantic run after refitting. These ocean newspapers, which are published by our associates Wireless Press, Ltd., rely on the news service "Shipress" transmitted from the G.P.O. Rugby station.

**American Books.**—We understand from Wireless Supplies Unlimited, of 264, Old Christchurch Road, Bournemouth, Hants, that they have a stock of the A.R.R.L. "Radio Amateur's Handbook, 1947," which we learn is now out of print in the U.S. They cost 13s 3d, including postage. A small supply of the A.R.R.L. "Antenna Book" will shortly be available also. They will cost about 5s.

**Marconi Memorial.**—The monument erected by the Canadian Marconi Company on Signal Hill, Newfoundland, to mark the site where Marconi received the first transatlantic signal on December 12th, 1901, was unveiled by the Governor of Newfoundland on July 16th. Its erection was started in 1939, but was not completed owing to the war.

**New Laboratories** of the British Scientific Instrument Research Association were recently opened at "Sira," Southill, Elmstead Woods, Chislehurst, Kent. (Tel.: Imperial 2237.)

**A Three-day Visit** to the various Mullard factories was recently arranged by the War Office as part of a telecommunications course for officers of the Royal Corps of Signals.

**Radio Officers.**—Owing to "an acute shortage of experienced 1st and 2nd Class certificated radio officers," provision has been made for officers who left the Merchant Navy to return, subject to their being able to satisfy the operating company's requirements in respect of qualifications, medical fitness, etc.

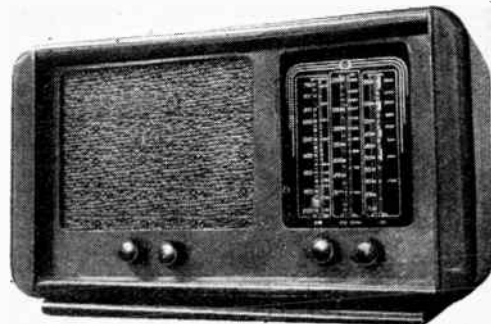

**Radiotelephone Services.**—The opening of the London-Malta radiotelephone service last month is part of a big scheme being developed by Cable and Wireless and the Post Office to interlink many parts of the Empire by telephone. Plans provide for the linking (via London) of Kenya and Bermuda with Australia and India, and Bermuda and Ceylon with South Africa.

**Polish Industry.**—In the State radio factory in Dzierzoniow, Lower Silesia, where some 3,000 ex-German receivers have recently been overhauled and repaired, production of 15,000 new sets was begun in July. At the moment about 70 per cent of the components are Swedish, but by 1949 it is hoped to be assembling the receivers entirely from Polish components.

**Scientific Instruments.**—An exhibition designed to show the importance of scientific instruments in everyday life was recently opened by the Minister of Supply at Charing Cross Underground Station. It was planned by the Ministry of Supply with the co-operation of the Scientific Instrument Manufacturers' Association.

**Instrument Finishes.**—Amateur constructors desiring a professional finish to their equipment are offered a service

**World of Wireless—**

of plating, painting and engraving by Labgear, Willow Place, Fair Street, Cambridge, who have set aside a section of their works for the purpose. All classes of plating, with the exception of chromium, can be undertaken and grey, smooth black and crackle paint finishes are available.

"Electronic Engineering" has been acquired from Hulton Press, Ltd., by Morgan Brothers (Publishers), Ltd., proprietors of *The Engineer*, *The Ironmonger* and *The Chemist and Druggist*. Geoffrey Parr is continuing as editor. The editorial and publishing offices are at 28, Essex Street, Strand, London, W.C.2.

**B.S.R.A.**—The secretary of the British Sound Recording Association, R. W. Lowden, has changed his address to Wayford, Napoleon Avenue, Farnborough, Hants.

**I.E.E. London Students' Section.**—Officers of the section elected for the 1947-48 Session are E. M. Hickin, chairman; A. Mason, B.Sc. (Eng.), vice-chairman; and P. W. Castle, secretary. The membership of the Section is 3,353 (2,420 students and 933 graduates).

An appeal to stop the destruction of salvageable paper has been made by the Waste Paper Recovery Association—a non-profit-making organization operating in collaboration with the Board of Trade. It is pointed out that in many industries the shortage of containers is becoming acute. Whilst the radio industry is well down the list of users of containers, the need is just as important, especially in the export field. "There is no such thing as waste paper; if it is recovered it can be used over and over again."

**INDUSTRIAL NEWS**

**G.E.C.** has installed a frequency-modulated E.H.F. communication system for the St. John Ambulance Brigade in Guernsey, Channel Islands. Simplex operation on 76.2 Mc/s is provided between the four ambulances and the headquarters' 10-watt control station which employs an end-fed dipole mounted on a ninety-foot mast. Complete coverage of the island is provided.

**Cossor Radar Co.** installed the shore radar station at Noordwijk, Holland (midway between Amsterdam and The Hague), which was opened by the Dutch Minister of Transport on July 7th. The P.P.I. of Holland's first radar station shows the whole of the six-mile channel between Amsterdam and Rotterdam.

**B.V.A. Officers.**—The new chairman and vice-chairman of the British Radio Valve Manufacturers' Association for the year commencing July 1st are G. A. Marriott and Frank Jones, respectively.

**R.C.A.**—The Radio Corporation of America has appointed Vice-Admiral W. A. Glassford, U.S.N. (Retd.) as European Manager. His headquarters will be at 43, Berkeley Square, London, W.1.

**Marconi Jubilee.**—A commemorative brochure has been issued by Marconi's to mark the fiftieth anniversary of the establishment of the company. In its 58 pp, which are well illustrated, the history of the company, originally the Wireless Telegraph and Signal Company, is briefly reviewed.

**Mullard Wireless Service Co.** has formed an Electro-Acoustic Division to market amplifiers for public address work. A range of three amplifiers (for export only, for the time being) has been produced comprising 25-, 50- and 100-watt types with three-channel inputs.

**Marconi International.**—In addition to the latest types of Marconi marine transmitting and receiving gear, the Canadian Pacific liner, *Empress of Canada*, is being fitted with an elaborate P.A. system in readiness for her first post-war voyage on the Canadian passenger service. Two sound-reproducing systems are being fitted. One is for entertainment and employs 32 loudspeakers, and the other is an "order" system providing two-way communication between the bridge and ten points on deck.

**Ultra.**—As a result of the recent visit of E. E. Rosen, managing director of Ultra Electric, Ultra sets will be manufactured in the Argentine. The recent embargo of the Argentine Government on the import of completed sets was made just before his arrival in the country so that his plans for marketing British-made sets had to be radically changed.

**Marconi.**—Two 100-kW short-wave broadcasting transmitters have been ordered from Marconi's by the Swedish Telegraph Administration for erection at Hörby. They will cost over £110,000. One transmitter will be equipped with an omni-directional aerial and will supplement the country's existing medium-wave service, whilst the other will employ directional aerials.

**Watson-Watt.**—We were misinformed regarding the address of Sir Robert Watson-Watt and Partners, Ltd., the recently formed company of scientific advisers. It is 7, Gayfere Street, London, S.W.1, (Tel.: Abbey 2956-7), and not as given in last month's issue.

**G.E.C.**—After tests with a number of receivers the G.E.C. Overseas 7 has been chosen by the Malayan broadcasting authorities for use in schools in Malaya.

**Philco.**—The recently held Radio Distributors' Convention at Atlantic City was attended by J. V. Holman, D. S. Spink and A. F. D. Knight, of Philco Radio and Television Corp.

**Electrical Sound and Television Patents, Ltd.**, of 12, Pembroke Street, London, N.1, will be closed from August 1st-11th for the annual holiday.

**TRADE ENQUIRIES**

**Belgium.**—La Transmission Electrique, of 63, rue Dr. Van Bockxstaele, Ghent, Belgium, wish to get into touch with British manufacturers of transformer core stampings.

**Siam.**—A firm in Siam requires a number of simple two-valve sets to

specification. Details from William Jacks & Co., Winchester House, Old Broad Street, London, E.C.2.

**CLUBS**

**Birkenhead.**—The Wirral Amateur Radio Society is meeting only once in August, on the 27th, at the Y.M.C.A., Whetstone Lane, Birkenhead. It is hoped to resume the two meetings a month in September. Sec.: B. O'Brien, G2AMV, 26, Coombe Road, Irby, Heswall, Cheshire.

**Birmingham.**—The second of a series of D.F. tests will be conducted by Slade Radio on August 31st. These tests are in addition to the fortnightly meetings held on Fridays at 8.0 at the Parochial Hall, Broomfield Road, Erdington, Birmingham, 23. August meetings will be held on the 8th and 22nd. Sec.: C. N. Smart, 110, Woolmore Road, Erdington, Birmingham, 23.

**Clapham.**—A radio club has been formed by the 56th (London) Armoured Divisional Signal Regiment, T.A.—one of the oldest signal units in the Territorial Army—as part of its wireless training scheme. It will have its own transmitter at the regimental H.Q. at 20, Atkins Road, Clapham, London, S.W.12, from where details of the club and conditions of service in the T.A. are obtainable.

**Harrogate.**—A talk on "Recent Developments in Radio Valves and Cathode-Ray Tubes" will be given by C. A. Norman, of the G.E.C., to members of the Harrogate and District Short-Wave Radio Society on August 6th at 7.30 at the Y.M.C.A., Victoria Avenue, Harrogate. Sec.: K. B. Moore, 2a, Wayside Crescent, Harrogate, Yorks.

**Harrow.**—Entries for the recently held constructional competition organized by the Radio Society of Harrow were exhibited in a local radio shop as part of a drive to create interest in the activities of the club. The winning entry was a flat-dweller's transmitter. Meetings are held on alternate Tuesdays at Northwick Café, Kenton Road, Kenton, at 7.30. Next meeting on July 29th. Sec.: J. F. A. Lavender, G2KA, 29, Crofts Road, Harrow, Middx.

**Hounslow.**—Meetings of the Hounslow and District Radio Society are held on alternate Wednesdays at the Grove Road Schools, Hounslow. The next meeting will be on August 6th. Sec.: A. H. Pottle, 11, Abinger Gardens, Isleworth, Middx.

**Kingston.**—Members of the Kingston and District Amateur Radio Society are meeting each Thursday at 8.0 in the Kingston Hotel, opposite the Southern Railway Station, until a more permanent meeting place can be found. Sec.: L. Knight, G2LP, 132, Elgar Avenue, Tolworth, Surrey.

**Worthing.**—The second annual general meeting of the Worthing Group of the R.S.G.B. will be held at the Thomas-a-Becket Hotel at 7.30 on September 4th. The group is now issuing a monthly duplicated news sheet. Sec.: G. W. Morton, 42, Southfarm Road, Worthing.

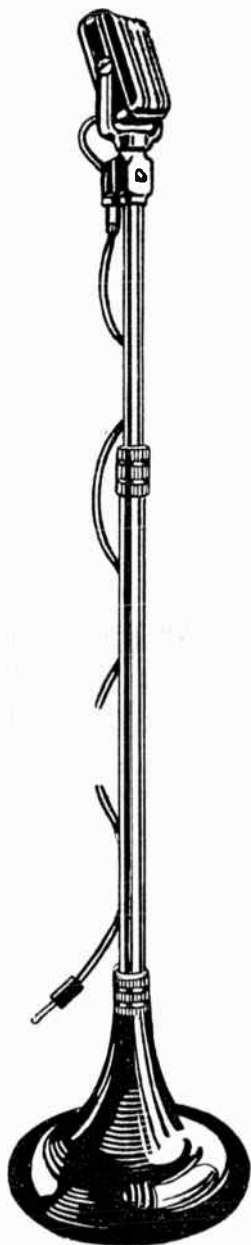

# Virtually Distortionless

## A.D/47 AMPLIFIER

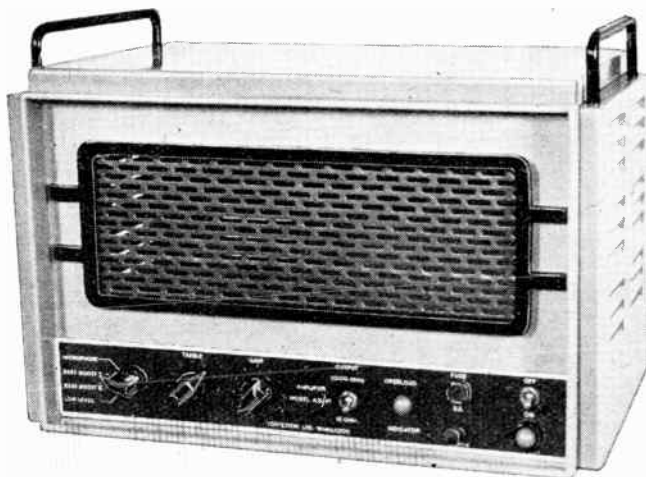

This is a 10-valve amplifier for recording and play-back purposes for which we claim an overall distortion of only 0.01 per cent., as measured on a distortion factor meter at middle frequencies for a 10-watt output.

The internal noise and amplitude distortion are thus negligible and the response is flat plus or minus nothing from 50 to 20,000 c/s and a maximum of .5 db down at 20 c/s.

A triple-screened input transformer for  $7\frac{1}{2}$  to 15 ohms is provided and the amplifier is push-pull throughout, terminating in cathode-follower triodes with additional feedback. The input needed for 15 watts output is only 0.7 millivolt on microphone and 7 millivolts on gramophone. The output transformer can be switched from 15 ohms to 2,000 ohms, for recording purposes, the measured damping factor being 40 times in each case.

Built-in switched record compensation networks are provided for each listening level on the front panel, together with overload indicator switch, scratch compensation control and fuse. All inputs and outputs are at the rear of the chassis.

Send for full details of Amplifier type AD/47.

*Vortexion*  
LIMITED

257/261, THE BROADWAY,  
WIMBLEDON, LONDON,  
S.W.19.

Telephones: LIBerty 2814 and 6242/3.

Telegrams: "VORTEXION, WIMBLE, LONDON."

# Careers in Electronics

There is vast scope for ambitious men and women in the new fields opened up by Electronic Science. The Correspondence and College Courses provided by E.M.I. Institutes which cover recognised diplomas such as the City and Guilds, etc. are written and supervised by E.M.I.★ scientists who are specialists in Electronic Science. Here are some of the careers for which you can be trained:

**SERVICE  
ENGINEERING**  
•  
**OPERATING**  
•  
**DESIGN AND  
DEVELOPMENT**  
•  
**TECHNICAL  
SALESMANSHIP**  
•  
**TEACHING**

TELEVISION and RADIO.  
COMMUNICATION ENGINEERING—Land, Sea and Air.  
RADAR.  
NAVIGATIONAL AIDS.  
INDUSTRIAL ELECTRONIC APPLICATIONS.  
MEDICAL EQUIPMENT.  
AUDIO-FREQUENCY, INCLUDING FILMS, etc.

Also short Courses for Executives, Amateurs, Schoolboys, etc.  
For full details apply to your local "H.M.V." Radio dealer or direct to:—

Principal: PROFESSOR H. F. TREWMAN, M.A. (Cantab), M.I.E.E.,  
M.I.Mech.E., M.Brit.I.R.E.



## E.M.I. INSTITUTES LTD.

Dept.16, 43 GROVE PARK ROAD, CHISWICK, LONDON, W.4

★ The E.M.I. Group includes "H.M.V.", Marconiphone and other important electronic interests.

E.3a

## PRECISION CONTROLS

for COMMUNICATIONS AND MEASURING EQUIPMENT

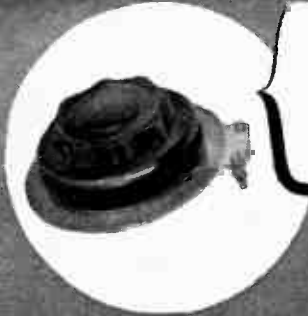

### SLOW-MOTION DRIVE

A Unique Control giving complete 360° rotation  
Double-friction epicyclic mechanism—enclosed  
in dust-proof bakelite housing  
Torque—12 inch-ounces before slipping  
Ratio—44 to 1 approximately  
Supplied with dials up to 6 inches diameter—  
any engraving.

PRICES ON APPLICATION

### DECADE SWITCH

A Precision Component embodying all the best design features  
Very low contact resistance. Positive location. Sturdy action.  
Twelve positions—providing two extra contacts—30°  
angular spacing simplifies dial calibration. Two types available  
— 416A (Shorting) and 416B (Non-Shorting).

Can also be supplied in ganged units of two or more switches

PRICES ON APPLICATION

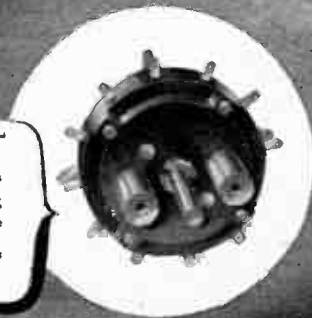

## SALFORD ELECTRICAL INSTRUMENTS LTD.

PEEL WORKS, SALFORD 3

Telephones: BLAckfriars 6688 (6 lines).

Telegrams and Cables: "SPARKLESS, MANCHESTER"

Proprietors: THE GENERAL ELECTRIC Co. Ltd., of England



# Unbiased

By FREE GRID

## Plugging P-B.T.

**P**USH-BUTTONS seem to be coming into favour once again after their wartime setback and I sincerely hope that the sets which are to be exhibited at Olympia in October will have push-buttons only. I am well aware that a very large number of my readers will be against me on this point, mainly on the grounds that they consider the use of such a device to be lazy, effeminate and symptomatic of the abrogation on the part of its users of any claim to take, what the Editor called in the July issue, "an intelligent interest in the technical means whereby broadcasting is brought to them".

So far from this being the case I maintain that a desire for push-button tuning indicates exactly the opposite; namely, that the listener has outgrown the "horseless carriage" era of wireless and has come to realize that simplicity and ease of control are no more symptomatic of such things in the case of a wireless set than they are in that of a car or any other instance of applied science.

If push-button tuning possessed no other advantages than simplicity and convenience it might not be worthy of serious consideration but so far from this being the case it has technical merits of the highest order. No designer who desires to produce a set which is equally efficient in every respect over the whole of the frequency band or bands which it covers can afford to use any other system of tuning.

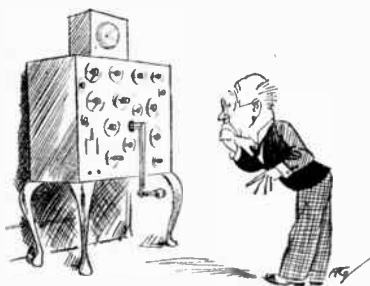

Multi-knob P-B Equivalent.

I should add that I am, of course, referring to that system of push-button tuning which employs pre-set circuits. It is fairly obvious

that with this system of tuning one can arrange to have optimum conditions for receiving any particular station, for by merely adding an extra cam on the push rod for the operation of another switch we can bring into circuit the most suitable degree of anything, ranging from aerial coupling to tone correction to suit the particular frequency upon which we wish to receive.

In fact we can have the equivalent of a multi-knob super-communication receiver for every station covered by the number of buttons available without the necessity of a skilled operator to tune it for us. The ordinary unskilled listener—even a woman—is put on an equal footing with the most practised knob twister.

There is, of course, nothing original in this idea. I believe, in fact, that it was the Editor who first advocated it, but it is high time that it was given greater publicity. As for those who still want to use the old system of tuning, let them at least be logical and use halfpenny dips in place of electric lighting in their homes. They will probably be compelled to do it next winter in any case—that is, of course, if they are able to buy the halfpenny dips.

## Ariel Subdues Caliban

**C**REDULITY is a human weakness usually associated with marines, just as superstition seems inseparable from sailors. Having mixed a good deal with both these sections of the community I must place on record the fact that while they are certainly not free from these traits of character, it ill behoves the rest of us to cast aspersions on them. Only the other day an amazing instance of credulity among the non-nautical classes came my way when I was prodding and elbowing my way through the motley throng that surrounds the stalls of a London street market lying almost in the shadow of the Old Bailey.

The thing which attracted my attention was a Caliban-like cacophony coming from a wireless receiver which sounded as though it were overloaded in every com-

ponent. This was not surprising as it was being operated without any vestige of an aerial and consequently was working "all-out" to make itself heard above the noises of the crowd. Man-made interference from all the unsuppressed electrical apparatus in the neighbourhood was adding to the truly appalling racket coming from the overburdened set.

I had just elbowed my way forward to remonstrate and offer the ribs of my umbrella as a makeshift aerial when suddenly the stallholder picked up a pretty little tubular device to each end of which was connected a short length of wire with gaily coloured insulation. He attached one wire to the aerial terminal of the set and the other to the canvas top of the stall so that the little condenser—for such



Signs of disapproval.

it obviously was—was suspended daintily in mid-air where it danced and pirouetted on the breeze like Prospero's "Dainty Ariel."

As if by magic the Caliban noises ceased and were succeeded by the calm beauty—relatively speaking—of a B.B.C. gale warning mingled with adenoidal noises from the stallholder who was endeavouring with considerable success to sell what he called his magic noise-eliminating aerial to the gaping crowd. Hastily mounting an adjacent soap box I delivered an impromptu lecture on the morality of the salesman, pointing out that precisely the same result could be had for very much less than 5s, the price charged for the "eliminator."

To my astonishment my advice to my fellow citizens to save their money and invest it instead in a few feet of copper wire led to nothing but a volley of abuse and other signs of disapproval, not only from the stallholder from whom I might have expected it but from the people whose interests I was endeavouring to serve. I might, in fact, have been a politician for all the thanks I got for my efforts, and to crown all, I was compelled to suffer the indignity of being moved on by a policeman.

# Permanent Magnets

By "CATHODE RAY"

ALTHOUGH electrically-energized magnetic circuits are discussed at length in most books on basic electrical engineering, permanent magnets are usually dismissed in a few descriptive paragraphs, leaving

A second troublesome feature, which is common to all iron-cored magnetic circuits, permanent or energized, is the non-linear rela-

linearity, and current without E.M.F. (apart from a rather nebulous electronic one). And as it is a simple and familiar circuit, it seems to be just the analogy that was wanted. The circuit in question is shown in Fig. 3a, and

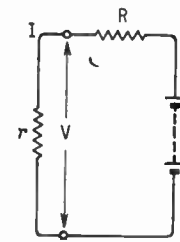

(a)

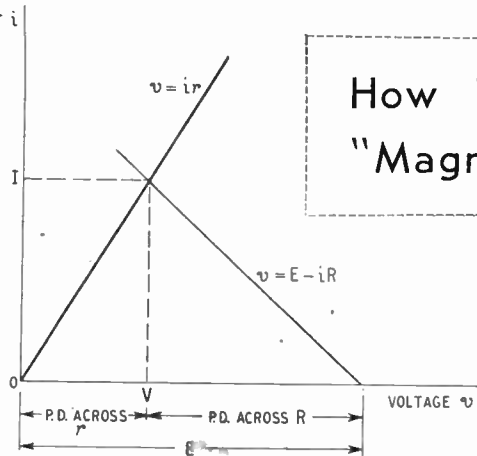

(b)

Fig. 1. Graphical method, based on Ohm's Law, of finding the current and voltage in a circuit with two resistances. When the resistances are linear, as here, it is quicker to do it mentally or by algebra, but in Fig. 2...

no very definite clues. Considering the scale on which permanent magnets are used in telecommunications, for loud speakers, gramophone pick-ups, microphones, telephone receivers, measuring instruments, and so forth, this seems strange.

relationship between magnetomotive force and flux.

Now it happens that there is an electrical circuit which combines both of these features — non-

The usual approach to magnetic circuits in general is by way of analogy from electrical circuits. Corresponding to electromotive force in the electrical circuit is magnetomotive force, expressed in ampere-turns. When one considers a permanent magnet circuit, however, where there are no ampere-turns (except for hypothetical ones in the molecular structure of the material), this concept does not get one very far. Yet the analogue of current—magnetic flux—is present; and one wants to be able to calculate how much of it one can get from a given magnet, or how much magnet and what shape will best give a required flux.

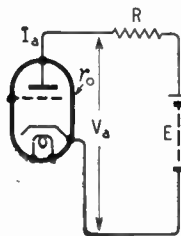

(a)

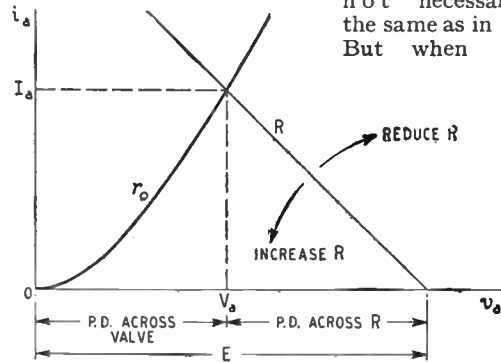

(b)

Fig. 2. The D.C. "resistance" of the valve,  $r_0$ , is known only as a graph, so the method of Fig. 1 must be used. This case is analogous to the simple magnetic circuit of Fig. 4. The effect on output, current and voltage of varying the load resistance can be seen by varying the slope of the load line.

How They Fit Into the "Magnetic Ohm's Law"

the graphical method of calculating the voltage and current in Fig. 3b.

So that the relationship between energized and permanent magnetic circuits may be clear, let us approach Fig. 3 via the still simpler case of Fig. 1. Consider the left-hand side only, consisting of  $r$ . If this is an ohmic resistance, any potential difference across it is related to the current through it by Ohm's Law:

$$v = ir \dots (1)$$

(The small letters  $v$  and  $i$  denote any values of voltage or current). Taking the right-hand side by itself, the voltage across the terminals is given by:

$$v = E - iR \dots (2)$$

Here  $v$  and  $i$  are not necessarily the same as in (1). But when the

two halves are put together,  $v$  and  $i$  must be the same in both. Call the particular values of  $v$  and  $i$ , which are the solutions of the above two simultaneous equations,  $V$  and  $I$ . Solving these equations:

$$I' = \frac{E_r}{R + r} \dots \dots (3)$$

$$I = \frac{E}{R + r} \dots \dots (4)$$

In case the solving of these equations is too great a strain on one's algebra, there is the alternative method of drawing the graphs representing the equations, as in Fig. 1b. The solution is given by their intersection, and as they are linear equations there is only one intersection.

Well, of course, that legendary creature "Any Schoolboy" could give the answers without setting pencil to paper in either method, because with ohmic or linear resistances it is so easy. If one or both of the resistances were expressible only by more involved equations, then some algebra might be necessary; while in the more likely event of their being known only as graphical curves, the second method would have to

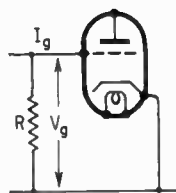

(a)

Fig. 3. This is similar in principle to Fig. 2, except that the source of E.M.F. is absent. It is analogous to a permanent magnet circuit; compare Fig. 7.

be used. For example,  $r$  might be  $r_o$ , the D.C. resistance of the anode-to-cathode path in a valve, and  $R$  its load resistance (Fig. 2a). The two graphs are then generally called the  $i_a/v_a$  characteristic of the valve and its load line respectively, and are very familiar in these guises (Fig. 2b). For brevity I have labelled them simply  $r_o$  and  $R$ , but, of course, the line "R" is really the graph of the linear equation  $v_a = E - i_a R$ . Incidentally, this graphical method

would be even more necessary if  $r$ , too, were a non-linear resistance,

Fig. 4. Analysis of energized magnetic circuit for comparison with Fig. 2.

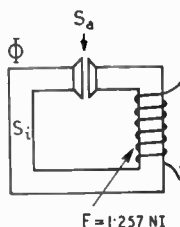

(a)

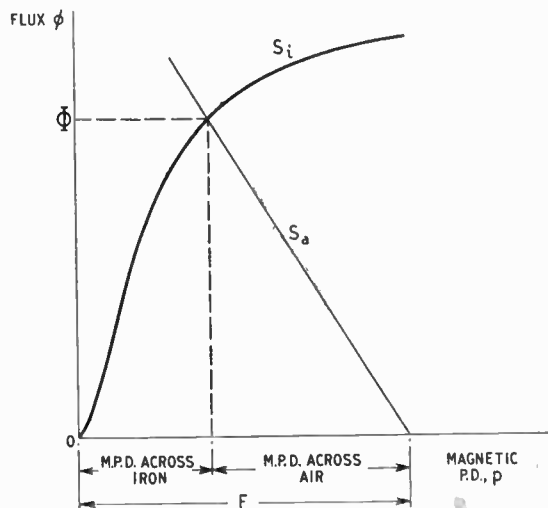

(b)

such as a lamp. Note also that a single scale serves for both potential difference and E.M.F., because both are reckoned in volts. Lastly, in Fig. 3, we have a

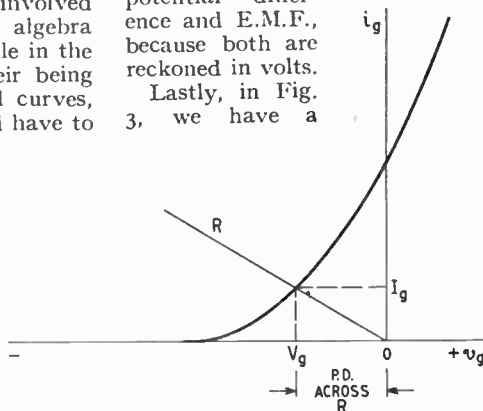

(b)

Fig. 2 is the analogue of a magnetic circuit consisting partly

of air (linear) and partly of iron (non-linear), energized by the magnetomotive force of a current-carrying coil; and Fig. 3 a similar circuit but with a permanent magnet and zero externally-applied M.M.F. ("Iron" herein means any magnetic metal). Corresponding to current is flux  $\phi$  measured in lines (= maxwells); and corresponding to E.M.F. is M.M.F.,  $F$ , which for practical convenience in the energized case is often reckoned in ampere-turns.

Supposing, then, one has an electromagnet operating in series with an air gap (Fig. 4a), it corresponds with the electrical circuit of Fig. 2a and can be calculated in the same way, merely changing the units (Fig. 4b). The "load line" is marked  $S_a$ , which stands for the reluctance of the air gap, and (in accordance with the magnetic "Ohm's Law") is equal to the magnetic difference of potential across it divided by  $\phi$ . So, corresponding exactly to (2), the equation of the line is:

$$p = F - \phi S_a \dots (5)$$

And  $S_i$  is just the flux/magnetic-potential characteristic of the iron core.

I admit that this is not exactly the usual way in which the matter is put, and may be quite novel to some readers. But the analogy between the electric and magnetic circuits is sometimes confused

**Permanent Magnets—**

because the two are not compared, as they are here, in their corresponding forms. There are very good practical reasons, which we shall come to in a minute, for dealing differently with magnetic circuits; but to get a good theoretical grasp of the matter beforehand it is advisable to compare Figs. 2 and 4 for a while. For instance, just as the E.M.F. developed by the battery in Fig. 2 is divided between the two resistive elements in the circuit, so the M.M.F. developed by the coil in Fig. 4 is divided between the two reluctances. If

as a short-circuited load would be in the electrical case.

Although the Fig. 4 form of diagram for the magnetic circuit is the most helpful for getting a clear picture of the theory by pondering on the similarities between it and the familiar valve loading diagrams, it is not the best for practical purposes. An  $i_a/v_a$  characteristic curve is useful only for the particular resistor or valve for which it has been drawn. With a valve, that is unfortunately unavoidable, because its "resistance" depends in a very complicated way on a large number of different variable

gradient (volts per cm.), the dimensions are incorporated into the co-ordinate scales, and we get a graph of  $\rho$  instead of  $r$ , one that applies to that material in general, irrespective of size. Thus, instead of plotting, as in Fig. 1b,

$$v = ir \left( = i \frac{l}{a} \rho \right)$$

we rearrange this to bring the  $l$  to the left-hand side:

$$\frac{v}{l} = \frac{i}{a} \rho \dots \dots \dots (7)$$

So the graph takes the form shown in Fig. 5a.

There is every reason for adopting the same policy for magnetic materials, because, unlike resistive materials, they are all very non-linear; but, like resistance, reluctance varies in the same way with  $l$  and  $a$ . The magnetic quantity corresponding to  $\rho$ , called reluctivity, is not commonly

used. But  $\rho = \frac{1}{\gamma}$ ,  $\gamma$  being called

the conductivity, and the magnetic equivalent of that is well known under the name of permeability,  $\mu$ . So corresponding to (6) (modified by substituting  $\frac{1}{\rho}$  for  $\rho$ ) is

$$S = \frac{1}{\mu} \frac{l}{a} \dots \dots \dots (8)$$

**B/H Curves**

The permeability of all magnetic materials varies in a way that can only be recorded as a graph; and nobody wants to draw a separate graph like Fig. 4b for every possible size and shape of piece, when one plotted as in Fig. 5b gives the essential information from which the reluctance of any size can quickly be calculated. That is why the scale of flux ( $\phi$ ) becomes one of flux per unit cross-section area, or flux density,  $B$ ; and the horizontal force (or magnetic potential difference) per unit length, which is rather confusingly called the magnetizing force,  $H$ . In other words, instead of plotting, as in the Fig. 4b type of curve:

$$\rho = \phi S \left( = \frac{l I}{a \mu} \right)$$

the core dimensions are trans-

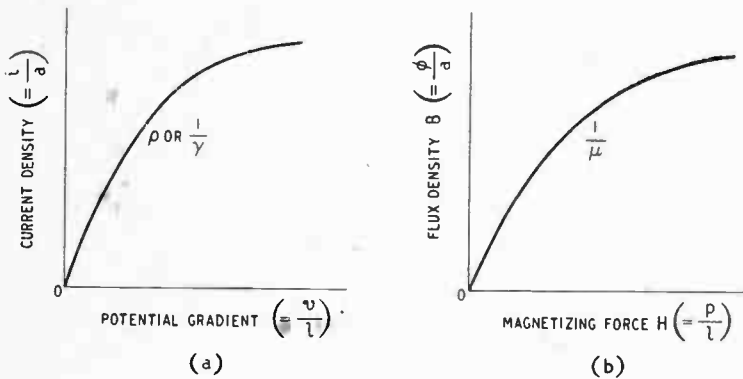

Fig. 5. When the non-linearity of a resistor is a peculiarity of the material of which it is made, it is more helpful to have a graph of the material, rather than of any particularly-sized piece of it, as would be shown in a Fig. 2b type of graph. This is done by altering the co-ordinate scales, as at *a*. The same argument applies to magnetic materials, which accounts for their graphs usually being plotted as at *b* (compare *a*) instead of as Fig. 4b.

the M.M.F. available for the load be increased, by raising its reluctance (decreasing the slope of the  $S_a$  line) it is at the expense of flux. It is generally the aim to get as much flux as possible in the air gap; and for this purpose it is fortunate that the characteristic curves of most irons rise steeply at first, like that of a pentode. But in order to get a slight increase on the flux indicated in Fig. 4b it would be necessary to steepen the air-gap line considerably; that is to say, make its reluctance much less. The increase is only moderate even if one goes so far as to draw the line vertical, representing zero reluctance, obtainable only by closing the gap completely and thereby making it as useless

such as the potentials of the various electrodes as well as all their dimensions. But the resistance of homogeneous solid materials is much simpler, being proportional to the length ( $l$ ) and inversely as the cross-section area ( $a$ ). The only other factor is the one that distinguishes materials from one another as regards resistiveness—the resistivity,  $\rho$ , which is the resistance of 1 cm. cube. So

$$r = \rho \frac{l}{a} \dots \dots \dots (6)$$

For non-linear materials, a curve of current against voltage ( $v = ir$ ) refers only to one particular size and shape of resistor. But by plotting current density (amps per sq. cm.) against voltage

ferred from the curve to the co-ordinates :

$$\frac{\phi}{l} = \frac{\phi}{a \mu}$$

$$\text{or } H = B \frac{1}{\mu}$$

$$\text{or } B = \mu H \dots \dots (9)$$

The information about any magnetic material, then, is usually given in the form of a B/H curve (as in Fig. 5b). Given the dimensions of any particular piece of it, the relationship  $\phi/p$  is obtained by multiplying B by  $a$  and H by  $l$ . If a core consists of several sections in series, each with a different constant cross-section area, the magnetic potential drops for each ( $p_1, p_2$ , etc.) are calculated and added together to give the M.M.F. (ampere-turns) required to maintain the desired flux throughout the circuit.

For the sake of making the permeability of vacuum (and, for all practical purposes, air and other non-magnetic materials) = 1 and to avoid having to talk about ampere-turns when permanent magnets are in question, there is the alternative and slightly smaller unit of M.M.F. called (with no humorous intent) the gilbert. To convert a number of ampere-turns to gilberts, multiply by 1.257 (=  $0.4\pi$ ). If H is in gilberts per cm, then B for air = H.

Since all this is very thoroughly

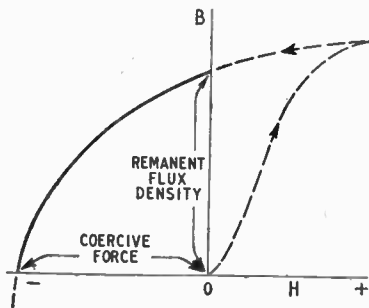

Fig. 6. Materials suitable for permanent magnets have a large part of their characteristic curve in the negative H quarter. (Compare Fig. 3b).

explained in textbooks we hurry on to the final goal—the permanent magnet circuit. Permanent magnets depend on the fact that when the magnetizing force

applied to magnetic material is reduced, the characteristic curve doesn't follow the same path downward as it did upward. Materials most suitable for permanent magnets are those in which the departure is particularly large, as in Fig. 6, where the flux density is still near its maximum even when the magnetizing force has been completely removed; and to reduce it to zero necessitates a considerable negative magnetizing force. It is the section of curve in between these two points that gives us what we want, corresponding (except for the generalized type of scales) to Fig. 3b.

If Fig. 6 is converted to the  $\phi/p$  co-ordinates of a particular magnet, by multiplying the B scale by  $a$  and the H scale by  $l$ , we get Fig. 7, which corresponds

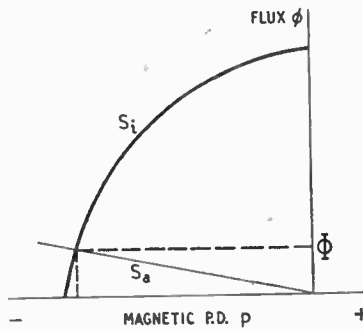

Fig. 7. This is the exact analogue of Fig. 3b, so the air-gap line,  $S_a$ , can be drawn in. But in practice the  $S_i$  line is not usually known, so the  $S_a$  line has to be transferred to a graph of the Fig. 6 type by multiplying the size factors, as in Fig. 8.

exactly to Fig. 3b, and can be used to investigate the magnet when in series with an air-gap, by drawing the  $S_a$  line, corresponding to the R line in Fig. 3b.

Neglecting magnetic leakage, the flux in iron and gap is the same, and is represented in Fig. 7 by the intersection of the two graphs, at value  $\phi$ . This diagram therefore shows the flux in the air gap when dimensions of gap and magnet are given. If these dimensions had been picked out of a hat or otherwise chosen at random, the chances would be that gap and magnet wouldn't match one another particularly well, any more than a valve

# THE NEW MULTITONE M.T.3 HEARING AID

BELIEVED TO BE THE SMALLEST IN THE WORLD, OFFERS TO THE HARD OF HEARING FACILITIES NEVER BEFORE PROVIDED BY A SINGLE INSTRUMENT.

M.T.3 stands for "Midget Telesonic 3-stage". The 3-stage amplifier consists of a space charge double tetrode, i.e., 2 valves in one bottle, and an output pentode, used as a pentode when a magnetic miniature earpiece or Bone Conductor is plugged in, or as a triode when a crystal earpiece is plugged in. The alteration is effected automatically by the difference in the wiring in the 3-socket earpiece plug. The crystal microphone used is not soldered in but plugged into a minute holder, similar to that used for the valves. Volume Control is obtained by novel means—a specially made type of differential condenser used in a negative reaction circuit. The whole mechanism, combined with the on/off switch, is very flat; it is placed under the crystal microphone. With an inductive load in the output the effect of the control is differential with respect to frequency, tending to reduce the high note response of the instrument and with it the background noise. The size of this instrument is  $3\frac{1}{2}$ " long x  $1-11/16$ " at its widest and  $1-5/16$ " at its narrowest end; depth varying from  $\frac{1}{2}$ " to  $11/16$ ". Weight  $2\frac{1}{2}$  ozs.

## TELESONIC PICK-UP

A jack socket is provided for connection of our Telesonic Coil. This automatically cuts out the microphone and enables the user to hear telephone conversation without any distortion and to hear perfectly in theatres, cinemas, churches and lecture halls equipped with the Telesonic installation.

# MULTITONE

ELECTRIC COMPANY LIMITED  
92, New Cavendish St., London, W.1  
(Langham 2734)

Signatories to the National Institute for the Deaf Agreement

**Permanent Magnets—**

picked at random would drive a particular loudspeaker with maximum efficiency. In Fig. 7, for example, the reluctance of the air gap is so large for the magnet that comparatively little flux is available in it. This is like a loudspeaker of excessively high impedance for the valve. Steepening the  $S_a$  line to represent a gap of lower reluctance, it is seen that the flux increases; until maximum flux is obtained by closing the gap completely—a magnetic short-circuit.

Generally one has an air gap of a particular size, and B/H curves of available magnet alloys, and one wants to know the dimensions of magnet that will give the required flux, or flux density; preferably using the smallest possible magnet. The dimensions of the magnet not being known, it is impossible to start by converting Fig. 6 (which one has) into Fig. 7.

There is a way, which for the sake of those sufficiently interested I will point out at the end, of getting over this by transferring the air-gap line to the B/H

circuit. Neither current nor flux can quietly vanish anywhere around a circuit. But it can leak off so that not all of the total flux goes through a particular localized air gap. If the circuit is well designed, this leakage flux is relatively small, and we shall neglect it. (In practical engineering, it is taken care of by a factor based on experience of similar magnet systems).

$$\text{So } \Phi = B_i a_i = B_a a_a \dots (10)$$

$$\therefore a_i = a_a \frac{B_a}{B_i} \dots (11)$$

You are quite right if you guess that the subscripts  $i$  and  $a$  indicate iron and air respectively. And as we presumably know the air-gap area,  $a_a$ , and its flux density,  $B_a$ , all we need to get the magnet cross-section area is its flux density,  $B_i$ .

The second principle is that the total M.M.F. (F) in a magnetic circuit is equal to the sum of all the magnetic potential drops. (Compare the corresponding Kirchhoff's Law for an electric circuit.) Applying it to our permanent magnet circuit; where there is zero F:

here we have the length of the magnet,  $l_i$ , in terms of  $H_i$ . (In practice, another factor is used to cover the fact that the effective length of the gap tends to increase near its edges.)

The B/H curve for the magnet metal gives  $H_i$  in terms of  $B_i$ , or vice versa; but how do we choose a particular combination of the two? Fig. 7 shows what seems to be a rather bad combination. The best, presumably, is that which requires the smallest magnet.

Combining (11) and (13).

$$\begin{aligned} \text{Volume of iron} &= l_i a_i \\ &= \frac{B_a^2 l_a a_a}{-H_i B_i} \dots (14) \end{aligned}$$

Therefore, for given air-gap dimensions and flux density, the smallest volume of iron is needed when  $-H_i B_i$  is a maximum. And, as you see, the volume of iron goes up in the same proportion as the volume of air gap, and as the square of the gap flux density.

The thing to do, then, is to plot  $-H_i B_i$  against B (a convenient place is in the empty space to the right of the B scale as in Fig. 8), and connect a horizontal line from the peak of that curve to intersect the B/H curve, thus showing the most economical  $B_i$  and  $H_i$ —the last remaining data needed for finding the magnet dimensions. Instead of bothering to plot the  $H_i B_i$  curve, a short cut that is near enough with most magnet curves is to complete the rectangle as shown dotted in Fig. 8, and use the  $B_i$  and  $H_i$  values given by the intersection of its diagonal with the B/H curve.

Suppose an air gap 0.25 cm long by 2 cm square (after using the factors that allow for flux "fringing") is to be given a flux density of 8,000 lines per sq. cm. (= 8,000 gauss), by means of a magnet made from alloy having the characteristics shown in Fig. 8. The most economical  $B_i$  is seen to be 5,000, corresponding to  $H =$

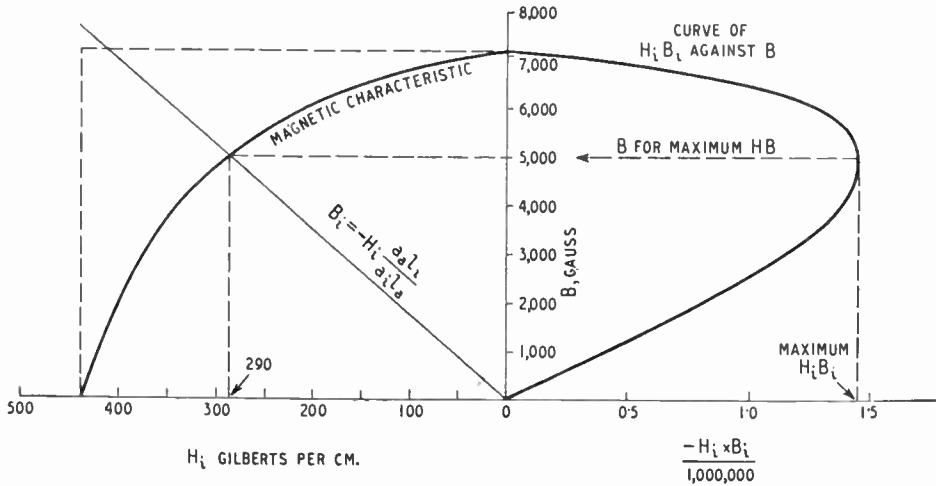

Fig. 8. Example of use of permanent-magnet B/H curve to find the smallest size of magnet necessary to excite a given gap.

diagram; but in the meantime we can use Fig. 7 merely as an aid to grasping the basic principles. These are two in number, and both very simple. The first we have already assumed, that the flux is constant throughout the circuit. That is absolutely true, just as for current in an electric

$$0 = p_i + p_a = H_i l_i + H_a l_a \dots (12)$$

$$\therefore l_i = l_a \frac{H_a}{-H_i} \dots (13)$$

We know that  $H_a$  is equal to  $B_a$  (because, if the right units are chosen,  $\mu$  for air = 1), and the length of the gap,  $l_a$ , is given, so

-290. Then, applying (11) and (13),  $a_i = \frac{B_a a_n}{B_i} = \frac{8,000 \times 4}{5,000}$   
 $= 6.4 \text{ sq. cm.}, \text{ and } l_i = \frac{B_a l_a}{-H_i}$   
 $= \frac{8,000 \times 0.25}{290} = 6.9 \text{ cm.}$

A magnet of these stubby dimensions may have to be connected to the given air gap by means of low-reluctance pole pieces; but that is as obvious as saying that a generator should be connected to its load by low-resistance leads. And in practice there are sometimes reasons for choosing magnet dimensions other than the most economical in material.

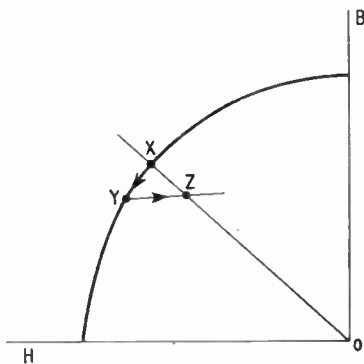

Fig. 9. If a magnetic circuit originally working at point X is demagnetized somewhat, say to Y; removing the demagnetizing influence causes it to return, not to X but to Z. To avoid the loss XZ taking place during service, magnets are previously brought by "aging" on to a flat curve like YZ.

To solve problems like the example above it is clear that no graph drawing is necessary so long as the best B of the magnet metal is given, and its corresponding H; only two easy formulæ.

There are cases, however, where it might at least be instructive to use the "load-line" technique of Fig. 7, if some means could be found of applying it to the B/H curve, instead of to a type of curve that cannot be drawn until we have the information we are trying to find. The  $S_a$  line of Fig. 7 mustn't be used in Fig. 6 (or Fig. 8) as it is, because the scales are wrong. To convert Fig. 6 to Fig. 7 we multiplied the B scale by  $a_i$  (giving  $\phi$ ), and the

H scale by  $l_i$  (giving  $p$ ). We could have done the same thing (less conveniently) by leaving the scale numbering alone—just changing the symbols—and fitting the curve to it by dividing its co-ordinates by the same factors. To convert a graph (to wit, the  $S_a$  line in Fig. 7) back to the original Fig. 6 scales of B and H, it is necessary to perform the reverse operation, viz., multiply the  $S_a$  line co-ordinates, so that what was a graph of

$$\phi = \frac{-p}{S_a} = \frac{-p a_a}{l_a}$$

becomes  $B a_i = \frac{-H a_n l_i}{l_a}$

or  $B = \frac{-H a_n l_i}{a_i l_a} \dots \dots (15)$

Given a B/H curve for the magnetic metal, then, a transferred air-gap line can be drawn, as in Fig. 8. Either the slope of the line is given by already-known iron and gap dimensions, in which case the resulting flux-density is shown; or one can draw the line to suit the B/H curve, and then calculate the unknown dimensions from the

slope. (Incidentally,  $\frac{a_n l_i}{a_i l_a}$  which is the ratio B/-H, is called the unit permeance).

It should be fairly obvious how to apply the foregoing principles to more complicated situations. For example, if there were some M.M.F. coming from a coil, assisting or opposing the magnet, the starting point of the air-gap line in Fig. 7 would have to be to the right or left respectively of zero, by an amount equal to the M.M.F.

In these calculations it has been assumed that the whole of the permanent magnet is working at the same point on its B/H curve. In actual fact it would not be, but the difference is not enough to justify the appalling difficulties one would get into by departing from this simplifying assumption.

This article is only a framework of theory, which serves as a first approximation in design. In practice there are other considerations for which there is no room here.

There is one very important thing, however. Suppose a permanent magnet in service, say in a moving coil meter, comes under

## RE-ENTRANT HORN TYPE 42 REH



The new 42REH has advantages of complete weather-proofness, smaller overall length, better weight distribution and consequently greater ease in handling, which make this one of the most popular of the new F.I. loud-speakers. The horn is designed for use with the standard F.I. L.S.7 Unit and allows for this unit to be driven to 12 watts input. A spun aluminium cover over the unit has room for housing a suitable matching transformer.

The construction has been designed so that the whole unit is assembled and held together with ONE LARGE NUT only. This construction enables a number of units to be packed for export in a space which is a fraction of that normally required; assembly is a matter of a few minutes unskilled labour. This unique feature will recommend itself to all export buyers particularly.

The 42REH is not of the "loud-hailer" type of speaker, but is designed to cover a range of frequencies considerably greater than those needed for purely "announcing" purposes: i.e., it is suitable for all normal requirements of high power reproduction of music as well as speech.

Dimensions assembled	... 22in. dia. x 24in.
Bell diameter	... 22in.
Cut-off frequency	... 175
Effective Air Column	... 42in.
Weight Horn only	... 8 lbs.
Shipping space	One—23in. x 23in. x 18in. 12—33in. x 33in. x 27in.

**F.I. for P.A.**  
**FILM INDUSTRIES LTD.**  
 60, PADDINGTON ST., W.1  
 Telephone: WELbeck 2385

**Permanent Magnets—**

the influence of an external magnetic field that opposes its own field, so that the working point moves downwards, say from X to Y in Fig. 9. When this disturbing influence is removed, the *status quo* is not restored. Instead, the working point goes to some such place as Z, the flux being very little more than at Y, and decidedly lower than at X. The accuracy of the meter is permanently ruined. To avoid this, magnets are "aged" by demagnetizing them in advance to a greater extent than they are likely to experience after calibration. So variations take place along a nearly flat curve such as YZ.

This also shows the reason for

warnings about it being a bad idea to take permanent magnet circuits to pieces. If the pole pieces are removed, the reluctance is increased, the "load line" moves anti-clockwise to some such position as in Fig. 7, and when put together again the system has lost a large part of its magnetism. One should also keep screwdrivers well away, because the horrid smack when such an implement is drawn against the magnet is also liable to de-gauss it appreciably.

Talking about gauss; magnetic units are a frequent source of confusion, which I shall try to dispel in a sequel. This inevitably brings in electric units as well, leading to consideration of the M.K.S. system of electro-magnetic units.

## V.H.F. Aircraft Equipment

### Transmitter-Receiver with Simplified Wave-changing

**M**ANY ingenious systems have been evolved for remote control of the wave-changing mechanism in V.H.F. communication equipment in aircraft, but few appear to rival that employed in the Standard Telephones STR12 transmitter-receiver.

this means provision is made for the immediate operation on any one of twelve spot frequencies between 118 and 128 Mc/s.

This simplicity of operation is

band circuits as inter-stage couplings throughout the transmitter and for certain stages of the receiver.

These two oscillators are both crystal controlled; they are similar in design and both operate as frequency doublers. As the crystal frequencies are necessarily low, eight stages in all of frequency doubling have to be employed in order to raise the frequency to the working value. The extra doublers are located on the transmitter and receiver chassis in the main assembly, which can be located in any convenient part of the aircraft. Coaxial cables terminating in band-pass filters convey the outputs of the two oscillators in the remote control unit to their respective frequency multipliers in the main assembly.

The transmitter chassis has two doubler stages followed by a driver amplifier and a pair of grounded-grid triodes connected in parallel and delivering approximately 3.5 watts of R.F. to the aerial.

The bandwidths of the interstage couplings are graded throughout the transmitter, being 2.5 Mc/s at the input and 10 Mc/s at the output. Thus the even harmonics up to the eighth of all crystal frequencies between 14.75 and 16 Mc/s are passed without the need for retuning.

A.F. modulation is applied simultaneously to the screen of the pen-

This view of the STR12 equipment shows the receiver chassis removed and the transmitter and power unit assembled. Shown also is the air filter removed from the front of the main assembly.

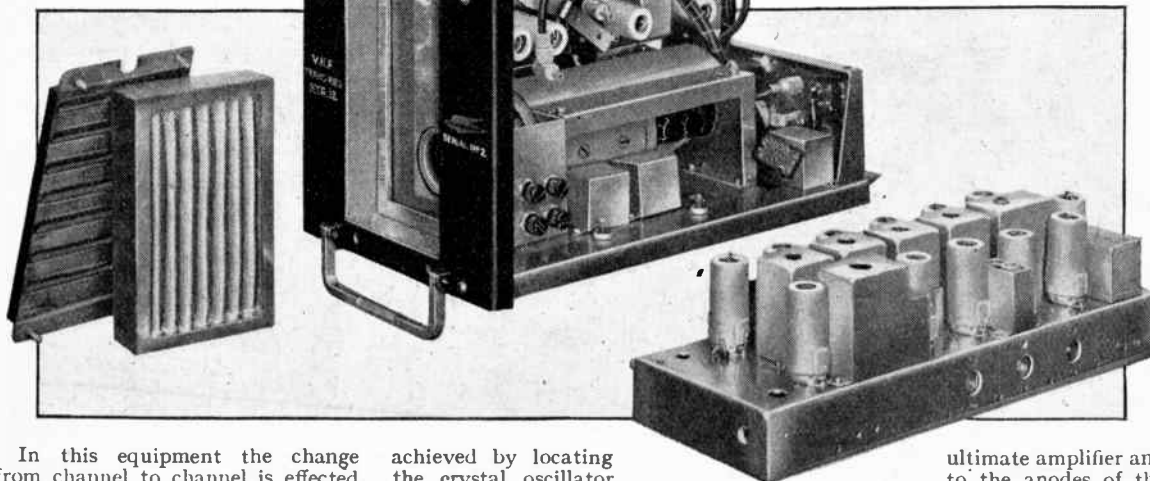

In this equipment the change from channel to channel is effected merely by selecting an appropriate pair of crystals, one for the transmitter and one for the receiver. By

achieved by locating the crystal oscillator stage of the transmitter and the local oscillator of the receiver in the remote control unit and using wide-

ultimate amplifier and to the anodes of the output valves and either telephony or M.C.W. can be employed. A detector for monitoring the trans-



mission through a side-tone valve on the receiver is also included in the transmitter.

One R.F. stage, a crystal-controlled local oscillator as already mentioned, four I.F. amplifiers at 20 Mc/s and with a bandwidth of  $\pm 40$  kc/s, A.G.C., noise limiter and muting circuit to suppress receiver noise in the absence of a signal are used in the receiver. Before the local oscillations are fed to the diode frequency changer they pass through two stages of frequency doublers coupled by wide-band circuits of the same kind used in the transmitter. In this case the final frequency lies between 98 and 108 Mc/s.

Power for the transmitter and the receiver is provided by a rotary transformer, which together with the smoothing circuits, is housed in the base of the main assembly. It produces 265 volts D.C. and supplies the transmitter and the receiver as required. L.T. for the valve heaters is obtained from a regulated supply

of 19 volts derived from the aircraft batteries.

The rotary transformer drives also a cooling and ventilating fan, the air drawn in being first passed through a filter located on the front face of the main assembly.

Miniature and tropicalized components are used extensively in the STR12 set and it has thus been possible to bring the overall size of the main assembly down to 7.9in x 12.5in x 7.8in. The control unit, which contains the two master oscillators, provision for 24 plug-in crystals and selector switch, on-off switch, volume control, microphone and telephone jacks, requires only 5.9in x 2.5in x 3.9in to accommodate it.

Miniaturization is extended even to the quartz crystal units themselves. These have been developed especially for aircraft use and measure only  $\frac{3}{16}$ in x  $\frac{1}{8}$ in x  $\frac{1}{16}$ in. The equipment is made by Standard Telephones and Cables, Ltd., New Southgate, London, N.11.

## National Physical Laboratory Annual Exhibition of Work

THE second demonstration of the N.P.L.'s scientific work and apparatus since the war was given this year from June 18th to 20th and included many items of interest to readers of this journal.

In the Radio Division methods of investigating site errors in direction finding at V.H.F. were demonstrated, using a scale model with rotating obstacle, synchronized with a cathode ray display. The trace showed general agreement with the calculated azimuthal error diagram. The technique of field strength measurement on centimetre wavelengths using a bolometer bridge in association with an aerial of known gain in relation to a half-wave dipole was shown; the same aerial radiating a known power provides a means of establishing a standard field strength.

The low-power klystron 1 cm transmitter and receiver with directional horn radiators, shown at last year's demonstration, were again seen in operation, this time in a demonstration of refraction through a Perspex prism. A parallel beam of red light passing through the same prism showed the same angle of refraction—a rather unexpected result in view of the ratio of 80 million in the wavelengths.

In the Electricity Division a method of measuring the velocity

of electromagnetic waves was shown, based on resonance in hollow conductors. Using a copper cylinder 8 cm in diameter and 8 cm long measured to less than  $10^{-5}$  cm, and determining the resonant frequency to a few parts in a million, the velocity obtained is 17 km/s greater than the accepted value derived by other methods of measurement. The work is being continued with electrical resonators of different shapes.

Apparatus for making overall measurements on hearing aids, including earpieces of all types in current use, was shown in the Physics Division. The acoustic measurement equipment is in course of extension and a new acoustically "dead" room with wedge cavity absorbent lining is under construction. An "infinite" duct, also making use of absorbent wedge termination is proving of great value in the absolute calibration of microphones at low frequencies. For the rapid and accurate determination of any given frequency from, say, a beat-frequency oscillator, an electronic decimal counter has been installed. This shows on a series of dials the number of cycles registered in the interval between standard second pulses received by line from the Metrology Division, and has proved a most convenient tool in routine acoustic measurements.

*And now—*

**A.C./D.C.**

**20-25-WATT UNIVERSAL AMPLIFIER—U885**

Gives considerably greater power output than usually expected from A.C./D.C. equipment. Constructed on the same lines as our 30-watt A.C. model and fitted with latest control panel carrying microphone, gramophone and tone controls, mains switch and pilot lamp and special 3-position switch providing either change-over or mixer circuit for gramophone and microphone. Three-stage high-gain type having four valves in parallel push-pull in output stage, a total of 10 valves. Output for high and low impedance speaker circuits.

Full details of this and other models sent on request.



**TRIX**  
Quality  
SOUND EQUIPMENT

**THE TRIX ELECTRICAL CO. LTD.**  
1-5 MAPLE PLACE, TOTTENHAM COURT ROAD, LONDON, W.1  
TELEPHONE: MUSEUM 5117 GRAMILE CABLES: TRIXRADIO, WESDO, LONDON.

## LETTERS TO THE EDITOR

### What is a Filter? ♦ Distortion and the "Average Receiver" ♦ Choice of Communication Frequencies ♦ Disc Records or . . . . ?

#### Tuned A.F. Filters

"A wave filter is a device for separating waves characterized by a difference in frequency."

THIS definition should be amplified in order to distinguish the highly specialized networks, usually called wave filters, from such systems as a continuous telephone line or a parallel tuned circuit, which do possess some frequency discrimination. We may say that "a wave filter is a network, whose ideal form has an attenuation which is zero in a band or bands of frequencies and is not zero outside these bands."<sup>2</sup>

Mr. Styles, in the July issue of *Wireless World* is most definitely not describing filter circuits, nor is it possible to envisage an untuned filter.

A somewhat more symmetrical treatment of the two circuits may be obtained by taking the resistive component of the series arm in the parallel tuned rejector in shunt with the coil. This is particularly useful when resistance-cancellation is employed to sharpen the response of a system of low  $Q$ .<sup>3</sup>

THOMAS RODDAM.

<sup>1</sup> G. A. Campbell, "Physical Theory of the Wave Filter," *Bell System Technical Journal*, p. 2, November 1922.

<sup>2</sup> A. T. Starr, "Electric Circuits and Wave Filters," p. 201, (2nd Edition, 1928) Pitman.

<sup>3</sup> Thomas Roddam, "Wavetraps with Infinite  $Q$ ," *Wireless World*, April, 1945.

#### B.B.C. Quality

I WAS very interested in the recent correspondence on the subject of the quality of the B.B.C.'s transmissions, but I refrained from making any immediate comment in order to give myself time to make more extensive observations.

Unlike Mr. Hartley, I am not in a position to make quantitative analyses of the distortion, but I have been able to make frequent qualitative tests on six different receivers. Two of these are commercial superhets of average quality, both ten years old; one of the others is an R.A.F. R1155 with 6V6 output and an eight-inch loud speaker. Of the remaining three receivers, one is a T.R.F. "quality" receiver, another a domestic T.R.F. set with triode output and an eight-inch loudspeaker, and the third is a T.R.F. midget with 3½-inch loudspeaker.

On all the receivers except the midget, distortion is present to a marked degree on certain transmissions. On the "quality" receiver about 10 per cent of all transmissions are above complaint. The R1155 and one of the commercial superhets give reasonable reproduction on about fifty per cent of broadcasts, while the two remaining receivers are satisfactory on about twenty per cent of transmissions. These figures seem to refute the contention that the distortion is not noticeable on the average receiver; the R1155 is certainly below average in this respect.

With regard to the incidence of distortion among the various programmes, the Home Service appears to be more free from this evil than the other two services. The Third Programme frequently regales us with a succession of the B.B.C.'s "muddy" recordings, and the Light Programme appears to be suffering from over-modulation most of the time. This fault is by no means confined to the Light Programme: one of the consistent offenders is "Music in the Morning" on the Home Service. This programme is frequently transmitted at a level more than twice that of the previous night's transmissions, accompanied by all the evils of harmonic distortion, intermodulation and sideband splash. In accordance with Mr. Bishop's suggestion (March issue) I have notified the B.B.C. of this complaint.

While most listeners will appreciate the Corporation's difficulties regarding equipment, etc., one cannot help feeling that much of the trouble is due, not to aged apparatus, but to careless monitoring of the transmissions.

GERALD R. W. LEWIS.  
Beckenham, Kent.

#### V.H.F. for Trunk Communications

IN his article "Wire or Wireless" in your July issue, Thomas Roddam appears to imply that the radio engineer has no propagation worries at V.H.F. and higher frequencies. But frequencies of the order of 42 to 50 Mc/s (which he quotes as being used in British Columbia, with the relatively high power, for a semi-optical service, of 250 watts) are capable of propagation beyond the

horizon; and because channel space is precious at these lower frequencies, they should be reserved for longer-than-optical links. Anyone who thinks that such links are all plain sailing should study the arguments which arose in U.S.A. over the transfer of the F.M. service from 40-50 Mc/s to around 100 Mc/s. Admittedly there were commercial interests involved, but there were plenty of genuine technical points in the Norton *versus* Dellinger arguments. (See, for example, "V.H.F. and U.H.F. Signal Ranges as Limited by Noise and Co-Channel Interference," E. J. Allen, *Proc. I.R.E.*, Feb. 1947, p. 128, and the discussion on this paper.)

At centimetre wavelengths we are practically limited to genuinely optical paths, but the tendency is for the beam to become so narrow that atmospheric refraction can divert it off the receiving aerial. In fact, it has even been proposed to use diversity reception in order to overcome fading at a frequency of some thousands of megacycles.

It is perhaps unfortunate that we are rather slow in publishing reports in this country, but one of the papers read to the I.E.E. Radio-communications Convention this year, entitled "Resumé of V.H.F. Point-to-Point Communication," gave an account of a number of V.H.F. multi-channel telephone circuits which are already in use in the Post Office telephone service. When this paper is printed, we shall not need to cross the Atlantic for examples of radio trunk lines, and incidentally the Post Office radio circuits are 12- and 24-channel links compared with the 1- and 6-channel examples from British Columbia.

D. A. BELL.  
British Telecommunications Research, Ltd.,  
Taplow, Berks.

#### "Degrees for ex-Servicemen"

WITH reference to recent correspondence in this column, I have received a total to date of ninety-three completed questionnaires. Of these fifty-one are from the London area, including Dartford and South-West Essex, and ten from Stoke-on-Trent. The numbers in each of the other localities are unfortunately too small to make it possible to ask the Ministry of Education to take action, but it is hoped that in London and Stoke it may be possible to bring about the desired results.

I am communicating with the Ministry of Education, to whom the questionnaires and an analysis of the results is being sent.

I should like very much to thank those who have completed question-

naires and to request that those to whom they have been sent and who have not yet returned them would do so immediately, especially if they wish to take courses in the London area or in Stoke.

O. S. PUCKLE,  
R.F. Equipment, Ltd.,  
Langley Park, Nr Slough, Bucks.

**"Squegger"**

**D**URING the first World War, while serving with the Royal Air Force in Egypt (in 1918), I read a report on a "Squegger."

The instrument was intended for testing grid leaks, and consisted of an oscillating valve with excessive retroaction, the grid leak being selected by operating a two-way switch.

The leak under test was compared with a standard leak by comparing the pitch of the two squeaks heard with the switch in alternative positions, a high squeak indicating a low resistance.

The description stated that the instrument, by *squeaking*, acted as a substitute for the (almost unobtainable) *Megger*, and was therefore called a "squegger."

In view of Mr. Round's explanation in your issue for July, 1947, this explanation appears to be untrue. Possibly it gained currency owing to its very plausible reason for the derivation of the last part of the word.

L. BAINBRIDGE-BELL,  
Witley, Surrey.

**Domestic Recordings: Disc v. Wrapped-up Systems**

**I**N past years much space in your publication has been devoted to the hoary problem of disc v. tape or film recording, and there is no need to cover old ground.

However, I agree with the conclusion of Mr. A. J. Little in his letter (July issue) that the disc system will remain for domestic recordings of short popular items, and that a "wrapped up" system (probably magnetic) will in due course be introduced commercially to cater for enthusiasts requiring high-quality long-playing musical or operatic recordings. Apart from the simplicity of the disc system for the average user, any competing system must have a technique of cheap, simple and quick multiple duplication of the master recording. These systems should, in my opinion, be regarded as complementary.

As a matter of interest, Mr. Little, and other readers, might like to know that R.C.A. in America have recently marketed a wire recorder, in which no threading or wire handling is necessary. A recording cart-

ridge, providing 15 or 30 minutes' running time, with a simple mechanism that drives two wires, is merely slipped into the unit.

Finally, it ought to be made clear that rather more than a suitable sound-head is required to convert a disc reproducer into a magnetic strip record reproducer, as Mr. Little suggests, but one novel method of solving the wire transport requirement, which is already incorporated in an American design, is to utilize the rim of the turntable, on which ordinary discs can be played, as a capstan around which the wire is wrapped.

DONALD W. ALDOUS,  
Torquay, Devon.

**Television Deflector Coils**

**I** HAVE followed the articles on television construction and have made a good job of the deflector coil assembly. It took me longer to make the coil formers than to do the winding and assembly, and I am writing to say that I am willing to lend my formers to any reader who is making the coils.\*

W. J. DAWSON,  
Burnham-on-Crouch, Essex.

\* We shall be pleased to forward letters from any readers wishing to avail themselves of Mr. Dawson's kind offer.—E.D.

**"Loudspeaker Damping"**

**I**N your April issue D. T. N. Williamson refers to electro-magnetic damping of a baffle-loaded loudspeaker, through low output resistance of the amplifier, as being important. I used to think so myself, and was the first to use the word "damping factor" but my belief was much shaken by the following argument.

If a loudspeaker can be represented by an equivalent circuit consisting of a resistance in series with an "ideal" loudspeaker of 100 per cent efficiency, then the damping must be applied across the input terminals. In this case, even if the amplifier output resistance is zero, the damping is limited by the series resistance which, for 5 per cent efficiency, would be twenty times the resistance of the ideal loudspeaker. This extreme simplification, of course, leaves out the reactive components of the speaker impedance, but the argument still holds qualitatively.

Can any reader of *Wireless World* point out any error in this argument? If it is true, there is very little gained by attempting to achieve excessively low output resistances.

F. LANGFORD-SMITH,  
Sydney, Australia.

In the interests of better quality...

The LABYRINTH LOUDSPEAKER (TYPE S. L. 15)

... for Music Societies—Schools Theatres — Quality P.A. — and all music lovers

A partitioned cabinet to form a folded pipe—the back of the unit coupled to it in such a way that the quarter and half wave resonances are under independent 'Q' control—cabinet acoustic resonances arranged to cancel pipe anti-resonances. The result is a smooth bass response down to 35 c.p.s.

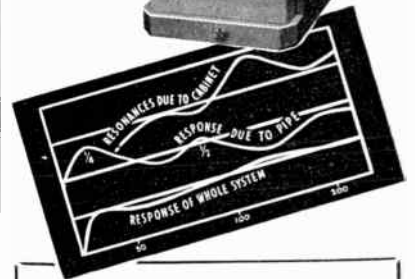

"ADDRESSING the PUBLIC"

The Fundamentals of good P.A. Technique

3/6d. POST FREE



ACOUSTICAL MANUFACTURING CO., LTD.  
HUNTINGDON · Telephone : HUNTINGDON 361

# RANDOM RADIATIONS

## An Occasion

THE I.E.E. *Conversazione*, held this time in the Science Museum instead of the Natural History Museum, was a most successful affair. After all these years of drabness and austerity a full-dress evening function, with its masculine white ties and its polychromatic feminine confections, was indeed a sight for sore eyes. And what a company was there! I heard many guesses made at the numbers, some pretty near, others wildly too big or too small; the official figure was, I understand, 2,500. I like the rather Victorian term "*conversazione*" for two reasons. First of all, it has been in use ever since these gatherings were started and suggests the respectable length of the Institution's history; secondly, it is descriptive, for the primary object of most of those who attend is to chat with friends old and new. You renew relations with people whom you hadn't seen for years and make all sorts of interesting fresh contacts. Recalling that so many of us had been away at the wars since 1939 and had laid up our evening togs, not in lavender, but in naphthalene and what not, I had warned Mrs. Diallist to prepare for the most formidable concentration of moth-ball perfume in the history of mankind. My fears, however, proved groundless, no doubt because the preceding spell of fine, sunny weather had provided heaven-sent opportunities for the preliminary airing of festive garments.

□ □ □

## Summertime Nuisances

THOUGH the B.B.C. suggests politely from time to time that in the season of warm evenings and open windows listeners should remember that a blaring loudspeaker can cause a great deal of annoyance to neighbours some distance away, there are always some who either won't believe it or don't care the now historic tinker's cuss. I'm lucky (says I, touching wood) in having neighbours who behave with due consideration for others. But a few evenings before this was written I found my ears assailed by a bellying and horribly distorted rendering of the light programme. A reconnoitring stroll tracked down the source of the din to a house 200 yards away, into which newcomers had recently moved. The blinds were up, the lights were on and there, right against the open window, was the *back* of the wireless receiver. What to do, as the French

say? Luckily, the owner emerged just at that moment to take his dog for its bedtime saunter and I joined him, bidding him welcome to the neighbourhood. We had to shout to make ourselves heard and so found some difficulty in the exchange of names. "I say," he said, "that can't be my wireless that's making the uproar; it couldn't be, for my loudspeaker's pointing into the room and it's the back of the set that's near the window." I suggested that quite a lot of noise could come from the back of a set and, having convinced him that his was the culprit, got him to walk up the road, counting his paces as he went, to see just how far such unintentional broadcasting could carry with nuisance value. When he'd counted up to 300 paces he turned round and went back almost at the double! There has been no further trouble and (fingers crossed) I don't fancy there will be.

□ □ □

## Worth Trying

A TEST that every listener should make, particularly in summertime, is this. Turn on the set and adjust the volume to your liking. Then go outside the house and see at what sort of distance the sound is likely to disturb other people. So long as it is confined to your own boundaries, well and good. But remember that, however much you may pride yourself on the quality of its reproduction, your receiver is not as a rule giving your neighbours a treat if they must perforce listen to it. It is *not* funny to have the third programme as something more than a background when you are trying to listen to Itma—or *vice versa*. It is still less funny to have incomprehensible speech or a travesty of music, consisting largely of resonance peaks, hurled at you when you are trying to read or work.

□ □ □

## Can You Beat It?

BEFORE now I've commented on the fine free disregard shown in American technical books and periodicals for the internationally accepted symbols and abbreviations of electricity in general and wireless in particular. The other day I added to my collection a specimen which seems to me to put all previous finds quite in the shade, particularly as it occurred in the advertisement of an important manufacturing firm. Capacitors of certain types are announced "with values up to 500 Mmfd." What they ap-

parently mean is 500 micro-microfarads, picofarads or "puffs." But the only meaning that 500 Mmfd can have, according to the internationally agreed symbols, is 500 mega-millifarads =  $500 \times 10^6 \times 10^{-3} \text{F} = 500,000 \text{F}$ ! I'd rather like to see a capacitor of that size, though I can't think off-hand of any useful application for it in the wireless receiver. A pity that this sort of thing should happen. The main

## By "DIALLIST"

purpose of the international system of symbols and abbreviations is to facilitate the understanding of text books, articles and so on written in languages foreign to the reader. Letters or signs should have fixed and unalterable meanings.

□ □ □

## English As She Is Translated

A FRENCH reader kindly sends me some comments on the alleged French version of the catalogue of this year's Components Exhibition. When an exhibition is staged largely with the purpose of attracting foreign buyers of our goods, in order to help the export drive, it is plainly good policy to print the catalogue not only in English, but in those other international languages, French and Spanish. But—and it is a big but—it is just as well to ensure that the French is French and the Spanish, Spanish. Something went wrong when French- and Spanish-speaking visitors (all potential buyers in the export markets that we are striving to expand) are reduced to helplessness by paroxysms of laughter on comparing the exhibits with their catalogue descriptions. To give but two examples: the "racks" of a radio assembly are not the kind of racks that are associated with pinions, though that's how they were translated for the benefit (?) of the foreign visitor; you can, in English, describe a refurbished component or piece of apparatus as "rehabilitated." But you can't call it *réhabilité* in French; that would mean that its reputation or its civil rights, lost as the result of some fall from grace, had been restored. Such bloomers are on a par with that of the schoolboy who was at first stumped by a "chest of drawers" in the French prose which was part of his evening's homework. Failing to find in the dictionary any equivalent for the whole expression, he looked up "chest" and found *poitrine* (= thorax); for "drawers" the dictionary suggested *caleçon* (= pants).

He therefore wrote *une poitrine de caleçons*.

□ □ □

### No Prizes Offered

HERE'S one of those little problems which, though they're absurdly easy, often puzzle for a bit those at whom they are fired suddenly. You have two small steel bars of identical size and appearance. One is magnetized; the other is not. No instruments or appliances of any kind are available—no compass; not even a piece of string with which to suspend them; no other piece of metal. How can you discover in a moment which is which? Got that one? Try this. Time allowed 15 seconds. As you look at the screen of a television C.R.T. current flows through the line-scan deflector coil so as to make the direction of the deflecting magnetic field upwards. Does the spot move towards your right hand, or towards your left? Test books not infrequently evade that issue either by stating merely that the spot is moved to the right or to the left according to the direction of the deflecting field, or by offering an illustration in which the field is shown by vertical straight lines with arrowheads at either end and the movements of the spot by a horizontal straight line, also arrow-headed at both ends. It's easy enough to work out; but don't forget that 15-second time limit!

□ □ □

### Electronics

MY sympathies are with L. Wafer, who expressed in last month's *W.W.* his dislike of the overworked and misused term "electronics." If we accept the definition adopted by the American I.E.E., the term becomes of absurdly wide application, as "Cathode-Ray" has pointed out. Is the sparking-plug, for instance, an electronic device? I suppose it must be, for its action depends on "the conduction of electricity through gases." One hardly thinks of either the sparking plug or the spark transmitter as electronic appliances, probably because they don't belong to "Cathode-Ray's" "glassware department of electricity." The definition would, I think, be better if it read: "... the conduction of electric current between cathode and anode sealed into an evacuated or gas-filled envelope." Even so, if we are to retain the term, I feel that it should be far less generally applied than it is at present. Before now I have been moved to mirth by a shop front with large and gaudy lettering which proclaimed some not over-bright electrician as an "Electrical, Radio and Electronic Engineer."

## a new foot-operated switch

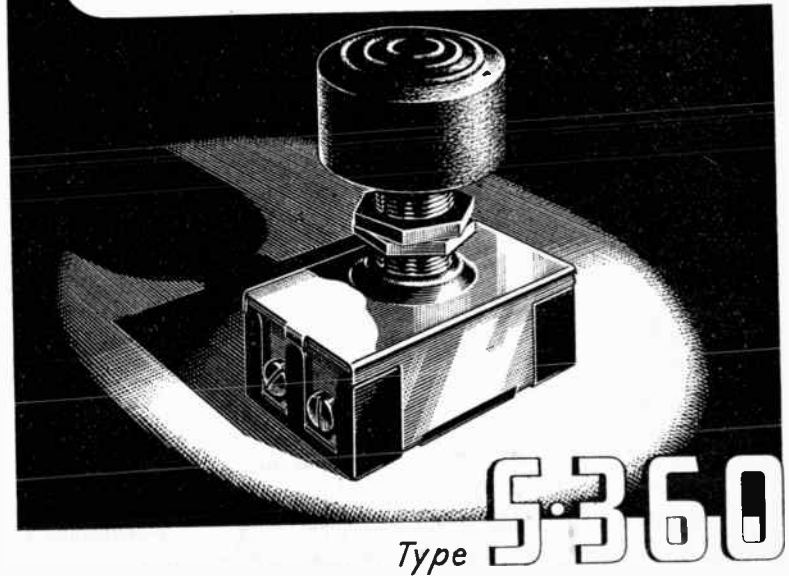

Type **S-360**

ESPECIALLY designed for appliances which are most effectively and conveniently controlled by a foot-operated switch this new Bulgin Type S 360 combines a high efficiency action with absolute reliability. Ideally suitable for vacuum cleaners, hair-dryers, foot-operated drills and other similar apparatus its application covers a wide range of commercial requirements. The S 360 is a Push/Push, Single Pole switch and fixes by a single  $\frac{1}{8}$ "  $\phi$  hole to panels up to  $\frac{1}{4}$ " thick. It is fitted with a large black rubber knob held captive but easily removable for mounting, and operated by  $\frac{1}{4}$ " displacement at  $4\frac{1}{2}$  lbs. min.,  $6\frac{1}{2}$  lbs. max. pressure. Rear of panel space is approximately  $1\frac{1}{2}$ " x  $1$ " x  $\frac{1}{8}$ " min. rear projection. End terminals are included for connections. Rating:—Working, 250 volt max., 2 A. max. for loads of 1—0.7 p.f. Tested at 1 KV. to E.

**Available for Prompt Delivery**

*"The Choice of Critics"*

# BULGIN

A. F. BULGIN & CO. LTD. · BYE-PASS-RD. · BARKING

Telephone: RlPpleway 3474 (5 lines).

# RECENT INVENTIONS

## A Selection of the More Interesting Radio Developments

### FREQUENCY MEASUREMENT

THE frequency of a variable signal is measured by passing it through two parallel circuits, one or both of which produce corresponding phase or amplitude variations, which are then

C-R frequency meter

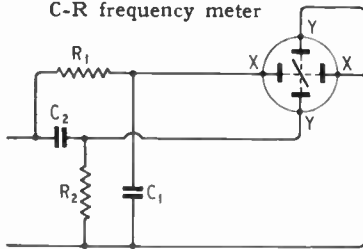

applied to the deflecting plates of a cathode ray tube.

In the simple arrangement shown, the input comprises two resistance-capacity branches  $C_1$ ,  $R_1$  and  $C_2$ ,  $R_2$ , the reactance of  $C_1$  being small compared with  $R_1$ , and that of  $C_2$  large compared with  $R_2$ . The first branch produces a voltage lead, and the second a voltage lag of 90 deg. so that when applied across the deflecting plates X, Y, they give a straight-line trace on the screen. In addition, one branch-circuit progressively lessens the amplitude of the higher frequencies, whilst the second branch has the reverse effect, thus causing the trace to rotate through an angle of 90 deg. over the whole frequency range. By the use of more elaborate delay and attenuating networks, the response can be increased to one or more complete rotations. The invention is applicable to radar and altimeter devices, particularly those using a variable-frequency exploring wave.

*Standard Telephones and Cables, Ltd., and C. W. Eurp. Application date April 21st, 1942. No. 581201.*

### WAVEGUIDE OSCILLATOR

STANDING waves are set up in a waveguide from its open end, the other end being closed by a sliding piston. The system is energized by projecting a stream of electrons from a cathode gun across the guide at a voltage loop and in a direction parallel with the field created in the resonating space bounded by the closed end of the guide. A reflector,

The British Abstracts published here are prepared with the permission of the Controller of H.M. Stationery Office, from specifications obtainable at the Patent Office, 25, Southampton Buildings, London, W.C.2, price 1/- each

arranged near the opposite wall of the guide, returns the electrons towards the gun, so that the stream is velocity-modulated on the forward journey, and "bunched" on the return, thus feeding energy to the oscillating field. A perforated diaphragm near the open end of the guide serves to prevent any excessive radiation damping of the resonating space.

In reception, signals are first rectified on a bend of the characteristic curve of the device, and are then mixed with an autodyne frequency. A flared horn may be attached to the open end of the guide.

*Standard Telephones and Cables, Ltd., and S. G. Tomlin. Application date August 29th, 1941. No. 581481.*

### PULSE GENERATORS

INTENSE voltage surges, suitable for shaping or modulating the pulsed exploring signals used in radio-location, are developed by suddenly interrupting the current passing

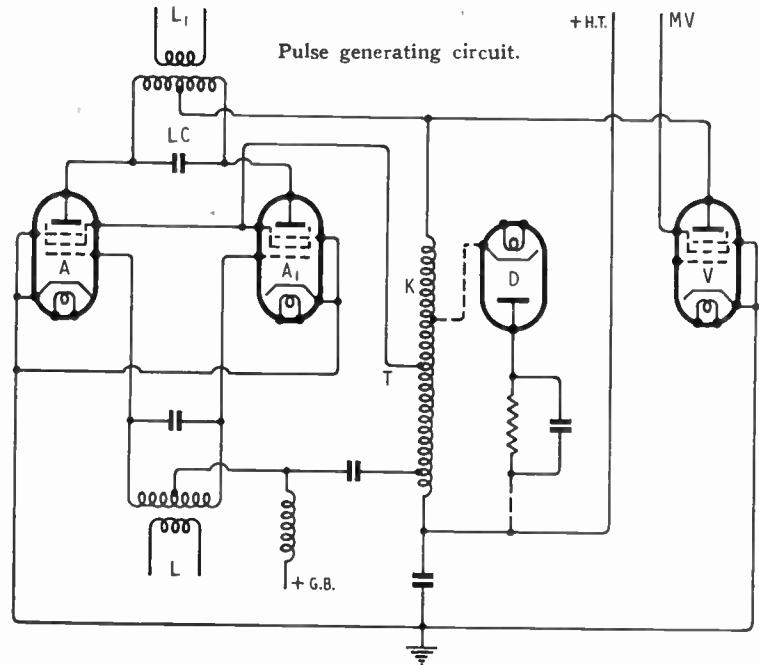

through a valve that is coupled to a highly inductive load.

Two R.F. amplifiers A, A1 are fed in push-pull by the output coil L from an oscillator, and are coupled through a coil L1 to the transmitting aerial. A valve V, which is normally non-conducting, is periodically triggered at MV by square-shaped waves from a multivibrator (not shown). This causes current first to build-up in the

load inductance K, and then to be rapidly cut-off. The resulting voltage "kick" is injected into the tuned anode circuit LC of the R.F. amplifiers, whilst a fraction of it is also applied to the screen grids, through a tapping T, causing a sharp pulse of radiation from the aerial.

With 1,000 volts H.T. on the anode of the valve V, the back-E.M.F. across K may reach a peak value of 7,000 volts, or more than enough to overload the valve were its duration not so short. A diode D helps to damp the inductance after each excitation. The inductance shown may be replaced by a time-delay network, which serves to shape the modulation voltage.

*A. D. Blumlein and E. L. C. White. Application date January 27th, 1940. No. 579725.*

### TUNING DEVICES

RELATES to the tuning of a hollow resonator, such as is used for generating oscillations by velocity modulation.

The resonator is approximately toroidal in shape, and may consist of a flat cylinder fitted with apertured end discs of suitable curvature. A curved strip of springy metal is fitted inside a selected part of the relatively rigid wall of the cylinder, and is flexed to-and-fro by an external control screw, so as to vary the effective size, and,

therefore, the tuning, of the resonant cavity. The strip is bent to a radius which is larger than that of the cylinder, so that its ends always keep in electrical contact with the wall. Or it may be permanently connected to the inner surface of the wall through corrugated end pieces of sufficient flexibility.

*A. F. Pearce. Application date February 13th, 1942. No. 579317.*



**ERIE**

*Electronic Component Products*

**RESISTORS • CERAMICONS • HI-K CERAMICONS**

**SUPPRESSORS • POTENTIOMETERS**

**VITREOUS ENAMELLED WIRE-WOUND RESISTORS**

**ERIE RESISTOR LIMITED**

**CARLISLE ROAD**  
TELEPHONE: COLINDALE 8011-4  
FACTORIES: LONDON,

**• THE HYDE • LONDON •**  
TELEGRAMS: RESISTOR, PHONE, LONDON  
**ENGLAND • TORONTO, CANADA**

**• N.W. 9 • ENGLAND**  
CABLES: RESISTOR, LONDON  
**• ERIE, PA., U.S.A.**

# Quality Enthusiasts

Here's a feast for you. Our new 1948 Range caters for every purse and each model provides a new revelation in sound production. See all these outstanding models on Stand 122 Radiolympia, Oct. 1-11.

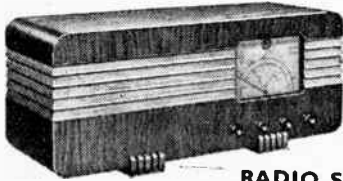

### RADIO SETS

Reynolds "Quality Eight." 8-valve 3 waveband superhet, twin chassis. Outstanding cabinet, bristling with new features. **PRICE 34 GNS. Plus Tax.** "Finest reproduction I have ever heard in a table model."—Radio enthusiast with 27 years' experience. Also the "ALL-INDIA EIGHT." As above, but specially designed for Indian conditions. Price on request. South African and Australian models also available. Export prices on request.



### AMPLIFIER Model T40

Our famous T40 now in use everywhere. For details see previous issues or write.

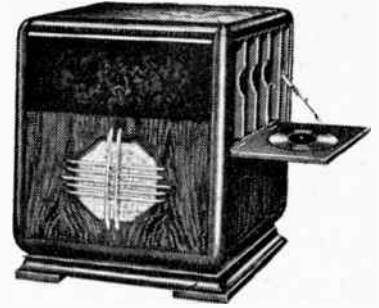

### REYNOLDS "MASTERPIECE" RADIOGRAM

10-valve 3 wave superhet with entirely new tone circuit. 12in. speaker, 10 watts output. Musical reproduction is amazing. You must hear this!

"It's unbelievable."—Symphony Orchestra Conductor. **PRICE 115 GNS. Plus Tax.**



### REYNOLDS CONCERT GRAND

The ultimate in sound reproduction. 16 valves, twin 12in. speakers, auto-record changer for 30 mixed 10in/12in. records, plays both sides, featuring ultra-sonic reproduction, 40 watts output.

"This is not Radio, it's the real thing."—Everyone who has heard it. **PRICE 395 gns.**

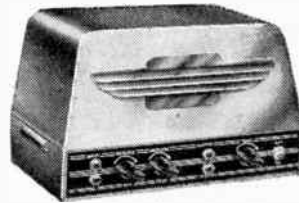

### AMPLIFIER Model T12

The smartest AC/DC Amplifier on the market. Outstanding performance, 10 watts output.

**PRICE 18 GNS.**

**REYNOLDS UNIVERSAL MANUFACTURING CO., LTD.,**  
410, DUDLEY ROAD, EDGBASTON, BIRMINGHAM, 16

EXPORT AND TRADE ENQUIRIES WELCOMED

Telephone: SMethwick 0201

## The ROTHERMEL "Vibromike" for all Stringed Instruments

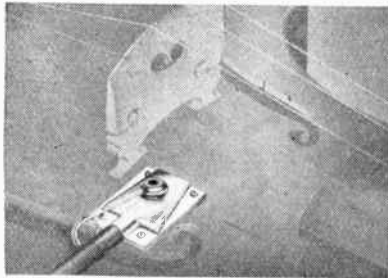

The ROTHERMEL 'Vibromike' is a contact microphone of the bender type designed for amplification of all stringed instruments, and is widely used for special orchestral effects. The crystal generating element is housed in a hermetically sealed case, and is therefore protected against adverse humidity conditions. When used with instruments such as violins, guitars, mandolins, etc., the output voltage is from .05 v to .1 v and higher. Any amplifier having high impedance input will be found satisfactory for use with the Vibromike.

● A full range of ROTHERMEL Crystal and other products in loose leaf catalogue form will be sent on receipt of 6d. to cover postage, etc.

**PRICE £4 10 0** complete with 8ft. of flexible shielded cable. Plus Purchase Tax.

**R. A. ROTHERMEL LTD.**  
Rothermel House, Canterbury Rd., London, N.W.6.

Telephone: MAIDA VALE 6066 (3 lines)



Manufacturers of  
LOUDSPEAKERS  
•  
LAMINATIONS  
•  
SCREENS  
In  
RADIOMETAL  
•  
PERMALLOY  
•  
SILICON ALLOYS

**ELECTRICAL SOUND & TELEVISION PATENTS LTD.**  
12, Pembroke Street, London, N.1. Terminus 4355  
2/4, Manor Way, Boreham Wood, Herts Elstree 2138



## The Problem

The directional response characteristic of single unit loudspeakers is very pronounced at the higher audio frequencies which are audible only in a comparatively narrow channel directly in front of the reproducer with a corresponding lack of intelligibility and brilliance elsewhere.

This feature is particularly troublesome when high quality sound reproduction is required in public halls, theatres and small cinemas where the size and expense of a large dual channel loudspeaker system is often not justified.

## The Solution

It is for such installations that the Vitavox Bitone Reproducer has been designed. High frequency reproduction in this instrument is handled by a small multicellular horn and moving coil pressure unit, this assembly providing adequate coverage and at the same time because of its high efficiency, a rising high note characteristic which is an advantage in auditorium reproduction. A 12" moving coil cone type loudspeaker operating in a vented enclosure reproduces low frequencies and a cross-over filter network is fitted to divide the frequency spectrum correctly between the two units. The whole assembly is mounted in a polished Walnut finished cabinet as standard, Oak and Mahogany veneered models being available to special order, and can be relied upon for applications where quality of performance rather than first cost is the main consideration.

### SPECIFICATION AND PRICES

Power Handling Capacity: Model 610—10 watts; Model 620—20 watts. Size: 32" x 21" x 20". Terminating Impedance: 7.5 ohms. Filter Attenuation: 12 d.b. per octave. H. F. Distribution (appx): 60° x 40°.

MODEL 610 — £42 0 0

MODEL 620 — £50 0 0

VITAVOX LTD., WESTMORELAND ROAD, LONDON, N.W.9. TEL: COLINDALE 8671-3

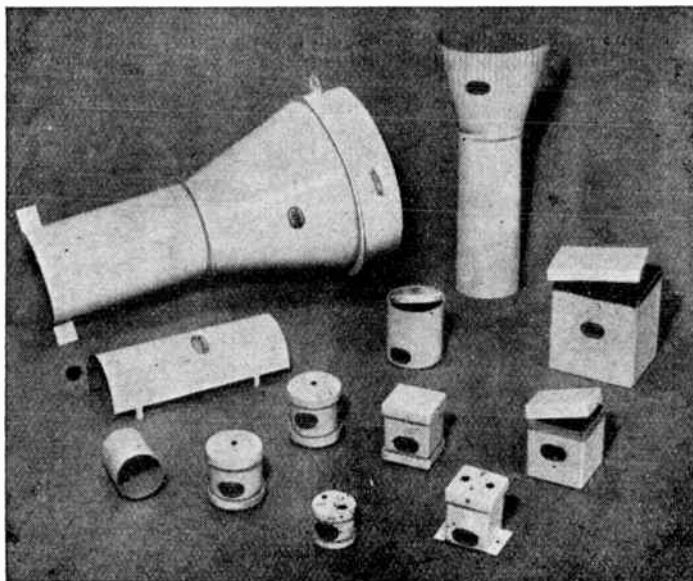

## MUMETAL

REGD.

### MAGNETIC SCREENS

The high permeability of MUMETAL makes it the outstanding material for the production of all types of magnetic screens. We are in a position to fabricate boxes and shields of practically any shape or size for the screening of delicate instruments and equipment from both uni-directional and alternating magnetic fluxes. A complete range of standard MUMETAL shields is available, examples of which are illustrated. Our technical experts will be pleased to assist in the solution of all screening problems. Your enquiries are invited.

THE TELEGRAPH CONSTRUCTION & MAINTENANCE CO. LTD.

Founded 1864

Head Office: 22 OLD BROAD ST., LONDON, E.C.2. Tel: LONDOn Wall 3141  
Enquiries to: TELCON WORKS, GREENWICH, S.E.10. Tel: GREEnwich 1040



## TELCON METALS

## The Connoisseur

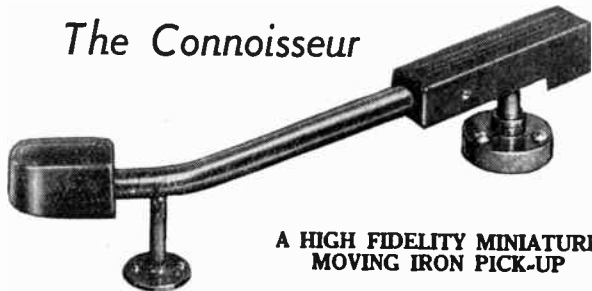

A HIGH FIDELITY MINIATURE  
MOVING IRON PICK-UP

Faithful reproduction of all recordings from 12,000 c.p.s. to 30 c.p.s. will win many new friends for the CONNOISSEUR miniature moving iron Pick-up in 1947.

The CONNOISSEUR reveals a wide range of notes and instruments that has hitherto been hidden by bass and treble resonance. The CONNOISSEUR will reproduce every sound on the record. Try it and prove it.

Note new prices. Pick-up 54/- plus 11/8½ p. tax  
Transformer 13/- nett

Apply to

Albion Electric Stores, 125, Albion Street, Leeds 1

or to

Lawton Bros. (Sales) Ltd., Henry Square, Ashton-under-Lyne

Made by

A. R. SUGDEN & Co. (Engineers) Ltd., Brighouse, Yorks

## SYLMAR RADIO LTD.

are now distributors of

### T.R.E.L. PRODUCTS

(Tolworth Radio & Electrics Ltd.)

**SUPERHET TUNING UNIT.** 16—50, 200—550, 1,000—2,000 m. Consisting of 2-gang Condenser, Silver Screen Dial, printed in blue, Drive. I.F.s., Coils. Completely wired and aligned on Broadcast signals. Price, with circuit £5.

#### Special Offer!

#### 5-VALVE 3-WAVEBAND AC/DC SUPERHET KITS.

All components mounted to chassis, size 12×6×2½ ins. Needs only Resistors and Condensers to be fitted and wired. Complete in every detail with valves and full instructions. £9 9s. 0d. plus £2 2s. 0d. P.T. The finest Kit on the market!

**Walnut Veneer Cabinet** for above £2 10s. 0d. extra.

**3-Wave Coil Packs.** Complete with trimmers and wavechange switch 30/-.

**T.R.F. Coils.** Medium and Long wave. Complete with circuit 6/6 pair.

**Superhet Coils.** 3 Ac. and 3 Osc. Set of 6, 12/-.

**5 in. P.M. Loudspeakers.** 17/6.

**Ex-Govt. Surplus. Condensers** 0.1 mfd. 6d., 0.01 mfd. 6d., 10 mfd. 450 v. 2/9, 25 mfd. 25 v. 1/9,

50 mfd. 12 v. 1/9. **Valveholders,** Octal 6d., Madza type 4d.

**Resistances,** all values 2/6 doz. **Potentiometers,** wire wound, 25,000 ohms. 1/3.

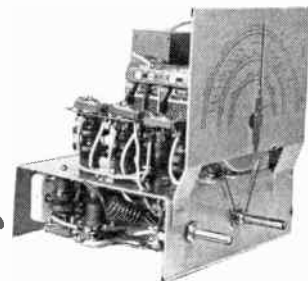

GET OUR QUOTATION for all your requirements.

Retailers Enquiries welcomed.

POST PAID.

Phone: PROspect 6651.

**SYLMAR RADIO LTD.** 197 LOWER RICHMOND ROAD,  
RICHMOND, SURREY.

# RM

HIGH PEAK PRIMARY  
COILS, Q100.

TYPE T.R.F. 34/35.

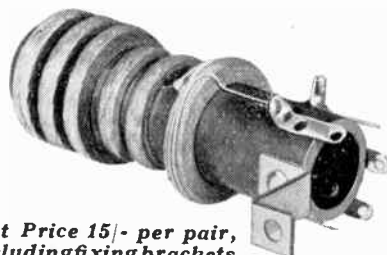

List Price 15/- per pair,  
including fixing brackets

Designed specially for midget T.R.F. receivers. They are small in physical size yet have High Q.

**R. M. ELECTRIC LTD.**  
**TEAM VALLEY, GATESHEAD. 11.**

**Varley**  
REGD. TRADE MARK

Products of  
Quality & Reliability

MAINS TRANSFORMERS  
A. F. TRANSFORMERS  
THERMAL DELAY SWITCHES  
SMOOTHING CHOKES  
POWER RESISTANCES

Made by

**OLIVER PELL CONTROL LTD**

Telephone: WOOLWICH 1422-1426  
CAMBRIDGE ROW · WOOLWICH · S.E.1P

Shortly for release  
A NEW RANGE  
of MOVING COIL  
MICROPHONES



Send for leaflet

**LUSTRAPHONE LTD.,** 84, BELSIZE LANE,  
LONDON, N.W.3

Telephone: HAN'ps:ead 5389 and 5515.

Rate 6/- for 2 lines or less and 3/- for every additional line or part thereof, average lines 5-3 words. Box Numbers 2 words, plus 1/- Press Day: September 1947 issue, first post Wednesday, August 6th. No responsibility accepted for errors.

WARNING

Readers are warned that Government surplus components which may be offered for sale through our columns carry no manufacturer's guarantee. Many of these components will have been designed for special purposes making them unsuitable for civilian use, or may have deteriorated as a result of the conditions under which they have been stored. We cannot undertake to deal with any complaints regarding any such components purchased.

NEW RECEIVERS AND AMPLIFIERS UNIVERSAL ELECTRONIC PRODUCTS, 36, Marylebone High St., London, W.1. Tel. No. Wel. 4058.

OUR U.E.7 amplifier is designed for the connoisseur who requires the best possible reproduction together with the highest standards of workmanship and materials. 10 watts undistorted output from 9 valves (triods) in double push-pull, with independent controls for treble and bass. We invite you to hear this instrument demonstrated; 2½d. stamp for details. [8069]

EDDYSTONE 540 receiver, absolutely new condition, Xtal Gate noise limiter, etc.; must realise; offers.—Box 1006. [7946]

H.R.O., 9 coils power pack, £45; Hallcrafters SX.27 £25; R.1155, modified with power unit and spkr., £15.—Box 1185.

COMMUNICATION receivers.—As soon as civilian supplies recommence we shall be at your service.—A.C.S. Radio, 44, Widmore Rd., Bromley, Kent. [4528]

EX-GOVT. rec.'s, model R103A, £9/10; model 134, special, 26-130 mc/s, beautiful job, all chromium plated, £25.—142, Rush Green Rd., Romford, Essex. [7941]

AMPLIFIERS, 6 watts push-pull output, complete with 10in speaker, for use on ac mains, good quality job, tone control, etc.; call and hear one or send for descriptive leaflet "W".

CHARLES BRITAIN (RADIO), Ltd., 2, Wilton St., London, E.C.2. [6835]

DEGALLIER'S, Ltd., announcement.—When token imports American receivers is permitted we shall have these; information will be in this column when available, please watch future issues. [7541]

AMPLIFIERS; new 1947 model Hi-Fi units, with triple tone controls, built to customer's specification.—Broadcast & Acoustic Equipment Co., Ltd., Broadcast House, Pombland, Norwich 2679.

EDDYSTONE 504 communication receiver now in stock £58/18/7; G.L. 12-watt ac gram. amplifier, complete; 11gn.—K. L. W. Cook, Bush and Murphy Dealer, 27, High St., Swindon. Tel. 3164. [7855]

R.107 communication receiver, with broad cast band, phones, £40; R.1155 receiver, 6L6 output, power pack, 10in speaker, £18; R.C.A. fidelity ribbon table mike, £7/10.—179 Stoke Rd., Guildford, Surrey. [7949]

1947, 2-wave receiver, universal mains, complete kit with valves, speaker, cabinet, instructions, diagrams, etc.; one hour assembly; limited numbers available; £7/5; 5/- carriage; c.o.d. or c.w.o.—Radio Unlimited, 16, Carnarvon Road, Leyton. [7833]

PARKER RADIO offer semi-midget 3-wave band superhets and table model receivers, housed in mahogany veneered cabinets; trade and export enquiries invited; receivers manufactured to specification. Parker Radio Manufacturing Co., 756, Harrow Rd., N.W.10.

WIRELESS WORLD Quality amplifier (page 161, May issue), built with quality parts to specification, tested and guaranteed complete with all valves; £25/10; 12in. speakers and gram. motors supplied to order.—Enquiries to R.T.S., Ltd., Laurel House, 141, Little Ealing Lane, W.5. Ealing 6962. [7691]

SANDRINGHAM 2-waveband semi-midget receiver; universal mains, waveband 200-550, 700-2,000; attractive moulded cabinet, walnut finish, complete, tested and carriage paid, £9/17/6, incl tax, c.w.o. or c.o.d.—Radio Unlimited, 16, Carnarvon Rd., Leyton, S.a.e. list other lines, gram. radio and amplifier equipment. [7944]

HIGH qual. reproduction with comm. rec sensitivity, instrument combining these features with great versatility & flexibility in both RF and audio circuits, offered in the Silver Dragon receiver, 9.8-2,000m., with band spread and variable selectivity.—Details of this and other interesting recs can be obtained from Moreton Cheyne Co., Ltd., Darkhouse Lane, Deepfields, Bilston, Staffs. 2½d stamp please Overseas enquiries especially invited. [8708]

Partridge News

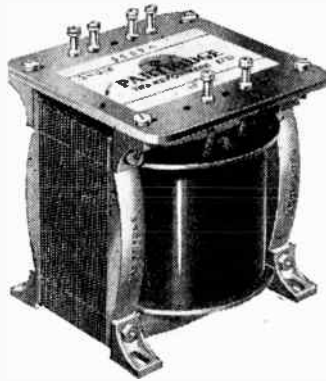

INDIVIDUAL DESIGN

PARTRIDGE Precision Built TRANSFORMERS wound to suit individual requirements now incorporate:—Silver plated current terminals giving a low potential drop and carrying up to 15 amps. Adequate room on each for easy soldering of several external circuit wires.

Firm clamping of the laminations by means of scientifically designed pressure die-castings.

Interlocked fixing feet providing alternative mounting.

Illustrated above is mounting style "DN" which can be employed if desired on all components wound to special requirements.

AVAILABLE STOCK

A comprehensive range of mains and audio components is now available from stock, and we can despatch small quantities of these per return. We would stress that before ordering you send for our list detailing these components. Our stock range now covers almost all normal requirements, and by availing yourself of this service you will save the inevitable delay in the production of a special component.

CATALOGUE

A new catalogue illustrating various mounting styles is now available. This incorporates full data on our components, including fixing dimensions, weight, method of termination, etc. You are invited to send 'or a copy, issued' free of charge.

Telephone:



Abbey 2244

PARTRIDGE TRANSFORMERS LTD

76-8, PETTY FRANCE, LONDON, S.W.1

TELEVISION sound receiver unit, H.F. det complete, 7 valves, 14in x 4in x 4in, ready for driving O.P. stage on parent chassis, £29/10; vision unit as above, £9/10; tested on A.P. before despatch; post free, cash with order please.—The Television Development Co., 4, The Parade, High Rd., Kilburn, London, N.W.6. Maida Vale 3991 (Est. 20 yrs.). [8028]

OSMOR A.C.-D.C. 5v 3-wave superhet radio heart, includes (fully assembled) chassis, coil pack, calibrated dial, 2-gang, I.F.S., V.C. choke, 8-16 dropper, circuit diagrams, small resistances and condensers only required, cabinets available; trade enquiries invited.—Morgan, Osborne & Co., Ltd., Southview Rd., Warrington, Surrey. [7287]

BAKER'S—New 7-valve "Wireless World" B Quality amplifier with tone control stage, 8 watts push-pull triode output, price includes super Quality triple cone, 12in permanent magnet speaker, with large output transformer and all valves; also as above but with 15 watts tetrode output, ideal for realistic reproduction or public address; 2½d stamp for particulars, prices, etc.—Baker's Selhurst Radio, 75, Sussex Rd., S. Croydon, Croydon 4226.

RECEIVERS, AMPLIFIERS—SECOND-HAND A.R.S.D. in perfect condition: £60.—Box 961. [7915]

R.1155 receivers, new, ex-store; £20.—58 Westmere, London, N.W.7. [7912]

SALE, B28/CR100 communication receiver; offers.—84, Embankment Rd., Plymouth.

RECONDITIONED ac/dc U.S.A. T.R.F. mid Regts, 200-250v, perf. cond.; £8/15.—Box 485.

TRANS. receiver for sale, rack mounted, 20 watt, 'phone/C.W., crystal control, offers.—Box 960. [7908]

A.R88L for sale in excellent order, 55gns, no offers.—G2CIN BM/CDN, London, W.C.1. Tulse Hill 1240. [7836]

HALLCRAFTER Defiant SX24, as new, £30, or exchange for miniature camera, cash adjustment.—Box 433. [7837]

15 WATT amplifier, Callaro turntable and pickup, 12in Goodman's speaker in cabinet; £25 lot.—Box 212. [7747]

C.R.100 communication rec. in perfect condition, M.C. spkr., M.C. ph.—Offers to 148, Cross Flatts Grove, Leeds, 11. [7821]

HALLCRAFTERS S.27, 27.8 to 143 mc/s, M/M/F.M. 8 meter, 110-230v, 15 valves, as new offers over £50.—Box 494. [7863]

M.C.R.1 comm. rec., 97-250v A.C./D.C., 20 M to 3,000 metres (complete) with power pack, aerial, speaker and coils; £8.—Box 1004.

SOUND Sales DX plus 7, chassis used few weeks only; offers over £25.—4, Swailes land Rd., Dartford, Kent. Tel. 3148. [7853]

R.M.E. 99, 13-valve communication receiver, 1941, perfect condition; £50 or offers.—9, Cecilia Rd., Clarendon Pk., Leicester.

R.1155 receiver, power pack, components, 6 valves PK4, KT63, U50, etc., 3 wave tuning unit; lot £15.—Bolton, 51, Station Rd., Chapelton, Sheffield. [7890]

MARCONI R58E receivers, 2,000 to 10 metres, unused, in perfect order, with converter for 12v battery operation, ideal for amateurs; £25.—Box 1328.

AMERICAN 8-valve short-wave receiver, as a new, frequency range 1.5 to 18 megacycles C-W oscillator, crystal phasing, handbook of complete instructions; £26.—Box 1443.

R.M.E.69 receiver, 230v ac with matched R speaker and 1 valve preselector, perfect order, best offer over £45; 5 meter converter, 2hf, lc and osc. button and acorn, solid job. £5/10.—Baxter, Nazeby Av., Liverpool, 23.

SHORT wave enthusiasts!—For sale, Hallcrafters Skyriker Marine model, as new, perfect condition, reproduction excellent; £30.—Can be seen at Radio Sales & Services, 29-31, Southampton Row, W.C.1. Holborn 4025.

EX-R.A.F. Loran radar sets with 5in electronic C.R.T., with time base, 26 valves including 6SN7, 6HG, 6SJ7, and calibrated 100kc crystal, suitable for conversion to oscillograph; £10.—Apply Box 405. [7797]

1155A R.A.F. communication receivers, very limited number offered at £12 each, each one aerial tested and complete with all valves in condition equal to new, dial calibrated from 7.5 mc/s to 1,500 kc/s, including strong metal cabinet, carriage extra.

G. W. SMITH & Co. (RADIO), Ltd., 3, Lisie St., London, W.C.2. [7894]

R.107 communications receiver (see "Wireless World," August, 1945), 110 volt-240 volt A.C., or 12 volt D.C., 10 valves, 2½ watt output stage, 12in speaker, 4 hours use only, first £25 secure; also two 6 volt batteries, new, £3 each.—Burtol, 40 High St., Canterbury. [7878]

berley.

1938 Cossor television set, large tube 12in screen, includes long, medium and short wave sound reception, owner moved outside television range of Alexandra Palace; £85 or near offer; can be seen by appointment.—Tel evenings and weekends Bloxham 219. Week days Finmere 200. Butcher. "The Paddock," Bloxham, Banbury, Oxon. [7933]

# YOU can become a first-class RADIO ENGINEER

We are specialists in Home-Study Tuition in Radio, Television and Mathematics. Post coupon now for free booklet and learn how you can qualify for well-paid employment or profitable spare-time work.

**T. & C. RADIO COLLEGE**  
North Road, Parkstone, Dorset

(Post in unsealed envelope, 1d. stamp)

Please send me free details of your Home-Study Mathematics and Radio courses.

NAME .....

ADDRESS .....

W.W.62

## LASKY'S RADIO SPECIAL BARGAIN OFFER

**CRYSTAL CONTROLLED TRANSMITTER UNITS.** 2 stage, oscillator and power amplifier. Complete with 2 valves 6L6 and EL32. Moving coil meter 0-5 M/A. Morse key, 7 wave bands, 3-16 M/CS. Strongly made best quality components. Tuning condensers and Yaxley switch ceramic insulation. In steel box with felt surround. Front panel black crackle finish. Size: 9 1/4 in. long, 6 1/2 in. wide, 5 1/2 in. deep. NEW AND UNUSED, COMPONENT VALUE OVER £5. LASKY'S PRICE 59/6. Postage 1/6 extra.

**5 MFD. OIL FILLED CONDENSERS 750 VOLTS WORKING,** with fixing feet and insulated terminals 7/6 each.

**5 MFD. 500 V.W. WAXED TUBULAR ELECTROLYTIC CONDENSERS,** wire ended, cardboard, 3/6 each, 36/- per doz.

**BRASS SPINDLE COUPLERS,** 1/2 in. 2 grub screws, 6d. each, 5/- per doz.

**EX-W.D. MOVING COIL AMMETERS,** by leading manufacturers, 2 1/2 in. circular. First grade. Res. .0037 ohms. Internal shunt can be removed. Calibrated 0-20 amp. Price 12/6 each. NEW AND UNUSED, AND BOXED.

**2in. MOVING COIL METER F.B.D.,** 0-500 Micro-Amps. Res. 100 ohms. Cal. 0-10, first grade. New and unused and boxed. Price 12/6 each.

**EX-A.M. PRESS BUTTON CONTROL BOXES,** No. 2. Containing 5-way press button unit, trans. rec. switch, etc. New and unused and each boxed separately. Price 6/6 each.

**WE HAVE A LARGE STOCK OF OVER 6,000 RADIO VALVES AT OFFICIAL LIST PRICES. WE HAVE SPACE FOR ONLY A FEW ITEMS OF OUR EXTENSIVE STOCK. SEND STAMP FOR OUR CURRENT LIST AND BULLETIN.**

**TERMS PRO FORMA. CASH WITH ORDER, OR C.O.D. (NO C.O.D. UNDER 21).**

**ALL GOODS COVERED BY OUR UNCONDITIONAL GUARANTEE. IT WILL PAY YOU TO PAY US A VISIT.**

**LASKY'S RADIO**  
370, Harrow Road, Paddington, W.9

(Opp. Paddington Hospital.)

Telephone: CUNNINGHAM 1979

Hours: Mon.-Sat. 9 a.m. to 6 p.m. Thursday Half-day

NOW in stock, sound on film amplifiers for 16mm talkies, 110 volts, 50 cps, 4 1/2 watts output pre-amplifier for P.E. cell with screwed 2-pin plug, also jack for gram input.—Write for details and price to Messrs. Wedcas Engineering Co., Ltd., Acre Moss Lane, Morecambe.

**TELEVISION** experimenter selling surplus equipment, complete vision RX (less cabinet) with 11in E.S. tube and sound feeder unit (20 valves), in 4 units ready switch on; all post-war, beautiful reproducer, £55; superhet, vision Rx 45 Mc, 4 Mc. B.W., complete video stage, suit distant experimenter (9 valves) less power, £11.—Box 959. [7907]

**EKCO** 7-valve EX.402 overseas receiver, 5 bands 30 mc/s-500 kc/s, push-pull OP, excellent condition, £30; Ekco 8-valve 3-band receiver, working but needs cleaning up, £8; Triplett 666H pocket test meter, brand new, £7; 14 useful tube U.S. valves, mostly new, including two 955s, £3; 30 misc. compts., variables, knobs, pots, jacks, £1/10.—Box 946.

**HALLICRAFTER** SX25 Super Defiant, in absol. new cond., with separate matching 12in spkr., 2 R.F. stages, Xtal gate, freq. meter tuning, built in "8" meter and automatic noise limiter, £65; also Hallicrafter speech amplifier, 7 valves, inputs for carbon and M.C. mikes or pick-up, built-in D.B. meter, £18.—Rampling, Bowderry, Torpoint, Cornwall.

**FX-GOVERNMENT** 4-valve receivers, complete with ac mains and 6 volt power pack, headphones, leads, etc., 3-waveband, 15-3 mcs., 18-100 metres, £7 15/-; 1FP receivers, type 3067, 11 valves, 12.24 volt dc motor generator, in good condition, 35/-; c.f. VIIF converter, 30-40 mcs., type 25, makes ideal converter for 10 metres by replacing Yaxley switches with 15pf tuning condenser, with 3 SP41 valves, 35/- ea; vibrator packs, 24 volts input or 12 volt by removing resistances, output 150 volts at 60 milliamps, complete with stabilising valve, 25/-; rotary converters, 24-volt dc input, 230-volt, 50 cycle ac output, size 10 1/2 x 1 1/2 x 8, with leather carrying strap, £7/10 c.f.; terms cash with order.—Radio Exchange, 9, Cauldwell St., Biddford, [7814a]

### TEST EQUIPMENT

**INSTRUMENTS**  
MOST makes in stock, some on easy terms.—Write for details and proposal forms to The Instrument Co., 244, Harrow Rd., London, W.2.

**A VO oscillator,** a few only, ac mains model; £13.—Massey, 58, Watfield Ave., Hull.

**BATTERY** signal tracer with diode probe, complete with batteries and instructions, less phones; £6/15.

**METERS,** signal tracers, valve testers, signal generators, valve voltmeters and R. & C. bridge, all in kit form.—Lists from L. A. MacLachlan & Co., 16, Thistle St., Stirling. [8011]

**UNIVERSAL** Avo Minor, as new, complete with all test leads, instruction book, in leather carrying case; Sigs.—Box 956 [7900]

**MARCONI** valve voltmeter, model 428B, new and unused, 40/-; all letters answered.—Dixon, The Wilderness, Spendon.

**TAYLOR** model 120a, 21-range ac-dc testers; £7/10 post free.—World Radio & Electric Co., 78, Radford Boulevard, Nottingham.

**UNIVERSAL** Avomator £5; 2 K.W.I.I. Ferranti meters, 200-250v 10 amps, £2; voltage stabiliser by Advance Components, £5.—Dawson, 101, Harwood Rd., Rishton. [7911]

**A VO model 40,** recently overhauled, £10; Avo test bridge, brand new, £9; latest model advance signal generator, unused, £18; Avo signal generator, £10.—Box 1310. [7984]

**COSSOR** D/B oscillograph Model 339 with radio service kit, brand new, owner going abroad; £45/10.—J. F. Wright, 21, Marlborough Rd., Hanworth, Midx. Fel. 2677.

**WEE-MEGGERS,** brand new, ex Govt., 250-volt, complete in leather case; list price £12, our price £8; 2nd hand ditto, £5, post free.—Auto Collections, Ltd., 126, St. Albans Av., Bedford Park, W.4. Tel. Chiswick 1601.

**TAYLOR** Junior 120a, £7; Avo sig. gen., £12/10; Avo valve tester, £16; Labgear electronic fault finder, £32; card reserves, brand new, surplus to requirements.—A. Daniel, 9, Thornbury Rd., Clacton, Essex. [7846]

**WHY** buy test gear you can build? Nuplans first Testgear Plans Series of 10 circuits is now complete; see recent issues of "W.W." or send an s.a.e. for list or ask for the mains signal generator, oscilloscope, signal tracer, etc., etc.—Each plan 2/6 from Bradley, Whinnie, Knowe, Escalls Cliff, Sennen, Cornwall.

**WAVEMETERS,** ex-Govt., class D No. 1 Mark II ranges 1,900-4,000 kc/s, 4,000-8,000 kc/s, check frequencies at intervals of 1 mc up to 25 mc/s, oscillator crystal check, battery operated, supplied with spare vibrator, spare valve, and instruction book, brand new; £6/15, carriage paid; send for fully descriptive leaflet; also a few only less spares at 85/- (carriage 3/-).—U.E.I. Corp., 138, Grays Inn Rd., London, W.C.1. [5910]

RECORD

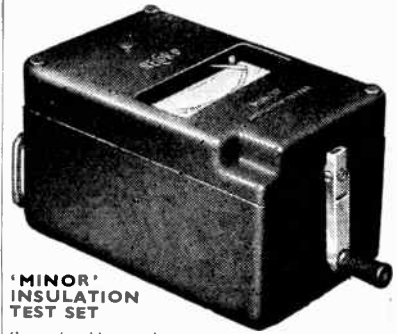

'MINOR' INSULATION TEST SET

Compact and inexpensive without sacrificing accuracy and reliability. Weighs only 3lb. Height allows for full awing of generator handle. Ranges up to 20 megohms 500 volts.



CONTINUITY TESTER

This latest addition to the Record Ohmmeter range is enclosed in a moulded bakelite case of pleasing appearance. Equipped with self-contained dry battery, specially designed test spikes and leads can be supplied, also a "test and carry" case in which the instrument may be used without removal. Ranges:—0.3—0.30 ohms, 0.30—0.300 ohms, 0.800—0.50,000 ohms, 0.1000—0.200,000 ohms.

**THE RECORD ELECTRICAL CO., LTD.,** Broadheath, Altrincham, Cheshire. Tel.: Altrincham 323/2. Grams: "Infusion," Altrincham. LONDON: 28, Victoria St., S.W.1. Phone: Abbey 5148.

## NOW IN STOCK RADIO HANDBOOK

The leading American Amateur Radio textbook!

**CONTENTS:** There are 28 Chapters dealing with—INTRODUCTION TO RADIO • FUNDAMENTAL ELECTRICAL AND RADIO THEORY • VACUUM TUBE THEORY • RADIO RECEIVER THEORY • RADIO RECEIVING TUBE CHARACTERISTICS • RADIO RECEIVER CONSTRUCTION • TRANSMITTER THEORY • RADIO TELEPHONY THEORY • FREQUENCY MODULATION • TRANSMITTING TUBES • TRANSMITTER DESIGN • EXCITERS AND LOW-POWERED TRANSMITTERS • MEDIUM AND HIGH POWER R.F. AMPLIFIERS • SPEECH AND MODULATION EQUIPMENT • POWER SUPPLIES • TRANSMITTER CONSTRUCTION • U.H.F. COMMUNICATION • U.H.F. RECEIVERS AND TRANSCEIVERS • U.H.G. TRANSMITTERS • ANTENNA THEORY AND OPERATION • DIRECTIVE ANTENNA ARRAYS • U.H.F. ANTENNAS • TRANSMITTER ADJUSTMENT TEST AND MEASURING EQUIPMENT • THE CATHODE RAY OSCILLOSCOPE • WORKSHOP PRACTICE • BROADCAST INTERFERENCE • RADIO MATHEMATICS AND CALCULATIONS • APPENDIX • INDEX

The above text occupies over 600 pages.

Illustrations and details of principal American products are given in a special 100-page "Buyers Guide"

This—the 10th Edition of the Radio Handbook has been fully revised and brought up-to-date.

PRICE 15/-

ORDER from Authorised Distributors:—

**DALE INTERNATIONAL**  
Publications, Ltd.,  
105, Bolsover St., London, W.1.

Telephone MUSeum 1023.

**TEST gears.**—Surplus to requirements, Cossor 359 c.r.o. £25; Evershed & Vignoles Bridge Megger, offers; model 40 Universal Avo. £8/10; all in perfect condition.—Electrad, Old Rudge Wks., Crow Lane, Coventry. [7881]

**AUDIO-FREQUENCY oscillators, resistance-capacity type,** range 25-16,000 c.p.s., output 1 volt, excellent stability and waveform, specially designed for radio-gramophone development and service, particularly suitable as bridge source, details and demonstration on request; price £30.—Donald Dun, Ltd., 129 Hollywood Rd., S.W.1. Flaxman 5705. [7499]

**NEW LOUDSPEAKERS**  
**£5/18/6.**—New Baker Super Quality 12in. Auditorium permanent magnet speaker with triple cone, manufactured by Bakers Selhurst Radio, the pioneer manufacturers of moving coil speakers since 1925, wide frequency range, even response, ideal for quality reproduction, fitted with magnet, having exceptionally high flux density in the air gap suitable for public address equipment when quality reproduction is first consideration, send 2/6 stamp for leaflet giving details of above and constructional details of a new acoustic chamber designed to extend loud speaker frequency range.

**£8/19/6.**—New Baker super power cinema permanent magnet speaker with 18in triple cone of new design, giving wide frequency response free from objectionable resonances; speech is clear and natural and music is reproduced with exceptional realism; fine engineering job, extremely sensitive; ideal for public address equipment when power handling capacity, plus realistic reproduction, is required, prompt delivery per pass train.—Bakers Selhurst Radio, 75, Sussex Rd., S. Croydon. (Croydon 4226).

**"REXONAX"** introduce an outstanding duplex reproducer consisting of low frequency and high frequency horn loaded units of specialised design incorporating separate output transformer and frequency dividing network; exceptionally smooth response from 40-12,000 c.p.s., efficiency approximately 35%; low intermodulation and harmonic distortion with high power handling capacity; even distribution of all frequencies over wide area from mouth equivalent of over 16 sq feet; adjustable "high-low" balance; compact dimensions; built to highest ideals, not down to a price, for those engaged in obtaining the most realistic reproduction of sound.—Details and demonstrations, "Rexonax," Lowther House, St. Marks Rd., Bromley, Ravensbourne, SE25 2EJ.

**LOUPE AND L.S. RECORDING AND HARTLEY TURNER model 215,** unused; £7.—Clews, Pensham, Pershore, Worcs.

**VOIGT H.C. corner horn speaker,** latest type, oak finish; offers over £50.—Nyblad, 74, Somerset Rd., Newport, Mon. [7872]

**LATEST improved model Hartley Turner L model 215,** used for test only; £7/10.—Morgan, 15, Whitby Rd., Ipswich. [7930]

**B.T.H. 12in. shaped cone, 1,000 ohm field, £4/10; P.P. output trans. match, P.X4s to above, 30/-—Body 22, Fabian Cres., Shirley, B'ham. [7970]**

**10IN p.m. loudspeakers, in strong carrying cases,** with leather handle and lead storage compartment, suitable for talkie projectors, or extension loudspeakers for radio, with or without pentode transformer, £4/4 each; also auto-transformers, tapped at 200, 230, 250, 110 and 150 volts, 100 watts, 30/- each.—City Sale & Exchange, Ltd., 90-94, Fleet St., E.C.4. [7979]

**2 Baird 12in C.R. tubes, mag. focus, unused, offers.—Box 943. [7868]**

**COSSOR television C.R. tube, 8in. electrostatic, No. 3221, as new, £10.—Box 1403.**

**SALE, U.I.F. types 832, 30/-; 954, 95s, 9004, 8/6 ea.; 9006, 9001, 6C4, 6KA5, 6.16, 6/6 ea.; also issues Q.S.T.—Box 1445.**

**NEW valves at advertised prices: RX, N GF6G, 6AD7G, 6J7, 6L6G, 6H6, 6BA7, 6K7, 6U5, 6G5, 6SF5, 5Z3, 5U4, 50L6G7, TX, 872/872A (1); c.o.d. or c.w.o.—Box 1316.**

**LARGEST and most comprehensive range in the country, British and U.S.A. types, at Board of Trade prices; send for lists (valves available), free, s.a.e.; valves sent c.o.d.; retailers not supplied. [7223]**

**RANSOM, Bond St., Brighton.**

**VALVES.**—Is your work held up for valves? If so, we may be able to help you; we have large stocks of all types available at best prices; send for monthly lists.—Scott's Valve Service (Dept. D), 14, Gardner St., Brighton.

**FOR sale, 9in. television CRT, Mazda CRM91, new, in sealed makers' cartons, £8/15; 2nd hand focus scanning and deflection coil assemblies, £2/10; rubber masks, 15/-.—A. Gordon Galloway & Co., 120a, Myddleton Rd., Boves Park, London, N.22, Boves Park 3472.**

**DYNAMOS, MOTORS, ETC.**

**BATTERY chargers for home and export, 4 models, 2-6-12v, 1, 2, or 4amp dc, any mains voltage; generous trade terms. Write for catalogue. Tel. Hoddesdon 2659.—The Banner Electric Co. Ltd., Hoddesdon, Herts.**

## Something here for You?

**TRANSFORMERS.** We have a special line of B.T.H. Transformers, double wound, 8½in. x 9in. x 6in., weight 60 lbs., input 200/230/250 V, 50 cycles, output 7½ to 75 volts 6 amp. with 15 taps and 2 volts 20 amps., 85/-, 230 volt 50 cycle to 4 volts C.T. 7½ amps., 17/6.

**METAL RECTIFIERS.** 36 volt 10 amps., 45/-, 150 V. ½ amp., 14/-; 24 V. 1a amps, 14/-; 24 volts ½ amp., 12/6.

**LOUDSPEAKERS.** P.M. moving coil speakers 5in. cone, new, high quality, 21/-, Goodman 12in. moving coil P.M. speaker, £5/10/-, new.

**MOTORS.** D.C. Shunt wound motors 1/12 h.p. 220 volts with 4 hole base plate, in new condition, 25/-, 1/20th h.p. Winding Machine motors, totally enclosed, high speed, 230 volts AC/DC, £4/10/-, 230 volts AC/DC motors 1/27 h.p., 4,000 r.p.m. £3/15/-, 12 volts 1/30 h.p., 3,000 r.p.m., £3/15/-.

**MOTOR PUMPS.** The Lexid Bijou Motor Pump 230 volts AC/DC lift 2 3/4 ft. head 10ft. capacity 100 gallons per hour, £5/10/-, 12 volt models for caravan use, £5/15/-, Foot valve and strainer, 17/6.

**D.C. DYNAMOS.** 12 volt 10 amps, £4, 30 v. 5 amps, £5/10/-, 24 volts 10 amps, £10, 100 volt 30 amps, speed 1,100 r.p.m., £15.

**FANS.** 110 volt D.C. Oscillating Fans, Table type with 12in. blade and guard, 55/-, 5 smaller model 220 volt with 10in. blade and guard, 45/-, Exhaust fans 15in. to 18in. Porthole type 220 volts D.C. with blade and guard, £5.

**MOTOR BLOWERS.** 12 volt D.C. small valve cooling or lab. blowers, £3/10/-, 32 volt D.C. Motor Blower 1/4 h.p. motor 50 cu. ft. per min., £8/10/-.

**SPEEDOMETERS.** New, by A.T. Speedometers, 4in. dia., 1,500 r.p.m. with driving dog ½in. x ½in. for flex drive, 35/-.

**HEADPHONES.** Ex-G.P.O. type 5.G.B. low resistance, single headphone, bakelite case and cap with band and cord, 4/- each, or 45/- per dozen.

**PORTABLE TELEPHONES.** The 5.T. Portable telephones for speech or telegraphy, self-contained, ideal for field work or sports meetings, used on 2 wires only or work perfectly on single line and earth circuit. Diagram with each set, as new 60/- per pair, delivery from stock.

**FIELD WIRE.** Short lengths 100ft. upwards, price 2/- per 100ft., small drums 2/6 each.

**BATTERY CHARGERS.** We have a large selection of first-class chargers—various sizes for A.C. mains supply. Send us your enquiries and let us quote.

**MAGNETS.** D.C. Electric magnets, weight 10 oz., lift on 2 volts, 1½ lb., 4 volts 3 lb., 6 volts 4 lb., new surplus, 7/6 each. Permanent powerful flat bar magnets, 2½in. x 1in. x ½in., 2/- pair. Send for special Magnet Leaflet "W."

**INDUCTOR ALTERNATORS.** 400 watts, beautifully made to Government specification, totally enclosed single or 3-phase 50 cycle 230 volts 4-ole, ball bearings speed 2,800 r.p.m. need ½ volt separate excitation; as new, £8/10/-.

**BUTTON MICROPHONES** provide interesting experiments for making outside listeners, sound transmission, etc. These ex-G.P.O. Voice Units are under lin. diam., fitted carbon granules and fitted mica diaphragm, 3/6 each. Special Transformer and Condenser, 5/-. Instruction Leaflet with each Button. G.P.O. Mike insets, 2/6.

**EX-G.P.O. 4-pin telephone plugs** with solid bakelite base, as illustrated, 1/- each, postage 3d., 10/- doz.

**RECORDER PARTS.** Precision made Recorder parts. Chart drum and clips, 5/6. Magnetic clutch 6 volt, 35/-; 9in. traverse shaft, 4in. threaded 120 to inch with bearings, 12/6. Stylus with carriage, rods and bracket, 7/6.

## ELECTRADIX RADIO

214, Queenstown Road, London. S.W. (late Queens Road)

Telephone · MACaulay 2159



**WATES rotary converter, 200-230 volts dc/ ac, 80 watts; £7/10.—Ellam, 103, Toriano Av., Kentish Town, N.W.5. [7976]**

**ROTARY converter, 240 D.C. to 230 A.C., 1,000 watts, with starter, condition perfect; £18 or offers.—Clark, 125, Thorpe Rd., Melton Mowbray. [7926]**

**All types of rotary converters, electric A motors, battery chargers, petrol-electric generator sets, etc., rotary transformers, input 12v d.c., output 600v at 250ma; price £4/10 each, nett, post paid.—Ward, Lordscroft Works, Haverhill, Suffolk. Haverhill 253/4. [7503]**

**DC to ac, motor alternators, E.D.C. manufacture, 110v dc input, 220v ac output at 250 watts, screen protected, ball bearings, new and as new; price, £12/10 each carriage paid; others up to 1,000 watts.—Johnson Engineering, 319, Kennington Rd., S.E.11. Reference 1412-3. [7705]**

**GRAMOPHONE AND SOUND EQUIPMENT**  
**J. H. BRIERLEY, Ltd.,** announce a complete range of new equipment:—

**RIBBON pick-up, £5/10 plus £1/7/6 tax;** special Mumetal screened transformer for ribbon pick-up, £2; armature pick-up, 5gns plus £1/6/9 tax; special Mumetal screened transformer for armature pick-up, £1; combined coupling transformer and domestic tone compensation unit for armature pick-up, £1/7/6; the latest JB/12/Q amplifier for use with the above pick-ups with many special features, £48; pre-amplifier, standard type, £9; filters, JB/LPF 1 and 2 with cut-off frequencies of 7,500 c/s and 13,000 c/s respectively, matched for a terminating impedance of 24,000 ohms, £3/10 each.

**FULL details of any or all the above items will be supplied on receipt of 3d in stamps.** WE have the following items, surplus to our requirements: Small quantities of 32 and 45 s.w.g. enamelled wire, laminations, 300 70T (Mumetal) insulated, 800 Rola No. 3, 17 gross Rola No. 4, 25 gross M.E.A. Silar 2 No. 29A; please state needs.—J. H. Brierley, Ltd., 46, Tithebarrow St., Liverpool, 2. [7226]

**L EXINGTON Junior pick-up, transformer, as new, cost £5/17; £3/15-6, Elmhurst Av., Northampton. [7867]**

**MAGNETIC wire reordler, portable, specially developed prototype unit; £90 or offers.—"Strathdee," Studley Rd., Torquay. Tel. 87325.**

**H.M.V. Automatic 8-record changer, 10in and 12in, as used on model 531, reconditioned, as new, 200-260v ac, 16gns. or offer.—Box 955. [7899]**

**TRANSFORMERS, tone control and filter chokes for all "W.W." circuits.—R. Clark, 30, Langland Crescent, Stanmore, Middx. Wor. 5321. [7532]**

**B.T.H. needle armature P.U., W.W. O.P. transformer, Baker triple cone energised L.S. 150/2500Q; offers.—Box 343. [7803]**

**R.C.A. crystal P.U. cartridges, new type R 38610 with replaceable sapphire; adaptable any lightweight arm; outstanding fidelity, 50/- each, c.o.d. or c.w.o.—Box 1318. [7998]**

**BRIERLEY 20-watt amplifier, bass and treble controls, gram. mike. S.O.F. inputs, £22/10; P.E. cells, new, 30/-; Weston electric horn units, 50/-—10, Newport Rd., Shifnal.**

**RECORDING machines, recording amplifiers, B.S.R. amplifiers and turntables, disc-trailer needles, all recording accessories.—Bristol & West Recording Service, 79, Old Market St., Bristol. [7987]**

**1947 Armstrong radiogram, 8-valve, 10 watt, 12in Goodman speaker, new Colaro gram unit, in beautiful adapted cabinet, wonderful tone; bargain, £55.—8pe, 8469, 22, Parkway, N.W.11. [7923]**

**RECORD playing units of every description; radiograms, players, desks, etc., amplifiers, speakers, pick-ups, chassis, etc.; s.a.e. for complete list.—Radio Unlimited, 16, Carnarvon Rd., Leyton. [7945]**

**RECORD players of every description; desk, portable or floor model; amplified or otherwise; also amplifiers, speakers, pick-ups, chassis; s.a.e. list.—Radio Unlimited, 16, Carnarvon Rd., Leyton. [7830]**

**RECORDING equipment and accessories for the connoisseur, blank discs, cutters, sapphires, radio units, mixer units, complete recorder; send stamp for descriptive catalogue.—University Recording Co., 113, Milton Rd., Cambridge. Tel. 54947. [7870]**

**LOWTHER-VOIGT sound equipment demonstrated in your home or club within radius of 50 miles London or Guildford; drop us a p.c. and we will arrange a demonstration at your convenience without obligation.—B.K. Fairners, 79, Elizabeth St., London. S.W.1.**

**MARCONI walnut cabinet and 8-record changer, Hypersen pick-up, £45; 12 watt amplifier, P.P., P.x25, radio tuner, Sound Sales, £20; latest Sound Sales Dx plus I feeder, unused, £14, Sound Sales tone control, bass treble unit, £5; Lexington pre-amplifier, unused, £4.—Siggers, Copse Edge, Coronation Rd., South Ascot, Berks. [7909]**

# Specialists in

HIGH POWER - HIGH QUALITY

**PUBLIC ADDRESS  
SYSTEMS  
★  
AMPLIFIERS**  
from 150 W to 1kW

**W. Bryan Savage Ltd**

WESTMORELAND ROAD, LONDON, N.W.9

Telephone: Colindale 7131



## ALL-WAVE SIGNAL- GENERATOR TYPE 5

This high-quality precision instrument 200-240 volts A/C working has a coverage of 100 Kc/s to 30 Mc/s in 5 ranges. Calibrated by hand against a standard frequency accurate to 0.01%. Constructed in BA.60 alloy and finished black and cream polymerised enamel. Price 14 Gns. delivery ex stock.

Illustrated leaflet on application to:

**R. R. DEVELOPMENT  
LABORATORIES LTD**  
BARNARD ROAD • BRADFORD

**BRAND** new Collaro amplified record player, unused, in makers' carton, cost £20/10; accept £18; would exchange for universal mains gram motor and cash to value.—Winwood, 12, Carnarvon Rd., Leyton. [7927]

**R. S.E.22** New Cross 2434.—New high fidelity 11-valve radiogram, variable selectivity, separate, top and base tone controls, 12in spkr., heavily lagged, walnut cabinet, £75. **3H** air core TC choke, 22/-; 1H ditto, 8/-; **Garrard P.U.**, 15/-; **Londex ML** relay, 10/-; 2 heavy 1G 0.0005 Cyldon, 3/- ea.; **G.P.O.** type key, 10/-; **S.M.D. Eddy** 637, 10/6; all as new; **6L6G**, **6N7G**, **6K8**, **3Q5GT**, **SP2**, **SP41**, new, 7/6 ea.; s.a.e. details.—Box 1324.

**PORTABLE** recording equipment: **M.S.S.** recording machine, 20 watt amplifier, new, from stock; Blank discs, cutting needles, trailer needles, microphones, lightweight pick-ups, matching transformers, speakers etc.; trade enquiries invited.—Sound Discs (Supplies), Ltd., 83a, Bold St., Liverpool. [6964]

**TELEVOX** playing desks incorporating high quality totally enclosed induction motor (100-240v A.C.), high fidelity crystal pick-up, 12in turntable, automatic stop and start mechanism, speed regulator and pick-up rest, all mounted on a strong 18 swg steel chassis, 14½in x 12¼in x 3½in deep, finished in black ripple and mounted on four rubber feet, model no. T.P.D.1 (X), price £115/10 including purchase tax, cash with order, packing and carriage 4/6 extra, no c.o.d. Still available in limited quantities.—Televox Sound Service, 37, Albert Rd., Southsea, Hants. Tel. Portsmouth 4982. [8080]

**CHARLES AMPLIFIERS** welcome lovers of recorded music to their new premises where their high fidelity amplifiers can be heard together with Lexington Connoisseur and Rothermel pick-ups and B. and A.E.C. Vitavox, and Wharfedale speakers, B. and A.E.C. acoustic chambers, infinite corner baffle deflectors, etc.; we like you to bring your own familiar records for comparison; this is a service devoted entirely to the high fidelity reproduction of music; one minute from the Albert Hall and Kensington High St. Station; buses 73, 49, stop at the door.—Charles Amplifiers, 1c, Palace Gate, Kensington London, W.8 [6642]

### MORSE EQUIPMENT

**MORSE** practice equipment for classroom or individual tuition; keys, audio oscillators for both batt. or main operation.—Webb's Radio, 14, Soho St., W.1, Ger. 2089. [2291]

### TRANSMITTING EQUIPMENT

**BARGAIN**, Tx, 250-150w circuits, photos **BAR88**; will separate; offers £80.—Box 1322.

**HALLICRAFTERS HT4** 500w phone/cw Xmitter, covers 80, 40 and 20m amateur bands, easily adapted for 10m, complete with aerial tuning unit and external speech amplifier, two microphones, key, spare valves, many spare parts, full range plug-in coils for VFO or crystal control, new condit.; price (far below original cost) £280.—Box 408 [7815]

**COMPONENTS—SECOND-HAND, SURPLUS**

**CHARLES BRITAIN RADIO** offers:—

**SPECIAL** bargain.—Brand new and crated ex-U.S. Navy indicator unit, complete with 11 new valves and 3in C.R. tube, valves include 7, 68N7, 1, 6x5, 1, 6G6, 1, 6H6, 1, 2X2 and tube mounted separately, type 3BP1, price, carr. free, £4/19/6; indicator units in metal case, with 6in electrostatic C.R. tube and 7 valves, easily converted into scope, £3/10, this item for callers only. New purchase: Brand new ex-Govt. M.C.R.1 miniature communication receivers, 20-3,000 metres, complete with power pack, 4 plug-in coils, phones, etc., 97-250 volts ac/dc, or from dry batteries, £8/5; batteries for the above, 10/- each, or two for 17/6; Walkie Talkie 38 sets, brand new, these are complete with valves, throat mikes, phones, junction box, haversack and telescopic aerial, range 7-4 to 9 mc/s (no batteries available), £4/5; oscillator, type 37, brand new, 22-70 mc/s, grey metal cabinet, osc. amfr. 807 P.A. valve, for use on ac mains 200-250 volts, 2in moving coil tuning meter, first class job, £7/10 plus 30/- (refundable) for crate. This month's special offer: 72 brand new wire ended tubular American metal cased condensers, 0.01, 0.1, 0.25, 0.5, all high voltage, 27/6. Send for our latest list of all standard components.—Charles Britain (Radio), Ltd., 2, Wilson St., E.C.2. Tel. Ris 2966. [8072]

**UNSURPASSED** bargains in components and American valves; send 1d. stamp for list.—Watts, 38, Chapel Ave., Addlestone, Surrey.

**R. S.E.22**—New +2434, special offer; brand new 3-gangs, .0005, 12/- each; smoothing chokes, 12ma., low resistance, 5/6; 1 meg switched volume controls, centralab, 4/6 8mfd. electrolytics, 500v and 375v, 3/-; octal valve holders, 1/6 doz; tubular condensers, .5, .25, .1mfd, 6/- doz; resistors, 6/- doz; multicore solder, 4/- lb. [7963]

# FUNDAMENTALS OF RADAR Ready Shortly

by Stephen A. Knight, F.R.S.A. This useful book surveys the principles underlying radar and shows how it has developed from ordinary radio engineering. A book of special interest to radio engineers and students of radar and television. Crown 8vo. Illustrated 128 pages. About 7s. 6d. net.

# RADIO RECEIVER SERVICING AND MAINTENANCE Second Edition

by E. J. G. Lewis. Completely revised and greatly enlarged, this new edition is indispensable to radio service men and keen amateurs. 8s. 6d. net. "The book is practical, replete with facts and well arranged."—*Wireless World*.

*Pitman Books*  
39, Parker Street, Kingsway, W.C.

# AMAZING BARGAIN

EX-GOVERNMENT

1½ METRE 10 VALVE  
SUPERHET UNITS



7  
GNS.

Carriage paid  
Cash with  
Order

Special discounts  
to Trade, Radio  
Societies, etc., in  
lots of 25 or more  
units.

IDEAL FOR  
CONVERSION INTO—

Circuit comprises: 1 Pre. Amp. Osc. Mixer 5 I F., Det. Video Amp. I.F. Frequency 12 Megs. Band-width 4 Megs Co-axial input & output sockets. External source of L.T. & H.T. supply is required. Manufactured to stringent Govt. specification by such famous makers as R.G.D., Fye, and Murphy. Brand new and unused, and in manufacturers sealed cartons. Complete with 10 Mazda valves.

Circuit Diagrams supplied Free with each set.  
Sold separately at 1/-.

**WIRELESS INSTRUMENTS  
(LEEDS) LTD.**  
54-56 THE HEADROW, LEEDS, 1

# USE THE BEST

—It's cheapest  
in the end

## ABSORPTION WAVE-METER AND PHONE MONITOR

All amateur bands are covered by means of plug-in inductances ... **35/-**  
Extra inductances 3/9 each.



## "Q-MAX" SLOW MOTION DIAL

for Individual Calibration, with escutcheon, glass, knob and dial engraved 5 blank and 1 calibrated scale.

**15/6** (postage 9d.)

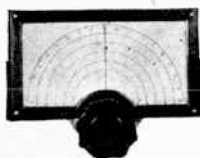

## "Q-MAX" CHASSIS CUTTER

Does away with tire, some drilling and scraping. Holes cut easily and cleanly.

**1 1/2" (octal) 10/6**

**1 1/2" and 1 1/4" 12/6**

(Post 9d. extra)



Pat. Applied for

## "Q-MAX" METAL CABINETS

Strongly built steel cabinets complete with chassis, panels with panel handles, hinged lids, louvered sides with side handles. Finished in black crackle.

**19" x 10 1/2" x 10" ... 94/6**

(Carriage 5/- extra).



ILLUSTRATED CATALOGUE 6d. POST FREE

**BERRY'S**  
(SHORT WAVE) LTD.  
25, HIGH HOLBORN,  
LONDON, W.C.1  
(OPPOSITE CHANCERY LANE)  
TEL.: HOLBORN 6231

**UNIVERSAL ELECTRONIC PRODUCTS** (G8UQ), 36, Marylebone High St., London, W.1. Tel. No. Wel. 4058.

**HIGH performance superhet tuning units**, covering 16-50, 20-550 and 1,000-2,000 metres, complete with i.f. transformers, valveholders and attractive edge lit glass dial, fully aligned and tested; type A for 6K8 and 6K7 valves, price (less valves), 25/8; type B, as above, but with addition of third valveholder (for 6Q7), together with volume control, wired, aligned and tested, price (less valves) 26/10, postage 2/6 extra in each case; R1155: If you are not satisfied with the performance of your set, write for details of our conversion. We now have a special department dealing with these receivers, and can offer prompt service. Our works are available for the construction of specialist type receiving or transmitting equipment to specification; prototype or development work undertaken. [8068]

**OPM6c heavy duty output trans.**, 15/1. 22/1, 45/1, with e.t., ex-Govt., unused, boxed; 25/- inc. post, listed 23/15.—63, Bisson Rd., London, E.15. [7856]

**B. & H. RADIO** have a comprehensive selection of component parts for the service engineer and component specialist; trade only; stamp for list.—B. & H. Radio, Huntley St., Darlington. [8051]

**SINGLE and twin screened flex**, volume controls, BA screws and nuts, laminator strip, iron dust cores, coil screen tins, main transformers, I.F. transformers, smoothing chokes; lists.—John Downton & Co., 89, High St., Epping. Tel. 2163. [7421]

**KITS of radio receivers** from 27/8; 4- and 5-valve, new materials, table models, semi-midget; our latest kit.—Wynon Star 1947 has connections for gramophone pick-up, extensions to loudspeaker A.V.C. 6 hours average time for constructing; full details, diagrams with each kit; c.w.o. or c.o.d.—Islerwoods, Reme House, 81, Plungington Rd., Preston. Tel. 3348. Estd. 1936. [6788]

**ELECTRAD offer:** All goods as in June issue; also 4-pole 2-way, Vaxley type switches, short spindle, 6d. each; 80,000 carbon pot. short spindle, 4d. each; 4in x 1/4in dia. ceramic extension rod, 3d. each; ceramic coil formers, 1 1/2in x 1/4in dia., 6d. each; lots of other goods in stock; we specialize for the constructor.—Electrad, Old Rudge Wks., Crow Lane, Coventry. [7880]

**GEE ELECTRIC**, 15, Little Newport St., London, W.C.2. Tel. Ger. 6794.—A few of the many lines held in stock: 32mid 650w tropical condensers, 12/6; 4mid 800w paper condensers, 5/-; 5mid 2,500w paper condensers, 7/6; 5in page speaker p.m., 16/6 each; 3 1/2in p.r.t., as per last month's issue, 24/10; this month's special ex-Gov. modulator unit type 76, containing relays, i.f.s. fuse holders, also condensers, transformers, resistors, and valve holders, all new, bargain price to clear, 27/6 each; trade supplied. [7886]

**BARGAINS in new and unused ex-Service equipment**—Indicator units type 6C, containing one 3in cathode ray tube, 2 VR91 (EP50) 2 VR54 (ECC31) valves, 20 various resistances, 4 potentiometers, 8 condensers, co-axial input and output sockets, etc., new and unused, in maker's sealed carton, 5gns each, carriage paid; 40 feet lengths flat twin R.F. feeder ribbon cable with connector, 300 ohm impedance, new and unused, in maker's original carton, 8/6 post paid; Phoenix glass lead-ins for window mounting, ideal for amateur transmitters, new and unused, in maker's carton, 2/6 each, post free; Browns high resistance, lightweight headphones, new and unused, 7/6 per pair, post free, 3 pairs for 21/-, post free; multitone low resistance lightweight headphones, new and unused, 6/- per pair, post free, 3 pairs 15/6, post free; moving coil head and microphone sets, ex-radar, 13/6, post free; Ferranti moving coil millimeters, type A, 5-0-10 ma, 2 1/2in dia., flush mounting, insulated for 2k working, fitted with safety glass dial, new and unused, in maker's sealed carton, 12/6 each, post free, 3 for 31/-, post free; Bifam ditto, 11/6 each, post free, 3 for 30/-, post free; test set type 5, comprising 0-6 thermo couple millimeter and potentiometer, co-axial input plug and lead, in steel case 7in x 4 1/2in x 2 1/2in, new and unused, in maker's sealed carton, 25/-, post free; transformers, ex-Admiralty type W4521, unused and in maker's sealed carton, 230-250 volts, 50 cycles input, 20 volt at 3 amp or 32 volts at 1.5 amps, wt. 7lb, 12/6 each, post free; ex-Admiralty type 62, 230 volts, 50 cycles primary, secondary 700-0-700, 0-1.200 volts, plus rectifier windings, rectifier valveholders fitted on top panel for RZ1/150 and U17 valves, a real super job in maker's sealed crate, carriage paid, 75/-; ex-R.A.F. type 256, oil filled 4kva, input 230 volts, 50 cycles, output 18kv, weight approx. 4 1/2wt, in maker's sealed crate, 25/- carriage forward.—Wireless Instruments (Leeds), Ltd., 54 and 56, The Headrow, Leeds, 1. Tel. 22262. [7766]

# ARMSTRONG



## INTRODUCING Model RF103

### 10 VALVE ALL-WAVE SUPERHET RADIOGRAM CHASSIS.

#### CIRCUIT.

Tuned aerial input to Variable-mu H.F. Pentode as Radio Frequency amplifier, Triode Hexode Frequency Changer (465 k.c.), I.F. transformer coupled to Variable-mu Pentode, Double Diode Triode as Second Detector, A.V.C. and first L.F. stage, Triode Phase Reverser, 2 Triodes in Push-pull giving 10 watts audio output, full wave rectifier. For 200-250 v. A.C. mains.

#### SPECIAL FEATURES.

- ★ 10 VALVE CIRCUIT.
- ★ R.F. PRE-AMPLIFIER.
- ★ WAVE BAND EXPANSION. (Short wave band covers over 20°.)
- ★ LARGE GLASS SCALE.
- ★ 3 STAGES A.V.C.
- ★ TREBLE LIFT CONTROL. (Operates on both radio and gramophone.)
- ★ PLUS 6 db. BASS LIFT ON GRAMOPHONE. (To restore bass cut on some records.)
- ★ 10 WATT PUSH-PULL OUTPUT.

## SEE THIS NEW CHASSIS AT RADIOLYMPIA

OCTOBER 1st—11th, on Stand 205

Demonstration Model now available for interested callers to hear and technical specifications will soon be ready. It is hoped that a very limited number will be available for early delivery. Price has yet to be fixed but every endeavour will be made to keep this below £20.

ALSO ON VIEW AT RADIOLYMPIA OUR POPULAR MODELS EXP 83 and UNI 83.

**ARMSTRONG WIRELESS & TELEVISION CO. LTD.**  
WALTERS ROAD, HOLLOWAY, LONDON N.1.  
Phone: NORTH 321

# HENRY'S

of  
**HARROW ROAD**

We still have available the following unparalleled Midget bargains.

**I.F. UNITS.** Comprising 174 Valve in ceramic holder, Midget iron-cored I.F. Trans. 465 Kcs., condensers and resistors. All in midget aluminium can. New, 15/- ea.

**R.F.O. UNIT.** Comprising 185 Valve in ceramic holder, midget B.F.O. coil in can, condensers and resistors. All in midget aluminium can. New, 12/6 only.

We regret that we are now no longer able to supply A.F. units as previously advertised.

The following are only a few of the lines shown in our latest list, available on receipt of stamp.

- BULGIN.** Jack Sockets, 1/8 ea.
- BULGIN.** Pilot Indicators, 1/9 ea.
- WEARITE.** Aerial, H.P. and Oscillator coils, for M. L. and S.W., 3/- ea.
- WEARITE.** Standard I.F. Tran, iron-cored, 465 Kcs./20/- pr.
- TUNING CONDENSERS.** Two-gang .0005 with trimmers and feet, 13/- ea.
- Less trimmers, 11/8 ea.
- .0005 Midget, 2 1/4 x 1 1/4, with trimmers, 13/8 ea.
- .0001 Midget, 1 1/4 x 1 1/4, with trimmers, ceramic, 8/6 ea.
- ELECTROLYTICS.** 8 mfd. 350 v., 3/6; 8 mfd. 500 v., 4/-; 8 x 8 mfd. 500 v., 6/-; 16 mfd. 500 v., 5/-; 16 x 8 mfd. 500 v., 9/-; 16 x 16 mfd. 350 v., 9/-; 40 mfd. 150 v., 4/-.
- BEST MAKES.**
- 6-VOLT VIBRATOR PACK.** A manufactured unit, completely smoothed, with self-rectifying vibrator, in black-crackle box, 5 1/2 x 5 1/2 in., complete with screened lead, ready for fixing. Output, 180 v. 40 mA., 6/6/- only.

It will pay you to send for our List.  
**CASH WITH ORDER or C.O.D. (over £1)**  
**TRADE SUPPLIED.**

**HENRY'S RADIO**  
5, HARROW RD., W.2.  
PAD 1008 9.

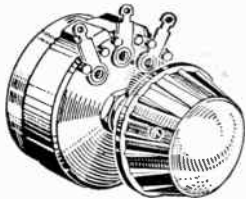

## Types T.W. and S.G.

As recently specified in the "Wireless World."

### "TELEVISION RECEIVER"

- One 1,000 ohms T.W. linear
- One 2,000 ohms T.W. linear
- One 10,000 ohms T.W. linear
- Two 2 megohms S.G. linear

### "HIGH QUALITY AMPLIFIER"

- One 25,000 ohms T.W. linear
  - Two 100 ohms T.W. linear
- are now available.

For full details of all types write to:

# RELIANCE

Manufacturing Co. (Southwark) L'd.

Sutherland Road, Higham Hill,  
Walthamstow, E.17

Telephone: Larkwood 3245

**MAINS** transformers £1, chokes 7/- out-puts 5/-, part-built car radio £5. R/C bridge and signal generator £10.—Body, 22. Fabian (resc. Shirley, Bham. [7969]  
**COPPER** wires, enamelled, tinned, cotton and silk covered, all gauges; B.A. screws, nuts, washers, tags; ebonite panels and tubes, coil formers, headphones, flexes, solder, etc.; comprehensive list on request; trade supplied.—Post Radio Supplies, 33, Bourne Gdns., London, E.4. [7719]

**A** LARGE quantity of radio components, including condensers, flexible couplings, 3 pole 3-way switches, line cord, multi range ohms meters, screened wire single and twin, 3-core flex., 2- and 4-way fuse boxes, etc.—"Phone or call L. Goodman (Radio), Ltd., 9, Percy St., Tottenham Ct Rd., W.1. Mus. 0216.  
**R**.103a receivers, 1.8 to 7.5 mc/s., 200-250 V. volts A.C. or 6 volts D.C., without valves or vibrator, 50/- complete with valves for A.C., £5; R.F. units, size 4in x 3in x 2in, containing midget 3-gang condenser, 3 short wave coils, trimmers, padders, resistors, 5/-; coil turrets, containing 4 coils, covering 12 to 100 metres with 4 position Xaley type switch, 2/6; 4mfd electrolytic condensers, 450 volt, 4 on panel, 4/-; stamp for complete list of many other useful items.—Baker, "Bervstedt," St. Helens Rd., Leamington Spa. [7918]

**HARRY JAMES PRODUCTIONS,** 270, Leith Walk, Edinburgh, 6.—Mail order only, c.o.d. or cash with order; electrolytics 8mids B.1., 3/6, 8+8 5/6, 16mids 4/9, 0.01, 0.05, 0.1 8d; volume controls, 1/4 and 1/2 meg., 4/9; multi ratio speaker transformers, 6/6; loudspeakers 5in, 19/9; 2-gang condensers, 0.0005, 12/-; valve holders, 5-, 7-pin, and Octal 6d, Amphenol type 9d; T.R.F. coils, m and l, with circuit, 8/6; T.R.F. chassis, 4/-; valves c.o.d., most English and American types in stock; let us have your enquiries for anything in radio. [7854]

**E.X.R.A.F.** Identification Friend or Foe receiving and transmitting units with 4 straight mains I.F. pentodes, Mazda, on Mullard E.F.50, 3 television diodes and 2 double-triode mains valves by Brimar; also 20 watts motor generator, 24 volt input, 480 volt 40 m.a. output, 50/- each, plus carriage 4/-; includes a wealth of small components such as carbon and w.w. resistors, tubular and mica condensers, all good valves, plus coils and condensers, magnetic relays and mechanical relays.—Uncle Tom's Radio Cabin, 128, Greengate, Salford, 3. [7650]

**C**LEARANCE sale.—Weymouth coil packs, 30/- each; Weymouth type 3-wave coils, 7/- per pair; Weymouth Midget I.F.s, 15/- per pair; Weymouth constructional drawings, 1/6 per set; new electrolytic condensers, dry can type, 16x8x4x4mfd, 570 volt, 7/6 each; 16x8mfd., 450 volt, 6/6 each; Summersby I.F. transformers, 0.1m-cored tuning coils, 3/3 each; terms c.w.o., postage 6d extra, no c.o.d. under £2; please note (postal address only) prior to moving to larger premises.—Castle Radio, 86, Abbeville Rd., Clapham, S.W.4.

**H. FRANKS,** 58, New Oxford St., W.C.1. Tel. Mus. 9594. Offers the following ex-Govt. equipment to callers only, comprising the following: AC mains driven oscillators, type 37, 22 to 70 m/cs, complete with 6 valves and milliammeter in output circuit; receiving units, type 69; C.R. units, type P246; C.R. power units, type 526; performance meters, type 53874; ac mains wavemeters, type W1252; battery wavemeters, type W1095; receivers, type 1147; receivers 3132; indicator modulators, auto transformers; C.R. units, type 198; receivers, type 76A; battery driven amplifiers, large assortment of volt. amp and milliammeters, neutralizing units with R.F. meters, metal rectifiers, relays, vibrator pentans, inter-com. sets, Benz. H.F. dummy antennas and loading units, complete with R.F. meters, 356 to 6.666 k/cs, 6-valve receivers, type R-25/ARC.5, complete with valves, etc.

**N**EW STC metal rectifiers, full-wave bridge-conn., damp-proof finish, makers ratings, 12v 1a 11/-, 1.5a 14/-, 2.5a 19/6, 4a 23/-, all p.l.; 5a 31/-, p. 1/-, 8-10a 37/9, p. 1/-, 24v 4a 42/1, 8a 64/10, 16a 126/5, 30v 5a 57/10, 50v 5a 81/6, 90v 5a 151/3, all p. 1/3; transformers, 200-250 i/p, sec. tapped for 6-12v charger, 2.5a 25/-, p. 1/-, 5-6a 48/-, p. 1/6, 8-10a 75/-, carr. 2/-; replacements for valve-type chargers, pse. state make and type. No. of valve and the o/p. tech. queries welcome. s.a.e. pse.; 1st gte. slider resistances, 150watt 13ohm 3a, 5.5ohm 5a, 1.25ohm 10a, etc., 22/6, p. 8d; vent. blk. steel cases w. lid, for chargers up to 12v 4a, 10in x 6in x 5in h., 9/-, p. 1/-; ex-W.D. steel boxes, hinged lid, 8 1/2in x 3 1/4in x 6 1/2in h., 7/-, p.l. tide. supp.; 40watt fluorescent lamps comp., from £6/9/6, plus carr.; also 80watt meters, new 4hp, 230/1/50 induction, 1st class make, £29/5 ea.; ditto, 1/4hp, £10/5, plus carr.; terms c.w.o. or proforma, c.o.d. rec'd and post goods only.—Pearce, 66 Gt. Percy St., W.C.1 (nr Angel).

# G. L. PRODUCTS



**MODEL AC/10. 8 Gns.**  
(The baby of a family of TEN).

Portable p.a. amplifiers in elaborate cases, outputs from 15 to 60 watts. AC/18 HG. For Mic. and Gram., 15w., 15 Gns. AC/25, General Concert. P.A., 25w., 18 Gns. Summary leaflet on entire range free upon request.

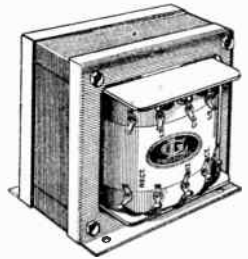

**MAINS TRANSFORMERS**  
Fifty varied ratings listed. Prices from 30/-  
Also Output Transformers and Chokes.  
Full Catalogues on G. L. Products, 3d.

**General Lamination Products Ltd.,**  
Winder House, Bexleyheath, Kent  
(Bexleyheath 30z11)

# MIDLAND INSTRUMENT Co.

**JONES PLUGS** with sockets to fit, 10-way, 3 6; 12-way 4/6. A.M. trimming, etc., tools, set of four, 2/6.

**MOVING COIL METERS,** high grade 0-1 m/A., flush panel mtg., 3/4in. dia., 25/-, 25/-, Moving coil meters, fitted thermocouple for R.F. 0-2 amp., to match above, 15/- Both meters brand new boxed.

**EX-A.M. D.R. MASTER UNIT** gyro compass contains three motors, 24-v., one a converter supplying A.C. current to the motor gyro, plus a wealth of other gear, cost over £80, condition as new, 70/-, crate and carriage, 7/6 extra.

**EX-GOV. UNITS,** fitted 11 valves, VR65A (4), CV6 (2) VR67 (2), VR92 (2), VR54 (1), also relays, var. condensers and 40 condensers, coils, chokes, etc., mounted on chassis 12in. x 8in. x 2 1/2in., fitted louvred cover, condition as new, 40/-, carr. paid.

**EX-A.M. R.F. UNITS,** types 24 and 25, fitted three VR65 valves, 5-way 3-bank ceramic switch, trimmers, coils, resistors and conds., etc., 25/-; ditto, less valves, 10/-.

**EX-A.M. POWER UNITS,** type 567, fitted 11-valves 3U4G (2), 5Z4G (2), 6X5G (1), 6V6G (1), CV188 (2) CV173 (1), VR91 (1), VU120 (1), also three transformers (40-v. 2000-cy.) four chokes, v-controls, high voltage condensers, resistors, etc., steel case, 12in. x 12in. x 8in., weight 35 lbs., brand new, unused, 70/- carriage 5/- extra.

**VIBRATOR PACKS,** complete 6-v. input, output 90-v 20-m/A. and 6-v. 15-m/A. MOTOR GENERATORS, input 12-v., output 500-v. 50-m/A., 20-v. SELECTOR SWITCHES, impulsive and homing, operates xaley switch, 12/24-v. 2/6. THERMOSTATIC SWITCHES 2/6.

Also in stock: 200-250-v. AC/DC MOTORS, ditto, with gears, RECEIVERS, AMPLIFIERS, MOTOR GENERATORS, WIRES, VALVES, BELAYS, CONTROL UNITS, METERS, RESISTORS, CONDENSERS and hundreds of other Radio, Electronic, and Mechanical Items. Send for our July lists, 2d., with s.a.e.

Orders over 30/- post paid, no C.O.D. under 20/-

**Moorpool Circle, Birmingham, 17**  
Tel.: HARborne 1308 or 2664



*You're SURE to get it at*  
**STERN'S**  
 ESTABLISHED 25 YEARS

Our range of WIRELESS COMPONENTS and VALVES is one of the largest in England.

★ We cannot show our extensive range here. Send 2½d. stamp for Our Stock List.

A few examples.

- MOVING COIL SPEAKERS.**  
 Rola 5in., PM, 2-3 ohms, less transf., 21/6, with transf., 27/6.  
 Rola 5in., Energised with transf., 1,000 ohms, 27/6.  
 Rola 8in., PM, 2-3 ohms, less transf., 24/-, with transf., 30/-.  
 Rola 8in., Energised, less transf., 1,500 ohms, 31/6, with transf., 2,000 ohms, 37/6.  
 Goodmans 10in., P.M., 2-3 ohms, 35/-.

- VARLEY MAINS TRANSFORMERS.**  
 425-0-425v. 150 m/a., 4v. 4 amp., 5v. 3a., 6.3v. 4 amp., 55/-.  
 300-0-300v., 70 m/a., 6.3v. 4 amp., 5v. 3 amp., 30/-.  
 375-0-375v., 200 m/a., 6.3v. 6 amp., 5v. 3 amp., 50/-.  
**Wearite I.F. Transf.,** 465 k/c, Standard Type, 20/- pr., Midget Type, 21/- pr.  
**Wearite "p" Coils.** Complete range in stock, 3/- each.  
**Denco Coils.** Complete range in stock, from 4/-.  
 Matched pair T.R.F. Coils, covering 200-557, 800-2,000 meters. Includes circuit, 6/9 pr.  
 Matched pair Superhet Coils, covers 16-50, 200-557, 800-2,000 meters. Includes circuit, 8/6 pr.

- A few Ex-Govt. Clearing lines.**  
 L.F. Choke, 15 Hny., 100 ohm, 300 m/a., 12/6, 9 Hny., 250 ohm, 120 m/a., 7/9.  
 Transformer, 250-0-250v., 60 m/a., 6.3v. 3 amp., 5v. 3 amp., 19/6.  
**30ft. Length Co-Axial Cable,** with two complete Conectors, 10/-.  
**Precision Slow Motion Drive** (by well-known Mfr.), ratio 50-1, 10/6.  
**Rotary Transformer.** Input 12 volts, output 240 volts, 120 m/a., 22/6.  
 Input 12 volts, output 490 volts, 18/6.  
**Condensers.** Single hole fixing, 8 mfd., 500 volts, 5/9.

★ Try us with your enquiries, we give you an immediate reply.

Terms C.O.D. or Cash with Order.

**STERN RADIO LTD.**  
 115, FLEET STREET, E.C.4.  
 Telephone: CENtral 5814

**INSTRUMENTS**  
*made to measure*  
 for all electrical  
 and communication  
 engineers



**QUADRANT WORKS, FINCHLEY LANE,**  
 HENDON. N.W.4 : Phone HEN 3682/3230

**G. A. RYALL,** 65, Nightingale Lane, London, S.W.12. Mail order only, no c.o.d. under £1 please; postage strictly extra. Please write plainly. U.A.S. mng 0.1mf tubulars, 500v wkg, metal cased wire ends, 6/6 dozen; resistances, ¼w, ½w, 1w, best makes, well graded assortment, from 100 ohms to 2 meg, 25 sizes, 40 for 5/-; special offer of resistance panels, 12-way with 33,000 2w, 350 ½w, 250 ¼w, 27,000 2w, 4,700 ½w, 47,000 1w, 3,300 1w, 22,000 1w, .01mf 350v, 0.05mf 350v, new, 3/- complete; panels with mtg bracket, with 3 0.05 mf 350v condensers, 1/3; 5-way panel, with 20,000 2w, 4,700 ½w, 68,000 ¼w, 50mm condensers 1/-; also 5-way, with 3 resistances and 25mf 12v electrolytic, 1/6; also 25mf 25v, with 3 resistances, 1/6; and panel with 5-pin UX ceramic VII, 8-turn choke coil, 4 res and cond, and 3 mica 0.01mf condensers, 2/-; special clearance offer of 4-gang straight type 0.0004 variable condensers, 7/6; meters, 0-1ma, scaled in usual 50 divisions, 2½in instrument, m/c brand new, 21/-; all goods advertised previous issues available; condensers, mica, 0.004mf, tag ends, new, 3/- dozen; silver mica type, 0.001, 3/- dozen; Mansbridge 1mf 500v wkg, 3 2/6; Octal plugs, with metal cap and paxolin valve holder for same, 3 2/6, with solder tags 3 3/-; switches, 9-way, single bank, 6-way, double bank, 3w 3p, double bank, Yaxley type short spindle, all brand new, 2/3 each; high resistance phones, with sponge earpads, good class microphone, complete with 4-way plug, new, 10/6 set, boxed; R.F. amplifiers, type 25, brand new in carton, 3 8P41 in three divisions, with 15 R.F. type trimmers, fixed tuning 30-40mc, ceramic 5-way sp 3-bank switch with good operating knob, complete in metal case, ceramic coils, easily detached for rewinding, 45/-; battery amplifiers, triode coupled to QP21, ex-R.A.F., all O.K., contain 4 input and output trans, 25/-; twin gang ceramic end plates, with offset vanes, silvered finish, 0.0005mf panel mtg type, fine S.W. job, 7/6; metal boxes, with paxolin panel, fixing lugs, etc., size approx 8½x7½x3½ deep, 6/9 complete, black finish.

**EX-GOVERNMENT** stock.—7,500 transmit-  
 ters, oscillators, power units, receivers  
 rotary converters, de luxe slow motion dials  
 12-24v motors, amp- and voltmeters, at frac-  
 tion of original cost; callers only.—Alec Davis  
 8, Percy St., W.1. [7225]

**PAPER** block condensers in metal cans for  
 television, test equipment, electro-medical  
 and heavy duty use, public announcement, etc.:  
 Type 1, 0.1mfid 3,000 volt dc working, 4/-  
 each; type 2, 0.1mfid 4,000 volt dc working,  
 5/- each; type 3, 0.1mfid 5,000 volt dc working,  
 6/- each; bargain parcel 5 condensers, 21/-,  
 consisting 1 type 1 condenser, 2 type 2 con-  
 densers, 2 type 3 condensers; immediate atten-  
 tion will be given to all orders, which should  
 be accompanied by P.O.; if ordered c.o.d., fee  
 will be charged, otherwise post free.—Write  
 Griffin, "Farndon," Withybed Corner, Tad-  
 worth, Surrey.

**H.T.** and l.t. rectifiers, battery charger kits,  
 not surplus, all new goods with full guar-  
 antee. New small space type selenium h.t.  
 rectifier for a.c./d.c. sets, 250v 60ma, takes  
 place of valve rectifier and occupies no spare  
 space, 9/6, post 6d.; ditto 120v 25ma for  
 eliminators, 7/6, post 6d., product of famous  
 manufacturer; selenium l.t. rectifiers, with in-  
 formative instruction sheet. 12v 0.75amp, 7/6;  
 12v 1.5amp, 10/6, post 4d.; 12v 2amp, 12/6,  
 post 7d.; 12v 3amp, 18/6; 12v 4amp, 25/-,  
 post 9d.; 12v 5amp, 27/6; also new heavy duty  
 aluminium cooling finned 12v 6amp giant type,  
 32/6, postage 1/-; 24v 2amp rectifiers, 29/6;  
 24v 5amp, 39/6; many different types in stock,  
 including types for conversion of garage  
 chargers; eliminator kit, transformer, 2 selenium  
 rectifiers, 2 8mlds condensers for 120v 20ma  
 eliminator, with 2v trickle charge, 39/6, post  
 10d.; charger kits, 50watt mains transformer  
 with 12v 3amp rectifier and ballast bulb for 2v  
 to 12v charger, no rheostat and ammeter needed,  
 foolproof, 48/6; ditto with 2.5amp rect., 44/-,  
 post 1/-; ditto with 2amp rectifier, 38/6, post  
 1/-; also as above but with 6v 2amp rectifier for  
 2v, 6v charger, 34/-, post 10d.; heavier type  
 75watt transformer with 12v 4amp rectifier  
 and ballast bulb for 2v to 12v charger, 62/-,  
 post 1/-; 140watt transformer and 12v 5amp  
 metal rectifier for 6v, 12v charger, 24/5, a  
 very fine job; trickle charger rectifier, 2v  
 0.5amp type with transformer, makes ideal  
 trickle charger for 2v cell, guaranteed one year,  
 13/6, post 7d.; for commercial charging, heavy  
 duty transformer, selenium rectifier, ballast  
 bulb, will run continuously for years, for 1 to  
 20 cells at 1amp, 24/15; for 1 to 12 cells at  
 2amps, 24/15; for 1 to 20 cells at 2amps,  
 26/15; all guaranteed one year; transformer  
 and rectifier specially designed for these;  
 ammeters, 0-6amp flush type, 12/6; sliding  
 rheostats, 0.4ohm 25amp, 15/-; Lustraphone  
 m/coil mikes, 24/10; Rothermel Bullet mikes,  
 22/18/6.  
**CHAMPION,** 43, Uplands Way, London, N.21.

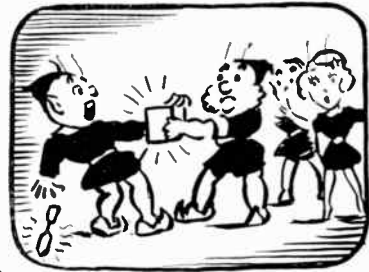

**THE "FLUXITE" QUINS AT WORK**

"These midget sets are alright,  
 And for soldering, so is FLUXITE,  
 But this beats the band.  
 Just look at my hand,  
 I've got the darn thing wedged in tight!"

See that FLUXITE is always by you — in the house — garage — workshop — wherever speedy soldering is needed. Used for over 30 years in Government works and by leading engineers and manufacturers. Of all Ironmongers—in tins, 10d., 1/6 & 3/-.

**TO CYCLISTS!** Your wheels will NOT keep round and true unless the spokes are tied with fine wire at the crossings AND SOLDERED. This makes a much stronger wheel. It's simple—with FLUXITE—but IMPORTANT.

The FLUXITE GUN puts FLUXITE where you want it by a simple pressure. Price 1/6, or filled, 2/6



ALL MECHANICS WILL HAVE

**FLUXITE**

IT SIMPLIFIES ALL SOLDERING

Write for Book on the ART OF "SOFT" SOLDERING and for Leaflets on CASE-HARDENING STEEL and TEMPERING TOOLS with FLUXITE. Price 1d. each.

**FLUXITE LTD.**

(Dept. W.W.), Bermondsey Street, S.E.1

"We Were  
Greatly Impressed"

This phrase was used by a leading Electrical Instrument concern in connection with

## TRANSFORMERS and CHOKES

supplied by us, and is praise to which we have become accustomed. Our modern factory is fully equipped with vacuum and pressure impregnators, and all the latest test equipment.

POWER RATINGS 8 V.A. to  
8 K.V.A.

AUDIO RATINGS 3 watts to  
200 watts.

OUTPUT TRANSFORMERS TO  
Mr. D. T. N. Williamson's Specification.  
£3. 10. 0.

PROMPT DELIVERIES

**AUSTIN MILLS LTD.**  
**LOWER CARRS,**  
**STOCKPORT**

Established 20 years

Phone: STO 3791

## The "UNLIMITEX" CHASSIS PUNCH & DIE

For speedy, simple, and perfectly clean punching of sheet metal. Drill a 3/16" pilot hole, and with a couple of taps with a hammer you're through! A precision toolmaker's job, cyanide hardened for long use. Illustrated instruction sheet supplied. Price only 9/6d. including packing and postage; despatched same day. Specify whether 1 1/2" or 1 1/4" required.

**WIRELESS SUPPLIES UNLIMITED**  
264-266, Old Christchurch Road,  
BOURNEMOUTH, Hants.

## WARD ROTARY CONVERTERS

For Radio, Neon Signs, Television, Fluorescent Lighting, X-ray, Cinema Equipment and innumerable other applications

We also manufacture:—

Petrol Electric Generating Plants, H.T. Generators, D.C. Motors, etc., up to 25 K.V.A.

**CHAS. F. WARD**  
LEROSCROFT WORKS, HAVERHILL, SUFFOLK  
Telephone: Haverhill 253 & 4.

**SUPREME RADIO**, 746B, Romford Rd., Manor Park, London, E.12, est. 15 years, Tel. ILF 1260, announcing useful Govt. surplus, set manufacturers enquiries invited: Mazda valve holders, 5/- gross; 4-pin UX American valve holders, porcelain, 12/- gross; anchoring tags, 3/- gross; filament or heater H.F. chokes for short wave set, 3/- doz; standard grid caps with lead, 2/- doz; ditto mounted on Paxalin panel with 57Ω 1/2w resistance attached to anchoring tag nut and bolt for fixing, 4/- doz; Paxalin panels with 8 anchoring tags components wired to same, 1 500Ω 2w resistance, 1 10,000Ω 2w, 1 170Ω 2w, 2 0.1 tubular condensers, 500vw, 2/- complete panel; panels with 3 anchoring tags, 0.002 condenser, 1,000vw, 1 2,000Ω 1/2w, fixing nut and bolt, 1/6; panels with 11 anchoring tags 5 5,600Ω 5w resistances, 3/-; panels with 3 anchoring tags, 1 3,300Ω 5w, 1/6; Coractual plug and socket, 1/6 complete; panels with anchoring tags, no components, 11-8-4 and 3-way, 1d per way; Westinghouse metal rectifiers, 5ma, 5/6 each; Westectors, 1/6 and 1/8 each; earphone inserts or mike, 30Ω, 3/6 each; earphones with headband and lead, 50Ω, 4/6 pair; pilot bulbs, 6v, 0.5 0.3 small head, B.T.H., 4/6 doz; tubular condensers 0.1 350vw, 4/6 doz; 0.01 1,000vw, 4/6 doz; 0.05 500vw, 4/6 doz; 0.2 250vw, 2/6 doz; 0.025 can condensers, 500vw wire ends fixing clip, 9/- doz; 8mfid can or cardboard, 3/6 each; volume controls, 2,000Ω, wire wound, 2/6 each; v/cs with switch, 4/6, less 4/-; resistances, 1, 1 1/2, 2 meg, 4/- doz; assorted wire wound, 1 and 2w, 2/6 doz; 1 watt resistances, 27,000Ω and 75,000Ω, 4/- doz; Erie 1.5 meg, 3/- doz or 24/- gross; 1/2 watt, 1,000Ω, 2,200Ω, 10,000Ω, 15,000Ω, 24,000Ω, 30,000Ω, 56,000Ω, 100,000Ω, 470,000Ω, and many other useful sizes, 3/- doz various sizes; 1/8 doz; condenser, short ends, or 24/- gross; resistances with short ends, various sizes, 1/8 doz; condenser, 0.1 500vw short ends, 0.002 1,000vw, 2/6 doz; test meters, calibrated, 5,000Ω-0ma range 0.6, 0.1-5 and 0-3v moving coil, internal resistance 250Ω size 2 1/2in flush mounting non-splint glass, £1 each. We hold a large stock of everyday components for servicing. Send 2 1/2d for list. Terms cash with order, 6d extra for postage orders under £5. [7981]

**RADIO CLEARANCE**, Ltd., 27, Tottenham Court Rd., W.1. Mus. 9188.—Ex-Army "38" sets, 5-valve trans-rec., range 7-9.9 mc/s, complete with 2 valves and junction box (as used in tanks with No. 19 sets), 45/-; 3 spare valves in metal case (1 A7P4 and 2 ARP12), 10/-; 2 section rod aerials in canvas case, 7/6; mains trans., 230v 50 c/s primaries, secs 300-0-300v 20mA, 5v 3a, 6.3v 2.5a, 6.3v 3a, 25/-; 300-0-300v 200 mA, 5v 3a, 6.3, 4.5a, 22/6; 2,000v 2mA, 2v 2a, 4v 2a, 21/-; 80v 1,000 c/s primary suitable for re-winding, 3/6; smoothing chokes, 2.5H 200mA, 7/6; 20H 400mA, 18/6; H.F. chokes, covers and M.W., 1/6; U.H.F., 1/-; Mansbridge conds., 1mf 350v 300v, 1mf 1,000v 1/3, 1mf 3,000v 2/6; 2mf 1,000v 1/3; 4mf 600v, 4/6; 4mf 1,500v, 5/-; 0.25mf 2,000v 1/9, 0.25 2,500v 2/-, 0.5 1,200v 1/-, 0.25 400v 5d; all working V; ex-R.A.F. visual indicators in bakelite case, inc. 2 complete Weston moving coil meter movements, 300 micro amps F.S.D., 6/11; 0-30ma moving coil milliammeters, 2 1/2in scale, flush mounting, 8/6; telescopic aerials, 103in extended, 15in closed, ideal for car aerials, dipoles, etc., 9/-; air dielectric variable conds., 30 P.F. 3/4in spindle 1/-, 50 P.F. diff. ceramic base, 1in spindle, 2/-; mica conds., 0.0001-2.35 ad, 0.001-2.4 5d, 0.01 6d, 0.005 1,000v wkg, 7d, 0.0001 3,000v wkg, 9d; ceramic conds., 2, 10, 20, 25, 50, 100 P.F., 6d; silver micas, most values, 10 P.F.-6,000 P.F., 6d; metal rectifiers, 12v 1a, bridge type 4/6, 250v 60ma H.W. 4/6; headphones, moving coil, slightly used, 10/6 pr.; standard low res., 6/11; volume controls, carbon with SW, 5K, 10K, 25K, 50K, 100K, 500K 5/-; carbon less SW, 10K, 20K, 50K, 100K, 500K, 1M, 2/6; wirewound 3W type, 200Ω, 400Ω, 500Ω, 1K, 2K, 10K, 20K, 50K, 2/6; 2-gang 500/500Ω, 4/-; 5K/50K 4/-; 15w 500Ω, 4/6; rheostats, 44Ω 13w, 4/6; switches, 1p 3w 1/9, 1p 9w 2/6, 1p 6w 2b 3/-, 1p 5w 3b 3/3, 2p 6w 2/6, 2p 5w 3b short spindle 2/9, 2p 5w 2b 3/6, ceramic 3p 3w 3/6, 4-bank switch with 3 2p 4w wafers and 1 p 4w on 8 1/2in locator with 2 1/2in spindle 6/6; resistors, vitreous, 5w wire ended, 5Ω, 45Ω, 470Ω, 1K, 2.7K, 3.9K, 4.7K, 6.8K, 8.2K, 22K, 27K, 1/-; 10w res., 50Ω, 250Ω, 500Ω, 1K, 1.2K, 1/6 20w with clips 120Ω, 200Ω, 2K, 2K, 2/-; 25w 350Ω, 2/6; 40w 14K tapped at 2K, 3/-; tubular conds., 0.001-2.5, 0.01, 1,000v wkg, 6d, 0.02 350v 6d, 0.05 500v 6d, 0.1 350v 7d, 0.25 500v 9d, 0.5 350v 1/-; I.F. trans., 465 kc/s, iron cored, 14/- pr., 480 kc/s 9/-; coils, M.W., A.E., L.W. A.E., M.W. osc., L.W. osc., separate coils on 1 1/2in x 1 1/2in formers 2/6 each; 465 kc/s iron cored I.F. trap, 2/9; set of 4 coils and tran 11/6; ceramic trimmers, 1-15 P.F., 3-50 P.F., 9d. [8071]

## CRYSTAL PICK-UP



WITH *Unbreakable* CRYSTAL

The ACOS G.P.10 combines purity of reproduction with extreme reliability. A unique flexible assembly renders the crystal virtually unbreakable, while a needle-pressure adjustment is incorporated in the base. Resonance-free response from 50-8,000 cps. Output 1.5v. at 1,000 cps. Needle pressure 1 1/2 ozs. (adjustable). Vibration-free arm movement. Screened lead. Flexible coupling A protects crystal B against breakage. Price in Great Britain 44/- (including P.T.).



Flexible coupling A protects crystal B against breakage. Price in Great Britain 44/- (including P.T.).

Obtainable only from Radio Dealers

**COSMOCORD LTD**  
ENFIELD: MIDDLESEX

## REWINDS

Send your "Burn outs" to be Rewound — no technical data wanted. Post Transformer, etc., labelled with your name and address marked "for Rewind."

**OUR WINDINGS ARE  
LAYER WOUND & IMPREGNATED  
SOUTHERN TRADE SERVICES, LTD.**  
297/299, HIGH ST., CROYDON  
Tel. 4870  
Manufacturers of "TELECRIT" PRODUCTS

## MILESTONES IN "QUALITY"

### TUNERS and AMPLIFIERS

by *Lowther*.

### CORNER HORN Type P.W.I.

(now evolving)

by *Voigt*.

Demonstrations daily at

**THE LOWTHER MANUFACTURING CO.**  
Lowther House, St. Mark's Road,  
BROMLEY, KENT.

Rev. 5225

# M. WILSON LTD

## BLUE PRINTS

Specification of our very successful  
**Circuit No. 20**

A.C.9 valve Superheterodyne Constructor's Kit Receiver 5-2,000 metres. Using our valve sequence: R.F. stage 6K7; 1st detector and Oscillator 6K8; I.F. Amp. 6K7; 2nd detector, A.V.C. 1st L.F. and noise limiter 6B8; Phase inverter 1163; Output two 6V6's in Push-pull with negative feedback; Tuning indicator Y63; Full wave rectifier 5U4G. Six wavebands 5-2,000 metres covering Televisions sound, A.V.C. on/off. Controls R.F. gain; Wavechange Switch; A.V.C. on/off. Audio gain control and on/off switch; tone control; radiogram switch. Output 12 watts. Full set of blue prints (Full size) 2 PRACTICAL and 1 theoretical with detailed priced list of components 5/- per set.

The **COIL KIT** for above consists of 3, 18 s.w.g. aluminium screens, with 18 iron core coils and 18 Ceramic trimmers, 2 ceramic padders, 3, two-pole 6-way switches with shorting plates, mounted ready for wiring up from a full size blue print. All A.V.C. resistors and decoupling condensers, fixed padders, screened sleeving, etc., included. Size approx. 5 1/2 x 5 1/2 x 3. Price 25 0 0.

## 6-VALVE SUPERHET CIRCUIT

3 Wavebands A.C. Only

A circuit that will please the most critical

This circuit has been designed to receive all worth while stations on the medium wave band (200-540 metres) with a high fidelity output. Short Waves (16-47 metres) are as good as obtained on some purely short wave receivers. Australia and America have been received regularly by many of our Customers at loudspeaker strength. Long Wave: The few stations now operating are well received. Valve sequence. Frequency changer ECH35. I.F. Amplifier EP38. Second detector, first L.F. Amplifier and AVC, EBC35. Connections for gramophone pick-up.

Coils. Dust Iron-cored unit, completely assembled, calibrated and tested. Chassis. 16 gauge aluminium, strong and rigid. Three fuses mounted on Mains Transformer, 2 for mains input primary, one in negative rectifier feed, giving absolute safety in case of breakdown of electrolytic condenser, overload or accidental short circuit, thus preventing burning out of mains transformer. Controls are as follows:

**Tone Control.** Audio Volume Control combined with on/off switch. 3 Wave Band Wave change switch. Tuning control with slow motion drive and the three wave band dial mounted on aluminium front panel with magic eye indicator above panel.

We should like to emphasize the excellent quality of reproduction. Blue Prints, 2 Practical and 1 theoretical with detailed priced list of components. 8/6 per set.

**307, HIGH HOLBORN,**  
LONDON W.C.1. Phone: **HOLborn 4631**

## MORSE CODE TRAINING



There are Candler Morse Code Courses for **BEGINNERS AND OPERATORS.**

Send for this Free **"BOOK OF FACTS"**

It gives full details concerning all Courses.

**THE CANDLER SYSTEM CO.,**  
(Room 55W), 121 Kingsway, London, W.C.2  
Candler System Co., Denver, Colorado, U.S.A.

NOTE.—From AUG 2nd to 11th. London Office CLOSED

**COOK,** of Christchurch.—Clearance sale. C line-cord, components, chassis, at pre-war prices; T.R.F. kits still available at £6; superhets ready shortly, details on request.—Cook, Old Barn Rd., Christchurch, Hants. [8000

**SOUTHERN RADIO'S** wireless bargains:—Portable T1333 transmitters, brand new, complete, crystal, 2 valves, aerial, hand generator, in original packing, 55/-, carriage and packing 5/6. Latest radio publications: Radio valve manual of British and American Types, 3/6; Radio Circuits, fully descriptive, receivers, power packs and transmitters 2/-; Amplifiers, 2/-; Coil and Transformer manual, 2/-; Short wave handbook, 2/-; Direct Disc recording manual, 2/-; Test Gear construction, 1/6; Radio Pocket book, 1/-; Television constructors manual, 3/6; Radio Aerial Handbook, 2/6; Ultra Short Wave Handbook, 2/6; Radio Hints manual, 2/6; 10 hours for radio constructors, 1/-; Bulgin Radio Service manual, 2/6; Radio Constructors manual, 3/-; Radio resistors, colour code at a flick chart, 1/-; Radio Reference Handbook, cloth bound, very comprehensive, 12/6; American Service manual's, Sparta-Emerson Crosley-Belmont (parts 1 and 2); Stewart-Warner-Fada, 12/6 per volume, postage extra. Ex-Govt. motor generators, brand new, type 10KB/21, input 12v, output 480v, 40ma D.C., 17/6 ea., plus 2/6 postage; type "F," 28v input, 1,280v output, 72ma D.C., 25/-, plus 2/6 postage; Yaxley type rotary switches, 2-way, 5/-; permanent crystal detectors, 2/6 ea.; aluminium panels, 16 gauge, 18x7in, 3/6; Cutler Harmer rheostats, 30 ohms and 10 ohms, 4/6; ex-service morse keys and buzzers, 1/6 ea. (15/- per dozen), brand new; Westectors, type WX6 and W112, 1/- ea. (10/- doz.); Lufbra adjustable hole cutters, cut metal, wood or plastic; 5/-, plus postage. **SOUTHERN RADIO SUPPLY Co.,** 46, Lisle St., London, W.C.2. [7805

**ROTARY** transformers, brand new, ex Govt. stock, suitable for car radios, mobile amplifiers, country house receivers, etc., solid frame with fixing feet; these transformers can be utilised for 6 or 12volt input, and will give with 6v input, output of 200v at 50ma for continuous operation, 150v at 80ma for periods up to 3 hours, or with 12v input, output of 480v at 40ma, continuous operation, 400v at 80ma periods up to 3 hours, size 7 1/2in x 3 1/4in, weight 6 1/2lb, original price £7/7, each 25/-; midlet m. wave, t.r.f. coils, high gain, 5/-; m.l. wave with reaction, circuit, 7/6; m.l. wave, iron core, adjustable cores, circuit, 10/6; a.m.l. ear. and osc. coils, circuit, 10/6; Weymouth midlet i.f.s. iron core, 465kc/s, per pr. 18/9; standard i.f.s. 465kc/s, per pr. 15/-; standard ditto, 2mc/s, each 3/6; Weymouth all-wave coil pack, 36/6; 2-gang condensers, 0.0005mfd, 12/6; ditto 0.0001mfd, 10/6; 3-gang 0.0001mfd, 12/6; 2-gang 0.00017mfd, split stator, 6/-; Tiny Tim 2-gang, fitted trimmers and perspex dust cover, 2in x 1 1/2in x 1 1/2in, 17/6; speakers, minus trans., p.m. 5in. 21/-; ditto p.m. 6in, 27/-; coloured ivoryine dials, a.m.l. wave, 4x3 1/2in, 2/-; ditto 5x5 1/2in, 2/6; celluloid m.l. wave, 5x5in, 1/6; slow motion drum drive, 3/-; epicycle drive, 3/3; square plane, m.l. drive assembly, with escutcheon, drive, glass, pointer, etc., 11/6; full vision 8ML wave drive assembly, with drive, dial, glass, escutcheon, etc., 12/6; Rothermel Senior piezo crystal pick-ups, 56/3; ditto, 8.8, at 52/6; pocket voltmeters, 0.5v-0.25v, 12/6; relays, 400ohms d.p.d.t., 3/-; plywood sheets, for backs, cabinets, etc., 22x14 1/4x 1/4in, 2/6; Avo capacity bridge, 2/-; condensers, 8x8mfd 500v, 7/6; 25mfd 25v, 2/6; 50mfd 12v, 2/-; 4mfd 1,000v, 7/6; 2mfd 1,000v, 3/-; 4mfd 100v, 9d.; line cord, 3-way, 0.3amp, yd 3/-; ditto 2-way, yd 2/-; Stanelco soldering irons, 200-240v, 19/6; mains droppers, 0.3amp 800ohms, 5/6; 0.2amp 1,000ohms, 4/6; 0.3amp 600ohms, 4/-; Bernards publication stockist, Television Constructor's Manual, 3/6, etc.; transformers, chokes, trimmers, etc., etc., comprehensive lists monthly; 2/6d. stamp enquiries; postage extra all orders.

**GREENLICK, Ltd.,** 34, Bancroft Rd., Cambridge Heath Rd., London, E.1. Tel. Stepney Green 1334. [7866

**WANTED, EXCHANGE, ETC.**

**SERVICE** sheets wanted for pre-war receivers. -12b, Uxbridge Rd., Kingston. [7902

**URGENTLY** wanted, "W.W." Nov. and Dec. 1946, Feb. 1947.—Box 1072. [7956

**WANTED,** quantity ex-Gov. EF36 valves.—N.R.S., 66, Parkhill Rd., London, N.W.3.

**WANTED,** electric gramophone motor, self-change preferred.—Roundwood, Tudor Close, Banstead, Surrey. [7948

**WANTED,** set of new or used correspondence courses for 1st class P.M.G. and 2nd class P.M.G., must be comprehensive and detailed.—Box 1009. [7876

**WANTED,** a number of pre-selector tuning mechanisms as fitted R.A.F. transmitter types 1154H, 1154M, 1154N; pay 10/- each if good condition.—Box 208. [7741

## These Cases



Electric Fire

A case which merely houses its contents is doing only half a job. We specialise in building cases that do a selling job as well.

## Make



Radio Cabinet

We can develop and style an individual modern case, exclusive to you, or work to rigid specifications, or supply standard cases from stock.

## Sales!

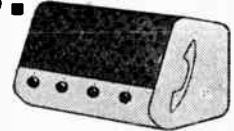

Amplifier Case

We use only materials of the finest quality. And we guarantee to deliver every order on time. Send today for free booklet.

# IMHOF'S

**PRECISION-BUILT INSTRUMENT CASES**

**ALFRED IMHOF, Ltd.,**

112, New Oxford Street, London, W.C.1.

Museum 5944.

### THESE ARE IN STOCK

**Radior Engineering**, by Donald G. Fink, 35s. Postage 9d.  
**Modern Radio Servicing**, by A. A. Ghirardi, 35s. Postage 10d.  
**Radio Engineering**, by F. E. Terman. 30s. Postage 9d.  
**Radio Upkeep and Repairs**, by A. T. Witty. 7s. 6d. Postage 5d.  
**Practical Wireless Circuits**, by F. J. Camm, 6s. Postage 4d.  
**Radio Engineer's Pocket Book**, by F. J. Camm, 3s. 6d. Postage 3d.  
**Television Receiving Equipment**, by W. T. Cocking, 12s. 6d. Postage 6d.  
**Radio Engineering Handbook**, by Keith Henney, 30s. Postage 8s.  
**Frequency Modulation**, by August Hund, 22s. 6d. Postage 9d.  
**Time Bases**, by O. S. Puckle, 16s. Postage 5d.  
**Radio Tube Vade Mecum**, by P. H. Brans, 12s. 6d. Postage 6d.  
**Thermionic Valve Circuits**, by E. Williams, 12s. 6d. Postage 6d.  
**The Wireless World Valve Data**, 2s. Postage 2d.

### THE MODERN BOOK CO.

(Dept. W.25), 19-21, Praed St., London, W.2.

Our original post-war plans have met many man-made setbacks.



**REVISED PLANS** are evolving. Please don't write, phone, or call. We will advise when ready.

### VOIGT PATENTS LTD.

## LONDEX for RELAYS



for A.C. and D.C.  
 2 VA Coil consumption from 2 to 600 volts and tested to 2000 volts, Aerial Changeover Relays, Mercury Relays, Measuring Relays and Time Delay Relays.

Multiple contact Relay LF      Ask for leaflet: RE/JWW

### LONDEX LTD

MANUFACTURERS OF RELAYS  
 207 ANERLEY ROAD · LONDON · S.E.20      SYDNEY 6258-9

## CALLING AMATEURS with BUGCLEUGH

### PRECISION BUILT EQUIPMENT



**STEEL CHASSIS SMOOTH BLACK**  
 17 1/2" x 10 1/2" x 2 1/2" 9/9, 17" x 10" x 2"-8/9  
**PANELS-CRACKLE**  
 19" x 3 1/2" -4/-, 19" x 7" -6/9,  
 19" x 8 1/2" -7/9, 19" x 10 1/2" -8/9  
**ANGLE BRACKETS** ... 12 1/2" long pair 7/6  
 (All in Bright Aluminium, same cost.)  
**COMPLETE RACK ASSEMBLY**  
 (Rigid 4-Pillar) 63"-83/5s  
**CHASSIS, etc., TO ORDER** at 1/4 sq. inch. (Include slides when costing).  
**PUNCHING CHARGES UP TO 1 1/2"-2d**  
**VALVE HOLES 1", 1 1/8" or 1 1/4"-8d**  
**METER HOLES, etc. 1/6**  
**SQUARE HOLES-2/-**

**BUGCLEUGH RADIO MANUFACTURERS**  
 1 & 2 MELVILLE TERRACE, EDINBURGH, 9  
 \*Grams: "Therm", Edinburgh.  
 Factory: Wheatfield St., Edinburgh.

S.O.S. amateurs. Urgent, wanted, Colvern, Colpack, or coil set for bandpass.—S. James, 2, Carnarvon Rd., Barnet, Herts. [7978]

**WANTED**, "Wireless World", all issues 1940 to 1945 inclusive; "Wireless Engineer," ditto, 1939 to 1945; "Electronic Engineering," ditto, 1942 to 1946; good condition, suitable for binding essential.—Box 1073.

**WE** buy for cash, new, used, radio, electrical equipment, all types; especially wanted, radios, radiograms, test equipment, motors, chargers, recording gear, etc.—If you want to sell at the maximum price, call write of 'phone to University Radio, Ltd., 22, Lisle St., Leicester Sq., W.C.2, Ger. 4447.

### REPAIRS AND SERVICE

**MAINS** transformers rewound, new transformers to any specification.

**MOTOR** rewinds and complete overhauls; first-class workmanship, fully guaranteed.

**F. M. ELECTRIC CO., Ltd.**, Potters Bldgs., Warser Gate, Nottingham, Est. 1917 Tel. 3855

**MAINS** transformer rewound and constructed to any specification; prompt delivery.—Brown, S. Bede Burn Ltd., Jarrow, 3460

**LOUDSPEAKER** repairs, British, American, Lany make, moderate prices.—Sinclair Speakers, 12, Pembroke St., London, N.1. Terminus 4355. [3308]

**LOUDSPEAKERS** repaired; transformers, clock coils, chokes, rewound; prompt attention; prices quoted.—E. Mason, 5, Balham Grove, Balham, London, S.W. [7667]

**ELECTRICAL** measuring instruments skillfully repaired and recalibrated.—Electrical Instrument Repair Service, 329, Kilburn Lane, London, W.9. Tel. Lad. 4168. [6935]

**PICK-UPS**, replacement coils for Garrard type, etc.; 5/3; trade enquiries invited.—Radiocrafts, 10, Goodmayes Rd., Goodmayes, Essex. Tel. Seven Kings 4557. [7919]

**SERVICE** with a Smile.—Repairers of all types of British and American receivers; coil rewinds; American valves, spares, line cord.—F.R.I. Ltd., 22, Howland St., W.15 Museum 5675. [1575]

**REPAIRS** to moving coil speakers, cones, R coils fitted, field rewound or altered; speaker transformers, clock coils rewound. guaranteed satisfaction, prompt service; no mains trans. accepted.

**L.S. REPAIR SERVICE**, 49, Trinity Rd., Upper Tooting, London, S.W.17. [4819]

**LOUDSPEAKER** and transformer repairs "almost by return of post"; we offer the quickest service in the trade, competitive prices.—A.W.F. Radio Products, Ltd., Borough Mills, Bradford, Yorks. [7167]

**STURDY** rewinds, mains transformers, chokes and fields; we give prompt delivery and guarantee satisfaction; 14 years' experience; prices on request.—Sturdy Electric Co., Ltd., Dipton, Newcastle-on-Tyne. [4316]

**LOUDSPEAKER** repairs, any make, reasonable prices, prompt delivery, to the trade and quality fans; 25 years' combined experience with Rola, Magnavox, Goodmans, Celebration.—Sound Service Radio, 80, Richmond Rd., Kingston-on-Thames, Kin. 8008. [4977]

**REWINDS**, mains transformers, speaker field coil, chokes, high-grade workmanship, 7-day delivery; new transformers constructed to customers' specification, singly or in quantities.—Metropolitan Radio Service Co., 1021, Finchley Rd., N.W.11, Speedwell 3000. [3719]

**24 HOUR** service, 6 months' guarantee, any transformer rewind, mains outputs and i.f.s., etc., all types of new trans., etc., supplied to specification; business heading or service card for trade prices.—Majestic Wind ing Co., 180, Windham Rd., Bournemouth.

**REWINDS**, mains transformers layer rewound wax impregnated, O/P transformers, chokes, fields, clock coils, pick-ups, fractional hp motors, competitive prices, prompt delivery; guaranteed work.—W. Groves, Manufacturing Electrical Engineer, 154, Icknield Port Rd., Birmingham, 16. [4547]

**TRANSFORMERS**, chokes, etc., of every description rewound, quick service; all rewinds carefully tested on elaborate test equipment before despatch; new transformers to any spec. "Wireless World" transformers a speciality.—Radio & Transformer Services, Manchester Rd., Hollinwood, Tel. Fai. 2507.

**LOUDSPEAKER** repairs.—L. Cottenham for your loudspeaker repairs at keen competitive prices; all types repaired; field coils fitted or rewound to any resistance; quick service and guaranteed satisfaction; send to L. Cottenham, loudspeaker repair factory, Whetley Lane, Bradford, Yorks. Your enquiries will receive immediate attention. [7377]

**NATIONAL RADIO SERVICE & TELEVISION CO.**—Trade service engineers; immediate service any district; rewinds to all types transformers, armatures, motors, loudspeaker cones, speech coils fitted, British and American components and valves; enquiries invited for contract trade service; multiple transformer winding.—63, High St., St. John's Wool N.W.8 Primrose 6725 [6752]

## 100 kcs. QUARTZ CRYSTAL UNIT Type Q5/100



**for Secondary Frequency Standards**

★ Accuracy better than 0.01%. ★ New angles of cut give a temperature coefficient of 2 parts in a million per degree Centigrade temperature change. ★ Vitreous silver electrodes fired direct on to the faces of the crystal itself, giving permanence of calibration. ★ Simple single valve circuit gives strong harmonics at 100 kcs. intervals up to 20 Mcs. ★ Octal based mount of compact dimensions. PRICE 45/- Post Free

Full details of the Q5/100, including circuit, are contained in our leaflet Q1. Send stamp-to-day for your copy

### THE QUARTZ CRYSTAL Co., Ltd.

63-71 Kingston Road, NEW MALDEN, SURREY  
 Telephone: MALden 0334

## Beethoven ROTARY CONVERTORS

220 D.C. to 220 A.C.

Details from—  
**BEETHOVEN ELECTRIC EQUIPMENT LTD.**  
 Beethoven Works, Chase Road London, N.W.10

## L-R-S DELIVERY from STOCK

**AVOMETER Model 7** ... £19 10 0  
 (Carr. and packing 2/6 extra)

**Avominer DC Test Meters** ... ... 4 Gns  
**Avominer AC/DC Test Meters** ... £8 10 0  
 \*Plus 1/- Regd. post and supplied on Easy Terms if desired.

**Stuart Centrifugal Electric Pumps**  
 for all pumping purposes, garden fountains, etc.  
 No. 10. 100 galls. p.h. ... .. £5 10 0  
 No. 11. 300 " " " " " " " " £6 10 0  
 Inc. foot valve and strainer, carr. paid. STUART adjustable fountain jet, 5/3.

**Morphy Richards Gylodon Door Chimes** ... 49/6  
 Post Free.

**The LONDON RADIO SUPPLY Co**  
 (The L.R. Supply Co. Ltd.) Est. 1925  
**BALCOMBE SUSSEX**

## POST-WAR TELEVISION

The advanced Radio Technique offers unlimited opportunities of high pay and secure posts for those Radio Engineers who have had the foresight to become technically qualified. How you can do this quickly and easily in your spare time is fully explained in our unique handbook.

Full details are given of A.M.I.E.E., A.M.Brit.I.R.E. City & Guilds Exams., and particulars of up-to-date courses in Wireless Engineering, Radio Servicing, Short Waves Television, Mathematics, etc., etc.

**We Guarantee "NO PASS—NO FEE"**

Prepare for to-morrow's opportunities and post-war competition by sending for your copy of this very informative 112-page guide NOW—FREE

**BRITISH INSTITUTE OF ENGINEERING TECHNOLOGY (Dept. 388)**  
 17, Stratford Place, London, W.1

**M.O.S.**  
announce the release of the  
**BURGOYNE**  
**AERIAL COAXIAL CONNECTOR**

PRICE  
**24/6**

This new Coaxial Cable Connector provides both commercial and amateur users with a means of making efficient watertight coaxial cable connections for aerials. It also serves as a centre insulator for a half wave doublet.

The Burgoyne Connector is made of aluminium with stearite insulation, and has two forged steel eyebolts equipped with convenient soldering connections. A bottle of weatherproof cement with a piece of 1/4 in. outside diameter rubber tubing, plus the necessary assembly screws, are supplied with each connector. The assembled connector weighs only 12 ounces.

Amateurs, and all listeners requiring perfect reception will welcome the Burgoyne Connector because it eliminates the necessity for crude, inefficient coaxial cable connections, thus saving them time and trouble due to the inroads of weather on home-made connections. Professional operators will find that it provides a quick, well-engineered means of doing an essential job.

**TRADE ENQUIRIES INVITED**  
Sole Distributors for the U.K.:  
**MAIL ORDER SUPPLY CO.**  
24, New Road, London, E.1.  
Stepney Green 2780, 3908.  
Send 2d. stamp for Illustrated Catalogue.

**HILL & CHURCHILL LTD.**  
**BOOKSELLERS**  
**SWANAGE, DORSET.**

Available from Stock:—

Fink	"Principles of Television Engineering" . . . . .	27/6
Emery	"Ultra-High-Frequency Radio Engineering" . . . . .	18/-
Laur, Lesnick, Matson	"Servomechanism Fundamentals" . . . . .	17/6
Brillouin	"Wave Propagation in Periodic Structures" . . . . .	20/-
MacColl	"Servomechanisms" . . . . .	12/6
Smith	"Applied Mathematics for Radio and Communication Engineers" . . . . .	17/6
Nelkon	"Physics and Radio" . . . . .	8/6
Jackson	"High Frequency Transmission Lines" . . . . .	6/-

Postage extra.

**We have a large selection of English and American Books on RADIO and TELECOMMUNICATION**

**CATALOGUE ON APPLICATION**

**COIL** specialists.—Tuning and oscillator coils, I.F., L.F., and mains transformers, chokes, etc., rewound and wound to specification; speaker repairs.—Electronic Services (R.T.R.A. Service Section), Arwenack St., Falmouth.

**DEGALLIER'S, Ltd.**—Service with a guarantee. If you cannot get your receiver serviced, let American specialists do the job; first-class workmanship only; specialising in Air-King, Belmont, Challenger, Delco, Detroit, de Wald, Emerson, Ferguson, Garod, Hammerlund, Hallcraft, Lucille, McMurdo Silver, Midwest, Majestic, Pilot, Philco, Scott, Spartan, Zenith, I.C.A., etc., also any British set; due to lack of accommodation our service branches are still dispersed; therefore apply for forwarding instructions before despatching sets; s.a.e. with all enquiries.—Degallier's, Ltd., BCM/DEGS, London, W.C.1. [8043]

**MISCELLANEOUS**  
W.W., Nov. 1942-Dec. 1946; 50/-—Hawkins, 45, St. Leonards Rd., Exeter. [7889]

**RECORD** cabinet, mahog., holds about 250; £20.—Siggers, Copse Edge, Coronation Rd., South Ascot, Berks. [7910]

**TIME** Recorders.—Write for particulars.—Gledhill Brook Time Recorders, Ltd., s-Fmrite Works, Huddersfield. [72419]

**SPARKS'** data sheets offer the widest range of tested and guaranteed designs, in full-size data sheet form, obtainable in this country.

**TINY** Two, just released, a 2-valve all-dry self-contained portable, med. waves.

**DESIGNED** for individual listening to local stations on speaker, size 5 1/2 x 5 1/2 x 5 1/4 in, 18-volt HT; 2/6.

**THREE-VALVE** all-dry portable, m/1 waves, 9x6x4 in, a most popular set; 2/6. Send a stamp for full list (W).

**SPARKS' Data Sheets (W)**, 9, Phoebe Rd., Brockley, S.E.4. Tel. Lee Green 0220. [6569]

**MIDGET** set cabinets, inside 10 1/2 in x 5 1/2 in, enamelled unit colours, with speaker fret, no dial cut out; 12/6 post free.—Morris, 9, Wicklow Ave., Stockport. [7983]

**WE** can supply ex stock some 7 or 8 different patterns iron dust cores; please send us your sample for our quotation.—John Downton & Co., 89, High St., Epping. Tel. 2163. [7709]

**ALUMINIUM** chassis and panels from 3/9, prompt delivery, any size, plain or punched; also supplied black crackle or cellulose finish.—Mead, 13, Bence Lane, Darton, Barnsley, Yorks. [7884]

**CIRCUIT** diagrams (individual designs) to order; query service, a half-a-crown (if no diagram involved); drawings and tracings from your sketches prepared; chassis built.—R. G. Young, 3a, Bridges Rd., Wimbledon.

**To clear** 100ft reels stranded bronze aerial wire, with clips; usual price 4/6, our price 2/3, post 8d.—Marble Arch Motor Supplies, Ltd., Head Office and Showrooms, 286-302, Camberwell Rd., S.E.5 (Rod, 2181), and at all branches. [7485]

**THE** set you have been waiting for. Dorset 4-valve all-dry portable (superhet), medium and long wave, new MSS: 4 sheets clear-cut drawings, 6 "How to do it" photos, point to point wiring instructions and parts list; price 3/6 post free.

**HOT Spot** (no electric mains) soldering outfit, 5/6; other Dorset circuits. 5-valve a.c., l. m. and s. wave superhet, also a.c./d.c. model, 4-valve all-dry battery superhet, 6-8 watt a.c./d.c. amplifier, 2/6 each, theoretical circuit of sets with price list, 2/4d. each.

**WELDONA RADIO ACCESSORIES, Ltd.**, 49, North St., Portlaine, Sussex. [7758]

**FOR** sale, P.V.C. sheathed cables, screened copper wire braided and polythene core, conductors from 1/0.022 to 7/0.032; also lead sheathed solid polythene with single conductors and semi-air-spaced poly. spider copper wire braided and P.V.C. sheathed, large quantities, new condition.—Box 206. [7735]

**TRANSPARENT** boxes for superior display and super salesmanship, made by Unicorn Mills, Ltd., 165, Tottenham Lane, London, N.8.

**WE** are equipped with the most modern machinery for manufacture of these boxes and are therefore able to give keen quotations combined with good service.

**AMERICAN** magazines are now available by annual subscription; post free for one year, F.M. and Television, 30/-; Radio Craft, 16/6; Q.S.T., 21/6; C.Q. (Radio Amateurs Mag.), 18/6; Radio Maintenance, 18/-.—For list of other magazines obtainable, send s.a.e. to Dept. W.W., Willen, Ltd., 120, St. George's Rd., London, E.10. [7452]

**BUILD** your own 1947 super quality radiogram at a fraction of the price asked for second-hand goods; we can supply a first class walnut veneered cabinet, beautifully designed and constructed; also a 5-valve universal 3-wave radio chassis and Colluro induction radiogram unit, assembly takes one hour; price 42gns., carriage paid.—Radio Unlimited, 16 Carnarvon Rd., Leyton [7943]

**BULLS**

means if you need VALVES it is logical to think of **BULLS**. Despite price increase for Valves **BULLS** are selling, stock permitting, at old prices, British and American from 5/10.

**RADIO VALVES:** British and American, from 5/10 All at official List Prices, not increased since 1940

**BRITMAE.**—1D6, 5B/250A, 6B6, 6G8, 6K6, 6K7, 6B7, 6S7, 6S7, 6T7, 6V8, 7B5, 7B7, 7B8, 7C6, 7D6, 7Y4, 8D2, 9D2, 10D1, 11D3, 11D6, 12BR7, 252A, 252B, 252C

**COSSOR.**—4TP8, 4T8P, 138PA, 41MP, 41MPT, 42 OT-DD, 42PTB, 203THA, 210DG, 210LF, 2200T, 220P, 220PA, 807, DDLA, MP/PEN, MS/PEN, MS/PEN B, MVB/PEN, OMA, OMC, OMP, PT10, 13VA, 41MHL, 418TH, 42PTB, 202VPE, 210DDT, 2156G, 220HPT

**HIVAC.**—XD1, XH, XL, XP, XSG

**MARCONI/OSRAM.**—CRT-E4109/B7, D41, D42, D63, DA30, DL63, DL74M, DN41, GTIC, GU50, H30, H63, HAZ, HD24, HL2, KT2, KT41, KT44, KT61, KT63, KT66, KT74, KTW61, KTW63, KTZ41, KTZ63, KTZ73M, L63, LP2, MH41, MIA, M84B, M93B, N14, P2, PK25, QP21, S23, U10, U17, U18/20, U31, U50, U62, U74, VM24, VM34B, W31, X41, X61M, X65, X71M, Y63, DQ2, DS, H12K, L2B, L55B, MKT4, U28, Z22, 301, 302, 303, 304

**MAZDA.**—AC2PenDD, AC6pen, AC6penDD, AC6pen, AC7P, AC7P, AC7H, AC7V1, D1, D1D207, D1H42D, H121DD, H123, H123DD, H141, H141DD, H142DD, H133DD, H14DD1320, P41, Pen 26, Pen 45DD, Pen 48, Pen 383, Pen 453D, E Pen DD4020, QP25, QP230, 80915, 8P41, 8P2220, T141, TF232, TH2321, TP22, TP26, TP26, TP2620, UC6, U17, Y914, YP23, VP41, VP133, VP132, DCP, DC8G, DD14, DD101, H210, PEN383, UY6300

**MULLARD.**—2D4A, 2D18C, 5Y3, 6C5, 6D6, 6J7, 6L6, 6Q7, 6R7, 6A4V, AZ1, AZ31, CCH35, CY1, 1F61, DL35, DQ25, DQ30, D1030, D1030, E834, EBC3, EBC35, EOC32, EOC31, ECH35, EFP, EFP3, EF80, EF84, EL2, EL3, EL33, EL35, EL38, EM34, EM36, FW4600, HL3c, 1W4/500, KBC32, KF35, K23C, K135, Pen4VA, Pen428, Pen4A, PM2, PM2EL, PM4DX, PM2M, PM202, QP22B, SP4, 4P48, SP13, TD, TD2A, TD113c, TE4B, TE61C, TH50C, TT4, U52, VP4, VP4A, VP18A, DF33, DM4/850, EOC32, EP22 EL36, EL50, HVR2, HVR2A, PW42D, PM5B, PM2A, PM22D, SP13c, UY31, 5U4

**PHILLIPS.**—C1, C1C, 328, 329, 340, 387, 452, 1012, 1028, 1150, 1561, 1729, 1738, 1821, 1916, 905, 1914, 1920, 1926, 2050

**TUNGSRAM.**—5X4, 6B8, 6J5, 6V6, 6X5, 6Y5, 6Y6, 807, APP4C, APP4G, DD13, DD18, ECH2, EFP2, EH2, EL5, EL11, EM4, EZ4, HL11, HP13, HP1018, HP1118, HP2018, HP2118, HP4106, HR210, MH118, LD210, LL28, PM2018, PFC8, SP228, SP48, SP48, 88210, VP48, H14, HP211C, LL4, LP220

**AMERICAN.**—02A, 1A8, 1C5, 1D7, 1E5, 1E7, 1F4, 1F5, 1F6, 1F7, 1G6, 1H5, 1H6, 1J6, LC5, 1LNS, 1NS, 184, 185, 1T4, 1T5, 2A6, 2A7, 2B6, 2B7, 5U4, 6V4, 5Y3, 5Z3, 5Z4, 6A4, 6A6, 6AE5, 6AE8, 6AG6, 6B7, 6B8, 6C3, 6X8, 6D5, 6D6, 6E6, 6F6, 6G7, 6G6, 6H6, 6J6, 6T7, 6J6, 6K5, 6K6, 6K7, 6K8, 12K7, 6L5, 6L6, 6L7, 6N7, 6Q7, 6P6, 6R7, 6S47, 6R7, 6R7, 6R7, 6R7, 6S7, 6T7, 6V6, 6X5, 6Y5, 7A6, 7A7, 7B5, 7B6, 7B7, 7B8, 7C5, 7C6, 7H7, 7Y4, 10, 12A, 12A5, 12A6, 12B7, 12J5, 12K8, 12Q7, 12SR7, 12Z5, 14A7, 15, 17, 20, 22, 25Y5, 25Z4, 31, 32, 33, 34, 3Z5, 37, 38, 46, 48, 49, 50, 53, 55, 57, 59, 71A, 77, 78, 80, 81, 83, 89, 907, 954, 955, 956, 11Z20, 1259A, 9001, 9002, 9003, 9004, 9005

**Further types just in**  
CL33, CY1C, CY31, DL33, ECC36, EF5, EP9, EP37, FC13, FC13C, KT33C, KT71, PenB4, 8130, 8P13C, U18, U403, VHTA, VP2B, VP41, VP41, 150/30, X76M, XY, 1LH4, 3B7/1291, 6A3, 6AC7/1852, 6AB7/1853, 6AG5, 6AG7, 6AK5, 6B4, 6C4, 6C8, 6E7, 6F8, 6H7, 6H7, 6Z5, 1226, 7C7, 7Q7, 12C8, 128Q7, 12S7, 128K7, 128N7, 128Q7, 25Y5, 25Z5, 26, 29, 30, 37, 39/44, 414, 42, 43, 76, 84, 813, 806A, 1625, 1626, and 101 more types.

Order C.O.D. above listed numbers or equivalents (subject to stock). Please enquire for any valve you require, even if not listed. We may have it. Old and new types are arriving daily.

**THIS MONTH'S SPECIALS:**  
"Radio Receiver Servicing and Maintenance" Book, with handy fault-finding summary, 8/6.  
"Radio Upkeep and Repair", 7/6  
Midget Speakers, 2inch, works the MCR1, also as extension, 7/6.  
Brimar Metal Rectifier SBE, o brimarine 12A7, 9/-.  
Ex-A.M. Indicator, 6c. CR. Unit, 24/10/-.  
Chassis Cutters, 1 1/2 in, 12/6, 1 1/2 inch 10/6.  
Electric Fans, 12in. blades, 15/10/-, 7in. blades, 25/12/6.  
Midget Hydrometers, ball type, 2/9.  
Alert! Car Alarm, protects car and contents, 27/10/-

**STOP PRESS:** Car Radio Superhet of excellent reproduction, complete £19 4 6

**BULL** & SONS (WV)  
246, High St.,  
Harlesden,  
N.W.10

**WAVEBAND COVERAGE**

**12.5-2000 metres**

**OBTAINED WITH OUR DC COILS**

For further details ask your dealer. Please note that all components are available through trade channels only.

**ENQUIRIES INVITED FROM MANUFACTURERS**

**WEYMOUTH RADIO MFG. CO.**  
Phone **CRESCENT WORKS,**  
701/2  
Grams 'Weyrad' **WEYMOUTH**

**EDDYSTONE '640'**

We are now booking orders for this first-class communications receiver. Demonstration model on view at our Show Room.

EDDYSTONE '504' in stock.

52 Page Catalogue of Components & Accessories 1/- Post Paid.

**B.T.S.**

The Radio Firm of the South.  
**63, London Road, Brighton 1, Sussex.**

**VALVES AVAILABLE**

At B.O.T. prices, British and American, these are only a selection of our 10,000 valves held in stock. Please send for our comprehensive Valves Available List, free, enclosing S.A.E. for reply. Postage 6d. extra. C.W.O. or C.O.D.

Mullard.—DF33, DL33, DL35, KK32, KF35, KBC32, KL35, VP2B, SP2, FM12M, TDD2A, PM2HL, PM2A, PM202, QP22B, EM4, EM35, EC35, EF6, EF29, EF36, EF37, EF50, EF54, EC31, EB34, EBC3, EBC33, EOC31, EOC32, EL2, EL32, EL3, EL33, EL35, EL50, FQ9AM, TH4B, VP4, SP4, SP4B, 2D4A, 3D4V, 164V, PenA4, PenB4, Pen4DD, FC13C, VP13C, SP13, SP13C, 2D13C, HL13C, CBL31, DW4360, CY1, CY31, AZ1, AZ31.

Brimar.—20D2, 15D2, 11D3, 11D5, 10D1, 9A1, 8A1, 8D2, 7D3, 4D1, 7A2, 1LA4, 1LH4, 7A7, 7B5, 7B6, 7B7, 7B8, 7C3, 7C8, 7C7, 7Y4, 1B, 1B, 2A4, 2B, 2T, 31, 32, 34, 42, 43, 46, 71, 75, 76, 77, 78, 79, 80, 83, 84, 89, 2103, 2A8, 2B7, 1N6, 5V4, 5Z4, 5Y3, 6A06, 6A8, 6B8, 6C5, 6F6, 6H6, 6J5, 6J7, 6K7, 6K8, 6L6, 6N7, 6Q7, 68N7, 6U7, 5V6, 6X5, 6L7, 6C6, 6D6, 6C8, 6B7, 608, 6K6, 6F8, 6J8, 6P8, 25Z4, 35Z3, 35Z5, 35L6, 35Z4, 80L6, 8A87, 12A8, 13L5, 12Q7, 12K3, 12E87, 12K7, 12J7, 12F5, 11Z6.

Mansia.—V914, DD41, DD207, DD6020, HL2, HL23, AC/HL, AC/2HL, HL41, AC/P, HL1320, HL133, 8G216, AC/8GV16, SP141, SP210, VP210, VP23, AC/VP1, VP41, SP41, SP42, VP133, TP22, TP23, TP25, TP26, AC/TH1, TH41, TP220, TP2321, TH233, AC/HLDD, HL/DD1320, Pen25, QP230, QP25, AC/Pen, AC2/PenDD, AC3/PenDD, Pen44, Pen45, Pen45DD, Pen46, Pen383, PenDD4040, Pen45DD, U08, U07, U08, U403, U31, U22, T41, Osmar.—U74, U59, U50, U31, U14, U10, H50, K774, DL74, KT98, KT93, KT61, DL63, DH63, D63, L63, H63, KT63, KT63, KT61, X65, X63, X61, DA30, FX25.

**H. RANSOM**

34, Bond Street, Brighton Phone: Brighton 5603

FOR sale, big surplus stocks of laminated plastic material, bakelite, Keramol, fibre in sheets, tubes, rods, blocks in various sizes; all material in new condition.—Please enquire at Rubber Raw Material, Ltd., Rubber House, Bloemfontein Avenue, London, W.12. [8067]

**WORK WANTED**

**J. CANTER (B. G.), Ltd.**, 216, Hackney Rd., E.2.—Now in the position to manufacture radio cabinets, etc., for holders of export licences. [7809]

**CAPACITY** available for radio and instrument assembly; facilities for stoving, sheet metal work, testing; keen quotations for sub-contracts.—Box 43. [7840]

**WE** make wireless and radiogram cabinets for home and export; immediate deliveries.—Radiac, Ltd., 26, Brondesbury Rd., London, N.W.6. Maida Vale 8792. [8025]

**CAPACITY** available press tools, plastic moulds, jigs and fixtures; production, 5% in capstan capacity.—Blair Tool Products, 112, Greyhound Lane, Streatham, S.W.16. [7959]

**QUALITY enthusiasts!** Have that new high fidelity set you are contemplating designed and/or built by specialist; all types of apparatus built to requirements.—Write for quotation to BCM/HIFI, London, W.C.1.

**CALLING all Hams!** Let us record your call sign, double-sided 10in record £2/1. copies 14/-; can be recorded personally or send script.—C.B. Recording Studios, 141, Park Rd., Baker St., London, N.W.8. Pri. 0153.

**ENGRAVING.**—Precision instrument firm in West London can undertake specialized machine engraving of knobs, dials, tapers or sundry components; excellent delivery on small quantities.—Write Box 1641, c/o Charles Barker & Sons, Ltd., 31, Budge Row, E.C.4.

**DRAWING** and tracing work for radio and electrical engineering, jig and tool and light engineering, photoprinting; full sets of drawings undertaken to commercial or Ministry standards.—Drawing & Tracing, Ltd., 456a, Ewell Rd., Tolworth, Surbiton. Phone Elmbridge 7405. [7703]

**TELEVISION** aerial installations and aerial maintenance, full range of antennas supplied and/or installed by experts; removals and re-erectations arranged; our pre-war Trade Service Dept. is now open.—Brochures from Walsey Television, Ltd., 87, Brixton Hill, S.W.2. Tulse Hill 1240. [7320]

**ALUMINIUM** sheet, 14.24 gauge, cut to required dimensions, 1/6 to 5/- per square foot; chassis made to specification; aluminium gauze, 1/4 per square foot, 50 square feet 50/-; aluminium hinges, 1/2 in closed, in lengths 3in-5 feet, one penny per inch.—W. Baker, Market Place, Irthlingborough, Wellingborough.

**BUSINESSES FOR SALE OR WANTED**  
**RADIO/ELEC.** N. London, sales/repairs; £1,500 plus stock; fine d.f. shop and 2 rooms, annual t.o. £3,475 (certified), excellent chance expansion; principals only.—Box 964.

**RADIO,** television, records and musical instruments; flourishing business for sale in N.W. London, showing profit £3,000 p.a., large premises in prominent position at low rent, held on long lease; price £10,000 all in, except s.a.v.—Principals only need apply to Box 1071. [7955]

**BUSINESS OPPORTUNITIES**

**WANTED,** Olympia exhibitor, to collaborate in marketing new device.—Box 1398.

**CAPITAL.**—Clients with £2,000 to £10,000 each for investment, want active or non-active partnerships in new or established businesses; proofs available of large volume of capital invested by clients.—Box 1312. [7986]

**PIPE** for immediate expansion, correspondence and day school, technical subjects, established 7 years, reputation unsurpassed; about £10,000 including excellent premises or consider dynamic partnership.—Box 1407.

**SITUATIONS VACANT**

**EXPERIENCED** service engineer req., Cobham, Surrey; good prospects for reliable man, knowledge car radio desirable.—Box 957.

**REQUIRED.** test engineer with knowledge of high-power, high-frequency valve generators.—Box 5222. [6885]

**A SKILLED** television and radio service engineer required at Harrow; good wages and working conditions.—Write Box 1399.

**RADIO** service manager with television experience, for Murphy dealer, permanent position.—Write full details to Box 1400.

**SERVICEMAN-SALESMAN** required for retail business in W.C.1, London area, developing H.A.M. side; good wages and commission to right man.—Box 1446. [8095]

**RADIO** testers required for alignment and fault-finding superhet receivers; previous experience essential.—Ace Radio, Ltd., Tower Rd., Willesden, N.W.10. Wil. 3904. [7951]

**RADIO** cabinet designer required for large North London company, previous experience essential.—Write full details to R.C.D., Box 0/541, A.K. Advg., 212a, Shaftesbury Ave., W.C.2. [7968]

**A.C.S. RADIO**

**Specialists** in short wave and high-class broadcast equipment, offer a wide range of components for the constructor and enthusiastic amateur.

**WE** are Agents for Eddystone, Raymart, Hamrad and Labgear components, including Variable Condensers for receiving and transmitting; Air Trimmer Condensers; plug-in Coils and Coil Formers; valve holders; R.F. and A.F. Chokes; Mains Transformers; mica, paper and electrolytic Condensers; volume controls; quartz crystals for the amateur bands, frequency standard and crystal gate receivers; aerial wire and equipment; meters and test sets by M.I.P. (Pullin) Ltd.; E.V.A. and American valves including transmitting types by Standard Telephones and specialised U.H.F. types; Cathode Ray Viewing Units by Labgear; Amplifiers and radio tuner units by Lowther Mfg. Co.; Voigt Speakers and Corner Horns; Amplifiers by Leak, including the famous Point-one Series.

**WE** have continually changing stock of new and secondhand communications receivers.

**Our New Components List "W.W." and List "W.W." of secondhand equipment will be sent on application to A.C.S. RADIO.**

**44 WIDMORE RD BROMLEY, KENT**  
Phone Ravensbourne 0156

**RADIO FREQUENCY WINDINGS**

**TO YOUR OWN SPECIFICATION**

We can also offer you a standard range of iron dust cored coils of exceptional efficiency and stability, suitable for super-het and T.R.F. receivers.

*Enquiries for small or large quantities welcomed.*

**MONOCHORD RADIO**  
(ESTABLISHED 1929)

**17, Streatham Hill, London, S.W.2.**

**X-R.A.F.**

Transmitter Receiver for short waves, 20-40 metres



Provision for crystal control. Uses standard head phones and microphone. Battery operated, requiring standard 120 volts h.t. and 2 volts l.t. includes 9 valves standard English types. Six valves in receiver and three in transmitter. **GARRIAGE PAID...** and Power. TX Osc. P.A. and Modulator..... **£6**

**THE STAMFORD RADIO CO.**

199, Stamford Street, Ashton-u-Lyne, Lancs.

Telephone: AShton 1964



**THIS USEFUL  
NEW FOLDER-**

... tells you all about the complete range of Henley SOLON Electric Soldering Irons, for the standard voltage ranges of 200/220 and 230/250; 65 watt and 125 watt models fitted with oval-tapered bits or pencil bits and 240 watt models fitted with oval-tapered bits are available.

Write to-day for the new folder ref. Y.10 describing



W. T. HENLEY'S  
TELEGRAPH WORKS CO. LTD.  
(Engineering Dept.)  
51-53 Hatton Garden, London, E.C.1

**COULPHONE RADIO**

"The Return of Post Mail Order Service."  
58 DERBY STREET, ORMSKIRK, LANCS.  
Phone: Ormskirk 496.

Telegrams: Coulpheon, Ormskirk  
NEW GOODS ONLY.  
C.W.O. or C.O.D. Post Free over 5/-.

**MAJORS TRANSFORMERS**

PRIMARYS for 200/300 volts: Universal 4, 5 and 6.3 v. L.T., 300-0-300 v. 60 mA., 23/6; 350-0-350 v. 100 mA., 28/6; 450-0-450 v. 200 mA. 4 v., 8 a. C.T., 4 v. 4 a. C.T., 4 v. 4 a., 45/-; 450-0-450 v. 200 mA., 6.3 v. 4 a. C.T., 6.3 v. 4 a. C.T., 5 v. 3 a., 45/-; 450-0-450 v. 200 mA., 6.3 v. 6 a. C.T., 4 v. 2 a. C.T., 4 v. 2 a. C.T., 5 v. 3 a., 47/6; 1,250-0,000-750-0-750-1,000-1,250 v. 300 mA. (no L.T.), 112/6; 4 or 6.3 v. 6 a. C.T. (Filament), 17/6 Auto (Filament), 4v. to 6.3v. 4a. (or vice versa) 13/6

**SMOOTHING CHOKES**

15 H. 40 mA. 380 ohm., 5/-  
20 H. 60 mA. 425 ohm., 6/-  
15 H. 90 mA. 240 ohm., 7/-  
20 H. 100 mA. 425 ohm., 12/6  
20 H. 200 mA. 150 ohm., 21/6  
30 H. 200 mA. 350 ohm., 25/-

**OUTPUT TRANSFORMERS**

Midget Power Fan, 5/6. Std. Univ., with C.T., 7/6. Large Univ., with C.T., 12/6. Heavy Duty Univ., for 3, 5 and 10L.T., 22/6. Extra Heavy Duty, 37/6. SPECIAL (to author's specification), for quality amplifier, described in April and May issues of "The Wireless World," 67/6.

**COILS, COIL PACKS, etc.**

WEYMOUTH TRF. COILS M. and L., with cct, pair 9/8. "P" Type, 2/9 ea.  
SUPERHET 2 W.B., with cct, 465 kc/s., pair 11/6.  
WEYMOUTH COIL PACKS. Completely aligned, 36/6.  
RS TUNING (FREEDER) UNIT. With R.F. stage. Completely aligned, station named scale, 28 15s.  
I.F. TRANSFORMERS. Midget, 18.9 pr. Standard. 18/- pr.

J.B. MIDGET 2-GANG CONDENSERS. 0005 L.Tr. 11/6; W/Tr., 12/6. 2-gang L.Tr., 15/6.

KITZ. 5v. 8/6et. 3 W.B. A.C. 412 10s.  
MULBREAD PRECISION REDUCTION DRIVES. 54:1, 12/6. J.B. Full Vison, 8:1, 12/6.

**SUNDRIES**

LINE CORD. .3 amp. 60Ω per ft., 2 w., 2/3 yd.; 3 w., 2/6 yd. P.B. Wire, 3d. yd.  
MAJORS DROPPERS. 2 a. 300Ω; 4/6; 2 a. 1,000Ω; 4/8.  
CARBON RESISTORS (50Ω to 5 MΩ), 1 w. 6d.; 1 w., 9d.  
EDDYSTONE SHORT WAVE GEAR.  
ROMAC SUPER CAR RADIO. VIDOR PORTABLES. Send 2d. stamp for new 24-page Catalogue.

**THE NORTHERN POLYTECHNIC, Hol-**

loway, N.7.  
THE Governing Body invite immediate applications for appointment as full-time lecturer in radio engineering to prepare students for the City and Guilds of London Institute Final Certificate in telecommunications engineering; salary scale £300×£155×£225, plus £36-£48 London allowance, together with other allowances in accordance with the Burnham award. Forms of application, together with full particulars, will be forwarded on receipt of a stamped addressed foolscap envelope.  
R. H. CURRELL, Clerk. [7891]

**S**ALES engineer with experience of estimating and technical correspondence on sound amplifying equipment; West Middlesex locality. -Reply, stating age, salary required, and experience, to Box 1186. [7972]

**R**ADIO service engineers required, permanent situation for all-round practical men; vacancies in various parts of the country; good rates for first class work. -Write, giving full particulars, to Box 949. [7893]

**C**HIEF engineer required with great exp. in commercial receivers and television; first class references necessary; excellent position offered in a known London radio factory; salary approximately £1,000 p.a. -Box 333. [7936]

**W**ELL-KNOWN loudspeaker manufacturers require senior and junior acoustic engineers for development work in research laboratory. -Write, stating age, qualctns., salary rec. and remuneration now req. to Box 1183. [7936]

**M**URPHY dealer requires skilled service engineer with television experience. sole charge of separate workshop; good wages and conditions. -Write or phone Wright, 3, Beeches Av., Carshalton, Surrey, Wallington 2119. [7936]

**D**EVELOPMENT and research engineer required by radio manufacturers, S.E. London district, with commercial, radio and television experience. -Apply in strict confidence, stating age, qualifications and experience, to Box 1396. [8029]

**E**NGINEER required for design development and testing of power and audio transformers and test equipment. Apply Personnel Manager, R.F. Equipment, Ltd., Langley Park, Slough, Bucks, giving details of qualification, experience and salary required. [7936]

**W**ELL-KNOWN firm require draughtsmen with experience in laying out and detailing of designs for broadcast and television receivers and communication equipment; stable posts for suitable applicants. -State experience and salary required to Box 951. [7896]

**L**ARGE organisation in West Middlesex requires field service engineers with good television and radio technical knowledge; smart appearance, car an advantage but not essential. -Reply, stating details of past experience, age and salary required, to Box 1319. [8003]

**M**ANUFACTURERS of high class radio components invite applications from suitably qualified persons to act as representatives; only those with first class wholesale radio trade connections need apply. -State qualifications and terms to Box 1182. [7965]

**T**HERE are vacancies for men capable of maintaining and repairing television receivers. -Application should be made to London Rediffusion, 67, Sloane Av., S.W.3, giving full particulars of qualifications and experience. Training facilities will, if necessary, be provided. [7954]

**A**SSISTANT foreman for large manufacturers, S.E. London area; knowledge of component part and line assembly, also coil wave winding machine setting; accustomed to control and training of female labour; good prospects and permanency for right man. -Apply Box 1320. [8004]

**S**ALES engineer to specialise in automobile radio equipment; experience in comparable field and adequate training essential; technical qualifications desirable; age 25-30; employment with leading London manufacturers; excellent prospects; salary according to experience. -Box 1521. [8006]

**W**ANTED, experienced engineer to take charge of loudspeaker and transformer service, must have had experience in this class of work, able to control staff and be good correspondent and handle customers' queries; good pay and prospects; well established company in Kingston area. -Box 944. [7869]

**E**LECTRONIC engineer required by progressive firm on East Coast for construction, development and maintenance of process test equipment, must be really practical man, 5-day week; please state full details education, training, experience, age; all applications will be treated with confidence. -Box 947. [7887]

**U**NIVERSITY COLLEGE, Southampton, invites applications for the post of lecturer in the Technical Department, University College, Southampton, for City and Guilds telecommunications up to Grade 5; salary Burnham scale. -Further particulars may be obtained from the Technical Officer, with whom applications should be lodged by 6th September, 1947. [7938]

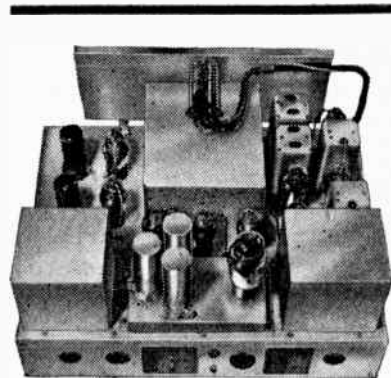

**PEERLESS TYPE 1546 CHASSIS  
Communications-type high fidelity**

**Receiver employs numerous important features including:—**

- 6 wave ranges.
- 60 mcs. to 150 kcs.
- crystal control
- variable selectivity
- independent base and treble control
- pre-amplifier for moving coil pick-up
- 20 watts output
- employs a total of 16 valves

—and a completely new Peerless Receiver

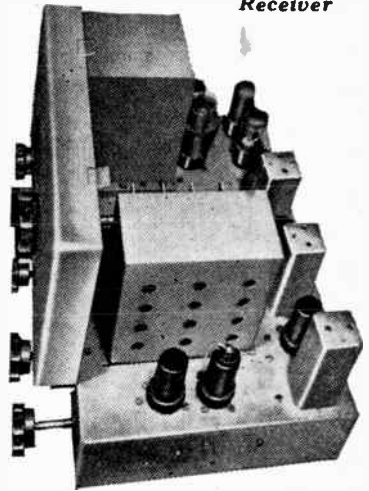

**TYPE 1047 RADIO-GRAM CHASSIS**

**Specification includes:—**

- 10 stage superhet circuit
- 10 valves (including magic eye)
- RF amplifier
- 2 IF stages
- 4 wave bands
- 10 Watts push pull output
- tropicalised components

Complete Specifications on request

Trade & Export Enquiries invited

**TELEMECHANICS LIMITED**

374 KENSINGTON HIGH ST., LONDON, W.14  
Phone: WEStern 1221

# COVENTRY RADIO

COMPONENT SPECIALISTS  
SINCE 1925

- Signal Lamps, D.49, red or green ..... 2/9
- Trimmers, 3-38 pf., air spaced ..... 9d.
- Cable Plugs, 8-pin Octal moulded..... 1/6
- Flexible Couplers for 1/4 in. spindles ... 1/6
- Condensers, .01 mf. 350-volt, tubular 5d.
- Mains Voltage Adj. Panels, with plug, 200, 220, 240 volt type ..... 1/3

All New Components by Well-known Manufacturers. Special low prices to large buyers. Send for 3d. list.

191, DUNSTABLE ROAD, LUTON.

## Type 69 Ex Am Receiver Units. Combined Switching Amplifier

Containing  
Three I.F. Stages, 4 L.F. Stages, EF50, 4 EBC33 Valves, Six L.F. Transformers, 3 Relays, 1 completely Filtered and Smoothed Motor Converter Unit, and many useful components.  
Case measures 7 1/2" x 8 1/2" x 14". Weight, 35 lbs. New and unused. Each £4 10s.

Motor Converter Units from the above.  
Windings 12V., 27V., 250V. D.C.  
Complete with I.F. Input and Output Filters and fully smoothed. Complete £2 10s.  
The above converters having Wound Fields are very adaptable. Any winding is suitable for Input or Output. They also make excellent A.C. or D.C. motors of about 1 h.p.

H.A.M.S. A.B.88 Receivers. Canadian R.C.A. In perfect condition. A very few only. £85.  
M.C.E.I. RECEIVERS. These are fast disappearing. You may be just in time. Each £8 8s.  
Many other lines. Write for list.

**MORTON & DISMORE**  
52c Oldchurch Rd., Chingford, E.4

# TELERADIO.

Model 42 Dry battery Car Radio, now redesigned and improved. Available for either single or two wave operation. Easily adaptable for short wave. A cheap and trouble-free radio for your car.  
Model 42 kit of parts with speaker ..... £6 13 4  
Model 42a kit of parts with speaker ..... £7 10 0  
Valves and case extra in both cases. Blueprints only. Set of three, 3s.  
Also Model A60. New Space Ranger 5-6 valve all wave superhet, giving outstanding sensitivity and quality. Kit of parts (less spkr. and valves) £9 2 6 including P.T. 5 valves, (magic eye extra) £3 2 3 incl. P.T. 10in. P.M. speaker, £2 5 0. Set of three blueprints, 5s.  
Send stamp for full details of these and other kits to  
**The TELERADIO Co.,**  
157, Fore Street, Edmonton, N.18.  
Phone: Tottenham 3386.

## BROOKES CRYSTALS LTD.

EST. 1929

FOR  
HIGH PERFORMANCE  
OSCILLATORS  
AND  
RESONATORS  
ACCURACY GUARANTEED

51-53 Greenwich Church Street,  
London, S.E.10 Phone: GRE. 1828

**ENGINEER - REPRESENTATIVE** required by British radio component manufacturers for investigation work in India. Write, giving detailed information re qualifications, experience, age and salary required, to Box 948.

**MECHANICAL** designers with experience in the design of small mechanisms are invited to apply for progressive posts with a leading firm manufacturing radio communication, civil aviation (airborne and ground), and radar equipment.—Applicants should give full details of experience and quote salary required, to Box 955. [7895]

**RADIO** and television service engineer required, resident in Chelmsford, to cover Essex; good theoretical and practical knowledge and clean driving licence essential; own car an advantage; payment by salary, bonus, allowances and expenses.—Apply Service Manager, Sobell Industries, Ltd., Langley Park, Slough, Bucks. [7935]

**BRITISH EUROPEAN AIRWAYS** are requiring radio mechanics conversant with ex-R.A.F. Transport Command, Bomber Command, signals and radar equipment, for servicing airborne equipment at Northolt Airport; basic pay 2/7 per hour.—Applications should be made to Personnel Officer, Northolt Airport, Ruislip, Middx. [7882]

**PHYSICIST** required by Marconi's Wireless Telegraph Co., Ltd., at their Gt. Baddow Research Laboratories, having specialised knowledge of crystallographic work, with particular reference to Piezo-Electric phenomena; some industrial experience of small-scale crystallisation processes and methods an advantage.—Apply Box 1184. [7967]

**IMPORTANT** radio manufacturing company in London requires first-class sales technical man with previous managerial experience if possible; must be good correspondent.—Full particulars of age, experience, academic qualifications if any, and salary required, to X.Y., Box O/5110, A.K. Advg., 212a, Shaftesbury Av., London, W.C.2. [7756]

**WOLVERHAMPTON** and Staffordshire Technical College.—Assistant (mechanical) and senior assistant (electrical) required in the Engineering Department of the above. Salaries on the appropriate Burnham Technical Scale.—Particulars, etc., on application to F. Lonsdale Mills, Clerk to the Governors, Education Offices, North St., Wolverhampton. [7940]

**RADIO** engineering company in South London requires engineer to take charge of test department specializing in radio navigational equipment; applicants must be able to prove they have first class technical qualifications combined with considerable experience in similar work; position offers good opportunities to the right man.—Write full details to Box 7429. [7202]

**REQUIRED** in Slough district, development and design engineers experienced in the following categories of radio work: (1) H.F. high power transmitters; (2) V.H.F. low power multiple-channel F.M. transmitters; (3) V.H.F. receivers for (2); (4) Portable single-channel transmitter/receiver sets. Salary according to experience.—Write Box 590, Dorlands, 1820 Regent St., London, S.W.1. [7731]

**APPLICATIONS** are invited by leading manufacturer of broadcast radio and television receivers in the Midland area for vacancies in their development laboratories for design engineers; candidates should be of degree status and have had experience of broadcast and/or television receiver design and development.—Apply, stating age, experience and salary required, to Box 953. [7899]

**REDIFFUSION, Ltd.**, have a vacancy in their development laboratory for a senior radio engineer capable of taking full responsibility development and design of transmitters varying powers and frequencies; only live men with practical experience need apply to Manager, Rediffusion, Ltd., Broomhill Rd., Wandsworth, S.W.18, giving details of technical qualifications, salary expected, and when available.

**BRITISH OVERSEAS AIRWAYS CORPORATION** have vacancies for ground radio operators, medically fit and willing to serve on a world-wide basis overseas. The upper age limit is 40 and preference will be given to single men. Basic rate of pay £5/15 to £6/10 a week, plus allowances overseas graded according to the local standard and cost of living. The initial tour of duty is three years, and successful candidates will be required to serve in any part of the world at the discretion of the Corporation. Essential qualifications: Postmaster-Generals First or Second-class Certificate or equivalent service experience. Candidates not holding certificates will be given proficiency tests on ground radio operating.—Applications in writing to Staff Appointments Superintendent, Stratton House, Piccadilly, W.1, stating age, certificates held and giving brief details of radio operating experience. Replies will be sent only to candidates called for interview. Mark envelopes "Ground Radio Operator." [7960]

**• Radiospares •**  
**Quality Parts**

**THE SERVICE ENGINEER'S FIRST CHOICE**

**TRANSFORMERS & COILS TO SPECIFICATION.**  
MANUFACTURED OR REWOUND  
**JOHN FACTOR LTD.,**  
(Formerly Stanley Cattell Ltd.),  
9-11 East Street, TORQUAY, Devon  
Phone: Torquay 2162.

**RADIO BATTERY TESTER**

Use "Quixo" method of battery testing.  
Reliable results. Guaranteed.  
Send for interesting leaflet R115 on battery testing.



**RUNBAKEN • MANGHESTER 1**

**REWINDS**  
Armatures, Fields, Transformers, Pick-ups, Vacuum Cleaners, Gram, Motors. Speakers Refitted New Cones & Speech Coils.  
All Guaranteed and promptly executed  
New Vacuum Cleaners, most popular makes. Send stamped addressed envelope for list of Radio Spares, and C.O.D. Services.  
261-3-5, Lichfield Road.  
**A.D.S. Co. ASTON, BIRMINGHAM, 6**

**THIS Does these**



**ACCURATELY and QUICKLY**  
Lhasiss, Brackets, Shrouds, Condenser and Transformer clips —  
REPAIRING Steel or Aluminium  
Five sizes — 12" to 36"  
Full particulars from  
**A. A. TOOLS, (W.),**  
197A, WHITEACRE ROAD  
ASHTON-UNDER-LYNE

**HARTLEY-TURNER**  
HIGHEST FIDELITY SERVICE

The cost of everything that goes to the making of a Hartley-Turner speaker steadily rises. Many customers have told us that £9 is too cheap for a speaker of this quality, but our policy has always been to provide the best at the lowest possible price. We don't "sting" our clients. So we are not going to raise the price—yet, even if it were justified. But in future we must make a charge for postage and packing. Orders by post must, therefore, include 6/6 for packing and postage, of which 5/- will be returned if the carton is sent back in good condition. If you can collect personally you not only save the postage but can discuss your problems with us at first hand. We don't charge for helping our customers. It's just part of the Hartley-Turner service.

**SPEAKER : MODEL 215—£9**  
**H. A. HARTLEY CO. LTD.**  
152 HAMMERSMITH RD., LONDON, W.6  
TELEPHONE : RIVERSIDE 7387  
RPL/P23



**AIRCRAFT** radio installation engineer required capable of dealing with all matters relating to prototype installations in commercial aircraft.—Apply, giving full particulars of qualifications and experience and stating salary required, to Personnel Department, Murphy Radio, Ltd., Welwyn Garden City, Herts.

**RADIO**—Energetic young man wanted to assist in the preparation of students for the final grouped technological certificate of the City and Guilds of London; previous teaching experience not essential, but applicants must be keenly interested in radio and youth activities.—Write, giving full particulars of certificates held, salary expected, etc., to the Principal, Wireless College, Colwyn Bay. [7975]

**A FIRM** which manufactures a very wide range of telecommunications equipment requires engineers to develop radio communications equipment in its rapidly expanding V.H.F. and centimetre fields, excellent opportunities exist for suitable applicants, the equivalent of a degree and preferably some experience is required.—Apply, stating age, experience and salary required, to Box 952. [7979]

**NEW ZEALAND**—Engineer-salesman for cinema equipment company allied to leading circuit, first-class technical training and thorough experience on installation and servicing of sound film equipment essential; commercial experience, energy, initiative and organising ability will enhance prospects; applications (in strict confidence) should give full details, including experience, qualifications, age, whether married, and present salary.—Write Box 1444.

**WELL-KNOWN** radio component manufacturer requires electrical inspector for their Wiltshire factory; applicants should have a sound electrical knowledge and preferably some experience of mechanical inspection, experience of mass production inspection is essential; the position offers excellent prospects to an inspector having initiative and the ability to control all inspection in a small radio factory.—Box 962. [7914]

**EXCEPTIONAL** opportunities for draughtsmen are afforded by an expansion of the Marconi drawing offices, Chelmsford, for the design of radio equipment; radio experience desirable but not essential, although drawing office experience of electrical and/or mechanical apparatus definitely required; much of the work is in close collaboration with the research and development engineers.—Apply English Electric Co., Ltd., Queen Hse., Kingsway, W.C.2.

**E.M.I. RESEARCH LABORATORIES, Ltd.**, have vacancies for qualified research engineers with experience in the design and development of: (a) High frequency transmitters; (b) transmitting aerial systems; (c) radio equipment; (d) electroacoustic equipment. Applications, giving full particulars of qualifications and experience, together with salary expected, should be addressed to Personnel Manager, Gramophone Co., Ltd., Hayes, Middlesex.

**MECHANICAL** designers, age 30-40, capable of completing mechanical design of fixed or mobile transmitters to electrical information supplied, supervising detail drawings, preparation of stock lists and purchasing specifications; location South-West London. Write, stating age, experience, salary required and when freed to commence, to Group Staff Officer (31) Philips Lamps, Ltd., Century House, Shaftesbury Av., London, W.C.2.

**EXPERIENCED** wireless mechanics capable of carrying out complete overhauls and repairs to various types of Army and trade pattern wireless transmitters and receivers; wages 104/6 per week, plus up to 20/- per week ability pay according to technical qualifications and skill.—Applications should contain full personal particulars of applicant and experience and should be forwarded in writing to Civilian Establishment Officer, Kinnegar Workshops R.E.M.E., Hollywood, Co. Down.

**TECHNICAL** assistants required for research and development department of large light electrical engineering factory in Ealing area of London; should have graduated in electrical engineering (or equivalent qualifications) with some previous practical engineering experience, required to work on electrical and mechanical testing of equipment and materials; commencing salary from £320 to £450 per annum, according to age and experience.—Please write, giving full details of age, qualifications and experience, to Box 954. [7903]

**UNIVERSITY** College, London, has a vacancy in the Department of Civil Engineering for a technician with the following qualifications: Skilled or semi-skilled mechanic or fitter with experience in laboratory and instrument cleaning, ability to follow and make up electric wiring from diagrams dealing with thermionic valves and their uses as rectifiers, detectors, oscillators and amplifiers; minimum wage £6 per week and above, according to qualifications; family allowance scheme and five weeks holiday.—Write in first instance for application form to Establishment Officer, University College, London, Gower St., W.C.1.

# GALPINS

ELECTRICAL STORES

408 HIGH STREET, LEWISHAM, LONDON, S.E.13

Telephone: Lee Green 0309. Near Lewisham Hospital.

TERMS: CASH WITH ORDER. NO C.O.D.

**VOLTAGE CHANGER TRANSFORMERS.** Ex-Govt., auto wound. Tapped 0, 10, 20, 25, 90, 130, 150, 190, 210, 230 volts, 1,000 watts, all tapping at 1,000 watts. New and unused £5/10/- each, carriage 5/-.

**MAINS TRANSFORMERS** by well-known makers. Input 200/250 volts, output 700/0/700 v., 80 m/a. 4 v. 3 a. 12 v. 1 a., 30/-, Ditto, 300/0/300 v., 200 m/a. 6.3 v. 20 amps. 5 v. 3 a., 45/-, Ditto, 450/0/450 v., 150 m/a. 5 v. 2 a. 6.3 v. 4 a., 37/6. Ditto, 500/0/500 v., 150 m/a. 4 v. 4 a. 6.3 v. 4 a. 5 v. 2 a., 55/-, Ditto, 350/0/350 v., 120 m/a. 4 v. 4 a. 5 v. 2 a. 6.3 v. 4 a., 35/-.

**AUTO WOUND MAINS TRANSFORMER** (Mains Booster). 1,500 watts tapped 0, 6, 10 19, 175, 200, 220, 225, 240 and 250 volts. New, ex-Govt., £5/10/- each, carriage 5/-.

**EX-R.A.F. AERIAL COUPLING UNITS**, absorption type. Range from 1.2 to 5.3 m/cycles. 7/6 each, post 1/-.

**VOLTAGE CHANGER TRANSFORMERS**, auto wound, fully guaranteed, immediate delivery, all tapped 0, 110, 200, 220, 240 volts, 250 watts, 45/-; 350 watts, 55/-; 500 watts, 70/-; 1,000 watts, £5/15/-; 2,000 watts, £8/15/-.

**SHUNT WOUND D.C.** 110 volt motors, 1,500 r.p.m., approx. 1/2 h.p., condition as new, 17/6 each, post 2/-.

**MAINS TRANSFORMERS (NEW) EX-GOVT. SURPLUS VOLTAGE CHANGERS.** Tapped 0, 150, 180, 230 volts at 2,000 watts, £7/10/0 each c/paid. Ditto 200, 250 volts input 14 and 17 1/2 volts output at 30.35 amp. output, useful for small welding or soil heater, £4/15/0, carriage 3/6. Aerial Variometers for No. 19 set complete with Dial, 5/- each, 1/- post.

**ELECTRIC LIGHT CHECK METERS**, for 200/250 volt 50 cyc. 1 phase, ideal for subletting, etc., guaranteed electrically 2 1/2 amp. load, 12/6, 5 amp. 12/6, 15 amp. 20/-, 20 amp. 25/-, 30 amp. 30/-, 40 amp. 35/-, 50 amp. 45/-, 100 amp. 50/- each, plus 1/6 carriage extra.

**EX-R.A.F. I.F.F. UNIT (Model)** 3002 complete with 10 valves types 3X70E, 1EFS0, 4VR65, 2XYT61A, and rotary converter 12 volts input. 450 volts 40 m/a. output. These units are as new. Price complete, £3/10/-, carriage paid.

**EX-R.A.F. CRYSTAL MONITORS TYPE 2.** 3-valve Battery working, complete and ready for use less valves and xtals, operational frequency depends on xstal frequency, condition as new. Price 10/- each, plus 1/6 carriage. Complete in carrying case, size 8 1/2 in. x 8 in. x 6 in.

**EX-R.A.F. MICROPHONE TESTERS.** These consist of a Ferranti 2 1/2 in. m/coil 0 to 1 m/a. meter with Westinghouse Rectifier incorporated, calibrated at present 0 to 10 volts, microphone transformer, jacks, etc., all contained in polished teak case, size 6 1/2 in. x 5 1/2 in. Condition as new. Price 37/6 each.

**METERS.** All first grade moving coil instruments, new, boxed, ex-Govt., 0 to 40 volts, with series resistance removed. 5 m/a. 15/- each, 0 to 10 amps. 15/-, 0 to 1 m/a. 21/-, All 2 1/2 in. scale and by well-known makers.

**EX-NAVAL CATHODE RAY RECTIFIER UNITS.** New and unused, sold for components which consist of—2 x 5 mf. 2,500 v., 1 x 1 5,000 v., 6 x 2 mf. 800 v., 2 x 8 mf. 800 v. approx.

15 volume controls, various values, approx 100 small condensers and resistances, smoothing choke and 9 v. holders, including 3 EF50 and 1 tube base. All components wired and with the addition of mains transformer would make a good oscilloscope. Price 55/-, carriage paid.

**EX-R.A.F. R.F. UNITS TYPE 110A.** New and unused, consisting of 5 valves, including grounded grid 750 m/cy. tube, small 12 volt motor and numerous other components, 55/- each, 5/- carriage.

**EX-R.A.F. RADAR IMPULSE TRANSFORMERS** (new, boxed). We have no actual data on these, but believe them to have an output of 15,000 volts at 3 kW. for a micro second. A bargain for the experimenter at 10/6 each. P.F. **EX-G.P.O. VERTICAL TYPE GALVANOMETERS**, centre zero reading 30/0/30, 7/6 each, post 1/-, Mallory 12 volt vibrators, new and unused, 7/6 each. Electrolytic condensers, 80 mf. 350 volt wkg., 5/6 each, post 9d.

**L.T. RECTIFIERS** (new), 6 volts, 1 1/2 amp., 7/6 each, 12 v. 1 1/2 amp. 10/6 each, 9d. post. Instrument Rectifiers, 5.H., 10 or 20 m/a. types, 4/6 each.

**SLIDER RESISTANCES** (useful as dimmers, etc., ex-Govt., new), 450 ohms, carry 1/2 amp., 30/-; ditto, 4,000 ohms, carry 1/2 amp., 35/- each.

**WESTON MOVING COIL METERS**, edge type with knife edge pointers, 2 1/2 in. scale, all 2 m/a. F.S.D. 0 to 300 m/a., 30/-; 0 to 2 amps., 27/6; 0 to 60 volts, 27/6; 0 to 150 volts, 27/6; ditto, 0 to 1 volt 1 m/a., 1,000 ohm per volt, 35/-; another 301 model 0 to 3 m/a., 35/-; 0 to 50 m/a., 30/-; 0 to 200 m/a., 32/6; another 501 model 0 to 50 m/a., 27/6; 0 to 10 m/a., 27/6.

**EX-NAVAL ROTARY CONVERTERS.** 24 volts D.C. input, 50 volts or 100 volts 500 cycles 1 phase at 300 watts output, good condition, £5 each, C/F. Ditto, 80 volt D.C. to 80 volt A.C. at 2,000 cycles 1 phase 8 amps output, £4/10/- each, C/F.

**SMALL MAINS MOTORS**, ex-naval fan type, approx. 1/16 h.p., series wound with laminated fields 200/240 volts, 27/6 each, carriage 1/6. A few only 100 v. also. Please state voltage when ordering.

**TRANSFORMER CORES.** These are new and complete with bobbin. 25 watt 4/-, 100 watt 8/6, 500 watt 17/6. We also have a few only larger cores, which please write for quotation.

**VARIAC BALANCER TRANSFORMERS.** Input 200/260 volts, output 220 volts at 1.65 kilowatts. Condition as new, 85/- each.

**EX-GOVT. ROTARY TRANSFORMERS.** D.C. to D.C. 12 volts input, 230 volts at 4 m/a. output, 21/- each. Another, 24 volts input, 450 volts at 40 m/amps output, 30/-, Another, 24 v. input, 450 v. at 60 m/a. output, 32/6.

**LARGE MAINS TRANSFORMERS** for welding, etc., input 0 to 250 volts in steps of 5 volts, output 30 volts, at 100 amps, £12/10/- each, C/F. Another, double-wound, ratio 2 to 1, 240 input, 120 output, or vice versa, and 4 kW, £12/10/- each, C/F. Both are new, ex-Govt.

Other items stocked for which please write for quotation. X-Ray Transformers, Control Tables, Switchboard Volt and Ampmeters, Valves. Sorry we have no lists of our stocks. Please write your requirements enclosing 5.A.E.

## CIRCUIT DATA

**R.1116a.** Battery Communication Receiver. Theoretical & practical wiring diagrams. 2/3 post free.

**R109.** Short Wave Car or Battery Receiver. 11 pages of circuiting and general dope, including fault-finding. 2/3 post free.

**MCR1.** Circuit diagrams, technical and theoretical and notes. 2/9 post free

**W (Walkie-Talkie).** Battery Transmitter-receiver. Copy of official working instructions, plus diagrams of set and vibratory power pack. 3/6 post free.

V.E.S.,

RADIO HOUSE, RUISLIP, MIDD

## NON-MAGNETIC TURNTABLES

with

**STROMBOSCOPIC MARKING**

An essential accessory for serious PICK-UP DESIGN RESEARCH

## SOUND SALES LIMITED

57 St. Martin's Lane, London, W.C.2

Temple Bar 4284

Works: Farnham, Surrey

**TELEPHONE** apparatus designer required by leading company of telecommunication engineers situated in S.E. London district manufacturing for G.P.O. (foreign and colonial administration).—Write fully, stating age, experience, and salary required, to Box 0/5483, A.K. Advs., 21, Shaftesbury Avenue, W.C.2.

**ELECTRONIC** engineer for large industrial concern in North-West London; applicant must have Degree, or equivalent, in Electrical Engineering, and sound theoretical knowledge of electronic control circuits and equipment, age preferably under 30; applicant should give full particulars of experience, qualifications, and salary reqd.—Box 541.

**BRITISH BROADCASTING CORPORATION** invites applications from men (British) for the post of engineer in the audio frequency section of the research department based in London. Candidates must possess a University degree in physics or electrical engineering or equivalent qualifications, and must have taken electrical communication as part of their training. A knowledge of electrical measurements, measuring instruments and electro acoustics and experience in microphone and loudspeaker technique is essential. An appreciation of problems of electrical reproduction as applied to music will be an advantage. The work includes research into microphones and loudspeakers and embraces all other aspects of audio frequency research, design and development. Preference will be given to a candidate with the ability to guide development work in drawing office and workshops. Salary on appointment will be dependent on qualifications and experience, and subject to favourable report will rise thereafter by annual increments of £30 to a maximum of £680 per annum.—Applications, stating age, qualifications and experience, should reach the Engineering Establishment Officer, Broadcasting House, London, W.1, within 14 days of the appearance of this advertisement. [7929]

**SITUATIONS WANTED**

**RADIO** officer, 27, 10 years' sea experience, requires shore position.—Box 1527. [8022]  
**RADIO** engineer, 25, B.Sc., 2½ years R.A.F. signals officer, seeks position.—Box 945.  
**TECHNICIAN**, 24, exp. AF, film reproducers, PA, rediffusion, constructional.—Box 1442. [8085]

**ELECTRONICS** engineer and physicist, 2 years' post-graduate experience, requires position; Leeds district preferred.—Box 181.

**ASSOC. Brit. I.R.E.**, in dead-end job, desires progressive position where ability and initiative will make up for lack of varied practical experience; £400.—Box 958. [7906]

**WORKS** or production manager, technical, fully experienced, equipment or component lines, time-study, bonus, costing, material control, co-ordinator, output-getter.—Box 1472.

**RADIO** engineer and designer with manufacturing experience and small rural business seeks position with more scope as working manager or partner in larger concern; Southern England preferred.—Box 1326. [8018]

**RADIO** engineer, 34, Assoc. (Brit.) I.R.E., A.I.R.E., experienced in charge radio receiver development, prototype workshops and drawing office, seeks similar responsible position with progressive organization.—Box 961.

**EX-OFFICER**, R.A.F., Public School, age 34, widely travelled, pre-war experience in electrical and radio engineering, including compilation of technical and publicity publications, administrative exp. in Services, requires app. in this country or will go overseas, preferably Dominions or Colonies.—Box 1311.

**ADVERTISER** (age 42, married, seeks interesting and progressive position requiring initiative and first-class technical and administrative qualities; at present technical director and manager of well-known component and acoustical factory in Eastern Europe; 20 years' experience of radio and electrical engineering; special knowledge of export trade, propaganda, industrial design; experienced in factory problems, quality control, assembly operation, costing and buying.—Box 1005.

**ENGINEERING OPPORTUNITIES**



This unique handbook shows the easy way to secure A.M.I.Mech.E., A.M.Brit.I.R.E., A.M.I.E.E., City and Guilds, etc.

**WE GUARANTEE—“NO PASS—NO FEE.”**

Details are given of over 150 Diploma courses in all branches of Civil, Mech., Elec., Motor, Aero., Radio, Television and Production Engineering, Tracing, Building, Govt. Employment, R.A.F. Maths., Matriculation, etc.

Safeguard your future; send for your copy at once—FREE

**B.I.E.T., 387, SHAKESPEARE HOUSE 17, STRATFORD PLACE, LONDON, W.1**

**THE NORTHERN POLYTECHNIC, HOLLOWAY ROAD, N.7.**

Principal: T. J. DRAKELEY, D.Sc., Ph.D., F.R.I.C., F.I.R.I.

Department of Radio and Musical Instrument Technology.

Head of Department:

S. A. Hurren M.C., M.Brit.I.R.E.

Full-time Day Courses in

**RADIO TECHNOLOGY**

in preparation for all recognised qualifications in this subject. Practical laboratory and workshop experience provided.

Prospectus free on application to Secretary  
 New Term begins September 22nd.

**PROTO-ELECTRIC CELLS**

for Talking Picture Apparatus.

We can supply Cells for 16 mm. Projectors.

**RADIO-ELECTRONICS LTD.,**

St. George's Works, South Norwood, London, S.E.25.

**TUITION THE British National Radio School**

**OFFERS** you a career. WRITE to-day for free booklet describing our wide range of training courses in radio, Radar, telecommunications, principles, mathematics, physics, and mechanics; correspondence and day classes for the new series of C. & G. examinations; we specialise in turning "operators" into "engineers," and for this purpose our "Four Year Plan" (leading to A.M.I.E.E. and A.M.Brit. I.R.E., with 9 C. and G. Certificates as interim rewards) is unsurpassed; our guarantee has no strings attached.—Studies Director, B.Sc., A.M.I.E.E., M. Brit. I.R.E., 66, Addiscombe Rd., Croydon, Surrey. [6811]

**BOTH** Government and industry have announced and emphasized that young men with technical knowledge and qualifications must receive every chance to rise to the highest positions within their capacity, in post-war engineering and allied industry; write to-day for "The Engineer's Guide to Success"—200 courses free—which shows you now you can become A.M.I.E.E., A.M.I.A.E., A.M.I.Mech.E., A.F.R.Ae.S., etc., and covers all branches in radio, automobile, mechanical, electrical, production, aeronautical, etc. THE Technological Institute of Great Britain, 82, Temple Bar House, London, E.C.4. [4918]

**RADIO** training.—P.M.G. exams, and I.E.E. Diplomas; prospectus free.—Technical College, Hull. [0611]

**WHY** not obtain recognised qualification? Practising graduate radio engineer offers personal postal courses for C. & G. exams, etc.—For interesting details without obligation write Engineer, 28, Marywood Sq., Glasgow, S.1. [7952]

**RADIO** Engineering, Television and Wireless Telegraphy, comprehensive postal courses of instruction.—Apply British School of Telegraphy, Ltd., 179, Clapham Rd., London, S.W.9 (Estd. 1906). Also instruction at school in field for H.M. Merchant Navy and R.A.F. [3249]

**ENGINEERING** opportunities.—Have you had your copy of this free guide to A.M.I.Mech.E., A.M.I.E.E., and all branches of engineering, building and plastics? Become technically trained on "no pass—no fee" terms for higher pay and security.—For free copy write B.I.E.T. (Dept. 387B), 17, Stratford Place, London, W.1. [6939]

**RADIO** and radar.—Technical courses for Postmaster-General Certificates (M.N. radio officers), Ministry of Civil Aviation Certificates (Aircrew Radio Officers and Ground Engineers), Ministry of Transport Radar Certificates (M.N. Radar Engineers), City and Guilds Certificates in Telecommunications and Radio Servicing, and Graduateship I.E.E. and Brit.I.R.E. Next Session commences September 29, 1947.—Prospectus from Technical Office, University College, Southampton.

**TECHNICAL TRAINING**

**MORSE** code training.—Please note, Candler System Co., London Offices, will be closed from August 2nd to 11th. [7974]

**A.M.I.E.E., City and Guilds**, etc., on "No Pass—No Fee" terms; over 95 % success; for full details of modern courses in all branches of electrical technology send for our 112-page handbook, free and post free.—B.I.E.T. (Dept. 388A), 17, Stratford Place, London, W.1. [6270]

**STABLE**  
to  
**Welwyn** carbon resistor

Resistors produced by the cracked carbon process remain stable to ± 1% of initial value.

★ Tolerance ± 1%  
± 2% ± 5%

Low temperature co-efficient.

**WELWYN ELECTRICAL LABORATORIES LTD.**  
Welwyn Garden City, Herts. Telephone: Welwyn Garden 3816 8

**AL** **UNIT OSCILLOSCOPE**  
A NEW CONCEPTION OF INDUSTRIAL NEEDS

interchangeable Amplifiers and Time Bases with a wide range of accessories cover every application. No loose wires, no unwanted controls, no complex switches, but standard snap-on units give rigid assembly with tailor-made performance.

**LYDIATE ASH LABORATORIES**  
RESEARCH AND DEVELOPMENT ENGINEER  
**Nr. BROMSGROVE**  
Telephone: Rubery 168/169

Printed in Great Britain for the Publishers, ISSFF and BONS LTD., Dorset House, Stamford Street, London, S.E.1, by THE CORNWALL PRESS LTD., Paris Garden, Stamford Street, London, S.E.1. "Wireless World" can be obtained abroad from the following—AUSTRALIA and NEW ZEALAND: Gordon & Gotch, Ltd. INDIA: A. H. Wheeler & Co. Ceylon: Imperial News Co.; Gordon & Gotch, Ltd. SOUTH AFRICA: Central News Agency, Ltd.; William Dawson & Sons (S.A.), Ltd. UNITED STATES: The International News Co.



*New List*  
**NOW READY**

**Capacitors**

**TCC**

**T**HE new 48-page list No. 132/RD 47 is a complete illustrated guide to the many ranges of T.C.C. Paper, Mica and Ceramic Capacitors available through the usual distributive channels. Together with List No. 123/RD 46 which covers Wet and Dry Electrolytics, this new catalogue offers to manufacturers, traders and constructors a range more comprehensive than ever before. We will be pleased to send you a copy on receipt of 2½d. stamps.

For more than 40 years, T.C.C. have been specialists and the leading specialists in the manufacture of Fixed Capacitors.

In the best sets you'll see T.C.C.

**THE TELEGRAPH CONDENSER CO., LTD.**

RADIO DIVISION

NORTH ACTON · LONDON · W.3. Telephone: ACORN 0061



*Modern  
Miniatures*

*by*

*Mazda*



*A completely new range of high efficiency Miniature Valves has been introduced by MAZDA to meet the requirements of the Electronic Engineer.*

THE EDISON SWAN ELECTRIC CO. LTD., 155, CHARING CROSS ROAD, LONDON, W.C.2.