

Wireless World

RADIO AND ELECTRONICS



APRIL 1947

1/6

Vol. LIII. No. 4

IN THIS
ISSUE :

NEW HIGH-QUALITY AMPLIFIER



The Research Engineer knows that the best speaker for any set is one that offers complete reliability plus true tonal fidelity. After exhaustive tests his advice is always the same —fit Rola and relax!

ROLA SPEAKERS
THEIR QUALITY SPEAKS FOR ITSELF

BRITISH ROLA LTD • 8 UPPER GROSVENOR STREET • LONDON W.1



AVO



MODEL 7
UNIVERSAL
AVOMETER



MODEL 40
UNIVERSAL
AVOMETER



MODEL 400
T.T.V.
BRIDGE



THE AVO
VALVE TESTER



THE
ALL WAVE
AVO OSCILLATOR

RADIO manufacturers, service engineers, workshops and laboratory technicians are familiar with the precision and dependability of "AVO" Electrical Testing Instruments. Long years of successful experience in the design and manufacture of first-grade instruments have produced a consistently high standard of accuracy which has become a tradition as well as a standard by which other instruments are frequently judged.

THE AUTOMATIC COIL WINDER & ELECTRICAL EQUIPMENT CO., LTD.
WINDER HOUSE · DOUGLAS STREET · LONDON · S.W.1 · TELEPHONE: VICTORIA 3404/7

S.S. White

STANDARD
CONNECTORS FOR
COAXIAL
WAVEGUIDES
TELEVISION
ROCKERS
CONNECTORS

THE S. S. WHITE COMPANY BRITANNIA WORKS
ST. PANCRAS WAY - CAMDEN TOWN LONDON N.W.1.
Cable Address: WHICODENTA, WESDO, PHONE, LONDON
Telephone: EUSTON 4758-4759

Roberts Sharp & Partners

W T 35



Series 35 Moving Iron Voltmeter.

**Series 35
MINIATURE
MOVING IRON
INSTRUMENTS**

by **PULLIN**

Provided with clear, open scales $3\frac{1}{2}$ " long. Flush pattern moulded cases. Well damped; suitable for D.C. & A.C. up to 100 cycles. Readings independent of wide variations in wave form. Movement of spring-controlled, repulsion type with high torque/weight ratio. Ammeters self-contained to 50 amps; power consumption does not exceed 1VA. Voltmeters self-contained to 500 volts; power consumption 1.5VA.

MEASURING INSTRUMENTS (PULLIN) LTD

Dept. 1, Great West Road, Brentford, Middlesex. Ealing 0011

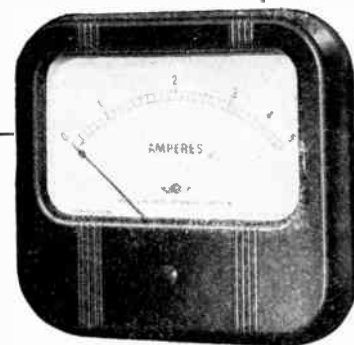

Series 35 Moving Iron Ammeter.

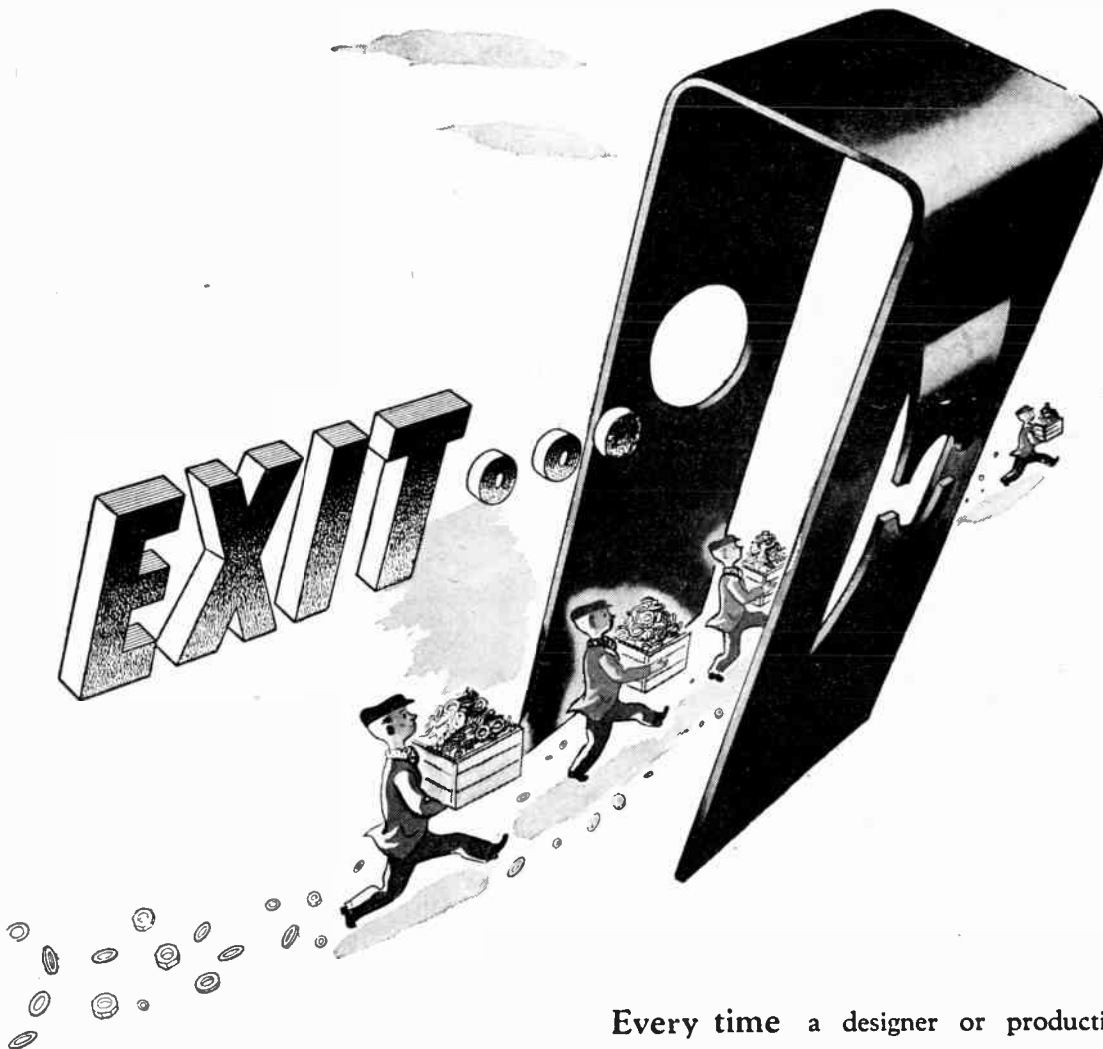

THAT'S Fixed THAT!

Type CA 725.

Fixing knobs to shafts. Sounds simple but if you're a radio manufacturer you know what a headache it can be. The Spire fixing was designed to solve that particular problem. The CA 725 is made to measure for shafts of various diameters. Then it is snapped into position in the hub of the knob and the knob pushed straight on to the shaft.

Don't think of Spire as a 'kind of nut'. It is a great deal more than any nut. It is a simplified and sure method of fixing. Especially awkward fixings!

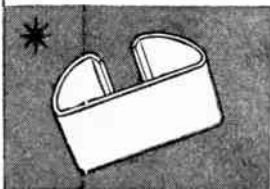

Spire

(REGD)

* **A BETTER way of fixing**

Simmonds Aerocessories Limited

Every time a designer or production engineer decides to use some form of Spire fixing, he puts a few thousand (or a few million) nuts and washers out of a job. No more fumbling and holding the bits together with one hand while you get to work with the other. Spire fixing can tackle and simplify most light assembly jobs. The best thing is to send us the job—or the drawings. If a Spire fixing will improve the job we'll design it for you and show it to you in a week or two. Then you can judge for yourself.

Wharfedale

NEW GOLDEN 10 inch LOUDSPEAKER...

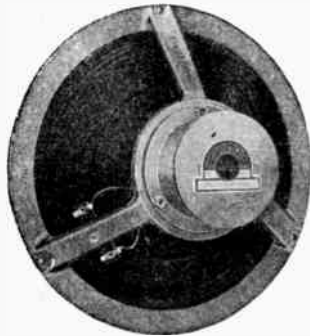

Speech coil
3 or 15 ohms
impedance
PRICE 75/-

During the last six years hundreds of Wharfedale Golden Units have been supplied, and are still being supplied, to the B.B.C. and G.P.O.

It was selected by reason of its level response.

The new model is fitted with precision die-cast chassis, improved spider, and Alcomax II Magnet increasing the flux density from 10,000 to 12,500. Delivery time 6/8 weeks.

Made and Guaranteed by
WHARFEDALE WIRELESS WORKS

BRADFORD ROAD, IDLE, BRADFORD

Telephone: IDLE 461.

Telegrams: Wharfedel, Idle, Bradford

ISOLATION FROM VIBRATION

NEW VIBRATION ELIMINATORS



"EQUIFLEX"
PATENTED AND FOREIGN PATENTS PENDING
MOUNTINGS

AN **AV** PRODUCT

"Equiflex" Mountings are invaluable for the mounting and suspension of machines, equipment, instruments, electrical apparatus, motors, etc., and wherever elimination of vibration and shock is required.

SPECIAL FEATURES

Flexible in all directions at an equal deflection. Can be loaded on any side, thus eliminating vibration in Vertical, Horizontal and Longitudinal planes employing best quality natural rubber spring elements and complete with snubbing device. Special Fittings made to suit customers' requirements.

Also available as previously advertised, the ALL-METAL construction comprising an ingenious Damped Spring System.

Write for illustrated brochure, and send us details of your requirements.

A. WELLS & CO. LTD. (Dept. W.W.),
STIRLING ROAD, WALTHAMSTOW, LONDON, E 17
Phone: Larkwood 2691

Here at last!
A REAL GEM

KILLICK'S
Sapphox
REPRODUCING INSTRUMENT
P.R.O. PATENT NO. 22214/45

REDUCES SURFACE NOISE
PRESERVES THE LIFE OF THE RECORD
DOES AWAY WITH NEEDLE CHANGING
STRAYS LIFE REPRODUCTION FROM 600 TO 14,000 CPS

This scientifically designed Patent Sapphire Instrument cannot touch the bottom of the groove, thus leaving it undamaged.

KILLICK & COMPANY, 118 FLEET STREET, E.C.4
Telephone: CENTRAL 2807
Manufacturers of Scientific Recording Instruments, Amplifiers, Radiograms, Cutting Stylus, Discs, Playback Sapphires, etc.

Saved Specialists

DUBILIER PRECISION WIRE WOUND RESISTORS

The remarkable accuracy of the DUBILIER PRECISION WIRE WOUND RESISTOR is due to its scientific construction. A slotted high insulation ceramic former is wound with enamelled resistance wire of not less than 0.0014" diameter. During winding the wire is subjected to tests to eliminate accidentally shorted turns and to ensure the essential high standard of insulation between turns. Contact between resistance element and terminals is by the exclusive DUBILIER moulded metal method which removes the possibility of weak, non positive or noisy connections. All units are suitable for use up to 50 Kc/s. *Full technical details on request.*

DUBILIER CONDENSER CO. (1925) LTD · DUCON WORKS · VICTORIA ROAD · N. ACTON · LONDON · W.3
 Telephones: ACOrn 2241 (5 lines) Telegrams: Hivoltcon, Phone, London. Cables: Hivoltcon, London. Marconi International Code.
 D.10

A NEW OSCILLOSCOPE



TYPE 1684B

PRINCIPAL FEATURES

- ★ TUBE. 3½ in. diam. Blue or green screen.
- ★ Shifts. D.C. thus instantaneous on both axes.
- ★ AMPLIFIERS. X and Y amplifiers are similar. D.C. to 3 Mc/s 24 mV. r.m.s. per cm. or D.C. to 1 Mc/s 8 mV. r.m.s. per cm.
- ★ TIME BASE. 0.2 c/s. to 200 Kc/s. Variable through X amplifier 0.2 to 5 screen diameters. Single sweep available.

The Type 1684B Oscilloscope has proved itself an exceptionally useful instrument in the television laboratory—it is provided with high gain, wide band amplifiers on both axes which serve to portray pulses such as those associated with television excellently and good pulse widths are obtainable on the screen.

PRICE £100

**SEE THIS INSTRUMENT
AT STAND No. D1679
B.I.F., OLYMPIA,
MAY 5th - 16th**



FURZE HILL LABORATORIES LTD

TELEPHONE
ELSTREE
1137

BOREHAM WOOD
HERTS

• ALL-POWER • Constant Voltage Power Supplies

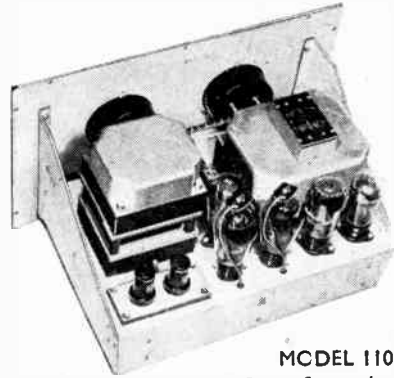

MODEL 1108-S

One of our low-priced industrial units.

LET ELECTRONIC STABILIZATION SOLVE YOUR POWER SUPPLY PROBLEMS

ALL-POWER TRANSFORMERS LTD.

8a Gladstone Rd., Wimbledon, S.W.19

Telephone: LIBerty 3303

SPHERE INSTRUMENTS

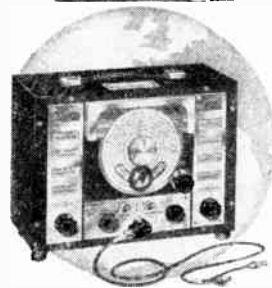

Introducing the ALL WAVE SIGNAL GENERATOR

TYPE 505

A portable Signal Generator for AC. Mains operation. Specially developed by SPHERE as a high class instrument, for general Laboratory and Workshop use, it is the ideal instrument for the aligning and testing of radio receivers and amplifiers.

This is a specially designed Generator, embodying several new and unique features and improvements, which radio engineers will find invaluable.

All "SPHERE" Test-instruments are entirely British made with highest quality materials and workmanship and carry a SIX Months' guarantee.

- Continuous Frequency coverage from 110 Kilocycles to 56 Megacycles, in six bands.
- Exclusive "SPHERE" "SEE AT A GLANCE" Band and Attenuator indicators.
- Built in ladder attenuator, with fine control, giving 1 Volt maximum, in five steps, in multiples of 10 Microvolts.
- Radio and Audio Frequency Voltages can be switched via single Test-lead.
- Variable control of 400 C.P.S. audio, from 0 to 1 Volt.

FOR RADIO SERVICE, RADIO ENGINEERING AND LABORATORY USE.

Write for List No. 505 S.G.

SPHERE RADIO LIMITED

Radio Instrument Manufacturers

HEATH LANE, WEST BROMWICH

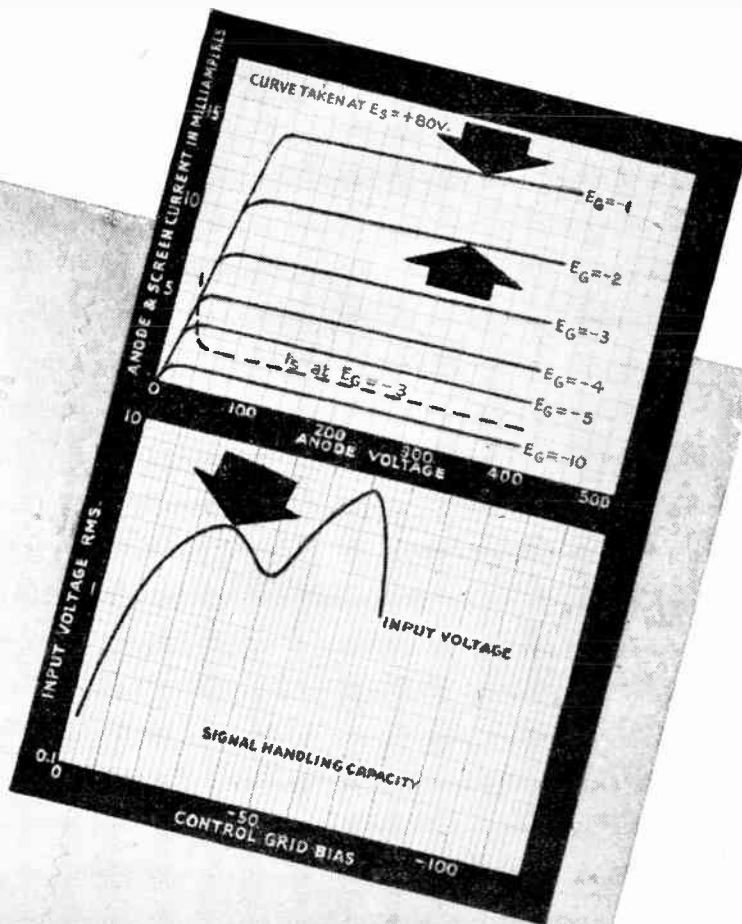

POINTERS FOR DESIGNERS

THE KTW61

A screened tetrode with suppressor plates and with variable-mu characteristics, the OSRAM KTW61 is specially suitable for use as an R.F. or I.F. amplifier in superhet receivers. Its outstanding features include:—

- ▶ High order of mutual conductance (2.9 mA/Volt) combined with low leakage capacitance (0.0025 $\mu\mu F$), which facilitates high stage gain.
- ▶ Negligible distortion with the maximum signal likely to be encountered in practice. Conditions of use — as an I.F. amplifier with screen dropping resistance, and in conjunction with OSRAM frequency changer X61M.
- ▶ Marked improvement in signal to noise ratio, particularly on the short waves, when used as an R.F. amplifier with fixed screen voltage.

A detailed technical data sheet is available on request.

Osram
PHOTO CELLS

G.E.C.
CATHODE RAY TUBES

Osram
VALVES

Advt. of The General Electric Co. Ltd., Magnet House, Kingsway, London, W.C.2.

LEWIS BERGER & SONS LTD.

(Established 1760)

35, BERKELEY SQUARE, LONDON, W.1 Telephone: MAYfair 9171

MANUFACTURERS OF INSULATING VARNISHES AND ENAMELS

AERIALS

“EXSTAT”
SHORT-WAVE
TELEVISION
CAR RADIO

STOCKED BY ALL THE
 LEADING DEALERS

ANTIFERRENCE
 LIMITED

67, Bryanston St., Marble Arch, London, W.1
 Telephone: Paddington 7253/4.



**FOR THE
 RADIO SERVICEMAN
 DEALER AND OWNER**

The man who enrolls for an I.C.S. Radio Course learns radio thoroughly, completely, practically. When he earns his Diploma, he will KNOW radio. We are not content merely to teach the principles of radio, we want to show our students how to apply that training in practical, every-day radio service work. We train them to be successful!

Write to the I.C.S. Advisory Dept. stating your requirements. Our advice is free and places you under no obligation.

-----You may use this coupon-----

INTERNATIONAL CORRESPONDENCE SCHOOLS Ltd.

DEPT. 38, INTERNATIONAL BUILDINGS, KINGSWAY, LONDON, W.C.2.

Please explain fully about your instruction in the subject marked X

Complete Radio Engineering Radio Service Engineering
 Elementary Radio

And the following Radio Examinations:—

- British Institution of Radio Engineers.
- P.M.G. Certificates for Wireless Operators.
- City and Guilds Telecommunications.
- Wireless Operator and Wireless Mechanics, R.A.F

Name

Age

Address

METALLISED CERAMICS

There's a size for every job
in the S.P. range of
metallised
bushes

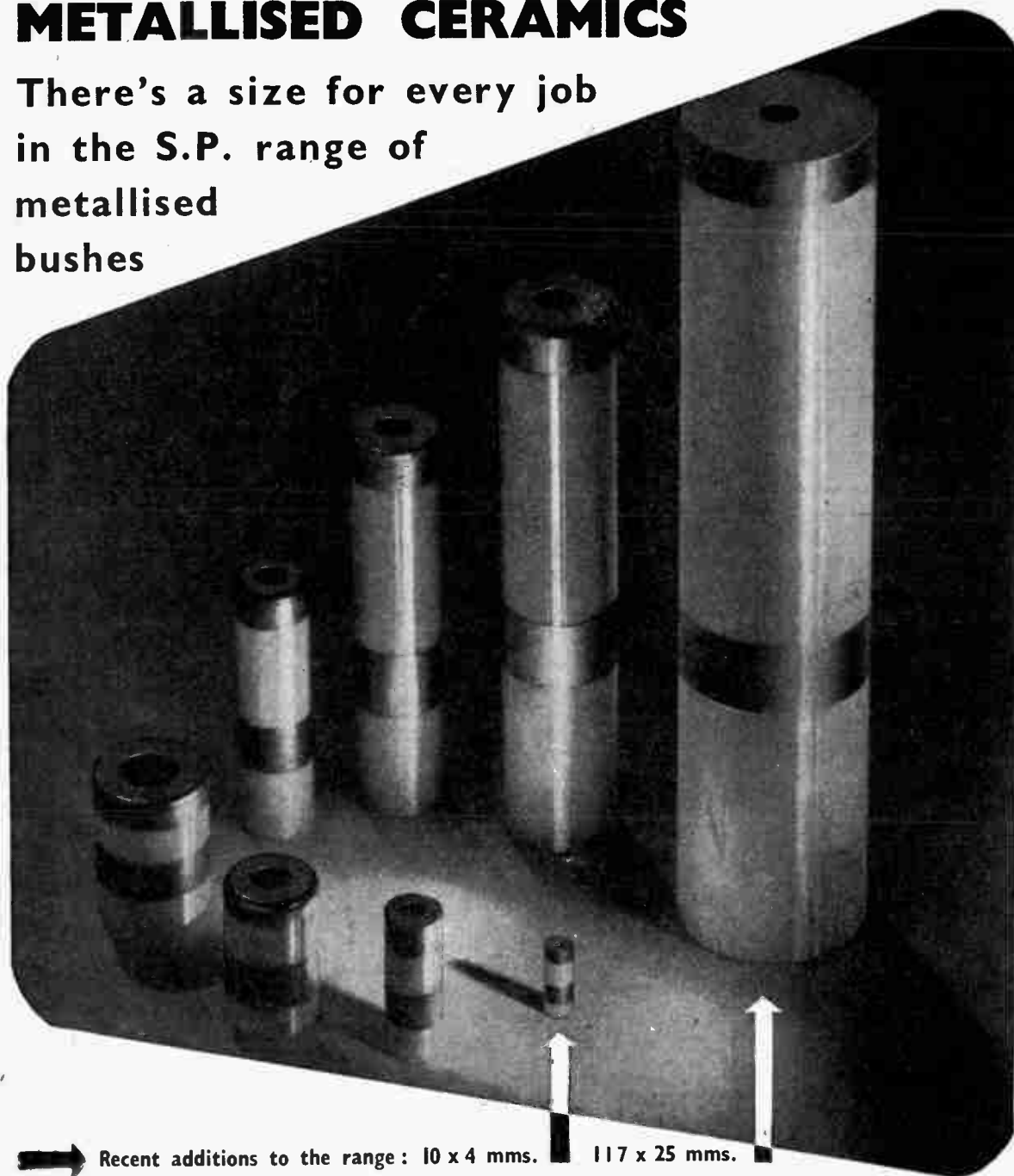

➔ Recent additions to the range : 10 x 4 mms. 117 x 25 mms.

For full information and prices please write to :

STEATITE & PORCELAIN PRODUCTS LTD.

STOURPORT-ON-SEVERN, WORCS. Telephone: Stourport III. Telegrams: Steatitain, Stourport.



S.P.44

Webb's RADIO

TEST INSTRUMENTS FROM STOCK

FURZEHILL OSCILLOSCOPE MODEL 1936,
 a new and useful 'scope covering many features at a reasonable price.
 2½" tube—Outside dimensions 6¼ × 9 × 14".
 Instantaneous shift—Time base 5 c/s to 20 kc/s.
 X gain control functions as sweep expander giving symmetrical expansion up to 5 diameters.
 Symmetrical X amplifier sensitivity 120 m. V r.m.s., c.m.
 Symmetrical Y amplifier sensitivity 10 m. V r.m.s., c.m. ... **£37 10 0**

WAYNE KERR COMPONENT BRIDGE B101.
 2% accuracy for C, R & L. (using internal standards).
 C = 0-500 mfd. in 8 ranges.
 R = 0-500 megohms in 8 ranges.
 L = 0-500 Hys. in four ranges.
 (Minimum measurement 100 millihenries).
 Leakage Test—Comparator by %.
 Power Factor—"Q" Calibration. **£27 6 0**

TAYLOR "JUNIOR"
 Model 120A (AC/DC—1,000 ohms per volt) **£8 10 0**
AVOMINOR UNIVERSAL **£8 10 0**
AVOMETER MODEL 40 **£17 10 0**

BROWNS MOVING COIL TELEPHONES.
 Type K.—For high fidelity reproduction.
 Resistance 90 ohms Per pair **£5 5 0**
 Matching transformer 7,000/90 ohms **7 0**

L.F. INDUCTORS. Partridge Transformers.
 recognised as pre-eminent in audio design, now stocked by Webb's:—
 Push-pull output (PX4's, etc.), 6,400 ohms to 15 ohms..... **£2 12 6**
 Modulation transformers:—
 Primary tapped 4,500-6,600-7,500 ohms plate to plate.
 Secondary 3,000-4,500-6,000 ohms.
 60 watts audio **£4 6 0**
 30 watts audio **£2 19 0**

WELWYN WIRE WOUND RESISTORS.
 Type AW3111—6 watt rating each **2 9**
 50, 100, 250, 350, 400, 500, 750, 1,250, 1,500, 1,750, 1,800, 2,500, 12,500, 15,000 ohms.
 Type AW3112—12 watt rating each **2 9**
 250, 500, 750, 2,500, 7,500, 12,000 ohms.
 Type AW3124—45 watt rating each **3 9**
 500, 1,000, 1,500, 2,000, 3,000, 5,000, 7,500, 10,000, 15K, 20K, 30K, 50K ohms.
 Type B3141—15 watt rating each **5 9**
 15K, 10K, 20K, 25K.
 Type C3146—280 watt rating each **10 9**
 25K, 30K, 50K, 75K, 100K.
 Types AW3111/3112 and AW3124 are wire ended Resistors.
 Types B3141 and C3146 require mounting clips, available at 1/- per pair.

WELWYN HIGH STABILITY CARBON 1 WATT RESISTORS, TYPE A3634.
 Tolerance ± 1%. 100, 250, 500, 750, 900, 2,000, 2.5K, 5K, 10K, 30K, 50K, .25M, .5M, 1M ohms.
 Tolerance ± 2%. 510, 1,000, .25K ohms.
 Tolerance ± 5%. 10, 100K, 3M, 5M ohms.
 FROM STOCKeach **2 6**

Write, phone or call

14 SOHO ST., OXFORD ST., LONDON, W.1.

Phone: GERrard 2089. Shop hours: 9 a.m.—5.30 p.m. Sats. 9 a.m.—1 p.m.

Miniature or Midget

HIVAC
 THE SCIENTIFIC VALVE
 BRITISH MADE

NEW TYPES FOR
 MIDGET RECEIVERS
 HEARING AIDS
 METEOROLOGICAL INSTRUMENTS
 ETC.

HIVAC LIMITED Greenhill Crescent. Phone HARROW Harrow on the Hill. Middx. O895

LABGEAR
ELECTRONIC FAULT TRACER

PRICE **£34-10-0**

MODERN SERVICE DEMANDS MORE PROFIT
LESS TIME MODERN METHODS

The Americans use Signal Tracing—Do You?
 BESIDES SIGNAL TRACING FACILITIES, COMBINED IN THIS ONE UNIT, THERE ARE THE FOLLOWING INSTRUMENTS:

- Signal Generator
- Capacity Bridge
- H.T. Power Supply
- Audio Oscillator
- Insulation Tester
- Voltage Indicator
- Resistance Bridge
- L.T. Supply Source

Write now to **LABGEAR** for List B.2001 W.W.
 Telephone: **WILLOW PLACE, CAMBRIDGE 2494 (2 lines)**
A "MUST" FOR PROGRESSIVE SERVICE MEN

IT COSTS LESS TO USE

*The Finest Cored Solder
in the World*

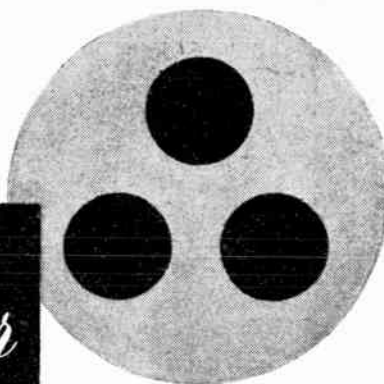

because

YOU AVOID WASTE. The three cores of flux in Ersin Multicore Solder ensure flux continuity, and eliminate solder lengths without flux.

because

YOU SAVE TIME. The three core construction of Multicore provides thinner solder walls and gives more rapid melting of the solder, thus speeding up soldering operations.

because

YOU ENSURE SOUND JOINTS. With correct soldering technique, Ersin Multicore Solder gives precision joints at high speed and avoids 'dry' or H.R. joints.

because

MULTICORE CONTAINS ERSIN. Multicore is the only solder in the world containing extra-active non-corrosive Ersin Flux—a high grade rosin subjected to a complex chemical process, enabling joints to be made on heavily oxidised surfaces. No extra flux is required.

SIZE 7 REEL for Factory use. SIZE 1 CARTON for Service Engineers and Workshops.
PRICES SIZE 1 CARTONS.

Catalogue Ref. No.	Alloy Tin/Lead	S.W.G.	Approx. length per carton	List price per carton (subject)	
				s.	d.
C 16014	60/40	14	55 feet	6	0
C 16018	60/40	18	145 feet	6	9
C 14013	40/60	13	35 feet	4	10
C 14016	40/60	16	80 feet	5	3

Manufacturers and service engineers are invited to write for information and samples.

Available from leading radio shops. In case of difficulty write to:

MULTICORE SOLDERS LIMITED

MELLIER HOUSE, ALBEMARLE STREET, LONDON, W.1.

Tel.: REGent 1411

Taylor
for the best in test equipment

MODEL
110A

The **TAYLOR**
A-C BRIDGE

These instruments give quick and accurate measurements of Capacity and Resistance. There are six Capacity ranges covering from .00001 to 120 mfd. and the Power factor can also be measured on each range. Six Resistance ranges are available measuring from 1ohm to 12 megohms. This bridge is A.C. mains operated and a leakage test is also available for detecting leaky paper or mica condensers.

Six Ranges of CAPACITY
Six Ranges of RESISTANCE



PRICE **£14.14.0**

We also manufacture a complete range of Radio Test Equipment, including Multirange Instruments, Signal Generators, Valve Testers, Output Meters, Insulation Testers, Circuit Analysers, Oscilloscopes, A.C. Measuring Bridges and Ohmmeters: also Moving Coil Instruments with scale lengths from 2" to 5".

Please write for technical brochure to:—

Taylor Electrical Instruments Ltd.

419-424 MONTROSE AVENUE, SLOUGH, BUCKS.
Tel: SLOUGH 21381 (4 lines) Grams: TAYLINS, SLOUGH

ROTHERMEL

HIGH FIDELITY PIEZO-ELECTRIC PRODUCTS
available from stock.

- PICKUPS
- MICROPHONES
- HEADPHONES
- THE HUSHATONE
- DEAF AID MICROPHONES
- CONTACT MICROPHONES
- A.C. AMPLIFIERS

Also the new ROTHERMEL GENUINE SAPPHIRE High-Fidelity Gramophone Needle—over 2,000 playings.

Send for Informative Literature on all ROTHERMEL Products.

★ **TWO NEW AMPLIFIERS**

For many years R. A. ROTHERMEL has made intensive research in Amplifier design and we present with confidence two new A.C. Amplifiers, the VR/2 4½-watt and the HG/308 8-watt, which have been specially designed for use in connection with all types of Crystal Microphones and Crystal Pickups. They are compact, robust, and represent the ultimate in design, workmanship, material, and quality of reproduction.

Write for Bulletin.

R. A. ROTHERMEL LTD.,
ROTHERMEL HOUSE, CANTERBURY ROAD, KILBURN, N.W.6.
Telephone: MAIDA VALE 6066 (6 lines).



5mmf/ft

NEW LOW LEVELS in capacity and attenuation of CO-AX Cables mean new possibilities in electronic equipment design both for the war effort and for the post-war electronic age.

Write for characteristics

BASICALLY BETTER
AIR-SPACED

CO-AX LOW LOSS CABLES

TRANSRADIO LTD. 16 THE HIGHWAY, BEACONSFIELD, 4-BUCKS.

PREMIER RADIO COMPANY

MORRIS & CO. (RADIO) LTD.

ALL POST ORDERS to 167 LOWER CLAPTON RD., LONDON, E.5. 'Phone : Amherst 4723
 ALL CALLERS to 169 FLEET STREET, LONDON, E.C.4. 'Phone : Central 2833

Send 2½d. stamp for our September, 1946 list

Terms of Business : Cash with order or C.O.D. over £1

MIDGET RADIO KIT. Build your own Midget Radio. A complete set of parts, including valves, loudspeaker and instructions. In fact, everything except cabinet necessary to build 4-valve Medium and Long Wave T.R.F. Radio operating on 200-250 v. Mains, A/C or D/C. Valve line-up, 6K7, 6J7, 25A6, 25Y5. Wavelengths covered 200-557 and 700-2,000. Size 10 x 6 x 6in. Completely drilled chassis. Price, including tax, **£3 17s. 6d.**

An attractive bakelite cabinet can be supplied at 25/- extra or wired and tested in cabinet. Price **£10 18s. 6d.**

SUPERHET MIDGET RADIO KIT. A complete kit of parts for a 5-valve superhet. Covers 16-50 and 200-557 metres. AC/DC 200-250 v. 6K8, 6K7, 6J7, 25A6, 25Y5. Size 10 x 6 x 6in. Completely drilled Chassis. Price, including tax, **£3 5s.**

An attractive bakelite cabinet can be supplied at 25/- extra.

1947 MODEL COLLARO MICROGRAM. A super quality 3½-watt amplifier contained in a neat leatherette-covered portable carrying case, with a quality Electric Motor, Pick-up and Loudspeaker incorporated. Just the thing for quality record reproduction. Price, **£20 10s. 8d.**

DENCO C.T.I. TURRETS. Completely wired and aligned tuning packs, complete with tuning condenser. 16-50, 200-550, 800-2,000 metres. Available for 1.6mc or 4.5 k/c. Price **55/-**.

DENCO C.T.3 TURRETS. Completely wired and aligned tuning packs, complete with 3-Gang Condenser, Dials and Knobs. Covers 10-2,000 metres in five bands. Incorporates an R.F. stage and band spread. All Denco packs incorporate Polystyrene Coil Formers, Iron Cores, Low loss Wavechange Switches. Price, **£6 8s.**

PUSH-BUTTON UNITS. 5-way. Each switch is S.P.D.T. or S.P., one make, one break. Complete with push-button and Escutcheon plate. **5/-**.

VIBRATOR PACKS. With complete smoothing. 12 volts input, output 150 volts, 40 m.a. Contained in neat steel case, and is combined with a single valve amplifier. (No valve supplied.) Price, **35/-**.

MAINS TRANSFORMERS. Government surplus, super quality. All 230 volts input.

Type 1.—4-volt 10 amps, twice. **15/-**.

Type 2.—40 volts 2 amps. (Excellent for rewinding). **15/-**.

Type 3.—600-0-500, 150 m/a, 4 v. 2½ a., 4 v. 1 a., 4 v. 5 a. **35/-**.

Type 4.—865-0-865 v. Tapped at 780 and 690 v. 500 milliamps. Complete with L.T. trans. for rect. heaters, 4 v. 3-8A twice. Price, **£5.**

Type 5.—450-0-450. Tapped at 300 v. 150 m/a, 4 v. 3-5 a., 4 v. 3-5 a. **30/-**.

Type 6.—15 v. at 60 amps. Tapped at 13.5 14 and 14.5 v. L.T. winding easily stripped for rewinding up to 1 kilowatt. Price, **40/-**.

Type 7.—6.3 v. 1-2 a., 4 v. 10a., 4 v. 10a., 4 v. 10a., 10 v. 8 a. **30/-**.

TRANSFORMERS. 70-watt size. Useful for laminations. Only 4/- each. 40/- per dozen. Special quotations for large quantities.

SHORT-WAVE CONDENSERS. High-grade Ceramic Insulation. Super Midget type. Single ganges available in 10, 20, 50, 75, 100 P.F. (75 P.F. has double spindle for ganging). Price **2/6**.

2-GANG, in 4.8, 9.6, 27.1, 50, 75 P.F. Price **5/-**.

2-GANG. Full size, 160 P.F. Price **5/-**.

CYLINDR 3-GANG. 50 + 50 + 25 P.F. Price **5/-**.

AIR-DIELECTRIC CERAMIC TRIMMERS, 25, 50, 100 P.F. Price **1/-**.

PHILLIPS AIR-DIELECTRIC CONCENTRIC TRIMMERS 8 P.F. and 30 P.F. **1/-** each.

WAVE CHANGE SWITCHES. Available with any of following Wafers. 2-pole, 3-way; 3-pole, 3-way; 4-pole, 2-way; 2-pole, 4-way; 1-pole, 4-way, with shorting bar; 2-pole, 5-way. 1-GANG, 4/- 2-GANG, 5/6; 3-GANG, 7/-.

SUPERHET TUNING PACKS. Completely wired and aligned. 13-40, 40-120, 190-570 metres. R.F. stage, 465 k.c., 9 connections only. Complete with 3-gang Condenser, calibrated, engraved Perspex dial, and 8/M drive. Litz wound polystyrene insulation permeability tuned I.F.'s, 7 k/c bandwidth. Price complete, **£3 17s. 6d.**

RADIOGRAM CABINETS



Dignified appearance and good workmanship. Size, 34½in. high, 19in. deep, 36in. wide. Cabinet only **£26**, with motor and pick-up, **£32 16s.**

FIVE 5-VALVE SUPERHET RADIO. Employ CCH35 EF39, EBC33, CL33, CY31 valves; operate on 100-250 volts AC/DC mains. Cover 13-40, 40-100, 200-550 metres. Gram position on wavechange switch. EXT 1/3 terminals, 8-inch energised Speaker; dial aperture 12 x 4in.; enamelled steel cabinet, 18in. high x 16in. wide x 9in. deep. Manufactured by Portogram Ltd., for Navy Welfare Centres. A fortunate purchase enables us to offer these fine sets at **£15 15s.**, including Purchase Tax. Packing and carriage 10/- extra. Strongly recommended as a Radiogram Chassis in conjunction with Cabinet, illustrated above.

PREMIER PEDAESTAL PLAYING DESK. A well-made mahogany finished pedestal Cabinet, containing a quality electric Gramophone motor, and pick-up in upper compartment, and record space in lower. Price **£18 18s.**, with crystal pick-up, 20/- extra.

BATTERY CHARGER KITS. Input 200/250v. A.C. output, charges 6 or 12 v. battery at 4 amps. Consist of trans., rect., var. res., and meter. Price **£3 15s.**

COLLARO PORTABLE RECORD PLAYERS. Consist of a super quality induction type gramophone motor 200-250 v. A/C with autostop and high-grade magnetic pick-up. Mounted in a leatherette carrying case. Price **£11 5s.** A few only. Delivery from stock.

MANBRIDGE TYPE CONDENSERS. Huge purchase of Military Surplus Paper Condensers. Super quality oil filled.

Capacity	Working Voltage	Size H	Price Each	Per Doz.
2 mf.	1,000	4½ x 1½ x 1	2/6	20s.
2 mf.	600	3½ x 1½ x 1	1/9	14s.
1 mf.	600	2½ x 1½ x 1	1/-	8s.

TYPE 103. Rotary Transformer. Normal rating is 19 v. D/C input. Output 300 volts 30 m/a and 6.5 volts 3 a. D/C. By applying between 200 and 250 volt D/C to the H.T. output side, the two low-tension windings may be used to charge accumulators. The 19-volt side will charge a 6-volt accumulator at 2-3 amps, the 6.5 side a 2-volt accumulator at 1-2 a. With a 12-volt input to the 19-volt side, 180 v. at 30 m/a and 4 v. at 3 a. may be obtained. With a 6-volt input to the 6.5 side, 160 v. at 30 m/a may be obtained. By extending the spindle which is flush with the frame and applying 200 to 250 v. D/C mains to the 300 v. side, the unit becomes a powerful high-speed electric motor, suitable for small drilling machines, etc. Similarly, it may be used with 6 or 12 v. input to the 6.5 v. or 19 v. side. It employs a powerful ring magnet and is of substantial construction costing originally over £5. A fortunate purchase enables us to offer these fine units at 10/-.

TYPE No. 111. A Rotary Transformer designed for an input of 6 or 12 volts D/C. With 6 volts input the output is 200 v. 50 m/a. With 12 v. input the output is 480 v. 40 m/a. These ratings are continuous. This unit may be run for up to 3 hours with 12 v. input when 80 m/a may be drawn at 400 v. **20/-**.

TYPE No. 201. Input 24 volts, output 1,200 volts, 200 m/a. **£3.**

TYPE 100. A Rotary Transformer with completely smoothed output, contained in a soundproof metal screening box. Input 6 v. D/C, output 220 v. 50 m/a D/C. **£3 10s.**

TYPE 113. A Rotary Transformer input 6, or 12 volts. With 12 v. input, output is 600 v. 250 m/a with 6 v. input, output is 300 v. 200 m/a. **£3.4**

TYPE 114. Input 12 v. D/C, output 230 v. 50 cycles A/C 30 w., **45/-**.

SILVER MICA CONDENSERS. Available in 2, 5, 10, 15, 25, 50, 80, 140, 200, 1,000, 1,600, 4,000 P.F. 9d. each, 7/6 dozen.

COMPLETE 1-VALVE LISTENING POST. Consists of 1-valve Receiver completely wired with coils covering 12-170 and 255-550 m. Valves, Headphones, Dry Batteries, Aerial Wire. Nothing else to buy. **£3 17s. 6d.**

2-VALVE, SHORT-WAVE BATTERY KIT. A complete kit of parts for a 2-valve receiver, covering 15-600 metres, including valves, coils, drilled chassis, H.T. and L.T. dry batteries to last approximately 6 to 12 months. A pair of double headphones and full instructions. Price **£3 10s.** An extra coil can be supplied, covering 600-1,900 metres at 4/-.

ALUMINIUM CHASSIS. Substantially made of bright aluminium, with four sides.
 7 x 3½ x 2½in. ... 4/6 9½ x 4½ x 2½in. ... 5/6
 10 x 8 x 2½in. ... 7/- 12 x 8 x 2½in. ... 7/6
 14 x 9 x 2½in. ... 8/3 16 x 8 x 2½in. ... 8/6
 20 x 8 x 2½in. ... 10/6 22 x 10 x 2½in. ... 13/6

MOVING COIL METERS. By famous manufacturer. 500 microamps, 2in. diam., 500 ohms. **21/-**.

SPECIAL OFFER. P.M. SPEAKERS AT HALF USUAL PRICES. 4in., 17/6; 5in., 15/-; 6in., 17/6; 8in., 20/-.

OUTPUT TRANSFORMERS for above. 6/-.
SUPER HEADPHONES. Corrugated aluminium diaphragms driven by balanced armature units, with nickel alloy magnets. The finest obtainable. Cost originally over £2.
 60 ohms Resistance. **5/-** per pair.

MATCHING TRANSFORMERS, if required. **2/6**.

POWER PACKS. Complete with 2 H.W. rect. valves, and all smoothing. In steel cabinet. Output 650 volts, 100 m.a. Price **50/-**.

VIBRATORS. 4-pin, 6 or 12 volt. Price **12/-**.

TRANSFORMERS for same. 250 v. 60 m.a. **12/6**.

VALVES AT LESS THAN HALF PRICE. 02A, 7/6; 6K6, 6/-; 6P6, 6/-; EL35, 7/6.

PREMIER MAINS TRANSFORMERS. All primaries tapped 210-230-250 v. All LT's centre tapped. All have screened primaries.

Output	Price
175-0-175 v. 50 m/a, 6.3 v. 2-3 a. 5 v. 2 a.	25/-
175-0-175 v. 50 m/a, 4 v. 1 a. 4 v. 2-3 a.	25/-
250-0-250 v. 60 m/a, 6.3 v. 2-3 a. 5 v. 2 a.	25/-
250-0-250 v. 60 m/a, 4 v. 1-2 a. 4 v. 3-5 a.	25/-
300-0-300 v. 60 m/a, 4 v. 2-3 a. 4 v. 3-5 a. 4 v. 1-2 a.	25/-
350-0-350 v. 100 m/a, 5 v. 2-3 a. 6.3 v. 2-3 a.	29/-
350-0-350 v. 100 m/a, 4 v. 2-3 a. 4 v. 2-3 a. 4 v. 3-5 a.	29/-
350-0-350 v. 150 m/a, 4 v. 1-2 a. 4 v. 2-3 a. 4 v. 3-5 a.	36/-
350-0-350 v. 150 m/a, 4 v. 2-3 a. 4 v. 3-5 a. 4 v. 1-2 a.	39/-
4 v. 1-2 a.	39/-
350-0-350 v. 150 m/a, 5 v. 2-3 a. 6.3 v. 2-3 a. 6.3 v.	36/-
2-3 a.	36/-
425-0-425 v. 200 m/a, 4 v. 2-3 a. 4 v. 2-3 a. 4 v. 3-5 a.	47/-
425-0-425 v. 200 m/a, 6.3 v. 2-3 a. 6.3 v. 2-3 a. 5 v.	47/-
2-3 a.	47/-
500-0-500 v. 150 m/a, 4 v. 2-3 a. 4 v. 2-3 a. 4 v. 2-3 a.	47/-
4 v. 2-3 a. 4 v. 3-5 a.	47/-
500-0-500 v. 150 m/a, 5 v. 2-3 a. 6.3 v. 2-3 a. 6.3 v.	50/-
3-5 v.	50/-
500-0-500 v. 250 m/a, 5 v. 2-3 a. 6.3 v. 2-3 a. 6.3 v.	65/-
3-5 a.	65/-
300-0-300 v. 120 m/a, 5 v. 2-3 a. 6.3 v. 3-4 a.	28/-
300-0-300 v. 120 m/a, 4 v. 2-3 a. 4 v. 2-3 a. 4 v. 3-5 a.	28/-
375-0-375 v. 250 m/a, 6.3 v. 2-3 a. 6.3 v. 3-5 a. 5 v.	46/-
3 a.	46/-
375-0-375 v. 250 m/a, 4 v. 2-3 a. 4 v. 2-3 a. 4 v. 3-5 a.	46/-
750-0-750 v. 250 m/a.	67/6
1,000-0-1,000 v. 200 m/a.	70/-

U.I.C.

*Metallised
Ceramics*

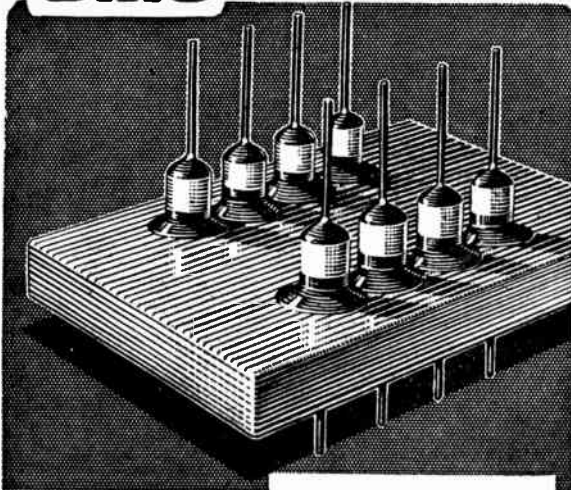

We specialise in the production of all types of Metallised Ceramic components — Hermetic Seals, Sealed Lids, Tag Boards, Bushes, Formers, etc. These are available in soldered, coppered or silvered finish, according to requirements. The suitability of any finish is a matter which we shall be pleased to discuss.

**HERMETIC SEAL
TYPE HS 421**

Flashover Voltage over outside path. 4.5 KVDC at 20° C.
Flashover Voltage over inside path 3.5 KVDC at 20° C.
Small size. Close assembly. Physically robust.



Components made to standard design or to customers' specific requirements. Write for details.

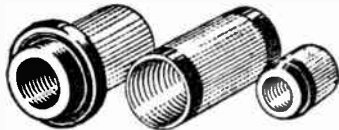

UNITED INSULATOR CO. LTD
Oakcroft Rd., Tolworth, Surbiton, Surrey
Telephone: Elmbridge 5241 Telegrams: Calanel, Surbiton

Unsurpassed In Ceramics

M.R. SUPPLIES Ltd.

Not only brand new and guaranteed material, with immediate delivery from stock. All prices nett.

EX-ARMY NO. 38 TRANSMITTER/RECEIVERS (Walkie Talkie). Range up to 10 miles. Wavelength 7.3 to 9 m/c. (approx. 30/40 metres), compact infantry type. Items sold separately: Transmitter/Receiver with valves, 55/- (despatch 8/-); box of 3 spare valves, 17/6; Throat Microphone, 10/-; Headphones with plug, 10/-; Telescopic Aerial in case, 7/6. The complete station (less 120 v. and 2/3 v. battery), 25 (despatch 5/6).

"FUZZY" WIRE JOINTERS. A large purchase enables us to present this opportunity. This very useful S.T.C. product electrically welds all gauges of wire from 50 to 30 a.w.g. (copper and resistance) instantly. No solder or flux, no dry-bright. Operation 200/250 v. A.C. Equipment comprises well-housed portable transformer, hand-tool with carbon electrodes and trigger, leads, ready for use. Further details, if required, but supply limited. 78/6 complete (des. 2/6).

MINIATURE COMMUNICATION RECEIVERS (M.C.R.1). An unbeatable M.R. offer. The 5-valve superhet in metal case approx. 9in. by 3in. by 2in., A.C./D.C. Power Pack in same size case, two H.T./L.T. Batteries (one spare), four coil units, headphones, aerial and earth, complete, universal and mobile, brand new in a hermetically sealed container, £10 (carr. 4/6). (The tuning ranges are: 188/3000 metres, 60/120 metres, 28/67 metres, 20/38 metres.)

MINIATURE PIEZO-CRYSTAL MICROPHONES (Rothermel-Brush). Only 1 1/4in diameter, with 5 megohm loading incorporated, made for deaf-aids but suitable for all m/c purposes. 29/6.

DIMMERS for Stage Lighting. Fully enclosed, with slow motion drive and hand-wheel, carbon break flicker-switch, rated to control stated load from full-bright to blackout at 220/240 v. 500 watts, 78/6 (des. 3/6); 1000 watts, 27/2/6 (des. 4/6); 1500 watts, 28/12/6 (des. 5/-); 2000 watts, 29/15/0 (des. 6/-).

PRECISION VOLTMETERS, 3 1/4in. flush panel rectified m/coil, 0/250 v. A.C. (in large demand at present for checking mains voltage), 76/6.

D.C./A.C. CONVERTERS, newest Vibrator types, for radio, radiograms, television, amplifier, etc. Silent in operation, fully smoothed output, trouble-free and guaranteed. 200/240 v. D.C. to 200/240 v. A.C. 50 cycles: 200-watt, 21/2 (des. 3/-); 100 watts, 29 (des. 2/-). NOTE: If for television we recommend the 75 cycle model, 200 watts, same price.

S.T.C. TOGGLE PRESSSES, Senior and Minor models again in stock. Double-acting, space-saving, precise tool suitable for all pressing operations in many trades. Senior, wt. 130 lbs., pressure 1 1/2 tons, £30; Minor, wt. 80 lbs., pressure 0.75 ton, £24/15/0 (prices ex this address).

L.T. RECTIFIERS (S.T.C.) for charging up to 12 v., all full-wave: 1.5 amp, 12/6; 4 amp, 22/6; 6 to 8 amp, 39/6. Suitable tapped sec. Mains Transformers to suit the 1.5 a. rect., 22/-; 4 a., 32/6; 8 a., 51/6.

ROTARY REGSTATS, with 3 1/4in. control knob, 3-hole mtg., 4 ohms 4.5 amp, 25/6; 115 ohms 1 amp, 25/6; 10 ohms 3 amps, 28/6, and others.

ROTHERMEL PIEZO-CRYSTAL PIECE-UPS. Replacement heads for Garrard or Collaro arms. Much improved performance, minimum record wear. 48/11.

ROTHERMEL SAPPHIRE GRAMO NEEDLES, the best permanent needle for any pick-up, 12/6 each.

VOXELION AMPLIFIERS. Ex stock. The new A.C. Mains/12 v. D.C. 15-watt Power Amplifiers. This compact, useful model has inputs for m/c m/c, any type pick-up and output matching for 7.5 and 15 ohms, fitted vol. and tone controls, steel housed 18in. by 9in. by 7in., £28 (des. 2/-).

Please include sufficient for packing and despatch.

M.R. SUPPLIES Ltd., 68, New Oxford Street, London, W.C.1.

Telephone: MUSEum 2959

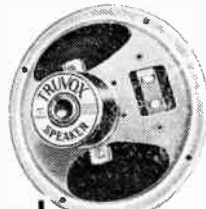

- Entirely new patented construction with single bolt fixing of components concentrically locates the chassis and complete magnet assembly.

- Brass centring ring prevents magnet being knocked out of centre.

- Special magnet steel gives powerful flux with compactness and light weight.

Pioneers in public address loudspeakers, TRUVOX now introduce a range of permanent magnet radio speakers of unique and very efficient construction under the name "MONOBOLT". First supplies, in 5", 6 1/4", 8" and 10" sizes, will be available to the radio amateur early in the New Year.

- Speech coil connections carried to suspension piece, ensuring freedom from rattles, cone distortion and cone tearing.

- Clean symmetrical surfaces, no awkward projections.

- Speech coil and former bakelised to prevent former distortion and speech coil turns slipping or becoming loose.

- Two point fixing to the suspension piece with four point suspension for the speech coil.

- Widely spaced fixing points for the suspension permit maximum movement of the cone, producing the lowest response physically obtainable from each size of speaker.

TRUVOX
ENGINEERING CO. LTD.

TRUVOX HOUSE, EXHIBITION GROUNDS, WEMBLEY, MIDDLESEX.

PAINTON *of* NORTHAMPTON *for* **STUD SWITCHES**

These robust instrument quality switches have applications in audio-frequency and small power circuits and are designed for long life and trouble-free service

Consistent self-cleaning contact is obtained through a wiper arm comprising two or three independent laminations. The contact studs and wiper arms are made of Beryllium copper, a material which offers extreme durability and exceptionally low contact resistance of the order of 0.001 ohms.

The range is comprehensive. Units are available having up to four poles and fifty steps, either singly, or in ganged sets operating from a common shaft.

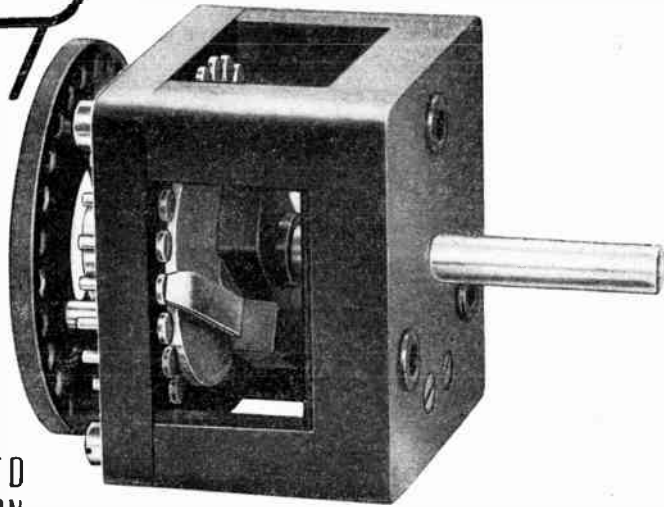

PAINTON & COMPANY LTD
KINGSTHORPE NORTHAMPTON

WESTINGHOUSE **WESTALITE** **H.T.** **RECTIFIERS**

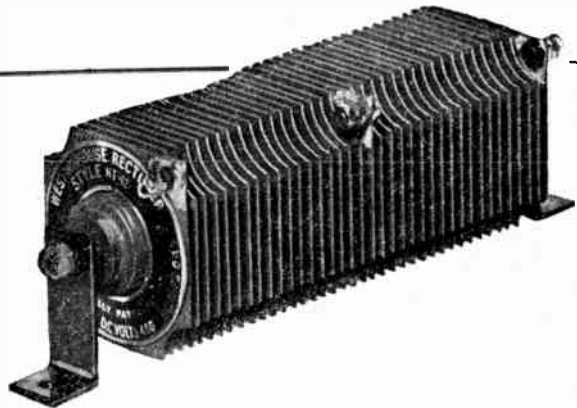

FOR

- A.C. Eliminators and Receivers.
- A.C./D.C. Eliminators and Receivers.
- Conversion of D.C. Battery Eliminators.
- Conversion of D.C. Mains Receivers.
- Operation of moving-coil loud-speakers.

Write to Dept. W.W. for Data Sheet No. 24.

WESTINGHOUSE BRAKE & SIGNAL CO., LTD., 82, York Way, King's Cross, London, N.1

No. 2

CLIX

**RADIO & TELEVISION
COMPONENTS . . .**

**. . . ARE USED BY
ALL THE LEADING SET MANUFACTURERS**

**BRITISH MECHANICAL PRODUCTIONS LTD.
21 BRUTON ST., LONDON, W.1**

Telephone : MAYfair 5543

Foremost in Valveholder design

POINTS OF LOW CONTACT RESISTANCE IN CIRCUIT DESIGN OF MINIATURE RECEIVERS

B7G MINIATURE LAMINATED VALVEHOLDER

For use with
1T4, 1R5, etc.,

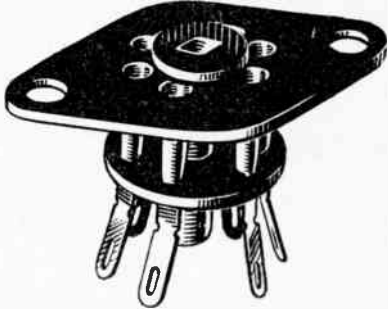

Designed with 7 special sockets giving extremely low contact resistance and ensuring positive location of pins. Tags and centre screen pre-tinned. Fixing centres .875, Hole Dia. .100.

PLATE DIMENSIONS
Major axis 1.093
Minor axis .680

for mounting either above or below chassis.

RM

ELIMINATOR TRICKLE CHARGER TYPE M.A.C.2.

Input. 200-250 v. A.C.

Output. H.T. 125 v.
15 m.a. Charging. 2v. $\frac{1}{2}$ Amp.

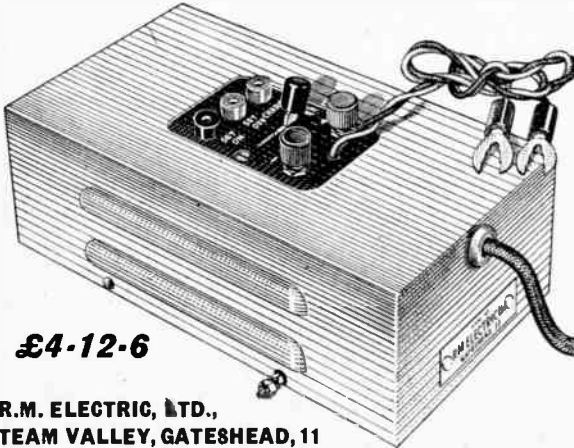

£4-12-6

**R.M. ELECTRIC, LTD.,
TEAM VALLEY, GATESHEAD, 11**

CLARITY



PERSONIFIED

**WITH THIS SENSITIVE
GRAMPIAN MIKE**

The Grampian M.C.R. Type Microphone reproduces voices with that crystal clearness which gives full value to every word and accentuates the "personality" of the speaker. Those who still have "make do" microphones on their P. A. Systems should take advantage of this up-to-date, highly sensitive model which Grampian are now in a position to supply. The M.C.R. is mounted in a spring suspension frame with the Unit Assembly housed in cast metal case. In crinkled black and nickel standard finish. Write for details now.



Type M. C. R. Frequency Range 80-7,500 cycles. Sensitivity Minus 45 d.b. Impedance 20 ohms. Size 2½ ins. by 3½ ins. frame. 6 ins. square with Base Adaptor threaded $\frac{1}{8}$ ins. B.S.F. weight 3½ lbs. List £5 - 0 - 0

GRAMPIAN

LOUDSPEAKERS

GRAMPIAN REPRODUCERS LTD. Hanworth Trading Estate, Feltham, Middlesex
Phone : Feltham 2657 Telegrams : Reamp, Feltham.

Scientific Gxz

**THE
COSSOR
HIGH VACUUM
DOUBLE BEAM
OSCILLOGRAPH**

giving

VISUAL TWO-DIMENSIONAL
delineation of any recurrent law.

RELATIVE TIMING OF EVENTS
and other comparative measurements
with extreme accuracy.

PHOTOGRAPHIC RECORDING
of transient phenomena

and

SIMULTANEOUS INDICATION
of two variables on a common time axis.

Completely embracing all the above functions, of which the last is unique, the Cossor Double Beam Oscillograph is inherently applicable to all problems arising in

RECORDING, INDICATING & MONITORING
when the effects examined can be made available as a voltage.

**A. C. COSSOR LTD.,
INSTRUMENT DEPT.,**

HIGHBURY, LONDON, N.5

Phone: CANonbury 1234 (30 lines)
Grams: Amplifiers, Phone, London

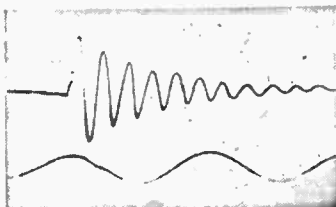

DID YOU READ

Wireless World July, 1946

Test Report

SOBELL Type 615

A.C. Table Model Superhet
(Five Valves + Rectifier)

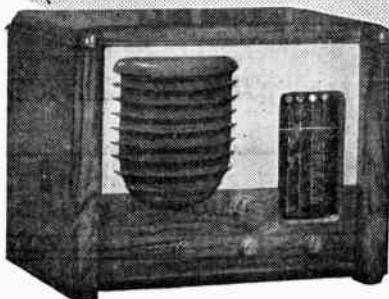

The following are brief extracts from a report which appeared in the July 1946 issue of "Wireless World" on the Sobell 615 6-valve A.C. Table Model Superhet :-

"The quality of reproduction is decidedly above the average for a table model . . . The lower register has breadth and an extended top response gives clarity and brightness without being shrill . . . With two I.F. stages there is no lack of sensitivity and the selectivity is exceptionally good. The division of the short-wave range into two parts gives a degree of band spread which makes for ease of tuning and both ranges provide a wide choice of stations. The sensitivity is well maintained at the high-frequency end . . . The chassis is of ample size and components are well spaced . . . The finish of the cabinet work is of a high order . . . The set is backed by a comprehensive free maintenance scheme for two years. In the event of breakdown the fault will be remedied or the chassis changed on the spot by one of the maker's servicemen"

Price 24 Gns., plus £5. 8. 4d. purchase tax.

SOBELL RADIO

TWO YEARS' FREE ALL-IN SERVICE IN THE HOME

SOBELL INDUSTRIES LTD., LANGLEY PARK, NR. SLOUGH, BUCKS.

A WOMAN'S INTUITION IS NOT ENOUGH

A woman's intuition will not help you to find a difficult fault in a wireless set. The easiest and quickest way to locate the trouble is to use a Weston Model E772 Analyser which is designed for systematic analysis. Its features include high sensitivity—20,000 ohms per volt on all D.C. ranges—wide range coverage, simplified controls, accuracy and robust construction. You will find this instrument universally useful—it will save you time, trouble and money and it is really reliable—it's a Weston.

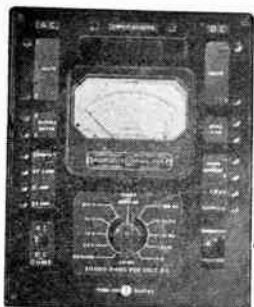

SYSTEMATIC SERVICING STARTS WITH A **WESTON**

SANGAMO WESTON LTD., ENFIELD, MIDDX. Telephone: Enfield 3434 & 1242

JUST RECEIVED !!!

BRAND NEW AMERICAN SINGLE BUTTON CARBON BREAST ASSEMBLY

Beautiful job. Ribbed aluminium diaphragm. Bakelite case. Complete with 3 position switch.

PRICE 9/6

Extra 3-position control switch with 10 ft. length 3-core flexible T.R.S. cable for above.

PRICE 3/6

Both the above items still in maker's sealed cartons.

MOVING COIL MICROPHONE & HEADPHONE ASSEMBLY

(Approx. Impedance of each unit 48 ohms) Microphone has "Press to talk" switch; worth £8.

Complete 15/6

Moving Coil Hand Mike with switch.

PRICE 6/6

Moving Coil Assembly in bakelite case with 3" grill. Can be used as midget speaker.

PRICE 4/6

(All above units have genuine Alni magnets.)

STRATTON MICRODENSERS (Eddystone)

Code E18. 18 mmfd triple spaced, 3/9. E40. 40 mmfd double spaced, 4/3
Code E60. 60 mmfd single spaced, 4/3. E100. 100 mmfd single spaced, 4/6

YAXLEY TYPE SWITCHES

Double pole 6-Way. Ideal meter or multi band switches - - - 2/6
Three pole 3-Way. 2 Wafer 3/6 Double pole 4-Way. 3 Wafer 3/6

SEND S.A.E. FOR DETAILS OF NUMEROUS OTHER INTERESTING BARGAIN LINES.

RADIOMART
GENT (HAM) LTD.

ASK FOR LIST No. 4
Telephone: Midland 3254

48 HOLLOWAY HEAD, BIRMINGHAM, 1

BSR

SOUND SYSTEMS AT THE

BIF

STAND No. C.1517, OLYMPIA HALL, LONDON

DISC RECORDING

We shall be demonstrating our new Disc Recorder and Recording Amplifier at the BIF, and the entire range of BSR sound equipments, which will include many new features, will be available for your inspection.

Home Trade and Overseas Visitors are cordially invited to our exhibit and well-informed people will make the BSR stand their rendezvous—a wise move towards "Sound Understanding."



BIRMINGHAM SOUND REPRODUCERS LTD.

CLAREMONT WORKS, OLD HILL, STAFFS. TEL: CRADLEY HEATH 6212-3
LONDON OFFICE: 115 GOWER STREET, W.C.1. TEL: EUSTON 7515

There is a TANNOY SPEECH BROADCASTING INSTALLATION to suit your requirements



TANNOY
 CALL SYSTEMS CREATE EFFICIENCY!

"Tannoy" is the registered trade mark of equipment manufactured by

GUY R. FOUNTAIN, LTD.

"THE SOUND PEOPLE"

West Norwood, S.E.27, and Branches
 Gipsy Hill 1131

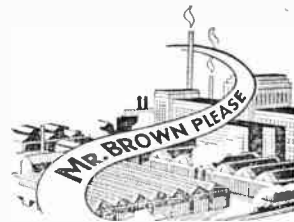
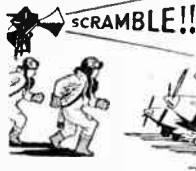

The largest organisation in Great Britain specialising SOLELY in Sound Equipment

**SCIENTISTS DEMAND . . .
 SCIENTISTS BUILD . . .**

Wego CAPACITORS

No matter what your problem in Radio or Electronics, we will create the Capacitor to fulfil your exacting demands and specification. Our technical and scientific advice is at your disposal.

WEGO CONDENSER COMPANY LIMITED
 BIDEFORD AVE · PERIVALE · GREENFORD · MIDDX · Tel. PERIVALE 4277





BALL DRIVE

- SMOOTH, RELIABLE & VERY POWERFUL
- Epicyclic friction drive, ratio 6 : 1
- May be used to increase ratios on other drives or attached direct to component spindle ($\frac{1}{2}$ " shaft).

[PRICE 3/3 RETAIL



JACKSON

BROS (LONDON) LIMITED
 KINGSWAY · WADDON · SURREY
 TELEPHONE: CROYDON 2754-5 TELEGRAMS: WALFILCO, PHONE, LONDON

Specialists in 'SPECIAL' Waxes

Most applications of wax in the manufacture of electrical components demand special characteristics which can be met from the regular range of

OKERIN WAXES & COMPOUNDS

or designed to specification. Grades are available for arctic or tropical service—stable, moisture-proof—fungi-resisting.

For expert advice, samples, etc., please
 Telephone TEMple Bar 5927

ASTOR BOISSELIER & LAWRENCE LTD.

(Sales Dept.)

Norfolk House, Norfolk St., Strand, London, W.C.2

TYPE SSTR — SQUARE LAW.

"Cyldon" TRANSMITTING Capacitors

SYDNEY S. BIRD & SONS, LTD.
 CAMBRIDGE ARTERIAL ROAD, ENFIELD, MIDDX.
 'Phone : Enfield 2071/2. 'Grams : "Capacity, Enfield."

Perfect P.A. amplification

Ardente have the most modern Public Address systems—fixed or mobile—for EVERY purpose, indoor or out. Combining technical quality with attractive appearance, the wide range available represents the very finest P.A. equipment obtainable to-day. Simple to operate; easy to instal.

By **Ardente**

● Write for trade terms direct to Sales Dept. TW.

ARDENTE ACOUSTIC LABORATORIES LTD.
 London Office : 309, Oxford St., W.1. Mayfair 7917-8.
 Works : GUILDFORD, SURREY. Guildford 3278-9.



Clear as a
Crystal

AND HERE IS THE REASON . . .

. . . the answer has been found in Bullers Low Loss Ceramics to the problem of Dielectric Loss in High Frequency circuits.

Years of Laboratory research and development have brought these materials to a high degree of efficiency. To-day they are in constant use for transmission and reception, and play a vital part in maintaining communications under all conditions.



Made in
Three
Principal
Materials

FREQUELEX

An Insulating material of Low Dielectric Loss, for Coil Formers, Aerial Insulators, Valve Holders, etc.

PERMALEX

A High Permittivity Material. For the construction of Condensers of the smallest possible dimensions.

TEMPLEX

A Condenser material of medium permittivity. For the construction of Condensers having a constant capacity at all temperatures.

BULLERS, LTD.
6, LAURENCE POUNTNEY HILL,
LONDON, E.C.4.
Telephone: Mansion House 9971 (3 lines)
Telegrams: Bullers, Cannon, London.

Bullers

LOW LOSS CERAMICS



LONDON CENTRAL RADIO STORES

EX-R.A.F. R1155 COMMUNICATION RECEIVERS
—NEW PURCHASE—

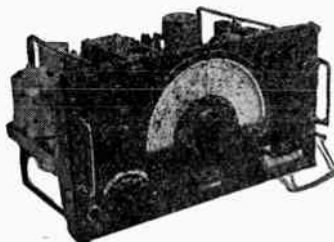

These sets are equal to new, need only a power pack for immediate use (see "W.W.," July, 1946). Freq. range, 7.5 mcs. or 1,500 kc., complete with 10 valves, including magic eye. Enclosed in strong metal l.o.c. Each receiver is aerial tested. **£17.10.0**

Carriage and packing 7/6 extra. No C.O.D.
POWER PACK 220-250 v. AC for above is available to CALLERS ONLY

EX-R.A.F. AIRBORNE G.P. TRANSMITTERS Type 1154

Complete with 4 valves. Frequency coverage; 600 kc/s, 200 kc/s, 10 mc/s, 3 mc/s, 2.35 mc/s, 8 mc/s, 2.5 mc/s. Power input 1,200 v., 200 m/a. H.T. 6 v. 4 amp. L.T. Chassis size, 15in. x 13 1/2in. x 8 1/2in. In metal cabinet, supplied in strong wood case, with metal bound corners and carrying handles, easily adapted amateur use. Less **£70.0**
Power Pack
Without Valves and Meters, 30/-.

Carriage and packing, 7/6 extra. No C.O.D.

Special Purchase TELEPHONE LINE or UNISELECTOR SWITCHES

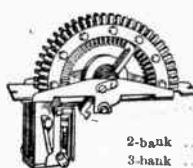

2- or 3-bank, 26 constants. Have various applications including automatic tuning, circuit selection, etc. Operates on 250/50 v.

2-bank 22 6
3-bank 25 -

SELF-ENERGISING TABLE MICROPHONE AND HEADSETS 24 1

The microphone is mounted on a fully adjustable stand with on-off switch. No batteries or current required to operate. UNUSED IN CARTONS 25 - per set. Two sets 47 6

EX-U.S. ARMY ULTRA LIGHTWEIGHT HEADSETS

Deaf-aid type earpieces 3/4 in. dia. with soft rubber ear fittings 100 ohms. Brand new 27/6 and packed

EX-GOVT. TELEPHONE HANDBETS

Self Energising. Needs no battery or current. Less wall bracket. Price per 30/- pair handsets

MOVING COIL INSERTS

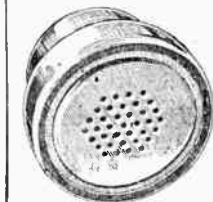

Can be used as Headphones Midget speakers (with transformer). Speech Mikes or adapted for Pick-ups. All new and perfect. Enclosed in metal 5/- case as shown. 3/6 Less case,

EX-ARMY REFLECTOR TYPE P.M. LOUD-SPEAKERS

In wood case, 9 x 9 x 7 1/2 in. 30/-

PLUGS AND JACKS
Per set, 2/9. Post 3d.

BIAS CONDENSERS
50 mfd., 12 v. wkg. 2 6

MIDGET CONDENSERS
3-gang, 0.00085 less trimmers 10 6

MINIATURE COMMUNICATION RECEIVER and POWER PACK. Type MRC1.

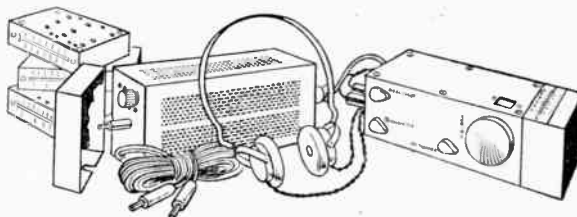

5-valve Superhet, using Midget valves (4, IT4s, 1, 1R5) for AC or DC mains, 97-250 volts 1 put. These sets are complete with aerial and earth equipment, lightweight headphones, mains lead, etc. Dimensions Receiver, 7 1/2 x 3 1/2 x 2 1/2 in. Power Pack, approx. same size. Range 100 kc/s-20 mc/s in four ranges. These sets are brand new, 10 Gns. ex-Govt., and sealed in metal containers, complete with operating instructions

All the above are available to the Trade. Write for terms.

Closed Thursdays 1 p.m. Open all day Saturday.

23, LISLE ST. (GER 2969) LONDON, W.C.2

The Connoisseur

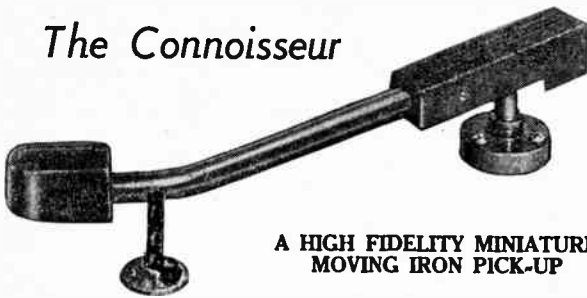

**A HIGH FIDELITY MINIATURE
MOVING IRON PICK-UP**

Faithful reproduction of all recordings from 12,000 c.p.s. to 30 c.p.s. will win many new friends for the CONNOISSEUR miniature moving iron Pick-up in 1947.

The CONNOISSEUR reveals a wide range of notes and instruments that has hitherto been hidden by bass and treble resonance. The CONNOISSEUR will reproduce every sound on the record. Try it and prove it.

Note new prices. Pick-up 54/- plus 11/8½ P. tax
Transformer 13/- nett

Apply to
Albion Electric Stores, 125, Albion Street, Leeds 1
or to
Lawton Bros. (Sales) Ltd., Henry Square, Ashton-under-Lyne

Made by
A. R. SUGDEN & Co, (Engineers) Ltd., Brighouse, Yorks



THE COMPLETE SERVICE FOR SOUND RECORDING AND REPRODUCTION

- ★ Mobile and Static Continuous Recording Outfits.
- ★ Recording Amplifiers.
- ★ Moving Coil and Crystal Microphones.
- ★ Sapphire Cutting and Reproducing Stylus.
- ★ Blank Recording Discs from 5" to 17" Single or Double sided.
- ★ Light-weight moving iron, permanent sapphire and "Lexington" moving coil pick-ups.
- ★ Label and Envelope Service.
- ★ A comprehensive range of accessories to meet every requirement of the sound recording engineer.
- ★★ And our latest development (of special interest to users of sapphire or delicate pick-ups)—The Simtrol.
This is a controlled micro-movement easily fitted for use with any type of pick-up to eliminate the danger of damage to the record or pick-up. This is achieved by a vernier lowering action of the pick-up head to the record.

Write for comprehensive lists or call at
Recorder House for demonstration.

**RECORDER HOUSE, 48/50 GEORGE ST.,
PORTMAN SQUARE, LONDON, W.1.**

Telephone: WEL 2371/2 Telegrams: Simsalo, Wesdo, London

A "Laboratory" INSTRUMENT... but NOT "Laboratory" Price!

The newest addition to the "Advance" range of Signal Generators places an instrument of laboratory class within the financial scope of every radio service engineer and experimenter.

The discerning engineer will appreciate its accuracy and stability, its exceptionally wide range which covers all frequencies required for radio and television receivers, and its accurate attenuating system which enables sensitivity measurements to be made on highly sensitive receivers up to 60 Mc/s. Send for fully descriptive pamphlet.

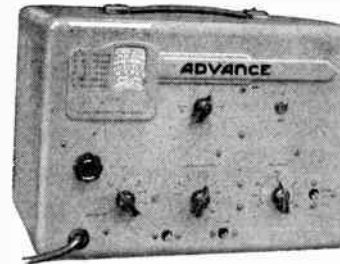

Price 19 Gns

Range: 100 Kc/s—60 Mc/s
on fundamentals (up to 120
Mc/s on Second Harmonic).
Accuracy:
Guaranteed within ± 1%
Attenuation: Constant impedance system embodying a matched 75 ohms transmission line.
Stray Field: Less than 3 microvolts at 60 megacycles.
Illuminated Dial:
Total scale length 30".
Power Supply:
110-210-230-250 volts.
Dimensions:
13" × 10½" × 7½" deep.
Weight: 15 lbs.

The New



ADVANCE COMPONENTS, LTD., Back Road, Sharnhall Street,
Walthamstow, London, E.17. Telephone: LARKSWOOD 4366/7

M. ALLEN (Radio) Ltd

113, CHARING CROSS ROAD,
LONDON, W.C.2

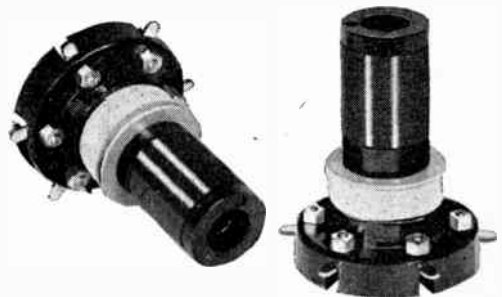

MAKE SURE YOU USE

"IVALEK"

Matched T.R.F. dual range coils

WHEN SET BUILDING

200-550 metres. 1,000-2,000 metres

A fine precision job. PRICE 9/- per pair.

Sent Post Free. Complete with circuit,
components for which can also be supplied.

Write for particulars of full range of
Radio, Television, Electronic, Electrical Instruments and components.
M. ALLEN (Radio) Ltd., 113, Charing Cross Rd., London, W.C.2.
Tel.: Gerrard 8734.

FIDELITY
EFFICIENCY

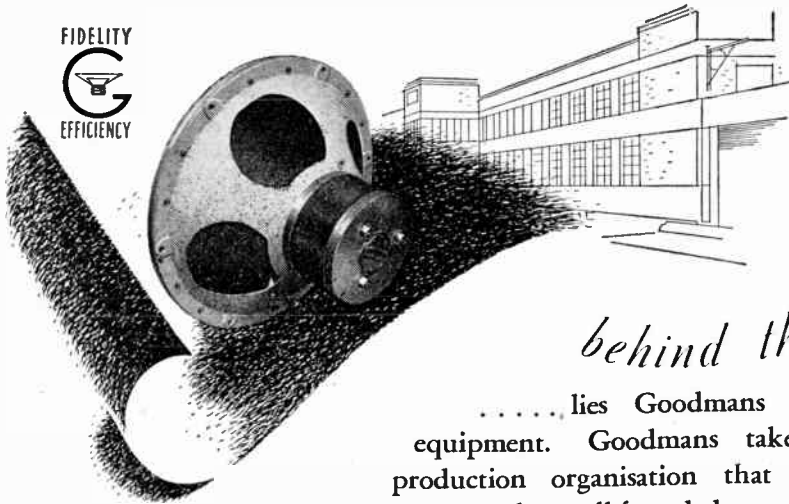

behind the blueprint...

..... lies Goodmans research, skill, craft and equipment. Goodmans take justifiable pride in a production organisation that faithfully interprets—for your service—the well-founded conclusions of their team of specialist acoustic engineers. That is why, Goodmans Loudspeaker performance is strictly “to specification,” why unflinchingly it conforms to published data. *The 15ins. illustrated, handles 25 watts of undistorted power.*

GOODMANS

Loudspeakers

GOODMANS INDUSTRIES LIMITED, LANCELOT ROAD, WEMBLEY, MIDDX.



Red Tape . . .

or white or green or purple. ‘Lassolastic’ is the ideal self-adhesive tape for all sealing, naming and identification purposes. No tools are needed to apply ‘Lassolastic’. Simply press on lightly with the fingers and it clings with a binding firmness to metal, wood, glass, plastics and any other smooth, dry material. ‘Lassolastic’ is resistant to water, oil and solvents. Being slightly extensible it moulds itself to hinges, seams, beadings and other irregularities. ‘Lassolastic’ thus forms a perfect air-tight seal for all types of food and chemical containers. It can be applied to cables and components for easy identification, or to furniture, toys and other articles as name tags.

Obtainable in a wide range of indelible colours, plain or printed to suit your own requirements. Printing cannot be erased. Further information on request.

LASSOLASTIC

REGD. TRADE MARK

Self-Adhesive Tape

SEALS • IDENTIFIES • LABELS



LASSO PRODUCTS (Proprietors HERTS PHARMACEUTICALS LTD.) Welwyn Garden City, Herts. Tel: Welwyn Garden 3333 (6 lines)

Remember-

Walter
U.K.A.

RADIO STAMPINGS **RADIO CHASSIS** **RADIO PRESSINGS**

FARM LANE, FULHAM, S.W.6. TELEPHONE: FULHAM 5234

from WHISPERING to SHOUTING

The R.S. TYPE 12 ABLY AND FAITHFULLY REPRODUCES

... what do you care whether he whispers with nervousness, or shouts with excitement into your Microphone, when you know that your R.S. Amplifier Type 12 will ably and faithfully 'put over' even the squeak of the mouse or the trumpet of the elephant, without loss of timbre or intonation. No more fearful moments for you with 'mike-unconscious' people or music which will 'blare' . . . the R.S. Type 12 takes care of all that. This amplifier is only a part of the R.S. completely new series of advanced Sound Equipment which you should know about . . . write to-day for full information.



**[MICROPHONES RADIOGRAMS
RADIO LOUDSPEAKERS
 AMPLIFIERS
 PORTABLE EQUIPMENT]**

R.S. Amplifiers Ltd., Reynolds Road, Acton Lane, London, W.4.
 Telephone: CHISWICK, 1011-3

Lexington

MOVING COIL PICK-UPS

The result of long experience and precision watch-making standards which give a finely constructed instrument.

DE LUXE MODEL. Robust design. Accidental dropping on record will not damage Pick-up. Extremely low moment of inertia (80 milligrams total weight of movement). Pure sine wave with no harmonic distortion. Automatic needle or sapphire changing opens new fidelity field to the amateur. Can be used with normal record changer without fear of damage. Price (without sapphire) £5. 10. 0 plus 24/6 P.T.

JUNIOR MODEL. Identical in design and workmanship to the De Luxe, the only difference being that it is not equipped with the Automatic Sapphire needle inserter and Extractor device and metal sole plate. Made to take standard steel and fibre needles this model enables every music lover to enjoy the fine reproduction which only a moving coil pick-up can give. £3. 9. 3 plus 15/5 P.T.

PLUG-IN HEADS. Available in both Junior and De Luxe types to fit Collaro and Garrard arms, thus providing easy change-over from Magnetic types. Input conversion may be required. (See our Technical Brochure.)

Price 49/6, plus 11/- P.T. Separate Ejector for De Luxe type 30/10 plus 6/10 P.T.

PRE-AMPLIFIERS having an inverse of the recording characteristic incorporated are available for use with Pick-ups. These are necessary with some amplifiers.

Price, Complete with Valve and Input Transformer £6. 1. 0.

Illustrated Technical Brochure upon request.
 Export and Trade Enquiries invited.

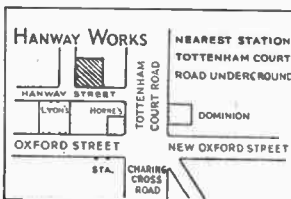

COOPER

MANUFACTURING CO.
HANWAY WORKS,
HANWAY ST., LONDON, W.1
 Telephone: MUSeum 9779
SALES OFFICES—Top Floor

A.I.S.

THE 40 COIL PACK
 Includes H.F. stage. 9 Iron-cored coils in All-wave Superhet circuit. 15-50, 200-550, 750-2,000 metres. For 465 Kc/s i.F. Aligned and tested before dispatch. Id. stamp brings price list.

Designed by creators of the Famous 30 coil pack.
Price 3 gns.

ALIGNED INSTRUMENTS SERVICES, 1, COLWORTH RD., LEFTTONSTONE, E.M.

Varley

REGD. TRADE MARK

THERMAL DELAY SWITCHES

Protect Your Radio Equipment

4 VOLT · 5 VOLT · 6.3 VOLT HEATERS

OLIVER PELL CONTROL LTD

Telephone: WOOLWICH 1422
CAMBRIDGE ROW · WOOLWICH S.E.18

RUBBER - TO - METAL BONDING

The Problem of Insulating delicate instrument panels from vibration and shock by means of Flexilant Mountings

"FLEXILANT" Mountings: Examples from the SERIES.

The "Flexilant" Mounting of which several varieties are illustrated here is so accurately made that its displacement under load can be calculated to within .010" of requirements. The series is designed to carry loads of from 1 to 45 lbs. per mounting and these may be arranged with bolt axis at 90° to position, or the complete mounting may be inverted. The mountings can be supplied with or without holder and they can be arranged so that two utilize the same bolt.

We should appreciate the opportunity of helping with your vibration problems.

RUBBER BONDERS Ltd.
Engineers in Rubber bonded to metal

FLEXILANT WORKS • WATLING STREET • DUNSTABLE, BEDS.
TELEPHONE: DUNSTABLE 803

TELEGRAMS: FLEXILANT, DUNSTABLE



R.B.L.

*Something new—
Something better...*

Two Models available
now

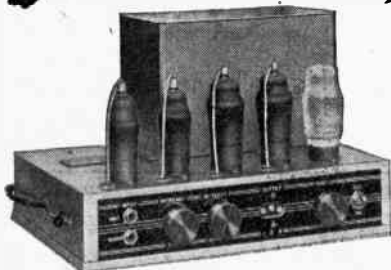

MODEL T.10 AMPLIFIER

Ideal for small or medium halls, cafes, clubrooms etc. AC or DC mains. 8/10 watts undistorted output. Separate inputs for Moving Coil microphone (matching transformer built into amplifier) and Crystal or Moving Iron gramophone pick-ups, separate MIC. and GRAM. volume controls. Overall dimensions 12½in. long, 7½in. high, 9in. wide. Guaranteed for 12 months, valves for 3 months. **PRICE COMPLETE** ready to operate **12 GNS.**

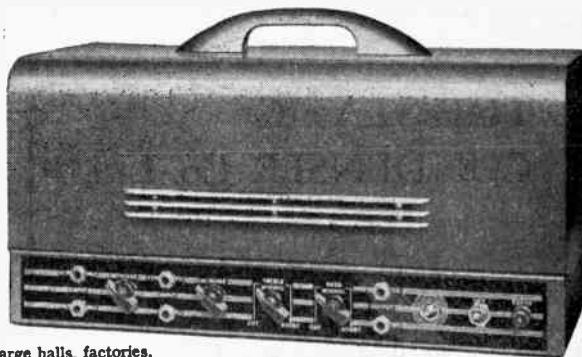

MODEL T.40 DE LUXE AMPLIFIER

For outdoor meetings, large halls, factories, etc. Superior in appearance, design and performance. 40 watts undistorted output. 4 separate matched inputs. Separate volume controls, electronic mixing, unique treble or bass tone control system.

Overall dimensions 18½in. long, 11in. high, 8½in. wide.

Guaranteed for 12 months, valves for 3 months.

PRICE COMPLETE, ready to operate **27 GNS.**

**AVAILABLE SHORTLY
AMPLIFIERS—IN STREAMLINED CASES.**

Model T.12 for AC/DC mains 12/15 watts output **12 GNS.**
MODEL T.25 for AC mains 200/250 volts 25 watts output **18 GNS.**
TABLE MODEL RADIO RECEIVER S63 AD. for AC/DC mains **22 GNS.**

"CRYSTATONE" DEAF AID UNIT

(Available Shortly)

Brings great enjoyment to those afflicted with hearing troubles. Genuine quality and value. Streamlined and pleasing in appearance, fits bag or pocket. Unbreakable plastic case.

Complete ready for use..... **10½ GNS.**

Full details on request.



OBTAINABLE FROM YOUR LOCAL DEALER AND IN CASE OF DIFFICULTY DIRECT FROM US. TRADE ENQUIRIES INVITED

REYNOLDS UNIVERSAL MANUFACTURING COMPANY LTD.

410, DUDLEY ROAD, EDGBASTON, BIRMINGHAM, 16.

Telephone: SMethwick 0201

OUR FIRST POST-WAR PRODUCT
THE ROMAC 106
"Personal" RECEIVER

£14 14 0 Complete, Plus P.T. £3 6 0

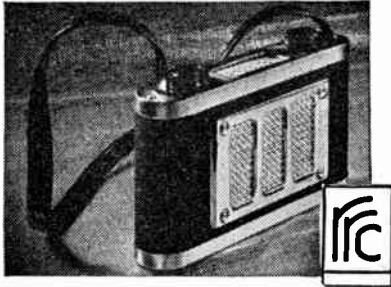

This Receiver was selected as an Exhibit at the "BRITAIN CAN MAKE IT" Exhibition.

Home and Export enquiries should be directed to:

ROMAC RADIO CORPN. LTD.
 THE HYDE · HENDON · LONDON, N.W.9.

PYROBRAZE

has been designed to meet the increasing demand for a universal and portable electric soldering and brazing machine

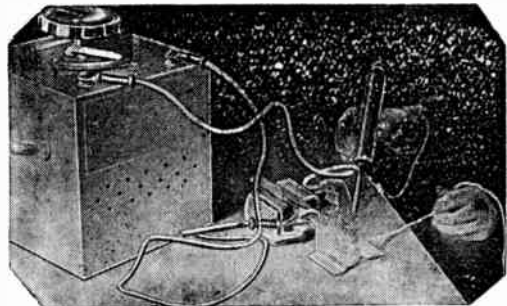

It is indispensable in every Factory or workshop where soldering has to be done.

PYROBRAZE 2 in operation

Solders heaviest gauges of all metals and even heavy castings, where every soldering iron fails.

Represents the latest development in contact soldering

Brazes up to 16 S.W.G.

The **ACRU**

ELECTRIC TOOL MANUFACTURING CO. LTD.,

Manufacturers of speciality Electrical Apparatus

123 HYDE ROAD, ARDWICK, MANCHESTER, 12

Tel: ARDwick 4284

**THE STATIC
 CONDENSER Co. Ltd.**

★ *Manufacturers of
 STATIC
 CONDENSERS*

**TOUTLEY WORKS,
 WOKINGHAM, Berks**

Telephone: WOKINGHAM 708



Resistors produced by the cracked carbon process remain stable to $\pm 1\%$ of initial value.

★ Tolerances $\pm 1\%$
 $\pm 2\%$ $\pm 5\%$

Low temperature co-efficient.

Welwyn carbon resistor

WELWYN ELECTRICAL LABORATORIES LTD.
 Welwyn Garden City, Herts. Telephone: Welwyn Garden 3816-8



**MOVING-COIL
 MICROPHONES**

BRIT. PAT.
 No. 556137

The outstanding performance of these scientifically designed and precision-built instruments makes them the choice of discriminating experts. Write Dept. W. W. 4 for full descriptive leaflet.

LUSTRAPHONE LTD., 84, BELSIZE LANE,
 LONDON, N.W.3.

Telephone: HAMpstead 5389 and 5515.

TELCON METALS

TELCOSEAL *Glass Sealing Alloys*

Where strain-free metal-to-glass seals are required the TELCOSEAL range of alloys is unsurpassed. The coefficients of thermal expansion are carefully controlled and adapted to most types of glass. Available as strip, rod and wire in various sizes.

BRIEF DATA OF PHYSICAL CHARACTERISTICS.

ALLOY	Expansion Coeff. $\times 10^{-7}$	Inflexion Temp. °C	Resistivity Microhms/cm ³	Density gm/cm ³	Hardness V.P.N. (Annealed)	GLASS
TELCOSEAL I	46—52	420—430	48	8.2	150	Borosilicate
” II	45—53	360—380	68	8.1	120	Lead Borosilicate
” III	96—103	440—460	95	8.0	—	Lead and Lime
” V	95—105	—	67	7.6	160	Soft Lead
” VI	89—98	510—520	50	8.3	120	Soft Lead & Soda Lime

Further details furnished on request

THE TELEGRAPH CONSTRUCTION & MAINTENANCE CO. LTD.

Head Office: 22, OLD BROAD STREET, LONDON, E.C.2
Telephone: LONDON Wall 3141

Founded 1864

Enquiries to: TELCON WORKS, GREENWICH, S.E.10
Telephone: GREENWICH 1040

* B.I.F. Olympia, Stand No. C.1524.

RADIO IN EVERY ROOM

with these

NEW & BETTER EXTENSION SPEAKERS

Are you enjoying the pleasure and convenience of having your radio instantly available in any room? These moderately priced Stentorian extension speakers, with their handsome acoustically designed wooden cabinets, give such superb quality of reproduction that you will be amazed at the difference a Stentorian makes to your receiver.

Ask your dealer for a demonstration.

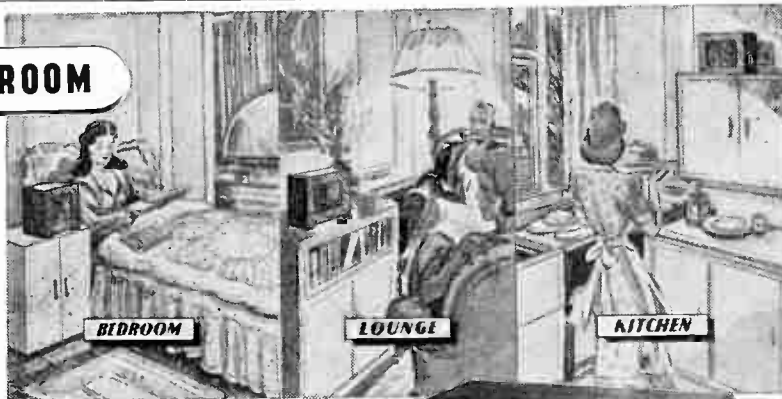

SENIOR MODEL
Type SC with Universal Transformer £5.15.6
" SX minus " £5. 2.6
Walnut Veneered wooden Cabinet. P.M. Unit
9" diameter. Handling Capacity 7 watts.
Magnet Flux density 12,000 lines/sq.cm.

JUNIOR MODEL
Type JC with Universal Transformer £5. 0.0
" JX minus " £4. 10.6
Walnut Veneered wooden Cabinet. P.M. Unit
8" diameter. Handling capacity 6 watts.
Magnet Flux density 10,000 lines/sq.cm.

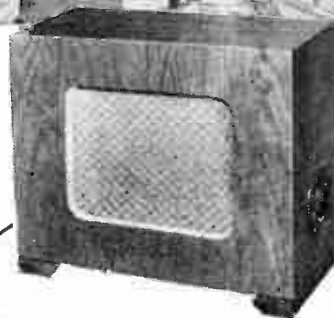

Stentorian

THE FINEST EXTRA SPEAKER FOR ANY SET

WHITELEY ELECTRICAL RADIO CO. LTD., MANSFIELD, NOTTS.



DECCA NAVIGATOR TOWERS

Built by



The aerial towers for the Decca Navigator transmitter were designed and constructed by B. I. Callender's. These galvanized steel lattice-type structures, 325 feet high, insulated from earth and carrying four 75 feet long flexible horizontal booms to support vertical antennæ wires, are examples of the kind of work on radio masts and towers which we undertake in all parts of the World.

BRITISH INSULATED CALLENDER'S CABLES LIMITED
NORFOLK HOUSE, NORFOLK STREET, LONDON W.C.2

Wireless World

Radio and Electronics

37th YEAR OF PUBLICATION

APRIL 1947

Proprietors:
ILIFFE & SONS LTD.

Managing Editor:
HUGH S. POCOCK,
M.I.E.E.

Editor:
H. F. SMITH

Editorial, Advertising
and Publishing Offices:
DORSET HOUSE,
STAMFORD STREET,
LONDON, S.E.1.

Telephone:
Waterloo 3333 (50 lines).
Telegrams:
"Ethaworld, Sedist, London."

△

PUBLISHED
MONTHLY

Price: 1/6

(Publication date 26th
of preceding month)

Subscription Rate:
Home and Abroad
20/- per annum.

MONTHLY COMMENTARY	117
DESIGN FOR A HIGH-QUALITY AMPLIFIER By D. T. N. Williamson	118
AUTOMATIC RECEIVER PRODUCTION	122
INTERLACING By W. T. Cocking	124
MAGNETOPHON RECORDERS	128
CIRCUIT CONVENTIONS By "Cathode Ray"	129
DESIGN DATA (12) R.C. Coupling	131
WORLD OF WIRELESS	132
UNBIASED By Free Grid	136
COMPONENTS FOR 1947	137
TROPICAL BROADCASTING By "Radiator"	139
SHORT-WAVE CONDITIONS By T. W. Ben- nington	140
WHISTLING METEORS By G. R. M. Garratt	141
DESIGNING AN F.M. RECEIVER. By Thomas Roddam	143
SAFETY IN THE AIR By J. A. McGillivray	146
LETTERS TO THE EDITOR	150
CAREERS IN RADIO	151
RANDOM RADIATIONS By "Diallist"	154
RECENT INVENTIONS	156

Branch Offices:

COVENTRY:
8-10, Corporation Street.
Telephone: Coventry 5210.
Telegrams:
"Autocar, Coventry."

BIRMINGHAM:
King Edward House,
New Street, 2.
Telephone:
Midland 7191 (7 lines).
Telegrams:
"Autopress, Birmingham."

MANCHESTER:
260, Deansgate, 3.
Telephone:
Blackfriars 4412 (4 lines).
Telegrams:
"Iliffe, Manchester."

GLASGOW:
26B, Renfield Street, C.2.
Telephone: Central 4857.
Telegrams: "Iliffe, Glasgow."

△

As many of the circuits and apparatus described in these pages are covered by patents, readers are advised, before making use of them, to satisfy themselves that they would not be infringing patents.

1788

DO "Hams" READ BACON?

Sir Francis Bacon, writing long before the birth of wireless, might not appeal to the "ham," but every radio enthusiast will want to read the new Wright & Weaire Components Catalogue. Giving a comprehensive description of the complete range of Wright & Weaire radio components, the easy-to-read Catalogue, illustrated with circuit blueprints, will be sent to you on receipt of the coupon below. Mail it at once and make certain of your copy.



VIBRATORS · VIBRAPOWER UNITS · CERAMIC SWITCHES
I.F. & A.F. TRANSFORMERS · COILS AND COIL PACKS

MAIL THIS COUPON NOW

Send me at once copy of your latest catalogue

Name.....

Address.....

WRIGHT & WEAIRE LIMITED
2 Lord North St., London, S.W.1. Tel.: Abbey 2126.



VALVES AND THEIR APPLICATIONS

By M. G. SCROGGIE, B.Sc., M.I.E.E.

No. 4: Mullard R.F. AMPLIFIER TETRODE QVO4-7

THE last two valves discussed in this series were particularly suitable for V.H.F. receivers, though I did mention that the EC52 triode is capable of putting out a sufficient number of watts to be useful in a transmitter. Normally, a V.H.F. transmitter is crystal-controlled via one or two frequency-multiplier stages, and it simplifies the design if back-coupling through the valves in these stages and in the output stage is minimized by using tetrodes or pentodes.

The QVO4-7, shown here, is a tetrode with characteristics that fit the needs of V.H.F. transmitters very nicely. Used as a Class "C" amplifier, the R.F. output per valve is about 8 watts at frequencies up to 30 Mc/s, and at least 6 watts at 150 Mc/s. This is at the rated maximum anode voltage, 300, which incidentally seems rather conservative. G_2 voltage is not critical; 150-250 is suitable, and owing to "beam" construction G_2 current is low — 5-6 mA at full output. Heater current is 0.6 A at 6.3 V.

Physically, it is the same size as the EC52, and like it is mounted on the "EF50" base. The pins, being rather small, are silver plated to minimize loss at the higher frequencies. Capacitances are: input, 8.2 pF; output, 6 pF; anode to grid, 0.1 pF.

The last is small enough to give no trouble in frequency-multiplier stages, but prevention of self-oscillation needs attention in the output stage. The input circuit should be carefully screened right up to the grid pin, and have low impedance, which is the easier on account of the fact that only about 50 volts peak drive is needed, so a step-down from the driver stage is feasible. At the highest frequencies a quarter-wave coaxial line, tapped at the lowest point that gives sufficient grid drive voltage, is a convenient form of screened input circuit. If a touch of neutralization is found to be necessary, a bent wire is sufficient capacitance.

For the output stage there is little or no advantage in greatly exceeding cut-off grid bias, and with 150 volts on G_2 about -30 to -35 volts is enough. The optimum for frequency-doubling is appreciably greater; and for trebling is slightly more still.

The limiting cathode current is 50 mA, which, after deducting G_2 current, leaves about 44 mA for the anode. Maximum anode input at 300 volts is therefore a little over 13 watts. But as the anode is rated at 7.5 watts maximum dissipation, it is necessary to take care that the R.F. output is always at least equal to the wattage by which the input exceeds 7.5. For example, a short-circuited feeder would be rather hard on a valve receiving 13 watts input.

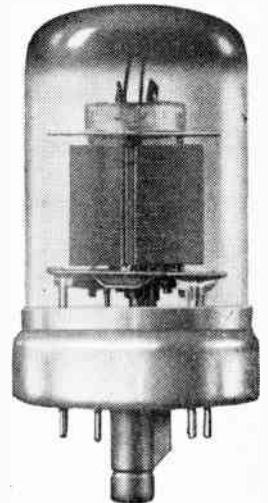

This is the fourth of a series of articles written by M. G. Scroggie, B.Sc., M.I.E.E., the well-known Consulting Radio Engineer. Reprints for schools and technical colleges may be obtained free of charge from:

**THE MULLARD WIRELESS SERVICE CO. LTD.,
TECHNICAL PUBLICATIONS DEPARTMENT,
CENTURY HOUSE, SHAFESBURY AVE., W.C.2**

Wireless World

Radio and Electronics

Vol. LIII. No. 4

APRIL, 1947

Price 1s. 6d.

Monthly Commentary

Classifying Frequencies and Wavelengths

A GOOD deal of unnecessary confusion is still being caused by the lack of a generally accepted classification of the wavebands, and particularly the frequency bands, used in radio communication. Without belittling the work of those standardizing bodies and others who have devoted much thought and ingenuity to devising classifications it is fair to say that none of their efforts have been accorded widespread acceptance. We think that this is because most of the classifications produced suffer to some extent from three major defects. They make use of unfamiliar terms; then fail to allow for the vagueness that is so often necessary at this stage of development of the art in speaking or writing of frequencies above 30 Mc/s, and they include arbitrary comparatives and superlatives that are not easily memorized.

Take the British Standard Glossary (BS204) classification of frequency bands in col. 3 of the table printed below. The relative highness of "very," "ultra" and "super" is by no means self-evident, and, perhaps worse still, the arbitrary assignment of precise significance to these words leaves us nothing to use when we wish to refer in general terms to all those frequencies having, say, visual-range propagation characteristics. The wave-band classification (col. 4) is rational and seemingly has all the advantages of potential international acceptance. But it has never been widely used, perhaps because it employs certain prefixes—myria-, hecto-, and deca— that are unfamiliar even to the most fervent of English-speaking advocates of the metric system. And the word "metric" itself, as applied to waves, seems to contain the seeds of confusion, suggesting as it

might to the intelligent layman that it relates not to a band but to waves in general classified or measured according to the metric system.

Of all the systems of classification so far presented the best and most realistic seem to us to be that devised by the Inter-Services Radio Circuit Symbols Committee, and given in col. 5 below. It starts by using terms that, though vague in themselves, have acquired generally accepted meanings and relate to wavebands in easily memorized round numbers. For the shorter wavelengths, where there is no risk of running counter to accepted usage, the terms are precise. Where precision is not needed, no barrier is placed in the way of calling all waves shorter than 10m "very short." This classification deserves wider currency.

Unfortunately the Inter-Services Committee has not produced a companion frequency classification, and here we venture to step into the breach, putting forward for consideration the very simple classification of col. 6. The only real departure from precedent is the abandonment of all attempts to sub-divide the frequency band below 30 Mc/s. When there is need for greater precision than is implied in "very high" the bands can always be defined in terms of their frequency in Mc/s, or, when dealing with the higher numbers, perhaps in kMc/s (kilo-megacycles per second). The ultra-, super- and hyper- prefixes in this context have always been a nuisance, and few will regret their loss. We find—admittedly with rather malicious pleasure—that few of those who advocate the retention of these out-dated and vague superlatives can say off-hand what is the significance officially assigned to them.

(1) Freq. Bands	(2) Wavebands (Metres)	(3) BS204 Freq. Bands	(4) BS204 Wavebands	(5) Inter-Services Wavebands	(6) Proposed Freq. Bands
Below 30 kc/s 30— 300 kc/s 300— 3,000 kc/s 3— 30 Mc/s 30— 300 Mc/s 300— 3,000 Mc/s 3,000—30,000 Mc/s	Above 10,000 10,000—1,000 1,000— 100 100— 10 10— 1 1— 0.1 0.1— 0.01	Very low Low Medium High Verv high Ultra-high Super	Myriametric Kilometric Hectometric Decametric Metric Decimetric Centimetric	} Long Medium Short Metre Decimetre Centimetre	} Low Medium High } Very high

DESIGN FOR A HIGH-QUALITY AMPLIFIER

1—Basic Requirements : Alternative Specifications

RECENT improvements in the field of commercial sound recording have made practicable the reproduction of a wider range of frequencies than hitherto. The useful range of shellac pressings has been extended from the limited 50-8,000 c/s which, with certain notable exceptions, has been standard from 1930 until the present, to a range of some 20-15,000 c/s. This increase in the frequency range has been accompanied by an overall reduction in distortion and the absence of peaks, and by the recording of a larger volume range, which combine to make possible a standard of reproduction not previously attainable from disc recordings. Further improvements, notably the substitution of low-noise plastic material for the present shellac composition, are likely to provide still further enhanced performance.

The resumption of the television service with its first-class sound quality, and the possible extension of U.H.F. high-quality transmissions, increase the available sources of high-quality sound.

Full utilization of these recordings and transmissions demands reproducing equipment with a standard of performance higher than that which has served in the past. Extension of the frequency range, involving the presence of large-amplitude low-frequency signals, gives greater likelihood of intermodulation distortion in the reproducing system, whilst the enhanced treble response makes this type of distortion more readily detectable and undesirable.

Reproduction of sound by electrical means involves the amplification of an electrical waveform which should be an exact counterpart of the air pressure waveform which constitutes the sound. The purpose of the amplifier is to produce an exact replica of the electrical input voltage waveform at a power level suitable for the operation of the loudspeaker. This in turn reconverts the elec-

trical waveform into a corresponding sound pressure waveform, which in an ideal system would be a replica of the original.

The performance of an amplifier intended to reproduce a given waveform is usually stated in terms of its ability to reproduce accurately the frequency com-

By
D. T. N. WILLIAMSON
(Late of the M.O. Valve Co.)

ponents of a mythical Fourier analysis of the waveform. While this method is convenient and indeed corresponds to the manner in which the mechanism of the ear analyses sound pressure waveforms into component frequencies and thereby transmits intelligence to the brain, the fact that the function of the system is to reproduce a waveform and not a band of frequencies should not be neglected. Sounds of a transient nature having identical frequency contents may yet be very different in character, the discrepancy being in the phase relationship of the component frequencies.

The requirements of such an amplifier may be listed as:—

(1) Negligible non-linear distortion up to the maximum rated output. (The term "non-linear distortion" includes the production of undesired harmonic frequencies and the intermodulation of component frequencies of the sound wave.) This requires that the dynamic output/input characteristic be linear within close limits up to maximum output at all frequencies within the audible range.

(2) (a) Linear frequency response within the audible frequency spectrum of 10-20,000 c/s.

(b) Constant power handling capacity for negligible non-linear distortion at any frequency within the audible frequency spectrum.

This requirement is less stringent at the high-frequency end of

the spectrum, but should the maximum power output/frequency response at either end of the spectrum (but especially, at the low-frequency end) be substantially less than that at medium frequencies, filters must be arranged to reduce the level of these frequencies *before* they reach the amplifier as otherwise severe intermodulation will occur. This is especially noticeable during the reproduction of an organ on incorrectly designed equipment where pedal notes of the order of 16-20 c/s cause bad distortion, even though they may be inaudible in the sound output.

(3) Negligible phase-shift within the audible range. Although the phase relationship between the component frequencies of a complex steady-state sound does not appear to affect the audible quality of the sound, the same is not true of sounds of a transient nature, the quality of which may be profoundly altered by disturbance of the phase relationship between component frequencies.

(4) Good transient response. In addition to low phase and frequency distortion, other factors which are essential for the accurate reproduction of transient waveforms are the elimination of changes in effective gain due to current and voltage cut-off in any stages, the utmost care in the design of iron-cored components, and the reduction of the number of such components to a minimum.

Changes in effective gain during "low-frequency" transients occur in amplifiers with output stages of the self-biased Class AB type, causing serious distortion which is not revealed by steady-state measurements. The transient causes the current in the output stage to rise, and this is followed, at a rate determined by the time constant of the biasing network, by a rise in bias voltage which alters the effective gain of the amplifier.

(5) Low output resistance. This requirement is concerned

with the attainment of good frequency and transient response from the loudspeaker system by ensuring that it has adequate electrical damping. The cone movement of a moving-coil loudspeaker is restricted by air loading, suspension stiffness and resistance, and electromagnetic damping. In the case of a baffle-loaded loudspeaker, the efficiency is rarely higher than 5-10 per cent, and the air loading, which determines the radiation, is not high. In order to avoid a high bass-resonance frequency, the suspension stiffness in a high-grade loudspeaker is kept low, and obviously the power loss in such a suspension cannot be large. Electro-magnetic damping is therefore important in controlling the motion of the cone. This effect is proportional to the current which can be generated in the coil circuit, and is therefore proportional to the total resistance of the circuit. Maximum damping will be achieved when the coil is effectively short-circuited, hence the output resistance of the amplifier should be much lower than the coil impedance.

(6) Adequate power reserve. The realistic reproduction of orchestral music in an average room requires peak power capabilities of the order of 15-20 watts when the electro-acoustic transducer is a baffle-loaded moving-coil loudspeaker system of normal efficiency. The use of horn-loaded loudspeakers may reduce the power requirement to the region of 10 watts.

The Output Stage

An output of the order of 15-20 watts may be obtained in one of three ways, namely, push-pull triodes, push-pull triodes with negative feedback, or push-pull tetrodes with negative feedback. The salient features of these methods are of interest.

Push-pull triode valves without the refinement of negative feedback form the mainstay of present-day high fidelity equipment. A stage of this type has a number of disadvantages. With reasonable efficiency in the power stage such an arrangement cannot be made to introduce non-linearity to an extent less than that represented by about 2-3 per cent

harmonic distortion. The output/input characteristic of such a stage is a gradual curve as in Fig. 1 (a). With this type of characteristic distortion will be introduced at all signal levels and intermodulation of the component signal frequencies will occur at all levels. The intermodulation with such a characteristic is very considerable and is responsible for the harshness and "mushiness" which characterizes amplifiers of this type. In addition, further non-linearity and considerable intermodulation will be introduced by the output transformer core.

If the load impedance is chosen to give maximum output the load impedance/output resistance ratio of the amplifier will be about 2, which is insufficient for good loudspeaker damping.

It is difficult to produce an adequate frequency response characteristic in a multi-stage amplifier of this type as the effect of multiple valve capacitances and the output transformer primary and leakage inductances becomes serious at the ends of the A.F. spectrum.

The application of negative feedback to push-pull triodes results in the more or less complete solution of the disadvantages outlined above. Feedback should be applied over the whole amplifier, from the output transformer secondary to the initial stage as

this method corrects distortion introduced by the output transformer and makes no additional demands upon the output capabilities of any stage of the amplifier.

The functions of negative feedback are:—

(a) To improve the linearity of the amplifier, and output transformer.

(b) To improve the frequency response of the amplifier and output transformer.

(c) To reduce the phase shift in the amplifier and output transformer within the audible frequency range.

(d) To improve the low-fre-

quency characteristics of the output transformer, particularly defects due to the non-linear relation between flux and magnetizing force.

(e) To reduce the output resistance of the amplifier.

(f) To reduce the effect of random changes of the parameters of the amplifier and supply voltage changes, and of any spurious defects.

A stage of this type is capable of fulfilling the highest fidelity requirements in a sound reproducing system. The output/input characteristic is of the type shown in Fig. 1 (b), and is virtually straight up to maximum output, when it curves sharply with the onset of grid current in the output stage. Non-linear distortion can be reduced to a degree represented by less than 0.1 per cent harmonic distortion, with no audible intermodulation. The frequency response of the whole amplifier from input to output transformer secondary can be made linear, and the power handling capacity constant over a range considerably wider than

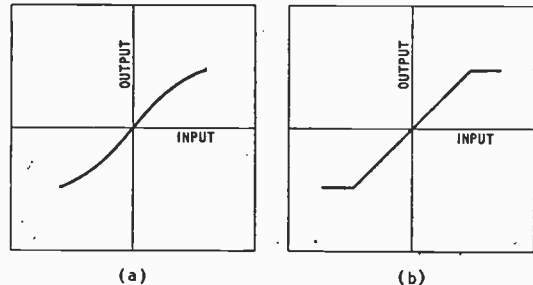

Fig. 1. Output/input characteristics (a) without feedback (b) with negative feedback.

that required for sound reproduction.

The output resistance, upon which the loudspeaker usually depends for most of the damping required, can be reduced to a small fraction of the speech coil impedance. A ratio of load impedance/output resistance (sometimes known as "damping factor") of 20-30 is easily obtained.

"Kinkless" or "beam" output tetrodes used with negative feedback can, with care, be made to give a performance midway between that of triodes with and without feedback. The advantages to be gained from the use of

Design for a High Quality Amplifier—tetrodes are increased power efficiency and lower drive voltage requirements.

It must be emphasized that the characteristics of the stage are dependent solely upon the character and amount of the negative feedback used. The feedback must remain effective at all frequencies within the A.F. spectrum under all operating conditions, if the quality is not to degenerate to the level usually associated with tetrodes without feedback. Great care must be taken with the design and operation of the amplifier to achieve this, and troubles such as parasitic oscillation and instability are liable to be encountered.

When equipment has to be operated from low-voltage power supplies a tetrode stage with negative feedback is the only choice; but where power supplies are not restricted, triodes are preferable because of ease of operation and certainty of results.

It appears then that the design of an amplifier for sound reproduction to give the highest possible fidelity should centre round a push-pull triode output stage and should incorporate negative feedback.

The most suitable types of valve for this service are the PX25 and the KT66. Of these the KT66 is to be preferred since it is a more modern indirectly-heated type with a 6.3-volt heater, and will simplify the heater supply problem. Triode-connected it has characteristics almost identical with those of the PX25.

Using a supply voltage of some 440 volts a power output of 15 watts per pair may be expected.

The Output Transformer

The output transformer is probably the most critical component in a high-fidelity amplifier. An incorrectly designed component is capable of producing distortion which is often mistakenly attributed to the electronic part of the amplifier. Distortion producible directly or indirectly by the output transformer may be listed as follows:—

(a) Frequency distortion due to low winding inductance, high leakage reactance and resonance phenomena.

(b) Distortion due to the phase shift produced when negative feedback is applied across the transformer. This usually takes the form of parasitic oscillation due to phase shift produced in the high frequency region by a high leakage reactance.

(c) Intermodulation and harmonic distortion in the output stage caused by overloading at low frequencies when the primary inductance is insufficient. This is primarily due to a reduction in the effective load impedance below the safe limit, resulting in a very reactive load at low frequencies.

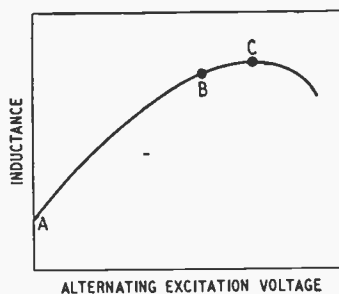

Fig. 2. Variation of iron-cored inductance with A.C. excitation.

This may cause the valves to be driven beyond cut-off since the load ellipse will tend to become circular.

(d) Harmonic and intermodulation distortion produced by the non-linear relation between flux and magnetizing force in the core material. This distortion is always present but will be greatly aggravated if the flux density in the core exceeds the safe limit.

(e) Harmonic distortion introduced by excessive resistance in the primary winding.

The design of a practical transformer has to be a compromise between these conflicting requirements.

At a low frequency f_b , such that the reactance of the output transformer primary is equal to the resistance formed by the load resistance and valve A.C. resistances in parallel, the output voltage will be 3db below that at medium frequencies. At a frequency $3f_b$ the response will be well maintained, the transformer reactance producing only 20° phase angle. Similarly at the high frequency end of the spectrum the

response will be 3db down at a frequency f_i such that the leakage reactance is equal to the sum of the load and valve A.C. resistances. Again at a frequency $f_i/3$ the response will be well maintained.

If then the required frequency range in the amplifier is from 10–20,000 c/s, f_b may be taken as 3.3 c/s and f_i as 60 kc/s. A transformer which is only 3db down at frequencies as widely spaced as these would be difficult to design for some conditions of operation, and where this is so the upper limit may be reduced, as the energy content of sound at these frequencies is not usually high. The limiting factor will be the necessity of achieving stability when feedback is applied across the transformer, i.e., that the loop gain should be less than unity at frequencies where the phase shift reaches 180° .

To illustrate the procedure, consider the specification of an output transformer coupling two push-pull KT66 type valves to a 15 ohm loudspeaker load.

Primary load impedance = 10,000 Ω

$$\text{Turns ratio} = \sqrt{\frac{10,000}{15}} = 25.8 : 1$$

Effective A.C. resistance of valves = 2500 Ω

Low-frequency responses

$$\text{Parallel load and valve resistance} = \frac{2500 \times 10,000}{12,500} = 2000 \Omega$$

$f_b = 3.3$ c/s ($\omega_b \approx 21$) response should be 3db down.

Primary incremental inductance

$$L = \frac{2000}{21} = 95 \text{ H.}$$

High-frequency Response

$$\begin{aligned} \text{Sum of load and AC resistances} \\ &= 10,000 + 2500 \\ &= 12500 \Omega \end{aligned}$$

At $f_i = 60$ kc/s ($\omega_i = 376,000$) response should be 3db down.

$$\begin{aligned} \therefore \text{Leakage reactance} &= \frac{12,500}{376} \\ &= 33 \text{ mH.} \end{aligned}$$

A 20-watt transformer having 10 primary and 8 secondary sections and using one of the better grades of core material can be made to comply with these requirements. Winding data will be given in an Appendix to the second part of this article.

Some confusion may arise when specifying an output transformer

as the apparent inductance of the windings will vary greatly with the method of measurement. The inductance of an iron-cored component is a function of the excitation, the variation being of the form shown in Fig. 2. The exact shape of the curve is dependent on the magnetization characteristic for the core material.

The maximum inductance, corresponding to point C occurs when the core material is nearing saturation and is commonly 4-6 times the "low excitation" or "incremental" value at A, which corresponds to operation near the origin of the magnetization curve. In a correctly designed output transformer the primary inductance corresponding to the voltage swing at maximum output at 50 c/s will lie in the region of B in Fig. 2.

In specifying the component, the important value is the incremental inductance corresponding to Point A, since this value determines the frequency response at low outputs.

The reduction of phase shift in amplifiers which are to operate with negative feedback is of

prime importance, as instability will result, should a phase shift of 180° occur at a frequency where the vector gain of the amplifier and feedback network is greater than unity. The introduction of more than one transformer into the feedback path is likely to give rise to trouble from instability. As it is desirable to apply feedback over the output transformer the rest of the amplifier should be R-C coupled.

Although the amplifier may contain push-pull stages it is desirable that the input and output should be "single ended" and have a common earth terminal. Three circuit arrangements suggest themselves.

The block diagram of Fig. 3 (a) shows the simplest circuit arrangement. The output valves are preceded by a phase splitter which is driven by the first stage. The feedback is taken from the output transformer secondary to the cathode of the first stage. This arrangement is advantageous in that the phase shift in the amplifier can easily be reduced to a low value as it contains the minimum number of stages. The

arrangement, however, has a number of disadvantages which render it unsuitable. The input

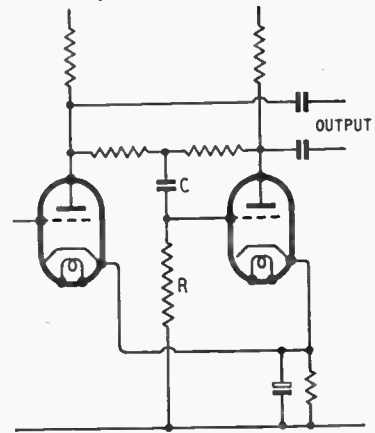

Fig. 4. "Paraphase" circuit combining the functions of phase splitter and push-pull driver stages.

voltage required by the phase splitter is rather more than can be obtained from the first stage for a reasonable distortion with the available HT voltage, and in addition the phase splitter is operating at an unduly high level. The gain of the circuit is low even if a pentode is used in the first stage, and where a low-impedance loudspeaker system is used insufficient feedback voltage will be available.

The addition of a push-pull driver stage to the previous arrangement as in Fig. 3 (b), provides a solution to most of the difficulties. Each stage then works well within its capabilities. The increased phase shift due to the extra stage has not been found unduly troublesome provided that suitable precautions are taken.

The functions of phase splitter and push-pull driver stage may be combined in a self-balancing "Paraphase" circuit giving the arrangement of Fig. 3 (c). The grid of one driver valve is fed directly from the first stage, the other being fed from a resistance network between the anodes of the driver valves as shown in Fig. 4. This arrangement forms a good alternative to the preceding one where it is desirable to use the minimum number of valves.

(To be concluded.)

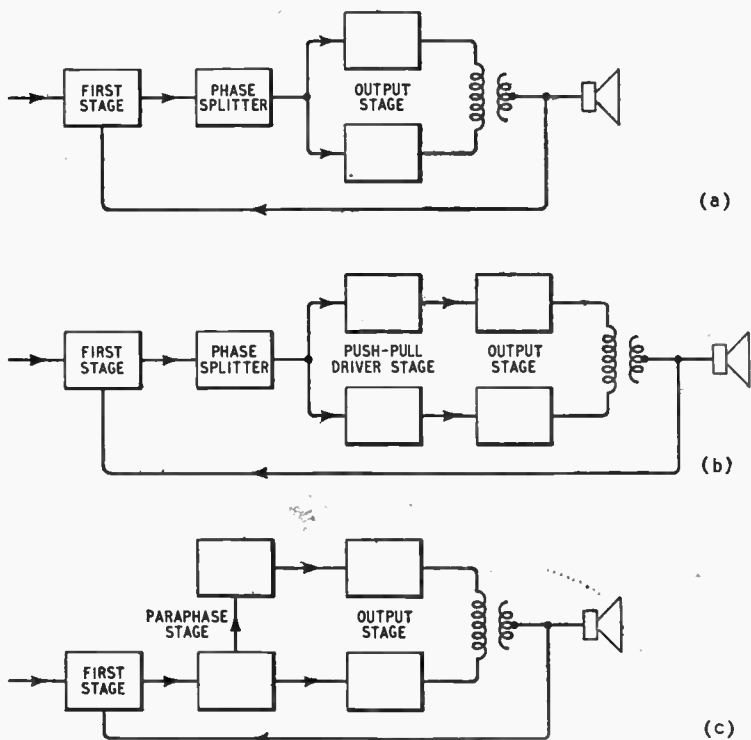

Fig. 3. Block diagrams of circuit arrangements discussed in the text.

AUTOMATIC RECEIVER PRODUCTION

Details of the E.C.M.E. System

A SYSTEM of broadcast receiver production containing a number of novel features not only in receiver design but in the method of manufacture has been evolved by John Sargrove in conjunction with Sargrove Electronics, Walton-on-Thames.

The basic idea is to eliminate conventional component assembly and wiring and to make wiring and components an integral part of a moulded panel or panels which can be brought together with the minimum of manual labour in a cabinet with loudspeaker, valves and perhaps plug-in electrolytic condensers to form a complete set. Once the moulding dies have been made, errors in wiring are impossible and manufacture is so cheap that

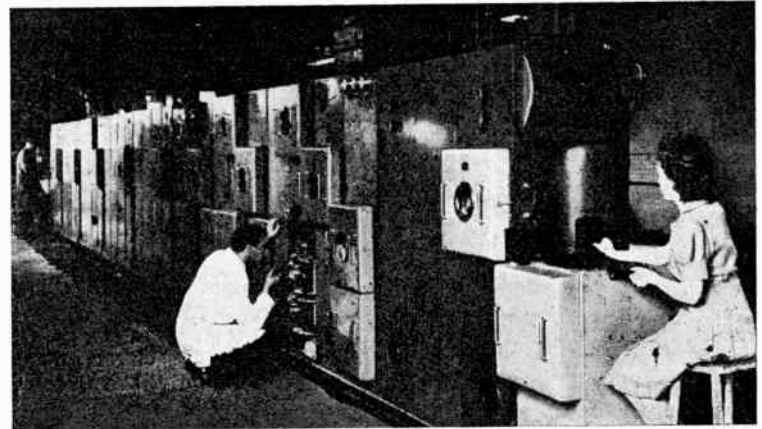

General view of E.C.M.E. from the input end.

Inductances are formed by spiral grooves filled with molten metal from a spray gun and it is claimed that the repetition accuracy is $\pm\frac{1}{2}$ per cent for "L" and ± 25 per cent for "Q." Resist-

are subjected to burnishing and ageing processes, after which they are capable of operating at a dissipation of 1 watt per sq in.

Capacitors consist of a thin web of moulded material integral with the panel and metal-sprayed on both sides. The thickness of the web is accurately controlled to 0.01 inch in moulding, and capacitances can be repeated to ± 10 per cent. Normally a flat or slightly concave web (to allow for thermal expansion) is used which provides a capacitance of 30pF per cm², but this can be increased to 100pF/cm² by corrugation and by a further factor of 10 or 20 if pellets of high dielectric constant material are used in the condenser apertures when

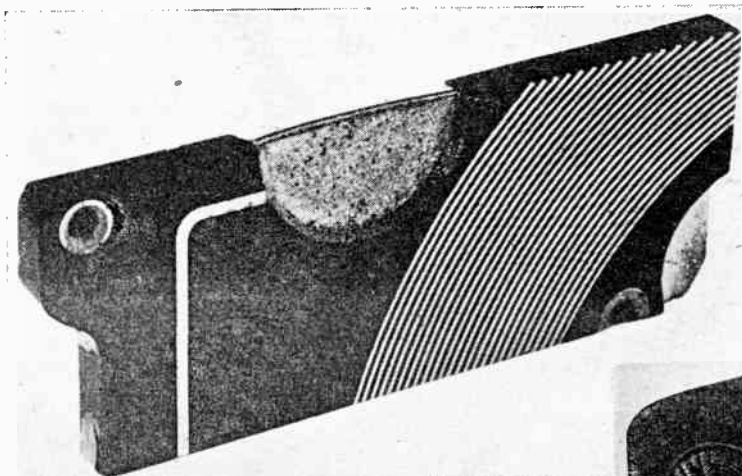

Section of panel showing reduced thickness and metal sprayed electrodes forming fixed capacitors. Part of a spiral-groove inductance is also shown. Two-valve universal mains receiver (right) constructed on the E.C.M.E. moulded panel system.

servicing for the failure of any part consists in replacement of the entire panel rather than in the precise location of the fault.

ances are of the graphite dispersion type and after spraying

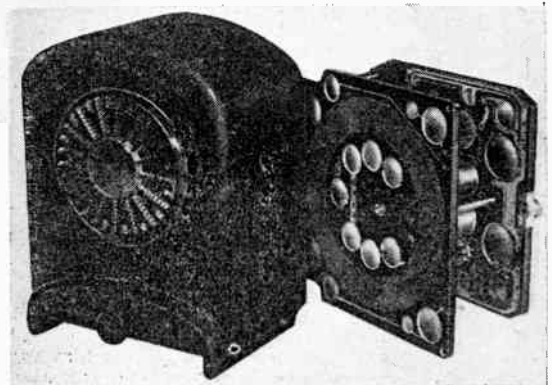

moulding the panels. In this way capacitances up to $0.005\mu F$ can be incorporated in the panel.

A two-valve A.C./D.C. mains set has already been designed and a most ingenious electronically-controlled continuous processing plant has been built for fabricating the panels. A photograph of this machine, which has been named E.C.M.E. (Electronic Circuit Making Equipment), appears at the head of this article.

Moulded plastic plates with the required grooves and depressions are fed in vertically and conveyed through units carrying out the following sequence of operations: Sand blasting to remove surface skin; metal spraying simultaneously on both sides; face milling to remove metal on surface

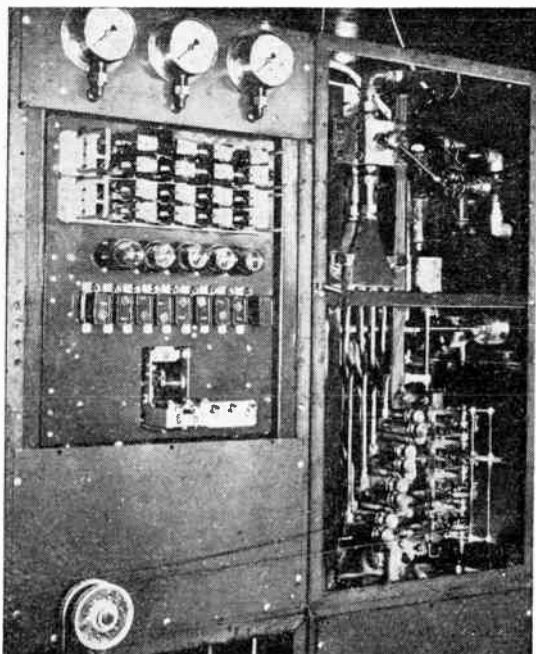

between indentations; electrical test; graphite resistance spraying through stencils, drying and burnishing; insertion of sockets for valves, etc.; electrical test; electrical and thermal ageing followed, while hot, by lacquer spray. The panels now pass to conventional conveyor machines for the addition of valves, loud-speaker, etc., and any other manual operations leading to the assembly of the set in its cabinet and a test on radio signals.

Many ingenious electronic con-

trol devices are incorporated in the circuit-making equipment to start up the metallizing flame spray guns, diamond high-speed cutters and other operations only when a panel arrives for treatment. Safety devices and quality control are also on an electronic basis, and one advantage of this independent stage-by-stage control is that if for any reason two successive panels are rejected for the same fault, the sections up to the point at which the fault is detected are stopped, but any sound panels which have passed this point continue through the machine until they are finished. This is a notable advance on most conveyor belt systems.

When the system gets into full production it should be possible to reduce costs to an unprecedentedly low level — at least for simple local-station receivers.

Metal spray guns for one side of panels. On the left are the relays for flame ignition and control.

There should be a wide market for these sets in Asia Minor, Africa, India, Central and South America and China, where the high cost of sets made by conventional methods has so far prevented further extension of sales.

Although this new manufacturing technique has so far been developed to the point where only the simplest of complete receivers can be said to have reached the practical production stage, there is little doubt that it could be employed with advantage for the manufacture of sub-assemblies in the more complex receivers at present wired throughout with the soldering iron. The simplification of stock-holding problems by the regulation of supply to demand, with virtually no time lag, will

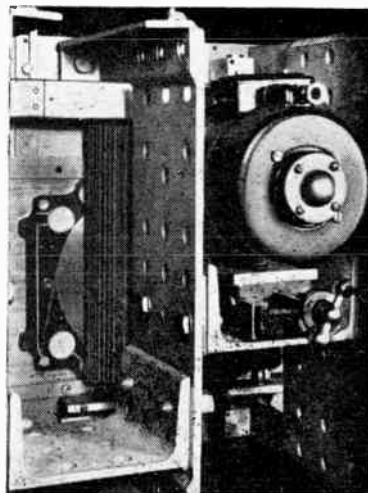

High-speed surface milling unit with panel emerging to left of feed roller.

commend itself to production managers, while the economy of power supply and wear and tear in the circuit-making equipment, resulting from the fact that each section automatically shuts itself down until supplied with work, are particularly topical virtues.

The present maximum rate of output is three panels per minute.

Quite apart from economic considerations, moulded circuit units have many technical advantages, e.g., in reducing flash-over in aircraft radio apparatus at high altitudes, ease of "tropicalization," compactness and low weight.

A detailed description of E.C.M.E. will appear in the *Journal Brit. I.R.E.*

Manufacturers' Literature

"CABLES for Radio Frequencies" (Publication No. 10,1947) giving characteristics of Telcon cables including post-war designs for television and laboratory use, from Telegraph Construction and Maintenance Co., Greenwich, London, S.E.10.

Illustrated catalogue of "Radyne" electronic heating equipment from Radio Heaters, Toutley Works, Wokingham, Berks..

Bulletin B.580A describing "Mag-slip" control and indicator mechanisms, from Muirhead & Co., Elmers End, Beckenham, Kent.

Illustrated leaflets describing the "Compensatore" hearing aid made by J. Cunningham Beattie, 49, Wigmore Street, London, W.1.

INTERLACING

Television Frame Synchronizing

By W. T. COCKING, M.I.E.E.

ONE of the most difficult problems confronting the designer of a television receiver is that of securing satisfactory interlacing. Superficially, it is a simple problem; practically, it is often hard to make a receiver give any approach to interlacing, let alone give good interlacing.

In theory interlacing is secured automatically by ensuring that the line and frame time bases are triggered regularly by the line and frame sync pulses in the transmission. There are 50 frame pulses and 405 line pulses a second and interlacing is secured because 405 is not a multiple of 50.

In odd frames, that is, in the first, third, and so on, the leading edge of the frame sync pulse does not coincide with a line pulse but occurs about half-way through a line. In even frames—the second, fourth and so on—the frame sync pulse does coincide with a line pulse. In each complete picture of two frames the synchronizing waveform as a whole is the same. It is the same in alternate frames, but not in successive frames.

The synchronizing waveform as transmitted, and as it appears in the output of the receiver sync separator, takes the familiar form shown in Fig. 1 (a). The line sync pulses proper are of 9.88 μ sec duration and occur regularly every 98.77 μ sec. The frame pulses are broken at similar intervals to ensure that effective synchronizing of the line time base is continued during the frame fly-back.

This breaking of the frame pulse gives a different form to the line pulses during this period, but this is normally unimportant. It is usual to differentiate the line pulses and then only their leading edges are important. It is true to say that the leading edges of the line sync pulses occur regularly at all times, including the periods devoted to frame synchronizing.

While Fig. 1 (a) shows the waveform correctly it is apt to

give the impression that the intervals between the onset of successive frame pulses are different in alternate frames. It does this because the two waveforms are lined up for comparison on the line pulses. It is equally correct to line them up on the leading edges of the frame pulses as in Fig. 1 (b) and it is clearer to do so when dealing with frame synchronizing problems. The interval between successive leading edges is 20 msec, and the duration of each segment of a frame pulse is 39.52 μ sec and the interval between successive segments is 9.88 μ sec.

The line time base runs regularly at 10,125 c/s, and there is rarely any difficulty in achieving this with sufficient accuracy. For perfect interlace the frame time

regularly at times coincident with the proper line pulses. All even frames are then perfectly superimposed. Consider, too, that all odd frames are started regularly, so that successive odd frames are superimposed, but at a time interval t_1 different from the correct time of 20 msec after an even frame (49.39 μ sec after a line pulse).

If this timing error t_1 is $\pm 49.39 \mu$ sec, then clearly the frame time base will be triggered coincident with the line pulses and the scanning lines of all frames will be superimposed. There will be no interlace at all.

The accuracy of timing must be considered in relation to the frame period, so that when the error reaches $\pm 4939/20,000 = \pm 0.247$ per cent the interlace is completely destroyed.

The error in positioning of successive frames is proportional to the timing error and it is prob-

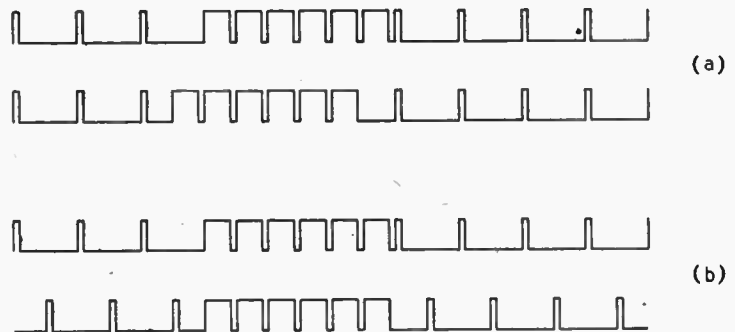

Fig. 1. The frame sync pulses for odd and even frames are shown lined up for comparison on line pulses at (a) and on frame pulses at (b).

base must run regularly at 50 c/s and deliver an output waveform which is exactly the same in every cycle.

Now in practice perfect timing and perfect identity of successive cycles are not possible and it is consequently important to know what variations from perfection are tolerable. Let us first of all consider timing, assuming that successive cycles are otherwise the same.

In the first place consider that the even frames are all started

able that a variation of ± 20 per cent of the line spacing is permissible. This is a timing error of $\pm 49.39/5 = \pm 9.88 \mu$ sec, so that the permissible error of the frame scan timing becomes $\pm 988/20,000 = \pm 0.0499$ per cent—say ± 0.05 per cent.

Now let us consider that the timing is perfect but that for some reason only alternate saw-teeth are of the same amplitude, and that successive ones differ as shown in Fig. 2 (a). Two successive cycles are shown superim-

Interlacing—

posed, for clarity, in Fig. 2 (b).

Such a waveform will obviously result in perfect interlacing at the top of the picture and a progressive deterioration to a maximum error at the bottom. There are 385 active lines in a picture, or 192.5 active lines in each frame. A difference of amplitude of 0.5/192.5 between successive frames will destroy the interlace at the bottom, since it needs a change of amplitude equivalent to that normally occurring in one-half the scanning time of one line to superimpose the lines.

If an error of spacing of ± 20 per cent is permissible, the percentage accuracy of amplitude must be within $\pm 50/192.5 \times 5 = \pm 0.052$ per cent or, say, ± 0.05 per cent.

A waveform like Fig. 2 is not one which is often found in practice. What can occur is a combination of timing and amplitude errors. Normally, the frame sync pulse terminates each frame scan at the correct intervals. Fly-back must occur before the start of the next scan stroke. The fly-back time, and hence, the scan-start time, depends on the circuit constants, including the voltages, so that the avoidance of variations in the timing of the start of the scan depends upon keeping the circuit "constants" sufficiently constant in successive frames. If, for any reason, fly-back is accomplished more quickly in the case of the even frames than with the odd ones, then the odd-frame scans will start a little earlier in relative time than the even. The effective scan will then be slightly longer and so the amplitude will also be greater.

This is illustrated in Fig. 3 in which two successive cycles having different fly-back times are shown at (a) and superimposed for clarity at (b).

It is now pertinent to enquire in what form the interlacing errors usually occur in practice. Sometimes the error is an obstinate

refusal to interlace at all, successive frames being almost exactly superimposed. Sometimes there is a more or less regular pairing of lines, indicating a more or less constant error which, however, is less than in the superimposed case. Frequently, there is weaving. This means that the error is varying, at a rate corresponding to a few cycles per second or less.



Fig. 2. Alternate saw-teeth are of different amplitude here (a); this is more easily seen in (b) where two cycles are superimposed.

Sometimes the interlacing condition is fairly steady over periods of minutes or hours, but suddenly changes for no obvious reason. Usually, with this the interlace is very good or very bad and it jumps from one condition to the other erratically.

It is very rare indeed for the interlace to vary over the picture. The condition illustrated in Fig. 2, for instance, is not often found in practice. The fact that the errors are the same at top and bottom of the picture indicates that the slope of the scanning waveform does not change appreciably in successive cycles.

The synchronizing pulses in the transmission control only the start of fly-back. They trip the time base at the end of each frame scan. For good interlacing three things are necessary; first, the sync pulses must trip the time base at as regular intervals as possible; secondly, all fly-backs must be as alike as possible in duration and amplitude; and thirdly, all scans must be as nearly as possible the same.

A good interlace is not possible if the first requirement is not met and this depends very largely upon the method adopted for separating the frame and line synchronizing pulses. The waveform in the output of the main sync separator, which removes the picture signal, is like Fig. 4 (a) and (b) for odd and even frames. It is necessary to remove the line pulses for otherwise the frame time base would almost certainly be tripped by one of the line pulses occurring a little before the frame pulse.

The usual way of doing this is by an integrator and limiter. Sometimes the limiter is dispensed with, but the circuit adjustments are then more critical. The output of the integrator has the form shown in Fig. 4 (c) and (d) and after limiting it becomes like (e) and (f).

The precise waveform depends on the time constant of the integrator, but in general it approximates to the form sketched here. The important thing to notice is that the sharp leading edges of the pulses are destroyed. Because of this any variation of amplitude of the pulses affects the times at which the time base is tripped. The outputs on alternate frames are not identical, because the interval between the last line pulse and the first frame pulse is different in successive frames with the result that the capacitor of the integrator has discharged to differing degrees at the onset of the frame pulses. This inevitably results in some variation in the timing of the frame time base. Theoretically, perfect interlacing is not possible with an integrator type of pulse separator.

In practice, however, the errors can be made quite small and it is capable of giving good enough interlace for practical needs. There is, however, an alternative which is more nearly perfect. If the pulse signal (a) and (b) of Fig. 4 is passed through a differentiator-type circuit of time constant equal to the duration of one frame pulse, some $40 \mu\text{sec}$, the output wave has the form of (g) and (h), and subsequent limiting brings it to (i) and (j).



Fig. 3. Regularly recurring waves of different fly-back time are illustrated at (a). Two cycles are superimposed (b).

The important thing is that the sharp edges of the pulses are retained, so that theoretically timing errors are eliminated. The leading edges of the pulses in (i)

and (j) are really the trailing edges of the pulses in (a) and (b), so that synchronization really base. In Fig. 4 no account has been taken of any reversals of phase caused by the limiters.

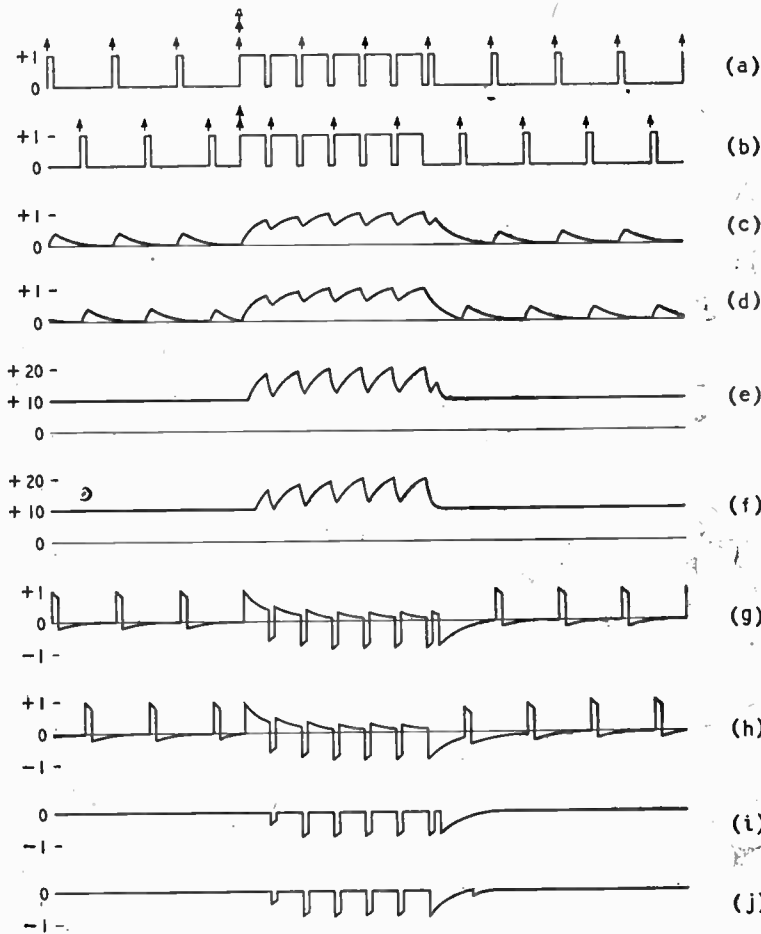

accordingly one expects that the use of such a pulse separator will result in good interlacing.

The writer's experience is that this is not the case and that more frequently than not the scanning lines of successive frames are superimposed rather than interlaced. He has investigated in some detail a typical case of this type. Careful inspection of the fly-back waveform with an oscilloscope having a greatly expanded time scale showed that the time-base was actually being tripped regularly by the sync pulses. By turning up the brightness control of the C.R. tube so that the fly-back became visible on the raster, it could be observed that an interlaced fly-back was being obtained. The correct picture is shown in Fig. 5 (a); with no interlace on the fly-back half the fly-back disappears (b), and with pairing the fly-back lines are unequally spaced (c). In spite of the inter-

Fig. 4. (a) and (b) show the waveforms of even and odd frame pulses respectively, while (c) and (d) indicate the effect of an integrator. Subsequent limiting and amplification produce (e) and (f). The effect of a differentiator on (a) and (b) is shown at (g) and (h) and subsequent limiting at (i) and (j).

Fig. 5. (Below) When the brightness control is turned up, the frame fly-back lines show as at (a) when the interlace is correct, but like (b) when there is no interlace. Pairing of lines gives a picture like (c).

takes place 40 μ sec late. As it is the same for all frames this is unimportant and merely reduces slightly the total time available for fly-back.

The waveforms at the beginning of the separated pulses are identical for all frames, but there is a difference at the ends. This is occasioned by the fact that the first line pulse after the frame pulses is close to them in one case and some distance away in the other. This is not usually important, but might be with some kinds of time base.

It will be observed that in Fig. 4 (i) and (j) the first separated pulse is of smaller amplitude than the others. This is not important provided that it is of sufficient amplitude reliably to trip the time



(a)

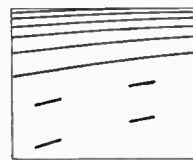

(b)

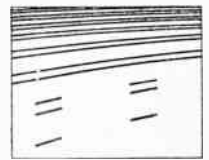

(c)

base. Such reversals may or may not occur depending on whether diode or multi-electrode limiters are used.

Now even the differentiator type separator is no guarantee of perfect interlacing. It can and does ensure that the start of every frame fly-back is correctly timed. It does nothing to ensure that successive fly-backs and scans are themselves identical. Normally one expects that they will be and

lance during fly-back, there was none on the scan and all lines were almost exactly superimposed. This is a condition which can result only from a regular irregularity in successive frames.

From these observed facts it is possible to deduce several characteristics of the scanning waveform. Because successive scans lie on one another, all scans must have the same slope, but be displaced in amplitude. Because

Interlacing—

the fly-backs interlace, the waveforms on successive fly-backs must be identical over the major part of their durations, but not necessarily over the whole of them. This last proviso is made because it was possible to observe the fly-back over part of its time only.

Now ideally successive sawtooth waves are identical and if drawn graphically or observed on an oscilloscope they superimpose perfectly. The symptoms observed above lead to the conclusion that if one wave has the form sketched by the full line A in Fig. 6 the scan part of the next must lie along BC or DE and the fly-back must lie within FG and HI.

This is shown more accurately in Fig. 7.

Scan Waveform

Since the scans are displaced and the timing is the same, the amplitudes at the end of the scan and at the start of fly-back must be different. In Fig. 7 the amplitude of A is point (2) at the end of the scan and that of the next cycle must be either (1) or (3). The start of fly-back which joins A at (7) must be at (4) if it starts at (1) or at (5) if it starts at (3). The start of fly-back for this cycle BC or DE must be at the level of (2) on A; that is, at the point (6).

If BC is the correct scan curve, the path of two cycles must be 7268147, while if DE is correct it must be 7269357.

For simplicity the fly-backs are shown as linear. In practice they

are exponential, which means that the lines in Fig. 7 indicating them are more nearly vertical at the start of the scan. Also, the ratio of scan to fly-back times shown is 5:1 instead of the actual 20:1. On the drawing it can be seen that for the path 7268147 there is a

placement errors are much smaller and almost certainly unobservable.

There is no doubt at all that waveforms varying in this general fashion do occur. Unfortunately it is quite difficult to track down precisely how and why they are produced. The variations between successive cycles are much too small to be observable on any normal oscilloscope.

The writer first noticed the effect when using a Transitron-Miller-integrator type of saw-tooth oscillator. In this there are two trigger actions in each cycle. The first is initiated by the sync pulse and starts the fly-back, while the second occurs in its own time and starts the scan. Since the second is uncontrolled it is liable to be started by any spurious voltages in the circuit. It was at first thought that this second trigger was being initiated by interference voltages from the line time-base, but no amount of screening or decoupling had the slightest effect on the interlace.

It was then thought that it might be caused by a difference between the ends of the frame sync pulses in successive frames, brought about by the different intervals between the last frame pulse proper and the first line pulse. Means were adopted substantially to avoid this difference, again without any improvement.

A change was then made to an entirely different kind of sawtooth generator—the well-known form of blocking oscillator shown in Fig. 8. In this, the grid, screen and cathode form a triode block-

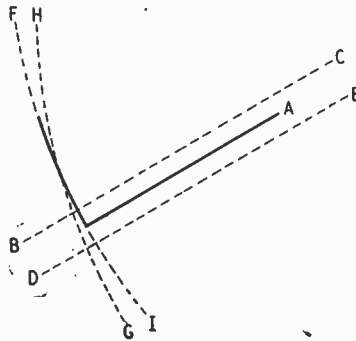

Fig. 6. When the fly-back appears to interlace but not the scan, if one wave is like A, the next must lie along BC or CD with the fly-back between FG and HI.

displacement of 0.2 on the fly-back for a horizontal timing displacement of 1 on the scan. In the real case of a 20:1 fly-back ratio this would be one quarter, or 0.05.

It is probable that this would be undetectable on the fly-back observed on the raster. This is especially so as the fly-back is actually exponential and therefore still more rapid initially, and it is only the initial part that can clearly be seen.

With the alternative path 7269357 the fly-backs actually cross, which means that the dis-

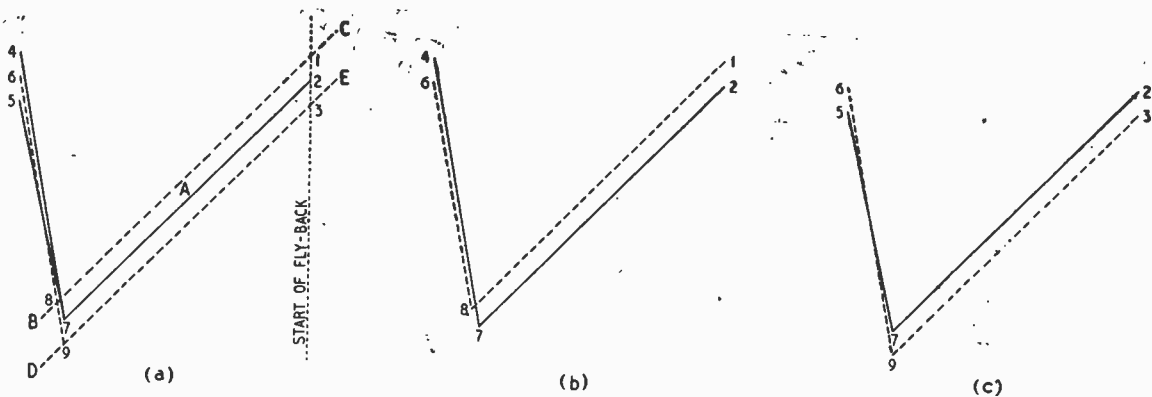

Fig. 7. Two dissimilar cycles are superimposed at (a), the operating paths must be 7268147 or 7269357 and these are shown by themselves in (b) and (c) for clarity.

ing oscillator and the anode-cathode path of the valve acts to discharge C_1 on fly-back. The results, however, were no better than with the Transitron.

The next step was to simplify the circuit further by utilizing the saw-tooth voltage across C instead of that across C_1 . Again there was no change in the interlacing. It was then noticed that in making the change R_1C_1 had inadvertently been left connected to the anode. When these components were disconnected, however, good interlacing was at once secured.

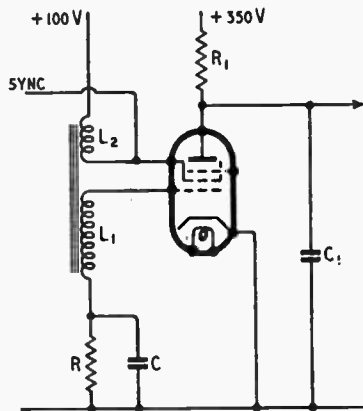

Fig. 8. Typical blocking oscillator saw-tooth generator in which C_1 is discharged by the anode-cathode path of the valve.

Further extensive tests showed the simple triode blocking oscillator to give reliable interlacing; also another circuit in which the blocking oscillator is used to control another entirely separate valve operating to discharge a capacitor proved satisfactory. The circuit of Fig. 8 in which a separate electrode of the same value was used for discharge could not be made to perform satisfactorily.

The reason for this is not known, but it seems clear that it must be due to interaction between the anode and screen currents.

The conclusion to be drawn from all this is that while careful design of the sync separator circuits is necessary for good interlacing, that alone is not sufficient. It is also necessary to pay particular attention to the saw-tooth generator.

MAGNETOPHON RECORDERS

Processes Involved in Manufacturing the Tape

THE principles underlying the German system of magnetic tape recording, using plastic tape impregnated with iron oxide powders, were described in an article in the June, 1946, issue of this journal. Since then a comprehensive report "The Magnetophon Sound Recording and Reproducing System" has been published by the British Intelligence Objectives Sub-Committee and is obtainable from H.M. Stationery Office, price 10s.

The report presents the findings of a team of investigators—M. J. L. Pulling (B.B.C.), E. M. Payne (Electrical and Musical Industries) and H. E. Parker (Ministry of Supply)—and includes circuit diagrams with component values, recording characteristics with and without correction and detailed descriptions with photographs of the tape-winding mechanism in the principal types of machine.

The methods of manufacturing the various types of tape are given in an appendix with descriptions of the chemical materials used. The latest type "LG" tape used in high-quality recorders consists of a backing of polyvinyl chloride coated with a layer of ferric oxide powder. The P.V.C. is mixed with titanium white and is rolled into sheets 0.05 mm thick, 60 cm wide and 400 metres long. It is then drawn under tension over electrically heated rollers until it is 0.04 mm thick, 32.5 cm wide and 1 kilometre long, which gives an appreciable increase of tensile strength in a longitudinal direction.

The ferric oxide powder is prepared by precipitating black Fe_3O_4 oxide from ferrous sulphate with ammonia and then heating the black oxide at 280-300° C to form red-brown Fe_2O_3 . After milling, the powder is air-blown through a sieve to a particle size of 0.2 to 1 micron and is then mixed with an equal quantity of P.V.C. powder and a small quantity of plasticiser and solvent to form lumps $\frac{1}{4}$ to $\frac{1}{2}$ in diameter for easy handling.

At the coating factory the lumps are milled and made up into a fluid paste with 10 parts

benzole and 15 parts tetrahydrofuran to 40 parts iron-oxide mixture. The paste is spread on the film base from a hopper fitted with a mixing paddle, and a bridge piece keeps the layer at the optimum thickness of 0.015 mm. It is found that thicker deposits give a shorter magnetic working range, while a thinner layer results in inadequate magnetization. After coating, the tape is dried in a tunnel through which air at 25° C is drawn, and then in a large drying chamber in which it is wound in a spiral on rollers. The tape takes about 6 minutes to pass through the drying tunnel and chamber.

The coated tape is then slit simultaneously into strips 6.5 mm wide by rotary knives, and after visual inspection electrical tests are made for low background noise and for modulation range at 1,000, 5,000 and 8,000 c/s, the waveform being reproduced on an oscilloscope. The tape can be easily joined, after removing the oxide layer, by the use of cyclohexanone as a solvent adhesive.

The report is a mine of information on this highly developed system of recording and contains a bibliography and also a list of relevant patents. There can be no doubt that the use of high-frequency biasing in conjunction with an iron-oxide dispersion as the recording medium is a notable advance in sound recording of which more is likely to be heard in the near future.

SURPLUS SCIENTIFIC GEAR

UNDER a scheme introduced by the Ministry of Supply some months ago, research centres, universities and educational authorities in this country and also the devastated countries abroad may purchase ex-Service scientific equipment.

Over one hundred research bodies and some 200 educational authorities regularly receive the Ministry's schedules of available equipment, which include radio and electronic gear. Whilst there is an abundance of some radio equipment such as meters and valves, there is only sufficient of the more valuable test equipment to meet a small part of the demand.

Stuck for a 12A7? - then **BRIMARIZE!**

12A7

Any of the valve types listed below together with a metal rectifier makes a good substitution for the 12A7.

TYPE 18 One of the U.X. types which can often be obtained. Its characteristics at low voltages are identical with those of the 12A7 pentode section. The rectifier section is conveniently replaced by a small *SenTerCel* selenium rectifier which is easily fixed to chassis or cabinet.

TYPE 43 Another U.X. type which is still being made and whose characteristics, if self bias is employed, are similar to those of the 18. It is advisable to make a small adjustment to the line cord when using type 43.

TYPE 25A6G The International Octal version of the 43, but more readily available at the moment.

PUNCH HOLES HERE

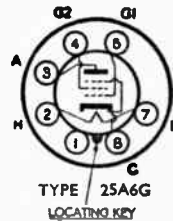
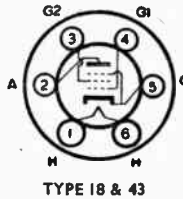
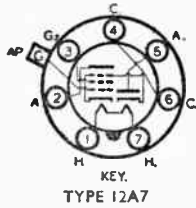

TYPE	Change Socket From	Change Socket To	Change Connections From Old Socket	Change Connections To New Socket	Other Work Necessary	Rectifier
18	U X 7 pin	U X 6 pin	Pin No. 1 " " 2 " " 3 " " 4 " " 5 " " 6 " " 7 Top Cap	Pin No. 1 " " 2 " " 3 Rect. + ve Rect. - ve Pin No. 5 " " 6 " " 4	NIL	SenTerCel miniature Selenium Rectifier Type H18/12/1/B2 (2 1/2" x 1" overall) may be fitted to chassis or cabinet in all three cases. Supplies are obtainable from :- S. T. & C. Ltd. Rectifier Division, Oakleigh Rd., New Southgate, N. 11. PRICE 7/10 List.
43	U X 7 pin	U X 6 pin	AS ABOVE	AS ABOVE	Reduce line cord by 40 ohms SEE NOTE	
25A6G	U X 7 pin	Int. Octal	Pin No. 1 " " 2 " " 3 " " 4 " " 5 " " 6 " " 7 Top Cap	Pin No. 2 " " 3 " " 4 Rect. + ve Rect. - ve Pin No. 8 " " 7 " " 5	Reduce line cord by 40 ohms SEE NOTE	

NOTE—When fixed Bias is used in the receiver it is necessary to insert a 33,000 ohm 1/2 watt resistor in series with the lead to the screen grid (Pin 3 of type 43 or Pin 4 of type 25A6G) together with a 2 mfd 150 V.W. condenser from screen grid to chassis.

BRIMAR RADIO VALVES

★ BRIMARIZE—verb transitive. Employed by knowing radio dealers in reference to a BRIMAR process by which a new lease of life can be given to sets with obsolete, obsolescent or otherwise unobtainable valves.

STANDARD TELEPHONES AND CABLES LIMITED, FOOTSCRAY, SIDCUP, KENT.

Special circumstances compel us to repeat this issue of the Series. The next issue will deal with Type 25A7G

INSTRUCTIONS: Punch holes where indicated and cut away this portion. Cut out and file them in the order in which they appear. This column will then give you a quick reference index.

1

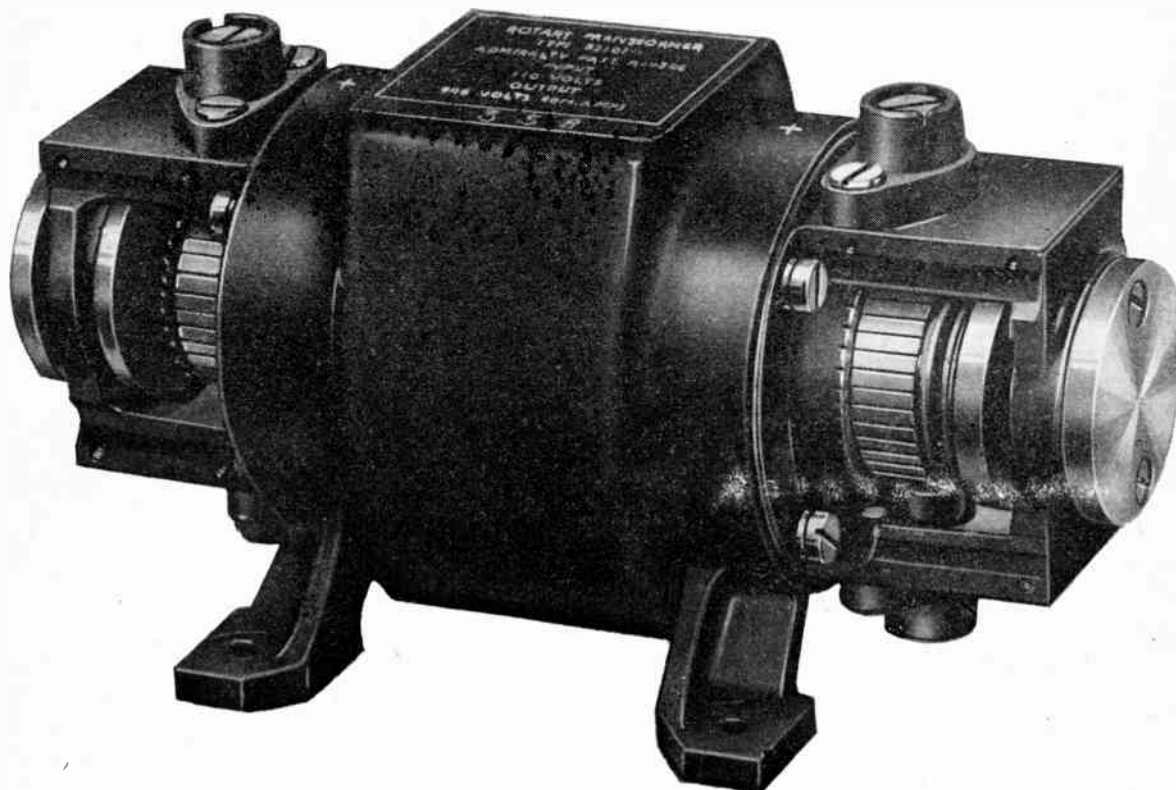

ROTARY TRANSFORMERS. Rotax offer the Radio Industry a range of Rotary transformers, invertors and convertors, from 5 to 250 watts output, D.C. to D.C. or D.C. to A.C. A series of 400 cycle machines is also available, capable of outputs up to 500 V.A. We invite you to discuss the applications of these machines with us.



ROTAX LIMITED · · LONDON, N.W.10 · · ENGLAND

CIRCUIT CONVENTIONS

The Valve "Equivalent Generator"

By "CATHODE RAY"

SOME time ago¹ I mentioned a number of the things that give rise to confusion in talking about circuits—questions of in which direction current flows, whether a condenser is being charged or discharged, which is series and which parallel, and so on. Among them I mentioned the controversy that had been raging about the valve "equivalent generator," but on this particular ground I refused to come

imaginary generator (Fig. 1b), giving a voltage μE_g and having an internal resistance r_a . The arguing starts when one draws arrows or + and - signs to show the directions of the voltages and currents.

These questions are not really matters of absolute right or wrong, any more than the question of driving to right or left of a road. The authorities can decide on either. But once it has been decided failure to conform is likely to lead to collisions and disputes. Seeing that the valve equivalent is a device intended to help the mind, it is a great advantage if the convention

adopted fits the facts and also fits other, already accepted, conventions. That is why there were protests when one authority showed two equal signal currents flowing in opposite directions, and another reversed the usual convention by reckoning the cathode voltage relative to the anode, so that (contrary to what is generally understood) anode and grid signal voltages were in phase. But why should there be any difficulty or dispute? The answer is quite simple; it is the H.T. supply. Conscious that this is really the ultimate source from which any power obtained from the valve comes, people feel they have to acknowledge the debt by using the H.T. as the standard of current and voltage direction. And to do so they may have to stand on their heads or perform other unnatural mental gymnastics. All this is quite unnecessary, and the whole thing is easy, clear, and altogether in line with the rest of simple circuit theory if

we don't try to mix Fig. 1b with Fig. 1a.

You will see I have left out the H.T.B. from Fig. 1b. I have done so because it has nothing to do with the imaginary generator. Its purpose is to feed the valve shown in Fig. 1a. To decide directions of voltages and currents in Fig. 1b according to the direction of the H.T. voltage and current in Fig. 1a is like a bricklayer wanting to start at the top of a building and work downwards because that is the way his breakfast went.

A much more relevant and fundamental convention than that is to reckon voltages with respect to the earthy side. In a valve circuit of the general type under discussion, anode and grid voltages are by general acceptance reckoned with respect to their common point, the cathode, which is usually earthed. Anybody who, for the sake of appeasing the H.T. supply, throws over this convention, is more likely to confuse than help. It is an undisputed fact that when the grid of a resistance-coupled or resonant amplifier is made relatively posi-

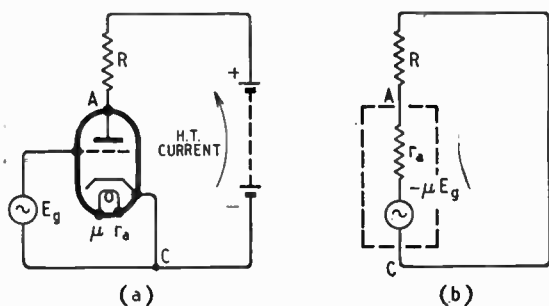

Fig. 1. (a) shows the essentials of a triode amplifier circuit, and (b) the equivalent generator circuit. A and C mark anode and cathode points respectively.

out into the open. Now that the big guns have been silent for some time it may be safe to do so. I have a feeling that many readers must have decided that any matter disputed by such eminent authorities must be too involved and uncertain for them even to attempt to understand. And yet it is constantly coming up in technical books and articles, so it is perhaps worth another attempt to get it clear. In case this sounds rather presumptuous on my part, I would say right away that I have nothing new to contribute beyond an attempt to show why I think the viewpoint of D. A. Bell in this country and F. E. Terman in U.S.A. is the most helpful for students to take.

The valve "equivalent generator" or "equivalent circuit" principle, of course, is an idea for simplifying the theory of valve amplifiers by replacing (on paper) the driven valve (Fig. 1a) by an

¹ Wireless World, Sept., 1946, p. 299.

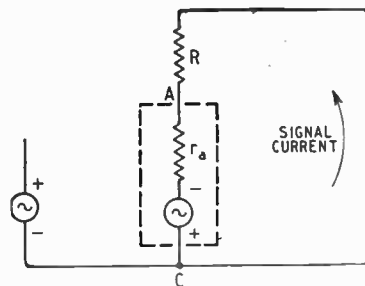

Fig. 2. When the grid signal voltage is positive (relative to C) the result in the anode circuit can be attributed to a positive (in-phase) generator voltage relative to A or a negative (180° out-of-phase) voltage relative to C. The latter way of putting it is preferable because the accepted custom is to specify both anode and grid voltages relative to C, and to reverse this custom with one of them is to invite confusion.

Circuit Conventions—

tive the anode goes relatively negative. That fixes the phase or direction of the output voltage. At such a moment the generator polarity must be as shown in Fig. 2, and the direction of the current (using the classical convention, which is opposite to the electron flow) must be as shown by the arrow, all of which agrees with experimental fact.

So what is all the argument about? Well, it seems to worry

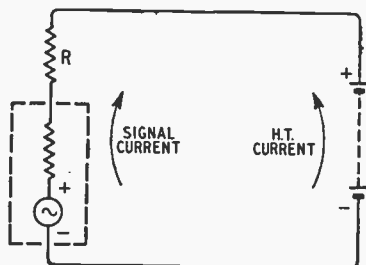

Fig. 3. When the imaginary generator is on its positive half-cycle, it opposes the H.T. source and reduces the steady current.

some people to have a *negative* voltage ($-\mu E_g$), causing a current which from the point of view of the H.T. source is *positive*. But why drag in the H.T. source? It is merely a device for keeping the valve in working condition, and when (for purposes of theoretical calculation) we have replaced the valve, and its H.T. supply unit, and its socket, and the maker's name on the glass, and everything else appertaining to the valve, by a generator inside a dotted line, which (within assumed limits) produces the same external effects, why display this irrational concern for the views of the H.T.?

When considering the signal voltages in an amplifier, it would be very tiresome if we had to be always thinking of the steady H.T. and G.B. voltages that happen to be necessary for the happy domestic life of the valve. The sort and quantity of food one eats admittedly has a lot to do with the efficiency of one's work, but it would be a distraction and waste of time to keep on about it throughout the working day. Similarly, in a signal voltage diagram or discussion it clarifies matters to leave steady

voltages out of it. This is so generally accepted that when a statement is made that the effect of a certain signal is to drive the anode of a valve negative it is not considered necessary to explain that the anode is not really absolutely negative, but only relative to its potential in the absence of the signal.

In this valve equivalent affair the mixing of domestic and business matters is bound to cause confusion. In Fig. 1a the source of power is a battery, and the direction of the power flow from it is right to left, and positive is anti-clockwise. In Fig. 1b the source of power is a generator, the direction of power left to right, and positive is clockwise. So, if the equivalent generator and H.T. battery are shown in the same diagram, as in Fig. 3, a positive generator voltage is seen to be in opposition to the battery. It is therefore perfectly natural for a *negative* generator voltage (corresponding to a positive half-cycle on the grid) to *assist* the battery and increase the anode current—as we know in fact it does.

The only room for question I can see is why the voltage of the fictitious generator should be assumed to be $-\mu E_g$ —apart, that is, from a not unnatural desire to make it fit the observed facts. D. A. Bell has given² a logical derivation on a basis of accepted conventions, although even he—quite unnecessarily, as it turns out—includes the steady current among his *Wireless Engineer* basic conditions.

He points out that the valve (unlike the imaginary generator) is a passive device; it has no voltage source inside it, and any changes of anode current are caused by varying the voltages applied, from outside it, to grid and anode. In the circuit in question the only variation in anode voltage is due to the drop in the anode load, and this voltage opposes the grid voltage changes, which is how the minus sign comes in.

Any real valve is non-linear; that is to say, the changes of anode current are not exactly proportional to the changes in ap-

plied voltage. But if the changes are small compared with the steady anode current, there is not a very serious difference between the real valve and an ideal valve in which the anode current changes are proportional to the voltage changes. It is this ideal valve that is imitated by the fictitious generator. So one mustn't expect too much of the generator idea if the signal voltage is so large that there is appreciable distortion. But until it is necessary to take account of distortion in the valve, the simple equivalent generator does help a lot—so long as one is quite clear about it.

Just one more point. For simplicity these arguments are concentrated on a circuit with a purely resistive anode load. But the generator substitute gives the right answer with any sort of load, and, in fact, it is with reactive loads that its help is most valuable.

ROBOT PHONE RECORDER

A SOUND recording device of considerable novelty has recently been invented and is being mass-produced in Switzerland. Known as the Ipsophone, this instrument, which employs a magnetic steel wire, is designed for use as an automatic message recorder on telephone circuits. On a number being called, in the subscriber's absence, this device answers the telephone in the following manner: "Here is Mr. Brown's Ipsophone. Your message is being automatically recorded. Go ahead."

This application is, of course, not new but the ingenious feature of the equipment is the safety code number. The subscriber, before leaving his home, sets one of 1,023 possible combinations of numbers. If when absent he rings his own number to hear any messages recorded, the machine counts from zero to nine three times, and the subscriber has to repeat with it the figures forming his code number. This actuates a circuit and starts the play-back mechanism.

If he desires to record his answer to the message for the advice of his secretary he has to say two words, e.g., "Hello, hello," and then dictate his remarks. If, however, he wishes to eliminate the recorded message, he merely speaks another code word and the wire is demagnetized.

² *Wireless Engineer*, Nov., 1945, p. 532, and *Electronic Engineering*, Feb., 1946, p. 56.

Design Data (12)

R.C. COUPLING

Response at Low-Frequencies

THE method of determining the value of a coupling capacitor in a resistance-capacitance coupled stage is quite well known for the usual case of a signal of sine waveform, but the method to be applied in the case of pulse and saw-tooth waves is not so generally understood.

The usual circuit is shown in Fig. 1 and its equivalent in Fig. 2. Here R_a is the A.C. resistance of the valve modified, if necessary, by any feedback. The impedance of the H.T. supply is assumed to be negligible. It is also assumed that the frequencies or the rates of change of current and voltage are low enough for the stray capacitance to have a negligible effect.

There are certain facts concealed in the formulæ which are well expressed as useful rules. They are:

1. For not more than 2 per cent distortion of a pulse or saw-tooth repetitive waveform the time constant must not be less than 50 times the pulse or saw-tooth duration. Time and time constant are to be in the same units; i.e., sec and F-Ω, msec and μF-kΩ, or μsec and pF-MΩ.
2. For a differentiating circuit the time constant should not exceed one-quarter of the pulse duration.
3. For a sine-wave input, the loss is 3 db when $T = 159/f$ (T in μF-kΩ, f in c/s).

Symbols

- μ = amplification factor of valve
- R_a = A.C. resistance of valve (kΩ)
- R_c = coupling resistance (kΩ)
- R_g = grid leak of following valve (kΩ)
- C = coupling capacitance (μF)
- $g_m = \mu/R_a$ = mutual conductance of valve (mA/V)
- T = circuit time constant = $C(R + R_g)$ (msec = μF - kΩ)
- $R = R_c R_a / (R_c + R_a)$ (kΩ)
- t = time (msec)
- f = frequency (c/s)
- A = E_o/e_{gc} = voltage amplification.

Formulae

$$A = \frac{g_m R R_g}{R + R_g} x \dots \dots \dots (1)$$

$$x = 1/\sqrt{1 + (159/fT)^2} \dots \dots \dots (2)$$

for a sine-wave input

$$x = e^{-t/T} \dots \dots \dots (3)$$

for a unit impulse input.

For a given response at a given frequency

$$T = \frac{159}{f} \cdot \frac{x}{\sqrt{1-x^2}} \dots \dots \dots (4)$$

For a given response at a given time after the application of a pulse

$$T = t/(2.3 \log_{10} 1/x) \dots \dots \dots (5)$$

and for values of x not less than 0.95

$$T = t/(1-x) \dots \dots \dots (5a)$$

Examples

(1) If $R_c = 207 \text{ k}\Omega$; $R_a = 10 \text{ k}\Omega$; $\mu = 20$; $R_g = 200 \text{ k}\Omega$; and a response of -1 db at 50 c/s is required, what coupling capacitance must be used, and what is the amplification at relatively high frequencies where C has a negligible effect?

We have $g_m = 2 \text{ mA/V}$; $R = 10 \times 20/30 = 6.6 \text{ k}\Omega$, so from (1).

$$A = \frac{2 \times 6.6 \times 200}{206.6} = 12.9. \text{ Then from (4)}$$

$$T = \frac{159}{50} \cdot \frac{0.89}{\sqrt{1-0.795}} = \frac{159 \times 0.89}{50 \times 0.456} = 6.22$$

since for a response of -1 db $x = 0.89$.

Fig. 2.

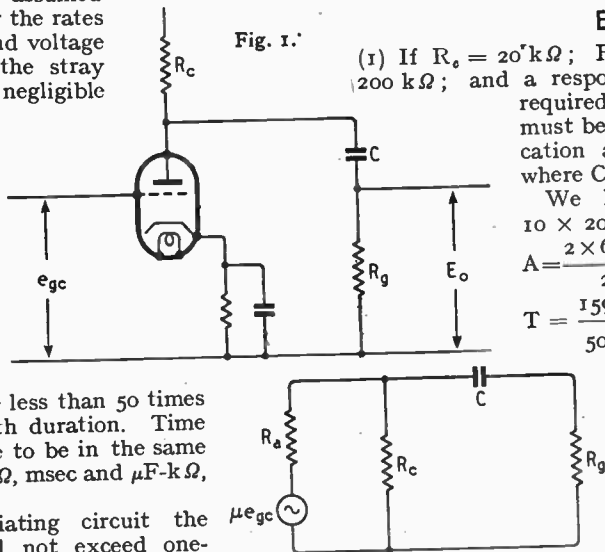

Since $R_g + R = 206.6 \text{ k}\Omega$, $C = 6.22/206.6 = 0.03 \text{ }\mu\text{F}$.
 (2) The same amplifier is to be used for a saw-tooth wave of 50-c/s recurrence frequency, and it is necessary that the drop in output should not exceed 2 per cent. What value of C must be used? For a 2 per cent drop, $x = 0.98$ and, ignoring the fly-back time, the duration of the saw-tooth wave is $1/50 = 0.02 \text{ sec}$, so $t = 20 \text{ msec}$. We use (5a) since $x > 0.98$ and have $T = 20/0.02 = 1000$ for $R + R_g = 206.6 \text{ k}\Omega$, $C = 1000/206.6 = 4.82 \text{ }\mu\text{F}$.

The enormously greater time-constant needed for low distortion of a pulse or saw-tooth wave is apparent.
 (3) With the same amplifier, a pulse of duration 10 μsec is applied, and it is desired that at the end of the pulse there should be substantially no output; that is, the circuit shall act as a differentiator. What value of C is now needed?

This is most easily solved from (3), and it is necessary to assume some arbitrary small value for x—say about 0.02. A table of exponentials gives $t/T = 4$ (about) for $e^{-t/T} = 0.02$. Therefore, $T = t/4 = 10/4 = 2.5 \text{ }\mu\text{sec} = 0.0025 \text{ msec}$, and $C = 0.0025/206.6 = 0.0000121 \text{ }\mu\text{F} = 121 \text{ pF}$.

World of Wireless

STANDARD FREQUENCY BROADCASTS

IMPROVEMENTS in the services broadcast by WWV are announced by the Central Radio Propagation Laboratory of the American National Bureau of Standards. Transmissions, now radiated on four additional frequencies (20, 25, 30 and 35 Mc/s), bringing the total to eight, include regular warnings of radio propagation disturbances.

To ensure reliable coverage of the United States and to extend the coverage in other parts of the world, seven or more transmitters are radiating throughout the twenty-four hours. The services provided are standard radio frequencies—listed below—time announcements (E.S.T.) in code each five minutes, standard time intervals, standard audio frequencies and radio propagation disturbance warnings.

The transmission schedule is:—

Radio Frequency (Mc/s)	Time (G.M.T.)	Power (kW)	Audio Frequency (c/s)
2.5	0000-1400	1	440
5	0000-1200	10	
5	1200-0000	10	440 and 4000
10		10	
15		10	440
20	continuously	0.1	
25		0.1	
30		0.1	
35		0.1	

The station's call letters WWV and other 'phone announcements are given each hour and half hour.

On each carrier frequency, the accuracy of which is now better than one in fifty million, a pulse of 0.005 second duration occurs at intervals of precisely one second. It consists of five cycles, each of 0.001 second duration, and is heard as a faint tick. The pulse is omitted on the 59th second of every minute.

A warning of radio propagation conditions is broadcast in code on each of the carrier frequencies at twenty and fifty minutes past the hour. If a warning is in effect, a series of "W's" (in morse) follows the time announcement; if no warning is in effect, a series of "N's" (in morse) follows the time announcement.

A warning means that radio propagation disturbance is anticipated within 12 hours, or is in progress, with its most severe effects on radio transmission paths crossing the North Atlantic; i.e., those paths for which the control points of transmission lie in or near the northern auroral zone. Disturbance is characterized by low intensities, accompanied by flutter or rapid fading on the normal frequen-

cies used at the different times of the day, or by complete blackout of signals.

The warnings do not apply to sudden ionospheric disturbances which are unpredictable.

The Bureau welcomes reports on reception—particularly on the new frequencies—which should be sent to the Central Radio Propagation Laboratory, National Bureau of Standards, Washington, 25, D.C.

SERVICEMEN IN INDUSTRY

IT is announced by the Air Ministry that agreement has been reached whereby airmen who received wartime training in certain trades and completed five years' service in their trade are eligible for admission as skilled men in certain engineering trades and allied civilian occupations.

Airmen in the following trades who were not in the electrical industry before the war may now join the Resettlement Section of the Electrical Trades Union if they enter the industry on release: Radar Mechanic (Air or Ground), Wireless and Electrical Mechanic, Wireless Mechanic and Wireless Operator Mechanic (Air or Ground).



MICRO-WAVE TOWER. A reproduction of the architect's model of the Federal Telecommunications Laboratories, New Jersey, showing the 300-foot tower which will be used for U.H.F. research.

PURCHASE TAX ON KITS

WE have been asked by the Commissioners of Customs and Excise to draw attention to the fact that the sale in parts of a receiver of the domestic or portable type does not affect its liability to Purchase Tax.

Constructors' kits of components for the building of sets (including loudspeaker or cabinet supplied therewith) are accordingly chargeable with tax at the rate of 33½ per cent of the wholesale value.

AUSTRALIAN AMATEURS

A NUMBER of new frequencies having recently been allocated to Australian amateurs, the most notable being an extension of the 20- and 40-metre bands, we give below a list of the bands now available.

3.5- 3.8 Mc/s	166- 170 Mc/s
7.0- 7.2 "	1345- 1425 "
14.0-14.4 "	2500- 2700 "
28.0-30.0 "	5250- 5650 "
50.0-54.0 "	10000-10500 "

AUXILIARY AIR FORCE

FORMER members of the R.A.F., particularly those with wartime experience of raid reporting and fighter control methods, may now volunteer to join new Auxiliary Air Force units being set up in nine counties—Hampshire, Kent, Middlesex, Norfolk, Northampton, Nottingham, Suffolk, Sussex and East Riding. These units will be required to man Fighter Command and Fighter Group operations rooms, and radar reporting stations. Their work will be operational rather than technical.

Training will take place during the evenings, at week ends, and during 15 days' camp or exercises annually. There are allowances for training expenses and travelling and an annual bounty for airmen and a retainer for officers. Former members of the W.A.A.F. will be recruited later.

CANADIAN AMATEURS

A CHAIN of emergency amateur radio stations, for use in case of civil emergency or disaster, was recently set up across Canada. Sponsored by the Royal Canadian Air Force, the Air Force Amateur Radio System, as it is called, is open to any Canadian citizen. It does not demand Reserve or Service attachments, and places no obligation on its members to enlist in a Fighting Service at any time. Among

the aims of the organization is to provide additional channels of radio communication throughout Canada that may be used to augment or replace telephone and telegraph services in time of civil emergency or disaster and to give Canadian amateurs a knowledge of Service communication procedures and equipment.

RADAR TRAINING

ACCORDING to the latest figures given by the Radio Officers' Union, some 60 radio officers have taken the examination held at the end of each of the six-weeks' technical courses in radar arranged by the Admiralty for the Merchant Navy. In addition to the technical course there is a short radar observer course for navigation officers.

Since the introduction in December, 1945, of the scheme for instructing Merchant Navy Officers in Admiralty establishments the courses have been given in H.M.S. Collingwood, but it is expected this school will soon be closed to Merchant seamen. A Radar Training Committee of the Ministry of Transport is at present investigating the whole question of training.

PERSONALITIES

Lord Trefgarne is the title adopted by G. M. Garro-Jones, chairman of the Television Advisory Board, who was created a Baron in the New Year Honours (not a Knight as stated in the February issue).

Major Edwin H. Armstrong has received the American Medal for Merit for his contributions to military communications especially in the field of frequency modulation. The citation states that he was "instrumental in influencing the Army to adopt F.M. for its mobile communications."

IN BRIEF

Amateurs' Examination.—The report on the City and Guilds examination for amateur transmitters held last November shows that 150 of the 216 candidates passed. The percentage of failures was 30.5 as compared with 22.2 at the previous examination. The only examination this year will be held on May 14th.

T.E.M.A.—As part of the celebrations to commemorate the centenary of the birth of Dr. Alexander Graham Bell, the Telecommunication Engineering and Manufacturing Association held a dinner at which Lord Listowel, the Postmaster-General, was a guest. Among the founder members of T.E.M.A., formed in 1943, are Marconi's, G.E.C., Plessey, Siemens and S.T.C.

The Freeze-up.—Some idea of the load imposed on the aerials of the Cable and Wireless transmitting station at Dorchester, where at one time all the arrays were on the ground, will be gained by the fact that No. 16 gauge wire was built up with ice to a circum-

ference of 5 inches. No damage was done to the sixteen 300ft masts because the balance weights which keep the arrays taut tripped off without failure. Six 100ft masts were, however, damaged.

Chinese Telecommunications.—A contract covering the supply of twelve telegraph/telephone transmitters—varying in power from 5 to 25 kW—30 triple-diversity high-speed receiving equipments and 150 commercial receivers to the Chinese government has been secured by Marconi's. Valued at nearly £300,000, the equipment is for the extension of China's overseas telecommunication services. Some months ago Marconi's received a similar order for the country's internal services.

station. The provision of a station in Europe and one to serve Eastern Asia and the Pacific is also included.

U.S. 'Phone Bands.—Because of the imminence of the world telecommunications conference the American Radio Relay League has withdrawn its year-old application to the U.S. Federal Communications Commission for the allocation of a 7-Mc/s 'phone band and the widening of the 14.2-14.3-Mc/s 'phone band. It will now await the result of the conference before making further application.

Athlone's new short-wave transmitter, which is now not expected to be operating until the end of the year, is to be supplied by Marconi's W.T. Co.

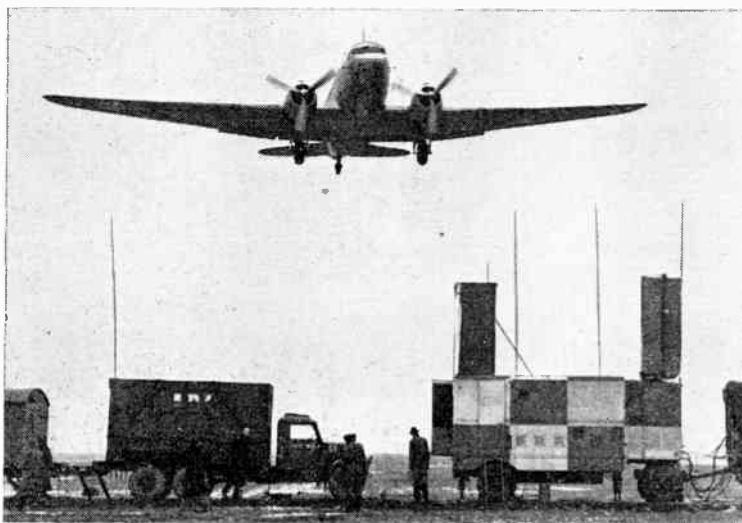

G.C.A.—Ground Controlled Approach—the radar system for "talking down" aircraft, was brought into operational use at London Airport on February 27th. Initially it is available on one runway only and from 0900 to 1700 daily. The channel normally to be used will be 118.1 Mc/s (2.54 m) but the equipment provides for two-way R/T communication on any one of twelve V.H.F. and 30 H.F. channels. G.C.A. employs two centimetre radar systems—one for marshalling the aircraft and the other for the runway approach. The only equipment necessary in the aircraft is a H.F. or V.H.F. receiver. The mobile G.C.A. gear is shown in use at London Airport.

"F.M. is now established on a sound, permanent post-war basis. In all, we at the F.C.C. expect some two thousand of these F.M. stations in the next few years—nearly twice as many as the present number of A.M. stations. . . . If I were buying a new radio today, I would certainly not buy one that did not include F.M."—E. K. Jett, U.S. Federal Communications Commissioner.

"Nation Shall Speak Peace. . ."—Plans have been laid before the General Assembly of the United Nations Organization for the establishment of an international broadcasting and telecommunications system. This plan, which will be considered at the next meeting of the Assembly in September, provides for the expenditure of six million dollars for the equipment. It is recommended that half this amount should be spent on the headquarters

Exeter's Transmitter.—A low-power station at Exeter was added to the existing group of synchronized transmitters working on 1,474 kc/s on February 26th, when the B.B.C.'s Third Programme was resumed after the interruption during the fuel crisis.

A Decrease.—The 10,691,900 broadcast receiving licences in force at the end of January is a decrease of over 86,000 compared with the figure at the end of the year. The January total included 11,200 television licences.

Cable and Wireless, Limited, will remain in being as a Government-owned company and will continue to own the assets and to operate the telecommunication services outside the United Kingdom, apart from those to be owned and operated by the respective national bodies in the Dominions, India and Southern Rhodesia as decided at

World of Wireless—

the recent Commonwealth Telecommunications Conference. All the assets in the United Kingdom will be transferred to the Post Office and the services integrated with those of the Post Office. The P.M.G. has taken over Ministerial responsibility for Cable and Wireless.

R.S.G.B. Council.—At the annual general meeting of the Radio Society of Great Britain, S. K. Lewer, G6LJ, was elected president, and V. M. Desmond, G5VM, vice-president.

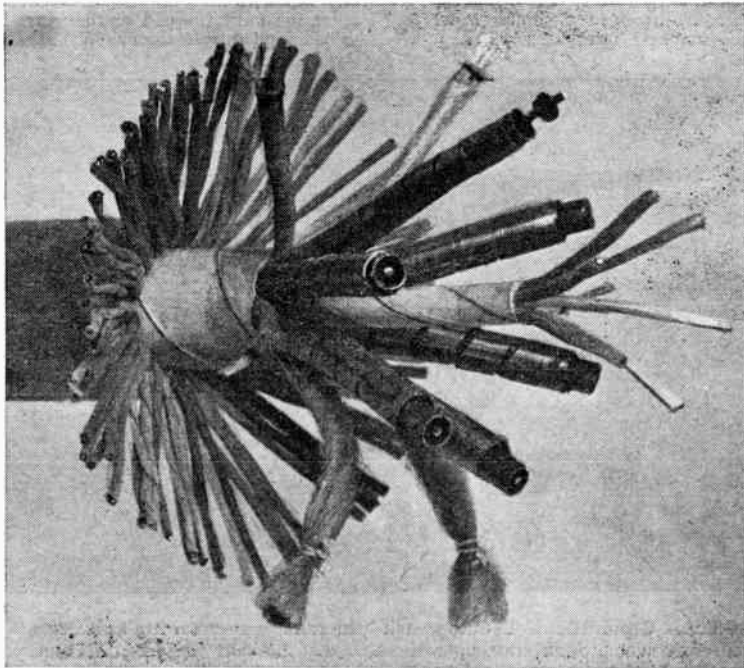

THE WASHINGTON—NEW YORK R.F. CABLE, shown here in section, includes six R.F. lines for television relaying, multi-channel telephony, etc., as well as a number of ordinary conductors.

Australia's overseas radio and cable services, which in the past were operated and controlled by Amalgamated Wireless (Australasia), have been taken over by the Australian Communications Commission which was set up in conformity with the Empire policy to place the communications services under government control.

Frequency Modulation is to be used experimentally in Australia. Two stations are being erected in Sydney and Melbourne and will soon be in operation. Transmission will be in the 88-108 Mc/s band.

A "Radio Paging" Service is planned by a New Yorker, who, according to *Radio News*, has been granted a construction permit by the F.C.C. for the erection of an experimental station. Clients of the service will carry a "vest pocket" pre-tuned receiver; on hearing their code number they will have to 'phone the headquarters of the service to receive the message addressed to them.

Radar Association.—The first reunion of the Radar Association was held in January, when some 300 ex-R.A.F. and ex-W.A.A.F. members of radar commands met. Founded in 1946, the association, of which A.V.M. D. C. T. Bennett and Sir Edward Appleton are vice-presidents, aims at preserving "the comradeship founded in the radar commands regardless of trade or rank." The secretary is C. W. Knight, 31, Currey Road, Greenford, Middx.

INDUSTRIAL NEWS

Imports from U.S.—According to our New York contemporary, *Tele-Tech*, the Federation of Anglo-American Importers is negotiating for the inclusion of American broadcast receivers in the list of Token Imports permitted by the Board of Trade. The Federation has secured licences for some 34 importers to purchase American valves.

R.C.E.E.A. Officers.—The council of the Radio Communication and Electronic Engineering Association—one of the constituent bodies of the Radio Industry Council—has re-elected C. O. Stanley, C.B.E. (Pye), as chairman and elected L. T. Hinton, B.Sc. (S.T.C.), as vice-chairman.

G.E.C. photo-cell equipment has been installed in H.M.S. *Vanguard* to give automatic indication of smoke density in the funnels.

Exide and Drydex.—A new sales depot has been opened by the Chloride Electrical Storage Co., at 89, Albion Street, Leeds, 1.

Wearite.—The whole of the production side of Wright and Weaire has been transferred to the company's new works at Simonside Works, South Shields, Durham. The London office is now at 2, Lord North Street, S.W.1. Tel. ABB 2126.

B.I. Callender's Cables has adopted a five-day working week. Although all the company's works will be closed on Saturdays, the head offices and branch offices will be open for urgent business.

Marconi's announce that they are to supply the 25-kW F.M. transmitter ordered by the B.B.C., to which reference was made last month.

Sperry Gyroscope Co. has been given the contract to install the shore radar system at Liverpool docks, which it is planned will be in operation in the spring of 1948.

John Factor, Ltd., is the new name of Stanley Cattell, Ltd., of 9-11, East Street, Torquay.

Sussex Industries Exhibition.—The second exhibition to be promoted by the Sussex Engineers' and Manufacturers' Association will be held in the Dome and Corn Exchange, Brighton,

"A Rose, by any other name. . ."—To meet the criticism that there are no details of medium-wave stations outside the European zone in our booklet, "Broadcasting Stations of the World," the second edition, which will be published in a few weeks, will be called "Guide to Broadcasting Stations." It has been revised and includes details of some 130 new stations—bringing the total to over 1,200. Frequency and geographical lists of some 300 long- and medium-wave European stations and some 900 short-wave stations of the world are given in the booklet, which is priced at 1s. (postage 1d.).

High Power.—The proposal has been made to the F.C.C. that twenty stations in the United States should be given exclusive frequencies and permitted to operate with a power of 750 kW. The plan is that five of these stations should be operated by each of the four major networks, giving a nation-wide coverage.

Television Bibliography.—Some 275 technical papers on television and closely related subjects, written by members of the Radio Corporation of America and published between 1929 and 1946 in some 30 different American journals, are listed in a booklet "Television: A Bibliography of Technical Papers," issued by *RCA Review*, R.C.A. Laboratories Division, Princeton, N.J., U.S.A.

"Trader Year Book."—The 1947 edition of this valuable trade reference book will be ready this month. New features included in this edition are:—complete receiver specifications, mains voltage directory and a country-wide analysis of receiving licence figures. The usual directories of manufacturers, wholesalers, trade names and buyers' guide have been revised. Copies are obtainable from Dorset House, Stamford Street, S.E.1, price 7s 6d to subscribers to *Wireless & Electrical Trader* and 10s 6d to non-subscribers.

from September 17th-27th. Information is obtainable from the exhibition organizer, Lt. Col. C. Hedley Briggs, O.B.E., 3, Marlborough Place, Brighton, 1, Sussex.

Exports.—The policy of the Radio Manufacturers' Association War Export Group, through which production quotas and raw materials were allocated to manufacturers, was recently criticized by the Electronic Manufacturers' Association. It is announced by E.M.A. that a company may now deal direct with the Ministry of Supply.

B.E.T.R.O.—The British Export Trade Research Organization recently completed its first year of full active work, during which it has handled some 600 overseas enquiries and research commissions. It is learned that a considerable number of enquiries have been received from the radio industry.

Birmingham office of G.W.B. Electric Furnaces, Ltd., is now at 21, Steelhouse Lane. Tel.: Central 6372.

CLUBS

Bradford.—Particulars of the Bradford Short-Wave Club, which meets each week at its headquarters, 1374A, Leeds Road, Bradford, are obtainable from V. W. Soven, G2BYC, Rushwood, Grange Park Drive, Cottingley, Bingley, Yorks.

Crayford.—The recently formed North Kent Radio Society meets on alternate Wednesdays at 7.30, in the Lecture Room of Crayford Library. The next meeting will be on April 2nd. Sec.: H. L. Overton, G4CW, 6, Lower Station Road, Crayford, Kent.

Cornwall.—Meetings of the West Cornwall Radio Club are held alternately in Penzance, on the first Thursday in each month at 7.30 at the Railway Hotel, and in Falmouth, on the third Thursday. Secretary, R. V. A. Allbright, G2JL, Greenacre, Lidden, Penzance, Cornwall.

Exeter.—Membership of the recently formed Exeter and District Amateur Short-Wave Radio Society is now 20. Meetings are held on Thursdays at 7.0 in the Mount Pleasant Chapel Schoolroom, Thurlow Road. Sec.: E. G. Wheatcroft, 7, Mount Pleasant Road, Exeter, Devon.

Manchester.—Re-formed in May last year, the Manchester and District Radio Society now has a membership of 100. The next meeting will be held on April 22nd at the School of Technology, Whitworth Street, Manchester, at 7.30. Sec.: H. Marshall, G4ND, 14, Greenway Close, Sale, Cheshire.

Manchester.—The next meeting of the Radio-Controlled Models Society on March 29th at 3.0 at the Y.M.C.A., Peter Street, Manchester, will be addressed by Peter Hunt, Technical Editor of the Model Aeronautical Press. Sec.: J. C. Hogg, 24, Springfield Road, Sale, Manchester.

Reading.—The next meeting of the Reading and District Amateur Radio Society will be held on March 29th at 6.30 at Palmer Hall, West Street, Read-

ing. Sec.: L. A. Hensford, B.E.M. (G2BHS), 30, Boston Avenue, Reading, Berks.

Southampton.—The new secretary of the Southampton Radio Club, which meets each Wednesday, is J. H. Silience, 80, The Drove, Coxford, Southampton, from whom details of membership are available.

Wellington.—The name of the Wrekin Amateur Radio Society has been amended to Wrekin and Y.M.C.A. Amateur Radio Society. Meetings are held on Mondays, Thursdays and Fridays at the Y.M.C.A., Wellington, where the club has a private room. Sec.: T. L. Stevens, G3XV, Sunny Cottage, Donnington Wood, Wellington, Salop.

MEETINGS

Institution of Electrical Engineers

Radio Section.—Discussion on "Does Standardization Conflict with Progress," opener J. W. Dagleish, B.Sc., on April 15th.

"New Possibilities in Speech Transmission," by D. Gabor, Dr. Ing., on April 23rd.

The above meetings will be held at 5.30 at the I.E.E., Savoy Place, London, W.C.2.

Cambridge Radio Group.—"The Pulse Testing of Wide-Band Networks," by D. C. Easley, D.Eng., E. C. Cherry, M.Sc., and M. M. Levy, on April 1st, at 6.30, at the Cavendish Laboratory.

"Dielectric Phenomena at High Radio Frequencies," by Professor Willis Jackson, D.Sc., D.Phil., on April 22nd, at 6.0, at the Cambridge-shire Technical College.

North-Western Radio Group.—"The Design of High-Fidelity Disc-Recording Equipment," by H. Davies, M.Eng., on April 10th, at 6.0, at the Engineers' Club, Albert Square, Manchester.

British Institution of Radio Engineers

Scottish Section.—Discussion on "Television Development in Scotland," opener A. Bogie, on April 10th, at 6.45, at the Institution of Engineers and Shipbuilders in Scotland, Elmbank Crescent, Glasgow, C.2.

North-Eastern Section.—"The Technique of Radio Design," by D. R. Parsons, on April 9th, at 6.0, at Neville Hall, Westgate Road, Newcastle-on-Tyne.

Institute of Physics

Electronics Group.—"Electron Multipliers," by S. Rodda, on April 22nd, at 5.30, at the Royal Society, Burlington House, London, W.1.

Radio Society of Great Britain

"The Design and Construction of Short-wave Amateur Transmitters," by W. H. Allen, M.B.E. (G2UJ) on April 11th, at 6.30, at the I.E.E., Savoy Place, London, W.C.2.

British Sound Recording Association

"Modern Direct Disc Recording," by A. H. Watts, on April 25th, at 7.0, at the Royal Society of Arts, John Adam Street, Strand, London, W.C.2.

BRITISH INDUSTRIES FAIR

ALTHOUGH the floor space to be occupied by the B.I.F. in London and Birmingham is slightly less than that of the last Fair (1939), the area allocated to the radio and music section at Olympia is more than twice as much—17,140 sq. ft. Sixty per cent of the exhibitors in this section are in the radio industry—their names are listed below. In addition, a number of radio manufacturers are exhibiting in the scientific and optical section.

Radio and Music Section.

AIRMEC International.
Allander Industries.
Amplion.
Associated Electronic Engineers.

BELLING & Lee.
Birmingham Sound Reproducers.
British Electronic Products.
British Rola.

CELESTION.
Central Rediffusion Services.
Cossor, A. C.

DALLAS, John E.
Dubilier.
Du Bois.

EASTICK, J. J.

GARRARD.
Gramplan Reproducers.

LABGEAR.
Leyland Instruments.

MARCONI'S.
Masteradio.

Mullard.
Multicore.
Multitone.

PHILIPS.
Pye.

RADIO Instruments.
Rediffusion.
Rees Mace.

SOBEL.

TAYLOR Electrical Instruments.
Telegraph Construction & Maintenance.
Telsen.
Thorn Electrical Industries.
Trix Electrical.

ULTRA.

VITAVOX.

WEGO Condenser.
Westinghouse.
Woden Transformer.

The Radio Industry Council is represented on the B.I.F. Advisory Committee of sixty-four members by W. M. York, G. J. Freshwater and H. J. Dyer.

Admission to the Fair, which will be open from May 5th to 16th will be restricted to home and overseas buyers until 4.30 each day, when the public will be admitted, except Saturday, May 10th, when it will be open all day to the public.

Scientific and Optical Section

ALLEN & Hanburys.
Amplivox.
Ardente.

BAIRD & Tatlock.
Baldwin Instrument.
British Physical Labs.

CAMBRIDGE Instrument.
Cinema-Television.

DAWE Instruments.

FURZEHILL Laboratories.

GAMBRELL.

HILGER, Adam.

MULLARD.
Multitone.

PARK Royal Scientific Instruments.

SALFORD Electrical Instruments.
Scophony.
Sperry Gyroscope.

TAYLOR, Taylor & Hobson.

UNBIASED

By *FREE GRID*

The Turn and the Bar

SOONER or later radar was bound to be blamed for the vagaries of the weather, and the only thing that surprises me is that it has not happened before. I fully expected that it would be made the scapegoat for the great deluge of waters that assailed us last summer. But it re-



mained for the great February freeze-up of this year to supply the necessary inspiration for one of our amateur meteorologists to take up his pen and write to a Sunday newspaper with a strong indictment of radar as the cause of our faces being as blank and dismal as the screens of our television sets.

I must say that the gentleman in question dealt with his subject with great thoroughness. After pointing out that the winter following the establishment of the pioneer radar station in 1935 was marked by weather of unusual severity, he stressed the fact that the great impetus given to radar by the outbreak of war was followed by very severe wintry weather. The almost unprecedented low temperatures of January, 1940, were scarcely exceeded even in the recent cold spell, which he naively puts down to the increasing use of radar in a civilian capacity.

Now, as I have pointed out in these columns, we heard all this sort of thing in the early days of broadcasting from amateur weather wise-acs, who forgot that the radio waves which they blamed had been used for over a quarter of a century earlier in the pre-broadcasting era of wireless. This time it is "radar waves" which are the scapegoat, and it is obvious that the writer thinks that they are altogether different from ordinary radio waves.

I am not really worried about the opinion of amateur meteorologists.

They and their opinions will pass into oblivion like those of earlier generations of their kind who have invariably attributed the vagaries of the weather to each new application of science.

What I *am* worried about, however, is the thoroughly unprofessional and technically slipshod way in which certain leading lights of the electrical industry described the public's habits of using electric fires in the days of the great freeze-up. After all, it must be remembered that the electrical industry is a poor and rather uncultured relation of our own radio industry, and

"Poor and uncultured relations."

any discredit its members bring upon themselves is a reflection also upon us. When, therefore, a prominent member of the electrical world publicly announces that the electric fire consumption was "up by many thousands of bars in each locality," it is time we asked ourselves whether "the bar" as a new electrical unit threatens to oust the old-fashioned kilowatt-hour in the same manner as "the turn" at one time threatened to rival the "microhenry" in the radio world.

How They Do It

IT goes almost without saying that the Third Programme is the only one which readers of this journal can afford to have it known they listen to unless they wish to suffer a serious loss of intellectual prestige. This programme is, after all, the only one which is at all commensurate with the more rarefied atmosphere to which *Wireless World* readers have become accustomed.

At the same time it is within my knowledge that there is a considerable number of the weaker brethren among the glittering galaxy of technical talent which surrounds the Editorial throne who listen to the Home Service and even to the Light Programme. This they do without loss of prestige by the simple expedient of using head-

phones and a personal portable disguised as a hearing aid while the domestic loudspeaker drones out the Third Programme unheeded.

These weaker brethren at any rate will be as familiar as I am with the fact that nearly all comedians, so-called and real, make a special feature of raising a laugh by imitating and caricaturing the efforts of other performers. In these efforts they show themselves to be so familiar with recent broadcasts of a wide variety of other performers that I have often wondered how they manage to find the necessary time to listen to them all, let alone mark, learn and inwardly digest them. Recently I put the question direct to a well-known comedian of my acquaintance. He would only let me know the secret on condition that I refrained from disclosing his identity, as he said that if there was one thing more than another that he liked to avoid it was publicity.

I gave my promise and, picking up the telephone, he dialled a certain number and requested some half-dozen recordings of recent broadcasts by certain fellow artistes. This done he promptly placed the 'phone receiver in a special rest so constructed that the earpiece fed its output into a microphone coupled via a suitable amplifier to a loudspeaker, thus legitimately dodging the P.M.G.'s regulations about making any direct attachment to the telephone.

It appeared from subsequent explanations that there is in existence a company which makes a recording of everything broadcast by the B.B.C., and as promoters of the company are not at all sure about their legal position, both with regard to recording rights and also the various copyright acts, to say nothing of the B.B.C., they are compelled to remain underground and operate in

Atmosphere for the Third Programme.



this manner. Their telephone number is disclosed to would-be clients only after the most elaborate enquiries as to their trustworthiness.

Vortexion

"SUPER FIFTY WATT" AMPLIFIER

This **AMPLIFIER** has a response of 30 cps. to 25,000 cps., within $\frac{1}{2}$ db, under 2 per cent. distortion at 40 watts and 1 per cent. at 15 watts, including noise and distortion of pre-amplifier and microphone transformer. Electronic mixing for microphone and gramophone of either high or low impedance with top and bass controls. Output for 15/250 ohms with generous voice coil feedback to minimise speaker distortion. New style easy access steel case gives recessed controls, making transport safe and easy. Exceedingly well ventilated for long life. Amplifier complete in steel case, with built-in 15 ohm mu-metal shielded microphone transformer, tropical finish.

As illustrated. Price **36 $\frac{1}{2}$ Gns.**

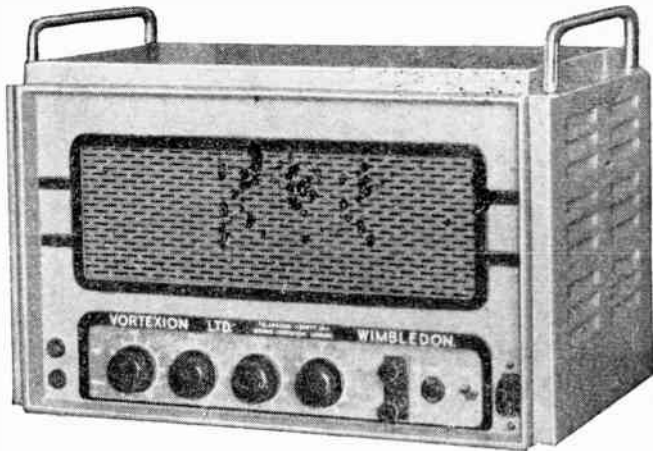

C.P.20A. 15 WATT AMPLIFIER

for 12 volt battery and A.C. Mains operation. This improved version has switch change-over from A. C. to D.C. and "stand by" positions and only consumes 5 $\frac{1}{2}$ amperes from 12 volt battery. Fitted mu-metal shielded microphone transformer for 15 ohm microphone, and provision for crystal or moving iron pick-up with tone control for bass and top and outputs for 7.5 and 15 ohms. Complete in steel case with valves.

As illustrated. Price **£28 0 0**

RECORD REPRODUCER CHASSIS

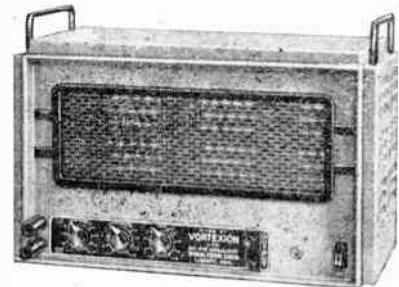

This is a development of the A.C.20 amplifier with special attention to low noise level, good response (30—18,000 cps.) and low harmonic distortion (1 per cent. at 10 watts). Suitable for any type of pick-up with switch for record compensation, double negative feedback circuit to minimise distortion generated by speaker. Has fitted plug to supply 6.3 v. 3 amp. L.T. and 300 v. 30 mA. H.T. to a mixer or feeder unit.

Price **£21 0 0**

Complete in metal cabinet and extra microphone stage. As illustrated. Price **25 $\frac{1}{2}$ Gns.**

Vortexion

LIMITED

257/261, THE BROADWAY,
WIMBLEDON, LONDON, S.W.19.

Telephones : LIBerty 2814 and 6242/3.

Telegrams : "VORTEXION, WIMBLE, LONDON."

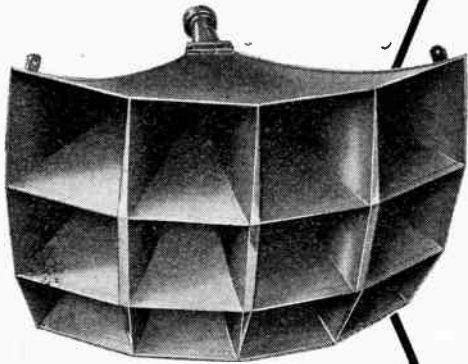

HERE IS THE WAY TO
BETTER SOUND DISTRIBUTION

The Multicellular type of horn has been developed to facilitate quality sound reproduction in auditoria by providing satisfactory distribution of the higher audio frequencies essential for intelligibility. Vitavox Multicell horns are available in two types having lower cut-off frequencies of 220 and 550 c.p.s. respectively and in a wide range of cell combinations to suit particular combinations.



MULTICELL HORNS

Obtainable from your VITAVOX Dealer but do not hesitate to consult us in case of difficulty or if you require further details.

Vitavox Limited, Westmoreland Road, London, N.W.9
Telephone: Colindale 8671-3

1218



THE GREEKS HAD A WORD FOR IT

but we prefer to call it "AUDIOSCOPE"

"Audioscope"—maybe we have invented a new word, but the meaning, when applied to WODEN AMPLIFIERS, is that their "audioscope" embraces not only perfected reproduction of any sound but such excellent amplification that it will reach the widest audience in hall or open space without the loss of the slightest undertone or the distortion of music's highest C. Designed for a long life of trouble-free service and built in the WODEN belief that Finest Materials + Expert Craftsmanship must = Quality. Now it's up to you to send us your name and address for further particulars . . . why not do so TO-DAY ?

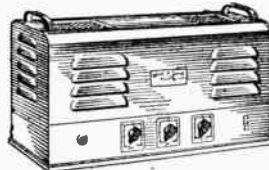

60 WATT "CLASSIC" AMPLIFIER
Mains supply 200-250 v. A.C. 50 cps. Transformer tapped at 0, 8, 15 and 200 ohms. Response 50-10,000 cycles \pm 2 db. Undistorted output of 60 watts. Finished in Light Grey Stove Enamel and Chromium. Retail Price £47. 10. 0.



20 WATT "JUNIOR" AMPLIFIER
Undistorted output of 20 watts. Transformer tapped at 0, 8 and 15 ohms. Flat from 50-10,000 cycles \pm 1 db. Controls consist of Mic. and Gram. Feeders and Tone. Finished in Light Grey Stove Enamel and Chromium. Retail Price £27. 10. 0.

WODEN
AMPLIFIERS

BUILT FOR THOSE WHO KNOW

WODEN TRANSFORMER COMPANY LIMITED : MOXLEY ROAD, BILSTON, STAFFS. : TELEPHONE: BILSTON 41959

COMPONENTS FOR 1947

The R.C.M.F. Exhibition

NEARLY 100 manufacturers of components, accessories, test gear and materials had stands at this year's annual private exhibition of the Radio Component Manufacturers' Federation, held March 10-13 in London. A classified list containing a selection of the principal groups of products on show is given below. The full titles of the firms appear in the list of exhibitors which follows.

A review of the exhibition will appear in our next issue.

LIST OF EXHIBITS

Aerial Equipment. Aerialite; Antiference; Belling-Lee; Labgear; Ripaults; Telegraph Construction.

Attenuators. Painton.

Bobbins. Associated Electronic Engineers; McMurdo Instrument.

Cabinets. Imhof; Stratton; Weymouth Radio.

Cables and Wires. Aerialite; Associated Technical Manufacturers; B.I.-Callenders; Duratube; Reliance Electrical Wire; Ripaults; Standard Telephones; Telegraph Construction; Suffix.

Capacitors, Fixed. Bulgin; British Electrolytic Condenser; B.I.-Callenders; British N.S.F.; Daly; Dubilier; Erie; Ferranti; Hunt; London Elect. Mfg.; Plessey; Static Condenser; T.C.C.; T.M.C.; United Insulator; Wego.

Capacitors, Variable and Pre-set. Sydney Bird; Bulgin; Dubilier; Hunt; Jackson; Labgear; Mullard; Plessey; Stratton; Walter Instruments; Wingrove & Rogers.

Ceramics. Geo. Bray; Bullers; Johnson Matthey; Steatite & Porcelain Prod.; Taylor, Tunncliffe; United Insulator.

Chassis. Imhof; Stratton; J. & H. Walter.

Chokes. Advance Components; Associated Electronic Engineers; Automatic Coil Winder & Elec. Equip.; Bulgin; Electro Acoustic Industries; Ferranti; Goldsman; Labgear; Parmeko; Partridge Transformers; Plessey; Radio Instruments; Stratton; Teledictor; Varley; Weymouth Radio Mfg.; Woden Transformer.

Coils, Tuning. Advance Components; Automatic Coil Winder and Elec. Equip.; Labgear; Plessey; Radio Instruments; Stratton; Weymouth Radio Mfg.; Wright & Weaire.

Connectors. Belling-Lee; B.I.-Callenders; British Mechanical Prod.; Bulgin; Carr Fastener; Plessey; Standard Telephones; Telegraph Construction.

Crystals, Quartz. Salford Elec. Instruments; Standard Telephones.

Dust Cores. Magnetic & Electrical Alloys; Plessey; Salford Elec. Instruments; T.M.C.

Fuses and Fuseholders. Belling-Lee; British Mechanical Prod.; Bulgin; Carr Fastener.

Gramophone Pick-ups. Cosmocord; Garrard; Plessey.

Gramophone Units, Record Changers. Garrard; Plessey.

Instruments, Measuring and Test. Advance Components; Automatic Coil Winder & Elec. Equip.; Dawe Instruments; Ferranti; Labgear; Plessey; Salford Elec. Instruments; Sifam; Taylor.

Insulators. Geo. Bray; Bullers; Steatite & Porcelain Prod.; Stratton; Taylor, Tunncliffe; United Insulator.

Insulating Materials and Sleeving. Associated Technical Mfrs.; Duratube and Wire; Hellermann Elec.; Long & Hambly; Micamite & Insulators; Spicers; H. D. Symons; Telegraph Construction.

Interference Suppressors. Antiference; Belling-Lee; Dubilier; Erie; Ferranti; Morgan Crucible; Wego.

Laminations. Magnetic and Electrical Alloys; Geo. L. Scott; Telegraph Construction.

Loudspeakers. Acoustic Products; British Rola; Celestion; Electro Acoustic Industries; Film Industries; Goodmans; Plessey; Reslo; Tannoy; Teledictor; Vitavox; Woden Transformer.

Magnetic Alloys. Magnetic and Electrical Alloys; Telegraph Construction.

Microphones. Cosmocord; Film Industries; Goodmans Industries; Reslo; Vitavox.

Mouldings, Plastic. British Mechanical Productions; Cosmocord; Shipton; Standard Telephones; Telegraph Construction.

Mouldings, Rubber. Long and Hambly.

Plugs and Sockets. Antiference; Belling-Lee; British Mechanical Productions; Bulgin; Carr Fastener; Long & Hambly; Painton; Plessey; Stratton; Telegraph Construction; T.M.C.

A.B. METAL Products, Ltd., Hatton Works, Feltham, Middx.

Acoustic Products, Ltd., 50-58, Britannia Walk, City Road, London, N.1.

Advance Components, Ltd., Back Road, Shornhall Street, London, E.17.

Aerialite, Ltd., Castle Works, Stalybridge, Cheshire.

Antiference, Ltd., Plender Place, Plender Street, London, N.W.1.

Associated Electronic Engineers, Ltd., Dalton Gdns, Stanmore, Middx.

Associated Technical Mfrs., Ltd., Vincent Works, New Islington, Manchester, 4, Lancs.

Automatic Coil Winder & Electrical Equipment Co., Ltd., Winder House, Douglas Street, London, S.W.1.

BELLING & Lee, Ltd., Cambridge Arterial Road, Enfield, Middx.

Bird, Sidney S., & Sons, Ltd., Cambridge Arterial Road, Enfield, Middx.

Bray, Geo., & Co., Ltd., Leicester Place, Blackmans Lane, Leeds, 2, Yorkshire.

British Electrical Resistance Co., Ltd., Queensway, Ponders End, Middx.

British Electrolytic Condenser Co., Ltd., 52, Vicarage Lane, Ilford, Essex.

British Insulated Callender's Cables, Ltd., Surrey House, Embankment, London, W.C.2; and Prescott, Lancs.

British Mechanical Productions, Ltd., 21, Bruton Street, London, W.1.

British N.S.F. Co., Ltd., Dalton Mill, Dalton Lane, Kelghley, Yorkshire.

Potentiometers. British Elec. Resistance; Bulgin; Colvern; Dubilier; Erg; Erie; Morgan Crucible; Painton; Plessey; Reliance; Taylor Elec. Instruments.

Rectifiers, Metal. Standard Telephones; Westinghouse.

Relays. Plessey; T.M.C.; Varley.

Resistors, Fixed. Automatic Coil Winder and Elec. Equip.; British Electric Resistance; British N.S.F.; Bulgin; Dubilier; Erg; Erie; J. L. Goldsman; Morgan Crucible; Mullard; Painton; Varley, Weymouth Electrical Labs.

Seals, Hermetic (Ceramic). Geo. Bray; Bullers; Steatite and Porcelain Products; Taylor, Tunncliffe; United Insulator.

Signal Generators. Advance Components; Taylor Electrical Instruments.

Solder, Flux Cored. B.I.-Callenders; Du Bois; H. J. Enthoven; Multicore.

Switches. A. B. Metal Products; British N.S.F.; British Electric Resistance; Bulgin; Labgear; Painton; Plessey; E. Shipton; T.M.C.; Varley; Walter Instruments; Wright & Weaire.

Transformers. Acoustic Products; Advance Components; Associated Electronic Engineers; Automatic Coil Winder and Elec. Equip.; Bulgin; British Electric Resistance; British Rola; Celestion; Electro Acoustic Industries; Ferranti; J. L. Goldsman; Goodmans; Labgear; Parmeko; Partridge; Plessey; Radio Instruments; Salford; Stratton; Tannoy; Teledictor; Varley; Vitavox; Weymouth; Woden; Wright & Weaire.

Valve Holders. Belling-Lee; British Mechanical Prod.; Bulgin; Carr Fastener; McMurdo Instrument; Plessey; Radio Instruments; E. Shipton.

Valve Retainers. Electrothermal Engineering; Long & Hambly.

Vibrators. Plessey; Wimbleton Engineering; Wright & Weaire.

LIST OF EXHIBITORS

British Rola, Ltd., Georgian House, Bury Street, London, S.W.1.

Bulgin, A. F., & Co., Ltd., By-Pass Road, Barking, Essex.

Bullers, Ltd., 6, Laurence Pountney Hill, Cannon Street, London, E.C.4.

CARR Fastener Co., Ltd., Nottingham Road, Stapleford, Notts; and Brantwood Works, Tariff Road, London, N.17.

Celestion, Ltd., London Road, Kingston, Surrey.

Colvern, Ltd., Mawneys Road, Romford, Essex.

Cosmocord, Ltd., 700, Gt. Cambridge Road, Enfield, Middx.

DALY (Condensers), Ltd., West Lodge Works, The Green, Ealing, W.5.

Dawe Instruments, Ltd., Harlequin Avenue, Great West Road, Brentford, Middx.

Dubilier Condenser Co. (1925), Ltd., Ducon Works, Victoria Road, North Acton, London, W.3.

Du Bois Co., Ltd., 15, Britannia Street, King's Cross, London, W.C.1.

Duratube & Wire, Ltd., Faggs Road, Feltham, Middx.

ELECTRO Acoustic Industries, Ltd., Stamford Works, Broad Lane, Tottenham, London, N.15.

Electrothermal Engineering Co., Ltd., 270, Neville Road, London, E.17.

Enthoven, H. J., & Sons, Ltd., Croydon Works, 230, Thornton Road, West Croydon, Surrey.

ERG Industrial Corporation, Ltd., 1021a, Finchley Road, London, N.W.11.
 Eric Resistor, Ltd., Carlisle Road, The Hyde, Hendon, London, N.W.9.
 FERRANTI, Ltd., 36, Kingsway, London, W.C.2; and Hollinwood, Lancashire.
 Film Industries, Ltd., 60, Paddington Street, London, W.1.
 GARRARD Engineering & Mfg. Co., Ltd., Newcastle Street, Swindon, Wilts.
 Goldsman, J. L., Ltd., 5, Torrens Street, City Road, London, E.C.1.
 Goodmans Industries, Ltd., Lancelot Road, Wembley, Middx.
 HELLERMANN Electric Co., Ltd., Goodtric Works, Brewer Street, Oxford.
 Hunt, A. H., & Co., Ltd., Bendon Valley, Garratt Lane, London, S.W.18.
 IMHOF, Alfred, Ltd., 112-6, New Oxford Street, London, W.C.1.
 JACKSON Bros., Ltd. (London), Kingsway, Waddon, Surrey.
 Johnson, Matthey & Co., Ltd., 78-83, Hatton Garden, London, E.C.1.
 LABGEAR, Ltd., Willow Place, Fair Street, Cambridge.
 London Electrical Manufacturing Co., Ltd., 469, Fulham Road, London, S.W.6.
 Long & Hambly, Ltd., Empire Works, Slater Street, High Wycombe, Bucks.
 MAGNETIC & Electrical Alloys, Ltd., 101-103, Baker Street, London, N.W.1.
 McMurdo Instrument Co., Ltd., Ashtead, Surrey.
 Micanite & Insulators, Ltd., Empire Works, Blackhorse Lane, London, E.17.
 Morgan Crucible Co., Ltd., Battersea Church Road, London, S.W.11.
 Mullard Wireless Service Co., Ltd., Century House, Shaftesbury Avenue, London, W.C.2.
 Multicoore Solders, Ltd., Mellier House, Albemarle Street, London, W.1.
 PAINTON & Co., Ltd., Kingsthorpe, Northampton.
 Parmeko, Ltd., Percy Road, Aylestone Park, Leicester.
 Partridge Transformers, Ltd., 76-8, Petty France, London, S.W.1.
 Plessey Company, Ltd., Vicarage Lane, Ilford, Essex.
 RADIO Instruments, Ltd., Purley Way, Croydon, Surrey.
 Reliance Electrical Wire Co., Ltd., Staffa Road, Leyton, London, E.10.
 Reliance Manufacturing Co. (Southwark), Ltd., Sutherland Road, Highams Hill, London, E.17.
 Resonance, Ltd., 359, City Road, London, E.C.1.
 Ribaults, Ltd., Southbury Road, Enfield, Middx.
 SALFORD Electrical Instruments, Ltd., Peel Works, Silk Street, Salford, 3, Lancashire.
 Scott, Geo. T., & Co., Ltd., Cromwell Road, Ellesmere Port, Cheshire.
 Shipton, E., & Co., Ltd., Ferndown, Northwood Hills, Middx.
 Sifam Electrical Instruments Co., Ltd., Leigh Court, Hr. Lincombe Road, Torquay, Devon.
 Spicers, Ltd., 19, New Bridge Street, London, E.C.4.
 Standard Telephones & Cables, Ltd., Connaught House, Aldwych, London, W.C.2.
 Static Condenser Co., Ltd., Toutley Works, Wokingham, Berkshire.
 Steatite & Porcelain Products, Ltd., Stourport-on-Severn, Worcestershire.
 Stratton & Co., Ltd., 2-5, Station Street, Birmingham, 5, Warwicks.
 Suffex, Ltd., Aintrec Road, Perivale, Greenford, Middx.
 Symons, H. D., & Co., Ltd., Park Works, Kingston Hill, Surrey.
 TANNoy Products (Guy R. Fountain), Ltd., Canterbury Grove, London, S.E.27.
 Taylor Electrical Instruments, Ltd., 419-424, Montrose Avenue, Slough, Bucks.
 Taylor, Tunncliffe & Co., Ltd., 125, High Holborn, London, W.C.1.
 Teledictor, Ltd., 214, Birmingham Road, Dudley.

Telegraph Condenser Co., Ltd., Wales Farm Road, North Acton, W.3.
 Telegraph Construction & Maintenance Co., Ltd., 22, Old Broad Street, London, E.C.2.
 Telephone Manufacturing Co., Ltd., Hollingsworth Works, West Dulwich, S.E.21.
 UNITED Insulator Co., Ltd., Oakcroft Road, Tolworth, Surbiton, Surrey.
 VARLEY (Oliver Pell Control), Ltd., Cambridge Row, Woolwich, S.E.15.
 Vitavox, Ltd., Westmoreland Road, London, N.W.9.
 WALTER Instruments, Ltd., Garth Road, Lower Borden, Surrey.
 Walter, J. & H., Ltd., 2, Caxton Street, London, S.W.1.

Wego Condenser Co., Ltd., Bideford Avenue, Perivale, Middx.
 Welwyn Electrical Laboratories, Ltd., 70, Bridge Road East, Welwyn Garden City, Herts.
 Westinghouse Brake & Signal Co., Ltd., 82, York Way, King's Cross, London, N.1.
 Weymouth Radio Manufacturing Co., Ltd., Crescent Street, Weymouth, Dorset.
 Wimbledon Engineering Co., Ltd., Garth Road, Lower Morden, Surrey.
 Wingrove & Rogers, Ltd., Broadway Court, Broadway, London, S.W.1; and Polar Works, Old Swan, Liverpool, Lancs.
 Woden Transformer Co., Ltd., Moxley Road, Bilston, Staffs.
 Wright & Weaire, Ltd., 740, High Road, Tottenham, N.17.

GARRARD HIGH-FIDELITY PICKUP

FURTHER details are now available of the new high-fidelity pick-up which is being fitted to Garrard record changers. A miniature moving iron movement is employed, and the coil is of the high-impedance type giving an output of the order of 0.35 volt, so that the pick-up can be connected to the input of the average amplifier without the additional expense of a transformer.

The armature measures approximately $\frac{3}{16}$ in \times $\frac{1}{16}$ in \times $\frac{1}{16}$ in and is mounted on

a V-section channel cut away to give torsional flexibility in the required direction of movement, limited vertical movement and high resistance to longitudinal stresses. Damping is

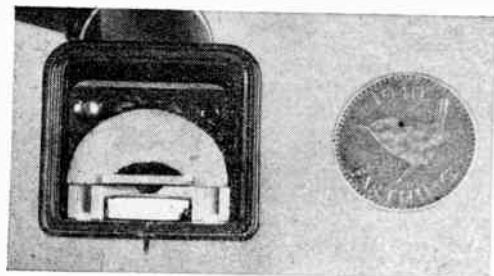

Comparison with a farthing gives some idea of the size of the latest Garrard pick-up. (Left) Component parts of the Garrard high-fidelity moving iron pick-up.

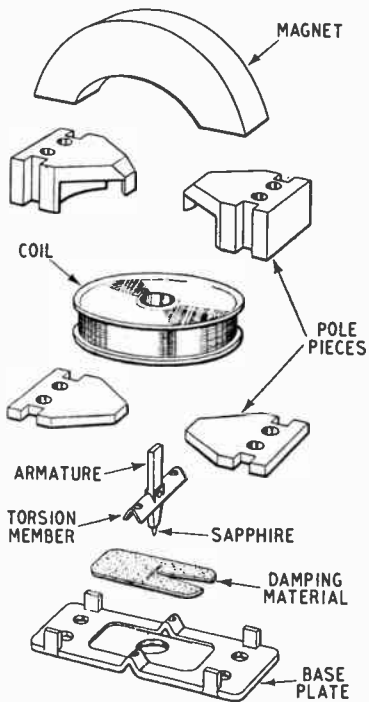

applied as a thin sheet lying under the torsion member, but is not relied upon to supply the restoring force necessary to keep the armature central in the gap.

The pole pieces are machined from the solid and provided with interlocking grooves and spigots which ensure accurate assembly.

No needle is employed, and the sapphire stylus is fixed directly into the armature assembly. The volume of magnetic material in the armature ensures a good output, but its mass is not sufficient to cause appreciable record wear.

According to the maker's curve, the output is level from 50 to 1,000 c/s, then falls 3 db from 1,000 to 10,000 c/s. It is recommended that the coil should be shunted with 0.25 MΩ with 0.0005 μF in parallel. The D.C. resistance is 4,000 ohms, and the impedance at 1,000 c/s 6,500 ohms.



TROPICAL BROADCASTING

Notes on Proposed Use of Metre Waves

By "RADIATOR"

THE problem of providing internal broadcast services in countries situated within or near the tropics, where the coverage attainable on medium waves is often reduced to uneconomical proportions because of the high prevailing noise level, is one which has exercised the minds of broadcast engineers for some long time past, and seems likely to continue to do so in the future.

In India—and in some of the other countries involved—the main internal coverage has, apart from that of a few of the larger towns, been given on "long - short" waves, where some allocations of wavelengths were made for this express purpose. But this is admittedly only a second-grade service, for, since the waves have first to be reflected from the ionosphere, the received signal is subject to all the deficiencies inherent in such an indirect-ray service. Some of the problems of broadcasting on the "tropical" wavelengths of 60-120 metres were discussed in *Wireless World* for June, 1945.

In a recent address to the Electrical Engineering Society, Indian Institute of Science,* Professor S. P. Chakravarti proposed that a first-grade service should be given in India on the very short, rather than on the medium waves. After pointing out the advantages attending the use of very short waves—chief of which is that, provided the right wavelengths are employed, it should be possible to give reliable first-grade coverage at all times of the year up to 35 miles from a transmitter of only $\frac{1}{2}$ kW radiated power—he went on to consider the problems involved.

Postulating that the frequencies

to be used should be from 60 to 150 Mc/s he states that those higher than 60 Mc/s "are never known to be returned by the F₂ region," presumably at most oblique incidence. This is true, though it is not true that they are not returned from the ionosphere at all, as it frequently happens that the M.U.F. for Sporadic E is greater than this. Above 150 Mc/s other disadvantages—such as multi-path transmission—are likely to arise. In the band proposed the atmospheric noise is negligible and that due to electri-

would be vertically polarized, a better signal/noise ratio would result if the transmissions were horizontally polarized. The type of the transmitting aerial is most important and, in order to secure a good circular pattern, the use, at a height of roof, of two half-wave horizontal radiators crossed at right angles and fed 90° out of phase is proposed. A second similar type of aerial is proposed if wide-band transmission to accommodate two programmes is undertaken. This would be a great advantage in India for, as is shown,

the areas served by the transmitters are generally inhabited by people speaking two different languages, so it is proposed to transmit two programmes simultaneously from each transmitter.

The modulation preferred is A.M. rather than F.M. for the following reasons: (1) F.M. equipment is the more expensive. (2) F.M. is inconvenient for the transmission of two programmes. (3) The improved signal/noise ratio with F.M. is not sufficient on these frequencies to justify its use. (4) The bandwidth required for two programmes with F.M. is too great. (5) Reception difficulties exist with F.M. which are not present with A.M. Altogether a strong case seems to have been made out for the use of A.M.

Coming to the economics of the proposed service the use of no fewer than 70 very short-wave transmitters is proposed—in addition to the existing medium-wave stations—and even these appear to leave an enormous part of the country uncovered. A comparison is made between the approximate cost of erecting and operating very short-wave stations and medium-wave stations, with much

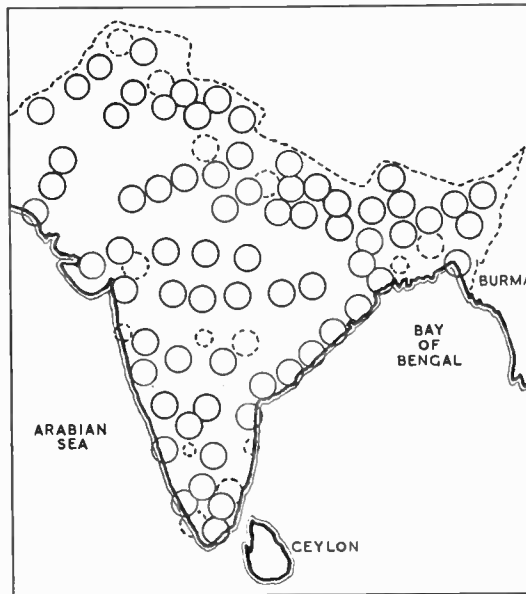

Courtesy "Electrotechnics."

Map showing distribution of proposed U.S.W. stations (full circles) in India. Service areas of existing M.W. stations shown by dotted circles.

cal machinery hardly appreciable.

A radiated power of $\frac{1}{2}$ kW in this frequency range from an aerial 100 ft high should give reliable coverage up to 30 miles, provided the receiving aerials are at least 30 ft high. The field strength should be more or less the same at this distance for either vertically or horizontally polarized waves, but since the electrical interference

* See *Electrotechnics* (Bangalore), December, 1946, pp. 5-18.

advantage to the former system. But no comparison is made between the cost of providing a first-grade service by very-short-waves and a second-grade service by short-waves, and it would appear that the substitution of a first-grade for the present second-grade

service over a large part of India would in any case be somewhat expensive. However, if it is to be done, the very-short rather than the medium waves certainly seem to offer the best solution to a problem that is arising in other tropical countries besides India.

for the use of those whose primary interest is the exploitation of certain frequency bands, and this indicates the highest frequency likely to be usable for about 25 per cent of the time during the month for communication by way of the regular layers:—

SHORT-WAVE CONDITIONS

Expectations for April

By T. W. BENNINGTON (Engineering Division, B.B.C.)

DURING February maximum usable frequencies for this latitude increased considerably during daytime and very considerably during night-time as compared with those of January. These variations are the normal seasonal ones, but they were accentuated by the increasing sunspot activity. Long-distance communication on exceptionally high frequencies was often possible during daytime, a particularly good day being the 6th, when several U.S.A. stations on frequencies above 40 Mc/s were well received in this country and one U.S.A. harmonic on 50 Mc/s was heard.

Conditions were not unduly disturbed at any time during the month, though ionosphere storms did occur during the periods 8th-10th, 12th-14th and 16th-20th.

Forecast.—During April daytime M.U.F.s in the Northern Hemisphere are expected to begin their seasonal decrease towards the mid-summer minimum, and the decrease during the month should be quite considerable. Night-time M.U.F.s, on the other hand, should continue their seasonal increase towards the midsummer maximum. Modifying these effects on most transmission paths is the fact that, since daylight will last longer, moderately high frequencies can remain in use for considerably longer periods. The net result is that during April working frequencies for most transmission paths will be somewhat lower than in March during the full daylight period, somewhat higher during the morning and evening periods, and considerably higher during the full darkness period.

Daytime communication on exceptionally high frequencies (like the 28-Mc/s band), though often still possible, is likely to be somewhat less so than of late. Over many circuits frequencies as high as 17 Mc/s should remain regularly

workable till after midnight, and frequencies lower than about 11 Mc/s will seldom be required at any time during the night.

For transmission over distances between about 600 and 1,000 miles the E layer will often control transmission during the daytime, leading to somewhat higher working frequencies than could otherwise be possible. Sporadic E, though it should begin to increase, is not likely to be very prevalent during the month.

Below are given, in terms of the broadcast bands, the working frequencies which should be regularly usable during April for four long-distance circuits running in different directions from this country. In addition a figure in brackets is given

Montreal :	0000	15 Mc/s	(21 Mc/s)
	0100	11 "	(17 ")
	0900	15 "	(21 ")
	1100	17 "	(25 ")
	1400	21 "	(29 ")
	1900	17 "	(25 ")
	2300	15 "	(22 ")
Buenos Aires :	0000	17 "	(23 ")
	0100	15 "	(21 ")
	0400	11 "	(19 ")
	0700	15 "	(21 ")
	0900	21 "	(28 ")
	1100	26 "	(35 ")
	1900	21 "	(28 ")
	2100	17 "	(24 ")
Cape Town :	0000	17 "	(25 ")
	0200	15 "	(21 ")
	0500	17 "	(24 ")
	0600	21 "	(29 ")
	0800	26 "	(30 ")
	1900	21 "	(24 ")
	2200	17 "	(26 ")
Chungking :	0000	11 "	(16 ")
	0400	15 "	(21 ")
	0600	17 "	(24 ")
	1000	21 "	(28 ")
	1600	17 "	(23 ")
	1900	15 "	(21 ")
	2100	11 "	(17 ")

During April a moderate amount of ionosphere storminess is usual. At the time of writing it would appear that ionosphere storms are more likely to occur during the periods 4th-6th, 12th-16th and 27th, than on the other days of the month.

NEW MOVING COIL MICROPHONE

THE new Type C46A Lustraphone microphone is a modification of the standard type and incorporates a corrugated cone diaphragm suspended on a fine gauze surround.

The permanent magnet is of generous proportions and gives a flux density of 8,000 lines/cm². A speech coil impedance of approximately 20 ohms is used and a 1:100 ratio matching transformer in a Mumetal box can be supplied.

Lustraphone Type C46A microphone partly dismantled.

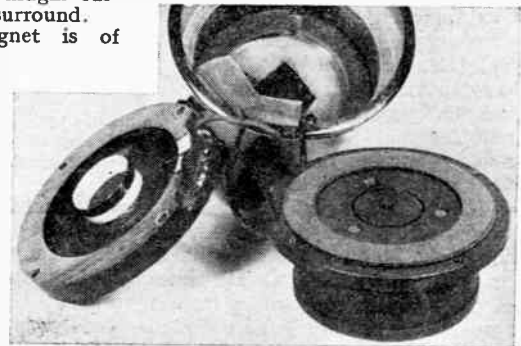

The makers state that over the range 50 to 8,000 c/s the deviation from level output does not exceed ± 6 db while the sensitivity is -75 db

referred to a level of 1V/dyne/cm².

A standard $\frac{1}{16}$ in brass thread bush mounting is provided and adaptors

are available for $\frac{1}{8}$ in B.S.F., etc. The price is $\pounds 6$ 16s 6d and the makers are Lustraphone, 84, Bel-size Lane, London, N.W.3.

WHISTLING METEORS

Audible Radio Reflections from Shooting Stars

SHOOTING stars, or, to give them their more scientific name, meteors, have held a fascination for mankind from the earliest times and although they are no longer regarded with superstition, they still form a subject of absorbing interest. They even have their uses, for it is now known that while the ionization in the upper atmosphere which makes long-distance radio communication possible, is maintained during the daytime by ultra-violet light from the sun, it is the continuous arrival of countless millions of microscopic meteors, travelling at enormous velocities, which maintains the level of ionization throughout the hours of darkness. Meteors are thus far more than a subject of scientific curiosity.

For several years radar methods have been used for the observation of meteors, and their transient echoes will be familiar to many radar operators. With the recent discovery, however, by two engineers of All India Radio, Messrs. Chamanlal and Venkataraman, that under suitable conditions, meteors can also be "heard" on an ordinary communication receiver, a new line of research has been opened up.

Variable-pitch Whistles

The transmitters of All India Radio at Delhi are situated about 10 miles from the Receiving Centre, and while monitoring the high-power short-wave transmitters it was noticed that feeble heterodyne whistles of an unusual nature could often be heard but they could not be explained by any of the known causes. The whistles were invariably of short duration, never lasting for longer than $1\frac{1}{2}$ -2 seconds; they commenced as a high-pitched note of about 2-3,000 cycles, fell rapidly in pitch and usually died away before reaching zero frequency. Only in rare cases did the whistle pass through zero and reappear as an ascending note before dying away. The whistles were most frequent between 2.0 and 6.0 a.m.

and were only rarely heard during the hours of daylight.

Searching to explain these unusual characteristics, Chamanlal and Venkataraman concluded that they could only be explained as a Doppler effect arising from the interference of the direct ground waves from the nearby transmitter with the waves reflected from some rapidly moving reflecting surface. Calculations showed that if this was the true

By

G. R. M. GARRATT,
M.A., A.M.I.E.E.

explanation, the reflecting surface would have to have the initial velocity of the order of 50-80 kilometres per second. Such velocities could only be associated with meteors entering the earth's upper atmosphere, and visual observation soon confirmed this theory by establishing a direct correlation between the arrival of a visible meteor and the occurrence of the audible whistle.

Although a visible meteor invariably produces a whistle of considerable intensity, a far greater number can be heard but not seen. In fact, at certain times of the year, the number arriving is so great as to make it impossible to maintain an accurate count.

Meteors can be broadly divided into two classes—the first being those which enter the earth's atmosphere from random directions, and the second those which are travelling in definite orbits comparable with those of a comet. From the point of view of radio communication those arriving from random directions are by far the most important since it is these which are now known to maintain the ionization in the upper atmosphere during the night. The number of such meteors is literally astronomic and

it has been computed that at least a thousand million encounter the atmosphere every 24 hours.

The vast majority of these meteors are of only microscopic size, but their very high velocities and their great number result in steady ionization of the atmosphere at high altitudes and give rise to the familiar reflecting layer. It is, of course, only the larger meteors which produce sufficient ionization to give an individual echo, and it must be a very large one to become visible to the naked eye as a "shooting star." "Large" and "small" are comparative terms, however, so it may be as well to remark that although estimates vary, a "small" meteor can be regarded as being about the size of a grain of sand while a "large" one, visible as a bright shooting star, is no larger than the top of a black-headed pin and has a mass which seldom exceeds 10-15 milligrams!

Although less important from the point of view of radio communication, those meteors which travel in regular orbits are by far the most spectacular since they give rise at times to brilliant "showers" during which very large numbers may be seen. Such meteors are probably the remains of disintegrated comets which continue to travel in the original orbit. The fragments tend to be spread out more or less along the whole length of the orbit, and if the earth should happen to pass through the track at the time when the main bulk is passing, a most brilliant display of shooting stars may be seen by the naked eye. There are nine principal meteoric showers during the year, but really brilliant displays are of rare occurrence.

Conditions for Whistles

In order to detect the arrival of a meteor on a normal radio receiver there are a number of special conditions which must be fulfilled if success is to be achieved. First, it is necessary to have a powerful transmitter—at least 10kW and

Whistling Meteors—

preferably about 50kW, radiating an unmodulated signal on a frequency of the order of 5-15 megacycles. The receiver requires to be situated about 8-15 miles from the transmitter so that it is within the skip distance but so that only a very weak ground wave is received. It is essential that the ground wave received should be a weak one since the reflected echoes may have a strength as low as only 1 millivolt or even less, and if a strong ground wave is received, the normal A.V.C. action of the receiver will so reduce the amplification as to make the feeble echoes entirely inaudible.

It will be appreciated that a highly sensitive receiver is required for these observations. A communication receiver with two R.F. stages before the mixer is most suitable although under good conditions a few of the stronger echoes can be picked up on a high-quality broadcast receiver.

Night-time Phenomenon

A somewhat inconvenient habit of these meteors is that, like the skylark, their peak period of whistling is during the hours just before dawn. A few can be heard from midnight onwards, but a far greater number will be audible about 4 a.m. and it is rare to hear one during the hours of daylight or during the evening. The reason for this state of affairs is easily understood if we recall some of our schoolboy astronomy and remember that besides rotating on its axis once every twenty-four hours, the earth makes a journey round the sun once every year. The earth travels round its elliptical path with an average velocity of 29 kilometres per second and it is obvious that as the earth rotates on its axis there is only one part which is "facing forwards" and where the highest relative velocities will be encountered between the earth and any meteors which it happens to meet. The area facing forwards will actually lie at some point within the tropics and at any moment will be on the longitude where the solar time is 6 hours before noon, i.e., 6 a.m. local time. Various other factors combine to place the peak period rather earlier than this and in practice the highest

number of meteors are encountered around 4 or 4.30 a.m.

Doppler Effect

As was mentioned earlier, the "whistle" is due to a Doppler effect produced by the beating between the ground waves and those reflected from the local area of ionization caused by the passage of the meteor through the atmosphere. The apparent frequency shift of the reflected waves is due to the component of the velocity of the reflecting surface towards the observer and it will be clear that if this velocity was constant, a whistle of constant frequency would be heard. In practice, this velocity is not constant for two reasons—first the meteor is retarded very rapidly in the earth's atmosphere, and secondly the component of velocity towards the observer clearly varies with the instantaneous position of the meteor in its track in relation to the observer. For example, suppose that a meteor was travelling at a constant velocity on a horizontal course which passed directly over the head of the observer. Such a meteor would have a component of velocity which would first be directed towards the observer but which would fall to zero as it passed overhead and then increase in the opposite direction as it receded. Such a meteor would cause a whistle which would first fall in pitch, pass through zero frequency and then increase again before dying away at 1-2,000 cycles.

A very small proportion of such whistles can in fact be heard but they are invariably very feeble since the meteors causing them are at extreme altitudes where the retardation of the earth's atmosphere has not entirely arrested their progress before they reach the point where the velocity towards the observer is zero.

Since the beat note is dependent on the direction of the meteor as well as its velocity, it is not possible to calculate the true velocity without simultaneous observations of its position and track. It is easy, however, to calculate the component velocity towards the observer. For example, assume that a beat note of 3 kc/s is heard using a transmis-

sion frequency of 6 Mc/s. Then the velocity v of the reflecting surface towards the observer is given by

$$v = \frac{Nc}{2f}$$

where N is the whistle frequency, c is the velocity of electromagnetic waves and f is the transmission frequency. In the example quoted,

$$v = \frac{3,000 \times 3 \times 10^{10}}{2 \times 6 \times 10^6} \text{ cms/sec} \\ = 75 \text{ km/sec.}$$

Although this figure is only a component, it gives some idea of the order of the velocity which may be possessed by a meteor and it is estimated that the real velocity may range from 20-180 km/sec. It should not be difficult to develop a technique employing two receiving stations making simultaneous observations of whistle frequency from which the real velocity could readily be ascertained. In fact, it seems likely that further research on meteors will be carried out on these lines.

Acknowledgment is made to Mr. Cecil Goyder, C.B.E., lately Chief Engineer of All India Radio, by whose courtesy the writer was enabled recently to pay several visits to the transmitters and receiving centre in New Delhi and to experience a first-hand demonstration of the phenomenon described above and which, so far as is known, has not been previously reported.

LOCAL BROADCASTING

A SECTION of the report recently issued by the New Towns Committee, appointed by the Minister of Town and Country Planning, under the chairmanship of Lord Reith, deals with the facilities which it considers should be available in every new town for the reception of broadcasting.

The value of a local broadcasting service is weighed and suggestions for the conduct of the service are put forward.

Ultra-short-wave broadcasting is proposed as the best means of transmission and the report adds "if the new towns in this country were to have their own stations they might well be anticipating a national development whereby the number of available programmes increased."

BELLING-LEE QUIZ (No. 10)

Answers to questions we are often asked by letter and telephone

Q. 38. *What is the purpose of the metallised paper wrapping under the wire screen of the Belling-Lee twin feeder (Cat. No. L.1221), and is it necessary to earth this to the screen at either or both ends? (by A. G. F., Highbury, who correctly answered the question in his letter).*

A. 38. (1) The purpose of the metallised paper wrapping is to maintain the characteristic impedance and attenuation loss constant over the life of the cable. It has been found that without this metallic paper the braided tinned copper shielding ultimately oxidises, causing an increased resistance at the points of intersection of the wires comprising the braid which has the effect of increasing both the characteristic impedance and the attenuation loss.

(2) There is no need to bond the metallised paper wrapping to the shield, as its capacity thereto may be regarded as the electrical connection at high radio frequencies.

This metallised paper feature is covered by a patent of Messrs. Telegraph Construction and Maintenance Co. (U.K. patent No. 559518).

The illustration above shows Belling-Lee (Catalogue No. L.1221) screened twin 70 ohms feeder discussed above and recommended as a suitable feeder for the "Eliminoise" *3 and "Skyrod" *4 anti-

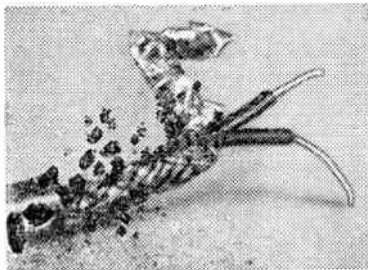

interference aerials. It is sometimes used as a balanced feeder for a television dipole, but is in our opinion unnecessarily extravagant used in this way, as the much cheaper L.336 *2 unscreened balanced feeder gives results so nearly comparable that a television user could not see (nor hear) the difference.

Q. 39. *How can a balanced feeder remain balanced when run in a house? Is it not affected by the presence of other conductors such as water pipes, gutters, conduits, etc.?*

A. 39. Theoretically there will be small changes in the characteristic impedance at various points along the line. These changes will be related to its proximity to various earthed objects, but at television frequencies the changes are so insignificant that they are immeasurable by any

ordinary means. In the case of a feeder with a characteristic impedance of the order of 400 ohms and typified by a spacing of a few inches between conductors, the presence of other incidental conductors closer to the feeder than this, would result in appreciable attenuation.

In L.336 the spacing between conductor centres is nominally 0.057". Therefore it is unlikely that outside conductors would have any practicable influence on the line characteristic.

*1. L.1221, Screened twin feeder per yard 1/9

*2. L.336, Balanced twin feeder per yard 7½d.

*3. ELIMINOISE (Reg. Trade Mark).

L.308/K. Complete aerial kit, comprising Aerial and Receiver end transformers, 60ft. Aerial wire, 50ft. of L.1221 screened feeder, earth wire, insulators and lightning arrester £6 6 0

*4 Skyrod (Reg. Trade Mark).

Type L.355/CK. 12ft. collector, downlead, 2 transformers, pole clamps and earth wire £7 7 0

Chimney lashings and brackets can be supplied at additional cost.

All prices quoted are subject to alteration without notice.

The new Catalogue for **HAMS**

RADIO AMATEURS
CATALOGUE OF
AERIALS
FEEDERS
SUPPRESSORS
COMPONENTS
AND
ACCESSORIES

ASK FOR PUBLICATION No. P339/w

Send for this booklet NOW!

enclosing 2½d. stamp for postage

IN presenting this catalogue we have for the first time aimed a section of our products straight at your dens. The components illustrated are, we know, used a great deal in Amateur Radio circles. They should be, because having undergone stiff electrical and mechanical tests in Service gear, they have proved to be reliable even under the most arduous conditions of modern warfare, and may therefore be used with complete confidence by the most discriminating ham.



Study television at its source! ★



★ read about
this new
opportunity

Special three-week practical Laboratory/Workshop Courses in Radio and Television Servicing are commencing in April. Send for details.

E.M.I. Research and Development Laboratories were largely responsible for the Marconi-E.M.I. system of television transmission used by the B.B.C. Service—the first in the world.

E.M.I. Factories produce the finest television receivers in the world.

E.M.I. Service department is the largest and most expertly equipped in the country.

NOW—E.M.I. have set up a TRAINING ORGANISATION to provide immediate courses on practical TELEVISION (Postal and College Courses.)

SOON this new Training College will extend its syllabus to cover all branches of Electronic Science.

This is your opportunity to secure a thorough training in Television from the very pioneers of the Science.

Ask your local H.M.V. dealer for further details or send for our free pamphlet which gives full details of this and other courses.

Associated Company of:

- THE GRAMOPHONE CO. LTD.
("HIS MASTER'S VOICE")
- THE MARCONIPHONE CO. LTD.
- MARCONI-E.M.I. TELEVISION CO. LTD.
- RADIOMOBILE LTD., ETC. ETC.

E.M.I. INSTITUTES, LTD.

Dept. 16 · 43 GROVE PARK ROAD · CHISWICK · LONDON · W.4

PRECISION CONTROLS for COMMUNICATIONS AND MEASURING EQUIPMENT

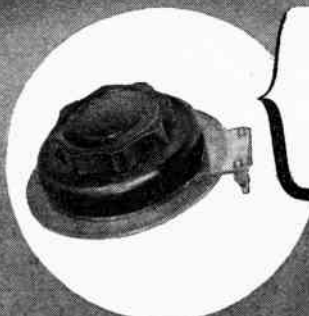

SLOW-MOTION DRIVE
A Unique Control giving complete 360° rotation
Double friction epicyclic mechanism — enclosed in dust-proof bakelite housing.
Torque — 12 inch-ounces before slipping
Ratio — 44 to 1 approximately
Supplied with dials up to 6 inches diameter — any engraving.
PRICES ON APPLICATION

DECADE SWITCH
A Precision Component embodying all the best design features
Very low contact resistance. Positive location. Sturdy action. Twelve positions — providing two extra contacts — 30° angular spacing simplifies dial calibration. Two types available — 416A (Shorting) and 416B (Non-Shorting).
Can also be supplied in ganged units of two or more switches
PRICES ON APPLICATION

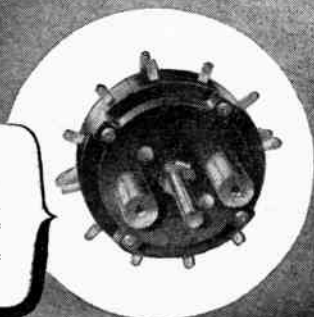

SALFORD ELECTRICAL INSTRUMENTS LTD.

PEEL WORKS, SALFORD 3

Telephones: BLAckfriars 6688 (6 lines).

Telegrams and Cables: "SPARKLESS, MANCHESTER"

Proprietors: THE GENERAL ELECTRIC Co. Ltd., of England

DESIGNING AN F.M. RECEIVER

1.—General Considerations

By THOMAS RODDAM

I HAVE already explained in the columns of *Wireless World* my objections to frequency modulation: for better or worse it is, however, on its way. The B.B.C. have been conducting experimental transmissions for some time, and some police authorities are using F.M. for routine communication purposes. The writer, who earns a precarious and wholly inadequate living by doing this sort of thing, has already had to construct part of an F.M. receiver. In the course of this work it became apparent that there are quite a number of things, which do not appear in the theoretical papers, which can provide some difficulties in practice. I must explain at the beginning that the receiver already constructed was for experimental work with very wide deviations at 60 Mc/s. In consequence all that this article will seek to do is to discuss the principles of design. This will not do any harm, for it is not advisable to start on an F.M. receiver unless you have a reasonable amount of measuring equipment and other facilities and can really make a job of it.

Frequency modulation, as all readers of *Wireless World* know, is a system of transmission in which the carrier level is kept constant and the carrier frequency wobbled about in accordance with the modulation. The maximum amount of wobble for sound broadcasting is usually 75 kc/s, so that with a nominal carrier frequency of 90 Mc/s the instantaneous frequency on the peaks of a 100 per cent modulated wave will be 90.075 Mc/s and on the troughs 89.925 Mc/s. I am not sure, here, whether pedants will not object to the terminology, but it is convenient to use the ideas already familiar in amplitude modulation. Although the deviation is only ± 75 kc/s, a spacing between stations of 400 kc/s is being adopted in America, and in order to get a linear phase response, and also

to allow for tuning drift and mistuning, a receiver bandwidth of 200 kc/s is normal practice. In England it will probably be some time before there are enough stations working to make selectivity a problem, and it is wise to err on the side of excessive bandwidth rather than to risk the distortion produced by the non-linear phase characteristic near the edge of the response curve.

These basic principles are quite well known, which is why they are discussed so briefly. The important features of F.M. which must constantly be kept in mind are (1) the bandwidth, and (2) the constancy of carrier level. It is these two features which result in the very low noise level obtained in the service area, and which provide almost perfect A.V.C. without any awkward time constants.

Essentially an F.M. receiver is an ordinary V.H.F. receiver with a wide-band response and a sort of detector circuit. If you already have a V.H.F. receiver for amplitude modulation it should be possible to modify it to receive F.M.

The modifications will reduce its sensitivity and involve the widening of the response and the addition of a limiter and discriminator to replace the detector. The A.V.C. is not wanted, but some designs of V.H.F. receiver already include a switch for fixed gain operation. The audio-frequency circuit will also need some modification, to provide de-emphasis on the one hand, and also to give a really high-fidelity performance free from hum so that full advan-

tage can be taken of the virtues of F.M.

The heart of an F.M. receiver is the limiter and discriminator section. The job of the limiter is to provide at its output a signal which is absolutely constant in amplitude in spite of its variation in frequency. The receiver carrier level will not be absolutely constant, because there is likely to be some fading. Most discriminator circuits are sensitive to amplitude modulation, and if the limiter does not fix the level absolutely constant the changes in level will be detected. This is a bad thing. The second cause of changes in level is noise. In Fig. 1(a) there is a sketch of a frequency-modulated carrier with

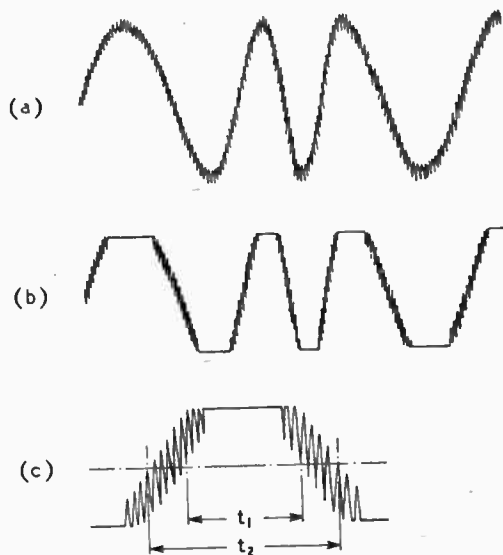

Fig. 1. (a) F.M. signal and noise, (b) effect of limiter, (c) uncertainty of instantaneous frequency resulting from noise.

noise on it. The resultant carrier level is clearly modulated by the noise, and the discriminator would detect this, and allow the noise to come through. The limiter alters the shape to that of Fig. 1(b), giving an apparently constant carrier level. Noise still has some effect, for if we try to determine the instantaneous frequency by measuring the time between an up-swing and a down-swing (Fig. 1(c)) we cannot be certain whether to take t_1 or t_2 , and this

Designing an F.M. Receiver—
 "uncertainty" represents a noise which appears in the output. It is, however, very much less than the noise which would be produced by amplitude modulation of the peaks. This reduction of noise when the limiter is operating is most striking, and is one of the most attractive features of F.M.

The job of discriminator is to turn the frequency-modulated signal into a variable voltage. One way of doing this, which is quite attractive at low frequencies, is to build a network having attenuation which is a function of frequency. In Fig. 2, for example, the voltage appearing across R is, neglecting the circuit to the right of R,

$$V = \frac{R}{R + 1/j\omega C} \cdot E$$

$$= \frac{j\omega CR}{1 + j\omega CR} \cdot E$$

In this expression, so long as CR is small, we can write

$$V = j\omega CR \cdot E,$$

so that the output voltage for constant carrier level E, is proportional to the frequency term $\omega (= 2\pi f)$. If we rectify and allow only the modulation frequency components to pass by means of a low-pass filter, this circuit can be used as a discriminator, and in fact it has been so used. The trouble with it is that C must be very small, and R must be very small, and so the output is microscopic. It does, however, illustrate the principle very well. The usual circuit is that known as the Foster-Seeley circuit, and this will be described in the second part of this article.

Let us now look at the receiver requirements. The limiter grid should receive about 10 volts drive under normal conditions, although less could be allowed at a pinch. For design purposes we shall take 10 volts as the level required. The input level to the receiver is very dependent on where it is to be used. Within 10 miles of Alexandra Palace the B.B.C. 1 kW test transmitter produces field strengths of more than

1 mV/metre, the provisional second class rural service is based on a field strength of $100\mu\text{V/m}$. The actual voltage developed at the first grid of the receiver will be very dependent on the aerial used and on the distance from the

transmitter, and is a matter for individual determination. Here we shall assume that we can get 1 millivolt: the gain before the limiter grid

must therefore be 10,000. If valves having mutual conductance of 5mA/volt are used, a stage gain of 50 can be obtained at an intermediate frequency of 10Mc/s. The gain of the stage before the limiter will be rather lower than this, because of the effect of the limiter grid circuit. A mixer gain of 10 is a reasonable allowance, giving $10 \times 40 \times (n \times 50)$ for a mixer and $(n+1)$ stages I.F. amplification. For two stages this is 20,000, which is more than we asked for so that there is some safety margin. The basic design will therefore be a mixer, two I.F. stages, followed by a limiter, discriminator and audio-frequency amplifier. If an additional factor of about 6-8 is required, an R.F. stage should be

different frequencies: stable multi-stage I.F. amplifiers can be built, as anyone who has seen a radar receiver will know, but they require very careful layout and screening.

A stage gain of 50 implies an anode load resistance of 10,000 ohms with a valve having a mutual conductance of 5mA/volt. The EF50 has been very widely used for this sort of job and it, or its successor the EF54, is an obvious choice here. The total capacity of the EF50 is about 16 pF, and with an allowance for wiring and valveholder capacity will probably be about 30 pF: the reactance of this at an intermediate frequency of 10Mc/s will be 500 ohms, so that without added capacity the circuit "Q" will be about 20. The bandwidth at 3db down will then be 500kc/s. This is definitely too wide, and the circuit capacity must be increased to about 75 pF for a 200kc/s band. The additional capacity will help to hold down any changes of valve capacity. To tune to 10Mc/s, an inductance of $3.3\mu\text{H}$ is needed.

The design takes more form now. The I.F. stages have EF50 (or EF54) valves, with 10,000 ohms anode load, and a capacity of 75 pF tuning $3.3\mu\text{H}$ coils. For a first model, simple tuned circuits between stages are recommended.

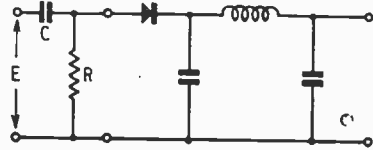

Fig. 2. Elementary discriminator circuit.

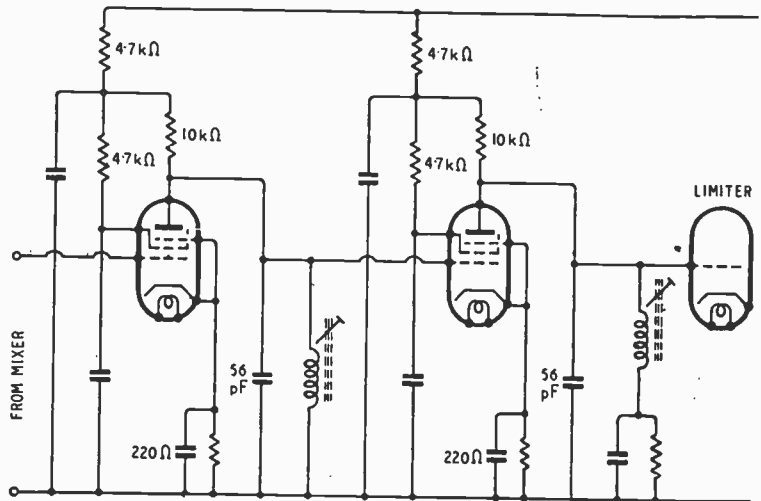

Fig. 3. I.F. stages for an F.M. receiver. Fixed capacitances are all $0.001\mu\text{F}$ and the bias resistors are for use with EF50 valves.

added, as it is much easier to make the system stable when the gain is distributed between two

It is true that they do not give such good adjacent channel selectivity as tuned transformers, but

they are easier to construct and there probably will not be any adjacent channel to get rid of. The circuit of the I.F. section becomes that shown in Fig. 3. The choice of putting the coils in grids or anodes is largely one of convenience: in the form shown, there is no D.C. applied to the coils, and with some constructions this is an advantage; it does, however, require a higher H.T. supply voltage. Decoupling condensers should be $0.001\mu\text{F}$, and each stage should be built as a unit: that is, all the earth connections should be brought back to a com-

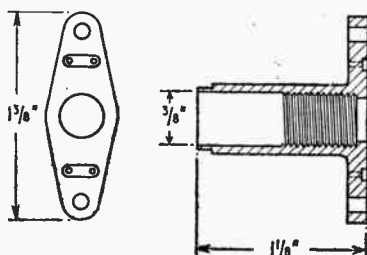

Fig. 4. Drawing of coil former used for I.F. coils.

mon point, preferably the chassis near the cathode pin of the valve.

I have shown fixed tuning capacities of 56 pF on the assumption that dust-cored coils with adjustable slugs will be used. One suitable former is that drawn in Fig. 4, and on this core about 16 turns of 26 S.W.G. wire wound as a single layer with turns touching will give the required inductance. The core can be screwed in and out for tuning, and the winding should begin right at the bottom to allow a maximum range of adjustment. With this pattern of coil an inductance variation of about 20% is obtained by screwing in the core, and this should be sufficient to allow for variations in stray capacitance: it will be enough to enable the circuit to be tuned up, for even if the capacities are too small or too large, the change of gain as the circuit is tuned will show whether turns should be added or removed. If coupled circuits are used, they should be adjusted for "maximal flatness" and not for a wide double-humped response. The reason is that the phase characteristic is more important than the amplitude characteristic in F.M. circuits, and a gently drooping

amplitude characteristic is usually associated with a good phase characteristic.

It is my personal view that care should be taken to prevent any limiting action in the I.F. amplifier proper. The reason is that the grid-current flow is accompanied by a detuning of the coupling stage, so that the overall frequency response is affected. The exact effect of this is rather difficult to predict but it seems likely to result in a lowering of the noise-reducing effect or in increased distortion.

It is preferable in building an experimental receiver to make use of a separate oscillator for the mixer circuit. A Colpitts circuit, with an EF50 valve, operating on 40 Mc/s may be used provided that the input circuit provides sufficient selectivity against 30 Mc/s. An EF50 may also be used as mixer. Whether a separate oscillator is used or whether a combined oscillator and mixer valve, the use of harmonic mixing is advisable in order that the tuning capacity of the oscillator circuit shall be mainly outside the valve. Stabilization of an 80 Mc/s oscillator is much more difficult. There would seem to be some advantage in adopting third harmonic operation, with the oscillator working on 26.7 Mc/s. The details of the mixer and input circuit are normal in V.H.F. receiver design and will not be discussed here.

There are other details which it is assumed only need recalling to the reader. Care in separating the circuits, short leads, especially for decoupling condensers, attention to the grouping of earth connections, decoupling circuits for the heater supplies; all these are points "well known in the art," and certainly this is no place to give a full description of them.

In the mention above of the audio-frequency amplifier, nothing was said about the de-emphasis circuits. At the transmitter,

pre-emphasis is used, giving an increase in the effective modulation of 14db at 16 kc/s over the modulation produced by an equal level of 1 kc/s signal. Pre-emphasis is just a highbrow way of saying top-boost. The reason for doing this is to counteract the "triangular noise distribution" associated with F.M. I am not going to explain this in more detail, but readers who understand the difference between phase and frequency modulation will realize that noise produces uniform phase modulation, and when detected as frequency modulation the noise output is proportional to frequency. By using pre-emphasis at the transmitter it is possible to use de-emphasis at the receiver; "top cut" to you, and thus avoid the high-pitched hiss effect. The amount of de-emphasis is usually given as the time constant in microseconds of a circuit having the required characteristic. Thus the proposed British standard is 50 microseconds. This is given by a resistance of 50,000 ohms in parallel with $0.001\mu\text{F}$, or 100,000 ohms in parallel with $0.0005\mu\text{F}$. The time-constant circuit can be used as load resistance in one stage of the audio-frequency amplifier, and the response should be 4db down at 4,000 c/s, 10db down at 10,000 c/s and 14db down at 16 kc/s. As other parts of the audio-frequency amplifier will probably make some contribution to the required response it will usually not be desirable to put a 50-microsecond circuit in by itself, but rather to put a smaller top-cut capacitance to supply what is needed.

So much for the conventional parts of a frequency-modulation receiver; as you see, they are midway between the sound and vision channels of a television receiver. In the second part of the article the design of the limiter and discriminator will be described.

OUR COVER

FEEDER LINES, switching tower and terminating rings at the B.B.C.'s short-wave station on Rampisham Down, Dorset, form the subject for our cover illustration this month. The outputs from the four 100-kW transmitters are taken to the switching tower whence they are fed to the appropriate aerial arrays. The station was originally brought into service in 1941.

SAFETY IN THE AIR

A User's Views on Radio Aids

NEARLY two years after the end of the European war, no agreement has been reached, even between the principal European governments concerning a standard air navigation system. Inter-continental airways are in an equally unsatisfactory position.

Several conferences on civil aviation have already been held, professedly in an effort to secure agreement on standardized aids. The various parties concerned at these conferences have usually

By J. A. MCGILLIVRAY

system for a specific purpose, but more to force acceptance of sponsored systems.

During the past eight years very considerable advances have been made in knowledge and application of radio and radar equipment. Much of the knowledge so gained is available for application to civil aviation, yet, in spite of this, the most generally used navigation aid is the airborne medium

craft. The need for such a device for British aircraft has long been obvious, and has been stressed. As long ago as February, 1939, there appeared in *Wireless World* a description of a similar automatic aid to air navigation, which produced no response from the industry. But information now is that at least three British companies are developing an automatic direction finder, and may be in production this year.

With more modern devices—radar and the like—the case is

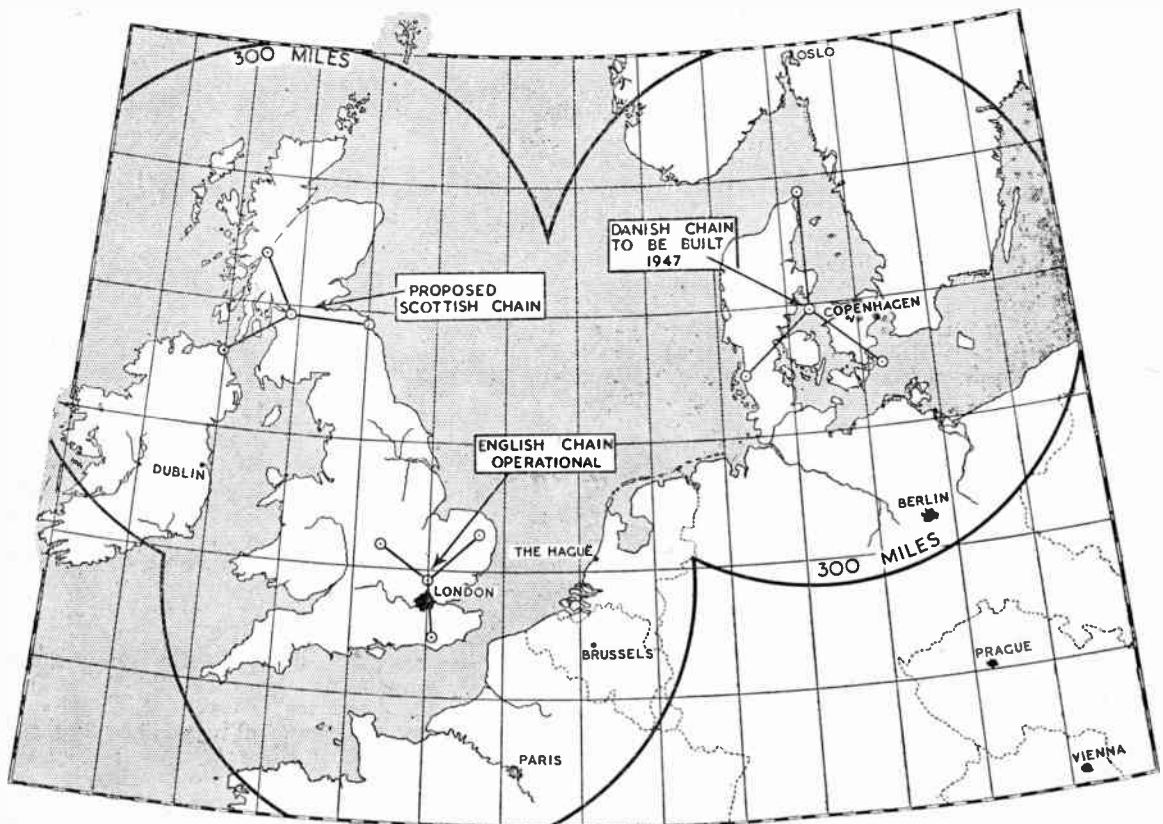

DANISH DECCA CHAIN. The Danish Government has authorized the Decca Navigator Company to erect a chain of stations in Denmark. The Danish system, which is expected to be in operation by the end of the year, is here shown in relationship to the existing English chain and the proposed Scottish chain—plans for which are being prepared for the consideration of the Ministry of Transport.

agreed on the obvious, but elected to disagree on points that really require co-operation. To an on-looker, it appears that the conferences are convened not in an effort to decide upon the most suitable

frequency direction finder, using a rotatable loop aerial—a device at least 25 years old. Since 1938, an automatic version has been available in the U.S.A. and this is generally fitted to American air-

craft that mental indigestion has prevented any general acceptance of systems. The trouble is embarrassment of riches; too many variants are available. One or other of the variants is fitted to

most transport aircraft—in some cases more than one system is necessary owing to lack of international standardization. The un-economics of carrying several heavy boxes around the world in an aircraft are obvious, and the un-economics are not confined to aircraft. In order completely to equip a first-class airport, it is necessary to cater for all potential users. At London Airport there are already four different bad-weather landing systems, and four separate short-range aids to navigation, with two more under construction. All this at the taxpayers' expense.

Most of the variants offer something useful and, almost invariably each is backed by either a big organization or a big name, tending to over-awe potential customers and then to overcome their sales resistance. Potential users, potential providers, and disinterested technicians (who always have something better just round the corner) cannot agree on users' requirements. Even the users cannot agree amongst themselves. So, an analysis of the pros and cons of the various alternatives, without too much detail, may be of interest. The problem is in three parts:—

- (1) A long-range aid to navigation.
- (2) A short-range aid to navigation, with a completely reliable range of 200 miles, under any conditions commonly to be encountered.
- (3) A radio aid to runway approach, for use in bad visibility, as an aid to safe landing.

It would appear obvious that any system which provides a satisfactory answer to more than one part of the problem is better than a system which satisfactorily answers one part only. Satisfactorily to answer all three would be better still. Further desiderata common to all aircraft equipment are simplicity, complete reliability, minimum of weight, minimum of volume, and provision for remote control. The manner in which the required information is presented to the crew is important. Interpretation should be patently, glaringly, obvious; something like a compass or a watch.

In order to achieve a high order

of accuracy, it is usually necessary to sacrifice some simplicity. Generally speaking, simplicity and reliability are closely related. Or, if you like it this way, if a very accurate result is needed, a spare set should be carried, because when the very accurate device breaks down, it's a specialist's job to mend it. Not like the loop aerial, which is as simple as can be, and reliable, within its accepted limits. That's why it is still in use, after all these years.

The systems to be analysed are put in alphabetical order (to give equal offence to everyone!). All systems to be considered are available, and all have been tried out. All have their supporters and their detractors.

Long-range Aids.—There are three long-range radio aids which are worth consideration. All three are available, and all three are in use at present. For economy's sake, let us make up our minds and concentrate on one, and say that we are going to fit it wherever we have jurisdiction.

Any long-range aid must automatically use a medium or low frequency in order to provide adequate ground-wave cover. All are subject to the well-known factors which adversely affect medium and low frequency transmission, but all are not affected to the same extent.

CONSOL is a system which uses directional transmission, described in *Wireless World* for July, 1946. The equipment required on the aircraft is nothing beyond the normal M/F communications receiver. The process of obtaining a position line is very simple; the whole process may take a minute—sometimes only thirty seconds. Then, either by simple interpolation or by use of a special chart, the observer identifies his bearing from the transmitter. Sector ambiguity is possible with this system, but should any doubt arise as to sector, a series of observations would soon resolve the ambiguity. The greater drawback to the extended use of the system is the interference to be expected from atmospheric. An accuracy of within 2 degrees is normally obtainable by day and night, and accuracy of within one degree, at day ranges of 800 miles, is regularly obtained. The sys-

Five Cases

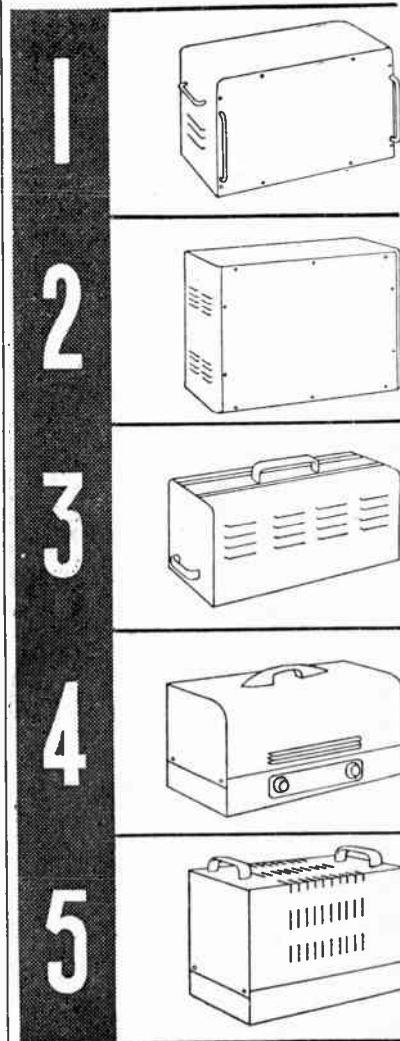

- | | | |
|----------------|---------------------------------|---------|
| 1. Type 1053A. | 15½" w. x 8" d. x 9" h. | £4 15 0 |
| Type 1053B. | 17½" w. x 9" d. x 10½" h. | £6 15 0 |
| Type 1053C. | 24" w. x 12" d. x 15" h. | £8 17 6 |
| 2. Type 1022A. | 21½" w. x 10½" d. x 10½" h. ... | £2 9 0 |
| Type 1022B. | 21½" w. x 10½" d. x 15" h. | £3 5 0 |
| Type 1022C. | 21½" w. x 10½" d. x 22" h. | £4 15 0 |
| Type 1022D. | 21½" w. x 10½" d. x 30" h. | £6 10 0 |
| 3. Type 1007. | 21½" w. x 9½" d. x 10½" h. | £6 0 0 |
| 4. Type 1056A. | 18" w. x 7" d. x 8½" h. | £4 15 0 |
| 5. Type 1023. | 14" w. x 7" d. x 9½" h. | £2 15 0 |

All these standard cases are made in highest quality sheet steel, strongly welded and beautifully finished in light grey, brown, yellow, red or black. Adequate ventilation, pressed feet and front panels fixed by screws in hank bushes are some of the special features. Handles from our standard range can be fitted to type 1022.



112/116 NEW OXFORD ST., W.C.1 MUSEUM 5944

Safety in the Air—

tem is exceedingly simple to use, is economical in airborne equipment, and is generally sufficiently serviceable and accurate for its purpose. The Atlantic seaboard of Europe already has Consol cover. Cost is low.

In the DECCA system, position fixing (as distinct from line-of-position finding) is carried out continuously and automatically, by a special receiver, which works in conjunction with specific transmitters. (See *Wireless World*, March, 1946.) Results are presented on three meters and no skilled interpretation is needed. Decca transmitters already exist in England and are being built on the Continent and round New York. Day coverage is up to one thousand miles, and error-free night coverage is three hundred miles. The system is equally accurate at long and short distances, and can be used for homing and airdrome approach. The makers claim that the system will operate satisfactorily through interference up to twice the strength of the Decca carrier.

LORAN is a pulse system requiring, like Decca, special ground and airborne equipment. The transmitters radiate pulses and the receiver is used to measure the differences in the transit times. The measurement is done on a cathode-ray tube, and the results are plotted on a chart which is overprinted with Loran position lines, as with Decca.

Loran is extremely accurate for long-range working, but less so for short-range. The fact that the actual pulses can be observed on the tube screen makes the elimination of interference less difficult, and errors due to night effect and other reflections can be similarly observed and discounted. A certain limited training is necessary in order to use the equipment and interpret the results correctly. The Atlantic seaboard of North America has complete Loran cover, which is effective up to halfway across the Atlantic. Loran could be satisfactorily operated in conditions of bad atmospheric interference when use of the cheaper Consol would be impossible. Loran cover is more expensive than the others.

Short-range Systems.—As with

long-range aids, so with the short-range counterparts there are again three immediate possibilities — Decca, Gee and O.R.B.

DECCA has already been dealt with as a long-range aid, but merits equal consideration for short-range uses.

GEE is the short-range equivalent of Loran. The basis of the system is pulse transmission on a frequency of between 20 and 30 megacycles, with interpretation on a cathode-ray tube. (See *Wireless World*, January, 1946).

Gee transmitters are already in operation in Southern England, and complete cover for the whole of Europe is projected. There is available an adequate supply of aircraft Gee receivers, and enough transmitters can be made available to provide the required cover. The governments of the European countries concerned are not overly enthusiastic about installing and maintaining the necessary Gee stations, and although an offer of free aircraft receivers has been made, it has not received a widespread welcome. There can be no doubt about the accuracy of Gee. The equipment is not affected by reflections nor atmospheric. In its present form presentation has very little appeal, but this drawback should be fully overcome in models projected for production this year.

O.R.B. (omni-directional radio beacon) is the short-range aid which has the approval of P.I.C.A.O. It is a V.H.F. beacon with simultaneous radiation of two signals. One signal, used as reference, produces in the receiver an alternating voltage, the phase of which is independent of direction. The second signal produces an alternating voltage of the same frequency, but with phase dependent on direction and with complete phase rotation in 360° of azimuth. Determination of bearing from the beacon is determined by turning a 360° scale until the needle indicator registers zero, the scale reading then being the bearing of the receiver from the beacon.

The system has been comprehensively tested, and is very effective. It is extremely simple to use, and gives its information in a direct manner, although unless some care is taken with siting, the

result may well be the bearing of a reflected signal. O.R.B. can for completeness be used in conjunction with a responder beacon, to give indication of distance as well as bearing, the two together providing a specific indication of position. The responder is essentially a V.H.F. pulse transmitter which can be triggered-off from the aircraft.

The exponents of O.R.B. plus responder have proved to their own satisfaction that it is the most accurate system possible, and provides the required coverage at the lowest cost. But it should be put on record that the exponents of Gee have proved a similar case for their favourite. O.R.B.-plus is not immediately available but has been internationally preferred because of its form of presentation.

Approach and Landing Aids.—Again there are three systems which must be considered.

B.A.B.S. (Beam Approach Beacon System) is a mobile system, developed during the war. It is a special type of low-power responder beacon, operating only when correctly triggered. Then it radiates directional pulses, alternately of long and short duration. The short pulses are directed to the right of the runway and the longer pulses are directed to the left. When the receiving aircraft is approaching from the correct direction, the pulses are observed to be of equal intensity, although not of equal duration. Observation is on a cathode-ray tube, which shows distance as well as direction.

B.A.B.S., for good results, requires team work. The navigator observes the C.R.T., interprets the results, and cons the pilot on the intercom.

The ground equipment, at present in short supply, is not excessively costly, and may be mounted in a 10-cwt van for complete mobility. The system operates only in conjunction with the appropriate transmitter-receiver on the aircraft, and, operating on about 200 Mc/s, requires rather careful siting to prevent reflection interference.

S.B.A. (Standard Beam Approach) is no newcomer. It was developed originally by Lorenz in Germany for use on about 36 Mc/s and installed in this country at

Heston in pre-war days. The transmitter radiates a narrow equi-signal path along the line of the main runway. The equi-signal is produced by the merging of two overlapping, interlocking morse signals. Along the line of approach, a steady note is heard, and deviation from the correct approach path causes the distinctive letter to be heard in the pilot's headphones. Distance from the airdrome boundary is indicated by short over-riding signals from marker beacons, which have a specific character according to the distance from the beginning of the runway. The system is well-proven, and very reliable. It has been installed extensively all over Western Europe and it is very simple to use.

I.L.S. (Instrument Landing System) which has been given the approval stamp of P.I.C.A.O. was developed in U.S.A. during the war, when it was known as S.C.S.51. It is very similar in principle to S.B.A., but works on a higher frequency band (about 110 Mc/s) and the result is shown on a meter, instead of being presented through headphones.

The equi-signal path is produced by the overlap of two radiated signals, on the same radio-frequency, but distinctively modulated. Movement of the indicator needle is to left or right, according to which signal is more strongly received, and the needle is centrally vertical when the aircraft is approaching from the correct direction. Within the same meter casing is a second, similar movement, but with the needle horizontally disposed. This second movement is used to indicate the correct approach path in the vertical plane—the "glide path indicator."

The glide path indication is from a second transmitter, similar to the approach path transmitter, but operating on a frequency of about 140 Mc/s. This transmission is modulated by two frequencies as in the approach path transmission, and deflection of the needle is similarly obtained. Distance indication is by marker beacons on 75 Mc/s.

Excellent results have been obtained from this system, in conditions of very bad visibility, but the glide path is apt to be affected

by changes in soil conductivity, due to change of weather. Equipment is in very short supply.

Many pilots object to visual presentation for a landing aid. Their eyes are already fully occupied, but their ears are spare.

Having selected the above nine from the surfeit of possibilities, we are faced with the choice of three complete systems, each to provide radio aid for navigation from airport to airport.

System one—the all-pulse system—is Loran plus Gee plus B.A.B.S. Loran plus Gee, as a composite aid, using separate receivers and a common indicator, has already been proposed. It is the obvious answer to a requirement (if one exists) for comprehensive coverage of large areas by pulse transmissions.

Secondly, there emerges Consol plus O.R.B. plus I.L.S. The two latter items carry the stamp of approval of P.I.C.A.O., the international organization which has been convened to consider such things. The fact must be borne in mind that neither of them is readily available.

System three is Decca plus S.B.A. Both are easy to use, and are in general use in Europe.

All the above, and many more, have been demonstrated individually. The demonstrations generally show that the equipment can do its job, but I submit that instead of showing how several items of equipment can each do the same job and leaving the choice to the bemused spectator, we demonstrate how one set of equipment can repeatedly and satisfactorily do its job, and impress on the prospective customer how good is the system of our choice.

The use of aircraft as a transport medium is extending very rapidly all over the world. For safe operation, radio aids to navigation are essential. In many of the countries concerned there is almost a radio vacuum, and for all-weather operation the vacuum must be at least partially filled.

Geographical proximity to the U.S.A. does not necessarily imply acceptance of U.S. systems. If we can demonstrate, by regular use, that we have something better for sale—immediately—we may find a ready market.

ONE LOUDSPEAKER —360° COVERAGE



CIRCORN—Redg. Trade Mark

This new type, called the CIRCORN, has horn-speaker efficiency together with completely uniform distribution throughout 360°

Typical advantages:—ONE centrally placed will cover the whole of a medium-sized area; used on a moving vehicle results are equal approaching, passing or receding, thus ideal for street processions, elections, etc.

List price—Horn only £7 0 0.
Complete £14 5 0.



M.5
Moving Coil
MICROPHONE

No polarising current, adequate frequency response, low impedance, high output due to a very efficient magnet and careful design.

List price £5 15 0.



L.S.7 HORN LOUDSPEAKER

Maximum sensitivity and volume. Average Impedance 12 ohms: handles 12 watts 170-10,000 c.p.s. 40 in. horn. List price £13 10 0.

F.I. for P.A.
FILM INDUSTRIES LTD.
60, PADDINGTON ST., W.1
Telephone: WELbeck 2385

LETTERS TO THE EDITOR

In Defence of B.B.C. Recordings ♦ Derivation of "-tron"

B.B.C. Quality and Recordings

WITH regard to recent correspondence on the above subject, I should like to point out that the quality of a programme is not entirely a matter of frequency response and distortion. The artistic content is of infinitely greater importance, and in this respect recorded programmes must inevitably excel "live" broadcasts; production can be carried out at leisure, and the programme can be polished before actual transmission. Also, artists can be recorded when available and with no regard to time of transmission. The Third Programme probably provides the supreme example of the intelligent use of recording.

With regard to relative quality of various transmitters, an interesting phenomenon occurs in the "Monday Night at Eight" programme, which includes rapid relays from three regions outside London. Listening to the London transmitter, the technical quality of the material originating in other regions (especially Bristol) is often better than that coming from the studio nearest the transmitter.

The B.B.C. should be congratulated on its new London aerial (recently illustrated in *Wireless World*), which has effectively transferred the whole of Lincolnshire from the North to the London region.

F. DUERDEN.

Cranwell, Lincs.

"Magic Eye" as Null Indicator

YOUR contributors, Messrs. Thacker and Walker, in their article on "Magic Eye Indicators" in the January issue of the *Wireless World*, raise a number of points with regard to the EM1 and EM34 valves. The position regarding these valves should perhaps be clarified.

It would appear that the pre-war EM1 was quite suitable for use in the positive feed-back circuit under discussion, but restrictions on the production of valves for civilian use during the war necessitated certain modifications to the structure. These modifications did not in any way impair its efficiency as a tuning indicator, the grid base remain-

ing substantially unchanged, but the V_g-I_g characteristic of the wartime EM1 rendered it unsuitable for use in high-sensitivity circuits using positive feed-back.

The EM1 is now listed as a "maintenance" type and has been virtually superseded by the EM34. We have, therefore, carried out some experiments with the EM34 with a view to ascertaining its performance in sensitive null indica-

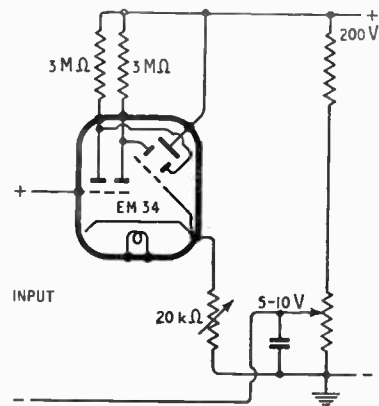

tors. The accompanying basic circuit gives a sensitivity approximately the same as that of the pre-war EM1, i.e., 5mV for a visible shadow deflection.

This improvement on the results obtained by your contributors is due to the use of higher values for the anode loads and cathode resistor. The alteration in the cathode resistor increases the positive feedback but necessitates the grid return lead being taken to a point which is slightly positive with respect to the earth line.

It should be possible to make this modification and to substitute the EM34 in any of the circuits mentioned in connection with the

EM1 while still maintaining the sensitivity of the apparatus.

D. A. WARD,
The Mullard Wireless Service
Co., Ltd.

Technical Service Department.

The -tron Family

IN your issue for February, 1947, your contributor "Free Grid" discusses the ending -tron which appears so frequently in the literature of electronic technique.

Reference to a Greek Lexicon will show that -tron (-τρον) is an ending which means, roughly, "the instrument by which."

Examples which have English derivatives are:—

θεατρον (theatron) "a place for seeing": a theatre from θεωμαι (theao-mai) "I gaze at." φιλτρον (philtro) "a spell to produce love"; a philtre from φιλεω (phileo) "I love."

These examples show that there is a respectable tradition for the use of the ending.

A writer in *Electronic Industries*, January, 1946, collected about eighty words ending in -tron ranging from Alphatron to Zyklotron. This list does not include recent terms such as phantatron or sanatron. L. H. BAINBRIDGE-BELL.

Witley, Surrey.

The New Standard Valves

TO avoid damage valves sometimes need to be eased out of their sockets with a screwdriver. How is this possible with the new type holder?

In the present economic state of the country the set manufacturer with the largest export trade will be able to offer the best value on the home market. It is hardly likely that he will upset production making types using different valves. I think it will be the set manufacturer, plus economics, and not the B.V.A., that will decide the future valves.

Buyers are becoming more discriminating, and many are holding off. They remember having to lay up their sets during the war, while the neighbours' sets that could use Lend-Lease and similar valves played merrily on.

Paisley. W. GALBRAITH.

UNAVOIDABLE DELAYS

Development of the television receiver that is being described month by month in *Wireless World* has been delayed by electricity "cuts" and suspension of transmissions. This month's instalment must therefore be held over.

Publication of the concluding instalment of the article on "Noise Factor" must unavoidably be postponed till next month.

CAREERS IN RADIO

Advice on Technical Training

Open Letter to Would-be Engineers

Dear Jackson,

THANKS for your long letter. It is always pleasant to hear from past students, especially when they can give so many interesting details of life with the B.A.O.R. Congratulations on your appointment as an education officer to the troops in your area. I know your keen interest in training and fitting the chaps for "Civvy Street," and I am sure you will enjoy the work.

You ask if I can help in advising your men on fitting themselves for a career in radio engineering when they are demobilized. This is a big question not easy to answer, but I will try my best. Before I begin with what they should do on leaving the Army, may I suggest that you can get the keen ones started immediately by encouraging them to prepare for the City and Guilds examinations in Telecommunications Engineering. Probably none can be made ready for the examinations this year—they always take place in May—but don't allow this to be a reason for delay. Procrastination is the greatest enemy of success in study. The syllabuses have been remodelled recently to cover post-war needs, and the course, which specializes in Telegraphy, Telephony or Radio Communication, extends over five years. It has been stiffened by including mathematics as well as by extension with Radio IV and Telecommunications Principles III, IV and V. I am delighted to see mathematics as a subject because I have always held that too many radio engineers neglect this most powerful and useful tool. An Intermediate, Final and Full Technological Certificate is issued on the successful completion of the second, third and fifth year's work respectively, and there are still the usual single-subject certificates.

You can obtain full details of the new course, which will, I believe, be fully operative by 1948,

by writing to the City and Guilds, Department of Technology, 31, Brechin Place, South Kensington, London, S.W.7. Since there may be some delay before you get this information where you are it might help if I indicated the broad outline of the syllabuses. Mathematics I covers algebra, trigonometry and mechanics in an elementary manner, Mathematics II is a more advanced edition of I and also includes elementary calculus and complex quantities. Mathematics III deals mostly with the Binomial Theorem, more advanced calculus, and hyperbolic functions. Mathematics IV advances on III and includes differential equations, there is no City and Guilds examination in this nor in Mathematics V, which suggests a number of subjects for study. Telecommunications Principles I concerns itself with elementary electrical theory and would seem to call mainly for descriptive treatment. Principles II introduces the valve and shows the first hint of a radio bias. Magnetic circuits, calculations on A.C. problems, resonance, modulation, detection, propagation of electromagnetic waves along lines, etc., are some of the many subjects included in Principles III. Radio frequency transmission, reception and measuring instruments are covered by Principles IV, whilst Principles V introduces telephone communication theory, pulse, frequency and phase modulation.

You may be a little surprised that the radio student should be required to take Elementary Telecommunications Practice in his first year, for it is almost entirely given over to a descriptive treatment of telephone and telegraph communication, but it should not be a difficult paper and will compel the student to obtain a good grounding in communication practice. Radio I, a second-year subject, requires an elementary, broad knowledge of general principles in radio- and audio-frequency engineering. Radio II is a more advanced treatment of Radio I subjects, covering valves, transmitters, receivers and their



30-WATT AMPLIFIER T.633B

Three stage, high gain type. Push-pull output circuit with inverse feed back. Embodying all the features responsible for the success and efficiency of the original T.633, with up-to-date refinements of design and finish. The new circuit provides facilities for speech/music switching or mixing to suit all conditions of operation.



Other Models available 5-500 watts and full range of accessories.

OLYMPIA & EARLS COURT
LONDON
5-16 MAY
SEE OUR EXHIBIT
Stand No. C.1532
OLYMPIA



TRIX

Quality
SOUND EQUIPMENT

THE TRIX ELECTRICAL CO. LTD.

1-3 MAPLE PLACE - TOTTENHAM COURT ROAD - LONDON, W.1
TELEPHONE: MUSEUM 5817 GRANGE & CABLES: TRIRADIO, WESDO, LONDON.

Careers in Radio— component parts. Propagation, aerials, power rectifiers, as well as more advanced work on transmitters and receivers are treated in Radio III. In his fifth year Radio IV requires the student to deal with short-wave propagation and reception problems, radio frequency power amplifiers, oscillator frequency stability, radio terminal equipment and measurements.

I think you would be fully competent to coach for these exams, but if you prefer not to do so there are several good correspondence courses available from England. You raise your eyebrows? Oh, I know that I have expressed disapproval of tuition by correspondence, and I still think it is a poor substitute for direct teaching, but half a loaf is better than none.

And now for the main problem; the advice to give to men returning to England and wanting to prepare for a career in radio.

I suppose broadly they will fall into four categories:—

(1) Those who have graduated at a university or have obtained a Higher National Certificate but have had little or no practical training.

(2) Those who might qualify for a university course.

(3) Those who will have to earn a living at the same time as studying, and

(4) Those who have a practical bent and need some form of specialized knowledge or training.

Largely at the instigation of the Institution of Electrical Engineers, the Ministry of Labour is now prepared to consider grants to help the first type to gain practical training in industry. The period of training may last two years, a year, or six months, according to the practical experience already gained by the applicant. The six-month course is intended simply as a refresher, whilst the two-year period is for those who have had practically no experience. A letter addressed to the Regional Appointments Officer through the local Labour Exchange should bring full details and advice to anyone who is interested in this scheme.

Now for the second type of would-be radio engineers, the

potential undergraduate. There are altogether eleven universities in England, four in Scotland, one in Wales and one in Northern Ireland, but none can offer a degree course specifically in radio engineering, though most provide one in Electrical Engineering or Physics, which can form a good foundation training for radio. A few do, however, specialize in Electrical Engineering with a bias to Communications, notably the City and Guilds College London, Victoria University Manchester, and Liverpool University. Personally I think there is scope for a school of radio engineering, as distinct from electrical engineering, to consist of a combination of electrical engineering, physics and mathematics in almost equal proportions. It is naturally difficult to suggest for which university the returning soldier should try; so much depends on personal circumstances and I think the best I can do is to examine the particular features of the universities as I know them. I shall try to be as unbiased as possible but you will know that this is not easy. Just one point of practical importance before I go on; see that your student puts in an application early in the year during which he is to be demobbed. Many universities require the form to be returned by May if the applicant hopes to start in October.

The universities can roughly be divided into the older residential ones like Oxford and Cambridge and the newer almost non-residential ones. London is a halfway house between these two. With all due deference to Bruce Truscot (I expect you have read his stimulating "Redbrick University") I would unhesitatingly advise a potential undergraduate to try for Oxford or Cambridge *at the present moment* if he can afford to spend about £300 for the 24 weeks' course per year. Costs at most other universities vary from £50 to £80 per year for tuition and incidental fees so that, with board and lodging, expenses for a 30-week year are likely to be about £200. I underline "at the present moment" because I think Redbrick University is likely to change to residential and seriously challenge the present

ascendancy of Oxbridge, which is due partly to its residential character and partly to the emphasis laid on reaching one's own conclusions and not accepting ready-made ones. The position may be summed up by saying that the Oxbridge graduate is generally socially superior but technically inferior to his Redbrick brother.

It may be that your student has a bias to a certain branch of radio. If he is clearly interested in audio-frequency telephonic problems with a view to a Post Office engineering career, City and Guilds College, London, would be an excellent choice. They also give a good general training in radio and this would fit a man for work in the research, development or production department of a radio manufacturer. If he is interested in valves and high-vacuum technique, Manchester University Electrotechnics Department covers this side. Apart from Liverpool most of the other university Engineering Departments give a broad general course biased to the machine and power side. As a recruiting and training officer for a company exclusively concerned with the manufacture of radio equipment, I received engineering graduates (who subsequently became satisfactory radio engineers) from Oxford, Cambridge, London (City and Guilds, University, King's and Queen Mary Colleges), Birmingham, Durham (King's College, Newcastle), Edinburgh (Heriot Watt College), Glasgow, Liverpool, Manchester (Victoria University and College of Technology), Sheffield, and physics graduates from Bristol, and Wales (Cardiff University College).

To sum up I would advise Oxford or Cambridge from an educational point of view, and City and Guilds College, Manchester or Liverpool on technical grounds, but I would stress that a degree in Electrical Engineering or Physics at other universities does not preclude a man from making a success in radio.

There are also the University Colleges of Hull and Nottingham, and one must not forget the London Polytechnics, Woolwich, Northampton, Battersea and Regent Street and also provincial

Careers in Radio—

technical colleges like Brighton.

For the less academic, more practically minded student I would recommend that he should consider one of the full-time Higher National Certificate Courses, lasting for 9 months. These cover Electrical Engineering principles and practice very thoroughly and exempt from the graduate examination of the Institution of Electrical Engineers; I believe that eleven colleges are operating the courses at the present time, and application for grants is made to the Ministry of Labour. To anticipate your question: there are no Higher National Certificate Courses in Radio or Communication Engineering. There should be.

And now for the third class of student who must earn a living while he is training. He will probably take up a post in a radio factory and is likely to have a technical college near at hand. Besides running Ordinary and Higher National Certificate courses in Electrical Engineering, these colleges are often operating classes specifically adapted to the needs of the locality and there is likely to be a course for the 5-year City and Guilds examination I mentioned early on in the letter. Success in this examination carries considerable weight with most employers concerned with communications equipment. If there

is no technical college in his area, remind him of the correspondence course, which caters for the graduate examination of the I.E.E. as well as the City and Guilds Exam.

The fourth class of would-be radio technician should be advised to take suitable Craft courses at his nearest technical college in the evenings. One can only offer a general recommendation that he should select the most suitable practical electrical course or if there is not one try to persuade sufficient of his associates to combine to form a class. Principals of technical colleges and Local Education Authorities are generally prepared to give every assistance when a genuine need for particular instruction is shown. Those of your men who carry out radio service work can try for the City and Guilds examination in "Radio Service Work," which has the backing of the Radio Manufacturers' Association. There is also a City and Guilds examination in "Electrical Installation Work," which would be quite valuable to the practical man.

This is, I am afraid, a long screed but you wanted rather a lot of information! Possibly there may be some further questions you would like to ask, and in any case I should be delighted to hear how your work progresses.

Yours sincerely,
A. U. Thor.

"BITONE" REPRODUCER

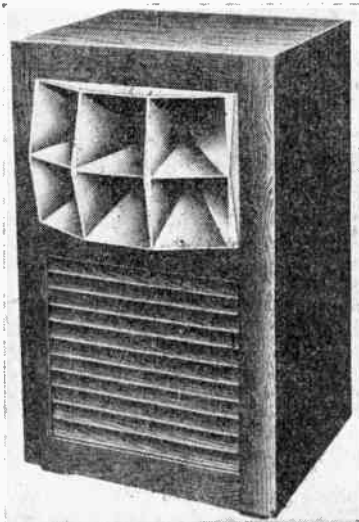

THIS is the name which has been given to the new wide-range loudspeaker made by Vitavox, Ltd., Westmoreland Road, London, N.W.9. A 12-inch cone loudspeaker working in a vented enclosure operates in conjunction with a multi-cellular horn driven by a pressure unit with duralumin diaphragm.

The units are connected through a dividing network with a crossover frequency of 1,000 c/s and the terminal impedance is 7.5 ohms. It is stated that the frequency range is approximately 50-12,000 c/s.

Two types will be available, with power-handling capacities of 10 watts and 20 watts. Both will be housed in cabinets measuring 32in high, 20in wide and 21in deep.

Vitavox "Bitone" wide-range loudspeaker.

**MULTITONE
are now
making—**

HEARING AIDS
smaller than ever

GROUP HEARING AIDS
for Schools and Churches

TELESONIC
(Inductive) Equipments for
Cinemas, Theatres, Lecture
Halls etc.

RADIO SETS
for the Deaf

**DOMESTIC
WIRELESS RECEIVERS**
for the overseas market

AMPLIFIERS
specially designed for Export

AUDIOMETERS

**ELECTRO-MEDICAL
APPARATUS**

also

**OPERATION TABLES
BLEASE ANAESTHETIC
EQUIPMENT**

HYPODERMIC SYRINGES

MULTITONE

ELECTRIC COMPANY LIMITED

Signatories to the National Institute for
the Deaf Agreement.

92, New Cavendish Street, London, W.1.
Langham 2734

RANDOM RADIATIONS

By "DIALLIST"

Temper-saving Screws

DO you know the recess-head screw? I was presented recently with a supply of 4BAs and 6BAs and I have been blessing them daily ever since. Instead of a single nick the head bears what looks like a + sign. This is the top of a tapered recess of cruciform section. The driver bit is exactly the same, only just the opposite, if you see what I mean! It has a + shaped protrusion at its business end, also tapered. If you want to start a screw in an awkward corner you need perform none of those manual gymnastics which the ordinary screw calls for in such circumstances—nor use any of the naughty words provoked by its usual refusal to play. Simply press your recess-head screw on to the screwdriver bit and it stays put in any position. You start it and turn it home without any fuss or bother. And when it's home the bit pulls out as easy as easy. Another joy is that the screwdriver simply cannot slip out of the nick. Now, I reckon that I can use an ordinary screwdriver with anyone. I don't bruise nicks in the ordinary way and only once in a blue moon, when I am thinking of something else, does the screwdriver slip out of the nick. But that blue moon and that fatal skid when they do occur usually happen as a screw is being driven into a piece of work whose surface has been finished with painstaking care. It is *not* funny to have a job of which you were going to be rather proud made into an eyesore by a cut from the blade of a slipping screwdriver. With recess-head screws that just can't happen: the bit stays in its proper place until you remove it by a gentle pull.

□ □ □

Over-Standardized?

RADIO manufacturers kicked heartily (and quite understandably) when the idea of the "utility" (or was it "austerity"? I always forget) receiver was first mooted. As each of them had been turning out up to the outbreak of war, the only set which furnished (with four valves plus rectifier!) "complete fidelity in reproduction," "world-wide sensitivity" (with four valves plus rectifier!!) and "the highest attainable selectivity" (with four valves plus rectifier!!!) it was in no way surprising that

every manufacturer should be reluctant to submerge his individual genius in the mass-production of a receiver for which no particular claims were made, though examination disclosed that it consisted of four valves plus rectifier. Some while ago the day of emancipation dawned: every maker was free to strike out his own unfettered line. And strike it almost each and almost every one did by giving to the world his own proudly acclaimed version of its finest fifteen-guinea set—with four valves plus rectifier! What is even more noteworthy is that you can draw with fair exactness the circuits of far too many of those sets without bothering overmuch to investigate what is within the cabinets. Rough in your guess: triode-hexode frequency-changer, vari-mu I.F., D.D.T. and pentode output. Two-gang tuning condenser; usual wave-change and A.V.C. arrangements. Pick-up and extension L.S. terminals and there you are, except that slight variations are to be found in the frequency-distorter, generally termed, euphemistically the tone-control. I'm all for standardization in the right places; but I'm all against the over-standardized and uninspired medium-priced receiver of to-day.

□ □ □

Meteors and the E-Layer

SIR EDWARD APPLETON threw new light on an old radio problem in the course of a recent lecture to the Physical Society. Why the E-layer should continue to act as a reflector to wireless waves all through the hours of darkness and should not cease to exist soon after sunset, owing to recombination of its ionized atoms, has long been something of a puzzle. The calculated recombination rate shows that the process would normally be completed very quickly when ultraviolet rays from the sun had ceased to arrive. Something must happen to keep ionization going; but what? From the evidence collected by four different teams of investigators there is good reason to believe that the E-layer is kept in working order by the arrival of meteors and meteoric dust. It has been known for some time that a meteor leaves behind it as it passes through the upper atmosphere a trail of ionized gases from which radar echoes can be obtained. Visible trails usually occur some miles below the average after-dark

height of the E-layer; but it is believed that the reflecting efficiency of this layer is maintained throughout the night by the arrival of countless small specks of meteoric dust. These do not penetrate so far as meteors into the atmosphere and they are too minute to produce visible trails or individual radar echoes.

Further Evidence

If meteors and meteoric dust are the shattered fragments of much larger bodies which have been broken up in celestial cataclysms, it is to be expected that the mass of the dust specks will vastly exceed that of the bigger chunks of matter which give rise to the visible shooting-star trails. It appears that mathematical analysis shows that meteor dust should produce exactly the observed effects on entering the atmosphere. One particularly interesting point is the "settling down" of the E-layer after midnight, which every medium-wave D.X. fan must have observed time and again. Some of us, no doubt, attributed the much better reception of North and South American stations obtainable in the small hours to the closing down of European stations. But that is not the whole story. After midnight, wherever you may be, you are on the forward side of the Earth as it rolls along in its orbit. If you walk rapidly through heavy rain, the front of your macintosh (always supposing that you had the coupons to buy one and the forethought to take it with you) becomes much wetter than the back. Similarly the forward side of the Earth, advancing into the clouds of meteors and meteor dust, receives by far the greater number of meteors and meteor dust specks. Hence between midnight and dawn the E-layer over this part of the Earth is kept in a specially efficient condition as a reflector of wireless waves.

□ □ □

Who was Kipp?

READERS who have to do with radar must have come across the Kipp relay, which forms part of the timebase generator circuit of some equipments. It's a lopsided multi-vibrator, whose mission in life is to generate a long negative pulse when triggered off by the arrival of a short negative sync pulse. The two valves which it contains are interconnected by criss-cross resistor and capacitor arrangements. Normally, V_2 conducts and V_1 is biased back beyond cut-off. The sync pulse closes down V_2 with a bang, and this causes the sudden opening

of V_1 . The latter valve is held open for a period depending on time constants in the resistor-capacitor criss-cross. Then it slams shut. The result is the generation of a long negative pulse at the anode of V_1 . Ingenious, though nothing to make a song about. What has always puzzled me—or rather had puzzled me till recently—about this relay is its name. Kipp was always spelt with a capital K, so presumably this was the name of the circuit's inventor. Who was he? A back-room boy? A research worker whose achievements were commemorated by the name of this one circuit? Searches high and low failed to disclose any book, paper or article from the pen of Kipp. No one seemed ever to have heard of him.

The Mystery Solved

The truth about Kipp is that "there never was no sich person," at any rate not in the ranks of radar researchers. The mystery was cleared up the other day by O. S. Puckle, the Timebase King, when I consulted him in my quest for information. The term Kipp relay was imported from Germany, probably by a translator who, not knowing what it meant and deceived by the capital K, took Kipp for a personal name. The word in German is *Kipprelais*, a mongrel combination, for the *relais* part is French, meaning (as you may have divined) relay. Being a noun "*Kipprelais*" is spelt with an initial capital, as all nouns are in German. The Kipp part is from the verb *kippen*, meaning to topple over. Hence the proper English translation of the term is the familiar "flip-flop." Kipp, I fear, must take his place in the galaxy of radio and radar talent beside Professor Eddy, discoverer of eddy currents and Herr Doktor Litz, inventor of litzendraht wire.

□ □ □

Tailpiece

DESCRIPTION of electricity heard during the Great Switch-off: "Nice stuff, if you can get it!"

BOOKS RECEIVED

Service Valve Equivalents. Lists of British Service and U.S. Signal Corps valves and their commercial equivalents, including names of manufacturers where available. Valves with ratings over 150 watts, and obsolete types have been omitted. A section is devoted to the coding of Continental valves and base connections are given for representative types. Published by the Incorporated Radio Society of Gt. Britain, New Ruskin House, Little Russell Street, London, W.C.1. Pp. 25. Price, 9d, postage paid.

RESPONSIBLE MEN



must rely upon
responsible components

CAPTAIN of Britain's newest air liner or pilot of an air taxi, the man at the controls relies on his instruments. On their performance rests the safety of his ship. They are good instruments, precision-built by British technicians—men who have developed the latest radio, radar and electronic devices. Such men in the Bulgin Research Laboratory produce reliable components for every branch of radio and television. You will know a Bulgin component by its sterling performance.

BULGIN

(REGD. TRADE MARK)

Famous since Broadcasting Began

A. F. BULGIN & CO., LTD.

BYE PASS ROAD - BARKING - ESSEX

NPPleway 3474 (5 lines)

RECENT INVENTIONS

A Selection of the More Interesting Radio Developments

VELOCITY MODULATION

WHEN a discharge tube embodying a hollow resonator is used for amplifying or mixing ultra-short waves, the signal-to-noise ratio is largely determined by the fact that the noise power is proportional to the impedance of the input circuit, whilst the signal modulation applied to the electron beam varies as the square root of the input impedance.

According to the invention, the tube is operated so that the impedance of the input, as presented to the electron beam, is substantially equal to the reciprocal of the mutual conductance of the tube. A mathematical analysis of the working conditions is given in the specification to establish the underlying theory.

C. S. Bull. Application date, April 11th, 1941. No. 577168.

RADAR

THE duration of each exploring-pulse P is sufficient to overlap a part of the resulting echo-signal Pr. As the receiver is blocked for the period

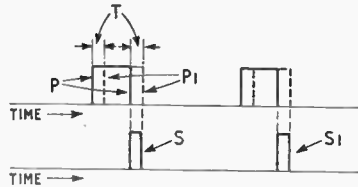

Measurement of short radar ranges.

of each transmission, it can only respond to the residual part T of the echo, which, as will be seen from the diagram, represents the go-and-return time, and therefore the distance to be measured. The output from the receiver is passed through a limiter-rectifier to form a series of pulses S, S_n, of constant amplitude, which can be integrated in a simple form of indicator such as a milliammeter. Accuracy is not affected by casual variations in the duration of individual pulses, provided an equal number of pulses are transmitted each second.

In systems using waves of continuously variable frequency, the normal beat frequency is utilized to derive a second difference frequency, which can readily be filtered out and integrated in a calibrated ammeter.

Standard Telephones and Cables, Ltd. (communicated by International Standard Electric Corp.). Application date December 26th, 1941. No. 577854.

SHORT-WAVE AERIALS

FOR radiating centimetre waves over a restricted service area, a dipole is set at the focus of an upwardly

directed parabolic reflector, a second reflector in the shape of an inverted cone being mounted vertically above the dipole. Energy from the aerial is first directed upwards, along the axis of the paraboloid, and is then broadcast outwards, and substantially downwards, from the inclined surface of the cone.

Both reflectors may be fixed near the top of an elevated mast, though by arranging the paraboloid near the base, the use of a long wave guide or feeder is avoided. The absence of any high-angle radiation prevents the type of interference that is caused by reflection from aircraft.

D. I. Lawson; D. Weighton; and Pye, Ltd. Application date April 8th, 1943. No. 578018.

CRYSTAL MIXERS

A SMALL amount of aluminium or beryllium, or of both these metals, is added to pure silicon by melting a mixture of the powdered ingredients in a crucible lined with beryllia, in an atmosphere of hydrogen or helium, or in vacuo. A plane surface of the cooled "melt" is polished, oxidized by exposure to air at a temperature of 1,050 deg C, and then treated with hydrofluoric acid. The metal contact is a tungsten wire 0.2 mm in diameter, sheared off to a point at 45 deg to the axis of the wire.

The resulting combination is stated to give a constant and optimum ratio of forward to reverse impedance at all points on the crystal surface. It deteriorates little with use, even when handling high voltages, and is particularly adapted for use as a mixer in ultra-short wave reception.

The General Electric Co., Ltd.; D. E. Jones; C. E. Ransley; J. W. Ryde; and S. V. Williams. Application dates August 20th and October 18th, 1941. No. 577181.

STAND-BY RECEIVERS

MOBILE receivers, such as those used on police cars and aircraft, are maintained under stand-by or no-signal conditions for long periods during which current is being consumed. To cut down this waste, the noise voltages that are constantly present in the set are applied, in the absence of a signal, to develop a control bias which automatically reduces the anode current of the A.F. amplifier.

The circuit includes a limiting valve which allows the "outward peaks" of the noise-voltage to pass through to a squelching valve, where they are built-up into a cut-off bias for the A.F. amplifier, thus reducing the drain on the storage battery. As soon as a signal comes in, the level of amplification rises so that the noise voltages are swamped in the limiter, whereupon reception is restored to normal. Simultaneously a noise-suppressing circuit

of known type automatically comes into action to free the speech channel from interference.

The British Thomson-Houston Co., Ltd. Convention date (U.S.A.), Jan. 22nd, 1943. No. 578201.

WAVE GUIDES

WAVES of the transverse electric type are transmitted through a hollow guide, provided the wavelength does not exceed that to which the cross-section of the guide is resonant. In the case of a rectangular guide filled with air, the maximum wave is approximately twice the length of the wider side.

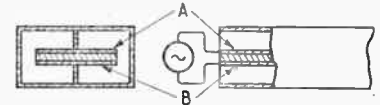

Wide-band wave guide.

As shown in the diagram two internal plates A, B are supported by centre ribs from the wider walls so as to lie, parallel with each other, on opposite sides of the axial plane of the guide; the space between them may be filled with dielectric. This subdivision of the interior increases the effective electrical distance between the walls, and so allows a longer wave to be transmitted by a guide of given external dimensions. The space between the plates A, B is a critical factor, and by making it variable the guide can be adapted to accept a wide range of wavelengths, or, alternatively, to serve as a high-pass filter.

The British Thomson-Houston Co., Ltd. Convention date (U.S.A.), Aug. 16th, 1943. No. 578466.

TELEVISION RECEIVERS

TO allow the picture to be seen more clearly in daylight, or under bright artificial illumination, a glass plate of the same monochromatic colour, say yellow, as the fluorescent image is mounted between the observer and the viewing-screen. Extraneous light passing through the coloured glass is deprived of all but the yellow rays, and so is reduced in overall intensity before reaching the viewing screen. Any yellow light that is reflected back will also be reduced in strength, because of its double passage, as compared with the fluorescent rays from the picture, which only pass through the filter once.

The plate is preferably mounted, inside the usual hood, at an angle to the line of vision, the adjacent surface of the hood being blackened to prevent glare.

J. L. Baird. Application date April 25th, 1944. No. 578108.

The British abstracts published here are prepared with the permission of the Controller of H.M. Stationery Office, from specifications obtainable at the Patent Office, 25, Southampton Buildings, London, W.C.2, price 1/- each.

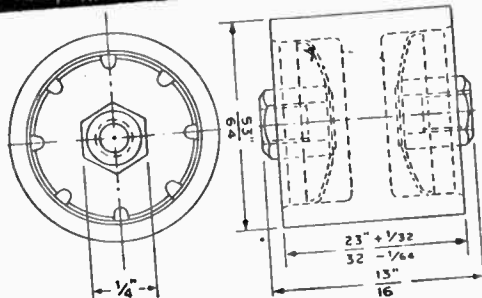

6.32 TAP 3/16" DEEP

ERIE DOUBLE - CUP CERAMICONS



RANGE AND CHARACTERISTICS

TYPE 741A		
Standard Capacities	Temperature Coefficient	Peak Wkg. Volts DC at Sea Level
20 MMF	P100	10,000
30 MMF	P100	6,500
39 MMF	P100	5,000
61 MMF	N750	10,000
75 MMF	N750	7,500
100 MMF	N750	5,500

Test Voltage: 50 cycle RMS equal to peak working voltage:

Temperature Coefficient:

P100=plus 100±30 parts/million/°C.

N750=minus 750±120 parts/million/°C.

Watch this page for release date and for advance information on other new products.

The ERIE Double-Cup Ceramicon, the first of a range of new products scheduled for production in 1947, is the result of the need for a high voltage ceramic condenser that will carry appreciable current at high voltage and will retain the advantage of being a compact, single-piece unit.

As the cross sectional drawing shows, the ceramic dielectric has a centre web which is integral with the tubular casing, providing the required long creepage path. The silver plates are fired on to the ceramic on each side of the web and carried without interruption to the rim of each cup, thus greatly increasing the voltage at which corona occurs. Electrical connections are made by means of electro-silver plated metal terminals soldered to the electrodes.

This design has the necessary basic features for high voltage applications at high frequencies. The web section is sufficiently thick to prevent breakdown of the dielectric, and the design described provides adequate protection against flash-over at the rated voltage. Heavy metal terminals serve to dissipate internal heat and provide a 360° contact for the current to fan out to the electrodes. Rating is 5 KVA.

The ceramic dielectric employed is made of the same titanium dioxide series as the well-known temperature compensating tubular Ceramicons. This material plus careful control of processing operations assures stability with respect to temperature, excellent retrace, and high Q factor.

ERIE Resistor Limited

CARLISLE ROAD, THE HYDE, LONDON, N.W.9, ENGLAND. Telephone: COLindale 8011. Cables: Resistor, London. FACTORIES IN LONDON, ENGLAND . TORONTO, CANADA . ERIE, PA., U.S.A.

"PETER PAN" MIDGET ELECTRIC RADIO

YOU CAN BUILD IN THREE HOURS
The "Peter Pan" model 461U is an entirely new conception of home constructor's kit. When completed the constructor has a receiver of the highest performance and appearance of the best factory-built model. Designed by experts for ease of assembly and wiring.

TECHNICAL SPECIFICATION :

- H.F. AMPLIFIER. A 6K7G valve is used as variable MU pentode giving maximum sensitivity.
- DETECTOR. A 6J7 or (KT233) valve being used as an anode bend detector which in conjunction with specially designed high "Q" coils gives excellent sensitivity.
- OUTPUT STAGE. A 25A6G valve is used which with careful matching gives approximately 2 watts undistorted output.
- RECTIFIER. A half-wave rectifier U31 is employed.
- WAVE RANGES 200-550 metres.
- 1,000 to 2,000 metres.

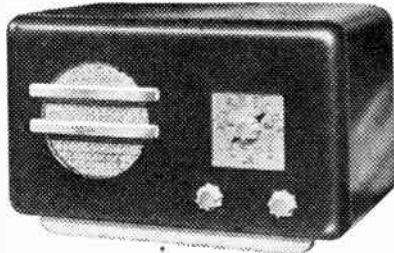

**Price 9 Guineas
plus Tax (£2 - 0 - 7)**

DESCRIPTIVE CATALOGUE IN COLOUR ON RECEIPT OF 2½d. STAMP.

- MAINS SUPPLY. 200-250 volts AC or DC mains.
- OVERALL SIZE. Height 7". Width 12½". Depth 4".
- CABINET. Black and white plastic of modern styling, giving a very attractive finish to the completed receiver

An up-to-the-minute luxury radio receiver at less than factory price DELIVERY PER RETURN

H. P. RADIO SERVICES LTD.
Tel.: Aintree 1445 55, County Road, Liverpool, 4 Estab. 1935



... IRON
DUST
CORES

High performance, Strength, Stability. Close electrical and mechanical tolerances. Grades to suit various applications.

neosid Limited

23 & 25, Hyde Way,
Welwyn Garden City, Herts.
Tel.: Welwyn Garden 925.

W.W.3



Manufacturers
of
LOUDSPEAKERS
●
LAMINATIONS
●
SCREENS
In
RADIOMETAL
●
PERMALLOY
●
SILICON ALLOYS

ELECTRICAL SOUND & TELEVISION PATENTS LTD.
12, Pembroke Street, London, N.1. Terminus 4355
2/4, Manor Way, Boreham Wood, Herts Elstree 2138

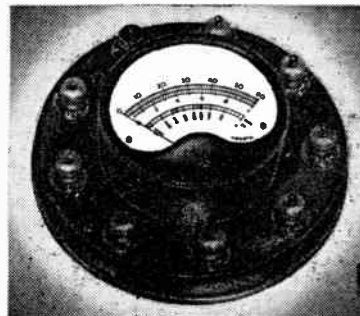

SIFAM
RADIO SERVICING
D.C. TEST SET
Type RT.10.

- 12 D.C. Ranges.
- No switches to go wrong.
- Long clear scales.
- Positive push-button selection.
- Accurate in any position.
- Made to stand heavy overload.
- 1,000 Ω per v.

22
Years
Specialised
Experience

RANGES:
100 MV. 2, 6, 120, 300 volts D.C. 1, 6,
800 MA. 6 amperes D.C., 50 000 ohms,
2,000 ohms at mid-scale.

**SIFAM ELECTRICAL
INSTRUMENT Co. Ltd.**
TORQUAY, DEVON.

**THE
TECHNICAL
ADVISORY
BUREAU**



(Principal—J. Mort B. Sc. Tech. (Hons.) A.M.I.E.E.)

CAN CALL UPON THE SERVICES OF OVER FIFTY ENGINEERS, EACH A SPECIALIST IN HIS OWN BRANCH OF RADIO OR ELECTRONICS.

LET US KNOW YOUR TECHNICAL PROBLEMS.
WE CAN HELP YOU TO SOLVE THEM.

42, BARN LANE, GOLBORNE, Nr. WARRINGTON

Write for details of our Services to the Trade and Amateur

MARCONI INSTRUMENTS LTD
 Masters of Measurement
 in Communications
can now supply their

**DISTORTION FACTOR
 METER
 TYPE TF 142E**

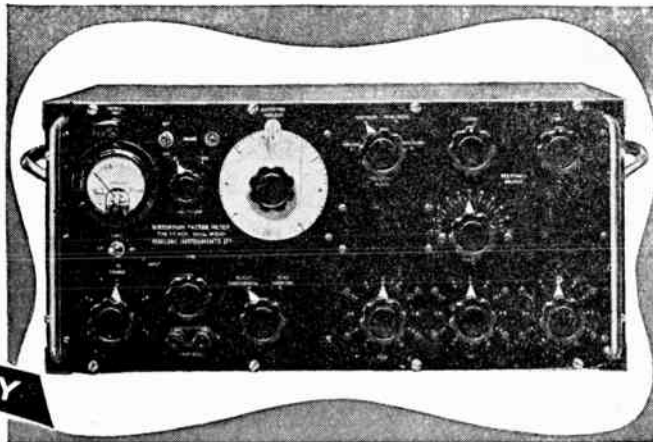

DELIVERY
FOR IMMEDIATE

Evolved for investigating distortion in AF amplifiers, the instrument directly measures the total harmonic content of voltage wave forms.

Meticulous workmanship ensures accuracy and trouble-free performance. Full specifications available on request.



MARCONI INSTRUMENTS LTD

ST. ALBANS, HERTS. Telephone: St. Albans 43236

Northern Office: 30, ALBION STREET, HULL. Hull 16144

Western Office: 10, PORTVIEW ROAD, AVONMOUTH. Avonmouth 438.

Southern Office: 109, EATON SQUARE, S.W.1. Sloane 8615



The
PIFCO
 ALL-IN-ONE
RADIOMETER

tests everything electrical
**RADIO, HOUSEHOLD APPLIANCES
 & MOTOR CAR LIGHTING ETC!**

25/-

Ask your local Factor to show you one of these remarkable instruments and to put your name down on his waiting list.

Rate 6 - for 3 lines or less and 3 - for every additional line or part thereof, average lines 5-8 words. Box Numbers 2 words plus 1 - Press Day: May 1947 issue, first post Tuesday April 8th. No responsibility accepted for errors.

WARNING

Readers are warned that Government surplus components which may be offered for sale through our columns carry no manufacturer's guarantee. Many of these components will have been designed for special purposes making them unsuitable for civilian use, or may have deteriorated as a result of the conditions under which they have been stored. We cannot undertake to deal with any complaints regarding any such components purchased.

NEW RECEIVERS AND AMPLIFIERS

5-VALVE, 8 stage all-wave superhet radio-gram chassis, precision built, £12/17/6, plus tax.—Below.

12-WATT High Fidelity amplifier; three stages of push-pull triode amplification frequency response 20-20,000 cycles, for A.C. only; £22/10, plus tax.

MEAD, 13, Bence Lane, Darton, Barnsley.

COMMUNICATION receivers.—As soon as civilian supplies recommence we shall be at your service.—A.C.S. Radio, 44, Widmore Rd., Bromley, Kent. [4528

COMMUNICATION receivers.—"Dale" will have them as soon as trading conditions allow.—Remember-Dale Electronics, Ltd., 105, Bolsover St., W.1. Mus. 1023.

AMPLIFIERS, 6 watts push-pull output, complete with 10in speaker, for use on ac mains, good quality job, tone control, etc.; call and hear one or send for descriptive leaflet "W".

CHARLES BRITAIN (RADIO), Ltd., 2, Wilton St., London, E.C.2. [6835

AMPLIFIERS; new 1947 model Hi-Fi units, with triple tone controls, built to customer's specification.—Broadcast & Acoustic Equipment Co., Ltd., Broadcast House, Tomland, Norwich 26970. [6433

DORIC Trutone 5-valve A.C.-D.C., 3 wave-band superhet, 16-50, 200-550, 1,000-2,000 metres, complete in attractive oak grained polished wood cabinet, size 13in x 8in x 6in; price £13/6/8 incl. tax.—Doric Radio Co., Lawson St., Darlington. [6947

SOUND SALES Console radio sets, £88/18/6; £28; Trix and B.S.R. amplifiers from £28; good stock of loudspeakers; range includes Sound Sales phase inverter, Wharfedale, W.12 and Vitavox.—Radio Dept., Wallace Heaton, 127, New Bond St., W.1. [7189

BUILD an a.c./d.c. sensitive superhet giving quality reproduction; pre-set i.f.s and 3-wave coils, matched 8in speaker, attractive cabinet, drawings and diagrams, everything necessary to complete a modern receiver; £10/10; write for photographs.—J. Morgan, 164, Whyteleaf Rd., Caterham. [6979

19 46-7 new radios.—Brand new Universal Midgets, a.c.-d.c. mains, med.-long waves, 4v, perfect goods, in makers' sealed cartons with guarantees; £12/17/6; cash with order; executed rotation; send s.a.c. for list leading makes sets.—Radio Bargains, 261-3-5, Lichfield Rd., Aston, Birmingham, 6. [6545

BRIERLEY "Ribbon" and "Armature" pick-ups. Please write your name and address in block letters and include 3s for booklet containing illustrations, responsive curves, technical details, delivery and prices. These booklets explain aspects of pick-up design, developments, including the "floating element" design leading to the use of ¼ and ½ oz downward pressures; the importance of adequate and constant point pressure and its practical achievement; correct point shape; the relation of pick-up weight, point pressure and vertical motion, etc.—J. H. Briery, Ltd., 46, Tithebarn St., Liverpool, 2. [5701

CHARLES AMPLIFIERS.—Announcing a new version of their famous HFA1 amplifier—the HFA3 incorporating a pre-amplifier to enable the use of moving coil pick-ups direct; this amplifier in conjunction with the Lexington moving coil pick-up and the B.A.E.C. twin cone speaker provides the highest obtainable fidelity of reproduction; the complete range now comprises amplifier HFA1 7watt cathode follower output for crystal pick-ups; HFA2 single-ended for crystal pick-up; the HFA3 for moving coil pick-ups; tuner unit TU2 combination superhet t.r.f. feeder unit; full constructional blueprints 2/6 each; full kits or separate components available or supplied ready assembled; stamp for comprehensive catalogue.—Charles Amplifiers, 16, Palace Gate, Kensington, W.8.

Partridge News

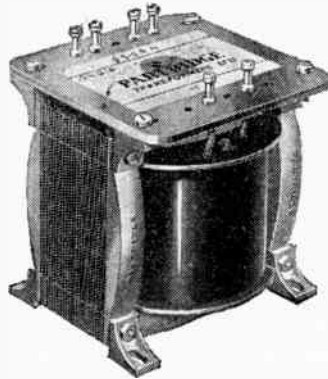

INDIVIDUAL DESIGN

PARTRIDGE Precision Built TRANSFORMERS wound to suit individual requirements now incorporate:—Silver plated turret terminals giving a low potential drop and carrying up to 15 amps. Adequate room on each for easy soldering of several external circuit wires.

Firm clamping of the laminations by means of scientifically designed pressure die-castings.

Interlocked fixing feet providing alternative mounting.

Illustrated above is mounting style "DN" which can be employed if desired on all components wound to special requirements.

AVAILABLE STOCK

A comprehensive range of mains and audio components is now available from stock, and we can despatch small quantities of these per return. We would stress that before ordering you send for our list detailing these components. Our stock range now covers almost all normal requirements, and by availing yourself of this service you will save the inevitable delay in the production of a special component.

CATALOGUE

A new catalogue illustrating various mounting styles is now available. This incorporates full data on our components, including fixing dimensions, weight, method of termination, etc. You are invited to send for a copy, issued free of charge.

Telephone:



Abbey 2244

PARTRIDGE TRANSFORMERS LTD

76-8, PETTY FRANCE, LONDON, S.W.1

TELEFRADIO have 50 only, 5v all-wave midget pocket superhets, size 7½ x 3¼ x 2¼; these are offered complete with universal power pack or battery, together with lightweight headphones and all leads and plugs; sensitivity is very high, and American reception can be guaranteed; illustrated leaflet is available, but as supplies are very limited, early ordering is advisable; in sealed carton at 10gns post paid; deposit will secure.

KIT'S.—5-6v all-wave superhet for ac, 12gns; 4.5watt ac/dc amplifier, £4/17/6; 4v all dry superhet, £5/16; 4v ac/dc tri, £7/3; 3v battery tri, £4/12; all above include valves, but speaker extra.

REPLACEMENT units (factory assembled). 5v model 50a R/G chassis, 12gns, plus P.T. 54/-; 3v model 65, high sensitivity amplifier for ac/dc, suitable for electric guitar, etc, £6/6; B.S.R. 10watt gram. amplifier, with record player, £38/2/1.

COMPREHENSIVE blueprint service is available to amateurs, and illustrated catalogue will gladly be forwarded on receipt of stamp.

COMPONENTS.—Head sets (low impedance), can be used on ext. spkr skts. 12/6 pair; high sensitivity coil packs for all purposes, from 30/-; iron cored high Q i.f. trans, 15/6 pr; Argphenol valve holders, 9d each, 7/6 doz; mains trans, semi shrouded, first quality, 350v h.t., 5 and 6v l.t. Oms, 25/-.

THE TELEFRADIO CO., 157, Fore St., Edmonton, N.18; and 155, High St., Ilfracombe, Tel. Totx, 3386 and Ilfracombe 587. [7042

BAKER'S.—New 7-valve "Wireless World" Quality amplifier with tone control stage. 8 watts push-pull triode output, price includes super quality triple cone, 12in permanent magnet speaker, with large output transformer and all valves; also as above but with 15 watts tetrode output, ideal for realistic reproduction or public address; 2½d stamp for parties., prices, etc.—Bakers Selhurst Radio, 75, Sussex Rd., S. Croydon. Croydon 4226.

COMPACT 28mcs and 56mcs transmitter, 15 watts output, with built-in 4-valve receiver for mobile and field use, on 12 volts D.C., price 15 gns; also available for A.C. mains operation; our new A.C.-D.C. super quality amplifiers, push-pull triode output, with matching for 2-3, 8 and 15 ohms; twin channel input, attractive cabinet with chrome-look handles; price 18gns; both models our latest type BVA valves throughout; world patents pending; illustrated leaflets on request.—Adams Radio, G2HHK, 655, Fulham Rd., London, S.W.6. [7182

RECEIVERS, AMPLIFIERS—SECOND-HAND R1155 R.A.F. receivers, excellent condition, R16 to 4,000 metres; £15.

IN nearly new condition, realigned and calibrated, guaranteed working order; £17/10. CAN be supplied with output stage/power pack and loudspeaker; £27/10.

FULLY modified, as follows, becomes an all-round super set with high quality output D.F. parts removed, new front panel, bass and treble boost with separate tone controls, R.C. coupled push-pull output (2-PX4s), gram input, other refinements, complete with loudspeaker; £35.—Write for details.

R1155s already purchased, modified and serviced and power packs supplied.—R.T.S., Ltd., 8, Gladstone Rd., Wimbledon, S.W.19. Tel. Lib. 3303. [7003

NAT. N.C. 80X, £30; also 4-valve R.X., £9. Nier-Tara, Hilltop Rd., Herne Bay. [7169

PAM amplifier, 2 loudspeakers, moving coil mike; £35, or near.—Collin, Ainsdale, Southport. [7186

R.C.A.-A.R.88 14-valve communication receiver, in perfect condition; offers over £50.—Box 6527. [7033

£20—1155 receiver, modified, with 3watt output, 220v ac.—E.H., 14, Sarre Rd., Cricklewood, N.W.2. [7137

AMPLIFIER, 8-10 watts, new valves and components; £14.—J. Balding, 16, Denmark St., Diss, Norfolk. [7169

50W amplifier, 4-baffle mounted Goodman's m/c mike, stand, Player cabinet, etc., unused; offers.—Box 7019. [7170

R.C.A. AR88 communication receiver, excellent condition, instruction manual, complete; offers £60.—Box 6427. [6970

MURPHY A40c receiver, fine order and unmarked; offers around £55; buyer collects, Northants.—Box 6984. [7158

H.M.V. television and radio receiver, Consoil model 907 (1940), recently overhauled; £120 immediate sale.—Box 6303. [6941

MURPHY television receiver, model A56V console, overhauled by makers, in perfect order; £55 or offer.—Worthing 1292. [7089

A.C.S. RADIO, 44, Widmore Rd., Bromley, Kent, offer small selection com. sets, radio receivers and amplifiers; list free.

HRO Senior, latest model, complete set coils, 50kc/s-30mc/s bandspread, power pack, spares; best offer over £50.—Box 7020. [7172]

MARCONI 11-valve comm rcvr, mains operated, 6 bands, 58kc-31.5Mc, new cond., £30, or Avro part exchange.—Box 6710.

HALLICRAFTERS S-20 Sky Champion, just back from Webb's and equal to new, set of spare valves; £25.—68, Hamilton Rd., Oxford. [7166]

FOR sale, Echophone communication receiver, Model EC-1B, with bandspread, new, just received from U.S.A.; £16.—Dalton, Cummersdale, Carlisle. [6938]

HM.V. model 907 radio television receiver, perfect condition, owner left London district; offers over £85.—54, Park View Dr., Lytham, Lancashire. [7085]

WWQA, 7 watts, phase splitters, separate inputs radio and gram, in crackle finished cabinet.—Offers to Bailey, Hamington, Basingstoke, Hants. [7072]

RC.A. 13-valve automatic motorised tuning, 5 wavebands, bandspread magic eye, walnut console, overhauled, £65.—Box 755, Harrod Advertising Agency, S.W.1. [7192]

AIRCRAFT communications wireless receiver, 12v dc, power pack, 200-260v ac, loud speaker, elegant teak cabinet.—Bacon, 76, Christchurch Rd., Tulse Hill. [7130]

FOR sale, S.X.28 as new with speaker and spares; also new H.R.O. with 9 coils 6 volt and 230 volt power packs.—Offers to Sutcliffe, 69 Cleckheaton Rd., Osdal, Bradford. [6949]

SX.24 Halliester comm. receiver, £38; ex-Government model 1155 receiver, complete with power pack, £20.—Alert Radio Co., 27, Temple Fortune Mans., N.W.11, Spe. 4352.

GE.C. Console television set (91-21), screen 10in x 8in, just overhauled by G.E.C., complete with new tube; price £75.—Cabitt & West, Estate Agents, Farnham (Tel. 5261).

FOR sale, R107 communications receiver, a.c. 110 to 250, or 12volt batteries, 4 hours' use only, with 2 new 6v batteries, spare vibrator, and converter to 6.0x0 metres; £40.—Box 6429. [6978]

6-8W. 7v. Quality amp. and B.T.H. auditorium speaker, £15; amp. £9; also quantity accessories; list on request.—Creeth, Oakmead, Nightingale Rd., E. Horsley, Surrey. Tel. E.H. 411. [7017]

ALL-WAVE Quality receiver with WW Quality amplifier and Voigt large corner speaker, hand-polished oak cabinet, suit connoisseur, purchaser arrange collection; £150.—"Radio," Chilmark, Walford Way, Highcliffe, Hants. [7077]

TELEVISION receiver, Marconi model 704, perfect condition, £52; Mullard capacity and resistance bridge, new, perfect, £15; new unused Canadian walkie-talkie transmitter receiver, £16; purchasers must collect.—Guildford House Hotel, Beach St., Deal. Tel. 927. [7087]

HRO National Senior, with 9 coils, mains power pack, hardly used, £35; few unused 6SG7, 616, 6B8, 6K6GT, 6AB7s, 5/- ea; I.E.E. and Proc. I.R.E. journals, 1942-46; offers; six HS resistor kits of 50 vit. enam. w. wound, 1/2 to 5 watt, 10/- ea; port. HMV gram, leather case, double spring, £5.—Box 6933. [7129]

AMERICAN R.C.A. 7-valve ac 110v push-pull 6L6 paraphase amplifiers, multi-output transformer, negative feedback, gram jack, tone control, Mu-Metal mike transformer, etc., high quality equipment, 18gms complete; new boxed R.C.A. 954, 956 Acorn valves, 12/6; R.G.D. Eko type, powerful ac 14-22 volts radio tuning motors, with muting switch, auto clutch, forward-reverse terminals, and geared approx 60rpm, 1/4 driving shafts, new boxed, 20/-; ac transformer, 230 to 24, 14, and 6 volts, 19/-; alum sheet, 12in x 12in; gauge 16 at 2/6.—Jack Porter, Ltd., "Radio," 22-31, College St., Worcester. Tel. 2442. [7043]

4 G.E.C. 14-watt amplifier, 200-250v, one used, three new, complete with valves; 1 G.E.C. microphone and handle, used; 3 gramophone pot-type speaker units (works on 5 to 20-watt output); 1 Tannoy 25-watt 11-valve Universal amplifier (used), complete with valves; 1 Tannoy p.m. speaker, type No. 328 (used); 6 Osram CMG/8 photo electric cells (little used); 3 Albion pull-through soundheads, complete with P.E.C. CMG/8; 3 Willday pull-through soundheads, complete with P.E.C. CMG/8, these 3 heads take 12 2w gasfilled 1/4 bulbs; 1 Sturdy transformer 1/P 250v 50 cycles 1 phase; D/P 12v 10 amps; 1 G.E.C. transformer, 1/P 240v O/P 12v.—Offers to Box 44, Young's Advertising Agency, 6, Melville St., Edinburgh, 3. [7048]

EXCELLENT BARGAINS!

L.T. DYNAMOS. Car type with circular body for direct charging from motor or engine, or the 6 and 12 v. models can be adapted for wind charging. Shunt wound, ball bearings; 6 v. 10 amps 1,000 r.p.m., £4. 12 v. 10 amps, 1,000 r.p.m., £4 10. 24 v. 40 amps, 1,000 r.p.m., £10. 30 v. 5 amps, 1,500 r.p.m., £7 10. 32 v. 6/8 amps, 1,800 r.p.m., £8 10. 50 v. 10 amps, 1,000 r.p.m., £12 10.

CIRCUIT BREAKERS. N.C.S., 7 1/2 amps A.C. enclosed type, 21/-. Ellison make mounted on sub-base, D.P.O/L200/230 v. A.C. single phase, 200 amps 15in. x 13in. x 1 1/2in., weight approx. 50 lbs., ditto 300 amps 17 1/2in. x 14in. x 1 1/2in., weight approx. 89 lbs, 220 volts, 1,000 amps, S.P 50 cy. D.P. with no hold-on coil, loose handle, switchboard mounting oil switches by Ferguson & Palin. All offered at very low prices to clear.

REGULATORS. 20 stud 500 ohm 0.2 amps with laminated arm and knob, enclosed type 30/-.

CUTOUTS. Air Ministry type with bakelite cover 4in. x 3 1/2in. x 3 1/2in., D.C. 12 volts 40 amps or 24 volts 40 amps, 35/- each.

MOTORS. Small Sewing Machine motor with bracket, 230 bolts, A.C./D.C. 1/20th H.P., ball bearings, high speed, £4 10 0. Square construction, adjustable brush gear totally enclosed, 1/80th H.P., 230 volts, 8,000 r.p.m., A.C./D.C., £4. 1/27th H.P. 230 volt A.C./D.C., 4,000 r.p.m., round construction with 4 hole base plate, £3 15.

MOTORS, D.C. 230 volt, 1.6 h.p. Newton shunt wound, 2,500 r.p.m., £12. 100 volt 1/100 H.P.K.B.B. shunt, protected type, 2,000 revs., with 20/1 reduction gear on C.I. base, 45/-.

MOTORS, A.C. 1/3 h.p., 4,000 revs., 230 volts A.C., 50 cycles, £9.

MOTOR PUMPS. Stuart Turner 12 volt D.C. 120 g.p.h., £5 5 0. 220 volt A.C., 150 g.p.h., £6 6 0, and £7 10 0 each. The Lexdix Bijou Motor Pump, 230 volts A.C./D.C., lift 3ft., throw 10ft., 120 g.p.h., £5 15 0.

METERS. D.C. moving coil micro-ammeters, new, 2in. flush panel, zero adjustment, 500 ohms resist., 500 micro-amps, 60/-; D.C. moving coil, Milli-ammeters, 0-1 mA, 2 1/2in. dia., 55/-; 4in. dia., 70/-; double range, first grade m.c. voltmeters, 0-10 v. and 0-40 v., by Elliott, 55/-; D.C. moving coil ammeters, Elliott, 2 1/2 in. dia., 2.5 amps, 55/-; delivery for stock.

HEADPHONES. Double L.R. Headphones with headband and cord, ex G.P.O., light weight type S.G.B. bakelite case and cap, 12/6 per pair. Single receiver with headband and cord, L.R. 8/6. High resistance as above 22/6 per pair. Headphone cords 2/6. 4-way 5ft. cord, heavy P.O. type, twisted; 3/- each.

CASES. The famous Mark III Receiver cases 5in. mahogany canvas covered 13in x 12in. x 7 1/2in., with hinged lid and carrying handle, 15/-. All-metal ex W.D. boxes 9in x 9in. x 8in., with 2 front fasteners and loops for carrying handle, rest for panel to be fitted, make fine instrument case, hinged with lid, 12/6.

VARIABLE RESISTANCES. Rotary type 4 ohm 4t amp. wire wound, with large knob, 7/6.

MAGNETS. D.C. Electric magnets, weight 10 oz., lift on 2 volts, 1 1/2 lb., 4 volts 3 lb., 6 volts 4 lb., new surplus, 7/6 each. Permanent powerful flat bar magnets, 2 1/2in. x 1in x 3/4in., drilled 2 holes each end, for any pole pieces, 2/- pair. AC/DC mains magnets, 2-pole, 220 volts, 7/6. The wonder Midget magnets, Alin perm steel disc; 3/4in. dia., 3/4in. thick, with 3/16in. centre hole, 3/6 each. Large stock of Horseshoe magnets. Send for special Magnet Leaflet "W."

TRANSFORMERS for all purposes. Send us your enquiries and we will quote; prompt delivery. DIMMERS and RESISTANCES can be made to your specifications, let us have your enquiries. OUR LIST is not yet ready for distribution, but we have Leaflets on **Dynamos, Relays, Magnets, Crystal Set, Headphones, Microphones, Telephone Constructors parts, Battery Chargers, Lighting Plants**, all these goods have been advertised in the *Wireless World* from time to time. Send for copies of those you are definitely interested in. Please mention this journal.

Please include postage for mail orders.
ELECTRADIX RADIOS
214, Queenstown Road, London, S.W.8
Telephone: MAcaulay 2159

ONLY £10; Emmerson midget receiver in light beech cabinet, 5-valve superbet, all new valves and electrolytics; s.a.e. for lists of other bargains.—Brown, 63, Salisbury Av., Farnham Rd., Slough, Bucks. [7108]

TEST EQUIPMENT
GANGING oscillator, Cossor 3343, unused, perfect.—Box 6860. [7122]

COSSOR oscilloscope 3332: £18 or near offer. Burley, 60, Balacava Rd., Derby. [7002]

TEST gear in kit form.—List from MacLachlan & Co., 16, Thistle St., Stirling. [7177]

TAYLORMETER 90a, new, Pifco 8-range; £16/10.—48, Brecks Cres., Rotherham.

AVO model 40 Universal test meter, as new; £13.—Renfret, 337, Charminster Rd., Bournemouth. [7179]

MULLARD GM3152 'scope, £50 or offer; M E669 meter, £6; E665 valve voltmeter, £15.—Box 6861. [7124]

EVERETT Edgcombe portable R.F. voltmeter, 0-150v; sell, exchange analyser, oscillator.—Box 6692. [7047]

MARCONI valve voltmeter for sale, list price £50, as new; £40.—Dixon, 68, Sitwell St., Spondon, Derbyshire. [7184]

MULLARD C.R.T. unit, type B100, with 3in tube, unused, as new; £9/10.—Packer, Rock Hill, Bromsgrove. [6936]

WESTON analyser, new, 20,000 o.p.v., £20; R.C.A. Junior Voltohmyst, electronic voltammeter, new, £20.—Box 5629.

AVO oscillators, new, mains £13, battery £12; a few available only, please write first.—R. Massey, 58, Wakefield Ave., Hull. [7146]

PHILLIPS oscilloscope single beam time base, 2-150,000 c/s, amplification x1,600; what offers.—Tel. Amherst 2937 after 7 p.m. for appt. to view. [7053]

COSSOR 33 and D-B oscillograph, A.C.-D.C. Avro minor, no case, record 500v insulation tester in case all perfect; enquiries/offers to: BM/ANLL, London, W.C.1. [7181]

METER rectifiers by Westinghouse, new, Midget tubular, 3/4in x 3/4in, tag ends, half-wave; 6/9 each, c.w.o.; trade enquiries invited.—Stott, 87, Brixton Hill, S.W.2. [7121]

SPEED up service by reading correct voltages; use the Holmer valve voltmeter, £18; list.—Makers: Holiday & Hemminger, Ltd., 74, Hardman St., Manchester, 3.

SPECIAL bargain; Avro universal minor, good condition, £4/15; Canadian No. 53 Transceiver, complete with power pack, headphones, microphone, etc., £9/10; s.a.e. for particulars of other equal bargains.—Box 6525.

COSSOR double-range oscilloscope model 339, £45; Dawe wide-range oscillator, type 400A, £60; Dawe standard resistance box, £20; inductance and resistance bridges and quantity of radio components; offers.—Tel. Fin. 5974. [7136]

THANKS for waiting.—The Roberts portable combined valve and circuit analyser ready for distribution (in rotation in March.—Particulars and price from Sole Distributors, Messrs. Kerry's (Great Britain), Ltd., Warton Rd., Stratford, London, E.15.

RC.A. oscilloscope type 155A, 115v input, X and Y wideband amps, linear BT, 15-22,000 c/s, int. or ext. sync., welded steel case, finished grey, polished panel, new, ideal for lab. or shack; prefer to sell to ham or club; offers over £40.—Box 7060. [7187]

1,000 kc oscillator units in metal screening boxes, complete with standard 1,000 kc bar in holder, only require valve inserting and connecting to 6.3 volts filament and 100 volts H.T. for perfect 1,000 kc signal generator; price 17/6 complete (excluding valve); special offer, 6/5 valves, sealed cartons 4/6 each.—Welsby, 1, Cobnar Drive, Sheffield. [7054]

WAVEMETERS, ex-Govt., class D, No. 1 Mark II, ranges 1,900-4,000 kc/s, 4,000-8,000 kc/s, check frequencies at intervals of 1 mc up to 25 mc/s, oscillator crystal check, battery operated, supplied with spare vibrator, spare valve, and instruction book, brand new; £6/15, carriage paid; send for fully descriptive leaflet; also a few only less spares at 25/- (carriage 3/-).—U.E.I. Corpn., 32, St. Gabriella Rd., London, N.W.2. [5910]

RADIO serviceman going abroad has for disposal at once 1 Phillips signal generator, 60 mc/s to 10u kc/s, 1 Avro valve tester, 1 Taylor meter 90A, 1 Taylor test bridge, model 110A, 1 Ekco television pattern generator (unused), 1 Wee megger, all these items have had less than 3 months' use; also approx. £200 working stock trade value, including 100 valves, etc., and approx. 1,000 service sheets covering most British sets back to 1937; best offer near £235 for quick sale.—Detailed list on application to Box 6428. [6977]



HEADPHONES. Double L.R. Headphones with headband and cord, ex G.P.O., light weight type S.G.B. bakelite case and cap, 12/6 per pair. Single receiver with headband and cord, L.R. 8/6. High resistance as above 22/6 per pair. Headphone cords 2/6. 4-way 5ft. cord, heavy P.O. type, twisted; 3/- each.

EX-GOVT. SETS OFFERED AT FRACTION OF ORIGINAL COST!

1 1/2 METRES 10 VALVE SUPERHET UNITS



7 GNS.

Carriage paid. Cash with Order

Special discounts to Trade, Radio Societies, etc., in lots of 25 or more receivers.

IDEAL FOR CONVERSION INTO

TELEVISION RECEIVERS

CIRCUIT COMPRISES

1 Pre. amp., Osc., Mixer, 5 I.F., Det., Video Amp I.F. Frequency 12 Mc's, Band-Width 4 Mc's, Co-axial input and output sockets. External source of L. T. and H.T. supply is required. Manufactured to stringent Government specification by such famous makers as R.G.D., Pye and Murphy. Brand new and unused in Manufacturers' sealed cartons. Complete with 10 Mazda Valves.

WIRELESS INSTRUMENTS (LEEDS) LTD.

54-56 THE HEADROW, LEEDS, 1

Tel.: 22262

YOU can become a first-class RADIO ENGINEER

We are specialists in Home-Study Tuition in Radio, Television and Mathematics. Post coupon now for free booklet and learn how you can qualify for well-paid employment or profitable spare-time work.

T. & C. RADIO COLLEGE North Road, Parkstone, Dorset

(For: in unsealed envelope, id. stamp)

Please send me free details of your Home-Study Mathematics and Radio courses.

NAME

ADDRESS

W.W.58.

COMPACT 3in oscilloscopes, combines all the necessary requirements for the amateur at reasonable price; switching provides access to X and Y plates direct or through high gain amplifiers, input potentiometers calibrated in volts; built-in sweep circuit, tropical construction, ECR50 tube working at 1,100v, guaranteed 12 months and fitted with latest BVA valves throughout, world patents pending; full catalogue on request; price 25gns.—Adams Radio, G2HHK, 655, Fulham Rd., London, S.W.6. [7183]

SERVICEMEN! Experimenters! Nuplans, the testgear specialists, announce besides the television test pattern generator the Nuplans signal tracer and fault finder; see the trouble—hear the trouble! Makes servicing a pleasure. Also the battery signal generator, simple, cheap to build, covering all frequencies up to television, has features found only in expensive gear; plans, circuits, details in full, 2/6 for each of the above. Notes on Signal Tracing, 1/- and stamp.—From E. N. Bradley, "Whinnie Knowe," Escalls Cliff, Sennen, Cornwall. [7110]

VALVES

813, 829, 829, TZ40, 35T, 1 pair each, new; what offers?—Box 6854. [7100]

CRIT's, E'static, brand new, 2 3/4in short type, £3/10; 1 1/2in, £3; bases, 4/6; 3 1/2in, £7; 6in, £8; bases, 5/6; post, etc., 1/6.—Houlgrave, 178, Highgate Rd., B'ham., 11. [7143]

ALL types of valves available at list prices, also 9001, 9002, 9004, 954, 955, 956; Acorn diode, triode and pentodes at 20% each to clear; c.w.o.—McWilliams, 7, Cowper Rd., Gillingham, Kent. [7010]

VALVES—X41, X65, TH41, AC/TH1, 11/6+2/6; KTW61, SP4, VP41, Pen45, 10/6+2/4; M1D4, DH63, TDD4, HL41DD, AC/PT, 9/6+2/1, HLL3DD, 7/6+1/3; cash with order or c.o.d.—Hunt & Co., Ltd., Newark, Notts. [7079]

FOR sale as new cathode ray tube, Mazda type CRM91, £10/10; mains transformer, 3.4v tapping, 1.2v tapping, 350-0-350 Ekco, £2/10; one set Ekco deflector coils and magnetic lens unit complete, £4.—Bishop, Larkbarrow (flat 2), South Down Rd., Woldingham, Surrey. [7078]

RADIOGRAPHIC, Ltd., 66, Osborne St., Glasgow, C.1.—Transmitting valves, Eimac 35T, 45/-; RCA 813, 110/-; RCA 805, 110/-; Hytron RK25, 40/-; RCA815, 45/-; Raytheon RK20A, 94/6; RCA 866/866A, 27/6; Gammatron 24G, 37/6; Kenrad 3625, 25/-; Hytron TZ40, 45/-; RCA 811, 52/6; RCA 6L6M, 19/10; RCA 807, 25/-; Eimac 100TH and other types available soon; all guaranteed; Radar R.F. amp. units, valves complete, 35/-; Loctal ceramic valve holders, 6d each; 5-pin ceramic valve holders, UX5, 9d each; 4,000 volt oil filled trans., new, 10/- each; mail order specialists.—Radiographic, Ltd., 66, Osborne St., Glasgow, C.1. [7133]

FRITH RADIOCRAFT, Ltd., the Leicester Specialists, offer from their comprehensive stocks: Over 5,000 receiving and transmitting valves including many difficult types, Wearite, Labgear and Atkins coils, most types, 3/- to 4/6 each; L.M. and S. s'het coil packs, 39/6; leaflet post free; 100% tried and tested designs for s'het 3-wave tuner, 5v A.C.-D.C. s'het midjet, 2/6 each; Serviceman's parcels of small condensers and resistors, £1 per 1/2 gross; all-wave S.M. dials, 7in x 4in, with glass and escutcheon, 12/6; Woden diecast output transformers, 6,000 and 10,000Ω, A to A, CT, 3-15Ω sec., 30w, 39/6; also most Woden types as maker's list; wide range of Eddy-stone, Raymart and Labgear components from stock. FRITH RADIOCRAFT, Ltd., Churchgate, Leicester. [7193]

MORSE EQUIPMENT

MORSE practice equipment for classroom or individual tuition; keys, audio oscillators for both batt. or main operation.—Webb's Radio, 14, Soho St., W.1. Ger. 2089. [2291]

NEW MAINS EQUIPMENT

10H 100ohms 100mA chokes, fully shrouded, ex-M.A.P., Vortexion Mfg., 15/- each, in quantities 12/6 each. VORTEXION mains transformer, output transformers, and chokes; imitated but unequalled. VORTEXION, Ltd., 257-261, The Broadway, Wimbledon, S.W.19. Tel. 2814-6242-3. Grams: Vortexion Wible London. [6958]

NEW LOUDSPEAKERS

SELECT your new speaker by direct comparison.—Holley's Radio Stores now demonstrating Goodmans "Infinite Baffle," Sound Sales "Phase Inverter," Hartley Turner and Wharfedale "Golden," also full range of amplifiers, feeder units, moving coil and hyper-sensitive pick-ups.—285, Camberwell Rd., S.E.5. Tel. Rodney 4988. [7058]

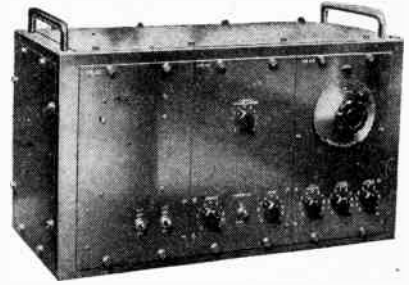

PUBLIC ADDRESS by ACOUSTICAL for the very best in REPRODUCTION DESIGN WORKMANSHIP SERVICE

We will gladly send you full details and specifications of the full range of ACOUSTICAL P. A. Equipment on request.



MANUFACTURING CO. LTD. HUNTINGDON. TEL: 361.



By direction of the Ministry of Supply, at the Ministry of Supply Depot, 12-14, TOWER BRIDGE ROAD, S.E.1. (Adjoining Old Kent Road and Close to the Bricklayers' Arms Station, S.R.L.)

MISCELLANEOUS NEW & SURPLUS STORES & EQUIPMENT, comprising **MACHINE TOOLS, CONTRACTORS' PLANT, COMPRESSORS, RADIO & ELECTRICAL COMPONENTS, TRANSFORMER LAMINATIONS, THIRTY THOUSAND CABLE DRUMS, ONE-QUARTER MILLION PRS. ANTI-GAS GLOVES, LENSES, CIVIL DEFENCE EQUIPMENT, PLATED, ARMOURD & WINDOW GLASS, HAND TOOLS, VARIOUS TYPES BRONZE, BRASS & DURALUMIN FITTINGS, CANVAS & TARPAULIN, SCALES & BALANCES, INSTRUMENT CASES & SUNDRY EQUIPMENT.**

To be Sold by Auction WITHOUT RESERVE by

STOCKER & ROBERTS

at the Depot as above on the THREE CONSECUTIVE DAYS, TUESDAY, WEDNESDAY & THURSDAY, 15th, 16th and 17th April, 1947, at 11 a.m. each day, with a lunch interval from 12.45 to 1.45 p.m.

The Stores will be ON VIEW on Thursday, Friday, Saturday and Monday, 10th, 11th, 12th, and 14th April, from 10 a.m. to 4.30 p.m., and on Saturday from 10 a.m. to 1.30 p.m.

Admission to view and sale will be by Catalogue only—price 6d.—obtainable from the Auctioneers' Offices, 29-31, Lewisham High St., S.E.13.

Telephone (for the Auction Stores Department) LEE GREEN 2137.

HIGH quality, precision-built speakers. Ticonal magnets, detachable diaphragms, die-cast chassis, twin cone.—Broad cast & Acoustic Equipment Co., Ltd., Broad cast House, Tombland, Norwich, 26970. [635
SUPPLIES of 5in to 15in P.M. speakers. Crystal, moving-coil microphones and stands; armature crystal and moving-coil P.U.s; all components, including matched resistors and valves available for high fidelity amplifiers and receivers and V.W. circuits; we stock only the highest grade components.—Write Rogers Developments Co., 15, Llanover Rd., Plumstead, S.E.18, or phone W. 4147.

£5 /18/6.—New Baker Super Quality 12in Auditorium permanent magnet speaker with triple cone, manufactured by Bakers Selhurst Radio, the pioneer manufacturers of moving coil speakers since 1925, wide frequency range, even response, ideal for quality reproduction, fitted with magnet, having exceptionally high flux density in the air gap suitable for public address equipment when quality reproduction is first consideration; send 2½d stamp for leaflet giving details of above and constructional details of a new acoustic chamber designed to extend loud speaker frequency range.

£8 /19/6.—New Baker super power cinema permanent magnet speaker with 18in triple cone of new design, giving wide frequency response free from objectionable resonances; speech is clear and natural and music is reproduced with exceptional realism; fine engineering job, extremely sensitive; ideal for public address equipment when power handling capacity, plus realistic reproduction, is required, prompt delivery per pass. train.—Bakers Selhurst Radio, 75, Sussex Rd., S. Croydon (Croydon 4226).

LOUDSPEAKERS, SECOND-HAND

LATEST Hartley-Turner 215, new; £8.—Whitehead, 96, Harpers Lane, Bolton.

GOODMANS 12in P.M., in polished mahog. cabinet, 3ft by 3ft, very solid; £11.—41, Ashridge Way, Morden. Lib. 5454. [7044

ROLA G12, 750 ohm field, £5/15; also pair Bakers' 12in triple-cone p.m., 15 ohm, £3 each.—Batt, 7, Tudor Drive, Watford.

FOR sale, quantity of Wharfedale 6in loudspeakers in attractive cabinets, insulators, angle irons, cleats and mains transformers removed from rediffusion system.—Offers to Senior Administrative Officer, R.A.F., Yatesbury, Wilts. [6919

DYNAMOS, MOTORS, ETC.

GENERATING sets, petrol eng. driven, 2.5 k.v.a., 110v ac, 1 ph., 60 cycles, new, with instr. bk.; £50 c. pd.; gen. set enquiries invited.—Kelly, Drakestone, Dursley, Glos.

ROTARY converter (Electro Dynamic Construction Co.), 240 d.c. to 230 a.c., 50watts, complete portable unit in soundproof cabinet, as new, cost £16; offers over £10.—Box 6519. [7004

ALL types of rotary converters, electric generator sets, etc., in stock, new and second-hand.—W.A.T.D., 37, White Post Lane, Hackney Wick, E.9. Tel. Amherst 1939. [4677

BATTERY chargers for home and export. 4 models, 2.6-12v 1, 2, or 4amp dc; mains voltage; generous trade terms. Write for catalogue. Tel. Hoddesdon 2659.—The Banner Electric Co., Ltd., Hoddesdon, Herts.

GRAMOPHONE AND SOUND EQUIPMENT MICROPHONE, S.T. & C. 4021 moving coil; £7.—Box 6985. [7160

WANTED, Simpson electric turntable, 240v 50c.—Hubble, 42, Station Rd., N.21.

RECORDING table, gravity driven, wax or direct, professional design, cost £150; offers—Addiscombe 4858. [7162

GARRARD R.C.50, A.C., mixed auto changer, in original carton, practically unused; offers.—Box 6397. [6963

UNUSED, Lexington Senior P.U., with sapphire transformer and pre-amplifier; £6/10.—520, Burton Rd., Derby. [6973

CONSOLE radiogram cabinet in polished mahogany by Camio, new condition, including part radio set; £13/10.—Cle. 4480.

RECORDING equipment, now including sapphire styli for lightweight p.u.s.; 2 inc P.T.—Technifon, Ltd., 99, Belgrave Rd., S.W.1. [6994

PORTABLE 16in recorder, 78 and 331/3 rpm heavy duty motor with flexible drive to synchronise with cinema projector; £20.—Cheetham, 5, High St., Chippenham [7015

RECORDER, complete A.C. portable direct play-back outfit by phono-disc, with stand microphone, Blanks, etc., D.C. A.C. converter available; £40.—Sheffield, 8, High St., Abbots Langley, Herts. [6937

ARMSTRONG

Model EXP83

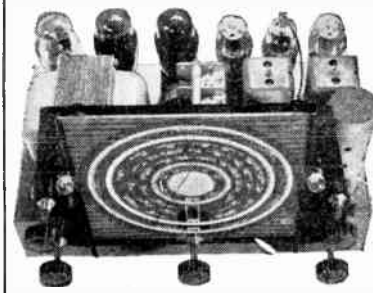

ALL-WAVE 8-VALVE SUPERHET CHASSIS

incorporating wave band expansion. Large glass scale treble boost control. Gram. switching. High quality push-pull output gives 10 watts audio. For 100-250 v. A.C. mains.

Price **14 gns.** plus tax

Model UNI-83

ALL-WAVE 8-VALVE SUPERHET CHASSIS

incorporating wave-band expansion, e.g. the 16-50 m. band covers just over 20 inches on the large glass scale, treble boost control, gram. switching, all controls work on both radio and gram., high quality push-pull output giving 6 watts audio. For 200-250 v. D.C. or A.C. mains.

Provisional Price **14 gns.** plus tax

* Model EXP53

ALL-WAVE 7-STAGE RADIOGRAM CHASSIS

This new radiogram chassis incorporates wave-band expansion on all bands. Volume and tone controls work on both Radio and Gram. 4½ watts R.C. coupled output. Supplied complete with full size loudspeaker. This chassis has a lively performance, good quality reproduction, and represents excellent value. For 200-250 v. A.C. mains.

Price **£13** plus tax with speaker

* Owing to the National Emergency and the consequent loss of production we may be compelled to suspend this Model temporarily. We shall, however, do everything possible to avoid this.

Model AMP14

HIGH GRADE AMPLIFIER CHASSIS

Two inputs, bass compensating circuit, treble boost control, 14 watts push-pull output preceded by 4 triodes.

Price **13 gns.**

Demonstration Sets are now available for interested callers to hear and illustrated technical specifications are now ready.

ARMSTRONG WIRELESS & TELEVISION CO. LTD.

WARTERS ROAD, HOLLOWAY, LONDON, N.7

Phone: NORth 3213

AUTO radiogram, Scott, 16-valve, 6 wave-bands, 8 mixed records, £80; Console cabinet, repolished, overhauled, £80.—Box 754, Harrods Advertising Agency, S.W.1.

D.A.30 push-pull rack-built amplifier, tuner, monitor, gram, mixers and tone control, cost over £100 to build; accept nearest £45.—Hcard at 41, Ashridge Way, Morden. Lib. 5454. [7045

H.M.V. autochange (8 records) 10-valve radiogram, perfect order, £65; Dulciphone amplifier, A.C./D.C. gram. and mike stages, as new, £20.—Marsh, 15, Le May Ave., Grove Park, S.E.12. Roy. 3022. [7070

COILS for W.W. tone control and filter circuits (Brierley and Hartley spec.); high fidelity, mic. line and output transformers; s.a.e. full list.—R. Clark, 30, Langland Crescent, Stanmore, Middx. Wor. 5321. [6971

SPECIALIST in high quality gramophone reproduction; demonstrations, installations and advice on the Lexington, Wilkinson & Wright and Connoisseur, etc., pick-up radio dept.—Wallace Heaton, 127, New Bond St., W.1. [7188

INFINITE Baffle corner deflectors, scientifically designed acoustic chambers as reviewed "Wireless World," June; send for catalogue.—Broadcast & Acoustic Equipment Co., Ltd., Broadcast House, Tombland, Norwich 26970. [6434

VOIGT H.C. horn and base chamber, made by Voigt Patents for owner; also handsome veneer walnut facade to same hand built, suit any decorative scheme; together £27/10.—Fell, Little Galton, Brooklands Rise, London, N.W.11. [7125

PORTABLE recording equipment: M.S.S. recording machine, 20 watt amplifier, new, from stock: Blank discs, cutting needles, trailer needles, microphones, lightweight pick-ups, matching transformers, speakers, etc.; trade enquiries invited.—Sound Discs (Supplies), Ltd., 83a, Bold St., Liverpool. [6964

NEW Scott Phantom ac 16-valve 4-wave-band superhet radiogram, in pale oak cabinet by Arundel Clark, with specially designed wrought iron grille, 12in speaker, output 13.5 watts, Gerrard gramophone and record changer, fully overhauled, a magnificent instrument; £150 for a quick sale.—Box 6708. [7086

RECORDING amplifier, 14 watts output to 15 or 2,000 ohms load, twin recorder change over switch, microphone and P.U. mixing input, independent controls for base treble compensation, modulation meter on front panel, external H.T., L.T. supplies for feeder unit, in carrying case with loudspeaker built into lid, unused; £52.—Chester Sound Recording Studios, Acre Wood, Burton, Wirral.

V.G. recording motor and cutter gear, 16in, 78 and 33½ rpm, 200/250 A.C., £35; Voigt twin cone speaker unit with field exciter unit, 200/250 A.C., £26; Woden 50 watt super amplifier, new, £25; Wharfedale 15in moving coil speaker chassis, 15 ohm, £8/10; Gramplan ribbon mike, 15 ohm, £7; Gramplan moving coil mike, square chrome type 135/10.—Silson, 261a, Town St., Bramley, Leeds. [7097

TECHNIFON, Ltd., manufacturers of direct recording equipment and accessories. Precision built traverse gear complete with first class quality cutting head, £15/15; delivery 3 wks.; s-sided 12in blank discs still available, 3/- each; for all lightweight pick-ups using push in styli, our h.f. type sapphire styli now available, 9/2 inc. P.T.; postage and packing extra.—Technifon, Ltd., 99, Belgrave Rd., London, S.W.1. Vic. 8814.

TELEVOX playing desks, incorporating high quality totally enclosed induction motor (100-240 volts ac), high fidelity magnetic pick-up, 12in. turntable, automatic stop, and start mechanism, speed regulator and pick-up rest, all fitted on a strong 18 swg steel chassis 14½x12¼x3¼in high, finished in black ripple, and mounted on 4 rubber feet; 8½gns., including tax; cash with order; packing and passenger train carriage, 4/6 extra, no c.o.d.—Still available in limited quantities from Televox Sound Service, 37, Albert Rd., Southsea, Hants. Tel. Portsmouth 73348. [7173

CHARLES AMPLIFIERS welcome lovers of recorded music to their new premises where their high fidelity amplifiers can be heard together with Lexington Connoisseur and Rothermel pick-ups and B. and A.E.C. Vitavox, and Wharfedale speakers, B. and A.E.C. acoustic chambers, infinite corner baffle deflectors, etc.; we like you to bring your own familiar records for comparison; this is a service devoted entirely to the high fidelity reproduction of music, one mile from the Albert Hall and Kensington High St. Station; buses 73, 49, stop at the door.—Charles Amplifiers, 1e, Palace Gate, Kensington, London, W.8. [6642



TRANSFORMERS

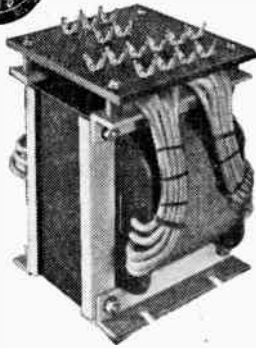

(Patent Applied for)

The AA2 Series of Bryce Transformers have been designed to cover a very wide range of application consistent with high percentage efficiency performance under difficult conditions. All windings are layer wound and interleaved, and coils are finally pre-heated and thoroughly dried out before being vacuum waxed or varnish impregnated.

Send for leaflet giving full specification.

W. ANDREW BRYCE & CO. LTD.
Shenley Road, Boreham Wood, Herts
Telephone: ELStree 1875 & 1117.

R.R. DEVELOPMENT LABORATORIES LTD CONSULTING ENGINEERS

TRANSFORMERS, CHOKES & COILS to your own Specification. Delivery 7 Days.

ALL-WAVE SIGNAL GENERATOR delivery after completion of present orders.

AMPLIFIERS 14-30 watt output. DECKS and CASES to your requirements.

Enquiries Invited.

Telephone: Bfd. 4902.

BARNARD RD • BRADFORD

PORTABLE automatic radio gram, latest American Portomatic 8-valve, short and medium wave, crystal pick-up, changer, plays eight records, operates on ac/dc 100-250 volts, excellent volume and sensitivity, built-in frame aerial, the whole contained in neat leather suitcase, weight only 16lb; 75gns.—Box 7022. [7178

WE have received numerous inquiries for delivery of the Sound Sales polyphonic radiogram fitted with automatic record changer; some customers state that they have been promised seven days for delivery by radio dealers. We wish to make it perfectly clear, without prejudice to all concerned, that although we are preparing a model with automatic record changer, we have not authorised anyone in the trade to give any delivery promise; in fact, the model has not been released. The moment we are in the happy position to announce this addition to our range, all agents, appointed by Sound Sales, Ltd., will be in possession of a demonstration model. [7119

TRANSMITTING EQUIPMENT

R.C.A. ribbon microphone, brand new with built-in transformer & grip switch on desk stand, £9/10; a.c. Elroy high speed code equipment, comprising motorised Xmitter, type RRD900-42 recorder & motorised TP890-742 tape puller and six rolls of tape £30 the three.—Harris, Strouds, Bradford, Berks.

COMPONENTS—SECOND-HAND, SURPLUS VALUE! Matt has it.

SPECIAL offer headphones, w/lead and jack plug, 5/6 per pair (boxed 2 pairs). **SPEAKERS**, P.M. 4in 17/6, 5in 15/6, 8in 22/6, all less transformers; transformers (output) to match, 5/6 ea. **CONDENSERS**, 0.1, 0.01, 9/- doz; 8 mfd (canned) 3/6; 8+8 (canned), 6/6; all 500v working 16 mfd electrolytics (chassis mounting), 7/6.

LINE cord, 0.3 amp (60 ohms per ft), 2-way 1/6 per yd, 3-way 2/6 per yd.

VOLUME controls (Centralab), various values, 1/s 3/6, w/s 4/9; Rothermel crystal pick-ups de luxe, £2/16/3 (inc. P. Tax); metal £2/12/6 (inc. P. Tax); Cosmo-cord-Magnetic P/ups, 33/-, inc. P. Tax; television cable (aerial lead-in), 1/- per yd; a large assortment of B.V.A. and V.S. valves always in stock; let us have your enquiries.

MATT RADIO SERVICE (Kingston 4881), 152, Richmond Rd., Kingston-on-Thames, Surrey. [7168

SOUTHERN RADIO'S Wireless Bargains:—

LATEST Radio Publications: Radio Valve Manual, equivalent and alternative American and British types with all data, 3/6; Radio Circuits, fully illustrated, receivers, power packs, etc., 2/-; Amplifiers, fully descriptive circuits, 2/-; Radio Coil and Transformer Manual, 2/-; Short Wave Handbook, 2/-; Manual of Direct Disc Recording, 2/-; Test Gear Construction Manual, 1/6; Radio Pocket Book formulas, tables, colour code, etc., 1/-; Ten Hows for Radio Constructors, 1/-; Bulgin Radio Service Manual, 2/6; Radio Constructors Manual, 3/-; Radio Resistor Chart colour codes at a flick, 1/-; Radio Reference Handbook, cloth bound, comprehensive and up-to-date; Covering all Branches of Radio, 12/6; American Service Manuals, Sparta-Emerson, Crosley-Belmont (Parts 1 and 2), Stewart-Warner-Pada, 12/6 per volume. Postage extra on all publications.

YAXLEY type rotary switches, 11-way, 5/-; resistances, assorted values, 2 watt to 1/4 watt, 20/- per 100; permanent crystal detectors, 2/6 each; aluminium panels, 16 gauge, 18in x 7in, 3/6; Cutler Harmer rheostats, 30 ohms and 10 ohms, 4/6; ex-Government Morse keys, brand new, 1/6 each (15/- per dozen); ex-Government buzzers, brand new, 1/6 each (15/- per dozen); Westectors, type WX6 and W112, 1/- each (10/- per dozen); Lufbra adjustable hole cutters for use on metal, wood, plastics, etc., 5/- each.

LATEST ex-Government purchase: Miniature communication receiver (M.C.R.I.), A.C.-D.C., complete with power pack phones, aerial, etc., for use on all voltages 20 to 3,000 metres, 5-valves, brand new in original cartons, £10/10, carriage and packing 6/6 extra; all goods advertised are postage extra.

SOUTHERN RADIO SUPPLY Co., 46, Lisle St., London, W.C. Gerrard 6653. [6981

PETER Pan midget mains receiver kit, in sealed carton, unwanted present; £10.—5, Baring Rd., Southbourne, Hants. [7138

EXPERIMENTER'S surplus; many valve types, 3 1/2in C.R. tube, mains tmfrs., meters, W. World 1942-46.—Box 6986. [7163

NEW and used R.X. and T.X. components; £15 the lot, or separate; send for list; Ex Ham.—Palfreman, Newbus Grange, Neasham, Darlington. [7144

RELIANCE POTENTIOMETERS

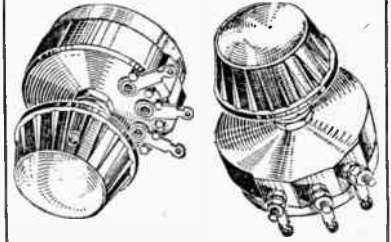

Type T.W.

Type T.T.

Continuous Wire-Wound

Rating: 5 watts (linear)
3 watts (graded)

Ranges: 10-100,000 Ω linear Max.
100-50,000 Ω graded
100-10,000 Ω Non-inductive

Characteristics:

Linear, tapered, graded, log., semi-log., inverse log., non-inductive, etc.

Write for full details to

RELIANCE

Manufacturing Co. (Southwark) Ltd.

Sutherland Road, Higham Hill, Walthamstow, E.17

Telephone: Larkwood 3245

LASKY'S RADIO

THIS MONTH'S SPECIAL OFFERS

MOVING COIL AMMETERS, 2" flush panel mounting, first grade, 0-10 amps. (shunt can be removed). Boxed. New and unused. Price 12/8 each.

EX-AM. PRESS BUTTON CONTROL BOXES, new and unused. Consisting of 5-way press button unit, 4-pole 3-way trans/rec switch indicators and 2-pin plug and socket. Price 8/6 each.

SOLID DIALECTRIC, VARIABLE CONDENSERS, .0005 and .0003 mfd. 2/11 each.

YAXLEY TYPE SWITCHES, 4-pole, 2-way, 2-bank. Price 2/6 each.

YAXLEY TYPE SWITCHES, 2-pole, 5-way midget. Price 2/6 each.

P.M. MOVING COIL SPEAKERS, 3 ohm. voice coil, less transformer. 5", 19/-; 5", 21/- (5" with O/Trans. 27/8 each).

ENERGISED MOVING COIL SPEAKERS: 5", with trans., 1,000 ohms. field, 3 ohm, V.C., 29/8 5", less trans., 1,500 ohms. field, 3 ohm, V.C., 29/8 10", with trans., 5,000 ohms. field, 3 ohm, V.C., 39/8

REAL MIDGET 2-GANG CONDENSERS, .0005 mfd., ceramic insulation and trimmers, dustproof transparent Perspex cover. Size: Length 2" x depth 2" x width 1 1/2", 1" spindle. Price 14/6 each.

MEDIUM AND LONG WAVE T.R.F. COILS, AF and OSC, high gain, with reaction. 8/6 per matched pair, circuit included.

SPECIAL PURCHASE P.T. 15's, as used in ex-R.A.F. T1154 transmitter. Ceramic, 5-pin English base. New and unused. 22/6 each, 42/6 per pair (postage extra).

ELECTROLYTIC CONDENSERS: 8+8 mfd., 5/6; 8 mfd., 4/-; 4 mfd., 2/11. 500 volts working, T.O.C. Pico-Pack, 30 mfd, 12 v.w., 2/6; 10 mfd, 25 v.w., 2/6; Tubular bias, 50 mfd, 12 v.w., 2/-; 25 mfd, 25 v.w., 1/9; 250 mfd, 12 v.w., 2/6. Tubular cardboard, 8 mfd, 150 v.w., 1/11; 16 mfd, 250 v.w., 3/6; 16 mfd, 450 v.w., 4/9; 8 mfd, 450 v.w., 4/-

8,000 RADIO VALVES OF ALL TYPES, AT OFFICIAL LIST PRICES.

We have space for only a few items from our extensive stocks. Send 1d. for our current list and bulletin.

Terms, Pro Forma, C.O.D., or cash with order (no C.O.D. under £1). Orders over £5 post free. All goods covered by our unconditional guarantee. It will pay you to pay us a visit!

LASKY'S RADIO

370, Harrow Road, Paddington, W.9

(Opp. Paddington Hospital.)

Telephone: Cuningham 1979

MICROPHONE transformers; 3,000 at 6d ea.
TELEPHONE key switches, 2-pole; 3,000 at 2/6 ea.
CONDENSERS, 4mfd 400v dc; 3,000 at 1/- ea.
CONDENSERS, 2mfd 400v dc; 3,000 at 6d ea.
CONDENSERS, .002mfd; 3,000 at 3d ea.
TELEPHONE key switches, 2-pole; 3,000 at 2/- ea.
TELEPHONE key switches, 4-pole; 3,000 at 3/6 ea.
RESISTORS, 2,000ohms R.M.A. 9; 3,000 at 1d ea.
HUZZERS, tuneable T Mk 1; 3,000 at 6d ea.
CHOKES, R.F. 650µH; 6,000 at 2d ea.
TERMINALS, high quality brass; 9,000 at 1d ea.
MORSE key (W.T. 8amp No. 2); 3,000 at 6d ea.
JACKS, 4-way; 3,000 at 6d ea.
JACKS, 2-way; 3,000 at 4d ea.
JACKS, 1-way; 3,000 at 3d ea.
BATTERY boxes, complete with battery leads; 3,000 at 2d ea.
METAL boxes, heavy gauge, with hinged lid, 8½in×5½in×5½in high; 3,000 at 6d.
 The above high grade components are being dismantled from new unused ex-Government radio equipment; the prices quoted are for quantities of 100 or over, carriage extra.
 H.S.E., 587-9, Bearwood Rd., Smethwick, Staffs. [7150]

CIRCUITS and coil packs (and other components).
LORSTET superhets, 3-wave 5v a.c. or a.c.-d.c., 4v all dry battery, manuscripts 5/- each; the best and most comprehensive set of drawings and instructions on the market; genuine 6/- worth of information; theoretical sheet only of any above circuits and price list 2/6d each. **COIL** packs—3-wave, set tested, guaranteed, available in any 3 ranges of P type coils, 37/6 each, with circuit; please state if a.c., a.c.-d.c. or battery and bands required; (standard 19-49m, 200-550m, 1,000-2,000m).—Write Weldon Radio Accessories, Ltd., Swanage. [7090]

SCOTLAND'S largest stockists.—Anything radio we have it.
EDDYSTONE—agents—Raymart.
 SEND for parts and kits list.
BUCCLEUCH RADIO MANUFACTURERS, Melville Terr., Edinburgh. Tel. Edinburgh 42803. Grams, Therm, Edin. [5139]

G. W. SMITH & Co. (RADIO), Ltd., offers the following:—
WESTON 0.4in 0.250 micro amp meters, 57/6; detector relays, 4-bank 25 contact 37.5 ohm; 22/6; I.F. coils, 100 kc/s, ironed cored, 5/6 each; wire wound resistors, 1watt, 100, 5,000, 7,000, 35,000 ohms, 6d each; wire wound, 5watt, 100, 150, 200, 250, 400, 500, 600, 50 ohms, 1/6 each; transformers, 230 input 350-0-350 90ma, 5v 2a, 6.3v 4amp, 3 times, 35/- each; 200-250 input, 540v, 4v, 6.3v, 22/6 each; 7/22 heavy duty hard twin rubber cable, 60/- per 100 yds.; Tannoy hand microphone, multi coil service type with switch in phone, 7/6 each; 8il mica can, 500, 440, 100, 80, 50, 40, 25, 15 p.f., 4d each, 3/- per doz.; chassis, 10½×6×3, 2/- each; 2mfd 250v, 1/6, 2mfd 400v 1/9; 0.1 1,000v, 0.25 2,500v 3/6 each; 0.25 3,000v, 0.1 3,000v 4/- each; 0.25 8,000 volt, 7/6; 0.1 10,000v 0.02 10,000 10/- each; sleeving 1mm, 2d per yd.; Westinghouse meter rectifiers, 5ma, 7/6 each; air spaced I.F. trimming condensers, 2/- each; screening cans, 3×2½×2½, 1/3 each; short reach jack plugs, 1/6 each; single headphones, low resistance, 3/- each; 1-1 interval transformers, very useful for condense plus postage, 2/- 250 mixed sizes plus postage.
G. W. SMITH & Co. (RADIO), Ltd., 2, Cecil Rd., Southgate, London, N.14. Enterprise 5463. [7038]

UNIVERSAL ELECTRONIC PRODUCTS (G8UQ), 36, Marylebone High St., London, W.1. Tel. Wel. 4058.
TUNING units, three waveband, complete with I.F. transformers and calibrated dial, completely aligned and tested, the heart of a first-class superhet, all ready for connecting to 6Q7 second detector and amplifier, less valves (requires 6K8 and 6K7); £5/5, postage 2/6.
 R1155: We will convert your receiver into a really efficient communications type receiver; s.a.e. for details.
OUR works are available for the construction of radio and electronic equipment to specification from an extension spindle to a complete 500-watt transmitter. [7155]

COVERED copper flexes, Litz wires, motor car ignition and lighting wires and cables, and domestic and industrial cables; large quantities available.—Box T. 538, Lee & Nightingale, Liverpool. [6926]

BERRY'S
 (SHORT WAVE) LTD
Round the World
 with the
"Q-Max"
All Dry Four

A flick of the knob brings you station after station on the Short Wavebands—full of excitement, interest, pleasure and education. Hairbreadth tuning—simplified controls. The inclusion of all dry valves does away with messy accumulators.



FEATURES
 Wavrange: 11-250 metres. Plug-in coils, 100/1 Slow motion dial operates precisely adjusted ceramic variable condensers. Speaker Jack. Jack for ear-phones. Black crackle finished metal cabinet.

VALVE CIRCUIT
 IN5 RF Amplifier; IC5 Detector; IH5 LF Amplifier; IC5 Output.
 Price: 12 guineas.
 (Speaker, Battery and Coils extra.)
 Purchase Tax £2.17.5.

JUST OUT!
 The "Q-MAX" VHF CONVERTOR embodying circuit refinements not found in any other make plus advantages of—
MONO-UNIT COILS
 Full Vision Calibrated Scale; One knob tuning and Extra Top Band Coil Range. Price (with 30 Mc/s or 56 Mc/s Coil Unit) 19 Guineas.
 (Extra Coil Units 30/- each.)

OTHER "Q-MAX" PRODUCTS
 Chassis cutters—1¼" (Octal) 10/6, 1½" and 1¾" 12/6 (Post 9d. extra). Complete Slow Motion assemblies—8—1 15/6; 50—1 £3.6. "R" meters for AR88's 59/6. Tank Coils Units, for powers up to 50 watts £2.15.0. Up to 150 watts £4.14.6. Obtainable from your local "Q-Max" dealer or direct from:—

BERRY'S (SHORTWAVE) LTD.
 25, HIGH HOLBORN, LONDON, W.C.1
 (Opposite Chancery Lane) Tel.: HOL 6231
 ILLUSTRATED CATALOGUE
 "W.W." 6d. Post Free

CHARLES BRITAIN RADIO.—A few selected lines from our latest list.
TRF coils, with reaction, medium, long wave, with diagram, 8/6 pr; superhet coils, all-wave, Ae. and Osc, with diagram, 10/6 pr; i.f. transformers, 465 kc. 12/6 pr; 2-gang condensers, 0.0005, less feet and trims, 9/- ea.
SPECIAL offers.—Movin' coil mikes, undamaged, with metal grille, 5/- ea. damaged 1/6 ea; parcel of 36 assorted tubular condensers from 0.0001 to 0.5 mfd, all new, 10/6; parcel of 72 new assorted resistors, 1, ½ and ¼-watt, from 100 ohms to 1 meg, 12/6; special parcel of new and used goods, exceptional value, £1; money refunded if not satisfied.
SPECIAL purchase of brand new ex-Government miniature radio receivers, covering 4 wavebands 20 metres to 3,000 metres, for ac/dc or dry battery operation, supplied complete with ear phones, power pack, instructions and all accessories, £27/19/6; these receivers were used by the Resistance Movement; limited number only available. Please order c.o.d.
NUMEROUS other lines in stock, including amplifiers, pick-ups, etc.; callers always welcome; trade supplied; terms, cash with order or c.o.d. over £1; send for latest list "W".
 Charles Britain (Radio), Ltd., Radio House, 2, Wilson St., London, E.C.2. Tel. Bis. 2966.

SELENIUM metal rectifiers, guaranteed charger kits, h.t. rectifiers, no surplus goods.
SELENIUM metal rectifiers, damp-proof finish, best make, new and with full manufacturers' guarantee, interesting and informative instruction sheet with each rectifier; 12v 1.5amp, 10/-, post 6d; 12v 2amp, 15/-, post 7d; 12v 3amp, 21/-; 12v 4amp, 27/6, post 9d; 12v 5amp, 32/-; 12v 8amp, 40/-; 24v 5amp, 42/-; 40v 5amp, 65/-; all bridge type; new small space selenium h.t. rectifiers, eliminator type, 120v 20ma, 7/3, post 4d; 250v 60ma type, for a.c./d.c. receivers, speaker field supply, etc., 9/6, post 6d.
INSTRUMENT rectifiers, M.E.S. 1 milliampl, also 5ma for Avo or Avometer, 12/6, post 3d.
METAL rectifiers in stock for converting valve type chargers to metal rectification, all types; charger kits, large 12v 3amp rectifier with 50watt transformer and ballast bulk for 2v to 12v charger, weight 7lb, no rheostat and ammeter needed, 48/6, post 1/-; ditto with 4amp rectifier and 75watt transformer, 61/-, post 1/-; ditto with 2amp rectifier, 39/6, post 10d.; with 1.5amp, 36/-; metal rectifier, 12v 5amp type, with transformer, 150watt, weigh 12lb, for 6v, 12v charger, £4/5; for small radio store, 150watt transformer, metal rectifier, ballast bulb for 1 to 20 cells in series at 1amp, guaranteed one year, £4/19/6, post 1/6; also 1 to 20 cells at 2amps, 2 circuit type, as above, £6/15, guaranteed one year; metal rectifier, 2v 0.5amp type with transformer, makes ideal trickle charger for 2v cell, guaranteed one year, 13/6, post 7d.; fluorescent lighting chokes, 80watt, boxed and impregnated, 230v, 19/6; tapped, 21/6, post 1/-.
ELIMINATOR kit.—Transformer, selenium h.t. rectifier, 120v 20ma, 2v 0.5 amp trickle charge rectifier, and two 8mfd condensers for 120v h.t. eliminator and trickle charger; 39/6, postage 10d.
CHAMPION, 43, Uplands Way, London, N.21. Tel. Lab. 4457.

QUANTITY Belling-Lee 3-pin plugs and sockets, also quantity radio 2-pin; offers.—Box 6937. [7145]

U.S.A. Government surplus.—Lightweight headphones (10ohms), total weight 5½oz, 19/6 pair, post free; adjustable microphones, with stand and switch, 8/6, post free.

GOVERNMENT surplus.—P/O type carbon microphones, 2/6, post free; headphone with band, 2/6, post free (low resistance); ex-R.A.F. throat microphones, 5/11, post free; rev. counters (0 to 1,000), 1/-, post free; new 4-way flexible telephone leads, tagged ends, 2yds long, 5/- per doz; new 2ft twin leads, tagged ends, 1/- doz, postage 4d.
ADMIRALTY surplus.—New nickel-plated telescopic microphone stands, standard pattern, 47 only to clear, usual price 3gns, our price 29/6 each, plus 1/6 post.

HAY & SON, 129, North St., Brighton. [6920]

CHASSIS and panels in aluminium, from 3/9 each; prompt delivery; any size, plain or punched for valveholders, etc.—Mead, 13, Bence Lane, Darton, Barnsley. [7065]
2,000 push-button switches, 5-way, multi contact oak type, all brand new, in manufacturer's packing; £200 the lot.—H.S.E., 587-9, Bearwood Rd., Smethwick. [7126]

ALUMINIUM chassis, panels, cabinets; metalwork for the amateur by precision engineers; trade enquiries invited; s.a.s. lista.—G.L.G. Radio, Morechard Bishop, Crediton.

Connections housed at end of handle - away from the heat!

There's no corrosion of the connections in the Solon Electric Soldering Iron. Tucked neatly away at the end of the handle, the heat can't get at them. Efficient rubber sleeve cord grip prevents sharp bending of the flexible. The heating element is INSIDE the copper bit—giving constant heat; no waste of current! Features that make Solon soldering quicker, cleaner, safer! All Solon irons are supplied with Gt. of Henley 3-core flexibles. Made for the following standard voltages—200/220, 230/250.

Made in England.

Illustration shows standard 240 watt model. Other types and sizes for various specialised jobs.

SOLON
Soldering Iron for Industrial Use

W. T. HENLEY'S TELEGRAPH WORKS CO. LTD.
Engineering Dept., 51-53, Hatton Garden, London, E.C.1

HENRY'S RADIO

A further selection from our comprehensive stock.

MIDGET TWO GANG. .000; 6, 2in. x 2in. x 1 1/2in. with trimmers. Vanes enclosed in Perspex. 14/6.

Midget I.F. Unit. In Aluminium can 4 1/2in. x 2 1/2in. x 1 1/2in. Comp. 465 K/C's midget I.F.T. 174 valve, 8 midget resistors and condensers. 15/-. New and Unused. Aluminium. 9 1/2in. x 7 1/2in., 20 gauge, ideal for midget chassis. 1/3 sheet.

T.C.C. Pico-packs. 20 mfd., 12 v.w. 10 mfd., 25 v.w. 2/6 each. (Midget).

Midget Chokes. 40 mfa., 360 ohms, 5/- each.

Midget O/P Trans. 40 mfa., 42-1.5/- each.

P.M. Speakers. Lens trans., 2 1/2in. at 27/-, 3 1/2in. at 30/-, 5in. at 19/- each, 9 1/2in. and 8in., 21/-, Trans. available. With trans., 6 1/2in. and 8in., 27/6. All leading makes.

Mains Energised Speakers. 5in. with trans., Plassey. 3.0 ohms. Rola, 1,000 ohms., 30/- each.

"Regal" Tuning Heart. High selectivity. 4-wave band. Comprising 8 precision wound coils, 465 K/C's. Attractive dial, and epicyclic tuning drive. Two gang .0003 Condenser. Wave change switch with "Gram" position. Completely wired with ceramic trimmers. With circuit. 13in x 3 1/2in. 31in x 70m, 200m-600m, 800m-2000m., 7/6 complete. Drilled chassis available. 7/6. Whistle Filter, 3/-.

M. & L. Wave Coils. With reaction, and circuit 8/8 pr. M. & S. Wave coils, Superhet with circuit, 9/6 pr.

Line Cord. .3, 60 ohms per ft., 3 way, 3/- yard. 2,100 ohms per ft., 2 way, 2/6 yard.

Chassis. T.R.F. Completely drilled, aluminium. Midget or standard, 4/6. Midget Superhet, 5/6. Weymouth, 6/6.

Car Radio Transformers, 6v. 15/-

Vibrators, 6v. and 12v. 4 pin, 9/6 each.

Plug Suppressors, 1/6 each.

Cash with Order, or C.O.D. over £1.

Send stamp for list.

Wholesale and retail.

5 HARROW ROAD, W.2
PADdington 1008/9.

SUPREME RADIO, 746b. Romford Rd., Manor Park, London, E.12. Est. 15 years. Tel. Ht. 1260. Always something you want; watch our adverts.

2-GANG condensers, long spindle, fixing feet, 9/6; Westectors, 1/6 each; d.p. toggle switches, 24/- doz; ex-R.A.F. morse tappers, 7/6; test meters, ex-Govt., calibrated 5,000Ω to 0Ω, m.a. range 0 to 6, 0 to 1.5v and 0 to 3v, moving coil, internal resistance, 250Ω, size 2 1/2in, flush mounting non-splint glass, £1 each; midget 15mfd can condensers, 250v peak working, 4/- each; 4mfd 500v working, can be used for fluorescent lighting, 4/6 each; .05mfd 500v working, 4/6 doz; .1 350v, 4/6 doz; .5 350v, 11/- doz; 25 350v, 9/- doz; 2 250v, 2/6 doz; .01 500v, 4/6 doz; resistances, well-known maker, 1/2w, 1,000Ω, 10,000Ω, 20,000Ω, 22,000Ω, 27,000Ω, 51,000Ω, 100,000Ω, 220,000Ω, 270,000Ω, 560,000Ω. 1meg, 1 1/2meg and 2meg, 3/- doz; 5watt 10,000Ω, 5/6 doz; 1watt 27,000Ω and 75,000Ω, 4/- doz; assorted wirewound resistance, 1 and 2watt, handy sizes, 2/6 doz; line droppers, .2 or .3 with feet, 4/-; line cord, 60Ω-70Ω ft, 20/- doz yards; volume controls with switch, 4/-; wirewound 10,000 less switch, 5/-; job line 2,000Ω, 2/6; all-wave ivorine dial, 3 1/2in x 4 1/2in, 1/6; 5 1/2in x 6in, 2/-; midget chokes, 60ma, 6/-; heavy duty 150ma, 10/-; midget speaker transformers, 4/6; sleeving, assorted colours, 3/- doz yds; screen caps, 8/- doz; U.S.A. uctal valve holders, 4/6 doz; job line midget volume controls, 10,000Ω, 9/- doz; Philips' knobs, 1in shank, 2/6 doz; 4 and 6BA nuts and bolts, 4/6 gross.

CASH with order; no c.o.d.; send 6d extra for post and packing all orders under £5; s.a.e. all enquiries and price list. [7194]

SILVER plating sets for tuning conds., wire coil holders, valveholders, small parts; 3d. stamp for illustrated folder; materials, 10/-—Argenta (E), 40, Harrogate Rd., E.9.

QUANTITY of surplus high qual. p.a. equipment, amplifiers, spkrs., microphones, by Partridge, Sound Sales, acoustics.—A. T. Moyie, Ltd., Buxted, Sussex. Tel. Buxted 232.

I.F. rejectors, small, neat; stops break-through of i.f. transmissions, mounted in pairs makes efficient i.f. transformer, 450-470 kc/s; 4/- each.—Douglas Electronic Industries, Ltd., Brinklow, Rugby. [7120]

MIDGET radio kits, 4v ac/dc m. and 1. wave complete with valves 6K7, 6J7, 25A6, 25Z6, 5in speaker and all components, £6, in lots of 2 for £23, cabinets extra; postage and packing 2/6, refundable.—Cook, Old Barn Rd., Christchurch. [7064]

CONDENSERS.—Large stock of tropicalised paper block and paper tubular condensers, T.C.C. and Sprague manufacture, all new and unused, majority in manufacturer's packing; send for list.—H.S.E., 587-9, Beardwood Rd., Smethwick, Staffs. [7112]

MIDGET adjustable iron-cored coils, aer. and osc., s., m. or l. wave, 7/6 pr; dual-wave coils, m., l. wave aer. and h.f., 9/6 pr; i.f. transformers, 465 kc/s, size 1in dia. x 1 1/2in high, 9/6 ea.—Monochord Radio, 235, Strathearn Rd., London, B.W.16. [6991]

ELECTRAD offer: Paper condensers, 10mfd 1,500v test, 5/-; 4mfd 1,500v test, 4/6; 2mfd 1,500v working, 5/-; metal con., 1mfd 250v wkg., 0.5 350v wkg., 0.1 350v wkg., 4d each; silver mica 5 to 5,000pf, 5 1/2d. each; ceramic conds., most values, 6d. each.

RESISTORS, 1watt 6d., 1/2watt 3d., 1/4watt 1 1/2d. each, most values available; 400hm W.W. 5watt with adjustable clip, 1/-; 110ohm W.W., wire ends, 9d.; red panel lights, 1/-.

VALVE holders, Amphenol Octal, 9d.; ceramic Octal, 1/3; Local EF50, 1/3; UX 4-pin pax, 3d.; 60volt SBC neons, 1/-; Pie wound h.t. chokes, TX 4/-, RX 2/-; valves, all types, at list prices; a few 210, 8. 6/- each.

WESTECTORS, metal, rectifiers, main transformers up to 1,500v, bakelite sheet and strip, steel and alum. panels and chassis, tagged group boards, metal cabinets, and many more items in stock; send us your enquiries.

TERMS: Cash with order (please include postage), c.o.d. over £1 postage paid; special prices for large quantities.—Electrad, Old Ridge Works, Crow Lane, Coventry. [7024]

I.F. transformer replacement bobbins (uses original can and trimmers), 6/- each; r.f. chokes, superhet type, 2/-; sectionalised all-wave, 3/-; type X coils, 1 1/2in x 1/2in dia., all ranges, 3/-; 3-band coil assemblies, 6/9 each.—Electronic Services, Arwenack St., Falmouth. [7116]

LONG and medium Midget superhet, coils mounted with trimmers, padders and switch, etc., boxed with full circuit diagram and instructions; quote Type M1, 22/6; manufacturers' and dealers' enquiries invited.—Douglas Electronic Industries, Ltd., Brinklow, Rugby. [6663]

Specialists in

HIGH POWER - HIGH QUALITY

PUBLIC ADDRESS SYSTEMS

★

AMPLIFIERS

from 150 W to 1kW

W. Bryan Savage Ltd
WESTMORELAND ROAD, LONDON, N.W.9
Telephone: Colindale 7131

RADIO CORNER

(Proprietor, T. E. WILLIAMS)

138 GRAY'S INN RD., LONDON, W.C.1
Terminus 7937

MAIL ORDER. Delivery by return. **THE BANNER CHARGER.** Type 1/1, 1 amp, ideal for Motorists, a really first-class job. Input 240 v A.C. Output 2, 6 or 12 v D.C., at £3. Designed for the motorist who likes to keep his batteries in tip-top condition.

RADIO VALVE MANUAL, giving American and British Valve Equivalents and Data. Price 3/6

Radio Constructors Manual. Price 3/-.

Radio Tuner Unit Manual. Price 2/6.

Engineers and Electricians Handbook. Price 1/-

Cathode Ray Oscilloscope Manual. Price 2/-.

Radio Reference Book. Price 12/6.

American Radio Valves. Types as under at controlled prices. 45Z5GT, 5Y3G, 1A5GT, 1C5GT, 1T5GT, 80G, 35Z5, at 11/- each. 6J5GT, 12J5GT, 1H5GT, 12S5GT, at 9/2 each. 6Q7GT, 12Q7GT, 12SQ7GT, at 11/7 each. 12SK7GT, 6K7GT, 6K6GT, 6V6GT, 42G, 43G, at 12/10 each. 6A8GT, 6K8GT, at 14/- each. Postage paid. Other types as they become available for distribution.

AMERICAN RADIO SERVICE MANUALS

Volume I. Spartan Emerson.

II. Crosley Belmont. Part I.

III. Crosley Belmont. Part II.

V. Emerson, Part II.

VI. Stewart Warren FADA.

At 12/6 per Volume, or complete set of six manuals £3 12s. 6d. These Manuals cover the complete range of American Radio Receivers as given and are invaluable and contain all the technical data necessary.

Terms. Cash with Order only. We regret that we are unable to send goods C.O.D. [6663]

SURPLUS.—Jones plugs, knobs, fixed condensers, trimmers, impulse valves and others, co-axial cable, flex, sleeving, nuts, bolts, studding, potentiometers, relays, valve butterfly condensers, relays, spring washers, useful small brass parts, numerous other lines; stamp for list.—Jones, 1, Burlington Rd., Chiswick, W.4. [7013

OSMOR Radio Heart equals complete first class 5-valve superhet, positively only small condensers and resistances to find, super efficient components, building instructions; £5/16; cabinets; trade invited.—Morgan Osborne, Ltd., Southview Rd., Upper Warlingham 2560, Surrey. [6226

SLEEPING.—A large quantity of new sleeving for disposal—silk and cotton covered P.V.C., varnished cotton, Idaglass, synthetic rubber, etc., in coils of 144yds and 1yd lengths, 1mm to 10mm diameter.—John Walton & Co. (Castleside), Ltd., Metalex Works, Gt. Cambridge Rd., Enfield. [6916

SANGAMO Synchronous Motors, self-starting, exceptionally good torque, rotor speed 200 r.p.m.; 200-250v A.C. 50c consumption 2½ watts, size 2¼x2, geared 1 rev 60 min, can be reset to zero by friction drive from front or back shaft ½inx1/10 to run clockwise, ideal movements for making electric clocks, time switches, etc., nickel-plated finish; price 22/6 each; 12-to-1 dial trains to fit above spindle, per set 2/6.

CHAMBERLAIN & Hookham synchronous motors (enclosed type), self-starting, exceptionally good torque, rotor speed 200 r.p.m., 200-250v A.C., 50c, consumption 3 watts, size 2¼x2, geared 1 rev 60 min, can be reset to zero by friction drive from front of back shaft, ½inx1/10, to run clockwise, ideal movements for making electric clocks, time-switches, etc., nickel-plated finish, price 25/- each; 12-to-1 dial trains to fit above spindle, per set 2/6.

MOVING coil headphones, P.M., energised by Alni magnets, 45 ohms, ¼in coil, ideal for mikes, miniature loudspeakers, etc., 1½in overall, in bakelite cases, with 3in front flange; 6/6 each.

MOVING coil microphones, fitted as hand mic with switch in handle, 45 ohms speech coil, 10/- each; throat microphones, fitted with elastic bands, 'phone, plug 15 ohms speech coils, etc., 7/6 each; respirator carbon microphones, fitted, 'phone plug, lead, etc.; 5/6 each.

15 AMP mercury switches, enclosed bakelite tubular cases, 2¼inx½in, fitted swivel saddle, connector block, etc.; 5/6 each. WIREWOUND non-inductive resistances, 2-watt, ideal for meter shunts, resistance boxes, etc., 2½% accuracy, wound on bakelite bobbins, ½inx¼in, one of each of the following ratings: 25, 50, 100, 200, 400, 600, 1,000 and 2,000 ohms; 5/6 per lot, postage paid; quantities available.

REMOTE contactor units, 6-24 volts D.C., fitted with relay and gears, etc.; 10/- each. ELECTRO magnets, 200-250 volts, A.C. resistance, 320 ohms, 1¼inx1¼in; 3/6 each.

6-VOLT vibrator units, complete with vibrator, smoothed output 150-volt, 30 ma D.C., ideal for car radios; 25/- each.

PRE-SET lamp-holders, suitable up to 500 watts, sturdy construction; 3/- each.

MANGIN mirrors, 2½in, hole in centre ¾in dia; 3/6 each. Relays, 110-volt, 1,600-ohm coils, makes ideal 200-250v A.C. mains buzzers; 3/6 each.

DIMMERS, 220-volt, 2,700-ohm 27 amps, stud control, in brass cases 7x7x4, 30/- each.

CASH with order, post paid on all above goods. To callers only; a comprehensive stock of scientific instruments, meters, gears, relays, etc.

H. FRANKS, Scientific Stores, 58, New Oxford St., London W.C.1. Tel. Museum 9594.

CAN type electrolytics (dry), 16x8, 450volts, 6/-; 16x8x4x4, 500volt, 6/6; 3-wave coil packs, 35/-; 3-wave superhet coils, with circuit, 10/- per pair; 2-wave T.R.F. coils with reaction, 9/- per pair; Summersby i.f. transformers, 15/- per pair; Summersby medium-wave T.R.F. coils, midget size, distance former, adjustable iron core, Q of 200, limited number only (surplus from export), 7/6 per pair.—Castle Radio, 101, Peverest Rd., Orpington, Kent. [7094

EX.R.A.F. "Identification Friend or Foe" receiving and transmitting units with 4 straight mains H.F. pentodes, Mazda, one Mullard E.F.50, 3 television diodes and 2 double-triode mains valves by Brimar; also 20 watts motor generator, 24 volt input, 480 volt 40 m.a. output, 50/- each, plus carriage 4/-; includes a wealth of small components such as carbon and w.w. resistors, tubular and mica condensers, all good values, plus coils and condensers, magnetic relays and mechanical relays.—W. Harford, 128, Greengate, Salford, 3. [7060



THE "FLUXITE QUINS" AT WORK

"Stop bawling for FLUXITE you hound!"
Yelled Old, "It's down there on the ground.
Fixing aerials here,
Is a headache—that's clear—
While this thing keeps on going round!"

See that FLUXITE is always by you—in the house—garage—workshop — wherever speedy soldering is needed. Used for over 30 years in Government works and by leading engineers and manufacturers. Of all Ironmongers—in tins, 10d., 1/6 & 3/-.

Ask to see the FLUXITE POCKET BLOW LAMP, price 2/6.

TO CYCLISTS! Your wheels will NOT keep round and true unless the spokes are tied with fine wire at the crossings AND SOLDERED. This makes a much stronger wheel. It's simple—with FLUXITE—but IMPORTANT.

The FLUXITE GUN puts FLUXITE where you want it by a simple pressure. Price 1/6, or filled. 2/6.



ALL MECHANICS WILL HAVE
FLUXITE
IT SIMPLIFIES ALL SOLDERING

Write for Book on the ART OF "SOFT" SOLDERING and for Leaflets on CASE-HARDENING STEEL and TEMPERING TOOLS with FLUXITE. Price 1d. each.

FLUXITE LTD.
(Dept. W.W.), Bermondsey Street, S.E.1

G. A. RYALL, 65, Nightingale Lane, London, S.W.12.—Mail order only. It is particularly requested that orders are not less than 5/- in value, and that customers should note that the minimum charge for parcels by post is eightpence. No c.o.d. under £1 please. Special wholesale list now ready for the trade only. Please note, postage extra on all orders, minimum 8d. U.S.A. make tubular screened 0.1mf 500v condensers, perfect insulation, per dozen 6/6; mica 0.01, best make, 3/2/6.

RESISTANCES, assorted 1watt, ½watt, ¼watt, all useful standard sizes from 82ohms to 2meg; our assortment only, 40 for 5/-; also special offers 1,800 wire wound, 1/- dozen; 2,000ohm non-insulated, 1/- dozen; 33,000 3watt, 3/- dozen; vitreous 20watt, 2/- each; also 2watt 150,000, 220,000, 36,000, 470,000, 820,000, all 3/- dozen; panels with screened 0.1mf and 12 ½watt resistances, 2/3 each; twin trimmers, 30mm, separate connections, 3 2/- (6); octal plugs with metal caps and chassis type sockets, 3 2/6; with solder tags, 3 3/-; valve holders, U.S.A. 4-5-6-pin chassis types, first class make, to clear at special price of 3/- dozen; Mansbridge 4mf 250v, will work O.K. on 350v, made for A.M., 1/6 each; volume controls, less switches, short spindles, ½meg metal cased, ½meg bakelite, 1mcg bakelite, all 1/6 each; bakelite 3000hm pre-set, 1/6; Yaxley type short spindle switches, 9-way, 2/6; special type 3-bank, 4-way, with middle screen, 2-pole, 3/9 postage 8d. on singles; double type mike and phone transformers secondaries, 175, 45, 100hms, 5/-, postage 9d; power microphones, work direct into speaker, unissued stores, 20/- each; Yaxley switches, some require alteration, single and double bank, 12/- dozen to clear. [6980

KITS of radio receivers from £7/8; 4- and 5-valve, new materials, table models, semi-midget; our latest kit—Wylwyn Star 1947 has connections for gramophone pick-up, extensions to loudspeaker A.V.C., 6 hours average time for constructing; full details, diagrams with each kit; c.w.o. or c.o.d.—Isherwoods, Remo House, 81, Plungington Rd., Preston. Tel. 3348. Estd. 1936. [6788

ROTARY transformers, brand new, ex-Govt. R stock, with 6v input, output 200v at 50ma continuous, or 150v at 80ma up to three hours, with 12v input, output 480v at 40ma continuous or 400v at 80ma up to three hours, size, length 7½in, height 3½in, weight 6½lb, ideal for car radios, mobile amplifiers, etc., original price £7/7, each 25/-; midget m. wave, t.r.f. coils, high gain, 5/-; m.l. wave, with reaction, circuit, 7/6; m.l. wave, iron cored, adjustable cores, circuit, 10/6; s.m.l. aer. and osc. coil, circuit, 10/6; Weymouth midget i.f.s. iron core, 465 kc/s, per pr. 18/9; standard i.f.s. 465 kc/s, per pr. 15/-; Weymouth all-wave coil pack 36/6; 2-gang condensers, 0.0005mf, 12/6; Tiny Tim ditto, fitted trimmers and perspex dust cover, 2½inx1½inx1½in, 17/6; speakers, minus tran., p.m., 5in, 21/-; ditto p.m., 6in, 27/-; speaker fabric, heavy quality, 8in squares, 1/-; volume controls with switch, long spindle, 10,000 ohms, 25,000 ohms, ¼, ½, 1 meg, 6/-; wire-wounds, P.C.O., 2,000 ohms and 50,000 ohms, 4/-; Paxolin valveholders, English-America, all types, 9d each, 8/- doz; screened valve top caps, English and octal, 9d each; moulded octal holders, 1/-; coloured ivoryine dials, s.m.l. wave, 4x3½in, 2/-; 5x5½in, 2/6; 6x5½in m.l. wave, 1/6; slow motion drum drive, 3/-; epicyclic drives, 3/3; Rothermel Senior piezo crystal pick-ups, 56/3; car aerials, roof mounting, chromed, screened lead-in, 30/-; midget cabinets, cream and green, 13inx7½inx6in, 40/-.

HUNTS capacitance and resistance analyzer, type ERB, £18/18; electrolytics, tubular, 2mf 150v, 2/6; 25mf 25v, 2/6; block, 2mf plus 24mf, 9/6; 8 plus 8mf 500v, 7/6; fixed condensers, tubular, 0.01, 0.02, 0.05, 0.1mf, 9d each, 8/- doz; 0.05mf 350v, 1/-; miniature rotary switches, d.p.d.t., 3/-; 2-pole 6-way, 3/6; 4-pole 3-way, 4/-; chokes, midget 50ma, 5/6; standard, 80ma, 8/6; heavy 150ma, 12/6; Simplex chassis, 11x4½x2½in, 6/-; W5V chassis for coil packs, 11½x5½x2½in, 7/-; all-chassis with 6in speaker cut-out and fully drilled all component holes; line cord, 3-way, 0.3 amp, yd. 3/-; 2-way 0.3 amp, 2/- yd; nuts, screws, 6BA or 4BA, per gross (gross nuts, gross bolts), 6/-; heavy duty output P.P. trans., 6,600 A, to A load, tapped output, 7.5 and 15 ohms, each 21/-; all Bernard's radio publications in stock; monthly comprehensive lists, well worth having, 2½d stamp; postage all orders.

O. GREENLICK, Ltd., 34, Bancroft Rd., Cambridge Heath Rd., London, E.1. Tel. Stepney Green 1334. [7021

G.L. TRANSFORMERS

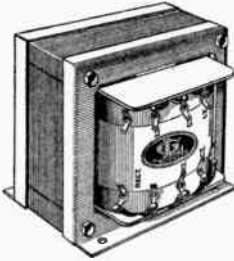

An entirely revised range of 50 power and audio transformers. Pressed steel clamps ensure silent operation. Solder tag or labelled leadouts. Surface or subchassis, skeleton or potted types. Mains and outputs. Our standard style as illustrated, 350-0-350 v., 100 ma. 5 v. and 6.3 v. L.T. Write for new catalogue.

Summary of audio amplifiers. Ready-built.

- | | |
|--|---------|
| 1. A.C./Gram. 3 valve, 10 watts, with two inputs for radio or gram. Fader controls | 7 gns. |
| 2. A.C./18 12 w. P.P. Concert Gramo. amp. | 11 gns. |
| 3. A.C./18 H.G., as above plus mic. stage | £13 5 0 |
| 4. A.C./24 General P.A. work 20 w. P.P. | £16 5 0 |

Also 50 watt types, combined speaker models, etc. Sixpence brings you our latest catalogue, also subsequent literature for three months.

General Lamination Products

LTD.,
WINDER HOUSE, BEXLEYHEATH,
KENT.
(Bexleyheath 3021)

REWINDS

Send your "Burn outs" to be Rewound — no technical data wanted. Post Transformer, etc., labelled with your name and address marked "for Rewind."

**OUR WINDINGS ARE
LAYER WOUND & IMPREGNATED
SOUTHERN TRADE SERVICES, LTD.
297/299, HIGH ST., CROYDON
Tel.: 4870
Manufacturers of "TELECRAFT" PRODUCTS**

LONDEX for RELAYS

AERIAL CHANGE-OVER RELAY

for Radio Frequency
Type AECO 4.

3 V.A. Coil Consumption, especially designed for Transmitters, High Frequency Heating, Amateur Stations, etc.

Ask for leaflet
112W/W

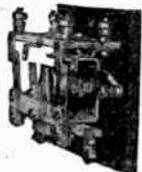

LONDEX LTD SYDNEY
MANUFACTURERS OF RELAYS
207 ANERLEY ROAD, LONDON S.E.20 6258-9

2/6 brings you comprehensive circuit and wiring diagram of a super ac/dc quality receiver, all components can be supplied from stock by return post, c.o.d.; 5in p.m. m/c speakers, 17/6; octal valve-holders, 5/-dozen; amplifier manuals, 2/-; 3-wave coil packs, 35/-; 3 1/2in p.m. m/c speakers, 27/6; moving coil meters, 2in and 3in, 5, 10, 25ma, 30v, etc., all at 30/- each, reduction for quantities; electrolytics, 8mf 500v, 3/-; 8-8mf 500v, 5/6; 16mf 500v, 4/6; s.a.e. for lists of other bargains.—Brown, 63, Salisbury Av., Farnham Rd., Slough, Bucks. [7109]

An exceptional coil, the new Summersby A.S.A.2, is a midget in size only, Litz wire wound on a distrene former, adjustable iron dust core; the performance of this medium wave coil at 1,500 kcs with 70 P1 has a Q of 90, and at 600 kcs with 490 P1 has a Q of 170; price 3/3 each; immediate delivery; we believe that we are the first manufacturers to offer post-war to the trade and public a tuning coil that does not need a variable condenser—the Summersby Permeability tuning coil will be on sale in August; be up to date, use Summersby products.—A. Summersby, Ltd., 106, Heath St., Hampstead, London, N.W.3. [7148]

GOOD quality components means reliability in your receiver, we can supply them. A few examples are: Electrolytic condensers, can all dry type, new and not surplus goods, 16x8mf 450volts, 6/6, 16x8x4x4mf 500volts, 7/6; 16mf 450volts, 4/6; 50mf 12volts, 1/10; 25mf 25volts, 1/10; 2-gang .0005 condensers from 10/-; Summersley i.f. 465 kc/s, Q130 permeability tuned, 15/- per pair; 3-wave coil pack, 36/6; 3-wave coils (superhet), 10/6 per pair; P type coils, 5/- per pair; constructional drawings, 2/6, plus 2 1/2d. postage; special 8in high fidelity p.m. speaker with trans, 35/-; resistors, condensers, etc.; immediate delivery.—A. Castle, 106, Heath St., Hampstead.

RADIO CLEARANCE, Ltd. 27, Tottenham Ct. Rd., W.1. Mus. 9188. L.F. chokes, 20h 300Ω 80ma, 12/6; P.M. speakers, all well-known makes, 2 1/2in 25/-, 3 1/2in 25/-, 5in 25/-, 8in 25/-, with trans., 27/6, 10in 40/-, with trans. 42/6; 2-gang condenser, 0.00035 short spindle 6/11; 3-gang 0.0005 Ceramic ins. 1in spindle, 7/6; superhet coils m.w. ae., m.w. osc., 1w. ae., l.w. osc., former size 1/2in x 1 1/2in, 2/5 ea; iron cored 465 kc/s, trap, 2/9; set of 4 coils and trap, 11/6; volume controls, with switch, 5k, 10k, 25k, 50k, 100k, 250k, 500k, 1m, 5/3; V.C., less switch, carb., 20k, 30k, 50k, 100k, 2/6; miniature 1k, 20k, 100k, 250k, 500k, 2/-; wire wound, 3w, 100Ω, 150Ω, 200Ω, 500Ω, 1k, 2k, 5k, 10k, 20k, 2/6; electrolytics, 8mf 500v 3/3, 20mf 50v 2/-, 50mf 12v 1/9; Mansbridge conds., 1mf 350v 9d, 1mf 1,000v 1/3, 2mf 300v 1/-, 4mf 600v 4/6, 4mf 1,500v 5/-, all wkg. V; switches, 1p 3w 1/9, 2p 4w 2/9, small 4p 2w short spindle 1/9, 2p 5w 3p short spindle 2/9, 1p 12w 3/-, 1p 9w 3b 4/-, 4p 4w 2b long spindle 4/6; tubular conds., 0.001-2.5, 0.01-2.5 6d. 0.1 350v 7d; mica conds., 0.0001-3.5 4d, 0.001-2.5 5d, 0.01 6d; silver micas, 6-6,000pf 6d; Ceramics, 2, 10, 20, 25, 50, 100pf. 6d; resistors, 1/4w 3d, 1/2w 4d, 1w 6d, 2w 10d, 3w 1/3, most values in stock; 3w wire wound, 5Ω, 45Ω, 470Ω, 3.9k, 6.8k, 47k, 1/-, 10w 50Ω, 250Ω, 500Ω, 1k, 1,200Ω, 1/6; 20w, with clips, 120Ω, 200Ω, 2k, 8k, 2/-; 25w, 350Ω, 5k, 2/6; 40w, 14k, tapped at 2k, 3/-; bakelized paper tubular conds., 0.17 250v 3d, 0.1 600v 6d, 100mf 12v electrolytic 1/-; Ally chassis, 10 1/2in x 10 1/2in x 2 1/2in, part drilled, 3/6; mains droppers, 2 sliders, 0.2a 1,000Ω 3/6, 0.3a 800Ω 4/-; U.H.F. chokes, 1/-; Ceramic trimmers, 1/15pf and 3/50pf, 9d; air spaced 30pf variable 3/4in spindle, 1/-; padders, 150pf, 750/1,250pf, 1/-; valveholders, 4-pin pax. 1d, 5-pin Brit. Amph. 6d, Mazda Oct. Amph. 6d, Int. Oct. Amph. 8d, U.X. 4-pin Amph. 6d, Brit. 7-pin Amph. 8d, E.F. 50 Pax. 6d, H.V. 5-pin Brit. 1/-; Ceramic 5- or 7-pin U.X., E.F. 50, 1/6; television line trans., 12/-; screened wire atranded centre rubber ins., single, 8d, V.D.; 465 kc/s iron-cored I.F.s 12/-, pr. also 1 1/2in x 3 1/2in iron-cored 14/6 pr; output trans., tropicalized C.T. sec., giving ratios 30 and 15-1, 4/-; 2-gang V.C., double 1m, 4/-; moving coil headphones, slightly used, 10/6 pr; power carbon mikes with switch in handle, 10/6; sub-assemblies carrying 2 0.17 350v tubulars, 1 bakelized tub. elect. 8mf 150v, 1 bakelized tub. elect. 100mf 12v and tax panel, 2/- ea complete; rotary toggles, 2/-; clareostats, 375Ω, 445Ω 665Ω, 9/6; 1/60hp single-phase 200/250v a.c. motors, 42/-; power units, 12v inpu, 250v 120ma and 450v 65ma output, smoothing included 35/-; power unit, 12 or 24v input, output 500v 80ma, 275v 120ma, complete with rotary converter, vibrator and QZ4, also spare vibrator and QZ4, complete with smoothing, 42ns; all orders under 10/- to include postage.

Valuable books on
RADIO
by
ALFRED T. WITTS
A.M.I.E.E.

THERMIONIC VALVES IN MODERN RADIO RECEIVERS

An up-to-date book for service engineers, students and keen amateurs, and for all engaged in commercial wireless work.
10s. 6d. net

THE SUPERHETERODYNE RECEIVER

Gives all the information necessary for a complete understanding of the operation and working principles of this type of receiver.
6s. net

RADIO UPKEEP AND REPAIRS

Enables the average radio receiver owner to diagnose the ordinary troubles of his radio set and to remedy them himself. 7s. 6d. net

WORKED RADIO CALCULATIONS

Contains worked examples of most of the important formulae met with in radio courses. Invaluable to service engineers and those studying for examinations in radio. 6s. 6d. net

PITMAN
Parker Street, Kingsway, London, W.C.2

'Radiospares' Quality Parts

THE SERVICE ENGINEER'S FIRST CHOICE

'TESTGEAR'

MAINS RESISTANCE
1,000 Ω .2a
600 Ω .3a

Nickel-Chrome wire, space-wound on robust Ceramic former only 3" x 1 1/2".
3 Heavy Brass Clips (one adjustable) One-hole fixing.

ROBUST COMPACT RELIABLE

4/9 Post Free

Trade enquiries welcomed
MORTON & DISMORE
52c Oldchurch Rd., Chingford, E.4

COULPHONE RADIO

The Return of Post Mail Order Service

Proprietor: C. COULBORN G3AJM

Tuning Units, Q3, S/M/L wave, FC and IF, £4 15s.
Heavy Duty Chokes, 200 mA 150 ohms, 21/6.
Eddystone Components, S.W. Manual, 2/6.
Resistors. 1 w. Gd.; 1 w., 9d. Droppers: .2A. 4/3; .3A, 4/6.
Excellent range Yazley Switches: 2p., 5w., 3bk. 10/6.
Tuning Units. E3 S/M/L HF, FC, IF, and DD. £8 15s.
Useful Barretters. K52B, K52H, K55H, C928B, each 3/6.
Receiver Kits. 4v. TRF., £8 10s.; 5v. S/H 3WB AC, £12 10s.
New Goods only. Spkr., Fret Material, 14" x 12", 3/-.
3-valve Holders Gd. All English and UK, Gd. Ex. Twin 14/36, Gd.; 23/34, 7d. yd. 75st. Aerial, 3/-.
PVC22 swg wire, asstd. colours, 2d. yd. PB wire, 3d. Output Trans. Midget Fow-Pen, 5/6; Std. Univ., 6/6.
Speakers. PM. 21", 25/-; 31", 28/6; 5", 20/6; 8", 23/6.
Tuning Coils. TRF, 9/6; 3WB S/H, 11/6; P type, 2/9.
Mains Transl. Univ. LTs, 300v. 60 mA., 19/6. Full range.
Aluminium chassis, 4 sides, 14" by 9" by 3", 10/6. I.F. Transi. Iron-cored, 466 kc. Std., 15/-; Mid., 18/9.
Line Cord. 2w., 1/6; 3w., 1/9 yd. Belling Lee terms 8.
Over 20,000 satisfied clients.
Resistance and Capacity Bridges, £12 10s.
Dialflex Ins. sleeving, 2 mm., 3d. yd.; Screened, 8d.
Eliminators. 120v. 25 mA, with Trickle Charger, 24 5s.
Range Tuning Condensers. 2g L/T, 11/6; W/T, 12/6.
Signal Generators. 100 k/s. to 56 mc/s., £16 16s. Every size Volume Control less sw., 3/9; w/s, 5/3.
Rectifiers, Metal, 325v. 65 mA, 8/6. Mtg. Strips, 3d.
Valves. Tangram and B.V.A. 886, equiv. 250/3000, 23/3.
1 in. Term. Strips 2-socket, 4d.; 6-screw type, 10d.
Coil Packs. 3WB S/H aligned with circuit, 36/6.
Everything previously advertised available.
C.W.O. or C.O.D. Over 5/- Post Free.
21d. Stamp for 18-page Catalogue.

58, DERBY STREET, ORMSKIRK, LANCs.

NEW UNUSED 12 VALVE TRANSMITTER-RECEIVER UNIT (RADAR 1FF UNIT, R.A.F. TYPE R3077)

THE COMPLETE EQUIPMENT WITH 12 NEW VALVES AND POWER SUPPLY (12v. D.C. Supply)

VALVE LINE-UP:—
 2 EF50
 6 SP41
 3 DI
 1 EI148

PRICE ONLY
£6/19/6

CARRIAGE PAID

FREQUENCY COVERAGE:— BAND SWITCHING
 58 - 84 Mcs.
 180 - 210 Mcs.

Power Supply:—
 12v. D.C. input Rotary Transformer with 480v. 400mA output.

M.O.S. (Mail Order Supply)
24 NEW RD., LONDON, E.1
 Send for information on the BURGONYNE Aerial Co-axial Connector. THIS is what you have waited for!

COPPER wires, cotton-covered 1/4lb reels, 18, 20g, 1/6; 22, 24g, 1/9; 26, 28g, 2/-; 30, 32g, 2/3; enamelled, same prices, including 34, 36g, 2/6; 38, 40g, 2/9; 42g, 3/6; silk-covered, 16g 1lb, 5/6; 18g 1lb, 7/1; 19, 20g, 4/1; 22g, 4/1; 24g, 4/1; 26g, 4/1; 28g, 4/1; 30g, 4/1; 32g, 4/1; 34g, 4/1; 36g, 4/1; 38g, 4/1; 40g, 4/1; 42g, 4/1; 44g, 4/1; 46g, 4/1; 48g, 4/1; 50g, 4/1; laminated bakelite panels, 1/2in thick, 6in x 4in, 1/6; 6in x 6in, 2/-; 8in x 6in, 2/6; 10in x 6in, 3/-; 10in x 8in, 3/9; 12in x 8in, 4/6; ditto 1/2in thick, same sizes, 1/-, 1/4, 1/8, 2/-, 2/6, 3/-; polished ebonite panels, 3/4in thick, sizes as above, 2/-, 3/9, 5/-, 6/6, 7/6 respectively ditto, 1/2in thick, 2/9, 4/-, 5/-, 6/9, 8/9, 10/- respectively; E.A. screws, gross useful sizes, 2/6; ditto, nuts, 2/6 gr.; assorted gross screws and nuts, 2/6; brass washers, 1/6 gr.; fibre washers, 1/6 gr.; assorted soldering tags, 2/- gr.; assorted small eyelets and rivets, 1/3 gr.; finest quality stranded and single push-back wire, 12yds, 2/3; reinforced solder, 1/2lb, 1/-; new ex-G.P.O. hand telephone with microphone, switch and leads, 12/6; used ex-R.A.F. low resistance earphone with switch 2/6; all postage extra; trade supplied.—Post Radio Supplies, 33, Bourne Gardens, London, E.4. [7147]

RADIOLETRON, 22, Frances St., Scunthorpe, Lincs. (Dept. A), coast-to-coast radio spares service.—New goods only, regular stock lines; battery H.T. eliminators, input 200-250v ac, output 60-75 and 120v at 20 mA with trickle charger, complete in metal case, with connecting wires, wander plugs and spades, ready for connecting up and switching on, 23 ea, postage 1/- extra; Picco all-in-one radiometers, tests everything electrical, 25/- ea; tuning condensers, 2-gang 0.0005mfd 11/-, with trimmers 12/6; tuning coils, high gain, t.r.f., med. and long-wave with react. and circuit, 9/3 pr; volume controls, all values, long spindles, 3/-, 4/6 with sw.; wire wound, less sw., 2k, 5k, 10k, 30k, 3/5; toggle switches, single pole, fixing, 8/6, on-off 2/6. S.A. D.T. 3/-, D.P. on-off 3/6, D.P. D.T. 4/-; transformers, intervalve, direct feed, ratio 3-1 and 5-1, 7/6; Class B driver, 7/6; output pentode 5/6, universal 6/6; power pan P.P. and class B, 7/-; resistors, all values, carbon 1/2 and 1-watt, 5d and 8d; wire wound 1/2-watt 11d, 1-watt 1/3, 5-watt 2/9; all capacities of tubular and electrolytic condensers in stock; state your requirements; s.a.e. to be included with enquiries; terms, cash with order or c.o.d. extra, post paid orders over 10/- . [6987]

HARRY JAMES PRODUCTIONS, 270, Leith Walk, Edinburgh, 6.—Mail order only. C.o.d. or cash with order. Loudspeakers, 5in, 19/9; coils, T.R.F. with circuit M & L, 8/6; condensers, 2 gang 0.0005, 12/-; T.R.F. 3 chassis, 4/-; resistances 1/2 watt 3d., 1/4 watt 4d., 1 watt 6d. all standard values; volume controls, 1/4 and 1/2 meg, 4/9; dropper resistances, 0.2 and 0.3 amp, with feet, 4/6; multi-ratio speaker transformers, 6/6; valve holders, 5, 7 pin and Octal, 6d.; Amphelion type, 9d.; electrolytics, 8mfd, 3/-, 8+8 5/6, 16mfd 4/9, 0.1, 0.01, 0.05, 8d.; valves, c.o.d., most English and American types in stock. Give us your enquiries for anything in radio. [7035]

NEW boxed S.T.C. selenium rectifiers, all f.w. bridge conn. and damp-proof finish; list prices and makers' ratings; 12v 1a 11/-, 1.5a 14/-, 2.5a 19/6, 4a 23/-, 5a 31/-, 8-10a 37/9, last two post 1/-; larger types for industrial use: 24v 4a 42/1, 8a 64/10, 16a 126/5, 30v 5a 57/10, 50v 5a 81/6, 95v 5a 151/3, all plus carr.; 1st gde. sliding resistances, 150watt 5a 5/20hm, 3a 13ohm, 22/6, post 7d.; all values available; strong steel boxes, 8 1/2 x 8 1/2 x 6 1/2, hinged lid, 7/- p.f. (not new) h.c.o.d.; circuits and advice on all charging and rectifier problems, s.a.e.; trade supp. Regret slight price increase. Makers' list revised w.e.f. 1/11/47.—Pearce, 66, Gt. Percy St., London, W.C.1 (nr. Angel). [6975]

FRIITH RADIOCRAFT, Ltd., the Leicester Specialists, offer from their comprehensive stocks: design for 3-wave superhet tuning unit, 2/6; ditto for 5v superhet midget, 2/6; both designs using U.S.A. octals and Wearite coils; Wearite "P" coils, most types, 3/- each; guaranteed condensers and resistors, 0.001, 0.002, 0.005, 0.01, 0.02, 0.05, 0.01 0.25, 0.5 mfd; 750, 1,500, 2.2M 1/2w, 75, 4,700, 10K 1/2w, 68K, 680K, 1 meg 1w, 20K, 33K, 100K, 150K, 300K, 2w, 4,700, 6,800, 3w, any assortment or one size £1 per 1/2-gross parcel; Stanelco soldering irons, 2G0 or 250v, list 21/-, our price 12/6; Woden de luxe diecast output transformers, 6,000Ω and 10,000Ω A. to A., CT, 2 to 15-ohm sec, 15 wats, 39/6; Rothermel Senior Xtal pick-ups, 58/3; sapphire needles, 12/6; S. G. Brown lightweight headphones, 23/-; agents for Quartz Xtals, Eddystone, Raymart, Woden and Labgear.—Friith Radiocraft, Ltd., 69-71, Church Gate, Leicester. [7028]

STERNs of FLEET STREET CAN SEND YOU

RADIO COMPONENTS, TEST GEAR AND INSTRUMENTS

Made by leading mfrs., viz.:—Avo, Taylors, Belling, Bulgin, B.I., Rola, Goodmans, Varley, Dubilier, T.C.C., Rochemel, I.B., etc. P.M. Speakers, 2-3 ohms, less Trans. 5in. Page, 16/9. Sin. Rola, 21/6. 2jin. Celestion, 27/6. 3jin. Goodmans, 30/-, 6jin. Rola, 22/6. 8in. Rola, 24/-, 9in. Grampian, 38/-, 10in. Goodmans, 35/-.

15 ohms, less Trans.
 3jin. Goodmans, 30/-, 9in. Grampian, 38/-, 10in. Goodmans, with T., 49/6. 12in. Goodmans, 15 w., £6/15/-, 12in. Vitavox 20 w., £11.

Energised. 2-3 ohms, S/Coil.
 8in. Rola, 1,500 ohm, 32/6, less T.
 6jin. Rola, 1,000 ohm, 27/6, less T.
 Sin. Rola, 1,000 ohm, 29/6, with T.

Mains Trans., some of many ranges.
 Woden, 350-0-350 80 m/a :
 6.3 v. 4 a. 5 v. 2 a. or 4 v. 4 a. 4 v. 2 a., 27/-
 Varley, 425-0-425 150 m/a :
 4 v. 4 a. 6.3 v. 4 a., 5 v. 3 a., 50/-
 Kingsway, 325-0-325 100 m/a :
 4 v. 6 a., 4 v. 2 a., 4 v. 2 a., 39/6.

All above have centre tapped L.T.s and Screened Prism.

I.F. Transformers.
 Wearite Midget Perm. Tuned 465 k/c, pr. 21/-
 Wearite Standard Perm Tuned 465 k/c, pr. 21/-
 Denco Midget Perm. Tuned, 116 m/c, pr. 19/6
 Iron Core Standard 465 and 110 k/c, pr. 15/-
 Weymouth 3 wave Coil Pack, diagram, 36/6.

Varley Chokes.
 L.F. 20 hy, 250 ohm 120 m/a, 16/-
 Tapped Tone Control, 3 hy, 11/-
 L.F. 15 hy, 100 ohm 300 m/a., 42/-

Midget L.F. Chokes.
 10 hy, 300 ohm 40 m/a., 4/9.
 10 hy, 1,250 ohm 20 m/a., 4/9.

Wharfedale O/Put Transformers.
 Ratio 30-1 to 90-1 L.T., 4 watts, 7/6.
 Multi Ratio Push Pull 12 watts, 21/-
 Midget Pentode O/Put Trans., 5/3.
 Rothermel Crystal Pick-ups, £2/16/3.
 Rothermel Sapphire Needles, 12/6.
 Rothermel Needle Pressure Adj. Units, 12/6.
 Cosmocoord Crystal Pick-ups, 42/-
 Goldring Magnetic Pick-ups, 30/6.

Resistances. Comprehensive range includes
 Bulgin, Erie, Dubilier : 1, 1, 3, 5, 10 and 20 watt. Prices 6d. to 4/3.

Condensers. By Dubilier, T.C.C., B.I., T.M.C. etc. Comprehensive range Canned, Paper, and Carton types. Midget and Standard also. .1, .01, .0001, .05 mfd., etc. Voltages from 150.

Centralab V/Controls. Values in stock between 5,000 ohms to 2 meg., with switch 6/-, less switch 4/3.

3 watt Wire Wound between 6 and 25,000 ohms, 5/6.

Valves. Over 5,000 in stock. Includes Hivac, Midget, I.4 volt, 1T4, 1S5 etc. U.S.A. and British. At official list prices.

Avo Meters.
 D.C. Minor, £4/4/-
 Universal Minor, £8/10/-
 No. 7, £19/10/-
 Valve Tester, £16/10/-

Drum Drives, 2 1/2 in. dia., 2/9.
 Ex-Govt. Muirhead Precision Slow Motion drive, 50-1 ratio, 12/6.

Mansbridge Type Condensers.
 2 mfd. 1,000 v., 2/6; 2 mfd. 600 v., 1/9.

Coils.
 Wearite P type range between 12 to 2,000 metres, A, H.F. and Osc., 3/-
 Matched pairs M. and L. wave with reac. 9/-
 Matched pairs, M. and L. wave, no reac. 8/6
 Matched pairs, med. wave, 6/6, diagrams incl.
 Ex-Govt. 0-1 m/a. Meters 2in., tested 21/-

Terms Cash with Order or C.O.D.

ENQUIRIES WELCOMED!
 The above represent only a few examples of our Stock.

STERN RADIO LTD.
115 FLEET STREET, E.C.4.
 Tel.: CENTRAL 5814.

**THE AMERICAN
POPULAR MECHANICS
MAGAZINE**



OVER
300
PAGES

150
ARTICLES
IN EACH
ISSUE

POPULAR MECHANICS the complete monthly science survey.

Hundreds of photographs and illustrations. Colour pages. Radio Constructors section. Plastics. Atoms. Photography. Automobiles. Aviation. Electronics. Railways. Industry. Ships. Models. Gardening. Constructional articles for every trade and hobby.

ORDER this famous American Magazine to be sent to you every month direct from Chicago, U.S.A. 12 months' subscription, only 17/6. **ONLY 17/6** Post Paid.

Send remittance of 17/6 with your order to :-

DALE INTERNATIONAL Publications Ltd.,
105 BOLSOVER STREET, LONDON, W.1
Museum 1023

**111 Pages
PACKED WITH INTEREST**

The most comprehensive Radio and Electronic Component Catalogue ever offered is yours for the asking. All lines are by well-known manufacturers including a complete valve range—No job clearance lines whatsoever. A shilling postal order will bring you this catalogue post-free.

SEND TO-DAY

B : I : S

63, London Road, Brighton 1, Sussex
Tel.: Brighton 1555.

POST-WAR TELEVISION

The advance in Radio Technique offers unlimited opportunities of high pay and secure posts for those Radio Engineers who have had the foresight to become technically qualified. How you can do this quickly and easily in your spare time is fully explained in our unique handbook.

Full details are given of A.M.I.E.E., A.M.Brit.I.R.E. City & Guilds Exams., and particulars of up-to-date courses in Wireless Engineering, Radio Servicing, Short Waves, Television, Mathematics, etc., etc.

We Guarantee "NO PASS—NO FEE"

Prepare for to-morrow's opportunities and post-war competition by sending for your copy of this very informative 112-page guide NOW—FREE.

**BRITISH INSTITUTE OF ENGINEERING
TECHNOLOGY (Dept. 388)**
17, Stratford Place, London, W.1

EX-R.A.F. "Identification Friend or Foe" receiving and transmitting units, covering 155-185 mcs. complete with 10 valves and 20 watts motor generator, 12v input, 480v 40ma output, also just arrived, I.F.F. model 3003 for 24v operation, price of either 79/6, plus 5/- carriage; the famous Canadian type 58 Mk. 1 Walkie Talkie, complete with valves, aerials, headphones and microphones, batteries, etc., ready to switch on, £10/10 ea, carriage 5/-; s.a.e. for component lists and refer to our offer of ex-Army wavemeters under Test Equipment column.—U.E.I. Corp., 32, St. Gabriel's Rd., London, N.W.2. [6824]

MISCELLANEOUS

SOLDERING difficulties solved.

HAVE you been put off making a set because of soldering difficulties, either through lack of electricity or low voltage? Here is the answer—use the "Dorset" Hot Spot soldering outfit in conjunction with any car battery (hired if necessary from garage); as used during recent cuts for construction of our coil packs, etc.; makes cleaner and neater joints and avoids damage to components; complete with instructions for use, 5/6.—Weldona Radio Accessories, Ltd., Swanage. [7141]

OFFERS wanted for 60ft air-spaced coaxial.—10, Holmes Rd., Manchester, 10. [7153]
WIRELESS Worlds. '32-'33, 6d.; '37-'39, 8d.; '42-'45, 1/3 each; send enquiries.—Box 6983. [7156]

TRIMMER tool kits (new) given in exchange for old service sheets.—Bulls, 246, High St., Harlesden, N.W.10. [7106]

TIME Recorders.—Write for particulars.—Gledhill Brook Time Recorders, Ltd., 84, Empire Works, Huddersfield. [2419]

IRON dust cores.—Several patterns in large quantities available; samples.—John Downton & Co., 89, High St., Epping, Tel. 2163. [7165]

SPARKS' data sheets offer the widest range of tested and guaranteed designs, in full-size data sheet form, obtainable in this country.

TINY Two, just released, a 2-valve all-dry self-contained portable, med. waves. **DESIGNED** for individual listening to local stations on speaker, size 5 3/4 x 5 1/2 x 5 1/4 in, 18-volt HT; 2/6.

THREE-valve all-dry portable, m/1 waves, 9x6x4in, a most popular set; 2/6. Send a stamp for full list (W).

SPARKS' Data Sheets (W), 9, Phoebeth Rd., Brockley, S.E.4. Tel. Lee Green 0220. [6609]

PERSPEX sheet, 5/32in, reduced from 1d. per sq in to 3/4d., cut to any size; discounts for quantity, post free over 15/—Enquiries, orders to Midland Hamgear Co, 3, Shrubbery St., Kidderminster [7057]

CIRCUIT diagrams (individual designs) to order; chassis assembled from parts supplied; will act as consultant on radio, mech. or elec. work; technical points explained.—Write R. G. Young, 5a, Bridges Rd., Wimbledon. [7111]

MR. R. W. EMERSON of Emerson Radio, late of 100, St. Johns Wood Terrace, is opening showrooms and workshops at 14, Circus Rd., St. Johns Wood; old friends and reps will be especially welcomed; all communications for the present to 3, St. Ann's Terrace. Tel. Primrose 1517. [719C]

COULPHONE RADIO, 58, Derby St., Ormskirk.—The return of post mail order service. Please see display advt., page 49. A typical comment on our service. "I am very grateful to you and have no hesitation in saying that it is the fastest delivery of goods I have ever had." (W. S., 29/1/47.) Coulphone deliver the goods. [7118]

AMERICAN magazines can now be supplied on a subscription basis; cost of one year's supply, including postage, "F.M. and Television," 30/-; "Popular Mechanics," 17/6; "Radio Craft," 16/6.—For complete list send stamped addressed envelope to Willen, Ltd., W.W. Dept., 120, St. George's Rd., London, E.10. [7049]

WANTED, EXCHANGE, ETC.

WANTED, wireless sets for export.—J. K. Wilkie & Co., Liverpool, 19. [7083]

WANTED, E. H. Scott Philharmonic or Phantom, condition immaterial; price, parties.—Box 6698. [7063]

WANTED, Douglas, or similar power driven coil winder, single or multi, complete with 220v A.C. motor.—Box 6858. [7105]

WANTED, all-wave feeder unit with R.F. and I.F. stages; also Midwest or Challenger multi-valve chassis.—Box 6474. [6989]

WE offer cash for good modern communication and all-wave receivers.—A.C.S. Radio, 44, Widmore Rd., Bromley, Kent.

**"We Were
Greatly Impressed"**

This phrase was used by a leading Electrical Instrument concern in connection with

**TRANSFORMERS
and
CHOKES**

supplied by us, and is praise to which we have become accustomed. Our modern factory is fully equipped with vacuum and pressure impregnators, and all the latest test equipment.

POWER RATINGS 8 V.A. to 8 K.V.A.

AUDIO RATINGS 3 watts to 200 watts.

We shall be pleased to quote for your requirements, large or small.

PROMPT DELIVERIES

**AUSTIN MILLS LTD.
LOWER CARRS,
STOCKPORT**

Established 20 years Phone: STO 3791

**MORSE CODE
TRAINING**



There are Candler Morse Code Courses for **BEGINNERS AND OPERATORS.**

Send for this Free **"BOOK OF FACTS"**

It gives full details concerning all Courses.

THE CANDLER SYSTEM CO.,
(Room 55W), 121 Kingsway, London, W.C.2
Candler System Co., Denver, Colorado, U.S.A.

TELERADIO for the **COMPLETE KIT** and **Replacement Chassis Service**

Send stamp for latest illustrated leaflets and entry on our mailing list.

THE TELERADIO COMPANY
157 FORE ST., EDMONTON, N.18
Tottenham 3386

THESE ARE IN STOCK

Television Receiving Equipment. By W. T. Cocking. 12s. 6d., postage 5d.
 Wireless Servicing Manual. By W. T. Cocking. 10s. 6d., postage 5d.
 Radio Tube Vade Mecum. By P. H. Brans. 12s. 6d., postage 6d.
 Radio Receiver Servicing and Maintenance. By E. J. G. Lewis. 8s. 6d., postage 5d.
 Fundamentals of Radio. By F. E. Terman. 20s. Postage 8d.
 Wireless World Valve Data. 2s., postage 2d.
 The Technique of Radio Design. By E. E. Zepher. 21s., postage 7d.
 Testing Radio Sets. By J. H. Reyner. 15s., postage 6d.
 Practical Wireless Circuits. By F. J. Camm. 6s., postage 4d.
 Radio Service Test Gear. By W. H. Cazaly. 6s., postage 4d.
 Luminous Tube Lighting. By H. A. Miller. 10s. 6d., postage 4d.
 Practical Wireless Service Manual. By F. J. Camm. 8s. 6d., postage 6d.

WE HAVE THE FINEST STOCK OF BRITISH AND AMERICAN RADIO BOOKS. WRITE OR CALL FOR COMPLETE LIST

THE MODERN BOOK CO.
 (Dept. W.21), 19-21, Praed St., London, W.2

MIDLAND INSTRUMENT CO.
SPECIAL OFFER OF EX-GOV. ALL-DRY BATTERIES
 Highest grade manufacture, tropical standard, in airtight packing, brand new and fully guaranteed by us, 90-v. H.T. plus 11-v. L.T. 5/-, post 8d. Sealed cartons of 8, 35/-, post paid. Trade applied. Above can easily be split to form three 30-v. H.T. units (size of U.2 cell), ideal for midget sets, deaf aids, etc. Hundreds of other items; send for our new March Lists, 2d., with a.s.o.

18, Harborne Park Road, Birmingham, 17.
 Tel.: HARborne 1308.

RADIO BATTERY TESTER

Use "Quixo" method of battery testing.
 Reliable results. Guaranteed.

Send for interesting leaflet
 R115 on battery testing.



RUNBAKEN • MANCHESTER

A.C.S. RADIO

SPECIALISTS IN SHORT WAVE and high-class broadcast equipment offer a wide range of components for the constructor and enthusiastic amateur.

We are Agents for Eddystone, Raymart, Hamrad and Labgear components including Variable Condensers for receiving and transmitting, Air Trimmer condensers; plug-in coils and coil formers; valve holders; R.F. and A.F. Chokes; Mains transformers; mica, paper and electrolytic condensers; volume controls; quartz crystals for the amateur bands; frequency standards and crystal gate receivers; aerial wire and equipment; meters and test sets by M.I.P. (Pullin) Ltd.; B.V.A. and American valves including transmitting types by Standard Telephones, and specialised U.H.F. types; Cathode Ray Viewing units by Labgear; Amplifiers and radio tuner units by Lowther Mfg. Co.

We have continually changing stock of Communications Receivers such as NATIONAL, RME, HALLICRAFTERS, HAMMARLUND and can often offer high grade American All-wave receivers, such as SCOTT, McMURDO SILVER, etc.

Our new Component List "W." and list of second-hand equipment will be sent on application to A.C.S. RADIO.

44 WIDMORE RD BROMLEY, KENT
 Phone RAvensbourne 0156

L OUD speaker repairs.—Speaker repairs are vital to-day; we repair all types at keen competitive prices; field coils fitted or rewound to any resistance.—For guaranteed efficiency reproduction send to L. Cottenham, Loud Speaker Repair Factory, Whetley Lane, Bradford, Yorks. Enquiries will receive immediate attention. [7115]

A LL makes and kinds of electrical and radio measuring instruments repaired by skilled technicians, A.I.D. approved; all work quoted by return without charge. Also for sale, large variety of voltmeters, ammeters, milli-ammeters, 2in and 2½in dial, reconditioned ex-Air Ministry stock.—W. O. Rescott, Ltd., Dept. D., 29-31, Cowcross St., E.C.1. Tel. Cle. 6783. [6205]

S TURDY rewinds, mains transformers, chokes and fields; we give prompt delivery and guarantee satisfaction; 14 years' experience; prices on request.—Sturdy Electric Co., Ltd., Dipton, Newcastle-on-Tyne. [4316]

R EWINDS, mains transformers, layer wound wax impregnated, O/P transformers, chokes, fields, clock coils, pick-ups, fractional hp motors, competitive prices; prompt delivery; guaranteed work.—W. Groves, Manufacturing Electrical Engineer, 154, Icknield Port Rd., Birmingham, 16. [4547]

L OUDSPEAKER repairs, any make, reasonable prices, prompt delivery, to the trade and quality fans; 25 years' combined experience with Rola, Magnavox, Goodmans, Celestion.—Sound Service Radio, 80, Richmond Rd., Kingston-on-Thames. Kin. 8008. 14977

N A T I O N A L R A D I O S E R V I C E & T E L E V I S I O N C O.—Trade service engineers; immediate service any district; rewinds to all types transformers, armatures, motors, loud-speaker cones, speech coils fitted; British and American components and valves; enquiries invited for contract trade service; multiple transformer winding.—63, Iligh St., St. John's Wood, N.W.8. Primrose 6725. [6752]

D E G A L L I E R ' S , L t d .—Service with a guarantee; if you cannot get your receiver serviced, let American specialists do the job; first-class workmanship only; specialising in Air-King, Belmont, Challenger, Delco, Detrola, De Wald, Emerson, Ferguson, Garod, Hallicrafer, Hammarlund, Lucille, McMurdo Silver, Midwest, Majestic, Pilot, Philco, Scott, Sparston, Stromberg Carlson, R.C.A., etc., also any British or Continental set; due to lack of accommodation our service branches are still dispersed; therefore apply for forwarding instructions before despatching sets; s.a.e. with all enquiries.

D E G A L L I E R ' S , L t d ., 9, Westbourne Court, London, W.2. [6410]

W O R K W A N T E D .
A M P L I F I E R S and power-packs manufactured to specification.—Electro-Equipment, 134, Queen St., Newton Abbot, S. Devon.

W E have available capacity to manufacture radio and radiogram cabinets in medium quantities, both for home market and export.—Box 6981. [7152]

W E make cabinets and radiograms for home and export; immediate deliveries.—Radiac, Ltd., 26, Brondesbury Rd., London N.W.6. Maida Vale 8792. [6990]

K E E P a permanent record of your circuits! complete blueprints drawn from your sketch, component valves, etc., inserted 5/-, extra copies 1/3.—Send to BCM/Manuscripts, London, W.C.1. [6856]

C A P A C I T Y available for instrument component assembly and wiring; fully equipped Service Dept. for final test and fault-finding.—F. A. Porritt, 13 and 27, Wastdale Rd., Forest Hill, S.E.23. For. 1292. [7185]

W E magnetize permanent magnets for the trade; speakers, meters, etc.; any quantity not less than 1 dozen; present delivery 7 days.—A. J. Pratt & Sons, Ltd., 7, Woodbridge St., London, E.C.1. [7084]

W O R K wanted; we have capacity for radio and electrical assembly and metal work; we specialise in sub-contracts; our charges are moderate and deliveries prompt.—Emdo, Ltd., Ace Works, Moor Lane, Staines. [7012]

T H E name to note for all kinds of radio, and electrical metal work to specification, modern rustproof, all shapes and sizes undertaken, and for tropical use; components and sub-assemblies executed to meet recognised wiring and material standards; consultation, advice without obligation.—Write Dept. 23, Sea Rescue Equipment, Ltd., Chiltern Works, Clarendon Rd., Watford, Herts. [5977]

B U S I N E S S E S F O R S A L E O R W A N T E D .
R A D I O elec business, 8, Bucks, turnover £2,000 year; equipment, fittings, goodwill, service van, £550, a.s.v., offer.—Box 6694.

R A D I O, electrical and public address service, Bucks town; rent £86; modern d.f. lock-up shop, office, workshop; net profit over £3,000; present hands 20 years; £2,750 all at.—Lansley, 53, Friar St., Reading. [7114]

COMPONENTS FOR PROTOTYPES



Commercial buyers for large industrial organisations requiring components for prototypes (especially when they are in a hurry—which is mostly always) are gradually finding that the quickest way to get what they want is to 'phone Pad. 6116, or call at 177, Edgware Road (not far from Marble Arch) and take the goods away with them. No matter what is required, if we haven't got it in stock we always do our utmost to get it quickly, and we usually know where—and how.

OUR OWN FACTORY.—We have acquired additional space on the premises and now have our own factory—primarily engaged on communications apparatus, transmitters and U.H.F. receivers. Mind you, it is only a little factory, but it is surprising sometimes what initiative and determined effort can do. WHEN you have a minute to spare—call in and see us—you will be quite interested.

TELE-RADIO (1943) LTD.,
177 EDGWARE ROAD, LONDON, W.2
 Telephone: PADdington 6116

VOIGT



WE APOLOGISE to those who have been waiting months for replies. Our post-war plans have been frustrated so far. Sorry!

VOIGT PATENTS LTD.

Be WISE and PATIENT

THIS — Does these —



ACCURATELY and QUICKLY
 Chassis, Brackets, Shrouds, Condenser and Transformer clips —
TREPANNING Steel or Aluminium.
 Five sizes—12" to 36"
 Full particulars from:
A. A. TOOLS, (W.),
 197A, WHITEACRE ROAD,
 ASH FOR-UNDER-LYNE

'WEYMOUTH' MIDGET I.F.

Q = 120

Size 2" x 1" x 1" Tropically impregnated pots, cores and coils (Litz). Of outstanding efficiency and stability.

Available from your local dealer.

RETAIL PRICE 18/9 pr.
WEYMOUTH RADIO Mfg. Co. Ltd.
CRESCENT ST., WEYMOUTH

SITUATIONS VACANT

GOVERNMENT Department has vacancies for:—

(A) RADIO engineers for station in South of England. Various grades open for transmitter engineers at salaries £250 to £600 p.a., according to experience and ability. Basic engineering training up to B.Sc. standard preferred in higher grades, but there are vacancies for men with sound knowledge of radio communications and workshop practice.

(B) ELECTRONIC development engineer. One vacancy for keen, imaginative engineer with sound theoretical and practical knowledge of electronic equipment. Good technical education, preferably to degree standard, with ability to be creative, is essential. Salary commencing according to ability with minimum of £400 p.a. [7099]

MINISTRY of Civil Aviation.—Appointment of Radio Mechanics, Grade II. APPLICATIONS are invited for appointment as radio mechanics at Civil Aviation Radio Stations in the United Kingdom. Candidates must possess a knowledge of the fundamental principles of radio and radar, with a general knowledge of one or more of the following radio aids for navigation: direction finding, Loran, Gee, radar beacons, A.C.R. or G.C.A. They should also have had practical experience in the use of tools, filing, drilling, hard and soft soldering, cabling and wiring, and be experienced in the use of electrical and radio measuring instruments, including cathode ray oscilloscopes. The possession of City and Guilds Certificates in Radio Communication and Technical Electricity will be an advantage. The pay will be 115% per week, inclusive, rising by annual increments of 3% a week to a maximum of 130% a week.—Applications, which must be in writing, stating date of birth, full details of qualifications and experience, and quoting the reference C.A./Est./R.M., should be addressed to the Establishment Division, Ministry of Civil Aviation, 10, Fleet St., London, E.C.4. [7096]

EXPERIENCED radio service engineer required; permanency.—Killbourn, Abingdon. [6886]

REQUIRED test engineer with knowledge of high-power, high-frequency valve generators.—Box 6222. [6886]

REQUIRED by instrument company engaged on industrial telecommunications and medical measuring equipment:— (A) ONE Development Engineer; good physics degree or equivalent and some years' experience in comparable work; age at least 25 years; salary according to experience. (B) ONE Mechanical Designer; radio experience and degree or equivalent essential; salary £430-£590 p.a. (C) ONE Technical Assistant; radio experience essential; salary £6 per week upwards according to experience.—Box 6857. [7104]

WANTED, keen young radio mechanic, experienced assembling and testing amplifiers; good opportunity; W.I. district.—Box 6936. [7140]

BUSH RADIO have vacancy for assistant to service manager.—Apply in writing, stating age, qualifications and experience, to Power Rd., Chiswick. [7131]

WANTED, radio engineers specialising in car radio service and installations; employment in West End London with leading manufacturer.—Apply Box 6704. [7076]

RADIO mechanics and electricians required for company operating York and Lanc aircraft; write, giving full particulars of past experience and present employment, to Box 6700. [7069]

TOOLMAKER required by Sound Sales Ltd.; adequate plant available; permanent job for the right man; please state experience, wages required, type of tools produced.—Box 6859. [7107]

SALES manager to control sales office and advertising for radio and electrical test equipment manufacturers; experienced and capable person is offered exceptional prospects; Bucks area.—Box 6695. [7061]

FEMALE laboratory assistant required for electrical component and materials testing, age 20 or over.—Write, stating qualifications and experience, to Personnel Manager, E. K. Cole, Ltd., Southend-on-Sea. [7061]

SALES manager required Birmingham area by sound equipment manufacturer making high-class equipment suitable for staff location, music for the workers, office inter-communication, etc.; applicants must have technical knowledge and sales experience of this type of equipment; commencing salary £400, plus commission; write, giving full particulars of qualifications and past experience.—Box 6703. [7075]

GALPINS

GOVERNMENT SURPLUS ELECTRICAL STORES

408 HIGH STREET, LEWISHAM, LONDON, S.E.13

Telephone: Lee Green 0309. Near Lewisham Hospital.

TERMS: CASH WITH ORDER. NO C.O.D.

MAINS TRANSFORMERS BY WELL KNOWN MAKERS, double wound, 230 volts to 110 volts at 4,000 watts, £17/10/- each, carriage fwd. ditto 200/250 volts input, 450/0/450 volts at 150 m/a 5 v. 2 a., 6.3 v. 4 amp, 37/6 each carr. 2/6. ditto 350/0/350 v. at 200 m/a, 5 v. 3 a., 6.3 v. at 20 amps 55/- each, post 2/6. Ditto 700/0/700 v. 80 m/a, 4 v. 2 a., 12 1/2 v. 1 a., 25/- each, 2/- post. Another with an 80/100 volt primary, 450/0/450 at 250 m/a, 6.3 v. at 6 a, 5 v. 2 1/2 a., 17/6 each, 2/- carriage.

Ex G.P.O. (U.S.A.) CONVERTERS, vibrator type 4/6 volts D.C. input, 100 volts A.C. output fitted in metal box size 9in. x 6in. x 6in., new and unused 27/6 each, 2/- post.

EX-G.P.O. REPEATERS, CARRIER TELEPHONE TYPE No. 2. These are complete— with valves and power pack for A.C. mains or battery working, consisting of 2 6v6's, 2 EF50, 12-volt Mallory Vibrator with necessary smoothing. New and unused, size 14 x 16 1/2 x 20in., frequency range 1-16 kc/s, weight 175 lbs., price £7/10/- each, 10/- carriage.

LARGE TYPE METAL RECTIFIERS, outputs, 12 volts 4 amps 42/6, 12 volts 6/8 amps, 55/-; 50 volts 1 amp, 35/-; 50 volts 2 amps, 42/6, carriage on all types 2/- . Mains transformers to suit the above tapped input tapped output 6, 12, 24 v. at 6/8 amps, 40/-, 2/- post. Transformers to suit the 50 v. rectifiers 42/6 each, 2/- carriage.

WESTON Moving Coil Meters, edge type, 2 1/2 in. scale, 0 to 0.3 amps, 30/-; 0 to 2 amps, 27/6; 0 to 60 volts, 27/6; 0 to 150 volts, 27/6; all have F.S.D. of 2 m/amps.; 0 to 1 volt, 1 m/a. F.S.D., 35/-; another 3 1/2 in. scale reading decibels 50 microamps., F.S.D., 70/-, another 301 model 0 to 3 m/a., 40/-; 0 to 50 m/a., 35/- . All 1/6 each, 35/-.

ELECTRIC LIGHT CHECK METERS, for 200/250 A.C. mains, 50 cycles 1 phase, for garages, sub-letting, etc. 5 amp. type, 12/6; 10 amp., 15/-; 15 amp., 20/-; 20 amp., 25/-; 25/30 amp., 30/-; 50 amp., 45/-; 100 amp., 55/- . All 1/6 each, carriage.

VOLTAGE CHANGER TRANSFORMERS, Auto-wound, fully guaranteed, immediate delivery. 250 watts, 45/- each; 500 watts, 70/-; 1,000 watts, £5/15/-; 2,000 watts, £8/15/- . All tapped 0, 110, 200, 220 and 240 volts.

EX-R.A.F. MASTER OSCILLATORS. New and unused. Range from 2 m/cs to 7 1/2 m/cs, complete with valves; 4x Neon Stabiliser, 2 Barretters and 8-07 output, price, 55/- each, 5/- carriage.

PERMANENT MAGNET MOVING COIL SPEAKERS. Makers Truvox, Tannoy, for extension, or small P.A. work. Fitted in wooden box, size 9in. x 9in. x 7in., price 37/6 each.

EX-R.A.F. CATHODE RAY RECTIFIER UNIT. Sold for components which consist of mains transformers, high voltage condensers, tube holders, 120 resistances and condensers, 15 Octal base v/holders, all mounted on metal baseboard and fitted in metal cabinet size 23in. x 11 1/2 in. x 11 1/2 in. Condition of all components as new. Price, 65/- carriage 5/-.

SHUNT WOUND D.C. 110 VOLT MOTORS 1,500 r.p.m., approx. 1/2 h.p., condition as new 17/6 each, carriage 2/-.

MAINS TRANSFORMERS by well known makers. Input 200/250 volts in steps of 5 volts output, 35 volts at 100 amps. Condition as new £15 each. C.F.

A.C. ALTERNATORS (New) 120 volts 50 cy. 1 phase at 22 amps output, 1,800 r.p.m., self excited, makers American, price £22/10/- each.

PRE-PAYMENT ELECTRIC LIGHT CHECK METERS. 1/- slot type, 200/250 volts A.C., for 5 amp load at 7d. p.u., but change wheels can be obtained from the makers for from 1d. to 1/- p.u. Good condition, price 45/- each. Carriage paid.

EX-G.P.O. PRE-UNISELECTORS, 3 ohm automatic relay operating a 4-way Yaxley switch, fitted with 2 condensers .01, 1 1/2 M.F., new, boxed, 5/- each. G.P.O. Polarised Telegraph Sounders in new condition, 10/- each. G.P.O. Polarised Relays, operating on 10/20 m/amps. coil resistance, 230 ohms, 12/6 each, as new.

SHORT WAVE H.F. CHOKES, 1/6; H.F. chokes, 1/-; .01 condensers, 4/- per doz. R.I.3 to 1 L.F. transformers, 6/-; condensers, 1 M.F., 1/3; 2 M.F., 2/-; 4 M.F., 3/6; 10 M.F., 5/6 each; smoothing chokes, 20/30 henrys, 80/100 m/amps., 8/6; electrolytic condensers, 80 M.F. 350 v. w/g., 7/6; 500 M.F. 50 v. w/g., 8/6.

SMALL ELECTRIC MOTORS, 80/100 volts A.C., D.C. approx. 1/20 h.p. 2,500 r.p.m., size 5 1/2 in. by 3 1/2 in. diameter, D.E. shaft, suitable for sewing machines, Pathe cines etc., 30/- each.

MAIN TRANSFORMERS, 200/250 v. Primary, 500/0/500 v. at 150 m/a., 4 v. 4 a., 5 v. 3 a. and 6 v. 5 amps., 55/- . Ditto, 350/0/350 volts at 100/120 m/amps, 4 v. 4 a., 5 v. 2 a., 6.3 v. 4 amps., 32/6. Ditto, 6 and 12 volts at 3.4 amps., 30/- each.

EX-GOVT. ROTARY CONVERTERS, input 12 to 18 volts D.C. at 3 1/2 amps., output 450 volts 60 m/amps., fitted with automatic switching and smoothing, 32/6 each. 2/6 carriage. Also a few only to clear, as above, but without brushes or brush caps, at 20/- each, post 2/6.

ROTARY CONVERTERS. Ex-Govt. 80 volts at 16 amps. D.C. input, 80 volts at 8 amps, 2,000 cycles output, £5 each, carriage 10/- . Another, 460 volts D.C. input, output 300 volts 50 cycles 1 phase at 4 kilowatts, constant rating, condition as new, £35, C.F.

LARGE SIZE 1 MFD. CONDENSERS, at 4,000 v. w/g., 10/- each, carriage 2/6. Selenium Rectifiers, output 200 volts at 1 amp., half-wave type, 27/6 each. Instrument Rectifiers, 5 m/a., and 10 m/a., 4/6 each. Ex-G.P.O. Multi-Contact Relays, 5/- each.

USEFUL PANELS, consisting of chokes, resistances, mod. transformers, condensers, calibrated to decibels, and various other components, all mounted on metal baseplate, size 19 x 5 x 10, each, post 2/6; 19 x 8 x 5, 15/- each, post 2/6; 19 x 12 x 5, 20/- each, carriage 3/6. All components as new. Makers Standard Telephone.

ROTARY CONVERTERS, D.C. to A.C., 20 volts D.C. to 75 volts A.C. at 250 m/amps., large size, weight 45 lbs., well-known makers, make useful rewinds, 45/- each, 5/- carriage.

X-RAY TRANSFORMERS, 100/250 volts 50 cy. 1 ph. input, 90 kv. at 2 1/2 xW. output, with Coolidge winding, small size, in oil, £25 each. Carriage forward.

EX-G.P.O. 2-TONE CONTROL UNITS. Consisting of 3 6v6's in Class AB—2 6v5G's, 8 WX6 Westectors, power pack, consists of Mallory 12-volt rectifier with all the necessary smoothing gear, numerous condensers and resistances, all in new condition, £5/10/- each C.P.

VARIABLE RESISTANCES, worm wheel drive, 2,000 ohms, to carry 250 m/amps, 35/- each. Electrolytic Condensers, 2,500 mf., 25 w. w/g., 25/- each; 250 mf. 250 v. w/g., 15/- each.

EX-G.P.O. PORTABLE SINGLE CHANNEL CARRIER TELEPHONE SYSTEM, TYPE SOG-1A (Active). These units are new and unused, consisting of all valves, 6D6, and cold rectifier, A.C. mains input, complete in metal case, 14 1/2 x 11 1/2 x 11 in., price £3/10/- . Carriage 5/-.

ERNEST TURNER, moving coil m/amp. meters, 2 in. scale, 0 to 10 m/a., 0 to 20 m/a., 0 to 50 m/a., 27/6 each; all fully guaranteed.

EX-G.P.O. MOVING COIL GALVANO-METERS, 25/- each, polarised galvos., 7/6 each, multi-contact relays 5/- each, low resistance single earphones, 3/- each, multi-leaf Dewar switches, 4/6 each.

CONDENSERS. 4 m.f. 300 v. A.C., w/g., sold in dozen lots only at 24/- per dozen. Mallory Vibrators 12 v. 4 pin type 7/6 each, low tension chokes, small type, useful as rewinds 3/6 each.

ROTARY CONVERTOR by well known maker, 110 volts D.C. input 230 volts at 350 watts A.C. output, new condition, £20. C.F.

Other items in stock, for which please let us quote. 250 watt Transmitter Valves, Battery Valves, Switchboard Volt and Ampmeters, Dynamos, Regulators, Transformers to your requirements, complete X-Ray Apparatus, etc., etc. Please note that all items advertised are guaranteed unless otherwise stated. Terms strictly cash with order. C.O.D. not accepted.

100 kcs.
QUARTZ
CRYSTAL
UNIT
Type
Q5/100



for Secondary Frequency Standards

★ Accuracy better than 0.01%. ★ New angles of cut give a temperature coefficient of 2 parts in a million per degree Centigrade temperature change. ★ Vitreous silver electrodes fired direct on to the faces of the crystal itself, giving permanence of calibration. ★ Simple single valve circuit gives strong harmonics at 100 kcs. to 20,000 kcs. ★ Octal based mount of compact dimensions.

PRICE 45/- Post Free

Full details of the Q5/100, including circuit, are contained in our leaflet Q1. Send stamp to-day for your copy.

THE QUARTZ CRYSTAL Co., Ltd.
43-71 Kingston Road,
NEW MALDEN, SURREY
Telephone: MALden 0334

**TRANSFORMERS & COILS
TO SPECIFICATION.**

MANUFACTURED OR REWOUND.
JOHN FACTOR LTD.,
(Formerly Stanley Cattell Ltd.),
9-11 East Street, **TORQUAY, Devon**
Phone: Torquay 2162.

Beethoven
ROTARY CONVERTORS
220 D.C. to 220 A.C.
Dedicated from
BEEHOVEN ELECTRIC EQUIPMENT LTD.
Beethoven Works, Chase Road, London, N.W.10

**EX AIR MINISTRY
Components**

-  **THERMO COUPLED RF AMMETERS, '5 amp. 2" dial, by leading makers. 15/-**
-  **MOVING COIL METERS, 0m.a. scale; movement .m.a. shunted, 2" dial, by leading makers. 15/-**
-  **3-GANG CONDENSER, 50 mmfd per section extension shaft and knob. 7/6**
- 2-GANG ditto. 5/6**
-  **RELAY D.P.C.O. with activating coil. 2/6**

Post Orders add 9d.

Write for list of other bargains.
THE STAMFORD RADIO CO.
199 STAMFORD STREET,
ASHTON-UNDER-LYNE, LANCs.
Telephone: ASHTon 1964.

LABORATORY engineers are required for development work on broadcast receivers; the laboratory is South West of London, 50 minutes from Waterloo; please write, stating age, salary expected, experience and qualifications.—Box 6705. [7080]

DESIGNER draughtsman required by Philips Laboratories, experienced in communications equipment (electrical and mechanical).—Apply in writing, giving full particulars, to Philips Transmission, Ltd., Brathway Rd., London, S.W.18. [6909]

DEVELOPMENT engineers required by firm in the Manchester area; applicants must have had experience in development of radar equipment and preferably some knowledge of Gee.—Please reply, giving full particulars of age, qualifications and experience, Box 6935.

NATIONAL company require radio service engineers of proved technical ability for permanent situations in various parts of the country; opportunities for promotion.—Write, giving full particulars and area preferred or whether willing to move elsewhere, to Box 6987. [7164]

CHIEF engineer required for company manufacturing radio test equipment, to take full charge of design of new equipment; also responsible for testing departments and quality control.—Apply, giving age, experience, technical qualifications and salary required, to Box 6855. [7102]

REQUIRED by factory in London a senior radio engineer with sound technical training and experience of high power high frequency engineering, for development of industrial electronic equipment.—State qualifications, experience, age and salary required to Box 6862. [7127]

YOUNG, energetic man with supervisory experience and technical background in light electrical production, to train to take control of manufacturing plant employing approximately 100 females, North-east Coast.—Write, stating age, salary and full details of experience.—Box 6980. [7151]

DRAUGHTSMEN and tracers required with exp. in prod. of working drawings from data supplied by designer; (1) mech. draughting (2) elect., preferably with exp. on radio comm. equipment; workshop exp. preferred.—Apply, in writing, giving full details, to Philips Transmission, Ltd., Brathway Rd., S.W.18.

SENIOR draughtsman required, with experience in light electrical engineering, for work on prototype equipment in connection with television transmitters; detail draughtsman also required for similar work.—Apply by letter only to the Research Laboratories of the General Electric Co., Ltd., N. Wembley, Middlesex. [7041]

ELECTRICAL draughtsman or engineer required with knowledge of public address equipment and the ability to prepare the theoretical and practical wiring diagrams, part lists, etc., necessary for large installations; some knowledge of drawing office practice an advantage; write, stating full particulars of qualifications and experience, also age and salary required.—Box 6706. [7081]

SERVICE department manager wanted for established radio manufacturers in London due to retirement of present manager; thoroughly experienced service engineer required, with knowledge of all makes radio and television; good organising ability and flair for correspondence; only men who have held previous similar position need apply; good prospects and working facilities; applications treated in strict confidence; write, stating fullest particulars, and salary reqd.—Box 6054.

LABORATORY assistant required for acoustics laboratory dealing mainly with hearing aid investigations; applicants should be between 20 and 30 years of age, should hold a National or Higher National certificate in Engineering or Electrical Engineering, or have had equivalent experience; initiative and adaptability are more essential qualifications than previous experience of audio-frequency work; salary according to qualifications, with superannuation.—Apply Secretary, National Institute for the Deaf, 105, Gower St., W.C.1.

DEVELOPMENT engineers, 22-28, with practical experience in electro-acoustic and audio-frequency work wanted for established manufacturer in Guildford-Farnham area; must have had at least three years' industrial experience in similar position, ability to tabulate and analyse results, capable of tracing bibliographically previous developments and of carrying an assignment through from start to finish; write, giving full details of experience, age, etc.; only those applicants complying with the above conditions can be considered; salary commensurate with ability and experience.—Box 6394. [6957]

HILL & CHURCHILL LTD
BOOKSELLERS
SWANAGE, DORSET

Available from stock:—

- Rider "Inside the Vacuum Tube" - - - 30/-
 - "Radio Handbook" tenth Edition, Cloth - - - - - 17/6
 - Hudson, "Introduction to Electronics" 15/-
 - Almsted, Davis & Stone, "Radio" (Fundamentals and Practices) - - - 12/-
 - (All above titles are American)
 - Missen, "Elementary Telegraphy" - - 12/6
 - Perkins, "Modern Telegraph Systems and Equipment" - - - - - 10/6
 - Perkins, "Telecommunications" - - - 12/6
 - Smith, "Radio Designers Handbook" 10/6
- Postage Extra.

We have a large selection of English and American Books on RADIO and TELECOMMUNICATION.

CATALOGUE ON APPLICATION

REWINDS
Armatures, Fields, Transformers, Pick-ups, Vacuum Cleaners, Gram Motors, Speakers Refitted New Cones & Speech Coils.
All Guaranteed and promptly executed. New Vacuum Cleaners, most popular makes. Send stamped addressed envelope for list of Radio Spares, and C.O.D. Service.
A.D.S. Co. 261-3-5, Lichfield Road, ASTON, BIRMINGHAM, 6

BATTERY CHARGERS and TRICKLE CHARGERS
Trouble-free Chargers fitted with selenium all-metal rectification. Good allowance on your old Charger. Thirty years experience behind every Runbaken product. Booklet R.15 describing 12 Models, on request.
RUNBAKEN MANCHESTER 11

RADIO CLEARANCE
Valve Holders, Paxolin, B.V.A., 4-pin, 4/- doz.; 5- and 7-pin, 5/- doz. Octal Mazda, 8/6 doz. U.S.A., 4, 6, 7- and 7-pin, Octal, 8/6 doz. Amphinol, 5-pin, B.V.A., Octal Mazda, 7/- doz.
Condensers (10z.)—4 x 600, 60/-; 2 x 350, 18/-; 25 x 600, 6/8; 25 x 350, 5/8; 17 x 250, 4/6; 1 x 500, 6/8; 01 x 1,000, 5/8; 02 x 750, 5/8; .002 x 1,000, 8/8. 75 P.F. mica, 5/8; 100, P.F. Ceramic, 7/8.
Trimmer Condensers—30 P.F., 8/-; 50 P.F., 12/6; 70 P.F., 14/6; 100 P.F., 16/6. All per doz.; 50,000 ohms, 17/- doz.
Speakers—5-in., P.M., 19/- each; 6-in., P.M., 24/- each; 8-in., Rola, 24/- each.
Yaxley Type Switches—1-pole, 3-way, 20/- doz.; 4-pole, 3-way, 40/- doz.
Telsen Flush Switch—4-point, 2-pole, 16/- doz.
Line Cord—3-way, 2/- per yard; 2-way, 1/6 per yard; 40 ohms, per ft.
Sleeving—14 mm., 2/- doz yards.
Sleeving Screened Single, 11/- doz. yards. Twin 15/- doz. yards.
Chokes—R.F., short-wave, 18/- doz.
Cabinets Midget (polished)—35/- each.
VALVE MANUAL—B.V.A. and American Types, with valve base, diagrams and service guide. Equivalent tables, all the "gen" you require for valves, 2/6 each.
10,000 Valves 10,000
Valves at Board of Trade prices. Retailers not supplied.
Orders, not accepted in less than 1 doz. quantities, if priced in doz. lots. C.W.O. or C.O.D.
H. RANSOM,
34, BOND STREET, BRIGHTON.
B'ton 3603.

SENIOR Service engineer required by Murphy dealer; must have first-class technical ability and practical radio and television experience; progressive position.—Write, giving full details and salary expected, Leake & Hickmott, 63, High St., Sidcup, Kent. [7040]

SITUATIONS WANTED

EXECUTIVE A.M.I.E.E., age 35, radar, radio, light electrical, requires change; salary £780.—Box 6393. [6956]

REPRESENTATIVE, travelling or similar, 13 years' servicing, desires change, Midlands preferred.—Box 6709. [7092]

R.A.F. wireless mech. (35), 5½ yrs' service, seeks sale and service, or other opportunity.—Taylor, 4, Edward Rd., E. Bedford., Middx. [7171]

GRAD. (British) I.R.E., ex-R.A.F. Cpl. W/M., with 2 yrs. civilian experience, age 26, fluent French and German, seeks post anywhere.—Box 6699. [7068]

RADIO engineer, Grad. I.E.E., A.M.I.E.E., age 34, 8 years in Far East in civil capacity, desires responsible, progressive post, Far East preferred.—Box 6934. [7132]

RADIO technician, 10 years' wide experience, including research, development, lab. maintenance, requires progressive post London area.—Box 6702. [7074]

BUYER, age 36, executive with radio and lighting manufacturers, requires similar position; can also take charge of transport and general office management.—Box 6053. [6893]

COMPETENT television and radio engineer, 7 years' pre-war experience, 1st class C. and G. Service Certificate, now with manufacturer, desires field service position; N, W or S.W. London area; own car; salary £7 week and car expenses.—Box 7021. [7174]

AVAILABLE to firm of excellence, services of qualified radio technician, with wide knowledge of salesmanship, business expansion and allied interests, unlimited experience with servicing matters; full responsibility taken; controlling interest preferred.—Box 6982. [7051]

EX-R.A.F. Flight Sergeant, radar mechanic, age 32, 8 years' pre-war radio experience, high standard of technical knowledge, desires progressive position; South Lancashire preferred, but not essential.—Box 6701. [7073]

RADAR Officer (38), amateur transmitter, 12 years' pre-war exp. in sales, service and retail management, seeks situation as retail shop or service dept. manager, or similar post where technical ability, business sense, and initiative can find reasonable remuneration; available April.—Box 6695. [7051]

TECHNICAL TRAINING

A.M.I.E.E., City and Guilds, etc., on "No Pass—No Fee" terms; over 95% successes; for full details of modern courses in all branches of electrical technology send for our 112-page handbook, free and post free.—B.I.E.T. (Dept. 388A), 17, Stratford Place, London, W.1. [6270]

TUITION

THE British National Radio School OFFERS you a career.

WRITE to-day for free booklet describing our wide range of training courses in radio, Radar, telecommunications, principles, mathematics, physics, and mechanics; correspondence and day classes for the new series of C. & G. examinations; we specialise in turning "operators" into "engineers," and for this purpose our "Four Year Plan" (leading to A.M.I.E.E. and A.M.Brit. I.R.E., with 9 C. and G. Certificates as interim rewards) is unsurpassed; "our guarantee has no strings attached."—Studies Director, B.Sc., A.M.I.E.E., M. Brit. I.R.E., 66, Adiscombe Rd., Croydon, Surrey. [6811]

ENGINEERING careers and qualifications.

BOTH Government and industry have announced and emphasised that young men with technical knowledge and qualifications must receive every chance to rise to the highest positions within their capacity, in post-war engineering and allied industry; write to-day for "The Engineer's Guide to Success"—200 courses free—which shows you how you can become A.M.I.E.E., A.M.I.A.E.E., A.M.I.Mech.E., A.F.R.Ae.S., etc., and covers all branches in radio, automobile, mechanical, electrical, production, aeronautical, etc.

THE Technological Institute of Great Britain, 82, Temple Bar House, London, E.C.4. [4918]

RADIO training.—P.M.G. exams, and I.R.E. Diploma; prospectus free.—Technical College, Hull [0611]

THE Institute of Practical Radio Engineers have available Home Study Courses covering elementary, theoretical, mathematical, practical and laboratory tuition in radio and television engineering; the text is suitable coaching matter for I.P.R.E. Service entry and progressive exams; tuitionary fees at pre-war rates—are moderate.—The Syllabus of Instructional Text may be obtained, post free, from the Secretary, 20, Fairfield Rd., Crouch End, N.8. [6722]

Magnetic Pick-ups



Mod. GP-6. Cosmocord's new Magnetic Pick-up and Head, Model G-P7. Designed for good quality reproduction. New arm construction giving vibration-free suspension and adjustable needle-pressure. List prices in Gt.

Britain, GP-6 27/- plus P.T., GP-7 21/- plus P.T.



COSMOCORD products are the result of long experience in manufacture and design of electric-acoustical components by

COSMOCORD LTD · ENFIELD · MIDDX · ENGLAND



★ From your Radio Dealer when supplies are more plentiful.

HIGH VOLTAGE COMPONENTS

Half Wave Valve Rectifiers, 6,000 volts.....	10/6
4-pin Ceramic Bases for same	1/3
.1 MFD 8,000v. working Tubular Condensers..	12/6
.1 MFD 6,000v. working Square Can Type ...	8/6
.03 MFD 3,000v. working 8,000v. Test Tubular	5/6
.02 MFD 5,000v. working 10,000v. Test Tubular	6/6
.001 MFD 5,000v. working 10,000v. Test Tubular	4/6
.001 MFD 5,000v. Test Meadon Flat Moulded..	2/9
Moving Coil Meter, 3½in. square face, 20,000 O.P.V. scale calibrated 0-5 kV. and 0-10 kV.	27/6
Television Test Set, 0-3 and 0-10 kV.....	23 17 6

Cash with order or C.O.D. Send stamp for illustrated comprehensive price list.

V.E.S. CO., RADIO HOUSE, RUISLIP, MIDDX

NON-MAGNETIC TURNTABLES

with **STROMBOSCOPIC MARKING**
An essential accessory for serious **PICK-UP DESIGN RESEARCH**

SOUND SALES LIMITED

57 St. Martin's Lane, London, W.C.2
Temple Bar 4284

Works: Farnham, Surrey

Partners in Creation

"LOWTHER-VOIGT"

Electronic Equipment and Accessories.

Loudspeakers and Pickups.

Demonstrations daily at

THE LOWTHER MANUFACTURING CO.

Lowther House, St. Mark's Road, BROMLEY, KENT.

Rav. S225

COVENTRY RADIO

COMPONENT SPECIALISTS SINCE 1925.

HAVE YOU RECEIVED OUR

1947 LIST

OF RADIO COMPONENTS?
THE MOST COMPREHENSIVE LIST AVAILABLE TODAY.

PRICE 3d. POST PAID.

COVENTRY RADIO,
DUNSTABLE ROAD, LUTON, BEDS.

"ENGINEERING OPPORTUNITIES"



This unique handbook shows the easy way to secure A.M.I.Mech.E., A.M.Brit.I.R.E., A.M.I.E.E., City and Guilds, etc.

WE GUARANTEE—"NO PASS—NO FEE."

Details are given of over 150 Diploma courses in all branches of Civil, Mech., Elec., Motor, Aero., Radio, Television and Production Engineering, Tracing, Building, Govt. Employment, R.A.F. Maths., Matriculation, etc.

Safeguard your future; send for your copy at once—FREE.

B.I.E.T., 387, SHAKESPEARE HOUSE, 17, STRATFORD PLACE, LONDON, W.1.

"ENGINEERING opportunities."—Have you had your copy of this free guide to A.M.I.Mech.E., A.M.I.E.E., and all branches of engineering, building and plastics? Become technically trained on "no pass—no fee" terms for higher pay and security.—For free copy write B.I.E.T. (Dept. 587B), 17, Stratford Place, London, W.1. [6939]

RADIO Engineering, Television and Wireless Telegraphy, comprehensive postal courses of instruction.—Apply British School of Telegraphy, Ltd., 179, Clapham Rd., London, S.W.9 (Est. 1906). Also instruction at school in wireless for H.M. Merchant Navy and R.A.F. [9249]

AGENCIES
WHOLESALERS with offices and stock-rooms, West End, London, are desirous contacting manufacturers in view sole selling agency.—Box 6707. [7082]

SOLE concessionaires car radio appointing agents counties North of line Severn to Wash and London area.—Communicate Disposals, Ltd., 122, Southwark St., S.E.1.

SOUTH Africa; engineer, M.A. (Cantab), wide experience of communication equipment and electronic devices, offers manufacturer representation in the sub-continent; installation and service facilities will be provided if required; write, full particulars, to: Box 7059. [7180]

BOOKS, INSTRUCTIONS, ETC.
RADIO TUBE VADE MECUM, by P. H. Brans, 12/6, an international reference handbook for obsolete to modern types; free quarterly supplement service.
THE Modern Book Co. (Dept. W.), 19-23, Praed St., London, W.2. [6865]

—RADIUM SCINTILLOSCOPES—

showing proof, and effect, of atoms continuously exploding, by numerous powerfully expelled completely invisible alpha particles causing unceasing show of brightly flashing points of light, on hitting round luminous screen, latter viewed through lens system. Continuous action, radium remains active a thousand years: compact well-made instrument, nickel tube 2" long x 1" dia., can be taken to pieces for viewing parts, reg. post free 30/-, inc. interesting leaflet on radioactivity.—Cefa Instruments, 38a York St., Twickenham, Middx. POPesgrove 6597.

—3 IMPORTANT AMERICAN BOOKS—

GHIRADI'S "MODERN RADIO SERVICING"
35/- (postage 1/-)

GHIRADI'S "RADIO PHYSICS COURSE"
35/- (postage 1/-)

CAMERON'S "SERVICING SOUND EQUIPMENT" including Public Address, Radio, Television (1946)
50/- (postage 1/-)

Limited supplies of these authentic textbooks are in stock. Enquiries invited:—

AMERICAN TECHNICAL BOOK CO.
37a, Kensington High Street, London, W.8
WESTern 0781/2

WARD ROTARY CONVERTERS

For Radio, Neon Signs, Television, Fluorescent Lighting, X-ray, Cinema Equipment and innumerable other applications

We also manufacture:—

Petrol Electric Generating Plants, H.T. Generators, D.C. Motors, etc., up to 25 K.V.A.

CHAS. F. WARD
37, WHITE POST LANE, HACKNEY WICK, E.9
Telephone: Amherst 1393

HARTLEY-TURNER
HIGHEST FIDELITY SERVICE

Following on our March announcement the plan of our high-fidelity service is taking shape. We believe that catering for intelligent customers needs an intelligent manufacturer. Probably our store of technical knowledge is greater than that of any one of you but infinitely less than that of all. To provide the service you want calls for co-operation, and our plan is the very antithesis of "take it or leave it". The past six months have re-established friendships all over the world, and we want to make new friends. Soon we shall send our plan to everyone on our list. If your name is not on it you will miss something. Start by sending for the leaflet on our

SPEAKER: MODEL 215—£9.

H. A. HARTLEY CO. LTD.
152 HAMMERSMITH RD., LONDON, W.6

ALUMINIUM CHASSIS



An engineering job, not just a folded sheet of metal. Fitted with steel straps, for extra rigidity, and tapped 2 B.A. for cabinet fixing. Open ends give greater accessibility for assembly and wiring. Light, strong, easy to work. Being free from rust or paint, as with cheap sheet-iron chassis, you get perfect bonding and earthing.

PLEASE NOTE REVISED PRICES

Undrilled, 5 1/2 in. x 9 1/2 in. x 2 1/2 in. deep	5/6
Undrilled, 7 in. x 7 in. x 2 in. deep	5/9
Undrilled, 11 in. x 7 in. x 2 in. deep	6/6
Undrilled, 12 in. x 9 in. x 3 in. deep	7/8
Undrilled, 17 in. x 10 in. x 2 in. deep	8/8
Undrilled, 17 in. x 10 in. x 2 in. deep in heavy (18) gauge	9/6
Punched, 10 in. x 5 1/2 in. x 2 in. deep for Midget Radio, with aperture for 6 in. Speaker and seven 1 1/2 in. holes	6/6

Packing and Postage 1/- each Chassis extra. C.W.O. Orders despatched on day of receipt, no waiting.

WIRELESS SUPPLIES UNLIMITED
284-286, Old Christchurch Rd., Bournemouth, Hants.

EME

for your individual requirements in **ELECTRONIC EQUIPMENT**

EXAMPLE—A Current Impulse Generator giving a Rectangular Wave Form with Amplitude, Frequency and Duration Control.

THE ELECTRO MEDICAL EQUIPMENT LABORATORY CO., LTD.
247-9 Burnt Oak Broadway, Edgware, Middlesex
Telephone: EDGware 0724

 **UNIT OSCILLOSCOPE**

A NEW CONCEPTION OF INDUSTRIAL NEEDS

Interchangeable Amplifiers and Time Bases with a wide range of accessories cover every application. No loose wires, no unwanted controls, no complex switches, but standard snap-on units give rigid assembly with tailor-made performance.

LYDIATE ASH LABORATORIES
RESEARCH AND DEVELOPMENT ENGINEERS
Nr. BROMSGROVE
Telephone: Rubery 168/169

Printed in Great Britain for the Publishers, LITTLE AND BONS LTD., Dorset House, Stamford Street, London, S.E.1, by THE CORNWALL PRESS LTD., Faria Garden, Stamford Street, London, S.E.1. "Wireless World" can be obtained abroad from the following:—AUSTRALIA and NEW ZEALAND: Gordon & Gotch, Ltd. INDIA: A. H. Wheeler & Co. CANADA: Imperial News Co.; GORDON & GOTCH, Ltd. SOUTH AFRICA: Central News Agency, Ltd.; WILLIAM DAWSON & BONS (S.A.), Ltd. UNITED STATES: The International News Co.

TCC

PAPER DIELECTRIC *Tropical* TUBULAR CAPACITORS



It is important that the condenser C, should have a high insulation resistance if the reading is not to be affected by D.C. potentials in the circuit to which

Electrical circuit using the meter. Resistances R3 are made equal to the meter resistance.

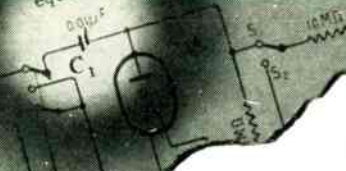

"METALMITE" (Miniature) TUBULAR PAPER CAPACITORS

Capacitance mFds.	Working Voltage D.C.		Dimensions Inches		Type No.	List Price each
	at 71°C.	at 100°C.	Lgth.	Dia.		
.001	500	350	1	.2	CP30S	1/9d.
.002	500	350	1	.2	CP30S	1/9d.
.005	500	350	1	.25	CP32S	1/10d.
.01	500	350	1	.34	CP33S	1/10d.
.02	500	350	1 1/2	.34	CP34S	1/10d.
.05	500	350	1 1/2	.3	CP36S	2/1d.
.005	350	200	1	.22	CP31N	1/8d.
.01	350	200	1	.25	CP32N	1/8d.
.02	350	200	1	.34	CP33N	1/9d.
.05	350	200	1 1/2	.3	CP35N	2/-
.1	350	200	1 1/2	.36	CP37N	2/3d.
.05	200	120	1 1/2	.34	CP34H	1/11d.
.1	200	120	1 1/2	.3	CP36H	2/2d.

"METALPACK" TUBULAR PAPER CAPACITORS

Capacitance mFds.	Working Voltage D.C.		Dimensions Inches		Type No.	List Price each
	at 71°C.	at 100°C.	Lgth.	Dia.		
.001	1000	750	1 1/2	.3	CP49W	1/10d.
.002	1000	750	1 1/2	.3	CP49W	1/10d.
.005	1000	750	1 1/2	.3	CP45W	1/10d.
.01	1000	750	1 1/2	.3	CP45W	1/10d.
.02	750	500	1 1/2	.3	CP45U	1/10d.
.05	500	350	1 1/2	.3	CP45S	2/1d.
.1	350	200	1 1/2	.3	CP45N	2/1d.
.1	500	350	2 1/2	.3	CP46S	2/2d.
.1	1000	750	2 1/2	.3	CP47W	2/6d.
.25	350	200	2 1/2	.3	CP48N	2/8d.
.25	500	350	2 1/2	.3	CP47S	2/10d.
.5	350	200	2 1/2	.3	CP47N	3/-
.5	500	350	2 1/2	.3	CP91S	3/10d.
1	350	200	2 1/2	.3	CP91N	4/-

FOR the ever-increasing applications where the maintenance of a high value of insulation resistance is of paramount importance, the T.C.C. "METALPACK" Tropical and "METALMITE" Miniature Tropical types are indispensable. By virtue of the aluminium tube, hermetically sealed construction, the initial insulation is maintained, even under the most arduous climatic conditions.

THE TELEGRAPH CONDENSER CO. LTD.

RADIO DIVISION

NORTH ACTON · LONDON · W·3

Telephone. ACORN 0061

KING OF THE SET

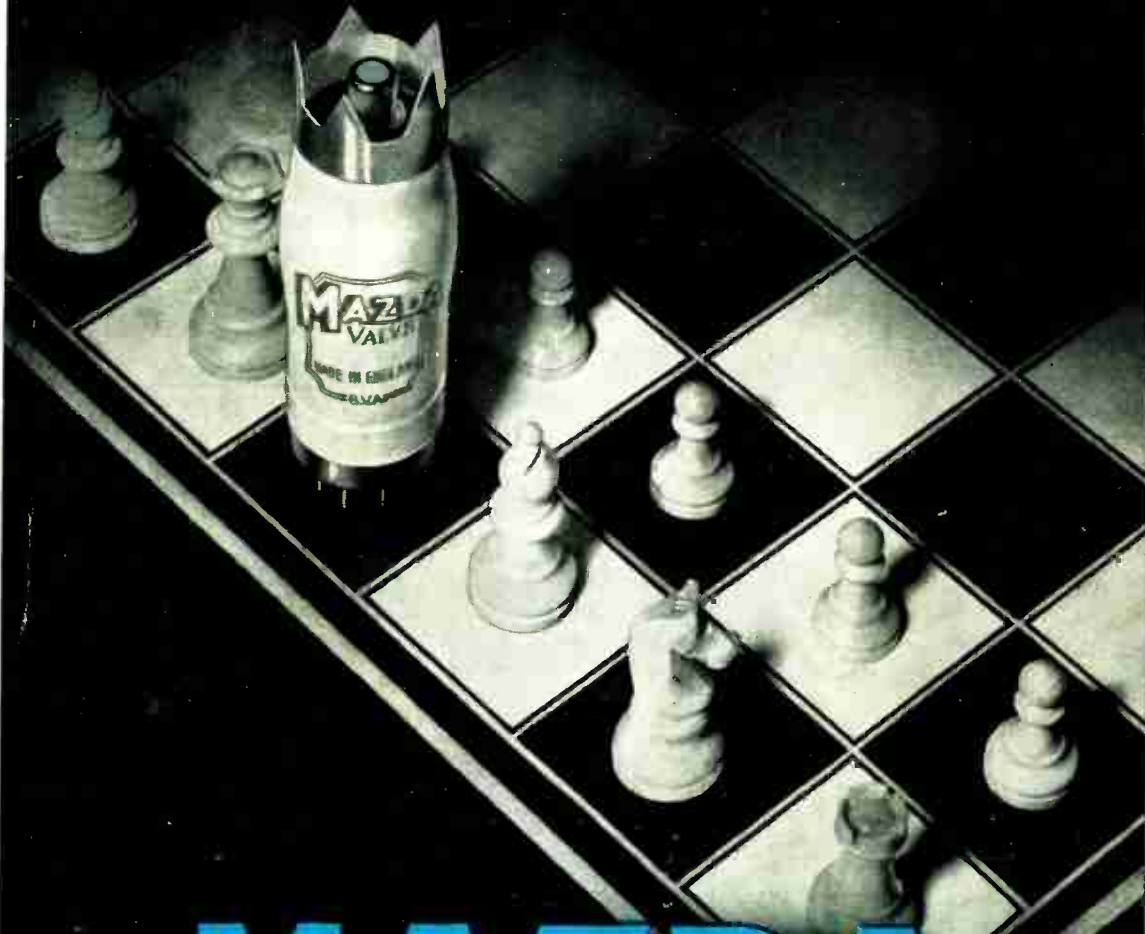

MAZDA

RADIO VALVES AND CATHODE RAY TUBES

THE EDISON SWAN ELECTRIC CO. LTD.  155 CHARING CROSS RD., LONDON W.C.2
(R.M. 42)