

Wireless World

RADIO and ELECTRONICS

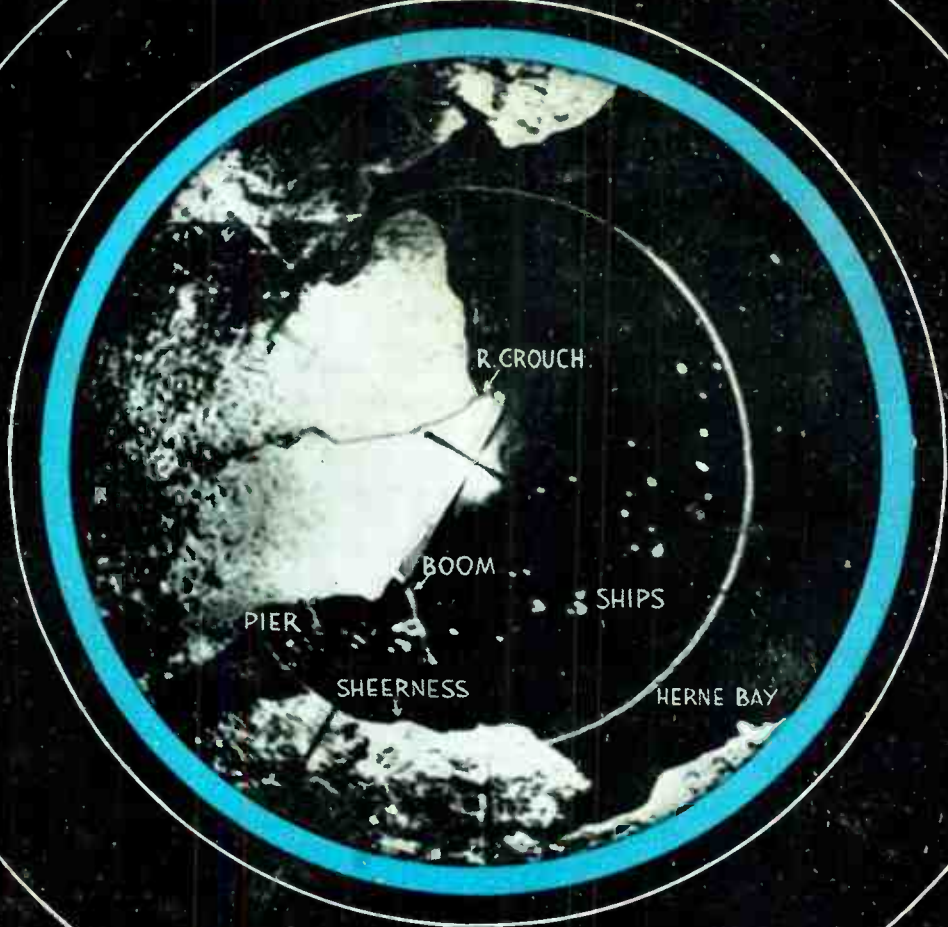

DEC. 1945

1/6

Vol. LI. No. 12

IN THIS
ISSUE:

AC/DC QUALITY AMPLIFIER



Rola Components

*The best you can buy -
made by the organisation
with the greatest experience*

BRITISH Rola LIMITED
GEORGIAN HOUSE, BURY STREET, ST. JAMES'S
LONDON S.W.1. ENGLAND



Regd. Trade Mark

PRECISION

TESTING INSTRUMENTS

HIGH accuracy, simplicity, exceptional versatility and proven reliability have won for "AVO" Instruments a world-wide reputation for supremacy wherever rapid precision test work is demanded. There is an "AVO" Instrument for every essential electrical test.



The **MODEL 7 50-Range Universal**
AVOMETER

Electrical Measuring Instrument

A self-contained, precision moving-coil instrument, conforming to B.S. 1st Grade accuracy requirements. Has 50 ranges, providing for measuring A.C. & D.C. volts, A.C. & D.C. amperes, resistance, capacity, audio-frequency power output and decibels. Direct readings. No external shunts or series resistances. Provided with automatic compensation for errors arising from variations in temperature, and is protected by an automatic cut-out against damage through overload.

Sole Proprietors and Manufacturers

THE AUTOMATIC COIL WINDER & ELECTRICAL EQUIPMENT CO. LTD., Winder House, Douglas Street, London, S.W.1. Phone: VICTORIA 3404/8

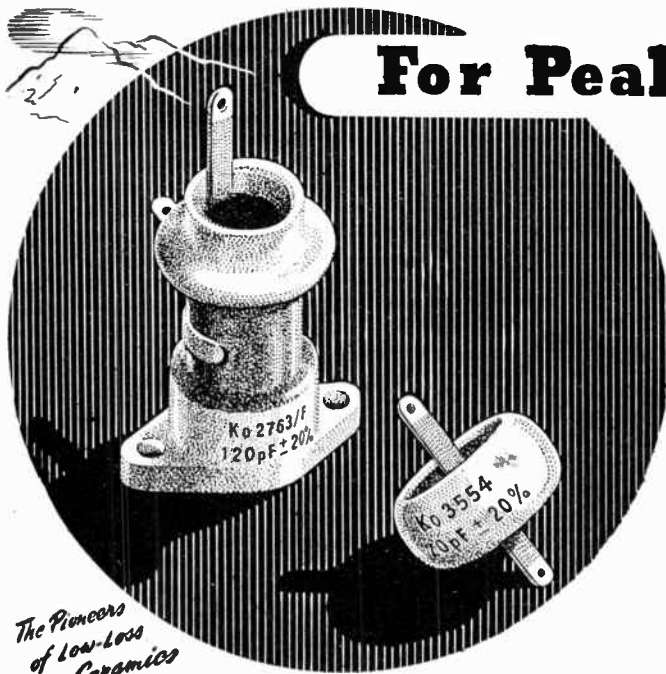

*The Pioneers
of Low-Loss
Ceramics*

For Peak Performance
with High Voltages

U.I.C. Fixed Ceramic Pot and Plate Capacitors have been primarily developed for use in transmitter circuits. Made only from the highest grade raw materials and subjected to the most rigorous mechanical and electrical inspection, their performance especially with H.F. loads and high voltages is unsurpassed. TYPE APPROVED. Full details on request.



CERAMIC
'High-Voltage'
CAPACITORS

UNITED INSULATOR CO. LTD., 12-22 LAYSTALL ST. LONDON, E.C.1.

Tel. TERminus 7383 (5 lines)

Grams: Calanel, Smith, London

Technical Reasons Why

**★ ERSIN
MULTICORE SOLDER**

Is the Finest Cored Solder in the World

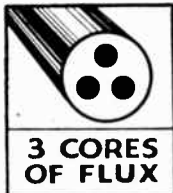

Three Cores of Flux ensure flux continuity. No lengths without flux are wasted. Consistent high quality joints are obtained with comparatively unskilled labour. Exactly the correct proportions of solder to flux are provided. Separate fluxing operations are obviated and no extra flux is required. The three cores of flux being evenly distributed over the cross section of the solder provide thinner

solder walls than otherwise. This gives rapid melting and speeds up soldering. The flux does not tend to run out of the cores; so there is always a supply available for the next joint. The utmost economy of solder and flux is achieved.



Ersin, contained in the three cores of Ersin Multicore Solder, is the fastest non-corrosive flux. Possessing all the non-corrosive advantages of rosin, it enables joints to be speedily made on oxidised or "difficult" surfaces such as nickel. Ersin not only avoids oxidation during soldering but removes surface oxide already present—this is particularly advantageous in respect of materials that

have been in stock or apparatus that is being serviced. The use of Ersin Multicore, with correct soldering technique, avoids "HR" or dry joints.

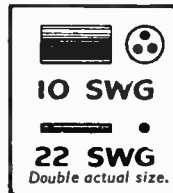

Ersin Multicore Solder is made in most gauges between 10 and 22 S.W.G. (.128—.028") (3.251—7109 m/ms). For general radio and electrical production and maintenance 13 and 16 S.W.G. are in most demand.

**Virgin
Tin & Lead**

Five alloys of Ersin Multicore Solder, made from virgin metals, are available—all antimony free. Under present circumstances 45% tin and 55% lead is the most widely used alloy.

Technically, Ersin Multicore Solder is far superior to any other cored solder. A practical laboratory or production test will demonstrate this and show you that it is the most economical solder to use. The majority of British and overseas manufacturers already enjoy the advantages of Multicore. If you do not, and are engaged upon Government contracts, write for further technical information and free samples.

Single reel rate nominal 1 lb. reels.

13 SWG - 4/10

16 SWG - 5/3

Above prices subject to usual trade discount.

‡ cwt.—ton lots at bulk rate. 6d. cartons for home use, available at most good radio and electrical dealers, ironmongers, etc.

MULTICORE SOLDERS LTD.

Mellier House, Albemarle St., London, W.1.

REGent 1411 (P.B.X. 4 Lines).



Slow-Motion Dials

High grade reduction drives have been in short supply. We can now offer famous Burndept slow-motion dial, dual ratio, panel mounting instrument type, calibrated degrees, 3½ in. overall diameter **12/6**

Four-Gang Condensers

Ceramic insulation, 300 m.mfd. per section, capacity increases anti-clockwise **17/6**

EDDYSTONE

Specialised radio components are now becoming easier in supply. New designs keep EDDYSTONE the pre-eminent name in Short-wave technique.

Flexible Driving Shaft

Type S530. Frequentite insulation, drives through 90 deg. Length adjustable between 4½ in. and 6 in. **5/-**

H.F. Chokes

Type 1010. The best S.W. choke, 5/180 metres **2/-**

Type 1022. Transmitting 250 m.a. . . **3/-**

Type 1011. U.H.F., 2.5 to 12 metres . . **1/6**

Type 1066. All Wave Choke, 12.5 to 2,000 metres **2/9**

Neutralising Condensers

Type S481. New and compact design, size 1½ in. x ½ in. x 1½ in. high. 1.5 to 4 m.mfd., Frequentite insulation, silver plated brass. 2,000 v. R.M.S. max. . . **3/6**

Insulators

Type 916. Beehive type stand-off . . **1/3**

Type 999. Aerial, low leakage type **1/-**

Type 1019. Midget stand-off **6d.**

Type 1018. Cone type lead through.. **1/3**

Temporary leaflet showing other available EDDYSTONE components 2½ d. post free.

**14 Soho Street, Oxford Street,
London, W.1**

Telephone: Gerrard 2089

We are available 9 a.m. till 6 p.m. for OFFICIAL business, but please note our revised SHOP HOURS—9 a.m. to 5 p.m. weekdays. (Saturdays 9 a.m. to 1 p.m.)

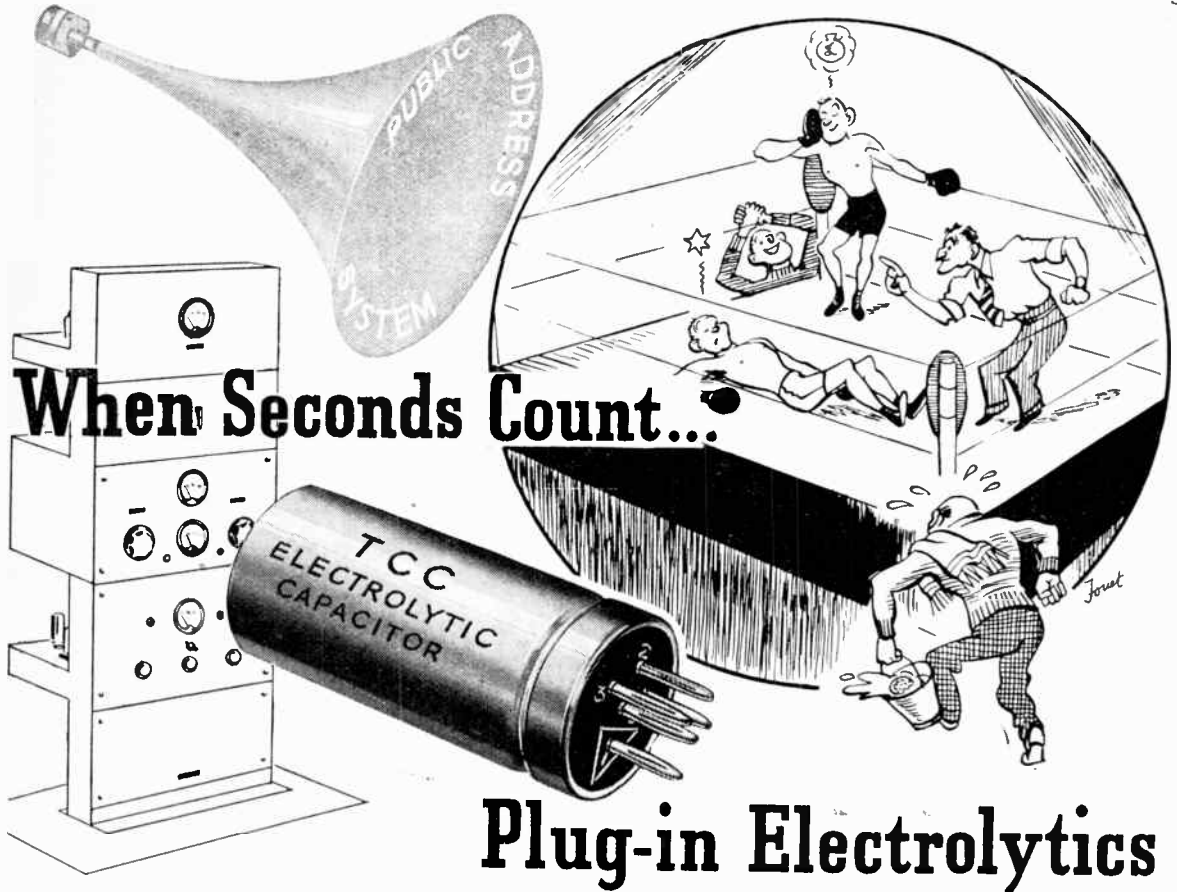

When Seconds Count...

Plug-in Electrolytics

RANGE	
Capacity MFDS.	Peak Working Volts
SINGLE SECTIONS	
16	500
	(600v. Surge)
32	450
	(550v. Surge)
100	250
250	100
500	50
1000	25
2000	12
DUAL SECTIONS	
8-8	500
	(600v. Surge)
16-16	450
	(550v. Surge, 350v.)
32-24	350v.
TRIPLE SECTIONS	
8-8-4	500
	(600v. Surge)
16-16-8	450
	(500v. Surge)
20-20-20	350v.

From being the wayward child, the Electrolytic Capacitor, as a result of continuous research and the rigours of hard usage under years of active service conditions, has become the model offspring in the matter of reliability and efficiency.

Even so, accidents must and will happen, and particularly at public meetings and functions it

is vital to be able to locate and correct a cause of breakdown instantly . . . or even before it happens.

It can be more than a mere inconvenience to have to locate by test a defaulting capacitor, disconnect from the wiring and replace with a new one. The advent of the T.C.C. Plug-in Electrolytic reduces such anxieties to almost nil and the replacement time to a matter of seconds. It now takes no longer to replace than a valve.

Although the present-day dependability of T.C.C. productions is such that you may never have to do this, you should be prepared for the time. . . .

WHEN SECONDS COUNT.

TCC

CAPACITORS

We show above the range at present standardised in an aluminium can measuring 3 3/8" x 1 1/8", fitted with 5-pin valve base. This list will be added to from time to time, according to demand.

THE TELEGRAPH CONDENSER CO., LTD.

RADIO DIVISION

NORTH ACTON · LONDON · W · 3

Telephone, ACORN 0061

The
TAYLOR A.C. BRIDGE
MODEL 110A

These instruments give quick and accurate measurements of Capacity and Resistance. There are six Capacity ranges covering from .00001 to 120 mfd. and the Power factor can also be measured on each range. Six Resistance ranges are available measuring from 1 ohm to 12 megohms. This bridge is A.C. mains operated and a leakage test is also available for detecting leaky paper or mica condensers. Price £14 14s. 0d.

Please write for technical leaflet.

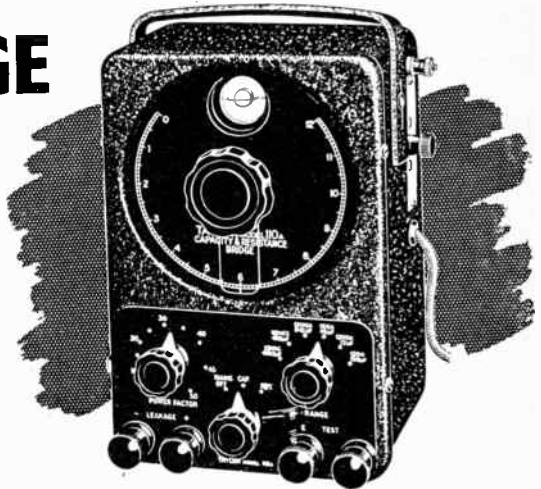

6 RANGES OF CAPACITY
RANGES OF RESISTANCE



Send your enquiries to:—

TAYLOR ELECTRICAL INSTRUMENTS LTD

419-424 MONTROSE AVE., SLOUGH, BUCKS.
Tel: Slough 21381 (4 lines) 'Grams: "Taylins", Slough.

3 1/2" unit
9,000 lines.

Wharfedale
LOUD SPEAKERS



25/-

These two units, although so different in size, have much in common. Both are fitted with new high-efficiency Magnets, and die-cast, rustless, non-resonant chassis with accurate rear-suspension and both . . . are Wharfedale products.



W.12

13,000 LINES

130/-

MADE AND GUARANTEED BY
WHARFEDALE WIRELESS WORKS
SOLE PROPRIETOR: D. E. BRIGGS
HUTCHINSON LANE, BRIGHOUSE, YORKS.
'PHONE: BRIGHOUSE 50. 'GRAMS: "WHARFDEL."



FLOATING ROTOR
DOUBLE CONTACT

-exclusive to the famous

DANK SWITCH

Millions in use

Manufactured by

BRITISH NSFCO., LTD.
KEIGHLEY YORKSHIRE
London Office: 25, MANCHESTER SQUARE, W.1
'Phone: Welbeck 7941 'Grams: Enesef, London

Is your showroom "Skyrod" working...?



"SKYROD"



Aerials

TELEVISION

Aerials



INTERFERENCE

Suppressors

AT last we are able to offer our range of [aerials and suppressors. They are not yet in stock all over the country, but difficulties are being overcome.

Dealers . . . are your "Skyrod" and Television Aerials ready for showroom demonstration? Those of you in the area served by the Alexandra Palace transmitter should check up, or get in touch with us.

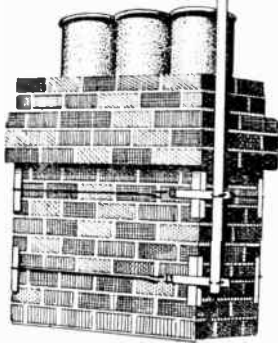

BELLING & LEE LTD
CAMBRIDGE ARTERIAL ROAD, ENFIELD, MIDDX

GA



RULE OF THUMB...

In communications, wherever measurement for testing purposes is involved, empiricism can be ruled out. Of no avail without scientific instruments is anything the eye can see, the hand feel or the most observant remember. The radio engineer, therefore, must have test gear on which he can rely and, thanks to the foresight of Marconi Instruments Ltd., has a wide selection from which to choose. And he finds exemplified in these Marconi products the qualities so characteristic of British engineering craftsmanship—rational design, precise workmanship and technical efficiency.

MARCONI INSTRUMENTS, LTD

ST. ALBANS, HERTFORDSHIRE

Telephone : St. Albans 4323-6

consult us on your

PLASTIC PROBLEMS

COSMOCORD LTD · ENFIELD

M.G. 1, 2 or 3 GANG CONDENSER

This small size condenser is of rigid construction, and is made in various capacities up to 540mmf. with tropical finish. It can be supplied with trimmers built in if required. The 2 Gang Frame is $2\frac{3}{4} \times 1\frac{3}{8} \times 2\frac{9}{16}$ over all.

JACKSON
BROS (LONDON) LIMITED
 KINGSWAY · WADDON · SURREY
 TELEPHONE: CROYDON 2754-5
 TELEGRAMS: WALFILCO, PHONE, LONDON

 REGISTERED TRADE MARK



THE COUNTERSIGN OF DEPENDABILITY IN ANY ELECTRONIC EQUIPMENT

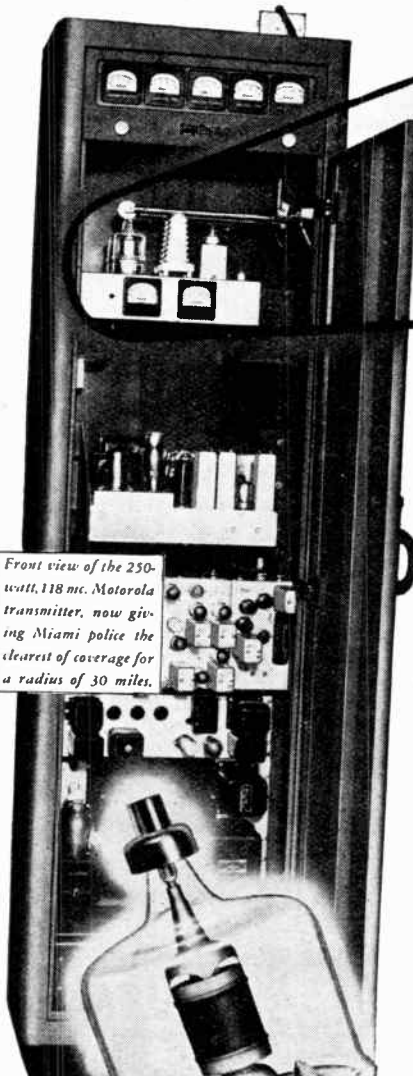

Front view of the 250-watt, 118 mc. Motorola transmitter, now giving Miami police the clearest of coverage for a radius of 30 miles.

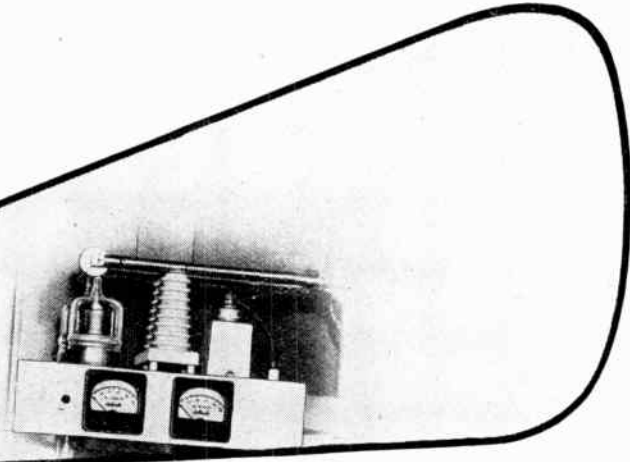

Top Spot

IN FM POLICE SYSTEMS

EIMAC TETRODE 4-125A

Top honors to Galvin Manufacturing Corporation for building it, and a salute to the police and fire departments of Miami, Florida, for putting it to work in spite of the skeptics! It's the first two-way police radiotelephone system in the United States on frequencies above 100 mc. Twenty-four hours a day, 12 patrol cars in Miami's busy area tune in on signals as solid as a dinner table conversation from this Motorola 250 watt, 118 mc. FM transmitter.

From the earliest experimental stages of FM broadcasting, Eimac valves have been lending a hand. Naturally, there are Eimac 4-125A tetrodes (pictured above) in the vital power output stage of Galvin's new Motorola success. Eimac 4-125A's were a logical choice for this transmitter because of their superlative high frequency performance capabilities and their low driving power requirements.

FOLLOW THE LEADERS TO



Ask for your copy of *Electronic Tubes*, the 64-page booklet giving the fundamentals of electronics. It will help electronic engineers explain the subject to laymen. Available in English and Spanish. No obligation, of course.

EITEL-McCULLOUGH, Inc., 1074 San Mateo Avenue, San Bruno, Calif.
Plants located at: San Bruno, California and Salt Lake City, Utah
Export Agents: Frazar & Hansen, 301 Clay St., San Francisco 11, Calif., U. S. A.

ELECTRICAL CHARACTERISTICS—4-125A TETRODE

Filament, Thoriated Tungsten	Direct Interelectrode Capacitances (Average)
Voltage 5.0 volts	Grid Plate (Without shielding, base grounded) 0.03 uufd.
Current 6.2 amperes	Input 10.3 uufd.
Plate Dissipation (Maximum) 125 watts	Output 3.0 uufd.
Transconductance ($\mu = 50 \text{ ma.}, E_k = 2500 \text{ v.}, E_{c2} = 400 \text{ v.}$) 2450 umhos	

Authorised Distributors: BERRY'S (SHORT-WAVE) LTD., 25 HIGH HOLBORN, LONDON, W.C.1.

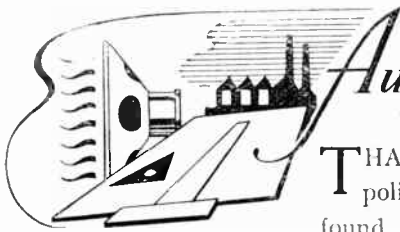

Augury for TOMORROW....

THAT tomorrow must be taken care of today has always been Goodmans policy. Constantly thinking and planning ahead Goodmans inevitably found themselves leaders in the field of Sound Reproduction. As a result, during the past critical years Goodmans have been entrusted with many onerous tasks in the designing and production of Loudspeakers, Microphones, and Earphones. True to their policy Goodmans tested and sifted to build data which might serve in the days to come. Now Goodmans stand ready to give of their greatly enhanced knowledge to the no less onerous tasks of Peace.

★
The GOODMANS RANGE
 Includes Loud-speakers from 2½ dia. (½ watt output) to 18 in. cone models and Industrial Types up to 20 watts output.

The TYPE T2/12. Overall Dia. 1233/8 in. Voice Coil Impedance 15 ohms at 400 C.P.S. Power Handling Capacity 12 w. Peak A.C. on flat 4 ft. baffle (15 w. horn loaded). Flux. Density 13,000 gauss.



GOODMANS
Loudspeakers

GOODMANS INDUSTRIES LTD · LANCELOT RD · WEMBLEY · MIDDX

DELIVERY

EX STOCK (subject to being unsold on receipt of order).



METAL RECTIFIERS

TYPES LT.41, LT.42, HT.41 & HT.42

TYPE	OUTPUT		PRICE *
	VOLTS	AMPS	
LT.41	12	1	27/-
LT.42	6	1	21/-
HT.41	200	0.1	25/-
HT.42	450	0.1	38/6

* Subject to alteration without notice.

Write for details to Dept. W.W.

WESTINGHOUSE BRAKE & SIGNAL CO., LTD.
 Pew Hill House, Chippenham, Wilts.

M.R. SUPPLIES

of the following brand-new and first-class RADIO and ELECTRICAL MATERIAL from stock. Prompt despatch. All prices nett.

ROTHERMEL-BRUSH PIEZO-CRYSTAL MICROPHONES. Resumption of our former popular offer of D.104, specially housed with knuckle-joint mount (for angle adjustment) and with 6ft. screened lead. Today's greatest value in "quality" microphones, 78/6. **STANDS** to suit. Table model, all chromium, extending, 29/6. Collapsible Floor model, ext. to 5ft. 6in. and folding to 2ft. all chrom., 47/6. **P.A. PROJECTOR SPEAKERS** (we are large stockists of this equipment). Latest Vitavox 10-watt P.M. Unit (15 ohms) with 30-inch all-metal square projection Horn, spec. offer, 29 10s. (desp. 7/6). Or with 42-inch all-metal round projection Horn, 110 10s. (desp. 7 6s). Also new (I.E.C.) type "A" Unit (10 watt, 15 ohms) with line transformer incorporated, on 30-inch Horn (as above), 211 (desp. 7/6). On 42-inch Horn (as above), 212 (desp. 7 6s). Immediate despatch. **HIGH-FIDELITY M COIL SPEAKERS.** The celebrated Vitavox K12 10 (10 watts, 15 ohms coil) fitted high-efficiency Ticonal Magnet, 12-inch dia., 27. Also the K12 20 (same spec. handling 20 watts), 211 (desp. either 5/-). We also supply from stock the amazing new Vitavox "Bitone" speaker comprising 12-inch hi-fi P.M. Unit and special "Tweeter" P.M. Unit with 6-cell horn and filter, all in massive grey-enamelled cabinet 32 by 17 by 15 inches, 231 10s. (ex this address, or we can quote for despatch). **S.T.C. METAL RECTIFIERS** for max. 12-volt charge at 6 amps, 39/6. Same voltage, 10 amps, 49 6 (desp. either 2/-). Also small relay-operating or bias S.T.C. Rectifiers, delivery 25 v. 75 m.a., 5/-.

STEP-DOWN MAINS TRANSFORMERS, 200/240 v. (tapped) to 5, 12 and 17 v. at 5 amps (suitable for 6 amp Rectifier, above), 49/6 (desp. 2/-). Also 200/240 v. (tapped) to 7, 11 and 15 v. at 2 amps, 20/-.

Also 200/240 v. (tapped) to 22 v. at 2 amps, 18/6. HEATER TRANSFORMERS, 220/230 v. to 6.3 v. 1 amp and 5 v. 1 amp, 17/6.

SLIDING RESISTANCES, all fully enclosed and constantly rated. 100-watt range: 4 ohms 5 amps, 10 ohms 3 amps, 50 ohms 1.4 amp, 100 ohms 1 amp, 200 ohms 0.7 amp and 400 ohms 0.5 amp, any one 25/-.

Also 150 watts, 1100 ohms 0.375 amp, 20 6. DIMMERS for Stage Lighting, controlling stated load from full-bright to blackout (220/240 v.) with slow motion drive and handwheel, 1000 watts, 26 17s. 6d.; 1500 watts, 28 8s.; 2500 watts, 29 17s. 6d. (desp. either 7/6 plus 20/- for returnable case).

L.F. CHOKES, 10 henry 150 m.a. (150 ohms), 18/6; 15 henry 100 m.a. (320 ohms), 12/6.

MAIN TRANSFORMERS, tropical spec., stand 50 per cent. overload, Prim. 180/250 v. (tapped). Secs.: 300/0/300 v. 50/75 m.a., 6.3 v., 1.5 a., 4 v. C.T. 2.5 a., in cast brackets with terminal board, 35/-.

Also same spec. Prim.: 180, 250 v. (tapped); Sec.: 120 and 160 v. at 400 m.a., 29/6.

TRANSFORMER BOBBINS, standard replacements for many popular receivers. Core opening 1½ sq. and 1½ through, Prim. 200/240 v. (tapped); Secs.: 350/0/350 v. 75 m.a., 4 v., 5 a., and 4 v., 3 a., 18/6.

HEAVY DUTY OUTPUT TRANSFORMERS, "W.W." spec., handling 25 watts, 11 ratios from 12/1 to 75/1 with C.T. for push-pull and tapped sec., weight 9½ lbs., 59/6 (desp. 2/-). There is no better output transformer.

PRECISION MEASURING INSTRUMENTS, flush mtg.: 0/1 m.a. 2½in. 49/6; 3½in. 63/-, 0/500 microamps, 3½in. 69/6. **PORTABLE COMBINED INSTRUMENTS** in crashproof bakelite case, 6 by 4 by 3 ins., with handle. 1000 ohms/volt. A.C./D.C. readings: m.a. 0/1, 0/10, 0/100, 0/500, volts, 0/10, 0/50, 0/100 and 0/500, ohms, 0/5000 28 17s. 6d.

(Guaranteed products of British Physical Laboratories.)

Please include sufficient for despatch where not stated.

M.R. SUPPLIES, 68, New Oxford Street, London, W.C.1

(Telephone: MUSeum 2958)

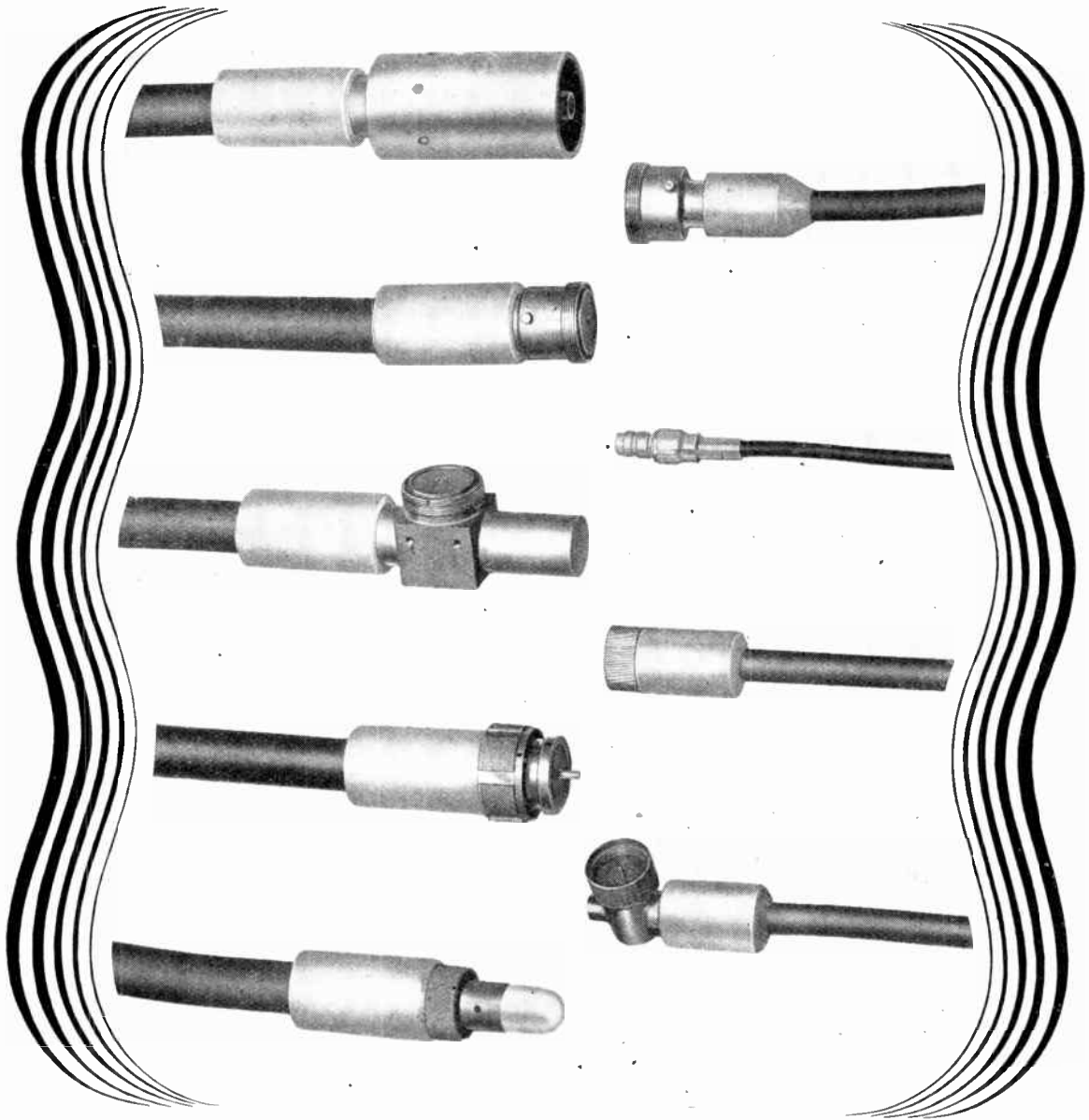

POLYETHYLENE MOULDED CONNECTORS

Pressure moulded by a new process that cannot yet be described in detail, these fittings are terminations and connections used in electronic circuits. The production of these polyethylene mouldings in quantity is the result of a new manufacturing technique successfully evolved by this company.

BRITISH INSULATED CALLENDER'S CABLES LIMITED

NORFOLK HOUSE, NORFOLK STREET, LONDON, W.C.2

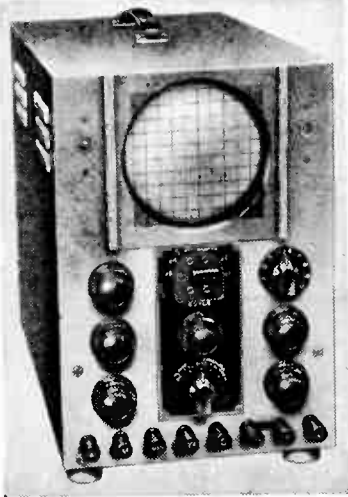

STATIC TWO-DIMENSIONAL
visual delineation of any recurrent
law.

RELATIVE TIMING OF EVENTS
and other comparative measure-
ments with extreme accuracy.

PHOTOGRAPHIC RECORDING
of transient phenomena.

SIMULTANEOUS INDICATION
of two variables on a common
time axis.

INDUSTRIAL INDICATING and TESTING afford in-
creasing scope for the Cathode Ray Tube as the only
device with the above inherent features of which the
last is unique in the Cossor DOUBLE BEAM Tube.

The **Model 339 Cossor Oscillograph** thus equipped
is invaluable on all problems of research, production
or operational testing, when the effect examined is
applied as a voltage. When recurrent the traces are
studied visually and when transient are recorded
photographically, using Model 427 camera.

A. C. COSSOR LTD.,
INSTRUMENT DEPT.

Cossor House, London, N.5.

'Phone : CANonbury 1234 (33 lines).
'Grams : Amplifiers Phone London.

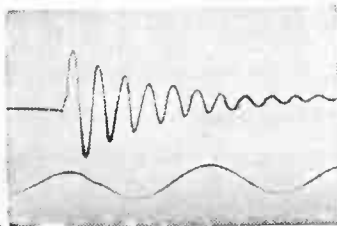

For
Reliability

Just
TRIX

Quality **SOUND** Equipment

THERE ARE TRIx AMPLIFIERS
FROM 5 to 500 WATTS FOR
PRIORITY WORK

THE TRIx ELECTRICAL CO., LTD.
1-5, MAPLE PLACE, TOTTENHAM CT. RD.
LONDON, W. 1.
Tele. MUSEUM: 5817 Grams & Cables: TRIxADIO, W.500, LONDON.

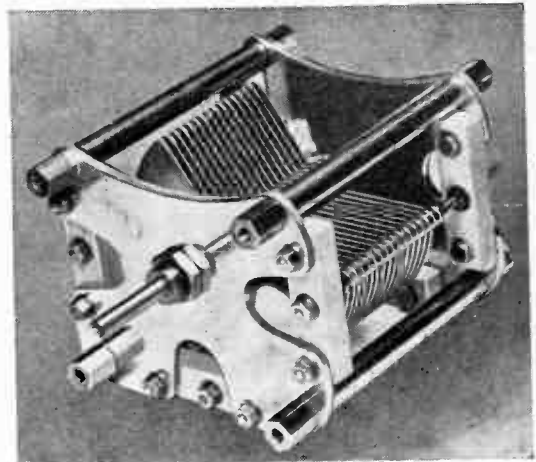

TYPE S.L.C. LINEAR CAPACITY

"Cyldon"
Variable Capacitors

SYDNEY S. BIRD & SONS LTD.
CAMBRIDGE ARTERIAL ROAD, ENFIELD.



Made in Three Principal Materials

FREQUELEX

An insulating material of Low Dielectric Loss, for Coil Formers, Aerial Insulators, Valve Holders, etc.

PERMALEX

A High Permittivity Material. For the construction of Condensers of the smallest possible dimensions.

TEMPLEX

A Condenser material of medium permittivity. For the construction of Condensers having a constant capacity at all temperatures.

Bullers



BULLERS LOW LOSS CERAMICS



BULLERS LTD., 6, LAURENCE POUNTNEY HILL, LONDON, E.C.4
 Telephone: Mansion House 9971 (3 lines) Telegrams: "Bullers, Cannon, London" Manchester Office: 196, Deansgate, Manchester



LASSO is making a mark for itself

Lasso Self-Adhesive Tape solves all your marking problems. These brilliant filmic markers can be cut off to length desired, are easy to apply, are ever-legible and are impervious to heat and fluids. Supplied in 10-yard rolls or individual labels, in colours to B.S. Specification and in shades matched to customers' requirements. Any type of wording, lettering or diagram produced.

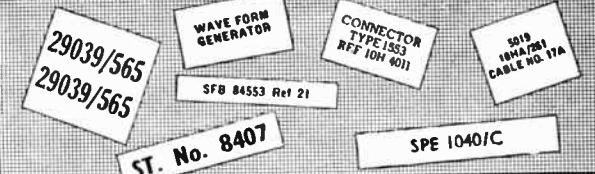
TYPICAL USES

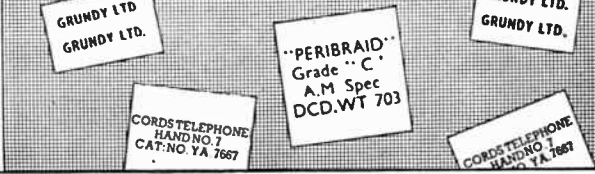
<p>IDENTIFICATION : Numbering of parts to simplify assembly of complicated circuits. Stores reference numbers, etc</p>	
<p>INSPECTION : Facilitates inspection by indicating treatment of components.</p>	
<p>INSTRUCTIONS : Labels with full details for assembly work or finished components.</p>	
<p>NAME TAPES : Ideal for sealing and labelling packages or finished components with your name.</p>	

Full details from **CABLE ASSEMBLIES LTD.** (Subsidiary of Herts Pharmaceuticals Ltd.) **BESSEMER ROAD, WELWYN GARDEN CITY**
 Telephone : Welwyn Garden 3333/6 Telegrams : Cablsembly, Welwyn Garden City



Designers and Manufacturers of Radio and Electronic Devices.

ROMAC RADIO CORPN. LTD.

Announce a range of **AMPLIFIERS** 12 watts—25 watts, built to a quality specification as regards performance, construction and to meet the requirements of the discerning purchaser. Full details, specification, price on request. The above can be delivered with Speakers, Microphones and Turntable units if required.

THE HYDE · HENDON · LONDON, N.W.9

THE STATIC CONDENSER Co. Ltd.

★ *Manufacturers of*
STATIC CONDENSERS

TOUTLEY WORKS,
WOKINGHAM, Berks
 Telephone: WOKINGHAM 708

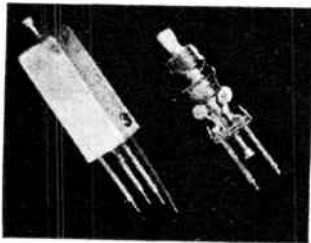

WORLD'S LARGEST RADIO COIL MANUFACTURERS

- RADIO FREQUENCY INDUCTORS
- INTERMEDIATE FREQUENCY TRANSFORMERS
- RADIO FREQUENCY COIL CHOKES
- MICA COMPRESSION CONDENSERS
- AIR DIELECTRIC CONDENSERS
- MICA MOULDED CONDENSERS
- SICKLES SILVER CAP CONDENSERS
- GANGED PERMEABILITY TUNING COMMUNICATIONS EQUIPMENT
- F.M. EQUIPMENT PARTS
- U.H.F. RADIO EQUIPMENT
- SPECIAL ELECTRONIC EQUIPMENT

The F. W. SICKLES Co.
CHICOPEE, MASS. U.S.A.



RAYTHEON "FLAT" Hearing Aid Tubes

So tiny they must be built under a high powered magnifying glass ... just as a jeweller assembles rare gems in a costly brooch. They're the hearts of famous hearing aids, providing utmost clarity and richness of tone



P. R. MALLORY & CO. Inc.
MALLORY VIBRATORS
ARE ALWAYS DEPENDABLE



Along every front Mallory has pioneered in Vibrator design to ensure safety, dependability and long service. Mallory offers synchronous and non-synchronous Vibrators for 6, 12 and 32 volt input, also a complete range of "STRATOSPHERE" Vibrators plus the world-famous Mallory "VIBRAPACK" (Reg. Trade Mark).

★ *Vibrapak is a registered trade mark, the property of P. R. Mallory & Co., Inc. Indianapolis, U.S.A. Units which do not bear this trade mark are not a genuine Mallory manufacture.*

P. R. MALLORY & CO. INC.
INDIANAPOLIS, INDIANA,
U.S.A.

Radio and Electronics Division

- ALSO
- "MYKROY" CERAMIC INSULATING MATERIALS
 - GENERAL ELECTRONIC VACUUM CONDENSERS

FOR THE FUTURE

These Manufacturers will help solve you post-war problems. Register your name now for full details which will be sent you when supply conditions again permit.

FRANK HEAVER LIMITED

Kingsley Road, BIDEFORD
N. Devon



VICTORY PRODUCTION

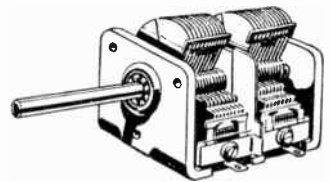

TYPE 2600 MIDGET VARIABLE CONDENSER

WE are now ready to help win the peace by making the best use of the still greater knowledge and experience gained in the manufacture of variable condensers, mechanical tuners, drives, etc

THE GENERAL INSTRUMENT CORPORATION
ELIZABETH, N.J., U.S.A.



- RADIO**
- AIR CONDITIONING
 - HEATING
 - and
 - REFRIGERATION EQUIPMENT

DOMESTIC APPLIANCES
etc., etc.

Ad. Auricema, Inc.
Manufacturers' Export Managers
89 BROAD STREET,
NEW YORK, 4 N.Y.
U.S.A

*Above the Bandsaws
jarring note!*

**WHERE
NOISE-
LEVEL
IS HIGH!**



In any noisy workshop, "music - while - you - work" demands a projector-type loudspeaker. Lately, P.A. engineers have not been able to tackle these "high-noise-level" spots, but now Gramplan are able to announce the release of the Gramplan type PVH Projector-Speaker. Go over your P.A. systems now and see where this type PVH would improve audibility. Early delivery can be given.

GRAMPIAN SPEAKER — Projector Type P.V.H. Unit. Max. loading 10 watts. Impedance 15 ohms. Horn, length 42", diam. 24". Cut off, 170 C.P.S. **PRICE £13.5**

GRAMPIAN MICROPHONE, TYPE M.C.8. Pressure operated. Swivel stand - adaptor. Frequency 70-8000 c. Impedance 20 ohms. Sensitivity 42 d.b. **PRICE £7.5**

GRAMPIAN
LOUDSPEAKERS
GRAMPIAN REPRODUCERS LTD., Hampton Road, Hanworth, Middx.
*Phone: Feltham 2667

Scientific G3

FAMOUS FASTENERS

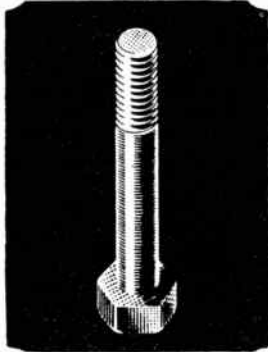

HIGH TENSILE HEXAGON BOLT

Three distinct tests ensure the standard of Linread Bolts. The first is checking of raw material, the second is specialised Quality Control during manufacture, and the third, inspection of finished products. Specialists in Cold Forging; Roll Threaded Screws; Solid and Tubular Rivets; Nuts and Bolts in all metals; Small Pressings; Auto and Capstan-turned Parts.

LINREAD LTD., STIRLING WORKS, COX ST., BIRMINGHAM, 3.
TELEPHONE No.: CEN. 3951 P.B.X.
TELEGRAMS: "LINREAD BIRMINGHAM."
London Office: Clifton House, Euston Road, London, N.W.1.
Tele. No.: Euston 8261.



OKERIN WAXES

AND DIELECTRIC COMPOUNDS TO GOVERNMENT SPECIFICATIONS—FOR

- CONDENSERS
- CABLES
- TRANSFORMERS
- COILS

A.I.D. AND C.I.E.M.E. TYPE APPROVED FOR ARCTIC AND TROPICAL CONDITIONS

Used and Recommended for Service Components

**ASTOR BOISSELIER
& LAWRENCE LTD.**
SALES DEPT.

NORFOLK HOUSE, NORFOLK ST., STRAND, LONDON, W.C.2
Telephone: TEMple 5927



5 mmf/ft
NEW LOW LEVELS in capacity and attenuation of CO-AX Cables mean new possibilities in electronic equipment design both for the war effort and for the post-war electronic age.

Write for characteristics

**BASICALLY BETTER
AIR-SPACED**

CO-AX LOW LOSS CABLES
TRANSRADIO LTD. 16 THE HIGHWAY, BEACONSFIELD, 4-BUCKS.

DUBILIER ELECTROLYTIC CAPACITORS— AGAIN AVAILABLE



"DRILITIC" CAPACITORS

OUT of evil — good! The destruction of our Electrolytic Capacitor Department by German bombs was a first class disaster at the time both for us and our customers. But it has led to two great advances:

We have designed an entirely new series of electrolytic capacitors, smaller and more efficient than any previously available. And we have fortunately been able to install completely new plant for their manufacture.

Capacitance μF.	Working Voltage max.	Type No.	Retail Price EACH	Size ins.		Terminals	Ripple Current max. m.a.	Capacitance tolerance
				Dia.	L.			
50	50	BR.505	3/6	1/2	2	2" long 20 SWG Tinned Copper Wires	190	-0.0% + 150%
8	500	BR.850	4/-	1/2	2		100	-0.0% + 75%

TO SERVICE ENGINEERS
AND RETAILERS

Production has commenced. Initial deliveries are being made and it is confidently expected we shall meet the demand promptly. The first of the new types available — the BR. DRILITIC CAPACITORS, described below, are suitable for all general replacement purposes.

TO DESIGNERS

Plans are in hand for range and productive capacity to meet all requirements.

DUBILIER
CONDENSER CO. (1925) LTD.

Still the pioneers

Hermetically sealed
to resist heat
and moisture

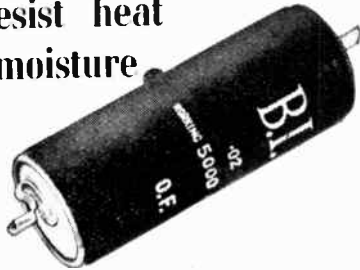

MOULDED TUBULAR CAPACITORS

Manufactured in a wide range of capacities and for working voltages up to and including 6,000 D.C. For high-voltage operation they provide the most effective solution where size and weight are important considerations and are designed to operate continuously in extremely arduous conditions of temperature and humidity. Manufactured in three sizes and supplied with soldering tags at each end, or alternatively with one soldering tag and a stud for base fixing.

BRITISH INSULATED CALLENDER'S CABLES LTD.
Main Works : Erith • Helsby • Leigh (Lancs.) • Prescot



FOR THE RADIO SERVICEMAN DEALER AND OWNER

The man who enrolls for an I.C.S. Radio Course learns radio thoroughly, completely, practically. When he earns his Diploma, he will KNOW radio. We are not content merely to teach the principles of radio, we want to show our students how to apply that training in practical, every-day radio service work. We train them to be successful!

Special terms for Members of H.M. Forces and discharged disabled members of H.M. Armed Forces

.....You may use this Coupon.....

INTERNATIONAL CORRESPONDENCE SCHOOLS Ltd.
DEPT. 38, INTERNATIONAL BUILDINGS, KINGSWAY, LONDON, W.C.2

Please explain fully about your instruction in the subject marked X

Complete Radio Engineering. Radio Service Engineers.
Elementary Radio.

And the following Radio Examinations :—

- British Institution of Radio Engineers.
- P.M.G. Certificates for Wireless Operators.
- City and Guilds Telecommunications.
- Wireless Operator and Wireless Mechanic, R.A.F.

Name, Age

Address

Constant Voltage

TRANSFORMERS

LINE VOLTAGE VARIATIONS OF
±15% REDUCED TO ±1%

TYPICAL SPECIFICATIONS

Input Voltage	100-200 v. 50 c.p.s.
Output Voltage	230 v. ±1%
Max. load	150 watts.
Input power factor	over 90%

Prices on application. Write for details

ADVANCE COMPONENTS LTD.

BACK RD., SHERNHALL ST., WALTHAMSTOW, E17. PHONE-LARKSWOOD 43662

ADASTRA

SECTIONAL STEEL
RADIO MASTS

Send for Catalogue **WQ/330**

POLES LTD TYBURN RE-ERDINGTON
BIRMINGHAM 24

**ARE YOU USING THE
SLEEVING BEST SUITED
TO THE JOB**



"Best suited" means an insulating sleeving that meets every Service or general requirement. The DELAFLEX range includes non-fraying Woven Fibre Glass and Tropical Grade ROLLED SILK in a complete range of colours and in sizes from 0.5 mm. to 35 mm. Thus, a recommendation from De La Rue Insulation Limited is unbiased . . . you get the sleeving best suited to your needs, not only from the standpoint of efficiency, but of economy as well. Fullest details, samples and prices gladly sent on request.

Delaflex

Insulating Sleeving

DE LA RUE INSULATION LTD
84 REGENT STREET • LONDON • W.1
TELEPHONE : REGENT 2901

 ROLLED SILK
 METAL SCREENED
 VARNISHED COTTON
 WOVEN FIBRE GLASS
 VARNISHED ART SILK

PULLIN INSTRUMENTS

for

MAINTAINED ACCURACY

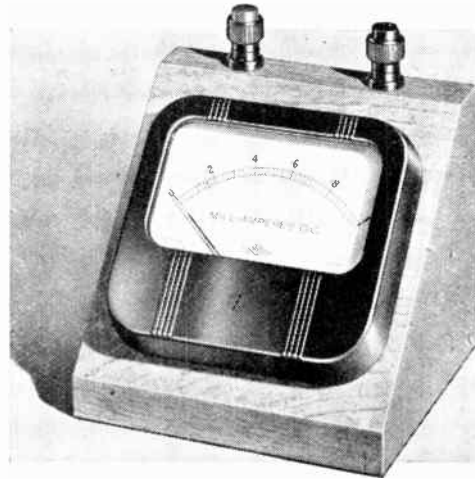

SERIES 35 for panel mounting or as bench instruments

Available either as single range panel instruments or mounted in sturdy bench stands, as illustrated, with up to three ranges self-contained. Scale length 3½".

Instrument size, 4½" x 4¾"; panel opening, 3¼".

Can be supplied (1) *Moving coil* — microammeters, milliammeters, ammeters, millivoltmeters, voltmeters, ohmmeters, decibelmeters.

(2) *Rectifier* — microammeters, milliammeters, voltmeters, decibelmeters.

(3) *Thermocouple* — milliammeters, ammeters, voltmeters. All available in all standard ranges.



**MEASURING INSTRUMENTS
(PULLIN) LTD**

WINCHESTER STREET, LONDON, W.2

Please address all correspondence to:
Phoenix Works, Great West Road, Brentford, Middlesex Ealing 0011

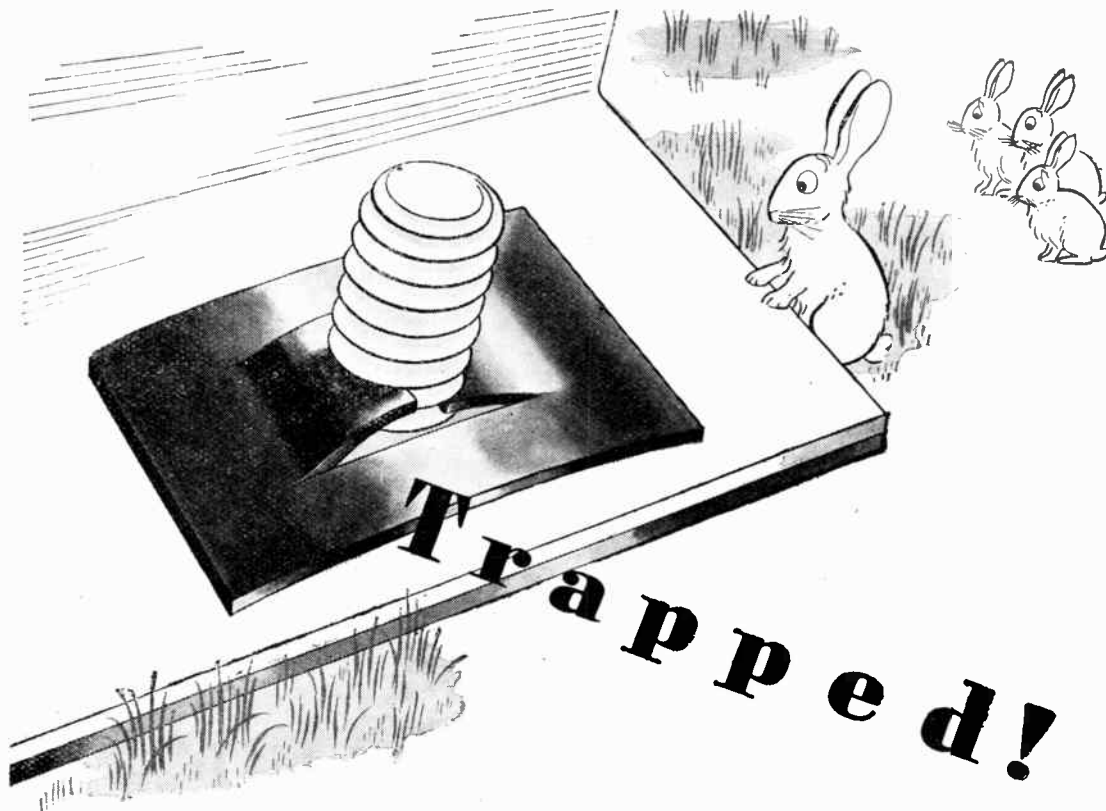

WHEN the 'jaws' of a Spire Nut grip the thread of a bolt, there's no letting go. The whole assembly is held fast—as though a trap had been sprung. And indeed that is exactly what does happen. A Spire Nut tightens and locks itself, biting hard on the bolt thread. Send us along the details (parts or drawings) on any light assembly job, and we'll see if Spire could make a better, simpler, quicker job of it.

Spire

* **A BETTER way of fixing**

— THAT'S Fixed THAT! —

The NP 164 is the simplest form of plate-type Spire fixing. It looks small and slim compared with the hexagon nut and washer it replaces, but it does the work of both of them more quickly, more firmly and more permanently. In other words it saves weight and material but increases security and simplifies assembly. No wonder that it is increasingly used throughout industry

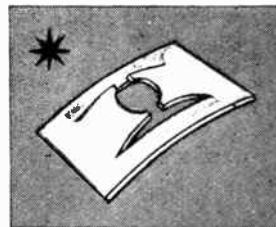

Simmonds Aerocessories Limited · Great West Road · London · A Company of the Simmonds Group

Wireless World

Radio and Electronics

35th YEAR OF PUBLICATION

DECEMBER 1945

Proprietors :
ILIFFE & SONS LTD.

Managing Editor :
HUGH S. POCOCK,
M.I.E.E.

Editor :
H. F. SMITH

Editorial, Advertising
and Publishing Offices:

DORSET HOUSE,
STAMFORD STREET,
LONDON, S.E.1.

Telephone :
Waterloo 3333 (55 lines).

Telegrams :
"Ethaworld, Sedist, London."

△

PUBLISHED
MONTHLY

Price : 1/6

(Publication date 26th
of preceding month)

Subscription Rate:
110s and Abroad
20/- per annum.

MONTHLY COMMENTARY	353
" WIRELESS WORLD " AC/DC AMPLIFIER ..	354
THE SHORT TIME-CONSTANT CIRCUIT By M. G. Scroggie	358
PULSE-WIDTH MODULATION	361
FUNDAMENTALS OF RADAR—3	363
UNBIASED By " Free Grid "	366
CRYSTAL-CONTROLLED FREQUENCY MODU- LATION By S. K. Lewer	367
TELEVISION DEVELOPMENTS	371
BIOLOGICAL AMPLIFIERS (concluded) By Dr. D. H. Parnum	373
WAR REPORTING By W. D. Richardson and P. H. Walker ..	377
WORLD OF WIRELESS	380
ARMY SET No. 10	383
LETTERS TO THE EDITOR	384
RANDOM RADIATIONS By " Diallist "	388

Branch Offices :

COVENTRY :
8-10, Corporation Street,
Telephone : Coventry 5210.
Telegrams :
" Autocar, Coventry."

BIRMINGHAM :
Guildhall Buildings,
Navigation Street, 2.
Telephone :
Midland 2971 (5 lines).
Telegrams :
" Autopress, Birmingham."

MANCHESTER :
260, Deansgate, 3.
Telephone :
Blackfriars 4412 (4 lines).
Telegrams :
" Iliffe, Manchester."

GLASGOW :
26B, Renfield Street, C.2.
Telephone : Central 4857.
Telegrams : "Iliffe Glasgow."

△

As many of the circuits and
apparatus described in these
pages are covered by patents,
readers are advised, before
making use of them, to satisfy
themselves that they would
not be infringing patents.

VIBRATORS • TRANSFORMERS • SWITCHES • COILS

MEET A GREAT LITTLE I.F.!

Specially designed to give the maximum gain and selectivity combined with lilliputian dimensions*. Wearite I.F. Transformers are provided with one-hole fixing, the terminal wires being fed through insulated bushings thus preventing movement after mounting. They are available in the following "preferred" frequencies.

M.400.....460 Kc/s M.405.....1.6 Mc/s
M.411.....2.1 Mc/s M.415.....4.86 Mc/s
M.418.....9.72 Mc/s

as well as in frequencies for particular applications.

- Coils enclosed in pot-type iron dust cores
- Tuning by means of adjustable iron dust centre cores
- Fixed tuning condensers contained in screening can

* Dimensions : — 1 1/8" square x 1 1/8" high.

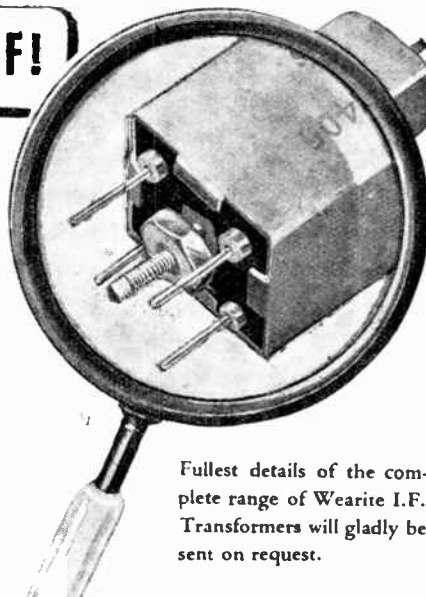

Fullest details of the complete range of Wearite I.F. Transformers will gladly be sent on request.

W R I G H T & W E A I R E L T D

A Name as Old as the Radio Industry

HIGH ROAD TOTTENHAM LONDON N 17 TELEPHONE: TOTTENHAM 3847-9



The letter Eta
(the Greek long e)
is known by
engineers as the **symbol**
for Efficiency.

The Philips emblem is
another **symbol for**
efficiency.



The world-wide
reputation of Philips
electrical products is based on the utmost efficiency
in design, construction and performance.

PHILIPS

**LAMPS • RADIO • X-RAY • COMMUNICATIONS EQUIPMENT
AND ALLIED ELECTRICAL PRODUCTS**

PHILIPS LAMPS LTD • CENTURY HOUSE • SHAFTESBURY AVENUE • LONDON • W.C.2

(126)

Wireless World

Radio and Electronics

Vol. LI. No. 12

DECEMBER 1945

Price 1s. 6d.

Monthly Commentary

Invitation to the Industry

SPEAKING to a conference of research associations early this month, Mr. Herbert Morrison, Lord President of the Council, said that the present Government would do everything possible to encourage British industry to use scientific research. He hoped that large firms would establish or extend research departments of their own, and went on to stress the advantages of co-operative organisations to the smaller concerns, which cannot be expected to have adequate departments of their own. Most of Mr. Morrison's speech was on this subject of co-operative research, to which he gave not only general assurances of Government support, but also concrete promises of financial help. Grants will be made indefinitely to a research organisation so long as the Department of Scientific and Industrial Research is satisfied with its work. In addition, extra grants may be made "to finance capital expenditure for such special purposes as buildings and re-equipment, the purchase of particularly expensive apparatus or the provision of semi-scale plant."

In radio we have all seen during the past few years the blessings of research, which has yielded radar as a kind of unexpected bonus. To many members of the industry the Government gesture, though made to no one in particular, will seem almost like an unspoken invitation to those concerned to form a co-operative Radio Research Association. Should such an invitation be accepted?

We imagine that few of the smaller manufacturing firms would welcome a state of affairs where their factories would become mere assembly lines, turning out products developed and designed by a central organisation. But that is not the idea; so much was made quite clear by Sir Edward Appleton, secretary of the Department of Scientific and Industrial Research, the body which has the task of implementing Government policy in this matter. Sir Edward's speech, which followed that of Mr. Morrison at the conference, touched as many points of real interest to the wireless industry.

He supported the idea that even the smaller firms should employ some scientific staff, even though they could not afford research organisations of their own. He also stressed the need for workers in research associations to retain their originality and freshness by frequent contacts with other organisations and expressed the opinion that one of the results of the war would be that many first-rate recruits for such associations would come forward.

The question of whether or not we need a Radio Research Association is arguable, but it is a question that should at least be argued—very fully and dispassionately. The first point to be settled is whether there are in fact suitable lines of research that could usefully be investigated by such an organisation for the benefit of a reasonably large proportion of its potential member firms. As Sir Edward Appleton shrewdly pointed out, a successful organisation is not brought into being by thinking of a sum of money, doubling it, and then trying to devise ways of spending it.

★ ★ ★

Wartime Hangovers

IS it inevitable that the broadcast listener should continue to endure a hangover from the wartime system of distribution? Now, nearly eight months after the end of the European war, complaints as to the poor quality of B.B.C. transmissions are coming in thick and fast from many parts of the country. Those whose great interest used to lie in high-quality musical reproduction have cheerfully tolerated six years of wartime conditions, but are now out of patience with a system that sometimes fails even to afford intelligible speech. We all know something of post-war difficulties, but at the least a frank and detailed statement from the B.B.C. is overdue.

Another wartime hangover is the excessive use of recordings. The greatest asset of broadcasting is its power of presenting living actualities, and failure to exploit this power is a psychological error of the first magnitude.

"Wireless World"

AC/DC QUALITY AMPLIFIER

Two-watt Output : Negative Feedback

IN AC/DC equipment there is virtually no alternative to the pentode output valve because of the limited HT voltage available. A pentode has a higher power efficiency than a triode, and it requires less grid bias. As bias is invariably obtained from the HT supply it robs the anode voltage, and when the HT voltage is fixed a valve needing a high value of bias must be operated at a lower anode voltage than one needing but little bias. This again results in a higher output from a pentode than from a triode.

These two factors make the pentode much more suitable than the triode for the output stage of AC/DC apparatus. But a pentode has certain drawbacks. Its anode AC resistance is very high, with the result that amplitude distortion is very likely to occur in the output transformer. The load circuit exercises very little straightening effect on the dynamic characteristics of the valve, and because of this, amplitude distortion in the valve itself is likely to be higher than with a triode.

Fortunately the same remedy cures both these faults. Negative feedback can give the amplifier a low output resistance, which eases transformer design, and it linearises the valve characteristic. From the point of view of quality the pentode with negative feedback can equal the triode, but its improved power efficiency is retained.

What is lost in using negative feedback is the high sensitivity of the pentode. The ability to obtain a large power output for a small signal input is sacrificed to obtain quality, and on both sensitivity and quality triode-type performance is obtained.

If the pentode with feedback gives results which are so close to those of a triode, it may be asked why one should contemplate its use, for the triode is not only

a simpler valve, but its circuit is simpler and demands fewer components. In the case of AC equipment in which the use of a mains transformer permits any desired HT voltage to be obtained easily, the choice between the two alternatives is often a difficult one.

If there is nothing to choose between the two on the grounds of quality and sensitivity, the selection must be made on the basis of their relative simplicity, reliability and cost. The pentode amplifier is slightly the more complicated and needs rather more components, but its higher power efficiency demands a smaller power supply.

There are two cases where the preference nearly always lies with pentodes. The first is in AC/DC equipment because of the limited HT voltage. The second is in AC apparatus of large output—say, over 15 watts—because the higher power efficiency cheapens the HT supply unit.

In AC equipment with outputs below 15 watts, there is often very little to choose between the two methods, and the greater simplicity of the triode is often the deciding factor in its favour.

Output Transformer

The AC/DC method of operation is particularly convenient when an undistorted output of less than about 2 watts will suffice, for this can be obtained with an HT current within the limitations of a single rectifier valve. If larger outputs are needed the HT current is heavier and the voltage lost in the smoothing equipment is greater; also more than a single rectifier valve will often be needed. The AC/DC system then soon becomes uneconomic.

Even when the output is 2 watts only, transformer distortion can be serious unless negative feedback is

used. It is convenient to assess the distortion reduction of feedback in terms of the reduction of the effective output resistance of the amplifier, since this enables a direct comparison with a triode to be made. In general, sufficient feedback to bring the output resistance to about the same figure as with a triode should be applied. This entails sufficient feedback to reduce a valve resistance of some 35,000 ohms to about 1,000 ohms.

The low-frequency response of the output stage and transformer is then governed by the reactance of the transformer primary in relation to the parallel values of the output resistance and the load resistance. If these are 1,000 ohms and 4,500 ohms, respectively, their combined value is 820 ohms. At 100 c/s, a primary inductance of 6H causes a drop in response of only 2 db. A considerably greater drop than this is usually permissible from the point of view of quality, and it would seem that a lower primary inductance could be used.

It is, however, necessary to consider the effect of the inductance on the load of the valve. At low frequencies the total load is the load resistance in shunt with the reactance of the primary of the transformer. With the above values, it becomes 2,850 ohms only.

With a pentode without negative feedback, the reduction of the load does not affect valve distortion to any appreciable extent. The alternating current is substantially independent of the load, and the voltage falls off as the load falls.

With a triode, however, there is an increase of distortion because with the low resistance of the valve the current increases and, with its optimum load, the valve is already giving its maximum undistorted current output. The effect with a

pentode and negative feedback is similar although the mechanism is different. The fall in output voltage with a drop in the load results in a smaller feedback voltage and hence in an increased input voltage to the output valve. This in turn increases the output current and the valve cannot give a bigger current without distortion. Matters are made still worse by the fact that the load has a reactive element and there is a phase angle between current and voltage.

For this effect to be negligible the transformer primary reactance should be some four times the load resistance, or about 18,000 ohms in this case. At 100 c/s, this calls for an inductance of 29 H and at 50 c/s, some 58 H. A single output valve means that the anode current, which is rarely less than 40 mA, flows through the primary, and it is not practicable to employ such large inductances with such values of direct current. They could be obtained, of course, but it would almost certainly be cheaper to adopt a push-pull output stage.

somewhat at the input to the amplifier, then the conditions as regards amplitude distortion become very much as though the transformer had a large primary inductance.

If the input is constant at all frequencies, then the output current tends to constancy, but the output power falls off at low frequencies. Without the pre-attenuation, the output current would increase and become distorted at low frequencies, but the output power would not fall off as much.

This procedure is a very satisfactory one to adopt in apparatus of limited output, where it is impracticable to employ a transformer inductance as high as theory would indicate to be necessary. With careful design, the loss of bass is small and it becomes possible to employ a 6-H primary with a pre-attenuation of only 4 db. at 100 c/s. In general, however, it is not necessary to go as far as this and a loss of some 2 db. only at this frequency is a reasonable compromise.

Fig. 1 shows the circuit of a

amplification with negative feedback, a high gain is needed in the input stage. An RF pentode is used and without any feedback its voltage amplification is about 100 times. Internal feedback from its cathode resistor reduces this to about 26 times.

The output valve is a high-slope pentode and the main feedback is taken from the output transformer secondary through R_4 to the cathode of V_1 . The bias resistance of V_1 consists of R_3 and R_4 in parallel, some 2,300 ohms. The

CIRCUIT VALUES

- R1 = Volume control with tapered element and value to suit input circuit (0.25 M Ω is a good average value).
- R2 = 2.2 M Ω , 1/10 watt, 20 per cent.
- R3 } See Table I, 1/10 watt.
- R4 }
- R5 = 100,000 Ω , 1/4 watt, 20 per cent.
- R6 = 22,000 Ω , 20 per cent.
- R7 = 330,000 Ω , 1/10 watt, 20 per cent.
- R8 = 470,000 Ω , 1/10 watt, 20 per cent.
- R9 = 680 Ω , 1/4 watt, 20 per cent.
- R10 = 220 Ω , 1/4 watt, 20 per cent.
- R11 = 47 Ω , 1/4 watt, 20 per cent.
- R12 See Table II.
- C1 = 0.001 μ F 200 volts working.
- C2 = 0.2 μ F
- C3 = 2 μ F } 350 volts working.
- C4 = 0.01 μ F
- C5 = 25 μ F 12 volts working.
- C6 = C7 = C8 = 8 μ F 350 volts working.
- C9 = 0.001 μ F 250 volts AC working.
- V1 = EF6 or EF36.
- V2 = Pen 36c or CL33.
- V3 = UR1C.
- CH1 = CH2 = 10-20 H, 250 Ω DC resistance, 60 mA.
- F1 = F2 = Fuse, 0.3 A.
- T1 = Output transformer. See Table I for ratio, also text.

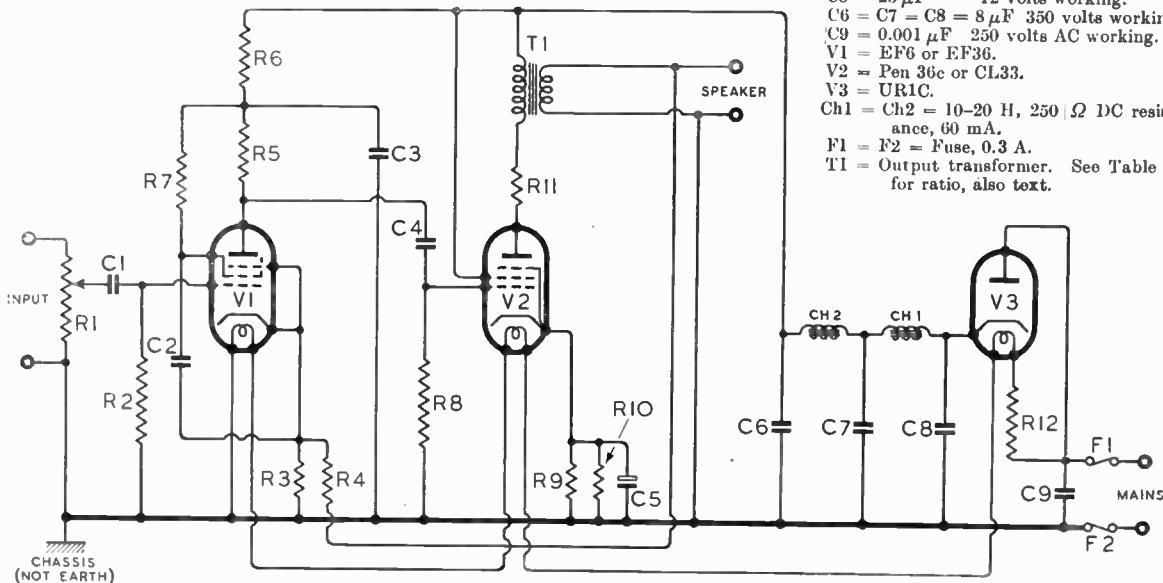

Fig. 1. The circuit diagram of the amplifier. The values of the feedback components R_3 and R_4 depend on the ratio of the output transformer T_1 .

As amplitude distortion is much worse than frequency distortion, the most practical course is to convert the amplitude distortion to frequency distortion. If the lower frequencies are attenuated

two-stage amplifier built on these lines. The pre-attenuation circuit is C_1R_2 ; R_2 is made as high as possible—some 2 M Ω —and C_1 is made only 0.001 μ F.

In order to obtain adequate

amount of feedback depends on the transformer ratio and on the values of R_3 and R_4 , while the transformer ratio depends on the speech-coil impedance of the loud speaker.

AC/DC Quality Amplifier—

Table I gives the correct transformer ratios for a number of different speech-coil impedances and also the theoretical values for R₃ and R₄. The nearest "Preferred Values" are also given for a 5 per cent. tolerance. Such a tolerance is very desirable and puts a 10 per cent. tolerance on the amount of feedback. Re-

level inaudible without using very large capacitance values. The smoothing capacitors C₆, C₇ and C₈ need be no more than 8μF apiece. They can be paper-dielectric types or electrolytic. If only one choke were used, it would not only have to be of considerably higher inductance than these, but the capacitors would have to be at least 16μF

covered with wax so that accidental contact is impossible. These are but elementary precautions with AC/DC equipment.

Some little difficulty arises in the pick-up connections from the safety point of view. A screened lead is necessary to avoid hum and the screening must be joined to chassis, not a local earth, if it is to be fully effective. It is, therefore, live to the mains. The screened lead itself must consequently be insulated, and there are in existence screened cables having external insulation, so that this point is satisfactorily covered.

The real difficulty is with a metal frame pick-up. It is definitely unsafe to connect the frame to the chassis, which is the right thing from the point of view of minimising hum. Some experiment may be needed to find the best solution, but in general, the pick-up frame should be earthed and connected to chassis through a capacitor. This capacitor should be rated for 250 volts AC working and be as small as possible;

TABLE I

Speech Coil Impedance Ω	Transformer Ratio	Ideal Values (Ω)		5 per cent. Preferred Values (Ω)	
		R3	R4	R3	R4
2.5	39.5	3,100	9,300	3,000	9,100
4	30.8	2,850	12,500	2,700	12,000
7.5	22.6	2,640	18,000	2,700	18,000
10	19.6	2,600	21,400	2,700	22,000
15	15.9	2,550	26,500	2,700	27,000

sistors of this tolerance are likely to be hard to obtain at present, but the desirability of using them does not entail the necessity for buying them, merely for checking the ones used. Thus, for a 12,000-ohm resistor, the value can be 11,400—12,600Ω. One may well find a 20 per cent. tolerance resistor of 10,000Ω rating which is suitable, since a high limit resistor would be 12,000 ohms.

Two resistors R₉, R₁₀ are shown for the cathode bias of V₂, simply because the required value 167 ohms, is not a standard one. It can be obtained, however, by two standard values in parallel.

Values of components are listed under the heading "Circuit Values," together with their minimum ratings. There is, of course, no objection to using capacitors of higher voltage or resistors of higher power ratings. The value of R₁₂ depends on the mains voltage and this will be found in Table II.

It will be noted that two smoothing chokes are used. This is unusual in AC/DC apparatus, but is necessary to keep the hum

three things in the circuit which run very hot—the rectifier, the output valve and R₁₂. It is important, therefore, to give these parts ample ventilation and to keep all capacitors well away from them.

The grid of V₁ is a danger point for hum. The grid lead must be kept very short, and it is a good plan to mount C₁ and R₂ on a small paxolin panel combined with the grid clip and so carried by the top cap of V₁. The leads can then easily be kept down to less than one-half inch. Even so, it may be necessary to fit a metal shield over the top of the valve and these components, the shield being joined to the chassis.

If used on radio, the volume control R₁, can be the diode load resistance and a value of 0.25 MΩ is normally suitable. For gramophone work, the value of R₁ depends on the pick-up; 0.25 MΩ is a good average value, but for a piezo-electric type some 2 MΩ is generally better.

It must not be forgotten that the chassis is live to the mains and it must, therefore, be protected against accidental contact. Do not forget to make sure that the grub screw of the volume control knob is deeply sunk and then

0.001 μF is ideal, but hum considerations may demand a larger value.

The output obtainable is some 2 watts for a total distortion of rather less than 2 per cent. each of second and third harmonic. The input needed is 0.6 volt RMS.

Some details of a suitable output transformer are given in Fig. 2.

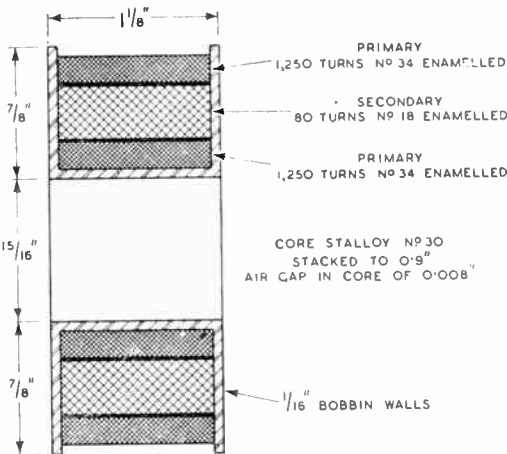

Fig. 2. This cross-section through a transformer bobbin shows typical windings for an output transformer. The secondary turns and wire gauge will vary with the ratio required.

TABLE II

Mains Voltage	R12	
	Ω	Watts
200	600	24
210	650	26
220	700	28
230	750	30
240	800	32
250	850	34

The primary consists of two sections wound in the same direction each of 1,250 turns of No. 34 enamelled wire. The outside of the inner section is connected to the inside of the outer. The secondary turns are 80 for a 4- Ω speech coil and No. 18 enamelled

wire is suitable. They should be wound in the same direction. The connections for negative feedback will then be right if the insides of the primary and secondary are joined respectively to positive HT and chassis.

For other speech-coil impe-

dances the number of secondary turns is found by dividing 2,500 by the turns ratio required. The wire gauge must, of course, be appropriately altered. Insulation between the sections is obtained by winding two layers of Empire tape between them.

RADAR PRE-HISTORY

RF Scanning : French "Obstacle Detectors"

AS *Wireless World* readers know, radar did not emerge fully fledged from nothingness during the war; its technique has been built up stage-by-stage from the contributions of many workers, and its history goes back for quite a respectable number of years. The main steps in the direct line of development have already been described in our pages, but as time goes on many other early uses of the radio echo principle will doubtless come to light.

British Patent No. 292,185, applied for by John Logie Baird as long ago as 1926, describes an arrangement that bears on the face of it a surprising resemblance to H2S, one of the most refined and highly developed applications of modern radar. Baird pointed out that wireless waves can be reflected and refracted like visible light waves, and contemplated "a method of viewing an object consisting in projecting upon it electromagnetic waves of short wavelength." Reflections from the object were passed through a scanning device to a receiver. The output of this receiver was to be used for modulating a source of visible light. A spot of light projected from this source would traverse a screen "in synchronism with the exploration of the object." The most obvious difference between Baird's scheme of 1926 and the present-day H2S is that scanning was done on the receiver side, and not by exploring the object with the transmitter beam.

French technicians were early in the radar field, and it would seem that the first "commercial" application of the principle was

in the "obstacle detector" installed aboard the *Normandie* in 1935. In a general review of French technical progress, including that made under great difficulties during the German occupation, P. Brenot, of the Société Française Radioélectrique, gives some interesting sidelights on early radar work. In this review, published in *L'Onde Electrique* for September, 1945, there is a short description of an experimental "obstacle location" station installed in 1936 by SFR at the entrance to the port of Havre. The apparatus worked on decimetre waves.

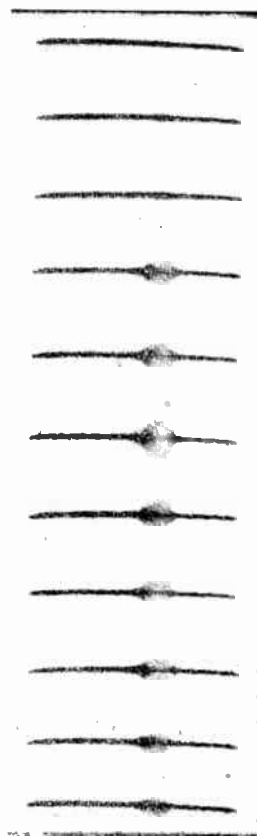

From "L'Onde Electrique"

The Sainte Adresse (Havre) experimental obstacle detector. The two parabolic reflectors explored a large sector. The surprisingly modern-looking "display" is also shown. The series of traces indicate echoes from a tug; they grow in amplitude up to the time that the tug cuts the axis of the projector, which was fixed for this test. The trace length represents a total distance of 10km; the measured distance of the tug is here about 4km.

The

SHORT-TIME-CONSTANT CIRCUIT

Graphical Illustration of the Fourier Principle

LEAVING aside those who by some freak of nature are born mathematical, most students no doubt receive with a certain lack of conviction the teaching that *any* waveform which repeats during equal time periods can be regarded as being composed of sine waves of appropriate amplitude and phase and integral multiples of frequency. It is not so much that the instructor's word is doubted—after all, it is little use doubting it, for he can always reply with a heavy barrage of mathematical symbols—but that the student has difficulty in actually visualising how extreme shapes, such as narrow perfectly squared-off pulses, can be made up of easy flowing sine curves and nothing else. And even when this by no means obvious fact is apprehended there is still room for doubt concerning how far what may appear to be a mere theoretical concept is able to stand up to the sort of treatment to which fancy waveforms are subjected in actual circuits.

For example, when a square wave (Fig. 1a) is passed through a short-time-constant circuit (Fig. 1b) the result is a peaky wave (Fig. 1c). The usual explanation of this process says nothing about the sine waves of which (a) is alleged to be composed. If these sine waves are followed separately through (b), will the results add up to the same as (c)?

The most convincing answer is to try to see for oneself. Unfortunately, the process of plotting and adding up an infinite number of sine waves twice over (or even a selection of the most prominent of them) is unbearably tedious. So the atmosphere of suspicion hangs as thickly as ever around the doctrine of the late M. Fourier.

The war brought this matter well within the province of great numbers of students of the non-academic kind, and it will probably continue to be so in post-war radio technique. So the writer

By M. G. SCROGGIE,
B.Sc., A.M.I.E.E.

has plotted sufficient component sine waves to add up to a reasonably convincing square wave; has calculated what comes out of a typical Fig. 1b circuit when each of these sine waves is separately applied to it; and has plotted these output waves and added them up together, giving what he hopes is a reasonably convincing approximation to the result that would have been obtained by the more normal classroom treatment. All he asks from readers is either that they take his word that the differences between his results and perfect square and peaky waves are due solely to the limited number of component sine waves he had the patience to draw, or that they keep on drawing more of them until belief does set in.

To make sure of what it is with which this roundabout alternative

momentarily appears across R as shown in Fig. 1c, causing a current to start flowing through R into C, charging it in the well-known exponential manner.* The smaller R is, the greater the current; and the smaller C is, the quicker a given current will charge it; therefore if $C \times R$ is small the voltage across C will rise rapidly. Because the applied voltage is constant, that part of it which is across R will correspondingly die away, as shown by the exponential curve in Fig. 1c between t_1 and t_2 . The circuit is described as having a short time constant; the time constant being the time necessary for the condenser to charge to 63 per cent. of the steady applied voltage. It is numerically equal to CR. At t_2 the process is repeated in the negative direction. And so on for successive waves.

Now for the synthetic method. The Fourier series for a square wave is a simple one; it consists of the fundamental and odd har-

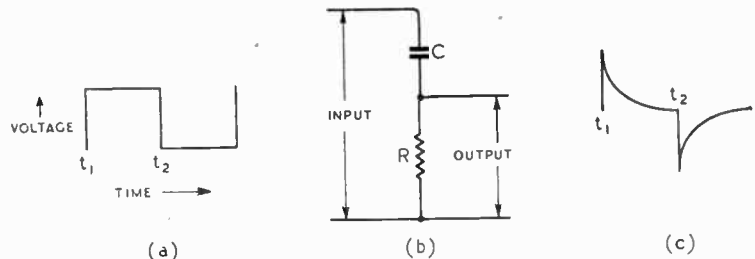

Fig. 1. When square waves, of which a sample is shown at (a), are applied to the input of a CR circuit (b) having a short time constant, the output is a peaked wave (c). This conclusion is arrived at via an unusual method in the following diagrams.

method is being compared, here is a condensed version of the "normal classroom treatment." At time t_1 in the cycle of the perfect square wave, the Fig. 1b circuit instantaneously receives a certain positive voltage. It is impossible for a condenser to acquire a new voltage instantaneously through a resistance, as it needs time to charge; and therefore the whole of the applied voltage

monics only, the amplitude of each harmonic being reduced in proportion to the number of the harmonic, and each is a sine wave starting off from scratch with no phase delay. It is, in fact, this simultaneous start of an infinite number of waves that adds up to

* I.e., one in which the rate of charge at any instant is proportional to the difference between the condenser voltage and the constant applied voltage, so that however rapidly it starts it dies away gradually.

form an infinitely steep wave front. Expressed mathematically, and assuming for simplicity that half-cycle that if they were continued for the second half-cycle they would make the same pattern

mental and the other harmonics at all corresponding parts of their cycles. The 1,000,001th harmonic starts off just as steeply as the fundamental, and as all start together the slope of the combined wave is infinitely great. It is only

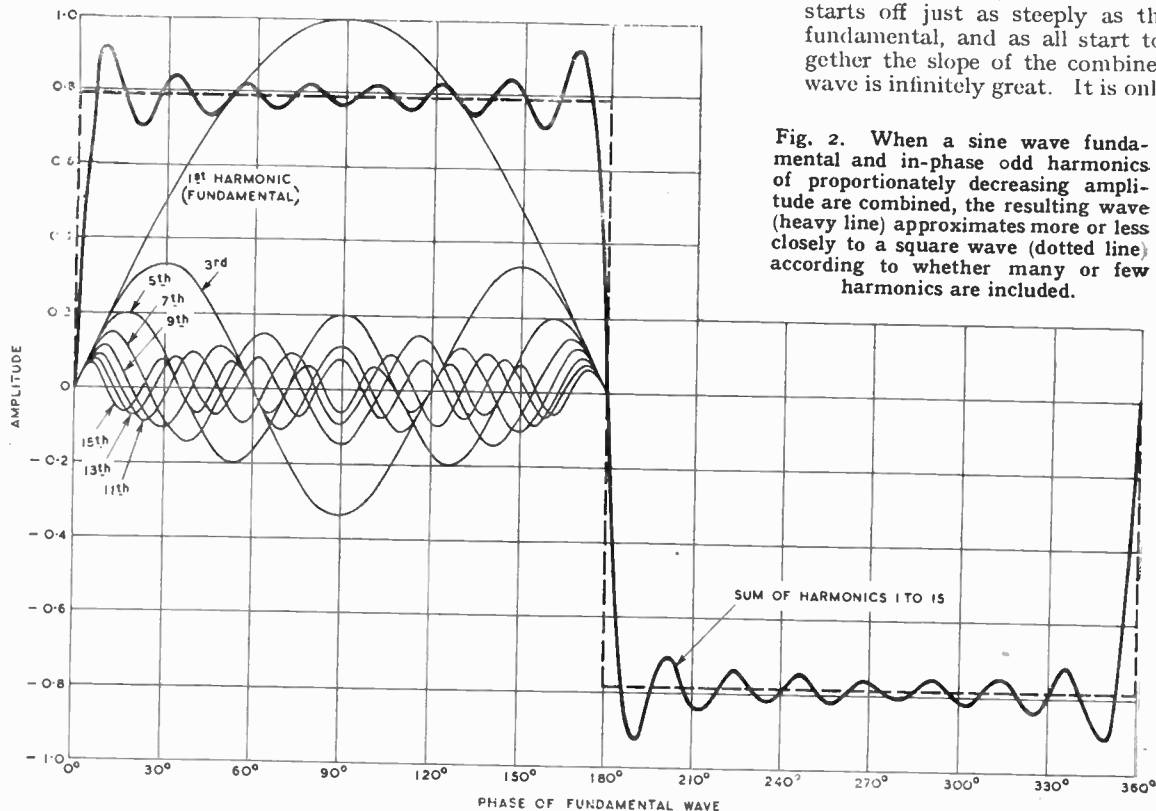

Fig. 2. When a sine wave fundamental and in-phase odd harmonics of proportionately decreasing amplitude are combined, the resulting wave (heavy line) approximates more or less closely to a square wave (dotted line) according to whether many or few harmonics are included.

the peak amplitude of the fundamental is 1, the series is :

$$\sin \omega t + \frac{\sin 3\omega t}{3} + \frac{\sin 5\omega t}{5} + \frac{\sin 7\omega t}{7} + \frac{\sin 9\omega t}{9} + \dots \text{ to } \infty$$

where ω is 2π times the frequency of the square wave and t is time. The amplitude of the 3rd harmonic is thus $1/3$, that of the 5th harmonic $1/5$, and so on. As tables of sines are in terms of angles, it is more convenient to express the series as $\sin \theta + \frac{\sin 3\theta}{3}$, etc., one

whole cycle of the square wave, or fundamental, being divided into 360° . Fig. 2 shows the series plotted up to and including the 15th harmonic, for half a cycle. Adding up the ordinates at frequent intervals along the half-cycle gives the waveform drawn in heavy line. It is obvious from the way the harmonics come into phase again at the end of the

but inverted; and so the composite wave has been repeated upside down to complete the cycle. It will be seen to fit fairly closely around a square wave drawn, in heavy dotted line, with amplitude $\pi/4$ (about 0.8) times that of the fundamental sine wave. The frequency of the superimposed ripple is the same as that of the highest harmonic included. If more harmonics were used, the ripple would become higher in frequency and less in amplitude, until ultimately it would be indistinguishable from the square wave. Incidentally, the heavy line illustrates the amount of distortion that would be suffered by a perfect square wave passed through a system having a top cut-off just above 15 times the frequency of the square wave.

As each harmonic in the series is reduced in scale from the fundamental by the same factor in both horizontal and vertical dimensions, it has the same slope as the funda-

at half-cycle intervals that all harmonics come into phase and form the vertical parts of the square wave; everywhere else the increasing values of some harmonics are offset by decreasing values of the others, and the total remains constant to form the flats of the square wave.

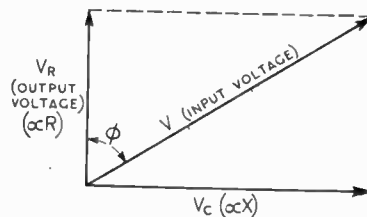

Fig. 3. Familiar graphical method of determining relative amplitudes of output and input sine waves.

Having pondered this sufficiently for the manufacture of sharp corners using only smooth curved ingredients to begin to look

Short-Time-Constant Circuit— less like a conjuring trick, the reader should turn to consider the simple device through which it is proposed to pass the mixture—the short-time-constant circuit, Fig. 1b. Again there is absolutely no deception; only well-understood basic principles of simple sine-wave AC are to be used. There are a variety of methods of finding the amplitude and phase of the voltage at the output of such a circuit,

relative to the input. In all of them it is necessary to know the ratio of the condenser's reactance, X_c , to the resistance, R ; and this is derived from the time constant. For the sake of a nicely-proportioned diagram and simple numbers, the time constant has here been chosen to be equal to one-tenth of a full cycle of the fundamental. As the duration of a cycle is the reciprocal of the frequency, this relationship can be written as:

$$CR = 1/10f_1$$

where the suffix 1 indicates that f_1 is the frequency of the fundamental (and, later on, other suffixes will distinguish the harmonics concerned). The reactance, X_c , of a condenser at the fundamental

frequency is:

$$X_c = 1/2\pi f_1 C$$

which, from the foregoing

$$= 10R/2\pi = 1.6R$$

Similarly

$$X_c = 1.6R/3, X_c = 1.6R/5, \text{ and so on.}$$

A graphical method of deriving the output phase and amplitude for each harmonic is shown in Fig. 3. In this, the lengths of V_R and V_c respectively represent to the same scale the output and input voltages, and ϕ is the angle by which the phase of the former is advanced. For the fundamental, V_c is drawn 1.6 times as long as V_R (that is to say, in proportion to X_c and R respectively—and at right angles to it; and, if the drawing is accurate, the

Fig. 4. Recombining the separate harmonics at the output gives a waveform (heavy line) approximating to that (dotted line) obtained by an alternative method (or by including all the odd harmonics to infinity).

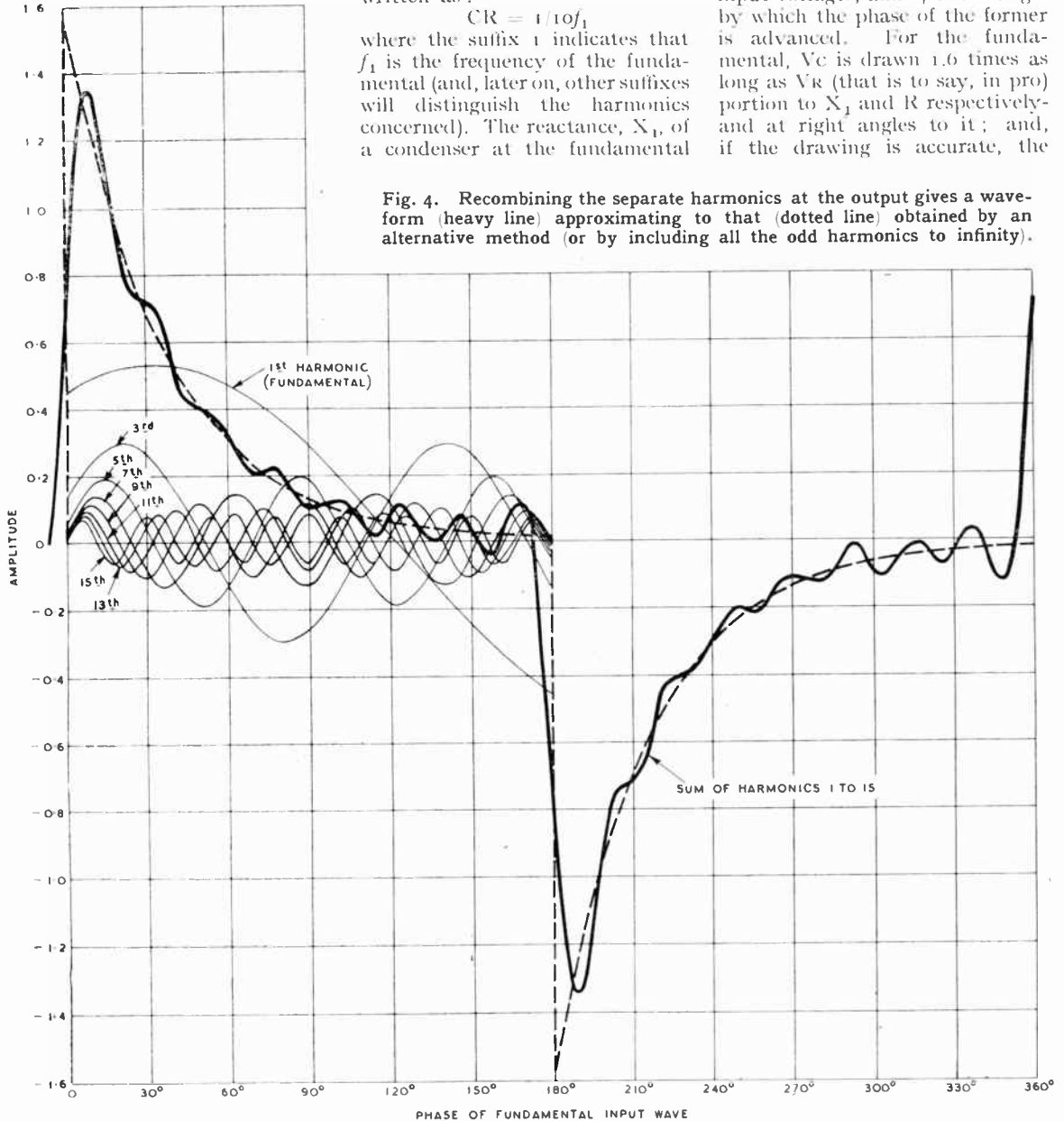

amplitude ratio, V_{R_1}/V_1 is found to be 0.53, and ϕ_1 is 58° . For the third harmonic, V_c is drawn one-third as long, so ϕ_3 is much less and V_{R_3} (the third harmonic voltage across R) is more nearly equal to V_3 . But it is really V_{R_3}/V_1 (ratio of third harmonic output voltage to *fundamental input*) that we want for plotting, and of course that is one-third as great. Similarly the phase shift in terms of the fundamental cycle is one-third as great as ϕ_3 .

The graphical method calls for an accurate large-scale drawing; and as ϕ_n is the angle whose tangent is X_n/R , and V_{R_n}/V_1 is $\cos \phi_n/n$, it is probably easier to derive them from tan and cos tables. Here are the results tabulated up to the 15th harmonic:

Columns 3 and 5 give the data with which each harmonic that

emerges from the "peaker" has been plotted in Fig. 4. Re-assembling these mangled bits by adding ordinates again, the result is the heavy-line curve. Comparing this with the heavy dotted line, which is the exponential curve obtained by the "classroom" method, it must be admitted that

Harmonic (n)	ϕ_n	ϕ_n/n	$\cos \phi_n$	$\cos \phi_n/n$
1	58°	58°	0.53	0.53
3	28°	9.3°	0.88	0.293
5	17.5°	3.5°	0.95	0.190
7	13°	1.9°	0.97	0.138
9	10°	1.1°	0.98	0.109
11	8.5°	0.75°	0.985	0.090
13	7°	0.54°	0.99	0.074
15	6°	0.4°	0.992	0.066

it clings too closely for the resemblance to be dismissed as, in the film sense, merely "coincidental." In the geometrical sense, however, it would actually coincide if all the (infinite number of) harmonics were included.

Some of us, oppressed with experience of our own fallibility, are never very happy or confident about the correctness of our calculations, be they financial or scientific, unless they reach the same answer by at least two entirely different routes. So it is hoped that the recognisably similar results achieved by such different approaches as the exponential charge and discharge of a condenser, and Fourier analysis and synthesis combined with plain alternating current theory, will increase readers' confidence in both these methods.

PULSE-WIDTH MODULATION

The Basic Principles Described

OF recent years pulses have become associated with radar to such an extent that one almost begins to believe that this is their only use. In fact, however, it is only one among many applications. Pulse technique was used in pre-war television to a very large extent and one has only to recall the line and frame synchronising pulses of the vision signal to realise their importance.

The use of pulses in sound transmission is not so widely known, however, and in certain cases it has important advantages. Before going into this, it will be well to clear up a possible source of misunderstanding, for the term "pulse modulation" is unfortunately often used in two different senses. It is used to describe the modulation of a radio-frequency carrier by pulses and also for the modulation of a series of pulses by some, usually audio, signal. In the former case, the pulses themselves may or may not be modulated and in the latter the modulated pulses may or may not themselves be used to modulate an RF carrier. In

Pulse modulation has many practical applications. One example of its use will be found in the Army "10 Set" described elsewhere in this issue. The pulse-width system explained in this article is employed in the Pye television sound apparatus, details of which are given on another page.

radar, the carrier is modulated by pulses which are themselves unmodulated; in a communication system, the carrier is modulated by modulated pulses so that it is analogous to a sub-carrier system in which the pulses form the sub-carrier. In this article, pulse modulation refers to the modulation of the pulses by an audio signal.

If a series of recurrent pulses is generated, it is possible to employ it to carry intelligence by varying some characteristic of the pulses in accordance with the intelligence. One can vary the amplitude, the duration, or the interval between the pulses for this purpose. For the present we need consider only one of these

—pulse-duration (or pulse-width) modulation.

Ten pulses of a recurrent unmodulated series are shown in Fig. 1(c). Each pulse lasts for a time interval t_1 and is followed by an interval t_2 in which nothing is transmitted. The total time t_1 and t_2 of one pulse and one interval is the time of one pulse cycle, and the pulse recurrence frequency is the reciprocal of this. It is usual to speak of recurrence frequency or pulse frequency and of pulse duration or width. To say that the pulse frequency is 10 kc/s and the pulse width is 40 μ sec. means that there are 10,000 complete pulse cycles a second and that one pulse cycle, therefore, lasts for 1/10,000 sec., or 100 μ sec. The interval between pulses is then 60 μ sec. Referring to Fig. 1(c), in such a case t_1 is 40 μ sec., and t_2 60 μ sec.

When such a pulse train is modulated in duration, the width of individual pulses is varied so that it is proportional to the amplitude of the modulating signal at that instant. This

Pulse-width Modulation—

is shown in (a) and (b) of Fig. 1: (a) is one cycle of a sine wave and represents the modulating signal and (c) is ten cycles of the pulse waveform in the unmodulated condition; (b) shows the modulated wave.

In the case shown the trailing edges (i.e., the right-hand edges) of the pulses occur at the same time whether they are modulated or not, but the timing of the leading edges depends on the modulating signal. It is clear that as the waveform (a) grows, the pulses of (b) start earlier and earlier, so that their duration increases. The maximum width occurs when the voltage (a) has

about the maximum allowable. For the case quoted of 40 $\mu\text{sec.}$ pulses this would mean a variation of 32 $\mu\text{sec.}$, so that the minimum or maximum pulse lengths would be 8 $\mu\text{sec.}$ and 72 $\mu\text{sec.}$ respectively.

It will be observed that the system virtually samples the modulating signal at intervals and in consequence the signal is not transmitted continuously. There is a minimum number of pulses needed for each cycle of the wave to be transmitted, therefore, if faithful reproduction is to be obtained. One would expect this would be at least several hundred, but in actual fact no more than three pulses

kc/s. This is very high for a maximum modulation frequency of some 3–5 kc/s only. The bandwidth radiated is, of course, double this for the usual double sideband transmission, so that the system is not one which is ever likely to be adopted on ordinary wavelengths where the space available is strictly limited.

Multi-Channel Systems

It is, however, of very great advantage on very short wavelengths where ordinary methods of modulation are difficult and where the band-width needed becomes unimportant. It also lends itself well to multi-channel working.

If the unmodulated pulse duration is considerably less than the interval between successive pulses, then another series of pulses, representing another channel of communication, can be inserted in these intervals. This is what is done in the Pye television system described elsewhere in this issue. The sound pulses are of 3 $\mu\text{sec.}$ duration and vary between 1 $\mu\text{sec.}$ and 5 $\mu\text{sec.}$ The whole vision signal, representing a second channel, is inserted in the gaps between them.

Before concluding, something should be said on the demodulation of the pulses to produce the audio-signal again at the receiver. With a single channel, the detector output is of the form of Fig. 1 (b) and it is necessary to produce from this the original wave (a). Surprising as it may seem, this can be done with nothing more than a simple low-pass filter. Mathematical analysis of the wave (b) shows that it is nothing but the wave (a) with the addition of a large number of higher frequency components of which the lowest is the pulse recurrence frequency and it is only necessary to filter out all these to obtain the original wave.

With the multi-channel systems, it is first necessary to sort out the pulses for each individual channel. In the Pye system, the pulses of the sound channel are of greater amplitude than the vision signal and can be separated by a simple amplitude filter. Passing the separated pulses through a low-pass filter then produces the audio signal.

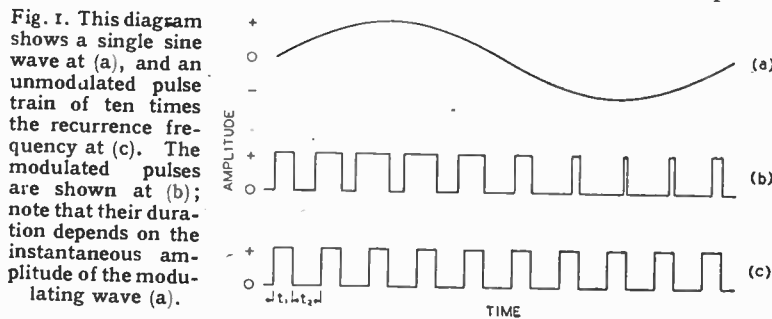

Fig. 1. This diagram shows a single sine wave at (a), and an unmodulated pulse train of ten times the recurrence frequency at (c). The modulated pulses are shown at (b); note that their duration depends on the instantaneous amplitude of the modulating wave (a).

its maximum positive value. After this point the pulse width decreases, and when (a) swings negatively the leading edges of the pulses start later than those of the unmodulated ones. Therefore the pulses are shorter. The minimum width occurs at the negative maximum of (a).

Modulation Depth

If the unmodulated pulse width is t_1 and it is symmetrically modulated, the maximum possible amplitude of modulation is also t_1 and then the pulse varies between the limits of $t_1 \pm t_1$, or from zero to $2t_1$. This is, of course, provided that the pulse t_1 is equal to or less than the interval t_2 between unmodulated pulses. This represents 100 per cent. modulation.

In practice, such deep modulation is undesirable because it means the disappearance of the pulse on the negative peak of modulation and in addition very narrow pulses demand an excessive frequency band for their transmission. In general, a modulation depth of 80 per cent. is

are needed and with some care quite good results are obtainable with two pulses per cycle only!

Usually, one takes it that the minimum pulse recurrence frequency is three times the highest modulating frequency, or some 30 kc/s for high-fidelity reproduction or 9 kc/s for ordinary commercial grade telephony.

So long as the sides of the pulses are vertical, the linearity of the apparatus handling the modulated pulses is unimportant; it is possible to use amplitude filters without causing distortion and often with a considerable reduction of noise. This is analogous to the methods frequently adopted in television reception of limiting the sync pulses to reduce the effects of noise and other interference.

The disadvantage of pulse modulation is the wide band of frequencies needed for its transmission. The highest frequency needed is of the order of the reciprocal of the narrowest pulse duration. In the example above this was 8 $\mu\text{sec.}$, so that the highest frequency is about 125

FUNDAMENTALS OF RADAR

3. Radar as a Weapon of Offence : ASV and H2S

IN the previous two articles in this series we examined radar in its original role as detector and locator of enemy aircraft, first from the ground as a warning device and later both from ground and air for counter-offensive action. This was part of what may be called the RDF phase of radar.

Airborne radar reached its peak with the introduction of H2S, and this month we shall examine the workings of H2S and its close relation ASV.

From September 1939 to the end of hostilities a continuous battle went on in the Atlantic, which was only kept in precarious balance by the sustained efforts in the radar laboratories. Only the use of ASV ("air to surface vessel" radar) enabled the submarine offensive to be contained. ASV development went through several stages of wavelength shortening, just as did AI, each new design appearing as the radar-tactical situation changed.

The first experimental ASV equipment was demonstrated during the fleet manoeuvres in September 1938. It became operational in October, 1939, and was thus the first airborne radar of the war; improvements in 1941 made possible the detection of surfaced submarines. This first ASV was in the 1½ metre band, in which most of the equipments of the period were working. It closely resembled the corresponding marks of AI equipment in principle. The transmitting aerial was carried on the nose of the aircraft and was beamed slightly to floodlight the sea in front of the aircraft. Out on each wing were mounted receiving aerials. These were usually of the "Yagi" type, giving a fairly narrow beam. The echoes from a target were picked up by the receiving aerials and presented alternately on the cathode ray tube by means of a rotating switch. This "split" display enabled the operator to judge when the aircraft was heading towards the target by the consequent equality of the echoes.

The distance of the target was given by the interval between the transmitted pulse and the echo. The final attack was made by visual bombing, eventually assisted at night by the Leigh Light which was introduced in the summer of 1942.

The range of this 1½ metre ASV equipment was about 10 miles for ship detection, but surfaced submarines could only be detected at shorter ranges. A single aircraft could, however, sweep a very large area of sea during a single flight. Another important feature of ASV was that aircraft returning from anti-submarine patrols could home on beacons, which transmitted artificial echoes when illuminated by radar pulses. Navigation problems were thereby simplified, for when the aircraft had arrived within about 50-100 miles of its base it could be navigated by ASV. This greatly increased the number of patrols which could be flown in bad weather.

By the end of the summer of 1942 it had become clear that radar was acting not only as a detector of submarines but also as a warning to them. Listening sets picked up the ASV pulses at ranges of possibly 50 miles, and long before the echoes were strong enough to be detected by the aircraft the submarine could submerge undetected. This installation of listening sets was part of a private

war which went on all the time, about which very little can be written. The original idea of radar was to detect "non co-operating objects." In doing so, the radar station itself co-operated in enabling the "object" to find the radar station. The blacked-out ship and unlit aircraft were carrying brilliant radiators of electromagnetic waves, and it was constantly necessary to introduce new wavelengths so that the enemy could not use the information thus offered to him. Much of the story of wartime radar development is a story of a search for novelty which would provide the element of surprise.

The ASV problem was already solved. Centimetre equipment was ready to go into service by the early spring of 1943, just as the enemy were seeking to profit by his 1½ metre listening sets and his apparent tactical freedom from air attack. The impact of a new radar technique against the unjustified confidence of the enemy submarine commander had a most devastating effect.

In many ways centimetre ASV resembles centimetre AI. The family likeness appears in the use of the magnetron, the Sutton tube local oscillator and the gas gap for common transmission and reception from the same aerial. We may digress at this point to indicate the action and use of the gas gap. The problem is to

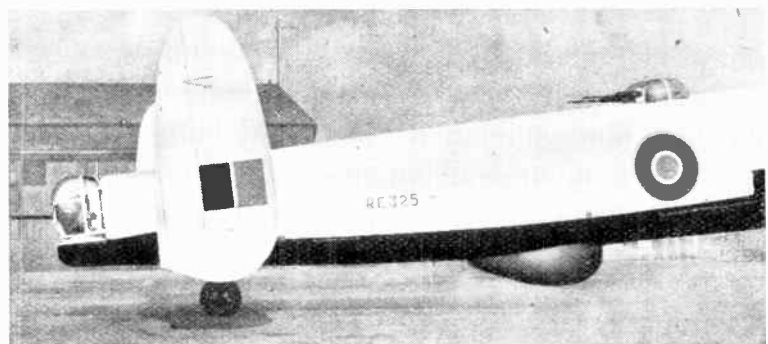

The blister enclosing the H2S scanner on the latest R.A.F. heavy bomber, the Lincoln, can be seen below the roundel.

Fundamentals of Radar—

connect, as efficiently as possible, a powerful transmitter and a sensitive receiver with a crystal mixer to the same aerial. Without some special precautions the crystal would be burnt out by the transmitter power, and the receiver would also absorb much of the power. The basic circuit is

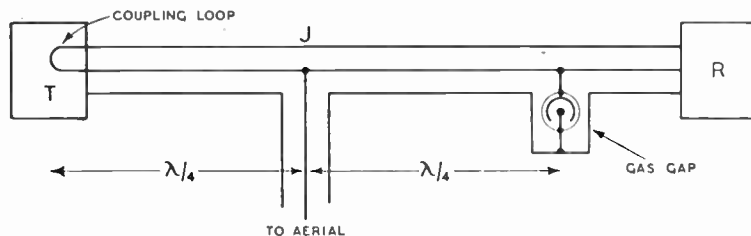

Fig. 1. Aerial switching arrangement in centimetre radar equipment.

shown in Fig. 1. The gas gap consists basically of two electrodes in a "soft" valve. When the transmitter is on "space," the coupling loop acts as a short circuit, and by the usual impedance-transforming property of a quarter-wave line an infinite impedance is presented by the left-hand section at J. Received pulses therefore pass to the receiver. The gas in the protective tube being unionised, the gap absorbs no energy and the whole signal reaches the receiver. When the transmitter "marks," the gap breaks down and the ionised gas provides an effective short circuit. The receiver line presents infinite impedance at J and all the power goes to the aerial. In practice refinements are necessary; the capacity of the gas gap must be allowed for in designing the system, impedance transformations are introduced to give maximum protection, and biasing voltages are applied to encourage the gas gap to ionise as soon as the transmitter mark begins. These details are not material to the present outline.

The display unit of ASV differs from that of AI in using a true PPI, which provides the observer with a map of the sea, with ships and coastline shown, just as the GCI operator was given a picture of the position of aircraft in the sky, so the ASV operator could see, as though plotted on a chart, the positions of all ships and coastlines within range. Often,

of course, it resembled the Bellman's Chart*

"representing the sea,

Without the least vestige of land:

And the crew were much pleased when they found it to be

A map they could all understand."

For convoy protection, however, the view of the whole convoy was invaluable.

Beam Shape in ASV

The aerial system was mounted in a turret placed below the nose or belly of the landplanes of

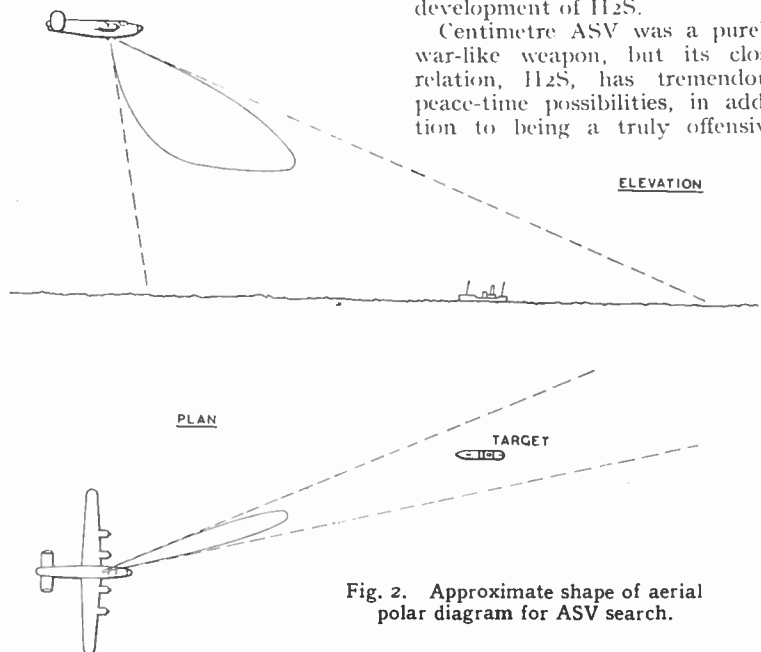

Fig. 2. Approximate shape of aerial polar diagram for ASV search.

Coastal Command. Inside the fairing an aerial and reflector were mounted so that they could rotate about a vertical axis.

A cut-down paraboloid is used and the resulting beam is narrow in azimuth, where the reflector has its full dimensions. In elevation, however, the beam is spread out in such a way that although most of the energy is sent out at a few degrees below the horizontal, the lobe is deformed at greater angles from the horizontal, and is free from minima (Fig. 2). The shape of the deformed lobe is such that an aircraft flying at its normal operational height will receive echoes of approximately equal strength from all targets within range.

By rotating the aerial system the whole sea can be searched within a circle whose radius equals the range of the equipment. As the aerial system rotates, the radial timebase of the PPI goes round in synchronism, and echoes brighten up the beam of the cathode-ray tube. When the aircraft comes within range of land the coastline is clearly shown and salient features can be used for navigation. This fact was made full use of in the development of H2S.

Centimetre ASV was a purely war-like weapon, but its close relation, H2S, has tremendous peace-time possibilities, in addition to being a truly offensive

war-weapon. If an ASV set is operated over a coastline it is found that in general land scatters back more energy than water and buildings scatter back more than open country. Thus over

* "Hunting of the Snark, Fit the Second."

land, rivers and lakes appear as black marks against a faint "land" background, while towns stand out quite brightly on the PPI. Changes in detail design

A transmitter T is at a height h_1 , above the ground, and a reflecting object O is at a height h_2 . Both heights are such that we may consider the ground range

equal to G the power available at the receiver will be

$$W_n \propto \frac{Qh_1^4h_2^4G^2}{\lambda^2R^8} \cdot W$$

Thus as the range is fixed by the minimum detectable value of W_n , which is a constant of the receiver, the range R is proportional to $W^{1/8}$, the eighth root of the power. The use of ten times the power results in a range only 33 per cent. greater. As we saw in the description of the free space case, the choice of G and λ are the most important factors in radar system design.

[The photograph of mechanism for spiral scanning on p. 328 of Part 2 of this series was reproduced by courtesy of the makers, Nash and Thompson of Tolworth, who were the principal producers of radar scanners.—ED.]

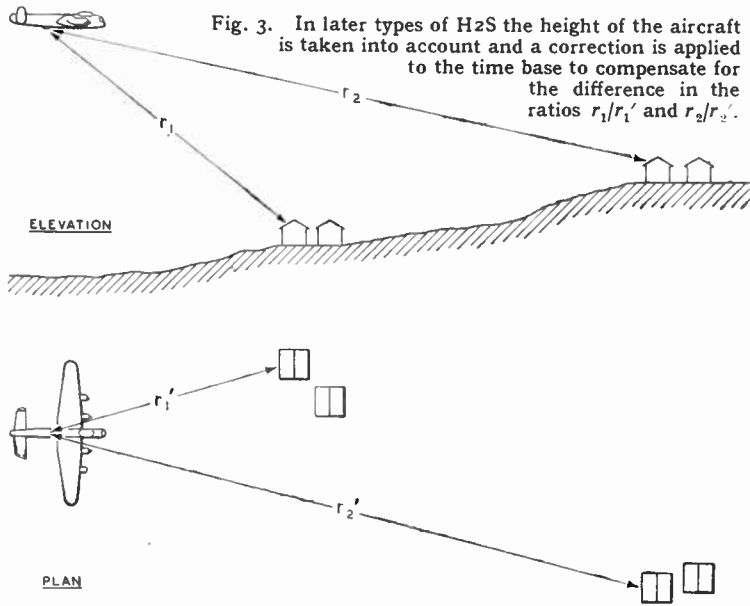

Fig. 3. In later types of H2S the height of the aircraft is taken into account and a correction is applied to the time base to compensate for the difference in the ratios r_1/r_1' and r_2/r_2' .

RADAR MAP

THE illustration on the front cover of this issue shows the trace reproduced on the CR tube of the latest version of H2S (designated H2X) when the aircraft was flying in dense cloud over the Thames estuary.

RADIO IN NORWAY

SIX of the sixteen broadcasting stations in Norway were destroyed during the war. They are those at Porsgrunn, Notodden, Vigra, Vadsoe, Narvik and Bodoe. As a result, listening conditions in many districts, particularly in the north, are very poor. To alleviate the difficulty a transportable 20-kW transmitter has been erected at Vigra until the new 100-kW transmitter is completed. New transmitters are being constructed as well as replacing those destroyed. Among the new stations is a 50-kW short-wave transmitter, which will replace the present 5-kW station, and is intended particularly for Norwegian listeners abroad.

Wireless sets valued at about 120,000,000 kroner (approximately £6,000,000) were confiscated by the Germans in Norway in 1941. A large number of these have now been restored to their owners, but many more are needed to meet the demand. The present policy is to import the components and manufacture the sets in Norway. The Norwegian Broadcasting Service has, therefore, ordered components for 120,000 sets, some of which are expected to be on sale at Christmas.

are necessary, for the operating height of a bomber is greater than that of a sea reconnaissance machine. In addition, the map presented on the PPI is a "slant range" map and is thus badly distorted in the region immediately below the aircraft. This is inconvenient both for navigation and for bombing, and it is necessary to distort the PPI timebase to make the H2S map resemble the ordinary geographical map. The difference can be seen from Fig. 3.

The H2S system is probably the most interesting radar device. It represents the introduction of a new sense for man, that of vision at centimetre wavelengths, with apparatus which can be carried in a fairly small aircraft.

We saw last month that the range of a radar system in free space was proportional to the fourth root of the transmitter power. In calculating the range of air-to-ground radar systems we must take into account the effect of the wave which reaches the target after reflection from the ground as well as the direct wave. For the case of horizontal polarisation we proceed as follows.

R equal to the slant range: that is we can write $1/R^2$ in the inverse square law. The field strength at O produced by a transmitter of power W at T can be shown to be:

$$\frac{40\pi h_1 h_2}{\lambda} \cdot \frac{\sqrt{W}}{R^2}$$

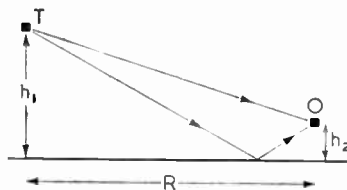

Fig. 4. Ground reflections must be taken into account in the H2S radar system.

If the power scattering coefficient of the reflector is Q, the power re-radiated will be

$$Q \left(\frac{40\pi h_1 h_2}{\lambda} \right)^2 \cdot \frac{W}{R^4}$$

This produces at T an available signal power which is proportional to

$$\frac{QW h_1^4 h_2^4}{\lambda^2 R^8}$$

This expression must be multiplied by the power gains of receiving and transmitting aeri- als, and if these are both

UNBIASED

A New Menace

DISQUIETING rumours reach me from some of my fifth columnists who toil for certain of the big wireless manufacturers. From what I hear, it seems that when the industry gets settled down once more to real and full-time peace production, we are likely to be provided with push-button broadcast receivers without any tuning dial at all, the argument being that push-buttons form the quickest and best method of tuning, and the elimination of dial tuning will greatly cheapen production, which will please the average citizen, who won't have to pay for a feature of the set which he doesn't want.

I can only hope that my information is wrong and that the counter-intelligence service of the manufacturers is putting out these rumours to throw dust in my eyes, for no policy could be more short-sighted and misguided than the omission of dial tuning. To illustrate my point let us suppose that we *do* get saddled with "push-buttons-only" sets. People will get to like them because of their simplicity, and in a few years a generation will spring up which has no more idea of how to tune in a station than the present-day motorist has of how ignition could be provided by non-electrical means which, of course, it actually was, round about the time of Majuba Hill, as I well remember.



"I hear from my spies."

Once this new generation has sprung up, the first part of the mischief will have been done, although it could only bring forth its evil fruit in the admittedly not very likely event of some home-grown Adolf suddenly seizing power in this country and dealing with us as the original Adolf did with his fellow Teutons. The nett result would be

By
**FREE
GRID**

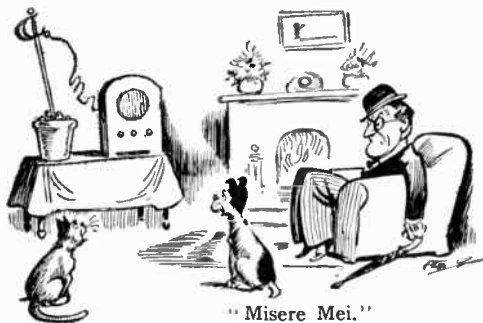

"Misere Mei."

almost as bad as if broadcasting by radio had been replaced by some wired method of programme distribution; namely, we should have to listen to what the "government" of the day wanted us to hear, for very few people would have the skill to delve into the set's innards and readjust the pre-set tuners to the wavelength of an over-sea freedom station.

It is true that the freedom transmitter could adjust itself to the fixed wavelength of one of the receiving channels, but all the same I don't like it. The people must retain their old skill and cunning with a tuning dial and they can only do that if manufacturers continue to turn out sets fitted with dials as well as with push buttons.

The most disquieting thing of all is that I hear from my spies that the whole business is sponsored by the G.P.O. mandarins as a sort of thin end of the wedge to a revival of their pre-war wired broadcasting ambitions which were so effectively nipped in the bud by those who saw the menace.

"Sursum Corda"

LATELY I have been spending a good deal of time reading wireless literature in the shape of elementary text-books in general, and, in particular, the instructional manuals which set manufacturers always give away with their products. As a result of my reading I am in a very depressed state indeed. To possess a wireless set is, I can well see, not for me and still less is it for the average non-technical citizens. The care and attentions which a set requires obviously calls for more time and patience than I or anybody else can afford to spend on it unless we are to desert our wives and children and all other interests and enter the cloisters of a sort of wireless monastery in order to devote our whole lives to it.

My complaint against these books is that trouble—with a capital "T"—is the theme-song running through them with nary a *sursum corda* any-

where to enlighten what Newman so aptly described as the "encircling gloom." Unfortunately, the writers of these books, however learned they may be in matters pertaining to the "elements" of wireless, don't seem to have studied the elements of psychology, for there is no joy in their writings. I am, therefore, thinking of writing a handbook myself on the elements of writing an elementary book on wireless—or, for that matter, on any other subject, for wireless books are not the only ones at fault.

Pick up an instructional book on any subject you like; keeping a dog, for instance. What do you find? Unless the dog is brushed regularly and its ears carefully examined every morning, the very least of its troubles will be mange and canker, whilst further "neglect" will mean diseases too ghastly to mention. An even worse instance is afforded by the "Keep 'it" and "Every Man His Own Doctor" books. I recently read one of these with the result that I had only just sufficient strength to totter to the telephone and ring up for the undertaker to come and take me away. It was fortunate for me that I got the wrong number and instead of the sepulchral voice which I had expected, I heard the comparatively joyous tones of the local dentist.

But to return to the wireless books. My aerial (so the book tells me) must be high but at the same time the downlead must be short, and, of course, the insulators must be cleaned regularly, whilst periodically the earth plate must be dug up and inspected. The receiver must be placed in such a position that it is free from damp but at the same time it must not be near the fireplace owing to the evil effects of the "products of combustion" (smoke, I suppose) which may get into it; in fact, I must be on the look-out for this during my diurnal dusting of the condenser vanes.

But I give up. *Misere Mei*. I would end it all with my ceremonial hara-kiri sword, but apparently Mrs. Free Grid is using it stuck in a flower-pot as an earth connection.

CRYSTAL-CONTROLLED FREQUENCY MODULATION

Direct Modulation of the Natural Frequency of the Crystal

By S. K. LEWER, B.Sc.

ONE of the most difficult problems in the design of FM transmitters is to provide for adequate variation of the frequency of the modulating signal while retaining a satisfactory measure of stabilisation of the mean frequency of the carrier.

It is customary in some types of FM transmitter to use a crystal-controlled oscillator for the generation of a frequency-stabilised mean carrier frequency and to produce the required frequency modulation by transitorily varying the phase of the oscillations in accordance with the modulation signal. This is the method used in Armstrong's system.¹ Unfortunately the extent to which the frequency can be made to deviate from its mean value by this application of phase modulation is quite small. In some applications, as in high-quality broadcast, it is necessary to increase the effective deviation by a process of frequency multiplication, perhaps as much as 3,000 times, but where the requirements are less stringent a multiplication of about 75 times has proved sufficient.²

In another system, a valve is used as a variable reactance in conjunction with the tuned circuit which determines the frequency of the fundamental oscillation. Although the degree of frequency excursion which can be accomplished by this method is so much greater as to require a multiplication of only a few times, it is necessary to incorporate a rather elaborate arrangement for the self-stabilisation of the mean frequency. This adds considerably to the general complexity of the complete transmitter.

Other methods have been proposed, but like the two just men-

tioned they all suffer from various drawbacks. With sufficient enterprise these drawbacks can in most cases be eliminated, but the possibility remains that with further effort new methods may be brought to light and eventually prove superior.

The problem is fundamentally one of varying the frequency sufficiently without appreciably altering its mean value.

The system of frequency modulation described here is offered as an alternative to the schemes which have so far been considered. Whether or not it possesses any features which might render it preferable to the methods at present in favour is a matter for further experiment.

Crystal Cuts

The basic principle of the new method is the direct modulation of the natural frequency of the piezoelectric element which is used for controlling the mean carrier frequency. As is well-known, a piezoelectric crystal possesses the property of changing its dimensions when a potential gradient is applied parallel to the electric axis. For the purpose of the present description there is no need to go into the question of crystal structure and the orientation of the various crystallographic axes. It will be sufficient to consider the properties of the simplest and most convenient type of crystal element, namely, an X-cut quartz plate.³

Nowadays the X-cut crystal is seldom mentioned in radio engineering. It has been superseded for most purposes by more intricate cuts, such as the AT and BT-cuts, in the demand for higher

frequency-stability.⁴ Nevertheless, the old-fashioned X-cut has certain features which can be utilised to great advantage in FM systems.

In high-frequency crystal plates the natural frequency of vibration is dependent on the thickness of the plate. The frequency is inversely proportional to the thickness. This is true for the thickness-shear vibration, as used in the AT and BT-cuts, and also for the simple thickness vibration, as used in the X-cut.

When a polarising potential-difference is applied to the electrodes of an X-cut plate there is a corresponding change in the thickness of the plate. The natural frequency of the thickness vibration is then modified, rising when the direction of the polarising potential is in such a direction as to cause a diminution of the thickness and falling when the direction is reversed. Over a range wide enough to be of practical interest, the relation between the frequency of oscillation and the polarising potential is substantially linear.

In comparison, the AT and BT-cuts would appear to be unsuitable for use in this system. The applied potential produces a thickness-shear in such plates, and the variation of natural frequency with potential-difference would be negligibly small, if not actually non-existent.

Experimental measurements have shown that with an X-cut plate having a fundamental frequency of 6.8 Mc/s an applied voltage of 300 volts DC produces a shift in frequency of 60 c/s. Over this range the variation was observed to be strictly linear. Expressing this in general terms, the relationship is $\delta f/f = 3V \times 10^{-8}$,

¹ E. H. Armstrong, *Proc. I.R.E.*, May 1936, Vol. 24, pp. 689-740.

² A. Hund, "Frequency Modulation," (McGraw Hill) pp. 118, 231.

³ C. F. Booth and E. J. C. Dixon, *J.I.E.E.*, 1935, Vol. 77, p. 197.

⁴ W. P. Mason, *Bell Syst. Tech. J.*, January 1940, 74.

Crystal-controlled Modulation—

where f is measured in cycles per second and V in volts.

The fundamental frequency f of an X-cut plate is related to its thickness t by the equation $f \times t = 2.87 \times 10^6$ where f is again in cycles per second and t is in millimetres. Therefore, the FM characteristic of an X-cut plate may be expressed as $\delta f = f \times 3V \times 10^{-8} = 8.61 \times 10^{-2} V/t$.

Obviously a limit will be set to the frequency shift by the maximum permissible value of V/t , for this is the potential gradient across the crystal, but from a practical standpoint a value of $V/t = 600$ volts/mm. is perfectly safe. It is not suggested that this figure is a working maximum, and it is quite possible that much higher values may be found satisfactory. The experimental figures quoted here are intended merely to show that the effect is of a practicable order.

Although the principle in itself is simple, certain other aspects of the problem must be considered, such as the choice of fundamental frequency of the modulated crystal and the question of temperature stabilisation. These problems are discussed later.

modulating voltage from affecting the oscillator valve directly. Equally it will be necessary to exclude RF currents from the modulator system. Since the crystal-oscillator frequency is likely to be at least 100 times the maximum modulation frequency, this should be a straightforward matter of high-pass and low-pass filters.

The essential elements of a circuit arrangement utilising the principle of direct modulation of the crystal frequency are shown in Fig. 1. In the right-hand section there appears a conventional crystal-controlled RF oscillator, X being the frequency-determining crystal. The left-hand section shows the final stage of a normal AF modulation amplifier. The output from the latter is applied through a suitable impedance-matching transformer T and a low-pass filter LC_1 to the electrodes of the crystal.

If the modulation voltage were allowed to reach the grid of the oscillator valve, a certain amount of amplitude modulation would result. Probably the modulation voltage thus applied would also influence the frequency of oscillation adversely by reason of the varying impedance load across

a suitable load simplifies the design problem and assists in achieving a linear overall frequency/voltage characteristic.

A numerical example will now be given to illustrate the practicability of the method and to indicate the magnitude of the various factors involved.

It is assumed in the first place that the mean carrier frequency will be of the order of 50 Mc/s, for FM is hardly suitable as a system of communication at frequencies much lower than this. Further, it may be supposed that the mean carrier frequency is to be maintained constant to within ± 0.01 per cent. The maximum deviation will be taken as ± 75 kc/s, which is the figure at present accepted as standard for high-quality broadcasting.

Some degree of frequency multiplication will obviously be necessary, for the grinding of X-cut crystals to a frequency as high as 50 Mc/s is still a prohibitively expensive proposition and nothing short of scientific trickery. To simplify the arrangement of frequency-multipliers and amplifiers as far as possible, it would be preferable to choose a crystal having a high fundamental frequency. Since the frequency deviation achieved by the piezoelectric change of thickness for a given modulation voltage increases with the fundamental frequency, this constitutes a further reason for choosing a crystal with as high a frequency as possible.

Taking the figures specified above, it is seen that the required shift of frequency of 75 kc/s in 50 Mc/s is 0.15 per cent. To produce a frequency deviation of this order directly with an X-cut plate would call for a peak modulation voltage of over 50,000 volts (according to the relationship $\delta f/f = 3V \times 10^{-8}$). This is unquestionably excessive from several points of view. With a lower voltage, no amount of direct frequency multiplication would yield this degree of frequency deviation.

It is therefore necessary to resort to the method used in Armstrong's system whereby the percentage deviation is artificially increased. The frequency-modulated oscillation is subjected first to a reasonable amount of multiplication, perhaps 10 times, and

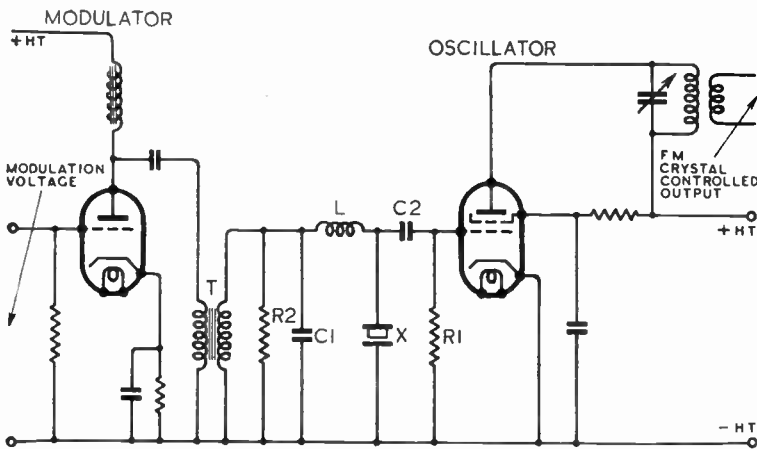

Fig. 1. Essential elements of a frequency-modulated crystal oscillator.

The frequency-determining crystal forms part of the RF generating circuit and also constitutes a load on the modulating system. Consequently, the modulator will be connected to the RF generator. In order to avoid spurious modulation effects, care should be exercised to prevent the

the crystal. A low-stop filter R_1C_2 is therefore inserted between the crystal and the oscillator grid.

The impedance-matching transformer T is desirable in view of the high impedance which the crystal presents over the range of modulation frequency. The use of a shunt resistance R_2 to provide

the resultant is heterodyned with a fixed oscillation having a frequency suitably close to it. The heterodyne difference-frequency is, of course, much lower than either of the two component frequencies, but the amount of the deviation of the difference-frequency from its mean value is the same as that of the modulated component.

Thus, suppose the initial generator produces an oscillation of 1 Mc/s which is modulated to the extent of ± 50 c/s. After a multiplication of 10 times, this modulated oscillation has a frequency of $10 \text{ Mc/s} \pm 500 \text{ c/s}$. If this is heterodyned with a fixed oscillation of 10.02 Mc/s (or 9.98 Mc/s), the mean difference-frequency will be 20 kc/s and this will be modulated to the extent of $\pm 500 \text{ c/s}$.

The highest frequency for which an X-cut plate can be prepared, apart from laboratory curiosities, is about 10 Mc/s . Let us suppose that a 5-Mc/s crystal is used. From the experimental relationship $\delta f = 3fV \times 10^{-8}$, we may expect a frequency variation of $\pm 150 \text{ c/s}$ for a modulating potential of $\pm 1,000$ volts peak. The frequency deviation directly obtainable is thus $150/5 \times 10^6$ or 0.003 per cent. This must be increased to 0.15 per cent. if we are to produce a modulation of $\pm 75 \text{ kc/s}$ with a carrier frequency of 50 Mc/s as specified above.

Suppose the initial crystal-controlled modulated oscillation of $5.0 \text{ Mc/s} \pm 150 \text{ c/s}$ is multiplied 5 times so that it becomes $25.0 \text{ Mc/s} \pm 750 \text{ c/s}$. By heterodyning this with a fixed oscillation of

lators with a reasonably high stability and to provide automatic correction for the other oscillator so as to stabilise the difference frequency. Oscillator A must depend on an X-cut crystal, since this is required for the modulation process, and therefore it will be subject to a closely predictable variation of frequency with temperature. An X-cut crystal has a frequency-temperature coefficient of $-23 \text{ cycles/Mc/deg. C.}$, whereas with other high-frequency cuts

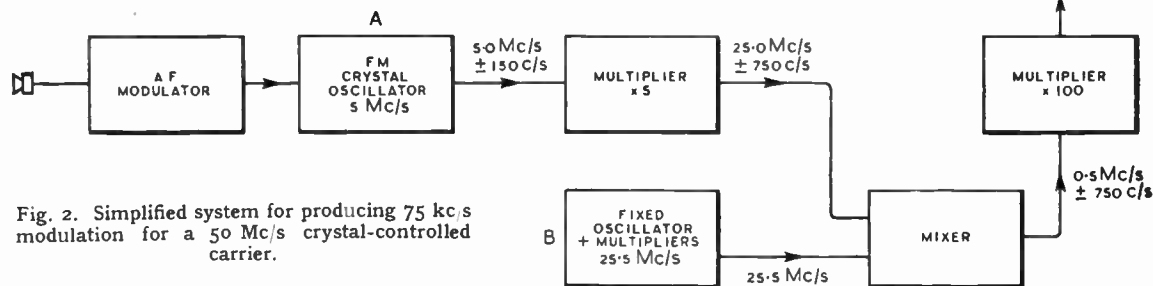

Fig. 2. Simplified system for producing 75 kc/s modulation for a 50 Mc/s crystal-controlled carrier.

Here the original modulation of $50/1,000,000$ or 0.005 per cent. has been converted to one of $500/20,000$ or 2.5 per cent.

This carrier frequency of 20 kc/s could be multiplied again by, say, 50 times, after which the frequency would again be 1 Mc/s but now with a modulation of $\pm 25 \text{ kc/s}$. If necessary, a further stage of the heterodyning and multiplying process could be added to increase the percentage frequency deviation at the same carrier output frequency.

The degree of frequency multiplication and the frequency at which heterodyning is best effected are matters to be settled by consideration of the specific circumstances. No definite rules can be laid down. For the present, it need only be remarked that the principle of magnifying the deviation is sound, that it is being successfully used and that there is a large measure of flexibility in adapting the principle to a specific problem.

25.5 Mc/s (or 24.5 Mc/s), a modulated difference frequency of $0.5 \text{ Mc/s} \pm 750 \text{ c/s}$ is obtained. When this is multiplied 100 times, the required output of $50 \text{ Mc/s} \pm 75 \text{ kc/s}$ is produced.

A block diagram setting out the general arrangement of such a system is shown in Fig. 2.

The degree of frequency stabilisation (± 0.01 per cent. in the above example) specified for the output obviously applies to the master oscillator stage from which the output is multiplied. The same degree of stabilisation is not necessarily required in each of the oscillators (A and B in Fig. 2), for it is merely the difference between their frequencies which has to be maintained constant within 0.01 per cent. If they both drifted higher or lower with a constant difference (in a manner analogous to tracking in a superheterodyne receiver) there would be no effect on the output frequency.

It would be preferable, however, to maintain one of the oscil-

lators with a reasonably high stability and to provide automatic correction for the other oscillator so as to stabilise the difference frequency. The oscillator may well be provided with any convenient high-stability crystal, perhaps thermostatically controlled, so as to generate a stable output of 25.5 Mc/s (or 24.5 Mc/s) through one or two multipliers.

The variation of frequency with temperature in the X-cut crystal of oscillator A can be used in the difference - frequency stabilising process by means of temperature control. Normally, the X-cut crystal would operate at some elevated temperature, say 60 deg. C. , and its frequency would then be adjusted automatically higher or lower by a suitable lowering or raising of its temperature. The heating current fed to its oven would have to be made to depend on the amount of drift of the difference - frequency from its mean value.

Crystal-controlled Modulation—

At this stage the problem involves nothing which is not already available in established techniques, and for the sake of brevity only an outline will be given of a suggested arrangement.

The difference frequency which is to be stabilised can be heterodyned by a standard oscillator having an output of, say, 500 kc/s. Such an oscillator can be designed to have a very high order

city of the temperature-controlling device, all transitory changes in the frequency due to normal modulation will be smoothed out.

Of course, any other method of automatic frequency-control may be used for maintaining the required difference-frequency, provided that it holds the frequency within sufficiently close limits. The technique of AFC is now well established and its adaptation to the present problem should

purpose is merely to outline a possible method of frequency-modulating a crystal-controlled oscillator.

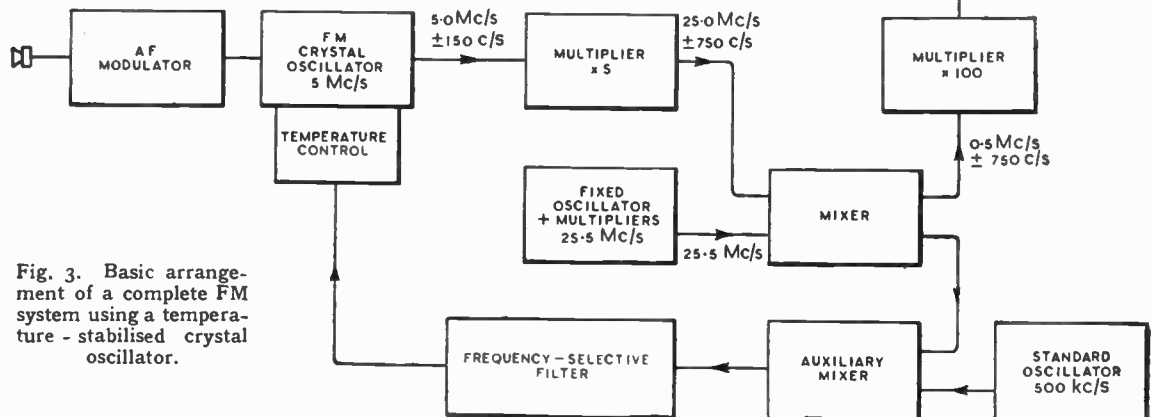

Fig. 3. Basic arrangement of a complete FM system using a temperature-stabilised crystal oscillator.

of stability. A 500 kc/s crystal mounted in a thermostatically controlled oven which regulates the temperature to within 1 deg. C. may be expected to maintain its frequency to within a tenth of a cycle per second.

The output thus obtained can be passed through a frequency-selective filter and rectified, so that a variation in the main difference-frequency will appear as a variation in a rectified voltage. This can be used to control the temperature of the oven in which the X-cut crystal is mounted (for instance by means of a gas triode) and so regulate the difference-frequency.

Any variation in the frequency of oscillator B in Fig. 2 is automatically taken care of and, in effect, the mean frequency of oscillator A will follow any shift in B while maintaining a stabilised difference.

Fig. 3 illustrates the basic arrangement of the suggested frequency-stabilising system.

It will be readily appreciated that the modulation of frequency which appears throughout the generator system has no effect on the stabilising process for, as a consequence of the thermal capa-

city of the temperature-controlling device, all transitory changes in the frequency due to normal modulation will be smoothed out.

of course, any other method of automatic frequency-control may be used for maintaining the required difference-frequency, provided that it holds the frequency within sufficiently close limits.

tor and to suggest the directions in which experimental work could most profitably be undertaken.



THE TELEMOBILE portable control desk for use with two television cameras. The equipment is mounted on hinged chassis which can be opened out for maintenance. It operates from AC and several units can be employed together if more than two cameras are used. It is designed by Television Products Inc., Hollywood, U.S.A.

TELEVISION DEVELOPMENTS

Sound and Vision on One Carrier

AN extremely interesting development in television technique was recently demonstrated by Pye, Ltd. It consists in utilising the time normally wasted by the transmission of synchronising pulses for the sound accompaniment. This not only saves the separate sound transmitter normally required but much of the sound receiver, and at the same time it reduces the total frequency band occupied by a complete television system.

The television signal itself is quite unchanged. The scanning system and video signals, and general form of the synchronising pulses are the same as in pre-war transmission. This means that the line scanning frequency is 10,125 c/s, so that the time

available for scanning each line and transmitting the line sync pulse is 98.5 μ sec. Of this time the sync pulse itself occupies 10 μ sec., and it is obtained by suppressing the carrier of the vision transmitter for this period.

The leading edge of the pulse triggers the time-base in the receiver at the end of the line and the pulse itself also suppresses the spot on the cathode-ray tube during the fly-back. While a pulse length of 10 μ sec. is not necessary for synchronising, a time interval of this order is needed for the fly-back, and it is difficult to reduce it economically. It does, however, represent waste time as far as the actual picture is concerned.

This time, however, can now

be utilised to convey the sound programme without detriment to the picture. Within the period devoted to the line sync pulse, a pulse-duration modulated signal can be inserted. This is a series of pulses with a mean duration of 3 μ sec. and a recurrence frequency of 10,125 c/s—the same as the line frequency. These pulses are all of constant amplitude, but their duration varies, within the limits of 1 μ sec. to 5 μ sec., in accordance with the amplitude of the sound signal at the instant of their occurrence.

The pulse amplitude is greater than the maximum video amplitude, and if the former is taken as 100 per cent. of the RF carrier, the maximum video amplitude corresponding to a peak "white"

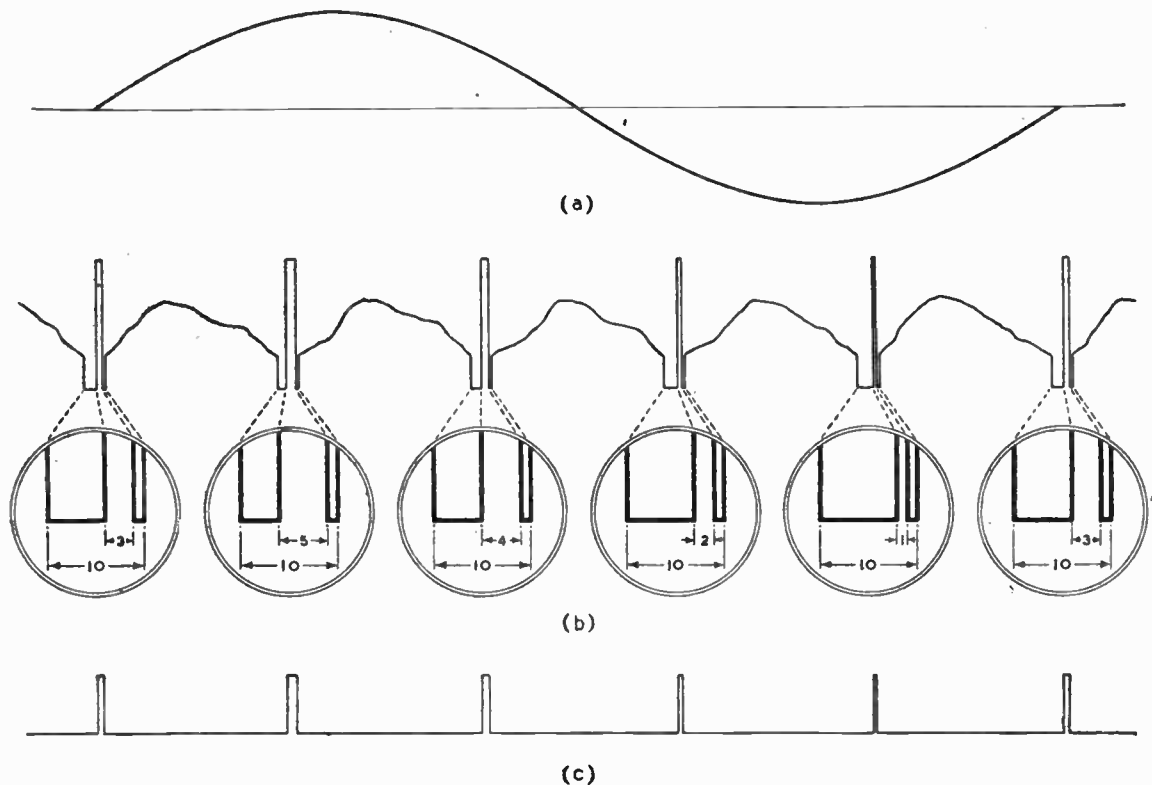

This diagram shows how a width-modulated pulse carrying the sound programme is inserted within the line sync pulse.

Television Developments—

signal is about 75 per cent. The waveform is shown in the figure where (a) shows one cycle of the audio wave and (b) illustrates a few lines of the complete television signal. The video signal and line sync pulses are clearly seen, and within the latter are the large-amplitude pulses conveying the sound signal.

Separation of the sound signal in the receiver is accomplished by a simple limiter which passes only signals of greater amplitude than the level corresponding to peak white. It thus provides an output only on the sound pulses of greater amplitude, and this separated waveform is shown at (c).

The sound causes no interference with the vision signal because it is non-existent during the scan time. It occurs during the fly-back, and it is necessary only to ensure that the scanning spot is completely blacked out during this time to avoid any trace of the sound signal on the picture.

This entails some slight complication in the receiver, for the sync pulse itself is usually employed to suppress the spot during the fly-back. It will no longer do this because of the sound pulse within it, but other methods of blacking out the spot are not hard to find.

The advantages of the system are obvious. Applied to a system such as that used before the war it would reduce the frequency band from 6 Mc/s to 5 Mc/s, since, as there is no separate sound transmitter, the 1 Mc/s guard band between the two is abolished also. This eases the design of the receiving aerial.

There is an obvious saving in the transmitter, since no separate sound transmitter is required and there is also a saving in the receiver. This is not quite so obvious, for many sets had several valves common to both sound and vision. The chief saving comes about through the easier separation of the sound and vision signals. With separate transmitters this must be effected by tuned circuits, and it is not always easy to secure adequate selectivity. With the new system only a simple limiter is needed. A further advantage is that with the

pulse system ignition interference on sound should be less. The large amplitude sound pulses also provide an easy way of obtaining automatic gain control.

The sound frequency response obtainable is, of course, limited by the recurrence frequency of the pulses and this in turn is fixed by the number of lines in the picture. Sound and picture quality thus becomes intimately tied together. With the 10,125-c/s pulse frequency set by a 405-line picture, the sound frequency limit is about 5,000 c/s and in practice would probably be somewhat less. The system is, therefore, one which lends itself better to very high definition television. With a 1,000-line 25-frame system, for instance, the pulse recurrence frequency would be 25 kc/s and there should then be no difficulty in obtaining high quality sound with a response up to 10,000 c/s.

The system was demonstrated using a local transmitter and gave exceedingly good results. Picture and sound were normal and free from mutual interference. The sound quality was of the standard reached in ordinary broadcasting and it was impossible to tell by looking or listening that sound and vision were on a common carrier.

The principle of inserting pulses within the time allocated to sync pulses is one which can be carried further. It would, for instance, be quite possible to insert two pulses in each line pulse and so obtain two independent sound channels which could be used to give binaural sound. Such pulses could also be used for conveying some of the additional information required in colour television.



This "board" was devised by Metrovick draughtsmen for their own use in preparing circuit diagrams. The drum, covered with semi-transparent paper backed by guide lines, is free to rotate. Horizontal lines are drawn along the straight edge, while vertical lines are made by rotating the drum against a fixed pencil point.

LONG-WAVE ADAPTOR**Add-on Unit for Wartime Civilian Receivers**

THE description, in last month's issue, of a long-wave converter for the Wartime Civilian Receiver has brought details of a commercially made article which provides the same facilities. This employs a 6K8 frequency changer, pre-set tuning and a range switch and it is designed to fit inside the cabinet of the parent receiver.

Installation is very simple as no modifications are required to the set; HT and LT are obtained by removing the output valve, plugging in an adaptor and inserting the valve in a socket provided on this adaptor.

The unit is designed for permanent fitting and should be screwed to the inside of the cabinet, a 3/4 in. diameter hole being required to pass out the spindle of the range switch. This range switch serves a three-fold purpose. In one position it provides long-wave reception, in another the 6K8 valve is converted into a low-gain RF amplifier, while in the third position the converter is muted and the aerial changed over to the parent receiver, thus reverting to the normal state.

The oscillator in the converter is pre-tuned before despatch to 360 kc/s, so that for reception on 200 kc/s (1,500m) the parent set must be tuned to 560 kc/s (536m). Reception is also possible of the BBC European programme on 250 kc/s (1,200m) by tuning the parent set to 610 kc/s (492m).

Made by I. Raleigh and Co., 239, Kilburn High Road, London. N.W.6, the converter, which is for AC sets, costs £2 17s. 6d. complete with valve.

CYLINDRICAL DRAWING "BOARD"

LINAGLOW LIMITED

We have purchased from a prominent manufacturer valuable stocks of all types of Radio Components, New and Unused, ex-Government Surplus

Full details will be published in next month's issue.

In the meantime we have selected the following :

EXTENSION LOUD SPEAKERS

In Bakelite Moulded Cases. Brown with white, green or red grille. State colour preferred. Dimensions, 11in. x 12in. x 5in., fitted with 8in. P.M. Speaker and Pentode Transformer, excellent in appearance and performance, 55/- complete.

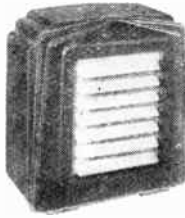

NOTE THE PRICES!

ELECTROLYTICS.—Tubular, 6-mfd. x 50 v., 1 6; 25-mfd. x 35 v., 1 6; 25-mfd. x 25 v., 1 9; 50-mfd. x 12 v., 1 9. Tubular tag end, 8-mfd., 500 v., 3 6; 8 x 8-mfd., 500 v., 5 9; 32-mfd., 350 v., 5 9; 4-mfd., 420 v., 3 -. Wet aluminium can, 8-mfd., 440 v., 6 9; 16-mfd., 440 v., 8 6.

LOUDSPEAKER TRANSFORMERS.—Pentode output, 40:1, 50 m.a., 2 6; Multi-ratio, 40:1, 60:1, 80:1, 9 6; also push-pull, 9 6; heavy-duty multi-ratio, 24:1, 41:1, 48:1, 58:1, 82:1, 115:1 and P.P., 80 m.a., 14 -; 3:1 inter-valve, 7 6; push-pull output, 20-watt, 4,000-0-4,000 primary, 2.5, 7.5 and 12.15 ohms, secondary, 25 -.

P.M. LOUDSPEAKERS.—3 ohm, voice coil, 8in., with transformer, 22 6; 2 1/2in. less transformer, 20 -; 3 1/2in. less transformer, 25/-; 8in., less transformer, 20 -; 12in. heavy magnet, less transformer, 24 10s.; 10in. Mains, energised 250 ohms, less transformer, 15 -; 10in. Mains, energised 1,140 ohms, with transformer, 30 -; 8in. energised, 2,000 ohms, with transformer, 25 6.

VOLUME CONTROLS.—5, 20, 50 and 100 thousand ohms, 1, 1 and 2 more, without switch, 3/- each; as above, with switch, 4 9; 100,000 ohms, 1-meg., double-pole switch, best American, 6 6; 2,000 ohms only, wire wound, 1 3; 1,000 ohms only, carbon screw adjustment, 1/-; Midget, 1-meg., with switch, 4 6, less switch, 1 6.

VARIABLE CONDENSERS.—Midget two-rang., .00035, 5 -.

H.W. DETECTOR.—36 v., R.M.S., 0.25 m.a., 2 6.

MAINS TRANSFORMERS.—350-0-350, 4 v. 6 amp. C.T.; 4 v. 2 amp., 100 m.a.; heavy laminations; bargain, 25 -. 350-0-350, 6.3 v. 3 amp. C.T.; 5 v. 2 amp., 100 m.a., 25 -.

L.F. CHOKES.—40 henries, 400 ohms, 150 m.a., 10 6.

RELAYS.—4 complete with circuit breaking switch, 200 250 v., A.C., 60 80 v.; D.C., 300 m.a.; 15-amp. switch, each, 2 6.

SPECIAL OFF BATTERY CHARGERS.—1 amp. type, 2, 6 or 12 volt, 200 240 volt input. Finished in black metal cabinet. Small and compact, 22 18s. 6d.

VIBRATORS.—4-pin, 6-volt, best quality American, 9 6.

VALVEHOLDERS.—English wafer type, 8-pin, octal, 6 for 1 3.

LINE CORD.—3-way, heavy duty, 3 amp., 360 ohms, 9 6; 480 ohms, 13 6; 600 ohms, 15 9; 2-way, 360 ohms, 5 6; 480 ohms, 7 6; 600 ohms, 9 3.

DE LUXE ALL-WAVE SERVICE SIGNAL GENERATOR

A.C. Mains, 200 250 v., 50 cycles, range covers from 20 M.C. to 100 K.C., all fundamentally in 5 bands, without gaps, 8 M. disk. Direct calibration in frequencies. Coarse and fine output attenuator. Internal modulation. 400 c.s. iron-cored coils. The generator is entirely screened in heavy metal cabinet. Dim., 10in. x 10in. x 12in., 16 gns. Case and packing, 10/- extra (refunded upon return of the case).

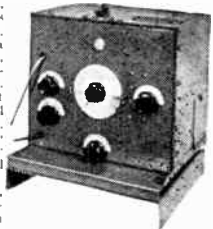

VALVES.—American types at B.O.T., controlled retail prices. For replacement purposes only. 12F5, 12F5, 12F5, 11F5, 9 2; 10F5, 11 -; 6Q7, 11 7; 6F6, 6K6, 12 10; 30F5, 1N5, 12 10; 6AN, 6B8, 1A7, 14 -; 35Z5, 11 -; 50L6, 12 10. All G.T. type. Also British valves at manufacturers' list prices. 6X5, 1U4, 1U6, 11 -; 101B4, 11 7; ACVP2, 11 4, EF39, KTW61, PEN45, SP41, SP42, 741, VP41, 42 10. Di diode, 1in. Peanut valve with valveholder, 12 10; ECH3, X63, 14 0; A615n, EL35, PEN46, 12 1, 616, 18 3. Prices include Purchase Tax. Please add 3d. per valve, postage.

HIGH VOLTAGE BRAIDED SLEEVING.—1, 1 1/2, 2 and 5 mm., first-class quality, 3 6 per dozen.

ALUMINIUM CHASSIS.—Partially drilled. Dimensions, 10 1/2in. x 9in. x 2 1/2in., and 10 1/2in. x 10 1/2in. x 2 1/2in., 16-gauge. Either type, 4/- each.

MACMURDO SILVER CHASSIS.—Heavy drilled chassis, chromium-plated, 20in. x 12in., x 3in., 14-gauge, 17 6 each.

FERRANTI TEST METERS

Complete in leather and velvet-lined case. Specs., 1,000 ohms per volt on all ranges; 600 v. A.C. D.C., 0-750 milliamps, 0-50,000 ohms, without external batteries, up to 20 megohms, with external batteries. New and unused, complete with test leads, multipliers and instructions, 28 18s. 6d.



SCREENED INTERLACED FLEXIBLE MICROPHONE CABLE.—Two 6 yds. for 6 9; single, 1/- per yard.

AERIAL AND OSCILLATOR COILS.—Best D.S.C. wire-wound, colour coded on bakelite formers, short, medium and long-wave, 16 50 m., 200 550 m., 1,000 2,000 m., with circuit diagram, 15 - the set.

I.F. TRANSFORMERS. 165 K.C.'s, iron-cored, 1/2w wound, aluminium can. Limited quantity, 17 6 matched pair, 9 6 each.

S.M. and L. T.R.F. COILS.—Phillips best quality in screened aluminium cans, 17-51, 220-385, 725-2,000 metres. (These coils equal to performance of superhet.) Complete with diagram, 9 6 the pair.

WAVE CHANGE SWITCH. to suit all above coils, 5 9.

MODEL RK. 10in. MAINS ENERGISED LOUD-SPEAKERS.—1,000 ohms, field; 15 ohms, speech; weight, 2s. 10c. Reconditioned as new. Ideal for P.A. work, 22 15s.

METAL RECTIFIERS. Suitable for chargers, etc., H wave H.T. 150-400 v., 50 200 m.a., 7 -.

METAL RECTIFIERS. Suitable for small chargers, relays, etc., 12 v., full wave, 100 m.a., 3 -; 6 v. H wave, 50 m.a., 3 -; 4 v. H wave, 30 m.a., 2 -; 2 v. H wave, 15 m.a., 2 -; H1, 2 1/2 v., D.C., 10 m.a., 2 -; 120 v., 60 m.a., F.W., 2 -.

PUSH-BUTTON UNITS.—Complete with escutcheon and knobs, 4-way, new, 4 6.

VALVEHOLDERS.—Amphoid type, International or English octal, chassis mounting, each, 6d.

SUPERIOR QUALITY KNOBS.—Suitable for radio for 1in. spindles; with grub screw, 1 1/2in., 9d.; 2in., 1 -; White Ivorine, 3in., with grub screw, 6d.

WANDER PLUGS.—In two colours, 1 - per dozen.

MAINS SWITCHES.—G.P.O. type, D.P.D.T. panel mounting, 1 6.

CAR AERIALS.—Telescopic, scuttle fixing, extending to 4ft. 6in., chrome plated, nickel-plated, 12 6.

TUBULAR PAPER CONDENSERS.—350 500 v., 1/2w. working. New, 0.001, 3d. each; .01, 4d. each; .1, 8d. each; .25, 1 - each; .5, 1 6 each. 1.8 mfd., 250 v., 1 3; .025 mfd., 11d. each; .05 mfd., 8d. each; .008, 7d. each; .002, 6d. each; .00025, 4d. each; .0005, 5d. each; .00005, 4d. each.

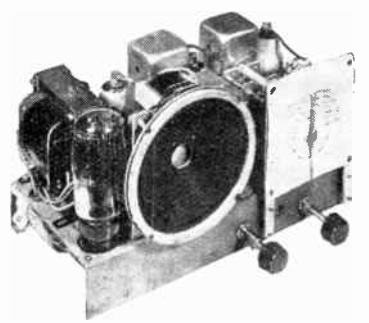

LINTONE

5-VALVE MIDGET SUPERHET CONSTRUCTORS KIT

Complete with Cabinet.
16-50, 200-550 metres.

A SUPER-SENSITIVE AND SELECTIVE CIRCUIT.
Brief specification: Frequency changer, 6 tuned circuit, 465 K.C.'s iron cored I.F.'s, 4-watt output. P.M. speaker and output transformer, all valves, chassis, practical and theoretical diagrams. Parts list, nuts, bolts and wire and modern cabinet. Dimensions: 12in. x 8in. x 6in. deep. Ready to assemble, 200 250 volts, A.C. Parts new and ex-televison. Including Purchase Tax, 13 2 Gns. Case and packing 10/- extra (refunded upon return of case).

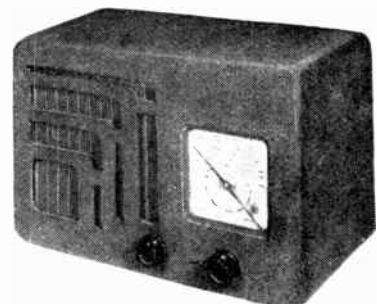

POST ORDERS ONLY WE REGRET THAT DUE TO PRESSURE OF BUSINESS WE ARE UNABLE TO HANDLE SHOWROOM OR CALLER TRADE UNTIL FURTHER NOTICE

LINAGLOW LTD., Dept. MO 52, 61, HIGHGATE HIGH ST., N.6

'Phone: MOUntview 9432

QUARTZ PLATES



REG^d TRADE MARK

Standard Crystals cover 3.5/10 Mc/s. — but can be supplied for other frequencies and for a wide range of frequency-temperature characteristics.

Made in hundreds of thousands per annum for the services all over the world.

Made by

SALFORD ELECTRICAL INSTRUMENTS LTD.

PEEL WORKS, SALFORD, 3.

Proprietors: **THE GENERAL ELECTRIC Co. Ltd., of England**



for
**Communication
Equipment**

— V O R T E X I O N —



“SUPER FIFTY WATT” AMPLIFIER

“SUPER FIFTY WATT” AMPLIFIER has a response of 30 cps. to 15,000 cps. within $\frac{1}{2}$ db, under 2 per cent. distortion at 40 watts and 1 per cent. at 15 watts. Electronic mixing for microphone and gramophone of either high or low impedance with top and bass controls. Output for 15/250 ohms with generous voice coil feedback to minimise speaker distortion. New style easy access steel case gives recessed controls, making transport safe and easy. Exceedingly well ventilated for long life.

Amplifier complete in steel case, with built-in 15 ohm mu-metal shielded microphone transformer, tropical finish Price 29½ gns.
Chassis only, with valves Price 25½ gns.
or
Complete with fitted microphone transformer Price 26½ gns.
Laboratory Model, 10 cps. to 35,000 cps., in above case Price 42 gns.

RECORD REPRODUCER.—This is a development of the A.C.20 amplifier with special attention to low noise level, good response (30—18,000 cps.) and low harmonic distortion (1 per cent. at 10 watts). Suitable for any type of pick-up with switch for record compensation, double negative feedback circuit to minimise distortion generated by speaker. Has fitted plug to supply 6.3 v. 3 amp. L.T. and 300 v. 30 M.a. H.T. to a mixer or feeder unit Price £18 0 0

A.C.20 AMPLIFIER.—This well-known model has been retained, and has a response 30—15,000 cps., mixing arranged for crystal pick-up and microphone, large output transformer for 4—7.5 and 15 ohms to deliver 16 watt at less than 5 per cent. total harmonic distortion to the speakers Price £15 15 0

4-WAY MIXER UNIT for use with Record Reproducer, suitable for high or low impedance pick-ups and two 15 ohm microphones. Mu-metal shielded transformers are built in. All or any of the microphones can be used at once Price £13 10 0

DEALERS AND EXPORT AGENTS should write for special terms to:—

VORTEXION LTD.

257-261 THE BROADWAY,
WIMBLEDON, S.W.19

Telephones: LIberty 2814 and 6128

Telegrams: VORTEXION, WIMBL., LONDON

BIOLOGICAL AMPLIFIERS

2.—“Compressor” Input Stages : Design for a Complete Amplifier

By D. H. PARNUM,
B.Sc., A.R.C.S., Ph.D.

(Concluded from page 340 of the November issue.)

IF push-pull stages throughout are not desired, the output from the balanced input stage must be “compressed” to operate a single-ended amplifier. Apart from the saving in cost and complexity, the final indicator may well be a cathode-ray tube of the type which needs an earthed input, so that the signal must be compressed sooner or later. The original Matthews circuit (Fig. 2 in Part 1 of this article) can be used for this purpose by a simple device. First the output is earthed at Q; but if the cathodes are also directly earthed, the second valve will be shorted out from anode to cathode, so the cathodes are earthed through a high resistance. This amounts to connecting the resistance across the anode and cathode of the second valve, reducing its gain and slightly unbalancing the stage. The unbalance could be corrected by connecting an equal resistance across anode and cathode of the other valve. But the stage is not really satisfactory, because it is almost entirely floating above earth. The floating batteries will be likely to cause erratic effects, and so will bad subject-earth insulation. In view of later developments there is no necessity to use this type of compressor to-day.

The circuit of Fig. 8 (a), described in the same year by both Matthews⁵ and Tönnies⁶, has been widely used. V₁ and V₂ are valves of the same type; there is a large common cathode resistor R_k, but only V₁ has an anode load, across which the output is taken.

For inphase signals the output is obviously small, since there is adding of currents in R_k and much negative feedback. The action for antiphase signals is understood better from Fig. 8 (b). Half the signal is applied to A and the other half, in opposite phase, to B. Since V₂ has no anode load it acts as a cathode-follower, and,

the signal at B appears with very little loss at C, in the same phase. This voltage e' is injected into the cathode circuit of V₁ at D. Thus the total grid-cathode voltage of V₁ is e + e', which is practically 2e, the total signal. It might appear, however, that V₁ would suffer negative feedback since its cathode returns to earth through R_k; but this is not so, because the cathode impedance of V₁ is the output impedance of V₂ acting as a cathode-follower. This is very low, about 200Ω if the mutual conductance of V₂ is 5 mA/V. The antiphase gain is therefore practically the full gain of V₁; actually V₁ behaves as if its internal resistance were doubled. The exact expression for the

This result has been given in full because it has been incorrectly given elsewhere. An article by Debski⁷ derives an incorrect result which is unfortunately quoted by Parr and Walter⁸ in an otherwise excellent paper. Debski also makes the error of comparing interference of e at each grid to a signal of +e and -e, i.e. a total signal of 2e. This naturally makes the stage look more favourable by a factor of 2.

When the valves are of the same type, μ₁ - μ₂ is small; if we also assume that R_a is much less than R_k, r becomes practically 1/g_mR_k, where g_m is the mutual conductance of V₂. With g_m = 5 mA/V and R_k = 50,000Ω, this is 1/250. The condition for good discrimination is high g_m and R_k, valve matching being unimportant. If V₁ is a pentode, the signal gain is increased. μ₁ - μ₂ is no longer small, and

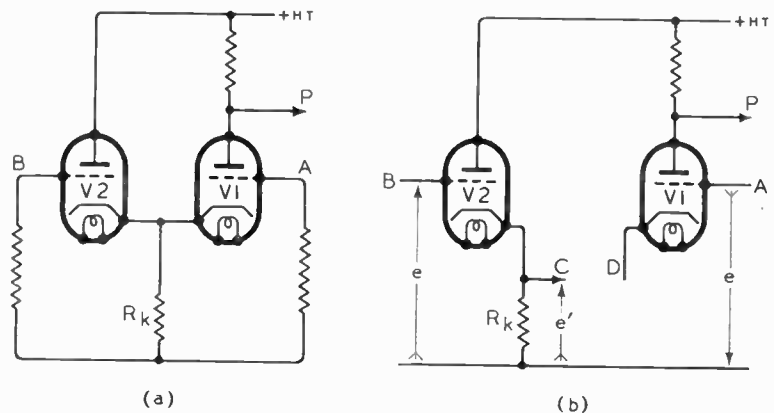

Fig. 8. “Compressor” input stage due to Matthews and Tönnies for feeding single-ended amplifier.

gain ratio (which for compressor stages is obviously the same as the output ratio) is:

$$r = \frac{1}{2} \cdot \frac{\mu_1 R_a + (\mu_1 - \mu_2)}{\mu_1 R_a + (\mu_1 + \mu_2 + 2\mu_1 \mu_2)}$$

where
R_a = internal resistance of V₂,
μ₁ = amplification factor of V₁,
μ₂ = amplification factor of V₂.

re-arrangement of the expression for r gives roughly r = 1/μ₂, i.e. of the order of 1/50.

The discrimination is quite good, and the circuit has been used successfully by many workers, but it is natural to enquire if r cannot be reduced to zero. The condition is at once

Biological Amplifiers—

found by tapping the exact expression for r equal to zero, which gives

$$\mu_1 = \mu_2 R_k / (R_k + R_a)$$

This shows that μ_1 must be somewhat less than μ_2 . The required reduction in μ_1 can be made by shunting V_1 from anode to cathode with a resistance of value R_k . Unfortunately this reduces the signal gain noticeably—it effectively increases the internal resistance of V_1 four times, if R_k is half the anode load—and if the shunt is made variable so as to act as an interference control.

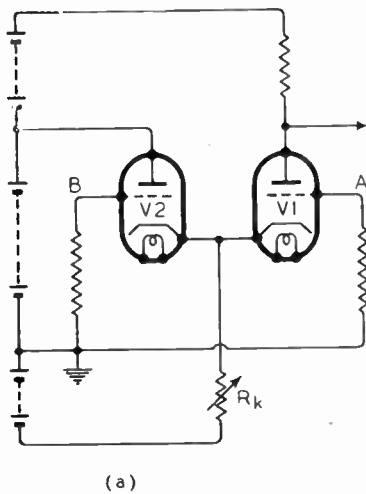

Fig. 9. Tönies compressor circuit in a ZF amplifier. (a) with batteries (b) suitable for mains operation.

the gain variations would be a nuisance. Also there are practical difficulties in applying such a shunt. Altogether this stage is little better adapted to interference control than the push-pull circuits.

Fig. 9 (a) shows the practical arrangement of the Tönies compressor as a ZF amplifier; this is also the only suitable arrangement as a biological input stage. V_2 operates at a lower HT voltage than V_1 in order to bring the anode currents to roughly the same value. Correct grid bias is obtained by returning the lower

end of R_k to a negative battery tapping. This tapping is adjusted initially to give approximately correct bias, and the final adjustment made by adjusting R_k .

Fig. 9 (b) shows an AC version. Grid bias is now obtained by taps on R_k , and blocking condensers are used in the grid leads. This circuit is not really suitable as an input stage for biological work, because it requires an earth return on the subject. It is included because it is a useful compressor circuit for AF amplifiers. As V_1 and V_2 can now be given separate bias, it is convenient to do this, as shown, and run both valves at the same HT voltage. The circuit gives signal gain, and will handle a large inphase input—roughly μ times its normal input. For this application the fitting of a correcting shunt to give zero r is practicable, but it is simpler in this case to reduce the input to V_1 slightly with a grid potential divider as shown.

It has already been noted that any balanced stage may be used as a single-ended amplifier. Fig. 9 is interesting in this way; a signal

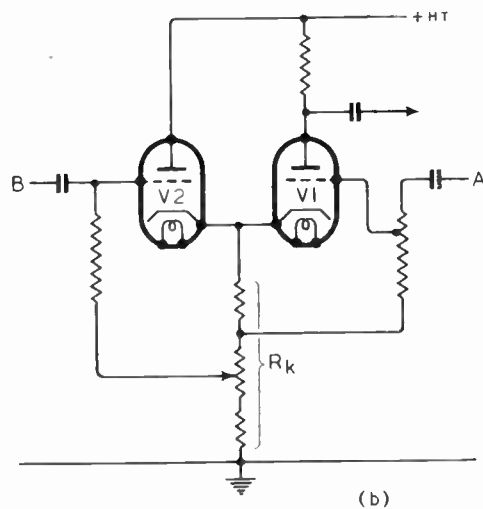

applied between A and earth gives a reversed phase output in the usual way, but when applied between B and earth gives an output in the same phase. The non-active grid must be tied to earth.

An interesting compressor has been described by Schmitt⁹ using two pentodes. Signals are applied

to the two control grids; one pentode reverses the phase of its own signal and applies it to the screen of the other. By suitable adjustments inphase signals can be made to cancel in the "mixing" pentode. This stage would not probably handle large inphase inputs, since there is no negative feedback and screen characteristics are seldom linear. It has the merit that variation of r is possible.

Inter-stage Coupling

There is one main choice: RC coupling or some type of ZF coupling. RC coupling is really satisfactory for nearly all biological work; the only point to consider is the LF loss. Suppose $4\mu\text{F}$ condensers and $1\text{ M}\Omega$ grid resistors are used; the time constant RC is 4 sec. The fractional loss per stage at frequency f is $1/8\pi^2(fRC)^2$ provided the loss is not too large. At $f = 0.1$ c/s the loss per stage is about 9 per cent. For four stages the loss will be about 30 per cent. This is probably good enough even for cardiography. RC coupling has considerable advantages: there is no difficulty about grid bias, the amplifier is not subject to long-period drift, and complicated initial adjustments are not needed. The only operating objection is that the later grids block when an abnormal input signal occurs, and owing to the long time constant it is some time before the amplifier is usable again. The trouble usually occurs when making adjustments to the subject, and as the gain control can be turned down while doing so, the objection is not serious.

Where there must be no doubt about the LF response, however, a ZF amplifier is the only solution. Since this means effectively a direct connection from each anode to the grid of the next stage, the chief practical difficulty is obtaining correct grid bias for all stages beyond the first. The difficulty of eliminating the effect of drift, due to valves or batteries in the first stage is almost as great. Undoubtedly the best solution of both difficulties is to use push-pull throughout in the manner of Fig. 6 of Part 1 of this article. Considering the coupling between the first and second stages as an example, the second stage cathodes

are lifted above earth by the drop in the common cathode resistor, and this backs off the large positive voltage received from the first stage anodes. Push-pull working is essential to remove the otherwise intolerable loss of gain due to negative feedback in the cathode resistor. It follows that the cathodes of each succeeding stage are at a progressively higher voltage, so that eventually no HT-cathode voltage is available, but with the number of stages normally needed this point is never reached.

The effect of valve and battery drift is greatly reduced by this method, because such drift is about the same in each half of the amplifier and is equivalent to an inphase signal. There is also the considerable practical advantage that only one HT supply, without tapping points, is needed. Goodwin states about the circuit of Fig. 6 that, after running-in, drift is less than 100 μ V per hour, and less than 10 μ V per hour when precautions against room temperature variations, etc., are taken.

An interesting variant of this method is used by Miller¹⁰; it consists of a series of Tönnies stages used as single-ended ZF amplifiers with the non-active grids held at a fixed voltage. This circuit is not really so good as a push-pull amplifier, since it uses just as many valves and does

not have the push-pull freedom from drift.

Power Supplies

It is common practice to operate at least the first stage, and often the first two, entirely by batteries. This is not so inconvenient as it sounds, because in these stages the signal level is very small, and only a small HT voltage is needed. The advantages are considerable; good stability over long periods is assured; the whole stage and its power supplies can be isolated and screened; and there is no possibility of AC ripple being introduced (even with stabilised mains HT, ripple may enter via the heaters if these are fed with AC). To secure these advantages with a mains-operated supply is complicated and costly. Miller's amplifier is all-mains, but even here the valve heaters are fed in series from an electronic voltage regulator employing 5 valves, and the maximum gain is only 250,000. For gains of over 1 million batteries are not only cheaper but better.

It must not be forgotten that the LF response of biological amplifiers is so good that ordinary decoupling of the HT feeds is useless; so that if one supply is used to feed more than two stages instability will result. HT batteries help here, because they can be used for the first two

stages and mains HT for the last two. More than four stages are seldom needed.

It seems wise in general to stabilise mains HT where used. Gas-tube regulators⁸ have slight inherent flicker and drift, but should be quite satisfactory for any but ZF amplifiers. Electronic regulators can be as good as is desired; references (4), (10) and (12) will be found helpful.

Design of an Amplifier

Some general conclusions will have emerged from the foregoing. A balanced input stage is essential. The main choice is then between push-pull throughout, or a compressor followed by a single-ended amplifier. If frequencies below about 0.1 c/s must be passed, then the choice is a ZF push-pull amplifier. Fig. 6 of Part 1 is an excellent prototype.

For frequencies above 0.1 c/s, RC coupling with a time constant of 4 sec. is perfectly satisfactory. Most of the push-pull advantages are not needed, and a Tönnies compressor input stage (Fig. 9a) followed by a single-ended amplifier is one of the best solutions.

The purpose of negative feedback has sometimes been misunderstood. Although the details cannot be gone into here, it can be said that it gives no reduction in background noise or valve drift. It has chiefly been used

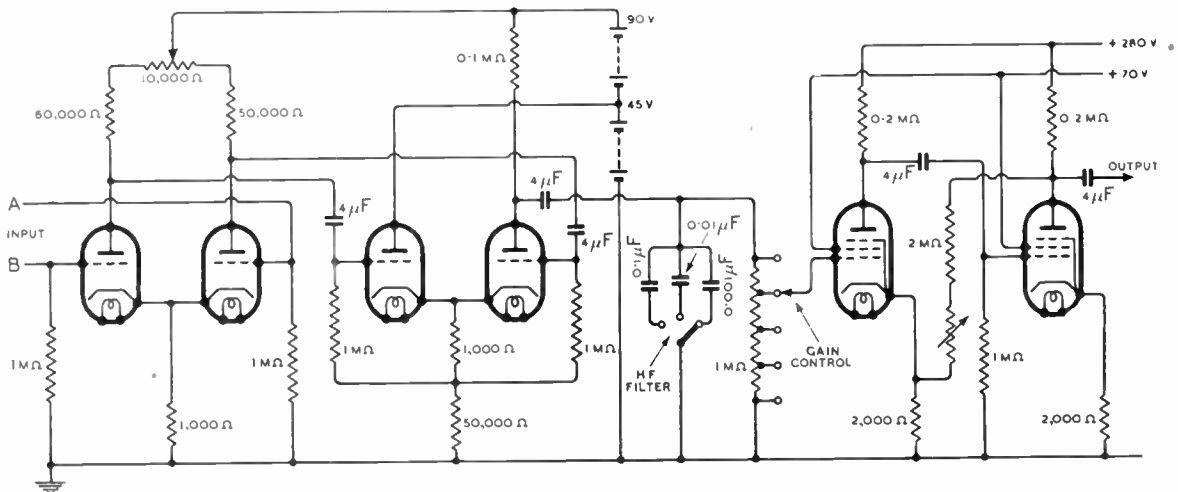

Fig. 10. Suggested amplifier circuit with input interference control and feedback in the output stage. Heaters of first two stages are fed from batteries.

Biological Amplifiers—

in the early stages; its value here, as has been shown, is to give inphase/antiphase discrimination; but it is pointless to use it on the signal, because the voltage level is so low that there is no possibility of distortion. There is a good case for using signal feedback over the output stages, but here the principle of varying the feedback factor to control gain is not worth while unless the feedback is enormous. It seems better to use the maximum feedback available and reduce gain in steps by a tapped grid resistor in a preceding stage.

Fig. 10 is shown more as an illustration of these and some other points than as a recommended circuit; it has not been given a practical test. The output indicator is assumed to be a cathode-ray tube with a sensitivity of about 1V/mm, and requiring an earthed input. The first stage is push-pull without a large bias resistor, and fitted with an interference control as in Fig. 7 of Part 1; the adjustment shown will control interference inequality of about $\pm 1\%$. One of the fixed anode loads is larger than the other to compensate for the residual inphase transmission of the second stage, which is of Tönnies compressor. These two stages are operated from a 90 V battery, tapped at 45 V; this allows the grid bias of both compressor valves to be the same, and makes the full battery voltage available for the first stage. The last two stages are supplied from a "Stabilovolt" regulator, which is convenient because it provides a 70 V low-impedance source for the screens.

Using high-slope triodes for the first two stages, or triode-connected high-slope pentodes, their gain will be at least 1,000. The last two stages, using SP41's, have an internal gain (allowing for the negative feedback in the cathode resistors) of about 14,000; the overall feedback reduces this to about 1,000. The total gain is thus about 1 million, giving an output sensitivity of about 1 μ V/mm. The output feedback reduces distortion to about 1/15, and a swing of 200 V peak-to-peak is available with not more than 2 per cent. distortion. Gain

control is by the tapped grid resistor of the third stage, operated by a good-quality selector switch. This can conveniently be arranged to give gain ratios of 1, 2, 4, 8, etc., or 1, 2, 5, 10, etc., as desired. The basic gain can be adjusted to a convenient round figure by the variable portion of the feedback resistor. When the correct value has been found by calibration, the variable might well be replaced by a fixed resistor to improve stability. The 2-megohm resistor must in any case be a high-stability component.

A simple HF filter is fitted between the second and third stages. It is always desirable to limit the HF response to that required by the signal, because this reduces background noise considerably. As far as thermal agitation and shot noise is concerned, analysis shows that there is no advantage in using anything sharper than a simple RC filter. The three values shown give passbands of about 0.1, 1, and 10 kc/s; the exact value depends on the internal resistance of the preceding valve, which has been assumed to be 10,000–20,000 Ω .

It is emphasised that many of the component values shown are tentative. The cathode resistors of the first two stages need adjusting to give a bias between 0.8 and 1 V, to avoid grid current yet to maintain gain. The bias of the output stages should be adjusted to give an anode voltage of about 150 V. The use of cathode bias, instead of battery bias, throughout allows the optimum bias to be given to every stage. There is no I.F. loss on this account because all the bias resistors are un-bypassed.

The writer wishes to thank Dr. G. H. Bell, of Glasgow University, for the suggestion that he should undertake this review, and also for supplying a number of references.

REFERENCES

- (5) Matthews, *J. Physiol.*, 1938, 93, p. 25P.
- (6) Tönnies, *Rev. Sci. Inst.*, 1938, 9, p. 95.
- (7) Debski, *Electronic Eng.*, 1942, 15, p. 80.
- (8) Parr and Walter, *Journal I.E.E.*, 1943, Vol. 90, Pt. III, p. 129.
- (9) Schmitt, *Rev. Sci. Inst.*, 1937, 8, p. 126.
- (10) Miller, *Electronics*, November 1941, p. 27.
- (11) Forbes and Grass, *J. Physiol.*, 1937, 91, p. 31.
- (12) Hogg, *Wireless World*, Nov.–Dec., 1943, pp. 327 and 371.

TIMING BY RADAR

THE Radar Division of the Royal Aircraft Establishment recently installed experimental equipment at Herne Bay for investigating the potentialities of radar for timing the high-speed Meteor aircraft.

Basic radar principles of measuring the time a pulse of radio energy takes to travel from a transmitter to an aircraft and back to an adjacent receiver are employed, but additional circuits have been added to an otherwise standard centimetre-wave radar set. By means of these additions two artificial signals are mixed with the received signals; the timing of these artificial signals is so adjusted that if they were fed to a cathode-ray tube, with a suitable time-base, they would appear as "blips," one corresponding to the distance of the start of the course from the transmitter, and the other marking its finish.

When the echo signal from the aircraft exactly coincides with the first marker pulse a circuit is tripped and an electronic device commences to count the pulses emitted by the transmitter.

The pulse repetition frequency of the transmitter, and the frequency of the marker pulses are both known very accurately, so that the number of pulses emitted during the time the aircraft echo takes to travel from the first to the second marker pulse is a measure of the speed and is easily converted into miles per hour.

Actual measurement of distance is unnecessary with this method, as distance is converted into time intervals in terms of pulse repetition frequency and the velocity of radio waves. Thus in order to obtain an artificial course length of 3 km, the time interval between the two marker pulses must be 1/50,000th second, bearing in mind the fact that a radar signal makes a double journey. This is the exact time of one complete cycle of a 50 kc/s oscillation.

Taking into account all sources of error it seems possible to achieve an accuracy in timing to 1 mph in 600 mph and the speed can be given in a matter of seconds after the aircraft has finished its run. H. B. D.

THE FIRST LIST OF Accredited Wholesalers OF



SOUND EQUIPMENT

Wholesalers Only:

A. J. Dew & Co., Ltd.,

Flinders (W'sale) Ltd.,
Lawton Bros. (Sales) Ltd.

Lugton & Co., Ltd.,

Robshaw Bros.

Priestly & Ford, Ltd.,

Westradio, Limited

Wholesale, Demonstration and Service:

Films & Equipments, Ltd.,

R. G. Jones

Sound Limited

15-20, New Inn Broadway,
LONDON, E.C.2.

IPSWICH and Branches.
13, Henry Square,
ASHTON-UNDER-LYNE.

210-2, Tottenham Ct. Road,
LONDON, W.1.

Canford Chambers,
St. Peter's Road,
BOURNEMOUTH and
9, Chapel Place,
TUNBRIDGE WELLS, Kent.

49, John Bright Street,
BIRMINGHAM, 5.

6, Park Row,
BRISTOL, 1.

138, Wardour Street,
LONDON, W.1.

Morden Park Sound Studios,
London Road,
MORDEN, Surrey.

46-48, Charles Street,
[CARDIFF.

AGENT FOR INDIA AND CEYLON

A. J. Snell

6, Phillips Street, Aston,
BIRMINGHAM, 6.

It will be appreciated if dealers would send all enquiries for VITAVOX Equipment, Loudspeakers and Microphones to any of the Wholesalers listed.

Retail enquiries should be made of your nearest dealer.

VITAVOX LIMITED
WESTMORELAND ROAD . LONDON . N.W.9
TELEPHONE: COLINDALE 8671-2-3

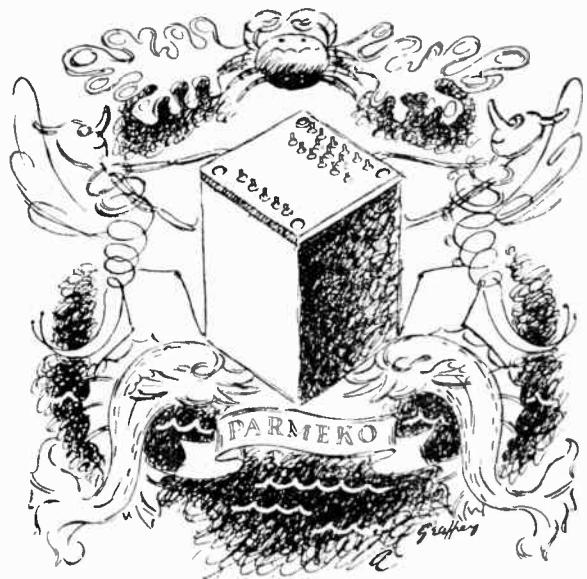

Microns Rampant

We asked an artist to produce some form of illustration which would take your eye and at the same time be typical of PARMEKO. Of course he turns out this silly coat of arms and we can't talk about that . . . we know nothing about heraldry, it is'n't our line of country at all. But we can tell you what really is up our street . . . TRANSFORMERS . . . millions of 'em in small or large quantities. Our research dept. can design Transformers for your particular individual needs and we have a large factory which was specially laid out to do the whole job in the finest possible way.

We specialise in Transformers and our whole staff and plant has been got together for the purpose and . . . you know the more you look at that coat of arms above the more you see in it . . . that artist is'n't the fool we thought if he can set us talking like this.



PARMEKO LTD., LEICESTER, Makers of Transformers



CERAMICONS



Hi-K CERAMICONS



SUPPRESSORS

1093

ERIE

Electronic Components

The engineering resources which produced hundreds of millions of Erie components for war-time needs are now at your service. May we advise you, quote you, or send you samples?

ERIE RESISTOR LTD.
 CARLISLE ROAD, THE HYDE,
 LONDON, N.W.9.
 Telephone: Colindale 8011
 FACTORIES: London, England
 Toronto, Canada • Erie, Pa., U.S.A.



CARBON RESISTORS (ACTUAL SIZE)



VITREOUS ENAMELED WIRE-WOUND RESISTORS



POTENTIOMETERS

Best between



and

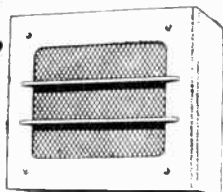

Woden Amplifiers are designed and built to give adequate volume and perfect reproduction when used with suitable microphones and speakers. Two models are available—the 15-watt “Junior” and the 50-watt “Classic.” We will gladly

WODEN send you fullest details and data on request.

WODEN TRANSFORMER CO. LTD
 MOXLEY RD • BILSTON • STAFFS TEL BILSTON 41959
 1075

LEAK

“POINT ONE” RANGE OF ALMOST DISTORTIONLESS AMPLIFIERS

Here are performance figures, inclusive of output transformer, for the type 15:—

TOTAL DISTORTION, including hum and noise, for 15 watts output. —

1,000 c.p.s. 0.1%, (one-tenth of one per cent)
 60 c.p.s. 0.2%, (one-fifth of one per cent)

FREQUENCY RESPONSE: level within 0.25db. 20-20,000 c.p.s.

LOAD DAMPING FACTOR: 20 (10 times better than for average Class A triode).

GAIN: The basic amplifier requires 0.5v RMS at grid impedance. An additional two stages can be supplied built into the chassis, thus reducing the input to 0.005v R.M.S.

Full information on leaflet S.15.

SPECIAL NOTE The above figures establish such radically new standards that they may occasion some surprise. We therefore wish to stress that no error appears in this announcement. The circuits are original, and result from war-time research in our laboratory.

H. I. LEAK & COMPANY LIMITED
 470 UXBRIDGE ROAD • LONDON • W.12
 TELEPHONE: SHEPHERDS BUSH 5626

WAR REPORTING

Equipment Used by the B.B.C.

LONG before the invasion of Europe it was decided that means must be provided for giving B.B.C. listeners direct reports from the front line, starting from the first landings and continuing up to the conclusion of the campaign. Clearly, radio provided the only possible means, but the detailed problem was not easy. The initial radio link might have to cover merely a short Channel crossing or, if the landings were made at more remote points, distances of several hundred miles. In the first case short waves would be unsuitable, but medium waves would be equally unsuitable for longer distances; therefore a wide range of frequencies would be needed. It was finally decided that the following sets of equipment, complete with their own power supplies and accessories, should be designed and built:—

- (1) One highly mobile 250-watt set, covering the frequency range 500-15,000 kc/s for use at the invasion landings.
- (2) Two $7\frac{1}{2}$ - kW equipments, less highly mobile, to work on short waves only; at the stage where they would come into operation, the Army would have advanced beyond economic medium - wave range of U.K.
- (3) One or more fixed stations.

All the gear had to be arranged for morse transmissions, to provide a link between London H.Q. (where a morse transmitter was installed in Broadcasting House) and the various units on the Continent. The fullest possible use was made of available commercial apparatus capable of being adapted for use as mobile trans-

By **W. D. RICHARDSON** and
P. H. WALKER, B.Sc., A.M.I.E.E.

(Engineering Division, British Broadcasting Corporation)

mitters, but much of the incidental technical equipment had to be specially developed. For example, commentators used a midget disc recorder,* designed for almost automatic operation and weighing under 30 lb. More substantial disc recorders were installed in ambulance trucks.

The 250-watt transmitter, which gave its output into a balanced load of 600 ohms or an unbalanced load of 50 ohms, was mounted in a three-ton Army lorry together with its 2-kW petrol-driven motor generator set, drive unit, re-broadcast and communication receivers, a small desk equipped with morse key and microphone, and all tools, spares, aerial and portable mast equip-

* *Wireless World*, May, 1944.

ment. Needless to say, the layout was somewhat cramped, but in spite of this the transmitter gave sterling service on the Normandy beachhead and afterwards.

No mobile transmitters of the required power were available for the $7\frac{1}{2}$ -kW sets and the B.B.C. decided to convert two stationary broadcast sets for the purpose. These transmitters used air-blast cooled valves, and their size and weight was such that it was impossible to mount them as they stood in any single vehicle. It was, therefore, decided to divide each transmitter into two parts: (a) the RF unit, complete with its modulator, and (b) the various HT and GB rectifiers.

These units were mounted directly on to the chassis of separate trailers with anti-vibration mountings of the bonded rubber-to-metal type. To save weight, the modulation feed reactor, weighing 10 cwt., was dispensed with, the HT feed to the modulated amplifier being passed

through the secondary of the modulation transformer; quality was not sensibly affected, and was quite satisfactory for the service contemplated. The RF trailer (No. 1) carried complete speech input equipment, re-broadcast and communication receivers, a complete twin-turntable gramophone unit, also monitoring and morse transmitting gear.

The second trailer carried the 2,000V, 4,000V and 6,000V HT rectifiers, the 1,500V grid bias rectifiers and the two RF drive units.

All connections between the two trailers were made by 20-yd. lengths of flexible cable. The power supply cable was 100 yds. long so that advantage could be taken of any available alternative supply, and



MCN parked in a factory yard in Germany. The transmitter trailers are in the rear while the studio and stores vehicles are in the foreground. In this instance factory chimneys were used for supporting the aerial.

War Reporting—

in order to cater for such an eventuality the transmitter was powered via an auto-transformer covering the range of 380 to 440 volts input.

One of the towing vehicles carried a 27.5-kVA diesel generator set, three 110ft. portable masts, stays, anchor plates, aerials and feeders. The other was loaded with sets of spares and tools to meet all eventualities.

A third lorry housed complete studio facilities, including reproducing gear, microphones and amplifiers sufficient to enable the various commentators to broadcast "live" to the listeners at home or to record their material for use later on. The power supply for this unit (a 6-kVA diesel generator set) was separate and independent of that used for the transmitters so that, if necessary, the studio could be divorced from the rest of the unit.

The whole unit was equipped with both main and emergency lighting, power sockets, etc., and in addition to normal equipment and a vast number of spares, a prismatic compass, first-aid box, cooking stoves, heaters and a battery charger were supplied.

The centre of the home organisation was the Traffic Room at Broadcasting House, London, where transmission schedules were arranged, and material received was passed on. The reception routine was not rigid, and could be modified to suit immediate needs. On one occasion we were unable to transmit an important story until after the 9 p.m. news had started, and yet we heard the story coming back in War Report only twelve minutes after it had been sent to London. On other occasions despatches were broadcast from the field transmitter direct into the B.B.C. programmes, but owing to the many interests of the Corporation it was impossible to make a regular practice of simultaneous re-broadcasting. American requirements were simpler, and whether their commentators spoke over our transmitters or their own whenever possible their despatches went "live" into the American network programmes. Australia, too, took from us many "live" contributions, relayed to

them via the B.B.C. overseas service.

Traffic Room was linked with the Normandy beachhead first with the 250-watt set, described earlier. This, together with a petrol generator set, portable masts, aerial gear, microphone amplifiers, all fitted into a 3-ton truck, with a crew of four engineers and the call sign MCO, set out on D plus 7. Using a tent and later a room in a château near Bayeux as a studio, this transmitter was responsible for sending home a large proportion of the Second Front news stories used by the B.B.C. in the first eight weeks of the invasion.

MCO was followed by a 5-kW double-channel short-wave set of

MCN, arrived at the Mulberry port of Arromanches during the subsequent British breakthrough.

MCN travelled to Brussels before going into service. The site used was formerly a Belgian Government receiving station, though, as we found it, it had been stripped of all its equipment, including masts, by the Germans. From here MCN covered British Army and R.A.F. operations until shortly after the withdrawal of the remnants of the airborne forces from Arnhem. We were more than grateful to the Belgian radio authorities for the facilities given to us at their studios and transmitter, and for their efforts to get the badly damaged cable between their studios and our



Royal Canadian Air Force photograph
The filament leads being replaced on an air-cooled CAT3 valve on arrival at a new site

very compact design, crated and packed with all accessories into two 3-ton trucks ready for installation in a building as a fixed station on arrival in France. Due to delays, the transmitter was not in operation till after the American break-through from the beachhead and the people for whom it was intended had moved forward. This station was later reinstalled in Paris for the use of correspondents at SHAEF. It was timely that the first of the 7.5-kW mobile transmitters,

transmitter site into working order again.

Soon after Arnhem, MCN moved up to Eindhoven and remained there until just before the Rhine crossing. In the meanwhile, some changes were made to the equipment. The towing trucks were replaced by Matador medium-gun tractors. It would be hard to find vehicles which were more suitable for the job.

The 27.5-kVA Diesel generator set was mounted on the floor of one Matador while the other

Matador was fitted up as a workshop, mess room and general store for transmitter spares, workshop materials and aerial gear.

As stated, MCN had been provided with additional studio facilities installed in another three-ton truck. Using the four-channel gramophone turntable unit, the most complicated mixing job could be handled easily; by letting down the small table a number of speakers could be grouped round a floor stand microphone, while the control room at the far end had in addition to normal microphone amplifiers and mixing circuits a comprehensive set of telephone line testing and equalising equipment. Every facility provided in this truck was used at one time or another and apart perhaps for smaller gramophone desks there is little that we would have had different in it.

Frequencies allocated to us were in the middle of Army operational bands, and, frankly, the Army did not like our high-power sets, because of the interference they caused. The use of directional aerials to reduce interference was desirable, but here various difficulties were encountered. Where necessary a rhombic aerial was used. This had the advantages that one aerial could be used for several wavelengths and any length of feeder required at a new site could be fitted without the need for retuning the transmitter output stage.

The transmitters in the American sector used principally dipole aerials, and sometimes horizontal V's—their fairly low power making it unnecessary to trouble unduly about back and side radiations. But the low power itself was a drawback in view of the tasks ahead. Arrangements were made for the second 7.5-kW mobile transmitter to come over and join the Americans. This set landed at Ostend and paused for a while at Brussels for testing, change-over to Matador towing vehicles, and for the modifications found desirable on MCN. The fixed station at Paris had been closed down and dismantled by this time so the new mobile took over the call sign MCP.

MCP went on from Brussels via Namur to Luxemburg, and thence followed the American armies to

and over the Rhine, eventually reaching Berlin to report the triumphal march through the city, and commentaries on the Potsdam conference.

Before crossing the Rhine, the allocation of a new and higher frequency in the 7 Mc/s band enabled the transmitters to operate further away from the Service channels and anti-interference measures were less necessary. At first the frequency was so high relative to the distance from London that complete fadeouts were experienced, but as the advance continued the channel provided very reliable communication. The allocation of the new frequency coincided with experiments to find an easily erected fairly directional aerial. The type used by all transmitters till the end of the tour was a centre-fed horizontal one of 1.25 wavelength overall length, sometimes with two 0.5-wavelength directors, all suspended from two masts using side strainers to get the necessary spacing. This length of aerial gave a forward gain of some 3 db. over that from the normal full-wave dipole.

With the help of the new frequency the 250-watt transmitter continued to give good service and was in operation in Flensburg almost immediately after the German surrender and before British troops arrived there in force. MCN was at Luneberg at the time and was able to transmit to London recordings of the German surrender to Field Marshal Montgomery.

In spite of the size of the 7.5-kW equipment, it was possible after some experience, and the modifications made, to be in operation 2½ hours after arrival at a new site—compared with two days when first erected at Brussels. Morning despatches could be transmitted, the unit dismantled and moved some 60 to 80 miles, and be in operation again in time to send news reports home the same evening.

Much of the smoothness of the operation during the whole campaign was due to willing co-operation from the Public Relations Services, Royal Signals, and other technical units. This opportunity is taken of thanking them all for their assistance.



Save Valuable
Executive Time
by installing

THE
TANNOY
LOUDSPEAKER
SOUND SYSTEM

For Staff Location, Announcements, 'Music While You Work' Programmes, Canteen & Concerts, Alarm and Time Signals, the TANNOY is an assurance of greater general efficiency, both in Factory and in Office

TANNOY
The Sound People

TANNOY is the registered trade mark of
equipment manufactured by

GUY R. FOUNTAIN LTD.
WEST NORWOOD, LONDON, S.E.27, & Branches
Phone: Gipsy Hill 1131

The largest organisation in Great Britain
specialising SOLELY in Sound Equipment

WORLD OF WIRELESS

BROADCAST RECEIVERS

THE manufacture and supply of receivers is still controlled under the Musical Instruments and Wireless Receivers Order, 1944 (S.R. & O., 658/45); licences have, therefore, been granted by the Board of Trade to some 70 manufacturers for the production of civilian sets, of which about one million are planned for the next twelve months. Of this quantity 400,000 are intended for export. It is stated that undertakings have been given by the industry that 50 per cent. by value of the production for the home market will be devoted to sets to be retailed at £15 or less, exclusive of Purchase Tax.

Owing to the limited quantity of timber available for cabinets, many of the manufacturers will be using plastic materials.

Before the war, the average annual production of sets in this country was about 1,400,000, of which approximately 66,000 were exported. It will be seen, therefore, that whereas the present programme visualises an overall production of only about 70 per cent. of the pre-war figure, there is a six-fold increase in exports.

WEATHER REPORTS

THE removal of wartime restrictions on the use of radio by ships at sea permits officers of British merchant ships to resume their observations for the Meteorological Office. Since November 1st they have again been transmitting

routine weather reports, a voluntary service undertaken for many years.

An Atlantic weather bulletin is now broadcast for merchant ships. This transmission, which is in plain language, includes details of existing weather and area forecasts in the North Atlantic.

The bulletin will follow the routine messages to British and Allied merchant ships broadcast by the Admiralty at 1000 and 2200 GMT. The frequencies employed are 149, 7.355 and 12.455 kc/s at 1000, and 149, 4.025 and 7.355 kc/s at 2200.

PICTURES BY WIRELESS

TWENTY-ONE years ago, on November 30th, 1924, the first picture was transmitted by wireless across the Atlantic.

When the half-plate photograph of the then Prince of Wales, reproduced below, was received in New York—having been transmitted from London—it had taken approximately twenty minutes to send. Now it takes only about six minutes to transmit a photograph double the size.

Before the war, Cable and Wireless operated only three phototelegraphic circuits, with Melbourne, New York and Buenos Aires. Traffic, however, was negligible, except on the New York circuit, which handled about 45 pictures every month.

To-day, although the whole of the London phototelegraph apparatus was lost in the fire which destroyed the company's Central Telegraph Station at Moorgate in May, 1941, eleven services are being operated with Empire and foreign countries, and nearly 2,000 photographs and facsimile documents a month are being transmitted and received. In addition to the direct circuits between London and Montreal, Melbourne, Capetown, Bombay, New York, San Francisco (relayed from New York by R.C.A.), Buenos Aires, Moscow, Stockholm, Berne and Cairo, there is a broadcast system from London, the phototelegrams being received regularly by Stockholm, Berne, Rome, Paris, Brussels, Lisbon, Casablanca, Leopoldville, Johannesburg, Cairo, Bombay and Istanbul.

Some idea of the advance made in phototelegraphy will be gained from a comparison of the two untouched photographs reproduced here.

The sub-carrier frequency-modulation system of transmission, which is at present in use, was introduced in 1939.

IN PARLIAMENT

THE Assistant Postmaster-General revealed in the House of Commons that no decision had yet been reached on the question whether the undertakings of broadcast relay companies should be acquired on the expiration of their licences as recommended by the Ulswater Committee in 1935, or whether the development of a Post Office service should be revived, plans for which were suspended in 1940. He also stated that the number of subscribers to the 274 relay exchanges was 584,018 on June 30th.

Several questions have been tabled regarding amateur activities.

Mr. W. A. Burke, the Asst. P.M.G., stated that no substantial change was contemplated in the conditions under which licences would be granted for experimental radio transmitters.

In reply to a question on November 1st it was stated that it was intended to begin returning impounded amateur gear to the 60,000 owners "in about a fortnight's time," but it would take some weeks to complete. Regarding the reallocation of wavelengths it was announced that the military authorities hoped to be able to release a limited number of frequencies for amateur working very shortly.

When asked whether, in view of the fact that many of those with special certificates as wireless operators were unable to qualify by sea service for second-class certificates



1924. One of the first pictures received by radio after crossing the Atlantic.



1945. A test picture transmitted from Stockholm and received in London in October.

owing to the absence of suitable vacancies, he would relax the condition as to sea service, or, alternatively, give some compensating advantage to holders of such certificates, the Asst. P.M.G. replied that as from January 1st, 1946, holders of special certificates as wireless operators might take the examination for second class certificates without having had any previous sea service; additionally, holders of special certificates obtained up to the end of 1945 might continue to serve on all British merchant ships until December 31st, 1946.

The President of the Board of Trade was asked if he was aware that "users of radio valves were being compelled to pay high prices through the operations of the B.V.A. ring." In reply he stated that he was asking the Central Price Regulation Committee to make enquiry and report whether the prices were, in their opinion, fair.

It is understood on enquiry from the B.R.V.M.A. that the Association has offered its help to the Central Price Regulation Committee in obtaining any information required.

The question of adapting wartime civilian receivers for the reception of long waves was raised by one M.P. In reply the President of the Board of Trade said that arrangements had been made with manufacturers for sets to be modified. Owners of utility sets who wish to have them adapted should get in touch with their retailers. The President stated that an adaptor costing 13s., including purchase tax, was on the market.

The Minister of Information announced that the B.B.C.'s capital expenditure on engineering works and equipment during the period September 1st, 1939, to March 31st, 1945, was about £3,550,000. In addition, Lend-Lease equipment to the value of £350,000 was brought into service by the Corporation.

It was stated by the Minister of Information, in reply to a question on the future of television, that steps were being taken to set up a Television Advisory Committee on the lines recommended in the Hankey Report. He added that, until this Committee is constituted and has taken stock of the position, it would be premature for him to make any statement on future television arrangements.

WIRELESS WORLD DIARY

PRODUCTION difficulties have delayed the publication of the *Wireless World Diary*, 1946, and it is regretted that copies will not be available until early in December. Owing to limited supplies, they will only be obtainable through booksellers or stationers, price 3s. 4d.

AM/FM SETS

AMERICAN listeners have been advised by a member of the Federal Communications Commission to buy a combined AM and FM receiver when purchasing a new set. It was pointed out that the speed with which FM develops will depend on "how rapidly listeners accept this new method of transmission."

The commissioner predicted that within four or five years at least half the homes of the U.S. will have sets equipped to receive FM transmissions. He stated that the extra cost for the FM equipment in a receiver would not be great—perhaps not more than that paid for the short-wave coverage in an ordinary broadcast set.

PERSONALITIES

Dr. C. C. Paterson, F.R.S., Director of the G.E.C. Research Laboratories, is now one of the members of the Advisory Council to the Committee of the Privy Council for Scientific and Industrial Research.

Capt. Spencer Freeman has relinquished his special duties in relation to the reconversion of the radio industry and his position as business member of the Industrial and Export Council.

A. P. Rowe, C.B.E., has been appointed Deputy Controller for Research and Development at the Admiralty, in which position he assists the Controller of the Navy in supervising the application of science, technology and design engineering and advises the Board of Admiralty on research and development generally. During the war he was head of T. R. E. Malvern—the largest radar establishment in the country—which has been responsible for the radar equipment both of the R.A.F. and Fleet Air Arm.

Dr. P. Dunsheath, O.B.E., President of the I.E.E., Director and Chief Engineer of W. T. Henley's Telegraph Works Co., has been appointed Consultant and Adviser to the Director of Electrical Engineering at the Admiralty.

Maurice Gorham, B.A. (Hons) is to take charge of the B.B.C.'s television service. He joined the B.B.C. in 1926, from 1933-41 he was Editor of the *Radio Times* and from 1941-44 Director of the North American Service.

D. R. Parsons has joined the staff of R.M. Electric, Ltd., Team Valley Estate, Gateshead, where he will be responsible for the Development Laboratory of the Receiver Section. For the past eight years he has held a similar position with G.E.C.

IN BRIEF

1946 Components Exhibition.—Preliminary arrangements have been made for the 1946 Radio Component Manufacturers' Federation Exhibition, which is to be held at Grosvenor House, Park



H.A.5 DEAF-AID CRYSTAL MICROPHONE

ASTATIC is ready to serve you again with high quality piezo-electro devices now that the 'All Clear' of Victory has sounded. Astatic deaf-aid microphones can be supplied only if Import Permits are established. Model H.A.5 illustrated is used as standard by America's leading hearing-aid instrument makers.



THE ASTATIC CORPORATION CONNEAUT, OHIO, U.S.A.

and TORONTO, CANADA.

Exclusively Represented by Frank Heaver Ltd. Kingsley Road, Bideford, N. Devon.

SOON
CRONAME
Designing and Engineering

will again be a factor in the plans of farsighted manufacturers of electronic equipment. From building precision parts for wartime devices the Croname group will turn to the processing of mechanical and decorative items for the electronic industry.

A place in the Crowe schedules has meant attractive, practical, saleable merchandise to many. Our facilities may be valuable to you.

Dial Scales.
Tuning Mechanisms.
Pointers, Escutchions.
Precision Controls, Knobs.

*
Exclusively Represented in Great Britain by
FRANK HEAVER LTD.
Kingsley Road, Bideford, N. Devon.

Croname Incorporated
FORMERLY
(Crowe Name Plate & Manufacturing Co.)
CHICAGO, ILL. U.S.A.

World of Wireless—

Lane, London, from February 19th-22nd inclusive. As in previous years, admission will be by ticket only, and it will not be open to the general public.

Anglo-French Relations.—Sir Edward Appleton, Secretary of the Department of Scientific and Industrial Research and President of the International Scientific Radio Union, recently addressed the French Society of Radio Electricians at the Sorbonne, Paris, on "Recent Radio Research in Great Britain." Professor H. Abraham, President of the Society in 1940, and many members were arrested and deported to Germany during the occupation. There is still no news of their whereabouts.

American Amateurs have again been on the air. The F.C.C. authorised transmission on the 112-115.5 Mc/s band for about two months. During this time they shared the band with the War Emergency Radio Service, the operation of which ended on November 15th. Holders of licences which were valid up to December 15th, 1942, were permitted to operate their stations.

Radio Luxembourg.—The United States Army has handed back the high-powered broadcasting station in Luxembourg to the Government of the Duchy. It appears from this that there is now little likelihood of using it as a United Nations station as was proposed. A new network of stations, comprising Frankfurt, Stuttgart and Munich, is now operating in the American zone of Germany.

Restoration.—Four of the twelve Cable and Wireless Far Eastern stations which were occupied by the Japanese—Singapore, Hongkong, Batavia and Penang—have now been wholly or partially restored. From Singapore two-way wireless circuits are being operated via the "Press Ship" in the harbour.

Motor Jubilee.—Few realise that it is only 50 years since the first demonstration in this country of the "Horseless Carriage." This fact is brought vividly to mind by the publication of the Special Jubilee Number of our associate *The Autocar*—the world's first motoring journal—on November 16th.

U.S.S.R. Radio.—According to a broadcast from Moscow a powerful new transmitter has been completed in the capital and is working on 360.6 m.

Cabinet Design.—"Shapes of Things to Come" is the title of a competition organised by the Central Institute of Art and Design. Designs for all types of household furniture are invited from British subjects of either sex under the age of 30, for which cash prizes are offered. Section 3 includes designs for radio cabinets. Entry forms can be obtained from The Central Institute of Art and Design, The National Gallery, Trafalgar Square, W.C.2; closing date for entries is March 31st, 1946.

Juvenile Radio Lectures will be given by Sir Robert Watson Watt at the Royal Institution, 21, Albemarle Street, London, W.1, on December 27th, 29th and January 1st, 3rd, 5th and 8th, commencing at 2.30. The fee for juveniles

between the ages of 10 and 17 is half a guinea.

Romford Radio Society is now having regular weekly meetings on Tuesdays at 8.30 at the Y.M.C.A. Red Triangle Club, North Street, Romford. Hon. Sec.—R. C. E. Beardow (G3FT), 3, Geneva Gardens, Whalebone Lane North, Chadwell Heath, Essex.

Edgware Short-Wave Society has commenced fortnightly meetings on the first and third Wednesdays of the month at the Constitutional Club, Edgware. Further details can be obtained from the Secretary, P. A. Thorogood (G4K1), 35, Gibbs Green, Edgware.

Leicester Radio Society is holding meetings at the Charles Street United Baptist Church (side entrance) at 7.30 on November 27th and December 11th. Hon. Secretary is O. D. Knight, 16, Berners Street, Leicester.

Decca Navigator.—It was announced by the Chairman of the Decca Record Company at the annual general meeting that the world rights and patents of the Decca Navigator, which we hope to describe in a forthcoming issue, are being transferred to the new subsidiary Decca Navigator Company.

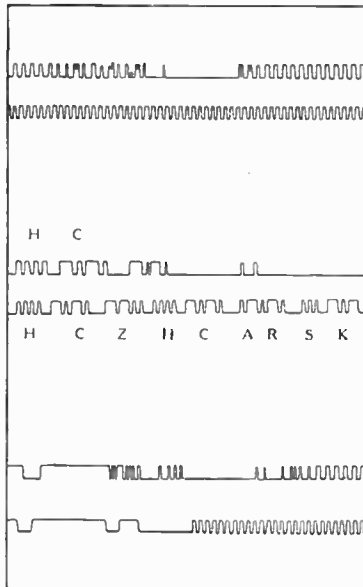

BLESSINGS OF DIVERSITY. The advantages derived from diversity reception are graphically shown in this illustration. It shows three pairs of undulator tapes simultaneously recording the same transmission; the upper of each pair was recorded on a good single-channel receiver and the lower on a diversity receiver. It will be seen from the centre pair that seven letters "lost" in single-channel reception were regained by diversity. Illustration from *AWA Technical Review* (Australia), March, 1945.

Change of Address.—The sales department of Measuring Instruments (Pullin), Ltd., is now at Phoenix Works, Great West Road, Brentford, Middx. (Telephone: Ealing 0011.)

Multicore Solders.—Owing to the continued Government requisitioning of their offices at Bush House, Multicore Solders, Ltd., are unable to return there. Their permanent address will, therefore, be Mellier House, Albemarle Street, London, W.1. (Telephone: Regent 1411.)

Marconi Instruments have established a Northern office at 30, Albion Street, Hull. (Telephone: Hull 16144.)

"Power Laundry."—This journal has now been acquired by our Publishers, and will in future be issued from Dorset House.

MEETINGS

Institution of Electrical Engineers

Radio Section.—Discussion on "Film Forming Materials used in Insulation" to be opened by C. R. Pye, B.Sc., on November 27th.

"The Design and Use of Radio-Frequency Open-Wire Transmission Lines and Switchgear for Broadcasting Systems" by F. C. McLean, B.Sc., and F. D. Bolt, B.Sc. December 5th.

Discussion on "The Servicing of Radio and Television Receivers" to be opened by R. C. G. Williams, Ph.D., B.Sc. (Eng.) on December 11th.

All meetings commence at 5.30 and will be held at the I.E.E., Savoy Place, London, W.C.2.

London Students' Section.—"Atmospherics and their Location" by C. Clarke, at 7.0, on December 18th at the I.E.E., London.

Cambridge Radio Group.—Repeat of Inaugural Address as Chairman of the London Radio Section by A. H. Mumford, B.Sc. (Eng.) at 6.0, on December 10th, in the Technical College, Collier Road, Cambridge.

British Institution of Radio Engineers
London Section.—"Ultra-High-Frequency Aerial Technique" by S. G. Button, at 6.0, on December 19th, at the Institution of Structural Engineers, 11, Upper Belgrave Street, S.W.1.

North-Western Section.—Discussion on "Post-War European Broadcasting" (R.I.C. Report), to be opened by G. Bernard Baker at 6.15, on November 28th, at Reynolds Hall, College of Technology, Manchester.

Scottish Section.—"Ultra-High-Frequency Technique" by Prof. M. G. Say, at 7.30, on December 11th, at the Herriot - Watt Memorial College, Edinburgh.

North-Eastern Section.—"Review of Industrial Electronics" by J. Hare and J. C. Finlay, at 6.0, December 12th, at the Mining Institute, Neville Hall, Westgate Road, Newcastle.

Midlands Section.—"Ultra-High-Frequency Aerial Technique" by S. G. Button, at 6.15, on December 14th, at Birmingham Chamber of Commerce, 95, New Street, Birmingham, 2.

Institute of Physics

Electronics Group.—"Dielectric Heating" by A. J. Maddock at 5.30, on November 28th, in the Lecture Theatre of the Royal Institution, 21, Albemarle Street, London, W.1.

ARMY SET No. 10

Centimetre Waves : Pulse Modulation : Multi-Channel

SOON after D-day the Army brought into use a piece of wireless equipment which was unique in the history of military communications. It was unique in that it combined the security from interception of the line circuit with the flexibility of wireless, and it achieved this primarily through the use of centimetre waves.

The military user of wireless communication has continually at the back of his mind the danger of enemy interception, and he has to regulate his use of wireless accordingly. There has consequently been in the past an understandable preference for line communications with which the chances of interception are much smaller.

The great drawbacks to lines, however, are the man-power and time needed for their erection and maintenance, and their vulnerability to enemy action. This will be realised when it is remembered that a line of only 20 miles requires the erection of some 700 poles for its support. The impossibility of erecting line circuits to follow up a rapid advance, such as that through France, is self-evident. It is here that centimetre-wave wireless steps in. Because of the peculiar properties of such waves, almost complete freedom from interception can be obtained, and yet a circuit can be established so quickly that communications can keep pace with the most rapid advance.

Centimetre Waves

The great advantage of the No. 10 set—its freedom from enemy interception—is secured through what is often considered to be a drawback of centimetre waves. This is the fact that their laws of propagation are very similar to those of light. Radiation progresses along substantially straight-line paths, and it is interrupted by any sizeable

obstacles in its way. It is, however, unaffected by fog and rain, and it takes but little notice of small obstacles.

In addition, the aerial can be large in terms of wavelength while still small physically, so that the radiation can be confined to a narrow beam, not unlike that of a searchlight. It is easy to see that under these conditions enemy interception is virtually impossible unless the beam is pointing straight at his territory. This, of course, cannot always be avoided, for one naturally desires to work to and from one's own lines, but it is here that the liability of centimetre waves to interruption by obstacles comes in. By siting the station so that there is a hill between the receiver and the enemy the signal can be prevented from reaching him.

By the use of beams and by choosing sites so that there are hills to block the beam from the enemy, it is not difficult to secure freedom from interception. It should be noted, too, that these same factors also prevent mutual interference between one's own sets—a very important point in peace as well as war.

The range obtainable is limited chiefly by the terrain, for while it is desirable to site stations so that hills interrupt the beam beyond the receiver, it is necessary to site them so that it is not interrupted along the required path. The range depends more on the nature of the country than on the equipment, therefore, and is usually about 20 miles. It is, however, sometimes well over 50 miles.

The use of centimetre waves confers another advantage. Ether space is not restricted, and large band-widths can be used. This in its turn permits the use of pulse modulation, and this is very desirable if only because it lends itself to a particularly simple form of multi-channel operation.

The No. 10 set is designed to handle eight speech channels

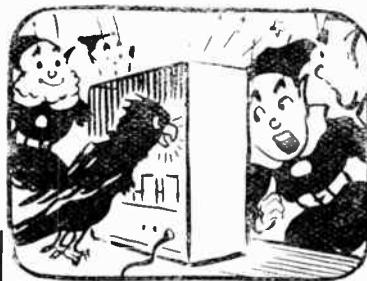

THE "FLUXITE QUINS" AT WORK

"Would you believe it?" said OH,
"I can't get this wireless to go..."
"Nonsense, old boy,
Hark! it's talking," cried OI,
"But it's FLUXITE it's needing, y'know."

See that FLUXITE is always by you—in the house—garage—workshop—wherever speedy soldering is needed. Used for over 30 years in Government works and by leading engineers and manufacturers. Of all Ironmongers—in tins, 8d., 1/4 & 2/8.

Ask to see the FLUXITE POCKET BLOW LAMP. Price 2/6.

TO CYCLISTS! Your wheels will NOT keep round and true unless the spokes are tied with fine wire at the crossings AND SOLDERED. This makes a much stronger wheel. It's simple—with FLUXITE—but IMPORTANT.

The FLUXITE GUN puts FLUXITE where you want it by a simple pressure. Price 1/6, or filled, 2/6.



ALL MECHANICS WILL HAVE

FLUXITE

IT SIMPLIFIES ALL SOLDERING

Write for Book on the ART OF "SOFT" SOLDERING and for Leaflets on CASE-HARDENING STEEL and TEMPERING TOOLS with FLUXITE. Price 1d. each.

FLUXITE LTD.

(Dept. W.W.), Bermondsey Street, S.E.1

simultaneously. The transmitter accepts the audio signals from eight lines, arranges for each channel to modulate a train of pulses, mixes the eight trains, and radiates bursts of RF energy corresponding to the pulses. The receiving equipment performs the inverse function; it sorts out the received pulses, routes them to their correct channels and demodulates them into the audio signals again.

The complete No. 10 set station is housed in a four-wheel trailer and is thus readily transportable. Circular mirrors form the aerials and are mounted on the roof, but if additional height is needed, a special transportable 60ft. tower can be employed to carry the mirrors.

The sets work in pairs to provide eight duplex telephone channels, and long distances can

be covered by using relay stations. Great use was made of such relays on the Continent, and on at least one occasion no fewer than ten links were used to connect Luneberg and Brussels. At Brussels the circuit joined the normal land line. Direct communication between Luneberg and Whitehall was thus maintained by a mixture of centimetre-wave wireless and ordinary land line.

Development and Use

The idea of the No. 10 set first arose as far back as 1941, and the credit must go chiefly to W. A. S. Butement, A. V. Oxford, E. W. Anderson and J. G. Macmillan of the Ministry of Supply. In 1942 the first experimental two-stage link was set up between Horsham and the roof of Berkeley Court in London. Later trials

were carried out on an overseas path from Ventnor, Isle of Wight, to Beachy Head, and then, just after D-day, came the first operational link—between Ventnor and Cherbourg. Thereafter, No. 10 sets followed the advance. For several weeks they provided the only speech communication over the Maas and the Rhine; Field-Marshal Montgomery's Tactical H.Q.s. were never out of touch with the whole of 21 Army Group and the War Office for more than one hour.

The security obtained was absolute, for although after the surrender the Germans claimed to have intercepted our wireless transmissions with ease, careful examination showed that they had never intercepted No. 10 set signals, and were completely unaware that we even possessed such equipment.

Letters to the Editor

Electrolytics : American Views • Colour-Coding for Valves • Radar Maintenance in the Field

In Defence of Electrolytics

WE are in sympathy with J. C. Finlay's defence of electrolytics, in the July issue. However, we are not in agreement on the method of rating he suggests or the implication that etched plate electrolytics cannot be made which perform satisfactorily in service.

In the first place we have examined some British electrolytics, and have found that a condenser rated 600 volts cannot be operated at this voltage continuously, particularly at a normal ambient temperature of 60 deg. C.

Consequently, this is not a "true rating" but rather indicates the maximum transient voltage which the condenser will withstand. Our practice is to put on the nameplate the maximum voltage at which the electrolytic condenser will operate continuously at a 60 deg. C. or 85 deg. C. ambient as the case may be. The condenser, however, will withstand a considerably higher vol-

tage; on the average, up to 20 per cent. over the nameplate value without breakdown.

The Services in this country have used etched plate electrolytics with good results. The difficulties that have arisen resulted from the fact that certain condensers were "designed" by the equipment manufacturers and then the condenser manufacturers were required to make them.

We agree with the analysis that electrolytic condenser failures are due to improper design (or improper use, depending on the point of view). We would add that the quality of the product is a major consideration. What we would like to emphasise is that if the requirements of use such as maximum and minimum temperature, AC ripple voltage, maximum surge voltage, and operating voltage are specified we can design an electrolytic condenser, be it etched or plain plate, to meet the service. Furthermore, this results in the best compro-

mise between reliability and minimum volume (two essentially contradictory requirements) for a given capacity and voltage rating.

J. BURNHAM,

Assistant Director of Research,
Sprague Electric Company,
North Adams, Mass., U.S.A.

Valve Coding

R. V. SHARMAN, in his letter in your July issue, seems to have overlooked that my original suggestion (June *Wireless World*) to colour-code valves was made under the assumption that valve standardisation comes through.

In both the previous attempts to standardise, viz., the American and the Continental European ones, it was the coding of heater ratings which let us down.

Otherwise I quite agree with him. The coding of functional groups should be done by letters preceding the type number. The Continental standard, of which we know in this country only its last

survivors, the "Red E" Series, showed a way. This, of course, will have to be improved on to satisfy present demands; for example:—

Coding Letter	Would stand for
A	Detector-diode or double-diode with common cathode.
B	High AC-resistance triode.
C	Medium AC-resistance triode.
D	Low AC-resistance triode (power triode).
E	Variable-mu HF pentode (or critical-space tetrode).
F	Straight HF pentode (or critical-space tetrode).
G	High-slope television pentode (or critical-space tetrode).
H	Hexode or heptode (suppressor grid hexode).
K	Octode or pentagrid (mixer-osc. heptode).
L	Power pentode or beam tetrode.
M	Magic eye.
N	Neon stabiliser.
P	Gas (trigger) triode.
R	Barretter.
V	One-way vacuum rectifier.
W	Two-way vacuum rectifier.
Y	Three-way vacuum rectifier.
X	Two-way gas-filled rectifier.

Such a system is quite flexible. Valves with more than one electron path could be coded by two letters; for example:—

- AA for split-cathode double-diodes.
- AC for double-diode and medium AC-resistance triode.
- BM for high AC-resistance triode and magic eye.
- CH for triode + hexode or triode + heptode.
- DD for double triode (class B).
- VV for double one-way rectifier (voltage doubler),
- and so on.

If colour-coding is adopted for heater-rating and letter-coding for functional groups the type num-

ber can be counted through quite irrespective of these.

It is obvious that even the most complex system cannot obviate occasional reference to data sheets. But what can be done to simplify recognition of types should be done.

K. E. MARCUS.

Uxbridge, Middx.

Radar Mechanics

THE story of radar (during 1940-42 particularly) is incomplete without mention of the radar mechanic. The work involved keeping radar equipment serviceable in aircraft and on the ground, especially during the night blitzes, was far from negligible. It not only necessitated brains, but fortitude, physical endurance and mechanical ability. Faults had to be diagnosed and rectified very quickly, and many modifications had to be effected in order to obtain first-class "airborne" serviceability. This work fell mainly on the shoulders of radar mechanics, at test-benches and in aircraft, and in many cases alternate 24-hour duties were carried out over a long period. Without exaggeration the aircrews concerned received invaluable help and advice on the operation of the radar equipment, and many voluntary flying hours were spent by the mechanics in testing apparatus and rectifying faults which were not evident on ground checks.

Experienced amateurs and pre-war radio mechanics composed the nucleus of this R.A.F. trade

GALPINS

ELECTRICAL STORES,

408, HIGH ST., LEWISHAM,

LONDON, S.E.13.

TERMS: CASH WITH ORDER. No C.O.D.

ELECTRIC LIGHT CHECK METERS, first-class condition, electrically guaranteed, for A.C. mains, 200/250 volts 50 cy. 1 phase 5 amp. load, each **12/6.**

METAL RECTIFIERS, large size, output 50 volts 1 amp., **35/-.**

METAL RECTIFIERS, output 12 volts 1 amp., **17/6.**

50 VOLT MOTOR, D.C., input 4 amps., 1/4 h.p., ball bearing, double ended shaft 1in. dia., slow speed, only 500 r.p.m., shunt wound, condition as new, also make good slow speed generator. Price **50/-.**

MOVING COIL METERS, all 2in. dia., flush mounting, 0.5 M/A, **40/-**; 0.20 M/A, **40/-**; 0.50 M/A, **37/6.**

LARGE PAXOLIN PANEL, size 14x7x1/2in., fitted massive switch arm, 12 large studs and contact blade, very smooth action, price **7/6** each.

BLOCK CONDENSERS, 2 MF, 1,500 v. D.C. working, **7/6** each.

X-RAY TRANSFORMER in oil, input 200 v., output 80,000 volts, rating 5 K.V.A., with Coolidge winding, **250**; ditto, 2 1/2 K.V.A. at 90,000 volts, **245**; ditto, dental type, 45,000 volts, **230.**

FLUORESCENT SCREENS, selt, 15x12, with lead glass, **25.**

LARGE FAN MOTORS, all direct current, approx. 1/4 h.p., 110 v. series wound, in first-class condition, **20/-** each; ditto, complete with stand, starter, cage and fan, **30/-.**

D.C. MOTORS, as above, only for 220 volts, in perfect order, **25/-**; ditto, complete with stand, starter, cage and fan, **35/-.**

ROTARY CONVERTER, input 230 v. D.C., output 230 v. A.C., 50 cycle, single phase, 1 1/2 kW., constant rating, a high-grade job of very solid construction, **235.**

TRANSFORMER CORE to suit 2 1/2 kW. transformer, complete with clamps and bolts, **25/-.**

LARGE OUTDOOR BELLS, 110 v. D.C. working, 6 in. gong, **17/6.**

D.C. MOTOR, totally enclosed, shunt wound, 220 v. D.C. 1/10 h.p., large size, high-grade, **45/-.**

AUTO TRANSFORMERS, tapped 0-110-200-220-240 step up or down, 500 watts, **23/10 0**; 2,000 watts, **29.**

MOVING COIL METER, reading 0-100 milliamps, 2 1/2in. dia., flush mounting, F.S.D., 5 M/A., **30/-.**

METAL RECTIFIERS, output 12 volts, 2 amps. large size, **32/6.**

PREPAYMENT METER for 230 v., A.C. 50 cycle, single phase, as new, 1/- slot, sixpence per unit, 5 amp. load, **23.**

BLOCK CONDENSERS, large size, in metal cases, 20 M.F., 300 v. A.C. working, **15/-.**

ROTARY CONVERTOR, input 220 v. D.C. at 9 amps., output 68/125 volts, five hundred cycles, single phase, 1 1/2 kW., massive construction. Price **212.**

BLOCK CONDENSER, large size, 4 M.F., 3,000 volts working, **20/-.**

FIXED RESISTANCES on fireproof mounts, size 12in. by 1in., 2 ohms, to carry 10 amps., **2/6.**

CLOSED half-day Thursday. **Open** all day Saturday.

Books issued in conjunction with "Wireless World"

	Net Price	By Post
FOUNDATIONS OF WIRELESS . Fourth Edition, by M. G. Scroggie	7/6	7/10
TELEVISION RECEIVING EQUIPMENT , by W. T. Cocking	10/6	10/10
RADIO LABORATORY HANDBOOK , by M. G. Scroggie. Second Edition	12/6	12/11
WIRELESS SERVICING MANUAL , by W. T. Cocking. Sixth Edition	7/6	7/10
HANDBOOK OF TECHNICAL INSTRUCTION FOR WIRELESS TELEGRAPHISTS , by H. M. Dowsett and L. E. Q. Walker. Seventh Edition	30/-	30/7
RADIO DATA CHARTS . Tbird Edition, Revised by J. McG. Sowerby, B.A., Grad. I.E.E.	7/6	7/10
RADIO INTERFERENCE SUPPRESSION , by G. W. Ingram	5/-	5/4
LEARNING MORSE . 335th thousand	6d.	72d.
INTRODUCTION TO VALVES , by F. E. Henderson	5/-	5/4
RADIO WAVES AND THE IONOSPHERE , by T. W. Bennington	6/-	6/3

Obtainable from leading booksellers or by post from

ILIFFE & SONS LTD., Dorset House, Stamford Street, London, S.E.1

and their work formed a very valuable link between the "Bofins" and the air crews.

Fault-finding and replacement of equipment in a night-fighter at dead of night or very early morning, aided by the glow from a dimmed torch and sometimes in complete darkness, is a unique experience, I assure you!

WALTER F. BALL.

Sutton, Surrey.

Telepathy or Radio-Telepathy ?

WHAT is *Wireless World* up to?

"Telepathy" and "astral phenomena"! What next? Presumably, we shall soon be reading serious attempts to explain "what the stars foretell" in terms of some ultra-electronic energy. It is to be hoped a serious radio periodical will not lend scientific colour to such beliefs.

But granting there is good evidence for telepathy: it is the height of fantasy to look to radio for the explanation. No doubt there are still mechanists who would say "thought" is an "electronic phenomenon," though they would probably think it a little far-fetched to talk of *ideas* being "radiated."

We had better stick to things concrete, and cease joining the hopeful behaviourists who devote their days to finding the explanation for what they think in "brain currents."

"DUALIST."

"Channel Hogging"

IT might have been added to the interesting letter in your June issue that quite a number of commercial morse stations seem to find it necessary to work on top of broadcast stations. Yet other parts of the dial are often, if not always, clear of transmissions. But, in spite of this, there is a movement afoot — notably in America—to stop international short-wave broadcasting on the grounds of lack of space.

Coupled with the emphasis being laid on wired broadcasting in certain quarters, it makes one wonder whether some political reason(s) exists for the above state of affairs. Perhaps international short-wave broadcasting does not lend itself to censorship so easily as the Press or wired broadcasting systems.

The opinion has been expressed that all fixed points should be connected by land or submarine cable, so surely the commercial

stations should surrender frequencies, if any need to be surrendered for new services.

D. O. FRENCH.

Norwich.

"EI" Amateurs

IN the November issue of *Wireless World* you state that amateur transmitters are again allowed to operate in Eire. This is not correct; our amateurs are *not* back on the "air." It is true that the Emergency Order under which our apparatus was seized and our licences cancelled has been revoked. The impounded apparatus held by the authorities has also been returned; but on condition that it is dismantled, and not used for transmitting purposes. No licences are being issued until the international position regarding amateur radio is clarified.

ANDREW C. WOODS,
Hon. Secretary, The Irish Radio Transmitters' Society.
Dublin.

A.I.D. TEST HOUSE

Production Testing of Aircraft Equipment

SITUATED at Harefield, some 20 miles N.W. of London, are the central testing laboratories of the Aeronautical Inspection Directorate of the Ministry of Aircraft Production. The main purpose of this establishment is to provide facilities for check testing the products of firms engaged in the manufacture of materials, parts, sub-assemblies and

accessories used in the construction of aircraft. Considerable time is also devoted to the investigation of methods of testing in order that hidden flaws and imperfections may be the more readily detected during production testing at the factory. There is quite a large section devoted to the radio industry.

One piece of apparatus in the

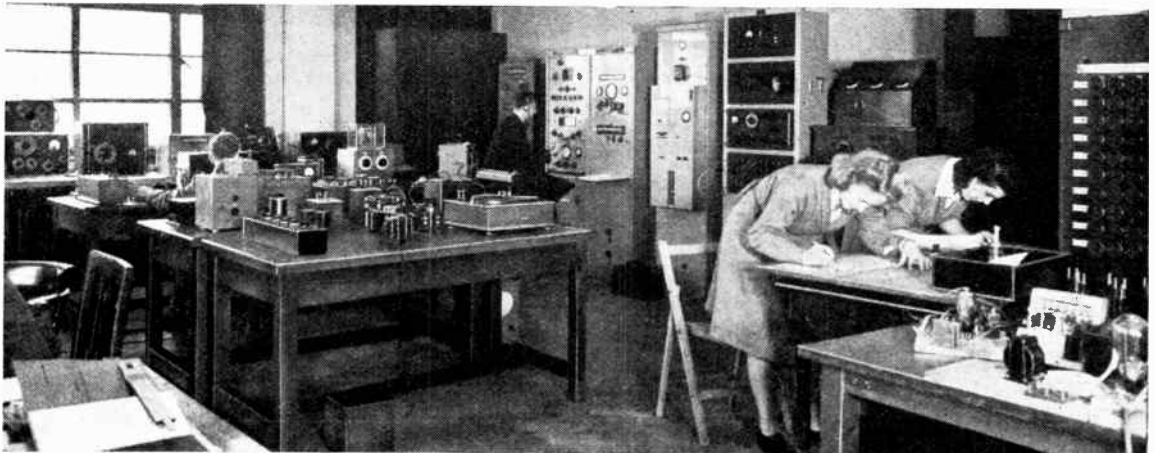

General view of the A.I.D. Electrical Standards Laboratory showing in the background (left) the standard frequency RF generator, with a beat frequency AF oscillator and harmonic analyser on its right.

Electrical Standards Laboratory illustrates the care taken to ensure a high order of accuracy. This consists of a master radio-frequency oscillator from which is derived harmonics and sub-divisions of the frequency for check-testing standard frequency generators. A fundamental frequency of 50 kc/s is generated by a crystal-controlled oscillator contained in a temperature-controlled oven. The output from the oscillator is fed to a series of multi-vibrators, some of which operate at a higher frequency and some at a lower frequency than the master oscillator. These are locked either to its harmonics, or to others in the chain that are so locked, and together they provide a number of spot frequencies up to 1 Mc/s.

The subdivision of frequency is carried down to 100 c/s and this is used to drive an electric clock which is periodically checked against Greenwich time signals. By a system of recording, differences of a minute fraction of a second can be determined and converted back as a check on the frequency of the master oscillator. Further checks are made by using the standard frequency transmissions radiated by WWV, Maryland, U.S.A.

Radio technique often plays a part in testing materials which are not themselves being used in the construction of radio apparatus. For example, use is made of a method similar to that described in our May, 1945, issue (p. 157) of testing by examination of echoes of super-sonic pulses propagated through metal objects. The system, of which the previously described application was for the measurement of thickness, is used for the detection of flaws, which, due to change of density, cause secondary reflections.

SELF-SOLDERING

AN apparently incongruous partnership between the Ministry of Supply, Bryant and May and the firm of Multicore Solders resulted in the production during the war of a novel soldering device. The "self-soldering sleeve," as it was called, was used for jointing field telephone cables, and not for wireless purposes, though the principle employed might well have applications in that field. The sleeve consists of a length of copper tube, partly filled with fluxed Multicore solder and coated externally with igniting material.

To make a joint, the bared ends of the cables are inserted in the sleeve and the covering is ignited by striking it with the edge of the packing box. Cable ends, sleeve and solder are heated to over 375 deg. C. and an excellent joint is made.

EVERY MILE OF THAT LONG, LONG ROAD...



EL ALAMEIN, Tunis, Sicily, Rome, Normandy, and over the Rhine . . .

Bulgin Components have travelled every mile of that road. With the tanks and the guns, in the planes that blasted the way ahead, in the little ships that covered our landings. It was a long bitter road, through dust, heat and sandstorms. A road that stretched so far, through rain and cold and slush, that only the strong could make it.

Those hardships were Bulgin's finest test. With everything against them, grit, mildew and rough handling, they did their job. Right from the word "go" until the white sheets were fluttering in Berlin.

You could not buy that Bulgin Coil, condenser or resistance you wanted while they were on vital work. You couldn't rebuild your old set or start planning that new one. Now the news is good news.

BULGIN COMPONENTS ARE COMING ON THE MARKET AGAIN

A steady trickle, not much at first, but enough to be going on with. Ministry requirements are tapering off. That means more for you at home, more for export overseas. Winter evenings and Bulgin components to build that dream set are something special to look forward to.

YOU'LL SOON BE GETTING
BULGIN

RADIO AND TELEVISION COMPONENTS

PUT YOUR NAME DOWN NOW. See your wireless dealer about Bulgin, tell him what you need.

A. F. BULGIN & CO. LTD., BYE PASS ROAD, BARKING, ESSEX

Tel.: R1Ppleway 3474 (5 lines)

RANDOM RADIATIONS

By "DIALLIST"

What is Radar?

THE controversy on the subject of what is and is not radar still continues and doesn't seem to be getting very much forrader. When the beans were first spilled both Smith Rose and Appleton laid it down that the characteristic which distinguished radar from all other systems of position finding and course plotting was that it required no co-operation on the part of the target. Systems such as "Gee," "Oboe" and "Rebecca-Eureka" do require such co-operation; in each of them, in fact, the target must be fitted with apparatus which, on receiving pulses from a questing transmitter is triggered off and emits pulses which a suitable receiver picks up. In other words, the return pulse is not an echo, as it must be in true radar. It isn't difficult to see how systems using triggered instead of true echo pulses came originally to be classed as radar equipment. So far as I know the first application of the triggered pulse principle was IFF, the system by means of which a friendly aircraft or ship automatically sends out an identifying signal when "hit" by radar pulses. IFF was designed by the men who specialised in designing radar equipment, fitted to radar apparatus and worked by radar operators. Hence it fell in the Services under the general classification of radar, and one doesn't quite see where else it could have fallen. Gee, Oboe and the rest followed in due course and were again, quite naturally, regarded for similar reasons as members of the radar family. But that is no reason why they should continue to occupy a place which does not rightly belong to them. I am all for avoiding confusion by making classification as rigid as possible. My own suggestion is that radar should be used to describe only such systems as rely on true echoes and that the triggering systems should be known as radio position finding (RPF), radio course control (RCC) or something of that kind.

□ □ □

A Connector Tip

DO you make any use in your wireless hook-ups of those handy little connectors which electricians often employ for joining up lighting leads inside junction boxes? In case you don't know them, they are made of porcelain, shaped like small thimbles and provided inside with a

tapering screw thread. You bare half an inch or so of the leads to be joined and twist the ends together; then you apply one of the little thimbles and simply screw it on. Its thread bites the wires with a bulldog grip, and when the connector is right home the bared ends are completely covered up and well insulated. They can be used, naturally, only for joining up fairly stout wires—fine wires would simply break as you tightened up and the joint would "come to pieces in yer and." But when you are dealing with wires of suitable gauge they certainly save a deal of time and trouble in the making up of experimental circuits. The joints they make are probably as sound electrically as any unsoldered joints can be and they have the special virtue (*not* possessed by crocodile clips) that no exposed "hot" points can be left ready to cause spectacular "shorts," or to cause the experimenter to leap high and profanely when in an absent-minded moment his hand strays on to them.

Buying It

Speaking of the stimulus, both physical and linguistic, that a "live" scrap of metal can provide when over-trustingly caressed by the careless hand reminds me of a real fourpenny one in the way of shocks that came my way a few days before this was written. I should perhaps mention that I am one of those luckless thin-skinned beings who are particularly susceptible to the effects of electric shocks. Nature, I always feel, fails singularly to do her stuff in the case of the electrical engineer. She helps the blacksmith to develop such toughness of hide that he airily lights his pipe with a glowing coal picked up by his bare fingers; professional gardeners grow backs that do not know what a crick is; a special muscle burgeons in the tinsmith's hand to enable him to use his shears effectively and without nipping bits out of himself with those horrible hooks at the ends of the handles; and there are countless other examples of the way in which she adapts the physique of the worker to the job which she assigns to him. But, having infected a man with a desire to follow electricity as a calling, does she help him to grow shockproof? She does not. Here and there you find the kind of human neon tube who smilingly detects the presence of real high-tension stuff (I have seen it done with sparking plugs) by licking a

finger and placing it where the volts should be. But taking them by and large the votaries of electricity do not become nearly as pachydermatous as they would if Nature played the game as well by them as she does by those in other walks of life. But to return to my shock.

Save Us from Our Friends

For some days I had been engaged with one whom I then regarded as a trusted friend in an interesting series of experiments. In these a metal chassis was involved and I had taken particular care to see that this was effectively earthed. The apparatus was connected to the mains by means of a three-pin plug and a switch-controlled socket, and I had taken equally good care to see that the switch broke the "line" and not the "neutral." Having to go away for a day or two, I left the conduct of experiments trustfully in the hands of the alleged friend. On my return I found a note from him saying that he had had to go away on the day after I left. He had, though, had time to make some interesting tests and left an account of these. I was just reading what he had written when another friend came in and at once cast inquiring eyes on the chassis. Of course, I began at once to show him what it was all about. Having explained its top side, I switched off, turned it over and, holding it firmly with my right hand, began to introduce him to what was beneath it. "That," I said, touching a metal tag with my left forefinger, "that is the . . ." It was at that moment that I leapt and spake winged words. The best part of two hours passed before I ceased to be all of a twitter, for it was one of those thorough and shattering shocks that leave you in no two minds as to whether or not you have bought it. Next day friend No. 1 returned and I asked if he'd done anything not mentioned in his notes. "Only one thing that I can think of," he said. "I didn't like the look of that lead-covered lead to the switch-socket. It went over the skirting board, if you remember. To tidy it up I took it behind the skirting and rewired the socket. I was specially careful over the earth connection." I could testify personally, I answered him, to the efficacy of the earth connection and after a brief discussion he agreed that you **must** always make sure that switches are inserted in the "live" lead.

BLOWERS for Electronic Equipment

Manufacturers of Electronic Equipment are invited to let us know their requirements.

We shall be very happy to discuss with you any Air Treatment problems in connection with your products, equipment or premises.

**COMPACT · ECONOMICAL
EASY TO INSTALL**

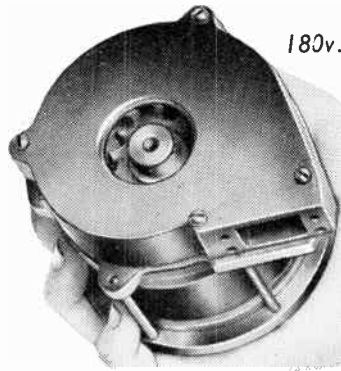

180v. 500c. Blower

**AIR CONTROL INSTALLATIONS LTD.
RUISLIP · MIDDLESEX**

Phone : RUISLIP 4066 (10 lines)

Grams : "Controlair " Ruislip



CAPACITORS that are "Custom-Built"

1069



**CONDENSER
COMPANY LTD**
BIDEFORD AVENUE
PERIVALE · GREENFORD
MIDDLESEX.

Telephone: PERIVALE 4277

Every type in the wide range of Wego Capacitors is a "design product," built with a purpose for the purpose, thus providing you with capacitors that can virtually be described as "custom built". We will gladly send you details of the standard Wego range or cooperate closely in the design and manufacture of units to your own requirements.

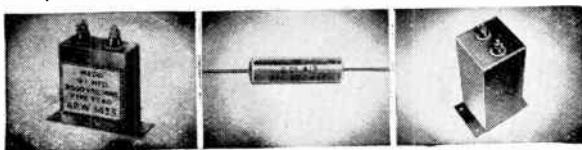

WHY YOU PREFER ACOUSTICAL—One of a series

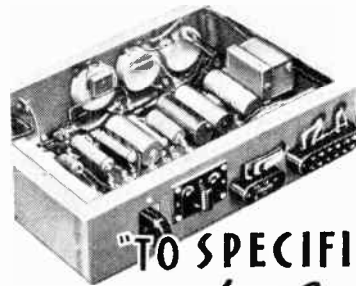

"TO SPECIFICATION"
- with a Capital "S"

All wiring and assembly in the M31 Amplifier, built by Acoustical, conforms to the Ministry of Aircraft Production Specification DGD.WT.1000. Just one more reason why you prefer Acoustical.

"Addressing the Public"—a booklet of useful information and diagrams for all those engaged on Public Address work. 1/- post free.



Remember-Walter

STAMPINGS • CHASSIS • PRESSINGS

RADIO RADIO RADIO

FARM LANE, FULHAM, S.W.6. TELEPHONE: FULHAM 5234

C.R.C.

FAN DISC LOCK WASHER
VIBRATION PROOF

Overlapping teeth cannot be flattened. Teeth grip and cannot shake loose. In steel or phosphor bronze. Sizes from 10 B.A. For all types of bolts and screws.

SEND FOR SAMPLES, PRICES & LITERATURE



FAN DISC LTD

NORTHWOOD ST., ST PAUL'S, BIRMINGHAM 3



Sinclair
SPEAKERS
LONDON N.1.

SOUND SALES

TRANSFORMERS—QUALITY RADIO & AMPLIFIERS
 WEST ST., FARNHAM, SURREY.

PREPARING TO GIVE YOU THE BENEFIT OF EXTRA INVALUABLE EXPERIENCE GAINED ON WAR SERVICE

ESTABLISHED 1930.



POCKET PRECISION

MODERN ROBUST CONSTRUCTION AND CONSTANT ACCURACY UNDER ALL CONDITIONS

SIFAM
 ELECTRICAL INSTRUMENT COMPANY LIMITED
 TORQUAY DEVON

M70 POCKET VOLTMETER

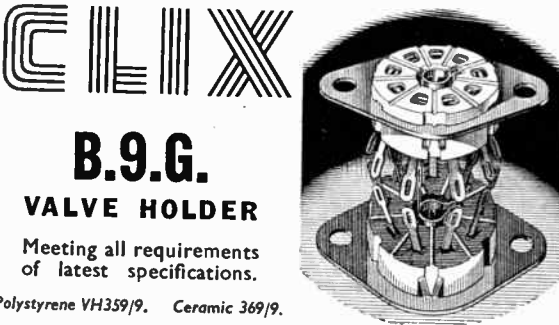

CLIX

B.9.G.
VALVE HOLDER

Meeting all requirements of latest specifications.

Polystyrene VH359/9. Ceramic 369/9.

BRITISH MECHANICAL PRODUCTIONS LTD.
 1, Church Road, Leatherhead, Surrey. Tel.: 3062.

Varley
TRANSFORMERS AND CHOKES
for Reliability

OLIVER PELL CONTROL LTD
 CAMBRIDGE ROW WOODWICH S.E.18
 TELEPHONE: WOODWICH 1422

I am the c.g.s. unit of energy—you'll find me in every radio circuit.



ERG

ERG is the trade mark that will identify our products of quality—small parts for big jobs.



ERG RESISTORS LTD.
 1021a, FINCHLEY ROAD, LONDON, N.W.11.
 PHONE: SPEEDWELL 6967

Rate 6/- for 2 lines or less and 3/- for every additional line or part thereof, average lines 5-8 words. Box Numbers 2 words, plus 1/- Press Day: January, 1946 in use, first post, Thursday, December 6th. No responsibility accepted for errors.

NEW RECEIVERS AND AMPLIFIERS
H.P. RADIO SERVICES, Ltd., offer:—

NEW Philips Voxmobile amplifier. 12v or 230v ac, 15 watts, crystal mike, 2-horn, L.S.; £25/10, super job; 1946 Ferguson 6v all-wave superhets, £25/15/4; 5w amplifiers with valves, neat chassis construction, £26/10.
ROGERSON ac eliminators and trickle charger, £4/15; home chargers, 12v 3amps, 90/-; ac eliminators (no charger), £4/10.
ROTHERMEL crystal pick-ups, £3/18/9; line cord, 3-core, 0.3amp, 2/- yard (180ohms); Varley 2v 40amp accumulators (charged), 16/9, posted safely.
LOUDSPEAKERS Rola 8in 19/6, 5in 18/6, 10in 45/-; Celestion 8in, with trans, 25/-; ditto, energised, 2,000ohms, 36/-; Vitavox 12in p.m., 10w, £7.
TRANSFORMERS, universal output, 6/6; microphone, 70/1, 8/6; mains standard type, shrouded (state), £25/-.
ELECTROLYTICS.—B.I. 8mld 500v, 3/1; 8 plus 8, 4/11; T.M.C. 25mld 25v, 2/6; block condensers, 500v, 2mld 1/6, 4mld 3/-.
COILS (circuits included).—M.W. Midget T.R.F., 5/- pair; all-wave, 9/- pair; aerial and oscillator for superhet, 12/6 pair; 455kc i.f. trans, aluminium cased, with trimmers, 12/6 pair; 0.0005 twin gang with trimmers, 12/6 pair; VOLUME controls, all sizes, less switch, 3/6, with switch 4/6; beautifully made household electric irons, 25/-, complete; all new goods; prompt dispatch. Satisfaction guaranteed; postage extra under £4.
H.P. RADIO SERVICES, Ltd., 55, County Rd., Liverpool, 4, Estab. 1935. Aintree 1445.
COMMUNICATION receivers.—“Dale” C will have them as soon as trading conditions allow.—Remember—Dale Electronics, Ltd., 105, Bolsover St., W.I. Mus. 1023.
T.R.F. ac/dc medium and long wave kit of parts, with drilled chassis, size 9½x4½ x1½, and all components, condensers, etc., and circuit, nothing, 25/-, complete; £4; valves, £2/10; 5in speaker, trans, 27/6.
HENRY'S, 5, Harrow Rd., Edgware Rd., W.2.
DEGALLIER'S, Ltd.—Register your name and for full details of American receivers which will be sent to you when import conditions permit.—Degallier's, Ltd., 9, Westbourne Court, London, W.2. Pad. 5130. [4401]
QUALITY.—We offer you a receiver combining all the features of local reception quality and the communications receiver sensitivity; something new, it will be worth while investigating.—Details from the Moreton Cheyney Company, BCM/REME, London, W.C.1.
ANLEY RADIO offer set of components for making M.W. semi-midget ac/dc t.r.f. receiver, including cabinet, valves, drilled chassis, 6½in speaker, screws, etc.; nothing more to buy; complete with circuit, £8.—Anley Radio, 36, Hindmans Rd., E. Dulwich, S.E.22.
BRIERLEY quality amplifiers, 200-250v ac, 5 watt, 8½gns., 12 watt £14; P.A. and S.O.F. types available; high fidelity microphone transformers, in mumetal screening box; s.a.e. for illustrated catalogue and copy of “Design for Quality.”—J. H. Brierley, Ltd., 46, Titchburn St., Liverpool, 2. [4422]
AMPLIFIERS.—Complete equipment for P.A. industrial, dance and stage installations and portable apparatus from 15 to 150w; early deliveries; illustrations and spec. on request.—Broadcast and Acoustic Equipment Co., Ltd., Broadcast House, Tombland, Norwich 26970.
BAKER'S.—New 7-valve “Wireless World” Quality amplifier with tone control stage, 8 watts push-pull triode output, price includes super Quality triple cone, 12in permanent magnet speaker, with large output transformer and all valves; also as above but with 15 watts tetrode output, ideal for realistic reproduction for public address; 2½d. stamp for particulars, prices, etc.—Bakers Selhurst Radio, Tel. Croydon 4226. [3580]
RECEIVERS, AMPLIFIERS—SECOND-HAND
H.R.O., 6 coils, power, 2 speakers, £50.—58, Daryngton Dr., Greenford, Middx. [4418]
H.R.O., table model, 9 coils, set, spare valves, perfect; cost £434; best offer over £60.—Box 4352. [4363]
HALLICRAFTER Sky Champion, only 2 months' use, stored since 1939, as new; £18.—Box 4023. [4297]
SOUND sales, DX quality feeder v-selecty non-d. A.V.C. 10½gns.—Roberts, 113, Kingsfield Av., N. Harrow. [4391]
I.G.E.C. and 1 Ekco dc receiver, perfect order; £6 each.—Marsh, Marlon House, Mark Lane, E.C. Royal 6162. [4282]
SMALL portable amplifier, gram mike inputs 12 vdc, but 12v rotary transformer; also Vitavox M.C. mike; offers.—Davies, 11, Porch Way, Whetstone, N.20. [4350]

THE PARTRIDGE ORGANISATION is at your service.

For the past 15 years we have devoted our energies exclusively to the manufacture of Transformers and Chokes. Although widely known for the production of mains frequency chokes and transformers (ranging in size from the very small to just over one kilowatt) we specialise in the field of **AUDIO FREQUENCY**. Our knowledge of this is such that we have no hesitation in offering to solve the more difficult design problems, including that of the Optimum application of negative Feedback. Our Technical Department will be pleased to give advice and constructive criticism.

We can help you! May we?

Telephax:  Abbey 2244

PARTRIDGE TRANSFORMERS LTD
76-8, PETTY FRANCE, LONDON, S.W.1

CABINET WORK

We are now in a position to manufacture Cabinets, Instrument Cases and any type of precision woodwork for the Radio Trade, but only against B.O.T. licences, etc., and Government Contract references. We regret that at the moment we are unable to manufacture for private requirements.

To facilitate our planning for the future it will help if all would-be customers will advise us of their requirements so that we can place their names on our files until such time as we are able to prepare literature and manufacture Radio Cabinets and Furniture.

All correspondence will be acknowledged



& COMPANY

67, Lowlands Road, Harrow, Mdx.

Phone: BYRon 3704

QUALITY amp & spkr., PX4s push-pull, bass & treble boost, dble. smoothng., £16.—Pnl. 4960. [4292]
HARTLEY-TURNER radio with duode He lux speaker, 12-watt output; offers.—No. 1, Raffin Lane, Pewsey, Marlborough; [4393]
VOIGT speaker (corner cabinet), complete, radiogram & amplifier; offers; perfect.—Giles, Down Place, Windsor Rd., Windsor.
SERVICE signal generator G.M. 2880F, by S. Mullard, 1st class cond.—Best offers to Higginbotham and Sons, Idle, Bradford, Yks.
GUTHMAN 7-valve con. rad., 6 whils., 2 spare valves, gd. cond., £25.—Simmons, 28a, Pembroke Hall, N.W.4. Hendon 1274.
HALLICRAFTER Sky Champion communication receiver; £35 or nearest offer; any evening.—460, Whitton Ave. West, Sudbury Hill, Greenford, Middx. [4374]
HALLICRAFTER S.27, 27 to 140m/cs, anode and frequency modulation; £60 or offer.—After 7 p.m., 43RR, 48, Glasford St., Tooting, London, S.W.17. [4385]
A short-wave receiver, 2 r.f.s., 9-60m, modern components, metal case, separate power supply and speaker, all O.K.; nearest £17.—Elliott, Tel. Ruislip 2311. [4416]
HALLICRAFTER Sky Champion, 1940 model, perfect condition; all mains set for every voltage; special DC vibrator attachment; £50 or near offer.—Box 4353. [4352]
MAGNIFICENT H.M.V. 11v, 5 waveband autoradiogram, special model, superb appearance, performance, condition; photo available; £130, carriage paid.—Box 4317.
A MATEUR'S semi-comm. r.c.vr. chassis, 14-valve, 5-wave, P.P. 6L6s, Q.A., sep. power pack, M.E. speaker, ideal radiogram; offers over £50.—Details, Shepherd, 91, Kensington Rd., Southend-on-Sea. [4405]
SUPERB Philips, 8v, all wave, magic eye, superhet receiver, television sound, contrast expansion, parallel, output valves, magnificent tone, appearance, performance; £35, nearest offer.—Box 4316. [4343]
10 V ac/dc class B amplifier, 7 valves & matched spkr., £12; Simpson's recording turntable, £10; 2 microammeters, 0-200, one centre zero, 30/- ea.—Burnett, 9, Oak Gdns., Shirley, Croydon. [4450]
12 VOLT 7-valve Philco car radios (6), with controls, but less aerials, each one tested before dispatch, £12/10 ea.; rotary transformers, input 12 volts, output 400 volts, 225 ma., £3/10 each.—Pearson, 263, Gallowgate, Glasgow, S.E. [4358]
TELEVISION receiver, 15in C.R.T., power pack and 5ft rack, lab. constn., £30; 8in C.R.T. Cossor 3221, £5; Oscillograph, Philips GM.3152, 3in, £15; oscillograph, 4½in C.R.T., lab. constn., with power pack, £30; communication receiver, amateur constructed, excl. job, 10 watts, new, £22/10.—Box 4420. [4387]
HARTLEY TURNER 7v RX. tuner, AC I.S.S., O.P.T., I.V.T., part built, full manual, £12; can supply balance new parts. Radiopak superhet tuner and amplifier, PX4s, 7v, tuner chassis needs service, £10. RX, power pack, coil box, 4v, Eddy's parts, o.k., £5. Halcyon S.W. adaptor, 354v valve, in case, 30/- Eye All above AC. Philips 4v+R, faulty, 50/- All with valves. 830B 5v tri batt. set, 50/- All with valves. Many L.S. all types new and used, meters, old sets cheap. 1 Sullivan 0.01mld 5v r.f. 7,600 Hz, 10/- Details.—J. Worden, Lightfoot Lane, Broughton, Preston, Lancs. [4288]
GENUINE offer.—Advertiser used apparatus for official war purposes, perfect condition. Eddystone “358” comm., RX 31,000 to 2,100 kc/s., £40; Eddystone “358” crystal set, 31,000 to 90 kc/s., a.d. pack, £65. Taylor model 30 oscilloscope, £17/10. Sullivan het., 5 and 10 metres, £9. Rotary converter DC/AC 230/230, 250 watts, enclosed in filter silencer cabinet, £14. Taylor 425 0/1 mA 60/-, Taylor 30 0/50 mA 35/-, Weston 0/20v DC 40/-, c.r. tubes 4081 35/-, AC81A 35/-, DC Avolimator for “358” 60/-, Universal Avolimator £6/10, Browns “A” phones 120 ohms 35/-, 2 prs. 4,000 ohms 37/6 ea.; quantity valves, high grade components, amplifier to value over £30, entire equipment cost over £300, will accept first offer £165, or sell separately.—Box 4301.
COMPONENTS—SECOND-HAND—SURPLUS
LOOK out for valves and circuit analyser; details later.—London Sound Labs, Ltd., 40, South Molton Lane, Bond St., London, W.1.
ELECTROLYTICS, 8mld 500v, 3/6; 8mfd 350v, 2/3; 50mfd 12v, 25mfd 25v, 1/11.—D. White, 17, Upland Rd., London, S.E.22.
PHILIPS carbon mikes, with transformers, 67/6; Mullard cathode ray tubes, 3in, 63/-, 3½in 126/-, 6in 147/-; Vitavox 12/10 units, £7; Vitavox 12/20 units, £11; stocks of Philips 3-wave coils exhausted; large quantity of soiled an. used P.A. gear for disposal; stamp for list.—Gregory, Union St., Cheddar.

NOW READY!!

Our New Loose Leaf Catalogue, fresh from print. Twenty pages of illustrations, descriptions and technical data, with prices of all products.

P.A. Amplifiers, Equipment, Speakers, Microphones, Power Packs, Transformers, etc.

All our previous literature is obsolete—prices are reduced, new lines added. Write, enclosing 6d. in stamps for your copy NOW.

This new catalogue, with durable cover and metal clips, can be enlarged as fresh pages are printed.

DEALERS: Please apply on Business Headings.

EXPORT. We have special facilities for OVERSEAS TRADE, owing to enormous amount of export of amplifier equipment, etc., we have arranged for individual attention for Overseas Enquiries. **PROMPT DESPATCH IN SPECIAL PACKINGS, BY THE QUICKEST ROUTE.**

Cable your enquiries please.

STILL BREAKING ALL SALES RECORDS. THE A20 AMPLIFIER
22 watts, in case, all complete to assemble.
£14.0.0 (List Price).

RADIO INSTRUMENT CO.



Radio Products
294, BROADWAY
BEXLEYHEATH, KENT

COMPONENTS

You may think it impossible, but you can actually get all your requirements from one source, saving endless chasing around and disappointment, to say nothing of time and cash. We carry unquestionably the most complete and comprehensive stocks in the whole of the Industry, and if you want first-class components and material (not salvage, etc.) and very keen prices, you should lose no time in contacting us. No catalogues, unfortunately, but if you send us your list of wants, worded clearly and simply, and enclose S.A.E., your enquiry will be dealt with the same day. Please print your name and address. Better still, come and see us!

WIRELESS SUPPLIES UNLIMITED

264-266 Old Christchurch Road, Lansdowne, Bournemouth, Hants.

Improved Germinal CLIPS



Well made of steel, double ridged for strength. Teeth on three sides of lower jaw and special design of upper jaw ensure firm grip and good contact.



CHURCH ROAD · HENDON · LONDON · N.W.4

VALUE! Matt has it!

LINE CORD.—2-way 2/6 per yd., 3-way 3/- per yd. (approx. 60 ohms per foot).
SPEAKERS.—"Celebration" P.M. 2 1/2 in., less trans., 27/-; 8 in. P.M., with trans., 27/6; 6 in. P.M. (multi-radio trans.), 28/6.
TWO-GANG condensers—0.0005, 12/6; Midget coils, 1/1 and aerial, 4/6 per pair.
VALVE HOLDERS (all types), Volume controls, less switch, 2/9; with switch, 3/9.
MAINS transformers, 4v and 6v, 27/6.
ROTHERMEL (crystal) pick-ups, metal, 8s, £3/13/6; Senior de Luxe, £3/18/9.
LET us quote you for all your requirements. Cash with order, plus postage.
MATT RADIO SERVICE, 152, Richmond Rd., Kingston-on-Thames, Surrey. [4159]
SOUTHERN RADIO'S wireless bargains:—

LATEST radio publications:
"RADIO Valve Manual," equivalent and alternative American and British types with all data, 3/6; "Radio Circuits," fully illustrated receivers, power packs, etc., 2/-; "Amplifiers," fully descriptive circuits, 2/-; "Radio Coil and Transformer Manual," 2/-; "Short Wave Handbook," 2/-; "Manual of Direct Disc Home Recording," 2/-; "Test Gear Construction Manual," 1/6; "Radio Pocket Book," formulas, tables, colour-code, etc., 1/-; "10-How for Radio Constructor," 1/-; Just published, "Radio Reference Handbook," comprehensive and up-to-date, covering all branches of radio, 10/6.

PAPER condensers Post Office type, upright, 2mfd, high working (used but guaranteed perfect), 2/6 each. Brand new 2mfd mains-bridge, 3/6, 1mfd 3/-, 1-1-1, 2/6; 4 C.C. electrolytic reversible 4-4mfd 70v, 3/6, multi-con mica condensers, 28 capacities in one, 4/-.
ACE "P.O." microphones, complete with transformer, usable with any receiver, 7/6. Permanent crystal detectors, 2/6. Crystals 6l., with cat whisker, 1/-; Insulated push back wire, 25 yards, 5/-. Insulated sleeving, assorted sizes and colours, 3/6 per dozen yard lengths. Single screened wire, 10/- per doz. yards. Twin screened wire, 17/- per dozen yards. Power rheostats, cutler harmer, 30 ohms and 10 ohms, 4/6 each. Press button switches, 3-way 4/-, 8-way 6/- (all complete with knobs). Escutcheons for 8-way switches, 1/6. Vaxley type rotary switches, 11-way single bank, 6/6. Hundreds more bargain lines.

SOUTHERN RADIO SUPPLY CO., 46, Lisle St., London, W.C. Gerrard 6653. [4234]

CHARLES BRITAIN RADIO invite you to their new premises. This month's offers include:—

PHILCO mains energised speakers, 2,000 fields with new cones, 7in, with pentode trans, 21/- ea. Two-gang condensers with trims, 7/6 ea. Bakelite dielectric condensers 0.0005 or 0.0003, 3/- ea. Moving coil mikes, 6/-.
ELECTROLYTIC condensers, 4mfd Micropar-200v wkg, 2/6 ea. 6mfd small cans, 175v wkg, reversible, 4/6 ea., 8mfd tubular 450v 4/- ea., block 4/3 ea., 25mfd 25v 2/6 ea., 12mfd 50v 2/- ea., 50mfd 12v 2/- ea.
COILS, All-wave aerial and oscillator coils, 465K/c with circuit, 14/- per set. Midget A and H.F. m.w. Litz wound 5/- pr; P. type coils, A and H.F., 2/- ea. I.F. transformers (465 k/c) Litz wound in all cans with trims, 12/- pair. Tuning condensers, 2 gang midget 12/6 ea., 3-gang 10/- ea. Volume controls, with switch, 1/2, 1 and 2 meg Morganite and Centralab, 5/6 ea. All values less switch Dubilier, 3/- ea. Knobs: best quality with brass inserts, 1 1/2 in dia 8/- doz, 1 1/4 in 7/- doz; black pointer knobs 8/- doz. Solid brass spindle extenders 1/4 bore, 6/- doz. Dials: Marconi glass vertical type only, 2/- ea; paper dials for midgets L and M.W., 8/- doz. SPECIAL offers, Epicyclic slow motion condenser drives, ex Ekco, 1/6 ea. Morganite volume controls, 50,000-ohm, short-spindle, less switch, 1/3 ea. Socket strips, engraved A.F. or P.U., 4/6 doz. Resistance stripped from Ekco, 3/6 doz. Tubular conds (dito), incl. bias types, 4/6 doz. Micas, 3/- doz. Band-pass aerial coils ex Ekco with diagram, 2/6 ea. I.F. trans 110 k/c in cans with trims, 3/6 pair. Three-gang condensers, tracked for 110 k/c, 3/6 ea. Small moving coil mikes (damaged), 1/6 ea. Send for new list "W." Terms: cash or c.o.d. over £1. Note new address: Charles Britain Radio, Radio House, 2, Wilson St., London, E.C.2. Tel. Bis. 5985, ext. 7.
ENAMELLED copper wire, 10 tons, slight salvage, for sale to bulk purchasers—Apply H. Leston, Ltd. (Government contractors), 5, Charles Lane, London, N.W.8, [4175]
2 VOIGT twin units, each £16/10; 2 Voigt 2ft horns, each £10; 2 Voigt 2ft horns, each £4/17; 2 Voigt corner horns, each £4/8; 3 40w field rectifiers, each £4/3.—Tower House, Wartersville Rd., Hornsey, London, N.19. Phone: Arc. 1016. [4286]

THE Lexington MOVING COIL PICK-UP Scientifically Engineered



And now to lead the new Post War era, this revolutionary type Moving Coil Pick-up gives full reproduction of the total audio frequency range. Technical difficulties in the past have been overcome. Note these features:

- Robust design. Accidental dropping on record will not damage Pick-up.
- Extreme low moment of inertia (80 milligrams total weight of movement).
- Pure sine wave with no harmonic distortion.
- Response curve flat from 30 c/s to 12 Kc/s
- Needle or sapphire can be changed by any amateur.
- Can be used with normal record changer without fear of damage.



Send stamp for illustrated pamphlet giving full technical details and price. Demonstrations at—

COOPER MANUFACTURING CO.,
134, Wardour Street, London, W.1
Gerrard 7950

THE AURI-PHONE

A miniature Ear-Phone with a high-fidelity reproduction of Speech and Music equal to best headphones known. 1 1/16 inch diam.; holds in ear without headband or wire loop. Two interchangeable nipples, large and small; two models, 10 ohms and 1000 ohms. Operate from prim. or sec. terminals of Speaker transformer, ideal for pocket radio. Valve or Crystal set. 5ft. flex cord. Price, black or flesh-colour enamel, 39/- each. NOTE: We do not make Deaf Aids.



CEFA INSTRUMENTS, 38a, York Street, TWICKENHAM, Middx.
POPesgrave 6597.

ENGINEERING OPPORTUNITIES



This unique handbook shows the easy way to secure A.M.I.Mech.E., A.M.Brit.I.R.E., A.M.I.E.E., City and Guilds, etc.

WE GUARANTEE— "NO PASS—NO FEE."

Details are given of over 150 Diploma Courses in all branches of Civil, Mech., Elec., Motor, Aero., Radio, Television and Production Engineering, Tracing, Building, Govt. Employment, R.A.F. Maths., Matriculation, etc.

Think of the future and send for your copy at once—FREE. B.I.E.T., 387, SHAKESPEARE HOUSE, 17, STRATFORD PLACE, LONDON, W.1.

AMATEUR WIRELESS SUPPLIES offer the following equipment: 250V 80MA, 5V 3A, 6.3V 3A, 25/7, 350V, 150 MA, 6.3V 4A, 5V 3A, 35/5; 500V 200MA, 6.3V 4A, 5V 3A, 60/1; 1,000V 250MA, 75/1; 6.3V 5A, 19 6; 5V 3A, 15 6; or to order. Chokes: 20H 80MA, 16H/20H 1,000MA, 20H/10H 200MA, 24/6; 10H 250MA, 27/6; swinging choke, 5/1511 250MA, 33/6; valves, rectifiers, 6L6, 6V6, etc. W W Quality output transformer (multi-trap), 35/-; 0.0005 2-gang, 12/-; 3-gang, 14/6; electrolytics, 450V, 8mfd., 3/9; 16mfd., 4/-; switches, 4-pole, 5-way, complete with selector, unselected points shorted, 6/6; send s.a. envelope for list.—16, Crystal Palace Parade, London, S.E.19. [4431]

SUPREME RADIO, 746b, Romford Rd., Manor Park, London E.12. Est. 15 years. Tel. H. 1260.

MIDGET 2-gang cond. trimmers, split valves, fixing bkts., 11/6; Midget coils, A.H.F.T.R.F., high gain circuit, 8/-; M.I., with circuit, 10/6; M.I., s.w.m. 2/3; all-wave dials, 3/6; 2in x 4, 1/9; speakers, 3/6, with trans., 29/-; less trans., 24/-; 6in 26/6, less trans., 21/6; 8in 25/6, less trans., 20/-; Celestion or Magnavox 10in R.A. with trans., 32 6, less trans., 27 6; R.A.M.C.F., 8in, 2,000Ω pot., 31 6; mains transformers, Marconi, 4v, 350+350, 31/6; other makes, 21/6. Midget chokes, 60mils., 6/-; heavy duty, 100mils., 10/-; P.P. trans., 6/6; droppers, 0.2a., 1,000Ω, 2 sliders, fixing feet, 3/9; 0.03, 800Ω, 5/-; Pvc replacement, 3 3; 0.2, 1,000Ω, 2 sliders, less feet, 3 3; V/ies with sw. 4/-, less sw 3/9; all sizes wire wound, 2,000Ω to 10,000Ω. 1lb reel, 2/-; sw. cleaner, 2/6; 200 240,000Ω, 2.4in, pkt., 7/6; bias cond., 50-50 3/6, 25 25 2/9; all sizes resistances, 1-watt type 8/- doz; 3-way line cord, 60Ω ft., 2/-; yd; tinned R.C. wire, 2/- doz yds; spindle couplings, 4 6 doz; pilot holders, 3/- doz; knobs, 1/6 spindle, 7/- doz; screen wire, single, 10d. yd., double 1/6; valve-holders, all types, 9/- doz; midget valve caps, actual at 1 a., 30/-; for 2 6 or 12 v. batt., at 1 a., 49/6; for 6 v. or 12 v. batt. at 4 a., 24.

MAJNS TRANSFORMERS, 300+300 v., 60 mA, three 4 v. 2.3 a. windings, 25/-; 350 + 350 100 mA, 5 v. 2.3 a., 6.3 v. 2.3 a., 29/-; 350 + 350 100 mA, three 4 v. 2.3 a. windings, 29/-, 350 + 350 150 mA, 4v. 2.2 a., 4 v. 2.3 a., 4 v. 1.2 a., windings 39/-; 350+350 150 mA, 5 v. 2 a., 6.3 v. 2 a., 6.3 v. 2 a., 36/-; 600+600 250 mA, 5 v. 3 a., 6.3 v. 2 a., 6.3 v. 4 a., 65/-; 425 + 425 200 mA, 4 v. 2.3 a., 4 v. 2.3 a., 4 v. 2.3 a., 47/-; 350 + 350 150 mA, 4 v. 1.2 a., 4 v. 2.3 a., 4 v. 2.3 a., 36/-; 500 + 500 150 mA, four 4 v. 2.3 a. LT windings, 47/-.

1-VALVE BATTERY 5W RECEIVER, with 2-volt valve, 4 coils, 12-170 m. bandspread tuning, 55/-, including tax.

CHASSIS, 10 x 8 x 2 1/2 in., 7/-; 16 x 8 in., 8/6; 20 x 8 in., 10/6; 12 x 8 x 2 1/2 in., 7/6.

SHORT-WAVE COILS, 10 ft. octal sockets. 4-pin aerial coils, 9-15, 12-26, 22-47, 41-94, or 76-170 m., 2/6 each; 150-350 or 255-550 m., 3/-; 490-1,000 or 1,000-2,000 m., 4/-; 6-pin H.F. Trans., 9-15, 12-26, 22-47, 41-94 or 76-170 m. 2/6. S.W. chokes, 10-100 m., 1/3; 5-200 m., 2/6.

SHORT-WAVE CONDENSERS, evenly ganged, 15 mfd., 2 1/2, 25 mfd., 3/3, 40 mfd., 3/3, 100 mfd., 3 1/2, 160 mfd., 4/8, 260 mfd., 5/8; shaft couplers, 6d.; flexible ditto, 1/-; Dual bandspread for use with 2-gang, 6/6.

MIDGET "P" TYPE COILS, 12-35, 16-47, 34-100, 91-261, 250-750, 700-2,000, 200-550, available as H.F. trans., aerial or osc. coil, 2/3 each. Vaxley type wave-change switches, every type available; locators, 2/6 each; wafers, 1/6 each. Small 2-gang condensers: 0.0005, 12/-; Matched pairs in-ordered 465 K.C. I.F. trans., 15/- pair; midget I.F. trans. size 1 1/2 in. x 1 1/2 in., 40s K/s, adjustable iron cores, 10/6 each; 90 mfd. trimmers, 1/-; osc. padder, 600 mfd., 1/9; B.F.O. coil, 2/3.

SMOOTHING CONDENSERS, 50 mf., 12 v., 2/3; 25 mf., 25 v., 2/3; 50 mf., 50 v., 3/-; 8 mf., 500 v., 3/-; 16 mf., 150 v., 3/-; 16 mf., 350 v., 3/3; 16 x 16 mf., 350 v., 5/6; 12 mf., 500 v., 4/6; 24 mf., 500 v., 6/6.

AMERICAN VALVES, 2525, 2526, 6V6, 6F6, 574, 80, 6L7, 6K7, 1N5, 1C5 IHS, IT5. Many others available.

SUPER GIANT PUSH-PULL INTER-VALVE TRANSFORMERS, 21/-; Midget type, 12/6.

MOVING COIL SPEAKERS, 8ola 8in, 21/6; 6in, 22/6; 8in, 24/-; Goodmans 3in., 30/-.

Above are less output trans. Pleassey 8-in. P.M. with trans., 29/6. 8in. 2,000 ohm enrgised speakers 35/-; Midget standard or P.P. trans. for any above, 10/6. Super quality giant Maktmaker output transformers, match any tube single or P.P. to any voice coil, 7-watt, 22/6; 15-watt, 30/-; 30-watt, 49/6; 60-watt, 59 6.

CHOKES 8H, 300 ohms, 40 mA., 4/6; 30H, 400 ohms, 60 mA., 9/6; 30H, 100 mA., 400 ohms, 15/-; 30H, 185 ohms, 150 mA., 25/-; 26H, 350 mA., 120 ohms, 39/6.

SUNDRIES, 5mm, 39/6.

Reinforced solder 6d. per coil or 4/6 per lb.; screened 2-pin plugs and socket, 9d.; ditto 8-pin, 2/-.

Octal sockets, 6d.; ditto, amphecol type, 1/-.

Valve screens 1/2, 6-volt vibrators, 4-pin, 12 6, 50ft. Indoor Aerial, 2 6.

Volume Controls, any value, 3/9; with switch, 6/7.

PREMIER RADIO

(MORRIS AND CO. (RADIO) LTD.)
ALL POST ORDERS TO:
JUBILEE WORKS, 187, LOWER CLAPTON ROAD, LONDON, E.5. (Amberst 4723.)
CALLERS TO:
169, FLEET STREET, E.C.4. (Central 2833.)

1945 LIST NOW AVAILABLE. HUNDREDS OF NEW LINES.

All enquiries must be accompanied by a 2d. stamp.

SUPERET TUNING KIT, comprising 9 midget coil, H.F. Aerial and Osc. covering 16-47, 200-557 and 700-2,000 m., suitable switch, all padders and trimmers, 38/10. Worth double. Also available a suitable 3-gang condenser with complete S.M. drive and dial, 30/-.

MIDGET MOVING COIL UNITS, 1 1/2 in. diam highly sensitive, may be used as mike or speaker (complete with trans (state whether L.S. or Mike trans. required), 22/6.

10-WAY PUSH BUTTON SWITCHES, complete with knobs and escutcheon plate, six iron cored coils. Trimmers and Padders. No circuit or other particulars available. To clear at 12/6. Original cost 45/-.

FIRST GRADE METERS, 3 1/2 in. diameter, 1 milliamper, £2 12s.; 500 microamps £2 18s. 6d. 4 1/2 in. 1 milliamper, £3 5s.; 500 microamps, £3 11s. 6d. Westinghouse Meter Rectifier for either type, 10/-.

Multiple switch, 10, 100, 500 mA/40-. Any value multiplier, 2/6 each.

12-WATT A.C. AMPLIFIERS, 3 stages. High and low gain inputs. Mike pick-up mixing feedback, provision for 2, 3, 4, 8 and 15 ohm output, 21/4 1/6.

SUPER QUALITY AC/DC 15 W. AMPLIFIER, 3-stage, high gain, push-pull, in steel cabinet, £15 15s.

AC/DC AMPLIFIERS, 5 watts output high gain three-stage, feedback, £8 8s.

BATTERY CHARGERS for 2 v. bat. at 1 a., 25/-; for 2, 4 or 6 v. batt. at 1 a., 45/-; for 6 v. batt. at 1 a., 30/-; for 2, 6 or 12 v. batt. at 1 a., 49/6; for 6 v. or 12 v. batt. at 4 a., 24.

MAINS TRANSFORMERS, 300+300 v., 60 mA, three 4 v. 2.3 a. windings, 25/-; 350 + 350 100 mA, 5 v. 2.3 a., 6.3 v. 2.3 a., 29/-; 350 + 350 100 mA, three 4 v. 2.3 a. windings, 29/-, 350 + 350 150 mA, 4v. 2.2 a., 4 v. 2.3 a., 4 v. 1.2 a., windings 39/-; 350+350 150 mA, 5 v. 2 a., 6.3 v. 2 a., 6.3 v. 2 a., 36/-; 600+600 250 mA, 5 v. 3 a., 6.3 v. 2 a., 6.3 v. 4 a., 65/-; 425 + 425 200 mA, 4 v. 2.3 a., 4 v. 2.3 a., 4 v. 2.3 a., 47/-; 350 + 350 150 mA, 4 v. 1.2 a., 4 v. 2.3 a., 4 v. 2.3 a., 36/-; 500 + 500 150 mA, four 4 v. 2.3 a. LT windings, 47/-.

1-VALVE BATTERY 5W RECEIVER, with 2-volt valve, 4 coils, 12-170 m. bandspread tuning, 55/-, including tax.

CHASSIS, 10 x 8 x 2 1/2 in., 7/-; 16 x 8 in., 8/6; 20 x 8 in., 10/6; 12 x 8 x 2 1/2 in., 7/6.

SHORT-WAVE COILS, 10 ft. octal sockets. 4-pin aerial coils, 9-15, 12-26, 22-47, 41-94, or 76-170 m., 2/6 each; 150-350 or 255-550 m., 3/-; 490-1,000 or 1,000-2,000 m., 4/-; 6-pin H.F. Trans., 9-15, 12-26, 22-47, 41-94 or 76-170 m. 2/6. S.W. chokes, 10-100 m., 1/3; 5-200 m., 2/6.

SHORT-WAVE CONDENSERS, evenly ganged, 15 mfd., 2 1/2, 25 mfd., 3/3, 40 mfd., 3/3, 100 mfd., 3 1/2, 160 mfd., 4/8, 260 mfd., 5/8; shaft couplers, 6d.; flexible ditto, 1/-; Dual bandspread for use with 2-gang, 6/6.

MIDGET "P" TYPE COILS, 12-35, 16-47, 34-100, 91-261, 250-750, 700-2,000, 200-550, available as H.F. trans., aerial or osc. coil, 2/3 each. Vaxley type wave-change switches, every type available; locators, 2/6 each; wafers, 1/6 each. Small 2-gang condensers: 0.0005, 12/-; Matched pairs in-ordered 465 K.C. I.F. trans., 15/- pair; midget I.F. trans. size 1 1/2 in. x 1 1/2 in., 40s K/s, adjustable iron cores, 10/6 each; 90 mfd. trimmers, 1/-; osc. padder, 600 mfd., 1/9; B.F.O. coil, 2/3.

SMOOTHING CONDENSERS, 50 mf., 12 v., 2/3; 25 mf., 25 v., 2/3; 50 mf., 50 v., 3/-; 8 mf., 500 v., 3/-; 16 mf., 150 v., 3/-; 16 mf., 350 v., 3/3; 16 x 16 mf., 350 v., 5/6; 12 mf., 500 v., 4/6; 24 mf., 500 v., 6/6.

AMERICAN VALVES, 2525, 2526, 6V6, 6F6, 574, 80, 6L7, 6K7, 1N5, 1C5 IHS, IT5. Many others available.

SUPER GIANT PUSH-PULL INTER-VALVE TRANSFORMERS, 21/-; Midget type, 12/6.

MOVING COIL SPEAKERS, 8ola 8in, 21/6; 6in, 22/6; 8in, 24/-; Goodmans 3in., 30/-.

Above are less output trans. Pleassey 8-in. P.M. with trans., 29/6. 8in. 2,000 ohm enrgised speakers 35/-; Midget standard or P.P. trans. for any above, 10/6. Super quality giant Maktmaker output transformers, match any tube single or P.P. to any voice coil, 7-watt, 22/6; 15-watt, 30/-; 30-watt, 49/6; 60-watt, 59 6.

CHOKES 8H, 300 ohms, 40 mA., 4/6; 30H, 400 ohms, 60 mA., 9/6; 30H, 100 mA., 400 ohms, 15/-; 30H, 185 ohms, 150 mA., 25/-; 26H, 350 mA., 120 ohms, 39/6.

SUNDRIES, 5mm, 39/6.

Reinforced solder 6d. per coil or 4/6 per lb.; screened 2-pin plugs and socket, 9d.; ditto 8-pin, 2/-.

Octal sockets, 6d.; ditto, amphecol type, 1/-.

Valve screens 1/2, 6-volt vibrators, 4-pin, 12 6, 50ft. Indoor Aerial, 2 6.

Volume Controls, any value, 3/9; with switch, 6/7.

VORTEXION transformers and chokes, etc., supplied to B.B.C., G.P.O. L.P.T.B.; why not yours? wound to any specification; imitated but unequalled.—Vortexion, Ltd., 257 261, The Broadway, Wimbeldon, S.W.19. Tel. Liberty 2814-6128. [4356]

SERVICEMEN.—The following products are well designed and of high quality; volume controls, carbon type, all values, with or less switch, wire-wound resistors, 1 to 60watts; dropper resistors, 0.2 and 0.3 amp; line cord and razor resistors; terms and quotations on req.—Lagor, Ltd., 5, Torrens St., London, E.C.1.

MOVING coil hand microphones, p.m., energised by Alni magnets, 45 ohms, 1 1/2 in. coil, fitted with switch in handle; 12/6 each. MOVING coil headphones, p.m., energised by Alni magnets, 45 ohms, 1 1/2 in. coil, ideal for mikes, miniature loudspeakers, etc., 1 1/2 in. overall ni bakelite cases with 3in front flange, 7/6 each, per pair with headband 16/6; throat microphones, fitted with elastic bands, 'phone plug, etc., 7/6 each.

SYNCHRONOUS motors, Sangamo, 200-250 volts ac, 50c, self-starting, fitted reduction gears, ideal movements for time switches, in industrial, dark room, electric clocks, etc., rotor speed 200 rpm, final speeds available: 1 rev 12 mins, 22/6, 1 rev 30 mins 25/6, 1 rev 60 mins 25/6, consumption 2 1/2 watts, size 2 1/2 x 2 1/2 x 1 1/2 in.; cash with order; registered post and packing 1/- extra.

TERMS: Cash with order.—H. Franks, Scientific Stores, 58, New Oxford St., W.C.1. Tel. Museum 9594. [3961]

TELE-RADIO (1943), Ltd., for new components at list prices. Precision standard condensers, 1% accuracy, 0.0001mf 37/6, 0.001mf 18/6, 0.01mf 21/-, 0.1mf 27 9. 1mf 45/-; wirewound precision resistors. Weston meter, 0-250 micro amps, centre zero, £3 5s.; C.R.T. tubes; Keston mains transformers, chokes and output transformers, instrument wave-change switches, 2-gang condensers with sm drive, 16 9 ca.; Vitavox and Celestion speakers; specialists in short wave work; new list ready shortly; send stamp.—Tele-Radio (1943), Ltd., 177, Edgware Rd., London, W.2. Phone: Pad. 6116. [4086]

INSTRUMENT Wires.—Lewcos enam. copper wires, 14-16-18-20-22-24-26-30-34-38-40-43 swg, 2 9, 3/3, 3/6, 3/9, 4/1, 4/3, 4/3, 5/3, 5/9, 6/-, 7/- per lb.; less than 1lb reels 2d. extra, over 1 to 2lb reel 4d. extra, over 2 to 8lb. reels 2/6 extra. All reels returnable. Also dc enam./scc Lumex, etc., coverings. Many other interesting radio and electronic items. Lists ld., s.a.e. Orders over 30/- post free.—Midland Instrument Co., 18, Hartburne Park Rd., Birmingham, 17. [4337]

BATTERY direct and save, complete kits; Vortexion 4v ac/dc, £6/19/6; L/MW 7 6 extra; Vortexion 3v S.G.; battery, automatic bias, £5/19/6; L/MW 7 6 extra; S.M. dials, escutcheon glass, round, square, 7/-; full vision 8/6; M.T. 350-0-350 90ma, 6v, 4v, shrouded, 23/6; 2-gang Midget S.M. trimmers, 14/6; line cord, 2-way 1/6 yd, 3 way 2/1; spk. cones, all 6/9, 1 1/2 enam. wire, all 2/3; 8mfd. 150v. 2/-; "P" coils, 2/3; 5 amp 2v chargers, 25/-; chassis, 4/6; send for full lists.—Buccleuch Radio Manufacturers, 1 and 2, Melville Terrace, Edinburgh. [4367]

PUSH-PULL, high fidelity output transformers, shrouded, surface mounted, grey finish; O.P.1 P.X.4, 10watt, tapped sec., 3, 8, 15 ohms, 25/-; O.P.2, 6F.6, 10watt, tapped sec., 2.5, 5 ohms, 25/-; O.P.3, 6L.6, 25watt, tapped sec., 3, 8, 15 ohms, 32 6; (O.P.4, P.X.25, 25watt, tapped sec., 3, 8, 15 ohms, 32/6; choke for O.P.1 and 2, 120ma 20H 200 ohms, 25/-; choke for O.P.3, 4, 200ma 20H 100 ohms, 30/-; choke for 6L.6, heavy duty, 1,000 ohms, 150ma, 35/-; any type transformer made to specification; cash with order, postage 1/- each.—Boscombe Radio, 595, Christchurch Rd., Boscombe. [4239]

THE Simplex Four, complete constructional details, Midget ac/dc receiver (full cost of construction £9), theoretical and full circuit layout diagrams, with instructions, per copy, 4/6; midget cabinets, in red or brown, 25/-; Midget in wave t.r.f. coils, high gain, 7/6 pair; the latest, iron core m and l wave, t.r.f. coils, adjustable cores, with circuit, 12 6 pair; ditto a and osc coils, m and l wave, for pocket receivers, i.f. at 465 kcs, with circuit, 17/6 pair; a and osc coils, s.m.l. wave, do i.f., with circuit, 15/- pair; midget i.f. transformers, 465 kcs, 15/- pair; midget speaker trans., 4/6; midget chokes, 6/-; standard chokes, 80ma, 8/-; heavy, 150ma, 12/6; chassis, drilled, 5 valves, 9 1/2 x 4 1/2 x 1 1/2 in., 4/6; 4 valves, 11 v. x 3 1/2 in., 7/6; midget 2-gang 0.0005mf variable condensers, 13/6; midget s.m.l. wave dial, 4 x 3 1/2 in., 2/6; etc., etc., monthly comprehensive lists, 2/4d. stamp with enquiries, postage all orders.—O. Greenlick, 34, Bancroft Rd., Cambridge Heath Rd., London, E.1. Ste. 1334. [4423]

SEXTON'S of

138, Gray's Inn Rd., London, W.C.1
for

SALES, SERVICE & SATISFACTION

Electric Smoothing Irons.
Weight, 5 lbs., for AC/DC Mains, 200/220 or 230/250 Volts. Strong Bakelite handle and thumb button. Fitted with Heavy Connector guard and back rest. Base specially designed for ironing under pleats, seams and buttons. Complete with two yards of best quality three-core flex and earthed connector. Beautifully finished in nickel and coloured pastel shades. **Blue, Red, Green and Gold.** Approved price of 33/4 each, including purchase tax. Post paid.

American Radio Valves.—Types as under at controlled prices. 45Z5GT, 5Y3G, 1A5GT, 1C5GT, 1Q5GT, 1T5GT, 3Q5GT, 80G at 11/- each. 6J5GT, 12J5GT, 1H5GT, 12SF5GT, at 9/2 each. 6Q7GT, 12Q7GT, 12SQ7GT, 75G, at 11/7 each. 12J7GT, 12SK7GT, 6J7GT, 6K7GT, 6K6GT, 6V6G, 25L6GT, 42G, 43G, 50L6GT at 12/10 each. 6A7G, 6A8GT, 6K8GT, at 14/- each. 6C6G, 6D6G, 11/- each. Postage paid.

LOUDSPEAKERS

"Goodman's" 3 1/2 in. with 2 1/2 ohms voice coil, 30/- each. "Rola," 5 in., less transformer, 21/6 each. "Celestion," with transformer, size 8 in., 27/6 each. "Magnavox" with multitratio trans. size 8 in., 30/- each, all the types as given are Permanent Magnet. "Celestion," size 10 in., Mains energised with 2,000 ohms field, less trans. 35/- each. Post paid.

Terms:—CASH WITH ORDER ONLY. We regret that we are unable to send goods C.O.D.
Telephone: TERMINUS 1304 and 4842.

THE BEST BOOKS

WIRELESS TERMS EXPLAINED

By "Decibel." An invaluable guide to the technical terms used in wireless. It explains the meaning of every term in the fullest and clearest manner, with numerous illustrations. Second Edition. 3s. net.

WIRELESS TELEGRAPHY: Notes for Students

Compiled by W. E. Crook, A.M.I.E.E., etc. This book represents the theoretical part of the Wireless Course given in England's Air Training Centre, and sets forth in simple language, with no more than the necessary minimum of formulae and mathematics, all that the candidates need know in order to satisfy the examiners of the adequacy of their knowledge. Third edition. 7s. 6d. net.

ELEMENTARY HANDBOOK FOR WIRELESS OPERATORS

By W. E. Crook. An up-to-date book presenting a general view of radio communication with an introduction to its technique. It gives all the information necessary for a complete understanding of the subject in a clear and easily understandable manner, with profuse diagrams. Second Edition. 4s. net.

D/F HANDBOOK FOR WIRELESS OPERATORS

By W. E. Crook. Gives a very clear explanation of the principles and theory of direction finding apparatus, together with an outline of general D/F practice. Second Edition, 3s. 6d. net.

PITMAN

PITMAN HOUSE, PARKER STREET, KINGSWAY, W.C.2

G. A. RYALL, 65, Nightingale Lane, Clapham, S.W.12.—Mail order only, no c.o.d. under £1 please; postage extra orders under 10/-.

VOLUME controls with switch, long spindle, new, Morganite, 1/2 meg. guaranteed, 4/-; ditto 1/4 meg, less switch, short spindle, 2/3; 1 meg, extra long spindle, 2/6; 10,000 ohm, less switch, 2/6; twin screened microphone cable, Aerialite, 3yds 2/6; Hunts 0.01 mica, 1/- each; aluminium coil cans, robust, 2 1/2 in. high, 2/6 across base, 2 for 1/3; Octal 8-pin plugs, with insulated metal caps, complete with International chassis type bases, 3 for 2/6, or 8/- dozen; with solder tags, 3 for 3/-, or 10/- dozen; miniature 4-pin plugs, robust pins, complete with metal caps and sockets, 3 for 1/6, 4/6 dozen, 29/- 100; condensers, 0.1 tubular, 350v, 7/6 dozen; 450v wkg. pairs mtd. on pax. strip, 8/6 per six pairs; cable, 10-way, with five 5-amp low tension conductors, 4/- yard; push-back stranded connecting wire, 12yd coil 1/6, or 12 coils 12/9.

ERIE 1/2 watt resistances, 330, 450, 10,000, 22,000, 33,000, 220,000, 470,000, 2 meg, insulated type except 33,000, 3/9 per dozen; Erie 2 watt resistances, 680, 6,800, 140,000, 150,000, 220,000, 470,000, 820,000, 2 for 1/-, 5/- per dozen; Morganite resistances, carbon, 500, 1,000, 50,000, 2 meg, 3/6 dozen; Erie 680, 3 watt, 1/3 each; T.C.C. mica condensers, 0.0001x0.0001, bakelite cased, five (ten condensers) for 1/3, or 12/6 per 100; valve holders chassis types, British 5 and 7-pin, American UX, 4, 5, 6-pin and international (Octal, all 4/- dozen or 29/- 100; set 5 Cyldon ceramic trimmers, 30mm, on metal base, 1/6 each, per dozen 12/-.

MANSBRIDGE 4mf high quality baseboard mtg. condensers, with terminals, T.M.C., 4/- each, 3 for 10/-; 250v wkg; Celestion 10-inch permanent magnet speakers with pentode transformers, high flux magnet of great power, 30/- each; meter switches, 1 1/2 way, long spindle, take lin behind panel, 4/9 each, 3 for 12/-; Yaxley type switches, 3-bank, 2-pole, 4-way, with middle screen, long spindle, 4 shorting bars, 4/9 each; Yaxley type switches, single pole, double throw, 2-bank 2/9; single bank 2/3; input strips, 2-way, with terminal screws, 2in x 1/4 in, 2/6 dozen; anchor or mtg. strips for resistances, 2/6 dozen.—G. A. Ryall.

METAL rectifiers, charger kits, 10ck-ups, condensers, metal rectifier 12v 1.5a type, with transformer and ballast bulb for 2v to 12v charger, no rheostat and ammeter needed, with circuit, 37/6, postage 10d.; ditto with 12v 2.5a rectifier, 46/6, post 10d.; metal rectifier, 2v 1/2 amp, with transformer, makes ideal trickle charger for 2v cell, 13/6, post 7d.; metal rectifier, well-known make, with circuit, 12v 4amp, 32/6; 12v 1.5a, 10/6, postage 7d.; Junior 12v lamp rectifier, 7/6, post 4d.; 12v 2amp, 16/6; 2.5amp, 17/6; 3amp, 27/-; M.B.S.I. instrument rectifiers, 18/6; charger, kit for 6v car battery at 2amp, 37/6, post 10d. METAL rectifiers all types stock, for conversion of valve type chargers to metal rectification. HEAVY duty charger kits, weight 15lb, transformer and rectifier for 6v-12v 4amp, £4; 6v-12v 5amp, £4/10, post 1/1; transformer, metal rectifier and ballast bulb for 3-cell to 20-cell at lamp charger, guaranteed one year, £5/10; charges up to 20 cells at full lamp, also transformer, rectifier and ballast bulb for 6v-12v 5amp charger, ideal for car battery, 59/6, post 1/1; Hunts 8mds 450v surge proof tubular electrolytics, 3/8, post 3d.; Rothermel senior bakelite pick-ups, 75/9.

MIKES.—Rothermel "Bullet" crystal microphones, black finish, £3; D.104 mike, plated housing, £4/4; Rothermel D.106 miniature deaf aid mike, £2/2; moving coil mikes and stands in stock.

CHAMPION, 43, Uplands Way, London, N.21. Tel. Lab. 4457. [4425

SERVICEMEN'S parcels, inclg. 2 gross 4 & 3 0.1 tubulars, 6 1/4w resistors, 10/6, post free.

—Radio, 110, Wellington Rd., Northampton. DRY cells.—Old-established battery firm now in production of all types of dry cells; D.R.3 speciality; delivery ex works; quotations by request; contracts invited.—The Abies Battery Co., 117, Anerley Rd., Anerley, S.E.20.

AVO oscillator, £13; Paul Unipivot micro-ammeter, £4/10; Morse inker, with tape, £6/10; Weston 0.10 ma, £1/5; Weston 0.50 ma, £1/5; T.C.C. 4-4, 1,700v, wkg, £2/10; parts for wire recorder (television and a.w. world), including recording head and 1/2 lb steel wire, £2/10; 500v alternators; these excellent little machines work well as a dc generator, giving 12v 3a self aligning roller bearings, laminated fields and armature, £1/5; Savage 1,000-0-1,000v 250 ma, £4/10; rectifier heater trans for above, £1/10; T.C.C. 0.5mf, uncased, 1,700v wkg, 3/- ea; Ultra car radio, needs one new valve and attention, £4/10; polarised relay, operates on 0.5 ma £1/5; G.E.C. 3in C.R. tube, £2/10, new.—G.S.J.V., 198, Harrow View, Harrow, Middx.

ARMSTRONG

THE FUTURE

The active war is over. Gradually restrictions are being removed. Now we can get down to preparing plans for our **NEW ARMSTRONG CHASSIS.**

ARMSTRONG QUALITY is well known. Our new chassis will make it even better known.

ARMSTRONG WIRELESS & TELEVISION CO. LTD.
WALTERS ROAD, HOLLOWAY, LONDON, N.7
'Phone: NORth 3213



W. BRYAN SAVAGE LTD.

Expert assistance in the solution of problems relating to

- TRANSFORMERS, CHOKES
- AMPLIFIERS
- POWER UNITS

and Specialised Equipment embodying

ELECTRONIC CONTROL

WESTMORELAND RD., N.W.8
COLINDALE 7131

"VIBRO-ARC" Engraving Pen

10/-



For rapid engraving any metal—hard or soft. Operates from 4-6v. Battery or A.C. Transformer giving 6-10 amps.

HOLBOROW,
46, Boroughbridge, Yorks.

POST-WAR TELEVISION

The advance in Radio Technique offers unlimited opportunities of high pay and secure posts for those Radio Engineers who have had the foresight to become technically qualified. How you can do this quickly and easily in your spare time is fully explained in our unique handbook.

Full details are given of A.M.I.E.E., A.M.Brit.I.E.E. City & Guilds Exams., and particulars of up-to-date courses in Wireless Engineering, Radio Servicing, Short Waves, Television, Mathematics, etc., etc.

We Guarantee "NO PASS—NO FEE"

Prepare for to-morrow's opportunities and post-war competition by sending for your copy of this very informative 112-page guide NOW—FREE.

BRITISH INSTITUTE OF ENGINEERING TECHNOLOGY (Dept. 388)

17, Stratford Place, London, W.1

● A really good transformer—

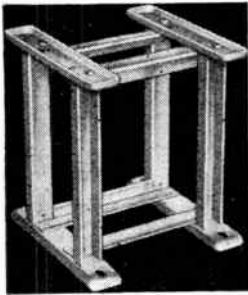

A really good transformer calls for equally good mounting methods. The illustration shows a skeleton framework as used on all A.E.E. Air-cooled transformers, rated from 5 VA, to 5 KVA. These are NOT just crude pieces of bent strip or brittle castings, but scientifically designed interlocking pressed steel sections.

This construction ensures:—

1. Absolute Rigidity.
2. No lamination buzz or vibration.
3. Fixing centres pre-determined and maintained to hairbreadth accuracy.
4. Winding Axis horizontal or vertical, as required.

Our other products include "Interlock" Transformer Bobbins, Power Supply Units, Audio Amplifiers, Electronic Test Equipment.

ASSOCIATED ELECTRONIC ENGINEERS LTD.
DALSTON GARDENS, STANMORE,
MIDDLESEX. Wordsworth 4474/5/6

Now available for
LOW VOLTAGES
12v. and 24v.

SOLON Industrial Type Electric Soldering Irons rated at 65 watts are now available for use where a low voltage system of supply is employed. There are two models, one fitted with an oval tapered bit as illustrated, the other with a round pencil bit, and they will do the same class of work as the well-known SOLONS of 65 watt rating for normal supply voltages.

Their design incorporates the many special SOLON features, including the fitting of the heating element inside the bit. Both models can be supplied fitted with elements for 12 volts or for 24 volts supply, as required. Complete with 6 feet of HENLEY twin core flexible. Write for details of the complete SOLON range of low and normal voltages.

SOLON
Soldering Iron for Industrial Use

W. T. HENLEY'S TELEGRAPH WORKS COMPANY, LIMITED,
Engineering Dept., 51/58 Hatton Garden, London, E.C.1

B.A. thread screws, gross useful sizes. 2/6; ditto, nuts, 2/6 gr.; assorted gross screws and nuts, 2/6 gr.; ditto, brass washers, 1/6 gr.; fibre washers, 1/6 gr.; assorted soldering tags, 2/- gr.; assorted small eyelets and rivets, 1/3 gr.; large stock of screws, etc.; state wants. Rubber-covered stranded copper wire, 1d. yard; heavier quality, 1 1/2d. yd.; very heavy quality, 2 1/2d. yd. Tinner copper connecting wire, 20ft coil, 6d.; ditto, rubber-covered, 10ft, 6d.; finest quality stranded push-back wire, 12yds, 2/3; twin bell wire, 12yds, 1/9; ditto, heavier quality, 12yds, 2/3; ditto, flat rubber covered, 3d. yd. Woods metal stick, 2 1/2in by 1/4in, 1/-; Cotton-covered copper instrument wire, 1/4lb, reels, 16, 20, 22, 24g., 1/6; 26, 28g., 1/9; 30, 32g., 2/-; 34g., 2/3. Enamelled ditto—same prices. Also 36g., 2/3; 38, 40g., 2/6. Silk-covered ditto, 20z. reels, 24, 26, 28g., 1/6; 30, 32, 34, 36g., 1/9; 42g., 2/-; 16g., D.S.C., 1lb., 5/-; all post extra; s.a.e. with enquiries.—Post Radio Supplies, 33, Bourne Gardens, London, E.4.

COULPHONE RADIO, Station Rd., New Longton, Nr. Preston.—Return of post mail order service; new goods only; c.o.d. or cash with order; all orders over 5/- post free. highest quality goods at unbeatable prices; all Tungsram and B.V.A. valves; mains transformers, 200-250v. primaries; 300-0-300v 60mA 4 or 6.3v. L.T. 1/6; 350-0-350v 100mA 4 or 6.3v. L.T. 2/-; 425-0-425v, 200mA, 4v 8a. 4v 4a, 4v 4a, or 6.3v 4a, 6.3v 4a, 5v 3a, 47/6; 350v 100mA bobbins, 15/6; chokes, 60mA 7/6, 100mA 15/-, 200mA 21/-; P.M. speakers, less transf., 2 1/2in 24/-, 3 1/2in 27/6, 5in 19/6, 6 1/2in 20/-, 8in 21/-, 10in 30/-; with Pentode transf., 6 1/2in 24/-, 8in 25/-; energised speakers with Pen. transf., 1,200 or 2,000 field, 30/-; Vita-vox 12in Super K12/10, £7; speaker field coils, 1,000, 1,500, 2,000 or 2,500 ohms, 6/6; speaker transformers, push-pull universal types, 4watt 6/6, 8w 10/6, 15w 21/-, 30w 37/6; Midget Pentode, 4/6; mains dropper resistors, feet, 2 sliders, 800Ω 0.3amp, 4/6; iron-cored i.f. transf., 465kc/s, 13/6 pr.; Rothermel Senior Xtal pick-ups, 78/9; push back wire, 2d. yd, 50ft 2/6, 100ft 4/6; tinned copper wire, 2/- 1/4lb reel; Systoflex 2mm, 2d. yd.; resin-cored solder, 4/- lb; 4 1/2in B.S. 1st grade milliammeters, 0-1ma, 70/-; midget 2-gangs, 0.0005, with trimmers and feet 11/6, 3 gangs 13/6; electrolytics, 8x450 4/6, 8x 8450 7/6, 2x350 3/-, 25x25, 50x12 2/-, 25x50 2/6, 50x50 2/9; line cord, 0.3 amp, 60Ω per ft., 2-way 1/6 yard, 3-way 1/9 yard; carbon resistors, 1/2w 6d., 1w 9d.; 2 W.B. TRF. coils, with reaction, 12/6 pr; 3W.B. superhet. coils, 465kc/s, 13/6 pr; valve-holders, all types, 6d.; Dubilier, Centralab. vol. controls, less switch 3/6, with sw. 4/9; Pyrobit instrument soldering irons, 21/-; 3-way cable, 6d. yd., 5w. 10d. yd; trimmers, 50pf. 9d., 500pf. 1/9; Vortexion and Brierley amplifiers. Send s.a.e. for comprehensive list. [4330]

NEW LOUDSPEAKERS
2 BAKERS 18in P.M. L.S., list £8/19/6, unused, £15 pair.—J. Worden, Lightfoot Lane, Broughton, Preston, Lancs. [4289]
£5 18/6—New Baker Super Quality 12in Auditorium permanent magnet speaker with triple cone, manufactured by Bakers Selhurst Radio, the pioneer manufacturers of moving coil speakers since 1925, wide frequency range, even response, ideal for quality reproduction, fitted with magnet, having exceptionally high flux density in the air gap, suitable for public address equipment when quality reproduction is first consideration; send 2 1/2d. stamp for leaflet giving details of above and constructional details of a new acoustic chamber designed to extend loud speaker frequency range.

£8/19/6—New Baker super power cinema permanent magnet speaker with 18in triple cone of new design, giving wide frequency response free from objectionable resonances; speech is clear and natural and music is reproduced with exceptional realism; fine engineering job, extremely sensitive; ideal for public address equipment when power handling capacity, plus realistic reproduction, is required; prompt delivery per pass. train.—Bakers Selhurst Radio, 75, Sussex Rd., S. Croydon (Croydon 6813).

LOUDSPEAKERS, SECOND-HAND
VOIGT light coil twin with H/C horn, £25; would separate.—Box 4089. [4301]
EPOCOT Domino, new condition, £6.—107, Tower Hill, Birmingham, 22A. [4371]
VOIGT unit and large horn; offers.—Cooper, 45, Muswell Rd., London, N.10. [4378]
MAGNAVOX "66", with power supply, 230v AC, beautiful tone; offers.—Box 4159.
BAKER 12in triple cone speaker, new, unused, surplus to requirements, £4/10.—Box 3986. [4291]
BAKERS 12in 15Ω, 1,250Ω field, £3. B.H.M.V. heavy 10in, 15Ω, 1,500Ω field, as new, 70/-, 50/-, 10/-, etc., some need repair, 5/- to 7/-—J. Worden, Lightfoot Lane, Broughton, Preston, Lancs. [4290]

ELECTRADIX

ROTACEPTORS. Pre-war type for E.H.T. at 50 cycles from 12 volts D.C. two sizes 5,000 volts and 10,000 volts at 20 m.a. for portable neon luminous tubes or daylight colour matching lamps. Completely ironclad with small interruptor motor at top, transformers and condensers below. Overall size 6" x 4 1/2" x 13 1/2" high, £6 10s. each.

ROTARY CONVERTERS. New D.C./A.C., 110/220 volts 100 watts, £12; 110/110 volt 100 watts, £10. All with smoothing units.

L.T. DYNAMOS. We are again able to offer a few Charging Dynamos 6, 12, 24 or 32 volts, 120/150 watts, circular body, car type. Send us your enquiries.

MOTOR BLOWERS. In addition to mains A.C./D.C. Blowers we have some of low voltage D.C. 32 volt 1/4 h.p. with output of 500 cub. ft. per minute, £8 10s.; also some small valve cooling or Lab. Blowers; work off 12 volts, £5 10s. We have other Blowers in stock up to 6 h.p.

FANS. Table model Fans, A.C. 220/230 volts, with 10" blade and guard, 45s. nett.

TRANSFORMERS. We have a number of 1/4 kW. Transformers, shrouded, with several taps, output unmarked, unused Government Surplus, 65/-; 3 W. Carcases with laminations and wire, damaged by blitz, 45/- each.

CONTACTORS. Auto Cutouts and Solenoids in all voltages from 24 volts and current to 500 amps.

ROTARY SWITCHES. "On-off," 10, 15 and 40 amps., 7/6, 10/- and 12/6 each.

FILTERS. 30 volt A.C./D.C. Filters in metal box, 12/6.

MICROPHONES. Studio and Announcers' Mikes, hand or stand, Tannoy multi-cell carbon mikes in case and mounted on chrome table stand, 75/-, or on extending floor stand, 80/-; Transformer, 10/- extra. Tannoy Hand Mike with switch in handle, 21/-.
Lesdix No. 11a Hand Mike, carbon inset in solid brass case, the sensitive diaphragm protected by a perforated metal panel, 8/6. Detectaphone Mike Buttons, 2/6. Transformer, 4/6.

BELLS. Outdoor Ironclad, Tangent, for works or schools, 230 volts A.C., 42/-.
Indoor House Bells, 5/9. Bell Transformer, 3-5-8 volts, 7/6.

BATTERY CHARGERS. Lesdix "NITNDAY" Chargers, metal rectification, 2 volts 1/2 amp., for wireless cells to large chargers for your car accumulator. Send for special Charger leaflet.

METERS. D.C. Moving-coil milli-ammeters, 0-1 ma., 100 ohms resistance, 2 1/2" flush panel, bakelite case, 55/-.
Instrument Rectifier, 10/6. Few large ironclad Switchboard Meters. Send us your enquiries.

PETROL ELECTRIC PLANTS. 500-watt direct coupled Stuart, 50 volt D.C., £45.—Stuart Turner 12 volt D.C. Motor Pumps, 120 g.p.h., 84/-.

SWITCHES. 8-way Lucas switch-box ex-R.A.F., 3/6; 6-way, 3/-.
G.P.O. Lab. Switches D.P. reversing, for model control motors, etc., 7/6. 10 amp. D.P.D.T. Rotary, 2/6 each.

MAGNETS. The wonder midget Magnet,alni perm. steel disc, weight only 1/2 oz., 1 1/2" dia., 1 1/2" thick with 3/16" centre hole, 3/6 each. Large selection of horseshoe Magnets in stock. Send for leaflet "W".

H.T. MOTOR GENERATORS. 28 volt D.C. input, 570 volt 160/200 ma. D.C. output, small and compact enclosed machines, General Electric, £5 10s. Double current Dynamos, ex-R.A.F., 6 volts 5 amps and 600 volt 80 ma., ball bearings, weight 17 lbs., 37/6.

SMALL D.C. MOTOR GENERATORS by E.D.C. and others, for use with Receivers and Car Radio: take the place of H.T. Batteries. Drives off 12-volt accumulator and gives 230 volts D.C. 30 ma. output, off 6-volt gives 110 volts 15 ma. Originally made for Government radios. Two commutators, ball bearings, laminated field, insulated brush gear, covered armature windings. A splendid job. In new condition, 75/-.

INVISIBLE RAY CONTROL. The famous Raycraft Kit with selenium bridge, in bakelite case, 10,000 ohm Relay, megostat, etc.; with instruction booklet, 42/-.

ELECTRADIX RADIOS

214, Queenstown Rd., London, S.W.8

Telephone: MACaulay 215

RADIO SPARES

MAINS TRANSFORMERS. Primaries 200/250 volts.		
Secondaries 350-0-350 volts.		
TYPE C. 100 ma. 4v. 5a., 4v. 3a.		34/6
TYPE D. 100 ma. 6.3v. 5a., 5v. 3a.		34/6
TYPE E. 120 ma. L.T.s as Type C.		37/6
TYPE F. 120 ma. L.T.s as Type D.		37/6
TYPE H. 200 ma. Three L.T.s of 4v. 6a. + 4v. 3a.		47/6
TYPE I. 200 ma. Three L.T.s of 6.3v. 6a. + 5v. 3a.		47/6
Secondaries 500-0-500.		
TYPE J. 200 ma. Three L.T.s of 6.3v. 6a. + 5v. 3a.		52/-
TYPE K. 200 ma. Three L.T.s of 4v. 6a. + 4v. 3a.		52/-
TYPE L. 250 ma. Three L.T.s of 6.3v. 6a. + 5v. 3a.		58/-
TYPE M. 250 ma. Three L.T.s of 4v. 6a. + 4v. 3a.		58/-
Secondaries 400-0-400.		
TYPE R. 120 ma. 4v. 5a., 4v. 3a.		40/-
TYPE S. 120 ma. 6.3v. 5a., 5v. 3a.		40/-
SPECIAL UNITS MANUFACTURED TO FRIENDS' REQUIREMENTS.		
Please note that, owing to dimensions and weight of TYPES H to M, kindly add 2/6 for carriage and packing.		
HEAVY DUTY MULTI-RATIO OUTPUT TRANSFORMER. 120 ma. 15 watts, tappings for 6L6s in push-pull. PX4s in push-pull, low impedance triode, low impedance pentode, high impedance triode. 27/6: complete instructions with each unit.		
SPEAKERS. Rola or Celestion. 8in. P.M. with transformer. 29/6. Less transformer 24/-. 10in. with transformer. 45/-.		
OUTPUT TRANSFORMERS. Special offer. Multi Ratio 30:1, 45:1, 60:1, 90:1, 60:1.		
SMOKING COCKS. 20 henrys, 100 or 120 ma., 10:1; 20 henrys 150 ma., 12/6: 30, 35 or 40 henrys 200 ma. or 250 ma., 21/6.		
DRIVER TRANSFORMER. Class B. 8/-. Orders accepted by post only. Please help us to eliminate clerical work by sending cash with order. Please include postage with order. PRICE LIST Id. stamp.		

H. W. FIELD & SON, Colchester Road, HAROLD PARK, Essex.

LONDEX for RELAYS



for A.C. and D.C.

2 VA Coil consumption from 2 to 600 volts and tested to 2000 volts. Aerial Changeover Relays, Mercury Relays, Measuring Relays and Time Delay Relays

Multiple contact Relay L.F. Ask for leaflet 205/WW

LONDEX LTD
MANUFACTURERS OF RELAYS
207-AMERLEY ROAD, LONDON S-E 20

Held-up for Special Cutting Tools?

Let BRIDGES make them for you

DRILLS • MILLING CUTTERS
• END MILLS • REAMERS •
COUNTER-SINKS • COUNTER-BORES

Phone RENOWN 2425 and ask for Mr. Bridges personally, or write to:

S. N. BRIDGES & CO. LTD.
6, PARSONS GREEN, LONDON, S.W.6

TEST EQUIPMENT

AVO mod. 7, as new, leather case, perfect; £22/10.—Box 4457. [4413]

FERRANTI universal test meter, as new, £6.—50, Falcon Grove, Nottingham. [4351]

HUNTS capacity and resistance bridge; £11/10.—BM/SIMMIE, London, W.C.C.

TAYLORMETER, model 90, as new, £11.—24, Courtleigh Gardens, London, N.W.11.

TAYLOR model 65A all-wave signal generator, with dummy aerial, good condition, £12/10.—Box 4411. [4372]

EQUIPMENT precision made to specification; test and amplifiers a speciality; in dividend response curves supplied.—Box 4158.

AVO meters, oscillators, valve testers available; stamp details; limited number only.—Electrocraft, BCM Electrocraft, London, W.C.1.

UNIVERSAL Avonion, £8/10; model 7 Avometer, £19/10, new cond., perfect.—Young, 134, Old Shoreham Rd., Southwick.

TAYLOR model 478, valve tester and d.c. multi-range meter, as new; offers.—Nicholson, 2, Matlock Rd., Ambergate, Derby.

AVO res-cap, Bridge, £10; Avo Minor meter, high res., £4/10; valve voltmeters, 500 micro-amp, £6; 50 micro-amp, £12.—Box 4421.

AVO meters, oscillators, valve testers, etc. A few in stock, no priority; wanted, test equipment, single range meters; s.a.e. with enquiries.—Massey, 58, Wakefield Ave., Hull.

OSCILLOSCOPES, signal generators, multi-range test meters, etc. Test gear of every description, British or American, repaired, serviced, recalibrated.—A. Huckelsbee, "Hazeljohn," Crofton Lane, Orpington, Kent. [3031]

16 YEARS ago this month we commenced marketing test apparatus in kit form, and this long experience is at your disposal. INTERIM lists (see Oct. ad.) describe 4in scale, 45-range multimeters, oscillators, V.V. meters, bridges, adjustable shunts (to suit any meter-wide selection of ranges), and include advance particulars of

PORTABLE laboratory, an exceptionally high-impedance AC/DC valve voltmeter with 6 ranges each ohms & cap., from 1/50th ohm to 500 meg Ω & 0.00005 to 500 m Ω . (Limited number of Ferranti AC/DC testers, 1000 ovy, in case £28.—Maclean and Co., Strathtyso.

VOMETER model 7, £13; 2 circuit valve-charger, 12-volt 6amp., with spare valve, 6gns.; brand new car battery charger, very compact, for hanging on garage wall, 12volts 4amps and 6 volts 5 amps, tapped input, double fused, 90/-; full wave metal rectifiers, 6volt 12amp., 30/-; 6volt 10amp., 26/-; 6volt 6amp., 22/6. 6volt 4amp., 17/6; wanted, 117/7gt. and pair 2A3 valves.—Box 4295.

CONSTRUCT your own crystal controlled frequency standard, using the new Q.C.C type Q5 100 kc quartz crystal unit; in a single valve Colpitts oscillator circuit it provides check points of 0.01% accuracy at 100 kc/s intervals from 100 kc/s to 15,000 kc/s, making an ideal radio frequency source for receiver calibration and alignment; price 45/-, complete in octal based mount; send stamp for leaflet Q5, which gives full technical details and circuit.—The Quartz Crystal Co., Ltd., 63-71, Kingston Rd., New Malden, Surrey, T. Maj., 0534. [4102]

GRAMOPHONE AND SOUND EQUIPMENT

HMV Hyper, latest Zohm model; offers.—Box 4161. [4314]

MARCONI pick-up N.25, Magnavox 8in. with rect; offers—Box 4456 [4412]

AMPLIFIER, 2PX25A's P.P., T.C., £25; A.R.K. speaker, new cone, £5; 4ft. sq. baffle, £7.—Hardy, Chichester Terr., Brighton.

M88, recording machine, 12-watt amplifier, virtually new, guaranteed £80; amplifier, £6; suit professional.—Box 4160.

COILS for filters, tone controls, all types of transformers for "Wireless World" circuits.—R. Clark, 30, Langland Cres., Stanmore, Wor. 5321. [4106]

16MM Peerless cine projector converted sound, 200w lamp, new sound head, 6w amp and 10in spkr., £100; or sound head, amp and spkr only, £60.—Box 3952. [4285]

CARRARD record changer, model RC 1A/2A, complete with pick-up, bronze motor plate, hardly used; offers by post.—Fortey, No. 4, Gloucester Walk, W.8. [4360]

THE new atomic fibre needles, unrivalled for quality reproduction; 2/6 per pkt. 10; keen trade prices; agents wanted.—A. Wilking, 132, Blackburn Rd. Gt. Harwood, Lancs.

DYNAMOS, MOTORS, ETC.

B.T.H. motor & generator, directly cpd, 110v dc, 1/2hp, output 120v; £19 or nearest.—5, Tobys Cotts., Brook Rd., Shotton, Chester.

£12 only—Motor alternators, Lawrence Scott, 220 dc to 230v 50c/s ac, 200 watts, robust, perfect—Wilkinson, 8, Railway Walk, Birkdale, Lancs. [4415]

CONVERTER, rotary dc 230 to ac 220, in steel cabinet, smoothing equipment, starter, recently overhauled; £20.—Marsh, Marlon House, Mark Lane, E.C. Royal 6162.



CLATONRITE
(PATENTED)
BATTERY TERMINAL OILER

IS A CHEAP INSURANCE AGAINST FAULTY STARTING AND LIGHTING.

Batteries have a habit of throwing a nasty green verdigris on the terminals and if not checked and regularly cleaned, corrode right through the cable—result—SUDDEN FAILURE of all electrical equipment. THE "CLATONRITE" BATTERY TERMINAL OILER cures this. Would you care to receive a leaflet explaining why?

Obtainable from all automobile agents, or from your Halford Depot or direct from the sole Manufacturers: Price 5/- per pair

HOWARD CLAYTON-WRIGHT LTD
TIDDINGTON RD., STRATFORD-ON-AVON
PHONE: 50N A 3601, 3602, 3603
GRAMS: CLATONRITE, 50N A.

REWINDS

Armatures, Fields, Transformers, Pick-ups, Vacuum Cleaners, Gram. Motors, Speakers Refitted New Cones & Speech Coils.

All Guaranteed and promptly executed. Valves, B.V.A. and American, good stocks. Send stamped addressed envelope for list of Radio Spares, and C.O.D. Service.

A.D.S. Co. 261-3-5, Lichfield Road, ASTON, BIRMINGHAM, 6

RUNNING A RADIO REPAIR BUSINESS

This manuscript contains a host of useful ideas which make for the successful running of a radio repair business. No matter whether you are just starting or whether you have been operating for some time you will find ideas which put into operation will bring rich reward and will help to make yours a sound and lasting business.

Price 5/3 Post Free.

V. E. S. (W), Radio House, Ruislip, Mdx.

THESE ARE IN STOCK

RADIO RECEIVER DESIGN. By K. R. Starley, Ph.D., B.Sc., M.I.E.E. Part 1 and 2. 28/- each. Postage 7d.

TELEVISION RECEIVING EQUIPMENT. By W. T. Cocking, A.M.I.E.E. 10/8. Postage 4d.

RADIO LABORATORY HANDBOOK, 3rd Ed. By M. G. Scroggie, B.S.A., M.I.E.E. 12/6. Postage 4d.

TIME BASES SCANNING GENERATORS. By O. B. Puckle, M.I.E.E. 18/-. Postage 6d.

HIGH VACUUM TECHNIQUE. By J. Yarwood, M.Sc., A.Inst.P. 12/6. Postage 6d.

THE WIRELESS WORLD VALVE DATA—Operating Conditions and Base Connections of the Principal Types and Makes. 2/-. Postage 2d.

VALVE REPLACEMENT MANUAL—For Radio Service Engineers. By A. C. Farnell and Arthur Woffenden. 2nd Edition. 6/- Postage 3d.

CATHODE-RAY OSCILLOGRAPHS. By J. H. Reynolds, B.Sc.(Hons.), A.C.G.I. 8/6. Postage 4d.

LUMINOUS TUBE LIGHTING. By H. Miller, A.M.I.E.E. 10/6. Postage 6d.

THEORY OF ALTERNATING CURRENT WAVE FORMS. By P. Kemp, M.Sc.Tech., M.I.E.E., A.I.Mech.E., M.A.I.E.E. 17/6. Postage 8d.

WRITE OR CALL FOR COMPLETE LIST 1a.

THE MODERN BOOK CO.
(Dept W.8) 19-23, PRAED STREET, LONDON, W.2.

ANSWERS AT YOUR FINGER-TIP

FLIK-O-DISK
Answers! Quick!

ELECTRICAL AND RADIO ENGINEERS OHM'S LAW CALCULATOR

Whether you are constructing, or servicing a radio set, problems involving voltage, current and resistance can delay progress.

Flik-o-Disk will give the answer in a jiffy. For example, what resistance should you use to obtain a voltage drop of 100 v. when current equals 25 m.a. ? A flick of the disk and there is your correct answer—4,000 ohms. The scales read from 1 millivolt to 1,000 volts. From 1 ohm to 1,000,000 ohms. From 1 milliamp to 10 amperes. From 1/10th of a milliwatt to 10,000 watts.

The calculator is sold complete and with full instructions at Radio Stores and Stationers. If unable to obtain, write to **IONIC LABORATORIES LTD.**, Dept. W., Cranbourne Terrace, SALT HILL, SLOUGH, BUCKS, for name and address of your nearest stockist.

PRICE **66**

A Message to All STUDENTS of the CANDLER System Company

May this Christmas and the New Year bring Happiness and a Prosperous Future to every one of you.

Yours sincerely,
H. FREEMAN,
London Manager.

ALL STUDENTS enrolled for Candler Morse Code Training, whose services during the war period have prevented them from completing their course, are advised that their agreements have been kept open, and they can resume their studies at any time.

Any reader of this advertisement who is interested in Morse Code Training, may write us for a copy of the Candler "Book of Facts."

THE Candler System Co.
(ROOM 55)

121 Kingsway, London, W.C.2
Candler System Co., Denver, Colorado, U.S.A.

NEW ac motors, 1/4hp, high starting torque. 200-250v. 45; 1/2hp, 45/10; 1/3hp, 47/10; 1hp, 49/15; all other sizes available; also machinery.—John W. W. Steel, Bingley, Yorks.

VALVES
2 9003, 2 9002, 3 954, R.C.A., new unboxed; £10 lot.—Harper, 32, Connaught Rd., N.4.
65 B.V.A. valves, all new, boxed; list price, pre-purchase tax.—Holland, 49, Christchurch Rd., London, S.W.2. Tulse Hill 4598.
A L.L. B.V.A. valves available, also number of discontinued types; list prices; pro forma or c.o.d.—David Robinson, Ltd., 100, High St., Bedford. [3421]

MISCELLANEOUS
TIME recorders.—Write for particulars.—Gledhill-Brook Time Recorders, Ltd., 84, Empire Works, Huddersfield. [2419]
SPARKES' data sheets.—These data sheets provide complete constructional details, together with full-size prints, etc., of tested and guaranteed designs.

ELECTRIC guitar units (3rd edition), 5/-.
ELECTRONIC one-string fiddle, 3/6; 6 watt ac/dc amplifier; phase inverter; push-pull output; neg. feedback; portable for use with above or mike, p.u., etc., 3/6.
A.C. two-valver, med. wave, coil details, 2/6; 3-watt ac amplifier, 2/6.
SPARKS' DATA SHEETS (W.), 9, Pheobeth Rd., Brockley, London, S.E.4. [3622]
BOOKS on radio.—We have the finest stock in the country, including many that are out of print; write or call for complete list; price 1d.—The Modern Book Company (Dept. W.7), 19-25, Praed St., London, W.2. [4249]

REPAIRS AND SERVICE
BEST quality rewinds in 24 hrs., guaranteed; competitive.—Radiowinds, Brundall, Nfk.
MAINS transformer rewound and constructed to any specification; prompt delivery.—Brown, 3, Bde Burn Rd., Jarrow. [3460]
LOUDSPEAKER repairs, British, American, any make; moderate prices.—Sinclair Speakers, 12, Pembroke St., London, N.1. Terminus 4355. [3308]

ACURATE radio rewinds, mains transformers, fields, op. transformers, etc.—Southern Trade Services, 297-299, High St., Croydon. [3971]

METROPOLITAN RADIO SERVICE CO. for guaranteed repairs to British and American receivers of all types.—(Service Dept. 1), 1021, Finchley Rd., N.W.11. [3886]

RADIO repairs quickly executed to all makes, English or American; lowest possible prices.—The Music Box, 89, London Rd., London, S.E.1 (Tel. Waterloo 4460 and 6766).
"SERVICE with a Smile."—Repairers of all types of British and American receivers; coil rewinds; American valves, spares, time cord.—F.R.I., Ltd., 22, Howland St., W.1. Museum, 5675. [1575]

STURDY rewinds, mains transformers, chokes and fields; we give prompt delivery and guarantee satisfaction; 14 years' experience; prices on request.—Sturdy Electric Co., Ltd., Dipton, Newcastle-upon-Tyne. [4316]

LOUDSPEAKER repairs.—We cannot accept any new dealers or wholesalers for our repairs department until further notice.—A.F.W. Radio Products, Borough Mills, Sharpe St., Bradford, Yorks. Tel. 1926. [4295]

A.L. makes and kinds of electrical and radio instruments repaired by skilled technicians A.I.D. approved; over 60,000 instruments repaired for R.A.F.; all work quoted by return without charge. C. Gertler, Dept. D, 71-79, Waterside, Chesham, Bucks. [4308]

REWINDS.—Repairs to moving coil speakers, cones, coils fitted, fields wound or altered, mains transformers, eliminators and clock coils rewound; competitive prices; speaker transformers and pick-ups repaired, 4/6 each; post free; guaranteed satisfaction; prompt service.—L.S. Repair Service, 49 Trinity Rd., Upper Tooting, London, S.W.17. [4227]

TRANSFORMER rewinds and replacement coils, machine layer wound on bakelite formers, interleaved, impregnated and clearly marked, rewinds £1, post paid, standard types to 70 watts; replacement coils, 15/6; larger types and additional secondaries pro rata; discount to trade; delivery by return post most types in common use; state model and iron size when ordering coils; cash with order or c.o.d.; fully guaranteed.—Radio Service, Field St. Works, Blackpool, R.T.R.A. Service members. Tel. 1774. [4227]

DEGALLIER'S, Ltd.—"Service with a guarantee." If you cannot get your receiver serviced, let American specialists do the job; first-class workmanship only; specialising in Air-King, Belmont, Challenger, Detroit, deWald, Emerson, Ferguson, Garod, Hallierafter, Hammerlund, McMurdo, Med-west Majestic, Pilot, Philco, Spartan, etc., also any British set. Remember, for 15 years we have handled as distributors American receivers; this is self-explanatory; s.a.e. with all enquiries.—Degallier's, Ltd., 9, Westbourne Court, London, W.2. [4402]

M. WILSON LTD

Everything we sell is absolutely new
No surplus or secondhand goods.

SPECIAL!

RADIO CHASSIS (riveted corners)
in 18-S.W.G. "ALCLAD," unfrilled, specially manufactured for us by a well-known firm of aircraft manufacturers, to Aircraft (A.I.I.) standards. Strong as steel, rigid yet easy to work. Dimensions 12 1/2 x 7 1/4 in. Price **12/6**. Post and packing 1/-.

I.F. TRANSFORMERS, 465 kc/s., permeability tuned iron-cored, centre-tapped, colour-coded, screened, 15/- per pair.

COILS, 3 wavebands on one former: Long (800-2,000 m.), Medium (200-500 m.) and Short (16-50 m.). Aerial and Osc., 12/6 per pair. A. & H.F. with enclosure, 12/6 per pair.

FOUR-WAVEBAND COILS, on one former: Long (800-2,000 m.), Medium (200-500 m.) and Short (12-20 and 19-50 m.), 15/- per pair.

FULL RANGE OF "WEARITE" P-TYPE COILS

PA. 4, 2/3	PHF. 4, 2/3	PO. 4, 2/3
PA. 5, 2/3	PHF. 5, 2/3	PO. 5, 2/3
PA. 6, 2/3	PHF. 6, 2/3	PO. 6, 2/3
PA. 7, 2/6	PHF. 7, 2/6	PO. 7, 2/6
PA. 8, 2/6	PHF. 8, 2/6	PO. 8, 2/6
PA. 9, 2/3	PHF. 9, 2/3	PO. 9, 2/3
R.F.O. 2/3	A.F. 2/3	R.F. 2/3

Also "Wearite" Iron Dust-cored I.F. Transformers, 15/- per pair.

INPUT TRANSFORMERS (Push-pull) Midset parallel-fed split secondary 4 to 1 ratio, 6/- standard, 9/6 Heavy Duty, 12/6.

CIRCUIT No. 17
7-VALVE SUPERHETERODYNE A.C. or (No. 18) A.C./D.C. RECEIVER. Valve sequence: Radio-frequency stage (6K7), first detector and oscillator (6K8), intermediate-frequency amplifier (6K7), second detector A.V.C. and first A.F. (6Q7), output beam tetrode (6V6) with negative feedback, Y63 tuning eye if required. Six wavebands covering 5 to 2,000 metres, including television-sound, A.V.C. rapid, normal and off. Controls: R.F. gain; wave-change switch; B.F.O. on/off; A.V.C. on/off; audio-gain control and on/off switch; tone-control; radio-gramophone switch. 6 watts output. Full-wave rectifier (5U4G).

CIRCUIT No. 20
10-VALVE SUPERHETERODYNE A.C. or (No. 21) A.C./D.C. RECEIVER. Brief specification: Valve sequence: Radio-frequency stage (6K7), first detector and oscillator (6K8), intermediate-frequency amplifier (6K7), second detector A.V.C. and first A.F. (6Q7), phase inverter and B.F.O. (6C8), output (two 6V6's) in push-pull with negative feedback, Y63 tuning indicator. Six wavebands covering 5 to 2,000 metres, including television-sound, A.V.C. rapid, normal and off. Controls: R.F. gain; wave-change switch; B.F.O. on/off; A.V.C. on/off; audio-gain control and on/off switch; tone-control; radio-gramophone switch. 12 watts output. Full-wave rectifier (5U4G) and noise-limiter valve (6K7).

Complete Sets of Blueprints (two practical and one theoretical), full size, with complete price list of components, all of which we can supply, for circuits Nos. 17, 18, 20 and 21; 5/- per set for each circuit.

For other Circuits see October issue.

IN STOCK—Resistors and Condensers. All standard values. Mains Transformers and Chokes. Loudspeakers. P.M. and mains-energised, from 21/6 to £6 18s. 6d. Wave-Change Switches to suit any coil circuit. 4-pole, 3-way midget, single pole, 2-way, etc. Volume Controls (wire-bound or carbon); all values.

Look out for Special Television Announcement

TO OVERSEAS TRADERS
Wholesale and retail enquiries are invited. Orders can be executed for B.A.O.R., C.M.F. and S.E.A.C. customers.

307, HIGH HOLBORN.
LONDON W.C.1. Phone: **HOLborn 4631**

IT'S HER VOICE YOU WANT TO HEAR!



LUSTRAPHONE
Moving Coil Microphones

84 BELSIZE LANE · LONDON · N-W 3
TEL. HAMPS TEAD 5389 & 5515

CONDENSER MICROPHONES and RECORDING MOTORS

THE MICROPHONE. A really superb instrument. No batteries, mains driven. Weight of moving element, **ONE GRAIN.**

The Microphone for those occasions where the highest quality only is permissible.

Ideal for disc and film recording.

THE MOTOR. Self contained, no gears, no belts, **SYNCHRONOUS, A.C.** only.

Write for particulars and demonstration.

BOURNE INSTRUMENT CO.
Bourne ————— Lincolnshire

HILL & CHURCHILL
BOOKSELLERS
SWANAGE DORSET

ENGLISH & AMERICAN
BOOKS IN STOCK ON
RADIO AND
TELECOMMUNICATION

CATALOGUE ON APPLICATION

WARD ROTARY CONVERTERS
Petrol Electric Generating Plants, H.T. Generators, D.C. Motors, Frequency Changers, etc., up to 25 K.V.A.

CHAS. F. WARD
37, WHITE POST LANE, HACKNEY WICK, E 9
Phone: Amherst 1393

ALL types of radio receivers serviced—Murphy and Pilot specialist; valves in stock; sound repairs for 15 years.—T. E. Fevery, F.I.P.R.E., 50, Vine St., Uxbridge, fields

48-HR. rewind service: trans, chokes, fields outputs, clock coils, pick-ups, vacuum motors repaired; guar. work; comp. prices.—Groves, 154, Ickneild Port Rd., B'ham, 16.

WANTED, EXCHANGE, ETC.

COSSOR 343 oscillator, test equipment, & 1st class communications receiver.—Box 4370.

COMMUNICATIONS receiver, good make; good price, cash; full parts.—Box 4369.

WANTED, Marconi 292 radiogram, in good condition; state price wanted.—Box 4298.

W.T.D., Ferrocart G.1, 2 & 3, perfect, med. & long.—West-Jones, Hospital Rd., Pt. Talbot.

WANTED, ac Record Player, less pick-up.—Hutchings, Devon Rise, London, N.2. Tnd. 2628. [4377]

WANTED, C. R. oscillograph and F.M. oscillator, Cossor 339 and 343 or similar. Coffin, Selsey, Sussex. [4411]

ENTHUSIAST desires personal practical tuition everything available; most congenial; N.W. London; first-class fee offered; immediately.—Box 4138. [4306]

PARTNERSHIP required in a progressive radio manufacturing organisation by engineer with number of years' senior executive experience prominent radio Co.—Box 4460.

TWO energetic experienced radio (transmitters and receivers) and electrical engineers, with capital, require working partnerships in manufacturing or trading concern.—Box 4212. [4324]

WANTED, mains driven b.f. audio oscillator, suitable for laboratory work; price no object for first-class instrument.—Details, etc., to J. Pacey, 141, Newtown Rd., Bedworth, Works. Phone: Bedworth 3142. [4345]

WE buy for cash, new, used, radio, electrical equipment all types; especially wanted, radios, radiograms, test equipment, motor chargers, recording gear, etc.—If you want to sell at the maximum price, call, write or phone to University Radio, Ltd., 22, Lisle St., Leicester Square, W.C.2. Ger. 4447. [4345]

TUITION

RADIO training.—P.M.G. exams. and I.E.E. Diploma; prospectus free. — Technical College, Hull. [0611]

I wish to learn practical radio repairing up to the standard of radio mechanic in spare time; anywhere.—A. Armstrong, c/o High St. P.O., Southampton. [4321]

RADIO Engineering.—Television and Wireless Telegraphy, comprehensive postal courses of instruction.—Apply British School of Telegraphy, Ltd., 179, Clapham Rd., London, S.W.9 (Estd. 1906). Also instruction at school in wireless for H.M. Merchant Navy and R.A.F. [9249]

THE Tuition Board of the Institute of Practical Radio Engineers have available home study courses covering elementary, theoretical, mathematical, practical and laboratory tuition in radio and television engineering; the text is suitable coaching matter for I.P.R.E. Service-entry and progressive exams, tuitionary fees—at pre-war rates—are moderate.—The Syllabus of Instructional Text may be obtained post free from Secretary, 20, Fairfield Rd., Bromley End, N.8

SITUATIONS VACANT

None of the vacancies in these columns relates to a man between the ages of 18 and 50 inclusive or a woman between the ages of 18 and 40 inclusive unless he or she is excepted from the provisions of the Control of Engagement Order, 1945, or the vacancy is for employment excepted from the provisions of that Order.

TELEVISION research engineer required; B.Sc. preferred.—Box 4364. [4357]

ADVERTISER can offer proposition, free rent, premises Oxford St., London, to radio repairer.—Gerrard 6153, Arnold 5737. [4394]

BROMLEY—Exp. service engineer, radio, television; gd. wages; perm.—Box 3345.

PROMINENT radio and electrical factors require stock-keeper & packers; good salary; permanent & progressive post.—Box 4294.

SERVICE engineer, experienced; state salary required, with details of past experience to Aneloy Radio, 36, Hindmans Rd., S.E.22.

RADIO designer, first-class permanent position to good man by progressive firm of radio manufacturers.—Apply in confidence with all information, Box 4121. [4304]

TEST engineer for radio/audio work; permanent good post available by progressive firm of radio manufacturers.—Apply in confidence, with all details, Box 4122. [4305]

LABORATORY engineer required for electronic devices, mainly audio frequencies.—Apply by letter to Vortexion, Ltd., 257-261, The Broadway, Wimbledon, S.W.19. [4355]

RADIO engineers for radio and television aerial installations; working knowledge of radio theory and good head for heights; excellent opening for right men.—Box 4242.

AVOMINOR TEST METERS

We can supply from stock the

UNIVERSAL A.C./D.C. Model £8 10 0
D.C. Model - - - - £4 4 0
(Regd. Post 10d. or C.O.D. 1/6)

Please order early. Stock is limited.

— ALSO AVAILABLE —

STUART CENTRIFUGAL ELECTRIC PUMPS

For all pumping purposes, garden fountains, etc. Delivery 2-3 weeks.

Please send 1d. stamp for specification.

The LONDON RADIO SUPPLY Co.
(Estd. 1925)

BALCOMBE - - SUSSEX

MATRICULATION
brings Success & Security

Whatever your age, you can now study for the all-important Matriculation Examination at home on "NO PASS—NO FEE" terms. "MATRIC" is the accepted passport to all careers, and opens up opportunities which would otherwise be completely closed to you. Ensure the success and security of you and yours through post-war difficulties by writing for our valuable "Guide to Matriculation" immediately—FREE.

B.T.I. (Dept. 114)
356, Oxford Street, London, W.1.

INSTRUMENT WIRES, ETC.

"Lewcos" enamelled copper wires, 14-16-18-20-22-24-26-28-30-34-38-40 s.w.g. 2/9, 3/-, 3/3, 3/6, 3/9, 4/-, 4/3, 4/6, 4/9, 5/3, 5/9, 6/- per lb. Less than 1-lb. reel 3d. extra. 1 to 3-lb. reel 1/- extra. 3 to 6-lb. reel 2/6 extra. All reels returnable. Also D.C.C. wires, and many other interesting Radio and Electronic items. Lists 1d. S.A.E. Orders over 30/- post free.

MIDLAND INSTRUMENT CO.,
18, Harborne Park Road, Birmingham, 17.

R. A. ROTHERMEL LTD

are now able to supply their well-known Piezo Crystal Products, including:—

PICK-UPS, MICROPHONES, HEAD- PHONES, NEEDLE PRESSURE UNITS.

Descriptive leaflets and prices on application.

ROTHERMEL HOUSE, CANTERBURY ROAD, LONDON, N.W.6.

VOIGT

WE look forward to the restoration of our pre-war right to go ahead in our own way and improve the standard of reproduction.

VOIGT PATENTS LTD.

15, SILVERDALE, LONDON, E.E.26

RADIO BATTERY TESTER

Use "Quixo" method of battery testing.

Reliable results. Guaranteed.

Send for interesting leaflet R115 on battery testing.

RUNBAKEN · MANCHESTER 1



FOR
**VACUUM
IMPREGNATION**
OF
**RADIO &
ELECTRICAL
COMPONENTS**
CONSULT
**GRIFFITHS BROS.
& Co., LONDON LTD.**

**VARNISH MANUFACTURERS
&
SPECIALISTS IN
IMPREGNATION**

**MACKS RD., BERMONDSEY,
LONDON, S.E.16. BER. 1151**

**YOU •
can become
a first-class
RADIO
ENGINEER**

We are specialists in Home-Study Tuition in Radio, Television and Mathematics. Post coupon now for free booklet and learn how you can qualify for well-paid employment or profitable spare-time work.

T. & C. RADIO COLLEGE
North Road, Parkstone, Dorset

(Post in unsealed envelope, rd. stamp)
Please send me free details of your Home-Study Mathematics and Radio courses

NAME.....

ADDRESS.....
W.W.44.

RADIO.—Repairers and testers urgently required. sound knowledge of modern radio receivers.—State wages & experience, Box 4312

COMPETENT repairing radio engineer, whole or part time; top pay; N.W. London; immediate; exc. conditions.—Box 4203.

RADIO testers conversant with superheterodyne receivers and audio amplifiers.—Apply personally to the British Capehart Corporation, Ackmar Works, Ackmar Rd., Parsons Green, S.W.6. [4238]

SERVICE engineer for leading makers of valve deaf aids; good knowledge of i.f. amplification essential; progressive post for man with drive and initiative; state experience and salary required.—Box 4358. [4348]

RADIO mechanics required for test and calibration work on communications measuring equipment; responsible positions with good prospects; Inter B.Sc. standard or considerable practical experience.—Box 4455. [4407]

DEPARTMENTAL manager required by company, West Country area, to take charge of large-scale loudspeaker production; applicants must have extensive experience in similar capacity.—Write details of qualifications, past experience, etc., to Box 4025. [4299]

HEAD foreman for coil winding department required by company engaged in large-scale manufacture of light to medium electrical products, West Country area; applicants must have extensive experience similar capacity with firms of repute.—Write full details of qualifications, past experience, Box 4024.

RADIO service engineers required; used to modern test gear, visual alignment, etc., in service department; excellent conditions and wages right men. Also electrician, good opportunity for capable practical man to take charge of and develop electrical dept of well-established firm.—Belding & Bennett, Wallington, Surrey. 'Phone: 7600. [4389]

RADIO service engineers for vacancies at Hayes, Middlesex and London, and also refrigeration service engineers for vacancies at Hayes, are urgently required by E.M.I. Service, Ltd., Sheraton Works.—Write, giving fullest details of training and experience, together with salary required, to Personnel Department, Gramophone Co., Ltd., Hayes, Mdx.

DESIGNER draughtsman required, experienced in design and development of light electro-mechanical apparatus, experience of communications laboratory gear preferred, knowledge of workshop practice and production problems essential; must be capable of working on own initiative.—Apply, stating age, qualifications, salary, etc., Box 4452. [4403]

TELEVISION and radio development engineers and draughtsmen required for progressive growing firm, with good prospects; similar experience essential; class A release men welcomed, our own employees have been notified.—Write fully, in confidence, giving age and salary required, to Personnel Officer, R. F. Equipment, Ltd., Amersham, Bucks.

LINAGLOW, Ltd., require a sales manager for their mail order trade and in connection with the sale of test equipment to manufacturers, etc.; applicants must have technical or good practical knowledge of test equipment and all types of radio components; previous experience of mail order trade an advantage; will also be required to assist in buying of raw material; a connection with manufacturers will be an asset; good salary; permanent and progressive post; no callers please.—Apply in first instance in writing, with full qualifications, to 2, Highgate High St., London, N.6. [4334]

OVERSEAS inspectors.—Radio Telegraph Government Posts and Telegraphs Department for one tour of 12 to 24 months in the first instance. Salary £600 a year plus local allowance £24 a year. Separation allowance for married men between £72 and £192 a year, according to number of children. Outfit allowance £60. Free quarters and passages. The duties of the post are those of a construction foreman engaged on the installation of radio diffusion or relay systems, including fitting central receiving stations with diversity reception receivers, lines and apparatus. Candidates should preferably have had experience with a company operating radio relay services in England or elsewhere. A sound practical knowledge of radio reception apparatus is of more importance than experience in underground and overhead distribution.

WRITTEN applications (no interviews) giving the following essential details (1) Full name; (2) Date of Birth; (3) Industrial training and experience; (4) Name and address of present employers; (5) Details of present work should be sent to The Secretary, Overseas Manpower Committee (Ref. 1436), Ministry of Labour and National Service, York House, Kingsway, London, W.C.2. Applications cannot be acknowledged. [4302]

R.A.F. RADIO!

We have secured a tremendous quantity of receiver chassis, components and other types of radio gear from the R.A.F. Below are just a few examples. Offered at a fraction of their cost.

R.1155. RECEIVER CHASSIS. Absolutely packed with valuable components. Total value of individual components nearly £15. Many experimenters have added valves and thus completed receiver. Includes 3-gang .0005 condenser, large-scale dial calibrated from 7.5 mc/s to 1,500 kc/s 7 variable switches, variable resistances, coils, chokes, condensers and fixed resistors of every type and value, coils, trimmers, etc., etc. All stamped "Air Ministry" and made to their stringent specifications. £5.

R.1125B. RECEIVER CHASSIS. 2 7-pin ceramic valveholders, 8 condensers, 8 resistors, 2 transformers, coils, plugs, sockets, etc. All on totally enclosed metal chassis. All to Air Ministry specifications. 17/6.

R.A.F. 3-GANG CONDENSERS. Same as used in R.1155 chassis. .0005 mfd. 12/6.

R.A.F. MIDGET VOLUME CONTROLS. 100,000 ohms. 1/9 each or 16/- doz.

R.A.F. TWIN VOLUME CONTROLS. 500,000 ohms each section. 5/6 each.

R.A.F. 2 mfd. CONDENSERS. Mansbridge type, 500 v. wkg. 1/3 each.

R.A.F. TUBULAR CONDENSERS. .1, .15 and .25 mfd. 350 v. wkg. 7/6 doz.

R.A.F. TUBULAR CONDENSERS. Metal-cased. .1+1+1 mfd., 500 v. wkg. 2/3 each.

R.A.F. TUBULAR CONDENSERS. .5 and .25 v. 350 v. wkg., with short wire ends. In 95 lots only. 5/6.

R.A.F. .02 MPD. CONDENSERS. 1,000 v. wkg., 7/6.

R.A.F. SELECTOR SWITCHES. Useful for remote control. 21/6.

R.A.F. 10-POINT DEWAR SWITCHES. 2/6.

R.A.F. PARCEL 1. Six each .1, .15, .25 mfd. Tubular Condensers, three .1+1+1 mfd. Tubular metal-cased, three Midget Volume Controls, 100,000 ohms, two Toggle Switches. 20/-.

R.A.F. PARCEL 2. Twelve each .1, .15, .25 mfd. Tubular Condensers, six Midget Volume Controls, 100,000 ohms, three Volume Controls, one gross 6 BA Nuts and Bolts, one gross 4 BA screws, one gross Rivets. 30/-.

ALL THE ABOVE ARE EX-R.A.F.
It will pay you to call and see our stocks, which are too numerous to advertise in detail.



**MULTI-RANGE
Moving Coil
TEST METERS**

New. First-grade army type in bakelite case. Ranges: 10, 50, 100 and 500 volts at 1,000 ohms per volt A.C. and D.C. 1, 10, 100 and 500 mA and **£8.15.0** 0-10,000 ohms.

MOVING COIL INSERTS. Originally manufactured as Moving Coil Headphones. Can be used as Midget Loudspeakers (with a suitable transformer), Speech Microphones, or adapted for Pick-ups. A powerful Alni P.M. energises the juu. coil, in sealed metal case. 1 1/2" diameter. 8/9 each, post free.

LOUDSPEAKERS, less transformers. Rola. 6iu., 19/6; 8iu., 21/6.

NEW MAINS TRANSFORMERS. Superior quality. 300-0.300 v., 6.3 v., 3 amp., 5 v. 2a. Also 300-0.300 v. 4 v. 3 a., 4 v. 2 a. Dim. 3 1/2 x 3 1/2 x 3. Weight, 4 1/2 lbs. Blue enamel finish. 24/6 each.

15 WATT P.A. AMPLIFIERS. Output 15 watts, 5 valves, 200-250 A.C. Pre-amplifier for microphone, gramophone and radio terminals. Multi-range output 2.5 ohms to 15 ohms. Fitted two volume controls and tone control. In black enamelled metal cabinets. **£16 10s. 0d.** (12in. P.M. VITAVOX Speaker 27 extra.)

ELECTRO-MAGNETIC COUNTERS, Ex-G.P.O., every one perfect, electro-magnetic, 500 ohm coil, counting to 9,999, operated from 25 v.-50 v. D.C. Has many industrial and domestic applications. 6/-

**LONDON READERS
SHOULD CALL AT**

**LONDON CENTRAL
RADIO STORES**

23, LISLE STREET, W.C.2
GER. 2969. Closed Thurs. 1 p.m.
Open all Sat.

OPPORTUNITY for practical man with initiative and good sound knowledge public address and l.f. relay work; knowledge microphone technique & capable assisting with stage production an advantage.—Box 4315.

DRAUGHTSMEN (3) required immediately by leading radio manufacturers in South-East London area for design department working on radio and television equipment; previous experience essential.—Write, stating age, experience and salary required, to Box 7902, A.K. Adv., 212a, Shaftesbury Ave., W.C.2.

SITUATIONS WANTED

EX-W.A.A.F. wireless mech. seeks prog. post. any district.—Box 4437. [4397]

SERVICE eng., radar, radio, V.H.F. and sound films; 3½ years' tech. instructor R.A.—and R.E.M.E., seeks progressive and responsible post.—Box 4458. [4414]

R.A.F. Sgt. wireless mech., 17 yrs' experience radar, servicing, design test gear, specials, etc., good driver, desires progressive sit.; release Group 26.—Box 4436. [4396]

STUDENT, returning to studies, release from S.R.A.F. within 6 mths., seeks part-time work, London area; eventually to study radio, willing to consider anything meanwhile.—Box 4213.

BUYING, progress and stores control.—Man, age 32, thoroughly experienced, with 12 years' continuous in radio and electrical industry, seeks responsible position.—Box 4414.

WELL-KNOWN pre-war qualified radio service manager, long exp. manufg., advertising, servicing organisations, free R.A.F. Dec., seeks responsible pos., pref. London.—Box 4413.

RADIO engineer, 36, at present in charge development dept., desires change; 15 years' manufacturing experience; would consider position production or test at suitable salary.—Box 4435. [4392]

TECHNICAL signals officer R.A.F., age 29, seeks progressive post; used to control large staff, not afraid of responsibility; studying graduation B.I.R.E.; release early December.—Box 4371. [4366]

CAPTAIN R.E.M.E. (telecommunications officer), released, seeks executive position with reputable radio manufacturer; 10 years' pre-war experience radio trade, with business connections Hants, Dorset & Som.—Box 4139.

SERVICE engineer, 5 years R.A.F. radar mechanic, 10 years' pre-war servicing experience, desires position as service manager with retail firm where plenty of work available; free on November.—Box 4352. [4349]

A SMALL team of electronics engineers, with wide experience of communications, radar, television and test gear, wish to contact a progressive manufacturer requiring technical staff with ideas, keenness and drive.—Box 4415.

LIEUT. (sp) R.N.V.R., age 29 years, Group 28, engaged on electrical and radio duties since 1940, desires situation as sales representative with established firm; 5 years' pre-war experience in general electrical and radio trade.—Box 4172. [4317]

QUALIFIED electronic engineer, pre-war radio and television development, 6 years signals and radar in R.A.F. (rank Sqd. Ldr.), desires responsible appointment requiring 1st-class technical knowledge & organising ability, with established firm; release Jan.—Box 4366.

NAVAL mechanic (early release), interested in mercantile or airway corporations developing commercial Radar, capable of maintenance, operational training and supervision; pre-war commercial experience adaptable to new trade and new conditions.—Box 4261.

R.A.F. tech. sigs. officer, age 27, available by Christmas; 6 years full time education in radio and electrical subjects (pre-war), Nat. Cert. E.E., specialist in telecommunications, widely experienced technically (transmission, reception, land-lines, all freqs.); interviews welcomed.—Box 4296. [4336]

NEW Zealand technician with 15 years' radio experience gained in business management, manufacture, testing, installation, repair and servicing British, American, Aus. tralasian radio apparatus, together with 4 years' radar theory, practice and administration in R.A.F., desires responsible permanent position with makers or distributors of acoustic, radar, radio, cathode-ray or other electronic devices.—Box 4461. [4428]

R.A.F. officer, 37, well educated, at present i/c large radio servicing section, due for discharge December, excellent practical, administrative and organising experience, ex-H.M.V., Philips, etc., qualified wireless and D/F theory instructor, chief service engineer series of large London stores, will consider offers where ability and genuine effort will command a good salary and prospects of advancement: home or overseas: can service, sell, design, construct, hold P.M.G. transmitting licence, knowledge television.—Box 4417.

ELECTROLYTIC CONDENSERS

ALL NEW AND TESTED BY WELL-KNOWN MANUFACTURERS.

8 mfd., 450 v.w. 3/6 8 mfd. wet can, 450 v.w. 6/6
8 mfd., 500 v.w. 4/6 16 mfd. wet can, 450 v.w. 7/6
8+8 mfd., 450 v.w. 5/9 32 mfd. wet can, 350 v.w. 7/6
8+8 mfd., 500 v.w. 6/9 16+16 mfd. Tub, 250 v.w. 6/9
8+8 mfd., 150 v.w. 3/6 16+8 mfd. Tub, 450 v.w. 7/9
4 mfd., 650 v.w. 5/9 500 v.w. 2/9 3/-
1/2 and 2/9.

Only a few examples of our extensive stocks.
.1 mfd., .01 mfd., .05 mfd., .02 mfd. and .004 mfd.
400 v.w., 81d., 8/- doz.

P.M. SPEAKERS, 3 ohms Voice Coil, Rola, 5", 21/-;
6", 22/6; 8", 23/6; 10", 35/-. All less trans.
Goodmans, 3", 21/6; 5", 22/-; 6", 23/6; 8", 23/6.
Less trans. Goodmans, 12", 15 ohms Voice Coil, large
Magnet. 28 15s. CELESTION, 6", with trans.,
27/6; 21", 21 7s., less trans. R. & A., 10",
with trans., 39/6; Plesey, 8", with trans., 26/6.

EMERGED SPEAKERS, 2,000 Ω and 1,000 ohm.
field, 6", with trans., 32/6; 8", with trans., 35/-
Magnavox and Celestion. Other types in stock.
Prices on application. **OUTPUT TRANSFORMERS**,
Midget type for pentode 5/9. **UNIVERSAL MULTI
RATIO**, 7/6 and 8/6. Rola Universal Multi ratio, 12/6
and 14/6. **VALVES**—We have stock over 6,000 Mains and
Battery types. Mullard, Bruhat, Cossor, Okram,
Marconi, Mazda, etc. Also most types of American
(T.T. & Metal types, at B.O.T. prices).

COILS—Medium wave, high rain coils, 5/6, 6/6 and
7/6 pair. Medium and long wave coils, with reaction
5/6 pair.

SERVICE KIT—36 assorted Resistances and 36
assorted Condensers, including 1, 8 mfd., 450 v.w. and
1, 8+8 mfd., 450 v.w., 22 12s. 6d., post free.

MAINS TRANSFORMERS—Mains standard, 350-0-
350, 75 m/a, 4 v., with feet, 29/6. Mains standard,
350-0-350, 75 m/a, 5.3 v., with feet, 32/6. Larger
or smaller types. Price on request.

Midget Smoothing Chokes, 500 Ω , 60 m/a, 6/6.
Line Cord, 2 amp. and 3 amp., 2-way and 3-way
2/6 and 3/- yd.

TERMS—Cash with order, C.O.D. or Pro Form.
No. C.O.D. under 21.
Send us your requirements and queries.
Satisfaction guaranteed. Order of 25 and over
post free.

Send 1d. for our latest List.
LASKY'S RADIO
364 & 371 Harrow Rd., Paddington, W.9
(Opp. Padd. Hospital). Phone: Cunningham 1979

BERRY'S
(SHORT WAVE) LTD.
A MOST COMPLETE
LIST W.W.
OF
**RADIO & ELECTRONIC
EQUIPMENT**
will be sent on receipt
of stamped envelope
25, HIGH HOLBORN, LONDON, W.C.1
(Tel: HOLBORN 6231)

**BATTERY CHARGERS and
TRICKLE CHARGERS**

Trouble-free Chargers fitted with selenium all-metal rectification. Good allowance on your old Charger. Thirty years experience behind every Runbaken product. Booklet R.15, describing 12 Models, on request.

RUNBAKEN-MANCHESTER

**TRANSFORMERS & COILS
TO SPECIFICATION.**
MANUFACTURED or REWOUND.
STANLEY CATTELL LTD.,
9-11, East Street, TORQUAY Devon.
Phone: Torquay 2102.

BATTERY CHARGERS and TRICKLE CHARGERS

Trouble-free Chargers fitted with selenium all-metal rectification. Good allowance on your old Charger. Thirty years experience behind every Runbaken product. Booklet R.15, describing 12 Models, on request.

RUNBAKEN-MANCHESTER

TRANSFORMERS & COILS TO SPECIFICATION.

MANUFACTURED or REWOUND.
STANLEY CATTELL LTD.,
9-11, East Street, TORQUAY Devon.
Phone: Torquay 2102.

ADVERTISER, just released Forces, 7 years sales and service experience radio and electrical trade, 4 years signals instructor R.A.F., experienced in maintenance of V.H.F., G.P.T.S., P.A. equipment, desires technical situation or position as radio sales and service manager.—Box 4459.

CHIEF instructor service radar school (senior rank), industrial experience and high qualifications in electrical and radio engineering, first-class lecturer and organiser, desires responsible post in modern technical institution or instructional organisation; release January.—Box 4367. [4362]

TECHNICAL executive, age 28, university, 3 yrs development labs, 2 yrs organising radio development for Govt. Dept., general experience transmitters, receivers, D/F, navigational aids, recording, industrial electronics, radio control, seeks job demanding energy and responsibility, good tech. correspondent; free Jan.—Box 3997. [4296]

GREAT possibilities exist for technically qualified engineers, key men in wartime and afterwards. Through the home-study courses of The T.I.G.B. take a recognised engineering qualification, such as A.M.I.Mech.E., A.M.I.E.E., A.F.R.Ae.S., A.M.I.Chem.E. C and etc., etc. in which examinations the T.I.G.B. students have passed. WRITE TODAY for "The Engineer's Guide to Success"—free—containing the world's widest choice of engineering courses covering all branches, including aeronautical, mechanical, electrical, wireless, chemical, etc.

**THE TECHNOLOGICAL INSTITUTE OF
GT. BRITAIN**, 82, Temple Bar House, E.C.4

PATENT AGENTS
A. E. HILL, chartered patent agent, 27,
Chancery Lane, London, W.C.2 [4368]

WANTED! a going concern, retail wireless shop, anywhere in London.—Box 4297.

RADIO receiving set manufacturers, sound and electrical engineers' business for sale, going concern with a turnover of £10,000 per annum (audited accounts); substantial contracts in hand; fully licensed for production and manufacture of all types of radio, sound and electrical equipment, complete plant; price £25,000 all at; genuine reason for sale.—Phillip L. Causley & Co., 20, Grosvenor Place, S.W.1. Sloane 7952. [4318]

WORK WANTED.
COIL winding, vacuum-pressure impregnating.—Godfrey Industries, Ltd., Brundall, Norfolk. Tel. 90. [3604]

DESIGN and development.—We have facilities particularly suited to this class of work, A.I.D. approved.

ENQUIRIES to: Green Electrical Industries, Ltd., 44-45, Tamworth Rd., West Croydon, Tel. Croydon 7417-8. [4400]

WIRELESS and loudspeaker cabinets manufactured to special design of each customer.—Birney Smallwood Products, Ltd., Swan Works, Fishers Lane, London, W.4.

CAPACITY for radio presswork of all kinds, chassis, brackets, transformer legs, formers, etc.; power and fly presses.—S.A.R. (Steel), Ltd., Cobham, Surrey. Tel. 2569.

8 designers and manufacturers of coils, chokes, transformers, output transformers, wave wound coils, relay coils, fluorescent lighting chokes, etc., of all types, we are able to offer you competitive prices and good deliveries.

SEND your enquiries to Green Electrical Industries, Ltd., 44-45, Tamworth Rd., West Croydon, Tel. Croydon 7417-8. [4399]

IMMEDIATE capacity available for manufacture of transformers, chokes, coils, wave winding, solenoid and relay coils of all types to standard specifications; trade enquiries invited; good deliveries; competitive prices.

GREEN ELECTRICAL INDUSTRIES, Ltd., 44-45, Tamworth Rd., Tel. Croydon 7417-8.

OLD-ESTABLISHED firm of electrical and mechanical engineers, with works situated 12 miles from London, desire to contact with companies requiring manufacture of all kinds; departments include centre lathe turning, capstan, milling, shaping, piece part stampings, bakelite and injection moulding and assembly; excellent drawing office and tool room are available for complete design and manufacture of electrical and mechanical components of all kinds; enquiries are invited from principals only, with a view to utilising this capacity for post-war markets.—Box 3595.

WEBB'S radio map of the world locates any station heard, size 40x30in. 4/6, post 6d.; on linen, 10/6, post free.—Webb's Radio, 14, Soho St., W.1. Gerrard 2089.

PRIMER ON RUBBER BONDING

NUMBER

11

IN SERIES

An Aero-Engine Mounting required the following characteristics:

FLEXIBILITY was needed to insulate the airframe from—

- (a) Torsional movements of engine about longitudinal C.G. axis.
- (b) Vertical forces and couples in the vertical plane.

STIFFNESS was needed to prevent—

- (a) Fore and aft movement of engine due to airscrew "pull" which would upset control settings.
- (b) Transverse "yawing" of engine.

SPACE WAS LIMITED—therefore a multi-bush type of mounting was adopted.

PRECAUTIONS had to be taken to limit the vertical shear movement.

As Moulded

Simple three-bush
moulding.

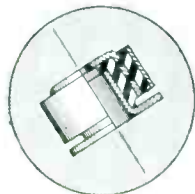

As Assembled

Two mouldings
with loose central
tube.

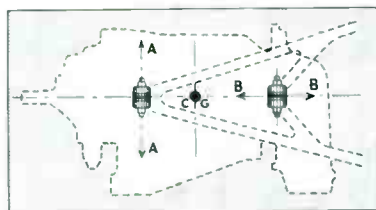
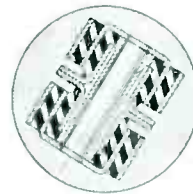

As Installed

Vertical shear movement in
direction of arrow "A" (limited
by stops); horizontal com-
pression movement in direction
of arrow "B" (high resistance).

*You may wonder whether a bonded product would solve
your problem. We should know—if you asked us.*

R R 34



RUBBER BONDERS LTD.

ENGINEERS IN RUBBER BONDED TO METAL

FLEXILANT WORKS · DUNSTABLE · BEDS.



Weather Forecast . . .

High in the sky . . . above the clouds . . . soars a balloon . . . automatically sending by radio, data on the always topical weather.

The meteorological stations are regularly releasing these upper-atmosphere mobile transmitters to predict the future weather.

Standard Mazda Valves are used in these balloon transmitters and once again their reliability is proved by the use in a device where, when the balloon has ascended, it is obvious that an engineer cannot be sent to change a faulty valve.

The same care and thought go into the Mazda Valves in your set.

**THE MOST FAMOUS
SET MAKERS FIT -**

**MAZDA
RADIO VALVES**



The Edison Swan Electric Co. Ltd., 155 Charing Cross Road, London, W.C.2