

Wireless World

RADIO • ELECTRONICS • ELECTRO-ACOUSTICS



AUG. 1943

1/3

Vol. XLIX. No. 8

OHMMETER DESIGN ♦ CALIBRATING A-F OSCILLATORS

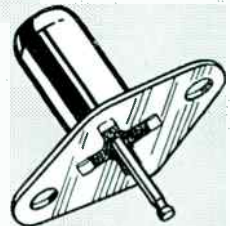
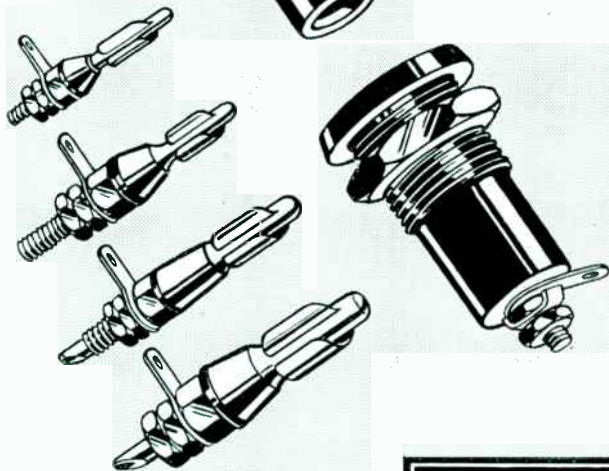
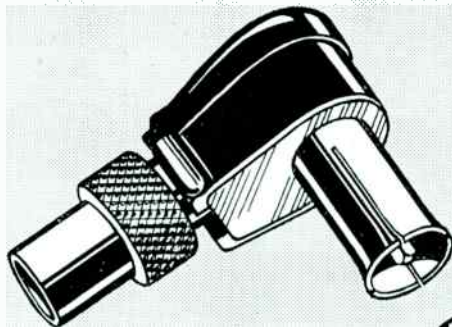
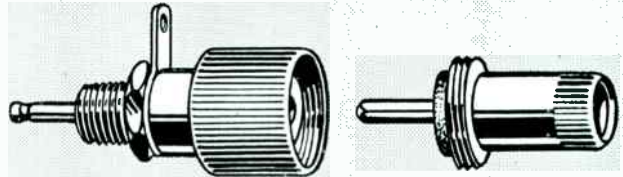
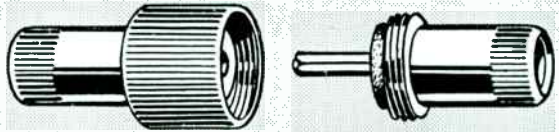
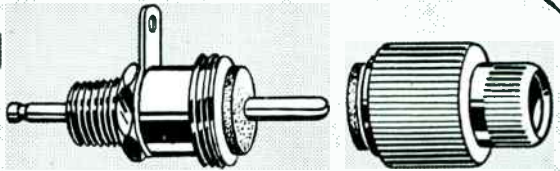
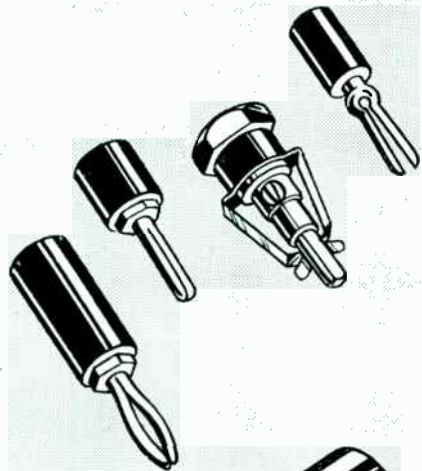
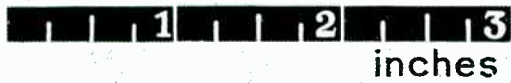

BELLING & LEE LTD
CAMBRIDGE ARTERIAL ROAD, ENFIELD, MIDDX

GA 6799

*Experts and
Experimenters Agree*

for **ACCURACY** rely on

AVO

Regd. Trade Mark

PRECISION
MEASURING
INSTRUMENTS

BRITISH MADE



The Model 7 Universal AvoMeter (illustrated) is a compact combination electrical measuring instrument of B.S. 1st Grade accuracy. Its 46 ranges cover A.C. and D.C. amperes and volts, resistance, capacity, audio-frequency power output and decibels. No external shunts or series resistances. Protected by automatic cut-out against damage through overload.

Some delay in delivery of Trade Orders is inevitable, but we shall continue to do our best to fulfil your requirements as promptly as possible.

In every sphere of electrical test work . . . in the laboratory, the workshop, the service engineer's bench or "out on a job," . . . the word "AVO" is synonymous with instruments of precision.

The "AVO" range embraces instruments for every essential electrical test. By reason of their reliability and maintained accuracy, even under the most searching of workshop conditions, they are frequently used as a standard by which other instruments are judged.

Write for literature fully descriptive of any "AVO" Instrument in which you are interested.

Sole Proprietors and Manufacturers :

AUTOMATIC COIL WINDER & ELECTRICAL EQUIPMENT Co., Ltd., Winder House, Douglas St., London, S.W.1

Telephone VICTORIA 3404/7

▲

On National Service WITH..



ROYAL ORDNANCE FACTORIES ★



AIRCRAFT WORKS ★



ASSEMBLY PLANTS ★



SCIENTIFIC INSTRUMENT MAKERS ★

... IN FACT, wherever a high-grade light lubricating and penetrating oil is required



is 'on the job'. 301 uses in Factory, Workshop and Office.

Enquiries to:

Sole Manufacturers:
A. S. BOYLE CO. LTD.,
Chenies Street, London, W.C.1

Trade Distributors:
ROLLINS & SONS (Ldn.) LTD.
107 Fleet Street, London, E.C.4

Electronic Engineering Services, Ltd.

24 STANLEY ROAD HEATON MOOR
STOCKPORT
TELEPHONE HEATONMOOR 3107

FOR AMERICAN EQUIPMENT

TRANSMITTERS AND RECEIVERS: A WIDE RANGE OF BOTH A.M. AND F.M. AVAILABLE. SPECIAL U.H.F. HIGH GRADE EQUIPMENT BUILT TO SPECIFICATION.

INSTRUMENTS: TEST GEAR OF NON-STANDARD TYPE BUILT TO SPECIFICATION.

MIDGET COMPONENTS: VALVES, CRYSTAL EARPHONES, VARIABLE & FIXED CONDENSERS, RESISTORS, CHOKES, ETC.

GENERAL: WE WELCOME ENQUIRIES FOR EQUIPMENT AND COMPONENTS UNOBTAINABLE IN THIS COUNTRY.

PRIORITIES ESSENTIAL.



FOR THE RADIO SERVICEMAN DEALER AND OWNER

The man who enrolls for an I.C.S. Radio Course learns radio thoroughly, completely, practically. When he earns his Diploma, he will KNOW radio. We are not content merely to teach the principles of radio, we want to show our students how to apply that training in practical, every-day radio service work. We train them to be *successful!*

Special terms for members of H.M. Forces.

.....You may use this Coupon.....

INTERNATIONAL CORRESPONDENCE SCHOOLS Ltd.
DEPT. 38, INTERNATIONAL BUILDINGS, KINGSWAY, LONDON, W.C.2

Please explain fully about your instruction in the subject marked X

Complete Radio Engineering. Radio Service Engineers.
Elementary Radio. Television.

And the following Radio Examinations:—

- British Institution of Radio Engineers.
- P.M.G. Certificate for Wireless Operators.
- Provisional Certificate in Radio Telephony and Telegraphy for Aircraft.
- City and Guilds Telecommunications.
- Wireless Operator and Wireless Mechanic, R.A.F.

Name..... Age.....

Address.....

1916



1943

It's happening in Radio, too!

Between Verdun and Tunisia is a great advance in weapons and technique. But while paratroopers fight in the public eye, the radio war goes on "behind the scenes." The benefits of modern development will not be seen until domestic radio sets are built again. Masteradio are looking ahead to that happy time and invite you to register NOW without obligation for post-war priority, stating home or car radio interest. Write to: Masteradio, Ltd., Watford, Herts.



★ One of a Series of Advertisements appearing in the National Press

MASTERADIO LIMITED • WATFORD • HERTS

SYMBOLS OF PRECISION



MICROSCOPE



MAZDA

RADIO
VALVES

THE EDISON SWAN ELECTRIC CO. LTD.



155, CHARING CROSS RD., LONDON, W.C.2

For full particulars write to Technical Service Department

*In all communications-
Condensers are at work*

TRADE **HUNTS** MARK

The
Home of Condensers

Advt. of A. H. HUNT LTD., LONDON, S.W.1B. Est. 1901

MALLORY VIBRATORS

IDEAS WILL POP FOR YOU

In the crucible that is war production, ideas pop into reality in bewildering numbers. Co-operative progress in techniques, in chemical, metallurgical and electrical applications of materials, has contributed astounding gains to man's control over Nature's resources. Comparatively few can have more than a vague notion of industrial accomplishment for the war effort. But the discoveries that have mechanised warfare and conquered the air, that have developed transportation and supplies to marvellous wartime results, represent ideas that will pop into an amazing variety of commercial contributions to post-war living standards.

P. R. MALLORY & CO. INC.
INDIANAPOLIS, INDIANA, U.S.A.
RADIO AND ELECTRONICS DIVISION

Represented exclusively in Gt. Britain by
FRANK HEAVER LTD., Kingsley Road, Bideford, N. Devon, Eng.

WRITE FOR
CATALOGUE
W.O./330

ADASTRA
RADIO MASTS
POLES LTD TYBURN RD ERDINGTON.
BIRMINGHAM. 24.

Enquiries should be accompanied by Government Priority Reference



one in a thousand

Ten years ago we introduced the first British-made low-loss ceramic. To-day the range of FREQUENTITE components covers more than a thousand pieces of every shape and size.

With such a store of manufacturing experience we are able to offer advice backed by practical knowledge on your insulation problem. Please consult us before you finalize your design.



STEATITE & PORCELAIN PRODUCTS LTD.

Head Office: Stourport-on-Severn, Worcs.

Telephone: Stourport 111.

Telegrams: Steatins, Stourport.

S.P.25

WEBB'S *Radio*

SPECIALISED RADIO COMPONENTS available from STOCK for Government work :

- Micrometers 0150 01100.
- Milliammeters 011 upwards.
Many readings. List available.
- Polystyrene rod, tube and sheet.
- Crystals and holders, oscillator and I.F. resonator.
- Concentric UHF Cable, Polystyrene bead insulators.

We give below a few items from our GENERAL STOCK :

- Tuning Coils. Wearite "P" Coils, full range available.
Price 2/3 and 2/6 each
- Pick-ups. Rothermel 58, Bakelite moulded tone arm 2 5 0
Plus Tax ... 1 13 9
- Condensers. Aerovox 40 mfd. 200 v. working wet electrolytic can type 4 6
T.C.C. type, F.W. 8 mfd. 500 v. Cardboard type (supply limited to two per customer for urgent repair work) 3 0
- Eddystone. 1027 Pointer Knobs and Dials ... 2 0
1044 Ditto 1 6
1013 Midget Condensers 5 6
1066 H.F. Chokes 10/2,000 metres 2 0
- Valveholders. Baseboard short-wave skeleton, low-loss construction on pillars—
British 4-, 5- and 7-pin all 1 0
British 4- and 5-pin Bakelite 1 0
British 7-pin Bakelite 1 6
- Shaft Couplers. Solid Brass, 3/16 in. bore with grub screws 3
- Ceramic Formers and Insulators. Heavy stand off for rod aerial support, 2 1/2 in. high, metal clamp for 3/16 in. rod... .. 2 6
Heavy stand off, 3 in. high, 2 in. base 1 6
Eddystone 1090 Former, 5 in. by 2 in. 5 0
Eddystone 916 Beehive stand off 1 1
Eddystone 1019 Midget stand off 6
Coil Formers, 1 1/2 in. long, 3/16 in. dia., 4 ribs, grooved 10 turns, winding length 3/16 in. ... 1 6
Coil Formers, 1 1/2 in. long, 3/16 in. dia., grooved 14 turns, winding length 1 1/2 in. 2 0
- Fuses. All values of standard type 1 in. cartridge fuses 6
Potentiometers. Wire wound, 400 ohms ... 4 6
I.F. Transformers. 465 kc/s Wearite I.F. Transformers 6 6
- Valves. Comprehensive stocks of British and U.S.A. types available for replacement purposes.

Additional charge of 1/- for postage and packing on orders below 10/-.

We welcome enquiries for anything appertaining to radio. Sorry no catalogue these days. Please let us have list of your requirements, we will price and indicate availability.

14 Soho Street, Oxford Street, London, W.1
Telephone : Gerrard 2089

We are available 9 a.m. till 6 p.m. for OFFICIAL business, but please note our SHOP HOURS—10 a.m. to 4 p.m. (Saturdays 10 a.m. to 12 noon.)



"THIS IS WHERE I COME IN" says Mark Cable

CONSULT US ON CABLE BINDING SYSTEMS WHEN PLANNING

SAVE TIME WITH
Hellermann
CABLE MARKERS

HELLERMANN ELECTRIC LIMITED
GOODTRIC WORKS, OXFORD. Oxford 2403

ROLA

LOUD
SPEAKERS

THE WORLD'S FINEST REPRODUCERS

TRANSFORMER
LAMINATIONS

Core Widths 1/16" to 1 1/2" (E's and I's.)

EIGHT STOCK SIZES

A Comprehensive Bulletin together with details of Associated Covers and Clamps with design data will be sent to manufacturers on request.

BRITISH ROLA LIMITED

MINERVA ROAD · PARK ROYAL · N.W.10 · WILlesden 4322

*For all practical purposes
Rubber is virtually incompressible*

THE capacity of rubber to absorb shock by *deformation* is frequently mistaken for a capacity to absorb it by *compression*. But, as these diagrams at the left show, the rubber before and during load, occupies the same volume—during load it is merely deformed.

BEFORE LOAD

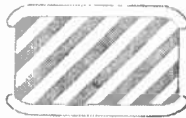

metal not bonded to rubber

UNDER LOAD



bad deformation

Used in this manner, rubber has in the past, possessed a value as an abutment for absorbing shock, but this capacity is much exceeded under the present practice of *scientifically using rubber in shear*, as shown at the right.

We specialise in the scientific application of rubber (and its synthetics) as an integral part of engineering systems for the control of all forms of vibration. This naturally involves the concomitant problems of bonding this rubber to metals—a science in itself without which, of course, these principles could not be exploited.

We further specialise in the solution of individual problems of shock and vibration and if we can help you, we shall only be too pleased to do so. Your enquiries will receive thorough attention.

BEFORE LOAD



UNDER LOAD



R.B.17

**RUBBER
BONDERS
LIMITED**

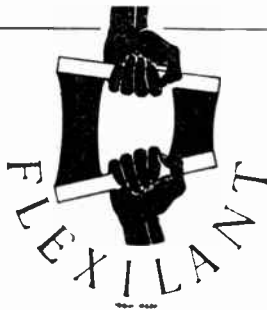

**ENGINEERS
IN RUBBER
BONDED TO
METAL**

FLEXILANT WORKS · DUNSTABLE · BEDS.

Telephone: Dunstable 715.

Telegrams: Flexilant, Dunstable



electronic briefs: **FM**

Radio is simply a method by which electrical energy is transmitted through space. By varying the intensity or frequency of this electrical energy, an intelligible signal can be created. The principle is the same whether dot dash code messages or voice and music are being transmitted. In the case of voice and music transmission the radio wave must be varied (modulated) at the same speed as the vibrations of the voice or music. The characteristics of electrical energy which can be varied or modulated are three: voltage, frequency and phase. Radio transmitters which vary the intensity (voltage) are called amplitude modulated and those which vary the frequency are called frequency modulated. The differences of these two systems can be understood easily by visualizing a beam of light. An audible signal can be transmitted by varying the light intensity (amplitude modulation) or by varying the color of the light beam (frequency modulation).

Static and other man-made electrical disturbances are identical in character to the amplitude modulated signal. Hence these disturbances are extremely bothersome to AM broadcasts. On the other hand these electrical disturbances do not essentially vary in frequency and consequently do not interfere with FM transmission. Another fortunate characteristic of FM is the fact that the nature characteristic of FM is the fact that the stronger of two signals predominates, thus eliminating much inter-station interference and cross-talk. Further, and of great importance, the fidelity of tone can be made nearly perfect even when the heaviest of musical scores is being broadcast.

In frequency modulation as in all things in the field of electronics, vacuum valves are the most important component. Eimac valves have the distinction of being first choice of most of the leading electronic engineers throughout the world. They are consequently first in the most important new developments in electronics... FM for example.



Army-Navy "E" flag awarded for high achievement in the production of war material.

Follow the leaders to

Eimac
VALVES

EITEL-McCULLOUGH, INC.
SAN BRUNO, CALIFORNIA

Export Agents: Frazar & Hansen 301 Clay Street, San Francisco, California

Between us windings
HY-MEG ... *makes Bigger & Better Production*

HY-MEG IMPREGNATING VARNISH V. 6934. Made specially for enamelled wire windings: but is equally suitable for Rayon and Glass-covered wire.

IMPEGNATORS of wire windings, especially fine wire, who are troubled with problems such as the attacking of enamelled wire or the failure of the impregnating medium under tropical service conditions, are advised to send for particulars of the new HY-MEG Process.

Briefly, HY-MEG provides complete impregnation with perfect through-drying by polymerisation even in the deepest and most complicated windings, and produces in shorter-than-usual stoving time a solid homogeneous plastic which safely withstands extreme working conditions and tropical heat. These facts are evidenced by the general Government approval of HY-MEG impregnated components. HY-MEG can be used with confidence in the knowledge that supplies are always available; both quality and quantity of your production will be improved.



Put YOUR Problem before our BRAINS TRUST Send us details of any particular insulation problem that is worrying you. The "bench of experts" whose research and wide experience created HY-MEG will be glad to elucidate it for you.

LEWIS BERGER & SONS LTD (Established 1760) LONDON E.9 'Phone: AMHerst 3321

MANUFACTURERS OF INSULATING VARNISHES AND ENAMELS

RIGHT: One of the large fleet of Daylight Mobile Cinemas covering the country on behalf of many Official campaigns. BELOW: Part of the interior of a Daylight Mobile Cinema showing the very latest 16 mm. Sound Film Projector.

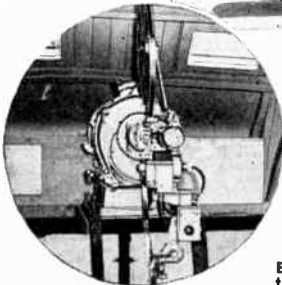

"We're taking the pictures to the family to-day!"

Every day of every week we are taking the pictures to the family... in the open air... in daylight... giving perfect projection! Naturally, this service is primarily used nowadays for the exhibition of Government films, but if you would like to know about the potentialities of the Mobile Cinema as it can affect your business we'll gladly send you full details.

BRITISH FILMS LTD.,
 Head Office: 199, Piccadilly, London, W.1. Regent 2828.
 Works: 260, High Rd., Balham, London, S.W. BATTERSEA 8506.



War-time installations show more conclusively than ever that
you can
trust
TRIX
 Quality SOUND Equipment
To priority order only

30 watt Amplifier Model T633

There are TRIX Amplifiers from 5-500 watts
 Send for details

TRIX ELECTRICAL CO. LTD., 65, Bolsover St., London, W.1.
 'Phone: EUS 6471/2. 'Grams: Trizadio, Wesdo, London.

◆ LINAGLOW LIMITED ◆

Unrepeatable Offer!!

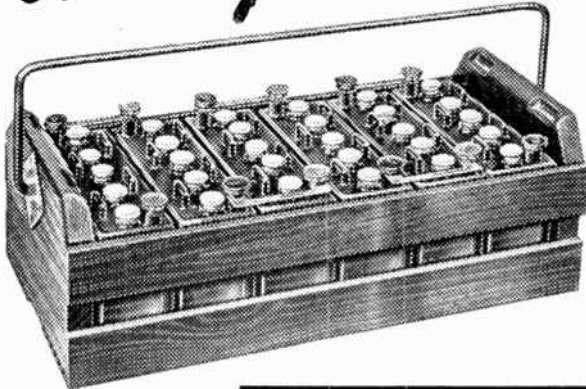

C.A.V. 60 VOLT H.T. ACCUMULATORS

TYPE G.103—5,000 m.a. at 1,000 hour rate, in strong carrying case with handle. Reconditioned as new, offered at less than pre-war price.

Size 17" x 8" x 6"—weight 40 lbs. Ideal for all types of radio sets, amplifiers, etc. Will last for years, much cheaper than continually replacing H.T. batteries which are also very difficult to obtain. Do not miss this opportunity, send your order now—limited stocks.

CARRIAGE **25/-** PAID EACH

VOLTAGE DROPPING RESISTORS AND LINE CORD REPLACEMENTS

suitable for every make of radio receiver, comprehensive ranges mentioned below.

950 ohm .2 amp. Chassis mounting, heavy duty on porcelain former, 2 adjustable tapings, 8/6 each; as above, 800 ohm, .3 amp., 8/6 each.

.2 amp. 675 ohm, tapped 100, 100, 425 and 50 ohms, suitable for Ekco and other makes, 4/- each.

.2 amp. 840 ohm, tapped 100, 100, 475, 115 and 50 ohm, for Ekco, etc., 4/-.

.2 amp. 945 ohm, tapped 100, 100, 100, 545 and 100 ohm, for Halcyon, etc., 4/6.

.2 amp. 510 ohm, tapped 60, 105, 85 and 260 ohm, for Coesor, etc., 4/6.

.2 amp. 690 ohm, tapped 150, 360, 120 and 30 ohm, for Pilot Little Maestro, etc., 4/6.

.3 amp. 547 ohm, tapped 80, 80, 387 ohm, for Ferranti, etc., 7/6.

.3 amp. 1,014 ohm, tapped 82, 82, 320 and 530 ohm, for Double Decca, 7/6.

.3 amp. 781 ohm, tapped 45, 45, 332, 166 and 193 ohm, for Ferguson, etc., 8/6.

.3 amp. 823 ohm, tapped 45, 45, 290, 166 and 277 ohm, for Ferguson, etc., 9/6.

.3 amp. 660 ohm, tapped 150, 360, 120 and 30 ohm, for Pilot Major Maestro, etc., 8/6.

SPECIAL HEAVY DUTY RESISTORS, 5-watt, for bias, etc., all values from 25 to 2,000 ohm, with copper clips, 1/9 each. Similar to above, but 10 watt, 2/3.

50 ohm centre tapped resistor, tapped at 25 ohm, for pilot lamps, 2/-.

.3 amp. **LINE CORD RESISTOR**, 360 ohm, 6/6; .3 amp. **LINE CORD RESISTOR**, with slider, any resistance obtained up to 750 ohm, 7/6.

SPECIAL MULTI-LINE CORD RESISTOR, 5 tapings 50 ohm, 1 tapping 750 ohm, with slider, .2 amp., 8/6.

RADIO MECHANIC'S SCREWDRIVERS. Set of three, bright steel shaft, insulated handles, 7/6 per set.

TUBULAR PAPER CONDENSERS, 350-500v., D.C. Working. .00005, .0001, .0003, .0006 mfd., 4/- doz.; .001, .0015, .002, .003, .004, 6/- doz.; .01, .025, .03, .05 mfd., 7/- doz.; .08, .1 mfd., 12/- doz.; .15, .2, .25, .3 mfd., 15/6 doz.; .5 mfd., 18/- doz.; or assorted parcel of 50 for 27/6. Minimum orders, 1 doz., any type.

MAINS TRANSFORMERS, 200/250, 350-0-350, 4v., 6 amp., 4v., 3 amp., 120 m.a., 6.3v., 3 amp., 5v., 2 amp., 37/6 each.

LOUDSPEAKER TRANSFORMERS. Philips Pentode 45 m.a., 5/6; Heavy Duty multi-ratio, 100 m.a., 12/6; Heavy Duty Pentode, 100 m.a., 10/6; Universal Output and Push-Pull, 100 m.a., 12/6; Push-Pull Output, 120 m.a., 15/-.

LOUDSPEAKERS. Rola P.M., 3 ohm voice coil without transformer, 5in., 21/-; 6in., 22/6; 8in., 25/6. Any of the above can be supplied with pentode output transformer at 10/6 extra. With multi-ratio at 12/6 extra.

R.G.D. 10in. ENERGISED M.C. SPEAKER. 1,200 ohm field, 2.5 ohm speech coil, corrugated cone, without transformer, 30/-; with heavy duty multi-ratio matching transformer, 42/6.

3in. GOODMAN P.M. LOUDSPEAKER. Extra heavy magnet for Midgets and communication Sets. Price 25/6 each.

FIXED CARBON RESISTORS. Wire ends, assorted and useful values. 1/2-watt, 24/-; 1-watt, 30/-; 1-watt, 36/-; 2-watt, 55/- per 100. Minimum orders, 50 assorted. Assorted parcel for £3. Contains 25 1/2-watt, 50 1-watt, 50 1-watt, 25 2-watt, 10 3-watt.

SCREENED INTERLACED FLEXIBLE MICROPHONE CABLE. Pre-war quality, single, 1/3 per yard.

DPDT SWITCHES, panel mounting, P.O. type, 2/6 each.

VOLUME CONTROLS. 5,000, 10,000, 25,000, 50,000, 100,000 ohm; 1/2, 1, 1 and 2 megohm, without switch, 4/9 each. As above, with switch, 6/9 each.

CYCLE DYNAMOS, complete with brackets for fitting and leads. Special Offer, 18/9 each.

AUTO-TRANSFORMERS. Step up or down, 110/210/220/240v., 100-watt, 32/6.

FLAT FLEX, 9-way, 14/30, 18/20ft. length, suitable for amplifiers, extension speakers, remote control and many other purposes. Finest quality pre-war manufacture, 7/6 per coil.

VALVES

LEASE-LEND AMERICAN TYPES AT B.O.T. CONTROLLED RETAIL PRICES. FOR REPLACEMENT PURPOSES ONLY

1H5, 6F5, 6J5, 12F5, at 9/2; 1A5, 1C5, 1T5, 5Y3, 25Z6, 35Z4, 35Z5, at 11/-; 6Q7, 12Q7, 12SQ7, at 11/7; 6I6, 6J7, 6K7, 12J7, 12K7, 12SJ7, 12SK7, 25A6, 26L6, 35L6, 36, 47, 50L6, at 12/10; 6A8, 6SA7, 12A8, 12SA7, at 14/-; 12A7, 25A7, 32L7, 70L7, 83, at 15/3. *6V6 at 12/10.

Also British Valves at Manufacturers List Prices. AC/ME, at 10/6; UU6, UU7, at 11/-; TDD4, at 11/7; AC/VP2, CL4, EF39, KTW61, VP41, at 12/10; AC/TP, ECH3, FC13, X03, X05, at 14/-; KT33C, at 14/8; EL35, at 18/4.

All above prices include Purchase tax.

All Orders taken in Strict Rotation.

Cash with Order or C.O.D. Add 3d. per valve postage.

***POST OFFICE PERMIT MUST BE OBTAINED TO PURCHASE THIS VALVE**

HUMDINGERS. 30, 25,000 and 50,000 ohm, 6d. each.

L.F. CHOKES. 20 hys., 100 m.a., brand new, 16/9.

ALUMINIUM SCREENED AERIAL COILS. Bargain Offer, 6 assorted for 15/-.

WALNUT VENERED LOUDSPEAKER CABINETS. Modern design, fitted silk and baffle, 35/- . As above, but complete with 8in. P.M. speaker, 55/-.

◆ PLEASE NOTE ◆

◆ **CALLERS** to Show Rooms, 61 HIGHGATE HIGH ST., N.6
Phone: MOUnview 9432.

When ordering replacement parts for American or British Radios, please state Model No. and, if possible, forward faulty component with your order.
2jd. stamped addressed envelope must accompany all enquiries.
C.O.D. or CASH WITH ORDER.

◆ **POST ORDERS** to Dept. M.O.3, 3 HAMPSTEAD LANE, N.6.

LONDON CENTRAL RADIO STORES

MAKE AND BREAK UNITS



Ex famous manufacturer, brand new electromagnetic make and break relays to operate on 1½ volts at 15 m.a. ... Price **5/6**
Postage 4d. extra.

CHASSIS



As illustrated, 12 x 4½ x 2½ in., drilled for 5 valves, etc. Enamelled blue. ... Post, etc., 7d. ... **4/-**
Also 11½ x 7 x 2½ in., drilled for 9 valves, etc. ... **3/6**
Post, 7d. ...
12 x 9 x 3 in., drilled for 5 valves, transformer, etc. ... **5/6**
Post., etc., 10d. extra.

MERCURY SWITCHES (Brand New)

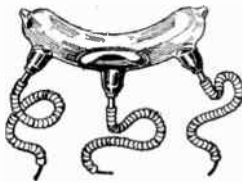

These switches are of the best manufacture and not easily obtainable to-day. Quick make and break and will carry 5 amps. Many hundreds of useful applications. Small quantity to clear. Price ... **8/6**
Post., etc., 6d.

OAK VIBRATOR UNITS — Synchronous
Input 6 volts. Output 250 volts 60 m.a. approx. These well-known units are fitted with 6-pin American bases... **15/6**
Post., etc., 8d.



ELECTRO-MAGNETIC COUNTERS

500 ohms. coil. Counting up to 9,999. Operating from 25 v. to 50 v. D.C. Many industrial and domestic applications. (S.H., ex-G.P.O., all perfect.) Post- **5/6**
age 9d.

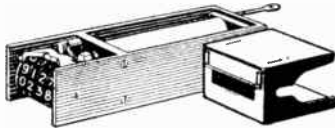

YAXLEY Type WAVE-CHANGE SWITCHES

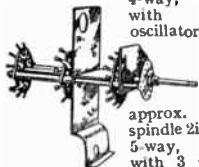

4-way, 3-bank, with shielded oscillator section. Length from stop plate approx. 5 in., spindle 2in. **5/6**
5-way, 6-bank, with 3 screened sections, adaptable to many uses. Length from stop plate approx. 6½ in., spindle 2in. **6/6**
3-way, 3 double banks, without shields, 2in. spindle. Length 6½ in. **5/6**. Post., etc., 9d. each.

YAXLEY PATTERN SWITCHES

5-way, single-bank, with on-off mains switch, carrying 1 amp. at 250v., 2in. spindle with knob **5/6**
3-way, single-bank, 1in. spindle, with knob ... **2/9**
Post., etc., 6d. extra.

OAK SWITCHES



2½ in. spindle, complete with knob.
4-way, 2-bank, with connecting block ... **4/6**
4-way, 2-bank ... **3/9**
Post., etc., 6d.

LOUDSPEAKERS
ROLA 5in. P.M. less **22/6**
transformer ...
Post. and pkg., 1/6 extra.
ROLA, 8in., less trans- **24/-**
former ...
CELESTION 8in. P.M. Pentode Output, with transformer. New ... **29/6**
Post., etc., on above, 2/- extra.

EX-BAIRD High Voltage TELEVISION TRANSFORMERS

6,000 v. approx. Fitted with Porcelain insulated terminals, as illustrated. Size 3½ x 6½ x 3½. Post., etc., **20/-**
4,000 v. approx. Size 4in. x 3½ x 3½. Post., etc., 1/6 ... **10/6**

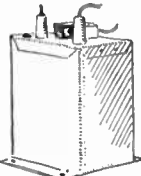

EX-GOVT. POTENTIOMETERS
Wire-wound. In bakelite case, 50,000 ohms. 2in. dia. x 1in. Without knob. Post., etc., **5/6**
6d.

OIL-FILLED CONDENSERS

0.1 mfd. 5,000 D.C. working. With porcelain insulated terminals. Size 2½ high x 3½ x 2in. Post., etc., **10/6**

23, LISLE STREET, LONDON, W.C.2

Phone—GERrard 2969

DAGENITE

AND

PERTRIX

— the dependable

BATTERIES



FOR
RADIO, CARS
MOTOR CYCLES
COMMERCIAL
VEHICLES
ETC.

Sales Concessionaires:
HOLSUN BATTERIES LIMITED

137 Vicsoria Street, London, S.W.1

• • • 42

HIVAC

THE SCIENTIFIC VALVE

BRITISH MADE



Specialists in

MIDGET VALVES

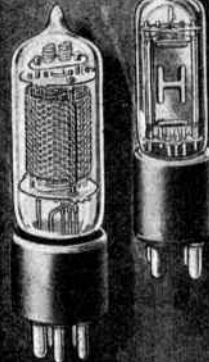

HIVAC LIMITED

Greenhill Crescent,
Harrow on the Hill, Middx.

Telephone: Harrow 0895

FLEXIBLE TORSIONAL REMOTE CONTROL



End-fittings can be re-arranged to suit requirements

THE S. S. WHITE COMPANY · BRITANNIA WORKS · ST. PANCRAS WAY · CAMDEN TOWN · LONDON N.W.1.
Cable Address: WHICODENTA, WESDO, PHONE, LONDON Telephone: EUSTON 4758 - 4759

W.T.18

Robert Sharp and Partners

B.I.

CONDENSERS



for arduous conditions

B.I. Tropical Type Paper Condensers in Moulded Tubes. (U.K. Patent No. 506024 and application pending) are designed to operate continuously in extremely arduous conditions of temperature and humidity.

BRITISH INSULATED CABLES LTD.
Head Office: PRESCOT-LANCS. Tel. No: PRESCOT 6571

IDENTIFICATION LABELS FOR CABLES & PIPELINES

(M.A.P. APPROVED) A.I.D. APPROVAL N° 2585/42

TRANSMITTER

Indelibly printed on white or coloured fabric for use in conjunction with transparent adhesive tape.

- Guaranteed 2/3 day delivery service.

P. P. PAYNE & SONS LTD
HAYDN ROAD NOTTINGHAM Phone: 64335
BUSH HOUSE LONDON Phone: TEMple Bar 6356

WAVES OKERIN

AND DIELECTRIC MATERIALS

Cable, Condenser, Coil, Transformer and Resistance Impregnating, dipping, sealing, filling and finishing.

A.I.D. and C.I.E.M.E. TYPE APPROVED WAXES to meet both ARCTIC and TROPICAL conditions.

TELEPHONE: WEST DRAYTON 2189

ASTOR BOISSELIER & LAWRENCE LTD

MIDDLESEX OIL & CHEMICAL WORKS

WEST DRAYTON, MIDDLESEX

M.R. SUPPLIES

Invite your urgent attention to the following high-class and brand new ELECTRICAL and INDUSTRIAL EQUIPMENT. Immediate delivery from stock. All prices nett cash.

SYNCHRONOUS TIME SWITCHES. 200/250 v. 50 c. Capacity 10 amps. Precision-made, complete movements, without housing. Fitted with removable solar device which automatically adjusts the positions of the riders to switch "on" at dusk and "off" at dawn (or vice versa) with instant pre-set for any month and for B.S.T. and B.D.S.T. This device can be readily dispensed with. If not required, using the two spare riders provided. Self-starting, silent, first-class German make, in factory-bright condition, 72/6. Also special model in 4in. by 4in. by 5in. weather-proof cast-iron housing, same voltage and capacity, with fully enclosed gearing, 97/6. A real opportunity for factory, laboratory and household use in process timing, time signalling, blackout warning, etc.

STAGE DIMMERS. Constantly rated and all with carbon break flicker switch and "off" position. For controlling stated load from full bright to blackout, at 230 v. Fitted screw motion drive and handwheel. 1,000-watts, 28/6/-; 1,500-watts, 27/15/- (part carr. on either, in returnable case, 5/-).

MINIATURE P.M. M/COIL UNITS. Only 3in. dia., fitted weighty alnico magnet, imp. 12 ohms. For use as speaker or microphone, and therefore ideal for intercom. systems, etc., 25/-.

ROTHERMEL-BRUSH PIEZO-CRYSTAL MICROPHONES. Continuation of our very popular offer of these specially housed D.104 Microphones. Fitted knuckle joint for angle adjustment and direct-fixing mounting boss. Response level to about 8,000 c/s. Sensitivity—60 db. With screened lead abt. 5ft., 75/-.

MICROPHONE FLOOR STANDS for above. Collapsible, chrom. plated, ext. to 5ft. 6in. and folding to 2ft., 37/6.

ROTHERMEL PIEZO-CRYSTAL PICK-UPS. Limited delivery of the latest black bakelite model at pre-war price plus P.T., totalling 23/18/9. Early application advised.

HEADPHONES. Brand new Ericsson, 2,000 ohms, with adjustable headband, 25/- pair. Also single PHONES, same make but secondhand, perfect, 3/9 each.

CENTRALAB VOLUME CONTROLS in following range only: 10,000, 50,000, 250,000, 500,000 ohms and 1 megohm. Less switch, 3/11. With switch, 5/3.

PUBLIC ADDRESS SPEAKERS. Latest model G.E.C., comprising 10-watt P.M. Projector Unit (16-ohms imp.) with 42in. Round all-metal Horn, 210/5/- (carr. 7/6 extra each). Also same unit with 30in. weatherproofed compo. square disperser Horn, 28/15/- (carr. 7/6).

TOGGLE PRESSES (by S.T.C.) double-acting, precise tool, exerting 14 tons pressure. Many advantages over fly press—space saving, rapidly and ease of operation. Height 32in., weight 130 lb. Immediate delivery from stock held here, 230 nett.

REBURY SWITCHES. S.P.C.O., glass tube 1 1/2in. long, with bead-insulated leads. Cap. 5 amps., 4/9.

THERMO-COUPLE M/COIL AMMETERS by Weston, Ferranti, Turner, etc., housed black bakelite with 2 1/2in. square flange, flush panel. Def. 0.2 1/2 amps., any frequency. A.C. or D.C. (de-shunted def. 1 1/2 to 2 1/2 m.a.—we cannot select), 37/6, ex-Govt., excellent condition, lab. tested.

Please include sufficient for postage and packing—excess refunded.

Will our customers please note that these premises will be closed from 9th to 14th August, inclusive.

M.R. SUPPLIES, 68, New Oxford Street, London, W.C.1.
(Telephone: MUScum 2986)

The glory of the future..



... when the tank gives pride of place to the "family 'bus" and engines of war to the instruments of peace, Goodmans will be able, once more, to give the connoisseur Loudspeakers that open up new possibilities in high fidelity reproduction.



GOODMANS

Makers of

HIGH GRADE LOUDSPEAKERS

Priority Orders only can be accepted

GOODMANS INDUSTRIES, LTD., LANCELOT ROAD, WEMBLEY, MIDDLESEX



SILVERED MICA CONDENSERS

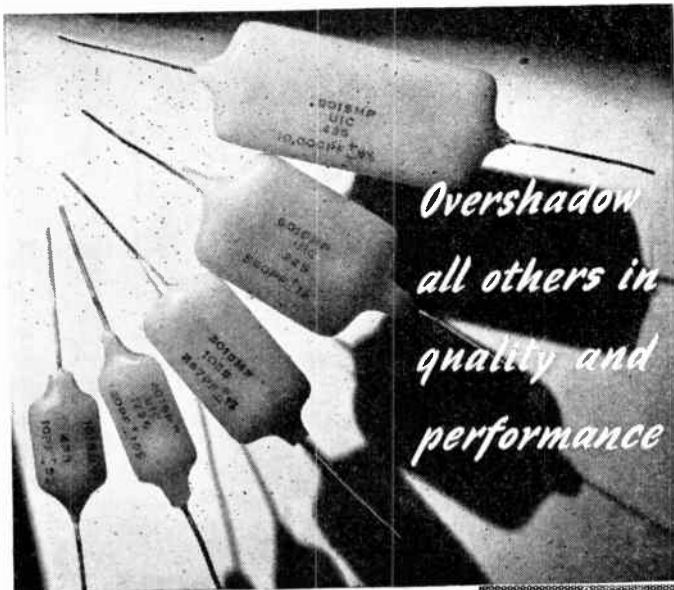

*Overshadow
all others in
quality and
performance*

Incessant progress in methods of manufacture and research linked with the most thorough mechanical and electrical inspection, are reasons for the outstanding superiority of U.I.C. Silvered Mica Condensers. Available in all standardized sizes. Suitable for tropical and arctic conditions. Type approved.



UNITED INSULATOR CO. LTD
12-22, LAYSTALL STREET, LONDON, E.C.1

Tel: TERminus 7383 (5 lines)
Grams: Calanel, Smith, London

THE PIONEERS OF LOW LOSS CERAMICS

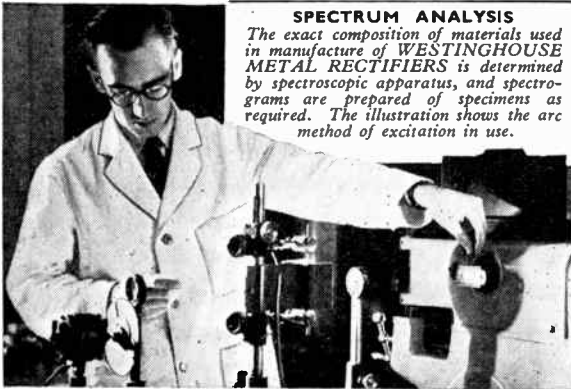

SPECTRUM ANALYSIS

The exact composition of materials used in manufacture of WESTINGHOUSE METAL RECTIFIERS is determined by spectroscopic apparatus, and spectrograms are prepared of specimens as required. The illustration shows the arc method of excitation in use.



Though Westinghouse Rectifiers are unfortunately in short supply, the groundwork of research and experiment is laying the foundation of the advanced Rectifiers of to-morrow. May the day soon dawn when these Rectifiers once more will be available for all uses.

Westinghouse Rectifiers

WESTINGHOUSE BRAKE & SIGNAL CO., LTD.
PEW HILL HOUSE, CHIPPENHAM, WILTS.

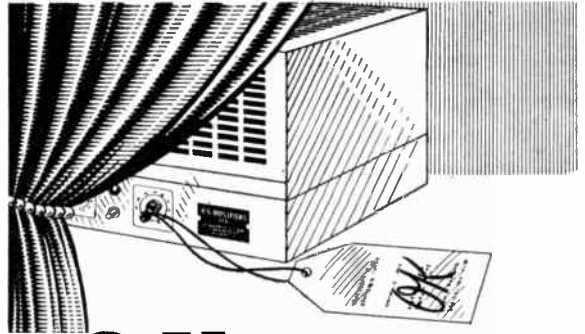

O.K.

{ good; true; [exact]; precise;
unquestioned; unchallenged;
approval; acceptance.

Roget's Thesaurus

Before its final release every piece of R & S Sound Equipment is O.K'd. But not before it has earned for itself this universal mark of approval by undergoing the stringent tests demanded... tests that signify a standard unusually high. Naturally, in these days, Sound Equipment of such calibre is not so, freely available for general use; but if you would like to have our latest list embodying details of the small range we are still able to supply, it will gladly be sent in exchange for a penny stamp.

R S
Amplifiers Limited

3-4, Highfield Rd., Shepperton, Middlesex. Tel.: Walton-on-Thames 1019

W.W. 8/43

CERAMIC GOODS AND INSULATORS

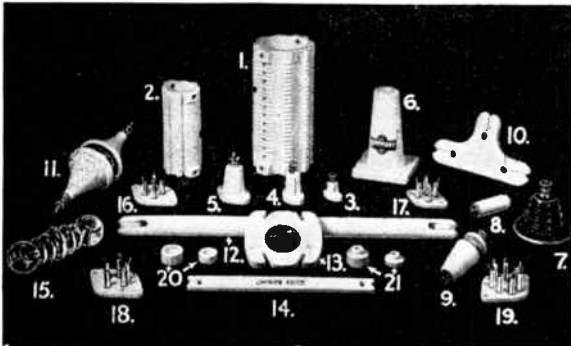

AN EXTENSIVE RANGE OF RAYMART CERAMIC GOODS & INSULATORS ARE AVAILABLE. MANY MORE LINES THAN THE TWENTY-ONE ILLUSTRATED ABOVE.

Those who are specially interested in Ceramic Valve-holders should refer to our advertisements (page 10, May, and page 24, June) in the "Wireless World."

Enquiries other than those from Government Departments or the Trade should be accompanied by stamped, addressed reply envelope.

RAYMART
CRAFT A CREED

48, HOLLOWAY HEAD, BIRMINGHAM, 1
Cables: Raymart, Birmingham. Telephone: Midland 3254.

BASICALLY BETTER...

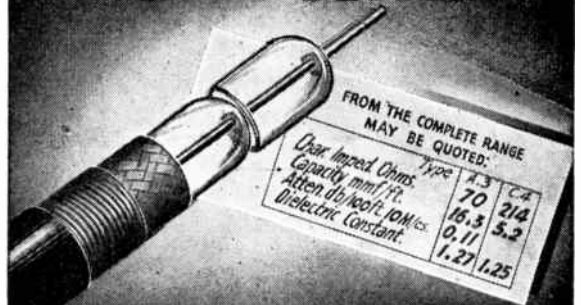

Air Insulation...

is the basic principle of

CO-AX LOW LOSS CABLES

Unequaled H.F. Properties

There is a CO-AX Cable for every H.F. Purpose

TRANSRADIO LTD. Inc. TELEQUIPMENT CO. 16 HIGHWAY BEACONSFIELD

74 RANGE UNIVERSAL TAYLORMETER



Combining a very wide range of measurements with high sensitivity and accuracy.

Self-contained A.C. and D.C. Volt ranges available up to 5,000 volts.

A.C. and D.C. Current ranges from 50 μ A to 10 Amperes full scale.

Resistance measurements from 0.1 ohms to 50 Megohms with internal batteries.

Capacity and Inductance measurements can be made with special adaptor.

Some delay in delivery is unavoidable, but every effort is being made to meet Trade requirements.

Nett Price

MODEL 83A (4,000 ohms per volt A.C. and D.C.) **15 gns.**

MODEL 83c (20,000 ohms per volt A.C. and D.C.) **19 gns.**

TAYLOR METERS

Write for complete specification to:-

TAYLOR ELECTRICAL INSTRUMENTS LIMITED
MONTROSE AVENUE, SLOUGH, BUCKS SLOUGH 21381 (4 lines)

THE SPECIALISTS



PROVIDE THE ANSWERS..

To-day the products of industry conform to rigid specification. In Radio, component and final assembly alike are tested, and re-tested, their performance measured against exacting standards. It is the special function of Marconi Instruments to find the answers to testing problems; to provide the means for determining specific performance in communica-

tion equipments. In this specialised work the Marconi organisation brings unrivalled resources to bear and a wealth of experience accumulated since the pioneer days of wireless communication. New demands are made and met with the traditional skill and craftsmanship of Marconi creative engineers.

MARCONI Instruments Ltd

ST. ALBANS · HERTS · TELEPHONE 4323

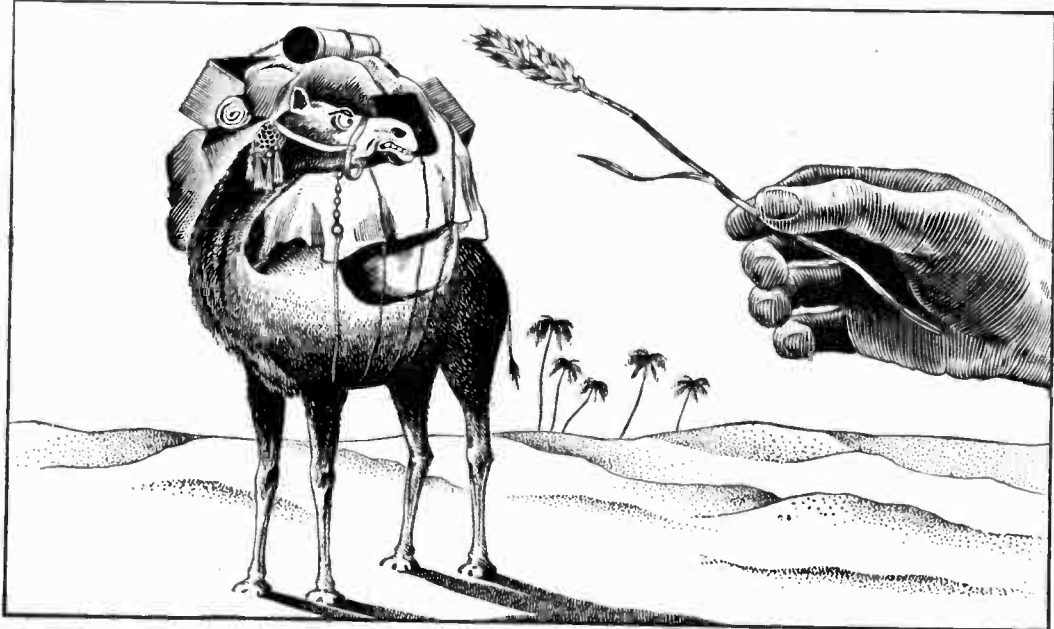

Last Straw

AS the pace of production quickens, the care-laden manufacturer must often feel like a camel contemplating the approach of the last straw. Can his oft-revised schedule carry yet another complication? Can he increase output still further without some impairment of quality?

The Simmonds products were designed to solve precisely this problem, and solving it they are, all over the country. Experience abundantly proves that they save time, they save material and they simplify assembly. They make it possible, in short, to quicken the tempo without detriment to the temper.

S I M M O N D S

In high service to

AERONAUTICAL, INDUSTRIAL & MARINE
Construction

THE SIMMONDS NUT · PINNACLE NUT · SPIRE NUT · SIMMONDS INSTRUMENTS,
CONTROLS AND ELECTRONIC PRODUCTS · FRAM OIL AND ENGINE CLEANER

SIMMONDS AEROCESSORIES LTD.
GREAT WEST ROAD, LONDON
A COMPANY OF THE SIMMONDS GROUP

LONDON MELBOURNE MONTREAL PARIS NEW YORK

Wireless World

Radio • Electronics • Electro-Acoustics

33rd YEAR OF PUBLICATION

AUGUST 1943

Proprietors :
ILIFFE & SONS LTD.

Managing Editor :
HUGH S. POCOCK,
M.I.E.E.

Editor :
H. F. SMITH.

Editorial, Advertising
and Publishing Offices :

DORSET HOUSE,
STAMFORD STREET,
LONDON, S.E.1.

Telephone :
Waterloo 3333 (35 lines).

Telegrams :
"Ethaworld, Sedist, London."



PUBLISHED
MONTHLY

Price : 1/3

(Publication date 25th
of preceding month)

Subscription Rate :
Home and Abroad
17/- per annum.

EDITORIAL. "Isolationist" Broadcasting ..	223
DESIGN OF SIMPLE OHMMETERS—I. By F. Livingston Hogg	224
"WIRELESS WORLD" BRAINS TRUST	227
DC/AC CONVERTER. By T. A. Ledward, A.M.I.E.E.	230
SENSITIVE RELAYS. By John H. Jupe	234
NEWS IN ENGLISH FROM ABROAD	237
RADIO DATA CHARTS.—No. 10 : Loudspeaker Dividing Networks. By J. McG. Sowerby, B.A., Grad.I.E.E.	238
LETTERS TO THE EDITOR	240
JAPANESE MORSE	242
VISUAL FREQUENCY COMPARISON. By G. D. Brittain, Stud.I.E.E.	243
WORLD OF WIRELESS	245
FM LOUDSPEAKER DISTORTION	248
UNBIASED. By Free Grid	250
RANDOM RADIATIONS. By "Diallist"	251
RECENT INVENTIONS	254

Branch Offices :

COVENTRY :
8-10, Corporation Street.
Telephone : Coventry 5210.
Telegrams :
"Autocar, Coventry."

BIRMINGHAM :
Guildhall Buildings,
Navigation Street, 2.
Telephone :
Midland 2971 (5 lines).
Telegrams :
"Autopress, Birmingham."

MANCHESTER :
260, Deansgate, 3.
Telephone :
Blackfriars 4412 (4 lines).
Telegrams :
"Iliffe, Manchester."

GLASGOW :
26B, Renfield Street, C.2.
Telephone : Central 4857.
Telegrams : "Iliffe, Glasgow."



As many of the circuits and
apparatus described in these
pages are covered by patents,
readers are advised, before
making use of them, to satisfy
themselves that they would
not be infringing patents.

Exclusive features

of the
'STRATOSIL'
series of
**SEALED
VIBRATORS**

for use at all altitudes

★ Owing to wartime restrictions on supply of raw materials, it is not possible to supply Wearite Components for purposes other than those connected directly with the war effort.

- 1 All steel construction—even to the rivets—ensuring uniform expansion under extremes of temperature.
- 2 Reed driving coil—wound on a bakelite moulded bobbin to meet all climatic conditions.
- 3 Metal can, sponge rubber lined—Acoustically and electrically shielding the Vibrator.
- 4 Driving contact of non-tarnishable precious metal—ensuring starting under the lightest of pressures and voltages.
- 5 Contacts ground almost to optical limits.
- 6 Stack assembly. Mica and steel only are used.
- 7 International Octal base sealed by the WEARITE STRATOSIL process.

Embodying "Oak Manufacturing Co.'s" patents 460470, etc.

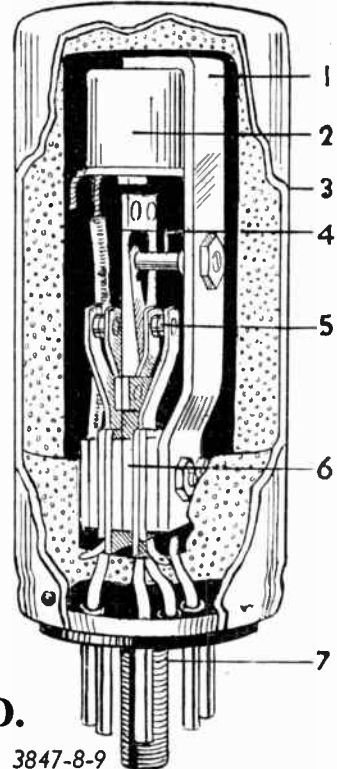

WRIGHT & WEAIRE LTD.

HIGH ROAD, TOTTENHAM, N.17. Telephones : TOTtenham 3847-8-9



Valves and Vehicles

The connection between valves and vehicles is frequently a very direct one — the contact pad in the road surface which controls the operation of traffic lights.

The equipment consists of electron tubes and relays, so arranged that when the contact pad is depressed a current impulse is released into the relay circuit and initiates the light sequence. The apparatus automatically resets itself after a time interval, or after the cessation

of further impulses. Sometimes, however, even the mechanical connection is eliminated. Then a "proximity" link is used, consisting of a particular arrangement of valves and circuit design which is sensitive to the proximity of vehicles. In other words, it can "feel" the approach of traffic.

This is yet another example of the indispensable services rendered to the community by the ubiquitous Thermionic Valve.

MULLARD

THE MASTER VALVE

A Valve for Every Purpose

DOMESTIC · COMMERCIAL · INDUSTRIAL · SCIENTIFIC · MEDICAL · EXPERIMENTAL

THE MULLARD WIRELESS SERVICE CO. LTD., CENTURY HOUSE, SHAFTESBURY AVENUE, LONDON, W.C.2. (55A)

Wireless World

Radio • Electronics • Electro-Acoustics

Vol. XLIX. No. 8

AUGUST 1943

Price 1s. 3d.

“Isolationist” Broadcasting

An Unwanted Hybrid

WRITING editorially in January, 1942, when there were strong rumours that plans were afoot to establish wire broadcasting, we said: “*Wireless World* would share the disquiet that seems to be felt if we thought that there was any possibility of this country being stampeded, immediately after the war, into accepting the wire as the main source of programmes.” In using that word “stampeded,” we chose better than we knew; it aptly describes the methods that we now think will be employed to foist on us a post-war broadcasting system that is not, we believe, in the best national interest.

Although the aspirations of those who seek to distribute broadcasting over the electric supply mains must not be forgotten, it seems that the first big move will be towards using the telephone wires, and it will be engineered by the Post Office. It is probable that the motives of that Department are not quite disinterested, and the whole scheme savours of what may be crudely described as a telephone selling “stunt.” We all remember how methods savouring of high-pressure salesmanship were beginning to be employed before the war by this branch of the Post Office, and it requires little imagination to see how the number of telephone subscribers could be greatly increased by judicious use of the broadcast bait. It may be argued that, as the telephone service would benefit, the move is justified in the public interest. But we believe that a wider public interest than that of the Post Office and its telephone subscribers is threatened by the scheme. If we are right, the experiment must be shelved until circumstances are more propitious.

We say “shelved” because there is so much in favour of wire broadcasting that doubtless it will eventually be widely used. But the difficult post-war period of reconstruction is most distinctly the wrong time to make such a drastic change in methods of programme distribution. Our main reasons for opposing any system in which the wire is the principal means of broadcast distribution have already been stated, and in this issue our objections are powerfully reinforced on political

and economic grounds by our “Brains Trust.”

One of the most potent economic arguments against wire broadcasting is that it would bring about something approaching wireless stagnation, leaving those countries that retained radiating methods free to forge ahead. Broadcasting has contributed in the past the main incentive and, perhaps more important, the funds for research. With wire distribution, the chief source of surplus revenue would dry up. As Sir Robert Watson Watt said recently, there would be plenty of scope for developing different types of receivers for wire systems, but we think the great mass of broadcast listeners would cease to take any great interest in what was offered to them. Wireless salesmen agree that the “magic of distance” is the main stimulus to buyers of new sets, and distant-station-getting capability is the real yardstick by which sets are judged. Remove these incentives, and it seems that nearly all public interest in the means of broadcast reception will have gone.

Handicap to Industry

If we adopted the wire, what would happen in other countries, say the United States? A recent issue of the American commercial journal *Broadcasting* is devoted almost entirely to post-war planning, and the question of what should be done in the States after the war is discussed from many angles. Television, frequency modulation, facsimile and inter-station wireless links are among the various developments considered, but there is not a word about wire distribution. America, and all other countries retaining radiated broadcasting, would go ahead in applying the technical progress of the war years to peacetime needs. It is not easy to believe that our own industry, labouring under the handicap of a domestic wire system, would be in a fit state to march with them.

Wired broadcasting—its very name is a contradiction in terms and suggests its limitations—lacks much as a medium for free democratic exchange of ideas in a civilised world. To the view expressed on another page that “We do not want it” we would add just one word—“yet.”

DESIGN OF SIMPLE OHMMETERS

I.—General Principles and Details of a Meter for High Resistances

By F. LIVINGSTON HOGG

OF the three fundamental measurements, voltage, current and resistance, it is perhaps surprising that the last is so much less convenient in practice than the other two. Yet in some ways it is the most useful of the three. For rapid fault-finding in the laboratory or in a factory, there is no more useful instrument than an ohmmeter.

The most usual methods of measuring resistance are by means of:

- (1) A Wheatstone bridge.
- (2) A special meter (crossed coil or similar type).
- (3) An indirect method, involving the measurement of a current or a voltage.

It is easy to get high accuracy on a Wheatstone bridge, but the method is clumsy and slow, besides being very expensive. For most purposes a direct-reading instrument is desirable, so that the answer can be seen clearly and at once on a dial. But the range to be covered is extremely great, from 0.01 ohm to 10 megohms not being at all ambitious—that is, a range of 1,000 million to 1! It is not easy to make the special types of meter using crossed coils and having an approximately linear scale, when it is desired to cover a very wide range. Further, they are specialised instruments which are not always readily available.

The third method is well known and exemplified by many universal test meters. These are often blamed for inaccuracy and inconvenience, but I would rather put it as a waste of a good instrument to use it, as is so often the case, as a kind of continuity meter.

It is proposed to discuss ways and means of designing easily made ohmmeters working on this principle, using standard or readily available parts, which will cover a wide range with a reasonable degree of accuracy, and yet are not unduly expensive. It is not intended to give an academically accurate discourse on the subject, but rather to try to show busy

service-men how they can make satisfactory instruments to do a given job, without having to do a corresponding amount of development work, both practical and theoretical.

There are two other points we might bear in mind. It is a great convenience to have a meter so made that when some careless fellow measures a resistance without first switching off the HT, our meter is not burnt out for us. It is also convenient not to have to readjust the setting control on changing ranges.

We now have our terms of reference. Two well-known circuits only will be considered, the series circuit and the shunt circuit. These are shown in Fig. 1. In each case R is the unknown resistance, E is an applied voltage, and M a meter. In Fig. 1 (a) if

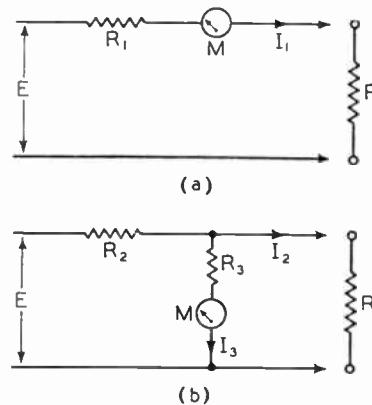

Fig. 1. Typical ohmmeter circuits. (a) Series-connected for high resistances. (b) Shunt-connected for low resistance measurements.

we short R and adjust R_1 so that M reads full-scale deflection, I_{max} , then it follows that when $R = R_1$ the meter current I_1 is $\frac{1}{2}I_{max}$. A simple manipulation produces the result

$$R = R_1 \left(\frac{I_{max}}{I_1} - 1 \right) \quad \dots (1)$$

In Fig. 1 (b), if R is an open circuit, and R_2 and R_3 are such

that the reading on the meter is then I_{max} , applying some value of R reduces the meter reading until, if R is zero, I_3 is also zero. We can arrive at the general result:

$$R = \frac{R_3}{\left(1 + \frac{R_3}{R_2} \right) \left(\frac{I_{max}}{I_3} - 1 \right)} \quad \dots (2)$$

In case anyone wonders why E does not appear in these results, it is because the assumption was made that the meter reads full scale on short and open circuit respectively, in other words, the resistances used are directly dependent upon E , which is therefore implicit in the equation.

It is obvious that the circuit of Fig. 1 (a) will be more convenient for measuring high resistances and that of Fig. 1 (b) for lower resistances. If we decide upon the mid-range values of resistance we wish to measure, and a value for I_{max} , we can calculate the scale calibration in resistance directly in terms of current. Fig. 2 shows typical ohm scales drawn against current scales for the two types of instrument. The values assumed are 1,000 ohms mid-scale and 100 microamperes for I_{max} in the series case, and 0.5 ohm and 100 mA for the shunt case. It will be seen that the resistance scales are reciprocally related, and further they are really independent of I_{max} , being controlled exclusively by the mid-scale values assumed. Unfortunately, the scales are crowded at both ends, but this is not so serious a difficulty in practice as it first appears, provided we have a sufficient number of ranges available.

We have now established a few principles in a general way. Can we apply these to get the results we want? Will the inaccuracies of the practical version be too great? It is clear that it would be very difficult to make either one type or the other cover the complete range, so we will first of all deal with a pair of instruments designed to overlap, and then we can see how the practical cases work out.

Fresh problems arise when we try to put our elementary principles into practice. How shall we obtain the required voltage? How shall we set up the instrument? Space will not permit of a detailed discussion of these and similar points, so a solution will be suggested, one of the many possible ones. Other solutions may be just as good or even better, but the type to be discussed has been proved over a number of years of hard use.

The High Ohmmeter

In choosing our meter we must compromise, as in most things. A 100-microamp. movement is quite delicate enough. If we use this and have a mid-scale reading of 1 megohm on the highest range, we shall have about 100 volts across the prods on open circuit,

protect the meter, two selenium rectifier discs are connected in opposite polarities across the meter circuit. Then any voltage across the prods will cause current to flow through the meter, and also through one rectifier or the other, according to polarity. The rectifier has a sharply non-linear characteristic, and takes most of the current as soon as a little more than full-scale current is passed through the meter. This gives quite worth-while protection.

It has been found that provided the volt drop across the rectifier discs does not exceed 70-100 millivolts, the resistance of the disc is nearly linear, and therefore behaves like a simple shunt resistance over the working range. There is some error in this assumption, the greater the protection the greater the error, but it

zero, whence by substituting in (5):

$$E = I_{max} \left[R_{17} + R_{18} + R_{20} + \frac{R_{20} (R_{17} + R_{18})}{R_{19}} \right] \dots (6)$$

Equating these two values of E and rearranging we get:

$$R = \left(\frac{I_{max}}{I_4} - 1 \right) \times \left[R_{20} + \frac{R_{19} (R_{17} + R_{18})}{R_{17} + R_{18} + R_{19}} \right] (7)$$

Compare equation (7) with (1), for the elementary circuit of Fig. 1. It can be seen that, most conveniently, a meter calibrated from the calculated values of the elementary case will be accurate in practice if we adjust our resistances. Rather surprisingly, the current drain in the potentiometer R₆, R₇, R₈, R₉ does not have to be large compared with the variable current drawn by the meter circuit, though there is usually no difficulty in making it so. It is also easily seen that whereas the value of R is dependent on R₁₇, this is only a second order effect and is negligible in practice.

We can now proceed to the details of design. Starting with the HT circuit, the running voltage of the neon lamp will probably be about 145 volts. We need a range of adjustment to compensate for differing lamps, etc. Further, we have a 100-microamp. meter shunted by a rectifier which may take 15 to 20 microamps. on full-scale deflection. It is therefore desirable to assume a working voltage e (Fig. 3) of about 130 volts, which will allow a reasonable margin. We will also assume R₆ + R₇ + R₈ + R₉ to total 20,000 ohms, and that R₅ is variable 0-4,000 ohms. For design purposes, the mid-value of 2,000 ohms will be assumed for R₅.

Starting on the highest range, we then have (Fig. 4) R₁₇ = 2,000 ohms, R₁₈ = 0, R₁₉ = 20,000 ohms, E = 145 volts.

Further, at mid-scale, R is 1 megohm. From (7), remembering that at mid scale

$$\left(\frac{I_{max}}{I_4} - 1 \right) = 1$$

we get R₂₀ = 998,200 ohms, whence from (6) I_{max} = 132 microamps.

We can now calculate the values for the other ranges in the

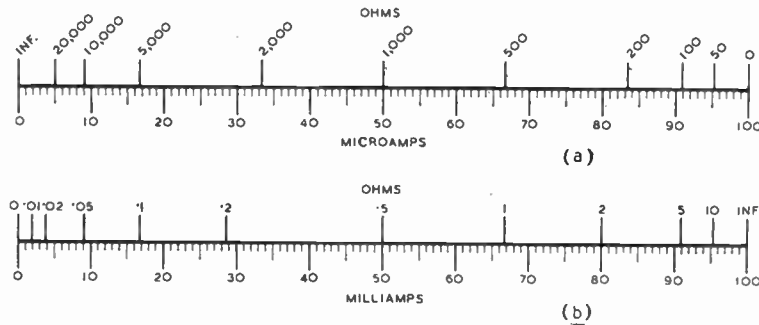

Fig. 2. Relation between resistance scale and meter current (a) in series-circuit (b) in shunt-circuit ohmmeter.

which is quite enough. On this scale we should get an indication of 10 megohms, though not to a very high degree of accuracy. We will take the necessary operating voltage from the mains, but it will be necessary to use a simple stabiliser, or fluctuating mains voltage will give erratic readings. Four ranges will be assumed, with mid-scale values of 1,000, 10,000, 100,000 ohms and 1 megohm, respectively. This will give us reasonable measurements from 100 ohms to 10 megohms. It is clear that we must reduce the applied voltage by ten times for each range, descending from the highest.

The complete circuit is shown in Fig. 3. A "beehive" neon lamp without resistance in the cap gives sufficient stabilisation for most purposes. The mains rectifier circuit is straightforward with a small amount of smoothing. R₅ is the setting control. To

will be assumed that 100 millivolts is a reasonable figure.

Fig. 4 is a simplified version of Fig. 3, which is equivalent on any given range when the appropriate values are inserted. The meter circuit M₁, R₁₄, R₁₅, R₁₆, V₂ and V₃ is replaced by the equivalent M₂ and R₂₀, which also includes R₁₀, R₁₁ and R₁₂ in the relevant cases.

This circuit can be calculated out as follows:

By equating volt drops we see

$$I_4 (R + R_{20}) = I_5 \cdot R_{19} \quad (3)$$

Whence

$$I_5 = I_4 \left(\frac{R + R_{20}}{R_{19}} \right) \dots (4)$$

But

$$E = \frac{(I_4 + I_5) (R_{17} + R_{18})}{I_4 (R + R_{20})} = I_4 \left[\frac{R + R_{17} + R_{18} + R_{20} + \frac{(R_{17} + R_{18}) (R + R_{20})}{R_{19}}}{R_{19}} \right] (5)$$

Now when I₄ = I_{max}, then R is

Design of Simple Ohmmeters— same way. These are all tabulated in Fig. 4, and give the final values shown in Fig. 3.

If our transformer delivers 240 volts AC to the rectifier, then a suitable value of R_1 is 5,000 ohms. Now everything is fixed except the meter circuit. We know that this has to have a total resistance of 980 ohms. The meter itself may have a resistance of anything

measured, and the scale marked accordingly. The meter circuit is then adjusted to give the correct values of resistance and full-scale current, as described above. The accuracy of adjustment of current is unimportant, except to ensure that R_5 is set at a convenient value—in fact R_{15} may be omitted, and any necessary extra resistance inserted in series with R_5 , with little loss of accuracy.

Fig. 3. Circuit diagram of mains-operated high ohmmeter. Circuit values are as follows: R_1 , 5,000 ohms; R_2 , 0-4,000 ohms; R_3 , 18,000 ohms; R_4 , 1,800 ohms; R_5 , 180 ohms; R_6 , 20 ohms; R_7 , 997,200 ohms; R_8 , 97,200 ohms; R_9 , 8,822 ohms; R_{10} , 1,000 ohms; R_{11} , R_{12} , R_{13} , R_{14} , R_{15} , R_{16} (see text); C_1 , 4 μ F; M_1 , 0 to 100 μ A; N_1 , "beehive" neon lamp without cap resistance; V_1 , Type H 18-24-1B2 selenium rectifier; V_2 , V_3 , Type H25 1-1 selenium rectifiers.

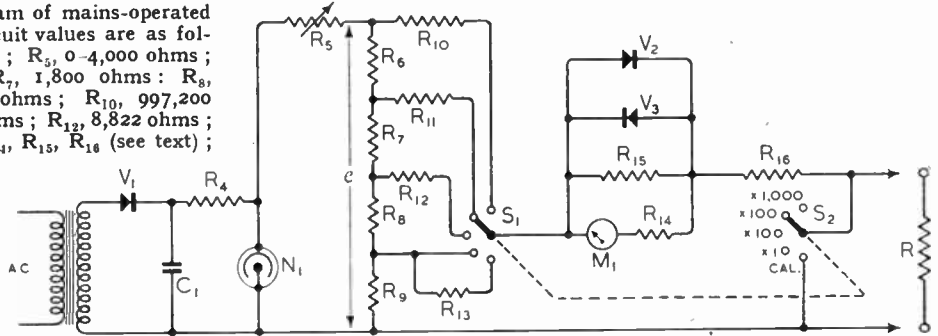

from 350 to 1,000 ohms, according to make. If the meter resistance is high, R_{14} can be low, or zero. In general, the sum of the meter resistance and R_{14} must not be less than 700 ohms, nor more than just over 1,000 ohms. Having chosen a suitable value, R_{15} is added to make the current taken by the whole meter circuit up to approximately 132 microamps. Usually a composition resistor 5,000 to 10,000 ohms, half watt, is about right, but it depends on the actual rectifier disc in use, as these vary slightly. R_{16} is then adjusted so that the resistance of the whole meter circuit is 980 ohms. Care should be taken that any current through the meter from the measuring device is of the correct polarity, and does not deflect it beyond full scale. If it does, the result will be in error because of the non-linearity of the disc.

Switches S_1 and S_2 are ganged, and are of the usual Yaxley or Oak type, with break before make contacts. R_{13} is a 1,000-ohm resistance used for setting up the instrument. A mark can be made on the scale at the exact value of this resistance, and R_5 is then adjusted so that the meter reads correctly when the switch is turned to the "Calibrate" position. The control does not then need adjustment on changing the range.

Any convenient method of con-

struction may be used. Connection to the circuit on test may be made by means of prods or clips. The only critical components are the resistances, some of which should be adjusted to better than 1 per cent, if possible. Wire-wound resistances should be used except for R_{10} , R_{11} and R_{15} . Resistances R_{10} and R_{11} may be metallised, but should be chosen to be under the nominal value.

and can then be built up with small-value composition resistors of reliable make. No values are given for wire sizes, owing to the difficulty of supplies, but it is not nearly as bad as it sounds to wind on a hand brace the 18,000-ohm resistance. Care must be taken that the gauge of wire used is large enough to ensure negligible temperature effect.

There are a number of obvious ways of lining up the instrument. One method, which necessitates a good Wheatstone bridge, but does

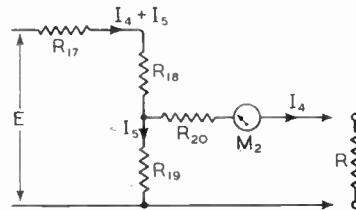

RANGE	RESISTANCE (OHMS)			
	R_{17}	R_{18}	R_{19}	R_{20}
x 1,000	2,000	0	20,000	998,200
x 100	2,000	18,000	2,000	98,180
x 10	2,000	19,800	200	9,802
x 1	2,000	19,980	20	980

Fig. 4. Simplified circuit equivalent to Fig. 3 with calculated values of "lumped" resistances on the four ranges.

not depend on standard resistances, is as follows: R_6 , R_7 , R_8 and R_9 are adjusted individually as accurately as possible. R_{13} is

However, if a number of similar instruments are being made, it is better to adjust the current to the same value in each case, to make the instruments consistent.

If we now set up to the calibrate mark, and then switch to range $\times 1$ and short the prods, we shall get full-scale deflection on the meter if all resistance values are correct. (If R_9 is known to be accurate, it is possible to adjust R_{16} to obtain this condition if the bridge available for measurement passes too much current through the meter.) Then R_{12} can be adjusted to give full-scale deflection with the prods shorted on $\times 10$. R_{11} should be built up on range $\times 100$, and R_{10} on $\times 1,000$.

It is better to use standard resistances having values approximating to mid-scale reading on each range, and adjust the instrument resistances to read correctly. It is essential to alter only the resistance mentioned on each step. No attempt should be made to adjust any other values unless it is fully understood what the effect of such adjustment will be. Adherence to this principle will save a lot of worry and disappointment.

Many obvious modifications can be imagined. An HT battery could be used if desired in place of all components to the left of R_5 ; the current drain would be about 7 milliamps. Less ambi-

(Concluded at foot of col. 1, page 227.)

Wireless World Brains Trust

Broadcast Distribution : The Case for Wireless

More views on Question No. 12. Is wired broadcasting wanted, and would it be in the public interest to adopt it as the main means of distribution ?

[In last month's issue the case for distribution by wire was stated by P. P. Eckersley, a staunch advocate of that method. This month it is the turn of those taking opposing views.]

"RADIATOR" deals with the international aspects of post-war broadcasting, and considers that the benefits it might confer could not be obtained from a wire distribution system.

THE main argument in favour of wired broadcasting is that it would provide reception, free from interference, of a number of contrasting programmes. The arguments against it, and in favour of radio, seem to me to be so overwhelmingly strong that no real case for wired broadcasting can be made out. Let us consider only one or two of them.

Though the wired programmes might well contrast one with the other, they would all emanate

DESIGN OF OHMMETERS

(Concluded from page 226)

tious requirements for the highest range would allow of a meter of higher current consumption being used, the values given being modified to suit particular cases.

The overall accuracy of the instrument depends greatly on how accurately individual adjustments are made. If the correct gear is available, the whole job of adjustment need not take a couple of hours. If no accurate bridge is available, it is possible to use high-grade voltmeters and milliammeters of suitable ranges. The errors then to be expected are much more serious unless extreme precautions are taken. It is difficult to specify accuracies in a universally useful way, but the formulae given are sufficient for the probable errors to be calculated for any given set of resistances and accuracies of adjustment.

from the one source—they would all be subject ultimately to Government control. We are to be entertained, educated and "propaganded" on the lines laid down by the Government, and we are to be precluded from hearing the numberless contrasting views on an infinite variety of topics put out by the rest of the nations of the world. We are to be prevented from listening to their music; from assimilating any of their culture; from hearing their views on religious, political and sociological questions—except in so far as the Government thinks it good for us. Such an arrangement seems to me to embody all the worst features of the system against which we are fighting, to uphold the principles underlying the production of the *Volksempfänger* and to be a direct negative to those of the Atlantic Charter. How is international understanding and good will to be fostered in the post-war world if such an "isolationist" broadcasting system is to be permitted? Think of the infinite variety of programme material which will emanate from all the world's medium- and short-wave broadcasting stations after the war, and then contrast this with the pitiful half-dozen programmes which are to be provided by the wired system—all of them subject to the same control. No; if the people of Britain are to play their part in the building of a better and war-free world, surely it is essential for them to be able to hear what the rest of the world is saying, and to do so in a manner free from the censorship of whatever political group happens to be in office.

One of the measures necessary for the promotion of better international understanding is the establishment of an international language (and this will come in the post-war world), so that "Nation shall speak Peace unto Nation." It will be useless for the people of Britain to be able to understand their fellow world-citizens if they are not permitted to listen to them. The

rest of the nations, then—assuming them to retain the use of radio—will, to their great benefit, continuously be exchanging views on every sort of subject, while Britain—with its wired broadcasting system—like a windjammer becalmed in the Doldrums, be left to its own narrow world of ideas. Surely this cannot but react unfavourably upon the mentality of the Britisher, as well as upon his interests overseas.

This brings us to another important point. We want not only to listen to other nations but to talk to them as well. We want them to understand us—to be of good will towards Britain and things British. Our Government could, of course, talk to them without permitting its people to listen to them—it could use its medium- and short-wave radio stations for foreign broadcasting, whilst restricting its own citizens to the use of a wired system. Such a non-reciprocal system would not, however, work; at least, it is certain that it would not cultivate the desired good will.

So, from the international aspect alone, there seems to be a good case for the continuance of radio broadcasting. But this is only one aspect of the matter, and it is by no means certain that an equally good case could not be made out for it were the international aspect entirely ignored.

W. H. CAZALY deals with the dangers of wire broadcasting as an anti-democratic weapon in the hands of those who might use it for the regimentation of public opinion.

IT is a pity, in my opinion, that this discussion on "wired" and "open" systems of broadcasting has begun in *Wireless World*. The main issues involved are political, not technical, and political controversy is out of order in a purely technical journal. The technical issues are hardly worth controversy. It is as absurd to argue technically about which system is "better"

Wireless World Brains Trust—

as it is to argue about which of two very different types of building is "better." Choice is determined simply by the requirements of the user. From the technical point of view, all that is needed is a clear and impartial presentation of the *performance* of each system, without reservations or bias, so that individuals may make their own choice. Specious technological pleading in favour of one or the other is unscientific.

Unfortunately, Eckersley himself, although a professional engineer and scientist, neither confines himself to such an impartial presentation, nor deals adequately with the political implications. Reluctantly, one is obliged, therefore, to reply to him

more deadly concealed methods of propagating views favourable to their own interests. They would be neither impartial nor chiefly concerned with the progressive welfare of the people of this country. It is nonsense to pretend that it would not happen that way with "wired" broadcasting, when it is quite obvious it has happened in every other large, effective and costly medium for the dissemination, directly or indirectly, of ideas, news and opinions. It is no use saying that, because Eckersley himself would be scrupulously fair, everyone else would be. The plant required for a nation-wide system of "wired" broadcasting—and it is difficult to see how it could avoid being nation-wide and fairly soon reduc-

likely to be as bad as the former.

As things are, I can listen to news and views from a great many widely different sources *at my own choice*. In wartime, regimentation of my body may be inevitable, but as an individualist I look on wireless as a great safeguard against regimentation of my mind as well. This, to me, far outweighs any technical or aesthetic advantage of the "wired" system. If this country went over to the "wired" system, it would be a crushing blow to the "freedom to listen" which is, I presume, one of the things for which we are fighting.

D.A. BELL *questions the claims of wire broadcasting on economic grounds, and contends that its very name brands it as "an illegitimate hybrid."*

THERE are both political and economic objections to wire broadcasting, objections which P. P. Eckersley has glossed over by making two unsubstantiated assumptions. The political objection has been well stated in a *Wireless World* Editorial, where it was pleaded that a radiated broadcasting system is a necessary safeguard of democracy. It was urged that a wired or "closed" system would be so dangerous a weapon in the hands of a dictatorial or usurping power that it was unwise, in a post-war world likely to be troubled with many problems, to run the risk of presenting such a broadcasting system ready to the hand of a possible enemy of our liberties.

To put clearly the technical and economic objection, I deny P. P. Eckersley's statement that the wire system is one "by the use of which all the population could receive any number of transmissions completely free from interference at any time." There are still houses in this country which are not connected to any system of wires—neither electric light nor telephone—and no scheme has been proposed which would cover the very substantial cost of laying on wires to these houses, especially those in rural areas. This is an expenditure which the electric power companies will not undertake, although the revenue which they would obtain would be many times the present wireless licence fee of 10s. per annum. As regards choice of programme, it is

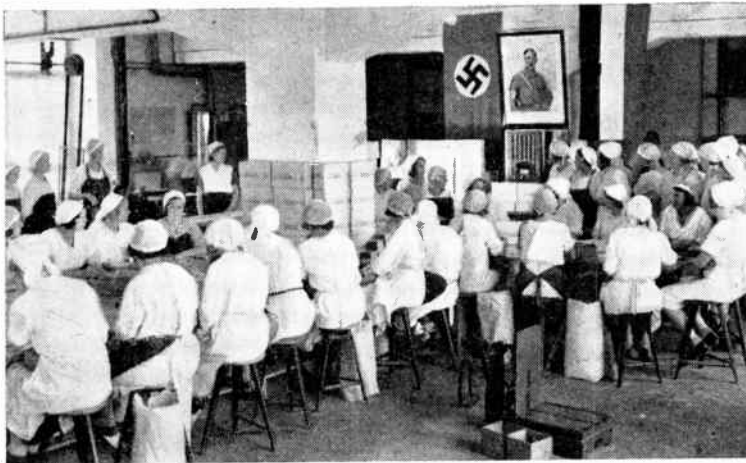

REGIMENTED LISTENING.—The idea of "piped" broadcasting for Britain clearly conjures up in the minds of most contributors to our Brains Trust a picture of what happened in Germany in the early days of the Hitler regime. Here are seen workers in a German chocolate factory listening to the Führer on a Telefunken "Kamerad," a set specially developed for "organised mass listening."

largely in political terms, since these are the main issues involved.

To put it bluntly, I, for one, as a politically conscious citizen as well as a technician, am dead against the supercession of even the present unsatisfactory "open" system of broadcasting by the "wired" system, which would, in my opinion, soon lead to the regimentation of public opinion in this country. I am quite certain that the owners of a wire distribution system would use the powers conferred by ownership to enforce policies in the choice of programme items. They would use both the blatant and the much

ing to negligible proportions the popular equipment for "open" broadcast listening—would be too expensive and permission to install it too difficult to obtain for anybody but corporations of great wealth or the Government itself to set it up. The former would insist that it was used to disseminate an overwhelming proportion of the notions of which they approved (as in the cases of the Press, the cinema and commercial sponsored broadcasting), while the latter would either be emasculated by officialdom or, since vested interests may be heavily represented in governments, is

true that a number of sound transmissions, possibly as large a number as could reasonably be desired, could be transmitted over a wire system, but I demand also freedom to receive any type of transmission, including television; I do not believe it is an economic proposition to distribute television by wires to any appreciable proportion of the population.

To sum up, open broadcasting is essential for (a) economic coverage of rural districts, (b) television, (c) foreign listening, (d) freedom from monopoly of programme control. On the other hand, "wire broadcasting" is an illegitimate hybrid, using a point-to-point communication method (wires) for a service which its very name (broadcasting) shows to be intended for universal and unrestricted distribution. We do not want it.

H. A. HARTLEY suggests that in this question of wired broadcasting the technician should subordinate his technical interests to his interests and duties as a citizen.

I should like to comment on the "wire versus wireless" controversy both as an engineer and as a citizen. As the events of the last tragic decade have so convincingly demonstrated, when citizens cease to take an interest in politics disaster inevitably follows; it therefore behoves engineers and citizens alike to consider very carefully just where they want to go.

If broadcasting is considered to be a matter of national news service, entertainment and instruction, then there can be no technical argument at all. Wired broadcasting, properly installed, will give a distortionless, interference-free service against which wireless cannot hope to compete. As an exponent of undistorted reproduction myself, therefore, I am solid for wired broadcasting, considering only the æsthetic side of the matter. Eckersley therefore presents an unanswerable case. To try and prove him wrong is simply a waste of time.

But is broadcasting just this and nothing more? As Sir Louis Sterling points out, broadcasting has been used for all sorts of purposes that were never envisaged when it first came into being. The dictators have used it to canalise what passes for intelligence in

their listeners; and the Axis has done its best to de-etherise broadcasting by making it an offence punishable by death to listen to anything but their own propaganda. Had broadcasting always been wired it would have made things easier for the Axis, and we would have had no counter-propaganda weapon. Considered, therefore, as a social and political service, wired broadcasting is totalitarian and anti-democratic. Sir Louis Sterling's case is also unanswerable.

It is futile to say "it couldn't happen here." All governments, human nature being what it is, are fundamentally anti-democratic. A small body of men determine on a certain policy. If there is a parliament, the customary political strategy is used to push the policy through. If there isn't a parliament, it goes through, willy-nilly. But that policy is naturally determined by the vested interests which can influence the government, and it is regrettable that present-day vested interests tend to be anti-social. The fact that the Government of this, our own, country has for years been trying to insinuate a totalitarian technique into broadcasting is not without significance; and for the engineer, arguing on purely technical grounds, to press for wired broadcasting, to the exclusion of the other sort, is simply playing into the hands of the vested interests.

The engineer must, therefore, align himself with his fellow citizens as a political creature, and take care that he first gets the sort of government he wants. Then, and only then, can he proceed to deal with the technical problems associated with an instrument which, although highly technical, is also highly dangerous. The problem is much graver than is generally supposed.

THE "X-STOPPER" AGAIN?

OUR contributor "Diallist" writes:—A recent news item in an important daily paper sets one thinking a bit. It records that the Goodyear Tyre Company demonstrated at Akron, Ohio, what they call a "radio station neutraliser," the invention of a research physicist, Mr. Gilbert Candrisen. How the device works is not clear, but if it does all that it claims it should make a wondrous difference to wireless reception. It is difficult to piece

anything together from the lay reporter's description, but it appears to be some kind of limiter valve, which automatically adjusts itself to cope with interference of any intensity. It is stated that it deals faithfully with man-made interference: in one test a short-wave programme from Europe was received whilst the output of a car ignition system was being fed directly into the aerial. But I think that the reporter's imagination ran away with him when he described the neutraliser as being able to reduce to a bare whisper "man-made disturbances more powerful than the greatest storms of thunder and lightning." Anti-interference devices of the limiter type have been brought out before; they are in fact older than the thermionic valve. None so far has proved completely effective. Anyhow, I look forward to seeing a technical description of the device.

SOLDERING IRON DESIGN

FOR some types of work—particularly instrument work—the ordinary long-shanked soldering iron is unhandy; the user's hand is too far from the bit to permit of easy and precise control. To overcome this the makers of "Pyrobit" irons have recently introduced a model which can be held like a pencil. To protect the operator's hand from heat, most of the shank is covered by a bell-shaped extension of the handle.



Another point about the iron is that the Steatite-insulated heating element is housed "on the job" inside the copper bit itself, thus minimising thermal losses.

The makers of "Pyrobit" irons are The Acru Electric Tool Manufacturing Company, Ltd., 123, Hyde Road, Ardwick, Manchester, 12.

DC/AC CONVERTER*

A Sensitive Method of Measuring Small DC Voltages

By

T. A. LEDWARD,
A.M.I.E.E.

THE amplification and transformation of DC voltage and current has always presented special difficulties that are not present when dealing with AC. Many DC amplifiers have been described, but it would seem that only recently has really satisfactory apparatus been evolved, and now there appears to be a choice between a few types employing different principles, but each of value in its own particular sphere.

To mention what are perhaps the two principal types that have recently made their appearance, there is the one due to Stewart E. Miller¹ and the other due to D. C. Gall.² In Miller's amplifier, valves are coupled together by resistances in a particular way and special means are applied to eliminate zero drift. It would appear to be particularly valuable where high gain and extremely rapid response are required, combined with absence of zero drift. A flat response from zero to 12,000 c/s at an output of ± 80 volts and ± 5 mA for an input of only 0.35 mV is clearly an excellent performance.

Gall's amplifier is different in principle and purpose. In this case, too, we have high gain and stability, but we have also a heavier power output, particularly suitable for operating commercial recording instruments. As

electric cell, there must necessarily be a small time lag and there is no question of comparing frequency response, but the time lag is too small to be of any consequence in the operation of commercial recording instruments.

Each of the above amplifiers has its own particular sphere and both indicate a good deal of careful work and ingenuity.

The amplifier to be described in this article employs yet another principle and may perhaps find its own particular sphere of usefulness. In its present form it gives an AC power output for a small DC voltage input, so that the output can be readily transformed to give any desired combination of voltage and current and may be converted to DC by the aid of a rectifier if desired.

The chief component is a device for converting the DC into AC, which is then amplified in the usual way. There are many ways in which DC may be converted into AC, or be made to control an AC supply,

and the writer has adopted a principle which he used in some experiments on magnetic polarisation in 1937, and described in a subsequent paper.³

In a particular experiment,

certain ring-shaped specimens of Stalloy were known to be polarised while subjected to AC magnetisation, so that the voltage across a secondary winding contained even harmonics. It was desired to separate the even harmonics from

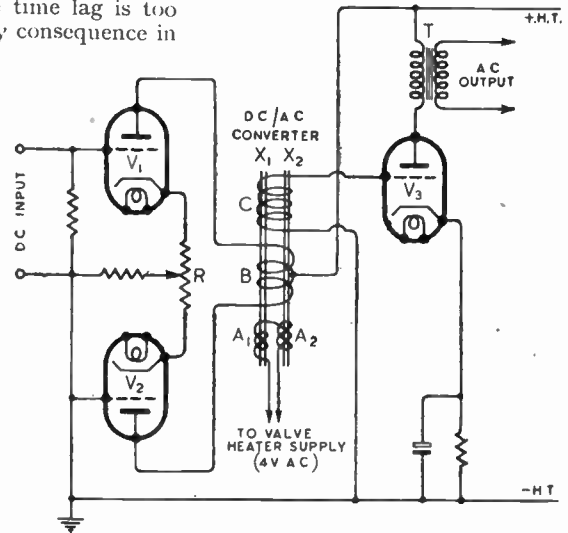

Fig. 2. DC/AC converter with high-impedance valve input circuit.

the fundamental and odd harmonics and so examine the even harmonic content alone. This was done by using two exactly similar specimens and so connecting their windings that in the secondary windings the odd harmonics opposed one another while the even harmonics were additive. Fig. 1, showing the connections and direction of polarisation, will make the principle clear. If the cores are *not* polarised there will be no output.

In the original experiment, the polarisation was maintained by tuning the secondary windings to the second harmonic frequency, but it is clear that the cores may be polarised by means of DC in the existing windings or in separate windings provided for the purpose. The output will then depend upon the DC magnetisation. If a rectifier be added to the secondary circuit we shall

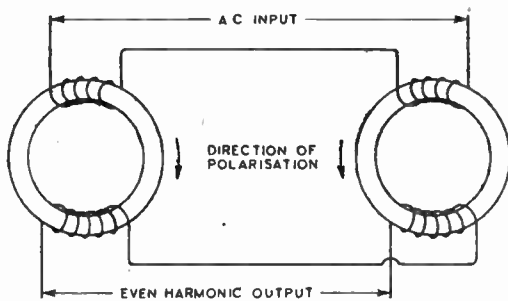

Fig. 1. Circuit for separation of even harmonics.

the operation depends initially upon the movement of a galvanometer mirror which reflects a beam of light on to a photo-

¹Electronics, Nov. 1941, and Wireless World, May 1942.

²Journal I.E.E., Vol. 89, Part 1, Mar. 1942.

³Journal I.E.E., Vol. 84, No. 505, Jan. 1939.

*MS. received by the Editor, June 3rd, 1942.

have, in effect, a DC transformer, the relation between DC input and DC output depending upon the turns ratio.

This arrangement alone can be

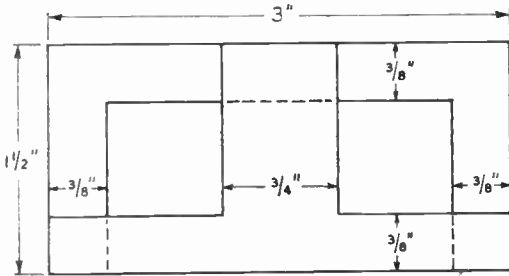

Fig. 3. Method of overlapping stampings in the converter core.

put to many uses, but for our present purpose we do not need a rectifier connected to the secondary winding. The AC harmonic output is caused to operate an AC amplifier and may then be rectified if desired. It is clear that a large range of input and output values can be made available by varying the windings.

It is perhaps better to call this piece of apparatus a DC/AC converter, rather than a DC transformer, except when a rectifier forms an integral part of the secondary circuit. Whether or not the converter is to be used with an amplifier, the DC may be fed direct to the input winding, but if this is done a series choke

should be used in order to prevent the circulation of even harmonic current in the input circuit. In many cases it is preferable to feed the input winding through a valve

stage. This serves to isolate AC voltages from the input DC and to give a very high input resistance. It can also provide a considerable proportion of the overall amplification. The possibility of zero drift due to this valve stage must not, however, be overlooked and suitable precautions would need to be

taken if the amplifier were designed for a very high gain. The double-triode arrangement used by Miller could no doubt be put to useful service in this connection. Up

type and very many possible modifications in detail suggest themselves.

A simple circuit arrangement is shown in Fig. 2. Two valves V_1 and V_2 are used on the input side, as the current through the two sections of winding B on the DC/AC converter must normally be balanced in order to avoid initial polarisation. A variable tap on the resistance R serves to adjust this balance.

Upon applying DC to the input terminals, this balance is upset and more current flows through one half of winding B than through the other half. The cores X_1, X_2 become polarised and this polarisation produces even harmonics in the alternating flux which is produced by the AC exciting windings A_1, A_2 . The latter windings are connected in opposition so that the fluxes in X_1, X_2 due to normal

Fig. 5. (a) Circuit connections of main winding, and (b) Section showing arrangement of windings on cores of converter unit.

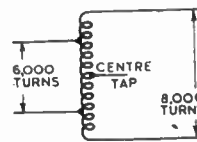

(a)

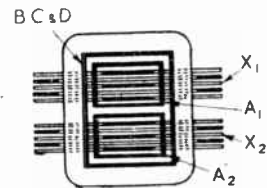

(b)

to the time of writing no attempt has been made to ascertain experimentally the highest practicable gain from an amplifier of this

exciting current are balanced and no voltage is induced in winding C. But the polarisation due to winding B is in the same direction in both cores, so that the even harmonic components of flux are additive and an even harmonic voltage is induced in C. This voltage is applied to the valve V_3 , in the anode circuit of which an output transformer T is connected. The transformer may have any desired ratio, depending upon the voltage and current required. If a DC output is required a rectifier must be added.

The results obtainable from such an amplifier depend principally upon the design of the DC/AC converter. There are many possible alternatives in the form and material of the cores, and the numbers of turns on the windings may be altered within wide limits to suit circumstances. The main factor that would appear to limit the possible amplification is the difficulty in obtaining a perfectly true magnetic balance in the two cores when there is no DC in the winding B. Fortunately,

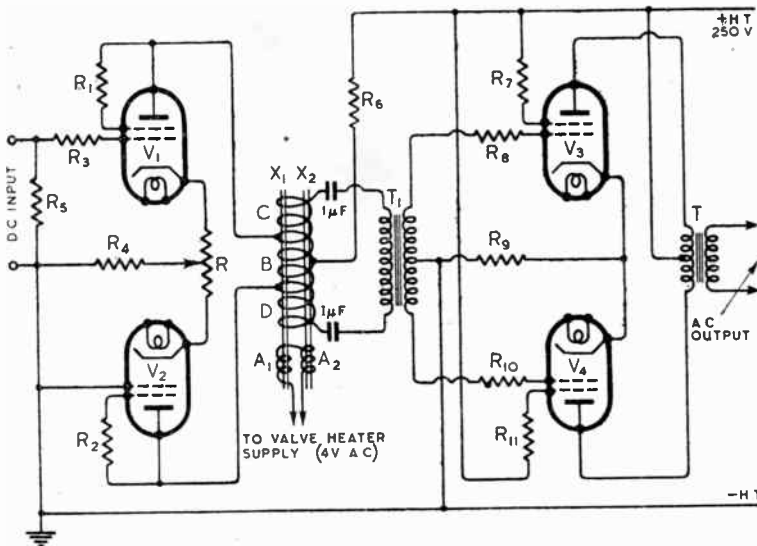
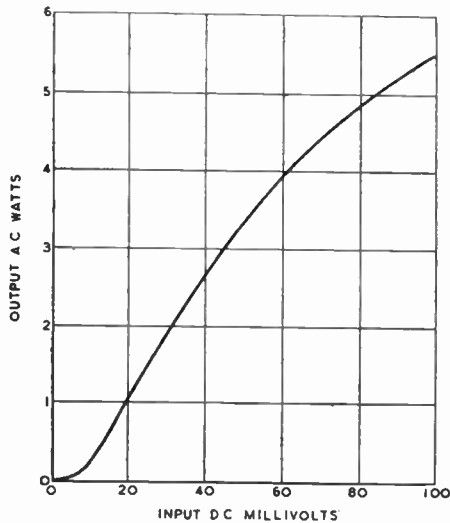

Fig. 4. Practical circuit with values suitable for use with KT41 valves throughout, $R_1, R_2, R_7, R_{11} = 200\Omega$; $R_3, R_8, R_{10} = 0.03 M\Omega$; $R_4 = 100\Omega$; $R_5 = 0.5 M\Omega$; $R_6 = 8000\Omega$; $R_9 = 50\Omega$. Potentiometer $R = 30\Omega$.

however, a small magnetic unbalance can be corrected by suitable adjustment of R.

The difficulties of obtaining magnetic materials at present has limited the experimental work



required is very small and it is possible to effect an appreciable economy in HT requirements by inserting a resistance R_6 of 8,000 ohms in series with the common anode supply to these valves.

The total HT then required for the four valves is 120 mA at 250 V.

The AC exciting windings A_1 and A_2 , Fig. 4, each comprise 800 turns of No. 38 SWG. The DC winding B is wound in two

Fig. 6. (Left) Characteristics of circuit shown in Fig. 4.

Fig. 7. (Right) Increased sensitivity results from the use of DC feedback as shown in Fig. 8.

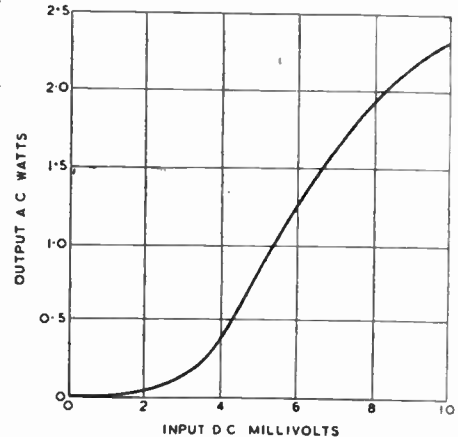

to some extent, but the writer had a few Mumetal stampings and these were found to give good results. The best results were obtained by overlapping the stampings⁴ in the manner shown in Fig. 3, in which their dimensions are also given.

Five stampings—three T's and two U's were thus arranged for each of the cores X_1 and X_2 .

The core section and winding space available were limited by these stampings and the effectiveness was found to be considerably enhanced by interposing an ordinary intervalve transformer between the winding C and the output valve V_3 .

Very good results have been obtained with the circuit shown in Fig. 4. Here it will be seen that the two windings B and C are replaced by an "auto-transformer" winding divided into sections and coupled to the output valves through an intervalve transformer. The output valves in this case are KT41 tetrodes in push-pull. The input valves V_1 and V_2 are also KT41 tetrodes, but are connected as triodes. The effectiveness of these valves for the input side of the converter is due to their high mutual conductance. The grid voltage range

sections, each having 3,000 turns of No. 43 SWG. This winding B, together with the end sections C and D, also forms the AC output winding. The sections C and D each have 1,000 turns of No. 43 SWG. All windings are enamelled copper wire. The main winding is shown more clearly in Fig. 5 (a), while Fig. 5 (b) indicates in section the general arrangement

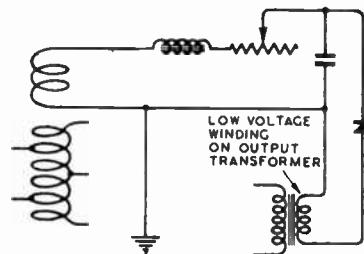

Fig. 8. Elements of additional DC feedback circuits.

of windings on the cores. The intervalve transformer T_1 was an old Marconi "Ideal" of 2.7 : 1 ratio.

The results obtained with the circuit set up exactly as described are shown by the curve in Fig. 6, in which output AC watts are plotted against input DC millivolts. The curve is only taken to 100 mV input as this is considered to be the useful range. The output at 100 mV input was

177 volts, 31½ mA RMS., or just over 5½ watts, from a 2 : 1 step-down transformer. Beyond this the curve gradually flattens out to a saturation value of 8½ watts output at about 600 mV input. The output waveform at 100 mV input as observed on an oscilloscope is shown in Fig. 9. The

fundamental output frequency is 100 c/s when the excitation frequency is 50 c/s.

DC Feedback

The sensitivity may be greatly increased by the use of DC feedback as shown by the curve of Fig. 7, which is plotted to 10 mV only, this being the useful range under these conditions. The necessary circuit additions are shown in Fig. 8. The feedback was not pushed to anywhere near the point of instability, so that this does seem to be quite a practical way of increasing the sensitivity. It is perhaps open to argument, however, whether this method of increasing the sensitivity of an instrument, in which maintenance of accuracy and reliability are of importance, is as satisfactory as the addition of an extra stage of AC amplification.

It is clear that an instrument of this kind should be fed from a stabilised AC supply. Not only are HT volts of some importance, but heater temperatures and AC exciting volts for the converter should be constant.

It is recommended that calibration should be done with input polarity as shown in Fig. 4, and the same polarity must be adhered to in subsequent use. It should also be noted that the DC/AC converter is very sensitive to

⁴For further comments on this mode of assembly, see article on "Magnetic Hysteresis Loops," in the *Electrician*, Aug. 21st, 1936.

external magnetic fields, *whether alternating or unidirectional*. It should, therefore, be sufficiently distant from either mains transformers or *permanent magnets*. Clearly, a good magnetic screen would be an advantage.

The usual precautions apply as regards stability of resistance elements in the amplifier, and the input grid lead should be protected from AC fields by screening. It is also worth while to screen the input valves. A condenser of, say, $1 \mu\text{F}$ connected across the input terminals as an

AC bypass is a useful further precaution when the conditions are such that it will not introduce



Fig. 9. Observed output waveform for a DC input of roomV.

an appreciable delay in the response.

INTERMEDIATE IMPEDANCE LOUDSPEAKERS?

Reducing Losses in Extension Leads

THERE are two principal methods by which an extension loudspeaker is coupled to a set. In the one which is most commonly used, the extension loudspeaker is connected in parallel with the speech coil of the one which is inside the set. This arrangement is thoroughly satisfactory if the extension is fairly short. With a long extension the ohmic resistance of the leads, unless they are very thick indeed, forms an appreciable part of the impedance of the whole circuit, and this means loss of power.

The second arrangement in quite common use is to take the extension from the high-impedance side of the loudspeaker transformer inside the set. In this case the resistance of the extension leads does not matter, but the capacity between the extension wires most certainly does, and high-note loss is very evident if the leads are at all long.

It would seem that there is a need here for a compromise method. If the impedance of the extension loudspeaker were made of some value considerably higher than the few ohms of the average loudspeaker, but in no way approaching that of the AC resistance of the output valve, and if at the same time manufacturers would give us an extra secondary winding of commensurate impedance on the loudspeaker transformer, we should be troubled neither by the resistance of the extension leads nor by their self-capacity.

Additional Cost?

There does not seem to be any argument against the scheme except that the additional secondary winding would add to the cost. Surely, however, this could be largely discounted by having no *additional* secondary winding, the normal wind-

ing being wound to the higher impedance value, and, of course, the internal loudspeaker having a few more turns on its speech coil. The extension loudspeaker would then be connected in parallel with the speech coil of the internal one.

N. M.

BOOK REVIEWS

A Course in Radio Fundamentals.

By George Grammer. Published by The American Radio Relay League. Price 50 cents.

This book is a reprint of a series of articles which appeared in the American periodical *QST*. It takes the form of a guide to a course of study, complete with examination questions and answers, based on "The Radio Amateur's Handbook" of the same publishers. The course is illustrated throughout by a series of experiments covering a wide field of radio knowledge, from electrostatic attraction and repulsion to Class C modulated amplifiers. All the experiments described can be carried out with the aid of a multi-range test instrument, a calibrated receiver, an oscillator and a valve voltmeter. The construction of the latter two pieces of equipment form interesting experiments in themselves. In addition a number of fixed condensers and resistances, certain to be possessed by the amateur experimenter, are required. Photographs of the base-board type of constructional work likely to be used in the experimental work are included and typical results and graphs are given. Some of the latter are particularly interesting and cannot be found in other published works on radio.

In view of the purpose of the book and its association with the A.R.R.L. it is natural to find a

bias towards transmitter technique and RF problems generally, but it is a little surprising to find no mention and no experimental work on audio-frequency power output stages, though admittedly it is difficult to devise experiments on this subject with apparatus as simple as that used throughout this course.

Altogether this is a unique and useful publication and can be recommended to serious students of radio.

S. W. A.

Electrical Technology for Telecommunications. By W. H. Date, B.Sc., A.M.I.E.E. Pp. 160: 115 diagrams. Published by Longmans, Green and Company, 43, Albert Drive, London, S.W.19. Price 5s.

This book is intended to provide a knowledge of those fundamentals without which satisfactory understanding of radio communication and line telephony and telegraphy is impossible. The standard of the work makes it suitable for use in the 1st and 2nd years of the City and Guilds course in Technical Electricity.

It begins with introductory chapters on the effects of an electric current and resistance, which lead to sections on inductance and capacitance. It then considers alternating currents in inductive, capacitive and resonant circuits and here it is noted that the author prefers to use the rather unusual form $\sin \theta$ instead of the conventional abbreviation $\sin \theta$, whereas he uses the standard forms ($\cos \theta$ and $\tan \theta$) for other trigonometrical ratios. He deals next with power in AC circuits, transformers and measuring instruments and ends with a chapter devoted to accumulators, in which both lead-acid and alkaline-electrolyte cells are treated.

The book is made eminently suitable for use by students by the inclusion of a large number of numerical examples, all of which are worked out with particular emphasis on the logical sequence of the various stages in the evaluation. Alternative methods of procedure are given in some examples.

The author has succeeded in his stated object, and the book should be very suitable for the purpose for which it is intended.

S. W. A.

WASTE PAPER

THE Director of Salvage and Recovery at the Ministry of Supply announced that London's target of five million volumes in the recent Book Drive had already been exceeded, although the task of counting the books collected is still not completed.

The amount of paper being collected each week is still many hundreds of tons below production needs, hoarding being chiefly responsible.

SENSITIVE RELAYS

Light-Current Devices for Radio and Allied Uses

By JOHN H. JUPE

WITH the growing application of radio and similar techniques to purposes of control there has been a parallel increase in the uses for relays of comparatively high sensitivity. It is proposed in this article to survey all the main groups, with the exception of thermal relays, which have already been dealt with. Many figures are averages and in some cases it is impossible to generalise at all. In the matter of sensitivity, the various groups overlap and in practice, cost or some technical point will be the deciding factor as to which type is adopted.

Moving Coil Relays.—These, in their general form, are similar to indicating instruments, with one contact attached to the pointer and the other(s) fixed near the end(s) of the scale. In ordinary types, the minimum current for satisfactory operation is about 15 microamperes and they can be obtained in all the usual forms of moving coil indicating instruments. There is one design in this group which will close on as little as 2 microamperes or 1 millivolt and which will safely carry up to 50 milliamperes, at 110 volts, through its local-circuit contacts. These are made of a magnetic material, silver plated, so that when the moving (pointer) contact approaches fairly closely to the fixed one, which is magnetised, the attraction between them takes control and they close suddenly and positively. Once closed, the contacts must be reset mechanically or electrically.

Moving coil relays of the highest sensitivity are somewhat delicate in construction, expensive and apt to be disturbed by vibrations; as well as operating with almost zero contact pressure. A point of importance in connection with them is the vibration induced by the control springs. These are, in effect, coils of several turns, carrying current and situated in a magnetic field, and, since they are almost, but not quite, at the neutral point, vibrations lasting several seconds

may be started when the relay closes.

Moving-Iron and "Telephone" Relays.—The moving-iron principle can be utilised to produce a highly sensitive relay in a manner similar to the moving coil. A type described below may be made to operate with a current as low as 10 microamperes but it has the disadvantage of a very small air gap between the contacts—5 to 15 thousandths of an inch.

A slender iron armature carries the moving contact and is mounted in pivoted bearings within the hollow core of a solenoid. The arrangement is polarised by

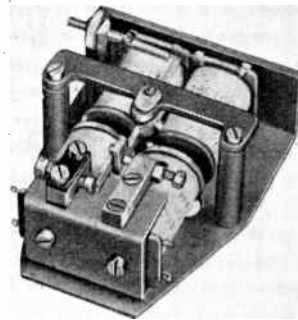

Four-coil polarised relay of specially sensitive type (*Automatic Telephone and Electric Company*).

means of a permanent magnet and the armature, which is carefully balanced mechanically, is caused to take up a position near the neutral magnetic point in the air gap, with the aid of an adjustable magnetic shunt. Under such conditions a very small current will cause change-over, normality being restored by the magnetic field.

"Telephone" relays are probably the most widely used of all light-current relays and are particularly suitable for operating in the anode circuits of electronic devices. Operating currents vary between about 0.5 and 1,000 milliamperes, but the other char-

acteristics vary so much between different manufacturers that it is not possible to quote average figures for all types and makers. For a given design of magnetic circuit and a given mechanical arrangement, the coil requirement in watts (DC) or volt-amperes (AC) is a constant, but the actual volts or amperes have maximum and minimum limiting values. For example, a certain design requires 0.008 watt DC and this may be obtained by

- 14.3 volts and 0.56 milliamp. and a coil resistance of 25,500 ohms (limit);
- 0.98 volt and 8.15 milliamps. and a coil resistance of 121 ohms;
- 0.056 volt and 144.5 milliamps. and a coil resistance of 0.385 ohm (limit).

Another factor in coil wattage dissipation for these relays is heating, which usually sets a limit of 1-2 watts per square inch of coil surface (omitting ends), when covered, or twice this value with free air circulation.

Of course, multiple contact relays of this group require more power than simple ones and for equal contact pressures the following ratios of ampere-turns may be taken as fair averages:

Single-pole ; " make "	..	100
Ditto, " make and break "	..	109
Double pole ; " make and break "	..	150
Three-pole ; " make and break "	..	200
Four-pole ; " make and break "	..	254

Within reasonable limits, the operating time of telephone relays may be increased by fitting copper sleeves or "slugs" over the coils. A relay will not close until the magnetic flux between the pole face and the armature has reached a maximum value or will not release until it has fallen to another value. Consequently, a copper sleeve around the armature end of the coil will have eddy currents induced in it, and the flux set up by these will oppose the main flux and make the relay slow to close. Conversely, one fitted at the opposite end will make it slow to

TABLE I.—CHARACTERISTICS OF TELEPHONE RELAYS

Resistance (ohms)	Operating current (mA.)	Minimum operating time (milliseccs.)	Maximum release time (milliseccs.)	Contact pressure, "break" (grams)	Contact pressure, "make" (grams)	Remarks
400	6	10	10	—	30	Release 2 mA.
1,300	20	30	5	40	30	"Slugged"
2,000	12	10	5	30	30	
800	13	10	500	20	20	Polarised
550	4.5	2	5	—	3	Polarised
7,010	1.2	3	5	—	3	
3,000	0.5	1	5	—	2	
50	15	10	10	—	14	Release 2.8 mA.
60	18	10	10	—	14	Release 2.8 mA.
120	12	10	10	—	20	
1	80	20	10	—	20	

NOTE: These figures are representative of relays made by a well-known British company but should not be taken as representative of "telephone" type relays in general.

release, and an overall sleeve will make it slow in both directions. The kind of change obtained by fitting "slugs" varies with the size, but possible figures are 0.1 second, unsleeved; 0.2 second, sleeved. For long delays mechanical dashpots must be fitted, but it should be noted that copper sleeves may also be fitted to relays to prevent chattering when AC is used to excite the coil. In some circuits, such as the anode circuits of valves, the ratio of "close" to "release" current is important. Suppose a relay closes on 1 milliampere; then if its release does not occur until current falls to 0.25 milliampere, sufficient negative grid bias to reduce the anode current to this figure will be required. Such a grid voltage change will be considerable, even with valves of high transconductance, and the overall sensitivity of the circuit will be poor. If, however, a relay closing at 1 milliampere and releasing at 0.5 milliampere were substituted, the corresponding grid voltage change, using the same valve, would be much less. A common pull-up/release ratio for ordinary telephone relays is for the release current to be half the closing current. Other representative figures are given in Table I.

Mercury Relays.—These form a class of wide variations, with contact ratings varying between about 5 and 50 amperes, at voltages up to 250 AC or more, and with slightly lower ratings for DC. Sensitivity is not of great

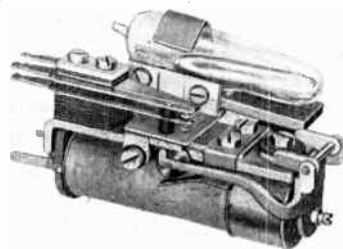

Tilting relay; the mercury contacts will carry up to 5 amps. at 230 volts AC or DC. (Automatic Telephone and Electric Company).

importance, and the chief data for coils concerns voltage, frequency and wattage. Contacts are of two types, solid metallic contacts using considerably greater contact pres-

sure than in the case of the more sensitive relays, since power consumption is not of prime importance, and mercury contacts, consisting of tilting glass containers, the general forms of which are well known. There are, however, some interesting variations. One of these is the plunger type, consisting of a vertical glass tube containing mercury and with an iron plunger floating in it. Surrounding the tube is the control coil, and the contacts are so placed above the surface of the mercury that when the plunger is drawn into the field of the coil, it sinks below the surface of the mercury, causing the level to rise and cover the contacts. Relays of this type can be operated reliably at angles up to 45 degrees from the vertical, and are thus quite suitable for use in a ship or in many mobile applications.

Another type, originally devised for use in gyroscopic apparatus, overcomes the large inertia of the mercury, which is sometimes troublesome, by using two small glass cisterns, connected top and bottom by glass tubes. The space above the mercury is filled with hydrogen, with a needle valve set at the mid-point of the upper tube. Consequently, when tilt takes place the change of gas pressure is controlled by the needle valve, and may be adjusted to stabilise the moving mercury. Sensitivity depends on the length of the tubes and the distance between the mercury and the contacts. With a tube five feet long and 0.002 inch

between contacts, an angle of 6.78 seconds of arc can be measured.

A third interesting type in the mercury class uses a transformer as its main feature. The primary is fixed and is connected to the mains, whilst the secondary, which is movable and has 24 volts induced in it, carries the mercury tube and is wound on the yoke of the core. When the 24-volt circuit is closed repulsion takes place between the fixed core and the moving yoke and the tube is tilted. Gravity returns the system to normal. The advantages of this method of construction are: absence of springs; mains operated but with only 24 volts in the control circuit; quiet operation; no armature-to-poleface chatter.

Gas Discharge Relays.—The best known of these is the gas-filled triode valve, consisting of a heated cathode, a grid and an anode, all mounted in a common container (often glass) with a little mercury. To start the arc, which passes through one or more holes in the anode, it is necessary for the electric field set up between the positive anode and the negative cathode to cause the electrons emitted by the cathode to be accelerated sufficiently to ionise the mercury vapour, or whatever gas is used as a filling.

The grid potential alters this field considerably and if it is sufficiently negative can practically stop the emission of electrons. Once the arc starts,

Sensitive Relays—

however, this control function ceases, as the grid is then charged to a potential sufficient to repel electrons. It also collects positive ions which confine its electric field by covering it with a sheath. Extinction of the arc can only take place by disconnecting the positive voltage from the anode. This takes place automatically on alternating current at the end of each positive half cycle, providing the gas or vapour within the bulb has had time to become de-ionised, a condition which is generally easily fulfilled.

Many control circuits are possible with relays of this type. Varying potentials may be applied directly to the grid, or the phase of its potential with respect to the anode may be varied. Table II gives the chief characteristics of gas-filled triodes or "Thyratrons" manufactured by The British Thomson-Houston Company.

Glow Relays.—This type of relay, which is essentially a neon lamp fitted with a third (control) electrode, is not so widely used as it could be. It possesses some desirable characteristics; these are: a minimum of primary current is required (10^{-10} ampere); energy consumption when working below the critical voltage is zero; inertia is completely absent; vibrations cause no disturbance; the secondary circuit current is of the order of 30–40 milliamperes and is ample to operate robust secondary relays. There is the disadvantage, under some circumstances, that a comparatively high operating voltage (about 200) is required, although lower values can be obtained if specially required.

Relay Contact Materials.—The best contacts are those made from the noble metals and their alloys. Taking into account all factors,

such as freedom from tarnish, cost, ease of working, contact resistance, etc., the best materials are gold, platinum and silver. Contacts made of tungsten or phosphor-bronze are definitely inferior for light-current work as they require either higher voltages or much greater contact pressure than those made from the noble metals. Phosphor-bronze requires about 28 volts to penetrate the tarnish film when pressure is almost zero, but over 30 volts it works well. Tungsten is best worked with not less than 50 volts, unless contact pressure can be maintained at not less than 100 grammes or more, with a minimum voltage of 3.

Contact Surfaces.—For light-current relays it is a fallacy to assume that contacts with large surfaces area are better than small ones, as two plane surfaces, free to align with each other, can only touch at three points unless the pressure is sufficient to distort the surfaces. Rather more important is the requirement that the contacts should not collect dust, and, coupled with other considerations, the ball/flat combination is the best.

Smooth, polished surfaces are not necessarily the best as they have fewer points (of microscopic dimensions) to pierce grease or tarnish films. In a test, two sheets were chromium-plated and one was highly polished whilst the other was left with a granular surface, just as it came from the plating bath. With about 5 grams contact pressure and a blunt copper point, the polished plate showed eight times the contact resistance of the unpolished one.

The majority of contact troubles are caused by grease; after that, by carbon deposits and what is called "coning and cratering"; this is caused by material being

transferred from one contact to the other by direct currents. These craters may fill with carbon or the contacts may even stick together completely. The trouble may be very effectively obviated by reversing current (if possible) at intervals.

Telephone relays with average contacts work best when not less than about 20 volts is used in the local circuit, with about 20/40 grams contact pressure. Actu-



Midget relay of the spring-controlled tilting-armature type. (Londex, Ltd.).

ally only about 2 volts is required if the contacts are of noble metals or their alloys, but grease soon causes this minimum to rise considerably, a point that should always be borne in mind when determining the local-circuit voltage of any type of relay.

Sparking at Contacts.—About the worst class of circuits from the point of view of contact damage are the non-inductive ones, such as metal filament lamps. At the moment of opening there is generally a certain amount of vibration of the contacts under industrial conditions, and in an inductive circuit the average current is quite low; whereas in a non-inductive one it is nearly at full value during the whole period of break.

To cure sparking by fitting a condenser across the contacts is extremely bad, as it definitely causes excessive welding to take place. Suppose, for example, that the condenser is charged to 20 volts when the contacts are open; then, if the short-circuit resistance is 0.02 ohm, the momentary current when closing takes place is 1,000 amperes. A resistance should always be placed in series with such a condenser to limit this short-circuit current. For delicate (moving coil) relays its value should be about 20 ohms

TABLE II.—THYRATRON CHARACTERISTICS

Type	BT 7	BT 9	BT 17	BT 19	BT 27	BT 29	BT 35
Filament Volts	5	5	5	2.5	5	5	5
Filament Amps.	10.5	20	10.5	5	10.5	20	4.5
Rated Anode Amps. (peak)							
50 cycles ..	15	75	25	2.0	25	75	12.5
Rated Anode Amps. (mean)	1	12.5	6	0.5	6	12.5	2.5
Anode Volts ..	10,000	10,000	1,000	1,000	1,000	2,000	1,000
Heating Time ..	5 mins.	15 mins.	5 mins.	20 secs.	5 mins.	5 mins.	5 mins.

Callender's

RADIO FREQUENCY= CABLES

We are fully engaged on war production and are manufacturing all types of low loss and low capacity cables for use at high frequencies.

We shall be pleased to make available the experience of our extensive research and technical organisations in connection with special cable problems directly related to the war effort.

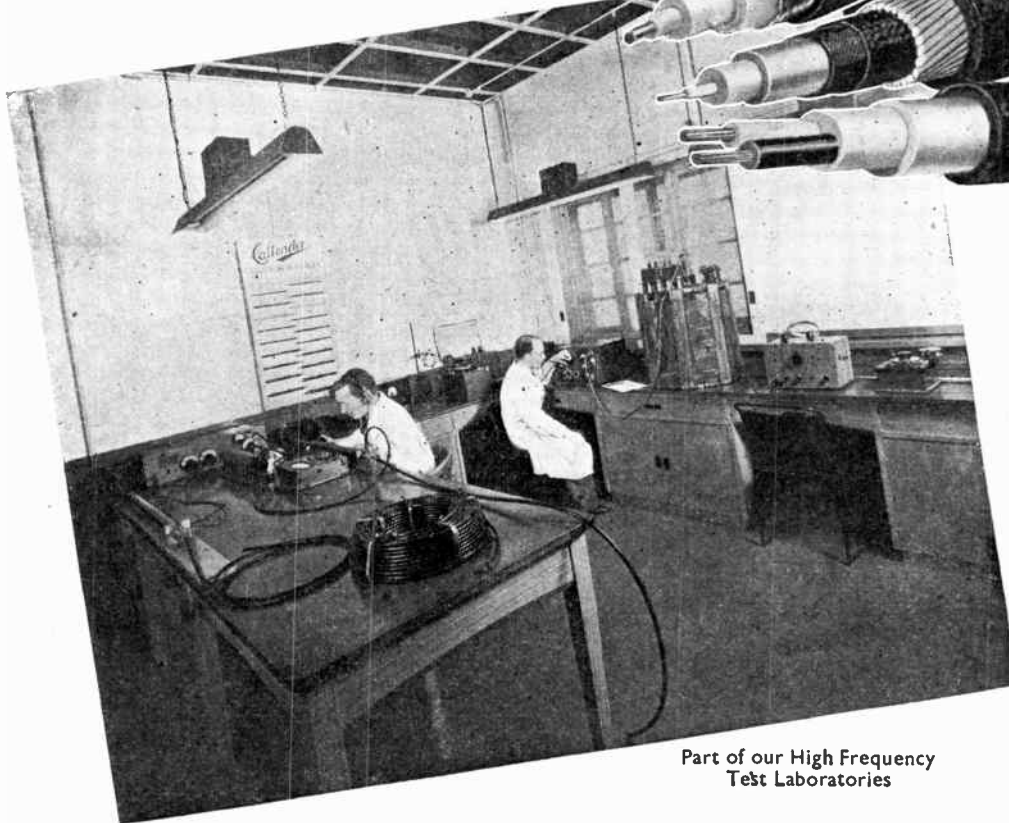
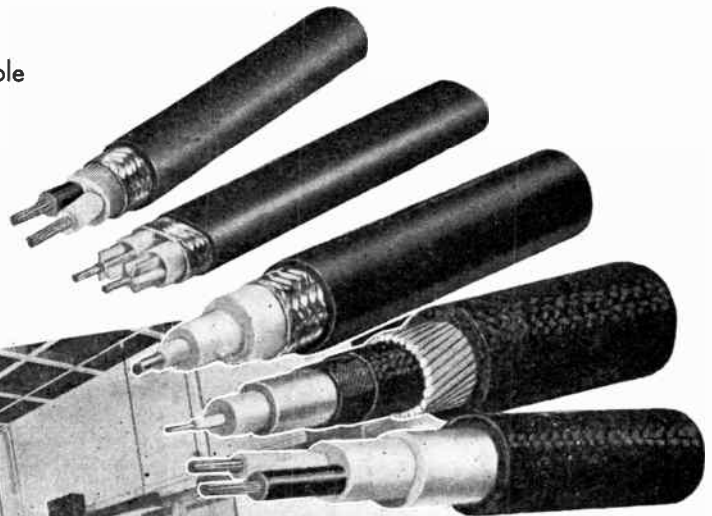

Part of our High Frequency
Test Laboratories

CALLENDER'S CABLE & CONSTRUCTION CO. LTD. HAMILTON HOUSE, VICTORIA EMBANKMENT, LONDON E.C.4

All over the World

"to Insulate"

Practically all waxes are used to "separate or isolate," but the degree of insulation provided by the different types of waxes varies enormously. There is obviously no higher degree of insulation required than that of electrical components and apparatus in intense electrical fields, especially in the extremes of conditions to which they are subjected to-day.

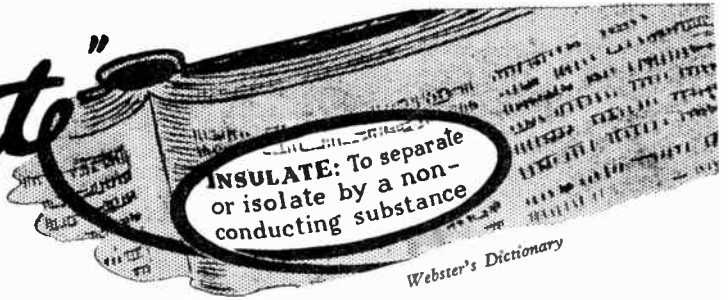

We specialise in the supply of
WAXES *for all purposes—under all conditions*

Our technical advice is at your disposal.

If you have any problem of

IMPREGNATING—DIPPING—FILLING

we, as consultants to the Industry, shall be glad to offer you a solution.

CLAUD CAMPBELL & CO. LTD.
 4, LLOYDS AVENUE—LONDON—E.C.3
 Telephone Nos. :—ROYAL 5403/4/5.

Rotary Cutting, Filing, Grinding and Polishing - *Economy and Accuracy*



Use **MORRISFLEX** Flexible Shaft Equipment, and **REX** Rotary Files and Cutters for cutting, filing, grinding and polishing components of aluminum, Elektron, non-ferrous alloys and ferrous metals. For metal buffing and cleaning we supply **MORREX** Rotary Wire Brushes, and **MORRISFLEX** Rotary Polishing Mops and Felts, also Felt Cones. **MORRISFLEX** Rotary Rasps are ideal for woodworking, and attachments for **MORRISFLEX** machines include Sanders and Grinders.

MORRISFLEX machines are available in overhead suspension, bench and floor types. Their use ensures speed with accuracy, and a high degree of finish. Write for Lists.

B. O. MORRIS LTD.
 SHIRLEY,
 BIRMINGHAM.

Shirley 1237.

'Grams :

Morrisflex, Birmingham.

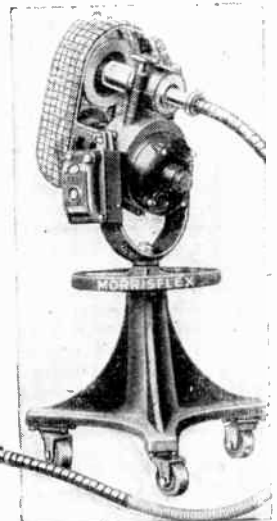

MORRISFLEX
FLEXIBLE SHAFT EQUIPMENT

Sensitive Relays—

per volt, but down to 1 ohm per volt may be satisfactory with other types. Another method of reducing contact destruction due to sparking is to place a condenser in series with the contacts, where circuit conditions permit. Such a plan is good, inasmuch as no heavy welding is possible, but there may sometimes be failure to "make" properly. By the time the contact has settled the PD across the condenser will equal the line voltage, with a consequence that the last "make" will not cause a current flow from the condenser. This is essential, as it is probable that a microscopic weld is necessary in any relay, in order to secure good contact under commercial conditions. Shunting

the condenser with a resistance, as low as is consistent with zero sparking will cure this trouble of unreliability.

Maintenance of Contacts.—Contact cleaning, particularly in moving coil and telephone relays, is deceptively easy. A file may improve matters for the time being and then the trouble returns, worse than before. It may be argued that it is fundamentally wrong to file contacts. This is untrue, as it was pointed out earlier that a rough surface provides a better contact than a polished one, providing that the roughness is not so great that jagged points project. No, the great danger of files is that they almost invariably contain grease

embedded in the channels between the teeth, and grease is the enemy of all light current contacts, especially when contact pressure is light.

If the surfaces are not coated with carbon or very badly cratered, the best plan is to wash them with a slip of smooth chamois, dipped in carbon tetrachloride or ether, and then to wipe them with a clean piece of chamois. One little jab is sufficient in each case. Avoid using paper or cloth, as they always leave fluff behind, and should it be necessary to use a file, use a dead smooth one which is washed from time to time in one of the above solvents and then, after filing, wash and wipe the contacts in the manner just described.

NEWS IN ENGLISH FROM ABROAD

REGULAR SHORT-WAVE TRANSMISSIONS

Country : Station	Mc/s	Metres	Daily Bulletins (BDST)	Country : Station	Mc/s	Metres	Daily Bulletins (BDST)
America				India			
WKRD	5.985	50.12	0700, 0800, 0900, 1000	VUD3 (Delhi) ..	7.290	41.15	0900, 1400, 1650
WLWO (Cincinnati)	6.080	49.34	0700, 0800	VUD4	9.590	31.28	0900, 1400, 1650
WBOS (Hull) .. .	6.140	48.86	1000, 1100‡	VUD3	15.290	19.62	0900, 1400
WCBX (Brentwood)	6.170	48.62	0600				
WGFA (Schenectady)	6.190	48.47	0615, 1100‡	Mozambique			
WKTM	6.370	47.10	0700, 0800, 0900, 1000	CR7BE (Lourenco Marques)	9.830	30.52	1255, 1812, 2015
WLWO (Cincinnati)	7.575	39.60	1000				
WKRD	7.820	38.36	0000, 0100, 0200, 0300 0400, 0500, 0600, 1100‡, 1200, 1300	Newfoundland			
				VONH (St. John's) ..	5.970	50.25	0015, 2345
WCRC (Brentwood)	9.650	31.09	0700	Spain			
WNBI (Bound Brook)	9.670	31.02	0100	EAQ (Aranjuez) ..	9.860	30.43	1915
WKRD	9.897	30.32	2200	Sweden			
WKRX	9.897	30.32	0200	SBV (Motala) .. .	9.535	31.46	2320‡
WCRC (Brentwood)	11.830	25.36	1200, 1300, 2145	Switzerland			
WGFA (Schenectady)	11.847	25.33	1300, 1400, 1600‡, 1700, 1800	HER3 (Schwarzenburg)	6.165	48.66	2250
				HER4	9.535	31.46	2250
WKRD	12.967	23.14	1400, 1600‡, 1700, 1800, 1900	Syria			
WLWO (Cincinnati)	15.250	19.67	1600‡, 2000‡, 2200, 2300	Beirut	8.035	37.34	1920
WCBX (Brentwood)	15.270	19.65	2145	Turkey			
WGFA (Schenectady)	15.330	19.57	1200, 1300	TAP (Ankara) .. .	9.465	31.70	1900
WRUW (Boston) ..	17.750	16.90	1600‡, 1700	U.S.S.R.			
WLWO (Cincinnati)	17.800	16.85	1800, 1900	Moscow	6.980	42.98	0000, 0035, 1340, 1800
					7.300	41.10	0000, 1900, 2100, 2200, 2300
					7.360	40.76	0000
					7.560	39.68	0000
					10.445	28.72	1340
					11.830	25.36	1700.
					12.190	24.61	0200
					15.110	19.85	0035, 0515
					15.230	19.70	0515, 1340
Australia				Vatican City			
VLG3 (Melbourne) ..	11.710	25.62	0855	HVJ	5.970	50.25	2015
VL12 (Sydney) .. .	11.872	25.27	0855				
VLG9 (Melbourne) ..	11.900	25.21	1615				
Brazil							
PRL8 (Rio de Janeiro)	11.715	25.61	2130‡				
China							
XGOY (Chungking)	9.635	31.14	2230				
	11.900	25.21	1500, 1700, 1815				
Egypt							
Cairo	5.785	51.85	1225, 1840				
	7.510	39.94	1225, 1840				
French Equatorial Africa							
FZI (Brazzaville) ..	11.970	25.06	2145				
				Ireland			
				Radio Eireann ..	kc/s	Metres	
					565	531	1440‡, 1945, 2310

It should be noted that the times are BDST—two hours ahead of G.M.T. ‡ Sundays excepted.

RADIO DATA CHARTS—10

Loudspeaker Dividing Networks

MUCH has been heard recently of high fidelity reproduction, and often great pains are taken to achieve a "straight line" response from the output terminals of a receiver or amplifier. Notoriously the weakest link in a chain determines its strength, and too little attention is often given to the loudspeaker system, resulting in a disappointing performance. Speakers have been designed faithfully to reproduce almost the entire audio range, but they are expensive and sometimes bulky. Quite often a considerable improvement can be obtained by the use of two speakers—one for the low frequencies, and one for the high.

to the wrong speaker it is desirable to have an attenuation outside the pass band of at least 10 db per octave. A half section will give an attenuation of about 12 db per octave, and a full section about 18 db per octave outside the pass bands. Fig. 1 (a) and (b) show half sections arranged for series and parallel operation respectively, whole sections are shown at (c) and (d). The various components are labelled, and when a filter configuration has been decided upon, it may be designed

the power distribution in music from an orchestra and it will be seen that most of the power to be radiated by the speakers lies below 600 c/s or so. Hence, if a small three-inch speaker is to be used for the "tweeter" then the cross-over frequency will have to lie well above this point. In this particular case 1,000 c/s to 1,200 c/s would be a reasonable choice, provided, of course, that the "woofer's" response does not begin to tail off until about 1,500 c/s or so is reached. Naturally, the same considerations apply if the dividing network is introduced earlier and two separate output stages are used. Incidentally, this method enables one to control the

By

J. McG. SOWERBY,

B.A., Grad.I.E.E.

(By permission of the Ministry of Supply)

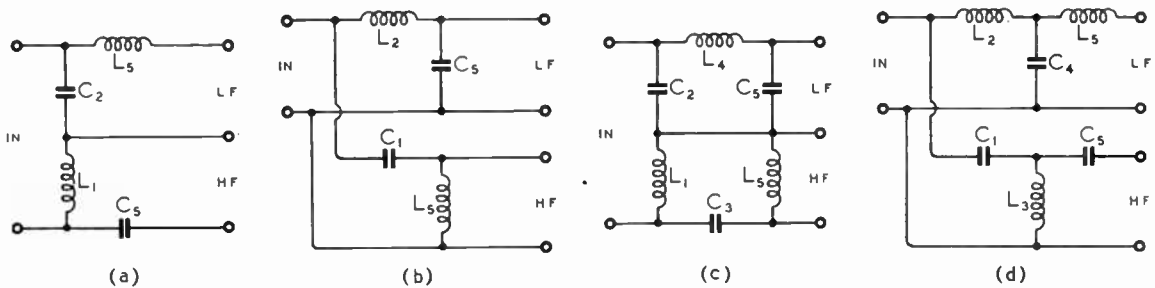

Fig. 1. Possible filter arrangements. (a) Half section, series. (b) Half section, parallel. (c) Whole section, series. (d) Whole section, parallel.

These are sometimes known respectively as "woofer" and "tweeter," for obvious reasons. Equally obvious it is necessary to have some means of dividing the total audio range up into two complementary sections to be fed to the two speakers, for otherwise the bass would overload the "tweeter," and the treble would be lost in the "woofer." This division may be carried out by means of filters placed between the output transformer and the speakers, or at an early stage in the audio amplifier when a separate output stage for each speaker is used. It is the purpose of this chart to enable the designer to choose and conveniently calculate the filters most suitable for his purpose in terms of cross-over frequency and speech coil (terminating) impedance.

To prevent peaks in the complementary ranges straying on

with the aid of the chart where the gauge points L_3 , C_3 , etc., refer to Fig. 1.

The choice of cross-over frequency (i.e. where the two speakers are being fed with equal amplitudes, and the filter loss is 3 db.) is not very critical and depends on the speakers available and their relative power-handling capacity. Fig. 2 shows roughly

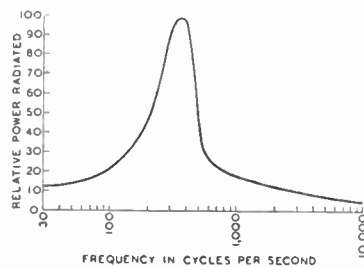

Fig. 2. Typical distribution curve of power from an orchestra over the audio-frequency spectrum.

volume fed to the two speakers independently, giving a form of tone control.

A word about mounting the speakers. They should be mounted as close to one another as practicable, for nothing is more disturbing than to hear consonants emanating from one place, while vowels come from another. Bass resonance in the "woofer" can be minimised by the use of an acoustic labyrinth. Damping is also important, and the speakers—especially the "woofer"—should be driven from a source of low impedance; for this reason pentodes or tetrodes should be used only with negative feedback for the best results.

Example

A dividing network is required for a cross-over frequency of 800 c/s for use with speakers of speech coil impedance 100 ohms. (Concluded at the foot of col. 1, p. 240)

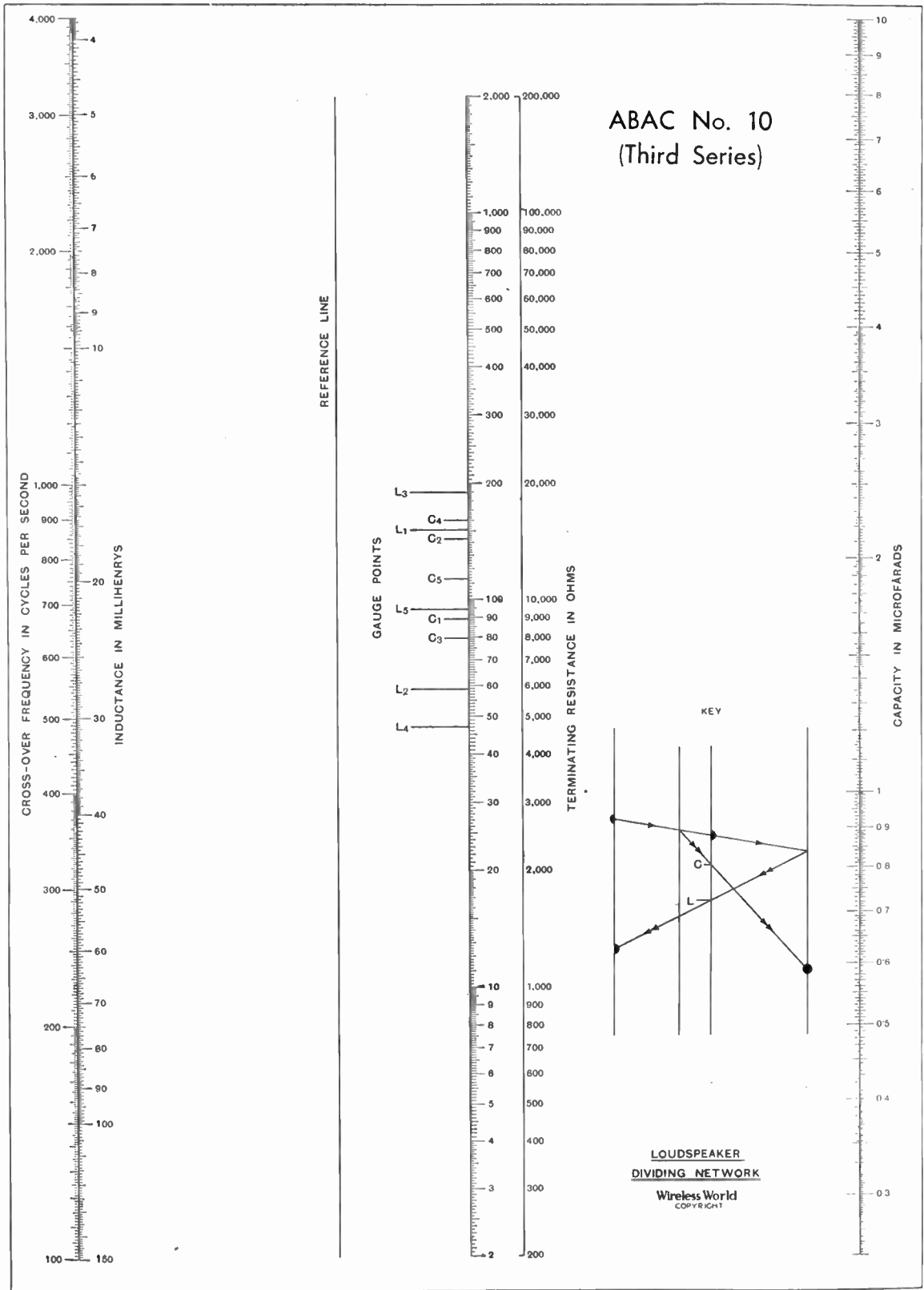

High-fidelity Reproduction • “Dynodes”

Contrast Expansion

MAY I re-enter the very interesting correspondence on this subject, a correspondence which has disclosed a gratifying unanimity at least with respect to the ultimate need for a system of controlled compression complemented by a controlled inverse expansion of amplitude?

Surely, however, Mr. Williamson (May issue) is fundamentally at fault when he questions earlier statements that contrast expansion (by itself) must either degrade transient response or increase non-linear (harmonic) distortion. This conclusion, he writes, is based on the assumption that the “pick-up” and “decline” delays are normally equal.

In fact, however, the conclusion is not based on that assumption; it is based on the condition that transient phenomena involve rates of change of instantaneous amplitude which are of the same order as those occurring in sine-wave alternations of audio frequency. It is, indeed, generally accepted that good transient performance can only be secured from, say, an amplifier or a loud speaker if its frequency characteristic extends well into the

upper audio frequencies. It follows, therefore, that if an expander has time delays which are long compared with the cycle time of any of the frequencies being handled, it cannot respond to transients; whilst if the time delays are shortened, distortion of the wave-shape (i.e., non-linear distortion) will occur.

Mr. Williamson's proposal that the “pick-up” delay should be short whilst the “decline” delay is long seems to me to be begging the question. Transients, after all, may consist of either a sudden increase of amplitude, or a sudden decrease of amplitude, or the one followed by the other. One would not deny that it may be better to be in a position to handle some types of transients rather than none at all, but that is not a real solution of the problem. In my opinion, neither Mr. Williamson nor Mr. Moir (March issue) is sufficiently separating the objective from the subjective aspects.

The objective goal of high-fidelity reproduction is that the reproducer should maintain *at the listener's ear* a sound field which is an undistorted replica (in wave-shape, in amplitude and in amplitude range) of that which would have existed *at his ear* if he had been present, in a favourable position, at the original performance. If that goal could be attained, the subjective requirements would be inherent and the listener would accept the reproduction as perfect.

Meanwhile, of course, this goal is not yet attained, and a compromise must often be made in which the use of a theoretically unsound device or system may give an overall result which, on balance, is pleasant and acceptable to the listener. It is, however, essential to bear in mind that any such compromise is subjective and its value will depend upon the circumstances and possibly upon the individual listener. There is a grave danger of regarding it as good in itself.

Judgment tests, as implied in Mr. Moir's group demonstrations, are not a reliable basis for objec-

tive research, although they doubtless have some value in arriving at a broadly acceptable compromise. In another sphere, telephone engineers have gained considerable experience of judgment tests and of other means of assessing the quality of microphones or reproducers. They have learnt how little relation there may be between the objective performance of a system and the opinion or judgment of listeners. High-fidelity reproduction is naturally agreeable, but all agreeable reproduction is not high-fidelity. The contrast expander, used alone, belongs to the same category as the “tone control”; it may have its uses, but should have no permanent place.

I still feel that the system to be aimed at must introduce a controlled non-linear distortion (rather than the normal amplitude distortion) at the transmitter or recorder with, of course, an inverse non-linear distortion at the reproducer. It would be very interesting to know if any of your readers is aware of experimental work which may have been done on such lines.

J. R. HUGHES.

London, N.W.7.

RADIO DATA CHARTS—10

(Concluded from page 238)

Full section parallel filters are to be used. Design the filters using the chart.

Following the key it is found that $L_5 = 19.9$ mH; $L_6 = 31.8$ mH; and $L_3 = 0.95$ mH. For the condensers the values are $C_5 = 1.99$ μ F; $C_4 = 3.98$ μ F; and $C_1 = 1.243$ μ F. The filters are connected as in Fig. 1 (d).

When working out filters for speech coils of very low impedance, multiply the impedance by 10 (or 100). The values of inductance given by the abac must then be divided by 10 (or 100) and the capacities multiplied by 10 (or 100). If the high-value impedance scale is used, resulting values of inductance must be multiplied by 100; capacities must be divided by 100.

Wireless Pioneers

YOUR “Brains Trust,” dealing with the conception of the idea of communication by means of electro-magnetic waves, has emphasized the importance of Marconi's work in the field of commercial exploitation. May I add a few facts, gathered from official publications of the U.S.S.R., regarding the early work of A. Popov, about which very little has been published?

At a lecture delivered at the Marine Officers' Club in Kronstadt in the spring of 1889, Popov acquainted marine specialists with the work of Hertz, and in a series of preliminary experiments demonstrated the possibility of sending messages with the aid of “Hertz' beam.” This was previous to somewhat similar predictions by Huber, Crookes, Tesla Rhigi, and Marconi, and was

accompanied by some demonstrations of a contributory nature.

A Russian journal as early as April, 1895, published a diagram of the circuit of Popov's apparatus with a detailed description, while on May 7th, 1895, at a session of the Russian Physical-Chemical Society, he publicly demonstrated his early experiments in reception.

In summing up, I think it safe to maintain that Popov, unhelpt by any save Hertz, discovered and published ways and means for the utilisation of electromagnetic waves for communication.

J. A. FIELD.

Wilstead, Beds.

[The original question was, "Who first conceived the idea of using Hertzian waves for communication?" The discussion has tended to wander into more vexed questions as to priority in practical application of the idea.

The discussion may be closed by saying that no evidence has been adduced to suggest that anyone preceded Popov in the conception of the idea. If, as our present correspondent implies, it can be established that the Russian physicist did indeed make the statements attributed to him "in the spring of 1889," the credit goes to him. It was not until December 1st of the same year that the German engineer Huber wrote to Hertz suggesting the use of his oscillations for communications. Hertz's letter, dated December 3rd, 1889, politely but firmly "turned down" the idea! —Ed.]

Electron Multiplier Nomenclature

IN your April issue D. Loman puts forward the terms "secrode" or "impactode" to describe the secondary emitting electrodes in multipliers.

Evidently he is unaware that the term "dynode" has been in use for some considerable time. In the United States R.C.A. are making a photo-multiplier (Type 931), and in the technical data the term "dynode" is used. The photo-sensitive surface is called the cathode, and the final electrode is called the anode, though I believe "collector" is often used. L. Myers in his "Electron Optics" (1939), also speaks of "dynodes," and implies that the term is due to P. T. Farnsworth,

the first paper quoted being dated 1934. Unfortunately, I have not yet had the opportunity to refer to the original paper, but assuming the term is American I feel it would be misplaced patriotism to launch forth on a rival term which would be bound to cause a muddle eventually.

J. MCG. SOWERBY.

Salisbury.

"Negative Feedback"

IN the article on "Negative Feedback," published in your July issue, no reference was made to the two different methods by which feedback can be applied. These may be described as "complete" feedback and "AC" feedback respectively. In the circuit shown in Fig. 10 of the article, changes in the anode current of the valve will be fed back to the grid, and alter the effective grid bias, but in the other circuits shown, the feedback path will only pass AC variations in the anode current of the valve, and, in consequence, only alternating voltages will be fed back to the valve input. This is the type referred to as "AC" feedback. The mathematical analysis of negative feedback assumes "complete" feedback, in which all products, whether DC or AC, are fed back to the amplifier input.

In the case of a valve which is biased to cut-off, which is dealt with on page 200, "complete" feedback is assumed. This type of feedback is not common in this case, as the only way in which it can be easily obtained is by the use of an un-bypassed auto-bias resistor. Auto bias is not nor-

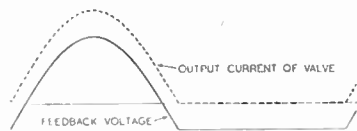

Fig. 1. Output current of valve biased to cut-off with sine wave input.

mally employed in Class B or C amplifiers, and in addition this type of circuit produces current feedback, which increases the frequency distortion.

In the case of an incorrectly biased valve producing an output such as that shown in Fig. 8 (a), the output (which is the same as that of a half-wave rectifier) contains a DC component which is

rejected in any form of AC feedback. Thus the feedback resulting from a sine wave applied to the valve will be as shown in my accompanying Fig. 1. It will be seen that the point on the input curve at which there is an instantaneous voltage of zero will produce a positive voltage feedback, which is equivalent to biasing the valve positively during the non-conducting half-wave. This will result in an improved wave form of the type shown in my Fig. 2,

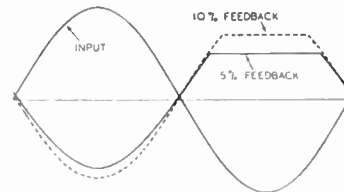

Fig. 2. Output of valve biased to cut-off with AC negative feedback.

which will be seen to be far less distorted than that shown in Fig. 8(b) of the article. The curves given are for a gain of 100 and feedback of 5 per cent. and 10 per cent. respectively, the valve having a straight characteristic and a sharp cut-off.

Ilford

H. COWLING.

Radio Interference from Power Lines

MY first object in writing is to express my appreciation of the article by J. S. Forrest, which appeared in your May issue; the information provided will do much to convince your readers that power lines in this country are not major sources of radio interference with reception.

My second object is to inform you that the "difficult ceramic problem" to which Mr. Forrest refers in his last paragraph has recently been solved after years of research, and that stabilised insulators for power lines and other applications are already being manufactured in this country by my company. The stabilisation of potential distribution will primarily benefit the power engineer when insulating the higher voltage lines, but it will also reduce still further radio interference; for this reason its use may be usefully extended to lower voltage insulators.

G. H. GILLAM,

Taylor, Tunnicliff & Co, Ltd.
London, S.W.2.

JAPANESE MORSE

Symbols for a 48-letter Alphabet

A NUMBER of readers have asked for information on the Japanese version of the Morse Code. Some, no doubt, expect sooner or later to come into wireless contact with the eastern end of the Axis, and feel that the ability at least to recognise enemy transmissions may be of value to them. Other enquirers are mildly curious to know how a "picture language" can be adapted to telegraphic purposes.

The Japanese code, with a brief description of the alphabet and its peculiarities, was given in an article by C. Shepard Lee in the May, 1940, issue of the American journal *Radio*, from which the following information is extracted.

Lee describes the Japanese alphabet, as used for telegraphic purposes, as being adapted from

Courtesy "Radio"
Fig. 2. Twenty-five additional characters made up by adding diacritical marks (shown on left) to certain letters given in Fig. 1.

¨	パ PA	バ BA	ダ DA	ザ ZA	ガ GA
°	ピ PI	ビ BI	ヂ JI	ジ JI	ギ GI
	プ PU	ブ BU	ヅ ZU	ズ ZU	グ GU
ツ (TSU)	へ PE	へ BE	テ DE	ゼ ZE	ゲ GE
丨	ホ PO	ホ BO	ド DO	ゾ ZO	ゴ GO

the Chinese pictorial symbols. It comprises 48 characters and four diacritical marks; only two of these latter are apparently used in telegraphy. Thus about twice as many morse symbols are needed for the transmissions of Japanese as for English. Standard International Code symbols are used for the Arabic numerals.

Japanese is rather like shorthand; except for the vowels and letter N each symbol represents

a syllable composed of a consonant followed by a vowel.

There are no separate letters for G, Z, D and B. These are indicated by a diacritical mark, in form like our quotation mark. The second diacritical mark, like a "degrees" sign, changes H to P. These marks and their corresponding morse symbols, together with the letters that are made up by their use, are shown in Fig. 2.

Two other diacritical marks, for which morse symbols are apparently not provided, are also shown for the sake of completeness. Mark No. 3 is inserted between syllables to double the following consonant and shorten the following vowel. No. 4 indicates that the preceding vowel should be lengthened.

There is in Japanese a number of diphthongs, formed, for example, by combining the syllables ending in I with YA, YU and YO. But, as these are transmitted as separate letters, as in English, they do not affect the composition of the code.

¨¨¨	¨¨¨	¨¨¨	¨¨¨	¨¨¨	¨¨¨	¨¨	¨¨¨¨	¨¨¨	¨¨¨¨
ワ WA	ラ RA	ヤ YA	マ MA	ハ HA	ナ NA	タ TA	サ SA	カ KA	ア A
¨¨¨¨	¨¨¨	¨¨	¨¨¨¨	¨¨¨¨	¨¨¨	¨¨¨	¨¨¨	¨¨¨	¨¨
ヰ WI	リ RI	イ (I)	ミ MI	ヒ HI	ニ NI	チ CHI	シ SHI	キ KI	イ I
¨¨	¨¨¨¨	¨¨¨¨	¨	¨¨¨	¨¨	¨¨¨	¨¨¨	¨¨	¨¨
ウ (U)	ル RU	ユ YU	ム MU	フ FU	ヌ NU	ツ TSU	ス SU	ク KU	ウ U
¨¨¨	¨¨¨	¨¨¨	¨¨¨	¨	¨¨¨	¨¨¨	¨¨¨	¨¨¨	¨¨¨
エ WE	レ RE	エ (E)	メ ME	ヘ HE	ネ NE	テ TE	セ SE	ケ KE	エ E
¨¨¨	¨¨¨	¨¨	¨¨¨	¨¨	¨¨¨	¨¨¨	¨¨¨	¨¨¨	¨¨¨
ヲ WO	ロ RO	ヨ YO	モ MO	ホ HO	ノ NO	ト TO	ソ SO	コ KO	オ O
¨¨¨									
ン N									

Courtesy "Radio"
Fig. 1. The Japanese telegraphic characters with the corresponding Japanese printed letter; the English transliteration given does not always follow the latest official version, but an older form, which, the author claims, in most cases more closely indicates the pronunciation.

VISUAL FREQUENCY COMPARISON

New "Magic Eye" Circuit for Calibrating AF Oscillators

By

G. D. BRITAIN, *Stud. I.E.E.*

AURAL methods of frequency comparison suffer from the disadvantage that a considerable amount of skill is necessary before two audio-frequency notes, one variable at will, can be accurately and speedily matched together by the "zero-beat" method. Furthermore, for checking a continuous frequency drift extending over a fairly long period, the presence of two audio-frequency notes becomes tiring to the ear. Another major disadvantage is that accurate harmonic comparison is not always possible.

The visual method by means of the cathode-ray oscilloscope has the advantage of being capable of a higher order of accuracy than the aural measurement, and harmonic comparison up to about 10:1 is available by the use of Lissajous figures. The main disadvantages are the cost and bulk of the apparatus required.

In the method about to be described use is made of a "magic-eye" cathode-ray type tuning indicator, where the shadow angle varies at the beat frequency. Whilst this system is not intended to replace aural measurements entirely, if used in conjunction with a preliminary aural test to set the variable source approximately to the desired frequency it forms a convenient means of following a continuous drift in frequency, using the "zero-beat" method and obtaining the frequency from the calibration of the variable oscillator.

Where several measurements are being carried out simultaneously in close proximity to one another, for aural measurement the use of headphones becomes necessary, with consequent fatigue and restriction on the movements of the operator. By the use of the visual indicator audio interference is eliminated and fatigue minimised. This principle is already commonly used for the synchronisation of the two RF generators in beat-frequency audio oscillators.

The AF indicator consists of a normal "magic-eye" cathode-ray tuning indicator with the triode pre-amplifier section operating non-linearly after the manner of a grid-leak detector as in Fig. 1. The two audio-frequency inputs are applied through suitable attenuating and DC isolating networks to the grid of the tube. Although the values of grid leak and condenser are not critical, it is necessary that the condenser C_1 should offer low reactance compared with R_1 to the frequencies being measured, and that the time constant of R_1C_1 should be sufficiently small so that the condenser has time to discharge through R_1 before the succeeding beat recharges it. Grid-leak rectification takes place in the grid circuit and the grid potential thus varies as the difference between the two

the shadow. Hence until the two applied frequencies are within some 20 c/s of one another, the actual movement of the shadow is not perceptible, as the shadow angle is varying more rapidly than the human eye can follow it. As zero-beat is approached the eye opens and closes more and more slowly, until at true zero-beat the shadow angle remains constant.

Harmonics

If frequencies f_1 and f_2 are being compared, the anode current contains components of frequencies f_1 , f_2 , $f_1 \pm f_2$, and also nf_1 and mf_2 where n and m are integers. These additional frequencies are due to the non-linear characteristic of the tube. This harmonic content will normally be small compared with the amplitudes of f_1 and f_2 so that when f_1 and f_2 are nearly equal the edges of the shadow are not perceptibly blurred. In order to assist in achieving a clean

edge to the shadow, it is desirable that the amplitude controls P_1 and P_2 be adjusted so that the amplitudes of the two components of the anode current which will beat together are approximately the same, and that the total effect is to reduce the shadow angle to about half the no-signal value.

In addition to its use as a comparator for two inputs of the same frequency, the indicator, due to its non-linear characteristic, is also capable of being used as a harmonic comparator up to ratios of about 12:1. For, suppose that two frequencies f_1 and f_2 are applied, and f_1 is approximately equal to nf_2 where n is any integer less than 12, then the shadow angle will vary at a frequency $(f_1 - nf_2)$, as the two components of the

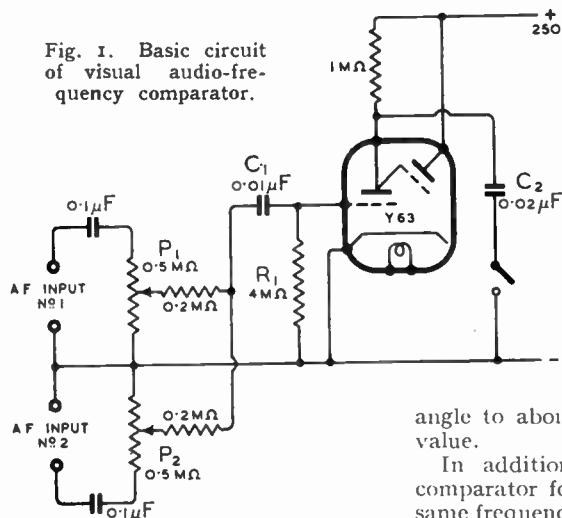

Fig. 1. Basic circuit of visual audio-frequency comparator.

frequencies by virtue of the "additive" mixing; and as the triode, anode is internally connected to the shadow grid, the shadow angle varies in sympathy. Due, however, to persistence of vision and after-glow of the screen, the opening and closing of the eye shows up as a general deflection with blurred edges to

Visual Frequency Comparison—

anode current of frequencies f_1 and nf_2 will beat together. As the ratio of the two frequencies becomes more nearly integral, the opening and closing of the eye becomes slower and finally the shadow angle remains constant when $f_1 = nf_2$.

Due to the fact that the amplitude of the n th harmonic of f_2 is small compared with f_2 , for this harmonic to be comparable in amplitude with the other input f_1 , it follows that the amplitude of f_2 will have to be very much greater than that of f_1 . Hence there will be a comparatively large component of the anode current of frequency f_2 and the shadow will be rapidly deflected to and fro at this frequency, causing blurring of the shadow edge and difficulty in observing the slow movement of the shadow.

It is thus desirable to eliminate this component of frequency f_2 . Since the ratio of maximum perceptible beat frequency to the lowest frequency likely to be compared is of the order of 1 : 5 the frequency f_2 can be eliminated by differential bypassing. The choice of the bypass condenser C_2 is a compromise, and $0.02\mu F$ is suggested where the lower frequency limit is about 150 c/s. A higher value will mean that the device will be insensitive to beat frequencies greater than about 20 c/s, whilst a lower value will mean that if f_2 is low a substantial component will be present across the anode load resistance, giving rise to a blurred image. By this bypassing, accurate measurements up to the 12th harmonic or sub-harmonic are possible. The tube will also give an indication of the frequency ratios 3 : 2 and 3 : 4, but, due to the high harmonics necessary, the change of deflection is very small when higher integers are involved. The author is indebted to Mr. A. H. Morser for having suggested the foregoing additional application, and also for the method of obviating the "halation" produced.

When used as a comparator for two inputs of the same frequency the bypass condenser is unnecessary. Its absence provides a check, as with all the other ratios the shadow edges will be blurred and a clear image will not be produced when the two inputs are in exact harmonic relationship.

An on-off switch, which may be of the ordinary toggle type, has therefore been included so that C_2 may be switched in at will.

The indicator and small associated components could be built into an AF oscillator and could then be used either to assist in direct frequency measurement, or, by the injection of a voltage of known frequency, to give calibration check points at the harmonics and sub-harmonics of the injected signal. If a valve-maintained tuning fork, or other source of constant frequency of about 500 c/s were available, the range 50-6,000 c/s could be checked in a few minutes.

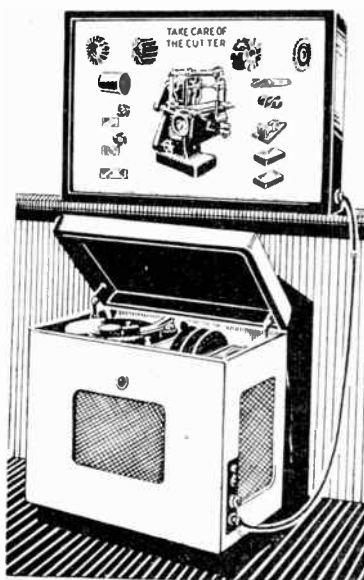

MECHANICAL LECTURER.—The "Synchrophone," designed by N. Sandor, of I.S.M. Limited, comprises two transportable units, (1) a sound unit, in appearance exactly like a radio-gramophone, on which are reproduced recorded lectures, and (2) a vision unit, comprising a 3ft. by 2ft. by 9in. frame with a translucent glass screen, on which appear by means of an automatic switching system, illuminated photographs, drawings or section diagrams forming the subject of the lecture, and synchronised with the relevant remarks. The talks are recorded on 12in. discs and the apparatus is operated electrically from the normal lighting or power circuit. This ingenious instrument is being used by all the services, by Royal Ordnance factories, and many war industries for teaching such subjects as map reading and navigation, explanations of gun mechanisms and electrical and radio equipment.

MURPHY RECEIVERS Fitting Alternative Valve Types

IN order to keep as many sets as possible in service during the war, Murphy Radio, Ltd., Welwyn Garden City, Herts, have produced service instructions indicating the types of alternative valves which may be used in their sets, and, where necessary, the simple circuit modifications which will be required. The information is set out in tabular form, and a folded sheet at the back of the booklet containing diagrams of valve-holder modifications may be pulled out for reference simultaneously with any of the foregoing pages.

Part I of "Service Instructions. Alternative Valve Types," is now available, price 1s., and deals with the following models: A3, A3A, A4, A8, A24, A26, A28, A30 and A34. A second part will be issued shortly.

ELECTRICAL INDUSTRIES RED CROSS FUND

DONATIONS and covenanted subscriptions to this Fund, to which the wireless industry is giving its support, now amount to about £16,000. The organisers, in a recent circular letter to members of the various electrical associations supporting the Fund, point out that many have not yet responded; it is asked that these may reconsider the matter at the earliest opportunity.

Among the names of wireless firms and firms with wireless interests that figure in recent lists are:—

	£	s.	d.
Philips Lamps	500	0	0
Pye, Ltd.	200	0	0
A. J. Balcombe, Ltd.	100	0	0
Automatic Coil Winder and Electrical Equipment Company	50	0	0

DONATIONS.

	£	s.	d.
Radio and Television Retailers' Association	10	0	0
A. F. Bulgin and Company	2	2	0
Multitone Electric Company	2	2	0
Redpath Radio	2	2	0
London Electric Firm	2	2	0

Information can be obtained from the Joint Secretaries of the Fund, c/o The E.D.A., 2, Savoy Hill, London, W.C.2. Contributions should be sent direct to the Electrical Industries Red Cross Fund, St. James's Palace, London, S.W.1.

MAINTAINING A SERVICE

DESPITE the continued difficulty of obtaining journals from overseas, the Abstracts and References section of our sister journal, *Wireless Engineer*, is being maintained at pre-war standard. In the current issue there are abstracts from, and references to, some 330 articles which have recently appeared in the world's technical journals.

The Publishers regret that, the demand for the journal being in excess of the supply, new subscribers cannot be accepted.

WORLD OF WIRELESS

"RADAR"—U.S. STATEMENT

A RECENT statement by the U.S. Naval authorities regarding "Radar," the American counterpart of radiolocation, has resulted in interesting facts being disclosed regarding early experiments on the other side of the Atlantic.

The U.S. journal *Broadcasting* says it is claimed by R.C.A. that as early as 1934 apparatus for the detection of aircraft and ships by the reflection of wireless waves was demonstrated to the U.S. Signal Corps. In 1938 equipment was installed on the U.S.S. *New York* for extensive tests which resulted in a number of radar sets being built to a Naval specification.

Western Electric asserts that Bell Laboratories had been working on radar equipment for three years before America entered the war, and that an organised attack on radar problems was made by a group of university scientists.

During the year prior to the outbreak of war in Europe the effectiveness of electronic equipment in giving pilots warning of aircraft approaching each other and, when used as an altimeter, of accurately determining the altitude of aircraft above the ground and not above sea level, was demonstrated. Owing to the similarity between this apparatus and radar equipment, announcements regarding the results were withheld.

It is pointed out in the Naval statement that British scientists were working independently on radiolocation, employing frequencies and circuits similar to radar.

Among the many American scientists and research workers mentioned in connection with the development of radar is Dr. J. H. Delinger, well known for his ionosphere research work.

SIR CECIL GRAVES

IT was recently announced that Sir Cecil Graves has resigned his position of Joint Director-General of the B.B.C. for reasons of health. He has successively held various administrative posts in the B.B.C., which he joined in 1926. During the interregnum between Sir John Reith's departure and Mr. F. W. Ogilvie's arrival as Director-General, Sir Cecil, who was then Deputy Director-General, bore the burden of responsibility. He was appointed Joint Director-General with Mr. Robt. Foot in January, 1942, when Mr. Ogilvie resigned.

He will best be remembered for

the work he did at the inauguration of the B.B.C.'s Empire Service in 1932, when he was appointed the first Empire Service Director.

Sir Cecil, who was created a K.C.M.G. in 1939, was one of the B.B.C.'s representatives at the meetings of the International Broadcasting Union, of which he became a vice-president.

OVERCROWDING THE ETHER

FIGURES recently issued by the Bureau of the International Union of Telecommunications show that there has been a remarkable increase during 1942 in the number of frequencies in the 6- and 20-Mc/s band utilised by the various telecommunication services. At the end of the year the total was 16,873—an increase of 374.

Particularly interesting is the increase in the use of frequencies within the 30 to 300 Mc/s band (10 to 1 metre). This increase, from 1,271 to 1,342 in the year, is stated to be largely due to the extension of television and frequency-modulation in the United States.

It is pointed out in the *U.I.R. Bulletin* that, except for the medium broadcasting band, which shows a decrease of 16 in the number of frequencies in use, and for the two bands at the upper and lower ends of the frequency spectrum, which remain practically unaltered, all other bands are becoming more and more crowded. The total number of channels in use at the end of 1942 was 44,454, as compared with 43,700 the previous year.

ARMY WIRELESS

SOME of the Army sets recently described in *Wireless World* can be seen and operated at the Army Exhibition recently opened on the site of a bombed store in Oxford Street, between Holles Street and Old Cavendish Street.

Among the exhibits of special interest to readers is the small No. 38 pack set, which employs a throat microphone. Visitors are given an opportunity of using the set.

All advocates of the standardisation of valves will be interested to see the 200 different types which form the normal standard equipment of a division.

GERMAN EQUIPMENT

SIGNAL equipment of the German army captured in North Africa is heavy and complicated, and not up to the standard of our apparatus. This is apparent from the

G.I. VICTORY PRODUCTION

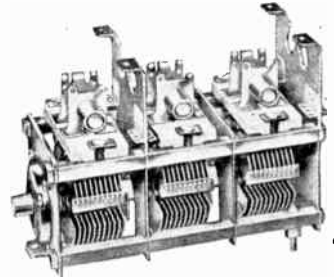

WHEN the mission of complete victory is accomplished, General Instrument will help "Win the Peace" by making the best use of still greater knowledge and experience in the manufacture of variable condensers and drives.

THE GENERAL INSTRUMENT CORPORATION
ELIZABETH, N.J., U.S.A.

Exclusively Represented by
Frank Heaver Ltd. Kingsley Road, Bideford, N. Devon

OF OUR ABILITIES AND FACILITIES WE GIVE GLADLY



PARAMOUNT above all else is the necessity of meeting urgent and immediate demands for the protection of cherished liberty.

Astatic's engineering and manufacturing facilities are therefore first at the disposal of Allied Governments.

Astatic will be ready to serve you again with high quality piezo-electric devices when the "All Clear" of Victory sounds.

Register your name with our Representative for your future benefit.

ASTATIC

THE ASTATIC CORPORATION
YOUNGSTOWN, OHIO, U.S.A.
TORONTO, CANADA.

Exclusively Represented by
Frank Heaver Ltd. Kingsley Road, Bideford, N. Devon

World of Wireless—

mobile exhibition of British and American signal equipment, with a representative collection of German equipment for comparison, which is touring the Middle East to demonstrate the latest types of Allied apparatus to staff officers and training schools. Most of the captured German equipment is said to have been designed and made before the war—some of it as long ago as 1936.

U.S. FORCES PROGRAMME

ARRANGEMENTS have recently been made between the Special Service Branch of the U.S. Army and the B.B.C. for the distribution of special programmes for the American Forces in this country.

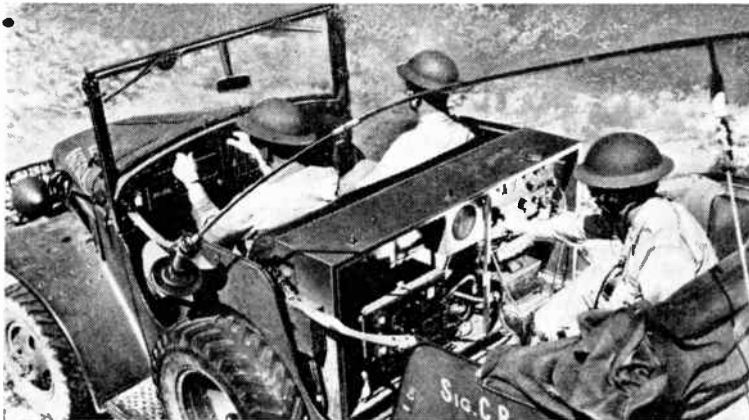

TRUCK-MOUNTED equipment as used by the U.S. Signal Corps, photographed at one of the Corps training centres. Note the method of tying down the aerial to stop "whipping" when travelling at speed.

Low-power transportable transmitters will be erected where there are concentrations of U.S. troops. The programmes, some of which are relays from America, are fed by land-line from a B.B.C. studio placed at the disposal of the American Forces.

It is understood the frequencies employed are 1,402 and 1,420 kc/s, which, according to the Lucerne Wavelength Plan, were shared by low-power transmitters in Bulgaria and Sweden and Spain, Finland and Yugoslavia, respectively.

APPLIED SCIENCE

RADIOLOCATION was instigated by Sir Edward Appleton at the opening of the new Physico-Chemical Laboratories Research Association as one of the most striking examples of the practical application of pure science. He pointed out that in this a "technique which had been developed by University scientists for purely scientific ends, has been magnificently applied by young British scientific workers to practical wartime uses."

"VOCAL LETTERS"

RELATIVES of sick and wounded soldiers in North Africa will shortly be able to hear "vocal letters" from their menfolk. These messages are recorded on 5in. cardboard discs coated with a special emulsion, and it is possible to record about 170 words in the one-minute playing time. The recordings will be made in the wards of base hospitals.

American mains-operated portable direct disc-recorders will be taken to the soldier's bedside so that he can read his "letter" into the microphone. Messages must be written out beforehand for purposes of censorship, but as soon as the record is made it can be handed to

I.E.E. AND PRISONERS OF WAR

ARRANGEMENTS have been made with the British Red Cross Society whereby prisoners of war in Germany may sit for the Associate Membership Examination of the Institution of Electrical Engineers. Nineteen candidates took the examination or parts thereof last year, eleven of whom were successful in passing Parts 1 and 2.

A special concession has been granted to prisoners of war allowing them to take one subject at a time if they so desire, and five candidates passed single subjects.

In recording these successes the Institution stresses the commendably high standard of marks reached.

A further seventeen candidates in Germany entered for the May, 1943, examinations, the results of which have not yet been announced.

SHORT-WAVE TRANSMISSIONS

STILL more frequencies in the 16- and 19-metre bands are being used by the B.B.C. The latest additions to the list are:—

—	17.73 Mc/s	16.92 metres
GWE	15.44	19.43
—	15.07	19.91

With these additions the number of frequencies above 6 Mc/s employed by the B.B.C. for the Oversea Services is over 50.

Below we give the latest schedule of the times (BDST) of the B.B.C. transmissions of news in English and the short wavelengths on which they are radiated:—

0000	31.25, 42.46,
0045	25.30, 25.68, 30.53, 31.32.
0115 †	25.30, 25.68, 30.53, 31.32, 42.16,
0306	25.68, 30.53, 30.96, 31.32, 41.96,
0445	42.13, 42.46, 48.43, 49.10,
0630	25.68, 30.53, 30.96, 31.32, 42.13,
	48.43, 49.10,
0705	19.91, 25.38, 25.47, 25.53, 25.68,
0815	30.53, 31.25, 31.55, 42.13,
0930	16.92, 19.91, 25.38, 25.53, 25.68,
	30.53, 31.55, 42.13,
1000	24.60, 25.58, 42.13,
	31.61, 31.75, 31.88, 31.25, 31.32,
	41.96, 42.46, 48.43, 49.50, 49.98,
1058§	16.92, 19.44, 19.60, 19.91, 25.53,
	25.68, 31.55,
1300	13.97, 16.64, 16.79, 16.84, 19.44,
	19.50, 19.60, 19.91, 25.53,
1500	13.97, 16.64, 16.79, 16.84, 16.92,
	19.44, 19.50, 19.60, 19.91, 25.53,
1700	13.97, 16.64, 16.79, 16.84, 16.92,
	19.44, 19.46, 19.50, 19.60, 24.92,
	25.68, 31.55,
1800	16.92, 19.66, 25.53,
2000	16.92, 19.66, 19.82, 25.29, 25.53,
	25.58, 31.75,
2245	16.92, 19.66, 25.29, 25.53, 25.58,
	30.53, 31.25, 31.41, 31.55, 31.88,
	41.49, 41.75, 41.96, 42.46, 48.98,
	49.42, 49.92,
2315	25.68, 31.32,
2345 §	25.30, 25.68, 30.53, 31.32.
†	Sundays only.
§	Sundays excepted.

the soldier for inclusion in his next letter home. About 20 playbacks are possible on any type of gramophone.

It is understood this service will cost the soldier 8d. per record.

FREQUENCY DISTRIBUTION IN N. AMERICA

THE distribution of frequencies in the medium-wave band (540 to 1600 kc/s) among the 900 broadcasting stations in the United States and Canada necessitates many stations sharing one wavelength. In North America there is an agreed frequency separation of 10 kc/s between stations, and not 9 kc/s as in Europe; there is, therefore, accommodation for only 107 separate channels within the medium-wave band.

The latest figures quoted by the *U.I.R. Bulletin* show that there are 89 stations sharing the common wavelength of 214.3 metres, and 83 sharing that of 241.9 metres. There are, incidentally, only 17 stations which have the use of an exclusive frequency.

IN BRIEF

Radio Trades Examination.—It is expected that the syllabus for the servicing examination to be conducted by the Radio Trades Examination Board, which is representative of the Radio Manufacturers' Association, the Scottish Radio Retailers' Association, the

Radio and Television Retailers' Association, and the British Institution of Radio Engineers, will be available early in August. The committee recommend that only candidates with not less than two years' actual employment in the radio industry or trade be admitted to the examination. We hope to be able to give further details in our next issue.

Canadian SW Station.—Authority has been granted to the Canadian Broadcasting Corporation to start work on the erection of the proposed short-wave broadcasting station at Sackville, New Brunswick. It is not expected, however, that the station will be in operation until the late summer of 1944. Difficulties have been encountered in securing equipment, which had to be obtained from the United States, owing to priority claims, but these have now been overcome.

I.E.E.—At the ordinary meeting of the Institution of Electrical Engineers, held recently, the result of the ballot to fill the vacancies on the Council for the year 1943-44 was announced, as follows: President, Col. Sir A. Stanley Angwin; vice-presidents, T. G. N. Haldane, Dr. E. B. Moullin; hon. treasurer, E. S. Byng; ordinary members, Brig.

F. T. Chapman, J. Hacking, A. L. Lunn, Dr. J. L. Miller, J. S. Forrest, E. C. S. Megaw, E. Leete.

Record Salvage.—The present campaign for old or unwanted gramophone records, recently referred to in these pages, may have obscured the fact that broken records are valuable salvage. Some firms are paying between 12s. and 15s. per hundredweight for old records, whole or smashed.

I.E.E. Wireless Section.—The following members have been elected for 1943-44 for the Wireless Section Committee of the Institution of Electrical Engineers: Chairman, T. E. Goldup; vice-chairman, Prof. Willis Jackson; immediate past chairman, Dr. R. L. Smith-Rose. Ordinary members of the committee: F. P. Best, Capt. C. F. Booth, C. W. Cosgrove, W. T. Gibson, H. G. Hughes, H. L. Kirke, E. C. S. Megaw, O. S. Puckle, J. A. Smale, Dr. H. A. Thomas, T. Wadsworth and Dr. R. C. G. Williams.

R.S.G.B. New Offices.—John Clarricoats, general secretary of the Incorporated Radio Society of Great Britain, informs us he will be pleased to meet visiting amateurs at the new headquarters of the Society at New Ruskin House, Little Russell Street, London, W.C.1. (Holborn 7373.) The membership of the Society has increased by 2,000 since September, 1939. The total membership is now 5,500, nearly 4,000 of whom are on active service.

Brit.I.R.E.—At the meeting of the General Council of the British Institution of Radio Engineers, held recently, the following officers were elected for 1943-44: President, Sir Louis Sterling; vice-presidents, Air Vice-Marshal R. S. Aitken, Vice-Admiral Lord Louis Mountbatten, L. McMichael, Sir William Noble and Dr. J. Robinson. The members of the general council of the Institution are: L. Grinstead (chairman), Sir Arrol Moir, Dr. N. W. McLachlan, L. H. Bedford, W. E. Miller, Dr. N. Partridge, J. A. Sargrove, W. W. Smith, G. A. V. Sowter, Sqd. Ldr. S. R. Chapman, J. Dimmick, Lt. Col. P. Northey.

Institution of Electronics.—A meeting of the N.W. England Section of the Institution of Electronics will be held at Reynolds Hall, Manchester, on September 10th at 6.30 p.m. The lecture, which will be given by Leslie F. Berry, is on the "Manufacture of Wireless Receiving Valves." Tickets are obtainable from L. F. Berry, 14, Heywood Avenue, Austerlands, Oldham. Papers read before the Institution are reprinted in the official journal the *Science Forum*, copies of which are obtainable from the hon. secretary.

R.T.R.A. Officers.—The Radio and Television Retailers' Association recently held their first annual general meeting, when it was announced that J. H. S. Smith, who has been chairman of the council since the formation of the Association, had been elected the first president. The following officers have also been elected for 1943-44: Chairman of the Council, R. C. Gilbert; vice-chairman, H. Nightingale.

Change of Address.—AWF Radio Products have extended the repair side of their business and taken new premises at 13, Lilycroft Road, Bradford.

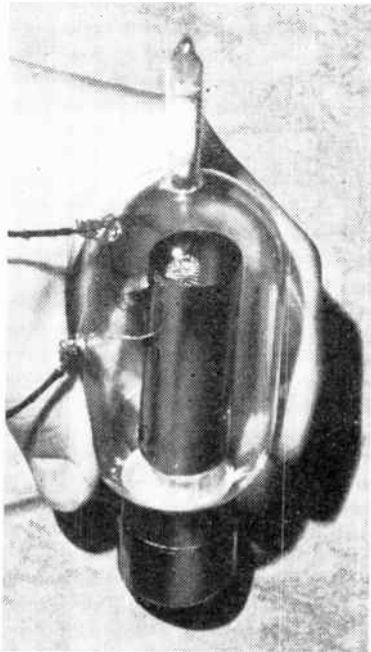

HISTORIC VALVE.—This specimen Round triode valve, of a type first produced in 1913, was recently presented to the Sydney (Australia) Technological Museum by *Wireless World*. It was employed during the last war mainly in the Marconi "No. 16" circuit as an RF amplifier preceding a crystal detector. The valve depended for its action on the presence of a certain amount of gas; when it showed signs of "hardening" with use, more gas was released by applying a match to the glass pip, which contained an asbestos pellet.

RAYTHEON - PROGRESS -



I.T.A. MIDGET.

RAYTHEON tubes for peacetime electronics era will incorporate all the engineering skill gained through scientific accomplishments in wartime. Your new RAYTHEON tubes will be adaptable to a wide scope of newly developed uses... with performance characteristics that have been time-tested through service in stringent military campaigns. You can look to RAYTHEON leadership when you again purchase tubes... no matter what type of function your requirements may be... you will find a RAYTHEON tube designed and engineered to faithfully perform its task

**WORLD'S LARGEST
EXCLUSIVE
TUBE MANUFACTURERS
RAYTHEON
PRODUCTION CORPORATION
NEWTON, MASS., U.S.A.**

Exclusively Represented by
**Frank Heaver Ltd. Kingsley Road
Bideford, N. Devon**

CROWNAME RADIO COMPONENTS

When the guns cease firing Crowe will resume its leadership in design and production of decorative parts for the radio industry throughout the world.

Exclusively Represented in Great Britain by
FRANK HEAVER LTD.
Kingsley Road, Bideford, N. Devon.

**CROWE NAME PLATE AND
MANUFACTURING CO.
CHICAGO, ILL. U.S.A.**

FM LOUDSPEAKER DISTORTION

Its Cause, Magnitude and Cure

READERS interested in high-quality reproduction are already acquainted with the principal sources of frequency, amplitude and transient distortion in loudspeakers. They may not be aware that there is yet another possible source of distortion which may be termed frequency-modulation distortion, and which arises when a loudspeaker is reproducing a note of high frequency and at the same time vibrating with large amplitude at a low frequency.

We have already referred in the pages of this journal to the cross modulation of high frequencies by a low frequency in loudspeakers with a non-uniform distribution of field in the air gap, but the distortion which forms the subject of this note is of acoustic origin and would occur even if the loudspeaker had a perfectly linear electro-acoustic response.

The origin of the distortion is the Doppler effect which causes the pitch to rise when the source of sound is advancing towards the listener and to fall when it is receding. Imagine a source of sound to be sending out pressure pulses at regular time intervals of 1/100th second (100 cycles per sec.). Taking 1,100ft. per sec. as the velocity of sound in air, one pulse will have travelled approximately 11ft. on its way to the listener before the following pulse

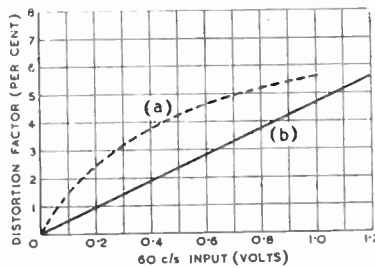

Fig. 2. Distortion in a 12-inch speaker with constant 5000 c/s note modulated by 60 c/s note of variable amplitude. (a) Observed total distortion, (b) calculated FM distortion.

1/100th second between pulses the source will have moved up 1.3ft., so that the distance separating the first and second air waves will now be 9.7ft. instead of 11ft. This is equivalent to an increase of frequency from 100 to 113 cycles per sec. Conversely, if the source were moving away from the observer at the same velocity the spacing between waves would be 11 + 1.3 = 12.3ft. and the apparent frequency would be 90 c/s.

The case of the loudspeaker radiating two notes simultaneously is not so easy to work out, since the direction and velocity of the "source" is continually changing, but it is easy to see that a 5,000 c/s note emanating from a diaphragm oscillating at 50 c/s would

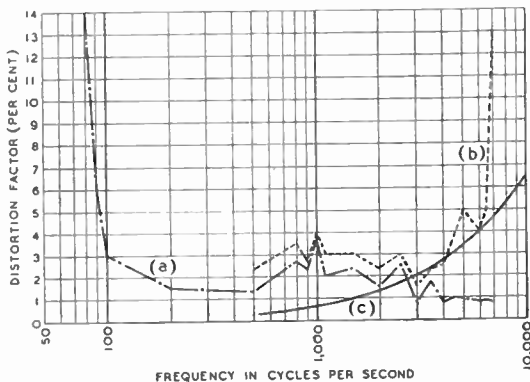

Fig. 1. Harmonic distortion in 12-inch cone loudspeaker (a) with single variable frequency, (b) with constant 60 c/s input and a variable frequency of equal power, (c) calculated FM distortion. Curve (b) represents the sum of both cross-modulation and FM distortion.

starts. Suppose now that the source of sound is moving towards the observer at 90 miles per hour, say 130ft. per sec. In the

have alternate groups of 50 cycles increased and lowered in pitch. A very full analysis of the problem is given in a recent paper* by

Beers and Belar. They point out that the loudspeaker output under such conditions can be resolved, like a frequency-modulated wave, into a carrier and sidebands, the "carrier" being represented by the original unmodulated high-frequency note. Regarding the sidebands as unwanted distortion and defining the distortion factor as the square root of the ratio of power in the sidebands to the total power output, the following formulae are deduced:

$$\begin{aligned} \text{Distortion factor (per cent.)} &= 0.033 A f_2 \dots \dots \dots (1) \\ \text{Distortion factor (per cent.)} &= \end{aligned}$$

$$2900 \frac{f_2 \sqrt{P}}{f_1^2 d^2} \dots \dots \dots (2)$$

where f_1 = modulating frequency, f_2 = modulated frequency. A = amplitude of cone motion in inches (each side of mean position), P acoustic power in watts at f_1 , d = cone diameter in inches.

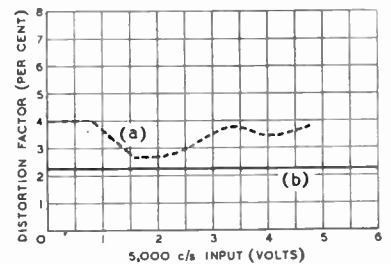

Fig. 3. Distortion in a 12-inch speaker with constant 60 c/s input and variable 5000 c/s input. (a) Observed total distortion, (b) calculated FM distortion.

The formulae hold for positions along the axis of the cone and formula (2) is based on the assumption that the cone is acting as a piston in an infinite flat baffle and is radiating on both sides.

Experimental verification of the magnitude of FM distortion is by no means easy owing to the presence of other forms of distortion. Ordinary harmonic distortion can be eliminated by first taking measurements over the frequency scale with single-frequency inputs, but cross modula-

* "Frequency-modulation Distortion in Loudspeakers" by G. L. Beers and H. Belar. Proc.I.R.E. April 1943.

tion due to lack of linearity in the gap is not so easy to separate since the sidebands resulting from this form of distortion are of the same frequencies as those given by FM distortion. However, in the case of cross modulation the distortion should be proportional

is generally the practice to use separate LF and HF reproducers in cinema sound equipment, and in PA equipment the distortion is held in check by the restriction of amplitude in the bass.

Quality enthusiasts who like plenty of volume have three courses open if they wish to circumvent this type of dis-

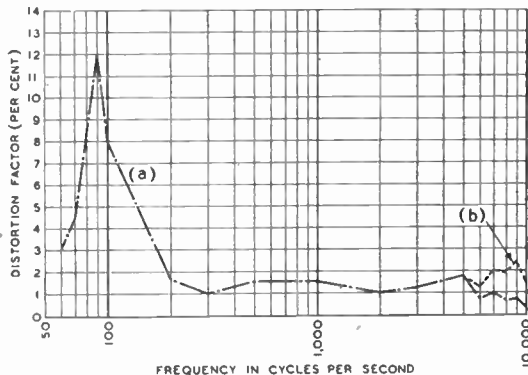

Fig. 4. Distortion with separate LF and HF loudspeakers. (a) Single frequency input (b) constant 60 c/s input plus variable-frequency input of equal power.

to the amplitudes of both frequencies, but independent of frequency, whereas FM distortion should increase with the amplitude of the modulating note and with the frequency but not the amplitude of the modulated note.

The curves of Figs. 1, 2 and 3 indicate that the increased distortion with two frequencies has all the earmarks of frequency modulation rather than of cross modulation. In making these measurements the authors used power inputs of 0.5 watt or less so that the distortion indicated is of the order which may be expected in domestic receivers. Higher-powered installations would give correspondingly greater distortion if single diaphragm speakers were used, but fortunately it

tortion. They can reduce the amplitude of motion of the cone at low frequencies by increasing its diameter or better still by using horn loading, or they can use separate speakers for high and low frequencies with a suitable dividing network in the amplifier or after the output stage. A comparison of the high-frequency end of the curve of Fig. 4 with that of Fig. 1 shows the improvement to be expected from the use of separate speakers.

"NEEDLE CLINIC"

OWING to the difficulty in supplying sharpening machines for "IM" long-playing gramophone needles, Alfred Imhof, Ltd., 112-116, New Oxford Street, London, W.C.1, have started a "Needle Clinic" where "IM" needles can be repointed. The minimum charge is 6d. for 1n, plus 3d. for packing and postage.

Books issued in conjunction with "Wireless World"

	Net Price	By Post
FOUNDATIONS OF WIRELESS, by A. L. M. Sowerby. Third Edition, revised by M. G. Scroggie	6/-	6/4
TELEVISION RECEIVING EQUIPMENT, by W. T. Cocking	10/6	10/10
RADIO LABORATORY HANDBOOK, by M. G. Scroggie. Second Edition	12/6	12/11
WIRELESS SERVICING MANUAL, by W. T. Cocking. Sixth Edition	7/6	7/10
HANDBOOK OF TECHNICAL INSTRUCTION FOR WIRELESS TELEGRAPHISTS, by H. M. Dowsett and L. E. Q. Walker. Seventh Edition	27/6	28/1
WIRELESS DIRECTION FINDING, by R. Keen. Third Edition	30/-	30/7
RADIO INTERFERENCE SUPPRESSION, by G. W. Ingram	5/-	5/4
LEARNING MORSE. 335th thousand	6d.	7½d.
INTRODUCTION TO VALVES, by F. E. Henderson	4/6	4/10
VALVE REPLACEMENT MANUAL, by A. C. Farnell and A. Woffenden	6/-	6/2

Obtainable from leading booksellers or by post from ILIFFE & SONS LTD., Dorset House, Stamford Street, London, S.E.1



THE "FLUXITE QUINS" AT WORK

"Where's Ol with our FLUXITE? He's dumb. 'Cheer up!' replied EH. 'Don't look glum! Our radio's gone soft, So I've sent him aloft. He'll be back in a minute, old chum.'"

See that FLUXITE is always by you — in the house — garage — workshop — wherever speedy soldering is needed. Used for over 30 years in Government works and by leading engineers and manufacturers. Of all Iron-mongers—in tins, 8d., 1/4 and 2/8.

Ask to see the FLUXITE SMALL-SPACE SOLDERING SET—compact but substantial—complete with full instructions, 7/6.

TO CYCLISTS! Your wheels will NOT keep round and true unless the spokes are tied with fine wire at the crossings AND SOLDERED. This makes a much stronger wheel. It's simple—with FLUXITE—but IMPORTANT.

The FLUXITE GUN puts FLUXITE where you want it by a simple pressure. Price 1/6. or filled, 2/6.



ALL MECHANICS WILL HAVE

FLUXITE IT SIMPLIFIES ALL SOLDERING

Write for Book on the ART OF "SOFT" SOLDERING and for Leaflets on CASE-HARDENING STEEL and TEMPERING TOOLS with FLUXITE. Price 1d. each.

FLUXITE LTD. (Dept. W.W.), Bermondsey Street, S.E.1

Honour Where It Is Due

PUBLIC Authorities and Corporations like the B.B.C., no less than Government Departments, have always been fair game for irresponsible mud-slingers and political columnists who are never at a loss to find willing listeners to their base and baseless allegations of bribery, corruption and general inefficiency. Far be it from me to decry this ancient sport of bureaucracy baiting, but I have always believed in giving even the devil his due, and I am, therefore, very sorry to see that amid all the plaudits and acclamations which have appeared in the Press concerning radiolocation not one word has appeared concerning the true originators and pioneers of this particular application of radio. Even *Wireless World*, with its unsurpassed technical news service, has been as guilty of this omission as any low lay journal.

It is true that as yet we have not been given any technical data whatever concerning radiolocation, being merely allowed to know that it is a method of locating aircraft by means of reflected radio waves. But this is no valid excuse for withholding from the G.P.O. the full measure of credit which is its due for the development of this great invention, which has been brought to a high pitch of perfection even in the late nineteen-twenties, judging by accounts then published of the activities of the G.P.O. detector vans, which, we were told, roamed around our streets searching out unlicensed wireless sets.



A coarse and unsympathetic policeman.

One journal from which I have a cutting told us that the apparatus in the van was capable of locating even a "disused and forgotten set stowed away in a lumber room," which feat would, I imagine, be no mean achievement even for the modern apparatus now used for sterner purposes.

It is quite evident, however, that even in those far-off years the

By FREE GRID

authorities must have had some inkling of the ultimate value to this country of these unlicensed locators, for not one word was ever published nor any hint given of their *modus operandi*. Nevertheless, I, metaphorically speaking, take off my hat to the G.P.O., even as I did in actual fact the other morning when I stood for a moment bareheaded in respectful silence in the middle of St. Martins-le-Grand until moved on by a coarse and unsympathetic policeman.

It is true that the G.P.O. has no easily pronounced and succinct word like radiolocation to denote their great achievement, but after all "Watt's in a name?"

Radiocution

I WAS extremely interested the other day to come across a book written by an ex-governor—or warden, as they call him in the U.S.A.—of the famous Sing-Sing prison in New York State, in which he gives a very full description of the electric chair. This appliance was not at all liked by the electrical industry when it was first installed over fifty years ago in 1890, since it drew unnecessary attention to the dangers of electricity at a time when efforts were being made to persuade people to have electric light in their homes.

The detailed figures which the book gives concerning such things as volts and amps. will gladden the hearts of many of the iconoclastic ultra-modern engineers to whom Ohm's law is old-fashioned and, therefore, anathema; for the amps. don't keep rigidly in step with the volts, and to superficial minds this discredits poor old Ohm completely instead of proving that resistance varies with voltage as it does in the case of valves and lots of other things.

However, the thing which really interests me is the relatively high current used, namely, 10 amps. This is all the more surprising because when I raised the question in this journal some years ago, several readers with much "book learning" but evidently without much experience of electric chairs, assured me that a lethal current was a mere matter of milliamperes, a state of affairs about which I had already expressed strong doubts.

Actually, so the book tells me, two thousand volts are applied for a period of three seconds, this usually producing a current of about 10 amps., although values as low as 7 and as high as 12 amps. are sometimes recorded. The voltage is then dropped to a quarter of its initial value for a further fifty-seven seconds; but the current rejoices the hearts of the anti-Ohmers by not falling off in the same ratio. There are considerable variations with different individuals, everybody having his own distinctive characteristic curve.



His characteristic curve.

However, electrocution is likely before very long to give place to something more modern, namely, radiocution. The proposed system is really nothing more or less than a development of diathermy, the unfortunate malefactor being merely turned loose in a room in the walls of which are buried giant electrodes, and he will die by a sort of eddy current effect. It is now the turn of the electro-medical practitioners, following the example of the 19th-century electricians, to protest that the new method draws unpleasant attention to the lethal potentialities of their art.

Now, I am no spoil-sport, but, quite frankly, I don't like this prostituting of radio and its allied branches of science to these base ends, and quite apart from this, I dislike the substitutes of cold, calculating science for the artistry of the skilled headman of Henry VIII's days. I feel quite sure that if the unfortunate Anne Boleyn had been given the choice she would have still chosen the famous headman of Calais, to whom her ever-considerate husband gave a special fee and his return fare for his good offices. There is only one thing in the scheme's favour; it is hoped to have the apparatus installed in time for Adolf to perform the opening ceremony in person.

RANDOM RADIATIONS

By "DIALLIST"

Implosions

MY note on the implosion of cathode-ray tubes brings some interesting letters from people who have had first-hand experience of such startling happenings. Those who write are agreed that when an implosion occurs there is an ear-shattering noise and that the glass is usually pulverised. Most correspondents have heard it stated that the electron gun and a selection of anodes are apt to be projected bodily from the tube at high velocity; none, however, has experienced this. The gun, the anodes and the plates of the tube are, in fact, usually found in a twisted and battered mass still attached to the base. One reader tells me of experiments on large television CRTs made by a firm with which he was connected. The tubes were deliberately made to implode with the aid of 0.22 rifle bullets. Again, pulverisation of the glass and no projection of the electrode assembly. Some who write tell me of implosions that were apparently spontaneous. In several instances a tube that wasn't even in its holder just went off with a bang for no reason that could be determined. These spontaneous implosions were rare even in the early days of CRTs, and I doubt whether they are met with often now; so much progress has been made in the manufacture of glass suitable for withstanding high pressures. Any kind of glass that has been badly annealed (I think that's the process responsible) is liable to break for no obvious reason. I expect you've come across the tumbler standing all by itself that suddenly goes ping and sheds a complete ring from its top.

Fatigue

But in glass subjected to pressure the question of fatigue also comes in. In the piping days of peace, when you visited a champagne cellar in Northern France they would show you how an unused empty bottle could be allowed to bounce down stone steps and wouldn't break. Then the same experiment was made with a bottle that had contained champagne, and it broke at the first bounce. Under the pressure that comes its way when the wine is corked up in it the glass is stretched beyond the elastic limit. I don't know whether this happens in the case of a big CRT, but quite likely glass that contains a fault of any kind is liable

to give way spontaneously under prolonged pressure from within or from without. The great thing is that such glass does not appear to splinter. The noise of an implosion or an explosion is alarming, and, though everything seems to be covered with powdered glass, injuries are rare. Once I had a soda-water-making appliance burst in my hands as I was shaking it. The crash was terrific, and my better half came dashing in, thinking that I'd blown myself up. I was covered with powdered glass but literally I hadn't a scratch on me. The syphon that exploded had been in use for five or six years, and I expect that fatigue was the cause of its violent end.

□ □ □

Standard Valves

IT'S good that the *Wireless World* Brains Trust is dealing with the thorny problem of valve standardisation. Readers will probably also take a hand in the correspondence columns. The originator of the question did well to supply the first answer himself, for it is difficult to conduct a round-the-world discussion in wartime. A pity that the Brains Trust does not contain someone to say, "Well, of course, it all depends on what you mean by a valve and by standardisation," and someone else to add, "All I can say is that when I was in Patagonia in 1920 the chiefs had a lot of bother with tribesmen who wanted the medicine men to cure the scalps they'd won in battle in different ways. The chiefs solved that one by having all the would-be innovators scalped. We might do something on those lines with people who won't agree to valve standardisation. Or that's how it seems to me, at any rate." To be serious, I do feel that the correspondent who has set the ball rolling has struck the right line by arguing that we must first set our house in order in the matter of replacement valves. I think I'm right in saying that almost every type of valve turned out by the big firms in the past dozen years was still being made—many probably in small quantities—when the war started. I remember being told by Cossor's, years after their original old "tin hat" valve had earned museum-piece status, that they still had a small but steady demand for it. When you come to think of it, it's ridiculous that any kind of bright-emitter receiving valve should have been in produc-

The Improved VORTEXION 50 WATT AMPLIFIER CHASSIS

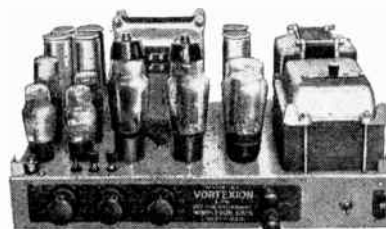

The new Vortexion 50 watt amplifier is the result of over seven years' development with valves of the 6L6 type. Every part of the circuit has been carefully developed, with the result that 50 watts is obtained after the output transformer at approximately 4% total distortion. Some idea of the efficiency of the output valves can be obtained from the fact that they draw only 60 ma. per pair no load, and 160 ma. full load anode current. Separate rectifiers are employed for anode and screen and a Westinghouse for bias.

The response curve is straight from 200 to 15,000 cycles. In the standard model the low frequency response has been purposely reduced to save damage to the speakers with which it may be used, due to excessive movement of the speech coil. Non-standard models should not be obtained unless used with special speakers loaded to three or four watts each.

A tone control is fitted, and the large eight-section output transformer is available in three types: 2-8-15-30 ohms; 4-15-30-60 ohms or 15-60-125-250 ohms. These output lines can be matched using all sections of windings and will deliver the full response to the loud speakers with extremely low overall harmonic distortion.

PRICE (with 807 etc. type valves) **£18.10.0**
Plus 25% War Increase

MANY HUNDREDS ALREADY IN USE
Supplied only against Government Contracts

VORTEXION LTD.

257, The Broadway, Wimbledon, S.W.19
Phone: LIBerty 2814

Random Radiations— tion after about 1930. We definitely need a replacements purge and a drastic one. Once the old stagers have been wiped off the list, it should be kept up to date by an annual revision. To save any complaint from the public, the B.V.A. might advertise at intervals that certain types would not be made after such and such a date; those who felt that they might need replacements would then have plenty of time to stock up with a few.

□ □ □

Reasons for 132 Kilovolts

IN the last issue of *Wireless World* I asked if anyone could tell me and others who were puzzled the reason why the Central Electricity Board chose 132,000 as the voltage figure for the main grid transmission lines. Several readers have kindly stepped into the breach, and though none of them supplies a complete answer, all give information of some kind and their replies can be pieced together to answer the question almost completely. First, why was a factor of 11 chosen—132 is 11×12 ? It appears that one of the earliest power lines, put up in the 19th century and extending over a considerable distance, guaranteed to deliver current at 1,000 volts. Ten per cent. was estimated for the volt drop in the line, and the voltage at the generating end was made 1,100 to allow for this. Lines erected subsequently, but before the advent of the grid system, made the same allowance for volt drop and figures of 6,600, 11,000, 22,000 and 33,000 are quoted by correspondents. The Central Electricity Board retained the ten per cent. margin and so adopted the factor 11. So much for that. The big problem was to discover what voltage would be the most economical for lines of the lengths likely to be needed in this country. The higher you make the line voltage, the smaller, of course, is the cost of the actual conductors, for the lower is the current that they have to carry. But as the voltage is increased another item goes up in cost by leaps and bounds; this is insulators. Further, there is a limit to the voltage that suspension insulators can be designed to cope with safely. One correspondent tells me that 132 kV was near the limit for suspension insulators in a three-phase line at the time when the grid system got under way. I rather doubt that last statement, for I seem to have heard of figures up to 200 kV for long transmission lines in the United States. Suspension insulators for voltages well above 132 kV in a three-phase line must therefore have been produced some time

ago. What does seem to be the answer to the question, "Why 132 kV?" is (a) that a factor of 11 was decided upon to meet the expected 10 per cent. volt drop and to match up with existing lines; and (b) that 132 kV is the figure beyond which any saving in the reduced size of conductors would be more than offset by the increased cost of suspension insulators.

Odd Voltages

But no one has offered a satisfactory explanation of the odd voltage delivered by the household supply mains in some parts of Scotland. As I have mentioned, it is 250 volts. One reader has suggested that a higher voltage may be used in the power lines in these parts because of their length and of the widely scattered places that they serve. That may be so; but it doesn't explain why the domestic supplies should be at 250 volts. It would surely be no more difficult to transform down to 230 V than to 250 V. When the grid scheme came in we were told that one of its most important features would be the standardisation throughout the country of voltage and current; we should in time have 230 V 50-cycle AC everywhere. It is to everyone's advantage that there should be strict uniformity; could lamp manufacturers, for example, concentrate on a 230-volt range and forget about everything else for household purposes, production costs would come down. And much the same applies to those who make electrical appliances of nearly every kind. The homes of this country are likely to have better and better opportunities of going "all electric" after the war, but progress in this direction is bound to be slowed down if appliances cost more than they need, largely because manufacturers have to cater for odd voltages.

□ □ □

Radar

THE Americans have always had the knack of producing short, snappy names for new things. Some, perhaps, haven't been very happy, but radar (radio detecting and ranging) seems to me a better and more convenient name than radiolocation for the art of pinpointing by wireless methods distant targets that may be invisible to the eye on account of their distance or

because of fog or darkness. Two syllables are certainly better than six. True, Radar is not so descriptive as radiolocation, which does tell you at a glance what it's concerned with. But that's not a serious objection, and the brevity of radar seems to me to outweigh other disadvantages. In a recent note on radar, Dr. Alexandersen recalls its beginnings in the U.S.A., stating that it was first planned as a device to enable pilots of aircraft to measure either their height above the ground or their distance from any hills that might be ahead of them. I remember reading accounts of that device some years ago. It consisted, so far as I can recollect, of a small transmitter situated in one wing of the plane and a small receiver in the other. The out-and-home journey of a radio signal was timed, and so the height or distance as the case might be was obtained. So far as I know, it didn't catch on. Probably unsuspected snags of some sort were encountered.

□ □ □

High Fidelity

AFTER the war I expect that listeners in the London area at any rate will get high-fidelity transmissions from the Alexandra Palace. When A.P. first started work as television headquarters the B.B.C. was strongly urged to relay all the National programmes on the sound frequency. The demand came partly from radio amateurs, desirous of hearing broadcast music as it could and should be reproduced, and partly from non-technical folk, who had heard the lovely quality of the sound accompanying the vision programmes as reproduced by really good sets. Many in the latter class would probably have been willing to buy expensive television receivers for use mainly as sound reproducers if only the all-day high-fidelity transmissions could have been guaranteed. Unfortunately, they could not. The B.B.C. was apparently willing enough to oblige, but a section of the radio industry feared that, if London listeners who possessed television receivers obtained full-time high-fidelity broadcasts, people in other parts of the country (and those who lived in or near London but hadn't televisions) might begin to make what they regarded as unreasonable demands about the quality of the reproduction of standard broadcast receivers. This seemed to me a most misguided standpoint, and I sincerely trust that we shall not find it after the war. Surely the logical outlook is this: high-fidelity broadcasts on the vision wavelengths will show those who can receive them

GOODS FOR EXPORT

The fact that goods made of raw materials in short supply owing to war conditions are advertised in this journal should not be taken as an indication that they are necessarily available for export.

what sound reproduction should be; their friends will hear their sets and will be encouraged to buy television receivers of their own; once the London area is bitten by the desire for high fidelity, the provinces will cry out for it and that will compel the authorities to extend the television service to other parts of the country; therefore, let all possible studio programmes be sent out on the television sound wavelength.

Costs of the Service

And there's more in it than just that. One reason why the public did not rush to buy television receivers was that they felt that they would not be getting their money's worth from programmes lasting but two or three hours a day. Educate them up to high fidelity, which probably would not need much doing (do you remember how they responded to the old "bring out the bass" campaign?), promise them all-day high-fidelity programmes and they will soon realise that in the television receiver they are buying something for constant use. The old bogey about the cost of the television services will disappear, too. The B.B.C. felt—and rightly—that they could not spend much on a service which benefited only a small proportion of listeners. And many listeners did not see why the cost of a service which could not be of any use to them should come out of the licence fees that they paid. Provide high-fidelity transmissions all over the country and there is every justification for spending on it all the money that is called for.

An Opportunity

By far the best thing would be to convert the present sound plant at the Alexandra Palace to frequency modulation and then to erect FM relays gradually all over the country. Even if vision could not be provided at all outside the London area, high-fidelity sound transmissions could be furnished pretty quickly in the more thickly populated parts of the country, spreading later to the rest of it. Post-war broadcast receivers would be of three kinds, to suit all pockets: (1) the low-priced set for AM long, medium and short waves; (2) the more expensive set, with a first-rate audio-frequency side, designed for AM long, medium and short-wave transmissions and for FM on its ultra-short range; (3) the combined sound and vision receiver. Manufacturers need not be afraid of a bold policy. So few sets have been sold during the war that there will be an immediate market for millions when it is over—and there will be plenty of money in the hands of the people to pay for them.

COMMUNICATIONS DEPEND...

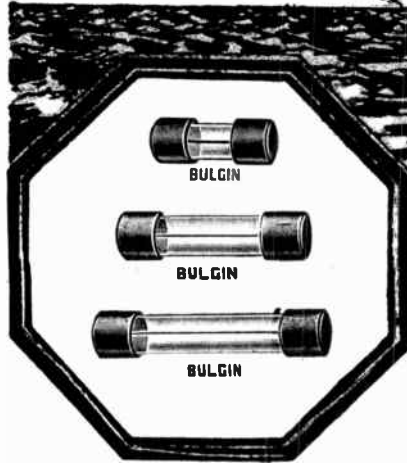
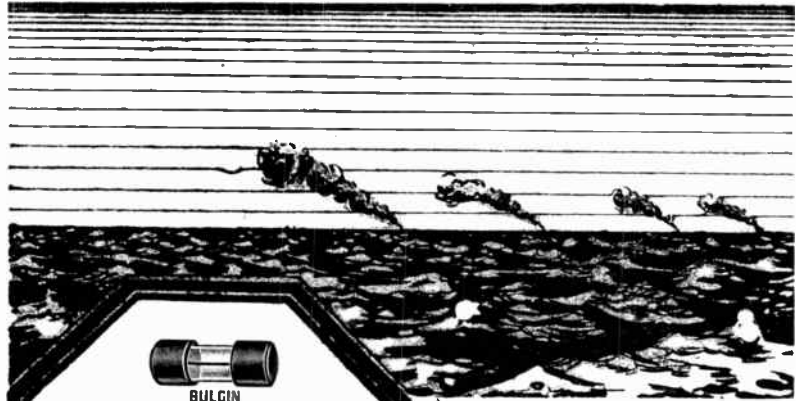

*The Choice
of Critics*

BULGIN

FOR

FUSES

The finest Radio and small Electrical glass-enclosed Fuses in the World. The comprehensive range, from 60 mA. to 25 A., covers every requirement. Accurate and uniform in characteristics and made to British Standard Specification No. 646, R.M.A., and R.C.M.F.-specification. Absolutely fireproof and safe, sure in action upon 50-75% overload.

ON SMALL PARTS...

In countless instances quite intricate pieces of apparatus are wholly dependent on the proved reputation and reliability of their component parts.

All products from the House of Bulgin are pre-eminent for superior design and workmanship and every article bearing our Trade Mark has to pass exacting and exhaustive tests during the course of its production.

We ask the kind indulgence of the Trade on delivery until peaceful conditions return.

"The Choice of Critics"

BULGIN

REGISTERED • TRADE • MARK

A. F. BULGIN & CO. LTD., BYE PASS RD., BARKING,

TEL. : RIPPLEWAY 3474 (4 lines).

ESSEX

RECENT INVENTIONS

CR TUBE PROTECTION

OPERATING voltages for the cathode-ray tube of a television receiver are usually supplied from the AC mains through a suitable step-up transformer coupled to a rectifier and a filter circuit. Owing to the high time-constant of the latter, the anode voltage tends to persist for some time after the deflecting circuit has ceased to function, so that the electron stream is kept focused and stationary, and therefore is likely to burn or damage the fluorescent screen.

In order to prevent this, a condenser is arranged in shunt with the supply voltage tube, so that it charges up when the mains switch is closed. When the power is switched off, the charge across the condenser is automatically applied to the cathode and instantly reduces the beam intensity.

Philco Radio and Television Corporation (Assignees of S. C. Spielman). Convention date (U.S.A.) March 21st, 1940. No. 546507.

HT SUPPLY FROM DC MAINS

THE large capacity of an electrolytic condenser renders it particularly suitable for smoothing the supply to a DC mains-driven set. On the other hand, this type of condenser is liable to be badly damaged or destroyed if the polarity of the supply voltage is reversed.

As shown in the drawing, the invention provides a safeguard against such a risk by keeping the smoothing condensers out of circuit except when the mains voltage is correctly applied. The smoothing chokes L_1 , L_2 , are in the positive lead and are shunted by the condensers K_1 , K_2 , when the relay P is closed by a winding W in the cathode lead of the last amplifier V of

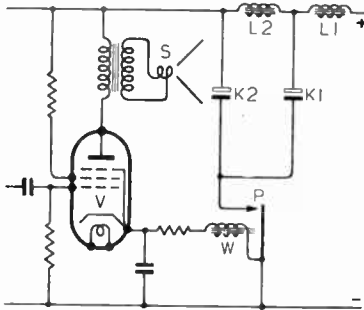

Protective circuit for condensers.

the set. Since the valve cannot pass current unless the anode is correctly polarised, the electrolytic condensers remain open-circuited until the correct working conditions are established. A suitable time-delay device may be interposed to cut out the loudspeaker S during the short interval during which the valve V passes unsmoothed current from the supply.

Philips Lamps, Ltd. (communicated by N. V. Philips' Gloeilampenfabrieken). Application date December 11th, 1941. No. 551234.

A Selection

of the More Interesting Radio Developments

FLUORESCENT SCREENS

THE fluorescent screen of a cathode-ray tube is subjected to two external sources of invisible light. One is a beam of ultra-violet light which would normally excite the screen to fluorescence, the other is a beam of infra-red rays which neutralises the effect of the first. Under the joint control of both beams the screen appears perfectly black.

In this condition, its response to the ordinary electron streams from the gun of the tube is to glow in the ordinary way, but with a limited degree of after-glow, reverting to dead black in between the scanning periods. One result is an improved definition of the televised picture. Another advantage is that the external control allows the screen to be made of materials that are generally considered unsuitable either because they show excessive phosphorescence or else have an undesirable background of natural colour.

The Fairey Aviation Co., Ltd.; J. L. Hills; and P. B. Hovell. Application date December 20th, 1939. No. 551176.

DIRECTION FINDING

A SYMMETRICAL arrangement of spaced dipoles, when used for direction finding, gives two critical indications which are displaced by 180 deg. The drawing shows a simple arrangement for resolving this ambiguity so as to show in which of the two opposite directions the distant transmitter lies.

The two half-wave dipoles A , B are normally coupled in opposition to a single receiver R through crossed feeders F and a pair of lead-in wires L . According to the invention, an additional pair of lead-in wires L_1 are tapped to a point P , say one-third of the distance between the cross-over point of the feeders and the dipole B , and are connected to the receiver through a switch S .

In operation, a minimum reading is first found with the wires L in circuit with the receiver. The switch S is then changed over to the wires L_1 , and a second minimum is found by swinging the aerial system about the axis OO . The direction of swing will then indicate the "sense" of the distant transmitter. The reason is that the dipole A must be moved nearer to, and the dipole B farther from the

source of the waves, in order to make the signals arrive simultaneously at the point P —which is the condition necessary to create a second minimum reading. It is necessary to arrange that each of the wires L , L_1 will pre-

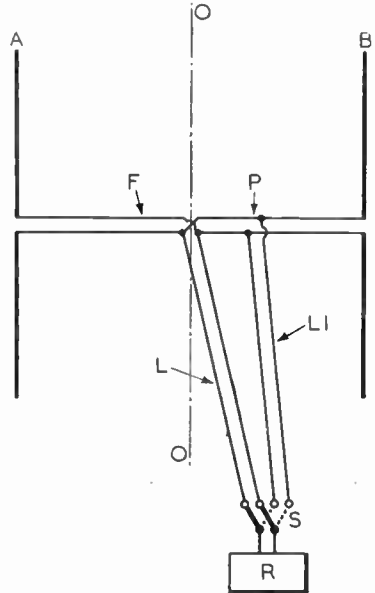

Dipole DF circuit.

sent infinite impedance to the signals when open-circuited.

A. C. Cossor, Ltd., and F. R. Wentworth Trafford. Application date September 13th, 1941. No. 551947.

PIEZO-ELECTRIC PICK-UPS

THE use of Rochelle salt as a piezo-electric unit is handicapped by the fact that the crystal tends to absorb or lose water under varying climatic conditions. At a temperature of 20 deg. C. its water of crystallisation is in equilibrium in air having a relative humidity of 40 per cent. If the air is drier, the crystal tends to dehydrate, whilst under moister conditions it slowly absorbs water and tends to dissolve. In both cases its piezo-electric properties are adversely affected.

It is not easy to mount the crystal in an hermetically closed casing and at the same time transmit the vibrations of the needle through the sealing. On the other hand, the use of a rigid damp-proof coating such as wax or asphalt is found to create excessive damping.

Such objections do not, however, apply to the use of certain semi-fluid mediums. Preferably the crystal is mounted in a casing filled with lanolin, which emulsifies any moisture that may percolate inside it, and by enclosing each globule in a coating of fat prevents the water from making intimate contact with the crystal.

Radio Corporation of America. Convention date (U.S.A.) January 31st, 1941. No. 551954.

The British abstracts published here are prepared with the permission of the Controller of H.M. Stationery Office, from specifications obtainable at the Patent Office, 25, Southampton Buildings, London, W.C.2, price 1/- each.

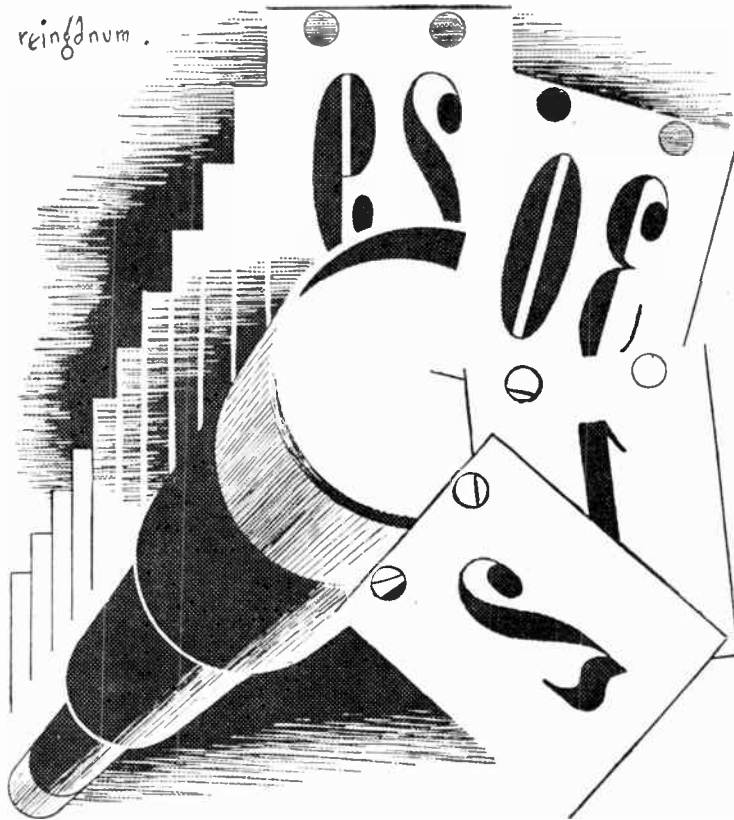

FORESIGHT

The march of Science, its tempo quickened by the needs of war, goes inexorably on . . . making some things obsolete and foreshadowing new developments in the utilisation of electricity. The House of Philips, as always during its fifty years of progress, is ever looking ahead to the needs of tomorrow.

PHILIPS



INCANDESCENT AND DISCHARGE LAMPS • FLUORESCENT LIGHTING • RADIO RECEIVERS AND TRANSMITTERS • COMMUNICATIONS EQUIPMENT • THERMIONIC VALVES AND OTHER DEVICES • X-RAY EQUIPMENT FOR ALL PURPOSES • ELECTRO-MEDICAL APPARATUS • ARC AND RESISTANCE WELDING PLANT AND ELECTRODES • MAGNETS AND MAGNETIC DEVICES • SOUND AMPLIFYING INSTALLATIONS

PHILIPS LAMPS LIMITED, CENTURY HOUSE, SHAFTESBURY AVENUE, LONDON, W.C.2

(124F)

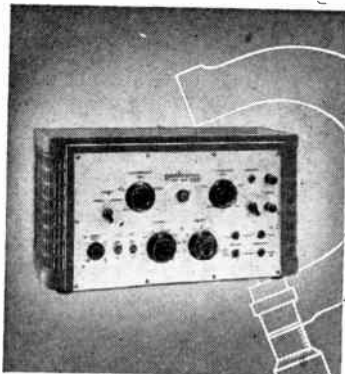

**AUDIO
AMPLIFIERS &
SUB-ASSEMBLIES**
TO *Critical* STANDARDS

In addition to Standard Amplifiers the activities of Acoustical include Special Amplifiers for Industrial Applications, Microphones, Transformers, Coil Winding, Sheet Metal Work, Stampings, Switch Assemblies, etc.



ACOUSTICAL
MANUFACTURING Co. LTD.
HUNTINGDON · TEL: 361



Postwar industry will be making wider use of industrial electronic technique developed during recent years. In this work Rogers Radio Tubes—the tubes which opened the way to all-mains wireless—have played and will play a recognised part. Rogers with an established reputation for quality, produce all standard types of radio receiving tubes, power tubes for radio transmission, audio frequency amplification and industrial electronic applications generally. At present engaged solely on official work, they look forward to future co-operation over a wide field of industry.

ROGERS RADIO TUBES LTD.

TORONTO (ONTARIO) CANADA

A subsidiary of BROADCAST RELAY SERVICE LIMITED,
VICTORIA STATION HOUSE, VICTORIA ST, LONDON, S.W.1.

BAMBEC D.C. RELAYS

ONE TO FOUR CONTACTS
NORMALLY OPEN OR
NORMALLY CLOSED

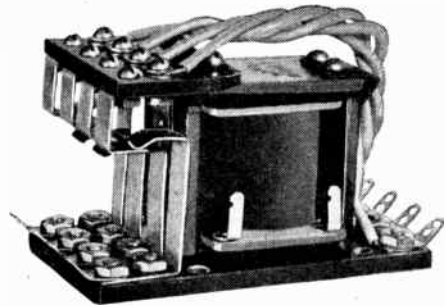

STOCK DELIVERY
SINGLE CONTACT
12 VOLT, 2 WATT COIL.
4-6 WEEKS
MULTI-CONTACT.

BAGSHAW & MORRIS LTD.
BERNARD ROAD, SOUTH TOTTENHAM,
LONDON, N.15.

STAMFORD HILL 3724

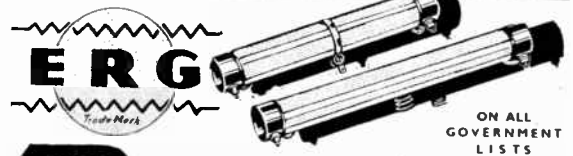

Resistors

MANUFACTURED BY

ERG RESISTORS LIMITED
1021a, FINCHLEY ROAD, LONDON, N.W.11

from 32 to 10,000 cycles !!

IM Needles reproduce a far wider range of frequencies than are at present commercially recorded. You can make the test (for yourself with frequency records and a first-class reproducer. And in spite of their marvellous top response they eliminate RECORD WEAR and NEEDLE SCRATCH.

Per "Top-hat" of TEN 2/- (Tax 1/4d.)

IM LONG-PLAYING NEEDLES

Alfred Imhof, Ltd., 112-116, New Oxford Street, London, W.C.1. MUSeum 5944

CLASSIFIED ADVERTISEMENTS. Rate 6/- for 2 lines or less and 3/- for every additional line or part thereof, average lines 5-8 words. Each paragraph charged separately. Press Day: September issue, first post Tuesday, August 10th one day earlier at branch offices. Box Numbers: 8 words, plus 1/- Deposit System: particulars on request. No responsibility accepted for errors.

OUR NEW HOME

On July 19th we moved into our new premises and are now installed at:

76-78 PETTY FRANCE, LONDON, S.W.1.

Telephone: **ABBEY 2244**

As promised, regular customers have been notified by post.

Our old address, King's Buildings, Dean Stanley Street, S.W.1, should not be used in future, but any correspondence recently sent there will be forwarded and will receive our usual prompt attention.

N. Partridge

Transformer Manufacturers,

76-78, PETTY FRANCE, LONDON, S.W.1. Telephone: **ABBEY 2244.**

ARMSTRONG SERVICE

OUR Service Department is still at your service.

Despite the many changes caused by over three years of war, and the difficulties in material and valve supplies, we have managed to maintain a very large proportion of Armstrong Chassis in good working order.

IN ADDITION to practically all Armstrong Chassis, including very old models, we can now undertake the repair and overhaul of many other makes of receivers, including American types.

ARMSTRONG MANUFACTURING CO.
WALTERS ROAD, HOLLOWAY, LONDON, N.7
Phone: **NORTH 3213**

NEW RECEIVERS AND AMPLIFIERS

DEGALLIER'S, Ltd.—See advert. under Repairs and Service. Sorry, no sales. [1867]
HIGH fidelity ac/dc amplifiers, 18 watts, U.D.O. mixing input channels, bass and treble controls, input and output transformers, octal base valves, complete chassis; 18gns.—Below.

30-WATT ac amplifiers, complete in chassis form or multiple rack assemblies to 150 watts, for P.A. and industrial installations; early deliveries.—Below.

DANCE and stage transportable amplifying equipment, comprising amplifier as above, m/c microphone, adj. stand, 2 auditorium speakers, cables; 36gns.—Broadcast and Acoustic Equipment Co., Ltd., Broadcast House, Tombland, Norwich. [1912]

£24 only new 7-valve "Wireless World" Quality amplifier with tone control stage, 8 watts push-pull triode output, price includes Super Quality 12 in permanent magnet speaker with large matched output transformer and all valves; as above, but with 15 watt tetrode output and super power cinema speaker with 18in cone, £29; ideal for quality reproduction; limited number available.—Bakers Selhurst Radio, 75, Sussex Rd., South Croydon. [1886]

RECEIVERS, AMPLIFIERS—SECOND-HAND
EKKO all-wave A.W.87 for ac, new cond., perf. order; £15.—Deadman, 6, Abingdon Rd., Kensington, London, W. [1894]

PORTABLE Watamps sound system unit, mike and loudspeaker, less batteries; £20.—Crefield, 9, Bedford House, Bedford Park, W.4. [1892]

"W.W." Monodial ac super chassis, complete with Rola G12, used 6 months, as new; £16.—Wheeler, 29, Stag Leys, Ashstead, Surrey. [1858]

Q.A. preset h.f., R.K.; offers.—Palmer, 20, Stuart Rd., E. Barnet. [1873]

TANNOY Ideal, 15watt, p.p. amp, oak cab. and gramo. turntable, complete, chrome mike on telescopic stand, energised speaker, cost £60; what offers?—Box 2914, c/o *Wireless World*. [1924]

SUPER quality p.p. PX25 amplifier, with Rola G12 ener. speaker, Gerrard auto. record-changer and pick-up, in mahog. cabinet, approx. 100 mod. records; £60.—Spencer, 16, Keswick Gardens, Ruslip, [1877]

VIRIZONE 15-valve communication receiver, in black crackle steel cabinet, also Rola G12 loudspeaker, in similar cabinet, 8 watts output, crystal filter, a.v.c.; this set is similar to those used by the B.B.C. and is one of the finest of its kind; price £60.—F. H. Howorth, Victoria Works, Farnworth, Lancs. Tel. Farnworth 59. [1891]

Wanted -

W.W. 3-band, A.C. Super or Trophy 8.—Catchlove, R.A.F. Hosp., Ely. [1925]

WANTED, ac communication receiver.—Box 2912, c/o *Wireless World*. [1917]

W.W. Straight Six.—Wignall, Bond Terr., Walmley Bridge, Nr. Preston. [1910]

A.C./D.C. communications rec.—Price and details, Box 2904, c/o *Wireless World*.

NATIONAL H.R.O. communication receiver required; good price paid for late model.—Box 2897, c/o *Wireless World*. [1950]

WE Offer Cash for Good Modern Communication and All-Wave Receivers.—A.C.S. Radio, 44, Widmore Rd., Bromley. [1541]

URGENTLY wanted, 110volt D.C. radiogram or small radio; good price given.—Full particulars to Box 2910, c/o *Wireless World*.

EX-R.A.F. pilot requires communication receiver, Sky Champion or similar, ac.—Macmillan, 3, Stanhope Gardens, London, N.6.

NATIONAL One-to-Ten RX, good cond. essential, 185Z, 76 valves, 2 d.p.d.t. spring-return switches wanted also.—Box 2907, c/o *Wireless World*. [1893]

W.W. pretuned tuner unit or sim., Voigt or Goodman inf. spkr.; offer in exchange

W.W. 2R.F. diode, triode, tuner, W.W. contrast expansion unit, spare valves, G12 P.M., multi range meter.—Astin, 49, Worsley Rd., Worsley. [1905]

LONDON CENTRAL RADIO STORES will pay good prices for receivers, radiograms, amplifiers, dynamos, converters, test equipment, electric gramophone motors, and all radio and electrical accessories.—London Central Radio Stores, 23, Lisle St., London, W.C.2. Gerrard 2989. [9836]

MORSE EQUIPMENT

FULL range of transmitting keys, practice sets and equipment for Morse training.—Webb's Radio, 14, Soho St., London, W.1. Tel. Gerrard 2089. [9553]

NEW LOUOSPEAKERS

SELECTION of auditorium, P.A. and horn type instruments for industrial installations, etc.—Broadcast & Acoustic Equipment Co., Ltd., Broadcast House, Tombland, Norwich. [1913]

Advertisers and buyers are reminded that under Defence Regulations 1939, Statutory Rules and Orders 1940, Number 1689, a permit (T 99 G) must be obtained before sale or purchase of certain electrical and wireless apparatus, particularly such valves and apparatus as are applicable to wireless transmission.

SEXTON'S for SALES, SERVICE, SATISFACTION

ELECTRIC SMOOTHING IRONS, super quality, for 100/110 volt, 200/220 volt, 230/250 volt A.C./D.C. mains, 5-5½ lbs. weight, strong wooden handle, with plated thumb rest, dome, connector guard and rest, ground and polished sole plate, complete with 6ft. 3-core flex, at 32/6 each. Please state voltage when ordering. Limited quantity available.

ELECTRIC KETTLES, 230/250 volt, 2½ pints size, sprayed gold, with heavy 3-core flex, suitable for A.C./D.C. mains, 75/- each. Limited quantity available.

AMERICAN LEASE-LEND RADIO VALVES. We carry an excellent range of most popular types, sold subject for immediate replacement only at Board of Trade controlled prices, as per the Radio Valves (Maximum Price) Order, S.R. & O., No. 1934 of 1942.

"BRIVARON" British-made Valves, American types 80, 5Y3, 5Y4, 5 volt rectifiers, type RF.120 4-volt rectifier, at 13/7 each.

LINE CORDS. 2-way, best quality, 350 ohms, at 7/6 each. 450 ohms, at 9/6 each. 600 ohms, at 12/- each. Line Cord Replacement Resistors, 360 ohms, at 5/6. 750 ohms, with variable slider, at 7/- 960 ohms, with variable slider, at 9/-. Postage 6d.

GOODMAN'S 3½in. P.M. SPEAKERS, 12 ohms voice coil, ideal for microphones, communication sets, at 25/- each.

EXTENSION LOUD SPEAKERS, "Rola," 3 ohm voice coil, size 5in., at 20/6. Size 6½in., at 22/6. Size 8in., at 24/-. Less Trans. "Celestion" 8in. chassis model, with Universal Trans., 3 watts, at 36/- each.

CYCLE DYNAMOS, complete with bracket and lead, less lamps, at 15/6 each.

TERMS: Cash with order only. Send I.d. stamp and S.A.E. for latest list of electrical appliances, fittings and accessories, radio valves, components, etc.

J. E. SEXTON & CO. LTD.
164, Grays Inn Road, London, W.C.1
Tel.: Terminus 1304 and 4842.

L.R.S. STUART PUMPS

As supplied to Govt. Depts. & County Councils



These Centrifugal Pumps are ideal for Machine Tool Cooling and all pumping purposes—hot or cold water. Supplied complete with foot-valve, strainer and hose union. Suitable rubber hose available from stock.

No. 10. 100 gals. per hour. Carr. 2/- extra. 25 2 6
No. 11. 280 gals. per hour. Carr. 2/- extra. 26 6 0
No. 12. 560 gals. per hour. Carr. 3/- extra. 27 12 0

Please send 2½d. stamp for specification.

THE STUART AUTOMATIC FLOAT SWITCH is the best method of controlling water. Post Paid level. Price complete with all fittings. . . . 22 6 0

LONDON RADIO SUPPLY CO.
Est. 1925
Ardingly Road, Balcombe, Sussex.

F.W.S.CO.
TRADE MARK
ESTD 1910



Sickles Midget Transformer and Trimmer.

OUR greatly increased manufacturing facilities in the War effort, coupled with our added production knowledge, will materially benefit you "when Victory is won." Quality has always been the dominant consideration in the design—in the choice of materials and in the method of manufacture of our products; and we look forward with confidence to the day when we shall once again continue our relationship with the Radio Industry of Great Britain with greater cordiality than ever before.

**I.F. TRANSFORMERS
AERIAL AND OSCILLATOR COILS
TRIMMER AND PADDER CONDENSERS
'SILVERCAP' CONDENSERS
COIL FORMS, etc.**

Register your name with our Representatives for your future benefit.

The F. W. SICKLES Co.
CHIOPEE, MASS., U.S.A.

★
Exclusively Represented by
Frank Heaver Ltd. Kingsley Road, Bideford, N. Devon

WE know what YOU want!

PROBLEMS IN RADIO ENGINEERING

By E. T. A. Rapson, A.C.G.I., D.I.C., etc. A classified collection of examination questions in Radio Communication, together with some useful notes and formulae bearing on the different groups of questions, and answers to those questions. Fifth Edition. 5s. net.

ACCUMULATOR CHARGING, MAINTENANCE AND REPAIR

By W. S. Ibbetson, B.Sc., A.M.I.E.E., etc. Contains descriptive matter on both lead Acid and Alkaline types, their construction, maintenance and repair. There is a chapter devoted to Ohms Law, and conversion from A.C. Eighth Edition. 6s. net.

RADIO SIMPLIFIED

By John Clarricoats. Provides a useful background of fundamental radio knowledge. There are many clear, interesting diagrams and chapters dealing with such subjects as Series and Parallel, the Measurement of Current, etc. Second Edition, 4s. 6d. net.

WIRELESS TERMS EXPLAINED

By "Decibel." An invaluable guide to the technical terms used in books and articles on wireless, and in manufacturers' catalogues. Second Edition. 3s. net.

Pitman Books
39 PARKER ST., KINGSWAY

£3/15 only.—Brand new Super Quality triple cone permanent magnet speaker, made by Bakers Selhurst Radio, the pioneer manufacturers of moving coil speakers since 1925; wide frequency range, even response, ideal for quality reproduction; limited number available under list price; send 2½d. stamp for leaflet describing above and giving constructional details of infinite baffle cabinet; every music lover interested in realistic reproduction should write for leaflet now. **£8/15 only**, brand new super power cinema p.m. speaker with 18in cone, will handle 20 watts U.D.O., ideal for quality p.a. equipment.—Bakers Selhurst Radio, 75, Sussex Rd., South Croydon. [1887

SECONDHAND LOUDSPEAKERS
SENIOR R.K. with rectifier.—Offers to **G3LB**, 25, Clotherholme Rd., Ripon, [1849
B.T.H. R.K. cinema type speakers, suitable for P.A., 15 ohms speech coil, 1,000 ohms energised, £5/10; packing, carr. 5/.—L. T. Dix, Bridge Street, Geddington, Northants.
LOUNDSPEAKERS, Goodmans 8in p.m., heavy duty magnets, with transformers, suitable for p.a. work, condition as new; 30/-, carr. paid; cash with order.—Box 104, Farrs, 121, Kingsway, London, W.C.2. [1889
VOIGT corner horn, incorporating diffused lighting, finished mahogany, complete twin diaphragm unit, perfect reproduction; exchange good disc recording unit, cash adjustment.—Box 2911, c/o *Wireless World*. [1852

Wanted
GOODMAN'S infinite baffle speaker.—Catchlove, R.A.F. Hosp., Ely. [1806
I2IN p.m. speaker, prof. Goodman's, 50% above list.—Smith 50, Granada Rd., Southsea, [1859
VOIGT corner horn, with bass chamber, 0.1mf mica condenser, good maker.—Huskinson, 14, Stuart Rd., Warrington, Surrey.
WANTED, in good condition, Goodmans Auditorium 10in twin-cone loud-speaker, and matching transformer for pentode.—State particulars to McLean, 120, Mearns Rd., Clarkston, Glasgow. [1864

QUALITY speaker, Magnavox 66 or similar, any field resistance or permag; also push-pull intervalve transformer, Ferranti AF5C or similar.—Hardwicke, 29, Warwick Ave., Crosby, Lanes. [1872
WANTED, 10in p.m. speakers, handle 7 watts at least; also gram motors, ac only; record players, H.M.V., Decca, Garrard, etc.—Offers to Tanser Sound Equipments, 26, Portland Rd., Rugby. [1898

NEW MAINS EQUIPMENT
VORTEXION mains transformers, chokes, etc., are supplied to G.P.O., B.B.C., L.P.T.B.; why not you? Imitated but unequalled; orders can only be accepted against Government contracts.
VORTEXION Ltd., 257, The Broadway, Wimbledon, London, S.W.19. Lib. 2814.

TEST EQUIPMENT
TAYLOR 90 multi-meter, as new; offers.—Box 2896, c/o *Wireless World*. [1847
OSCILLOSCOPE, W.W. circuit, brand new, complete with c.r. tube; £25.—Box 2902, c/o *Wireless World*. [1874
UNIVERSAL Avometer, with Avodapter and plug, for valve measurements, as new; best offer secures.—Box 2901, *Wireless World*.
TEST OSCROPE, used everywhere by radio service engineers, makes 20 important tests; send for interesting leaflet "R.I."—Runbaken, Manchester, 1. [1074
CO.D. only.—We have a few only Avominor AC/DC and DC meters in stock; £8/10 and £3/10; send no cash in case sold; c.o.d. and post charges 1/6 extra.—London Radio Supply Co., Ardingly Rd., Balcombe, Sussex.
FERRANTI meters, one 0-7.5-15-30ma, one 0-250v ac rectifier instrument, 1,000 o.p.v., one 0-10-50-250v dc, 1,000 o.p.v., all very good condition; £10 the three, or would exchange Radiolab workshop testing set.—Griffith, Parkway, Horley, Surrey. [1914

Wanted
UNIVERSAL Avominor.—Hubbard, 23, Mill Lane, Shoreham-on-Sea, Sx. [1876
5 E665 and E772.—Box 2913, c/o *Wireless World*. [1922
ONE 0-1 mA and one 0-2 mA meters, panel mounting, long scale.—Box 2898, c/o *Wireless World*. [1852
GOOD valve tester wanted, new or second hand; top price paid.—Morgan, 137, Shirehall Rd., Sheffield, 5. [1895
MODEL 7 Avo, must be first-class condition; also Avo valve tester.—Owen, 538a, Mansfield Rd., Nottingham. [1923
AVO valve tester with Universal valve-panel to test all English, American and Continental valves.—Box 2899, c/o *Wireless World*.
SOLAR capacity Analyser and resistance bridge, universal model for AC or DC; several instruments are required, first-class condition imperative.—Offers to Box 2883, c/o *Wireless World*. [1789



SOLON
SOLDERING
for speed-safety-simplicity

With the Solon there's no waste heat — the heating element is inside the copper bit itself! All the heat is at the point — where you want it. The terminals are at the other end, safely housed away from the heat and easy to get at. Every Solon is supplied complete with 6ft. of Henley 3-core flexible. Made for the following standard voltages: — 100/110, 200/220, 230/250. Supplies are, of course, only available for essential war work. Order well in advance as demands are heavy.
Made in England

SOLON
Electric
SOLDERING IRON FOR INDUSTRIAL USE

W. T. HENLEY'S TELEGRAPH WORKS CO. LTD.
Engineering Dept., Milton Court, Westcott, Dorking, Surrey

W/T OPERATORS

are urgently required in practically every branch of the Services—

**ARMY—NAVY—AIR FORCE—
MERCANTILE MARINE.**

Many who would like to become skilled W/T Operators are located too far away from the few schools which they might attend, whilst others cannot spare the time used up in travelling to and from classes.

**The CANDLER SYSTEM of
MORSE CODE TRAINING
IS CARRIED OUT IN YOUR OWN HOME**

Read these extracts from a Candler student's letter.
"I had no knowledge of Morse before taking the Candler Course . . . I have a perfect 100% receiving speed of 27 w.p.m. code, 29.4 plain language, figure speeds 19 groups per min. (5 figs. per group) and 24 groups per min. short numerals . . . I have a knowledge of 67 different Q signals and nearly all the abbreviated signals listed in your course. Rugby Press comes in like reading a book . . . I have secured a Government post as a Telegraphist, thanks to the Candler System." Ref. No. 3171. R. G. S.

The original of this and many similar letters may be inspected at the London Office.

Courses for Beginners & Operators

In the "BOOK OF FACTS," sent FREE on request, full information is given concerning all Candler Courses. JUNIOR Scientific Code Course for beginners. Teaches all the necessary code fundamentals scientifically. **ADVANCED** High-speed Telegraphing for operators who want to increase their w.p.m. speed and improve their technique. **TELEGRAPH** Touch Typewriting for becoming expert in recording messages on a typewriter.
Code Courses on Cash or Monthly payment terms.

COUPON

Please send me a Free Copy of "Book of Facts."

NAME

ADDRESS

Post Coupon in ld. unsealed envelope to
THE CANDLER SYSTEM CO. (Room 65 W),
121 Kingsway, London, W.C.2.
Candler System Co., Denver, Colorado, U.S.A. (843)

**COME AND SEE US AT OUR
NEW SHOWROOMS
214, QUEENSTOWN ROAD**

It is convenient from anywhere. No. 137 bus from Marble Arch or Oxford St. stops outside; almost next door to Queen's Rd. Station, S.Rly.; only two stations from Waterloo.

OUR BARGAINS INCLUDE:

PETROL ELECTRIC PLANTS. Pelopone or Stuart 500-watt cyl. 2-stroke, water-cooled self-ignition engine; mag. ign. coupled to 50/70 volts, 10 amps. shunt dynamo, 1,000 r.p.m. £42.

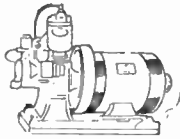

ASTER 4-Cyl. W.C. Engine. 3 kW. Coupled to 100/150v., 25 amps. Crompton D.C. Dynamo.

4 1/2 kW. AUSTIN. 4-cyl. water-cooled Engine, mag. ignition and 110 volt 25 amps. coupled 1 1/2 kW. D.C. dynamo 50/70 volts 25 amps., mag. ignition.

PETROL ENGINES. Almost new; twin cyl. Douglas, fan-cooled, governed, mag. ignition, light weight, 2 1/2 h.p., £15.

AIR COMPRESSORS. A.C. and D.C., portable 220 volt electric type on wheels for paint spray, inflator, etc., £15. No pump. Compressors only, Vicker's multi-blade rotor, £5/10-. Small 1 1/2 cu. ft. vertical inflator type, £3/10-. Motor Blowers, K.B. Cyclone, etc., high pressure type and exhausters. Electric Fans, table and wall.



DYNAMOS, MOTORS, ROTARIES. As you know, we have many in stock for quick delivery. Do any of these interest you? Fine modern A.C. 1 h.p. Induction motors, self-start, 1,450 revs., as new. D.C. Motors, 1 h.p., 110 volts and 220 volts, shunt, 1,750 revs. D.C. Motors, 1 h.p., 230/250 volts, shunt, 700 revs. L.H., D.C., 2 h.p., 110 volts, 2,000 revs. W. Another D.C., 2 h.p., 250 volts, 1,050 revs. N. 5 h.p. ditto, 230 volts, 2,100 revs., etc., etc.

ROTARIES FOR RADIO. E.D.C. and Crypto, etc. Various D.C. inputs and 60 cycle A.C. output for mains A.C. Receivers and Radiograms on D.C.

CHARGING MOTOR GEN'S. D.C. Output 8 volts 250 amps., coupled to 3 h.p. 220 volt D.C. motor. Another fine charger D.C. output, 9 volts 50 amps. for 220 v. D.C. units. Smaller output 16 volts 5 amps., coupled to 220 v. d.c. motor, also for 110 volt motor. A.C. type charger for 50 cycle, 210 220 volt mains with generator, output 16 volts 12 amps, 1,400 revs.; another with 220 volt, 5 amps. D.C. output.

GENERATORS. We can still supply small 6 volt and 12 volt high speed dynamos, 17/6. Carriage paid England and Wales.

MOTOR CONTROL FLOOR FOOT SWITCHES. Ironclad 5 to 50 amps., 10/-. For other switchgear, see last month's advertisement.

METERS. We have some full-size switchboard meters, 4in. and 6in. dials, etc. A.C. and D.C. At low prices to callers.

INDICATORS. Water level for tanks, with ball-float geared to watch-dial panel gauge. Range 9in. rise or fall, 7/6. Battery Charge indicators, "Mentor" thermal type, red light, 2 1/2in. flush panel case, 6 or 12 volts, 5/-.
PRESSURE GAUGES. Air or Oil, to 4 lbs., 2/6; to 50 lbs., 3/6; to 90 lbs., 4/6; to 120 atmospheres, 10/6.



PHOTO-CELLS. For control by light rays. Raycraft selenium bridge, as illus., with instruction book, 21/-. Sensitive "R" 10,000 ohm Relay, 22/6, or the pair with accessories, 42/-.
NITRIDAY CHARGERS. For A.C. mains. Leaflet of sizes on request. Stamp.

SIGNAL EQUIPMENT. Keys, Buzzers, Telephones, Morse Recorders, Cable, Crystal Sets, etc.

Do not be too late for these bargains. Order whilst stocks are available. We can still supply some of the bargains listed in last month's advertisement.

COME TO US FOR:—Waxmeters, Direction-Finders, Micro Galvan and Reflector Scales, Lab. Resistor Boxes and Wheatstone Bridges, Switchboard Meters, D.C. Elements, Blowers, Fans, Pumps A.C. or D.C., Motor Pumps for all purposes. Rheostats and Resistances, Slate Panels, any size or thickness, to order. Headphones, House-phones, Portable phones and Microphones.

For other bargains see our advertisement in previous issues. Please add postage on Mail Orders, and send stamped envelope for replies to enquiries.

Note our new Showrooms address and how to get here. See opening paragraph to this advertisement.

ELECTRADIX RADIOS

214, Queenstown Road, Battersea, London, S.W.8.
Telephone: Macaulay 2159

WANTED. U.R. tube, 3-6in, also 2 885 or equiv. gas triodes, new or little used.—Woodburn, 223, Quinton Lane, Quinton, Birmingham. [1915]

GRAMOPHONE EQUIPMENT

QUALITY 12in p.m. speaker, ac, turntable, swing records.—Fiddin, R.A.F., Rousdon, S. Devon. [1897]

COILS for filters, tone controls, etc., all types of transformers for "W.W." circuits accurately wound.—R Clark, 69, Longley Ave, Alperton, Middx. [1855]

Wanted

WANTED, in good condition, crystal pick-up, any make, but preferably Astatic; also Astatic equaliser.—State particulars to Anderson, 409, W. Western Rd., Glasgow.
COMPONENTS SECOND-HAND, SURPLUS SUPPLIES for the radio serviceman.

VALVES.—We have large stocks of English and American types; please order, c.o.d.; retailers not supplied.

COMPONENTS.—Rola Six p.m. speakers, less trans.; 21/-.

VOLUME CONTROLS, less switch, long spindle, 1/4in dia., 7/6, 1/2, 1 and 750ohms, 3/6; with switch, long spindle, 1/4in dia, 10,000 ohms, 6/6; 1 1/2in spindle, centre tapped, 1,000 ohms, 5/6; Bakelite knobs, 1/4in spindle fitting, with fixing screw, 7/6 doz.; barretter replacement resistors, 5/6; handsome speaker cabinets, polished, 29/6; soldering irons, excellent quality, 60watt, 12/6.

ELIMINATORS, Dulci ac, 95/-. dc 37/6; Varley 20v accumulators, 14/4; Servisol, 5/- per tin; assorted radio fuses, 3/6 doz.; mains droppers, 9 assorted on display card, 35/- per card, splendid value; spiral elements, 750watt 1/9, 1,000watt 2/-; iron elements, 450 watt, 2/1; insulating tape, 6d. and 10 1/2d. reel; all goods brand new, quality guaranteed; please order components cash with order.—C. and H. Smith, 1 and 2, Middlemarsh House, Newdegate St., Nunceaton. [1909]

LONDON CENTRAL RADIO STORES offer the finest radio and electrical bargains.

ELECTRIC soldering irons, 200-250v. 75 watts; 12/6; post 8d.

PUSH-BUTTON mechanism only unit, complete with buttons; 4/6; post 8d.
T.C.C. condensers, 0.1mfd 5,000v, dc wkg.; 9/6 each; post 8d.

SCREENED cable, fine quality, heavy duty, 15 strand, 30 gauge, 5mm rubber covering, with two layers of Empire tape, 1/9 yd.

RUBBER cord, flex, wire, tinned copper, 17 strands, 9ft. lengths; 3d. yd.

PHILCO bleeder resistances, in metal cans, 100, 150, 250ohms; all 10w; 2/6; post 3d.

TUBULAR condensers, 0.5mfd, 500v working; 2/6; post, etc., 4d.

MULLARD EA50 diodes, 60mm x 12mm overall, 6.3v heater at 15a; 10/6; post 3d.

POTENTIOMETERS, carbon: 700,000ohms, less switch, 3/6; 100,000ohms, with 2-pole m and b switch, 4/6; post 6d.

LONDON CENTRAL RADIO STORES, 23, Lisle St., London, W.C.2. Gerrard 2969.

VIBRATOR, 84 rectifier and power transformer, 6v input; 35/-; Box 2909, c/o Wireless World. [1904]

FERRANTI 8mfd 500v condensers, 10/4 each; new dc valves, list price.—Rush-ton, 77, St. Helier's Pl., Prescott. [1896]

SOUTHERN RADIO'S wireless bargains:

—Screws and nuts, assorted gross of ea. (2 gross in all), 10/-; soldering tags, including spade ends, 6/-; Philco 3-point car aeriels, excellent for short wave and home aeriels, 7/6; limit tone arms, universal fixing for all types of sound boxes and pick-up heads, 10/-; Ace P.O. microphones, complete with trans., ready for use with any receiver, 7/-; metal panels, undrilled rigid, 18 1/4in x 8 1/4in, 2/6; circular magnets, very powerful, 1 1/4in diameter by 3/4in thick, 1/6 each, 15/- per dozen; Erie resistances, brand new, wire ends, all low value from 0.8 ohms upwards, a few higher value are included in ea. parcel, 14, 1/2, 1 and 2-watt, 100 resist., for 30/-; Multicon Master mica condensers, 28 capacities in one, from 0.001, etc., etc., 4/- each. Special assorted parcel for Service men: 100 Erie resistances (description above), 24 assorted tubular condensers, 6 reaction condensers, 0.0001, 12 lengths insulated sleeving, 75ft push-back connecting wire, soldering tags, screws, wire, etc., 65/-, all brand new. Crystals (Dr. Cecil), 6d, with cat's whisker, 9d; complete crystal detectors, 2/6; 75ft wire for aeriels, etc., 2/6; 25 yds push-back wire, 5/-; Telsen large disc drives, 0.0001, 1/9 each; Telsen large disc drives, complete with knob, etc. (boxed), type W124, 2/6 ea.; insulated sleeving, assorted, yd lgths, 3/6 dozen; single screened wire, doz. yds, 10/-; speaker units, unshrouded, Midget type, 4/-; metal cased condensers, 0.1+0.1+0.1, 2/6; many bargains for callers.—Southern Radio Supply Co., 46, Lisle St., London, W.C.2. Gerrard 6653. [1845]

E.H. WILSON

A.C. & BATTERY
CONSTRUCTORS' KITS

3-V. T.R.F.

When assembled these Kits give excellent reproduction on Medium and Long Waves. Supplied complete with chassis 8in. x 6 1/2in. x 2 1/2in. Valves, M.C. Speaker, and wiring diagram. (Regret, no cabinets.) 3 controls.

A.C. 3-V. (+ RECTIFIER) KIT. V.M.H.F. Pen., Triode, L.F. Pen., Rectifier, 6in. or 7in. M.C. Speaker. Price £9 9s. Post 1/1, plus 3/6 packing (returnable).

BATTERY 3-V. KIT. V.M.H.F. Pen., Triode Detector and Output Tetrode, 6in. or 7in. P.M. Speaker. Price £6 10s. Post 1/1, plus 3/6 packing (returnable).

KINDLY NOTE. We cannot undertake the assembly of these Kits. Many readers have asked us to do so, but present conditions make it impossible. Awfully sorry!

Orders executed in rotation. Delivery approx. one month. No C.O.D.

● CALL FOR DEMONSTRATION ●

MAINS TRANSFORMERS. Input, 200/250. Output, 350-0-350 100 ma. 4 v. 4 amp., 4 v. 2 amp., 27/6. Input, 200/250, output, 350-0-350 100 ma., 6.3 v. 4 amp., 5v. 2 amp., 27/6. Both with mounting brackets. Colour coded. Postage 8d.

COILS. Aerial and osc. iron core. Superhet coil unit, 6 push buttons, adjustable permeability tuned, complete with button. New. Colour coded circuits supplied, £1/10-. Midget Aerial and Osc. Superhet. 465 k/cs. Three wave-band coils, mounted on panel, new, 12/6 per pair.

Aerial and HF Transformer, with reaction, colour coded connections, 8/6 per pair.

IF TRANSFORMERS. 450/470 k/cs iron core permeability tuned, centre tapped, first-class component, new, 12/6 per pair.

MAINS VOLT DROPPING RESISTORS. 2 amp. 1,000 ohms, 2 variable sliders, 4/6; 3 amp. 750 ohms, 1 variable slider, 6/-.

9/10-WATT WIRE-WOUND RESISTORS. 2,000, 500 and 150 ohm, 2/6 each.

PADDERS. Twin ceramic, .0003 mmfd. (max.) and .0006 mmfd. (max.), 1/6 each. T.C.C. Condensers, air spaced, 0 to 35 mmfd., 1/- each.

CHASSIS. Steel, painted, new, 10 1/2 x 8 x 2 1/2in.; 7/6; 8 x 6 x 2 1/2in., 4/6 each.

WESTECTORS. Type W6, 5/- each.

SWITCHES. New, Yaxley type, single bank, single pole, 4-way, 2/9 each. (Midget) single bank, 3-pole, 3-way, 3/6 each; 2 bank, 2-pole, 3-way, 5/- each; 3-bank, 2-pole, 4-way screened, 7/6 each; 4-pole, 4-way, midget, 4/6 each.

PARALLEL FEED TRANSFORMERS. Midget. Colour coded circuit, 6/-. H.F. Choke Amplion, 2/6 each.

VALVE HOLDERS. 4-, 5-, 6-, 7-pin Paxolin, 6d. International Octal, moulded bakelite, 9d. each.

CONDENSERS. Tubular, .0005 mfd. to .005, 6d. each; .02 to .1, 9d. each. Mica, .01, .001 mfd., 2,200 volt test, 1/6. Silver mica, .00015, .0002, .0005 mfd., .00005 mfd., 9d. each.

PAXOLIN. Polished, flat, strong, 36 x 23 x 3/32nds approx., 2/6 each. Soldering Tags, 3d. dozen. Terminal Strips, from 3d. to 9d. Eye-lets, 1/2 to 1/6 gross. Resistors, 1-watt, 6d.; 1-watt, 1/- each, most values available. Spiro Clips, 2 a 1d.

SPEAKER OUTPUT TRANSFORMER. Heavy duty Pentode, 10/- each.

A good selection of shop-soiled and odd components available to callers only. Cheap.

VOLUME CONTROLS. 1/4 and 1/2 meg., with switch, 5/6 each.

License to export to Northern Ireland and Irish Free State. Please add postage for enquiries and mail orders. C.O.D. orders accepted.

51-52, CHANCERY LANE

LONDON, W.C.2. Telephone HOLborn 4631

Of course we're Proud

Justifiable pride has never yet carried harm in its wake. Rather does it act as a spur to even greater efforts for the slightest slackening of purpose may turn it into mere arrogance and vain-glory. Which is why that at Gardners Radio you will find us very jealous of the pride we take in building components as good as they possibly can be. And nowhere in the Gardner range is this pride more justified than in the Small Power Transformers up to 4 kva. So when next you need this type of product why not let us prove to you how justified we are in being proud.

We regret that at present Small Power Transformers are available for highest priority orders only.



GARDNERS RADIO LIMITED
SOMERFORD, CHRISTCHURCH, HANTS.

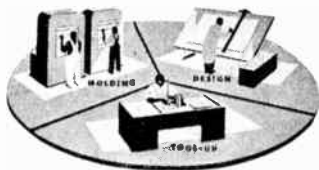

WHEN you think of plastic mouldings for post-war products we suggest you consult the Kurz-Kasch "Plastic Round Table"—a group of specialists in design, materials, tool-up and moulding. Kurz-Kasch can give you complete service under one roof, one responsibility.

Register your name with our representative now. He will forward you information of our products as soon as they become available.

KURZ-KASCH INC.
Moulders of Plastics,
DAYTON, OHIO
U.S.A.

Exclusively Represented by
Frank Heaver Ltd. Kingsley Road, Bideford, N. Devon

G. A. RYALL, 69, Wharfdale Gardens, Thornton Heath, Surrey.—Please note new temporary address; mail order only. **ERIE** resistances.— $\frac{1}{2}$ W, 680 ohms, 3/- doz.; Erie 2W, 150, 3,900, 140,000, 270,000, 3 1/6; Erie 3W, 6,800 ohms, 2 1/6.

T.C.C. 0.1 non-inductive tubular condensers, in paxolin tubes, type 330, 350v wks., 6/6 dozen, 75/- gross.

SLOW motion (epicyclic) drives, in well-finished brass, ratio 8-1, shaft $1\frac{1}{2}$ in long, $\frac{1}{2}$ in dia., drilled to take pointer, 1/3 each.

DIAL plates.—Berners 4 wave band in 4 colours, brass stiffed edges, size $6\frac{1}{2}$ x4 approx., 1/6 each.

PAXOLIN strip, $2\frac{1}{2}$ in wide, 12 in lengths, 3 1/6 or 100 25/-; short lengths cut to any board size, 6 1/3.

KB wave traps, iron core, suitable medium and long wave, 1/3 each; thimble top caps, 24 1/3; insulating tape, black, 1/3 lb; Wearite switches, ebonite with silver-plated contacts, for 2hf and band pass with dial lights, 1/6 each.

YAXLEY switch screens, size approx. 4in x $3\frac{1}{2}$ in, drilled with mounting flange, 3 for 1/5; thimble top caps, std. size, 24 for 1/3.

LEASKY'S RADIO, 370, Harrow Rd., Paddington, W.9, offer for sale the following condensers: 0.15mfd 2,000v at 1/6 each, 0.02mfd 2,000v at 1/- each, 0.23mfd 2,000v at 1/6 each, 0.05mfd 2,000v at 1/- each, 0.002mfd 2,000v at 1/- each, 2mfd cond., 700v, at 2/6 each; 50mfd 12v tubular, 16/- doz, 25mfd 25v tubular, 18/- doz; 0.1mfd 350v tubular, 6/- doz; 10mfd 25v tubular, 1/6 each; speakers, speaker output transformers from 6/-; $6\frac{1}{2}$ in Rola speakers, less transformers, at 17/6, plus postage; 8in Rola speakers, less transformers, at 21/-, plus postage; 5in Rola speakers, less transformers, 17/6, plus postage; 8in Rola speakers, with transformers, 27/6; 10in Rola speaker, less trans., 31/6, plus postage; terms cash with order or c.o.d. Send us your requirements. [1737]

500 microamp meters, 0.1ma meters, by Elliott, Weston, etc., 2in scale, 65/-; instrument rectifiers, good make, 17/6; mains transformers, 200-250 primary, 350-0-350 4v 2a, 4v 5a, 350-0-350 5v 2amp, 6.3v 4amp, 28/-; M/C loudspeakers, p.m. and energised, 1st-class make, 8in 25/-, 10in 37/6, will handle 8-10watts; switched vol. controls, 6/6, less switch 4/6, any value; electrolytics, 16mfd, 250v wkg., 8/6; multi ratio output transformers, 9/6; thousands of components and valves in stock; send us your requirements.

—Patrick, 4, Stanway Rd., Shirley, B'ham.

H.M.V. Auto d.c. record changer and pick-up, Model 117, in cabinet, best offer above £10; Hartley Turner speaker, 2,500 ohms, 4-ohm coil, best offer above £5; Ferranti M.I. speaker, 20 ohms coil, perm. mag., best offer above £5; Ferranti A.P.F. 7, A.F.6, A.F.5c, O.P.M.6c, O.P.M.3c; R.I. Varley choke, 14/7 henries, 120 ohms, 100-200 mA; Hartley Turner A.P. coupling unit, 2-1, without trans., 40-1; W.W. amplifier feeder unit for 12-watt amp, with addit. improvements, black metal carrying case, new valves, as new; offers.—Box 2900, c/o Wireless World, [1857]

COULPHONE Radio, New Longton, nr. Preston.—New goods only. Tungstrom valves, mains transis., 350v 120mA, 4v 8A, 4v $2\frac{1}{2}$ A, 4v $1\frac{1}{2}$ A, 33/6; 350v 120mA, 6.3v 3A 5v 3A, 32/6; Celestion, 8in p.m., with transf., 24/6; Rola p.m., less transf., 5in 20/-, $6\frac{1}{2}$ in 22/-, 8in 24/-, 10in 28/6; cored solder, 4/6 lb; tinned copper wire, 2/3 $\frac{1}{4}$ lb; 2mm Systoflex, 3d, yd; Barrett resistors, 6/-; line cord replacement resistors, 800 ohm 2 adj. taps, 6/9; Parafed L.F. transf., 4-1, 4/9; 50 mfd 12v, 1/9; 25 mfd 25v, 1/9; Erie resistors, 1w 9d, $\frac{1}{2}$ w 6d, $\frac{1}{4}$ w 4d; Pushback wire, 100ft 6/-; switch cleaner, 2/3 bott.; output transf., 7/6; Bell transf., 6/6; valveholders, 1d per pin; Stanelco el. soldering irons, 21/-; tubular and mica condensers, V controls, with sw., 5/9, less sw. 4/9; s.a.e. for stock list. [1856]

BATTERY charging.—Metal rectifiers, 6v 0.5amp 6/3, 12v 0.5amp 11/6, postage 3d.; 12v 3amp, 34/6; special transformer for same, 23/6, postage 10d.; metal rectifier, 6v 2.5amp, 15/6, with special transformer and ballast bulb 42/6, post 10d.; also transformer, rectifier and ballast bulb for 2v, 6v, 1amp, 29/6; ditto 1.5amp, 35/-, postage 10d.; transformer and rectifier for 2v 0.5amp charger, 14/6, post 7d.; ditto 2v 0.3amp, 11/6; instrument type rectifiers for meters, 1ma 18/6, 5ma 15/6, 10ma and 50ma 14/6, new goods, good make, postage 3d.; one milliamp full scale meters, $3\frac{1}{4}$ in dia., flush mounting, 65/-; Rothermel bakelite crystal pickups, latest model, 78/6; famous Rothermel Bullet microphones, for stand mounting, new tilting mount, black crackle, finished housing, really good tonal quality at a modest price, £3, stands in stock; also few only D.104 microphones, £4/15; miniature deaf-aid mikes, crystal, 42/6, post 6d.—Champion, 42, Howitt Rd., London, N.W.3. [1918]

Cabinets?

Increased production facilities enable us to give immediate attention to orders for urgent requirements and we are now in a position to accept further contracts or sub-contracts for Government work.

We specialise in **AMPLIFIER** and **EXTENSION SPEAKER CABINETS**.

All enquiries should be accompanied by Priority No.

HIRSH & HYAMS, LTD.

Cabinet Manufacturers,

93, Hackney Road, London, E.2. *Bish. 4212.*

HILL AND CHURCHILL

BOOKSELLERS

SWANAGE DORSET

ENGLISH & AMERICAN
BOOKS IN STOCK ON
RADIO AND
TELECOMMUNICATION

CATALOGUE ON APPLICATION



For high quality
loud speakers
when the good
times come again.

The Courts, Silverdale, London, E.E.26. 'Phone: SYD 6666.

GECALLOY RADIO CORES

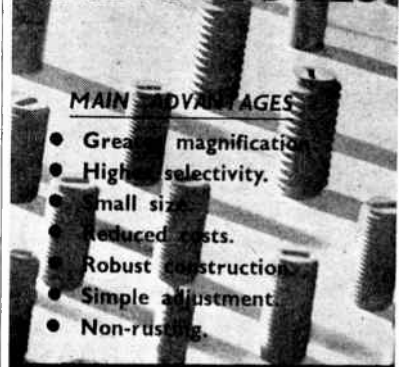

MAIN ADVANTAGES

- Great magnification
- High selectivity.
- Small size
- Reduced costs.
- Robust construction
- Simple adjustment
- Non-rusting.

Salford Electrical Instruments Ltd.

PEEL WORKS, SILK STREET, SALFORD, 3
Telephones: BLAckfrans 6688 (6 lines)
Proprietors: The General Electric Co. Ltd., of England

LASKY'S RADIO

for
Valves, Speakers, Condensers and ELECTROLYTICS

WE HAVE A LARGE SELECTION OF ENGLISH AND U.S.A. VALVES IN STOCK as per example.

1A5, 5Z8, 5Z4, 6A8, 6F6, 6K6, 6K7, 6K8, 1C5, 6Q7, 12A8, 12Q7, 12S3J7, 2B14, 2B26, 6B8, 32L7, 35L6, 35Z4, 3Z2S, 50L8, 70L7, 117Z8, 80, 6X5, 12B8, 12F5, 6J7, etc., etc. All at B.O.T. Fixed Retail Prices Plus Tax. English AC, AC/DC & Battery Valves as follows: U60, HL4, HL13, MV8PEN, VP4, 8P4, FC4, MU14, X65, MU12, U12, FCH3, DW4/500, EBL1, FC2, U15, X63, KTW61, KT65, WD40, TDD4, etc., etc. Speakers, Speaker Transformers, Volume Controls, with and without switch. Rola P.M. Speakers in stock: 5", 6", 8", 10", with or without Transformer.

The following List of Components and Condensers in stock.

U.S.A. Octal Base Valve Holders, 8d. each	7/6 doz.
Wander Plugs, assorted, 3d. each	2/6 "
Assorted Volume Controls, less Switch	2/9 each
Ditto, with Switch	4/9 "
2 mfd. 700v. Block Paper Condensers	2/6 "
.15 mfd. 2,000v. Tubular Condensers	1/8 "
.02 mfd. 2,000v. ditto	1/- "
.23 mfd. 2,000v. ditto	1/8 "
.05 mfd. 2,000v. ditto	1/- "
.002 mfd. 2,000v. ditto	1/- "
50 mfd. 12v. ditto	18/- doz.
25 mfd. 25v. ditto	16/- "
.1 mfd. 350v. ditto	6/- "
10 mfd. 25v. ditto	1/8 each
2 mfd. 400v. Can Electrolytics	4/3 "
Toggle Switches	3/6 "
Spade Terminals for Accumulators, 9d. doz.	7/6 gross

Send us your requirements.

LASKY'S RADIO,
370, Harrow Road, Paddington, W.9.
Telephone: Cunningham 1979.
CASH WITH ORDER OR C.O.D.

PLAN YOUR FUTURE NOW

Big developments in radio and television have been forecast. There will be splendid opportunities for technically trained men to secure well-paid positions. Hundreds of our students now doing important work owe their progress solely to our training. Our specialised method of Home-Study tuition is a proved success. Now is the time to prepare yourself for well-paid employment or profitable spare-time work. Post coupon for free details of our Home-Study Courses in Radio Reception, Transmission, Servicing, Radio Calculations, Television and Mathematics. **YOU MUST KNOW MATHS.** If you wish to make progress in any type of technical work, you must know maths. Our method of tuition makes maths really interesting and easy to understand.

T. & C. RADIO COLLEGE

2, THE MALL, EALING, W.5

Please note new address

(Post in unsealed envelope, 1d. stamp.)

Please send me free details of your Home-Study Mathematics and Radio Courses.

NAME

ADDRESS

W.W.20

DEGALLIER'S, Ltd., "Service with a guarantee"; let American specialists do the job, first-class workmanship only, at competitive prices; we specialise in the following: Air-King, Belmont, Pilot, Challenger, Ham-murland, Garod, Ferguson, Delco, deWald, Midwest, Philco, Wells Gardner, Hallcrafters, etc.; also any British set; 2½d. stamp with all enquiries—Degallier's, Ltd., 9, Westbourne Court, London, W.2. [1860]

RADIO repairs to the public and the trade; repairs executed to the following, both American and English: Midgets, portables, transportables, table and console models, radiograms, autoradiograms, amplifiers, sound recording equip, elec. guitars, and all types of radio and electrical instruments; forward, packed well, chassis and valves only, sets in cabinets may be sent, but not advised, as cabinets get scratched in transport; special prices to the trade; any quantity taken; average time 2-10 days.—Apply L. E. Healey, 125-125a, Old Rd., Clacton, Essex. [1899]

MISCELLANEOUS
ELEC. shaver parts: Oxford, Roto, Lektro, leather cases, coils, cutters, resistances, etc.; s.a.e.—Ilaven, 2nd Ave., Lt. Oaks, Milton, Stoke-on-Trent. [1881]

RUBBER stamps made up to your special requirements, and design, typical ex-ample, stamp showing name, address and pro-fession; 9/6 post free.—V.E.S., Radio House, Ruislip. [1884]

REPUTABLE firm of toy manufacturers and electrical engineers seek ideas for electrical and mechanical toys for post-war pro-gramme; generous terms.—Apply Box 2869, c/o Wireless World. [1719]

FOR disposal, ac 250v slot and check meters at £2 and £1 each, good, work-ing order; also some T.R.S. cable, single and twin, light and heavy gauge.—Gee Electric, 15, Little Newport St., W.C.2. [1888]

LIGHTERS—Utility cigarette lighters, British made, bakelite, also gaslighters; both lighters are soundly constructed and fully guaranteed; price 6/6 each (incl. tax), plus 6d. for postage and packing; cash with order only, money returned if dissatisfied.—J. Bull & Sons, Dept. H, 246, High St., Harles-den, N.W.10. [1919]

ADVERTISER wishes to contact a few of the most eminent engineers in the country, or men who have held the highest appointments in prominent engineering con-cerns, to criticise manuscripts of a practical and technical nature dealing with civil, mechanical, electrical, aeronautical, auto-mobile and radio engineering. Interesting work, non-repetitive, could be carried out leisurely in spare time. A high fee is offered.—Write in strictest confidence, stating position, salary, etc., to Box 2839, c/o Wireless World. [1821]

ADVERTISER wishes to get in touch with physicists and engineers (radio or elec-trical) having designs or ideas for develop-ment in the following fields: (1) Radio, tele-vision, V.H.F.; (2) industrial and general electronic equipment; (3) electronic test equipment for all types of applications, par-ticularly as in No. 1 above. Assistance, financial or practical, would be available to those originating suitable projects, and any information given will be treated in the strictest confidence.—Write, giving fullest pos-sible details, to Box 2893, c/o Wireless World.

SITUATIONS VACANT
SERVICE manager for valve det. aids, Lon-don, W.1, good correspondent, personality, knowledge L.F. amplifier; permanency.—Box 2906, c/o Wireless World. [1890]

RADIO technical writers, capable of pre-paring handbooks, operating instruc-tions, etc., required by scheduled undertaking in North London; applicants must be able to follow up new developments and design and formulate results in a manner readily under-standable to the operators in the field.—Write, stating experience, age and salary re-quired, to Box 1414, A.K. Adv., 4, Talbot Mans., Museum St., London, W.C.1. [1840]

SITUATIONS WANTED
RADIO engineer, exp. B.O. & C. Bristol Aero Co., and E. K. Cole, discharged R.A.F., requires responsible position.—Box 2895, c/o Wireless World. [1846]

RADIO instructor, A.M. Brit. I.R.E., formerly service manager, with 10 years' exp. re-tail trade, seeks situation either capacity; exempt; free list Nov.—Box 2905, c/o Wire-less World. [1883]

ENGINEER, 35, grad. Brit. I.R.E., matric., desires change; wide experience radio and sound cinema; laboratory work preferred, but production or service considered.—Box 2903, c/o Wireless World. [1875]

ENGINEER, electrical, mechanical and sound apparatus, seeks engagement; con-siderable experience 16 and 35mm sound film equipment and servicing same; experienced driver.—Box 2908, c/o Wireless World. [1903]



W. BRYAN SAVAGE LTD.

Expert assistance in the solution of problems relating to

- TRANSFORMERS, CHOKES
- AMPLIFIERS
- POWER UNITS

and Specialised Equipment embodying

ELECTRONIC CONTROL

WESTMORELAND RD., N.W.9
COLINDALE 7131

RADIO COMPONENTS—AND VALVES

Parcels of Assorted New and Second-hand Radio Components, consisting of Single and Twin-gang Condensers, Audio Transformer or Choke, Dual Range Coil, Smoothing Choke or Speaker Field Pot, H.F. Choke, 1 and 1 watt Resistors, Grid-leaks, fixed Condensers, Valve-Holders, Switches, Connecting Wire, Insulators, Fuse Wire, and various odd parts. Exceptional value—£1 per parcel. Satisfaction guaranteed.

VALVES, 2-volt Battery H.F. Det. and L.F., 3/-, Power, 4/-, Tungaram Super Power, 6/-, Philco Screened-grid, 1A4E and 1B4E, 9/- each. Output Pentode, Type 1F5G, 11/-.

A.C./D.C. Types, Tungaram DDT13 and DDT188, 11/3. TX129 and TX21, 13/8. Barretters, 4-pin and side-contact, 9/-.

American Types, 7C6, 6K7, 12/8. 01A, 35/51, 33, 6G6, 10/3. 6Y6, 6B8G, 6J8G, 13/6.

4-volt A.C. Types, Tungaram HL4, 9/2. DDT4, 11/3.

Terms—cash with order, postage extra. Please send stamp with all enquiries.

E. H. ROBINS TRADING CO. LTD.,
44, Kyle Crescent South, Whitchurch, Glam.

LONDEX for RELAYS

for A.C. and D.C.

TWO STEP RELAY LF/F8
(Heavy Silver Contacts)



First Impulse
"ON." Second
Impulse "OFF."

Also Aerial
Change-over
Relays.

Ask for
leaflet 88A/WW

LONDEX LTD

MANUFACTURERS OF RELAYS
AMERLEY 207, AMERLEY ROAD, LONDON S.E.20
PHONE: STAMFORD K1509

COVENTRY—RADIO

MAINS TRANSFORMERS 350-0-350v-120ma, 4v.5a.; 4v.4a., or 6-3v.4a.; 5v.3a. 25/6

I.F. TRANSFORMERS 465 kc. Scnd. 6/6, 8/6

DUBLIER 2 and 3 watt Resistors 1/3

ROLA, CELESTION P.M. Speakers, with 10 years' exp. or without transformer. Lowest list prices.

5,000 VALVES in stock. List prices plus tax

COMPONENTS—Wires, condensers, resistors, coils, sleeveing, etc. Large stocks. Quotations. Stamped envelope please.

COVENTRY CO. Estd. 1925.

191, DUNSTABLE ROAD, LUTON.
[Phone: LUTon 2677.]

TECHNICAL TRAINING

A.M.I.E.E., City and Guilds, etc., on "No pass-no fee" terms; over 95% successes: for full details of Electrical Technology send for our 112-page handbook, free and post free.

GREAT possibilities exist for technically qualified engineers, key men in wartime and afterwards. Through the home-study courses of The T.I.G.B. take a recognised engineering qualification, such as A.M.I.Mech.E., A.M.I.E.E., A.F.R.Ae.S., A.M.I.Chem.E., C. and G., etc., in which examinations the T.I.G.B. students have gained 25 FIRST PLACES and hundreds of passes.

THE TECHNICAL INSTITUTE OF GREAT BRITAIN, 82, Temple Bar House, London, E.C.4.

TUITION

LEARN Morse code the candler way. See advertisement on page 26. RADIO training.—P.M.G. exams. and I.E.E. Diploma; prospectus free.

WANTED, practical tuition electricity and radio; apparatus essential; W1 London area preferred.—Write G. W., c/o Streets, 6, Gracechurch St., E.C.3.

RADIO Engineering.—"Television and Wireless Telegraphy," comprehensive postal courses of instruction. Apply British School of Telegraphy, Ltd., 179, Clapham Rd., London, S.W.9 (Estd. 1906). Also instruction at school in wireless for H.M. Merchant Navy and R.A.F.

ENGINEERING opportunities.—Free 112-page guide to training for A.M.I.Mech.E., A.M.I.E.E., and all branches of engineering and building; full of advice for expert or novice; write for free copy, and make your peacetime future secure.—B.I.E.T. (Dept. 387B), 17, Stratford Place, London, W.1.

A POSTAL training in electrical engineering—power or radio; individual correspondence tuition by highly qualified engineers with wide teaching and technical experience. Elementary or advanced courses. Preparation for recognised examinations. Pre-service training specially arranged.—G. B., 18, Springfield Mount, Kingsbury, N.W.9.

THE Tuitionary Board of the Institute of Practical Radio Engineers have available home study courses covering elementary, theoretical, mathematical, practical, and laboratory tuition in radio and television engineering; the text is suitable coaching matter for I.P.R.E. Service-entry and progressive exams; tuitionary fees—at pre-war rates—are moderate.—The Syllabus of Instructional Text may be obtained post free from the Secretary, Bush House, Walton Avenue, Henley-on-Thames, Oxon.

PATENT NOTICES

THE proprietors of British Patent No. 475750, dated July 20, 1936, relating to improvements in electric wave signalling, are desirous of entering into arrangements by way of a licence or otherwise on reasonable terms for the purpose of exploiting the above patent and ensuring its practical working in Great Britain.—Enquiries to Singer, Ehlerst, Stern and Carlberg, Chrysler Bldg., New York City, N.Y., U.S.A.

VALVES

(RETAILERS NOT SUPPLIED) AMERICAN VALVES.

- O1A 11/-; OZ4 15/3; 1A4 15/3; 1A6 16/6; 1B4 16/7; 1B5 15/3; 1B7 15/3; 1C7 18/3; 1D5 16/3; 1D7 18/3; 1E5 15/-; 1E7 18/3; 1F5 15/-; 1F6 18/3; 1E7 18/3; 1G5 15/-; 1G6 18/3; 1H4 15/-; 1H6 18/3; 1H5 15/-; 1J6 18/3; 1K5 15/-; 2A6 14/-; 2A7 15/-; 2B6 14/-; 2B7 15/-; 2E5 15/-; 5Y3 5Y4 5Y4 14/6; 6A3 18/3; 6A4 18/3; 6A8 14/-; 6B4 18/3; 6B6 13/-; 6B7 14/-; 6B8 15/3; 6C8 17/6; 6D5 15/-; 6E6 15/-; 6F7 9/2; 6F6 12/10; 6F8 18/3; 6G6 18/3; 6H6 6/10; 6J5 18/3; 6J7 12/10; 6J8 12/10; 6K6 13/-; 6K7 12/10; 6K8 14/-; 6L5 15/-; 6L6 18/3; 6L7 12/10; 6M6 18/3; 6N7 11/7; 6K7 11/7; 6A7 14/-; 6B7 18/3; 6S7 12/10; 6T5 15/3; 6T8H9 14/-; 6V6 12/10; 6X5 11/-; 6Y6 15/-; 6Y6 18/3; 6Z3 18/3; 6Z5 18/3; 6Z7 18/3; 7A6, 7A7, 7A8, 7B7, 7B8, 7C6, 15/3; 10 18/3; 12A 15/-; 12A 16/-; 12B8 15/3; 12C8 18/3; 13 18/-; 15 18/-; 17 15/-; 19 18/-; 24 15/-; 25A6 12/10; 25L6 12/10; 25Z6 11/-; 26 15/-; 25A6 29 14/-; 30 12/10; 31 12/10; 32 15/-; 33 14/-; 34 15/-; 35 13/-; 36 12/10; 37 15/6; 38 17/6; 39 12/10; 40 15/-; 42 12/10; 46 15/-; 48 22/6; 49 18/6; 50 25/3; 52 23/-; 63 16/6; 65 13/6; 56 15/-; 67 14/-; 58 15/-; 68 18/6; 71A 14/6; 75 14/6; 77 12/10; 78 12/10; 79 18/3; 80 14/6; 81 21/-; 85 14/6; 89 18/3.

4-VOLT A.C. MAINS TYPES

- ACTP, TH3A, TH3B, PC4, 14/-; VP4, SP4, VP4B, SP4B, ACSPB, 12/10; TD4A, MH4A, 11/7; H42, 354V, H14, 9/2; P42A 12/10; PenB4 14/8; Pen428 30/6; also Cosmor MSPen, MVSPen, MSPenB, MVSPenB 12/10; 4IMP6 14/-.

A.C./D.C. TYPES

- CL, CIC, 10/6; FC13, FC13C, TH21C, TH30C, 15D2, 14/-; VP13A, VP13C, SP13C, 9D2, 8D2, 12/10; HL13C, 2D13C, 2D13A, 9/2; TD130, 11/7; CL33 12/10; CBL1 15/3; KTW61, KTW63, KT61, KT63, 12/10; also Cosmor VP13A, SP13A, 12/10; VP20 & SP20 equivalent 15/3.

MAZDA OCTALS

- TH41 14/-; VP41 12/10; SP41 12/10; DD41 11/-; UV6 11/-; HL41DD 11/7; HL42DD 11/7; Pen45 12/10; UUT 11/-; TH23 14/-; HL133DD 11/7; V133 12/10; V133 12/10; V133 12/10; H123 5/10; QP26 15/3; VP23 11/-; HL23DD 9/2.

MULLARD E TYPES

- EB4 12/10; EBC3 11/7; EBC3 11/7; EBF2 15/3; EBL1 15/3; EBL3 15/3; ECH2 14/-; ECH3 14/-; ECH3 14/-; ECH3 14/-; EP5 14/-; EP6 14/-; EP9 12/10; EP9 12/10; EP39 12/10; EK2 14/-; EK3 15/3; EL2 14/-; EL3 12/10; EL3 12/10; EL3 12/10; EL3 12/10; EL3 12/10; CBL1 15/3.

VALVES AND CONVERSION UNITS are available for the following "unobtainable" Valve-Types:

MAZDA

- UUS, 22/9; U403, 18/6; TP22, 17/6; TP23, 17/6; QP230, 19/9; QP240, 19/9; TP2820, 18/6; AC'PEN 5-pin, 17/6; PEN383, 17/6; PEN3520, 17/6; PEN3820, 17/6; PENND4020/1, 19/9.

PHILCO and other AMERIC

- 25RE, 15/6; 33RE, 15/6; 43, 17/6; 2101, 15/6; 2102, 14/6; 2103, 19/9; 15, 18/6; PENDD61, 19/9; 2151, 17/6; 76, 15/6; 523, 22/9; 84/824, 15/6.

These Valves and Conversion Units will in most cases give as good a result as the original valve, but in all cases perfect reception is assured of the local programmes. Add Postage to above prices.

For Electrolytic Condensers and Spares see last month's advertisement. Send 1d. for complete list. Postage must be added on all orders under 22.

J. BULL & SONS 249, HIGH ST., HARLESDEN, N.W.10

THE proprietors of British Patent No. 505632, dated November 12, 1937, for Improvements in and relating to cathode-ray tubes, are desirous of entering into arrangements by way of a licence or otherwise on reasonable terms for the purpose of exploiting the above patent and ensuring its practical working in Great Britain.—Enquiries to Singer, Ehlerst, Stern and Carlberg, Chrysler Bldg., New York City, N.Y., U.S.A. [1843

THE proprietors of British Patent No. 465747, relating to "Improvements in variable coils," are desirous of entering into negotiations with one or more firms in Great Britain for the purpose of exploiting the invention, either by sale of the patent rights or by the grant of licences on reasonable terms.—Interested parties who desire further particulars should apply to Albert L. Mond and Thiemann, of 14 to 18, Holborn, London, E.C.1. [1839

THE proprietors of British Patent No. 504934, dated November 1, 1937, relating to improvements in closures for evacuated envelopes and method of manufacturing the same, are desirous of entering into arrangements by way of a licence or otherwise on reasonable terms for the purpose of exploiting the above patent and ensuring its practical working in Great Britain.—Enquiries to Singer, Ehlerst, Stern and Carlberg, Chrysler Bldg., New York City, N.Y., U.S.A. [1780

BOOKS, INSTRUCTIONS, ETC.

WIRELESS Eng. wanted, 10/- offer. Williamson, 41a, Westgate, Sleaford, Lincs.

WANTED, back numbers W.W. Q.A. Rider manuals 6-10; good price.—Box 2894, c/o Wireless World. [1842

WEBB'S radio map of the world locates any station heard, size 40x30in, 4/6, post 6d., on linen, 10/6, post free.—Webb's Radio, 14, Soho St., London, W.1. Tel. GUR47 2089. [19947

AMERICAN service manuals.—Wartime booklet, containing 14 Spartan and 4 Emerson circuit diagrams and alignment sheets, complete with all particulars; all orders will be treated in strict rotation, quantity limited; 12/6; cash with order, post free.—Champion Electric Corporation, 84, Newman St., London, W.1. [1844

AFTER THE WAR!

The advance in Radio Technique after the war will offer unlimited opportunities of high pay and secure posts for those Radio Engineers who have had the foresight to become technically qualified. How can you do this quickly and easily in your spare time is fully explained in our unique handbook.

Full details are given of A.M.I.E.E., A.M.Brit.I.R.E. City & Guilds Exams., and particulars of up-to-date courses in Wireless Engineering, Radio Servicing, Short Waves, Television, Mathematics, etc., etc.

We Guarantee "NO PASS—NO FEE"

Prepare for to-morrow's opportunities and post-war competition by sending for your copy of this very informative 112-page guide NOW—FREE.

BRITISH INSTITUTE OF ENGINEERING TECHNOLOGY (Dept. 388) 17, Stratford Place, London, W.1.

M.O.R.S.E.

COMPLETE PRACTICE UNIT

as supplied to many branches of H.M. Service No. 1261. Complete Morse Practice Unit. Heavy commercial Key with nickel silver contacts and sensitive triple adjustment. High-tone Buzzer with silver contacts, mounted on bakelite base with cover. Battery Holder, complete with 4.5 Ever

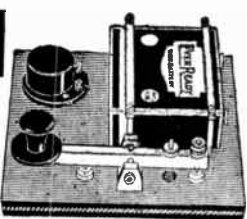

Ready battery. All metal parts heavily nickel plated, and the whole mtd. on polished Mahogany 29/6 Base, 6 1/2 in. x 6 1/2 in. Post paid.

Send 1d. stamp for Illustrated List. SIGNALLING EQUIPMENT LTD. (Dept. 8) Merit House, Southgate Road, Potters Bar. Phone: Potters Bar 3133

MARTIN'S HAVE IT—IN STOCK:

- Mains Transformers. Well made Standard Replacements, 4-v. and 6.3-v., 37/8 each. 8 M.F.D. Can Type Dry 450.V/W, 10/6 each. .01 and .03 Tubular Fixed Condensers, 1,500 V.D.C., 8d. each. .05 Tubular Fixed Condensers, 1,500 V.D.C., 1/3 each. 25 M.F.D. Tubular, 25 V.W., 2/6 each. 25 M.F.D., 12 V.W., 2/3 each. .0001 Boxed Condensers, 2/- each. Boxed. Faxley Type Switches, 5-way, 1 Bank, 2 pole, 3/6 each. Resistors, 1 watt, 100 ohms to 2 meg. mixed, 72/- gross. Resistors, 1/2 watt, 100 ohms to 2 meg. mixed, 63/- gross.

MARTIN'S (Edmonton) LTD. 3/4 The Broadway, Edmonton, London N.9. TOTtenham 4188.

THE RADIO INSTRUMENT CO.

Manufacturers and Distributors of Components to the **RADIO SERVICING TRADES**
MAINS TRANSFORMERS. Primary 0/210/230/250 v. Secondary H.T. 350/0/350v. (except Type Z).
Type
A 80/100 ma. 4v. 2a. and 4v. 4a. CT, 25/-.
B 80/100 5v. 2a. and 6.3v. 4a. CT, 25/-.
M 80ma. 4v. 2a. and 4v. 2a. and 4v. 4a. CT, 28/-.
T 80/100ma. 4v. 2a. and 4v. 2a. and 4v. 2a. and 4v. 4a. CT, 32/6.
X 120 ma. 4v. 3a. and 4v. 6a. CT, 35/-.
Y 120 ma. 5v. 3a. and 6.3v. 6a. CT, 35/-.
Z 500/0/500v. 120ma., 4v. 3a. and 4v. 6a. CT, 39/6.
ZA 500/0/500v. 120 ma., 5v. 3a. and 6.3v. 6a. CT, 39/6.
 Delivery of all types governed by requirements of Essential Works Contracts. Please Quote Priority Numbers where possible.
0P12 OUTPUT TRANSFORMER. Heavy duty, primary 120ma., twelve ratio. Primary and secondary lapped, full descriptive leaflet upon request, 39/6.
CHOKES. Smoothing. Types CH1 80ma., 8/6. CH2 120 ma., 17/6. CH3 200ma., 22/6. All above 500 ohm FR type, 2,500 ohm, 17/6.
SUPPRESSOR CHOKES, for mains leads, 1 amp., 2/9. (Condensers for above. 1 mfd., 2,250v. Test, 1/8).
AUTO TRANSFORMERS. Step up or down. 60 watt 110/230v., 22/6.
SPEAKER REPLACEMENT BOBBINS, for Roia, Celestion, etc. Tapped. 2/9.
VOLUME CONTROLS. All values less switch, 3/6. With switch, 5/9.
LINE CORD DROPPERS IN PROTECTIVE CAGE. 750 ohm for 2- or 3-way cord replacements, fit on wall or set cabinet at rear, 10/6.
SWITCHES. Toggle on/off, 2/11. DPDT, 3/6. Wavechange, 3-bank, 3-way, 6/6. 4-waveband, 6-bank, 8/6.
DUBLIERE MICA CONDENSERS. All cap. from .0001 to .005, 6/- doz.
Resistors. 2-watt 500 ohm, 9d. 3,000, 5,000, 10,000, 9d.
Bias condra. 15mf. 9v. and 25mf. 4v., 8/6 doz.
THERMEL Crystal pick-ups, 23/18/9. Mikes, 23/12/6.
EVERYTHING FOR THE SERVICE DEPOT. SPARES, VALVES, ETC. FULL LIST (21d.) ON APPLICATION.
 Please note new address to which all enquiries should be sent:—

THE RADIO INSTRUMENT CO.
 (G. Lavington)
 294, THE BROADWAY,
 BEXLEYHEATH, KENT

THE POLYTECHNIC
 REGENT STREET, LONDON, W.1
SCHOOL OF ENGINEERING

Head of School:
 PHILIP KEMP, M.Sc. Tech., M.I.E.E.,
 A.I.Mech.E.
RADIO-ENGINEERING. - A FULL-TIME DAY COURSE in tele-communications, extending over a period of three years, preparing for all recognised examinations and for the radio and telephone industries.
 School reopens on 13th September, 1943.
EVENING CLASSES in these subjects commence on 20th September. Enrolment from 13th to 15th September, 6 to 8 p.m.
Further particulars may be obtained on application to the Director of Education.

ENGINEERING OPPORTUNITIES



This unique handbook shows the easy way to secure A.M.I.Mech.E., A.M.Brit.I.R.E., A.M.I.E.E., etc.
WE GUARANTEE— "NO PASS—NO FEE."
 Details are given of over 150 Diploma Courses in all branches of Civil, Mech., Elec., Motor, Aero, Radio-Television and Production Engineering, Tracing, Building, Govt. Employment, R.A.F. Maths., Matric., etc.
 Think of the future and send for your copy at once—FREE.
B.I.E.T., 367, SHAKESPEARE HOUSE
 17, STRATFORD PLACE, LONDON, W.1

Past

Starting with a lively interest in Sound Recording technique we concentrated on supplying readers with discs and the necessary small equipment. This early beginning rapidly developed and our activities soon embraced the Professional field.

Present

We have recently acquired new premises and all enquiries and correspondence should be addressed to:—
 4 BITTACY PARK AVENUE,
 MILL HILL, N.W.7.

In addition to equipment previously advertised we now have completely mobile RECORDING AND SOUND AMPLIFYING EQUIPMENT available for hire in all parts of the country. Further details on application.
 Enquiries are invited for all types of Sound Equipment.

We take this opportunity to apologise for any delay in the despatch of equipment owing to our present shortage of staff and the large amount of priority work which we have in hand.

Future

We are looking ahead and have already made our post-war plans. Our after-the-war address will be "The Elms," Warham Road, South Croydon, Surrey, where large studios with every modern facility for high quality recording will be available

SOUTHERN SOUND STUDIOS

4 Bittacy Park Avenue, Mill Hill, N.W.7

SPEAKER REPAIRS by Specialists

Any make, British or American Best Service Moderate Charges
TRADE ONLY
 Also Components for Service Men at keenest prices. List 1d.
A. W. F. RADIO PRODUCTS 'Phone: 11632
 13, Lilycroft Road, Bradford, Yorks.

WARD ROTARY CONVERTERS

Petrol Electric Generating Plants, H.T. Generators, D.C. Motors, Frequency Chargers, etc., up to 25 K.V.A.
CHAS. F. WARD
 37, WHITE POST LANE, HACKNEY WICK, E9.
 'Phone: Amhurst 1393

BATTERY CHARGERS & TRICKLE CHARGERS

for all purposes
"QUICK-CHARGE" CHARGERS
 well known for reliability
 Booklet R.15, giving useful information and describing 12 Models, on request
RUNBAKEN-MANCHESTER-1



INVENTORS

We invite new inventions which, guided by the technical knowledge, manufacturing facilities and world-wide marketing organisation of the Simmonds Group, may be developed to play vital parts in modern history.

ALL COMMUNICATIONS MUST BE IN WRITING IN FIRST INSTANCE TO—

The
SIMMONDS GROUP

LONDON
 MELBOURNE
 PARIS
 NEW YORK
 LOS ANGELES

SIMMONDS DEVELOPMENT CORPORATION LTD. 2-3 NORFOLK ST. W.C.2

Printed in England for the Publishers, ILLIFF AND SONS LTD., Dorset House, Stamford Street, London, S.E.1, by THE CORNWALL PRESS LTD., Paris Garden, Stamford Street, London, S.E.1. "The Wireless World" can be obtained abroad from the following: AUSTRALIA and NEW ZEALAND: Gordon & Gotch, Ltd. INDIA: A. H. Wheeler & Co. CANADA: Imperial News Co.; GORDON & GOTCH, Ltd. SOUTH AFRICA: Central News Agency, Ltd.; Wm. Dawson & Sons (S.A.), Ltd. UNITED STATES: The International News Co.



Clear as a Crystal

AND HERE IS THE REASON..

• • • the answer has been found in Bullers Low Loss Ceramics to the problem of Dielectric Loss in High Frequency circuits.

Years of laboratory research and development have brought these materials to a high degree of efficiency. To-day they are in constant use for transmission and reception, and play a vital part in maintaining communications under all conditions.

Made in Three Principal Materials

FREQUELEX—An Insulating material of Low Dielectric Loss, for Coil Formers, Aerial Insulators, Valve Holders, etc.

PERMALEX—A High Permittivity Material. For the construction of Condensers of the smallest possible dimensions.

TEMPLEX—A Condenser material of medium permittivity. For the construction of Condensers having a constant capacity at all temperatures.



Bullers

LOW LOSS CERAMICS

BULLERS, LTD., THE HALL, OATLANDS DRIVE, WEYBRIDGE, SURREY

Telephone: Walton-on-Thames 2451. Manchester Office: 196, Deansgate, Manchester.





Exide BATTERIES

THE CHLORIDE ELECTRICAL STORAGE COMPANY LTD.
 Grosvenor Gardens House, Grosvenor Gardens, London, S.W.1
 Telephone : VICtoria 2299. Telegrams : Chloridic, Sowest, London.