

# Wireless World

RADIO • ELECTRONICS • ELECTRO-ACOUSTICS

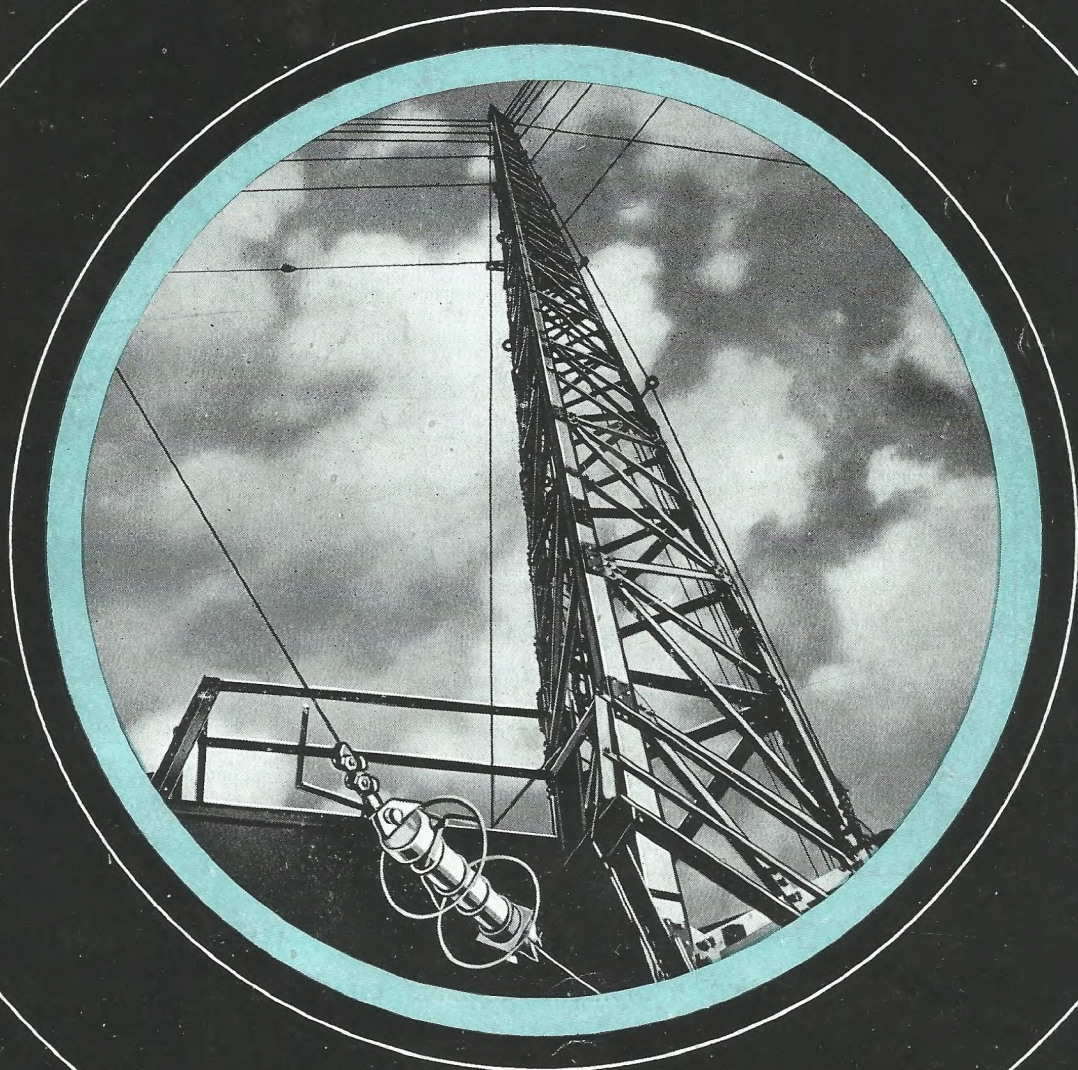

NOV. 1942

1/3

OVERHAULING MOVING-COIL METERS

Vol. XLVIII No. 11





*Good Team Work* by the various components of communication equipment depends on sound engineering design.

**REDIFFUSION LIMITED**  
A subsidiary of  
**BROADCAST RELAY SERVICE LIMITED**

DESIGNERS AND MANUFACTURERS OF COMMUNICATION EQUIPMENT  
VICTORIA STATION HOUSE • VICTORIA STREET • LONDON • S.W.1 (PHONE VICTORIA 8831)



46-range Model 7  
 Universal AvoMeter

40-range Model 40  
 Universal AvoMeter

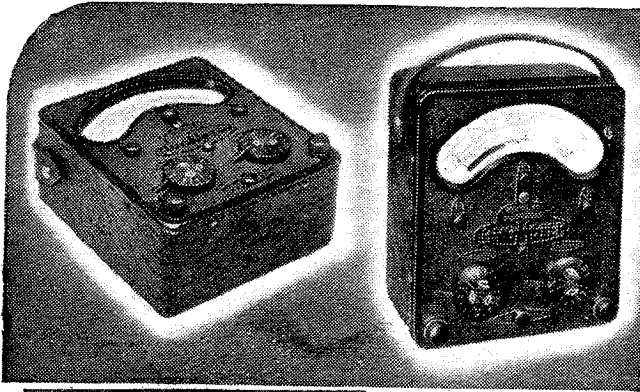

*Meters that Matter*

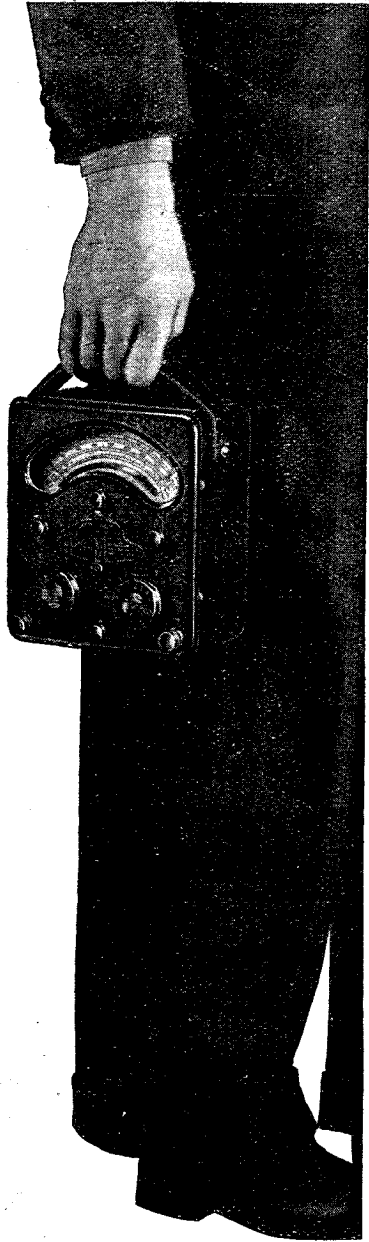

In every sphere of electrical test work . . . in the laboratory, the workshop, the service engineer's bench or "out on a job," . . . the word "AVO" is synonymous with instruments of precision. The "AVO" range embraces instruments for every essential electrical test. By reason of their reliability and maintained accuracy, even under the most searching of workshop conditions, they are frequently used as a standard by which other instruments are judged.

*Write for literature fully descriptive of any "AVO" Instrument in which you are interested.*

*Sole Proprietors and Manufacturer:*

**THE AUTOMATIC COIL WINDER & ELECTRICAL EQUIPMENT Co. Ltd.**  
 Winder House, Douglas Street, London, S.W. 1. Phone: VICTORIA 3404-7.

Some delay in delivery of Trade orders is inevitable, but we shall continue to do our best to fulfil your requirements as promptly as possible.

All-Wave "Avo" Oscillator

"Avo" Test Bridge

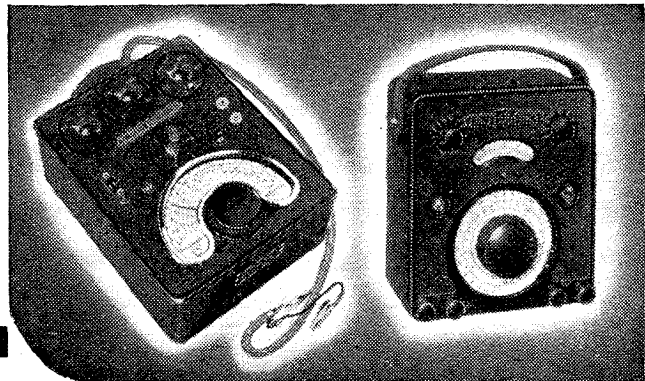

# RUBBER-TO-METAL BONDING

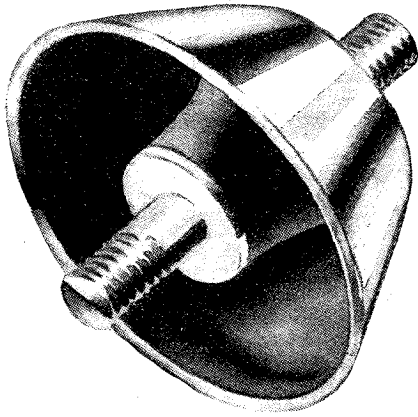

Another very interesting problem in **VIBRATION**—and its solution.

**PROBLEM:** An instrument panel requires immunisation from shock arising in any or all of three dimensions.

**SOLUTION:**

The R.B. Mushroom Mounting Type D.T.

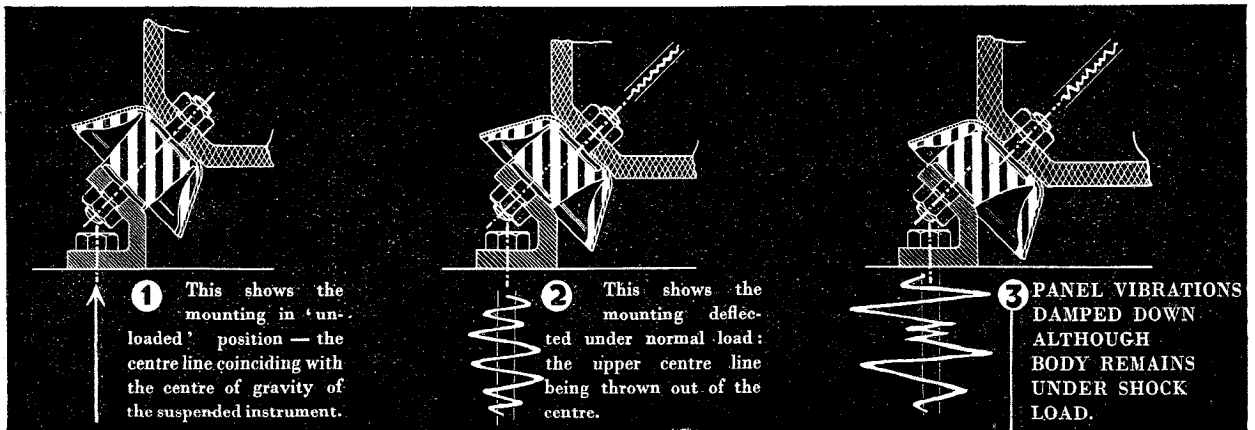

Here is a problem in Vibration solved by the Rubber-to-Metal Bonding Technology of Rubber Bonders Ltd.

Vibrations are represented diagrammatically and the isolating effect of the Type D.T. Mushroom Mounting is clearly seen. This mounting is proving valuable in eliminating persistent vibration or shock.

Rubber Bonders Ltd., are successful because their scientific staff deal with every problem *individually*. Why not send a typical "vibration headache" to Flexilant Works, Dunstable for cure?

This shows the mounting deflected under shock load. The upper centre line being still further thrown out of centre. You will notice the progressive 'abutment' of the rubber profile which gives a stiffening effect that increases as the deflection increases.



A semi-technical booklet entitled "A Short Review of 'FLEXILANT' Products" has just been published and is available upon enquiry.

**RUBBER BONDERS LIMITED**  
*Engineers in Rubber bonded to metal*  
**FLEXILANT WORKS · WATLING ST · DUNSTABLE · BEDS**  
 TELEGRAMS: FLEXILANT DUNSTABLE TELEPHONE: DUNSTABLE 715



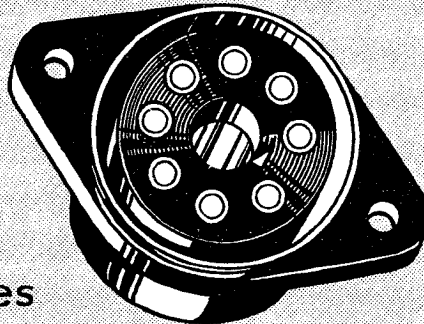
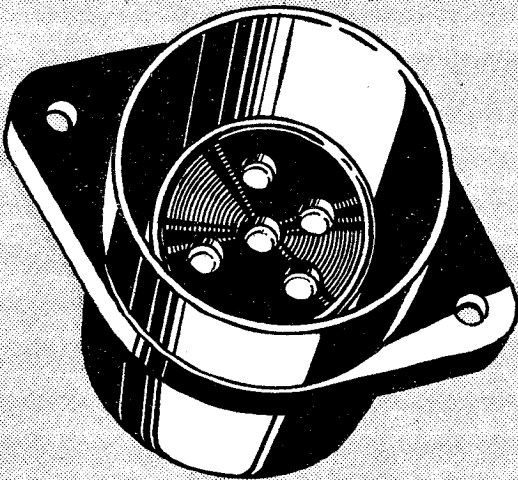
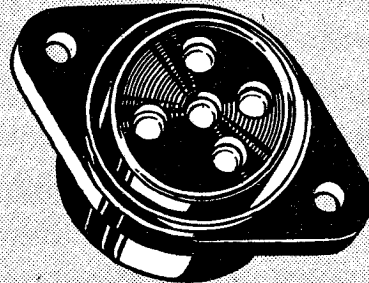
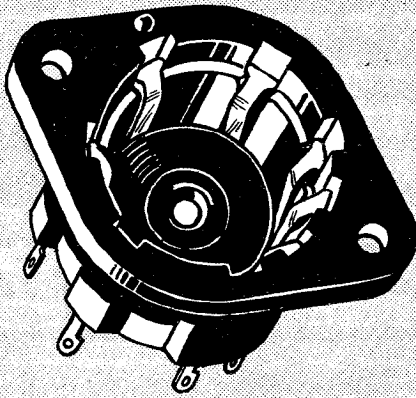
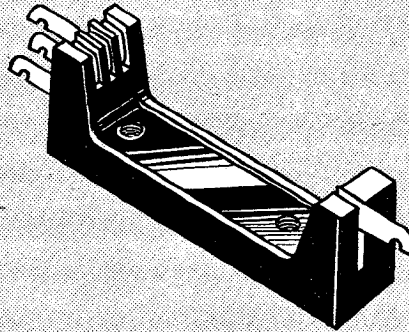
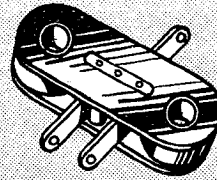
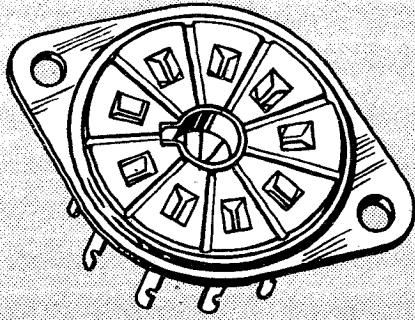

1 2 3 inches

**BELLING & LEE LTD**  
CAMBRIDGE ARTERIAL ROAD, ENFIELD, MIDDX



# SPEED UP ASSEMBLY

with *Spire* TENSION LOCK Nuts

Spire Nuts eliminate the need for conventional threaded nuts and washers. One Spire Nut frequently replaces as many as four parts. Handling and assembly times are reduced and considerable economies in costs and materials are effected.

Spire Nuts are unaffected by vibration and absorb any movement due to temperature changes. They are invaluable for 'blind' locations. Porcelain, plastics or glass may be securely held without damage.

We are glad to advise on the selection of the most suitable types from our wide range of standard Spire Nuts.

**THE ONLY ONE PIECE FASTENING DEVICE WITH A DOUBLE LOCK**

A PRODUCT OF THE SIMMONDS GROUP



**SIMMONDS AEROCESSORIES LTD**  
GREAT WEST ROAD, LONDON.







## LEADERSHIP

To radio technicians the name Mazda has always been synonymous with all that is progressive in valve development.

In design and performance MAZDA RADIO VALVES will always merit their title to leadership . . . the proud position they have held so long.

**MAZDA**  
RADIO  
VALVES

THE EDISON SWAN  ELECTRIC CO. LTD

155 CHARING CROSS ROAD, LONDON, W.C.2

*For full particulars write to Technical Sales Department.*





# Keeping **FAITH**

In the wider interests of the country we are compelled to disappoint many users of our products. It is impossible for us to supply or repair any apparatus except on Government contract. But, to all those radio workers who have supported and encouraged our efforts in the past, let us say at once that we will neither forget them nor the aims which we set ourselves. One day, apparatus created by the research and experience we have gained in war years will bring you loudspeakers that set new standards of perfection in sound reproduction.

## GOODMANS INDUSTRIES LIMITED

Lancelot Road, Wembley, Middx.



## ELECTRIC SOLDERING IRONS

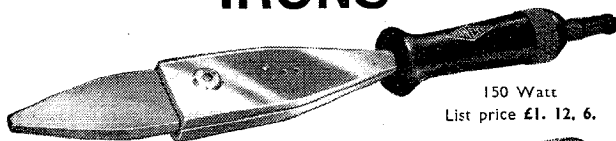

150 Watt  
List price £1. 12. 6.

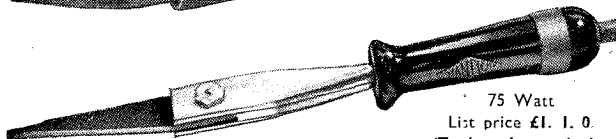

75 Watt  
List price £1. 1. 0.  
(Trade only supplied)

**S**tanelco Electric Soldering Irons have been designed for industrial purposes. Heating elements and copper bits can easily be fitted when replacements are necessary. The 150 watt type is fitted with a general purpose bit and the 75 watt type is available with either long, short, or hammer bit. Each Iron, fitted with 5½ feet of 3-core flexible cable, is available for 100/110, 200/220, 230/250 voltages.

When ordering, the voltage and type of bit required should be specified.

RESIN CORED SOLDER, SOLDER WIRE, Etc.

# Stanelco Products

PROPRIETORS: STANDARD TELEPHONES AND CABLES LIMITED  
FERNDOWN, NORTHWOOD HILLS, NORTHWOOD, MIDDLESEX  
Telephone: PINNER 4385

P. R. MALLORY & CO. Inc.

# MALLORY

## PRECISION RADIO PRODUCTS

**M**ALLORY Vibrapacks, Vibrators, Switches, Condensers, Chargers and other precision radio products are all helping to bring the day of Victory closer.

Mallory serves the Aviation, Aviation Instrument, Army, Navy and Communication Field with these parts, and other items extending far beyond the radio interests.

Mallory looks forward to the time when the existing but necessary buying restrictions are withdrawn, when Mallory engineering and manufacturing facilities will be ready to solve your problems and serve your needs.

★ Register your name with our Representative now. He will forward you information on our products as soon as they become available.

**P. R. MALLORY & CO. INC.**  
INDIANAPOLIS, INDIANA, U.S.A.

—Exclusively represented in Gt. Britain by—

**FRANK HEAVER LTD.**, Kingsley Rd., Bideford, N. Devon, Eng.



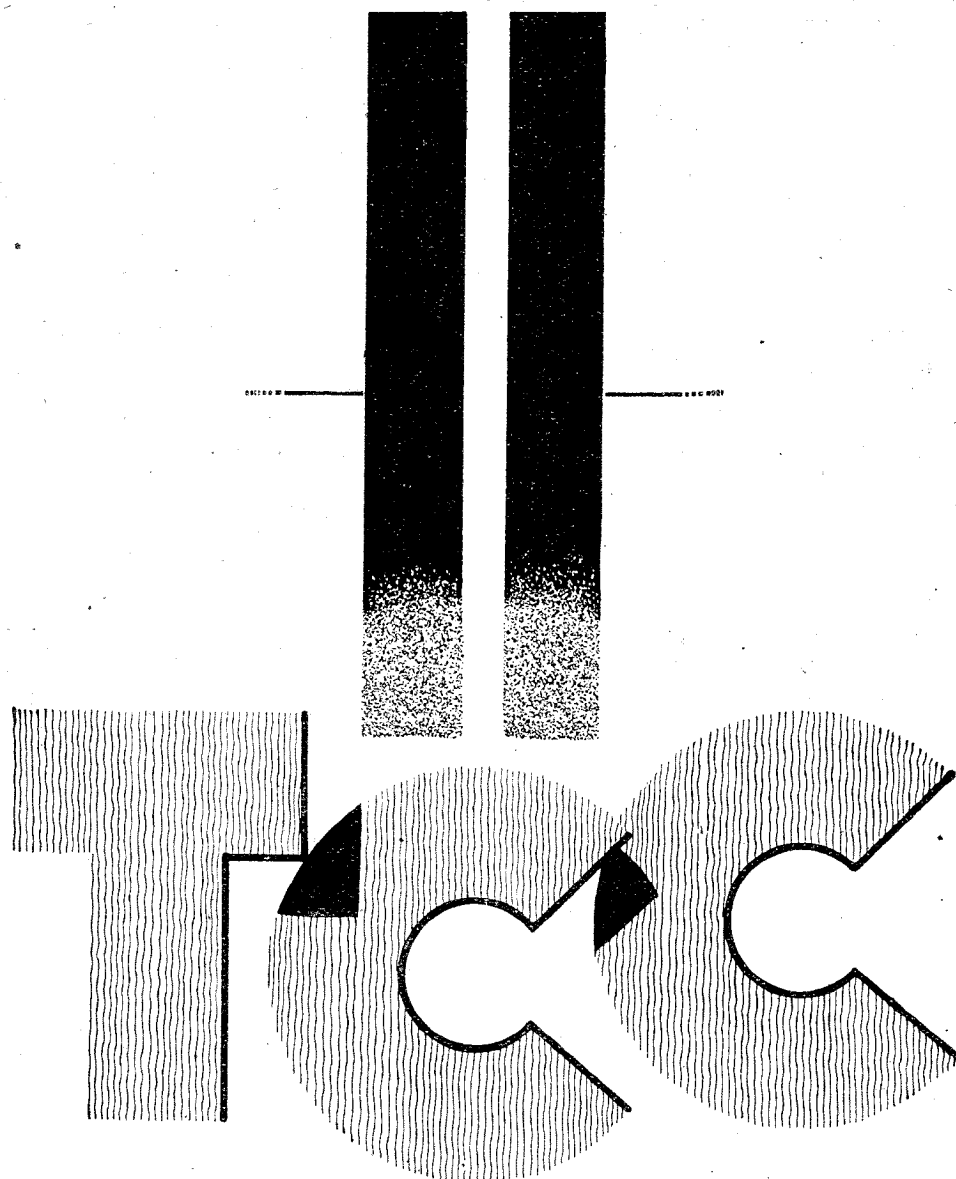

**PRE-EMINENT IN PEACE  
INDISPENSABLE IN WAR**

**ADVERTISEMENT OF THE TELEGRAPH CONDENSER CO., LTD.**

## COSMOCORD CRYSTAL PICK-UP SERIES III

It is regretted that production is severely curtailed and only very limited supplies are available through existing channels.

Sole Selling Agents :

**SALE, TILNEY & Co. LTD.**  
3, LLOYD'S AVENUE, LONDON, E.C.3

Phone : ROYal 4811

## SERVICE ON COSMOCORD CRYSTAL PICK-UPS IS MAINTAINED AS HITHERTO

Owing to lack of replacement parts and shortage of labour it is regretted that service on all other products and apparatus must be discontinued.

## THINGS TO COME— HIGH FIDELITY REPRODUCTION

Are you interested? If so, will you kindly forward your name and address to

**COSMOCORD LTD.**

SERVICE DEPT.

700, GREAT CAMBRIDGE ROAD,  
ENFIELD, MIDDLESEX

**DAGENITE**  
AND  
**PERTRIX**

—the dependable

**BATTERIES**



FOR  
RADIO, CARS  
MOTOR CYCLES  
COMMERCIAL  
VEHICLES  
ETC.

Sales Concessionaires:

**HOLSUN BATTERIES LIMITED**

137 Victoria Street, London, S.W.1

D 9 c 42

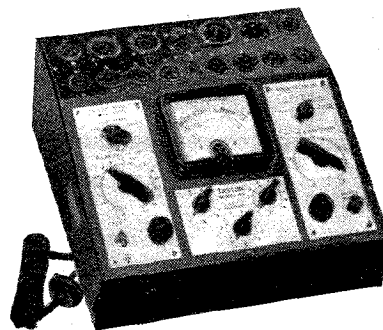

## TAYLOR MUTUAL CONDUCTANCE VALVE TESTER

MODEL 45

A robust, compact and accurate test instrument essential to all radio manufacturers, servicemen and dealers.

Operates on A.C. 200/250 volts, 40/100 cycles.

PRICE

**£15.15.0**

Portable Model 45P, with compartment for tools, £17/6/6.

Taylor Valve Testers are supplied with a book of instructions, including wiring diagram, a valve chart covering over 1,000 types of valves, and a grid connecting lead.

Further details on request.

BRITISH MADE AND  
GUARANTEED 6 MONTHS

### SPECIFICATION

**Mutual Conductance.** Accurate and quick measurements are available for practically all British, American and Continental valves, from 0.25 to 24 mA/V.

**Valveholders.** 17 holders cover all modern types and include Loktal, Octal, Mazda Octal and side contact types.

**Tests.** Additional tests are available for Filament Continuity, Electrode Shorts, Cathode Leakage and Rectifier and Diode Emission.

Each section of full-wave Rectifiers, Double Diodes, Frequency Changers, etc., are tested independently. Anode and Screen Volts are adjustable to suit the valve under test, and a choice of 17 Filament Volts are available.

**Meter.** The meter has separate scales for Mutual Conductance, Cathode Leakage, and also a coloured scale for Replace, ? , Good.

**TAYLOR** ELECTRICAL INSTRUMENTS LTD.  
419-422, Montrose Avenue, Slough, Bucks.  
Telephone : SLOUGH 21381



*Value proved by long service*

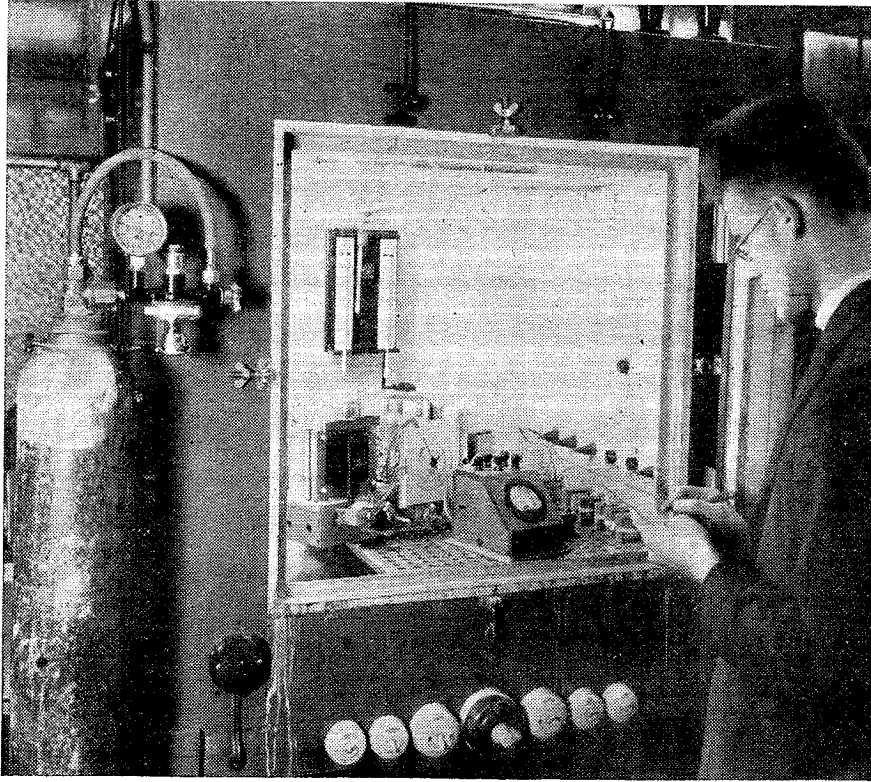

# Osram Valves

MADE IN  
ENGLAND

Ever since the advent of radio Osram Valves have been closely connected with all the progressive stages of development in radio science. Intensive research still goes on by improvements in design and technique to keep pace with the advancing times, and which will ultimately be of benefit to all.

MINISTRY  
OF SUPPLY



Defence (General)  
Regulations 1939  
No. 55, S.R. & O.  
1942, No. 1770

# AN ORDER RUBBER MUST NOT BE DESTROYED THROWN AWAY OR MIXED WITH REFUSE

The Minister of Supply in exercise of the powers conferred on him by Regulation 55 of the Defence (General) Regulations 1939, has made an Order which provides as follows :-

1 No person shall, except under the authority of and in accordance with a licence granted or a special or general direction issued by the Minister of Supply,

- (a) destroy any waste rubber
- (b) throw away or abandon any waste rubber
- (c) put any waste rubber in a refuse bin or other receptacle used for domestic or trade refuse, or
- (d) cause or permit any waste rubber awaiting or in the course of collection or sale to be or become mixed with any material or article other than waste rubber.

Provided that nothing in this Order shall prohibit or restrict the destruction of any waste rubber if and so far as necessary in the course of any process of manufacture, or for the purpose of saving property from immediate danger of destruction or damage by fire.

2 (1) The holder of any licence granted under this Order shall comply with any conditions contained or incorporated in the licence.  
(2) If any licence so granted is revoked by the Minister of Supply, the holder of the licence shall forthwith deliver up the licence to the Minister or as directed by him

3 IN THIS ORDER :

"rubber" includes reclaimed rubber, liquid latex, gutta percha and balata, and "waste rubber" means any worn-out, disused, discarded or waste material or article of the classes or descriptions specified in the Schedule to this Order, but does not include any material or article which is injurious to health or otherwise offensive.

4 This Order shall come into force on the 7th day of September, 1942, and may be cited as the Salvage of Waste Materials (No. 4) Order 1942.

THE SCHEDULE

(a) Articles or materials of any of the following descriptions made wholly or partly of rubber :-

- Balloons • Balls — sports and toy • Bathing-caps • Beds — inflated and sponge • Bulbs — horn, surgical, etc. • Carpet underlay • Catapult strip • Corks and Closures • Corsets — all rubber • Crepe-soled Footwear • Cushions — inflated and sponge • Door-stops • Draught-excluders • Ear Plugs • Elastic Cord and Thread • Electric Cable and Wiring • Football Bladders • Footwear (including Wellingtons and Gum Boots) • Flooring and Tiling • Gloves • Goloshes • Grips — handlebars, etc. • Horse-shoes and pads • Hose and Tubing • Hot-water bottles • Jar-rings • Mats and Matting • Mattresses — inflated and sponge • Milking Rubbers • Pedal-rubbers • Radiator Hose • Rollers • Soles and Heels • Sponge-backed Flooring • Sponges • Squeegees • Stair-treads and nosings • Stopper-rings • Teapot Spouts • Teats and Soothers • Tobacco Pouches • Tubing • Tyres — Pneumatic (Covers, Tubes and Flaps), Solid and Cushion of all types • Upholstery.

(b) Articles or materials of any other description made wholly or mainly of rubber.

**THIS ORDER CAME INTO FORCE SEPT. 7**

# WHARFEDALE

## MIDGET 3½-inch UNIT

### ALCOMAX MAGNET

Flux Density 8,000 lines.

Speech Coil 15 ohms or 2/3 ohms. The first Wharfedale Unit using the new ALCOMAX magnet steel which gives extremely high flux density with small size. Designed for use as Microphone or Midget Speaker. Very sensitive

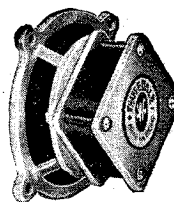

Supplies are available for **PRICE**  
**PRIORITY ORDERS ONLY 28/6**  
(list)

## WHARFEDALE WIRELESS WORKS

(SOLE PROPRIETOR: D. E. BRIGGS)

HUTCHINSON LANE • BRIGHOUSE • YORKS  
PHONE: BRIGHOUSE 50 GRAMS: "WHARFEDALE"

# Microtube Valves

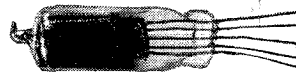
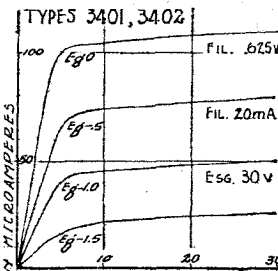

Dimensions 1½" x 3/8" Dia.

### UNUSUALLY SMALL SIZE

- Low H.T. currents
- LOWEST FILAMENT CURRENTS**
- Sharp knee in characteristics

### LINEAR AT LOW ANODE VOLTAGE

- Standard tetrodes and triodes

### SPECIAL DIODE-TRIODES & SCREEN GRID VALVES TO ORDER

- Prompt delivery from manufacturers (U.S.A.)

### MICROTUBE LABORATORIES

- The pioneers of Sub-midget valves

Write for details of Sub-midget valves and components to

Electronic Engineering Services, Ltd.

SOLE BRITISH DISTRIBUTORS

24, STANLEY ROAD, HEATON MOOR  
STOCKPORT

TELEPHONE: HEATONMOOR 3107.



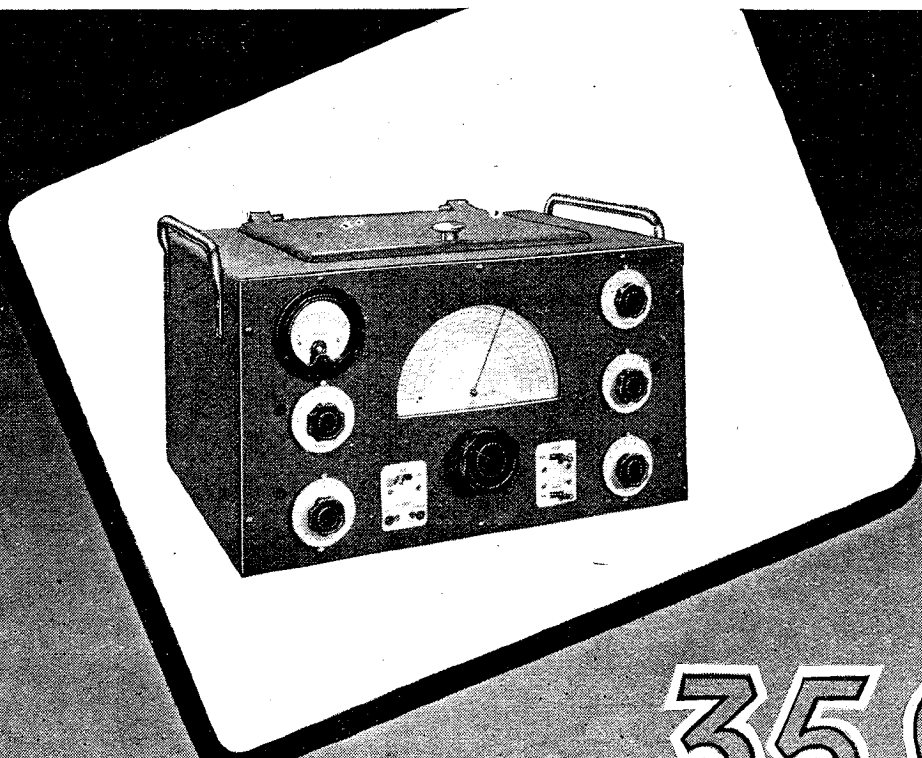

**EDDYSTONE 358X**  
*Communication Receiver*

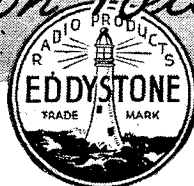

**WITH BANDPASS CRYSTAL FILTER**

The advantage crystal control gives in improved rejection of interference outside the band and correspondingly better signal-to-noise ratio has been fully exploited by Eddystone designers. This receiver at the moment, can only be supplied to holders of priority orders.

**WEBB'S**  
**RADIO**

*The Short-Wave Specialists*

**ON PRIORITY ORDER ONLY**

HOURS OF BUSINESS: 9 A.M. TO 4 P.M. SATS. 9 A.M.-12 NOON

**14 SOHO STREET, LONDON, W.1. Tel: Gerrard 2089**

# B.I.

## RADIO MATERIALS

We have had a long experience in the manufacture of all kinds of Cables and Wires, Static Condensers, Insulators and Iron Work, Telephone Cords and Copper Earthing Rods, for Radio use.



U.K. Regd. Trade Mark.

**BRITISH INSULATED CABLES LTD.**  
 CABLE MAKERS AND ELECTRICAL ENGINEERS  
 Head Office:  
**PRESCOT, LANCS. Tel.No. PRESCOT 6571**

**HIVAC**  
 THE SCIENTIFIC  
 VALVE  
 BRITISH MADE

*Specialists in*  
**MIDGET VALVES**

**HIVAC LIMITED**  
 Greenhill Crescent,  
 Harrow on the Hill, Middx.

Telephone: Harrow 0895.

# KEYSTONE OF POWER

**MASTERADIO VIBRATOR PACKS**

Wherever Portable Power—sturdy, reliable, efficient—is required for Transmitters, Receivers, Amplifiers, etc., this Supply Unit is the most obvious choice.

*Masteradio* LTD. GRAMS: MASTIOLA  
 PHONE: WATFORD 9885/9890  
 VIBRANT WORKS, WATFORD, HERTS.

Greenwood

# ROLA

**LOUD SPEAKERS**  
 THE WORLD'S FINEST REPRODUCERS

**TRANSFORMER LAMINATIONS**  
 Core Widths  $\frac{3}{16}$ " to  $1\frac{1}{2}$ " (E's and I's.)  
 EIGHT STOCK SIZES

A Comprehensive Bulletin together with details of Associated Covers and Clamps with design data will be sent to manufacturers on request.

**BRITISH ROLA LIMITED**  
 MINERVA ROAD · PARK ROYAL · N.W.10 · WILLESDEN 4322





*From the fiery*  
**FURNACES . . .**

. . . of Britain's factories, from her shipyards and laboratories and mines has come many an invention, many a discovery that has changed the course of history. We search for and hold fast to whatever good we can. We know full well that by perseverance only shall we blot out hatred and destruction, misery and hardship and emerge with a fierce determination to make the world a better, safer place. It is our wish always to be associated with that spirit of true comradeship which shall be continued on through happier days.

**DUBILIER**  
CONDENSER CO. (1925) LTD.



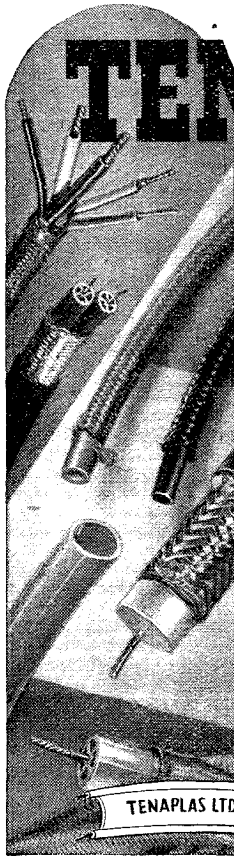

# TENAPLAS

## EXTRUDED PLASTICS

The Tenaplas Method of Extruding Plastics ensures products of uniform quality and dimensional accuracy. Although at the present time Tenaplas Products are manufactured mainly for Electrical and Chemical Insulation there are many industries in which Tenaplas Extruded Plastics could be used with great advantage. Where technical excellence is of first importance Tenaplas can be recommended to fulfil every requirement.

TENAPLAS LTD, Head Office, 7 PARK LANE, LONDON, W.1.

### OBSERVATION OF CRYSTAL FORMATION BY METALLURGICAL PHOTO-MICROSCOPE.

All material used in WESTINGHOUSE METAL RECTIFIERS,

both in manufacture and experimental work, is microscopically examined for purity and correctness of grade by means of the metallurgical photo-microscope.

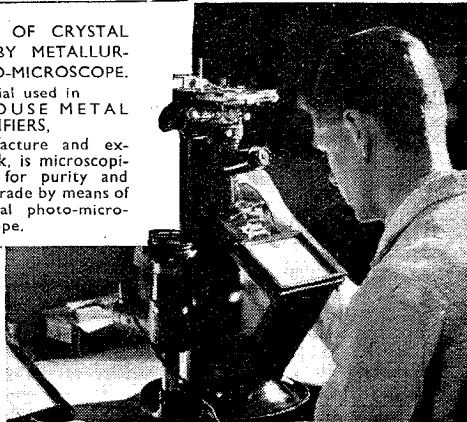

Behind the non-stop production of Westinghouse Rectifiers, our technical staff are ceaselessly at work. We sincerely regret that very limited supplies only are available, but we know that our customers will understand. To-day's intensive research, however, will release remarkable features of design when Westinghouse Rectifiers are again freely available to industry.

*Westinghouse*

WESTINGHOUSE BRAKE & SIGNAL CO. LTD.  
PEW HILL HOUSE,  
CHIPPENHAM, WILTS.

*Rectifiers*

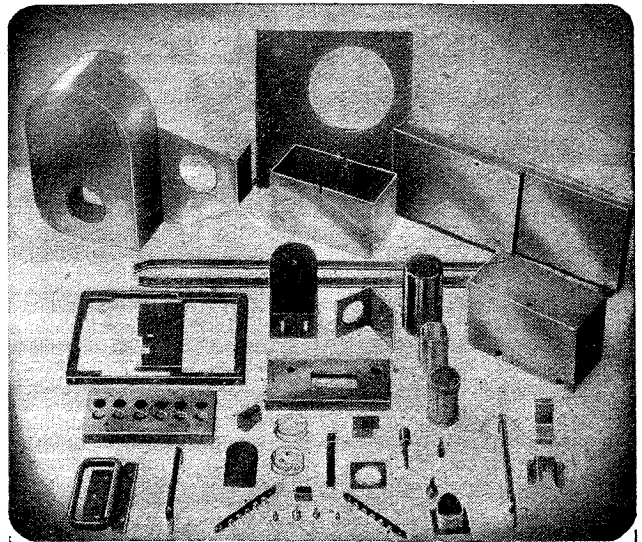

## INSTRUMENT CASES

Our fully equipped modern factory produces all types of metal instrument cases, radio chassis, panels, brackets, boxes and other metal components. Complete amplifying equipments designed and manufactured for special requirements.

Enquiries to be addressed to our Head Office:—Alfred Imhof Ltd., 112-116, New Oxford Street, London, W. C.1. Museum 5944

# IMHOF'S

## — VALVES —

**AMERICAN AND INTERNATIONAL OCTAL.** Mostly glass types 00A, 17/6; 01A, 11/-; 02A, 14/-; 1A4, 12/6; 1A6, 14/-; 1B4, 15/-; 1B5, 15/-; 1C5, 16/-; 1D5, 15/-; 1E5, 15/-; 1F5, 15/-; 1F7, 15/-; 1G5, 15/-; 1H6, 14/6; 1J5, 15/-; 1T5, 16/-; 2A6, 14/-; 2A7, 15; 2B7, 15/-; 5Y3, 14/6; 5Z3, 18/6; 5Z4, 14/6; 6A6, 14/-; 6A7, 14/-; 6A8, 14/-; 6AC5, 11/6; 6AC6, 11/6; 6B6, 13/-; 6B7, 14/-; 6B8, 16/-; 6C5, 13/-; 6C6, 14/-; 6D6, 14/-; 6D7, 15/-; 6E6, 13/-; 6F7, 17/-; 6H6, 10/-; 6J7, 13/-; 6K5, 13/-; 6K6, 13/-; 6K7, 13/-; 6K8, 14/-; 6L7, 14/-; 6P7, 17/6; 6Q7, 11/6; 6R7, 13/-; 6SA7, 14/-; 6SCT, 15/-; 6SR5, 14/-; 6U7, 13/-; 6V6, 13/-; 6X5, 15/-; 6Z5, 18/-; 7A7, 13/-; 7C5, 13/-; 7B6, 11/6; 7B8, 14/-; 6L7, 13/-; 12B8, 15/-; 15, 18/-; 19, 18/-; 24, 13/-; 25A6, 14/6; 26, 12/-; 29, 14/-; 30, 12/-; 31, 12/-; 32, 15/-; 33, 14/-; 34, 15/-; 35, 13/-; 36, 14/-; 38, 12/6; 39/44, 12/6; 42, 13/-; 46, 15/-; 48, 25/-; 50, 25/-; 51, 13/-; 52, 23/-; 53, 16/-; 55, 13/-; 56, 12/-; 57, 14/-; 58, 14/-; 59, 16/-; 71, 11/-; 79, 15/-; 80, 14/-; 81, 21/-; 84/6 24, 14/-; 85, 12/-; 89, 18/6; 2101, 15/-; K55H, 15/-; M49HG, 15/-; M55HG, 15/-.

**RECTIFIERS.** Non B.V.A. Replacement Types, all 14/6 each. Replacements for American 80, 5Y3, 5Z4, Marconi Osram, U50, U10, U12, MU12, Mullard 1W2, 1W3, 1W4, DW2, DW3, Cossor 422BU, 506BU, Brimar R1, R2, R3, Phillips 1821, etc.

**BRITISH VALVES.** B.V.A. Equivalent types most numbers in stock; also Mullard and Mazda Octal types.

**RADIO REPAIR MEN.** We make special arrangements for your valve problems. The fact that you do not see the valve you require listed here does not mean we are without it. We may be able to get it or suggest a suitable alternative.

## — SPARES —

With the exception of Trimming Tools most of the items offered last month are still available. The following lines are also in stock:—

**VOLUME CONTROLS** with switch, 4/9 each. The following values only: 5,000, 10,000, 25,000, 50,000, 100,000 ohms, 1/4 meg., 1/2 meg., 1 meg., 2 meg.

**LINE CORD.** 3 core 60-70 ohm per ft., 4/6 per yd. 100 ohm per ft. 5/- per yd. **STANDARD 110-230,** 360 ohm, 7/6 each.

**SMOOTH CONDENSERS.** 8 mfd., 150 volt working, 2/9 each. 32 mfd. for Phillips. 20-20 for Pilot Maestro.

**H.T. BATTERIES.** 120 volt, 16/6 each. Grid Bias Batteries, 1/61d. each.

**CELLULOSE Cement** for sealing valve bases, speaker cones, etc., 1-pint tin.

**ROLA** 4-in. Speakers with O.P. Transformer, £1.1.6 each.

**BANANA Plugs,** 2/d. each. Sockets, 3d.

**TERMS:** Cash with order or C.O.D. We prefer C.O.D. orders but such orders cannot be accepted for H.M. Forces, etc.

**J. BULL & SONS, Radio House, Melthorne Drive, Ruislip, Middx.**



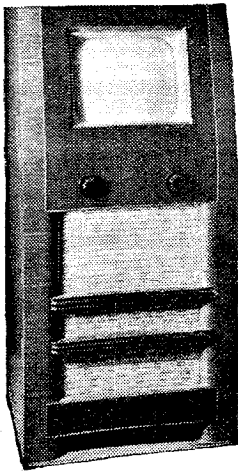

# TELEVISION RECEIVERS

## BAIRD Brand New Model T26

Offered at the cost of parts only!! Every receiver is in perfect working order. Cabinet dimensions 3ft. 4in. high, 20in. wide, 17in. deep. Picture screen size 10in. by 8in. Pick-up sockets are fitted enabling it to be used as a Gramophone Amplifier. Extra loudspeaker sockets. 14 valves. Simple to operate. Only two main controls, one for picture contrast and the other for sound broadcast.

**PRICE £35.10.0**  
Carriage extra.

## ONLY 2 LEFT MURPHY Model A56V

complete in pedestal cabinets (size 18in. x 18in. x 34in. high), with 15 Valves + 3 Rectifiers, Cathode Ray Tube Type CRM91 (picture size 7½in. x 6in.), 10in. M.C. Speaker. Altogether a first-class job such as Murphy always make. This Receiver was designed to receive Television, Sound and Vision, and interested readers should refer to their copy of "Wireless World," dated May 4th, 1939, for illustrated description and full Test Report.

**£28**  
Price, carr. extra

vision, Sound and Vision, and interested readers should refer to their copy of "Wireless World," dated May 4th, 1939, for illustrated description and full Test Report.

### TABLE MICROPHONES



A new hand/table microphone, fitted with the famous ROTHERMEL D104 Microphone insert housed in new metal casing, mounted on heavy stand and base as illustrated, with joint for angle adjustment. 50-80,000 cycles, output level 60 d.b. Price - - - **82/6**

### PUSH-BUTTON CONDENSERS

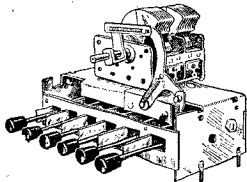

A chance for Experimenters! 0.0005 mfd. 2-gang, 6 push-button Superhet Condensers. Mechanical cam lever type (not trimmer type), easily adjustable, to receive any six stations desired. Excellent workmanship. A product of General Instrument Corp., U.S.A. A real bargain. Price **10/6**

### VARIABLE POTENTIOMETERS

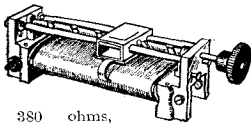

380 ohms, 10 watts. To clear **7/6**

### TELEPHONE HAND-PIECE



Combined Transmitter and Receiver, as illustrated. All in good working order. Price **7/6**

**★ Postage MUST be ★ included with all orders**

Write your name and address in Block Capitals. No orders can be sent C.O.D. Orders cannot be accepted from Eire or Northern Ireland.

**SPECIAL NOTE. All Standard Telephone Transformers are now sold, but we can supply the well-known**

### PHILIPS HIGH VOLTAGE TRANSFORMER

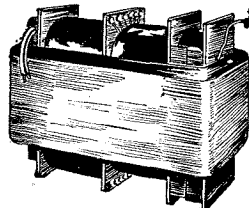

They are robust in construction; weight approx. 13 lb. Dimensions: 5½ x 5½ x 4½in. Specification: 350-0-350 v., 70 m.a. Four tapplings giving 4 v. 3 amps., 6.3 v. 4 amps., 4 v. 0.65 amp. and 4,000 v. at 3 m.a. Input 100/250. Free wiring diagram. Carriage forward. Price **32/6**

### OAK SWITCHES

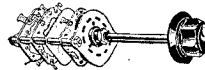

2½in. spindle. Complete with knob:  
4-way, 3-bank ..... **4/6**  
4-way, 2-bank ..... **3/9**

### CELESTION AMPHENOL VALVE HOLDERS

8-pin International Octal

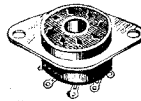

**1/3**

### SPEAKERS

ROLA P.M., new, 10in. M.C. with transformer for power, super power and pentode output. **39/6**

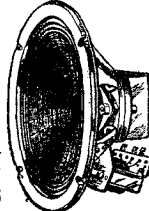

CELESTION 8in. P.M. moving coil, pentode out. New. **25/6**

GOODMANS 8in. P.M. moving coil Universal transformer, suitable for all output valves. **27/6**

### MOVING IRON D.C. VOLT-METERS



A good quality panel mounting meter with clear-reading 2½in. dial. Voltage measurement. Fitted with terminals at back. Price **20/-**

## L-C-R Economy Column

**ELECTRIC SOLDERING IRONS.** 200-250 v. 65/75 watts. **12/6.**

**PHILIPS DIAL LAMPS.** 240v., 15 watts. Miniature screw cap. **1/6.**

**SPEECH COIL RIBBON WIRE.** Enamelled copper. Gauge approx. 20 thou. by 5½ thou. Per 1 lb. reel, **3/-.**

**Manufacturers** are invited to enquire price for quantities.

**YAXLEY TYPE SWITCHES.** Twin bank, 3-way, **3/9.** Single bank, 3-way, **2/6.**

**DOUBLE-THROW PANEL KNIFE SWITCHES,** new. **1/9.**

**MINIATURE ROTARY SWITCH** on porcelain base, **1/3** each.

**SMALL TRICKLE CHARGERS,** Skeleton Type. Metal rectification. Input 200-220 v. A.C. Output 2 v. ½ amp. Reliable and Shockproof. **17/6.**

**SINGLE R.A.F. EARPHONES,** resistance 750 ohms D.C. approx., 4/- each; ex-Govt. low-resistance single earphones, **2/6** each; microphone buttons, well-known make, **2/-** each.

**THREADED BRASS ROD,** 12in. lengths, 2 and 4 B.A., **6d.** per length. **5/6** per doz. **PLAIN** 12in. lengths 2 B.A., **6d.** each. **5/6** per dozen.

**SISTOFLEX.** Big purchase of this fine insulated sleeving, 3 mm., 4 mm., 5 mm., **3d.** each per yd. length, **2/6** doz. yards. 8 mm., **5d.** yd. length, **4/6** doz. yds. 16 mm., **7d.** yd. length, **6/6** doz. yds. Special price for quantities.

**SCREENED WIRE,** 7/026 SWG, rubber covered, **1/9** per yard.

**REACTION CONDENSERS.** Mica spaced. 0.0003 mfd., 2in. spindles. **2/-** each.

**VALVES** are in short supply; stock of Mullard T.S.P. 4's and H.V.R. 2's to be cleared at **17/6** each; first come, first served.

**CONDENSERS.**—Special offer of metal-cased paper condensers, 350 v. working 0.0005+0.1, 1 in. 360 v. working, all brand new and unused 2 mfd., **2/6**, 1 mfd. x 1 mfd. **2/-**, 1 mfd. **2/-.**

**VARIABLE CONDENSERS.**—Ceramic mountings. Well-made heavy 2-gang superhet condensers, die cast frames in first class condition. 0.0005, **6/9.**

**DECORATIVE CABINET GRILLES,** 4-bar 14½in. x 1½in. wide. Solid brass chrome plated. **2/6** each. Heavier quality, **3/6.** Also Rectangular Speaker Grilles, 7½in. x 5½in. **1/6.**

**PHILIPS HIGH VOLTAGE CONDENSERS.**—0.1 mfd. 5,000 v. D.C. working. **10/6** each.

**TRIMMERS.**—Twin trimmers on ceramic base, brand new; to clear, **6d.** each; **5/-** doz.

**TUBULAR WIRE-END CONDENSERS.** brand new first quality components, 0.0003 mfd., **7d.**; 0.005 mfd., **7d.**; 0.01 mfd., **10d.**; 0.1 mfd., **1/-** each.

**ELECTROLYTIC TUBULAR CONDENSERS,** 25 mfd., 12 v.; 25 mfd., 25 v.; 50 mfd., 25 v.; 50 mfd., 12 v., **2/-** each. 0.5 mfd., 350 v. D.C. working, **2/-** each.

**CHASSIS.**—Beautifully finished, new cadmium-plated Chassis. Superbly made. 12in. x 8½in. x 3in. Drilled for 5 valves, transformer, etc., **4/-** each. Also heavy gauge metal Chassis, plated as above, 12 in. x 5½in. x 2½in., **1/3** each. All drilled for valves, etc.

**PUSH-PULL INPUT TRANSFORMERS,** by well-known maker, nickel iron core, in metal case, size 2in. x 1½in. x 1½in. high, ratio 5:1. Price **6/6.**

**OUTPUT TRANSFORMERS,** primary 300 ohms D.C., secondary 0.5 ohm D.C., brand new, manufacturer's type, **5/6**; also new chokes, 30 henrys. 150 ohms, **5/-** each.

**ELECTRO-MAGNETIC COUNTERS,** resistance 500 ohms, from 1-12,999, size 4½in. x 2in. x 1½in., ex-G.P.O., invaluable for countless purposes, **9/6** each, a smaller type, 1-1,999, size 4½in. x 1½in. x 1½in., **5/6.**

**RELAYS.**—Small relays for operation on 2 v. D.C. with 6-way make and break switches. New, **5/-.**

**FLEXIBLE DRIVES,** well made, shielded cable drives for remote control, ideal for radiogramophones, approx. 2ft. long; to clear, **4/-** each.

**MOVING COIL METERS.**—A large selection of Ferranti and other well-known makes are offered to CALLERS ONLY.

**BULGIN HIGH VOLTAGE ANODE VALVE CAPS.** **9d.** each.

**ASSORTED RESISTORS.** **3/6** per dozen.

**COIL FORMERS,** paxolin, assorted sizes, useful for experimenters. **2/9** doz.

**WIREWOUND POTENTIOMETERS.** Without switch, 1 ohm, 800 and 2,000 ohms, **3/6** each.

**MIDGET VOLUME CONTROLS,** 5,000 ohms, **3/6** each. Also ½-meg., **4/6.**

**WIREWOUND VOLUME CONTROLS.** 50,000 ohm with double switch, 1½in. spindle, **6/6.**

**CARBON VOLUME CONTROLS.** 500,000 ohm with switch, 1½in. spindle, **5/6.**

**VOLUME CONTROLS.**—Without switch, 1 meg., 1½in. spindle; ½ meg., ½in. spindle; ¼ meg., 3in. spindle, **4/6** each.

See previous issues for other stock lines.

# LONDON CENTRAL RADIO STORES

23, LISLE STREET, GERrard 2969 LONDON, W.C.2

# We're looking for trouble

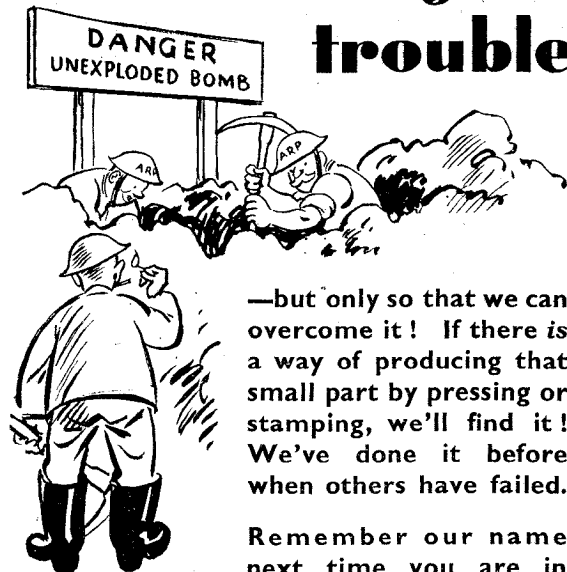

—but only so that we can overcome it! If there is a way of producing that small part by pressing or stamping, we'll find it! We've done it before when others have failed.

Remember our name next time you are in difficulties.

**F. Dowler & Sons**  
ASTON BIRMINGHAM

From Footlights ..... to Factory

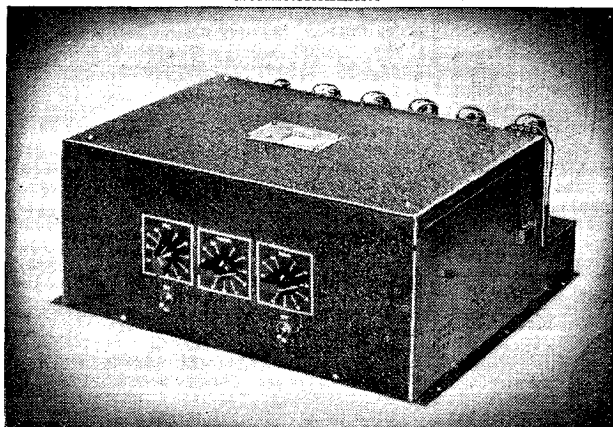

they all trust

In town tonight—at famous theatres and fashionable restaurants you will find Trix Sound Equipment. Like the war workers in the great factories, they all trust the reliability of Trix.

Amplifier (illustrated), Model T.633, Undistorted output 30 watts. Suitable for audiences of up to several thousand people.

TRIX ELECTRICAL CO. LTD.  
65, Bolsover St., London, W.1.

Phone: EUS 5471/2. Grams: Trixradio, Wesdo, London.

**TRIX**  
Quality  
**SOUND**  
Equipment

AVAILABLE FOR PRIORITY WORK

## M.R. SUPPLIES

offer from stock the following brand new **INDUSTRIAL** and **ELECTRO-TECHNICAL EQUIPMENT**, for which early application is essential. All prices nett cash.

**TOGGLE PRESSES** (by Standard Telephones). Quick-acting and accurate bench model exerting 1½ tons pressure. Height 32in., weight 130 lbs. Many advantages over fly press—space saving, rapidity, ease of operation. A further small supply for immediate delivery from stock. Details on request, £30 nett, carriage forward.

**SMALL GEARED MOTORS**, constant speed induction, 200/250v. A.C. In metal housing 4½in. dia., silent running and precision made, with flex and plug. Very useful in research depts., etc., for recording instruments, operation timing and switching. Model "A" (high torque) final speed 3 r.p.m., 42/-. Model "B" (low torque) final speed infinitely variable from 1 to 6 r.p.m., 32/6.

**RELAYS**, new compact model with powerful electro-magnetic action, operating from 4 to 12 v. D.C. and useful for L.T. switching and emergency lighting control. In 2in. by 1in. metal housing, 8/6. (Capacity, 6 amps.). Large range of Lontex Relays in stock, 200/250v. A.C. coils, with mercury switches of various capacities and duties.

**MERCURY SWITCHES**, S.P.C.O., tube 2in. long, with bead-insulated leads, capacity 6 amps., 4/9.

**SLIDING RHEOSTATS**. Most useful range of well-made instruments. Fully enclosed with bushed cable entry and laminated brush contacts. Overall length 7in., 100 watts capacity, following range: 4 ohms 5 amps., 10 ohms 3 amps., 50 ohms 1.5 amp., 100 ohms 1 amp., 200 ohms 0.7 amp., and 400 ohms 0.5 amp. Any one 21/-. Other ratings made up to order within 14 days, only against Government contracts.

**NEON TESTERS** (150/400v. A.C./D.C.). Handy pocket model for testing polarity, continuity, leakages and type of current, 12/6.

**ROTHERMEL-BRUSH PIEZO-CRYSTAL MICROPHONES**. Continuation of our very popular offer of these well-housed, knuckle-jointed, high-fidelity microphones. Response level to 8,000 c/s. Output level—60 db. Fitted 6ft. screened lead, 72/6. **FLOOR STANDS** to suit, plated collapsible type extending to 5ft. 6in. and collapsing to 2ft. for transport, quite rigid when erected, 37/6.

**INDUSTRIAL LOUDSPEAKERS** (G.E.C.). Opportunity ex stock. New senior model, handling 8/10 watts, in 10½in. grey metal drum with front and rear grilles and mounting brackets. Fitted multi-transformer, 75/- (pkg. and carr. 2/6). Also 6-watt model in 9in. drum, with multi-transformer, 45/-.

**ELECTRIC SOLDERING IRONS** (S.T.C.). All voltages, 100/110, 200/220 and 230/250v. 75 watt with ¼in. pointed bit, 21/-. (Spare elements—all voltages, 6/-, spare right-angle hatchet bits, 2/-). Also same make with massive flat bit, 150 watts, 32/6. We quote special prices for minimum half-dozen lots.

**RESIN-CORED SOLDER**, by prominent cable firm, 13 swg. highest tin content available. On 1 lb. reels. 40 per cent. tin, 4/6 reel, 65 per cent. tin, 5/11 reel. Opportunity.

**PHOTO-ELECTRIC CELLS**. Visitron type 79-A. Average 80 microamps per lumen. 90 volts operating, caesium. Please note size:—Bulb 2½in. dia., overall length 4in. Brand new, 59/6.

**VOLTAGE CHANGING TRANSFORMERS**. Fully shielded, with sunk-terminal blocks. 100/110 to 200/250v. (and vice versa), 75 watt, 22/6. 120 watt, 29/6.

**STEP-DOWN MAINS TRANSFORMERS**, 200/250v. to 7, 11 and 18v. at 1.5 amp. Suitable for chargers, models, lighting, etc., 14/6.

The following are offered strictly to **CALLERS ONLY**.

**ALL-STEEL TOOL OR AMPLIFIER RACKS**. Height 30in., with three strong trays each 16in. by 16in., sprayed black, 27/6.

**G.E.C. PROJECTOR P.A. SPEAKERS**, with 10 watt P.M. unit and 42in. metal horn, brand new, £11 5s., complete.

**AMPLIFIERS** (A.C. operation) in chassis form, 15 and 30 watt models. Details per 'phone.

Please include sufficient for packing and postage where not stated.

**M.R. SUPPLIES, 68, New Oxford St., London, W.C.1**

(\*Phone: MUSEum 2958)

# CO-AX CABLES

FOR HIGH FREQUENCIES

*Unequalled*

In performance \* range of characteristics \*

**AIR-Insulated**  
and flexible

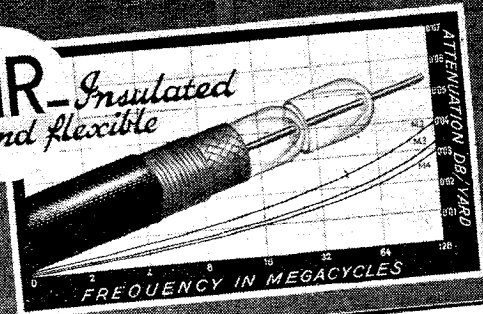

**CO-AX Valve Connectors**  
Very low and constant capacity.

**TELEQUIPMENT CO.**  
16, THE HIGHWAY, BEACONSFIELD, BUCKS.

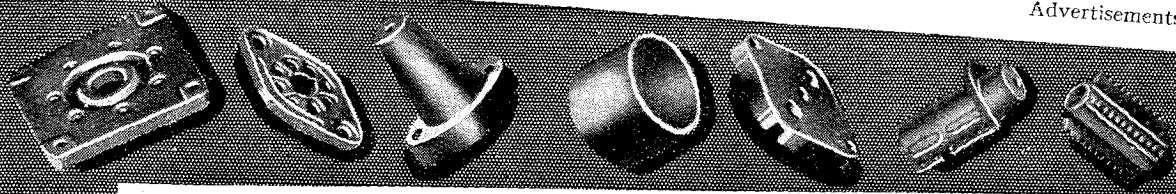

*Going one better*

**IN COMMUNICATIONS**



To-day, wherever Bullers Low Loss Ceramics are used, reception is clearer and better than ever before.

Years of research in Bullers Laboratories have developed these materials to such a high level of efficiency that Dielectric Loss is virtually eliminated. Bullers Ceramics are now playing a vital part in maintaining communications under all conditions.

**Made  
in Three  
Principal  
Materials**

**FREQUELEX.** An Insulating material of Low Dielectric Loss. For Coil Formers, Aerial Insulators, Valve Holders, etc.

**PERMALEX.** A High Permittivity Material. For the construction of Condensers of the smallest possible dimensions.

**TEMPLEX.** A Condenser material of medium permittivity. For the construction of Condensers having a constant capacity at all temperatures.

**BULLERS LIMITED**  
THE HALL, OATLANDS DRIVE, WEYBRIDGE, SURREY  
Telephone: Walton-on-Thames 2451  
Manchester Office: 196 Deansgate, Manchester.

**Bullers**

**LOW LOSS CERAMICS**

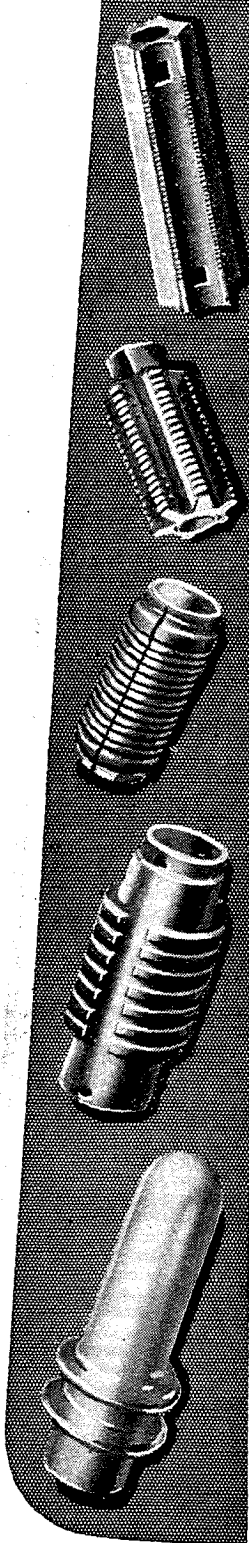



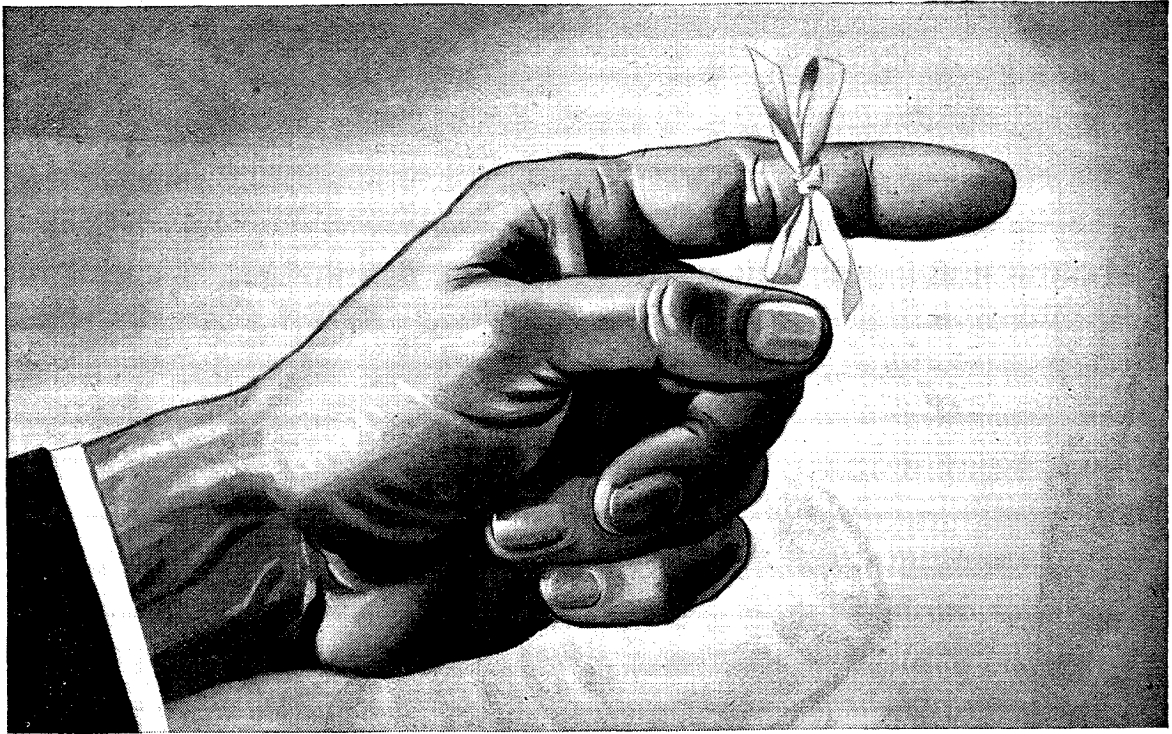

## Remember to Forget

A WISE man subjects his knowledge and experience to a continual process of pruning—cutting away the dead wood of out-worn concepts and methods—making his mind receptive to fresh ideas.

He will find a kindred spirit in The Simmonds Organization whose many products have revolutionized design and manufacture in a number of widely separated industries, enhancing output and reducing man hours.

# S I M M O N D S

THE SIMMONDS "SIA" NUT  
SIMMONDS-CORSEY CONTROLS  
SIMMONDS CONTENTS GAUGES  
FOR AIRCRAFT.  
SIMMONDS POSITION INDICATORS  
SIMMONDS ELECTRIC TEMPERATURE  
AND PRESSURE GAUGES  
SIMMONDS AIRCRAFT FLOORING



SPIRE "SIA" NUTS  
FRAM OIL & ENGINE CLEANER  
SIMMONDS INDUSTRIAL AND  
MARINE CONTENTS GAUGES  
SIMMONDS JOINTING COMPOUND  
SIMMONDS CRYSTAL UNITS  
SIMMONDS-GOUDIME  
NAVIGATIONAL INSTRUMENTS

**SIMMONDS AEROCESSORIES LTD**

A COMPANY OF THE SIMMONDS GROUP  
LONDON · MELBOURNE · PARIS · NEW YORK.

P.10.

ALL ENQUIRIES TO GREAT WEST ROAD, LONDON.

# Wireless World

Radio • Electronics • Electro-Acoustics

32nd YEAR OF PUBLICATION

NOVEMBER 1942

Proprietors :  
ILIFFE & SONS LTD.

Managing Editor :  
HUGH S. POCOCK,  
M.I.E.E.

Editor :  
H. F. SMITH.

Editorial, Advertising  
and Publishing Offices :  
DORSET HOUSE,  
STAMFORD STREET,  
LONDON, S.E.1.

Telephone:  
Waterloo 3333 (35 lines).  
Telegrams:  
"Ethaworld, Sedist, London."

△

**PUBLISHED  
MONTHLY**

Price : 1/3

(Publication date 20th  
of preceding month)

Subscription Rate  
Home and Abroad  
17/- per annum.

EDITORIAL .....	249
OVERHAULING MOVING-COIL METERS. By "Tiffey" .....	250
ULTRA-SHORT-WAVE DIFFRACTION .....	252
"WIRELESS WORLD" BRAINS TRUST .....	253
RADIO DATA CHARTS.—No. 2: Effect of a Screen- ing Can on the Inductance and Resistance of a Coil. By J. McG. Sowerby, B.A., Grad.I.E.E. ....	254
HOME-MADE PICK-UP. By John Brierley .....	258
PHYSICAL FOUNDATIONS OF RADIO.—III: Hot Cathode Emission (Metallic). By Martin Johnson, D.Sc. ....	259
INSTRUMENTS.—VII: Valve Testers. By W. H. Cazaly .....	262
MULTIVIBRATOR ACTION. By Edward Hughes, D.Sc., M.I.E.E. ....	266
WORLD OF WIRELESS .....	268
LETTERS TO THE EDITOR .....	271
RANDOM RADIATIONS. By "Diallist" .....	272
UNBIASED. By Free Grid .....	274
RECENT INVENTIONS .....	275

Branch Offices :

COVENTRY:  
8-10, Corporation Street.  
Telephone: Coventry 5210.  
Telegrams: "Autocar, Coventry."

BIRMINGHAM:  
Guildhall Buildings,  
Navigation Street, 2.  
Telephone:  
Midland 2971 (5 lines).  
Telegrams:  
"Autopress, Birmingham."

MANCHESTER:  
260, Deansgate, 3.  
Telephone:  
Blackfriars 4412 (4 lines).  
Telegrams:  
"Iliffe, Manchester."

GLASGOW:  
26B, Renfield Street, C.2.  
Telephone: Central 4857.  
Telegrams: "Iliffe, Glasgow."

△

*As many of the circuits and  
apparatus described in these  
pages are covered by patents,  
readers are advised before  
making use of them, to satisfy  
themselves that they would  
not be infringing patents.*

*Exclusive features*

of the  
**'STRATOSIL'**  
series of  
**SEALED  
VIBRATORS**  
for use at all altitudes

- 1 All steel construction—even to the rivets—ensuring uniform expansion under extremes of temperature.
- 2 Reed driving coil—wound on a bakelite moulded bobbin to meet all climatic conditions.
- 3 Metal can, sponge rubber lined—Acoustically and electrically shielding the Vibrator.
- 4 Driving contact of non-tarnishable precious metal—ensuring starting under the lightest of pressures and voltages.
- 5 Contacts ground almost to optical limits.
- 6 Stack assembly. Mica and steel only are used.
- 7 International Octal base sealed by the WEARITE STRATOSIL process.

*Embodying "Oak Manufacturing Co.'s"  
patent's 400470, etc.*

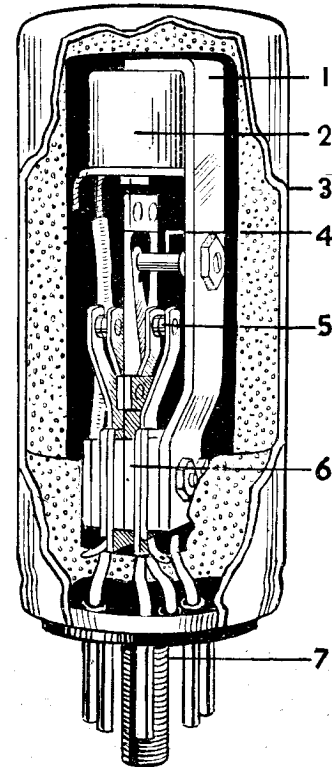

**WRIGHT & WEAIRE LTD.**

HIGH ROAD, TOTTENHAM, N.17. Telephones: TOTTENHAM 3847-8-9

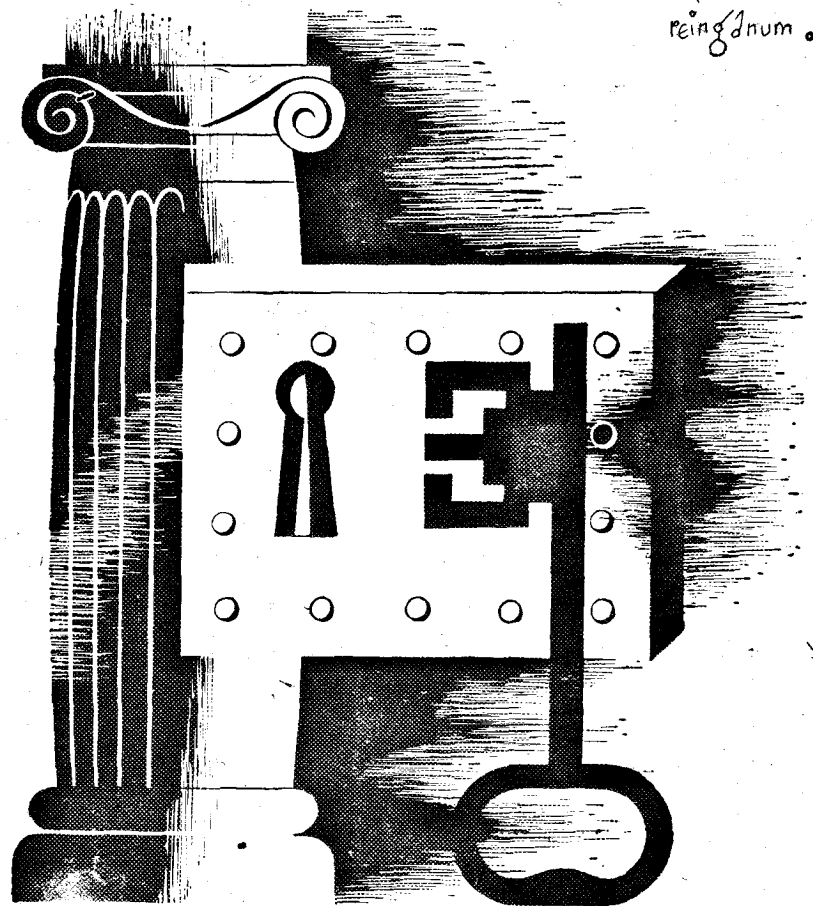

## INTEGRITY

*“To make electricity the still more ubiquitous and efficient servant of man; to devise and create new products and processes to that end . . . and by building with the determination to make performance live up to promise, Philips have striven always to keep faith with the public they serve.”*

# PHILIPS



LAMPS • DISCHARGE LIGHTING • RADIO RECEIVERS • TRANSMITTERS • VALVES & THERMIONIC DEVICES • MEDICAL & INDUSTRIAL X-RAY & ELECTRO-MEDICAL EQUIPMENT • ARC WELDING EQUIPMENT & ELECTRODES • LIGHT ALLOY RESISTANCE WELDING PLANT • MAGNETIC OIL FILTERS • MAGNETS • SOUND AMPLIFYING INSTALLATIONS



# Wireless World

Radio • Electronics • Electro-Acoustics

Vol. XLVIII. No. 11

NOVEMBER 1942

Price 1s. 3d.

## Our Brains Trust

### *Stimulating Constructive Thought*

WHEN we started the *Wireless World* "Brains Trust" (acknowledgments for the title to the B.B.C., and, going back farther, to President Roosevelt's "New Dealers") it was hoped that the feature might eventually grow into a forum where all controversial matters within our scope might be usefully discussed by acknowledged experts, each working in his own particular field. Fallacies that have gained wide credence might be corrected, and constructive thinking might be stimulated in many directions. This journal is fortunate in being able to call upon the services of specialists in many fields, and there were no misgivings as to whether answers well worth while recording would be forthcoming to any reasonable question.

It was decided that the ideal type of question should deal with matters that are within the knowledge, or at any rate, have come under the observation of practically all readers, but preferably with subjects on which few have given deep thought or have much precise and specialised knowledge. Technical subjects of a kind that are best described as text-book material were ruled out, as were all highly specialised questions that would interest only a strictly limited circle of readers. Another subject with which few readers would wish us to deal is the make-up of broadcast programmes, although a possible exception to this rule might exist with regard to fundamental questions touching the basic principles of utilising the medium of broadcasting.

So far, the tendency has been for questions published to be confined to severely technical topics, but there are indications that many readers consider that "Brains Trust" is a section of the journal that might well deal on occasion with such political, commercial, economic or even sociological problems that especially affect the lives and work of those concerned with wireless. With this view we are in agreement, and questions of this nature will certainly be considered.

Perhaps the best of all "Brains Trust" questions will prove to be on those subjects relating to his work on which a wireless man might devote thought during his spare time—on subjects sufficiently divorced from his daily tasks to afford real relaxation. One of the most desirable attributes of a question is that it should stimulate thought, and occasions will arise when each reader will himself have to find the answer that satisfies him best. Under present conditions, shortage of space will sometimes make it impossible to present all possible shades of opinion on highly controversial subjects, and, indeed, attempts to do so might in the end become wearisome.

#### *Invitation to Readers*

The time has now come when questions from readers may be definitely invited. Already a large number have been submitted, but, if a criticism may be allowed, the great majority are of so specialised a nature to be of interest only to the questioner—or at best, to comparatively few readers. Those who propose to submit questions are asked to frame them in conformity with the general principles set out in the preceding paragraphs. In the interests of national economy—which includes the ever-present need for saving paper—readers are asked to forgo the usual acknowledgment of their questions, and not to expect us to enter into correspondence concerning them.

Finally it may be pointed out that the success of our "Brains Trust" will ultimately depend on the quality of the questions asked by readers themselves. The question is more than half the battle: a good one can hardly fail to evoke a good answer. Given the co-operation of readers, the new section of the journal will, we hope, do something more than contribute to their entertainment; it should make at least some contribution to the progress of the wireless art.

## Overhauling

## MOVING-COIL METERS

THE moving-coil milli- or micro-ammeter is used as the basic indicating instrument in the large majority of multi-range meters. It is a comparatively simple piece of mechanism and well worth a little careful attention to keep it working in these times when meters of all kinds are at a premium. To reassure those who have not before attempted the repair or cleaning of a MC meter, it may be said at once that the chief difficulties arise in the process of calibration or construction of shunts, multipliers, current transformers, and such accessories; the meter itself demands only patience, good eyesight, and steady fingers for its renovation.

Fig. 1 shows the construction of a fairly typical moving-coil milliammeter. The majority are of this screwed-together type, with pole pieces carrying the movement structure. A few may be met with, however, in which the bearing structures—pillars, bridging pieces, etc.—are mounted directly on the magnet, the pole faces of which are made concave. Occasionally, too, it is found that a movement is merely "stuck together" with shellac, instead of being built up with bolted parts; this type is difficult to repair because the proximity of the hot iron needed to melt the shellac in one part softens the rest of the structure. The tools needed for overhauling and minor repairs to meters are as follow:—

A really small plain soldering iron. This can be easily made from an inch or so of 10 SWG copper wire fixed to a stiff iron wire handle, and can be heated over a small gas Bunsen flame or spirit lamp. The "pencil" bit, or added small extension bit of an ordinary electric iron is not satisfactory, as it does not get hot enough.

Finely pointed tweezers; small, long-nosed pliers; a set of small watchmakers' screwdrivers; very small box spanners to deal with 8 and 10 BA nuts. These, save for the pliers, are fairly easily constructed out of odds and ends of steel by the handyman of average skill if they cannot be bought nowadays.

A watchmaker's eye-glass; a small camel-hair artist's brush; a few sticks of pith or very soft wood; a lump of Plasticine; a simple mask for the nose and mouth to keep the breath diverted when dealing with delicate moving parts; a strong pencil-beam spotlight—sunlight reflected from a mirror is best of all.

## Procedure for Carrying Out a Delicate Operation

By "TIFFEY"

These are all the tools required. All work on meters should be done on a clean, firm table with plenty of elbow room, and the work in hand should be done over a clean sheet of white paper. The ordinary work-bench is not really suitable. It is bound to be covered with very minute iron dust particles, and these have a knack of positively floating through the air to the magnetic pole faces, where they may ruin a movement that has taken a long time to set up nicely.

### Common Defects

The things that normally require either minor repair or adjustment in an old or misused meter are more or less as follow—of course, such tricky major repairs as rewinding open-circuited coils, fitting new pivots or spring ligaments, are really only suitable for handling by skilled professionals. The cleanliness of the jewel or steel pivot cups, and the pivot points; their accurate adjustment for tightness; the alignment of the bear-

ing structure so that the coil moves centrally round the gap between the iron core and the wall of the pole faces; the levelling of a damaged or warped spring ligament; the adjustment of zero controls; the replacement or straightening of a bent or damaged pointer; the balancing of the pointer—these can be attended to by a patient, unhurried and steady fingered amateur with a little common sense.

The first thing to do is to free the meter itself from all its attachments to the accessories and lift it out on to the clean sheet of white paper. It is probable that the magnet can now be separated from the soft iron pole pieces carrying the bearing structures; either there will be some simple bolt arrangement holding the magnet, or it may be so constructed as to grip the pole pieces by pressure and can be cautiously eased off them. When the magnet is removed it is very important that a keeper should at once be placed across the poles, and that it should not be subjected to a violent jar or blow; rough treatment can bring about disastrous results to the sensitivity of the meter. A keeper is simply any piece of iron that will complete the magnetic circuit.

What is done next depends on the nature of the defect in the meter. It is assumed that previous tests have determined that the coil is not open-circuited, and that the fault does not lie in the accessories, such as the

shunts, multipliers, current transformers, rectifiers, switches, etc. It is probable, in that case, that the defect in the movement shows itself by "stickiness" of movement of the pointer over the scale—it seems to stick at certain points, especially at the ends of the scale. It may be difficult to set at zero, or it may not hold its zero adjustment for

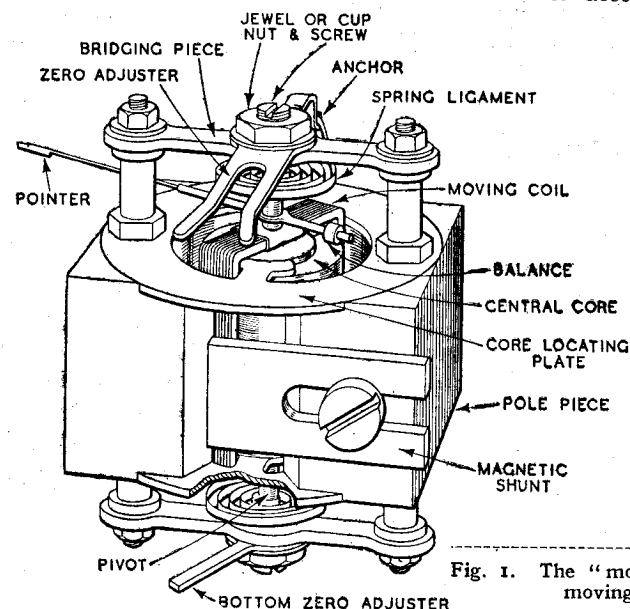

Fig. 1. The "movement" of a typical moving-coil meter.

long. The indications, too, may be erratic—it does not give the same reading twice running for the same voltage or current it is measuring.

Whatever it is, a defect of this nature demands the dismantling of the movement structure, its cleaning, and its reassembly. The first step in this is to unsolder the spring ligaments from the anchor points, which are on the zero adjusters at the top and bottom. For this, the little soldering-iron must be well heated and tinned and just touched to the points for long enough for the spring ligaments to fall away. This must be done *quickly* and steadily. The iron must be hotter than is usual in order to minimise the time it is held to the anchoring point. The spring ligaments are made of phosphor bronze or some such non-magnetic metal, and their temper is obtained by the rolling process, and is quickly destroyed by heat.

Next, the small box-spanners can be used to loosen the nuts holding down the bridging pieces. It is advisable to have ready a few rectangular wood blocks on which to rest the pole pieces, to avoid the weight coming on to the lower pivots when the structure is loosened. When the nuts have been removed, the tweezers can be used to separate the various bits and pieces, and the eye-glass will give a better vision to avoid damage. The ligaments should not be removed from the pivots, or the pivots detached from the coil and former; they are difficult to replace. Usually, it will be found that, once the bridging pieces have been removed, the whole structure separates quite easily, and the coil and iron core can be taken out of the gap. The current is conveyed to the coil through the spring ligaments, which are in contact with the anchor points, which are held to the bridging pieces by the jewel or cup nuts, and the bridging pieces are, therefore, insulated from the pillars by tiny insulating washers which should not be lost.

### Methods of Cleaning

The parts can now be cleaned by brushing with the camel-hair brush. No spirit or liquid must be used for the cleaning. To remove any traces of iron dust, Plasticine can be pressed on to the concave pole faces and over the iron core. The jewel or cup is cleaned by twirling a point of pith into it, and the pivot point by being stuck into pith a few times.

Now comes the touchiest part, the reassembling of the structure. The first thing is to loosen the jewel nuts and unscrew the jewel or cup screws one or

two turns in order to make quite sure that, when the bridging pieces are put back, undue pressure is not put on the pivot points. Reassembly is a matter of common sense, but the utmost care must be taken to avoid excessive pressure on the pivot points. Adjusting them is quite a tricky and delicate piece of work, since both the nut and the screw holding the cup or jewel must be exactly right. A useful tool is a hollow box spanner down the inside of which may be passed a screw-driver, so that both the nut and the screw are under control. The idea is to have the pivot point fitting into the cup so that, while there is not a trace of friction, there is also no lateral play. It is also very important that the coil should move parallel with the inner concave faces of the pole pieces and be exactly midway at all times between the iron core and these inner pole piece faces. Never move the pointer with the fingers; to test the movement, it should be either gently blown round or pushed round with the camel-hair brush. It must be remembered that an apparently trivial strain on the pivot points may do serious damage.

### Refitting the Ligaments

When soldering the ligaments back to the anchor points, the process should be done in stages as follows: First, the top zero adjuster is set at right angles to the bridging piece; then the top ligament is soldered to the anchor point on this zero adjuster, regardless of the resulting position taken up by the pointer; next, the bottom zero adjuster is moved so that its anchor point is exactly in position to make contact with the free end of the bottom ligament—it does not matter whether this zero adjuster is at right angles to the bridging piece or not; then the bottom ligament is fixed by a touch of the soldering-iron to the anchor point. If this is done, it will be found that the pointer can be brought *approximately* to the zero mark on the meter scale by moving the *bottom* zero adjuster. The top zero adjuster should not be moved; it remains at right angles to the bridging piece until the meter is put back into its case, when the external zero adjuster screw engages with the slot in the top zero adjuster.

The pointer of a meter is normally made of aluminium, either as a channelled strip or as a slender tube. If bent, it can be straightened, using care not to put much strain on the pivots. It will usually be found to be stuck on with shellac or, if a tube, slipped over a stub. It is possible to construct

these thin aluminium tubes out of the foil from old electrolytic condensers—if one has a draw-plate. The difficulty is to make the draw-plate without suitable drills. The author, however, has discovered—the thing was probably old in Faraday's time!—that excellent pointers can be made from naturally dead and dried grass stalks. Gathered in the autumn, nothing is left of them but a thin, tubular shell of cellulose fibre, very light and strong and easily dyed black with Indian ink. These "natural" pointers, being tubes, can be slipped over the stub at the coil, or stuck with shellac. They do not appear to be affected by humidity, and although it is difficult to obtain them absolutely dead straight in lengths of more than a few inches, in the short lengths needed for pointers their curvature is negligible.

When the movement has been thus reassembled and the magnet replaced, the movement can be finally checked for perfection of motion. This is done electrically. Either the existing scale, or a temporary blank one, is fixed so that the position of the pointer can be accurately marked. Then the meter is connected in a circuit as given in Fig. 2. The pointer is brought accurately to the zero mark on the scale, with no current flowing, by the top zero adjuster. Then the circuit is closed and the current *slowly* increased until the first unity mark on the scale of the *standard* meter is reached. This must be done slowly and with the pointer *always moving in the same direction*—if the mark is passed, it is no good decreasing the current to come back to it; this vitiates the test

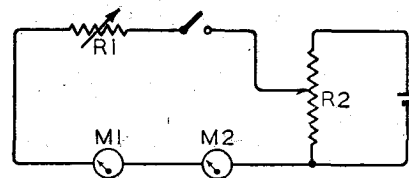

Fig. 2. Circuit for testing the movement of a milliammeter. M1 is a standard meter; M2 the meter under test. R1 provides fine control of current and R2 is the coarse control.

When the pointer of the standard meter, then, stands at the first unity mark, the position of the pointer on the scale of the *test* meter is marked accurately with a pencil dot. It does not matter whether it reads exactly the same as the standard or not. Then the current is increased until the next unity mark is reached on the standard meter, and again the corresponding position of the test meter pointer marked with a dot on the scale. This is continued until full-scale deflection



**Moving-coil Meters—**

of the test meter is reached. There will now be a line of dots on the test meter scale. Next, the current is slowly *decreased*, again stopping as each unity point on the standard meter is reached. If the test meter movement is good its pointer should stop, with that of the standard meter, exactly at the dots that mark its stopping places on the "way up" the scale. If, however, it does not stop at the same places on the way down, its movement is untrustworthy and

must be re-examined mechanically. This test is purely of the movement alone, although it may be combined with calibration in some cases.

While the movement is still exposed and a scale is fitted, it is possible to balance the pointer. Since the pointer has some weight, its position both at zero and on the rest of the scale, while giving indications, will be affected by the position of the whole meter; i.e., it may give one reading while the meter is lying on its back and another when the meter is vertical. This is

avoided by a counterweight on the stub on the coil in the opposite direction to the stub carrying the pointer. This small counterweight may consist of a metal tube that can be slid along the stub, or of a small knurled nut that can be adjusted by screwing along the stub. Balance—i.e., a condition in which the pointer always returns to zero, no matter what the position of the meter as a whole—is secured by trial adjustments of the counterweight along its stub. This balancing should be done, of course, before calibration.

## Ultra-Short-Wave Diffraction —

### —and the Earth's Curvature

RADIO waves produced by simple dipole aerials are linearly polarised, that is to say, the "strain" or "force" in the electric and magnetic fields of which they are composed is in a constant direction, the strain in the electric field being at right angles to that in the magnetic field. In order to define the direction of polarisation the direction of the *electric* strain is always referred to. Thus a horizontally polarised wave, such as would be produced by a horizontal dipole, is a linearly polarised wave in which the

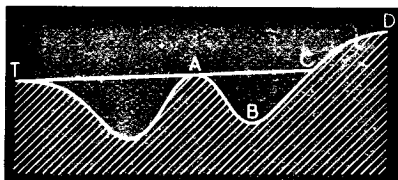

[Courtesy *Nature*

Fig. 1. Section of the terrain over which the experiments were conducted.

direction of strain in the electric field is horizontal. Similarly, a vertically polarised wave, such as a vertical dipole would produce, is one in which the direction of strain in the electric field is vertical.

It has for some time been known, and has been pointed out by McPetrie and Saxton<sup>(1)</sup> that ultra-short waves which are vertically polarised provide much stronger fields in the shadow of hills than do horizontally polarised waves. These investigators have recently observed some further effects in this connection, which they describe in a recent letter to *Nature*<sup>(2)</sup>.

Fig. 1, which is taken from this letter, represents the terrain over which they obtained the results described. T represents the transmitter situated at the top of a ridge from which horizontally and vertically polarised waves were sent out on a wavelength of 3 metres. Over the

region ABC, which is within the shadow of the hill A, the vertical field was greater than the horizontal field, the ratio of vertical to horizontal fields being least at A and C and greatest at B. A table showing the field strengths in  $\mu\text{V}/\text{m}$  for both vertically and horizontally polarised waves for position A, B and C—as well as for a number of intervening points—is given, and this is continued for a number of points over the region CD. Over this region, which is outside the shadow cast by hill A, horizontal polarisation gave the strongest field.

Similar results would be expected in transmitting over a relatively great distance with a flat terrain, where the obstruction caused by hill A was replaced by that due to the earth's curvature. At all receiver positions

within the shadow cast by the earth's curvature, vertically polarised waves would provide the greatest field, but an elevated receiver located above them so as to be within the optical path would be better served by horizontally polarised waves. It is also stated that in practice horizontal polarisation may be better even at ground level and within the optical path where there is tree-clad country, because at ultra-short wavelengths greater attenuation is caused by trees to vertically than to horizontally polarised waves.

These results will probably be of significance in connection with various ultra-short-wave developments which we may expect to see in the post-war world. Among these may be mentioned the establishment of a television service on a nation-wide basis, and the use of radio guidance for aircraft.

T. W. B.

### BOOKS ON WIRELESS

Issued in conjunction with "Wireless World"

	Net Price	By Post
"FOUNDATIONS OF WIRELESS," by A. L. M. Sowerby, M.Sc. Third Edition revised by M. G. Scroggie, B.Sc., A.M.I.E.E. ... ..	6/-	6/4
"RADIO LABORATORY HANDBOOK," by M. G. Scroggie, B.Sc., A.M.I.E.E. Second Edition Revised and Enlarged ...	12/6	12/11
"WIRELESS SERVICING MANUAL," by W. T. Cocking, A.M.I.E.E. Sixth Edition Revised and Enlarged ... ..	7/6	7/10
"HANDBOOK OF TECHNICAL INSTRUCTION FOR WIRELESS TELEGRAPHISTS," by H. M. Dowsett, M.I.E.E., F.Inst.P., M.Inst.R.E., and L. E. Q. Walker, A.R.C.S. Seventh Edition ... ..	27/6	28/3
"WIRELESS DIRECTION FINDING," by R. Keen, B.Eng. Hons. Sheffield, A.M.I.E.E. Third Edition ... ..	27/6	28/3
"RADIO DATA CHARTS," by R. T. Beatty, M.A., B.E., D.Sc. Second Edition Revised ... ..	6/-	6/3
"TELEVISION RECEIVING EQUIPMENT," by W. T. Cocking, A.M.I.E.E. ... ..	8/6	9/-
"RADIO INTERFERENCE SUPPRESSION," by Gordon W. Ingram, B.Sc. ... ..	5/-	5/4
"LEARNING MORSE," Tenth Edition. 285th thousand ... ..	6d.	7½d.
"RADIO DESIGNER'S HANDBOOK," Edited by F. Langford Smith, B.Sc., B.E. ... ..	10/6	11/1
"INTRODUCTION TO VALVES," by F. E. Henderson, A.M.I.E.E. ... ..	4/6	4/9
"WIRELESS WORLD" DIARY and Reference Book ... ..	3/1	3/2½

(including Purchase Tax)

Obtainable from Leading Booksellers or by post from

LIFFE & SONS LTD., Dorset House, Stamford Street, London, S.E.1

(1) J. S. McPetrie, J. A. Saxton, *Nature*, Oct. 7th, 1939  
 (2) J. S. McPetrie, J. A. Saxton, *Nature*, Sept. 5th, 1942

## Wireless World Brains Trust—No. 5

# More Views on Interplanetary Communication

**"CATHODE RAY," in a postscript to his letter which is printed on page 271, writes:—**

I, my capacity of Member of the Wireless World Brains Trust, and referring to the question of whether there are any inexplicable radiations reaching us from outer space, I recall that in 1933 Karl Jansky reported in *Proc. I.R.E.*, as a result of at least a year's experiments, that he obtained continuous reception of radio waves from a certain stellar region. So far as I know, this matter has never been cleared up.

**ARTHUR C. CLARKE, Hon. Treasurer of the British Interplanetary Society, adds a note:—**

THE fantastic figure of six million kW, quoted as necessary to produce a 5 microvolt/metre field on the nearest planet, presumably relates to spherical radiation, which no one for a moment considers. The use of beam technique would reduce power requirements to a minute fraction of this. Moreover, there seems very good evidence that radio waves from comparatively low-powered transmitters have travelled distances which are almost interplanetary. The existence of echoes of several seconds' duration (equivalent to the distance of the moon) is well established, and delays of up to ten minutes or so have been reported—corresponding to distances of several times those of Mars or Venus at perigee.

Secondly, the evidence that radiation reaches the earth from space is quite strong, and I am surprised that your contributor did not mention it. I refer to Jansky's reports on the subject (*Proc. I.R.E.*, Oct., 1935). Jansky reports this "star-static" as lying between 9-21 Mc/s and being 10-30 db. above the level of thermal agitation. (See also Jansky, *Proc. I.R.E.*, Dec., 1937, and Friis and Feldman, *Proc. I.R.E.*, July, 1937, for a further discussion of this matter.)

Finally, if radio is incapable of really long-range communication (which I doubt) the solution to the problem lies in the modulated light beam. Light can be focussed with extreme accuracy and the sensitivity of a photo-cell collecting light at the focus of a giant reflector, and backed by an electron multiplier and the usual amplifying stages, is so enormous as to be almost meaningless. It is certainly capable of maintaining communication between all the planets in so

small a space as the Solar System! As to the objection that most planets have opaque atmospheres, I would answer that all except Venus have airless satellites very close to them to which they could be linked by UHF.

**"T.W.B.," the Member who wrote the original reply as published last month, now sums up in the light of these comments:—**

TO the first part of the question, "Is it theoretically possible to hold communication with other planets?" the answer given was "Yes—in the case of some planets." Surely this did not imply that radio is incapable of really long-range communication—on the contrary, the whole of the first part of the answer was intended to show that it is. But, in discussing the present day *practicability* of holding communication with a planet, the use of an *existing* transmitting station was assumed. The rough estimate of 6,000,000 kW. was for spherical radiation, but was given merely as a starting point, and in order to give some idea of the effect of spatial attenuation at such a distance with ordinary technique. Using a highly directive but perfectly practicable type of short-wave transmitting array, and assuming the required field intensity at the planet to be only 1 microvolt per metre, it would appear that the radiated power might be reduced to somewhat less than 1,000 kW, which still is greater than that used by most existing stations. However, if the frequency used were such as to permit the employment of some type of parabolic reflector, and special equipment were built for the job, then there would not appear to be anything highly impracticable about it, since the spatial attenuation would be reduced to negligible proportions. It is important, in connection with the choice of frequency, to remember the possible effect of a planetary ionosphere, which might impose severe limitations.

As Mr. Clarke says, echoes of several seconds' delay have been well established, but the time delays in these cases are too short for planetary distances to be involved, though they do fit in with the distance between earth and moon. As to the echoes of long delay—running into several minutes—these were discovered about 1929 by the Norwegian, Jorgen Hals, and were afterwards confirmed by Professor Störmer, of Norway, and by Dr. van

der Pol, of Holland. But I think it is true to say—and in doing so would mention that I have the greatest respect for the opinions of these very eminent scientists—that they have never been repeated, and there is now some considerable doubt as to whether they were, in fact, echoes from space at all. A long period of mass listening about 1937—in which hundreds of listeners took part—failed to yield any conclusive results as to these long delay echoes, and it is very difficult to account for the strength of the echoes if they had indeed been returned from points in space so far distant as the time delays would imply.

Coming to the matter of the Jansky "star-static" mentioned both by Mr. Clarke and by "Cathode Ray," this ought perhaps to have been mentioned, but it was omitted from the Brains Trust answer for two reasons. Firstly, Jansky proved early in his investigations that its source was far outside the solar system and so it could not have its origin in a planet—and planets appeared to be the main concern of the questioner—and, secondly, recent work by Reber (see *Proc. I.R.E.*, August, 1942) has shown that these radiations are not entirely inexplicable. They were first noticed by Jansky in 1932, who then thought that their source was associated with the sun. Later he proved that it was outside the solar system altogether, and subsequently found the radiations to come from the direction of the Galaxy. He found that this interstellar noise set the lower limit for the noise-level in his receiver, i.e., that it was always above that due to the thermal agitation in the receiver. In 1940 Reber reported that he had made some experiments with a view to locating the source of the noise and of explaining its origin, and it is of interest to us here that his repeated attempts to measure radiation from Mars—the only planet with which he seems to have concerned himself—yielded no results. Recently—and it must be mentioned that the paper has only just arrived in this country and so may not have been seen by these two correspondents—Reber has done further work with a highly directive system, and now suggests that the Jansky noise is really thermal agitation noise caused by electrons which have been erupted from stars and float in interstellar space, all space being the conductor in which the thermal agitation is set up.

# RADIO DATA CHARTS

By

J. MCG. SOWERBY,

B.A., Grad. I.E.E.

(By Permission of the Ministry of Supply)

It is well known that if a screening can is placed round a radio coil there is a fall of inductance and of  $Q$ , the magnification of the coil. It is not impossible to calculate these changes *exactly*, but there is no doubt that the final formulae would be unwieldy in the extreme, and the great labour of computation would mean, in practice, that the formulae would never be used. However, it is fortunate that the effects of a screening can on a coil may be expressed by more reasonable formulae to an accuracy of about 2 per cent., which is sufficiently accurate for the great majority of purposes.

It has been shown by A. G. Bogle (*Journ. I.E.E.*, Vol. 87, p. 299, Sept. 1940) that, making certain assumptions, the inductance of a screened coil is

$$L_o = L \left\{ 1 - \frac{l/g}{lg + 1.55} \cdot \frac{b^2}{a^2} \right\} \dots (I)$$

where  $L_o$  = screened inductance,  $L$  = unscreened inductance and the other symbols are as shown in Fig. 1. The assumptions are (i) that the coil is cylindrical, (ii) that the screen is cylindrical, (iii) that the coil and screen are coaxial, (iv) that the gap between the ends of the winding and the ends of the screen is equal to or greater than the gap "g" and (v) that the screen is not unreasonably thin.

Since coils are generally wound on fairly rigid formers for stability, there will normally be no marked deviation from (i). The screen—especially if made of thin sheet—may easily be slightly deformed and become elliptical instead of cylindrical. If the diameter of the screen is reduced by 10 per cent. (e.g. from 2in. to 1.8in.) in one direction by compression, the resultant inaccuracy of equation (I) is about 1 per cent. Assumption (ii) is therefore not serious. The coil may not be placed exactly coaxially in the screen due to accidental circumstances. If the coil is displaced by 10 per cent. of the screen diameter the inaccuracy of equation (I) will be about 1.4 per cent. Hence assumption (iii) is not serious. For equation (I) to apply, assumption (iv) must be complied with, but this condition presents no practical difficulty and is hardly even a limitation. If the screen consists of an insulator with an exceedingly thin conducting film (of graphite for instance) on its inside surface, equation (I) may not apply; but for all normal sheet metal screens a change of thickness will have a negligible effect at the frequencies at which

## No. 2. (3rd Series)— Effect of a Screening Can on the Induc- tance and Resistance of a Coil

radio coils are used. For further information on these and other points reference should be made to Bogle's paper.

The chart for the change of inductance due to a screening can is based on equation (I), and Bogle claims this to be accurate within 2 per cent. Fig. 1 shows the various dimensions involved and the relations between them, and the key indicates the procedure to be adopted on the chart. One example will be given by way of illustration.

*Example 1.* A solenoid coil of 20.6  $\mu$ H unscreened is placed coaxially in a cylindrical screening can, and the dimensions are  $l = 1.75$ in.,  $g = 0.75$ in.,  $b = 1.25$ in.,  $a = 2.75$ in. What is the inductance when screened?

Starting at  $l = 1.75$  and joining this to  $g = 0.75$ , a point of intersection is

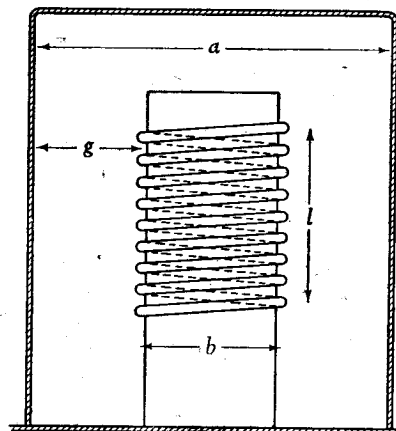

Fig. 1. Section of screened coil showing essential dimensions required in calculations.

found on the reference line. From this point draw a tangent to the curve, and the ruler cuts the winding length scale at a point. Join this point to 1.25 on the "b" scale, and a second point of intersection is found on the reference line. Join this point to  $a = 2.75$  on the screen diameter scale and the ruler cuts the inductance ratio scale at 0.876. Thus the screen inductance is  $20.6 \times 0.876 = 18.05 \mu$ H. Opposite 0.876 on the inductance ratio scale is 0.124 on the  $\Delta L/L$  scale. A note should be made of this figure as it will be used in the second chart for finding the increase in resistance of the coil due to the screening can.

Part of Bogle's paper is devoted to the analysis of the effect of the screening can on the resistance, and this is a matter of considerable importance, as will be shown later. Making the same assumptions as before, Bogle has shown that the additional resistance  $R^1$  due to the screening can is given by the formula

$$R^1 = \frac{\Delta L}{L} \frac{N^2 b^2 l}{a} \sqrt{\rho f} \cdot \frac{2\pi^2}{10^4 \sqrt{10}} \dots (II)$$

Where the symbols are as before,  $N$  = turns per inch,  $\rho$  = specific resistivity of screening can material in microhm-cms., and  $f$  = frequency in megacycles. Practically all the remarks about the accuracy of equation (I) apply to equation (II). The chart for computing this added resistance is based on (II), using copper as the screening material. For any other material the  $R^1$  given by the chart must be multiplied by a factor depending on that material. The factors for the common screening materials are given in Table I.

TABLE I

Material	Factor
Copper .. .. .	1
Aluminium .. .. .	1.28
Brass .. .. .	2.16
Zinc .. .. .	1.85
Nickel .. .. .	2.05
Phosphor Bronze .. .. .	2.16
Silver .. .. .	0.97

The chart is quite straightforward to use, and the procedure is indicated in the key. Let us do an example:

*Example 1A.* The screening can of Example 1 is made of aluminium, the winding pitch is 20 turns per inch, and the working frequency is 1 Mc/s. What is the added resistance  $R^1$ ?

Join

$$\frac{\Delta L}{L} = 0.124 \text{ to } l/a = \frac{1.75}{2.75} = 0.636$$

(Continued on page 257)



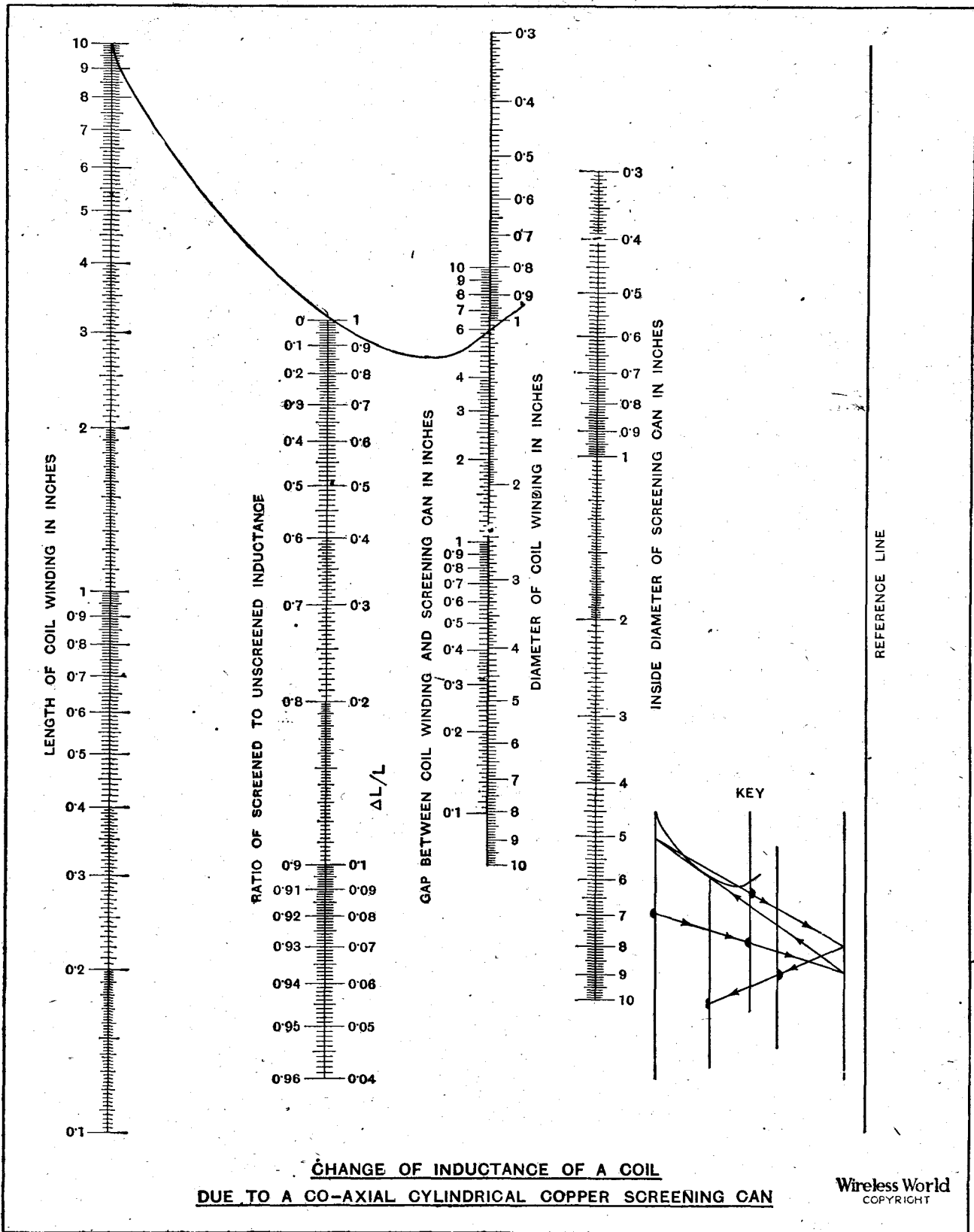

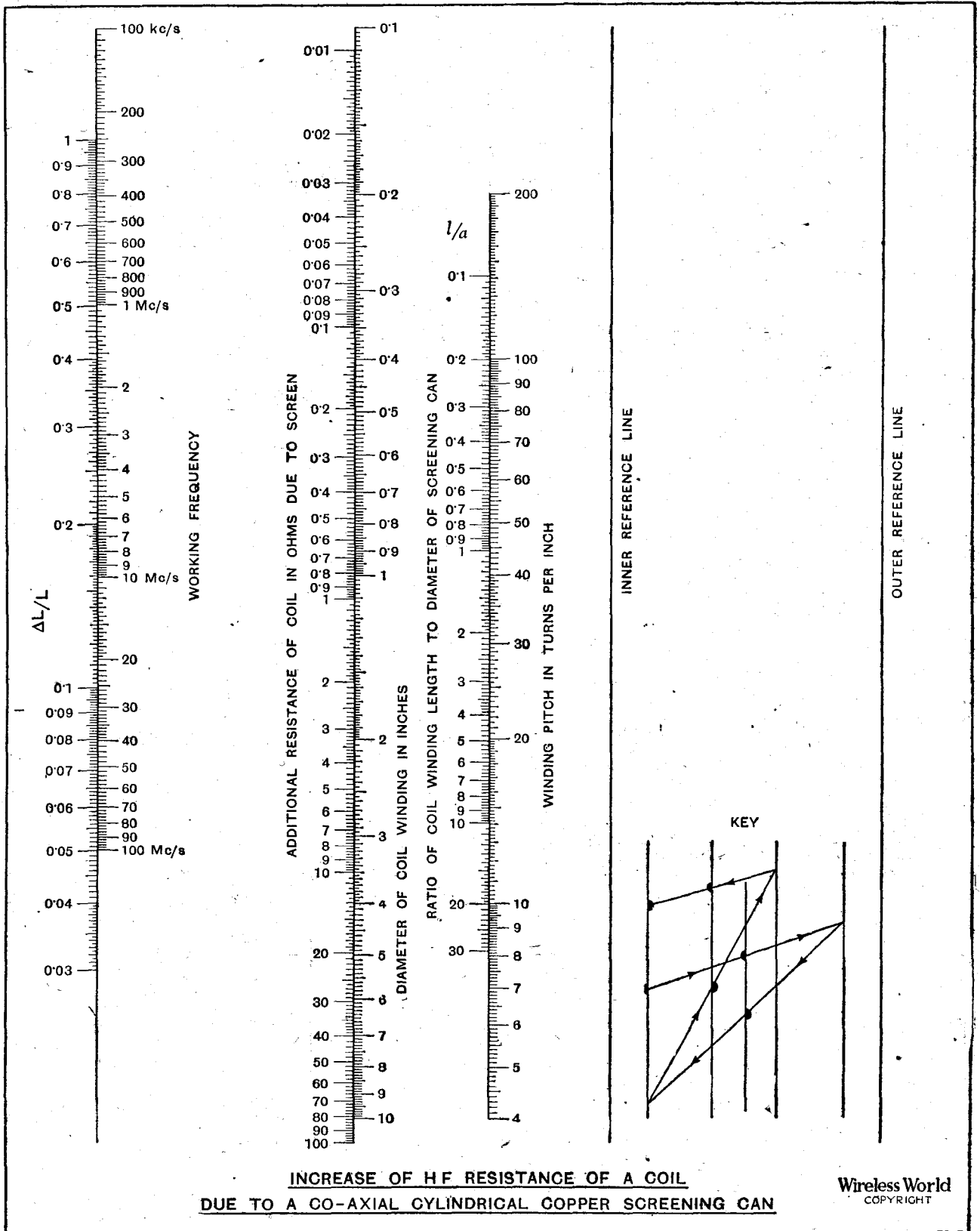

**INCREASE OF H F RESISTANCE OF A COIL  
 DUE TO A CO-AXIAL CYLINDRICAL COPPER SCREENING CAN**

and produce to a point on the outer reference line. Join this point to 20 on the turns per inch scale and produce to a point on the  $\frac{4L}{L}$  scale. Join this point to  $b = 1.25$  in. and produce to a point on the inner reference line. Join this point to 1 Mc/s and the ruler cuts the  $R^1$  scale at 0.0402 ohms. This is the added resistance due to screening if the screen were of copper. It is actually aluminium, and reference to Table I gives 1.28 as the factor for this material. Hence the required added resistance is  $0.0402 \times 1.28 = 0.0515$  ohms. This looks negligibly small, but let us find the total effect on the  $Q$  of the coil at 1 Mc/s. We may take the RF resistance (including skin effect) as 0.75 ohms, and the  $Q$  of the unscreened coil is

$$\frac{2\pi fL}{r} = Q = \frac{2\pi \times 10^6 \times 20.6 \times 10^{-6}}{0.75} = 173.$$

Taking the screened value of the inductance, and adding the value for  $R^1$ , the  $Q$  of the screened coil is

$$Q^1 = \frac{2\pi \times 10^6 \times 18.05 \times 10^{-6}}{0.75 + 0.0515} = 142.$$

This represents a change of  $Q$  due to screening in the specified manner of nearly 18 per cent. If  $R^1$  had been ignored as being negligible,  $Q^1$  would have been 151, representing a change of  $Q$  due to screening of 12.7 per cent. In many cases  $R^1$  will be found to have a considerably greater effect on  $Q$ . The example shows that even when the coil-can clearances are quite large, screening produces a marked deterioration in the goodness of the coil.

### The R.E.M.E. and Telecommunications

IT should, perhaps, be pointed out that the formation of the new Corps of Royal Electrical and Mechanical Engineers referred to in our last issue will have very little effect, other than in change of badge and button, on the personnel who are responsible for the engineering aspect of army tele-

communication equipment—the collective term adopted in the R.E.M.E. for radiolocation, wireless and line gear. Of course, the R.E.M.E. has many tasks other than those associated with telecommunication apparatus, but such matters are outside the scope of this journal.

The whole of the R.A.O.C. Engi-

neering Branch is being incorporated in the new corps, while a much smaller number of personnel from the R.E.s and R.A.S.C. is being transferred. The R.A.O.C., and not the R.E.M.E. as previously stated, will continue to supply telecommunications equipment, while the new corps will keep it working to maximum efficiency.

## S.A.A.F. Signals Section

DURING the Abyssinian campaigns, the official history of which has recently been published, the Signals Section of the South African Air Force played a very important part. It was the vital link in the chain of communications between the Air Force squadrons, which were continuously penetrating deeper over enemy-occupied country, and headquarters.

The Signals Section, which includes air crew operators and ground staff—comprising operators and maintenance personnel—is responsible for wireless and line communication in the field.

A Section under the command of a Signals Officer is attached to each Squadron and Headquarters, but the personnel varies in number according to the type of work on which the unit is engaged.

The larger of the mobile ground stations in general use comprises three 3-ton trucks. In one is installed

two medium-power transmitters, each of which work in the high-frequency band. The 7-kW power supply for the transmitters, which can also be worked off 220-volt AC mains when available, is contained in a separate truck. A receiving station, comprising two communication-type receivers, is installed in the third vehicle.

During the Abyssinian campaigns these transmitters frequently provided the only means of communication with bases, which were not infrequently well over a thousand miles away.

The smaller type of station is fitted in a small truck and comprises a low-power transmitter and receiver working in the high-frequency band. The apparatus is battery operated, and a portable charging set is, therefore, part of the equipment.

Owing to the extremely fluid type of warfare experienced in Abyssinia and also in the Middle East, the

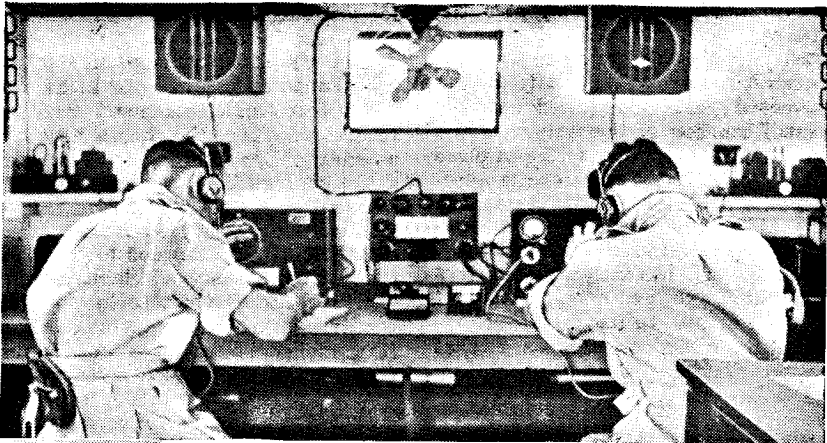

Operators of the S. A. A. F. Signals Section in the receiving van of the larger of the two mobile stations. (Left) The self-contained low-power station.

amount of traffic handled by these mobile stations, which deal with 'phone, CW and MCW, was considerable. Many of the operators are amateurs and high praise has been accorded to their efficiency.

Because of their frequently isolated position the personnel have to be capable of undertaking major repairs, and their training, therefore, takes this into consideration.

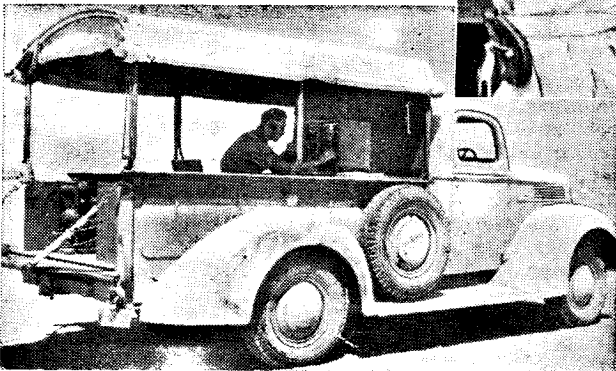

# HOME-MADE PICK-UP

## Further Notes : Author's Replies to Queries

IT is gratifying that the description of my moving-coil pick-up in the July *Wireless World* has aroused interest, and I am grateful for the comments made by correspondents.

My remarks regarding the desirability of a light head and arm were, based on the fact that records stored in a certain popular album are consistently warped in a manner which makes it necessary for the head to be able to move with an acceleration of 30 cm. per sec. per sec. without affecting the downward pressure appreciably. Owing to the fact that this peak figure exists for only a small fraction of a second, it happens in practice that a variation to only 25 per cent. of the average downward pressure can pass unnoticed; indeed, unless by some coincidence the note at this part of the record is such as to require the full downward pressure for good needle tracking, no harmful effect can result. There are, however, some records (usually containing long-sustained notes) in which such an effect does become noticeable, so I think all possible precautions should be taken to avoid this defect on any record.

Dr. Mole is, I think, a little optimistic in calculating that it is possible to reduce the downward pressure of his pick-up head (105 grams), plus the arm, to 15 grams, with a counterbalance of only 25 grams effective at the head. The fact is that, as the downward pressure required becomes a small fraction of the weight of the head, etc., the use of a spring in place of a counterbalance reduces the effective mass by nearly half. As on the type of warped record I have mentioned, the downward pressure of Dr. Mole's pick-up will vary by  $\frac{1}{4}$  oz. (approximately 50 per cent.), I would recommend him to try in further experiments either an Eclipse Pocket Magnet or Type M.5535 of Messrs. Darwin's, which is an Alnico U magnet weighing slightly over 1 oz.

With regard to the trailing angle, in its absence, the needle and armature of the usual commercial pick-up would vibrate in a way that would cause considerable distortion, but with an adequate trailing edge this would necessitate the point bouncing on the record. If the point is given adequate support, a trailing angle becomes unnecessary.

I can't agree with Mr. Hay that there is any practicable arrangement

By

JOHN BRIERLEY

of the tone arm that will reduce the moment of any torsional forces to zero—the arrangement he describes will not. While generally they can be reduced (not to zero) by keeping the tone arm axis low, the cross-sectional area of the arm (and hence its rigidity) will probably have to be reduced, too, which might in certain circumstances aggravate rather than mitigate this trouble.

### Needle Changing

The references to the choice of and suitability of celluloid prompt me to explain the reason for its use. While I was examining the various causes which contributed to the buzz output in pick-ups, I noticed that an undamped top resonance had a considerable effect. As in pick-ups using miniature moving parts, advantage is generally taken of the natural period being high, to reduce the damping, it is desirable to make them as self-damping as possible. A Silent Stylus needle, even cut down as I suggested in my article, is springy enough to make this impossible, whilst if the needle holder is made of springy material, too, such as would be good for gripping the needle well, the top resonance becomes too pronounced. The only satisfactory solution is to use much smaller points. As I did not think this would commend itself to readers to whom this was a new and possibly rather fiddling type of constructional work, I accepted the faults inherent in a steel needle and recommended the toothbrush handle grade of celluloid which seemed to be about the best compromise available. I think it will be found that, so long as the needle is inserted with reasonable care (the smaller the tool used for this purpose the better), and the former is not cut too finely round the needle, the hole will not become enlarged, and the former will last indefinitely. The needle is gripped just above the tapered part and pushed in until the tool touches the former. It cannot, therefore, be inserted too far except deliberately. It is the length of the tapered portion, and the fact that a little above this has to be left for gripping the needle for inserting and extracting, that limit the length to which it can be cut.

The query regarding the practicable

needle life obtained is difficult to answer, as it depends to a very great extent on the type of associated apparatus employed—particularly the loud speaker; also new records wear the point very much less than old ones, and dust in the grooves (and how few people keep their records really clean!) halves the life of a point. With first-class apparatus I think 30 sides is the absolute limit with  $\frac{1}{2}$  oz. downward pressure, and 15 to 20 is probably the normal average number. There appears to be excessive wear quite often owing to the rather poor contact the point makes with the groove, and this makes the needle peculiarly susceptible to variations in groove shape. I find that a less acutely shaped point gives better results on the whole. Getting a point of good average fit is one of the prime difficulties of gramophone reproduction. Another difficulty which has assumed greater importance lately is the variation in groove shape, as the groove direction departs from the tangent. It would be interesting to know if the recording engineers can see their way to making improvements in this respect.

Finally, I would like to point out that pick-ups using an elongated coil, such as I have described, come, I think, under a patent taken out by P. G. A. H. Voigt.

### Broadcasting Statistics

COMPARATIVE figures giving the number of broadcasting stations throughout the world at the end of 1939 and 1941 are published in the *U.I.R. Bulletin*. It is noticeable that in countries where the broadcasting service is monopolised the number of stations is small, but they are high powered, whilst in countries where there are commercial stations there is a preponderance of low-powered transmitters.

The number of transmitters in the world is given as 2,768, compared with 2,509 in 1939, although the average power remains at 7.8 kW. In Europe there is stated to be 470 transmitters with an average power of 25.86 kW, whilst in North America there are 1,122 stations, the average power of which is 5.09 kW. Although in Central America the number of stations has increased during the two years from 195 to 279, the average power has dropped from 1.24 kW to below one kilowatt.



*Insist on Safety—USE*

# ERSIN MULTICORE

THE SOLDER WIRE WITH 3 CORES  
OF NON-CORROSIVE ERSIN FLUX

Manufacturers cannot afford to jeopardise their reputations by using solders which are cheap, because that initial "cheapness," as often as not, costs far more than it saves.

ERSIN MULTICORE—the A.I.D. approved Solder Wire with three cores of non-corrosive Ersin Flux—with the correct and rapid soldering technique, safeguards you against H.R. or dry joints, and—what is equally important—speeds up production.

Works engaged upon Government Contracts are invited to write for free samples.



**MULTICORE SOLDERS LIMITED, BUSH HOUSE, W.C.2. Phone Temp. Bar 5583/4**

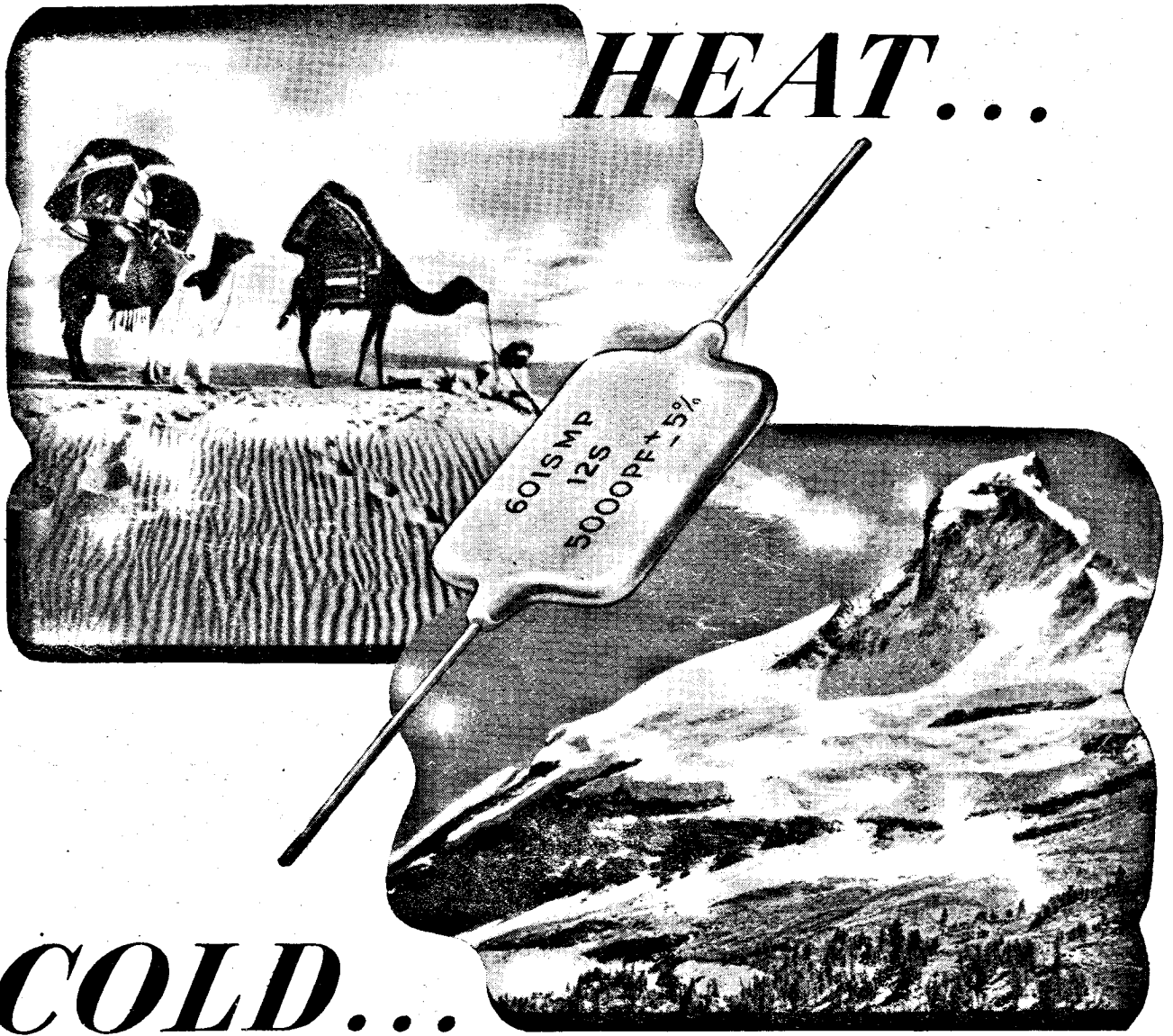

# HEAT...

# COLD...

*In the Heat of the Desert or the Jungles,  
The Cold of Winter or High Altitudes,  
Silvered Mica Condensers have to do their job  
and maintain their stability*



TYPE APPROVED

## UNITED INSULATOR CO. LTD.

12-20 LAYSTALL ST., LONDON, E.C.1

Telephone: TERminus 7383

Telegrams: Calanel, Smith, London

*The Pioneers of Low-loss Ceramics*

# PHYSICAL FOUNDATIONS OF RADIO

## III.—Hot Cathode Emission (Metallic)

By

MARTIN JOHNSON,

D.Sc.

**I**N the two preceding articles the meaning of "free" electrons was discussed for idealised metals and for practical alloys, and some grounds were given for the differing resistivity of various chemical structures. The familiar phenomenon of cathode emission next raised the question as to what physical factors control the escape of these electrons from surfaces which are either heated, bombarded by other electrons or ions, or exposed to radiation. We begin with thermionic emission, and will follow as before the policy of developing simplified mechanisms and diagrams to suggest reasons underlying the facts met by any radio experimenter.

**Potential Diagrams at a Cathode Surface**—We previously considered the status of the electron in the metal from two closely related points of view, the work required to remove it from one equipotential to another, and the potential barriers obstructing its free movement. The "wave-like" aspect of certain electronic properties allowed barriers to be penetrated if they are not more than a few atoms in thickness, even when the electron has not acquired sufficient kinetic energy to reach the summit of the barrier on the potential diagram.

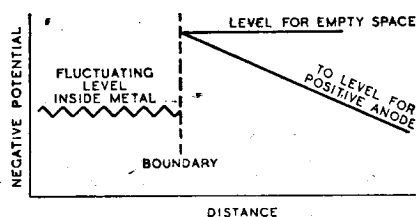

Fig. 1. Potential for electron passing from region of periodic pattern among lattice atoms to vacuum outside the cathode and then to anode.

In problems of conduction within the metal, these barriers and energy increments were merely those concerned in the passage from atom to atom or from one crystal grain across an impurity to another micro-structure in the same substance. But in problems of emission, the barrier to be similarly discussed is the high wall of potential separating the whole metal interior from the vacuous space outside it; the step on the potential distance diagram is from the level of averaged influence of all the positive lattice points in the

cathode material to the level of complete absence of any material between the electrodes of the valve, and finally to the level of a strongly positive anode. (Fig. 1) Ordinates on such potential diagrams are conveniently in electron-volts, the familiar work unit  $eV$  representing energy acquired by a single electronic charge  $e$  falling through so many volts  $V$ . In these units radio experimenters know that they will find "work-functions" controlling emission with their magnitudes ranging from about  $1\frac{1}{2}$  for coated filaments containing barium to about six for platinum: because of the high work function, platinum, although the material used for many of the early fundamental experiments, is quite unsuitable for even "bright emitter" valves.

### Interpretation of Work Functions.

—In terms of the diagrams which we have used for illustrating the theory of metals, the work function measures the extra energy needed to enable the free electron to negotiate its barrier and escape from the metal lattice. This will therefore be the difference between the "inner potential," which characterises the interior relative to exterior of the metal, and the maximum energy of the electrons in the cold lattice. On the older theories these quantities were not easy to interpret, but they have been among the successes of the Fermi and Dirac method of calculating the distribution of energy in the "free electron gas" to which reference has previously been made.

Calculated on this basis, for example, the energy of the "cold" electrons in a nickel filament would be either 11.7 or 7.4 electron-volts, according to whether an average of two electrons or one is liberated from each parent atom. The "inner potential" is about 16.5, estimated from experiments on the diffraction

of an electron beam from a nickel surface. The work-function for nickel ought therefore to be about 5 or about 9 for these two alternatives respectively. The fact that it is found by measurement to be 5.03 volts makes it clear that the theory is on correct lines if two, not one, electrons per atom become "free" in nickel. Much progress in the understanding of the mechanism of emission has been due, in this country, to R. H. Fowler and his pupils, beginning with Nordheim who calculated the probability of electron waves from the interior being reflected or transmitted at various kinds of surface barrier.

### Image Force and Schottky Effect.

When we have defined and measured a work-function, it is reasonable to ask what makes up this work which has to be done in getting the electron away from the metal. One important part is certainly contributed by the so-called "image force": an electrostatic charge when just outside a conducting surface may be considered as inducing its opposite or "image" in the reflecting mirror of the metal. (Fig. 2). Attraction between the negative and positive pair must occur according to the usual electrostatic law of inverse square of distance and product of charges; this holds back the escaping electron and requires work to be done against such a force

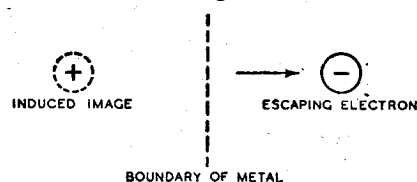

Fig. 2. Image attraction at metal surface.

for the electron to get clear away. This simple electrostatic attraction is only part of the story, which must also include the lesser-known chemical and polarisation attractions between the electron and the last atomic layer of the metallic structure, constituting forces of shorter range than the image force.

The image force betrays its presence, since it must round-off the shape of any potential barrier which we have hitherto supposed to be merely a vertical step on the diagram; this rounding of the potential step is

**Physical Foundations of Radio—**

probably what causes the "Schottky effect," or incomplete saturation of the current/potential line on the diode characteristic for even the purest metal filaments. In Fig. 3 different anode potentials provide differently sloping lines away from the surface on the potential diagram; it is seen that the more gradual the potential step the more the growth of anode potential succeeds in "shaving off the summit" of the hill. Maximum height of a rectangular barrier is scarcely affected by anode potential, so that for such a case at fixed cathode temperature a potential on the anode sufficient to collect electrons from the space-charge will give the maximum possible current. But the more rounded hill of the image force will be cut into more and more by increasing anode potentials, lowering the summit, reducing slightly the effective work function and allowing the current to rise above the first apparent saturation. Schottky's calculations of this effect fit experiment excellently, and it is interesting to note orders of magnitude; in a field

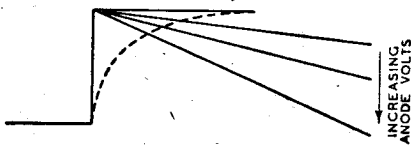

Fig. 3. Schottky effect (exaggerated): increasing anode potentials slightly diminish the summit of the potential barrier to electron emission if it is rounded (dotted curve) by image attraction. (Compare Fig. 1.)

of  $10^8$  volts per cm. the summit of the hill, between image attraction and anode slope, occurs at  $17\frac{1}{2} \times 10^{-8}$  cm. from the idealised "boundary" and the effective work function is reduced from 4.54 to 4.16 volts for pure tungsten. This gives considerable rise in current as the summit of the potential curve is considerably "shaved." The effect upon the diode characteristic appears in Fig. 4.

This Schottky effect of anode potential must be distinguished from two others, the infra-saturation region of Fig. 4 to which we next devote some detail, and also the phenomenon of "field emission" from cold electrodes at enormous fields which will be dealt with in a later article on non-thermal emissions.

**Infra-Saturation Currents and Space Charge.**—The lower portion of the diode characteristic (x) in Fig. 4 shows a dependence upon anode voltage which is also calculable upon a basis of Coulomb's law of electrostatic attraction and repulsion. The

mathematics is that of integrating Poisson's differential equation for a space charge accumulating in a region bounded according to the geometry of the various shaped electrodes.

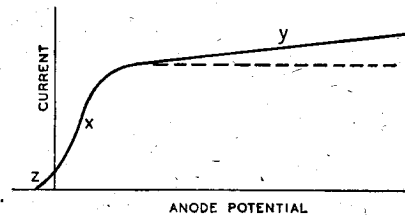

Fig. 4. Diode characteristic showing region (y) with imperfect saturation due to Schottky effect, and region (x) of the  $3/2$  power law. The region (z) of finite emission velocity is here exaggerated to show its existence.

Fig. 5 shows a plot of potential (ordinates) against the distance between two idealised parallel plane electrodes. AA' gives the potential from cathode to anode across a valve. For an isolated electron in this space, nothing disturbs the linearity of ABA'. But when emission is copious and the crowding of electrons become dense enough to constitute a finite space-charge outside the cathode, this will progressively disturb the anode attraction and cause the line to sag to ACA', ADA', etc. Where the graph sags so distinctly as to show a horizontal tangent, the slope has become zero and there is no longer a pull from the anode collecting electrons from the vicinity of the cathode, since the slope of potential against distance was the force of attraction. If space charge becomes excessive enough for the graph to dip below the horizontal, AEA', there is even a reversed force between cathode and bottom of this dip.

The point E, the minimum in the curve, contains the germ of the notion of "virtual cathodes," as it replaces the cathode surface as a new starting point for any electron. Radio experimenters will be familiar with this term, as much care in design of multi-electrode valves has been expended in arranging virtual cathodes to be situated at various points in the inter-electrode space to provide very uniform flow to subsequent electrodes.

It was the analysis of these curves that led Langmuir and other pioneers to the well-known "three-halves power law," that the anode current for moderate voltages rises proportionally to  $V^{3/2}$ . The various proportionality factors cover varied shape and size of electrodes, and the mathematics becomes awkward for any case except plane or cylindrical. It should also be remembered that the law is some-

what vitiated by "local" fields at the surface of composite or impure metallic cathodes, and that in any case it ignores initial velocity of emission and so is unable to fit the bottom of the characteristic curve of the actual valve.

**Temperature Law and Richardson Plots.**—

Consider the nearly flat portion of a diode characteristic: the valve is presumably "hard" so that there are no gaseous ions, and the anode potential is not enormous, so that there is no "field emission," but approximate saturation has been reached and the extra current can be eliminated by calculating the excess due to Schottky effect. (Fig. 4, region y). The thermionic current can under these circumstances be regarded as a purely thermal phenomenon, i.e. an evaporation of electrons from their free state in the metal similar to the evaporation of the molecules of a liquid when they attain their vapour stage of escape from an exposed surface. In fact the electron emission can be calculated by analogous means to that employed by physical chemists in their calculation of vapour pressure. Various alternative derivations on slightly differing thermodynamic arguments all agree to give the law associated with the pioneer discoveries of Sir Owen Richardson

$$\text{Current per unit area} = AT^2 e^{-\phi/kT}$$

In the early days  $T^{1/2}$  was preferred to  $T^2$ , which would require  $\phi$  adjusting to different temperatures, but this variation of work function with temperature is "taken care of" in the

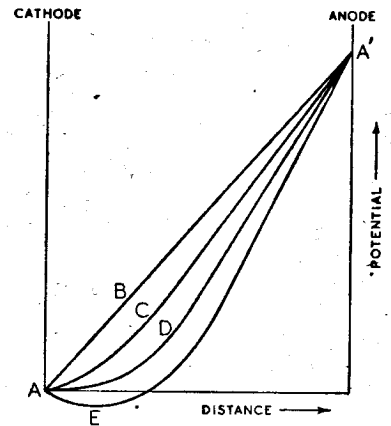

Fig. 5. Potential/distance graph between idealised plane electrodes with successive stages of growth in space-charge. E has "virtual cathode" properties.

$T^2$  form of the law. Thus  $\phi$  is pictured as a fixed work function analogous to a latent heat of evaporation;  $k$  is



the Boltzmann constant, in this case  $\frac{2}{3}$  of the value of the constant referred to in our previous discussion of metals,  $T$  is temperature on the "absolute" scale which describes the freezing point of water as 273 deg. The two constants characterising any metal emitter can therefore be obtained from experiments recorded in a "Richardson plot" (Fig. 6) of  $\log_{10} i - 2 \log_{10} T$  against  $1/T$ , in which the slope multiplied by 2.3 (the conversion factor between common and Napierian logs) gives  $\phi/k$  while the maximum vertical intercept gives  $\log A$ . When later

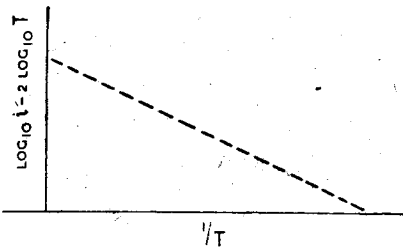

Fig. 6. "Richardson plot." The slope multiplied by the logarithmic constant 2.3 gives  $\phi/k$ . The maximum vertical intercept gives  $\log A$ .

discussing composite surfaces it will be important to know what to do with the curved Richardson plots which have puzzled many workers; they obviously imply non-constant conditions of emission.

**Emission Constants.**—It is clear that  $A$ , as inferred from the logarithmic plot, will not be very accurately determined. In fact the magnitude of this quantity, known as the emission constant, has been disputed over a wide range even for the same material, and for composite filaments may have fantastic values. Much ingenuity has been expended in distributing the responsibility for "queer" emitters between their  $\phi$  and their  $A$ . It is worth noting that  $e^{-\phi/kT}$  is the dominant term in temperature, in fact distinction between the alternatives  $T^{1/2}$  and  $T^2$  in the other factor has not always been easy.  $e^{-\phi/kT}$  will however always be a very small quantity: for  $k$  is  $1.37 \times 10^{-16}$  ergs per degree or  $8.6 \times 10^{-5}$  electron-volts per degree, so that if the work function is in electron-volts it must be multiplied by the reciprocal of  $k$  or 11,600 to obtain  $\phi/kT$  for any given emitting temperature. For example, the work function for pure tungsten used in bright emitters is 4.54 so that  $e^{-\phi/kT}$  at 2,000 degrees is  $e^{-x}$  where  $x$  is  $4.54 \times 11,600/2,000$ . This is about  $e^{-26}$  or  $10^{-11}$ . For actual emission to be at all considerable for such a work function the constant  $A$  must be very large. On the modern Fermi-Dirac

theory of electrons to which we have before referred,  $A$  has a maximum possible value  $A_0$ , given by

$$A_0 = \frac{4\pi me k^2}{h^3} \text{ where}$$

$m$  is the electron mass  $8.9 \times 10^{-28}$  gm.,  $k$  is as before,  $e$  is in this case the electronic charge  $4.8 \times 10^{-10}$  electrostatic units, and  $h$  is Planck's constant  $6.55 \times 10^{-27}$  erg seconds. This makes  $A_0$  to be  $3.6 \times 10^{11}$  electrostatic units per  $\text{cm}^2$  per  $\text{deg}^2$  or 120 amps. per  $\text{cm}^2$  per  $\text{deg}^2$ . For instance, tungsten at 2,000 degrees would have an emission per  $\text{cm}^2$  area of filament  $120 \times 2,000^2 \times 10^{-11}$  or about 5 milliamps. In practice this is not attained as  $A$  never reaches the maximum  $A_0$ , there being more internal reflection of the electrons than accounted for in the theory. The merit of a tungsten emitter is that it can stand very high temperature, and a filament of 0.1

millimetre diameter can be run at a temperature giving 22 milliamps. per cm. length. But this means only 8 milliamps. per watt of cathode heating. The Richardson equation shows that reduction of work function from  $4\frac{1}{2}$  to 2 volts alters  $e^{-26}$  to  $e^{-11}$  at the same 2,000 degrees. This increases emission a millionfold. But metals refractory enough to stand high temperatures all have high work functions. We reach in our treatment of emission, therefore, the urgent need for the "dull emitter" or filament of composite material instead of the pure metal. The laws of such are not so simple as those of the pure metal emitter, but are understandable when compared with the "pure" properties which we have here outlined. The search for composite filament material of low work function will be discussed in the next article.

## I.E.E. Wireless Section

### Inaugural Address of the New Chairman

AT the first meeting of the 1942-43 session of the Wireless Section of the I.E.E. on October 7th, appreciation was expressed of the work of the retiring Chairman, Mr. H. Bishop, C.B.E., and the new Chairman, Dr. R. L. Smith-Rose, delivered his inaugural address. This was divided into three parts, dealing successively with the growth of the Wireless Section of the Institution, a review of the work of the Radio Research Board, and a technical paper on recent advances in the measurement of the speed of travel of electromagnetic waves.

In a brief survey of the origin and growth of the Wireless Section, which has now been in existence for 23 years and has a membership of 1,100, he mentioned the occasions when movements have been set on foot to detach the section and to establish a separate Institution and the steps which were regarded as rendering such a course unnecessary—for instance, the decision as early as 1926 to welcome physicists whose qualifications, although not those of the electrical engineer, specially fitted them for many branches of wireless development work.

His remarks on the past and present work of the Radio Research Board were in support of the wisdom of fundamental research without regard to immediate applications. Many of the researches initiated years ago were now providing valuable material for the rapid extension of wartime radio-technique.

The final section dealt with refinements in the measurement of the velocity of light and wireless waves. The work of Michelson, Pease and Pearson, in America, using a rotating mirror and a vacuum tube a mile long, was described, and also the recent work of W. C. Anderson with more compact apparatus, using a Kerr cell with frequencies up to 56 Mc/s as an interrupter. Both methods gave a value of  $2.9977 \times 10^{10}$  cm/sec. in vacuo. The direct measurement of the velocity of wireless waves was more difficult, and comparable accuracy was not yet in sight, but the work of Ross and Slow at the N.P.L. in 1937 on the phase velocity of waves in separate aerial systems had given  $2.95 \times 10^{10}$  cm/sec.  $\pm 5$  per cent. In the U.S.S.R. Mandelstam and Papalexii had recently completed an outstanding research involving the transmission of waves to a distant receiver, frequency conversion and retransmission back to the starting point. Modification of the phase throughout all parts of the apparatus was traced with an accuracy of one part in 1,000, and the number of whole wavelengths and fractions of a wavelength between the two stations deduced. The results gave a velocity lying between  $2.990$  and  $2.995 \times 10^{10}$  cm/sec. in clear air over the sea.

This work was by no means academic as an accurate knowledge of the velocity of waves in free space was necessary before the more complex problem of transit time between stations could be investigated.

# INSTRUMENTS: *Test and Measuring Gear and Its Uses*

By W. H. CAZALY

## VII.—Valve Testers

A VALVE tester is a device that gives sufficient indication of the all-round goodness of a valve for an observer to ascertain whether the valve is going to perform satisfactorily in a wireless set or amplifier. For such purposes the goodness of a valve is dependent upon several factors, of which the chief are (a) the emissivity of the cathode; (b) the degree of vacuum inside the glass envelope; (c) in the case of indirectly heated cathode valves used in mains sets, the insulation between heater and cathode, particularly when hot, as in working conditions; and (d) the mechanical condition of the electrodes inside the glass envelope, including their insulation from each other.

It is perhaps best to consider each of these factors separately at first, in order to perceive how, in commercial valve testers, ingenious arrangements enable their effects to be observed by the movement of a pointer across a meter dial. Taking the last-mentioned factor first—the mechanical condition and insulation of the electrodes—the testing of this factor is very simple. A valve with mechanically defective electrodes will, save in rare cases, be "microphonic"—that is, it will set

Fig. 1. (a) Indirectly heated diode "leak and condenser" rectifier. (b) Circuit showing how the same principles are used to indicate faulty cathode-heater insulation in a valve when the cathode is hot, as in normal operation.

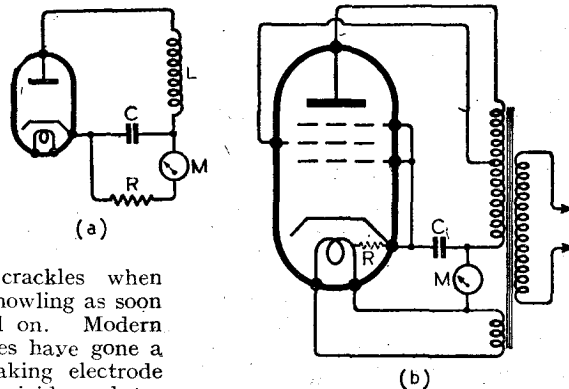

up anything from crackles when tapped to continuous howling as soon as the set is switched on. Modern manufacturing processes have gone a long way towards making electrode structures strong and rigid, and towards attaching the various parts of the structure to each other very firmly—usually by spot welding—but perfection is impossible; a turn of the control grid may become detached, or a strut of the anode, and hang loose or ready to vibrate with the slightest jar; overheating, even of short duration, of the filament of a battery valve

may cause it to sag without breaking and become vibrant when jarred. There is no quantitative test possible, or needed, for valve microphony—the ear is a sufficiently competent tester, if the valve is lightly tapped.

### Inter-electrode Insulation

The insulation between the electrodes of a valve is best tested by some sort of megger or neon circuit, since it must be extremely high to be satisfactory. Several commercial valve testers have something of the sort incorporated, for the preliminary test of a valve in this respect before its insertion in the tester, since a short-circuit between electrodes might damage the tester.

Taking the matter of cathode-heater insulation next, this is a factor that can be measured quite accurately. It is essential, however, that it should be measured "hot" as well as "cold"; and, if possible, with working voltages applied to the other electrodes. This is because leakage paths between heater and cathode quite often do not appear until the normal working heat has expanded the parts involved. Tested when cold, the in-

strument insulating the heating source very carefully from the cathode. But a rather simpler arrangement from a practical viewpoint, especially when mains supplies are used for power, as is usual in valve testers, is given in Fig. 1.

How it works may be understood by reference to Fig. 1 (a), which is that of a simple diode with a leak and condenser. When an alternating voltage is developed across the coil L, the condenser C becomes charged on account of the rectifying action of the diode and discharges through the leak resistance R, which normally is included deliberately in such a circuit as this. A sensitive microammeter in series with R, as shown by M in Fig. 1 (a) would measure the value of the discharge current. A similar principle is involved in the circuit of Fig. 1 (b). Here, the required alternating voltage is supplied by the secondary of a mains input transformer (of which another secondary provides the heater supply in addition) and the leak resistance R is provided by the leakage path, if any, between cathode and heater, as shown in dotted line. If insulation is good, i.e., R is very high, little, if any, movement will be observed of the pointer of the meter M, the dial of which may even be calibrated, if desired, in terms of megohms leakage. The valve under test—in the circuit shown it is a pentode—is being made to act as a rectifier.

### Softness

The vacuum inside the envelopes of modern valves is extremely high, except in the case of special types such as certain power rectifiers, neon types, etc. The slightest crack in the envelope, even if invisible, or defect in the sealing between the glass and the leads-out of the electrodes, lets in sufficient air to ruin this vacuum. Moreover, the heating of the electrodes when the valve is in use may cause them to release a residuum of occluded gas. Elaborate precautions are taken against it, of course, in manufacture, but valves are still liable to "go soft" in this way.

The easiest way to test a valve for softness is to measure the anode cur-

insulation between cathode and heater may appear quite satisfactory—i.e., some 1 MΩ at least, and usually very much higher; as soon as the valve is put back into the receiver and used, it may give rise to intolerable hum. It would, of course, be possible to test hot cathode-heater insulation directly with a fairly obvious arrange-

rent with and without a high-resistance between the control grid and the cathode. If the vacuum is satisfactory, the presence or absence of high resistance (say 2 MΩ) between grid

Now, the constants of valves  $\mu$ ,  $R_a$ , and  $G_m$ , are derived from the slopes of the characteristics; hence change in the emissivity of the cathode affects the valve constants considerably.

being given for switching to the correct taps for the various types of valves to be tested. The valve being a uni-directional current device, the registering meter is merely a DC moving-coil instrument. A skeleton circuit showing the principles is given in Fig. 3. The scale of the meter is usually marked arbitrarily and is used with a table of the deflections to be expected with various types of valve.

Another form of valve tester does reveal approximately the slope of the  $I_a/V_g$  characteristic, by showing the amount of alternating current component developed in the anode circuit of a valve when a standard alternating voltage is applied to the grid. The principle is shown by the circuit given in Fig. 4. It will be evident from a consideration of the  $I_a/V_g$  characteristic shown in Fig. 2 (a) that the application of an alternating voltage, to the grid of a valve having this characteristic, of a valve of about 0.75 volt RMS will produce an AC component superimposed on the steady DC flowing in the anode circuit (with 140V as  $V_a$  of about 2 mA RMS. If, however, the slope is less steep, as in

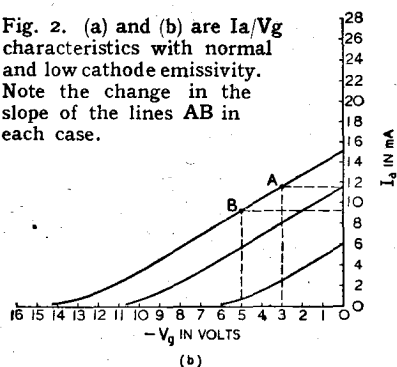
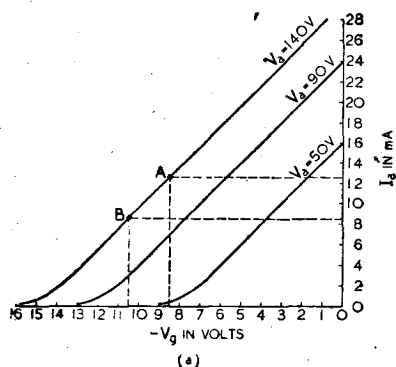

Fig. 2. (a) and (b) are  $I_a/V_g$  characteristics with normal and low cathode emissivity. Note the change in the slope of the lines AB in each case.

and cathode should make no appreciable difference to the anode current. If the valve is soft, however, the anode current will not be the same in both cases: with high resistance in the grid circuit, the anode current will be greater than when the grid is returned directly to cathode.

A few commercial valve testers merely test the emissivity of the cathode, without attempting to give any idea of the slope of any characteristic. It is assumed that if a valve does not pass the normal anode current when the filament or heater current, and the voltages applied to

Finally, there is the factor of emissivity of the cathode which, apart from anything else, determines inevitably the life of a valve. Most modern receiving valves are expected, if used normally, to have a satisfactory operational life of about 1,500 hours, although a lot depends on how much distortion or other falling off in performance a user is willing to tolerate. The important effect of loss of emissivity lies in the change it makes in the slopes of the families of characteristic curves. Two main families of curves are outlined in Figs. 2 (a) and (b), and the thing to note about them is that a change in cathode emissivity makes a change in the slope of the lines to a greater extent than does a change of any of the other parameters.

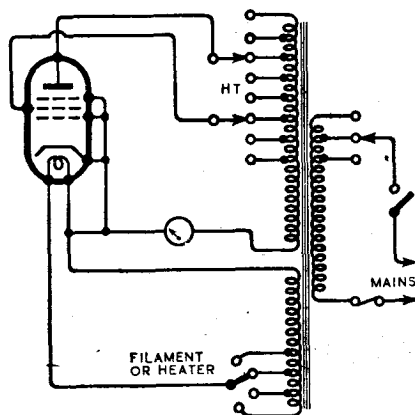

Fig. 3. Circuit showing a simple form of cathode emission valve tester, using AC only.

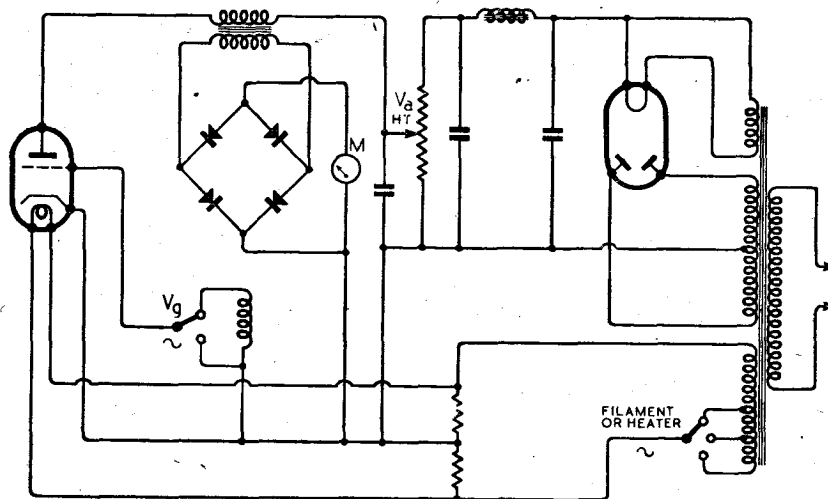

Fig. 4. Simplified circuit of a form of valve tester that registers the effect, in a rectifier type AC meter, of the AC produced in the anode circuit of a valve by the application of a suitable alternating voltage to the grid.

the other electrodes, are normal, the slopes of the characteristics will be altered. As a rough check on the condition of a valve, this is often good enough.

Instruments of this class are comparatively simple in construction, require only meters of a very moderate order of sensitivity, and are easy to use. When mains driven, they consist of little more than a transformer with multi-tapped secondaries for filament or heater supplier and for HT voltages to the other electrodes, a table

Fig. 2 (b), the same  $V_g$  will produce only about 1.5 mA.

To make the point clearer, it will be assumed first, referring to Fig. 4 in conjunction with Fig. 2 (a), that the grid of the valve is not excited from the voltage developed across the coil  $L_1$ , but is kept steady at -9.5 volts, while  $V_a$  is 140 volts. A steady current will flow through the primary of the meter transformer, at 10.5 mA. Since this current is perfectly constant, no voltage is induced across the secondary of the transformer and the

**Instruments—**

meter will, therefore, register zero. Now if the grid is connected to a tap on coil L<sub>1</sub> such that the potential on the grid rises to -8.5 volts, returns to -9.5 volts, falls to -10.5 volts, and returns again to -9.5 volts—as would happen if the voltage developed by this tap on L<sub>1</sub> developed a sine-wave alternating voltage of 1 volt peak to peak (0.707V. RMS)—the current through the transformer primary would no longer be steady; it would start at 10.5 mA, rise with the grid voltage to 12.5 mA, return to 10.5 mA, fall to 8.5 mA, and return again

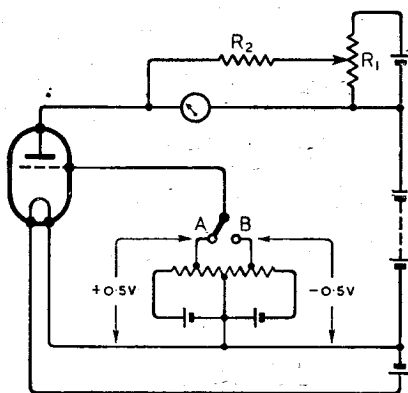

Fig. 5. Circuit showing principle employed in measuring the mutual conductance of a valve with DC power supplies.

to 10.5 mA. That is, an alternating component of a peak to peak value of 4 mA would appear in the current through the transformer primary, and this component would induce a voltage across the secondary that would operate the meter M. Applying the same alternating voltage to the grid of a valve of which the  $I_a/V_g$  characteristic had a less steep slope, as in Fig. 2 (b), would produce an alternating component of less than 3 mA with corresponding smaller effect on the meter.

In practice, of course, a valve tester of this type is mains driven, and L<sub>1</sub> consists conveniently of a winding on the mains power transformer, developing 0.5 volt RMS—i.e., a peak to peak grid voltage swing of 1.4 volts—and the resulting alternating current component occurring in the anode circuit, varying in amount according to the slopes of the valves being tested, is registered on the rectifier-type meter M. Since manufacturers' valve data regarding mutual conductance (which is the slope of the  $I_a/V_g$  characteristic) is normally given with mean  $V_g=0$ , no standing bias need be provided. Tables are provided to enable the testing conditions for each type of

valve to be set up by use of control knobs and switches, and the meter dial may be marked in terms of mutual conductance.

Another type of valve tester measures the slope of the  $I_a/V_g$  characteristic directly—i.e., the actual change in anode current brought about by a change of grid potential of 1 volt is measured. Ingenious use is made of alternating voltage alone, without the complications of providing DC for both anode and grid voltages. Before considering the simplified circuit of this type, given in Fig. 6, the main principle can be grasped by a study of the circuit given in Fig. 5, in which DC is supposed to be employed. The grid of the triode valve that is supposed to be under test is taken to a bias source that can provide a grid potential relative to the filament of either + or -0.5 volt. When the switch connects the grid to 0.5 volt negative, the anode current is a certain  $I_1$  as registered on the meter. If the grid is then switched to 0.5 volt positive—a total change of 1 volt—the anode current will change to  $I_2$ . Then the mutual conductance in terms of mA/V is  $(I_2 - I_1)$  mA per volt.

**Backing-off Circuit**

This simple arrangement, apart from anything else, has one serious snag: if the valve under test is, say, a power output type passing a standing  $I_a$  of the order of 20 or 30 mA, the small change of  $I_a$ —which is the important factor—will not be easily or accurately observed on a meter that is capable of passing such a heavy current. To enable a sensitive meter to be used, therefore, which will be capable of giving a large readable deflection with or change of  $I_a$  of less than 1 mA, a backing-off circuit is provided, formed by a cell, in series with the positive end of the HT battery, with a potential divider,  $R_1$ , across it. The sides of this potential divider is adjusted, with the valve passing anode current when the grid is switched to 0.5 volt negative, so that the voltage developed across the meter (through  $R_2$ ) from this backing-off circuit is exactly equal and opposite to the p.d. set up across the meter itself by the passage of anode current through it. The meter then gives no deflection. As soon, however, as the grid is switched to 0.5 volt positive, the increase of anode current is registered on the meter, since the p.d. across the meter (due to this increase of current becomes greater, whereas the voltage due to the backing-off potential divider remains the same as before. Thus, even a change of a fraction of a milliamp. of  $I_a$  is readily

observed on a sensitive meter without it being affected by the passage of heavy current. The resistance  $R_2$  should be many times greater than the resistance of the meter in order to avoid an excessive shunting effect.

From the foregoing, the operation of the circuit of Fig. 6 can be derived. Referring to this figure the anode voltage is obtained from a HT secondary winding suitably tapped on the mains input transformer, as is the heater or filament supply from another tapped winding. The valve, therefore, only passes anode current during the positive half-cycles of voltage at the anode end of the secondary winding. How much anode current it passes depends on whether the grid is connected by the switch to the "in-phase" or the "out-of-phase" side of the centre-tapped winding (additional to the two previously mentioned), that supplies grid potential. "In-phase" and "out-of-phase" refer to the polarity of the grid potential in relation to the anode potential; i.e., if the grid is positive when the anode end of the HT winding is positive, it is "in-phase" and vice versa.

Assuming, then, that the valve is in position and that suitable anode and filament voltages have been selected by the switches, the procedure is on the following lines: first, the grid is switched to the "out-of-phase" end of the grid voltage winding, say at B:

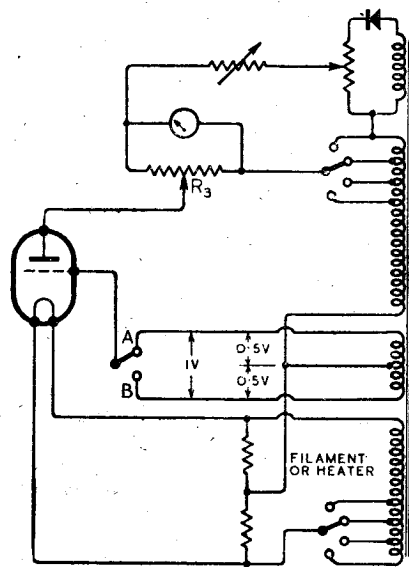

Fig. 6. Simplified circuit of a valve tester using alternating supplies to provide the working voltages for measurement of mutual conductance.

the resulting standing anode current (actually, of course, unidirectional pulses of current each positive half-cycle at the anode end of the HT



secondary) is backed off by the adjustment of the slider of a potential divider across a continuation of the HT winding until the meter registers zero. Then the grid is switched to the "in-phase" end of the grid voltage winding at A; this changes the effective grid potential by 1 volt in the positive direction, and the resulting increase of anode current is registered on the meter. The function of the half-wave rectifier in the backing-off circuit is to prevent a reverse current flowing through the meter during the negative half-cycles in the HT and backing-off windings.

The shunt potential divider R<sub>3</sub> across the meter may serve two purposes. One is to adjust the sensitivity of the meter circuit to suit various mutual conductance constants. The other may be to provide means of showing the state of a valve in a rough but attractive way by colourings or similar devices on the meter scale. The slider of this shunt potential divider is adjusted, by reference to a table or dial markings, to such a position that, if the increase of current brought about by the switching of the grid

from the "out-of-phase" to the "in-phase" connection is normal, the meter is sensitive enough to give nearly a full scale deflection—or, for instance, for the pointer to swing over to a part of the meter scale marked "Good" or coloured brightly. If, however, the increase of current is below normal—indicating a less steep Ia/Vg characteristic, probably due to loss of cathode emissivity—the pointer only swings as far as the "Indifferent" or "Bad" part of the meter scale, or an appropriate colour which much impresses the lay customer, in whose view "meters do not lie"! Plainly, much depends on the accuracy with which the slider on the meter shunt is adjusted.

For the rest, rapidity and ease of preparation for test of many valve testers are facilitated by various forms of semi-automatic switching by means of perforated cards, numbered switches, etc., that also tend to make such instruments almost fool-proof. When a number of valves, of many different types, have to be quickly tested, such devices are of considerable and quite satisfactory service.

## American Morse Symbols

MANY readers of the *Wireless World* booklet "Learning Morse" have enquired about the original code devised by Samuel Morse which was mentioned briefly in the booklet. Although of purely academic interest to the modern wireless operator, it is worth while putting it on record. The

American code was used even for wireless communication up to the time that the United States joined the International Radiotelegraphic Convention and adopted the International Code. Some of the symbols survived much longer in unofficial abbreviations, notably OK (shorter than International) and the "&" sign.

American morse differs mainly from the International code in the fact that spacing between the elements of individual letters plays a more important part. The ordinary dash is equal in duration to three dots; the space between the elements of most letters is equal to one dot. So far this corresponds to the International Code, but in American morse there are five letters (C, O, R, Y, Z) with double spaces equivalent to two dots. There are also two long dashes; the L symbol is 1½ times the length of T and o (zero) is twice the length. All the symbols are shown with their correct relative length and spacing in the accompanying table. Characters that are the same in both the American and International codes are shown in the table by shaded symbols. The code as given here is in the form finally standardised for American internal communications, and has a number of differences from the original version, of which a copy was attached to Morse's application for patent protection in 1837.

THE ALPHABET	
A ■■■	N ■■■■
B ■■■■	O ■■■■
C ■■■■	P ■■■■
D ■■■■	Q ■■■■
E ■■■■	R ■■■■
F ■■■■	S ■■■■
G ■■■■	T ■■■■
H ■■■■	U ■■■■
I ■■■■	V ■■■■
J ■■■■	W ■■■■
K ■■■■	X ■■■■
L ■■■■	Y ■■■■
M ■■■■	Z ■■■■
NUMERALS	
1 ■■■■	6 ■■■■
2 ■■■■	7 ■■■■
3 ■■■■	8 ■■■■
4 ■■■■	9 ■■■■
5 ■■■■	0 ■■■■
PUNCTUATION MARKS, etc	
• Full Stop ■■■■	
, Comma ■■■■	
? Interrogation ■■■■	
! Exclamation ■■■■	
& ■■■■	

In American morse the symbols for certain letters, and also for the "&" sign, contain double-length spaces.



### COME LOVELY FLOWERS

And so it is that from the darkness of the present hour will emerge a brighter day when the brain and brawn of modern industry will be utilised in furthering peacetime products and pursuits. While serving the Government to-day we are broadening both creative and manufacturing possibilities for a happier world to-morrow. Astatic engineers are available to work in co-operation with electronic engineers in the development of new wartime equipment, especially as it may have to do with pickup and transmission of sound. Astatic crystal microphones, pickups, cartridges and recording devices will be available again for your use when those brighter days are here.

Register your name with our Representative for your future benefit.



THE ASTATIC CORPORATION  
YOUNGSTOWN, OHIO, U.S.A.  
TORONTO, CANADA.

Exclusively Represented by  
**Frank Heaver Ltd.** Kingsley Road,  
Bideford, N. Devon

## VARIABLE CONDENSERS —DRIVES— AUTOMATIC TUNERS

WE are designing and building even better equipment with our enlarged, and extended facilities and these improvements will be available for your use when the present struggle is over.

For the time being domestic receiver design and production has ceased but your radio receiver manufacturers will be ready to equip their sets with General Instrument variable condensers, automatic tuners and other G.I. devices as soon as conditions permit.

Always remember General Instruments  
**VARIABLE CONDENSERS—DRIVES  
—AUTOMATIC TUNERS**

Register your name with our Representative now. He will forward you information on our products as soon as they become available.

### THE GENERAL INSTRUMENT CORPORATION

## ELIZABETH, N.J., U.S.A.

Exclusively Represented by  
**Frank Heaver Ltd.** Kingsley Road,  
 Bideford, N. Devon

# MULTIVIBRATOR ACTION

## Principles of Operation

By

EDWARD HUGHES,

D.Sc., M.I.E.E.

THE multivibrator has latterly attained great importance, and much discussion has taken place as to how its principle of action should be presented to students and even as to how it operates, especially as the oscillograms given in several of the most reputable textbooks are misleading and some are incorrect.

It is suggested that the principle of action of the multivibrator should be dealt with after the students have seen the cathode-ray oscillograms referred to below and that the explanation and the derivation of the waveforms should be based upon the waveforms of anode currents in the asymmetrical multivibrator. These waveforms are easily obtained by inserting additional resistances  $R_5$  and  $R_6$ , as shown in Fig. 1. That these resistances have little effect upon the waveforms can be checked by making  $R_5$  and  $R_6$  small and using an amplifier stage on the oscillograph. In practice, it is simpler to use values such as those suggested in Fig. 1, thereby avoiding having to switch over from amplifier to "direct" or vice versa when shifting the oscillograph tappings to the circuit.

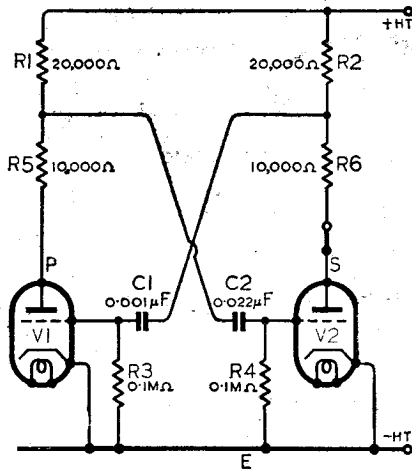

Fig. 1. Circuit of a multivibrator, with additional resistances  $R_5$  and  $R_6$  inserted.

The oscillograms in Fig. 2 are typical waveforms of the PD's across  $R_5$ , etc. It is extremely important that the zero axis should be inserted for each oscillogram. This axis can be obtained by merely disconnecting the HT supply.

Let us first assume that the switch S in the anode circuit of  $V_2$  is open. Anode current flows through  $V_1$ ;  $C_2$

is charged to the PD existing across  $R_5$  and  $V_1$ , and the PD across  $C_1$  becomes equal to the voltage of the HT supply. The various PD's are as represented at instant  $a$  in Fig. 2.

Suppose the switch to be closed at instant  $b$ . The PD across  $R_2$  due to the anode current of  $V_2$  reduces the PD across  $R_6$  and  $V_2$  so that  $C_1$  discharges through  $V_2$  and  $R_3$ , making the grid end of  $R_3$  negative relatively to the cathode end. Consequently, the anode current of  $V_1$  and the PD across  $R_1$  are reduced. The increased PD across  $R_5$  and  $V_1$  sends a charging current to  $C_2$ , making the grid of  $V_2$  positive relatively to its cathode, thereby accentuating the growth of anode current in  $V_2$  responsible for starting the cycle of reactions. The latter, though taking long to describe, occur at such a rate that the anode current of  $V_2$  increases to its maximum and that of  $V_1$  falls to zero simultaneously and practically instantaneously.

The anode current of  $V_1$  remains zero as long as the grid of  $V_1$  remains sufficiently negative. Owing, however, to  $C_1$  being small, it discharges quickly, as indicated by curve L. Also, the PD across PE increases instantly at  $b$ , and would be equal to the HT voltage had it not been for the voltage drop in  $R_1$  due to the charging current of  $C_2$ .

At instant  $c$ , the combination of anode and grid voltages on  $V_1$  is such as to allow anode current to flow, and the reactions, described earlier, follow one another but in the reverse direction. Hence, the anode current of  $V_1$  rises instantly to its maximum while that of  $V_2$  falls to zero equally suddenly. Condenser  $C_2$  now discharges through  $V_1$  and  $R_4$ ; but owing to the time constant of circuit  $C_2$ - $R_4$  being far greater than that of  $C_1$ - $R_3$ ,  $C_2$  discharges comparatively slowly. Consequently, the grid of  $V_2$  is maintained negative for a correspondingly long time, as shown by curve M in Fig. 2. The shape of M is not quite exponential owing to the variation of the PD across  $R_5$  and  $V_1$ .

At instant  $c$ , the PD across SE increases almost instantly to that of the HT supply, any delay being due to the charging current of  $C_1$  flowing through

$R_2$ . But since  $C_1$  is relatively small, this delay is also small. That the PD across SE during interval  $cd$  is equal to the HT voltage can easily be demonstrated by opening switch S.

Let us next consider what is happening at  $V_1$  during the interval  $cd$ . From the oscillogram for the PD across  $R_5$ , we find that at  $c$ , the anode current suddenly grows to its maximum, as explained above, and then falls to a steady value corresponding to X. This transient effect is due to

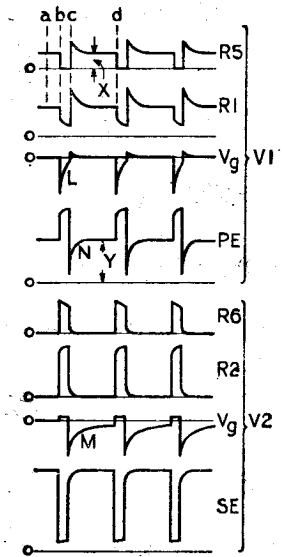

Fig. 2. Typical waveforms as developed by the circuit of Fig. 1.

the corresponding positive potential or the grid of  $V_1$  caused by the charging current of  $C_1$ . As the anode current of  $V_1$  falls to a steady value, the PD across PE increases, as shown by curve N, to a steady value Y. That X and Y represent the corresponding values under static conditions can be checked by opening switch S and noting the deflections when the oscillograph is connected across  $R_5$  and PE respectively.

At  $c$ , the positive potential on the grid of  $V_1$  is accompanied by grid current of such a value that most of the charging current of  $C_1$  flows via the grid. Consequently, the corresponding PD across  $R_3$  is very small; and owing to the smallness of  $C_1$  the latter is quickly charged and the grid-cathode voltage falls to zero accordingly.

At instant  $d$ , the negative grid voltage on  $V_2$  has decreased to such an

**Multivibrator Action—**

extent that anode current begins to flow in  $V_2$ , thereby producing reactions similar to those which occurred when switch  $S$  was closed.

During interval  $bc$ , most of the charging current of  $C_2$  flows as grid current in  $V_2$ , so that the grid potential of the latter becomes only slightly positive. Also, during this interval, the PD across  $SE$  is comparatively small owing to the large voltage drop in  $R_2$  and  $R_6$ .

It will now be evident that the duration of intervals  $bc$  and  $cd$  depends upon the rate of discharge of  $C_1$  and  $C_2$  respectively. Hence, the frequency of the oscillations is determined mainly by the time constants of circuits  $C_1-R_3$  and  $C_2-R_4$ ; while the asymmetry of the oscillations depends upon the relative values of these time

constants. Also, it is seen from Fig. 2 that during the latter part of interval  $cd$ , valve  $V_1$  is operating under static conditions and is just waiting for  $C_2$  to discharge until the grid potential of  $V_2$  has fallen sufficiently for anode current to commence.

We may summarise the above treatment thus: (1) The anode currents of an asymmetric multivibrator can be drawn roughly as complementary rectangles of unequal widths. (2) When the anode current is zero, the grid potential is negative but decreasing at a rate depending upon the time constant of the grid condenser and leak, and the anode-cathode voltage tends to rise to the HT value. (3) When anode current is flowing, the grid voltage may be slightly positive and decreasing, and the anode-cathode voltage tends to rise to its static value.

## European Listeners

### Comparative Figures of Radio Density

THE U.I.R. recently issued a synoptic table drawn up by its Geneva office showing the increase in the number of listeners in Europe and the European zone from 1939 to 1941. One part of the graph shows the number of listeners and the other the radio density in the different countries.

Owing to the exigencies of war it is not practicable to draw comparisons between the totals at the end of 1940 and 1941; an examination, however, of the figures for those countries for which they are available showed, with a few exceptions, that the number of listeners continues to grow.

Germany claims the first place with 15,843,144 listeners, the increase for 1941 being 878,096.

Owing to the fact that details of the listeners in the U.S.S.R. were not available, Great Britain, with its 8,625,579 listeners, which is a reduction of 506,621 on the previous year, is second. The U.S.S.R. had 10,551,361 listeners in 1940 and was second in that year.

France, with its 5,262,642 listeners—an increase of 129,607 on the preceding year—takes third place, with Italy fourth, although having only 1,674,546.

Among the less densely populated countries Sweden, with its 1,550,691 listeners, is first. Its increase of 80,316 is remarkable, since it has the highest figure for radio density in Europe. Then comes Holland, one of the few cases in which there is a decrease, its 1,531,791 listeners being fewer by 8,835 than the year before.

Perhaps the most instructive comparisons can be drawn from the

radio density figures for some of the countries.

Sweden comes first with 243.4 per thousand, followed closely by Denmark with 233.91 per thousand. They compete with each other for the laurels and it is only two years ago that Sweden succeeded in surpassing Denmark. Commenting on these figures in the *U.I.R. Bulletin*, the secretary of the Union points out that the two countries offer an example of the satisfactory results that may be attained by broadcasting under very different geographical conditions. In Denmark, which is comparatively flat, with no great forests, and where the population is dense, one single long-wave station is sufficient to assure good reception everywhere. In Sweden, on the other hand, with its great distances, its many mountains and forests, and its sparsely populated country districts, a different system had to be adopted; its wide-spreading network contains 33 stations, mostly for local reception only. Both countries show an increase in radio density: 11.50 per thousand for Sweden and 8.48 for Denmark.

Next come Great Britain, with a density of 187.51 per thousand, and Germany, with 177.48 per thousand. This is a decrease of 10.19 per thousand for Great Britain and an increase of 11.21 for Germany.

The total number of receivers in Europe at the end of 1941 is given as 51,794,499, an increase of 2,458,447 over the previous year. With an average of four listeners to each receiver the total number of listeners in the European zone was 207,177,996.

# CROWE

RADIO COMPONENTS

ESCUTCHEONS  
TUNING CONTROLS  
DIALS—REMOTE CONTROLS  
POINTERS, ETC

FOR BOTH HOME AND COMMUNICATION EQUIPMENT

The Crowe organisation, now a part of the Arsenal of Democracy, will have available enlarged facilities after the war.

The Crowe plant will again be devoted to the supply of smartly designed and executed dials, dial scales, escutcheons, pointers and the like for radio receiver manufacturers all over the World.

Crowe also manufactures precision tuning devices for Communication Receivers.

Register your name now with our British Representative for details as soon as available of Crowe Products.

**CROWE NAME PLATE & MANUFACTURING CO.**

3701 RAVENSWOOD AVENUE  
CHICAGO, ILL., U.S.A.

Exclusively Represented in Great Britain by  
**Frank Heaver Ltd.** Kingsley Road,  
Bideford, N. Devon

# RAYTHEON

WORLD'S LARGEST  
EXCLUSIVE TUBE  
MANUFACTURER

NEW Electronic developments have created new valve designs. We at Raytheon are indeed fortunate to be placed in the advantageous position of engineering these new intricate designs. Our research engineers have developed special valves to meet the newest of today's electronic developments. We are meeting the demand for valves used in special applications... Raytheon has always been proud of the ability of its engineers to meet any emergency demand for unorthodox valve designs. To-day our pride has been more than justified by the electronic problems they have solved and the quality of the product they are fabricating. When the present conflict is over RAYTHEON engineers will be in possession of priceless electronic experience to build advanced valve designs for better transmission and reception.

Register your name with our Representative now for your future benefit.

**RAYTHEON**  
PRODUCTION CORPORATION  
NEWTON, MASS., U.S.A.

\* \* \*  
Exclusively Represented by  
**Frank Heaver Ltd.** Kingsley Road,  
Bideford, N. Devon

# THE WORLD OF WIRELESS

## BATTERY SUPPLIES

THE President of the Board of Trade was recently asked in the House of Commons if he was aware of the difficulties experienced by people in country districts in obtaining renewals of batteries for wireless sets and what steps he was taking in the matter.

In his reply, Mr. Dalton said that increased Service requirements had led to a temporary decrease in the number of HT batteries for wireless sets available for the public; but steps had been taken to secure a substantial increase in production and an improvement in distribution.

Replying to supplementary questions he announced that two new factories would come into production shortly and that he hoped that the output from these would be available early in the new year.

In an endeavour to improve the present method of distribution the Radio and Television Retailers' Association and the Scottish Radio Retailers' Association have, with the approval of the Board of Trade, devised a scheme of voluntary registration for HT batteries.

A window bill displayed by retailers asks battery set users to register before October 30th with their dealer for future supplies of HT batteries. The notice adds: "Whilst we cannot guarantee supplies we will do our best to see that a battery is available when you require one."

It is pointed out by the R.T.R.A. that whilst a retailer "must not make it a condition of sale to a prospective customer that he must be registered with him" he can, "refuse sale from stocks to any customer if such sale would interfere with arrangements made by him for an orderly disposal of stocks among regular customers."

## PASSING OF POULSEN

NEWS has been received through devious channels that Dr. Valdemar Poulsen, the Danish wireless pioneer, died recently at the age of 63.

In 1903 Poulsen patented the continuous-wave system of telephony transmission based on Duddell's arc which he improved by placing the electrodes in a chamber containing hydrogen, coal gas, alcohol vapour or other gas of high thermal conductive power. Poulsen arc transmitters were installed at two British Post Office stations.

## A VITAL LINK.

Men from headquarters with pack transceiver move-up with a battalion of the Queen's Own Royal West Kent Regiment during a recent combined operations exercise when a successful landing on "enemy occupied" beaches was made.



## AMERICAN VALVE RELEASE

A CONSIDERABLE quantity of American valves, of the types which have for some time been difficult to obtain, are being released through normal trade channels by the Board of Trade solely for replacements in domestic receivers.

After consultation with the Central Price Regulation Committee, the Board of Trade has made an Order (S.R. & O. 1942 No. 1934) which came into force on September 28th, controlling the prices to be charged for these valves, which are imported under the Lease-Lend Agreement with the United States.

Approximately 120 types are listed covering the requirements of midget AC/DC receivers, "all-dry" battery portables, as well as the larger domestic receivers and radiogramophones. Most are of the international octal type, but there is a representative selection of UX valves, including the 43 output-pentode and the type 80 rectifier. Retail prices (including purchase tax) range from 9s. 2d. for simple triodes to 18s. 3d. for power output valves such as the 6L6. Frequency changers average 14s., RF pentodes 12s. 10d., and power rectifiers 11s.

## NEW I.E.E. PRESIDENT

IN his inaugural address, delivered on October 1st, Prof. C. L. Fortescue, O.B.E., M.A., the new President of the Institution of Electrical Engineers, pleaded that all engineers should study social, political and economic questions. By doing so, they would be able to play their part in bringing about better social organisation and a better industrial system in the post-war world.

Prof. Fortescue, who is professor of

electrical engineering at the City and Guilds College, South Kensington, was, from 1911 to 1922, professor of physics at the Royal Naval College, Greenwich. He has undertaken valuable research in the development of wireless telegraphy and has published his findings in a number of papers read before the Institution.

The retiring president, Sir Noel Ashbridge, Director of Engineering of the B.B.C., announced that Lord Hirst of Witton (Chairman of the G.E.C.) had given £20,000 for the use of the I.E.E. Benevolent Fund.

## RECEIVER MAINTENANCE

TWO questions have been raised in the House of Commons during the past month on the difficulties of receiver maintenance.

The Minister of Labour was asked in view of the essential nature of wireless sets in wartime whether he would exempt skilled radio service-men from further call-up in order that they might cope with the large number of sets requiring repairs.

Mr. Bevin, in reply, said: "I appreciate the importance of making provision for the maintenance of wireless receiving sets. Applications for deferment in respect of wireless repairers or mechanics are granted to the extent necessary to ensure adequate servicing facilities in the locality. Men not granted deferment are either called up for the Services in their trade capacity or are transferred to other work in their own occupation."

Subsequently the President of the Board of Trade was asked "whether, in the national interest and by arrangement with the appropriate trades, he would set up official wireless repair shops in each district to which



all sections could have access, and where spares, irrespective of make or origin, could be obtainable at reasonable prices or repairs carried out with more expedition than was at present possible." Capt. Waterhouse, the Parliamentary Secretary to the Board of Trade, said that the President had no evidence to show that the existing arrangements did not give as good service to the public as the limited resources of labour and components permitted. He was, therefore, unable to accept the suggestion.

### ASPECTS OF MODULATION

AT the first meeting of the 1942-43 session of the British Institution of Radio Engineers, Dr. James Robinson, vice-president of the Institution, delivered a paper on "Aspects of Modulation." He reviewed and compared methods employed to increase the efficiency of our use of the ether, from the point of view of accommodating the greatest number of communication channels in the available spectrum.

Dr. Robinson discussed beam transmission, which effected an economy in a geographical sense; single-sideband transmission, which effected a 50 per cent. saving in the spectrum with a considerable economy in transmission power; and suppressed carrier transmission, which was not suitable for general broadcasting work. He added that he did not think the answer lay in wired broadcasting.

The relative merits of amplitude modulation and frequency modulation occupied the major part of the paper, with special reference to the author's "Stenode" system as applied to transmission and reception; the demodulation of a weak signal by a strong one at the detector was explained in detail.

### CANADA'S S-W STATION

FOR many months frequent requests have been made in the Canadian House of Commons for the establishment of a powerful short-wave broadcasting station in the Dominion.

It is now announced that the Government has authorised the Canadian Broadcasting Corporation to erect as soon as possible a high-power station at Sackville, New Brunswick, at the estimated cost of \$800,000. The purpose of the station, the proposed power of which is 50 kilowatts, is to provide a means of counter-attacking Axis propaganda.

When the Government Radio Committee were investigating the proposal it was pointed out that the nine short-wave channels allocated to Canada at the 1939 Cairo Conference are now in use by other countries.

### N.B.C. LONDON REPRESENTATIVE

THE U.S. National Broadcasting Company recently announced the appointment of Stanley Richardson as director of its London office. Eighteen months ago Mr. Richardson was appointed co-ordinator of international broadcasting, and in that position he represented the six American international short-wave broadcasting companies, acting in a liaison capacity between them and the United States Government. He was granted six months' leave of absence from that post to act as adviser to the U.S. director of censorship on the censoring of material transmitted by short waves.

It is not without significance that Mr. Richardson has had a very wide diplomatic experience, for prior to his appointment as co-ordinator of international broadcasting he had served with the U.S. Embassies in a number of countries.

### IN BRIEF

#### Post-war Television and FM

THE recently re-elected chairman of the U.S. Federal Communications Commission, James Fey, stated that he had the greatest hopes that both television and FM would be important factors in staving off any possible depression in the industry in the post-war years. He further stated "Both the FM and television fields are now set for unlimited commercial expansion immediately after the war. There is already one FM network and the linking of television stations into one or more networks is clearly foreshadowed."

#### Official News in Morse

ALTHOUGH no changes have been made in the schedule of the transmissions of official news bulletins radiated in morse from the Post Office stations since the last published details, the schedule is repeated for the convenience of those concerned with the reception of the bulletins. The call signs and the wavelengths employed for these transmissions, which are intended for oversea, are:—

GIA: 15.27 m.	GIH: 28.17 m.
GAD: 15.40 m.	GAY: 33.67 m.
GBL: 20.47 m.	GBR: 18.750 m.
GID: 22.13 m.	

The times (GMT) of the transmissions and the transmitters used are:—

0930: GBR, GIA, GID, GIH.
1200: GBR, GAD, GIA, GID.
1600: GBR, GAD, GIA, GID.
1930: GBR, GAY, GBL, GID.
2330: GBR, GAY, GIH.

#### Servicing Certificates

AN agreement has been concluded between the Brit.I.R.E., the R.T.R.A. and the Scottish R.R.A. for the formation of a Radio Trade Examination Board for the purpose of holding half-yearly radio servicing examinations and awarding certificates.

#### I.E.E. Meetings

THE chairman of the I.E.E. Wireless Section, Dr. R. L. Smith-Rose, will de-



The "Fluxite Quins" at work

"I shall have to climb down!" OI yelled out,  
"Sixty feet to the ground—just about."

Said EH in his ear,

"Here's the FLUXITE—don't fear,  
Just stay where you are—you young scout."

See that FLUXITE is always by you—in the house—garage—workshop—wherever speedy soldering is needed. Used for 30 years in Government works and by leading engineers and manufacturers. Of Ironmongers—in tins, 4d., 8d., 1/4 and 2/8.

Ask to see the FLUXITE SMALL-SPACE SOLDERING SET—compact but substantial—complete with full instructions, 7/6.

Write for Free Book on the art of "soft" soldering and ask for Leaflet on CASE-HARDENING STEEL and TEMPERING TOOLS with FLUXITE.

TO CYCLISTS! Your wheels will NOT keep round and true unless the spokes are tied with fine wire at the crossings AND SOLDERED. This makes a much stronger wheel. It's simple—with FLUXITE—but IMPORTANT.

## THE FLUXITE GUN

puts Fluxite where you want it by a simple pressure. Price 1/6, or filed 2/6.

FLUXITE LTD.

(Dept. W.V.),  
BERMONDSEY  
STREET, S.E.1.

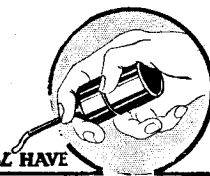

ALL MECHANICS WILL HAVE

# FLUXITE

IT SIMPLIFIES ALL SOLDERING

**World of Wireless—**

liver a paper jointly with Miss A. C. Stickland, M.Sc., at the meeting of the Section on Wednesday, November 4th, at 5.30 p.m. The subject will be "A Study of Propagation over the Ultra-Short-Wave Radio Link between Guernsey and England on wavelengths of 5 and 8 metres." At the Informal Meeting on Tuesday, November 17th, at 5.30 p.m., a discussion on "Plastics in Radio Production" will be opened by C. C. Last.

**Radio-Mindedness**

ACCORDING to statistics issued by the National Broadcasting Company, 13,800,000 sets were purchased by Americans during 1941. It is further estimated that there are more than 56,000,000 receivers in use in the country, where 90 per cent. of the houses have receivers. This is stated to be more than twice the percentage of houses fitted with baths!

**U.S. Soldiers' Portable**

AMERICAN soldiers have been equipped by the Special Service Branch of the U.S. Army with a portable "radio-phonograph-library kit." Each of these kits contains a medium- and short-wave receiver, a gramophone turntable with electric and acoustic pick-ups, 50 gramophone records, 25 half-hour transcriptions of sponsored broadcast programmes and a collection of books. A set of spare batteries and valves is included in the kit which, contained in a wooden case, weighs 250lb. The gramophone is spring-driven and runs for 15 minutes with one winding.

**A Hardy Annual**

THE *Wireless World Dairy and Reference Book* for 1943, which includes much useful data, is now on sale. Our publishers inform us that supplies are limited and readers are, therefore, advised to obtain their copies without delay from stationers, booksellers, or bookstalls. The price, including purchase tax, is 3s. 1d.

**Empire News Bulletin**

NEWS in English is transmitted in the B.B.C. short-wave Empire Service at the following times (BST) and in the wavebands listed:—

0200 : 31, 25.	1600 : 31, 25, 19, 16.
0345 : 49, 31, 25.	1800 : 31, 25, 19, 16.
0530 : 49, 41, 31.	2045 : 31, 25, 19.
0715 : 41, 31.	2145 : 49, 41, 31.
0900 : 49, 41, 31, 25.	2345 : 31, 25.
1200 : 25, 19, 16.	2345 : 31, 25.

**I.E.E. Premiums**

CERTIFICATES for the three Wireless Section Premiums for papers during the 1941-42 I.E.E. session were presented at the last meeting. The Duddell premium (£20) was awarded to O. S. Puckle for his paper "Time Bases." Dr. D. C. Espley and D. O. Walter received the £10 Ambrose Fleming premium for their paper "Television Film Transmitters Using Apertured Scanning Discs." Another £10 premium was awarded to J. E. Thwaites and F. J. M. Laver for their paper "The Technique of Frequency Measurement and its Applications to Telecommunications."

**Brit. I.R.E.**

L. H. BEDFORD will deliver a paper on "Theory of Units" at the meeting of the Brit. I.R.E. on October 23rd at 6.30 p.m.

**Appointments**

THE name of Sir Lawrence Bragg, Cavendish Professor of Experimental Physics at Cambridge, and chairman of the Institute of Physics, appears among those of four scientists who have been appointed by the Lord President of the Council to the Department of Scientific and Industrial Research.

Sir Robert Renwick has been appointed to take charge of all questions of telecommunications equipment at the Ministry of Aircraft Production with the title of Controller of Communication Equipment. Sir Robert Watson Watt will assist him and has been appointed vice-controller. They both hold similar appointments at the Air Ministry.

H. J. Allcock has been appointed Director General of Communication Equipment at the Ministry of Aircraft Production. He was formerly process manager in Callender's Cable and Construction Co.

Sir Edward Wilshaw, K.C.M.G., chairman and managing director of Cable and Wireless, has been appointed to the board of Marconi's Wireless Telegraph Company of Egypt, S.A.

**Resignation**

SIR FRANK SMITH has resigned his position as Controller of Telecommunications Equipment at the Ministry of Aircraft Production, which he has held for the past two years.

**Record Salvage**

THE closing date of the Record Salvage Campaign organised by the British Legion is advanced to October 31st.

**NEWS IN ENGLISH FROM ABROAD**

REGULAR SHORT-WAVE TRANSMISSIONS

Country : Station	Mc/s	Metres	Daily Bulletins (BST)	Country : Station	Mc/s	Metres	Daily Bulletins (BST)
<b>America</b>				<b>Sweden</b>			
WNBI (Bound Brook)	17.780	16.87	2.0†, 2.45‡, 4.0§, 6.0.	SBU (Motala)	9.535	31.46	10.20.
WRCA (Bound Brook)	9.670	31.02	7.0 a.m., 9.45 a.m.	SBT	15.150	19.80	4.0.
WRCA	15.150	19.80	2.0†, 2.45‡, 4.0§, 6.0.	<b>Turkey</b>			
WGEO (Schenectady)	9.530	31.48	9.45 a.m., 9.0†, 10.55‡.	TAP (Ankara)	9.465	31.70	8.15.
WGEA (Schenectady)	15.330	19.57	2.0, 3.0, 7.45‡, 11.0.	<b>U.S.S.R.</b>			
WBOS (Hull)	11.870	25.27	12.45 a.m.†, 12.0 mdt.	Moscow	5.890	50.93	11.0.
WBOS	15.210	19.72	2.0†, 2.45‡, 4.0§, 6.0.		6.970	43.04	11.45.
WCAB (Philadelphia)	6.060	49.50	6.0 a.m.		7.300	41.10	8.0, 9.0, 10.0, 11.0.
WCBX (Wayne)	15.270	19.65	11.30 a.m., 3.30, 7.30†, 9.30.		7.360	40.78	11.0.
WCRC (Wayne)	11.860	25.30	11.30 a.m., 3.30, 7.30†, 9.30.		7.560	39.68	11.0.
WCW (New York)	15.870	18.90	3.0, 4.0, 5.0, 6.0, 7.0, 8.0, 9.0, 10.0.		9.390	31.95	4.0.
WRUL (Boston)	11.790	25.45	9.30‡, 11.45§.		11.830	25.36	4.0, 6.0.
WRUL	17.750	16.90	3.0‡, 3.45‡.		15.110	19.85	2.15 a.m., 12.40, 11.45.
WLWO (Cincinnati)	6.080	49.34	6.0 a.m., 7.0 a.m.		15.180	19.76	12.40, 11.45.
WLWO	11.710	25.62	7.0, 8.0, 9.0, 10.0.		15.230	19.70	2.15 a.m., 11.45.
WLWO	15.250	19.67	3.0, 4.0, 5.0.		15.270	19.65	12.40.
<b>Australia</b>					15.750	19.05	1.0 a.m., 2.0 a.m., 11.45.
VLQ6 (Sydney)	9.580	31.32	8.0 a.m.	Kuibyshev	8.050	37.27	8.33.
VLG6 (Melbourne)	15.230	19.69	8.0 a.m.		13.010	23.06	6.0 a.m., 2.0, 2.45.
<b>China</b>					14.410	20.82	2.0, 2.45.
Chungking	11.900	25.21	2.0, 4.0, 5.15, 10.30.	<b>Vatican City</b>			
<b>French Equatorial Africa</b>				HVJ	5.970	50.25	8.15.
FZI (Brazzaville)	11.970	25.06	8.45.	<b>MEDIUM-WAVE TRANSMISSIONS</b>			
<b>India</b>				<b>Ireland</b>			
VUD4 (Delhi)	9.590	31.28	9.0 a.m., 1.30, 4.50.	Radio Eireann	565	531	1.40‡, 6.45, 10.0.
VUD3	11.830	25.36	1.30.				
VUD3	15.290	19.62	9.0 a.m.				

It should be noted that the times are BST—one hour ahead of GMT—and are p.m. unless otherwise stated. The times of the transmission of news in English in the B.B.C. Short-wave Service are given at the top of this page.

\* Saturdays only.      † Saturdays excepted.      ‡ Sundays only.      † Sundays excepted.

# LETTERS to the EDITOR

# VORTEXION 50w. AMPLIFIER CHASSIS

## Player-Piano v. Gramophone

WHILE gratefully acknowledging the tribute to my versatility paid by "Free Grid" in the October issue, I must correct his references to my "too-long-disused pen" and the length of memory necessary to recall my contributions to your esteemed journal. Leading psychologists are well aware of the egoism to which prominent authors are prone, manifesting itself in such ways as reluctance to read any other writings than their own. This may, indeed, be the "psychic factor" to which "Free Grid" himself alludes, and which under the subconscious influence of a sex inversion complex he attributes to an undoubtedly imaginary lady. There may, of course, be other influences, induced by war conditions, which cause "Free Grid" to be unaware that as recently as the previous month I appeared in your pages as a member of the *Wireless World* Brains Trust; while a little earlier I participated in a heated dog-fight on the "Valve Equivalent Circuit."

The theory that "Free Grid" is the victim of grave mental perturbations is strengthened by the nature of the problem which he invites me to consider, namely, the reason for the reproduction of a player-piano being better than that of an exceptionally well-designed gramophone. If "Free Grid" has been less zealous than myself in contributions to paper salvage collections he may be able to check the precise wording of a statement due, I believe, to no less an authority than Sir James Jeans, that "pianist's touch," such an important part of the *ck-in-trade* of concert promoters, is *not* bunk, and that exactly the same result is produced whether the sounding of a note on the pianoforte is due to the finger of Moiseiwitsch or the tail of an ape, or even the dropping of an inanimate body on the key from the correct height.

Assuming that the player-piano has been properly designed, therefore, and the record properly made, the result should be indistinguishable from that produced by the same instrument played by the live pianist; and stereo-phony, scale distortion, and whatnot, do not enter into the subject at all.

On the other hand, a whole chain of processes is interposed between the original performance and reproduction from a gramophone, which as a source of sound normally differs in shape and size from a piano.

"CATHODE RAY."

## Classification of Frequencies

UNCERTAINTY often arises over the use of expressions such as "low-frequency waves," "HF waves," "ultra-short waves," since the significance of such terms must always depend to some extent on the context and on the instantaneous state of development of the art. I suggest that greater clarity might be attained by the adoption of a numerical reference system on the lines of, though not necessarily identical with, that given below:—

Frequencies from 1 cycle per sec. (inclusive) to 10 cycles per sec. (non-inclusive): Range 0.

Frequencies from 10 (inclusive) to 100 (non-inclusive): Range 1.

Frequencies from 10<sup>6</sup> (inclusive) to 10<sup>7</sup> (non-inclusive): Range 6.

This reference system can be extended whenever technical developments demand it, without a hectic search for "hypers," "supers," etc. Southall, Mddx. D LOMAN.

## Electrolytic Condensers

YOUR contributor W. H. Cazaly, in his article on "Instruments" in the October issue, implies that the relatively high power factor of electrolytic condensers is due to their leakage current. This is not entirely true, as a simple calculation will show.

Imagine a good quality mica condenser of capacity 10  $\mu$ F and power factor 0.0003 (a normal value for mica). Now suppose it be shunted by a 5 megohm resistance to give a leak of 0.1 mA at 500 V, as might reasonably be obtained with a 10  $\mu$ F electrolytic condenser. The effect on the power factor at 50 c/s will be merely to increase it to 0.000364. Even if the condenser be shunted by 50,000 ohms to give a leak of 10 mA at 500 V, i.e. 100 times greater than might reasonably be expected of a good electrolytic condenser, the power factor would only be 0.00667, still only about one-tenth of the normal figure.

Actually, the power factor of an electrolytic condenser is largely due to the series resistance of the electrolyte, which explains why the power factor increases rapidly with frequency.

J. H. COZENS.

Research Department,  
Telegraph Condenser Company.

## Hearing Aids

THE article in your October issue on "Types of Deafness" gives a broad classification of the physical aspects of

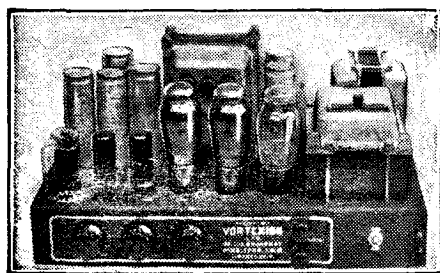

A pair of matched 6L6's with 10 per cent. negative feed-back is fitted in the output stage, and the separate HT supplies to the anode and screen have better than 4 per cent. regulation, while a separate rectifier provides bias.

The 6L6's are driven by a 6F6 triode connected through a driver transformer incorporating feed-back. This is preceded by a 6N7, electronic mixing for pick-up and microphone. The additional 6F5 operating as first stage on microphone only is suitable for any microphone. A tone control is fitted and the large eight-section output transformer is available in three types:—2-3-15-30 ohms; 4-15-30-60 ohms or 15-60-125-250 ohms. These output lines can be matched using all sections of windings and will deliver the full response (40-18,000 c/s) to the loud speakers, with extremely low overall harmonic distortion.

- CHASSIS with valves and plugs ..... £17 10 0
- Moving Coil Microphones ..... £5 5 0
- Chromium Microphone Stands, 'rom ..... £1 5 0

Many hundreds already in use

## 15w. AC & 12-VOLT DC AMPLIFIER

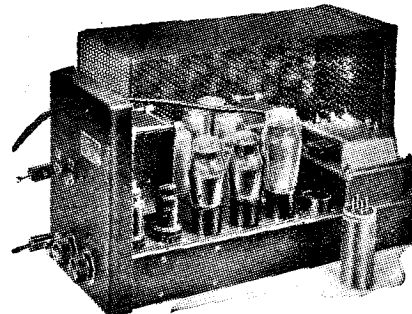

TYPE CP20

This small Portable Amplifier operating either from AC mains or 12-volt battery, was tested by the "WIRELESS WORLD," October 1st, 1937, and has proved so popular that at customers' demand it remains unaltered except that the output has been increased to 17.2 watts and the battery consumption lowered to 6 amperes. Read what the "Wireless World" said:—

"During tests an output of 14.7 watts was obtained without any trace of distortion so that the rating of 15 watts is quite justified. The measured response shows an upper limit to 18,000 c/s and a lower of 30 c/s. Its performance is exceptionally good. Another outstanding feature is its exceptionally low hum level when AC operated even without an earth connection. In order to obtain the maximum undistorted output an input to the microphone jack of 0.037 volt was required. The two independent volume controls enable one to adjust the gain of the amplifier for the same power output from both sources, as well as superimpose one on the other or fade out one and bring the other up to full volume. The secondary of the output transformer is tapped for loud speaker or fine impedances of 4, 7.5 and 15 ohms. Prices

- AC and 12-volt CHASSIS with valves, etc. . . . £12 12 0
- AC only CHASSIS with valves, etc. . . . . £8 18 6

Gauze Case for either chassis, 12/6 extra.

Plus 25% War increase on all above prices.

Orders can only be accepted against Government Contracts

Vortexion Ltd., 257, The Broadway,  
Wimbledon, S.W.19. Phone: LIBerty 2814

## Letters to the Editor—

deafness. While it advocates co-operation with the medical profession it says nothing of the dangers of non-co-operation mentioned in Mr. Jowitt's letter (August) and by "Diallist" (October).

What is the degree of these dangers?

Those who claim that deaf aids should not be distributed through the wireless dealer have still to show that their views are justified by a material number of deaf people being liable to use dangerously unsuitable aids.

The automatic volume control of the ear itself is a safeguard against unexpected and transient noise. I believe that continual exposure to noise of excessive volume will destroy the power of hearing the frequencies used. Can the hearing ever be endangered in this way without the threshold of pain being reached? Does the threshold of pain not warn the patient in the dangerous cases in question?

If it does, the case for restriction of trading rights to "oticians" is gravely weakened, although some such qualification would still be desirable on its merits.

JOHN A. HAMILTON.

Peterculter, Aberdeenshire.

## B.S.R.A. Activities

MAY I beg a little space to deny a rumour which has reached me from various sources to the effect that the British Sound Recording Association is now entirely defunct?

Since 1940 it has not been possible to hold any meetings or arrange visits, etc., but the Association still acts as a clearing-house for information on aspects of sound recording by all known systems, and its members maintain contact through correspondence. Reports of any activities and publications have appeared in the technical Press, e.g., *The Electrician* and, through your courtesy, in *Wireless World*. Present research in the field of plastics holds some promising developments for sound-recording media when it is permissible for the details to be released.

All communications should be addressed to me at "Strathdee," Studley Road, Torquay, and, if from a non-member requiring a reply, please enclose postage. If this letter should catch the attention of Member C. L. Appleby (believed R.A.F., number 1258460), please do not fail to get in touch. DONALD W. ALDOUS.

Technical Secretary, B.S.R.A.

bases appear on the screen. The degree of split can be regulated by a knob, and, if you wish, you can use one part of the beam to show a voltage wave-form, and the other to form a horizontal reference or zero line. I used the CRT a good deal before the war, both for valve work and for adjusting my short-wave and broadcast receivers. But I'm determined to use it a great deal more when peace returns, and one of the first jobs I've promised myself when I can get my workshop going again is the making of a top-notch cathode-ray oscilloscope.

## Exact Results

To take one example: You remember how in making up circuits we used (possibly after working out impedances and time-constants, possibly not!) to try combination after combination of resistances and condensers until the best result appeared to have been achieved. It was a matter of trial and error, with too much guesswork about it. With the CRO there's no guesswork. You can see what you're getting both in and from the circuit. Not only that, but you have a ready and accurate means of determining the quality and the condition of most of the radio components in your stock. If, by the way, you're not *au fait* with the CRT and CRO, and would like to know more about them, there's an excellent and simply written little book, "The Cathode Ray Oscilloscope," by W. E. Miller,\* that I can thoroughly recommend.



## The Call-up

MR. BEVIN has admitted the importance of maintaining broadcast receivers to the extent of undertaking that deferment of call-up will be granted to service-men who are necessary to ensure "adequate servicing facilities in the locality." But he has not promised that no more service-men will be called up, which is, to my mind, somewhat disquieting. Surely there are few enough left already. The needs of the Services must, of course, come first, and there's no doubt that men with a knowledge of radio equipment are required in large numbers. But all three Services have their own training arrangements, which have been working since the early days of the war, and by means of which a steady stream of men (and women) with the necessary specialised training in Navy, Army and Air Force equipment is always flowing in. My own experience, for what it is worth, is that, so long as care is exercised in

\*Published by Iliffe & Sons; 2s. 6d.; by post 2s. 8d.

## RANDOM RADIATIONS By "DIALLIST"

## The Wonderful CRT

WHAT a marvellous thing the cathode-ray tube is! And yet, like not a few other wonder-working appliances, it's a perfectly simple affair. Just a combination of heater, cathode, coated grid, anode assembly, a couple of pairs of plates and a fluorescent screen; it's not so complicated in its make-up as some valves. But think of its uses. It is, of course, the heart and soul of the television set, and in the laboratory, besides providing the fastest and most accurate of stop-watches, it has probably done more to further the study of the behaviour of condensers, inductances, rectifiers, detectors, oscillators and amplifiers than any other single instrument. It is one of the good radio service-man's chief standbys, and in the lecture room there's nothing to equal it as a demonstrator of the truth of formulæ and theories. The other day I saw a most elaborate and useful CRT set-up for training purposes. A medium-sized soft tube, giving a trace of considerable brilliancy, was connected to an ingenious and pretty complicated switchboard, which had been built up gradually in five or six years as more and more new uses for the CRT as demonstrator were found.

## So Simple!

With this instrument in use there is never any need to draw valve curves on the blackboard—in fact, its originator told me that he had first installed it in self-defence to meet the needs of the moment when the establishment found itself short of blackboard chalk! Tetrode curves? In goes a screen-grid to the heater holder. Flick! And as the heater warms up the anode-volts/anode-current curve spreads over the screen. Flick! The screen-volts/screen current curve takes its place. Put in a pentode, and flicks demonstrate the constant-current properties of this valve. Rectification? In goes a single diode, and first we see the 50-cycle AC input. Then comes unsmoothed output, and, as condensers, resistances and chokes are switched in, the ironing out of the rectified current is convincingly demonstrated. And so it goes on, with almost unlimited possibilities.

## Split Beam

Do you, I wonder, know the double-beam CRT? That is an even better instrument for certain demonstration purposes. By means of a splitter plate the horizontal beam is divided into two, so that a pair of horizontal time-

the choice of trainees (and I can assure you that, it is exercised), it doesn't matter enormously whether or not they had wireless experience in civil life or not. I've mentioned before that some of the best radio men I've come across in the Army had never done more in that way in civil life than the twiddling of the knobs of a broadcast receiver. Now, in wartime it's a matter of extreme difficulty to train men to keep civilian wireless receivers in order, for neither the men to conduct the training nor the facilities for doing it are readily found. It's also of vast importance that the authorities should be able to keep in touch with the civil population through the medium of the broadcasting stations. Therefore, I maintain that they should think twice before they thin further the already depleted ranks of those who repair and adjust the receivers of John Citizen.



**American Valves Again**

'TIS good to learn that the importation of a certain number of American valves of various widely used types is to be allowed again. When the war broke out there were thousands of American sets in use in the country, and as time went on two things happened: their valves wore out and the importation of new ones from the States to replace them was prohibited. The result was that large numbers of these sets either went out of commission or could be re-valved only at very high cost. At one time certain types of U.S.A. valves were selling at several times their cost price. The number of imported valves won't be large, but it will be sufficient to ease the position; and, as prices will be strictly controlled, the cost of replacements should not be too stiff. It may be some little time before supplies find their way on the market, but they'll come along all right, and many a set now silent will find its voice again. Let's hope that one outcome of the war will be not only a thorough purge of our own super-abundant valve types; but also a getting together with the United States valve industry for the adoption of similar types in both countries.

**GOODS FOR EXPORT**

The fact that goods made of raw materials in short supply owing to war conditions are advertised in this journal should not be taken as an indication that they are necessarily available for export

**COMMUNICATIONS DEPEND....**

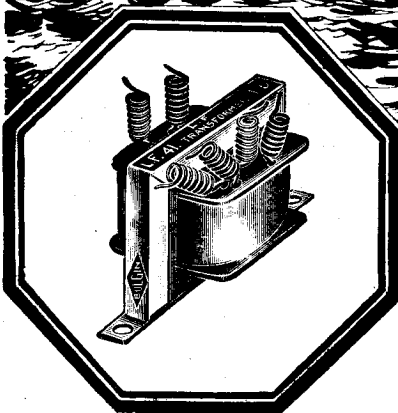
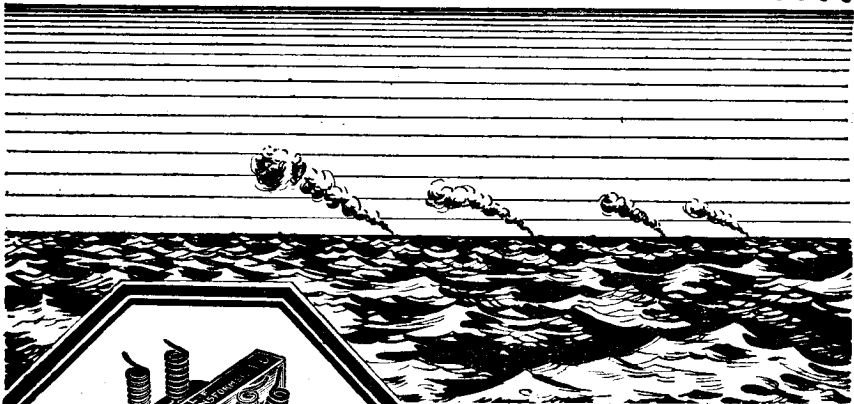

**ON SMALL PARTS....**

IN countless instances quite intricate pieces of apparatus are wholly dependent on the proved reputation and reliability of their component parts.

*The Choice of Critics*

**BULGIN FOR TRANSFORMERS**

THE largest and most extensive range of midget and ultra small intervalve (voltage) transformers in the world. Provided with high- $\mu$  cores and carefully proportioned windings of finest enamelled-copper wires. All joints welded; mono-metallic from start to finish for long life under all conditions.

All products from the House of Bulgin are pre-eminent for superior design and workmanship and every article bearing our Trade Mark has to pass exacting and exhaustive tests during the course of its production.

We ask the kind indulgence of the Trade on delivery until peaceful conditions return.

**"The Choice of Critics"**

**BULGIN**

REGISTERED • TRADE • MARK

A. F. BULGIN & CO. LTD., BY-PASS RD., BARKING, ESSEX.  
TEL.: RIPPLEWAY 3474 (4 lines).



# UNBIASED

By

## FREE GRID

### Relativity and Radio

MY recent note in which I endeavoured to bring home the great truth that time and space are infinite has resulted in my being deluged with acrimonious correspondence. Certain so-called scientists who have written—some holding the degree of D.Sc.—do not even seem to have heard of Einstein or Relativity. They question my views that each atom with its extraordinary resemblance to the solar system is in actual fact a solar system with intelligent beings dwelling on its satellite planets or electrons, the conglomeration of atoms which go to make up matter being galactic systems like our own "milky way."

The stumbling block to their apparently finite minds is that each time we smash up such sub-atomic stellar systems as, for instance, when we drop a brick, we suddenly, in the twinkling of an eye, smash up whole worlds and their inhabitants and we are doing this every day. It is quite evident that they neither understand nor appreciate the grandeur of the whole idea of relativity. To the inhabitants of one of these worlds which we destroy, one of our minutes represents countless ages of time. The travel of one of their worlds around its orbit, although taking but a split micro-second to us, represents a full year on the sub-atomic scale.

Similarly, of course, our old earth and the solar system to which it be-

longs, represents merely an atom of the chalk or cheese of a vast world, utterly beyond our comprehension, and the æons during which our world and its inhabitants have slowly and painfully evolved from the primitive nebula which gave us birth represent but the tick of a clock in this mightier world of which we form part, and so *ad infinitum*.

Lest it be thought that we on this earth are a sort of half-way house between these universes consisting of the inconceivably small and the unimaginably large, I would point out that this is impossible since if a thing has neither beginning nor ending, it obviously cannot have a middle or half-way house. Swift undoubtedly had a glimmering of the truth when he wrote "Gulliver's Travels." As will be seen from my illustration, another writer seems to have had somewhat similar ideas to mine nigh on ninety years ago.

### Rampant Radio Ramp

THE radio industry has been singularly free from the racketeering ramps which beset other great industries. It is true, of course, that it has not been entirely free; indeed, at one time "Radio Ramp" was quite a familiar title of a news item in the daily Press. But this, of course, only goes to show how comparatively rare they were. Ramps in other industries have always been so commonplace that they have been on a par with "dog bites man," and did not constitute news. It is only when a man bites a dog, or, in other words, when there is a ramp in the radio industry that it constitutes news worthy of an honourable mention in our great dailies.

Unfortunately, the great valve famine has resulted in one of these rare radio ramps rearing its ugly head. But the racketeers are at least carrying out their project with a degree of finesse well worthy of wireless men, knowing full well that such a blatantly vulgar and unscientific thing as a black market in valves would be entirely out of keeping with the traditions of radio. Their *modus operandi* is delightfully simple.

Supposing, as some of you must have done, you have trudged wearily round to all the radio dealers in search of a valve replacement. You are for the most part met with a sorrowful shake of the head, with here and there an offer to put your name on the waiting list which, like a woman's minute, is practically endless. Suddenly, however, your whole world changes from the drab and dirty grey of Manchester in a November fog to the glory of a "rosy-fingered dawn arising from the wine-coloured sea," as one of "Diallist's" friends so succinctly puts it, and like the same gentleman you cry "Eureka!"

The dealer actually has a valve and, what is more, the price he is asking is no ramping overcharge but the official figure. But the dealer is adamant in his refusal to let you have it unless he has your set in for "test"

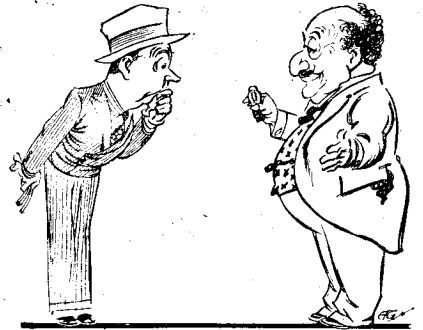

"Eureka!"

for, as he very reasonably explains, in these days of valve shortage it would be very unfair to other valve users to risk the precious valve being wasted as would be the case if your set had developed some defect like a broken down smoothing condenser, which spells speedy death to the mains rectifier, that scarcest of valves, rarer than rubies and more precious than pearls.

Now all this may, and often does, happen in the case of a perfectly honest dealer, and it is only when you get the bill for the "test" and "necessary repairs" that you can distinguish between the two, for the racketeers' charge can only be compared in breath-taking nerve with that of the Light Brigade at Balaclava. But don't be misled into condemning an honest dealer for the modest charge he makes for his services. After all, you know, dealers do eat, although I will admit that, judging by the amount of stuff they get to sell nowadays, it is a marvel how they manage to do it.

**SCIENTIFIC CERTAINTIES**

OF

**Planetary Life:**

OR,

**NEPTUNE'S LIGHT AS GREAT AS OURS,**

WITH

VARIOUS OTHER HITHERTO UNCONSIDERED FACTS CONNECTED WITH THE RESIDENCE OF MORAL AGENTS IN THE WORLDS THAT SURROUND THE STARS.

**By T. C. SIMON,**

AUTHOR OF "THE MISSION AND MAINTENANCE OF ST. PETER,"  
"THE NATURE AND ELEMENTS OF THE INTERNAL WORLD,"  
ETC.

LONDON:

T. BOSWORTH, 215, REGENT STREET.

1855.

Evidence from the past.

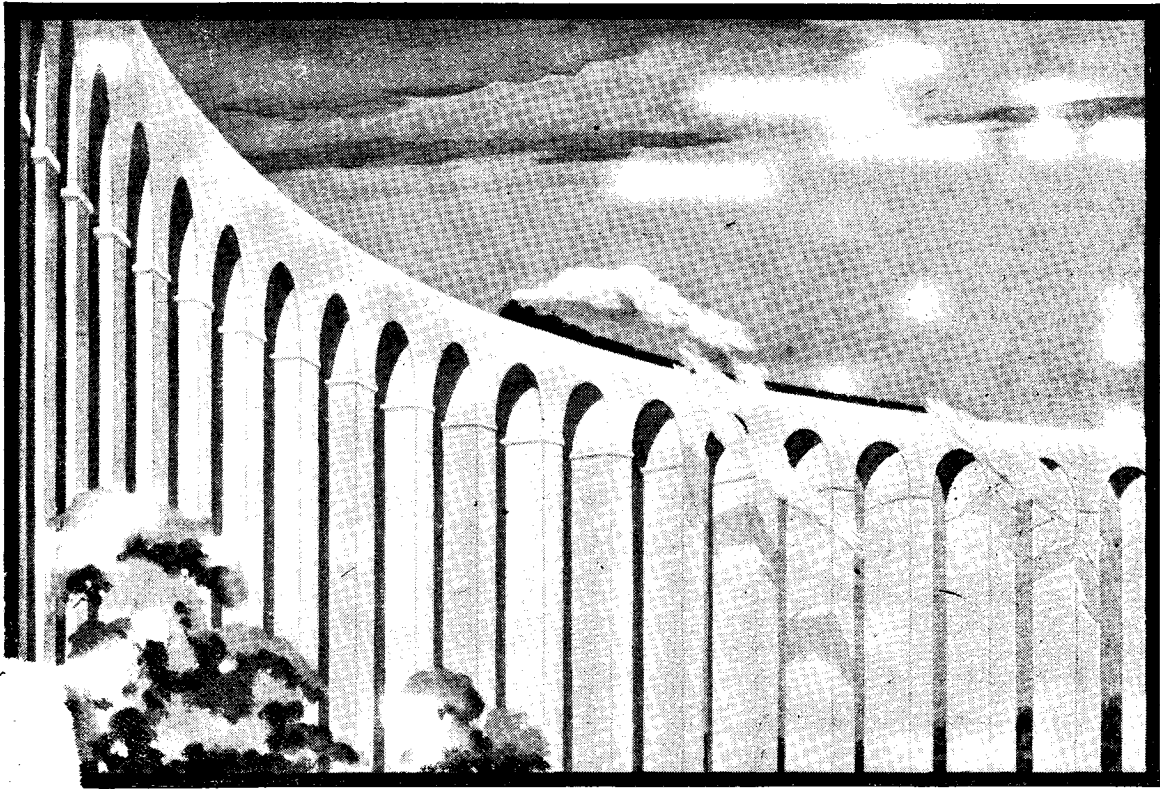

## Valves and Viaducts

To the engineer, accurate knowledge of the presence and precise form of vibrations is a matter of paramount importance.

The structural engineer needs to define and evaluate the stresses and strains on massive girders and framework; the mechanical engineer is concerned with the smooth transmission of power and the elimination of heavy wear and tear on plant and machinery.

With the aid of Mullard Valves in specially designed apparatus, vibrations having an amplitude as low as a few microns can be easily and accurately measured.

In almost every branch of engineering practice, problems are constantly being solved and the field of knowledge widened through the application of the thermionic valve — and Mullard have the right valve for the purpose.

**MULLARD**  
THE MASTER VALVE

*A Valve for Every Purpose*

DOMESTIC · COMMERCIAL · INDUSTRIAL · SCIENTIFIC · MEDICAL · EXPERIMENTAL

THE MULLARD WIRELESS SERVICE COMPANY LIMITED, CENTURY HOUSE, SHAFTESBURY AVENUE, LONDON, W.C.2. (44)

**BEAM AERIALS**

**A**N aerial array for producing a highly concentrated beam consists of a number of elements or rods, each several wavelengths long, and each fitted with means for suppressing alternate half-waves, so that the remaining energy is all radiated in phase. The suppressors take the form of quarter-wave sleeves or cylinders which are strung over the main rod at quarter-wave intervals, and are electrically connected to it by a flange, only at their top ends, standing away from the rod for the remainder of their length. Carrier-current flows in the space between the outer surface of the centre rod and the inner surface of the overlapping sleeve, arriving at the bottom of each sleeve in phase-opposition, so that it cancels out. The current then continues along the outer surface of the sleeve and the succeeding "open" quarter-wavelength of the rod, to form a succession of half-wave "loops" of current which slightly overlap along the effective length of each aerial element. This method of suppression is stated to produce comparatively low attenuation losses.

*Standard Telephones and Cables, Ltd. (Assignees of A. B. Bailey). Convention date (U.S.A.), January 26th, 1940. No. 543.337.*

**"MAGNETIC" GUIDE-LINE**

**T**HE sketch (a) shows a side-view, with a part broken away, and (b) an end view of a transmission line in which ultra-high-frequency energy is conveyed by a maximum of magnetic flux. In the simple form illustrated the "line" consists of a tubular conductor with two internal fins F, F<sub>1</sub>, which extend continuously along the length of the line and towards the centre, leaving a uniform gap G between their inner ends. The UHF input M is applied across the two fins, so that oscillations are set up in a plane at right-angles to the axis of the line, as shown by the arrows in Fig. (b). The line carries maximum energy when the capacitive reactance of the gap and the inductive reactance of the metal cross section of the tube are resonant to the applied frequency. This coincides with

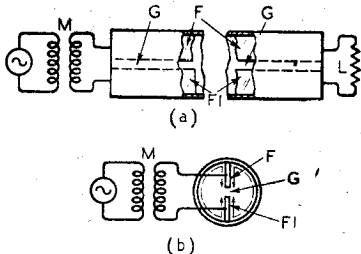

Arrangement for UHF transmission line.

the production of maximum magnetic flux inside the hollow tube. As in the case of a dielectric guide, the physical dimensions of the line determine its efficiency in transmitting currents of a

# RECENT INVENTIONS

## A Selection of the More Interesting Radio Developments

given frequency. The output is taken by a load L connected across the two fins.

*Marconi's Wireless Telegraph Co., Ltd. (Assignee of G. L. Usselman). Convention date (U.S.A.), 16th August, 1939. No. 543.334.*

**FEEDING AERIAL-ARRAYS**

**A** PERSPECTIVE view (Fig. a) and a cross-section (Fig. b) is given of a flanged or gapped tube T acting as a transmission line for an array of dipole aerials A. Power is applied across the gap from a source S. The dimensions of the tube and gap are such that each cross-sectional slice resonates to the applied frequency, as indicated by the arrows in Fig. b, with a voltage loop across the gap or condenser feeding the

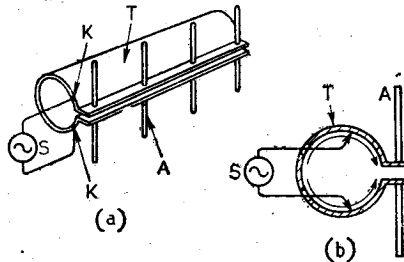

USW transmission-line coupling system.

aerials, and a current loop at the section of the line immediately opposite. The characteristic frequency of the line is altered by varying the size of the gap or of the flanges, whilst its impedance is matched with that of the feeder (or generator) by adjusting the position of the tapping points K relatively to the gap. When setting up the installation, the spacing of the aerials may be varied for optimum results.

*Marconi's Wireless Telegraph Co., Ltd. (Assignees of G. L. Usselman). Convention date (U.S.A.), 19th September, 1939. No. 543.471.*

**INTENSIFYING TELEVISION PICTURES**

**T**HE limitations of the fluorescent screen, both as regards size and brilliance, are avoided by a method of reproducing the picture, on an external screen, by direct projection through a sensitive diaphragm inside a cathode-ray tube from a source of light outside the tube.

The sensitive diaphragm D consists of a thin layer of oil and gum which, under the electrostatic changes produced by the scanning action of a modulated

electron stream, is deformed into a series of small lenses.

Normally the layer is homogeneous, and light from an arc lamp L is focussed on to a small mirror M which reflects it back again, so that none reaches the

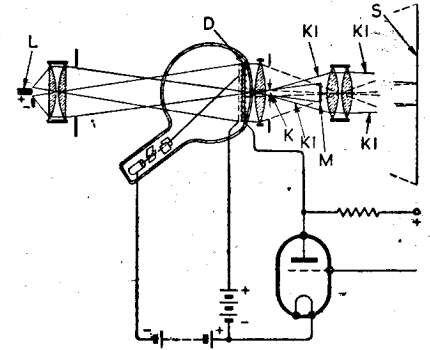

Externally projected television pictures.

viewing screen S. The effect of the small lens as formed by the scanning electron stream alters the focusing of the system, and allows an image to be formed at the point K, as projected by the marginal rays on the viewing screen S. At the same time, the composition of the diaphragm D is restored to its original shape by some method of obtaining a second electron stream, the prevailing static charge

*Ges. zur Förderung der Hochschule, Zurich. (Switzerland), 8th November, 1939. No. 543.485.*

**TELEPHONE INTERFERENCE**

**D**IALLING an automatic telephone makes and breaks contacts across a line which includes a source of voltage, and so creates surges of current which, though small, are sufficient to cause interference in a nearby receiver.

The invention provides an eliminator unit which consists of two pieces of metal foil separated by several sheets of paper, the whole being wound around a small core of permalloy. The assembly is sufficiently compact to fit inside the cover of the telephone dial, where it is connected in shunt across the line. The piece of foil next to the permalloy core acts as the inductance of the filter, and also as one plate of a condenser. The outer piece of foil is the second plate of the condenser, and also serves as an electrostatic shield.

*Standard Telephones and Cables, Ltd. (Assignees of A. J. Christopher and F. W. Webb). Convention date (U.S.A.), 29th September, 1939. No. 544.144.*

The British abstracts published here are prepared with the permission of the Controller of H.M. Stationery Office, from specifications obtainable at the Patent Office, 25, Southampton Buildings, London, W.C.2, price 1/- each.

CLASSIFIED ADVERTISEMENTS. The charge is 6/- for each paragraph of 2 lines or less, and 3/- for every additional line or part thereof, average 7 words to a line. Each paragraph is charged separately.

ADVERTISEMENTS for the December issue are accepted up to First Post on Tuesday, November 10th, at the Head Offices of Dorset House, Stamford Street, London, S.E.1, or one day earlier at provincial Offices.

THE PROPRIETORS retain the right to refuse or withdraw advertisements at their discretion. They are not responsible for clerical or printers' errors although every care is taken to avoid mistakes. Cheques and postal orders should be made payable to Hiffe & Sons Ltd. and crossed. Notes are legal tender and cannot be traced if lost in transit.

ADVERTISERS may have letters, other than circulars addressed to numbers at this office. The words Box 000, c/o "WIRELESS WORLD" must be paid for and a further 1/- added for registration and forwarding replies.

DEPOSIT SYSTEM. Full particulars upon application to the Deposit Dept., "Wireless World," Dorset House, Stamford Street, London, S.E.1.

# Ode Partridge

No. 20

## COAL-ESCENCE

Ole King Coal was a merry old soul,  
A merry old soul was he.  
But now he's sad, the reason why  
Is plain for all to see.

He is the stuff to keep the troops,  
The ships and works on top,  
Without his smile the whole show's sunk,  
Our efforts one huge flop.

It's not his fault he's moping there.  
Like us he's quite befuddled  
At all the marv'lous schemes and hopes  
So gloriously muddled.

Because the coal is down below  
Instead of up above,  
Someone must meet the deficit  
To speed the Peaceful Dove.

So once again we "fools" rush in  
Where "Angels" feared to tread.  
Short of fuel? You watch us save,  
We'll do it on our head!

# N. Partridge

Makers of Transformers and Chokes  
King's Bldgs., Dean Stanley Street,  
LONDON, S.W.1. Phone: VICTORIA 5035

Advertisers and buyers are reminded that under Defence Regulations 1939, Statutory Rules and Orders 1940, Number 1689, a permit (T 99 G) must be obtained before sale or purchase of certain electrical and wireless apparatus, particularly such valves and apparatus as are applicable to wireless transmission.

**NEW RECEIVERS AND AMPLIFIERS**  
DANCE and Stage Amplifying Equipment, complete transportable units, Universal, 18 watt, twin faders, M/C microphone, folding telescopic pedestal stand, pair auditorium speakers, all cables; 36gns.—Broadcast and Acoustic Equipment Co., Ltd., Broadcast House, Tombland, Norwich. [1288]

£19/10 Only.—7-valve "Wireless World" Quality amplifier chassis with tone control stage, 8 watts push-pull Triode output; price includes all valves, large output transformer and 12in. speaker, with triple cones; limited number.—Bakers Selhurst Radio, 75, Sussex Rd., South Croydon. [1239]

**RECEIVERS & AMPLIFIERS—SECONDHAND, ETC.**  
MIDWEST Console 18-37, 18 valves, 2-2,000 metres, recently overhauled; offers.—Box 2758, c/o Wireless World. [1300]

SELECTION Radiograms and Receivers, reconditioned; inspection invited.—A.C.S. Radio, 44, Widmore Rd., Bromley. [1295]

HALLICRAFTERS S20R, with Simmonds XTAL filter unit, perfect condition. What offers?—Box 2747, c/o Wireless World. [1262]

FOR Sale, "Wireless World" 4-band A.C. Super Six Radiogram, with quality amplifier, in new condition; £35; London district.—Box 2756, c/o Wireless World. [1290]

FOR Sale, following owner's death, Scott console receiver, Phantom 16, S/No. 10063, with Scott super doublet aerial, cost approximately £60 in February, as new.—Stephen, 14, Heath Mansions, N.W.3. [1280]

McMURDO Masterpiece VI 25-valve, high fidelity communication receiver, 18in. speaker, 60 watts output, 2 high-gain 1852 H.F. stages, variable selectivity, chromium plated throughout, spare valves; £80 or offer.—Below.

16-WATT P.A. Amplifier, 2 6F6 output valves, U.T.C. chrome transformers, high grade components, Varimatch output transformer; £19.—Below.

D.B.20, unused latest model; £12/10.—11a, Tre-tawn Gardens, Mill Hill, London. Mill Hill 4400. [1270]

1939 American McMurdo Silver 21-valve Chassis, with 18in. Jensen speaker and separate power pack, 20-watt output, 1/2 microvolt sensitivity, 45m-2,000 metres, mike and gram. input expander separate, fidelity, bass and treble controls, whole chassis chromium plated.—Box 2749, c/o Wireless World. [1271]

£105, or near offer.—High Fidelity Radiogram, built owner's specification, undistorted, output about 20 W, separate baffle, 3 speakers, twin Garrard turntables, 2 crystal pickups, 5 meters, first-class components; and reproduction; also quantity records, spare components, valves, pick-ups, etc.—Phone: Fairlands 8529. [1261]

PROBABLY World's Finest Receiver, R.C.A. Special Luxury Auto-Radiogram, purchased new 1939, 16 valves, all wave, armchair motorised tuning, expansion amplifier in magnificent cabinet, hardly used owing to evacuation, with service manual and option spare set of new R.C.A. valves. Will be sold for pre-war price in America, \$490 plus one-third duty.—Harris & Gillow, 80, Wardour St., W.1. [1274]

**Wanted**

ALL Wave Superhet Tuner Unit.—36, Kempster St., Lr. Broughton, Salford, 7, Lancs. [1303]

WANTED, communications receiver; cash paid. Not a dealer.—Box 2766, c/o Wireless World. [1318]

R.G.D. Auto Radiogram, immed. cash paid for modern instrument.—Burton, 31, Highgate Rd., Birmingham, 12. [1323]

WE Offer Cash for Good Modern Communication and All-wave Receivers.—A.C.S. Radio, 44, Widmore Rd., Bromley. [1293]

WANTED, high-class communication receiver, preferably Hallicraftor 824; good price paid.—Box No. 76, Parris, 121, Kingsway, London, W.C.2. [1309]

DISCRIMINATING Listener Offers Spot Cash for Second-hand All-wave Radio, Mains or Battery.—Box 2750, c/o The Wireless World. [1277]

LONDON CENTRAL RADIO STORES Will Pay good prices for Receivers, Radiograms, Amplifiers, Dynamos, Converters, Test Equipment, Electric Gramophone Motors, and all Radio and Electrical Accessories.—London Central Radio Stores, 23, Lisle St., London, W.C.2. Gerrard 2969. [19836]

# ARMSTRONG SERVICE

After three years of war and despite the changed conditions we have succeeded in keeping our Service Department in operation.

Many difficulties have arisen owing to material and valve shortage but on the whole we have managed to maintain a very large proportion of Armstrong Chassis in good working order.

We can still undertake the repair and overhaul of practically all Armstrong Chassis including very old models.

We still have a limited number of new and unused component parts, as below:—

New Moving Coil Speakers, available at the old prices. These speakers are suitable for use with practically all Armstrong Chassis.—

10in. Model, 1,000 ohms Field, fitted with centre tapped transformer for Push-pull output. Price 35/-, post 1/-.

8in. Model, 2,500 ohms Field, fitted with Pentode transformer. Price 21/-, post 1/-.

Genuine Low Loss 3-gang .0005 Tuning Condensers with Ceramic insulation, as fitted to our AV-125 chassis, and can be used for any purpose where a high quality condenser is required. Price 12/6. Or with dual ratio slow-motion drive, 17/6.

ARMSTRONG MANUFACTURING CO.  
WALTERS ROAD HOLLOWAY, LONDON, N.7  
Phone: NORTH 3213



## KURZ - KASCH

### RADIO KNOBS—DIALS INSTRUMENT KNOBS

Modern plastics are materially helping to bring the war to a successful conclusion, and Kurz-Kasch with its extensive plant and equipment is assisting in that direction.

Apart from those good-looking and well-designed knobs which form equipment of test instruments and receivers, we are moulding other very important items for the combined Services.

Kurz-Kasch Inc. look forward to serving you again as soon as circumstances permit.

Register your name with our Representative now. He will forward you information on our products as soon as they become available.

### KURZ-KASCH INC.

Moulders of Plastics,  
DAYTON, OHIO, U.S.A.

Exclusively represented by  
Frank Heaver Ltd. Kingsley Road,  
Bideford, N. Devon.

## L.R.S.

Can again Supply from Stock

## STUART

### Nos. 10 & 11 Centrifugal PUMPS

Complete with Foot-valve, Strainer and Hose Union.

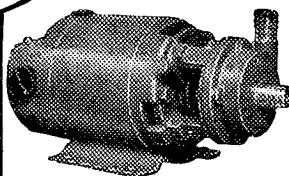

Suitable Rubbe: Hose available from stock.

No. 10. 100 gals. per hour. Carr. 2/- extra £5 2 6  
No. 11. 280 gals. per hour. Carr. 2/- extra £6 6 0

Suitable for Machine Tool Cooling and all pumping purposes, for hot or cold water.

Please enquire regarding delivery of:  
No. 12. 560 gals. per hour. Carr. 3/- extra £7 12 0  
Please send 2d. stamp for specification.

### The STUART AUTOMATIC FLOAT SWITCH

is the best method of controlling water. Post Paid level. Price complete with all fittings ... £2 6 0

## LONDON RADIO SUPPLY CO.

Est. 1925  
"Winden," Ardingly Road, Balcombe, Sussex. [19836]

## The Rainbow's End

At the end of the rainbow, 'tis said, there's a pot of gold. Whether this is also true of our own particular rainbow, and whether we shall ever reach its end we know not: but what we one day hope to find is—perfection. We are finding our journey a pleasant one for we have the firm knowledge that at every stage we are able to give you Transformers just that little much better and which make our rainbow's end seem that little much closer. And nowhere in the Gardner range is its proximity more apparent than in our Small Power Transformers up to 4kva.; so when next you need supplies of this component and the specification says, in effect, it must be made at our 'rainbow's end,' drop us a line. Please remember to quote priority numbers.



**GARDNERS RADIO LIMITED**  
SOMERFORD • CHRISTCHURCH • HANTS Q.3.

## ARE YOU MINUS MATHS?

If you wish to understand radio or any other technical subject thoroughly, you must know maths.

Our new Mathematics Courses have proved an outstanding success. We have already helped many men in the Forces and in other war-time occupations to qualify for promotion. We can help you too. By our simplified method of Home-Studying, you can now learn maths really thoroughly in your spare-time.

**RADIO.** If you wish to qualify for radio duties with the R.A.F. or for full-time or part-time radio work we can train you. Hundreds of men now serving in the Forces, or doing other important radio work, have been accepted solely as a result of our training.

★ Post coupon now for free details ★

## T. & C. RADIO COLLEGE

29, Market Place, READING

(Post in unsealed envelope, 1d. stamp.)  
Please send me free details of your Home-Study Mathematics and Radio Courses.

NAME .....

ADDRESS .....

W W 11 .....

**WANTED,** Amplifier, output 5 watts undistorted, for either 24 or 50 volt D.C. working; also G.12 Voigt or Hartley Turner Unit.—Buttfield, The Hermitage, Detling, Maidstone, Kent. [1312]

**NEW MAINS EQUIPMENT**  
**VORTEXION** Mains Transformers, chokes, etc., are supplied to G.P.O., B.B.C., L.P.T.B.; why not you? Imitated but unequalled. Orders can only be accepted against Government contracts.  
**VORTEXION, Ltd.,** 257, The Broadway, Wimbledon, London, S.W.19. Phone: Lib. 2814. [9942]

**NEW LOUDSPEAKERS**  
**300** G.E.C. P.M. Speakers, with transformers, in stock, complete in metal cabinet, £2 5s. each, c.w.o., postage and packing 1s. extra. All the above are brand new in maker's carton.—A. Imhof, Ltd., 112-116, New Oxford St., W.C.1. [1264]

**BAKERS SELHURST'S RADIO,** the pioneer manufacturers of moving coil speakers since 1925.—Bakers' brand new surplus speaker bargains; every music lover interested in realistic reproduction should write for free descriptive leaflet now; £3/10, brand new super quality triple cone speaker, permanent magnet model; limited number available under list price, wide frequency range, even response, ideal for quality reproduction; leaflet giving constructional details of an infinite baffle cabinet suitable for use with the above speaker free upon receipt of stamp.—Bakers Selhurst Radio, 75, Sussex Rd., South Croydon. [1240]

**SECONDHAND LOUDSPEAKERS**  
**PAMPHONIC** 16in., with tweeter cone, 1,000 ohm field, condition as new; £7.—Davis, 56, Fountain House, Park St., London, W.1. [1268]

**EPOCH** Domino, with brand new Baker triple cone, 1,250 ohm field, 15 ohm speech; £5/10.—Blake, 160, Tessel Lane, Northfield Birmingham, 31. [1263]  
**EXCHANGE** Murphy type A 40 C Speaker for Goodman's Junior Auditorium, E.D.C. Rotary Converter, 230 D.C. to 230 A.C., 100w.; £10 complete.—10, Delburn Street, Motherwell. [1313]

**LOUDSPEAKER** Transformers. Limited quantity available. Pentode 6/- each, Universal (Multi Ratio) 7/6 each. Terms: Carriage paid, cash with order or C.O.D.—Box 2764, c/o *Wireless World*. [1315]

**PERFECT** Unused Rola G12, 1,250 ohm field, fitted push pull (PX4) transformer; Partridge transformers for single and 2-valve microphone pre amplifiers; what offers?—Farr, 121, Admitt Rd., Northampton. [1305]

**ROLA** G.12 (energised), £2/10; Magnavox Duodec (energised), £4; Magnavox 8in. (energised), £1/10; latest Rothermel pick-up De Luxe, 30/-; earlier Rothermel De Luxe pick-up, 25/-; "Savage" multi-ratio output transformer, £1; Simpson turntable, £1/10; near offers considered.—Box 2751, c/o *Wireless World*. [1278]

**LIMITED** number of the noted Rola P.M. Loudspeaker. Avail yourself of this opportunity. 8in. at 18/9 each, carriage and packing free. Cash with order. 25 only Rola 10in. P.M. special 15oz. heavy Magnet. The ideal loudspeaker for perfect reproduction, 24/- each; C.O.D., postage and packing extra. 50 only Cabinet Extension Loudspeakers, fitted with 5in. Rola P.M.—Pleasing design in three colours, black, green and blue. Orders in strict rotation, 32/6 each, post paid. Cash with order.—Box 2763, c/o *Wireless World*. [1314]

**Wanted**  
**VOIGT** Corner Horn, with or without unit.—Box 2767, c/o *Wireless World*. [1319]

**WANTED,** Voigt corner cabinet horn, also unit.—Whittle, 228, St. Ann's Well Rd., Nottingham. [1304]

**BY** Soldier; Voigt, Goodman's, Magnavox 66, RK Senior, etc.; also tweeter, pick up, electric gram motor.—27, Millet St., Bury, Lancs. [1296]

**WANTED,** B.T.H. R.K. 10in. P.M. speakers, or similar, 15 watt, 15 ohm P.M. speakers.—W. H. Tanser, 26, Portland Rd., Rugby. [1285]

**MAGNAVOX** 66 P.M. or similar high-class speaker, 10/15 ohm coil.—Send particulars, S/Lr. Davis, 56, Fountain House, Park St., London, W.1. [1263]

**HIGH** Fidelity P.M. and Goodman Baffle Speakers, also m. coil pick-up. For sale, Hartley Turner Duodec, 1,250 Ω field.—Read, 110, Nottingham Rd., S.E.9. [1279]

**MORSE EQUIPMENT**  
**FULL** Range of Transmitting Keys, practice sets and equipment for Morse training.—Webb's Radio, 14 Soho St., London, W.1 Phone: Gerrard 2039. [9553]

**TEST EQUIPMENT**  
**PYE** Generator, Pye Test Alarm, Cossor 3332 Scope, Avo. No. 7 Wee Megger; offers.—Box 2748, c/o *Wireless World*. [1267]

**TESTSCOPE,** used everywhere by radio service engineers, makes 20 important tests. Send for interesting leaflet "R1."—Runbaken, Manchester, 1. [1074]

**MURHEAD** Oscillator, Type 7A, M. L. and 2 1/2 LF ranges, £5; Radwin's universal test set, 50/-; Mifer capacity bridge, 30/-; Park Royal pocket ohmmeter, 0-10,000 Ω, 30/-; wall or counter V.M., 12 and 120 V. M/C, 3 1/2in. dial, 16,000 Ω, 15/-.—87, Woodhall Lane, Welwyn Garden City, Herts. [1320]

**COMPONENTS, SECOND-HAND, SURPLUS, ETC.**  
**E.D.C.** Converter, 240 DC to 240 AC, .208 amps, £5; Brown's A phones, 50/-; Premier MC mike, 45/-.—11, 2, Dunstable Mews, Upper Wimpole St., W.1. [1317]

**200** Only, 2-volt 45 amp. glass accumulators, brand new, boxed; 10/6 each; carriage paid cash with order or c.o.d.—Box 2762, c/o *Wireless World*. [1311]

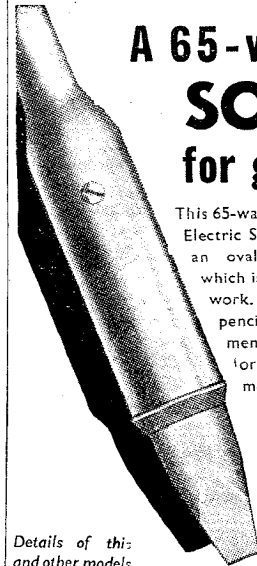

## A 65-watt SOLON for general use

This 65-watt Industrial type SOLON Electric Soldering Irons fitted with an oval tapered bit—a shape which is suitable for most general work. For specialised work the pencil bit model is recommended, whilst bigger jobs call for the 125-watt or 240-watt models.

Supplies of these various models are only available for essential war work, of course; and due to heavy demands it is necessary to order well in advance to avoid disappointment in delivery.

Details of this and other models sent on request.



MADE FOR USUAL STANDARD VOLTAGES

W. T. HENLEY'S TELEGRAPH WORKS CO. LTD.,  
Engineering Dept., Milton Court,  
WESTCOTT DORKING SURREY.

## Joining the R.A.F.?

**ARMY—NAVY—MERCANTILE MARINE OR TAKING UP WORK OF NATIONAL IMPORTANCE** in which a thorough knowledge of the Morse Code is essential for becoming a skilled W/T operator? Then investigate the proved Candler method of

### MORSE CODE TRAINING

There are courses for beginners and operators. These Candler trained operators now serving in the R.A.F. say —

"... I should like to thank both yourself and the company for the great start which I obtained through taking your Junior Code Course. The experience which I gained from that, has kept me 'miles in front' of others who relied on obsolete means of learning code." F. W. M.  
"I am pleased to state that I have already found a marked improvement in both sending and receiving... I can now send 5 w.p.m. faster and receive two or three letters behind." T. C.

Fill in the Coupon and learn more about this highly efficient Candler method of Code training in your own home.

**JUNIOR Scientific Code Course** for beginners. It teaches all the necessary code fundamentals scientifically, **ADVANCED and High-Speed Telegraphing Course** for operators who want to increase their w.p.m. speed and improve their technique.

**TELEGRAPH Touch-Typewriting Course** for W/T operators who want to become expert in using a typewriter for recording messages.

Courses supplied on Cash or Monthly Payment terms.

### COUPON

Please send me a Free Copy of Candler "Book of Facts."

NAME .....

ADDRESS .....

.....

**CANDLER SYSTEM CO. (55.W.),**  
121 Kingsway, London, W.C.2.

Candler System Co., Denver, Colorado, U.S.A. 1142







**I.F. TRANSFORMERS**  
of all types  
**AERIAL & OSCILLATOR COILS**  
**TRIMMER & PADDER**  
**CONDENSERS**  
**"SILVERCAP" CONDENSERS**  
**COIL FORMS, etc.**

Our factory has been expanded considerably, our knowledge is increasing daily and our added experience and facilities will be available for you as soon as conditions permit.

We are making many intricate parts for the U.S. Army, Navy, Air and Signal Corps, and we are happy to assist in the great effort to bring this struggle to a successful conclusion.

Sickles I.F. transformers, coils, trimmers and other radio parts will be ready for you again in due course.

Register your name with our Representative now. He will forward you information on our products as soon as they become available.

**THE F. W. SICKLES CO.**  
**CHICOPEE,**  
**MASS., U.S.A.**

Exclusively represented by

**Frank Heaver Ltd.** Kingsley Road,  
Bideford, N. Devon



# FOR THE RADIO SERVICE MAN, DEALER AND OWNER

The man who enrolls for an I. C. S. Radio Course learns radio thoroughly, completely, practically. When he earns his diploma, he will KNOW radio. We are not content merely to teach the principles of radio, we want to show our students how to apply that training in practical, every-day, radio service work. We train them to be successful!

**INTERNATIONAL CORRESPONDENCE SCHOOLS**

Dept. 38, International Buildings,  
Kingsway, London, W.C.2

Please explain fully about your instruction in the subject marked X.

**Complete Radio Engineering**  
**Radio Service Engineers**  
**Elementary Radio**      **Television**

And the following Radio examinations:  
**British Institution of Radio Engineers**  
**P.M.G. Certificate for Wireless Operators**  
**Provisional Certificate in Radio Telephony and**  
**Telegraphy for Aircraft**  
**City and Guilds Telecommunications**  
**Wireless Operator and Wireless Mechanic, R.A.F.**

Name..... Age.....  
Address.....

**SOUTHERN RADIO'S Wireless Bargains:—**

**7/6.**—Assorted Components contained in attractive permanent box: 2 volume controls, 12 assorted condensers, 9 assorted valve holders, 6 resistances, choke, wire, plug circuits, etc., 7/6; postage 7d.

**25/—**Assorted Parcel of useful components, including tubular condensers, resistances, sleeving, trimmers, knobs, volume controls, switches, etc., etc., 25/-; postage 1/1.

**8/—**12 assorted tubular condensers to 6mfd. 50 working, 8/—.

**10/6.**—12 Fixed condensers, sizes including 1 and 2mfd., 10/6.

**9/—**Gross assorted screws and nuts, complete, 9/—.

**6/—**Gross soldering tags, including spade ends, 6/—.

**ORMOND** Loudspeaker Units, largest 4-pole type, 6/6; smaller unshrouded type, 3/-; Ace P.O. Microphones, complete with transformer, ready for use, 6/6. Goodman 8in. permanent Magnet Speakers, 21/-, postage 1/-. Tungsram H.R.210 general purpose battery valves, 4/9. Telsen Radio Magazines, No. 6, complete with 4 circuits, 9d.; wireless crystals (Dr. Cecil), 6d. each, 5/6 per doz., with cat's-whisker 8d. each, 8/- doz.; permanent detectors, 2/6; binocular I.F. chokes, 1/6; 75lb. wire suitable for aerials (covered), 2/6; small powerful circular magnets, 1 1/2in. diameter, 3/8in. thick, 1/6 each, 15/- dozen; Bakelite Morse practice keys, 4/-; buzzers, 4/-; engineers' wire brushes, 10d. Many bargains for callers. Post orders postage extra. All goods guaranteed.

**SOUTHERN RADIO SUPPLY Co.**, 46, Lisle St., London, W.C. Gerrard 6653. [1226]

**EPOCH** 12in. Auditorium Speaker and Rectifier, large television cabinet, Parmeko 350 transformer with metal rectifier, Parmeko 60 hy. choke, 4 mfd. 650 test and 10 mfd. 600 test paper condensers, Ferranti A.F.3, 3-gang condenser, coils, small resistances and condensers, Cossor MVSG, 41 MHL, Mullard Do 24; nearest £10 secures.—Graves, 2, West Court, South Side Streatham Common, S.W.16. [1289]

**WANTED**  
pair Marconi-Ekco moving coil headphones.—Box 2755, c/o *Wireless World*. [1287]

**WANTED**, 2 T.C.C. paper condensers, type 105, 8 mfd., 750 volts D.C. working, also 30-henry 150 m.a. choke.—Marsden, 4, Brownswood Rd., Finsbury Park, N.4. [1272]

**WANTED**, a number of first-class Microphones, preferably moving coil; also Westinghouse Metal Rectifier, 150 amp. 60 V approx. 400 V 50 cycle, 3 ph. input.—Hippodrome, Dudley. [1265]

**GRAMOPHONE EQUIPMENT**  
**AUTO** Record Changer, Garrard, A.C., as new; £23.—Box 2753, c/o *Wireless World*. [1282]

**GARRARD** 202A Motor, turntable, and auto-brake, complete; state age, condition and price.—S. C. Blackshaw, 73, Worcester St., Wolverhampton. [1321]

**24 P/A** Wooden Horns for Disposal Cheap, fire and weatherproof, very good quality, by famous maker.—Particulars from Box 2759, c/o *Wireless World*. [1301]

**Wanted**  
recording outfit and Auto Radiogram, either separate or combined.—Maiden, 419, Lord St., Southport, Tel.: 2647. After hours 2540. [1212]

**DYNAMOS, MOTORS, ETC.**  
A.C./D.C. Converters, reconditioned, for sale; list.—A.C.S. Radio, 44, Widmore Rd., Bromley. [1294]

**ALL** Types of Rotary Converters, electric motors, battery chargers, petrol-electric generator sets, etc., in stock, new and second-hand.

**WARD**, 37, White Post Lane, Hackney Wick, E.9. Tel.: Amherst 1393. [0518]

**ROTARY** Converter, Neco 220v. D.C. to 12v. 12a. D.C., £4; E.D.C. 200v. D.C. to 230v. 2,000w. A.C., £35. Many others, all sizes and voltages.—Harris, Strouds, Bradford, Berks. [1275]

**MOTOR-ALTERNATOR** by Croydon Eng. Co., 110 or 220 volts D.C. to 220 volts 50 cycles A.C. 200 watts with Creod electric governor and starter, all mounted on base. £12/10.—Harris, Strouds, Bradford. [1275]

**L.T.** Dynamos for Charging or Windmill, Lucas-Rotax, 6-12 volts 8 amps. D.C., 3rd brush, weight 11lb., size 8in. x 4 1/2in., unused ex W.D., cost £10, to clear 17/- each, carr. paid; H.T. and L.T. G.E.C. double-end 6 volts and 600 volts, 17lb ditto, 27/6 carr. paid.—Electradix, 19, Broughton St., London, S.W.8. [9993]

**CABINETS**  
We regret that, owing to all our employees having joined H.M. Forces, we are unable to accept orders for cabinets except to callers. Limited stock only. We have a large stock of radio components.—H. L. Smith and Co., Ltd., 289, Edgware Rd., London, W.2 Tel.: Pad. 5891. [9683]

**VALVES**  
Valves.—Thousands in stock; send requirements, s.a.e.—Davies, 28, Mount Vernon Cres., Barnslay. [1073]

**1,000** Valves in Stock, s.a.e. for printed list: VP4B, 12/10; PM24M, 12/10; Pen A4, 12/10; Pen 4DD, 15/3; UU6, 11/-; C16, 12/10; AZ1, 11/-; 6Q7G, 11/7; 45, 11/7; 78, 12/10; 80, 14/-; postage extra.—Ransom, 34, Bond St., Brighton. [1284]

**Wanted**  
SEVERAL E.707 or D.O.27 Valves for Works Canteen.—86, Blenheim Cres., Luton Beds. [1291]

**MARCONI** X30, WD30, American 12SA7, 12SQ7; good price offered.—14, Kennerley Ave., Exeter. [1322]

# GECCALLOY

NI ALLOY POWDER

## THE LATEST DEVELOPMENT IN MAGNETIC POWDER METALLURGY

**MAIN ADVANTAGES:**

1. Higher Permeability.
2. Higher Particle Specific Resistance.
3. Low Eddy Current Loss.
4. Non-Rusting.

**SALFORD ELECTRICAL INSTRUMENTS LTD.,**

**PEEL WORKS, SILK STREET, SALFORD, 3**  
Proprietors: The General Electric Co., Ltd., of England.

# LINAGLOW

ANNOUNCE PURCHASE

of well-known Manufacturer's Stock and offer

**SILVER MICA FIXED CONDENSERS**  
ASSORTED AND USEFUL VALUES  
FLAT WIRE-END TYPE

**BEST QUALITY**  
**CLOSE TOLERANCE** **17/6 per 100**

(Normal trade price, pre-war, £1 per 100)

**ALL CONDENSERS GUARANTEED BRAND NEW (Boxed)**  
**DO NOT MISS THIS OPPORTUNITY**

Carriage paid cash with order or C.O.D.

**LINAGLOW LTD.**  
**3, HAMPSTEAD LANE, LONDON, N.6**  
Tel.: MOUntview 9482.

# RAYMART

CRAFT A CREED

## REMINDERS TO READERS!

From June to October our advertisements in the *Wireless World* have dealt with the following Raymart products:—

**JUNE. INSULATORS AND CERAMIC GOODS**  
See advertisement on Page 10

**JULY. HIGH FREQUENCY COIL FORMER**  
See advertisement on Page 10

**AUGUST. RAYMART "SPEED" KEY**  
See advertisement on Page 24

**SEPTEMBER. KIT FOR G.P.O. TYPE MORSE KEY.** See advertisement on Page 8

**OCTOBER. RAYMART KNOBS**  
See advertisement on Page 10

**NOTE.** Please add postage on all orders valued at 5/- or less. Send stamped, addressed envelope with all enquiries.

**RAYMART** 48 HOLLOWAY HEAD,  
BIRMINGHAM, 1  
Telephone: Midland 3254



**H. WILSON**

for

**QUALITY COMPONENTS & ACCESSORIES**

**DESIGN YOUR OWN**

**4-V. + Rectifier 3-Waveband SUPERHET RECEIVER**

from this special

**KIT of COMPONENTS**

**Receiver Kit.** Steel Chassis, undrilled, 10 1/2" x 8 1/2" x 2 1/2". 3-waveband 465 Kc Coil Unit, wired up, with switch. Connections colour coded. 2-IF Transformers, screened 465 Kc, 3-Gang Condenser, 0.5 meg. Vol. Control with switch. Resistors, Condensers, Screened Cable, Wire, Valve Sockets, Cable Plug and Socket, etc.

**Power Pack Kit.** Steel Chassis, undrilled, 10 1/2" x 8 1/2" x 2 1/2". Mains Transformer 350-0-350, 4v. 4a., 4v. 2a. 2-8 mfd. Electrolytics 500 v. working. Rectifying valve-holder. Connecting wire, etc.

No circuit is issued.

PRICE for complete Receiver and Power Pack Kits (less Valves and Speaker) - - - **£6**

**STOCKS ARE LIMITED!**

**COMPLETE KIT OF PARTS**

for building

**3-v. BATTERY RECEIVER**

S.G.—Det.—output

— includes —

Valves, Chassis (size overall with components mounted 12 1/2" x 8" x 9 1/2"), P.M. Speaker, all components, wire, etc., with circuit.

**Specification.**

Straight 3-valve Tuned Radio Frequency circuit, i.e., not superhet. An aerial transformer coupled to a variable mu H.F. pentode feeding into an H.F. transformer coupled to a triode detector. The L.F. coupling is a parallel feed transformer unit with automatic grid bias. No grid bias battery needed. All components mounted on a steel chassis with P.M. moving coil speaker. Straight line slow motion drive complete with escutcheon.

Wiring diagrams sent with every receiver. The set works off 120-volt standard battery and 2-volt accumulator.

All B.B.C. stations at good strength and quality. Reception of foreign stations depends on local conditions.

Price **£4.12.6** Carr. Paid

Less batteries & cabinet. (Regret no cabinets available).

We supply kits to your specification

**NEW STEEL CHASSIS**, undrilled, 10 1/2" x 8 1/2" x 2 1/2", 7/6

**OCTAL CABLE PLUGS AND SOCKETS**, 1/6 complete.

**CELLULOID DIALS** Only. "Selmer" calibrated 3-wave band, coloured, 3d.; **Steering**, red, black, yellow, blue, green, brown, good quality, 41d. per yard length. **Toggle Switches**, s.p.s.t., 1/6; **Dial Lamp Holders**, clip-on type, 4d. **Ceramic Trimmers**, single, 6d. **Padders**, twin long & med., 1/-; **Screened Cable**, twin, 1/9; single, 1/6 per yd. **Rubber Covered Wire**, suitable for wiring sets, 7 assorted colours, 4d. per yd.

**HOURS:** 9-4 p.m., Saturdays 1 p.m. C.O.D. orders accepted; prices subject to alteration without notice; special terms to members of H.M. Forces and Civil Defence workers; licence to export to Northern Ireland and Irish Free State; please add postage for enquiries and mail orders.

**51-52 CHANCERY LANE.**  
LONDON. W.C.2. Telephone H0LBORN 4631.

**WANTED** Immediate, two PM24E valves, new.—A. E. Dees, Ltd., 3, Charlotte Sq., Newcastle-upon-Tyne, 1. [1283]

**VALVES** Wanted, any quantity from one upwards; also test equipment, service sheets and spares.—J. Bull, 4, Melthorne Drive, Ruislip. [9732]

**RK52 Triode Valves**, 10,000 ohm Relay Ceramic Octal Valveholders, 100,000 Wire-wound Pots (good prices given).—Porter, 66, Timberdine Ave., Worcester. [1260]

**REPAIRS AND SERVICE**

**L.T.P. Repair** All Mains Transformers and Chokes. Prompt delivery.

**LONDON TRANSFORMER PRODUCTS, Ltd.** Willesden, N.W.10. Wil. 6486 (3 lines). [9552]

**MIDWEST**, etc., we are the American experts.—Bennett's, 4, Humberstone Drive, Leicester. [1299]

**TRANSFORMERS**, pick-ups, motor rewinds, repairs of all descriptions to the wireless trade.—Marshall, 137, Windmill Lane, Nottingham. [1307]

**METROPOLITAN RADIO SERVICE Co.** Guarantee Repairs to American and British Receivers. 1,021, Finchley Rd., N.W.11. Spe 3000. [9641]

**ACCURATE** Radio Rewinds, mains transformers, Fields O.P. Transformers, etc., and all loudspeaker repairs, prompt service.—Southern Trade Services, 75a, George St., Croydon. [1039]

**MAINS** Transformers Service, repairs, rewinds, or construction to specification of any type, competitive prices and prompt service.—Sturdy Electric Co., Ltd., Dipton, Newcastle-upon-Tyne. [9651]

**S** of British and American receivers; coil rewinds; American valves, spares, line cords.—F.R.I., Ltd., 22, Howland St., W.1. Museum 5675. [8934]

**COIL WINDING MACHINE**

**DOUGLAS** Coil Winding Machines Wanted.—Details to Premier Radio Co., Jubilee Works, 167, Lower Clapton Rd., London, E.5. 'Phone: Anherst 4723. [1297]

**BUSINESS OPPORTUNITY**

**NEON** Generators.—For sale, sole rights, mfg details and two models of foolproof, low consumption, unlimited output outfits; components obtainable right price now; a 500% end-of-backlog investment.—Box 2757, c/o Wireless World. [1298]

**SITUATIONS VACANT**

**WAREHOUSE** Manager for Electrical and Radio Distributors, competent to handle staff, offer military age or exempt; good remuneration.—Box 2752, c/o Wireless World. [1281]

**HEAD** Foreman Required to Take Complete Charge of Assembly of Electrical and Wireless Equipment for Company in London N.W. District Engaged on Essential Work.—Write with full particulars to Box 2754, c/o Wireless World. [1286]

**SITUATIONS WANTED**

**ENGINEER**, electrical, radio, seeks change, technical manager, 30 years' experience, practical, technical and commercial, good organiser.—Box 2760, c/o Wireless World. [1302]

**TUITION**

**LEARN** Morse Code the Candler Way. See advertisement on page 25. [1292]

**RADIO** Training.—P.M.G. exams, and I.E.E. Diploma, prospectus free.—Technical College, Hull [0611]

**PRACTICAL** Postal Radio Courses; coaching for I.P.R.E. exams; and post-war appointments; booklet free.—Secretary, I.P.R.E., Bush House, Walton Ave., Henley-on-Thames. [1215]

**RADIO** Engineering.—Television and Wireless Telegraphy, comprehensive postal courses of instruction. Apply British School of Telegraphy, Ltd., 179, Clapham Rd., London, S.W.9. (Estd. 1906). Also instruction at school in wireless for H.M. Merchant Navy and R.A.F. [9249]

**MISCELLANEOUS**

**100** ONLY best quality British made 60 watt 200-250 volt Soldering Irons, chrome plated body, copper bit (interchangeable), fitted flex, 12/- each. Worth double. Carriage paid, cash with order or C.O.D.—Box 2785, c/o Wireless World. [1316]

**BOOKS, INSTRUCTIONS, ETC.**

**WEBB'S** Radio Map of the World Locates any Station Heard. Size 40x30in., 4/6, post 6d.; on linen, 10/6, post 6d.—Webb's Radio, 14, Soho St., London, W.1. 'Phone: Gerrard 2089. [9947]

**Wanted**

**I**—Vocabulaire Telephonique International en six Langues, 2nd Edition, 1938; Librairie de l'Enseignement Technique, Paris.—H.M. Stationery Office, Publications Department, Room 505, 421-429, Oxford St., W.1. [1275]

**We will buy**

**at your price**

**USED Radios, Testmeters, Amplifiers, Converters, Radio and Electrical Accessories, etc.**

Write or 'phone

**WE WILL CALL!**

**UNIVERSITY RADIO LIMITED**  
238, Euston Rd., London, N.W.1 GERrard 4447

**ELECTRADIX BARGAINS**

**2/6** RHEOSTATS to 1 ohm and off. Carries 4 amps, for any current 2/6 regulation sub-circuit battery charge, or for dimming on 6 to 12 volts. One-hole fixing with plated bracket for table or rack. Translucent pull-off knob has bulb socket. U.S.A. make. New, in carton, 2/6. Well worth 5/-.

**MAGNETS.** The Wonder Midget 2-oz. Permanent Magnet. Discs of AlNi Steel. Tremendous magnetic force and only 1.3/10in. dia. x 3/16in. thick, with soft centre for drilling. One loop of the table to meet another. Uses: Any magnetic duty, metal separation, magnetic chucks and lifters. Cut-out core, polariser, solenoid cores, headphone re-magnetisers, etc., 2/6 each, or 4/6 pair. A.C./D.C. Mains Magnets. 2 wound poles, 110 or 220 volts, 7 lb. lit. 5/6. Small 12-volt solenoids, 2in. x 1/4in. plunger, 6/6.

**ELECTRIC** Miniature 12 volts Autopulse Pumps, metal diaphragm, with filter. Suction and delivery, totally enclosed for spirit, petrol or water, 15/-.

**HOME GUARD** Handombs. Micro-telephones or Transceivers for field telephones. Govt. all-metal type No. 16, with centre finger switch, 15/-; 4-way Cords, 2/6 extra. There are a number with centre switch damaged in transit, no cords, sale price, 7/6.

**BZZERS**, etc. A.C. Mains Buzzers for 6 volts, 4/-. A.C. House Bell, 6 to 8 volts, 2/6in. long, 4/6. Combination A.C. Bell and Mains Transformer, 10/6. Practice Buzzer, bakelite case, 2/-. Square brass case, 4/6. Heavy Type, bakelite case, 5/6. D111 double core multi-wound Buzzers, less contacts, 5/6. The famous Tiny Townsend Buzzer, 10/-.

**PERISCOPES.** Trench type, opens 25in. high x 4 1/2in. x 3in., with spare mirror, folding into canvas carrying case and sling, 12/6.

**DEY CELLS.** 1 1/2 volt, for Telephones and Field Sets, Siemens Type No. 2, or 8/4in. x 1 1/2in. x 1 1/2in., 2/6, plus tax 10d.

**SOLE VARIABLE AIR CONDENSERS** for Wavemeters and single Circuit Tuning, logarithmic blades, .0005 mfd., new. Type F, boxed, 4/6. Condensers. Fixed, 2 mfd. C.P.O. for smoothing, 2/6. H.T. Mica Fixed Condensers, 1 mfd., 4,000 volts, 10/-. Large 1 mfd., 2,000 volts, 10/6. 1 mfd., 6,000 volts, 10/6. Oil-filled B1 condensers, 35/-; 2 mfd., 4,000 volts, cased, 45/-.

**MULTI-SWITCH** 8-way boxes. Lucas change-over and fuse, 3/6. 6-way push-button Switches, R.A.F. aero, 2/9. Rotary Switches, R.I. 7 stud, box base, 7/6.

**CHUCK JAWS**, New. 100 sets of 3-jaw self-centring Cushman type 1/2in. set, 25in. set, 2 1/2in. set, 3 jaws, 6/-; 3in. jaws, 8/- set. Size 4in. jaws, 10/-, set of three.

**ELECTRIC SOLDERING IRONS**, 60 watts. Copper bits and heaters replaceable, 12/6.

**DRILLS.** Electric Bench Drills, D.C. Wolf, 110 volts, massive pillar type, geared feed, counter weight rise, No. 1 Morse socket for 3/4in. steel. Can be unshipped for portable use. 12 for delivery without permit, £8 10/- each.

**DYNAMO BARGAINS.** Rotax, 6/12 volts, 8 amps., D.C. 3rd brush size, 8in. x 4 1/2in., 11 lb., cost £10, unused, 17/6, erg. paid Eng. & Wales. G.E.C. Double current Dynamos, 6 volts and 600 volts, ball-bearings, 17 lb., as new, 27/6, erg. paid Eng. & Wales. Changing Dynamos, 30 volts, 13 amps., Cropton, 3,000 revs., £6 10/-.

**ENGINES** for direct coupling; twin cyl. Douglas fan-cooled, 1 1/2 h.p., governed, mag. ignition, light weight, £12. Larger, 2 1/2 h.p. ditto, £15. 12-volt Petrol-Electric Lighting Set, second-hand, Stuart type, with two 6-volt batteries, £15. 50-volt, 1 kW. Sets, water cooled, £25.

**PULVOGRAPH.** Chart Drum and Clips, 5/6. Magnetic Clutch, G.F. volts, complete, 25/-. 9in. Traverse Shaft, 4in. threaded 120 to inch, with bearings, 12/6. Stylus, with carriage rods and brackets, 7/6. 5-pin plugs, with panel socket and cords, midget type, 4/6 pair. 14-way Plug and Socket, with cord, 7/6. Radio 2-pin Midget Belling Plug and Socket, 9d. Plugs only, 5/- doz. 5 pairs of sockets on panel, 2/-; 3in. Aluminium Panel, drilled 13in. x 6 1/2in., 7/-. Bakelite ditto, 7in. x 6 1/2in., 2/3.

**A.C. SLOT HOUSEMETERS** for Shillings, new Chamberlain & Hookham, 10 amps., for fuel controlling.

**OZONIZERS.** For air purification. Small wall one-tube type for A.C. Mains, enclosed in white enamelled case, 21/-.

Please add postage for all mail orders. Send stamped envelope for replies to all enquiries.



**ELECTRADIX RADIOS**

19, Broughton St., Battersea, London, S.W.8.

Telephone: Macaulay 2159

Railway Station, Queen's Road, Battersea, from Waterloo.

**LONDEX for RELAYS**

**FOR A.C. and D.C.**

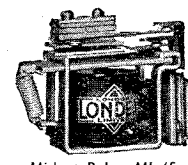

Midget Relay ML (for D.C. only)

Apply for Leaflet SPN/WW.

**LONDEX LTD**

MANUFACTURERS OF RELAYS

ANERLEY 207 ANERLEY ROAD LONDON S.E.20 PHONE: 5706RHAM 6250/9

# AUDIO AMPLIFIERS

## and SUB-ASSEMBLIES

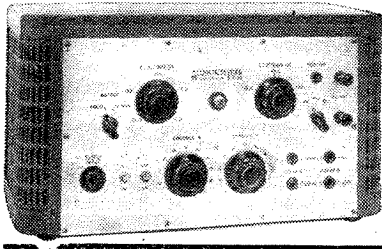

One of our range of Standard Amplifiers available for work of National Importance

Standard Amplifiers • Special Amplifiers for Industrial Applications • Transformers and Coil Winding • Sheet Metal Work and Stampings • Switch Assemblies • Microphones, etc.

# ACOUSTICAL

MANUFACTURING COMPANY LTD.  
HUNTINGDON  
TEL: 361

## W. BRYAN SAVAGE LTD.

Expert assistance in the solution of problems relating to

- TRANSFORMERS, CHOKES
- AMPLIFIERS
- POWER UNITS

and Specialised Equipment embodying  
**ELECTRONIC CONTROL**

WESTMORELAND RD. N.W.9.  
COLINDALE 7131

## ENGINEERING OPPORTUNITIES

This unique Handbook shows the easy way to secure

- A.M.I.C.E.
- A.M.I. Mech. E.
- A.M.I.E.E., A.M.I.A.E.
- A.M. Brit. I.R.E.

and similar qualifications. **WE GUARANTEE—“NO PASS—NO FEE.”** Details are given of over 150 Diploma Courses in all branches of Civil, Mech., Elec., Motor, Aero, Radio and Production Engineering, Draughtsmanship, Tracing, Inspection, Government Employment, BUILDING (gr. at supp.), HAYRIG, R.A.F. MATIS, etc. Send for your copy at once—FREE and post-free. Men with Radio knowledge can obtain attractive posts in the Service.

**BRITISH INSTITUTE OF ENGINEERING TECHNOLOGY, 387, Shakespeare House, 17, 18, 19, Stratford Place, London, W.1**

Book sent post free

## HILL AND CHURCHILL BOOKSELLERS

SWANAGE DORSET

ENGLISH & AMERICAN BOOKS IN STOCK ON

### RADIO AND TELECOMMUNICATION

CATALOGUE ON APPLICATION

## ARDUX

Ardux is a quick-setting adhesive for mouldings and laminated plastics. No preparation of the surfaces is necessary. Ardux is doing a valuable job in eliminating wastage and in reducing machining in the production of aircraft components. Ardux can probably help you in your problem; may we show you how?

**AERO RESEARCH LIMITED**  
PIONEERS OF SYNTHETIC ADHESIVES  
DUXFORD CAMBRIDGE Telephone: Newton 167.

## LINAGLOW ANNOUNCE PURCHASE

of well-known Manufacturer's Stock and offer

ASSORTED VOLUME AND TONE CONTROLS WITH AND WITHOUT SWITCH, LONG AND SHORT SPINDLE.

Suitable for all well-known makes of radio.

To-day's **OUR BARGAIN OFFER** trade value **7/6 each. 6 ASSORTED TYPES FOR - - - £1**

**BRAND NEW AND GUARANTEED**

The ridiculously low price at which these are offered is entirely due to the fact that we have purchased the stock of a manufacturer in liquidation. **DO NOT MISS THESE. IMMEDIATE DESPATCH ON RECEIPT OF ORDER.**

CARRIAGE PAID CASH WITH ORDER OR C.O.D.

**LINAGLOW LTD.** 3, Hampstead Lane, London, N.6. T-1. MOUtelvic 9432

## WARD ROTARY CONVERTERS

Petrol Electric Generating Plants, H.T. Generators, D.C. Motors, Frequency Changers, etc., up to 25 K.V.A.

**CHAS. F. WARD 37 WHITE POST LANE**  
Phone: Amherst 1393. HACKNEY WICK, E.9

SAVE TO SPEND Why! not!

**VOIGT PATENTS LTD.**

SEE OUR POST-WAR DELIVERY SCHEME "W.W." MAY p. 20

The Courts, Silverdale, London, S.E.26.

Phone SYD. 6666.

## KESSLERS (London) LTD.

for TURNING and MACHINING OF PLASTIC MATERIAL

SIGNAL LAMP CAPS SWITCH KNOBS AND HANDLES

Albion House, 201-3, Church St., London, N.16  
Tel.: Clissold 6247

## The SIMMONDS GROUP

LONDON. MELBOURNE. PARIS. NEW YORK. LOS ANGELES.

## INVENTORS

We continually seek new inventions and products in all branches of industry for development and production by the manufacturing companies of the Simmonds Group throughout the world.

**SIMMONDS DEVELOPMENT CORPORATION LTD. BUSH HOUSE · W C 2**

Printed in England for the Publishers, LIFFE AND SONS LTD., Dorset House, Stamford Street, London, S.E.1. by THE CORNWALL PRESS LTD., Paris Garden, Stamford Street, London, S.E.1. "The Wireless World" can be obtained abroad from the following: AUSTRALIA AND NEW ZEALAND: Gordon & Gotch, Ltd. INDIA: A. H. Wheeler & Co. CANADA: Imperial News Co.; Gordon & Gotch, Ltd. AFRICA: Central News Agency, Ltd.; Wm. Dawson & Bone (S.A.), Ltd. UNITED STATES: The International News Co.



# DEPENDABLE COMPENSATION

for frequency drift

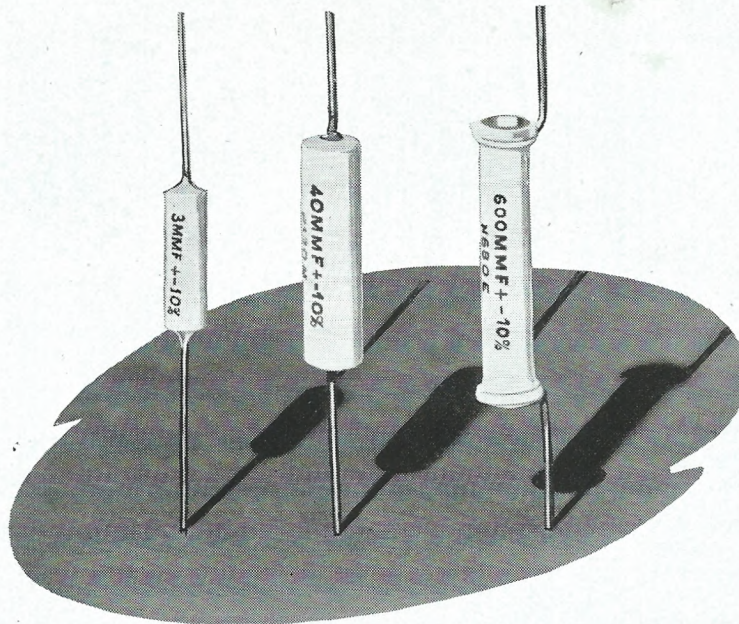

## IN ESSENTIAL COMMUNICATIONS

**E**RIE Ceramicons are small ceramic dielectric condensers having inherently stable retrace characteristics in respect to temperature due to a unique method of applying silver plates directly to the surface of the dielectric, which eliminates the possibility of air space or of wax-filled pockets.

A change of less than  $\frac{1}{4}$  of 1% will be found after subjecting Ceramicons to

repeated heating and cooling cycles of 200 hours at 212°F and 200 hours at -40°F, and when properly used these units will provide dependable compensation for drift in other components caused by temperature. Insulated Ceramicons are available up to 375 MMF and non-insulated Ceramicons up to 1,100 MMF, but the closest tolerance we can supply in either type is  $\pm 0.25$  MMF or  $\pm 1\%$ , whichever happens to be the greater.

**ERIE RESISTOR LIMITED**

CARLISLE ROAD, THE HYDE  
LONDON - - N.W.9

Telephone: Colindale 8011

**ERIE** *Ceramicons*

REG. U. S. PAT. OFF.



**FREQUENTITE**

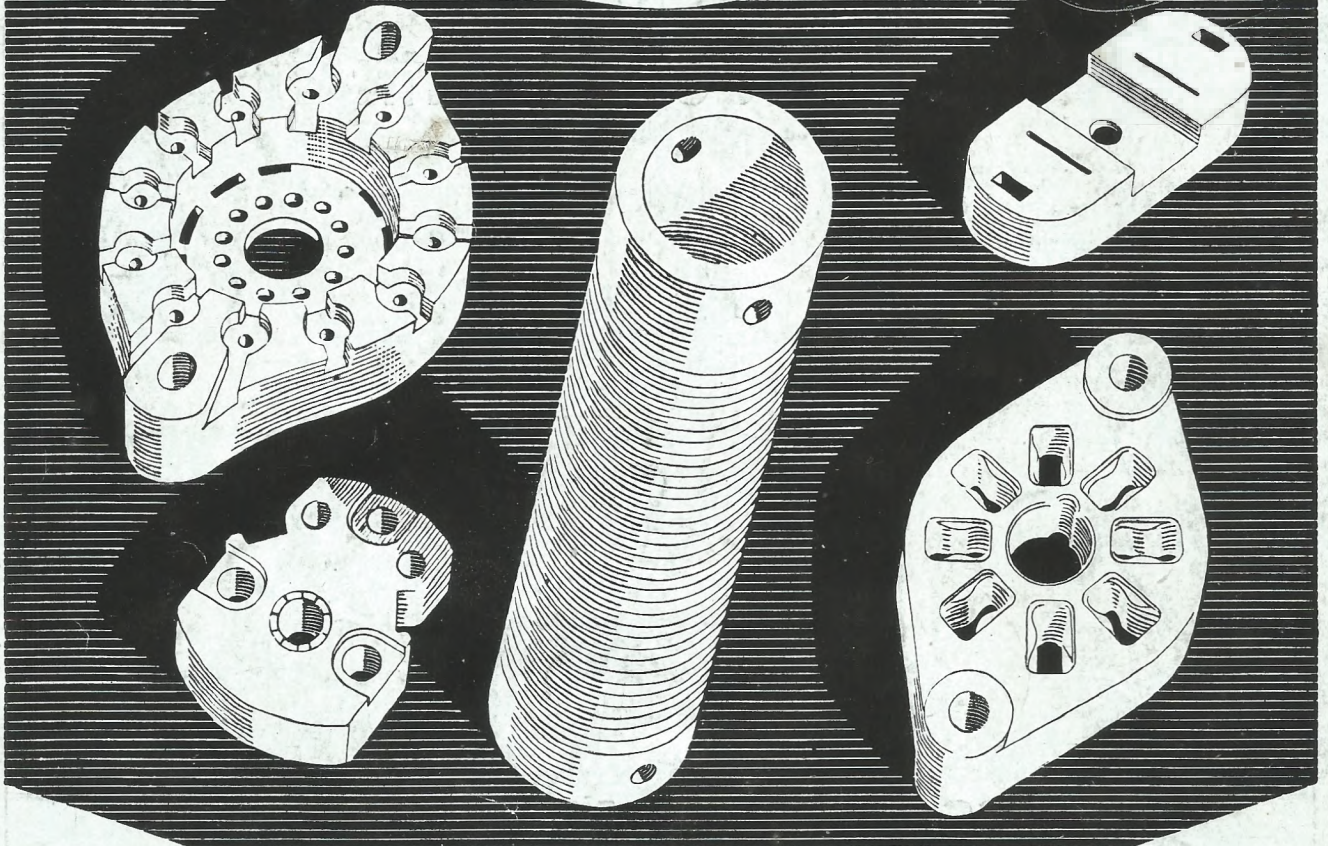

**THE PIONEER BRITISH-MADE LOW LOSS CERAMIC**

THE DEMAND for Frequentite, which possesses outstanding properties of Low Loss and High Mechanical Strength, continues to increase rapidly—and to be met. Production capacity has been stepped up over a period of years by extensions to plant, the employment of

specialised new equipment, and progressive improvements in manufacturing technique. Bulk supplies of the most intricate designs can be delivered promptly, and all manufacturers are invited to write for Catalogue No. S.P.10.

**STEATITE & PORCELAIN PRODUCTS LTD.**

Head Office :

STOURPORT-ON-SEVERN, WORCS.

Telephone : Stourport 111.

Telegrams : Steatite, Stourport.