

The Wireless World

AND
RADIO REVIEW
(21st Year of Publication)

No. 666.

WEDNESDAY, JUNE 1ST, 1932.

VOL. XXX. No. 22.

Editor: HUGH S. POCKOCK.

Editorial Offices: 116-117, FLEET STREET, LONDON, E.C.4.

Editorial Telephone: City 9472 (5 lines).

Advertising and Publishing Offices: DORSET HOUSE, TUDOR STREET, LONDON, E.C.4.
Telephone: City 2846 (15 lines).

Telegrams: "Ethaworld, Fleet, London."

COVENTRY: Hertford St. BIRMINGHAM: Guildhall Bldgs., Navigation St. MANCHESTER: 260, Deansgate. GLASGOW: 26B, Renfield Street, C.2.

Telegrams: "Cyclist, Coventry."
Telephone: 5210 Coventry.

Telegrams: "Autopress, Birmingham."
Telephone: 2970 Midland (3 lines)

Telegrams: "Hiffe, Manchester."
Telephone: Blackfriars 4412 (4 lines).

Telegrams: "Hiffe, Glasgow."
Telephone: Central 4557.

PUBLISHED WEEKLY.

ENTERED AS SECOND CLASS MATTER AT NEW YORK, N.Y.

Subscription Rates: Home, £1 1s. 8d.; Canada, £1 1s. 8d.; other countries abroad, £1 3s. 10d. per annum.

As many of the circuits and apparatus described in these pages are covered by patents, readers are advised, before making use of them, to satisfy themselves that they would not be infringing patents.

EDITORIAL COMMENT.

Condenser Ratings and Price.

AS a result of the publication of the article last week on "Choosing Paper Condensers," by A. L. M. Sowerby, a number of readers have raised the question of cost, suggesting that the prices charged for the higher voltage condensers is unreasonable.

The difference between a paper condenser rated to work at 250 volts and one rated for 500 volts lies almost entirely in the paper used to insulate one set of foils from the other. It is fairly evident that the thicker the paper, other things being equal, the greater is the voltage necessary to puncture it and allow a current to pass. In consequence, condensers are made with various thicknesses of dielectric material in order that, whatever the voltage they may be called upon to withstand in the set, a suitable pattern may be obtained.

One might quite reasonably ask whether it would not be enough to take into consideration the highest voltage ever met with in any receiver, and make all condensers with paper thick enough to be safe from breakdown on that voltage. If it were only a question of the paper that simple arrangement would probably be found extremely convenient, but there are other factors.

If, say, a 4-mfd. condenser is taken to pieces, and then rebuilt with a paper four times as thick as that previously used, it is true that the condenser will now stand without breakdown about four times the voltage that could safely have been applied to it before the alteration. But its capacity will now only be 1 mfd. owing to the greater separation between the foils. If we want to retain the original 4 mfd. while increasing the safe voltage four times, we shall therefore have to rebuild four low-voltage 4-mfd. condensers and con-

nect them in parallel. The resulting block will now contain sixteen times as much paper (four times the original area, and four times as thick) as the original 4-mfd. low-voltage condenser.

While the rebuilding process just described is hardly practical, the description of it does bring out that in making the condenser safe for a higher voltage a great deal more is involved than the mere substitution of one thickness of paper for another. In terms of price, one would expect that a 2-mfd. condenser rated to work at 800 volts would cost about twice as much as one rated to work at 400 volts. Reference to catalogues issued by manufacturers shows that, generally speaking, this price-relationship is not far wrong.

These comments will, we hope, reassure those readers who have felt uneasy about the prices ordinarily charged for high-voltage condensers, and may also serve to emphasise the importance of avoiding the use of condensers for mains receivers which are rated below the voltages which they are required to withstand.

Programmes from Abroad.

IN this issue we resume the publication of certain programmes from abroad which some time back was a feature of *The Wireless World* week by week. Readers have expressed the desire to have in *The Wireless World* sufficient programme material to assist them in the identification of foreign stations, and, by including transmissions for one or two days, we believe that we shall be meeting these requirements.

We have also been able to arrange for the inclusion of details of programmes for the week of those transmissions from abroad intended for British listeners, which are organised by the International Broadcasting Company.

Grid Bias

Choosing the Right Self-Bias Resistance.

By

W. T. COCKING.

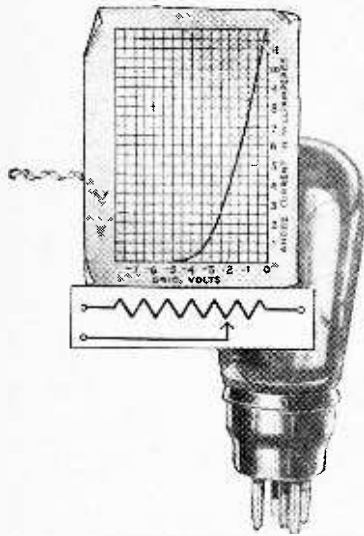

IN actual practice, the design and calculation of automatic grid bias arrangements is one of the simplest problems which confronts the set designer. So simple is it, in fact, that it usually solves itself and all that has to be done is to calculate the actual values of the resistances required from a simple application of Ohm's law.

The apparent difficulty has arisen from the fact that there are two alternative methods of obtaining grid bias and that both have been freely used in the past. One of these is extremely simple and is becoming more and more commonly employed, whereas the other is decidedly complex in design, and as a result it is not so often used, particularly as it offers no advantage over the simpler method.

The difficulty in grid bias circuits arises from the fact that, while it is easy to see how the various positive potentials for the anode and screen grids are derived, it is not at first glance apparent how one can obtain a negative voltage from the same supply system. That grid bias is equally simple may be seen from Fig. 1, which shows the skeleton circuit of a triode valve. There is a continuous current flowing through the whole circuit, and as a result there is a gradual voltage drop along it. The most negative point is that of the negative of the H.T. supply, and so every other point in the current circuit must be positive with respect to it. The cathode, therefore, is positive with respect to negative H.T., but is negative with respect to the anode, which is joined to positive H.T. Now the grid is joined to negative H.T. and so takes the same potential as it is not included within the current circuit; the cathode, therefore, is positive with respect to the grid.

THE principles of H.T. supply from A.C. mains are by now thoroughly understood, and few find difficulty in working out the somewhat complicated voltage dropping and anode feed circuits, whereas the calculation of grid bias circuits often presents difficulties which are more imaginary than real. The fact that a cathode which is positive with respect to the grid is the same as a grid negatively biased with respect to the cathode probably causes some confusion. The author here shows how to calculate the various bias resistances required for all the valve stages in a modern receiver.

But if the cathode is positive with respect to the grid, then the grid is negative with respect to the cathode, which is what we require for negative grid bias.

It considerably simplifies the design and understanding of these grid bias circuits if one looks upon the bias, not as negative grid bias, but as a positive cathode bias. In the design of the grid bias circuits, therefore, all that we do is to connect all the grids to negative H.T. and to bias each cathode positively by the amount of grid bias required. It should be noted, however, that this simple method is in general only applicable to cases where indirectly heated cathode valves are used throughout a receiver, or where any directly heated valves have separate windings on the mains transformer for their filaments.

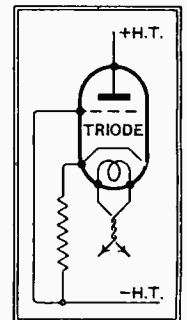

Fig. 1.—The fundamental grid bias circuit. Negative H.T. is the most negative point in the current circuit, and so all other points are positive with respect to it.

A Practical Case.

In Fig. 2 the skeleton circuit is given of a three-valve receiver employing a screen grid H.F. valve, a power grid detector,

and a pentode output valve, and it is instructive to calculate the values required in practice for the grid bias resistances. We shall not deal here with the design of the H.T. supply, but consider only the biasing circuits. In order to bring the discussion down to concrete form, let us assume that we are going to use M.S.4, M.H.4, and M.P.T.4 valves.

It will be observed that each grid return circuit is taken to the same point, namely, negative H.T., and that the bias is obtained by the insertion of a resistance between the cathode of each valve and negative H.T. The anode and screen current of each valve flows through its own bias resistance, and so biases the cathode of that valve positively, and hence the grid negatively with respect to the cathode by an amount depending upon the value of the resistance and

Grid Bias.—

upon the total current through it. Before we can calculate the values of the resistances, therefore, we must know the necessary value of grid bias for the particular valve with which we are dealing, and we must also know the anode and screen currents of the valve. Both these sets of figures can be obtained from the valve makers' catalogue or from *The Wireless World Valve Data Sheet*.

Let us take the pentode first; the anode current is 32 mA. and the screen current is 5 mA., so that we get a total of 37 mA., and the required value of bias is 11 volts. Now the value of the bias resistance in thousands of ohms is equal to the bias required divided by the current in milliamperes. It will be seen, therefore, that in this case the resistance (R_3 of Fig. 2) should have a value of $11/37=0.297$ thousand ohms, or 297 ohms; in practice, of course, we should use the standard value of 300 ohms.

The M.H.4 requires no bias when it is used as a detector, and so the grid leak is returned directly to the cathode; when it is used as an amplifier for gramophone reproduction, however, the normal bias is needed, and so we have to calculate the value of R_2 . The bias should be three volts with an anode current of 4.5 mA.; the bias resistance, therefore, has a value of $3/4.5=0.666$ thousand ohms, or 666 ohms, but in practice either of the standard values of 600 or 700 ohms would be sufficiently accurate.

Turning now to the M.S.4 we find that the bias should be 1.5 volts and that the anode current is 2.5 mA. We have to add to this the screen current, and this is not usually given in valve lists. We shall not be far wrong, however, if we assume that it is 0.5 mA., and so we

It should be noted carefully that in many cases the screen grid potentiometer P is not returned directly to negative H.T., but to the H.F. valve cathode, as shown dotted in Fig. 2. In this case the current through the

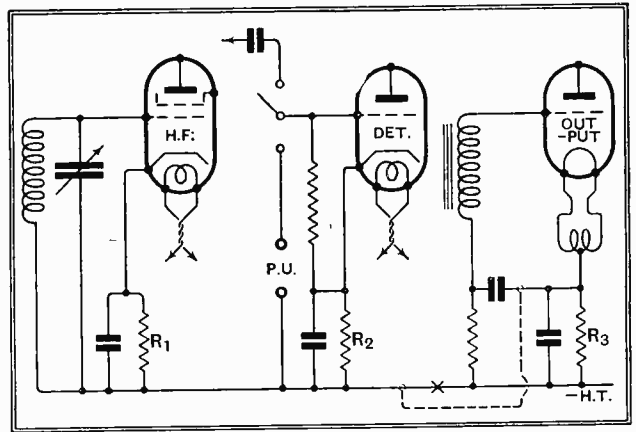

Fig. 3.—A similar circuit to Fig. 2 but with a directly heated output valve. Separate windings on the mains transformer for the two types of valve are recommended.

bias resistance is increased by the amount of the potentiometer current, and if this be 3 mA., a not uncommon figure, the total current will be 6 mA., and so we shall have to use a bias resistance of only 250 ohms.

Automatic Regulation.

It will thus be seen that there is no difficulty in deciding upon the values of the bias resistances in cases where indirectly heated valves are employed, and each is individually biased by a resistance in its cathode lead. Doubt often arises, however, as to the value of resistance to use when the valve is not being worked with its maximum rated H.T. voltage, for which the figures for bias and anode current are usually given. It is safe to say that in most cases the value of resistance calculated for the valve working under its full rated voltages will also be the correct value for the same valve under reduced H.T. conditions.

It is true that with reduced H.T. the valve will require less grid bias, but it must not be forgotten that the anode current will also be reduced; therefore, the voltage drop along the same bias resistance will be less, which is what we require. This applies almost without exception to all valves other than the larger output types, and for these valves the makers usually quote figures for the anode current and grid bias at several different H.T. voltages so that no difficulty should arise.

It has been pointed out that the foregoing procedure applies to indirectly heated cathode valves, but it is the common practice to use the directly heated type in the

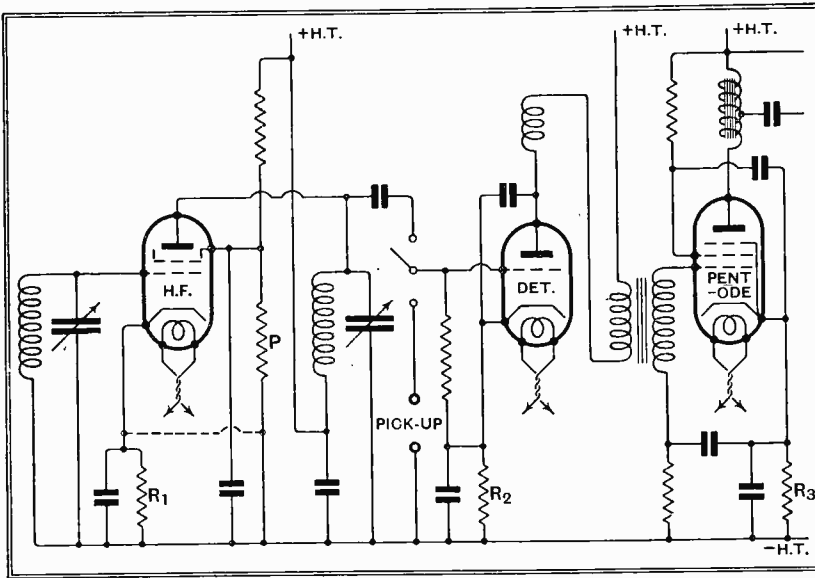

Fig. 2.—A typical three-valve circuit with indirectly heated valves, illustrating the application of automatic bias.

get a total of 3 mA. for the current. The resistance value, therefore, is $1.5/3=0.5$ thousand ohms, or 500 ohms.

Grid Bias.—

output stage, and so we must give some consideration to this type of circuit. In Fig. 3, therefore, are given the connections for a similar receiver to that of Fig. 2, but with a directly heated output valve. It will be seen that the circuit is essentially the same, and the resistance values are calculated in exactly the same manner.

It is important to note, however, that if the same winding on the mains transformer be used for all valves, the grid bias of the output valve will appear as a potential difference between the heaters and cathodes of the early valves, and this is not always desirable. In most cases this potential difference will do no harm, but it is always wiser to avoid it by using separate windings on the mains transformer for the output valve and the early valves. The difficulty may be got over in another manner, however, by breaking the connection at the point "X" and connecting the cathode return leads of the early valves, not to negative H.T., but directly to the centre tap on the transformer winding, as shown dotted.

The circuit is now one of the more complex type mentioned at the beginning of this article. The complexity arises from the fact that the value of the output valve bias resistance R_o depends no longer upon

complete independence in the biasing conditions, for the bias on any one valve is determined solely by the anode current of that valve; as a result, a faulty valve can be found at once with a milliammeter.

The Variable-Mu Valves.

An article on grid bias methods would be incomplete without some mention of the circuits necessary for the new variable-mu valves, even although this question has been dealt with previously.¹ The circuit is shown in Fig. 4a, and it should be noted that when the volume control is at maximum, the bias is determined solely by the voltage drop along the cathode resistances R , which also act as decoupling resistances, and these are consequently calculated in the manner just described. When the volume control is at minimum, however, the anode and screen currents are practically zero, and the resistances R have a negligible effect. The bias in this case is determined by the voltage drop along the potentiometer due to its standing current.

It should be noted, however, that a somewhat simpler circuit can be used where the receiver is very stable and grid circuit decoupling is unnecessary. This is shown in Fig. 4b, and it will be seen that the cathodes are all connected together and taken to the slider of the volume

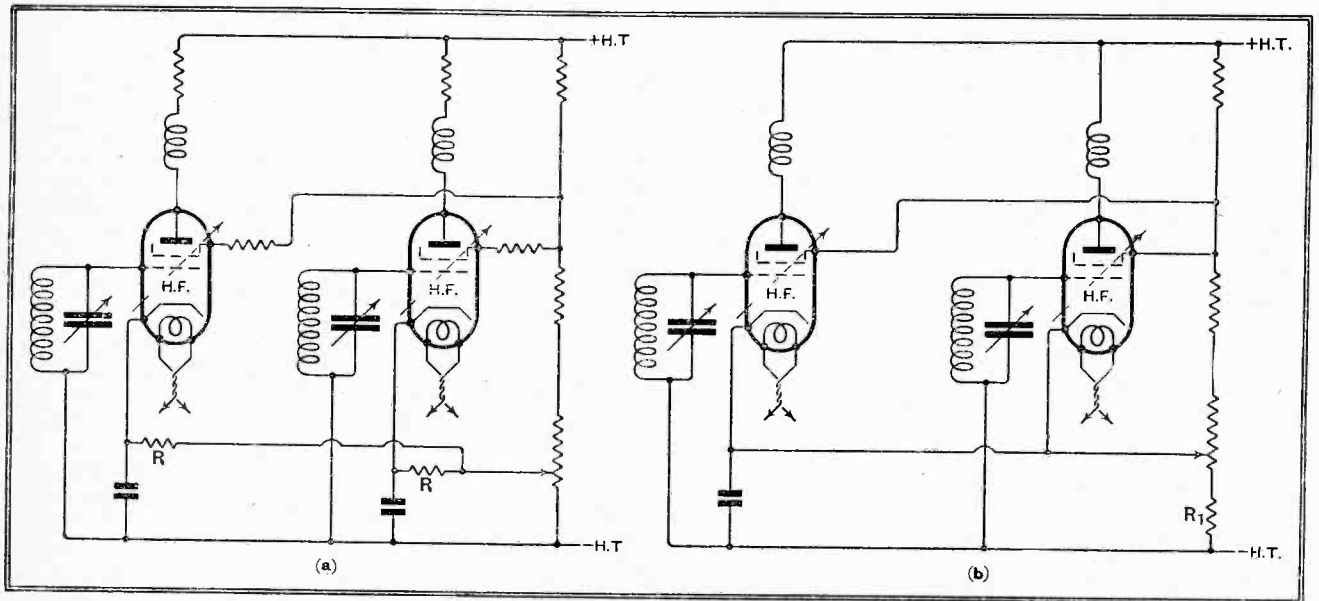

Fig. 4.—The biasing of variable-mu valves. At (a) is shown the recommended scheme where decoupling is necessary, but (b) can often be used in superheterodynes or other very stable sets.

the anode current of that valve alone, but upon the total anode current of the set. As a result, the value of the output valve bias will be affected by a faulty valve in another portion of the set, and will even vary slightly with the signal strength if the detector shows a large change of anode current with a signal.

Fault finding is thus needlessly complicated, for anything which makes the total current of the set abnormal affects the output valve bias, and in some modifications of the circuit that of the other valves as well, and so masks the effect of the fault. The circuit of Fig. 2, on the other hand, has the supreme merit of allowing

control potentiometer, whose value is decided as in the circuit of Fig. 4a. The bias with the control at maximum, however, is in this case decided by the resistance R_1 , through which flow the anode and screen currents of all the variable-mu valves, in addition to the standing potentiometer current. As the total current of two V.M.S.4 valves and their screen potentiometer may be some 25 mA. to 30 mA., it will be seen that a resistance of 100 ohms will give a bias of 2.5 to 3 volts.

¹ "Controlling Volume with the Variable-Mu Valve," by N. R. Bligh and E. D. Whitehead, November 25th, 1931.

Unbiased.

A Loud Speaker Point.

WHY is it that loud speaker makers will keep on emphasising the sensitivity of their instruments in their advertisements? Except for those who dwell umpteen miles from a broadcasting station, and who at the same time may not be able to afford anything more ambitious than a battery-driven two-valve set, sensitivity is quite unimportant. The great thing is the power-handling capacity, and manufacturers rarely bother to tell us anything about this. The case is rather analogous to that of the valve makers, who a few years ago used to dwell on the merits of their output valves from the sensitivity or high amplification point of view rather than that of power output.

I am moved to this protest by a comparatively new reader who has written to me concerning a recently acquired loud speaker. He asks how much power it will handle before it distorts, and how the necessary calculations are made in order to get at this figure. Although I know the instrument well—it is of a good moving-coil type—he has stumped me on both questions, since no manufacturer rates his loud speaker in terms of power-handling capacity, and I confess that I have not the ghost of a notion how it could be done, except empirically.

Now that we have got valves with official power ratings, however, I see no reason why loud speaker makers should not stir their pins and endeavour to find a way of giving us a power-handling capacity figure for their products.

If you go on pushing more and more undistorted power into a loud speaker it is obvious that the time will come when it will itself distort, and so it would be necessary to impose a limit of permissible distortion, just as in the case of a power valve. In the case of moving-iron loud speakers, it is obvious that the amount of power a loud speaker will handle depends, among other things, on the adjusting knob at the back, which complicates matters.

By FREE GRID.

While on the subject of loud speakers, I ought to mention that there are several big surprises in store for August, and, if carefully laid plans, to which I recently secured access, do not go astray, we shall have some really good condenser loud speakers available at Olympia.

Missing Links.

"THIS 'ere progress, it goes on," is a true and apt quotation with which all of you who were as well behaved and attentive as myself when at school will be able to identify. I was reminded of it the other day when walking through one of the many bungalowoid excrescences which seem to be spoiling the countryside around all our towns. I had not proceeded far, picking my way carefully through the mud, before I was brought up with a round turn by a bespatted individual clad in Gents' Smart Spring Suiting and armed with a large notebook.

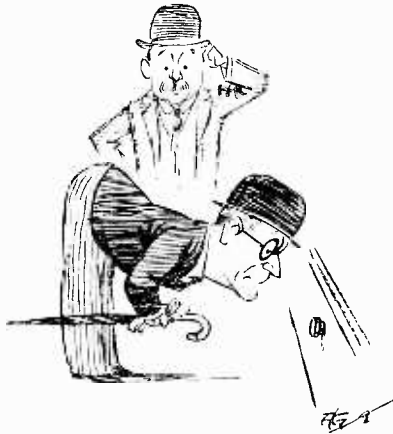

Began to show a little interest.

After a few moments of bewilderment, I gathered that he wanted me to spend my hard-earned money in acquiring a bungalow. I declined in no uncertain terms. He was nothing daunted, however, and commenced subtle flattery by suggesting that I

was obviously the sort of person who demanded something a little better, and before I could protest he had beckoned up a magnificent car and bundled me into it.

We soon arrived at some two-storied buildings, and, being hustled into a fifteen-hundred-pound house, I was compelled to listen to a dissertation on main drainage and other themes. Only when he began to enlarge upon the fact that electric power points were conveniently placed in all rooms did I begin to show a little interest, demanding that he show me the loud speaker plug points. This completely non-plussed him, and I learned, to my amazement, that houses are still being built without the inclusion of loud speaker extension wiring.

My demand for these wireless amenities seemed to send me up several points in his estimation, for he straightway escorted me back to the car and drove me to some in the two-thousand-pound region. Hurrying into the largest of the three reception rooms, which was oak-panelled (at least, he said it was oak) he pointed, with obvious pride, to the central panel over the fireplace, which was in the form of a grille. Opening it, he disclosed a moving-coil loud speaker affixed behind it, and wired to an all-mains receiver mounted behind another panel on the right. This bore projecting control knobs.

The electricity supply not having been connected we could make no test, but, nevertheless, he invited my criticisms. Of the set and loud speaker I had nothing to say, except that it was strange that such a convenience was not built into any house costing less than two thousand pounds. I pointed out, however, that the space behind the loud speaker was so cramped and confined that acoustic trouble from this source would probably result. When he somewhat impertinently asked me how I would remedy this defect, I retorted that I was neither an architect nor a builder.

The point which really roused my anger and led me to say things which I afterwards regretted was that no provision had been made for a loud speaker in other parts of the house. Furthermore, there were no contrivances for remote control.

The Design of

By M. G. SCROGGIE, B.Sc., A.M.I.E.E.

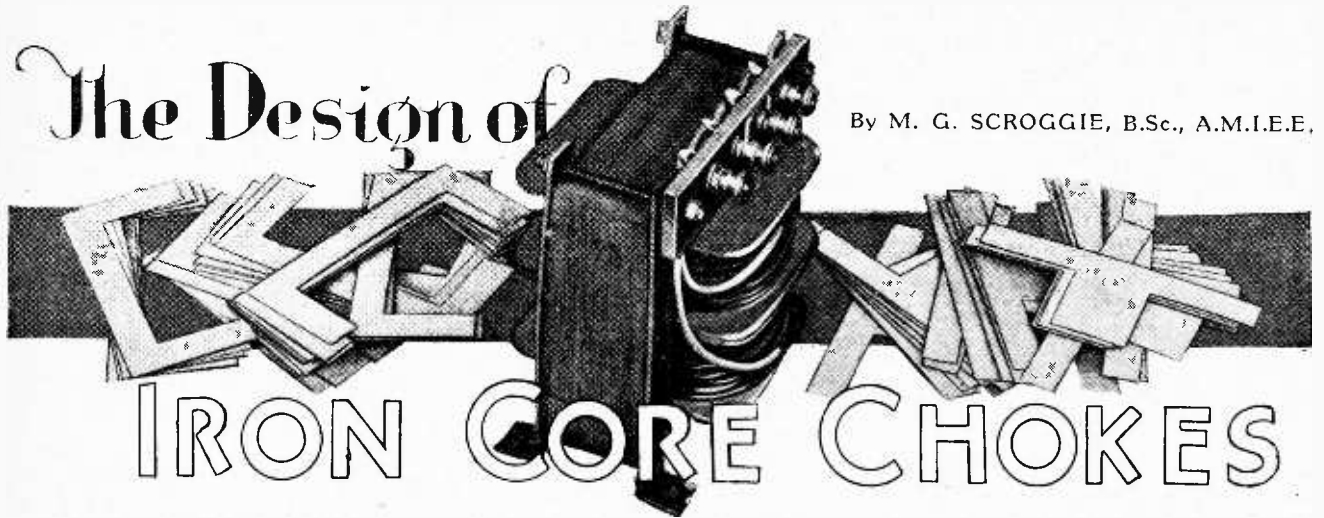

IRON CORE CHOKES

Simplified Calculation Making Use of Graphs.

CHOKES used in wireless receivers, and required to possess so much inductance that an iron core is necessary, are usually compelled not only to serve the purpose indicated by their name in relation to A.C., but to act also as an easy path for D.C. Examples are the chokes used for smoothing rectified current, for intervalve coupling, or for loud speaker output circuits. Intervalve and output transformers present the same problem, unless chokes are used to divert the D.C. It is generally supposed that the only alternative to cut-and-try methods of designing such chokes is a very elaborate piece of calculation based on obscure and dubious data. In this article it is proposed to put forward a straightforward system involving no more abstruse work than simple arithmetic, whereby

chokes may be designed to meet fixed requirements in the most economical manner. The method has been used over a period of years for designing large numbers of iron-core chokes, and the measured results have invariably been very close to the predicted values.

Before giving the design data, let us make sure that we understand why special measures must be adopted to take account of the D.C. component.

The inductance of a coil is proportional to the number of turns multiplied by the number of magnetic lines of force (or flux) linked with those turns when a certain current flows, say one ampere. As the number of turns is increased, the flux is thereby also increased, so the inductance increases as the square of the number of turns. In order to obtain a very large inductance, of an appreciable number of henrys, the coil would either be enormously bulky or else would require exceedingly fine wire were it not for the use of an iron core, which has the effect

of multiplying the flux by a figure (called the permeability μ) which, in some cases, amounts to many thousands. It would make things delightfully easy if the permeability were a fixed quantity for any given type of core material, but actually it depends upon the degree of magnetisation, starting off low, increasing fairly rapidly to a maximum, and then tailing off, becoming ultimately little more than that of air or other non-magnetic materials. Fig. 1 shows the low-magnetisation portions of permeability curves for "Stalloy," a typical transformer iron, and "Laminic," one of the nickel-iron alloys which give remarkably high permeability to start with, but soon falls off.

Consequently the flux increases first slowly, then rapidly, and then slowly again, in a manner which brings to mind a valve characteristic curve (Fig. 2). Now, the alternating current which the choke is required to handle is usually very small—the whole idea of the choke is to keep it small—and one can therefore make good use of the permeability of magnetic cores. But where the coil also carries D.C., the latter is usually

SO many factors are encountered in the design of L.F. chokes that the amateur cannot memorise the mathematics involved. Choke construction is here simplified by reference to practical examples and by the inclusion of graphs giving essential data.

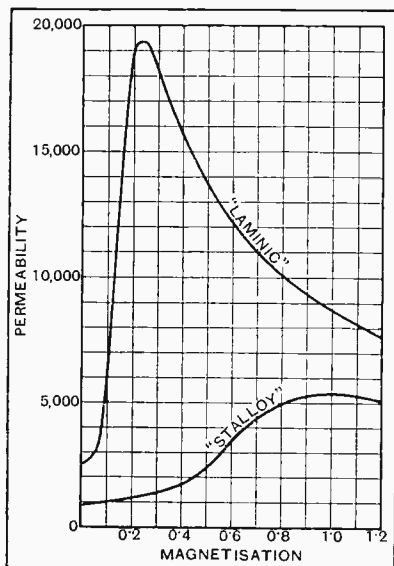

Fig. 1.—Showing the change of permeability with magnetisation in the case of Stalloy and Laminic. The latter is a high-permeability nickel-iron alloy.

The Design of Iron Core Chokes.—

large in comparison and tends to saturate the core and render it much less effective. Not only so, but all magnetic materials are characterised by a sort of sluggishness in responding to the magnetisation produced by varying electric currents, so that the periodic *change* of magnetism induced by a very small alternating current is not what one would expect from looking at the curve.

The Problem of the Gap.

Thus, if our A.C. ripple is represented by a small distance AB either side of D (Fig. 2), where OD represents the D.C. component, the change in flux is not FG, but a much smaller amount HJ. Obviously, if the D.C. is larger, OD', bringing the starting point up on the saturation part of the curve, the magnetic variation (and consequently the inductance of the coil) is far smaller still, too small to show on the diagram. This smaller multiplying value of the iron when A.C. is concerned, is called the differential (or incremental) permeability μ' . Roughly speaking, differential permeability can only boast of its hundreds where normal permeability has its thousands. By leaving a small gap in a core which would otherwise be saturated, the total magnetisation is reduced, but the differential permeability is increased, and if the gap is very small will more than compensate for the loss introduced thereby. Increasing the gap beyond a certain amount does not produce a net improvement, for after a while the further rise in differential permeability ceases to be worth having. The whole problem is to arrive at that certain amount which is the best gap, and as so many of the quantities depend upon one another, it is not altogether an easy matter. However, C. R. Hanna has described a method of deriving curves, the theory of which will not be given here, which make it quite a

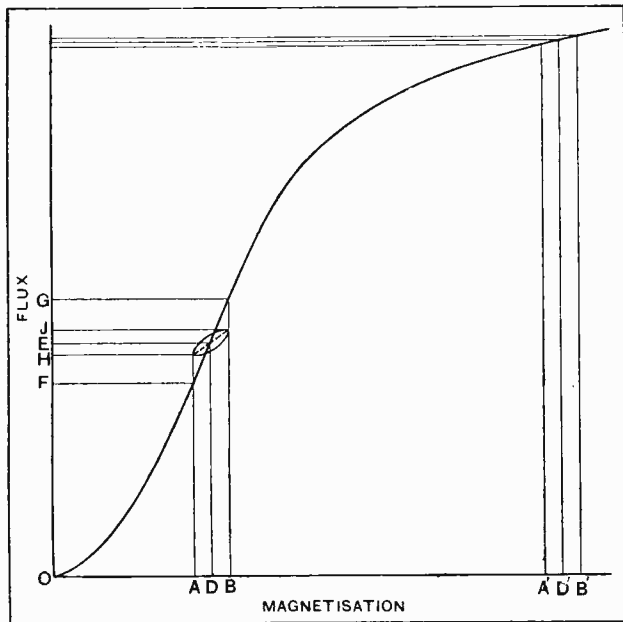

Fig. 2.—Similar in shape to a valve characteristic—the curve showing change of flux when the magnetisation is increased.

A 11

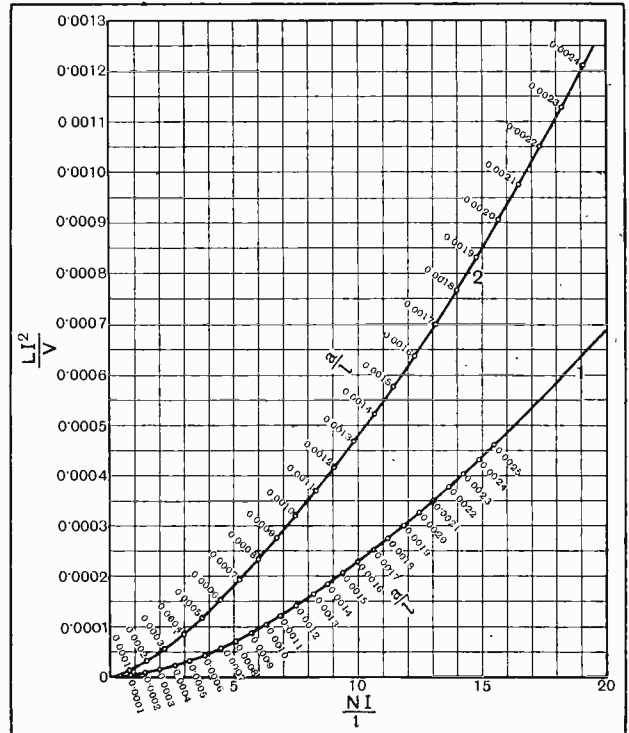

Fig. 3.—In designing a choke there are generally six quantities involved; these are taken into account in these graphs. Curve 1 is for the case where there is a very small A.C. component, and curve 2 for larger values.

simple process. The problem usually appears in one of two forms, both of which can be solved by the curves. It may be necessary to design a choke in the most economical manner to fulfil given requirements, or one may start off with a suitable size and endeavour to obtain the highest inductance. In both cases the allowable resistance has the last word in deciding the matter.

The A.C. Component.

The curves reproduced in Fig. 3 are calculated for the grade of stamping known as "Stantranis," supplied by Messrs. George L. Scott & Co., Ltd., 86-88, Acre-lane, London, S.W.2, but the same results apply fairly well to "Stalloy" (Messrs. J. Sankey & Co., Ltd., Biston, Staffs). There are six quantities involved.

- L The inductance in henrys;
- I the D.C. in amperes;
- N the number of turns of wire in the coil;
- l the length of magnetic path in the iron core in centimetres;
- a the length of the gap, also in centimetres;
- V the volume of the core in c.cms.

There is also the amplitude of the A.C. to be considered, but this is generally not known, so Curve (1) is drawn for a very minute A.C., and one can count on the inductance never being less than that calculated from this curve. If, however, it is known that the A.C. component is not negligible but, say, 5 per cent. or 10 per cent. of the D.C., Curve (2) can be used to give a more accurate result.

If a definite inductance is required, the number of

The Design of Iron Core Chokes.—

henrys is multiplied by the square of the D.C. in amperes and divided by the volume of what is judged to be a suitable core, taken from Table I, which gives data for some representative types of Scott 0.0014 in. stampings. The figure in column V is the net volume in c.c.s of a core with a square section centre limb, this being the most economical cross section, and it allows for the insulation with which the stampings are coated, and also the loss of iron volume due to the stampings being not too tightly packed, but assembled with the number of stampings given in the column headed n. These pile up to a thickness equal to C without severe squeezing. If none of the square cores is found to be suitable, n may be increased or decreased accordingly, and V adjusted in proportion.

The figure $\frac{LI^2}{V}$ is found on the vertical scale of Fig. 3 and followed along horizontally until the appropriate curve is encountered, and then a vertical dropped to meet the lower scale, which gives $\frac{NI}{l}$. I is known, l is found from Table I, so it is simple to find N, the number of turns. To find the best air-gap (any non-

metallic material is described as air for this purpose), note the figure along the curve nearest to the point at which it was met, which gives the ratio of air path to iron path, and hence the former.

Suppose, for example, one wishes to design a 200H choke to carry 5 mA. D.C. and a very small A.C. No. 82 stamping is a nice compact size, and V is 45 c.c.s, so $LI^2/V = (200 \times 0.005^2)/45$ or 0.00011. This meets Curve (1) at $\frac{a}{l} = 0.00105$, and l is 15.6, so a is

0.0164 cm. From the horizontal scale $\frac{NI}{l} = 6.6$, so

$N = (15.6 \times 6.6)/0.005 = 20600$. It will be noted that the type of core described possesses two gaps in series, the two side ones counting as one, for they cut only half the core section each, so the figure 0.0164 must be halved to give the thickness of each gap. Also it is wise to deduct 0.002 from each in order to allow for imperfection in fitting. The gap, therefore, consists of a piece of paper or other suitable material 0.0062 cm. or 2½ mils thick inserted to separate the two halves of the core at all three places. Metal, even though non-magnetic, must not be used, for it would act as a short-circuited winding and enormously reduce the inductance. The mechanical design of clamps, etc., to hold the core together need not be dealt with here, nor will the methods of winding.

Choosing the Right Core.

It is now necessary to check the choice of core by seeing whether the resistance of a coil of N turns capable of being wound on it is within allowable limits. This part of the calculation depends on the type of former used for winding, the type of wire, etc. Assuming fairly normal construction and the use of either double silk-covered wire, or enamelled wire with paper interleave, the resistance R in ohms in the case of a core of square section is roughly equal to $\frac{GN^2}{10^6}$, G

being taken from Table I. It must be realised that this is merely a rough check and does not claim to predict the value of the resistance with an extreme degree of accuracy, but it may be noted that if the wire is heavy gauge, such as 20 s.w.g., for comparatively low inductance chokes, the resistance may be rather lower than that calculated, perhaps 10 per cent.; while with fine wire such as 40 s.w.g., R may be 10-15 per cent. higher, and with d.c.c. wire anything up to 30 per cent. higher. A bulky former, loose winding, or heavy interleaving will also send the resistance up. It is well to err on the high side in estimating the probable resistance.

In the case of our example, the resistance would work out at $\frac{7.8 \times 20600^2}{10^6}$

= 3,300, giving about 16.5 volts drop. If this is too high it will be necessary to select a core with a greater volume

TABLE I

REF. NO. OF STAMPING	V IN C.C.S.	n	l IN C.M.S.	DIMENSIONS (INCHES)							
				A	B	C	D	E	F	G	
82	45	48	15.6	3/8	2 1/2	3/4	1 3/16	1 3/4	3/8	7/8	
69	47	56	14.7	3 3/16	2 1/4	13/16	2 5/32	1 7/16	1 3/32	10.0	
79	54	60	12	3 9/16	1 5/8	1 5/16	7/8	3/4	7/16	19.5	
84	60	56	15	3 1/4	2 1/2	7/8	3/4	1 5/8	7/16	9.5	
39	63	60	14	3 9/16	2	1 5/16	7/8	1 1/8	7/16	13.0	
42	72	60	16	3 9/16	2 3/8	1 5/16	7/8	1 1/2	7/16	9.8	
85	80	56	20	3 1/2	3 1/4	7/8	7/8	2 3/8	7/16	6.0	
4	90	60	20	3 9/16	3	1 5/16	7/8	2	7/16	7.4	
65	99	64	19	4 1/4	2 3/4	1	1 1/8	1 3/4	1/2	7.6	
26	108	64	21	4	3 3/8	1	1	2 3/8	1/2	5.9	
60	194	80	24	4 1/2	4	1 1/4	1	2 3/4	5/8	5.8	
25	218	80	27	5	4 1/4	1 1/4	1 1/4	3	5/8	4.7	
76	350	96	30	5	4 1/4	1 1/2	2	2 3/4	3/4	4.5	
45	390	96	33.5	6 1/4	5 1/4	1 1/2	1 5/8	3 3/4	3/4	3.6	
78	775	112	49	6 3/4	6 3/4	1 3/4	3 1/4	5	7/8	2.18	

TABLE II

COPPER WIRE S.W.G.	OHMS PER YARD
16	0.00746
18	0.01326
20	0.0236
22	0.0390
24	0.0632
26	0.0944
28	0.1395
30	0.1988
32	0.2621
34	0.3612
36	0.5292
38	0.8491
40	1.327
42	1.910
44	2.985

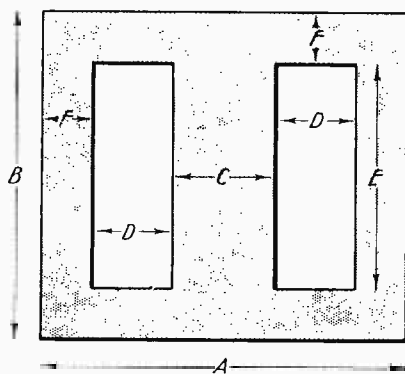

Reference data and lettering showing dimensions of stampings.

The Design of Iron Core Chokes.—

of iron; either a different size of stamping or even more stampings may be needed, preferably the former, as an elongated core section is less efficient in its use of materials, also the relatively simple formula given above for resistance is not applicable. On the other hand, if it is lower than need be, a smaller core will serve. This consideration is, of course, mainly important if the choke is a large one, in which the cost of materials is a serious item.

Having arrived at a suitable core, it remains to fix the gauge of wire, as the calculation of resistance was based on the assumption that wire of exactly the correct diameter could be used, whereas the wire drawers do not, in fact, provide us with an infinite variety of gauges. Table II is now used in conjunction with the formula—ohms per yard = $\frac{73 N}{DE \times 10^6}$.

If in the "ohms per yard" column of Table II there is a figure very slightly lower than that calculated, that gauge may be chosen, particularly if there is reason to believe that there is more room for winding than has actually been assumed in calculating R. Otherwise, it is necessary to select the gauge with the next higher resistance per yard, and the resistance of the choke will be correspondingly greater, while the space occupied by the wire, will be somewhat less. A little experience helps a great deal in balancing the quantities so as to give accurate estimates of how the choke will work out

in practice. In our example, the "ohms per yard" works out at 1.06, so 40 gauge will allow a margin to take account of the fact that, being a fairly fine gauge, the winding will occupy rather more space than that allowed for in the formula for calculating R.

The other way of approaching the problem is to assume a size of core and a permissible resistance and to calculate the highest obtainable inductance. This may be the most economical way of designing the choke from the commencement, or owing to the exigencies of gauge or space in connection with the previous method, it may be preferable to adjust the number of turns rather than juggle about with the size of the core, and it is then desirable to know how much the inductance will depart from the amount originally specified. R being known, N is estimated from the formula already given (subject to the assumptions stated), and so $\frac{NI}{L}$ is known, and one repeats the process with the curve sheet, but in the reverse direction, finding $\frac{LI^2}{V}$ and hence L.

The foregoing methods apply to transformers carrying D.C. in so far as it is usually necessary to make sure that the inductance of the primary under working conditions is sufficiently high. The A.C. is often comparable in strength to the D.C. in the case of transformers, and the inductance consequently rather larger even than that predicted by Curve (2).

ROTHERMEL R.C. MULTI-WAVE SUPERHET.

A NEW receiver shortly to be introduced by the Rothermel Corporation, Ltd., Rothermel House, 1, Willesden Lane, London, N.W.6, and to be known as the R.C. Multi-Wave Superhet, is now undergoing final tests prior to production, during the course of which we were

six-valve superheterodyne circuit. It is entirely A.C. mains operated. Band-pass tuning is incorporated as a matter of course, and the selectivity, sensitivity, and quality are all of a very high standard. It is British made throughout.

The operation is simple and straightforward, as there are three controls only, their respective functions being tuning, wave-change, and volume level adjustment. The switching is deserving of comment, for this one control serves to adjust the

circuits for reception between 15 and 75 metres, 200 to 600 metres, and 900 to 2,000 metres, while a fourth position enables the L.F. amplifier to be used for gramophone reproduction.

Special attention is being given to the cabinets selected for the receiver, and it is probable that at least two models will be available. The table model will be housed in a well-finished walnut cabinet, while there will be a radio-gramophone in a large pedestal cabinet, the samples of which we examined being exceptionally well made, and quite handsome pieces of furniture.

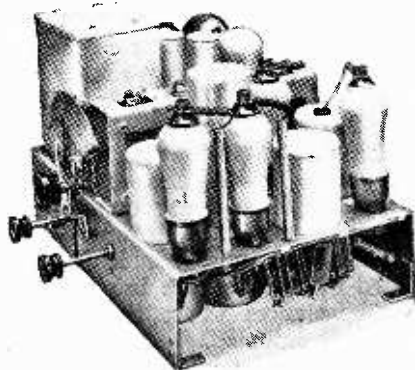

Chassis of R.C. six-valve Multi-wave Superhet.

afforded the opportunity to formulate an opinion as to its merits as a general-purpose receiver. That it can justifiably claim this distinction is exemplified by the fact that provision is made for the short, medium, and long wavebands.

The receiver is designed on modern lines, being chassis-built and embodying a

THE WIRELESS ENGINEER.

Principal Contents for June, 1932.

ACOUSTIC NOMENCLATURE AND DEFINITIONS.

A Discussion of the Need for Standardisation of Terms used in connection with the Science of Acoustics, by Prof. G. W. O. Howe.

A VALVE VOLTMETER METHOD OF HARMONIC ANALYSIS,

by W. Greenwood, B.Sc. A Practical article describing the Measurement of Harmonics produced by Audio-frequency Transformers.

CAPACITIVE OUTPUT COUPLING, by L. G. A. Sims, Ph.D.

ANALYSIS AND DESIGN OF A CHAIN OF RESONANT CIRCUITS (Part 2), by M. Reed, M.Sc.

AN APERIODIC IMPEDANCE MEASURING SET,

by A. T. Starr, M.A., B.Sc., describing a Method using only two Variable Resistances, which gives the impedance in a form which is independent of frequency, so that the frequency need only be known if a frequency characteristic is to be plotted.

ELECTRO-MECHANICAL RECTIFICATION.

A Phenomenon of Moving Coil Loud Speakers, by N. W. McLachlan, D.Sc.

The issue also contains the monthly abstracts of the World's Wireless Literature.

PRACTICAL HINTS AND TIPS.

AIDS TO BETTER RECEPTION.

IT has often been pointed out in the pages of this journal that one of the commonest sources of hum in an A.C. mains operated receiver is interaction between the mains transformer and the L.F. transformer. The usual rule for eliminating it is to disconnect the primary, connect across it a resistance equal in value to the preceding valve's internal A.C. resistance, and then to orientate the transformer to the position of minimum hum. This position is often critical, but it is usually quite definite, so that its exact location is easy.

When the connections are replaced to normal, however, it is sometimes found that the hum is reintroduced. In the majority of cases this hum will be found to be due to the preceding valve's H.T. supply, and can be removed by an increase in the smoothing. Occasionally, however, all efforts to remove the hum fail, and it persists no matter how much additional smoothing be included.

It is obvious that in such cases the H.T. supply is not the real offender, but there may appear to be no other possible source for the hum. It should not be forgotten, however, that the H.F. choke which is usually included in the detector anode circuit contains many turns of wire and it often has a considerable external field. With chokes of this type, therefore, interaction with the mains transformer may be experienced, just as with an L.F. transformer. In obstinate cases of hum one should not omit to try positioning the H.F. choke.

In general, little trouble will be caused by small binocular chokes, and the tendency to pick up hum is at its greatest when using high-inductance chokes of the kind often employed in heterodyne whistle filters. This type of hum may, fortunately, be readily tested for by

the simple procedure of short-circuiting the H.F. choke; if the hum continues, obviously the choke circuit is not at fault; if it disappears, equally obviously, the choke is responsible for it.

IN spite of improvements in valve construction, it sometimes happens that the moulded base of a valve becomes loose, due to a failure of the cemented joint between the glass bulb and the cap. So far as

Home Valve Repairing.

electrical efficiency is concerned, this state of affairs does not necessarily imply that anything is wrong, but it is probable that, as a result of handling the valve, one or more of the leading-out wires which connect the internal electrodes to the pins will eventually be broken.

To reduce the possibility of this occurrence, a stout rubber band may be slipped over the lower end of the bulb in such a way as to embrace both bulb and cap, as indicated in the accompanying illustration. A

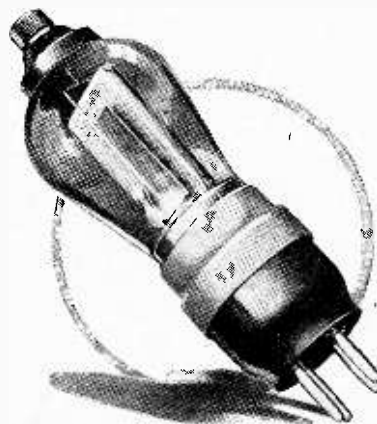

A loosened valve base may be kept firmly in position by means of a broad rubber band.

one-inch section of bicycle-tyre tube is ideal for the purpose.

In the event of one of the leading-out wires being actually broken

through looseness of the cap, it is quite possible for the amateur handyman to effect a satisfactory repair, although it cannot be denied that the operation calls for a fair measure of manual dexterity. The connecting wires are normally passed through the hollow external pins and soldered to their tips; these wires must obviously be unsoldered before the cap can be removed. It is just possible to do this operation with an ordinary soldering iron by applying pressure to the loose cap in the right direction, but it is much easier to heat the tips of all the pins simultaneously by placing them on a small sheet of copper or brass which is heated to the necessary temperature by means of a spirit lamp or blow-lamp placed underneath it.

While the cap is being removed, great care must be taken to identify the various leads, as their internal connections can seldom be traced by examination.

Having removed the cap, an extra length of wire is soldered on the broken connection, and to facilitate replacement the other connections should also be lengthened.

AS a complete or partial short-circuit is responsible for a fair proportion of the breakdowns to which a wireless receiver is liable, it is natural that we should regard this condition with extreme suspicion, and that we should be reluctant ever to introduce a short-circuit deliberately.

Testing by Short- circuiting.

But it has recently been shown that the cause of hum in mains-operated sets may best be localised by making a series of short-circuits in the correct sequence; the same procedure has its uses when making other tests, and it is proposed to describe here briefly some of the instances where the method might be adopted. As compared with tests made by the method of substitution, short-circuiting offers the great advantage of quickness; one can tell in a moment the effect of making a change before the original impression conveyed to the ear has been forgotten.

Although discrimination must obviously be used in applying short-circuits, it may be taken as a general

rule that any component in a grid circuit may be momentarily bridged with impunity. Taking the circuit diagram of Fig. 1 as an illustration, the band-pass coupling condenser C_1 may be eliminated in order to find whether there is excessive stray coupling between the component circuits, or perhaps for the purpose

series-connected smoothing choke may be determined in a moment without risk or uncertainty. When a cessation of signals is thought to be due to a burnt-out choke, this may be confirmed by short-circuiting the suspected component.

Tuning coils: deliberate short-circuits can do no damage, and may

The condenser C_3 is an example.

Reaction condensers, power transformer windings, and loud speaker feed condensers, when joined between anode and earth, must never be short-circuited, although C_5 can be so treated.

Lastly, there are a few doubtful cases which must be decided on their

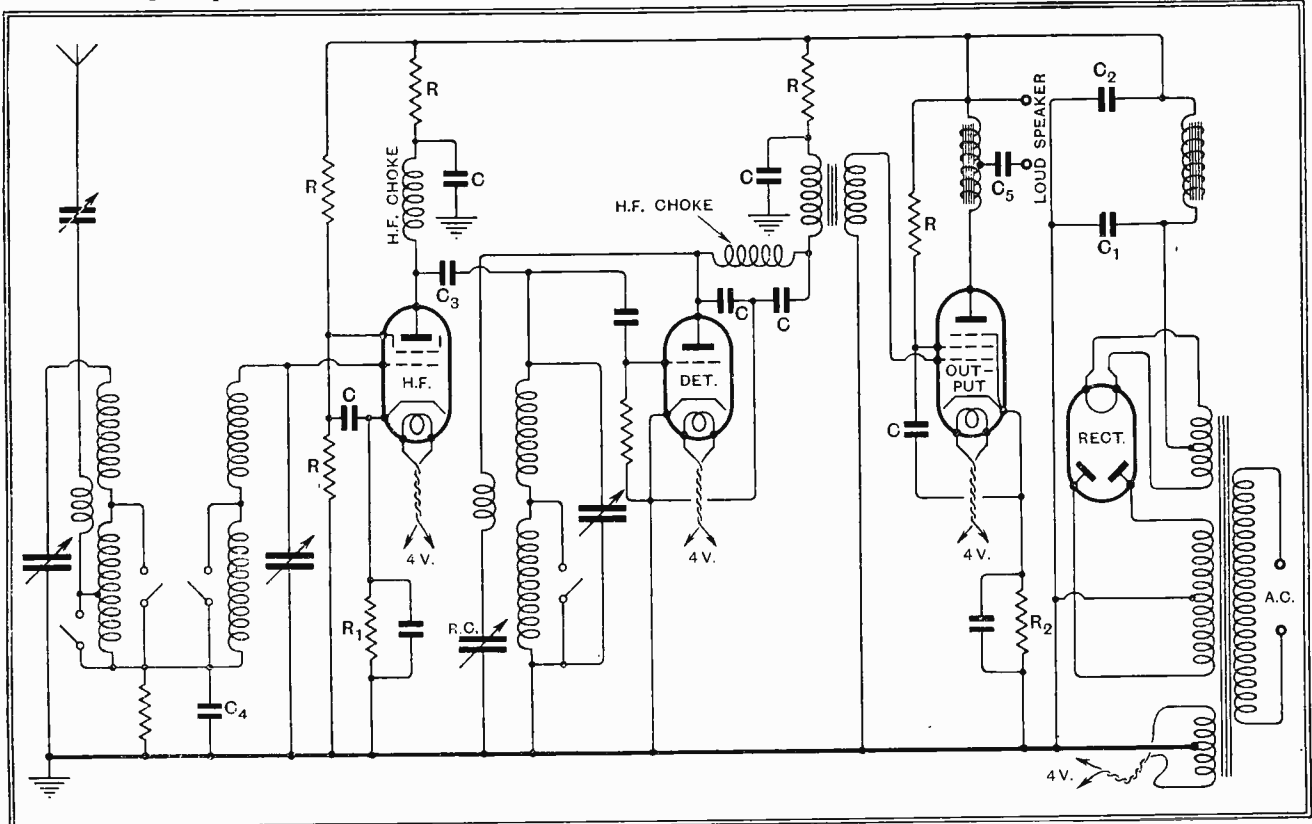

Fig. 1.—Diagram of a typical 3-valve A.C. receiver, which serves to illustrate those positions where temporary short-circuits may be introduced when testing for faults while the set is actually in operation.

of setting the ganged condensers under conditions of minimum coupling. Tuning condensers may always be treated in a similar way, and where they are linked together mechanically it is possible in this way to find the actual unit in which an intermittent short-circuit between fixed and moving vanes is present.

A few other cases where short-circuits may be applied with advantage when testing for a fault may now be summarised:—

H.F. or L.F. transformer primaries: noises due to intermittent disconnections or breakdowns in the windings may be traced. The same applies to secondaries.

Smoothing chokes: the beneficial effect—or otherwise—of an extra

prove whether wave-range switches are functioning properly.

Turning to positions where short-circuits are inadmissible, we come to the anode circuits; here the rule is, of course, that no short-circuit should be applied between H.T. positive and earth, either directly or through a resistance of normal value. None of the anode by-pass condensers (marked C in the diagram) should be shorted, while the same applies to the smoothing condensers C_1 and C_2 . Particular care should also be taken to avoid short-circuits across coupling condensers, which serve to pass H.F. or L.F. impulses to the grid of a succeeding valve, while at the same time insulating it from the H.T. supply.

individual merits. Anode feed resistors (R in the diagram) may sometimes be short-circuited momentarily as a quick check on whether they have broken down, but this course will generally result in the application of an excessive voltage to the valve, and is only likely to be entirely safe where the maximum rectified H.T. voltage is low. Similarly, bias resistors (R_1 and R_2) may be short-circuited momentarily when they are associated with high-impedance valves, thus providing a rough check as to whether grid bias is actually effective. If it is, a distinct increase in anode current will take place. As a rule, low-impedance output valves should not be operated under zero bias conditions.

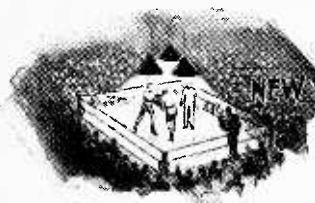

Modern Phototelegraphy

By R. C. WALKER, B.Sc.

Recent Developments in the Bartlane System.

THE general principles involved in the chief commercial systems of phototelegraphy for sending newspaper pictures over telegraph lines, such as the Siemens Karolous, the Bell, and Belin systems of direct transmission, have been described from time to time, and are well known.

The Bartlane system, and some of its recent improvements, have many unique features and advantages not possessed by other systems. The photograph is first coded into a message on a punched tape at the transmitting station. The telegraphic tape is then passed through a normal telegraphic transmitter and handled by the telegraph company exactly like an ordinary message and an identical perforated tape produced at the receiving end through the medium of the signals sent along the line. The telegraphic signals cannot, of course, be distinguished from a message in code. The new tape at the receiving end is then

PHOTOTELEGRAPHY is now playing an important part in journalism. This is not surprising seeing that it is possible to send a photograph of an event of international importance across the Atlantic in 40 minutes by the recently improved Bartlane process, and the definition of the final picture leaves little to be desired. This article gives a complete description of the system.

passed through the photo-receiving apparatus, where the perforations in the tape act as light shutters and control the exposure of a sensitive photographic paper.

The original photograph, as in other systems, is wrapped round a drum, which is rotated so that each point of the photograph comes successively under a pencil of light from a lamp. The light reflected from

the point is directed on to a photo cell, the magnitude of the photoelectric current being determined by the whiteness of the particular point in question. In the preparation of the tape, the Baudet, or five-unit telegraphic code is used, and the marking contacts of the selective relays are connected to the circuits of five punching magnets of the tape-perforating machine.

Actually, each relay has a restraining winding fed from a separate D.C. supply, this winding being in opposition to that fed from the amplified photoelectric current. By adjustment it is easy to predetermine the current at which each relay will operate. The whiteness of any small area of the photograph is represented by the number of relays which operate when that area is illuminated by the spot of light.

The optical equipment used for scanning the photograph comprises a lamp, a lens, a perforated disc, motor driven, for interrupting the light, a reflector to collect the light from the illuminated spot on the photograph, and a photoelectric cell connected to an amplifier. The circuit outline is shown on the right of Fig. 1.

Each time the photograph moves through a distance equal to the diameter of the light spot the contactor B, which is geared to the picture cylinder, interrupts the amplified current and allows the relays to reset after each selective operation, and another contactor A interrupts the supply to the punch magnets, thus preventing sparking at the relay contacts. Fig. 1 also includes the receiving apparatus, the same motor and gear box

Table A.

The Tone Values in Original Photograph.	The Relays which Operate.	The Position of Holes Punched in the Tape.
Black 0	None	.
1	1	. 0
2	1 - 2	. 00
3	1 - 2 - 3	0 . 00
4	4	0.
5	4 - 1	0. 0
6	4 - 1 - 2	0. 00
7	4 - 1 - 2 - 3	00. 00
8	8 - 4b	.0
9	8 - 4b - 1	.00
10	8 - 4b - 1 - 2	.000
11	8 - 4b - 1 - 2 - 3	0.000
12	12 - 8 - 4b	0.0
13	12 - 8 - 4b - 1	0.00
14	12 - 8 - 4b - 1 - 2	0.000
White 15	12 - 8 - 4b - 1 - 2 - 3	00.000

Modern Phototelegraphy.—

driving either the transmitting or receiving cylinder. It will be clear from the illustration that during reception the perforated tape is interposed between the projector lamp and the sensitive paper, so that the light passes through the punched holes. Immediately behind the tape are five adjustable light stops, which enable the quantity of light passed through any lateral row of holes in the tape to give the desired amount of exposure on the paper. Fig. 2 is a sample of the perforated tape.

An improved system has also been developed in which fifteen tones of the original picture are distinguished and coded into fifteen combinations of the five-unit telegraphic code, thus obtaining much more detail in

the received picture. These fifteen combinations of punch magnets are secured by a scheme using seven relays only, and five punch magnets on the perforating machine. These relays are shown in the left-hand diagram of Fig. 1, their numbers representing respectively the comparative values in amplifier output current at which they operate. It will be seen that they are divided into

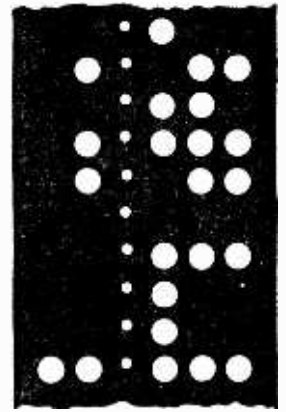

Fig. 2.—A sample of the perforated tape enlarged to double the actual size.

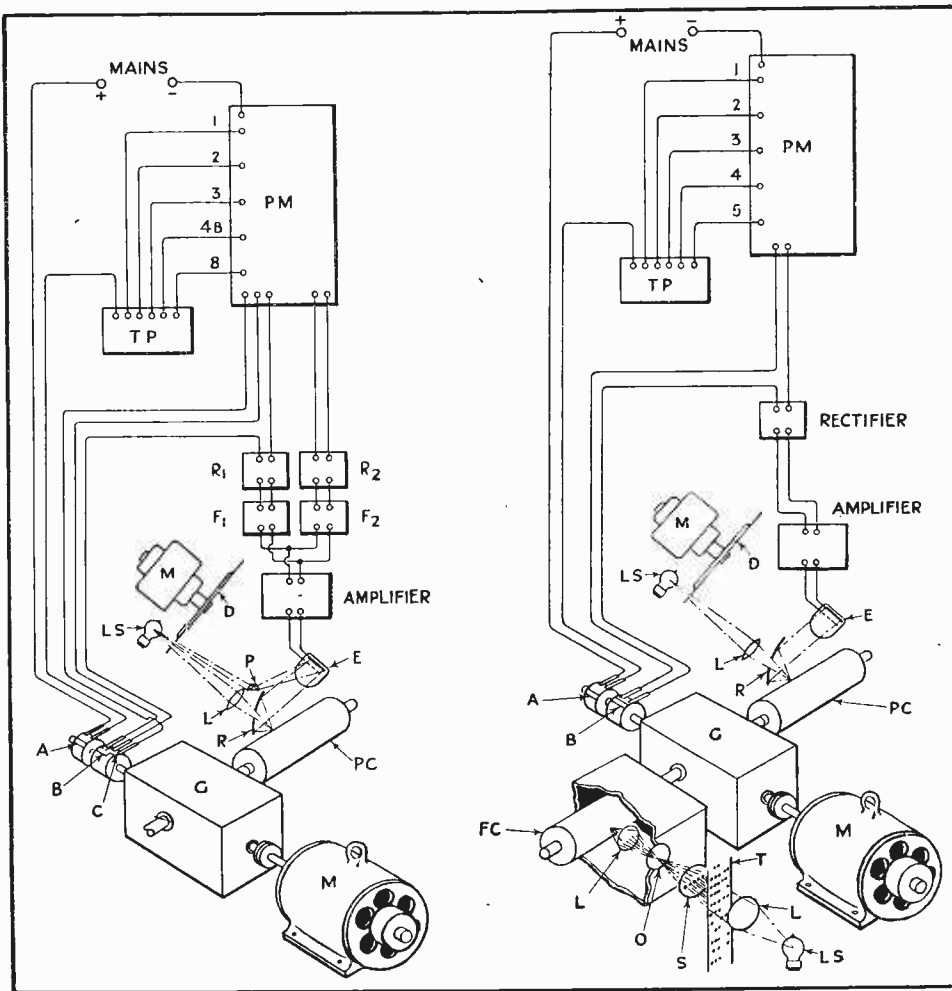

Fig. 1.—(Right) The optical equipment in the Bartlane system which gives five-tone reproduction. The letter references are as follows: PM, punch magnet system; TP, tape perforator; M, motor; D, interruptor disc; LS, light source; L, lens; R, parabolic reflector; E, photo-electric cell; A and B, rotary contacts; G, gear box; PC, picture transmitting cylinder; FC, picture receiving cylinder; O, aperture; T, telegraphic tape. (Left) An improved fifteen-tone system—the Mirrotone—in which the received picture has considerably more detail. PM, punch magnet system; TP, tape perforator; R₁, rectifier and F₁, filter, both for picture current; R₂, rectifier and F₂, filter, both for restraining current; M, motor; D, interruptor disc; LS, light source; L, lens; P, prism; R, parabolic reflector; E, photo-electric cell; PC, picture cylinder; G, gear box; A, B and C, rotary contacts.

two groups; relays 4, 8, and 12 in circuit with the contactor B being pre-selectors to the relays 1, 2, and 3 in circuit with the contactor marked C. By means of resistances, the values of the operating currents of relays 1, 2, and 3 are increased in three successive stages as relays 4, 8, and 12 operate respectively.

The combination of holes punched in the tape for fifteen-tone values which the relays select from the photograph are given in Table A. The receiver is very similar to the Bartlane instrument, but differs in the adjustment of the light stops behind the tape.

Two-frequency System.

It is clear that in the foregoing apparatus any change in the optical system, or the amplifier, or variation in voltage applied to the photo cell would immediately alter the combination of holes punched in the tape and completely upset the adjustment of the transmitter. To avoid this, and to permit the whole apparatus to be operated from supply mains, a two-frequency control system has been evolved which automatically compensates any such variations which may occur. The method of securing this is

Modern Phototelegraphy.—

shown in the diagram, where it will be seen that the photo cell is illuminated by two beams from the same lamp. One beam, termed the "picture illumination,"

restraining windings, which in the previous systems were fed from a separate D.C. source. If any change occurs in the lamp or amplifier, the amplitude of the currents at both frequencies will be altered to the same extent so that the point at which the photoelectric current overcomes the restraining current will be unaffected and external voltage changes will not upset the adjustment.

The operation of the two-frequency principle has made possible the use of mains-fed rectifying units to supply the amplifier, photo cell, and projection lamp. In addition, amplification is not critical, and, consequently, does not require frequent adjustment.

Before transmitting a picture it is only necessary to check the performance of the relays by using a length of photographic paper uniformly graded from white to black on the transmitter and perforating a length of tape sufficient to see that the combinations of perforations are in the correct order and uniformly spaced.

In the case of transmission of black and white drawings or sketches by this system each elemental area of the original is transmitted either as signal or no signal, and occupies the space of time required to transmit a dot signal of the morse code. The number of elemental areas is approximately 3,750 per square inch, giving, for a full-sized picture 4in. by 4in., a total of 60,000 areas. The length of message for a black and white drawing would thus be that of 60,000 dots.

In the case of photographs each elemental area is coded into a letter of the five-unit telegraphic code, and is therefore sent in the time occupied to transmit five dots, and, consequently, takes five times as long as a black and white drawing. Photographs have been sent by this system between London and New York, over Western Union Tele-

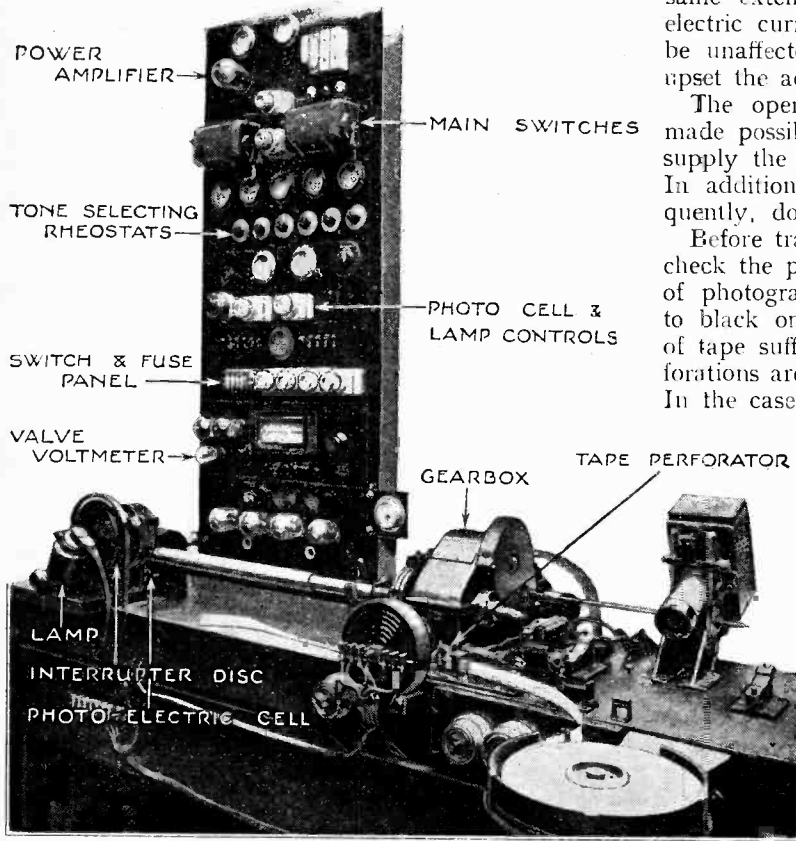

Fig. 3.—General view of the apparatus including switchboard. A complete photograph can be sent between London and New York in 40 minutes.

is directed on to the photograph, as in the previous systems, while the other beam, called the "standard illumination," is projected through a prism on to the photo cell.

Each beam is interrupted by the same rotating disc, but each by a separate circle of holes differing in number, hence giving two different frequencies of interruption. The "picture" current, the amplitude of which is controlled by the tone of the photograph, is separated by filters from the "standard" current, and after rectification is fed to the operating coils of the relays. The "standard" current is also rectified and sent to the

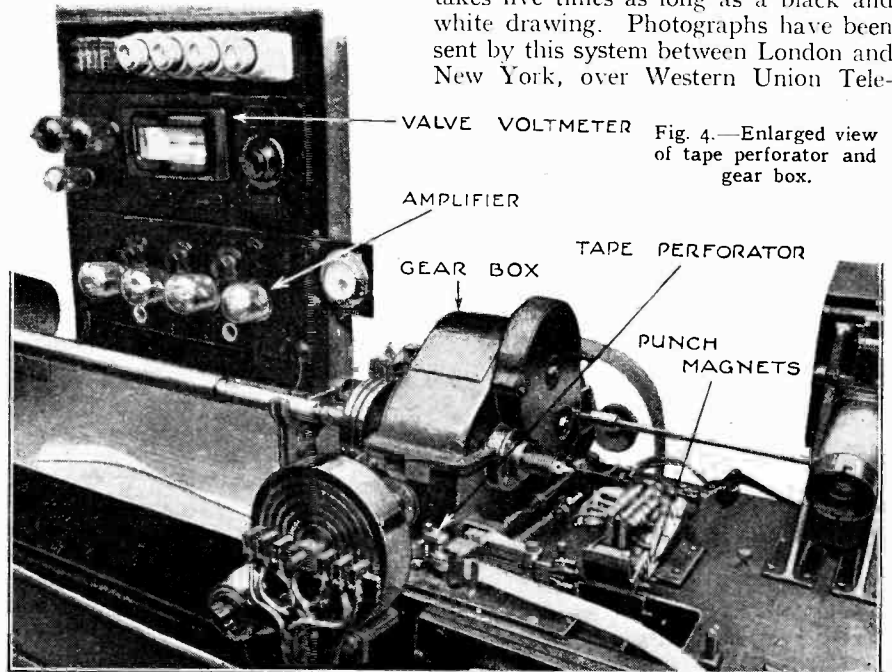

Fig. 4.—Enlarged view of tape perforator and gear box.

[Courtesy, "The Daily Mirror."]

Modern Phototelegraphy.—

graph Company's cables, at 1,500 letters per minute, giving a total time of forty minutes for the complete photograph. If several channels are used the time can, of course, be correspondingly reduced. Fig. 3 shows a general view of the apparatus.

These systems have a number of advantages not common to other methods of phototelegraphy now in general use. For instance, before the message is handed to the telegraph company for transmission it is passed through the local receiving apparatus and a film exposed, thus producing, locally, a copy of what will be received at the distant station. This enables the

sender to know beforehand the quality of the received photo. The system is flexible in the matter of transmission, since any cable or wireless company can handle the tape and be able to effect suitable telegraphic communication. The tape is a permanent record and, if broken, is not destroyed, since a special signal is sent out at each revolution of the cylinder to mark the edge of the photograph, and it is only necessary to restart the sending tape at a point corresponding to the interruption and to join correctly the tape at the receiving end. In addition, the tape can be cut into several sections and each transmitted separately by cable, radio, or both.

INFORMAL INTERNATIONAL RADIO.**The Society of Katowice.**

IT is probable that many listeners in this country have picked up from time to time the Polish station at Katowice, working on a wavelength of 408 metres. Relatively few English listeners, however, may be aware of the fact that on two nights each week an informal broadcast of a very novel nature takes place at the end of the regular programme.

The writer's own experiences go back a matter of rather more than three and a half years, to one Friday night when a new "hook-up" was being tried out.

A Microphone Personality.

A man was talking in French. But *what* a pleasing voice! There was something very arresting and refreshing about it after the customary robot precision of the B.B.C. monotonously intoning about depressions and "feht stock," and so the listener felt compelled to sit back and listen. Not that the subject matter was of any particular importance; on the contrary, it was very commonplace, but its method of presentation was so full of life that it was not difficult to visualise the speaker as a very kindly man of around fifty, probably not over-fussy about his personal appearance, having, for certain, a beard of ample proportions and friendly eyes which looked at you through gold-rimmed pince-nez perched at an angle on a large nose. Such, in fact, proved to be Monsieur Stéphan Tymieniecki, Director of Programmes of the Katowice Station and founder of one of the most remarkable international

organisations which has originated from broadcasting.

The Society is now a little over four years old. In that time its membership has grown from nothing to millions; and the only formal thing about it is its name: "La Société Internationale des Katoviçards." Its birth was not premeditated, but was due to a typically temperamental outburst on the part of Monsieur Stéphan Tymieniecki, who implored his listeners, one night in 1928, to write to him and make themselves known to him and say what they thought of his programmes, so that he might have the pleasure of working for friends instead of pouring his soul into a machine. The result was as remarkable as it was unforeseen, for within a few days letters of appreciation were received not only from Poland, but from listeners in France, Germany, England, Switzerland, Italy, and Belgium. Monsieur Tymieniecki thanked his correspondents heartily, and, incidentally, bubbled over with good feeling towards everyone. More letters followed, many from distant listeners incapacitated by ill-health or cut off from their fellows and anxious to establish contact with those more fortunately situated. A selection of these was answered personally, Monsieur Stéphan calling his new friends by name and replying informally via the microphone. From these small beginnings the present international society of friends of the ether has gradually come into existence, and to-day boasts a membership scattered throughout Europe,

Northern Africa, the Canary Islands, and even farther afield; and quite a number of romances can be traced to the friendships which have grown out of it through listeners drifting into correspondence with each other, exchanging visits, and arranging social functions.

Local "Katoviçard" Clubs.

The organisation is non-political, and membership costs nothing. Whilst idealistic in principle, it does not engage in propaganda or "uplift." It has its own badge bearing the appropriate inscription, "Loin des yeux, près du cœur," in an attractive design, the work of Dr. Rudolf Rauch, of Vienna, an enthusiastic member and advocate of international fellowship. In some Continental towns, members have organised themselves into a local club under the patronage of Monsieur Stéphan, and meetings are arranged and advertised from Katowice, everything being conducted in the friendliest manner.

As for Monsieur Stéphan himself, he has for a long time now been more affectionately known as "Papa Stéphan," and his talks at 11 p.m. on Wednesdays and Fridays, when he plays the part of genial host to his family circle, are amongst the most popular features of Continental broadcasting.

The Society is open to anyone to join, and, as a British listener was informed recently in reply to an enquiry: "Il n'y a aucune formalité à remplir; c'est purement une question de cœur." And Monsieur Stéphan might have added that it is not at all necessary to be a French scholar to enjoy the pleasure of making his acquaintance.

EDWARD HANSEN.

WIRELESS ENCYCLOPEDIA

HARMONICS. *The component sine waves into which any periodic wave may be resolved, however complex its form may be.*

A PERIODIC wave is one which passes repeatedly through the same sequence of values at regular intervals, and constitutes a graphical means of representing any mechanical or electrical vibration of a sustained nature. A sound wave representing a sustained note of constant intensity may be very complex in form, but it passes through a definite number of identical cycles of variation every second, and the number of such cycles occurring in a second represents the *frequency* of the vibration or the *pitch* of the note.

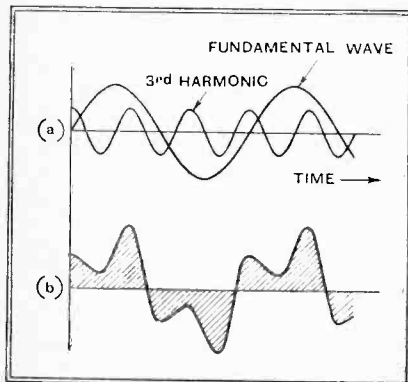

Fig. 1.—The complex wave at (b) is equivalent to the sum of the fundamental and 3rd harmonic sine waves shown at (a).

Now, it has been proved by Fourier that any periodic or alternating quantity, however complex the waveform, can be regarded as the sum of a number of pure sine waves. The most important of these sine waves has a frequency equal to that of the actual complex wave, and is referred to as the *fundamental wave*. All the remaining component waves are called *harmonics*, and have frequencies higher than that of the fundamental wave. A point of the utmost importance is that *the frequencies of*

all the harmonics are exact multiples of the fundamental frequency; that is to say, each harmonic frequency is exactly divisible by the fundamental frequency. A harmonic whose frequency is twice that of the fundamental wave is called the second harmonic (except in music, when it is referred to as the first overtone, being an octave higher), one whose frequency is three times as great is called the third harmonic, and so on.

The manner in which an irregular wave can be resolved into a fundamental sine wave and one or more harmonics is perhaps best shown by a reversal of the process, that is, by adding together graphically two or more sine waves whose frequencies are such that the lowest is exactly divisible into each of the others. The result is a complex wave which repeats itself cycle by cycle. For instance, Fig. 1 (a) shows two sine waves where one has three times the frequency of the other, namely, a fundamental wave and a third harmonic. In this case the amplitude or maximum height of the harmonic is just half that of the fundamental—it is usual for harmonics to have lower amplitudes than the fundamental wave.

The irregular curve shown at (b) is the result of adding together the two sine waves at (a), simultaneous values being taken instant by instant. Conversely, the complex wave of Fig. 1 (b) may be resolved into the fundamental sine wave, and the third harmonic shown at (a). The analysis of complex waves and their resolution into the equivalent fundamental and harmonic waves is a somewhat complicated and tedious process beyond the present scope. But in electric circuits and mechanical vibratory systems the various component sine waves act independently of each other, and it is possible, by means of a resonant circuit to pick out any one harmonic frequency from a complex wave.

Reverting to the simple illustration of Fig. 1, it is quite obvious that the shape of the resultant complex wave will depend not only on the relative amplitudes of the funda-

No. 16

Brief Definitions with Expanded Explanations.

mental and harmonic waves, but also on their relative phase displacements. The effect of a change in phase displacement is shown in Fig. 2, where the fundamental and harmonic waves have the same amplitudes as in Fig. 1, but occupy relatively different positions along the time-base line. The resultant complex wave is here of quite a different shape from that of Fig. 1.

Pitch and Quality of a Note.

In sound a pure tone is one which has no harmonics, and is therefore represented by a single pure sine wave, the pitch of the note being determined by its frequency. When

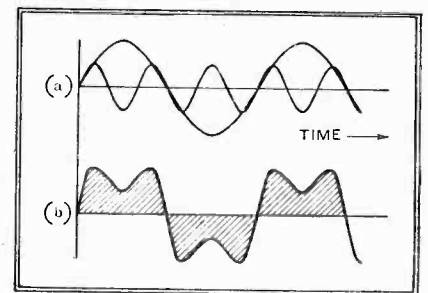

Fig. 2.—At (a) are the same two sine waves as shown in Fig. 1, but bearing a different phase relation to each other. The resultant complex wave has an entirely different shape.

harmonics are present the pitch of the note is determined by the frequency of the fundamental wave, and the quality or timbre by the number and amplitudes of the harmonics. The human ear does not normally separate out the harmonics, but is very sensitive to any change in quality. A musician can easily distinguish the subtle difference between one violin and another due to some slight difference in the harmonics. This emphasises the importance of ensuring that a radio receiver shall deal with all harmonic frequencies in their proper proportion if good reproduction is to result.

The relative phase displacements between the fundamental and various harmonics have no effect whatever on the timbre or quality of a note. A change in phase relationship makes no aural difference.

PROGRAMMES FROM ABROAD



Friday, June 3rd.

ALGIEERS (363.3 metres); 13 kW.—7.30 p.m., (Grook in his Music Hall Sketch. 7.55, News and Time. 8.0, Orchestral Concert. Overture. Les Dragons de Villars (Maillart). The Whistler and his Dog (Pryor). Selection from Couchette No. 3 (Szulc). Dans le Jardin (Debussy). Suite from Messidor (Bruneau). Selection from La Navarraise (Massenet). Eglogue (Rabaud). Rigaudon (Dardanus). 9.15, Songs from Sound Films. 9.30, Dance Music from the Municipal Casino.

BARCELONA (Radio-Barcelona) Call EAJI (349 metres); 8 kW.—8.0 p.m., Trio Concert. Les Papillons (Couperin); Selection from Le Cid (Massenet); Gavotte (Lully); La Serenata (Draga). 8.30, Exchange Quotations; Request Gramophone Records and News. 10.0, Chimes from the Cathedral; Weather Forecast; Market Prices; Exchange Quotations and Relay of Foreign Stations. 10.15, Concert of Dance Music by the Demon's Jazz Band. 11.0, Concert by the Station Orchestra; Selection from Boris Godounov (Moussorgsky); Selection (Jessel); Reverie (Staub); In a Chinese Temple Garden (Ketilbey). 11.30, Argentine Programme by Pili Canete. 12.0 Midnight, Concert by the Vilalta Orchestra relayed from the Café Espanol. 1.0 a.m. (Saturday), Close Down.

BELGRADE (430.4 metres); 2.5 kW.—6.55 p.m., Time and Programme Announcements. 7.0, Czech Lesson. 7.30, Recital of Yugoslavian Songs. 8.0, Talk for Young People. 8.30, Concert from Works of Yugoslavian Composers. 9.30, Violin and Pianoforte Recital. 10.30, News and Sports Notes. 10.50, Cigány Music from the Potrosacka Zadruga Restaurant.

BERLIN (Königs Wusterhausen) (1,635 metres); 60 kW.—12 Noon, Weather for Farmers. 12.2 p.m., Gramophone Concert of Classical and Light Music, followed by Weather for Farmers. 12.55, Time Signal. 1.30, News Bulletin. 2.0, Gramophone Concert of Classical Music, relayed from Berlin (Witzleben). 3.0, Talk: German Girls in London. 3.30, Weather and Exchange. 3.40, Talk: The Toradors' Training School in Spain. 4.30, See Leipzig. 5.30, Talk: Risks Run by Men of To-day. 6.0, Talk with Vocal Illustrations; The Music of Bach's Time.—H. G. Graun. 6.30, Talk: German Insurance in the Time of the Crisis. 6.55, Weather for Farmers. 6.57, Talk: Goethe and Medicine. 7.35, Talk for Workers: The Coal Industry, followed by Weather for Farmers. 8.0-10.20, See Stuttgart. 10.20, Weather; News and Sports Notes. 10.30 (approx.), Concert from Berlin (Witzleben).

BERLIN (Witzleben) (419.5 metres); 1.5 kW.—4.30 p.m., Concert from the Café Berlin. 5.20, Review of New Books. 5.30, Programme for Children. 5.50, Talk: German Literati as Artists. 6.15, Choral Concert: O blicke (Kahn); Ein gutes Liedlein (Häser-Leichtentritt); Wenn wir hinausziehen (Donath, arr. Thiel); Sommernacht (Tiesseu); Spielmann und Mädchen (Röntgen); Polk Melody, Es steht ein Lind (arr. Lendvai); Die singende Stadt (Lendvai). 6.35, Topical Programme. 6.55, The Witzleben Station informs its Listeners. . . . 7.0, Topical Talk. 7.10, Dance Music with Leo Monosson (Tenor). In the interval, hints for the Weekend. 9.0, News and Sports Notes. 9.10, Quintet in C, Op. 163 (Schubert). 10.0, Political Press Review. 10.20, Weather and News. 10.30 (approx.), Unfamiliar Works of Johann Strauss; Concert by the Symphony Orchestra, conducted by Efreim Kurtz; Overture, Karneval in Rom; Waltz, Die Gemüthlichen; Polka, Es gibt nur eine Kaiserstadt; Selection from Der lustige Krieg; Banermpolka; Quadrille, Ninetta; Waltz, Auf den Bergen; Gavotte from The Queen's Kerechief. Overture, Prinz Methusalem; Waltz, Nachtfalter; Diplomatenpolka; Persian March. 12 Midnight, Close Down.

BORDEAUX-LAFAYETTE (304 metres); 13 kW.—6.0 p.m., Talk: The Languages of Modern Europe. 7.30, News Bulletin. 7.40, Educational Talk. 7.55, Lottery Results. 8.0, Advanced Spanish Lesson. 8.15, News Bulletin and Weather Report. 8.30, Concert by the Symphony Orchestra, conducted by A. Guitraud; Soloist, Mme. Chauveau Bourdil (Songs); Selection from Don Giovanni (Mozart-Salabert); Petite Suite (Debussy-Mouton); Songs: (a) Aria

from Rigoletto (Verdi); (b) Song from Manon (Massenet); Selection from Lilac Time (Schubert-Berté-Mouton); Selection from A Midsummer Night's Dream (Mendelssohn-Weingner). Songs: (a) Air from The Barber of Seville (Rossini); (b) Song from Si j'étais Roi (Adam); Selection from Louise (Charpentier-Casadesus).

BRATISLAVA (279 metres); 14 kW.—7.0, See Brno. 7.45, See Prague. 10.30, Announcements. 10.35, See Prague.

BRESLAU (325 metres); 1.5 kW, and **GLEIWITZ (253 metres)—6.50 p.m.,** Talk: The East Germans. 7.15, Weather Forecast. 7.20, Talk: Old Germanic Civilisation at its Height. 7.40, Weather Forecast. 7.45, Concert of Popular Music by the Silesian Philharmonic Orchestra, conducted by Franz Marszalek; Overture, Anacreon (Cherulini); Legend, No. 4 (Dvorak); Symphonic Scherzo (Friedl); Lyric Suite (Grieg); (a) Shepherd Boy, (b) Norwegian Peasants' March, (c) Nocturne, (d) March of the Dwarfs; Tanzspuk (Schroeder); Waltz, Wiener Blut (Johann Strauss); Dances from Nell Gwynn (German). 9.0, News Bulletin. 9.10, Concert of Music by American Composers by the Silesian Philharmonic Orchestra, conducted by Ernst Hoffmann; Oriental Suite (Woodin); Symphonic Poem: The Pleasure Dome of Kubla Khan (Griffes); Humorous Piece for Orchestra, The Ten Millionth Ford (Conserve). 10.0, Time Signal, Weather Forecast, News Bulletin, Sports Notes and Programme Announcements. 10.20, Talk: Football Rules. 10.45, Concert from Berlin (Witzleben); In the interval, at 11.10 (approx.), Weekly Sound News from the Gloria Palast. 12.0 Midnight (approx.), Close Down.

BRNO (342 metres); 35 kW.—7.0 p.m., Dramatic Programme. 7.45, See Prague. 10.30, News Bulletin. 10.35, See Prague.

BRUSSELS (No. 1), (509 metres); 15 kW.—12 Noon, Trio Concert: Franz Wigy (Violin), P. Loeuans (Pianoforte), and De Necker (Cello). 12.30 p.m., Weather Report. 12.40, Concert (continued). 1.0, Gramophone Concert of Light Music. 5.0, Wagner Concert by the Station Symphony Orchestra, conducted by Arthur Meulemans; March of the Nobles; Siegfried Idyll; Overture, Rienzi; O Star of Eve, from Tannhäuser; Prelude to Lohengrin; Albumblatt; Introduction to Act 3 of Lohengrin. 6.0, Gramophone Records (Sibelius); The Swan of Tuonela; Symphonic Poem, Finlandia. 6.15, Talk: A Belgian Painter—Fernand Verry. 6.30, Gramophone Records; Hymn to the Legion of Honour (Zouhalov); Selection from Le Grand Mogul (Audran); Waltz, Künstlerleben (Johann Strauss); A la médaille militaire (Foré); Hungarian Rhapsody, No. 12 (Liszt); Scherzo from A Midsummer Night's Dream (Mendelssohn); Dionysiaques (Schmitt). 7.15, Talk: The Economic Situation in Europe—France. 7.30, A Music Review by Marcel Foot. 8.0, Gramophone Records; Prelude to the First Act of Le Roi malgré lui (Chabrier); Waltz: Le Nuit en-oreclee (Chopin-Albert); Kamarinskaja (Glinka). 8.15, Reading from the Works of the Walloon Poet, Charles Malissart. 9.0, Orchestral Concert, conducted by Franz André; Waltz: España (Waldteufel); Selection from Il Trovatore (Verdi); Dances (Grétry); Selections by Madame Cambier; Hungarian Rhapsody (Liszt); Two Selections. 10.0, Le Journal Parlé. 10.10, Concert (continued); Overture; Die Fledermäus (Johann Strauss); Christine Potpourri (Salabert); selections by Madame Cambier; Way Down South (Myddleton); Cranignons Liégeois; Ballet Music

from Carmen (Bizet); Roll on, Mississippi, roll on (West); If you're really and truly in Love (Butler); Waltz: It Happened in Monterey (Wayne); Sweet and Lovely (Arnheim); Let's get Friendly (Dougherty); Bubbling Over with Love (Russel and Ager). 11.0 (approx.), Close Down.

BRUSSELS (No. 2), N.I.R. (338.2 metres); 15 kW.—Programme in Flemish. 12 Noon, The Barber of Seville—Opera (Rossini), given in Italian on Gramophone Records; In the interval, at 12.30 p.m., Weather. 5.0, Orchestral Concert, conducted by Franz André. 5.45, Programme for Children. 6.15, Talk: Youth and Joy. 6.30, Gramophone Concert. 7.30, Talk: Natural History. 8.0, Orchestral Concert, conducted by Arthur Meulemans. 8.45, Talk: Aristide Briand. 9.0, Concert (continued). 10.0, Le Journal Parlé. 10.10, Gramophone Dance Music. 11.0 (approx.), Close Down.

BUCHAREST (394 metres); 12 kW.—6.0, Talk on Philosophy and Religion. 6.40, Light Music on Gramophone Records. 7.0, Violin Recital by Alex Theodoresco; Sonata in D Major (Handel); Poem (Notara). 7.30, Choral Concert of Sacred Music and Roumanian Music. 8.0, Talk (to be announced). 8.15, Choral Concert (contd.). 8.45, News and Close Down.

BUDAPEST (550 metres); 18.5 kW.—Programme also relayed on 210 metres from 7.0 p.m. to Close Down. 5.30 p.m., Concert of Light Music conducted by Stefan Bertha. 6.30, Shorthand Lesson. 7.0, Song Recital by Josef Cselenyi. 7.45, Talk: The Rowing Competition, Berlin-Vienna-Budapest. 8.10, Last Concert of the Season, relayed from the Hochschule für Musik. The Orchestra conducted by Anton Fleischer; Chaconne (Vitali); Dramatic Scene for Soprano and Orchestra, Sappho (Volkmann); Danse Macabre (Liszt); Cantata No. 76 (Bach); Memorial Speech on the Haydn Bi-Centenary, by Count Zichy; Symphony in D (Haydn). 9.0, Talk: The General Political Position. 10.10, Concert by the Karl Bura Cigany Band, relayed from the Markus Restaurant. 11.0, Dance Music by the Broadway Boys Dance Band, relayed from the Tarjan Restaurant.

COPENHAGEN (281 metres) 0.75 kW., and KALUNDBORG (1,153 metres); 7.5 kW.—12.15 p.m., Talk for Schools: Sicily. 12.45, String Ensemble Concert conducted by A. Bendix, relayed from the Wivex Restaurant. 2.0-3.0, Interval. 3.0, Orchestral Concert conducted by Launy Grondahl; Overture, His Life for the Czar (Glinka); Valse Lyrique (Sibelius); Aragonese (Falla); Selection from The Barber of Seville (Rossini); Salut D'amour (Elgar); The Norwegian Artists' Carnival (Svendsen); Reading; Overture, The Secret Marriage (Cimarosa); Babillage (Bossi); Selection from Hansel and Gretel (Humperdinck); Autumn and November, from The Seasons (Tchaikovsky); Mandoline Serenade for Strings and Pianoforte (Desormes); Zulu March (Alberti). 5.0, Programme for Children. 5.40, Exchange and Fish Market Prices. 5.50, Recital of Old Icelandic Lyrics. 6.20, German Lesson for Beginners. 6.50, Weather Forecast. 7.0, News Bulletin. 7.15, Time Signal. 7.32, Talk. 8.0, Chimes from the Town Hall. 8.2, Items by Per Knutzen. 8.10, Orchestral Concert of Finnish Music: Selections from the Diversimento (Melartin). (a) Prelude, (b) Minuet, and (c) Dance; Selections (Sibelius), (a) Valse Triste, (b) Four Selections from the Music to Strindberg's Svanevit. 8.40, Heikki and Lakkala—Play (Otto Schrayli). 9.10, Chamber Music. Trio in B flat for Pianoforte, Violin and Cello (Mozart); Variations for Pianoforte, Violin and Cello on Müller's Song, "Ich bin der Schneider Kakadu" (Beethoven). 9.45, News Bulletin. 10.0, Relay of the Spring Festival of the Copenhagen Rowing Club from the Lorry Etablissement. 1.0 a.m. (Saturday), Close Down.

DUBLIN. Call 2RN (413 metres); 1.2 kW., and **CORK (224.4 metres)—1.30-2.0 p.m.,** Time Signal, Weather Forecast, Stock Report and Light Music on Gramophone Records. 6.0, Popular Music on Gramophone Records. 6.15, Programme for Children. 7.0, Light Music on Gramophone Records. 7.20, News Bulletin. 7.30, Time Signal. 7.31, Talk on Gardening. 7.45,

Programmes from Abroad—

FRIDAY—continued.

10.45, Concert from Frankfurt. 12 midnight (approx.). Close Down.

LEIPZIG (259 metres); 2 kW., and **DRESDEN (319 metres).**—4.30 p.m., Concert by the Leipzig Symphony Orchestra conducted by Theodor Blumer: Selections (Lecoco), (a) Overture, Giorle-Girolina, (b) Overture, Graziella; Waltz, Die Schönbrunner (Lanner); Selections from Der Sternruker (Lehar); Petite Suite (Debussy); Intermezzo from A Waltz Dream (O. Strauss); Gallop, Flirt (Ziehrer). 5.30, Review of Technical Books. 5.50, News Bulletin. 6.0, Talk: Backward Children. 6.25, English Lesson. 6.50, Talk: The Right Procedure after a Motor Accident. 7.5, Talk for Employees. 7.30, Concert by the Leipzig Concertina Orchestra, conducted by Walter Nitsche: Romantic Overture (Kéler-Béla); Waltz, A Spring Morning (Naef); Fantasia on Silcher's Song, Anchen von Tharau (Fries); March, Adlerflug (Blankenburg). 8.0, Economic Notes. 8.15, Concert by the Leipzig Symphony Orchestra, conducted by Erich Band; Soloist: Lubka Kolessa (Pianoforte); Symphony No. 3 in D (Schubert); Pianoforte Concerto in A Minor, Op. 54 (Schumann); Overture in G Minor (Bruckner); Symphony in B Flat, Op. 60, No. 4 (Beethoven). 10.5, News Bulletin, followed by Dance Music. 11.30 (approx.). Close Down.

LJUBLJANA (574.7 metres); 2.5 kW.—8.0 p.m., Quintet Concert. 7.0, French Lesson. 7.30, Programme for Women. 8.0, Talk for Young. 8.30, Programme relayed from Belgrade. 10.30, Time Signal, News, and Close Down.

LWOW (381 metres); 16 kW.—7.25 p.m., Facing Notes. 7.45-12 midnight. See Warsaw. 12 midnight (approx.). Close Down.

LYONS, La Doua (PTT) (465.8 metres); 1.5 kW.—7.0 p.m., Light Music on Gramophone Records. 7.30, Radio Gazette for Lyons and the South East. 8.30, Instrumental Concert, Jean Witkowski (Pianoforte), Etienne Genin (Violin), Gustave Fellet (Cello), M. Bonal (Horn), and M. Chevalier (Baritone). Trio in E for Pianoforte, Violin and Cello (Mozart), Nocturne in E Flat (Chopin); The Bee (Schubert); Baritone Solos: (a) Romance (Nicolo Isouard), (b) Sérénade (Schubert); Romances, Nah (Lindblad); Sonata for Pianoforte and Horn (Beethoven); Baritone Solos: (a) Chanson du petit Cheval (De Séverac), (b) Chanson du Pêcheur (Fauré), (c) Nocturne (César Franck); Violin Solos: (a) Bercesue (César Cui), (b) Sicilienne and Rigaudon (Francoeur); Cello Solos: (a) Two Romances (Mendelssohn), (b) Sérénade (Saint-Saëns).

MADRID (Union Radio) (Call EAJJ) (424.3 metres); 2 kW.—8.0 p.m., Chimes, Exchange Market Prices, and Request Gramophone Records. In the Interval at 8.30, Educational Talk. 9.15-9.30, News Bulletin and Political Review. 10.30, Chimes, Time Signal, and Political Review. 10.45 (approx.), Symphony Concert on Gramophone Records. Overture, A Midsummer Night's Dream (Mendelssohn); Death and Transfiguration (Richard Strauss); Symphony (Haydn); Selection from Petroniska (Stravinsky). 12.45 a.m. (Saturday), News bulletin and Programme Announcements for Listeners Abroad. 1.0, Chimes and Close Down.

MORAVSKA-OSTRAVA (263.8 metres); 1 kW.—7.0 p.m., See BRNO. 7.45, See Prague. 10.30, Programme Announcements and Theatre Notes. 10.35, See Prague.

MUNICH (533 metres); 1.5 kW. Relayed by Augsburg and Kaiserslautern (660 metres) and Nürnberg (239 metres)—5.0 p.m., Orchestral Concert conducted by Erich Kloss; Soloist: Hugo Reker (Violin); Festival Overture (Leutner); Adagio from the Violin Concerto (Brahm); Selection from Ariadne auf Naxos (Richard Strauss); Waltz, Delirium (Johann Strauss); Ballet Suite (Poppy); Sérénade at Buio (de Micheli); Polish Dance (Scharwenka); March, The Gladiators' Farewell (Blankenburg). 6.15, Time Signal, Weather Report, and Agricultural Notes. 6.25, Talk: Collapsible Boats. 6.45, Talk: Avoiding Accidents with Collapsible Boats. 7.5, Talk, by C. Scherler: My Experiences with a Collapsible Boat. 7.25, Pianoforte Recital by Egon Petri, Gavotte (Gluck-Brahms); Sérénade from Don Giovanni (Mozart); Fantasia on Carmen (Bizet-Busoni); Four Preludes (Debussy): (a) La Vile aux Cheveux de lin, (b) La Sérénade interrompue (c) La cathédrale engloutie, (d) Minstrels; Fantasia in F Minor (Chopin). Songs arranged for Pianoforte (Schubert-Liszt): (a) Die-Forelle, (b) Gretchen am Spinnrad, (c) Auf dem Wasser zu singen, (d) Erlkönig. 8.50, The Trial of Socrates—Radio Play in Four Acts (Kysar). 10.20, Time Signal, Weather Report, News Bulletin, Sports Notes, and Traffic Report.

Talk (to be announced). 8.0, Concert by the Station Symphony Orchestra, conducted by Vincent O'Brien. 10.30, Time Signal, News, Weather Forecast and Close Down.

FRANKFURT (390 metres); 1.5 kW., and **CASSEL (246 metres).**—12 noon, Orchestral Concert of Marches and Waltzes: March, Mit klingendem Spiel (Translater); Anina Waltz from Die Chansonette (Bellinger); Selections (F. Strauss). (a) March, Sarazenen, (b) Waltz, Tanz-Kandidaten, (c) Jubel-Walzer; March, Frisch gewagt (v. Blon); Waltz, Gräfenberger (Gung'l); Waltz, Wiener Kinder (Jos. Strauss); Kinderlieder Marsch (Fetras). 12.50, News and Weather. 12.55, Time Signal. 1.0, See Stuttgart. 2.0, News Bulletin. 2.10, Sponsored Concert. 3.0, Weather Report. 3.10, Time and Economic Notes. 4.55, Economic Notes. 5.0, Concert from Munich. 5.15, Economic Notes. 6.25, Talk: At the Garibaldi Memorial on the Fiftieth Anniversary of his Death. 6.50, Mandoline Concert. 7.15, Time and Announcements. 7.30, Legal Talk: Young Offenders. 8.0-10.20, See Stuttgart. 10.20, Time and News. 10.45, Concert. 12 midnight, Close Down.

HAMBURG, Call ha (in Morse); (372 metres); 1.5 kW.—Relayed by Bremen (270 metres); Flensburg (218 metres); and Hanover (566 metres) and Kiel (232.2 metres).—6.10 p.m., Variety Programme. 6.35, Talk for Workers. 6.55, Frankfurt Exchange and Hamburg Market Prices. 7.0, Topical Talk. 7.15, Weather Report. 7.20, Points of View—Readings. 8.15 (from Kiel), Festival Concert by the Kiel Municipal Orchestra on its Twenty-fifth Anniversary. Conductors: Eugen Jochum, Prof. Rudolf Krasselt, Prof. Ludwig Neubeck and Richard Richter. Leonora Overture No. 3 (Beethoven). Talk by the President of the Kiel Musical Society. Variations on a Theme by Haydn (Brahms). Prelude and Selection from Tristan and Isolde (Wagner). Tod und Verklärung (R. Strauss). Prelude to The Mastersingers (Wagner). 10.0, Time and News. 10.20, Concert from the Hotel Reichshof.

HEILSBURG (276.5 metres); 60 kW.; and **DANZIG (453.2 metres).**—11.30 a.m., Concert from Breslau. 1.5 p.m., Concert conducted by Eugen Willeken. March, Uncle Teddy (Fucik); Waltz, Aquarellen (Joseph Strauss). Overture, Fra Diavolo (Auber). Canzonetta (d'Ambrosio). Waltz (Ackermann). Selection from The Tales of Hoffmann (Offenbach). Suite, In einem Puppenhaus (Engelmann). Waltz, Madeleine (Waldteufel). Selection from The Gipsy Baron (Johann Strauss). 2.30, Sponsored Programme with Gramophone Records. 4.0, Programme for Children. 4.30, Orchestral Concert conducted by Eugen Willeken. March, Vorwärts! Aufwärts! (Hohmann-Webau). Waltz, Roses and Marguerites (Waldteufel). Overture, Die Feisenmühle (Reissiger). Ballet Divertissement (Blättermann). Küsse im Dunkeln (Micheli). Debreczini (Meisel). Gounod Potpourri (Urbech). Waltz, Der erste Brief (Reggvo). Selection from The Merry Peasant (Fall). 5.55, Review of New Books. 6.15, Agricultural Market Prices. 6.25, Talk: Dogs in Towns. 6.50, Detlev von Liliencron. Programme of Literature and Music. 7.35, Weather Report. 7.40, Mozart Concert by the Königsberg Opera House Orchestra, conducted by Erich Seidler. Soloist, Bruno Eisner (Pianoforte). Concert Suite (arranged Busoni). Pianoforte Concerto in G. Symphony in D. 8.40, Programme Announcements. 8.50, Chitra, a Play (Rabindranath Tagore); Music by Lendvai. 10.0 (approx.). Weather, News and Sports Notes.

HILVERSUM (296.1 metres); 20 kW (7 kW up to 4.40 p.m.—6.25 to 9.40 a.m., Programme of the Workers' Radio Society (V.A.R.A.). 6.25 to 6.40 and 7.10 to 7.25, Gymnastics. 7.40, Gramophone Records of Variety Music. 8.40, Septet Concert. 9.40, Religious Programme by the Liberal Protestant Radio Society (V.P.R.O.). 9.55 to 11.40, V.A.R.A. Programme. 9.55, Recitations. 10.10, Septet Concert. 10.40, Recitations. 10.55, Concert (continued). 11.40 a.m. to 3.40 p.m., Programme of the Allgemeine Vereinigung Radio Omroep (A.V.R.O.). 11.40, Orchestral Concert conducted by Nico Treep. 1.40 p.m., Transmission for Schools. 2.10, Orchestral Concert conducted by Hennes. Overture, Le Lac des Fées (Auber). Cavatina (Saint-Saëns). Selection from La Gioconda (Ponchielli). Minuet from Falstaff (Verdi); Romance (d'Ambrosio); La Mousmé (Ganne); Gramophone Records of Variety Music; Waltz, Neu Wien (Johann Strauss); Selection from Polenlied (Nedbal); Studentenpolka (Millöcker); Annenpolka (Johann Strauss); March, Hand in Hand (V. Blon). 3.40 to 7.40, V.A.R.A. Programme. 3.40, Pianoforte Recital.

4.10, Programme for Children. 4.40, Orchestral Concert conducted by Hugo de Groot, with Gramophone Records in the intervals. 6.20, Organ Recital. 6.40, Gramophone Records of Variety Music. 6.55, Orchestral Concert (continued). 7.40 to 10.40, V.P.R.O. Programme. 7.40, Talk for Young People. 8.10, Pianoforte Recital: Theme with Variations in E (Handel); Three Sonatas (Scarlatti); (a) in F Sharp, (b) in D, (c) in A; Variations (Mendelssohn). 8.40, Talk. 9.10, Pianoforte Recital (continued): Selections (Chopin), (a) Mazurka in C Sharp, Minor op. 30 No. 4, (b) Waltz in C Sharp Minor op. 64 No. 2, (c) Etude in G Flat op. 25 No. 9, (d) Etude in A Flat; Three Selections (Liszt), (a) Un sospiro, (b) Sonetto del Petrarca, (c) Légende de St. François de Paul marchant sur les flots. 9.40, Religious Notes. 9.45, News Bulletin. 9.55, Recitations. 10.25, Gramophone Records of Variety Music. 10.40, V.A.R.A. Programme. Gramophone Records of Variety Music. 11.40 (approx.). Close Down.

HUIZEN (1,875 metres); 8.5 kW.—Programme of the Catholic Radio Society (K.R.O.). 7.40 a.m., Gramophone Records of Variety Music. 8.55-9.40, Interval. 9.40, Gramophone Records of Variety Music. 11.10, Programme for Hospitals. 11.40, Police Notes. 11.55, Quintet Concert. 1.40, Vocal and Instrumental Concert. Soloists: Mlle. Els Berentzen (Violin), Mischa Fokin (Bass-Baritone), and Fred. Boshart (Pianoforte). Sonata in D for Violin and Pianoforte (Beethoven). Russian National Melodies. Larghetto (Handel-Hubay). Tambourin (Leclair-Kreisler). Canzonetta (Tchaikovsky). Aubade (d'Ambrosio). National Russian Melodies. 3.0, Gramophone Records: Selections from Die Fledermans (Johann Strauss). 3.40, Vocal and Instrumental Concert. Soloists: Mme. Sophie Brantigan-Ides (Soprano) and Mlle. Agnes Maria Luns (Pianoforte). French Songs of the Eighteenth Century; Three Songs; Vöglein (Grieg); Aus mein Tagebuch (Reger); Es blüht ein Blümlein roseurot (Reger); Am schönsten Sommerabend (Grieg); Mit einer Primula Veris (Grieg); Obsession (Luns); Le Secret (Fauré); Mandoline (Debussy). 4.40, Talk by Herr Ritter. 4.55, Concert by the K.R.O. Ensemble. 6.20, Talk on Horticulture. 6.50, Talk by J. van der Hoeven Leonhard. 7.10, Police Notes. 7.40, Orchestral Concert conducted by Johann Gerritsen. Soloist, Piet Hertvelt (Violin): Overture, Anacreon (Cherubini); Concerto for Violin in E flat (Mozart); Petite Suite (Debussy); Havannaise (Saint-Saëns); Overture, Nordische Sennfahrt (Gade); Second Suite from Peer Gynt (Grieg); Overture, Die Fledermans (Johann Strauss); Kaiserwalzer (Strauss); Radetzky March (Strauss). 10.40, Gramophone Records of Variety Music. 11.40 (approx.). Close Down.

KATOWICE (408 metres); 16 kW.—7.20 p.m., Talk: Polish Students in Czechoslovakia. 8.15, Symphony Concert by the Warsaw Philharmonic Orchestra. 10.45, News Bulletin. 11.0, Answers to Correspondents, in French.

LAHTI (1,796 metres); 6.4 kW. Relayed by Helsinki (368.1 metres)—5.15 p.m., Songs and Stories for Children. 6.40, Talk. 7.5, Choral Concert. 7.30, Dramatic Programme. 8.0, Orchestral-Concert from Helsinki. 8.45, News in Finnish and Swedish. 9.15, Military Music from the Kappeli Restaurant. 10.0 (approx.). Close Down.

LANGENBERG (473 metres); 60 kW.—12 noon, Concert from Frankfurt. 12.50 p.m., Weather, Announcements and Time. 1.0, Concert conducted by Wolf. 2.30, Sponsored Gramophone Concert. 3.30, Economic Notes and Time. 3.50, Programme for Children. 5.0, Concert conducted by Wolf; Overture, Alfonso and Estrella (Schubert); Waltz from Faust (Gounod); First Suite from Peer Gynt (Grieg); Selections (Clemens): (a) Mädeln und Bürschen, (b) Militär-Burleske; Ballet égyptien (Luigini); Sérénade (René); Selection from Frühlingluft (Josef Strauss-Reiterer). 6.15, Talk: German Destiny as Mirrored in German Towns—Trier. 6.40, English Conversation. 7.0, Weather, Time, Economic Notes and Sports Results. 7.15, Topical Talk. 7.30, Talk: The Labour Market. 8.0, Orchestral Concert conducted by Kühn; March, Gruss in die Ferne (Döring); Overture, Si j'étais Roi (Adam); Dance from The Huguenots (Meyerbeer); Selections (Joh. Strauss): (a) Waltz, Gruss aus Wien, (b) Annen-Polka; Ballet Music from Carmen (Bizet); Selections from Der liebe Augustin (Fall); Waltz, Frauenliebe und Leben (Blon); Suite from Les Millions d'Arlequin (Drigo); Selections from The Gipsy Baron (Joh. Strauss); March, Unter Brief und Siegel (Becker). In the interval, Songs of Europe, by Annemarie Trojan (Soprano). 10.0, News and Sports Notes.

Programmes from Abroad—

OSLO (1,083 metres); 60 kW. Relayed by **Fredriksstad (367.6 metres); Hamar (560 metres); Notodden (447.1 metres); Porsgrund (453.2 metres); and Rjukan (447.1 metres).**—5.0 p.m., Gramophone Records of Variety Music. 5.30, Theatre Review. 6.0, French Lesson. 6.30, Chamber Music: Sonata in C op. 10 for Piano-forte and Violin (Arvid Kleven); Fantasia (Alnaes). 7.0, Weather and News. 7.30, English Lesson. 8.0, Time Signal. 8.2, National Programme from Trysil. 9.10, Talk: Wagner's Tristan and Isolde. 9.40, Weather and News. 10.15, Quartet Concert for Oboe, Clarinet, Cornet and Bassoon. 10.45 (approx.). Close Down. **PALERMO (Ente Italiano Audizioni Radiofoniche) (542 metres);** 3 kW.—5.30-6.30 p.m., Concert of Variety Music and Dance Music. 8.0, Announcements, Radio Giornale dell'Emil., Agricultural Notes, Report of the Royal Geographical Society and Giornale Radio. 8.20, Popular Music on Gramophone Records. In the interval at 8.30, Time Signal and Announcements. 8.45, Instrumental and Vocal Concert. Soloists: G. Scala (Pianoforte), R. Padova (Soprano), and A. Grignani (Tenor). Pianoforte Solos: (a) Sonata (Mortaci). (b) Serenata (Savasta). (c) La Trottola (Setacoli). Soprano Solos: (a) Selection from La Wally (Catalani). (b) Song from Gianni Schicchi (Puccini). Tenor Solos: (a) The Flower Song from Carmen. (b) Serenata (Mascagni). Talk by F. De Maria. Pianoforte Solos: (a) Zephyr (Suk). (b) Nocturne (Chopin). (c) Etude (Chopin). Soprano Solos: (a) Song from L'Amico Fritz (Mascagni). (b) Song from Tosca (Puccini). Tenor Solos: (a) Song from I Pagliacci (Leoncavallo). (b) Ochi di Fata (Denza). After the Concert, Dance Music on Gramophone Records. 10.55, News and Close Down.

PARIS (Eiffel Tower), Call FLE (1,445.7 metres); 13 kW.—Time Signals (on 2,650 metres) at 10.26 a.m. and 11.26 p.m. (preliminary and 6-dot signals).—6.45 p.m., Theatre Review. 7.0, Le Journal Parle. 8.20, Weather Report. 8.30, Bébé prend médecine.—Radio Play in One Act (du Pontavice). 9.0, Symphony Concert. Soloists: M. Manouvrier (Flute) and M. Bas (Violin). Conductor: Edouard Flament. Selection from Antar (Rimsky-Korsakov). Flute Solo: Minuet from Orpheus (Gluck). Two Lyric Pieces (Grieg): (a) Herz-wunden. (b) An den Frühling. Violin Solo: Fifteen Extracts from the Rubaiyat of Omar Khayyam, with Music by René Lenormand. Bacchanale from Samson and Delilah (Saint-Saëns). Waltz, The Passing of Salome (Joyce-Salabert). 10.0 (approx.). Close Down.

PARIS (Post Parisien) (328.2 metres); 60 kW.—6.45 p.m., Sponsored Concert. 7.45, Popular Music on Gramophone Records, News and Announcements. 8.30, Gramophone Records, Talk, and News. 8.45, Concert of French Songs by Music Hall Artists. 9.45, Dance Music on Gramophone Records.

PARIS (Radio Paris), Call CFR (1,725 metres); 75 kW.—6.45 a.m., Physical Culture Lesson. 7.30, Weather and Physical Culture (continued). 7.45, Gramophone Records, Minuet (Mozart). Pièce en forme de Habanera (Ravel). Le Printemps (Milhaud). Tambourin (Leclair). 8.0, News, Weather, and Press Review. 12 Noon, Jewish Programme: Readings and Music. 12.30 p.m., Gardens and Fountains—Gramophone Concert: In a Monastery Garden (Kételbey). A la Fontaine (Charpentier). Le Jardin des amours (Mouret). In the Garden of Allah (Rico). The Fairy Garden from Mother Goose (Ravel). La Fontaine de Carahout (Létorey). Jeux d'eau (Ravel). La Belle est au jardin d'amour (Weckerlin). Night in the Gardens of Spain (Falla). My Garden of Roses (Wood). Fountain Scene from Pelléas et Mélisande (Debussy). In the Flower Garden from Marouf (Rahaud). Jardins sous la pluie (Debussy). Le Fontane di Roma (Respighi). In the intervals at 1.0, Exchange, News and Weather; at 1.30, Exchange; and at 2.0, Exchange and Announcements. 3.45, Weather, Agricultural Report, Agricultural Talk and Racing Results. 7.30, Talk: The Cotton Problem and the French Colonies. 7.45, Commercial Prices and News. 8.0, Concert. The Orchestra, conducted by Henri Défosse. Soloists: Madeleine Whita, Suzanne Balguérie and Georges Jouatte (Songs), Overture, Coriolanus (Beethoven). Songs: An die ferne Geliebte (Beethoven). 8.30, News and Weather. 8.40, Gastronomic Review. 8.45, Concert (continued). Duet and Death of Isolde, from Tristan and Isolde (Wagner). 9.15, Press Review and News. 9.30, Concert (continued). Walter's Prize Song and Overture to The Mastersingers (Wagner).

PITTSBURGH (Westinghouse Electric) (KDKA

FRIDAY—continued.

(306 metres); 25 kW. 9.0 p.m., Teaberry Baseball Scores. 9.5, Business News. 9.15, Rita Cavalieri (Spanish Soprano). 9.30, Pebeco Weather Report. 9.33, Market Reports. 9.45, K.D.K.A. Kiddies' Klub. 10.0, Teaberry Baseball Scores. 10.5, David Lawrence Dispatch. 10.10, KDKA Artist Bulletin. 10.12, Programme Announcements. 10.15, KDKA Orchestra, Thé Dansante. 10.30, The Singing Lady from New York. 10.45, Little Orphan Annie, from New York. 11.0, Time Signal. 11.1, Temperature Report. 11.2, Who's News To-day. 11.7, Teaberry Sport Review. 11.12, Press News-Reeler. 11.15, KDKA Orchestra. 11.30, Royal Vagabonds, from New York. 11.45, Literary Digest Topics in Brief by Lowell Thomas, from New York. 11.59, Time Signal. 12 midnight-3.45 a.m. (Saturday), New York Relay. 12 midnight, Pepesod, Amos 'n' Andy. 12.15 a.m. (Saturday), L'Esso Programme, Elsie Janis. 12.30, Stebbins Boys. 12.45, Billy Jones and Ernie Hare. 1.0, Nestlé's Programme. 1.30, Ivory Programme. 1.45, Sisters of the Skillet. 2.0, Friendship Town. 2.30, Armour Programme. 3.0, Whiteann's Pontiac Chieftains. 3.30, Love Songs and Waltzes. 3.45, Programme to be announced. 4.0, Time Signal. 4.1, Teaberry Sport Review. 4.11, Temperature Report. 4.12, Weather Report. 4.15, Press Last Minute News Flashes. 4.20, Hotel William Penn Orchestra. 5.0, Cotton Club Orchestra, from New York. 5.15, Time Signal and Goodnight.

POZNAN (335 metres); 1.9 kW.—7.15 p.m., Italian Lesson on Linguaphone Records. 7.30, Talk: Public Opinion in France. 7.45-10.45, See Warsaw. 10.45, Topical Talk. 11.0, Sports Notes and Police Report. 11.15, Dance Music on Gramophone Records. 12 midnight (approx.). Close Down.

PRAGUE (488.6 metres); 120 kW.—6.0 p.m., Talk: The National Theatre in Vienna in 1892. 6.10, Agricultural Report. 6.15, Talk for Workers: Holidays. 6.25, German Transmission: Announcements and Two Talks. 7.0, See Brno. 7.45, The Hermit's Bell—Comic Opera in Three Acts (Mailart). 9.0 (in the interval), Time and News. 10.15, Announcements. 10.35, Gramophone Records of Light Music.

RADIO-SUISSE ROMANDE (SOTTENS) (403 metres); 25 kW. Lausanne (680 metres), and Geneva (760 metres).—12.30 p.m., Time Signal from Neuchâtel Observatory. 12.31, Weather Forecast and News Bulletin. 12.40 (from Geneva), Gramophone Concert of Light Music 1.0, Exchange Quotations. 1.5, Gramophone Concert (contd.). 1.45-5.0, Interval. 5.0, Time Signal from Neuchâtel Observatory. 5.1 (from Geneva), Programme for Women. 5.45, Concert by a String Orchestra conducted by Robert Echenard. 7.0, Weather Forecast. 7.1 (from Lausanne), Sports Notes. 7.20 (from Lausanne), Report of the Swiss Automobile Club. 7.30 (from Geneva), Talk: The Work of the Disarmament Conference. 7.55, Announcements. 8.0 (from Geneva), Anecdotes by Pierre Duniton. 8.10 (from Geneva), Music relayed from the Cathedral, The Lausanne Male Voice Choir and the Ladies' Choir of the Conservatoire, conducted by A. Dénégraz. Soloists: Mlle. Roset (Soprano), M. Schwartz (Tenor), Mme. Troyon-Blaesi (Pianoforte), and Charles Fallier (Organ). 11th Century Hymn to Dionysius by Male Voice Choir and Organ. Tenor Solo with Organ: Die Ehre Gottes in der Natur. Male Voice Choir and Organ: Mass in C (Liszt). Soprano Solo with Organ: (a) Ave Maria (Cherubini). (e) Air from St. Paul (Mendelssohn). Mixed Choir: Le Luth Silencieux (Dénégraz). Die Wallfahrt nach Ke-laar (Humperdinck). 10.10, Weather Forecast and News Bulletin. 10.20 (approx.). Close Down.

RIGA (625 metres); 15 kW.—7.5 p.m., Chamber Music: Serenade for String Instruments (Volk-mann). Divertissement for Wind Instruments (Bernard). Suite for String Instruments (Berghout). Sinfonietta for Wind Instruments (Novacek). 8.0, News Bulletin. 8.20, Soprano Solos. 8.40, Bizet Orchestral Concert: First Suite from L'Arlesienne. Selection from The Pearl Fishers. 9.0 (in the interval), Weather and News. 9.35, Popular Concert. 10.30 (approx.). Close Down.

ROME Call 1R0 (441 metres); 50 kW. Relayed by **Naples (319 metres) and 2R0 (43 metres).**—8.15-8.30 a.m. (Giornale Radio and Announcements. 12 (Noon), Gramophone Records of Variety Music. 12.35 p.m., Weather Forecast. 12.45-2.0, Sextet Concert: Pattuglia di zigani (Ranzato), Ronda dei pierrots (Sinigaglia). Figurine di Carnevale (Piek-Mangiagalli). Dance of the Waves from Loreley (Catalani). Tanzende Liebe (Schebeck). Selection (Ripp). In the intervals at 1.15, Giornale Radio and Exchange,

and at 1.30, Time and Announcements. 4.45 (Naples), Talk for Women. 5.0, Exchange, Children's Radio Review, Giornale Radio and Announcements. 5.30, Song Recital by Ivana Cecchi (mezzo-soprano); Aria from A Masked Ball (Verdi); Aria from La Favorita (Donizetti); Habanera from Carmen (Bizet). 5.45, Concert: Selection from The Italian Girl in Algiers (Rossini); Waltz, Donna Grazia (Kavasin); Cortège orientale (Ganne); Entr'acte (Annat-Alvez); Rumba, To a Rose (Simons); Selection (Abraham) 6.15, Giornale dell'Emil. 6.55 (Naples), Shipping and Sports Notes. 7.0, Agricultural Report, Announcements, Giornale Radio and Press Review. 7.50, Gramophone Records of Variety Music. 8.0, Time, Announcements, and Report of the International Institute of Agriculture (in Italian, French, English, German, and Spanish). 8.30, Sports Notes and Announcements. 8.45, Orchestral Concert, with Bianca Stagno-Bellincioni (soprano) and Emilio Livi (tenor); Selection from Un viaggio a Reims (Rossini); Pianoforte solos: (a) Gagliarda (Galilei, arranged by Respighi), (b) Ballet from Il Conte Orlando (Molinaro, transcribed by Respighi); Soprano solos: (a) Two Arias from Forza d'amor paterno (Stradella, arranged by Gentili), (b) Berceuse de Jocelyn (Godard), with violin obbligato; Two Selections for Orchestra (Chambrier): (a) Idyll from the Pastoral Suite, (b) Rhapsody, España; Tenor solos: (a) Rondini al nido (de Crescenzi), (b) Aria from Mephistopheles (Boito), (c) Aria from L'elisir d'amore (Donizetti). Talk on Garibaldi. Selections from Manon (Masseten). Invitation to the Dance (Weber-Berlioz). News after the Programme.

SCHENEGTADY (WGY) (379.5 metres); 50 kW. Relayed at intervals by **W2XF (31.48 metres)** and by **W2XD (19.56 metres).**—9.0 p.m., Decorating Notes from New York. 9.15, Old Time Tunes. 9.30, Musical Ad Men. 9.50, News Items. 10.0, Stock Reports and Police Notices. 10.15, Skippy, from New York. 10.30, The Success Doctor. 10.45, New York State Department Talk. 11.0, Musical Programme. 11.24, Baseball Scores. 11.30, with Grey McClintock in the Canadian North-West. 11.45, Silver Streaks. 12 (Midnight) (WGY only), General Electric Programme. 12 (Midnight) (W2XF only), Stock Reports and News Items. 12.15 a.m. (Saturday), Weather Report. 12.16, New Kenmore Orchestra. 12.45, Trials of the Goldbergs, from New York. 1.0 (WGY only), The Cities Service Programme, from New York. 1.0 (W2XF only), International General Electric Programme. 1.30, WGY Farm Forum. 2.0-4.0, New York Relay. 2.0, Clequot Club Eskimos. 2.30, Pond's Programme. 3.0, National Oratorio Society Programme. 4.0, Freddy Engel's Orchestra. 4.30, De Witt (Clinton Orchestra). 5.0-5.30, New York Relay. 5.0, Ralph Kirbry (Dream Singer). 5.5, Hotel New Yorker Orchestra. 5.30, New Kenmore Orchestra. 6.0 (approx.). Close down.

SCHWEIZERISCHER LANDESENDER (BEROMUNSTER) (459 metres), 60 kW., Basle (244.1 metres), and Berne (246 metres).—12.28 p.m., Time Signal from Neuchâtel Observatory. 12.30, Weather Report and News Bulletin. 12.40, Concert by the Station Orchestra. 1.35, Weather Report and Exchange Quotations. 1.45, Interval. 3.30, Dance Music on Gramophone Records. 4.0, Danish and Scandinavian Music on Gramophone Records. 4.30 (from Berne), Fairy Tales for Children. 5.0-6.30, Interval. 6.30 (from Berne), Talk on Natural History: Fishes. 7.0, Time Signal, Weather Forecast, Market Prices, Tourist Report, and Sports Notes, followed by Swiss Country Music on Gramophone Records. 7.30 (from Berne), Agricultural Talk. 8.0, Concert by the Station Orchestra. 8.35 (from Berne), Dr. Gittüfel—Play in Swiss Dialect. 9.30, Weather Forecast and News Bulletin. 9.45, The Passion Plays in Selzach. Report from the Selzach Passion Play Theatre; Talk on Selzach and its Tradition; Interviews with the Producers, Actors, etc.; Relay of a Rehearsal of a Scene from the Passion Plays. 10.30 (approx.). Close Down.

STOCKHOLM, Call SASA (436 metres), 55 kW. Relayed by **Boden (1,229.5 metres), Göteborg (322 metres), Hörby (257 metres), Motala (1,348 metres), Östersund (770 metres), and Sundsvall (542 metres).**—5.20 p.m., Song Recital by Georg Funkquist, with Hawaiian Guitar Selection in the Interval. 5.45, Gramophone Concert of Light Music. 6.45, Talk. 7.15, Weather Report and News Bulletin. 7.30, See Vienna. 8.30, Orchestral Concert by the Malmö Musical Society, conducted by Georg Schmevoigt, relayed from **Malmö (231 metres);** Polish Festival (Lindberg); Symphonie Poem, The Song (Atterberg); Rhapsody, Midsommarvaka (Alfvén). 9.0, Talk: Sweden as a Country for Tourists. 9.20, Brahms' Pianoforte Recital by Greta Berven: Two Inter-

Programmes from Abroad—

ludes. Romance in F. Rhapsody in G minor. 9.45, Weather Report and News Bulletin. 10.0, Light Music by a String Orchestra. 11.0 p.m. (approx.). Close Down.

STRASBOURG (345 metres); 11.5 kW.—11.30 a.m., Gramophone Concert of Operatic and Classical Music. 12.45, News in French and German. 1.0, Time Signal. 1.2, Gramophone Concert (continued). 2.0-4.45, Interval. 4.45, Literary Talk in French. 5.0, Dance Music. 6.0, Topical Talk in German. 6.15, Legal Talk in German. 6.30, Orchestral Concert: Overture, Die schöne Melusine (Mendelssohn). Selection from L'Africaine (Meyerbeer). Dance of the Waves from Loreley (Catalini). Ballet égyptien (Luigini). Selections from La Reine Pâramette (Leroux). 7.30, Time Signal. 7.32, News in French and German. 7.45, Orchestral Concert: March, Jasper Scout (Demaele). Hesitation Waltz (Antiga). Overture, La Fille de Madame Angot (Lecocq). Chinese Serenade (Siede). Selection from The Merry Widow (Lehar). Intermezzo, Amber Eyes (Löhner). Sérénade nuptiale (Klose). Marche des Copains (Krier). 8.30, Band Concert relayed from Metz. 10.30, Relay from Paris of the evening arranged by the Radio Colonial Station. 11.0 (approx.). Close Down.

STUTTGART (Mühlacker) (360.5 metres); 60 kW.; and **FREIBURG (570 metres)**—10 a.m., Song Recital by Elisa Keller. Songs (Mahler): (a) Liebst du um Schönheit, (b) Ich bin der Welt abhanden gekommen, (c) Wer hat dies Liedlein erdacht? Four Songs (Richard Strauss): (a) Traum durch die Dämmerung, (b) Ach Lieb, ich muss nun scheiden, (c) Nachtag, (d) Ruhememe Seele. Three Songs (Ottmar Schneck): (a) Das Ziel, (b) Ravenna, (c) Hufschmid. 10.20 (from Freiburg), Talk for Schools. 11.0, Time, Weather and News. 11.15, Sponsored Concert. 12 Noon, See Frankfurt. 12.50 p.m., Time, Weather, News and Programme Announcements. 1.0 (from Freiburg), Concert by the Freiburg Concert Orchestra, conducted by Richard Fried. Soloist: Herbert Fröhlich (Violin). Overture, L'isola disabitata (Haydn). Violin Concerto in A minor No. 219 (Mozart). Movements from the Haffner Serenade. Violin Solos: (a) Melody (Gluck-Kreisler), (b) Rondino on a Theme by Beethoven (Kreisler), (c) Poem (Fibich), (d) Waltz (Hummel-Burmester). 1.55, News Bulletin. 2.0-2.15, Sponsored Musical Programme. 2.30-3.0, Advanced English Lesson. 4.0 (from Badenweiler), Concert by the Badenweiler Orchestra, conducted by Albert Iltzig: Homage March from Sigurd Jorsalfar (Grieg). Overture, Mater Dolorosa (Scassola). Serenata d'Amalfi (Becca). Selection from Rigoletto (Verdi). Ridonami la calma (Tosti). Selection from The Circus Princess (Kálmán). 5.0, Concert from Munich. 6.15, Time, Weather and Agricultural Notes. 6.25 (from Freiburg), Talk: Hygiene without Money. 6.50, Mandoline Recital. 7.15, Time and Programme Announcements in Esperanto for the Coming Week. 7.30, See Frankfurt. 8.0, Concert of Swabian Folk Music, by a Peasant Orchestra and Chorus, conducted by Emil Kahn. 8.30, Everyady Poisons: From Tea to Alcohol. A Variety Programme (Dr. Curt Elwenspoek). The Station Orchestra, conducted by Gustav Görlich, Karl Köstlin, Curt Elwenspoek, Käthe Mann, Hans Haus, Carl Struve and Otto Seyfert. 9.15, Concert by the Stuttgart Philharmonic Orchestra, conducted by Emil Kahn. Overture to a Puppet Play (Gal). Le Tombeau de Couperin (Ravel). Serenade in G (Reger). 10.20, Time, Weather, News, Programme Announcements and Sports Notes. 10.45, See Frankfurt. 12 Midnight (approx.). Close Down.

TOULOUSE (Radiophonie du Midi) (385 metres); 8 kW.—5.0 p.m., Transmission of Pictures. 5.15, Exchange Quotations. 5.30, Orchestral Selections. Ballet Music from Hérodiate (Massenet). Selection from L'Africaine (Meyerbeer). 5.45, Sound Film Music. 6.0, Orchestral Selections (Wagner): (a) Overture, Rienzi, (b) Selection from Taubmähner. 6.15, Orchestral Selections from (a) The Czardas Princess (Kálmán) and (b) Pas sur la bouche (Yvain). 6.30, Exchange Quotations. 6.45, Spanish Songs. 7.0, Talk. 7.15, Accordion Solos. 7.30, News Bulletin. 7.45, French Military Music (Pares). 8.0, Songs from (a) The Barber of Seville (Rossini). (b) Tosca (Puccini), and (c) Manon (Massenet). 8.15, Orchestral Selections. 8.45, Light Music. 9.0, Orchestral Concert from the Café des Américains. 10.30, North African News. 10.45, Orchestral Concert (continued). 11.0, Organ Solos. Gipsy Love Song (Agen). Indian Love Call (Friml). Yesterday (Harrison). My Blue Heaven (Donaldson). 11.15, Orchestral Concert. La Prière d'une vierge. The Little Gnomes (Eilenberg). Valse poudrée (Popy). Ma Poupée chérie

FRIDAY—continued.

(Sévérac). Un peu d'amour (Silesu). La Lettre de Manon (Gillet). Selection from Rosamunde (Schubert). Aria for Strings (Bach). Polonaise No. 1 in A (Chopin). Hungarian Dances Nos. 1 and 2 (Brahms). Minuet in G (Beethoven). Norwegian Dances (Grieg). 12 Midnight, Weather and Announcements. 12.5 a.m. (Saturday), English Music. 12.30 a.m., Close Down.

TRIESTE (247.7 metres); 10 kW.—7.10 p.m., Quintet Concert: Vent'anni (Marf). Selection from The Last Waltz (Oscar Straus). Notte stellata (Cortopassi). A la Martiniuca (Maccagno). Per voi, signora (Chiappo). Selection from Herbstmäher (Kálmán). Passa una donna (Ruggier). 8.0, till Close Down, see Turin.

TURIN (273.7 metres); 7 kW.—Relayed by Milan (331.5 metres), Genoa (312.8 metres), and Florence (500.8 metres). 6.45 p.m., Agricultural Notes and Report of the Royal Geographical Society. 7.5, Announcements. 7.10, Musical Selections: Patria (Pennati-Malvezzi); Farfalle (Mattani); Rauschi (Sonntag); Selection from Les Saltimbanques (Ganne). 7.30, Time, Announcements, and Gramophone Records of Variety Music. 8.0, Giornale Radio. Weather and Gramophone Records of Variety Music. 8.45, Radio Talk. 8.50, Concert of Chamber Music. 9.50, Review of New Books. 10.0, Variety Programme. In the intervals: Talk and Literary Notes. 11.0, Giornale Radio.

VIENNA (517 metres); 15 kW.—Relayed by Graz (352.1 metres), Innsbruck (233 metres), Klagenfurt (453.2 metres), Linz (246 metres), and Salzburg (218 metres). 5.5 p.m., Orchestral Concert: March, Tiroler Holzbockbauh'n (Wagner); Overture, Růbezhalk (Plotow); Waltz, Vindobona (Klein); Nocturne, Selige Stunden (Mayer-Aichhorn); Waltz, Faschingskinder (Ziehrer); Selection from Where the Lark sings (Lehar); Parade of the Tin Soldiers (Jessel); Humoresque (Dvorak); Marionetten (O. Weber); Fox-trot, Marie Marie (Roland); Tango, Ohne Worte lass uns scheiden (Jurmann); March, The Star Spangled Banner (Souza). 6.15, Tourist Report. 6.30, Talk: Austria in the Tenth Olympic Games at Los Angeles. 6.45, Weekly Sports Report. 7.0, Talk: The Fiftieth Anniversary of the Rudolfiner Haus Hospital. 7.30, Time and Announcements. 7.40, Concert of Swedish Folk Music, by the Austro-Swedish A-Cappella Choir, conducted by Karl Söderberg. 8.30, Franz Schmidt Concert by the Vienna Symphony Orchestra, conducted by the Conductor: Third Symphony in A; Variations on a Hussar Song. 9.55, News Bulletin. 10.10, Dance Music from the Café Saclier.

WARSAW (1,411 metres); 120 kW.—12.5 p.m., Programme Announcements. 12.10, Light Music on Gramophone Records. 1.20, Weather Report. 1.35, Popular Music on Gramophone Records. 1.55, Interval. 2.45, Variety Music on Gramophone Records. 3.5 Economic Report and Exchange Quotations. 3.15, Report of a Polish Musical Society. 3.20, Interval. 3.25, Talk from Cracow. 3.45, Hydrographic Report. 3.50, Light Music on Gramophone Records. 4.20, Talk relayed from Wilno (563 metres). 4.40, Popular Music on Gramophone Records. 4.55, Linguaphone English Lesson. 5.10, Talk: The Fantastic World of Automata. 5.35, Concert of Light Music by the State Police Orchestra, conducted by Al. Sielski; Rakoczy Overture (Kéler-Béla); Valse des Fillettes (Idali); Egyptian Serenade, Anina (Lincke); Mazurka, Bondarczuk (Levandovsky); Selection from The Circus Princess (Kálmán); Japanese Serenade, Etagezjah (Nehi); March, Soort (Huber). 6.50, Miscellaneous Items. 7.15, Agricultural Press Review, relayed from Wilno. 7.25, Programme Announcements. 7.30, Sports Notes. 7.35, Light Music on Gramophone Records. 7.45, Radio Journal. 8.0, Talk on Music. 8.15, Symphony Concert by the Warsaw Philharmonic Orchestra, conducted by Emil Mlynarsky, Soloist, Henri Sztompka (Pianoforte): Overture, The Tatra Mountains (Zelensky); Polish Fantasia for Pianoforte and Orchestra (Paderewsky); Children's Symphony (Palestra); Symphony in A Minor—the Scottish Symphony (Mendelssohn); Literary Feuilleton in the interval. 10.40 Radio Journal. 10.45, Weather and Police Notes. 10.50, Dance Music. 12.0 (midnight) (approx.). Close Down.

Saturday, June 4th.

ALGIERS (363.3 metres), 13 kW.—7.30 p.m., Orchestral Concert. 8.30, Request Gramophone Concert.

BARCELONA (Radio-Barcelona), Call EAJI (349

metres), 8 kW.—7.0 p.m., Programme for Children, followed by Trio Concert and Humorous Picture Transmission. 8.30, Exchange Quotations, Request Gramophone Records, and News Bulletin. 10.0, Chimes from the Cathedral. Weather and Exchange Quotations. 10.15, Concert by the Station Orchestra: Pasodoble, Lecumberri (Franco); Baile español (Fernández); Paysage (Doulez); Ballet, Panadés (Sancho Marfaco). 11.0, Programme from Madrid.

BELGRADE (430.4 metres), 2.5 kW.—4.0 p.m., Request Concert on Gramophone Records. 5.0, Balalaika Concert by the Ivascenko Orchestra. 6.55, Time and Programme Announcements. 7.0, Talk. 8.0, Orchestral Concert: Overture, Djamilah (Bizet); Ballet Suite, La Source (Delibes); Selection from Boris Goloumov (Moussorgsky). 8.50, Programme to be announced. 9.45, Saxophone Recital by Herr Alexander Nicolie. 10.15, News Bulletin. 10.35, Relay of Foreign Stations.

BERLIN (Königs Wusterhausen) (1,635 metres), 60 kW.—12 Noon, Weather for Farmers. 12.2 p.m., Gramophone Concert of Opera Music, followed by Weather for Farmers. 12.55 p.m., Time Signal. 1.30, News Bulletin. 2.0, Gramophone Concert of Operetta Music, relayed from Berlin (Witzleben). 3.0, Programme for Children. 3.30, Weather and Exchange. 3.45, Talk for Women. 4.0, Talk: Forgotten Pioneers. 4.30, See Hamburg. 5.30, Health Talk. 5.50, Talk: What Everyone should know about Accidents in the Water. 6.10, Talk: The Town of Ilaithabu. 6.30, Talk: Naturalism in the Literature of the Nineteenth Century. 6.55, Weather for Farmers. 7.0, English Lesson. 7.30, Religious Talk, followed by Weather for Farmers. 8.0, See Frankfurt. 10.20, Weather, News, and Sports Notes. 10.30 (approx.), Dance Music from Berlin (Witzleben). 12.30 a.m. (Sunday), Close Down.

BERLIN (Witzleben) (419.5 metres), 1.5 kW.—4.5 p.m., Orchestral Concert: Overture, Zampa (Hérold); Hungarian Rhapsody, No. 1 (Liszt); Largo from the Symphony, From the New World (Dvorak); Suite from The Sleeping Beauty (Tchaikovsky); Overture, His Life for the Czar (Glinka); Selection from Cavalleria Rusticana (Mascagni); The Musical Box (Liadov); Two Elegiac Melodies (Grieg); Waltz, Die Kosenden (Lanner). 6.0, The Narrative of the Week. 6.25, Talk: American Journalism. 6.50, Labour Market Report. 6.55, The Witzleben Station informs its Listeners. . . . 7.0, Topical Talk. 7.10, Extracts from Sicilian Vespers—Opera (Verdi) on Gramophone Records. 7.50, Sports Notes. 8.0, See Munich. 9.10, News and Sports Notes. 9.20, Cabaret Concert. 10.25, Weather, News, and Sports Notes. 10.30 (approx.), Dance Music, 12.30 a.m. (Sunday), Close Down.

BORDEAUX-LAFAYETTE (364 metres); 13 kW.—6.30 p.m., Radio Journal. 8.0, News Bulletin, Exchange Quotations, and Lottery Results. 8.5, Sports Notes. 8.10, Advanced English Lesson. 8.25, News Bulletin and Weather Forecast. 8.30, Concert of Opera Music on Gramophone Records: Selection from Manon (Massenet); Selection from Le Roi d'Ys (Lalo); Air from Manon (Massenet); Selection from Hérodate (Verdi); Selection from Faust (Gounod). 9.0, Villa des Mimosas—One-Act Comedy (Vovard); The Taming of the Housewife—Comedy in One Act (Weber).

BRATISLAVA (279 metres); 14 kW.—7.0 p.m., Recital of Yugoslavian Songs. 7.40, See Prague. 10.15, Announcements. 10.20, See Moravska-Ostrava.

BRESLAU (325 metres); 1.5 kW.; and **GLEITWITZ (253 metres)**—5.30 p.m., Report on the International Tennis Tournament, relayed from the Südpark. 6.0, Review of the Week's Talks and Literary Items. 6.30, Reading. 6.45, Weather Forecast. 6.50, Gramophone Concert of Light Music: March (Seifert); Waltz, Wiener Bonbons (Johann Strauss); Madrigale (Simonetti); Czardas (Monti); Spanish Serenade (Margutti); Gavotte, Alfonsina (Taraflo); The Kiss (Arditi); Doll Dance (Debussy); Burlesque, The Juggler (Toch); Musik muss sein (May); Das tapfere Schneiderlein (May); (Clog Dance (Flynn); Potpourri (Oscar Straus). 7.40, Weather Forecast, followed by This will interest you!—Programme to be announced. 8.0, See Munich. 9.15, Rund um die Saule—a Silesian Radio Play with Music (Schenke and Szuka). 10.20, Time Signal, Weather Forecast, News Bulletin, Sports Notes, and Programme Announcements. 10.30, Dance Music from the Kurpark Hotel, Bad Salzbrunn. 12.0 midnight (approx.). Close Down.

BRNO (342 metres); 35 kW.—7.0 p.m., A Comedy in One Act (Peran). 7.40, See Prague. 10.15, News Bulletin. 10.20, See Moravska-Ostrava.

Programmes from Abroad—

BRUSSELS (No. 1); I.N.R. (509 metres); 15 kW.—12 noon, Concert by Max Alexys and his Orchestra. 12.30 p.m., Weather. 12.40, Concert (continued). 5.0, Concert conducted by Charles Walpot: March, Perusa (Heymann); Waltz, The Polar Star (Waldteufel); Overture, Masanello (Anber); The Vision of Fuji San (Ketelbey); Gipsy Desire (Nicklass); Selection from Les Cloches de Corneville (Planquette); Tango, Primer amor (de Car); Potpourri, Ilallo, Hallo! Hier Wien (Morena). 6.0, Gramophone Concert: Les Plaisirs champêtres (Montclair-Casadesus); Aria from The Marriage of Figaro (Mozart); Die Fabelle (Schubert); Aria from The Marriage of Figaro (Mozart); Nocturne from the Quartet in D (Borodin); Scherzo from the Quartet Op. 12 (Rimsky-Korsakov). 7.15, Talk: The Political Situation in Europe—England. 7.20, Literary Review. 8.0, Orchestral Concert conducted by Jean Kumps. Soloist: Mlle. Strulers (Songs); Overture, The Barber of Bagdad (Cornelius); Gynopédies (Satie); L'après-midi d'un faune (Debussy); The Nursery (Inggelbrecht). 8.45, What a Life!—Sketch (Grevesse). 9.0, Concert (continued): Selection from Arlequin (d'Ollone); Aria from Faust (Gounod); Selection from Louise (Charpentier); Two Arias from The Tales of Hoffmann (Offenbach); Waltz from Faust (Gounod). 10.0, Talk on Gardening. 10.10, Concert by the Tea-Room Orchestra: Florentine March (Fueck); Strauss Waltz Potpourri (Weber); Petite Suite for Piano and Orchestra (Olsen); Ronde des Lutins (d'Ambrosio); Selection from Lilac Time (Schubert-Berté); Tango, Rosario (Novno); Fantasia on Italian Songs (de Micheli); Wiltz, Dance away the Night (Thompson); Foxtrot, Do-ray-mi-fah-soh (Sylviano). 11.0 (approx.), Close Down.

BRUSSELS (No. 2); N.I.R. (338.2 metres); 15 kW; Programme in Flemish.—12 noon, Gramophone Concert of Light Music. In the interval at 12.30 p.m., Weather. 1.0, Trio Concert: Frans Wigy (Violin), P. Leemans (Piano) and De Nocker (Cello): Spanish March (Volpatti); Waltz, Etincelles (Waldteufel); Narcissus (Nevin); Selection from Monsieur Beaucaire (Messager); Cradle Song (Gretchaninov); Aubade printanière (Lacombe); Selection from Sylvia (Delibes); Soir à Rio (Callemien); Scherzo for Cello (Van Goens); Petite Suite (Chamianade). 5.0, Orchestral Concert conducted by Jean Kumps: Symphony in B Flat (Schubert); Two Basque Airs (Kumps); Romance in F for Violin (Beethoven); Scherzo and Nocturne from A Midsummer Night's Dream (Mendelssohn); Village Dances (Grétry). 6.0, Gramophone Records: Selections from Ronny (Kálmán); Selection from Paganini (Lehár). 6.15, Reading. 6.30, Gramophone Records of Variety Music. 7.15, Talk. 7.30, Agricultural Report. 8.0, Knokkelbeen, Operetta in Three Acts (Hullebroeck). In the intervals at 8.45, Dramatic Programme, and at 10.0, Le Journal Parlé. 10.30, Gramophone Dance Music: Foxtrot, It's great to be in love; Selection from Waltzes from Vienna; Foxtrot, Blues in my heart; Waltz, Beautiful Ohio; Tango, Wenn du einmal mich betrügst; Foxtrot, I'm a dreamer; Waltz, Missouri; Tango, Vergib, vergib Paloma; Foxtrot, Singing in the bath tub. 11.0 (approx.), Close Down.

BUCHAREST (394 metres); 12 kW.—4.0 p.m., Concert of Light Music and Rumanian Music by the Sibiceano Orchestra. 5.0, News and Time Signal. 5.10, Concert (continued). 6.0, Talk on History and Geography. 6.40, Popular Music on Gramophone Records. 7.0, Dramatic Programme. 7.45, Rumanian Music by the Luca Orchestra. 8.45, News Bulletin and Close Down.

BUDAPEST (550 metres); 18.5 kW.—Also relayed on 210 metres from 7.40 p.m. till Close Down.—5.0 p.m., Concert by the Karl Toil Gipsy Band. 6.0, Talk on the Education of Children. 6.30, Cembalo Recital by Andor Krudy. 7.0, Answers to Correspondents. 7.40, Recital of Alois Tarnay's Songs by Nikolaus Szedó, accompanied by the Composer. 8.15, Variety Programme by Ila Szász and Ludwig Szendy. 9.0, Concert by the Band of the First Royal Hungarian Infantry Regiment, conducted by Richard Friesay: March from Bizet (Wagner); Waltz (Johann Strauss); Hungarian Overture (Schemmel); Selection from Lucia di Lammermoor (Donizetti); Kurnez Fantasia (Fricsay); In einem Musik-Automaten Salon. 10.30, Time Signal, Weather Report and News Bulletin, followed by Concert by the Nándor Szóvanka Gipsy Band, relayed from the Baross Café.

COPENHAGEN (281 metres), 0.75 kW., and KALUNDHAGEN (1,153 metres), 7.5 kW.—12 Noon, Time and Chimes from the Town Hall. 12.2 p.m.,

SATURDAY—continued.

String Ensemble Concert relayed from the Hotel d'Angleterre. 2.0-2.30, Interval. 2.30, Gramophone Concert.—Kerstin Thorborg: Berceuse de Jocelyn (Godard). Beniamino Gigli: Good-bye (Tosti). Eva Turner: Aria from Aida (Verdi). Two Selections (May)—(a) Musik muss sein, (b) Wenn ich vernügt bin. Richard Crooks: I'll Always be True (Benatzky). Sid Phillips: Grauny's Photo-Album (Greer). Rudy Valle: Begging for Love (I. Berlin). 3.0, Programme for Children. 3.30, Orchestral Concert conducted by Emil Reesen: Soloist, Minna Nyegaard (Violin); Overture, Mascarade (Carl Nielsen); Waltz, Dolores (Waldteufel); Serenade (Rygaard); Suite, Four Ways (E. Coates); Waltz from Pierrette's Veil (Dohnányi); Violin Solos—(a) Louise valsante (Poldini-Kreisler), (b) Lotus Land (C. Scott). (c) Spanish Dance (Falla-Kreisler); Prelude to Vifandaka (Foltz); Fantasia on Hebrew Melodies (Jul. Reesen); Three Pieces arranged for Strings (Launy Grondahl)—(a) Bourree, (b) Aria, (c) Minuet; Swedish Dance, No. 4 in D (Anlin). 5.40, Exchange and Fish Market Prices. 5.50, Talk. 6.20, French Lesson. 6.50, Weather Forecast. 7.0, News Bulletin. 7.15, Time Signal. 7.32 (from the Odense Studio), Talk arranged by the Tourist Society. 8.0, Chimes from the Town Hall. 8.2, International Programme of Workers' Songs and Poems—English Song, Russian Song, French Song (de Geyter). Readings: (a) Denmark—Aage Herrmann; (b) Switzerland—Marcel Martinet; (c) Germany—Fritz Riebold. Austrian Song (Scheu), Dutch Song (Nobel), Swedish Song, Polish Song. 8.45, Orchestral Concert of Operetta Music, conducted by Launy Grondahl: Overture, Giroflé-Girofla (Lecocq); Selection from Mam'zelle Nitouche (Hervé); Selection from Der Bettelstudent (Müllöcker); Overture, Prinz Methusalem (Joh. Strauss). 9.15, Readings. 9.45, Song Recital by Inger Stockmarr Hermann. 10.5, News Bulletin. 10.20, Orchestral Concert conducted by Launy Grondahl: Overture, Le Roi d'Yvetot (Adam); Secrets (Ancliff); Oriental Procession (Ganne); Waltz, Mein Lebenslauf ist Lieb und Lust (Jos. Strauss); Perpetuum mobile (Joh. Strauss); Manœuvre March (Jul. Reesen). 10.45, Dance Music from the Lodberg Restaurant. In the interval, at 12 Midnight, Time and Chimes from the Town Hall. 12.15 a.m. (Sunday), Close Down.

DUBLIN, Call 2RN (413 metres), 1.2 kW., and Cork (224.4 metres).—1.30-2.0 p.m., Time Signal, Weather Forecast, Stock Report, and Light Music on Gramophone Records. 7.20, News Bulletin. 7.30, Time Signal. 7.31, Talk (to be announced). 7.45, Gaedhlig. 8.0, R. O'Dwyer Concert by the Augmented Station Orchestra, conducted by the Composer. 8.30, Variety Programme. 9.0, The Augmented Station Orchestra. 9.30, Selections from The Quaker Girl (Lionel Monckton), by Hilda White (Soprano). 9.40, The Augmented Station Orchestra. 10.30, Time Signal, News and Weather Forecast. 10.40, Weekly Sports Review and Close Down.

FRANKFURT (390 metres), 1.5 kW., and Cassel (246 metres).—12 Noon, Concert. 12.50, News and Weather. 12.55 Time Signal. 1.0, Gramophone Concert: Selection from The Gipsy Baron (Joh. Strauss); Waltz, Transaktionen (Jos. Strauss); Song from The Arabian Nights (Joh. Strauss); Waltz, Es war einmal ein Walzer (Lehár); Potpourri of Old Viennese Songs, Wiener Erinnerung; Song from The Rose of Stamboul (Fall); Duet from Das Fürstentum (Lehár); Two Pieces from Liselott (Künnecke-Gründgens-Liedtke-Rehner); Hungarian Song from Gitta entdeckt ihr Herz (Brodszky); Two Songs from The Czarevitch (Lehár); Potpourri for Soloists, Choir, and Orchestra, White Horse Inn (Benatzky); Funiculi-Funicula (Denza). 2.0 (in the interval), News. 2.40, Sponsored Concert. 3.20, Weather Report. 3.25, Time and Economic Notes. 3.30, Programme for Children. 4.55, Economic Notes. 5.0, See Stuttgart. 6.15, Economic Notes. 6.25, A Discussion: The Stage and Dancing. 6.50, See Stuttgart. 7.15, Time and Announcements. 7.30, An Interview with Johannes Schlaf on the Occasion of the Author's Seventieth Birthday. At the Microphone: Johannes Schlaf and Friedrich K. Roedemeyer. 8.0, Variety Programme from the Kurbacher, Bad Homburg, including a One-Act Comedy (Johann Nestroy), and a Radio Potpourri arranged and conducted by Eduard Künnecke. 10.20, Time and News. 10.45, Concert from Langenberg. 12 Midnight (approx.), Close Down.

HAMBURG, Call HA (in Morse) (372 metres); 1.5 kW.; Relayed by BREMEN (270 metres);

FLENSBURG (218 metres); HANOVER (566 metres); and KIEL (232.2 metres).—4.30 p.m. (from Hanover), Concert from Bad Nenndorf;

Overture: The Barber of Bagdad (Cornelius); Siegfried Idyll (Wagner); Selection from Boris Godounov (Moussorgsky); Selection from The Czarevitch (Lehár); Overture: A Waltz Dream (O. Strauss); Selection from Der Frauenfresser (Eysler); Triumphal March from Aida (Verdi). 6.0, Talk for Country Women. 6.5, Talk for Antiquarians. 6.50, Dialogue: Mining in Malay. 7.0, Topical Talk. 7.15, Weather Report. 7.20 (from Kiel), Variety Concert by the Grüss Gott Double Quartet: Im Herbst da muss man trinken (Marschner); Folk Melody: Das Monchlein; Von den zwei Hasen (Othebraven); Lütt Matten de Has (Solbrügg); Jägerlust (Astholtz); Folk Melody: Pappelmaulchen; Feuer hier (Reinecke); Der Tauber und die Täubin (Kirchl); Heda, Wein her! (Zöllner); Heiratsgalopp (Kuntze). 8.0, Nebelhorn—a New Cabaret with Willy Hagen. 10.0, Time and News. 10.20, Dance Music from the Haas Siegler.

HEILSBURG (276.5 metres); 60 kW, and Danzig (453.2 metres).—11.30 a.m., Concert by the Little Wireless Orchestra, conducted by Eugen Wilcken; Overture: Maritana (Wallace); Suite from Peer Gynt (Grieg); Nilfutenwalzer (Johann Strauss); Bizet Potpourri (Urbaeh); Overture: Boccaccio (Suppé); Was Blumen träumen (Translatour); Slavonic Rhapsody (Friedemann); Selection from The Czarevitch (Lehár). 1.5 p.m., Gramophone Concert, Overture: The Thieving Magpie (Rossini); Liebesfeier (Weingartner); Malied (Blume); Ballet Music (Popy); Madonna mia (Ruggiero); The Last Tango; Rudolph Valentino (Volkov); Selection from White Horse Inn (Benatzky); So im Vorübergeh'n (Meisel); Sihoney (Lecuona); Three Little Tins (Hajos); Mädi in Wien wird es Frühling (Doelle); Stolz Potpourri. 2.30-3.30, Interval. 3.30 (from Danzig), Handwork for Children. 4.0, Concert by the Königsberg Opera House Orchestra, conducted by Karl Hrubetz; March: Perpetuum mobile (von Blon); Overture: Czár and Carpenter (Lortzing); Ballet Music from Rund um Wien (Bayer); Potpourri of Hungarian Songs (Hrubetz); Overture: La Clochette de l'Ermite (Mallart), Im Walzerpausch (Lincke), Der Spielmann (Sommer); Dutch Folk Songs; Internezzo, Dünen-Geister (Plügge); Pizzicato-Walzer, Pavlova (Meyer-Hellmünd); Concert Polka: Waldreherl, Kuckuck und Frosch (Wagner); March: Hoch Wien (Bayer). In the interval at 5.0 (approx.), Film Review from Danzig. 6.0, Programme Announcements. 6.10, Programme Announcements in Esperanto. 6.15, Agricultural Press Review. 6.30, Market Prices. 6.45, Talk: The Tercentenary of Rössel Grammar School. 7.0, Talk: Foreign Mails. 7.20, Weather Report. 7.30, See Frankfurt. 8.0 (from Danzig), Variety Programme arranged by Otto Normann. In the interval, Weather, News and Sports Notes. After the Programmes Dance Music from Berlin (Witzleben). 12.30 a.m. (Sunday), Close Down.

HILVERSUM (296.1 metres); 20 kW (7 kW up to 4.40 p.m.).—6.25-9.40 a.m., Programme of the Workers' Radio Society (VARA), 6.25 to 6.40 and 7.10 to 7.25, Physical Culture Lesson. 7.40, Variety Music on Gramophone Records. 8.40, Concert by the Drukker Trio. 9.40, Religious Programme by the Liberal Protestant Radio Society (VPRO). 9.55, Concert by the Drukker Trio. 11.40, Septet Concert, conducted by Is. Eyl, with Gramophone Interludes. 1.25-1.55, Interval. 1.55, Educational Talk for Workers. 2.10, Flute Recital by J. Feltkamp; P. Tiggers at the Piano: Sonata No. 8 (Matheson); Joueurs de flüte (Roussel). 2.40, Popular Music on Gramophone Records. 3.10, Talk on Sports. 3.25, Concert by the Hollandia Three (Accordions). 3.40, Talk on Journalism. 4.0, Accordion Concert (continued). 4.10, Programme for Children; Selections by the De Roodhorstjes Children's Choir, conducted by Leida Hulscher; Jo Kickhefer at the Piano: 4.40, Programme for Children. 5.40, Chamber Music Concert conducted by P. Tiggers. 6.10, Topical Talk. 6.25, Variety Music on Gramophone Records. 6.40, Variety Programme: the VARA Orchestra, conducted by Hugo De Groot; the VARA Dramatic Ensemble and Soloists: Mia Dorel (Songs), Johan Jong (Organ), A. Roodenburg (Violin), Daaf Wins (Piano), Teun de Klepperman (Topical Talk), and Lou Bandy (Talk). In the interval at 10.40, News and Football Report. 11.40 (approx.), Close down.

HUIZEN (1,875 metres); 8.5 kW.—Programme of the Catholic Radio Society (K.R.O.). 7.40 a.m., Gramophone Records of Variety Music. 8.55-9.40, Interval. 9.40, Instrumental Concert. 11.10, Religious Address. 11.40, Time and Police Notes. 11.55, Sextet Concert. 1.25-1.40, Interval. 1.40, Gramophone Records of Variety Music. 2.10, Programme for Children. 3.40, Swimming Lesson. 4.10, Gramophone Records of Variety Music. 5.10, Esperanto

Programmes from Abroad—

Notes. 6.0, Press Review. 6.20, Gramophone Records of Variety Music. 6.50, Talk. 7.10, Programme to be announced. 7.25, Sports Talk. 7.40, Concert by the K.R.O. Orchestra, conducted by Marinus van 't Woud; March from Bocaccio (Suppé); Selection from The Girl in the Taxi (Gilbert-Petras); Overture, Gri-Gri (Lincke); Vilja Song from The Merry Widow (Lehár); Selection from Der liebe Augustin (Fall); Two Selections from Das Veilchen vom Montmartre (Kálmán); Selection from "The Geisha" (Jones); Potpourri, Klänge aus Arkaidea (Morena); The Caravan (Bayer); By the Blue Hawaiian Waters (Kettelbey); Old Dutch Dances (Slep), Niki-Marsch (Strauss); Serenade (Heykens); Parade der Dickhäute (Aubert); The Clock and the Dresden Figures (Kettelbey); The Knight of the Hobby Horse (Evans). 8.55 (in an interval), News. 10.40, Gramophone Records of Variety Music. 11.40 (approx.). Close Down.

KATOWICE (408 metres); 16 kW.—8.15, Concert of Light Music. 10.10, Chopin Piano Recital. 10.45, Weather Forecast. 10.55, Dance Music. **LAHTI (1,796 metres)**; 54 kW. Relayed by **HELSINKI (368.1 metres)**.—6.15 p.m., Orchestral Selection: Suite, Caucasian Sketches (Ippolitov-Ivanov). 6.40, Talk. 7.5, Vocal Quartet Selections. 7.25, A Dialogue. 7.50, Finnish Songs. 8.10, Orchestral Concert of Waltzes: Donauweibchen (Strauss); Träume auf dem Ozean (Gung'l); Hofballtänze (Lanner). 8.45, News in Finnish and Swedish. 9.15, Military Music from the Kappell Restaurant. 10.0 (approx.). Close Down.

LANGENBERG (473 metres); 60 kW.—12 Noon, Concert from Frankfurt. 12.50 p.m., Weather; Announcements and Time. 1.0, Concert, conducted by Wolf; March, Die Freundschaftslage (Blon); Overture, The Black Domino (Auber); Suite, Ans aller Herren Länder (Moszkovsky); Serenade, Dein Bild (Holland); Selections from Stradella (Plotow); Waltz, Gräfin Pepi (Strauss); Potpourri of Russian Folk Songs and Dance Music, Wolga-Klänge (Lindenmann); Champagner Galopp (Wiegand). 2.35, Gramophone Concert of Popular Music. 3.30, Economic Notes and Time. 3.50, Programme for Children. 4.20, Talk: Touring in the Rhineland and Westphalia—From the River Sieg to the River Lahn in Four Days. 4.40, English Lesson. 5.0, Concert. 6.15, Talk: Marriage in the Modern Novel. 6.40, Talk: The Formation of Character. 7.0, Weather, Time, Economic Notes, and Sports Results. 7.15, Wireless Notes. 7.30, Talk: The Fiftieth Anniversary of the Evangelical Workers' Society. 7.55, News Bulletin. 8.0, Variety Programme by the Orchestra conducted by Breuer. 10.5, News and Sports Notes. 10.20, Concert conducted by Wolf. 12 Midnight, Dance Music. 1.0 a.m. (Sunday). Close Down.

LEIPZIG (259 metres); 2 kW.; and **DRESDEN (319 metres)**.—5.0 p.m., Concert by the Leipzig Symphony Orchestra, conducted by Theodor Blumer. Selection from Der Kuhreigen (Kienzl); Waltz, Elegy, and Finale from the Serenade for Strings, Op. 48 (Tchaikovsky); Turkish March from the Sonata in A (Mozart); Tone Pictures from King Alfred (Reinecke); Waltz, Aquarellen (Josef Strauss); Schlummerlied (Ries); Selection from The Duchess of Chicago (Kálmán); Waltz from Der Schatzmeister (Ziehrer). 6.30, Talk: Be Brief. 6.50, A Modern Dictionary. 7.0, Talk: The Extinction of Prehistoric Animals and the Future of Mankind. 7.30, Two Eastern Legends (Dorosevic, translated from the Russian by Johannes Dietrich). 8.0, Ligen haben kurze Beine—Children's Cantata in Two Parts (Dessau); The Dessau Children's Choir and the orchestra of the Friedrich Theatre, Dessau, conducted by Erich Rex. 8.30, Cabaret Programme from Langenberg. 10.5, News Bulletin. 10.15 (approx.), Concert relayed from the Castle in Belvedere Park, Weimar; The Weimar Municipal Orchestra, conducted by Ernst Pretorius; and the Freundschaftsängerbund, conducted by Karl Fischer. Soloist, Grete Wetz (Soprano); Nachtgesang im Walde, Op. 139 (Schubert); Nocturne No. 3 for Orchestra (Haydn); Nachtmusik, Op. 64 (Zücher).

LJUBLJANA (574.7 metres); 2.5 kW.—6.30 p.m., Gymnastic Course. 7.0, English Lesson. 7.30, Talk: Radio Announcers. 8.0, Concert by a Military Band. 9.0, Concert by a Vocal Octet. 9.30, Concert of Light Music. 10.0, Time Signal and News Bulletin. 10.15, Concert of Light Music (cont'd.).

LWOW (381 metres); 16 kW.—4.10 to 4.55 p.m., See Warsaw. 4.55, Programme for Children. 5.20, Concert conducted by Seredynsky. 6.0, Divine Service relayed from Wlno (563 metres). 7.0, Miscellaneous Items. 7.25, Talk by Albert

SATURDAY—continued.

Castelo 7.40 to 10.50, see Warsaw. 10.50, Illustrated Talk on Music. 12 midnight (approx.), Close Down.

LYONS (La Doua) (PTT) (465.8 metres); 1.5 kW.—7.0 p.m., Light Music on Gramophone Records. 7.30, Radio Gazette for Lyons and the South-East. 8.30, Programme arranged by the Chamber of Commerce.

MADRID (Union Radio) (Call, EAJ7) (424.3 metres); 2 kW.—8.0 p.m., Chimes, Market Prices, Technical Talk, and Request Gramophone Concert. 9.15 to 9.30, News Bulletin. 10.0, Linguaphone French Lesson. 10.30, Chimes, Time Signal, and Musical Comedy Selections. 12.45 a.m. (Sunday), News Bulletin. 1.0, Chimes and Close Down.

MORAVSKA-OSTRAVA (263.8 metres); 11 kW.—7.0 p.m., See Prague. 10.15, Programme Announcements and Theatre Notes. 10.20, Caught, Comedy in One Act (Schlegel and Marvan), followed by Vocal and Orchestral Concert.

MUNICH (533 metres); 1.5 kW. Relayed by **Augsburg and Kaiserslautern (560 metres)** and **Nürnberg (239 metres)**.—5.0 p.m., Orchestral Concert, conducted by Erich Kloss. 6.15, Programme for Children. 7.0, Elsa von Wolzogen, in Songs to the Lute. 7.25, Talk: The Speed Track Racer. 7.45, Wireless Notes. 8.0, Variety Programme. 9.10, See Breslau. 10.20, Time Signal, Weather Report, News Bulletin, and Sports Notes. 10.45, See Langenberg.

OSLO (1,083 metres); 60 kW. Relayed by **Fredrikstad (367.6 metres)**; **Hamar (560 metres)**; **Notodden (417.1 metres)**; **Porsgrund (453.2 metres)**; and **Rjukan (447.1 metres)**.—5.15 p.m., Programme for Children. 6.15, Norwegian Music on National Instruments. 6.45, Talk on Economics. 7.0, Announcements, Weather and News. 7.30, Talk. 8.0, Time Signal. 8.2, Orchestral Concert, conducted by Hugo Kramm. Soloists: John Neergaard and Axel Nicolaysen (Vocalists); March, Hallo, Oslo Calling (Grünström); Overture (Reissiger); Potpourri of Norwegian Melodies (Birknes); Chant de Veslemøy (Halvorsen); Waltz (Sinding); An den Frühling (Grieg); Persian Dance (Svendesen); Choral Selections; Suite, Caucasian Sketches (Ippolitov-Ivanov); In a Monastery Garden (Kettelbey); Spanish Dance (Glazunov); Waltz (Vinsnes); Selection (Eilenberg); Czardas (Grossman); March, Sonja (Jacobsen). 9.40, Weather and News. 10.0, Topical Talk. 10.15, Reading. 10.45, Dance Music. 12 midnight (approx.). Close Down.

PALERMO (Ente Italiano Audizioni Radiofoniche) (542 metres); 3 kW.—5.30 p.m., Light Music on Gramophone Records. 6.0 to 6.30, Programme for Children. 8.0, Announcements. Radio Giornale dell'Enit. Agricultural Notes and Giornale Radio. 8.20, Light Music on Gramophone Records. In the interval at 8.25, Sports Notes, Time Signal, and Announcements. 8.45, **La Reginetta delle Rose** (The Little Queen of the Roses), Opera in Three Acts (Leoncavallo). In the intervals, Review of New Books and Miscellaneous Announcements. 10.55, News Bulletin and Close Down.

PARIS (Eiffel Tower), Call FLE (1,445.7 metres); 13 kW.—Time Signals (on 2,650 metres) at 10.26 a.m. and 11.26 p.m. (preliminary and 6-dot signals). 6.45 p.m., Musical Programme. 7.0, Le Journal Parlé. 8.20, Weather Report. 8.30, Dramatic Programme: (a) Angloisses, Comedy in Three Episodes (Caillas). (b) Le Candidat, Vaudeville in One Act (Mondjardin). (c) Yvette a de l'Ordre, One-Act Play (Roudic). In the interval, Wireless Notes. 10.0 (approx.). Close Down.

PARIS (Poste Parisien) (328.2 metres); 60 kW.—7.0 p.m., Light Music on Gramophone Records, News, and Announcements. 7.30, Sponsored Gramophone Concert. 8.30, Gramophone Records, Talk, and News. 8.45, Vocal and Orchestral Concert: Introduction to the Lyric Drama L'Étranger (d'Indy); Horn Solo, Pavane pour une Infante Défunte (Ravel); Souvenir, Berceuse and Claironnerie, from the Petite Suite (Ducasse); cor Anglais Solo: Nuages from Nocturnes (Debussy); Suite Française (Casadesu); Ballet Suite from Le Pavillon d'Armide (Tcherépin); The Swan of Tuonela (Sibelius); Little Suite (Borodin); Serenade Burlesque (Schmitt); Marche de Fête (Blüsser).

PARIS (Radio Paris), Call CFF (1,725 metres); 75 kW.—6.45 a.m., Physical Culture. 7.30, Weather and Physical Culture (cont'd.). 7.45, Gramophone Records. 8.0, News, Weather and Press Review. 12.30 p.m., Gramophone Concert: Amons dans le Mystère (Persiani-Bonnier-Charpentier); Marionettes (Glazunov); Vision de Salomé (Joyce); El Relicario (Padilla);

Miami (Loyraux); GINETTE (Paradis); Clair de Lune (Kettelbey); Polka des As (Marceau); Ay, Ay, Ay (Perez Freire); Jack Baby (Loyraux); The Blue Waltz (Margis); Piccolo (Oscar Straus); Emuna Livry (Pirouelle); Tesoro Mio (Buccaci); Le Temps des Cerises (Renard); Romance (Svendesen); Circus Memories (Peter); Simple Aven (Thomé); Glow-worm Gavotte (Lincke); A Wedding Procession in Lilliput (Translaten). In the interval, News and Weather. 3.0, Programme for Children. 3.45, Market Prices. 6.30, Market Prices, Weather, Agricultural Report, Agricultural Talk, and Racing Results. 7.0, Talk arranged by the Union des Grandes Associations Françaises. 7.10, Technical Talk by Colonel Bourzoïn. 7.30, Elementary Book-keeping Lesson. 7.45, Press Review, Commercial Prices and News. 8.0, Literary Reading. 8.30, News, Sports Notes, and Weather. 8.40, Review by René Dorin. 8.45, Humorous Programme. 9.15, Press Review and News. 9.30, Concert by Bela Rex and his Viennese Orchestra: Selection from Countess Maritza (Kálmán); Moonlight on the Alster (Petras); Lehár Potpourri; Gipsy Song; The Two Guitars; Das Lied ist Aus (Stolz).

PITTSBURGH, Westinghouse Electric (KDKA) (306 metres); 25 kW.—9.0 p.m., Teaberry Baseball Scores. 9.5, Pebecco Weather Report. 9.7, Rhythmic Serenade from New York. 9.30, Tales of the Pennsylvania State Police: Behind the Law. 9.45, KDKA Kiddies' Klub. 10.0, Teaberry Baseball Scores. 10.5, David Lawrence Dispatch. 10.10, KDKA Artist Bulletin. 10.12, Programme Announcements. 10.15, Roseylits, by A. K. Rowswell. 10.30, Stories for Children by Louise Guiraud. 10.45, Little Orphan Annie, from New York. 10.50, Temperature Report. 10.51, Weather Report. 11.0, Time Signal. 11.1, Temperature Report. 11.2, Who's News Today. 11.7, Teaberry Sport Review. 11.12, Press News-Reeler. 11.15, Programme to be announced. 11.30, Hotel William Penn Orchestra. 11.59, Time Signal. 12 midnight—3.0 a.m. (Sunday), New York Relay. 12 midnight, Pepsodent Amos 'n Andy. 12.15, Tastyest Jesters. 12.30, Sacred Songs. 1.0, Danger Fighters. 1.30, Dance with the Countess D'Orsay. 2.0, Porto-Rican, American Tobacco Programme. 2.30, The First-nighter. 3.0, Programme to be announced. 3.15, Homey and Old-fashioned Quartet. 3.30, Twenty Fingers of Sweetness from New York. 3.45, McCravy Brothers from New York. 4.0, Time Signal. 4.1, Teaberry Sport Review. 4.11, Temperature Report. 4.12, Weather Report. 4.15, Press Last-minute News. 4.20, Messages to Explorers and Missionaries.

POZNAN (335 metres); 1.9 kW.—7.0 p.m., Miscellaneous Items and Announcements. 7.15, Topical Talk. 7.30, Talk on Journalism. 7.45-10.45, See Warsaw. 10.45, Sports Notes and Police Report. 11.0, Dance Music from the Polonia Café. 12 midnight (approx.). Close Down.

PRAGUE (488.6 metres); 120 kW.—6.0 p.m., Talk on Infinity. 6.10, Agricultural Report. 6.15, Talk: Women in Business. 6.25, German Transmission: Announcements. 6.30, Talk: The Instruments of the Orchestra. 7.0, Mandoline and Guitar Concert: March, La Villanella (Sartori); Waltz, Taramoto (Sartori); March, Salve Lucerna (Gargano); Popular Potpourri (Sartori); March, Al Brenere (Turati). 7.40, Popular Programme. 9.0, Announcements. 9.5 (approx.), Brass Band Concert, conducted by Kofeta. 10.0, Time and News. 10.15, Announcements. 10.20, See Moravská-Ostrava.

RADIO-SUISSE ROMANDE (SOTTENS) (403 metres); 25 kW.; **Lausanne (680 metres)** and **Geneva (760 metres)**.—12.30 p.m., Time Signal from Neuchâtel Observatory. 12.51, Weather Forecast and News Bulletin. 12.40 (from Lausanne), Gramophone Concert of Light Music. 1.0, Exchange Quotations. 1.5, Gramophone Concert (continued). 2.0 to 5.0, Interval. 5.0, Time Signal from Neuchâtel Observatory. 5.0 (from Vevey), Thirty-third Festival of Swiss Music: Quartet for Two Violins, Viola and Cello, Op. 8 (Hans Joachim Schaeuble) by the Berne Quartet; Neues Hoffen, Song Cycle for Mezzo-Soprano and Pianoforte by Mme. Dona Durigo and Walter Frey; Suite for Cello and Pianoforte (Lang), by Franz Hindernann and the Composer; Two Songs for Voice and Pianoforte (François Demierre), by Isabelle Bard and the Composer; Quartet for Two Violins, Viola and Cello (Binet) by the de Ribaupierre Quartet; Quartet for Clarinet, Trumpet, Bassoon and Pianoforte (Rudolf Wittelsbach). 7.0, Weather Forecast. 7.1 (from Geneva), Dance Music on Gramophone Records. 7.30, Talk: The Week in International Politics. 7.55, Announcements. 8.0, Orchestral Concert conducted by Robert Echenard. 9.0 (from Geneva), Two Stories, by

Programmes from Abroad—

Pencil. 9.20 (from **Lausanne**), Concert of Country Music by the Orchestra "Les Wourzis," of Vevey. Humorous Anecdotes in the interval. 10.0, Weather Forecast and News Bulletin. 10.10 (from **Montreux**), Dance Music relayed from the Restaurant Le Perroquet. 11.30 (approx.). Close Down.

RIGA (525 metres); 15 kW.—6.0 p.m., French Lesson. 6.30, Agricultural Talk. 7.0, Weather Report. 7.5, Intermezzo, Comedy in Three Acts (Schmitzer). 8.0, News Bulletin. 8.20, Concert. 9.0, Weather and News. 9.15, The Link, Drama in One Act (Strindberg). 9.45, Dance Music. 11.0 (approx.). Close Down.

ROME, Call **1RO** (441 metres); 50 kW.—Relayed by **Naples** (319 metres) and **2RO** (43 metres).—8.15 to 8.30 a.m., Giornale Radio and Announcements. 12 noon, Gramophone Records of Variety Music. 12.35, Weather Forecast. 12.45 to 2.0, Sextet Concert with Walter Somme (Cello): L'histoire d'un Pierrot (Costa); Serenade, To you (Zabulka); Intermezzo. Bumbolo Lenzi (Marcello); Cello Solos: (a) Intermezzo, Goyecas (Granados-Cassado), (b) Hungarian Caprice (Dunkler); Selection from La Mascotte (Andran); Pimpinella (Zucconi); Le baruffe traste-verine (Cardoni). In the intervals at 1.15, Giornale Radio and Exchange, and at 1.30, Time and Announcements. 5.0, Exchange. Report of the Royal Geographical Society, Giornale Radio and Announcements. 5.45, Reading. 5.30, Duets for Two Sopranos by Virginia Brunetti and Maria Soccorsi; Quando lo stral spezzai (Paisiello); La pesca (Rossini); Through the Leaves (Rubinstein). 5.45, Concert: Selection from Semiramide (Rossini); The Waltz you gave to me (King); Intermezzo, Mars and Venus (Ganne); Violin Solo: Tambourin chinois (Delibes); Nocturne from Coppélia (Delibes); You didn't have to tell me (Donaldson). 6.15, Giornale del'Edit. 6.25, Talk: Bologna. 6.55 (**Naples**), Shipping and Sports Notes. 7.0, Atmospheric Signals, Lesson in Morse, Agricultural Notes, Giornale Radio and Press Review. 8.0, Time, Announcements and Gramophone Records of Variety Music. 8.30, Sports Notes and Announcements. 8.45, 1 Puritani (The Puritans), Opera in Four Acts (Bellini). In the intervals: Review of Books and Talk: At Table with the Chinese. News after the Programme.

SCHENECTADY (WGY) (379.5 metres); 50 kW. Relayed at intervals by **W2XAF** (31.48 metres) and by **W2XAD** (19.56 metres).—9.0 p.m., Alex Dressein's Orchestra from New York. 9.45, The Studio Ensemble. 10.15-11.0, New York Relay. 10.15, Skippy. 10.30, Soloist. 10.45, Laudt Trio. 11.0, Joe and Eddie. 11.15, Waldorf Orchestra from New York. 11.30, American Trio. 11.45, De Witt Clinton Orchestra. 11.55, Baseball Scores. 12 Midnight (WGY only), De Witt Clinton Orchestra. 12 Midnight (W2XAF only), Stock Reports and News Items. 12.15 a.m. (Sunday), Weather Report. 12.16-1.15, New York Relay. 12.16, Laws that Safeguard Society. 12.30, June Pursell in Popular Ballads. 12.45, Trials of the Goldbergs. 1.0, Bridge Lesson. 1.15, Bernard Silberg (Cello). 1.30-4.0, New York Relay. 1.30, National Advisory Council in Radio on Education. 2.0, Drama K-7. 2.30, Club Yalspar. 3.0, Lucky Strike Dance Hour. 4.0, De Witt Clinton Orchestra. 4.30-5.30, New York Relay. 4.30, Hotel New Yorker Orchestra. 5.0, Ralph Kirberry (Dream Singer). 5.5, Buddy Rogers and his Californian Cavaliers. 5.30, New Kenmore Orchestra. 6.0 (approx.). Close Down.

SCHWEIZERISCHER LANDESSENDER (Bero-Münster) (459 metres); 60 kW.; **BASLE** (244.1 metres); and **BERNE** (246 metres).—12.28 p.m., Time Signal from Neuchâtel Observatory. 12.30, Weather Report and News Bulletin. 12.40, Variety Programme on Gramophone Records. 1.15 (approx.), Surprise Item, followed by Variety Programme (continued). 1.50, Interval. 3.30, Popular Music on Gramophone Records. 4.30 (from **Basle**), Talk for Workers: The Basle Municipal Labour Market. 5.0 (from **Basle**), Accordion Concert by the Meister Accordion Club. 5.30 (from **Basle**), Health Talk. 6.0, Variety Music on Gramophone Records. 6.15 (from **Basle**), Listeners' Quarter of an Hour. 6.30 (from **Zürich**), Technical Talk. 7.0 (from **Zürich**), Chimes and Market Prices. 7.30, Musical Programme. 8.0 (from **Basle**), Swiss Programme for Foreigners. Programme by the Basle Orchestra, conducted by Gottfried Becker; Swiss Songs by the Basle Reveille Choir; and Readings by Werner Haumann, Otto Kluth, and Alois Rückli from the works of Swiss Authors in German, French, and Italian. 9.30, Weather Forecast and News Bulletin. 9.45, Old and New Dance Music on Gramophone Records. 11.0 (approx.). Close Down.

STOCKHOLM, Call **SASA** (436 metres); 55 kW.

SATURDAY—continued.

Relayed by **BODEN** (1,229.5 metres); **GOTEBORG** (322 metres); **HORBY** (257 metres); **MOTALA** (1,348 metres); **OSTERSUND** (770 metres); and **SUNDSVALL** (542 metres).—5.30, Gramophone Concert of Popular Music. 6.30, Variety Programme. 7.15, Weather Forecast and News Bulletin. 7.30, Talk: Sweden as a Country for Tourists. 7.50 (from **Ostersund**), Military Band Concert. 8.50, Talk. 9.45, Weather Forecast and News Bulletin. 10.0, Dance Music by Helge Lindbergs Orchestra. 11.0 (approx.). Close Down.

STRASBOURG (345 metres); 11.5 kW.—11.30 a.m., Gramophone Concert of Operatic and Light Music. 12.45, News in French and German. 1.0, Time Signal. 1.2, Gramophone Concert (continued). 2.0, Talk in French. 2.15, Dance Music on Gramophone Records. 3.15-3.45, Interval. 3.45, Music Talk in French with Illustrations: J. S. Bach. 4.0, Dance Music on Gramophone Records. 4.45, Talk in French: The Place of the Cinema in Social Life. 5.0, Orchestral Concert, conducted by Roskam: March, The Honey-moon (Rosey). Waltz, Ein de siècle (Waldfenfel). Overture Le Maçon (Auber). Andalusian Romance (Sarasate). Selection from Tristan und Isolde (Wagner). Ballet Music from Hérodiade (Massenet). Nuits d'étoiles (Debussy). Spanish Caprice (Volkman). 6.0, French Lesson in German. 6.15, Horticultural Talk in French. 6.30, Gramophone Concert. Selection from Benvenuto Cellini (Berlioz). Hungarian March (Berlioz). Potpourri, Fortissimo (Kahnman). Selection from Zampa (Hérold). Künstlerleben (Joh. Strauss). Selection from The Daughter of the Regiment (Donizetti). Aie pitie (Bakaleimov). Moscow Bells (Karnavalov). Le tango des mimosas (Rawson). La vraie valse de Minuit. 7.30, Time Signal. 7.32, News in French and German. 7.45, Gramophone Records of Light Music. 8.30, The Grand Mogul; Opera in Four Acts (Andran). 10.30, Dance Music from the Savoy. 12 Midnight (approx.). Close Down.

STUTTGART (Mühlacker) (360.5 metres); 60 kW; and **Freiburg** (570 metres).—10.0 a.m., Song Recital by Hermann Lingor. Two Songs (Grieg): (a) Eros, (b) Ein Traum; Two Songs (Liszt): (a) Du bist wie eine Blume, (b) Es muss ein Wunderbares sein; Two Songs (Mendelssohn): (a) Durch den Wald, (b) In dem Walde. 10.20 (from Freiburg), Talk for Schools. 11.0, Time and News, followed by Concert of Chamber Music in connection with the Fifteenth German Bach Festival, relayed from the University, Heidelberg. 12 Noon, Weather Report. 12.5 p.m., Sponsored Music. 12.15 (approx.). Concert from **Frankfurt**. 12.50, Time, Weather, News and Programme Announcements. 1.0, Gramophone Concert: Heinrich Schlimsus (a) Aria from Czar and Carpenter (Lortzing), (b) Aria from Zaza (Leoncavallo); Martin Abenbroth (a) Odlins Meeresritt (Löwe), (b) Heinrich Frits Soot; Brindisi, from Cavalleria Rusticana (Mascagni); der Vögler (Löwe); Ohelge Roswagne; Aria from Il Trovatore (Verdi); The Berlin State Opera Orchestra: (a) Intermezzo from Cavalleria Rusticana (Mascagni), (b) Ballet Music from Aida (Verdi); Marguerite Perras: Two Arias from Madame Butterfly (Puccini); Theodor Scheidl: (a) Aria from A Masked Ball (Verdi), (b) Aria from Othello (Verdi); The State Opera House Choir: Selection from Aida (Verdi); Herbert Janssen: Two Arias from Tannhäuser (Wagner); Karin Branzell: (a) Aria from Der Evangelinmann (Kienzl), (a) Aria from The Rhinegold (Wagner); Marcell Witttrich: (a) Uebers Meer (Krene and Rotter), (b) Schlaf ein, mein Blondengelein (Perez Freire); Vera Schwarz: O schöner Mai, from Eine Nacht in Venedig (Johann Strauss). 2.30, Choral Concert conducted by Otto Alt. Male Voice Choir: Du fernes Land (Uhlmann); Women's Choir: der Freiheit Mäienritt (Uhlmann); Mixed Choir: Frühlingsschotschaft (Uhlmann); Mixed Choir: Östern am Tiberstrom (Vierling); Mixed Choir: Erlöse dich (Lendvai). 3.0, Reading from the Works of Theodor Storm. 3.30, See **Frankfurt**. 4.30 (from **Mannheim**), Concert by the Riehl Schrammel-Quintet: Erzhzog-Albrecht-Marsch (Komzak); Tölzer Schützennarsch (Kretzner); Konzert-Ländler (Riehl-Kastl); Wiener Weisen (Schmidt); Gaitaler Jägermarsch (Koschat). 5.0, Orchestral Concert conducted by Gustav Görlich. Soloist: Oskar Wolf (Flute); Selection from Pique dame (Teljakovsky); Selection from Don Carlos (Verdi); Romance for Flute (Saint-Saens); Overture, Nakiris Hochzeit (Lincke); Waltz, Goldregen (Wildtfeufel); Volksliedchen und Märchen (Komzak); Mariana Waltz (Dellinger); Potpourri of Marches (Komzak). 6.15, Time and Sports Notes. 6.25,

Talk: Goethe and Technique. 6.50, Talk: Problems of the Future Career of University Students. 7.15, Time and Weather. 7.30, See **Frankfurt**. 12.20, Time, Weather, News, and Programme Announcements. 10.45, Concert from **Langenberg**. 12 midnight (approx.), Close Down.

TOULOUSE (Radiophonie du Midi) (385 metres); 8 kW.—5.45, Songs from Werther (Massenet). 6.0, Accordion Solos. 6.15, Orchestral Selection: Ballet égyptien (Luigini). 6.30, Exchange Quotations and Racing Results. 6.45, Sound Film Music. 7.0, Orchestral Selections. 7.15, Songs from (a) The Gipsy Baron (Joh. Strauss), (b) Ciboulette (Hahn), and (c) La Mascotte (Andran). 7.30, News Bulletin. 7.45, Orchestral Selections. 8.15, Songs (Massenet) from (a) Manon, and (b) Le Roi de Lahore. 8.30, Military Music: A Hunting Scene (Bucalossi); The Mill in the Black Forest (Eilenberg); Overture, Morning, Noon and Night (Suppé). 8.45, Accordion Solos. 9.0, Concert: Desire (Maufred); Le promenoir des deux amants (Debussy); J'ai compris (Lenoir); Solveig's Song (Grieg). Dance Music. 9.30, Orchestral Selections. 9.45, Songs from (a) Ciboulette (Hahn) and (b) My Wife (Irving). 10.0, Orchestral Selections. 10.30, North African News. 10.45, Orchestral Selections from (a) The Thieving Magpie (Rossini) and (b) The Magic Flute (Mozart). 11.0, Concert of Light Music. 12 midnight, Weather and Announcements. 12.5 a.m., (Sunday), English Music. 12.30 a.m. (approx.). Close Down.

TRIESTE (247.7 metres); 10 kW.—7.5 p.m., Quintet Concert. In the interval at 7.25, French Lesson on Gramophone Records. 8.0 till Close Down. See **Turin**.

TURIN (273.7 metres); 7 kW. Relayed by **Milan** (331.5 metres), **Genoa** (312.8 metres), and **Florence** (500.8 metres).—6.45 p.m., Agricultural Notes. 7.0, Announcements. 7.5, Musical selections: Stars and Stripes (Souza); Serenata fiorentina (Castagnoli); Selection (Katscher); Selection from Lilac Time (Schubert-Berte). 7.30, Time, Announcements, and Gramophone Records of Variety Music. 8.0, Giornale radio and Weather. 8.15, Musical Selections: Pulcinella (de Nardis); Chants russes (Lalo); Intermezzo, Punch and Judy (Herbert); Cupido in randa (Fiordini). 8.45, Talk: Events and Problems. 9.0, Programme to be announced. In the interval: Review of New Books. 11.0, Giornale radio and Dance Music from the Fischatteria Toscana, Milan. 11.55, News Bulletin.

VIFNNA (517 metres), 15 kW. Relayed by **GRAZ** (352.1 metres), **INNSBRUCK** (283 metres), **KLAGENFURT** (453.2 metres), **LINZ** (246 metres), and **SALZBURG** (218 metres).—4.0 p.m. Opening of the International Workers' Dwellings Exhibition, relayed from **Lainz**. 4.30, Martina Wied reads from her Own Works. 5.0, Orchestral Concert: Overture, The Land of Smiles (Lehár); Lagoon Waltz from A Night in Venice (Johann Strauss); Dance of the Waves from The Loreley (Catalani); Violin Solo: Ave Maria (Hummer); Intermezzo from the Third Act of Lamico Fritz (Mascagni); Selection from Boccaccio (Suppé); Mezzanotte a Venezia (Ranzato); Potpourri, Von Wien durch die Welt (Hruby); Tango: Du darfst nicht glauben, dass du der einzige bist (Steczyński). 6.35, Music of the Streets; Talk with Gramophone Illustrations. 7.5, Topical Programme. 7.35, Recital for Two Violins—Sonata in D for Two Violins, op. 23 (Arthur Willner). Canon and Fugue op. 131 b (Beger); Duets in E flat, op. 39 (Spohr); Passacaglia for Two Violins (Handel). 8.10, Time, Weather, and Programme Announcements. 8.25, "John Law," a Radio Play (Paul Frischer). 10.0, News and Weather. 10.15, Concert by the Adolf Pauscher Orchestra, with Viktor Sternau (vocalist): Marching Song, Ein bisschen Freude (Michael Krausz); Slow Fox-trot, Es gibt noch Märchen (Lehár); Fox-trot, Joszi (Böhm-Sobotka); Waltz, Nur um dich zu lieben, möcht ich ewig leben (Stolz); A Life Story in Melody and Verse (PetraK-Sternau); Fox-trot, Täglich Musik (Mackeben); Tango, Willst du nicht was Liebes mir sagen (Kálmán); Tango from The Song of Love (Johann Strauss-Korngold); Fox-trot, Es ist so wunderschön aufzustehen (Michael Krausz); Jazzsinfonietta in D (Adolf Pauscher); Paso-doble (Sylvio Ricardo); Rumba, Wienerwald (Abraham); Third Waltz Potpourri (Robrecht); Fox-trot, Schlagertzeit (Damborg); Tango, Wie gern möcht' ich dich verwöhnen (Jurmank-Kaper); Tango, Süsser, süsser (Wiga); Fox-trot, Ausgeschlossen (Emil Schaele); Rumba, Sag', was sagt der Don zur Donna in Sevilla (Stolz); Fox-trot, Wenn in Mai in der Krieanu (Max Pfeffer); Fox-trot, Ist das dein Glas? (Peter Kreuder); One-step, Trink mit mir auf Du und Du (Fenstad).

Programmes from Abroad—

WARSAW (1,411 metres), 120 kW.—11.20 a.m., Aviation Weather Report. 11.25, Interval. 11.45, Press Review. 11.58, Time Signal and Bugle Call from the Tower of St. Mary's Church, Cracow. 12.5 p.m., Programme Announcements. 12.10, Educational Programme from **Lwow**. 12.45, Light Music on Gramophone Records. 12.0, Weather Report. 1.25, Popular Music on Gramophone Records. 1.35, Interval. 2.45, Variety Music on Gramophone Records. 3.5, Economic Report and Exchange Quotations. 3.15, Answers to Correspondents on Military Questions. 3.25, Review of Periodicals. 3.45, Hydrographic Report. 3.50, Light Music on Gramophone Records. 4.10,

SATURDAY—continued.

Answers to Correspondents. 4.30, Talk: The World Crisis and Technics. 4.55, Programme for Children from **Lwow**. 5.20, Talk on Stanislas Moniuszko. 5.30, Moniuszko Song Recital by M. Janossky. 5.55, Interval. 6.0, Religious service relayed from **Wilno** (563 metres). 7.0, Miscellaneous Items. 7.25, Agricultural Report. 7.35, Programme Announcements. 7.40, Sports Notes. 7.45, Radio Journal. 8.0, On the Horizon. 8.15, Concert of Light Music by the Station Orchestra, conducted by St. Navrot: Soloist, G. Banaszkievicz (tenor); Overture, Gri-Gri (Lincke); Birthday Serenade (Lincke); Waltz,

Gold and Silver (Lehar); Habanera (Filipucci); Three Songs from Les Cloches de Corneville (Planquette); Potpourri, From Vienna through the World (Hruby); Serenade, Lisonja (Armandola); Tenor Solos—(a) Still wie die Nacht (Bohm), (b) Air (Mikulsky), (c) Rievie (Schir), (d) Air from Countess Maritza (Kalmán); Czardas from Der Geist des Wojewoden (Grossman); Waltz, Abendsterne (Lanner); Italian Serenade (Helmberg-Holmes); Gavotte, Clementine (Czbulka); Polka from Gasparone (Millöcker); Mazurka (Vronsky). 9.55, Feuilleton. 10.0, Chopin Pianoforte Recital by Mue. Robosvka: Polonaise in B Flat Minor. Sonata in C Minor, Op. 4. 10.40, Radio Journal. 10.45, Weather and Police Notes. 10.50, Dance Music.

CONTINENTAL PROGRAMMES FOR BRITISH LISTENERS.

(By special arrangement with the International Broadcasting Company we are able to give below a complete week of programmes to be broadcast by Radio-Normandie (Fécamp) and, in addition, the Sunday transmissions from Radio Paris.)

Sunday, June 5th.

RADIO-PARIS (1,725 metres); 174 Kc/s. 75 kW. 2.0 p.m., Concert of Decca Records. Mr. Christopher Stone announcing. A Pleasure Cruise with Lawrence Wright (Pt. 1), Arthur Lally and his Orchestra; You are My Heart's Delight, Franz Bolker (Tenor); Illegal, Selection, Harold Ramsay at the organ of the Granada, Walthamstow; By the Fireside, Jack Hyton and his Orchestra; By Silent Hearth, Fritz Wolff (Tenor); Il est Charmant (Selection), Alfredo Cantoli and his Salon Orchestra; Lovable, Roy Fox and his Band; When it's Spring time in the Blue Ridge Mountains, Carson Radison and his Pioneers; The Drummer Boy, Heinrich Schlusmus (Baritone); Auf wiedersehen, my dear, Greta Jeller; Kashmiri Song, Alfred Piccaver (Tenor); My Sweet, Gertrude Lawrence; Mephistopheles, Serenade, Ludwig Hofmann (Bass); Lawd you made the Nights too Long, Morris Elwin (Baritone); On a Local Train Journey, Victor Ricardo and his Orchestra; Sally, Mary Hagen. 3.0, Interval. 4.0, Concert on behalf of the Gaumont British Picture Corporation of Great Britain, Limited, Non-Stop Variety. 5.0, Interval. 6.45, Concert on behalf of the Gaumont British Picture Corporation of Great Britain, Limited. Music by the Alhambra-Paris Orchestra, under Lucien Goldy. Captain C. Clayton-Hutton announcing. 7.45, Announcement on behalf of the Graham-Farish Gard Lightning Arrestor.

RADIO-NORMANDIE (Fécamp) (223 metres); 1,364 Kc/s., 10 kW.—Mr. J. H. M. Stanforth and Mr. S. H. C. Williams Announcing. 6.0 p.m., The Children's Corner. 6.30, A Recital: Nicolo Manzoni (Tenor), The I.B.C. Symphony Orchestra, conducted by Bernard Muir; Orchestra, Rigoletto (Verdi); Nicolo Manzoni, M'appari tutt' amor (Flotow); Rimpiancino (Toselli); Orchestra, Cavalleria Rusticana (Mascagni); Nicolo Manzoni, La Donna é Mobile (Verdi); Vesti la Giubba (Leoncavallo); Orchestra, Les Troubadours (arr. Muir). 7.0, Norman de Salis at the Wurlitzer Organ. 7.30, A Programme of March Music: The Military Band. 8.0, Interval. 9.0, a Recital of Gramophone Records, arranged and presented by Kenneth Wakefield. 9.30, Mariano Martinez and his Mexicans. 10.0, Alastir, Angus and Mac (Alastir, violin; Angus, baritone; Mac, piano); Alastir, The March of the Cameron Men; Angus, Johnnie Cope, Kirkconnel Lea; Alastir, Mary Morison, Lord Lovat's Lament; Angus, Ae fond Kiss, The De'il's Awa' with th' Excise-man; Alastir, Lea Rigs. 10.30, Armand Lubrin's Casino Orchestra. C. T. Craven, Xylophone. 11.0, The Sentimental Songsters. 11.30, The Romany Chals Gipsy Band, directed by Anton Taux: (1) Gaida Troika; (2) Pöschelae; (3) Two Guitars; (4) Caucasian Gipsy Songs; (5) Réve d'Artiste; (6) Tales from the Vienna Woods; (7) Czardas; (8) Zakuska. 12.0 (midnight), Irish Melodies. James Doyle (Tenor) and the I.B.C. Light Orchestra (Section B), conducted by Herbert Foster. Orchestra: The Four-leaved Shamrock; James Doyle. A Little Bit of Heaven, Mother Machree; Orchestra, On Liffey's Banks; James Doyle. When Irish Eyes are Smiling, Danny Boy; Orchestra, The Blackbird. 12.30 a.m., The I.B.C. Light Orchestra (Section B), conducted by Herbert Foster; Vienna City of My Dreams (Sieczynski); Butterfly (Bendix); Gipsy Princess Waltz (Kahman); Serenade (Piemé); Intermezzo (Ancliffe); Musical Medley (arr. Baynes); My Sunshine is You (Stolz); Goodnight Sweetheart (Connolly). 1.0, Vaudeville. 2.0, Dance Music by Roy Lick's Columbians. 2.57, I.B.C. Goodnight Melody. 3.0, Close Down.

Monday, June 6th.

RADIO-NORMANDIE.—11.0 p.m., A Waltz Programme: (1) The Blue Danube; (2) The Skaters; (3) Ecstasy; (4) Wine, Women, and Song; (5) Gold and Silver; (6) Kaiser Waltz; (7) All the Favourites (Medley). 11.30, Variety: (1) Orchestra, The Grand Boulevards; (2) Song, O How He Looks at Me; (3) Song, When your Hair has Turned to Silver; (4) Xylophone Solo, Gypsy Rondo; (5) Handbells, Two of Irish; (6) Song, Please Percy; (7) Song, Wedding Bells are Ringing for Sally; (8) Orchestra, In the Bois de Boulogne. 12.0 (midnight), Dance Music: (1) One-step, Happy Feet; (2) Foxtrot, Bessie Couldn't Help It; (3) Foxtrot, I Like to Do Things for You; (4) Foxtrot, Cinderella Brown; (5) Blues, Dancing Time; (6) Waltz, Under the Roofs of Paris; (7) Foxtrot, Kalua; (8) Foxtrot, Adeline; (9) Foxtrot, The Sun is at my Window; (10) Waltz, What Have I Done? (11) Foxtrot, Little White Lies; (12) Foxtrot, Love Made a Gypsy out of me; (13) Foxtrot, Melancholy; (14) Foxtrot, With You; (15) Foxtrot, Nobody but You; (16) Waltz, The Sacred Flame. 12.57 a.m., I.B.C. Goodnight Melody. 1.0, Close Down.

Tuesday, June 7th.

RADIO-NORMANDIE.—11.0 p.m., I.B.C. Light Orchestra: (1) Springtime Reminds me of you; (2) Souvenir d'Ukraine; (3) Stephanie Gavotte; (4) Roses from the South; (5) Serenade Standchen; (6) Musette; (7) Moonbeams Dance. 11.30, Variety: (1) Song, There's a Good Time Coming; (2) Song, Harry Lauder Fantasy; (3) Harmonica, Polly; (4) Song, We All go OO HA HA Together; (5) Accordeon, Ragtime Medley; (6) Guitar, Dear Old Pal of Mine; (7) Song, Sittin' on a Five-barred Gate; (8) Orchestra, Grammy's Old Photo Album. 12.0 (midnight), Dance Music: (1) Foxtrot, When the Circus Comes to Town; (2) Foxtrot, Love is Like That; (3) Foxtrot, Song of Happiness; (4) Soldier on the Shelf; (5) You were my Salvation; (6) Waltz, Somewhere in Old Wyoming; (7) Foxtrot, To-day I Feel So Happy; (8) Foxtrot, My Future Jus' Passed; (9) Foxtrot, Time Will Tell; (10) Foxtrot, Sitting at a Table Laid for Two; (11) Waltz, I Believe in you; (12) Foxtrot, The Pick-up; (13) Foxtrot, Adeline; (14) Foxtrot, You Taught Me All I Know; (15) Waltz, Dancing with Tears in My Eyes; (16) Waltz, Falling in Love Again. 12.57 a.m., I.B.C. Goodnight Melody. 1.0, Close Down.

Wednesday, June 8th.

RADIO-NORMANDIE.—11.0 p.m., An Irish Half-hour: (1) Orchestra, Erin-go-bragh; (2) Song, Eileen Alannah; (3) Song, Come Back to Erin; (4) Accordeon, Irish Jigs; (5) Banjo, Mullingar Races; (6) Song, The Last Rose of Summer; (7) Song, Danny Boy; (8) Orchestra, Donnybrook Fair. 11.30, A Scottish Half-hour: (1) Orchestra, Caledonia; (2) Songs, Mary Morison; (3) Song, Bonnie Wee Thing; (4) Accordeon, Scottish Reels; (5) Pipes, Kilts and Sporrans; (6) Choral, A Glen Sing-song; (7) Orchestra, Swirling Kilts. 12.0 (midnight), Dance Music: (1) Foxtrot, Livin' in the Sunlight; (2) Foxtrot, Me; (3) Foxtrot, You Brought a New Kind of Love to Me; (4) Waltz, For You; (5) Foxtrot, There's Happiness Over the Hill; (6) Foxtrot, You're Just the One Girl; (7) Foxtrot, Good-bye to All That; (8) Waltz, The Love Waltz; (9) Foxtrot, Don't Wear

Your Heart on Your Sleeve; (10) Foxtrot, More Than You Know; (11) Foxtrot, Follow the Star; (12) Waltz, Gypsy Melody; (13) Foxtrot, Blue Turning Grey Over You; (14) Foxtrot, Just Imagine; (15) Foxtrot, My Secret Passion; (16) Waltz, Same as We Used to Do. 12.57 a.m., I.B.C. Goodnight Melody. 1.0, Close Down.

Thursday, June 9th.

RADIO-NORMANDIE.—11.0 p.m., Organ Recital: (1) Life is Just a Bowl of Cherries; (2) Home; (3) Whistling Waltz; (4) There's a Ring Around the Moon; (5) In a Monastery Garden; (6) The Sanctuary of the Heart; (7) Love's Dream; (8) Poem. Announcement on behalf of the "Sunday Referee". 11.30, Light Orchestra with Songs: (1) Orchestra, A Little Kiss Each Morning; (2) Song, My Sweet Tooth Says I Wanna; (3) Song, You're Blasé; (4) Orchestra, Love's Old Sweet Song; (5) Orchestra, Consolation; (6) Song, I Don't Know Why; (7) Song, To-day I Feel So Happy; (8) Orchestra, Alone with My Dreams. 12.0 (midnight), Dance Music: (1) Foxtrot, Cheer Up and Smile; (2) Foxtrot, The Chum Song; (3) Foxtrot, Here Comes Emily Brown; (4) Foxtrot, One Night Alone with You; (5) Waltz, Under the Roofs of Paris; (6) Foxtrot, Without My Gal; (7) Foxtrot, I'm in the Market for You; (8) Foxtrot, Gone; (9) Foxtrot, Let Me Sing and I'm Happy; (10) Blues, High Society; (11) Waltz, Springtime in the Rockies; (12) Foxtrot, To My Mammy; (13) Foxtrot, Sing You Sinners; (14) Foxtrot, I Still Get a Thrill; (15) Foxtrot, Yours Sincerely; (16) Waltz, Lorette. 12.57 a.m., I.B.C. Goodnight Melody. 1.0, Close Down.

Friday, June 10th.

RADIO-NORMANDIE.—11.0 p.m., Hawaiian Band: (1) Kiss Me Good-night; (2) My Bluebird; (3) Time Alone Will Tell; (4) Somewhere in Old Wyoming. 11.15, Sentimental Songsters: (1) Piano, Melodies of the Moment; (2) Duets, Put Your Loving Arms Around Me; (3) Duet, For the Sake of the Days Gone By; (4) Piano, Popular Songs Medley; (5) Duet, Kiss Me Again; (6) Duet, Good-night, Sweetheart; (7) Piano, Snatches of To-day's Best Tunes. 11.45, Banjo Quartet: (1) Quartet, Downtown Dandies; (2) Solo, Slick Fingers; (3) Solo, That Red-headed Frail; (4) Quartet, Rummy-Tummy. 12.0 (midnight), Dance Music: (1) Foxtrot, Always in All Ways; (2) Foxtrot, Elizabeth; (3) Foxtrot, Beyond the Blue Horizon; (4) Waltz, You Will Remember Vienna; (5) Foxtrot, You're Driving Me Crazy; (6) Foxtrot, I Bring a Love Song; (7) Quick Step, Lady of Spain; (8) Waltz, Balls, Picnics and Parties; (9) Foxtrot, Happy Days; (10) Foxtrot, Me; (11) Foxtrot, It Always Starts to Rain; (12) Waltz, Pagan Serenade; (13) Foxtrot, Joey the Clown; (14) Foxtrot, Just One More Chance; (15) Foxtrot, Spring Is Here; (16) Foxtrot, Kiss Me Good-night. 12.57 a.m., I.B.C. Good-night Melody. 1.0, Close Down.

Saturday, June 11th.

RADIO-NORMANDIE.—11.0 p.m., Scottish Ballad Concert. 11.40, Songs with Piano. 12.0 (midnight), I.B.C. Light Orchestra. 1.0 a.m., Washington Comedy Four. Trans-Atlantic Humorous Vocalist. 1.30, Film Fans' Dance Programme. 2.0, Dance Music. 2.57, I.B.C. Good-night Melody. 3.0, Close Down.

NEWS OF THE WEEK.

Current Events in Brief Review.

Derby Day Radio.

THE day when every policeman's helmet will be an ultra short-wave station is brought nearer by the use of the Cierva Autogiro, fitted with short-wave Marconi equipment, to control traffic on the roads leading to Epsom this morning.

The Autogiro carries a Marconi short-wave portable telephone transmitter and receiver, operating on a wavelength of about 100 metres. The ground station receiver is a Marconi short-wave set of new design — the A.D.27A — incorporating tuned anode, tuned grid, and reaction circuits. A short-wave telephone transmitter is also being used on the ground, so that two-way communication will be possible with the Autogiro as it hovers over the strategical points on the great trek to the Epsom Downs.

The "Ultra Shorts" in Berlin.

BERLIN'S new ultra short-wave transmitter is to be used principally for television. The apparatus has now been thoroughly tested and is about to be placed near to the famous "Funkturn," or broadcasting tower, in the Berlin Exhibition ground. The feeder lines from the ultra short-wave transmitter will pass through the roof of the Exhibition hall straight to the top of the tower; thus the aerial will probably be the highest of its type in Europe. The aerial power will be in the neighbourhood of 3.5 kW. for telephony, and 15 kW. for telegraphy. The transmitter can work on any wavelength between 6 and 8 metres.

The 200-kW. Voice.

THE European ether may shortly resound with the voice of a young German girl, aged twenty-four, who has been engaged as the announcer at the new Luxembourg 200-kW. publicity broadcasting station. It is understood that, in addition to German, she speaks French and English fluently.

The Marchese Solari.

MARCHESE MARCONI'S associate and friend, the Marchese Luigi Solari, is to be congratulated on his narrow escape from death in the revolver attack on him a few days ago by a former employee of the Italian Marconi Company, of which he is manager. We trust that his recovery will be speedy.

A Trade Triumph.

THE remarkable development of the Telsen Electric Co., Ltd., is once more indicated by the new issue of 60,000 shares of £1 each at £3 per share. Mr. A. W. MacNamara, the managing director, founded his business eight years ago with a capital of only £50, renting a small work-place in Birmingham for 7s. 6d. a week. From this humble begin-

ning he has built up an organisation which to-day has an authorised capital of £250,000 and turns out many thousands of wireless components per day.

The Olympia Show.

THE keynote of this year's National Radio Exhibition will be the celebration of the tenth anniversary of broadcasting in Britain. The Exhibition, which will be almost twice the size of last year's event, will for the first time occupy the main hall at Olympia. Two terraces are to be built inside the hall, and access to the higher terrace will be gained by an escalator staircase. There will be fifty soundproof audition rooms.

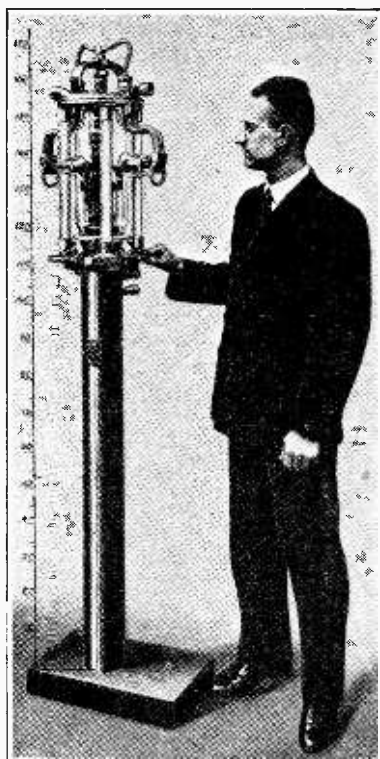

GERMANY'S BIGGEST VALVE. This new 300-kW. valve, manufactured by the Telefunken Company, carries an anode voltage of 12,000 and passes 30 amps.

New Form of Static.

IT is understood that all Soviet broadcasting stations have adopted as an identification signal the sound of a hammer striking an anvil.

Portugal Calling.

PORTUGAL'S first official broadcasting station will soon be heard in this country. We understand that the power will be of the order of 15 kW., and the wavelength between 400 and 500 metres.

An Omen?

A CORRESPONDENT, impressed by the announcement that Prague now heralds its 6.30 a.m. transmission with a "cock-a-doodle-doo," hopes that it may never be said of this station, in Shakespearean parlance, that "It fades on the crowing of the cock" (*Hamlet*, Act I, Scene 1).

Music on the 'Phone.

TELEPHONE enquirers who cannot be immediately switched through to the persons with whom they wish to speak at the Gramophone Company's London offices are now connected to an electric pick-up to hear the latest light music recordings.

Loud Speakers and Pedestrians.

DURING Pedestrians' Safety Week, to be held shortly in Berlin, extensive use will be made of loud speakers installed at traffic centres. Throughout the day (writes a correspondent) announcers will keep up a stream of warnings and admonitions to enable the luckless walker to do the right thing at the right time. Motor cars equipped with loud speakers will swoop down on careless pedestrians, stopping only just in time to avoid an accident. After the walker has been duly scolded, he will be told by loud speakers how he should have acted in the peculiar circumstances.

We hope that none of these mock accidents will become real by accident.

Wireless in the West.

BRISTOL'S Wireless Week, which is always an important event in the West Country calendar, will this year be held in September. It is understood that plans will be shown for the projected broadcasting studio enabling Bristol to share with Cardiff the honour of supplying programmes for Western Regional.

U.S. Amateurs Alarmed.

SOMEWHAT affrighted by the possibility of having to pay licence fees, America's transmitting amateurs have addressed a petition to Congress strongly protesting against the proposal that they should be included in the licence fee schedule for all radio stations in the U.S. Under the scheme now before Congress, an amateur will be required to pay a minimum of 5 dollars per year, while a less favourable interpretation of the bill might raise the figure to 50 dollars.

The American Radio Relay League declares that amateurs should be excused all licence fees on the grounds that they alone among radio interests derive no profit from their operations, but rather expend money without hope of material return. We commend this argument to the "pirates" of Britain!

In justice to American amateurs, it should be remembered that numbers of them perform national service; for example, arrangements are now being concluded for amateurs to handle emergency communication along the Northern Pacific Railway, and on several recent occasions of national emergency U.S. amateurs have placed their communication facilities unreservedly at the disposal of the State.

R.G.D. "SUPERSONIC" RADIO GRAMOPHONE

Special 50-Watt Model (10 Watts Undistorted Output).

REGULAR readers of this journal are already well acquainted with the technical merits of this design. Their opinion is recorded in the results of *The Wireless World* Olympia Show Competition, when the R.G.D. "Supersonic" radio-gramophone was voted the best receiver employing more than four valves and also the outstanding single exhibit of the Show.

Many people will say that it is expensive. Closer examination will show, however, that this is hardly a term which can be applied with justice. True, it may be beyond the pocket of the average broadcast listener, but we can give it as our considered opinion that the performance provided is worth every penny of the purchase price. In every industry there will be found a group of firms catering for the connoisseur, and in the wireless industry R.G.D. have earned a high place in that so far limited class.

Low-frequency Response.

The instrument which we have had under test is the special 50-watt model. It differs from the standard model in that two Mazda PP5/400 valves are used in push-pull in the output stage instead of the usual AC/PI's. The undistorted output is between 10 and 12 watts, and two balanced moving coil loud speakers are required to handle this power. To supply the additional demand on the H.T. supply a separate power unit incorporating a U12 rectifier is fitted in the base of the cabinet to feed the output valves. The U12 in the main chassis supplies the remaining stages and the loud speaker fields as in the standard model.

To have at one's disposal a power handling capacity of 10 watts is an experience which is not easily forgotten, for with it one can re-create the thrill which only a full orchestra playing *forte* can give. The response

of the L.F. amplifier is straight down to 50 cycles, and the full breadth and body of the double basses is reproduced with amazing fidelity. This

FEATURES.

Circuit.—Seven-stage superheterodyne (ten valves including two full-wave rectifiers and push-pull output valves). Band-pass input and intermediate amplifier valves.

Controls.—(1) Single-dial tuning. (2) H.F. volume control. (3) Radio-gramophone volume-control fader. (4) Tone control. (5) Wave-range switch.

General.—Output stage rated at 50 watts dissipation, 10-12 watts undistorted output. Twin moving-coil loud speakers. Automatic record changer.

Price.—118 gns., in oak. Record changer, 20 gns. extra.

Makers.—Radio Gramophone Development Co., Ltd., 17-20, Frederick Street, Birmingham.

to discover new and hitherto unsuspected qualities in the recording.

The full volume of which the set is capable will be used only on rare occasions, but even if it were never used at all there is much to be said for an ample reserve of power. At normal volume levels there is never any fear of overloading on transient peaks, and the reproduction assumes a natural and unforced quality which is absent from amplifiers of lower capacity.

Range and Selectivity.

Though quality of reproduction is naturally the first thing to be noticed on switching on the set, the range and selectivity of the radio receiver is equally impressive when sufficient time has been gained to appreciate its performance. The same set has been tried out both in London and in the Midlands, and there can be little doubt of its capability of giving a good account of itself under the most adverse reception conditions. In London Mühlacker is easily separated from London Regional, and, in Birmingham, Sottens can be received clear of Midland Regional. At both places the number of European broadcasting stations available on medium waves must be at least 75 per cent. of the total number listed, while on long waves fifteen stations were received at full loud speaker strength.

A tone control consisting of a variable condenser between the grids of the push-pull output valves can be used with good effect in conjunction with the volume control in eliminating background noise, and upwards of thirty foreign programmes on medium waves can be tuned in as though they were all local stations. It is only occasionally that the tone control is called upon to deal with a heterodyne whistle, as the majority of these are disposed of by the band-pass intermediate stages.



effect is the same whether the source be broadcasting or gramophone records, and to play a familiar record on the R.G.D. radio gramophone is

A HIGH-GRADE RADIO-GRAM FOR THE CONNOISSEUR.

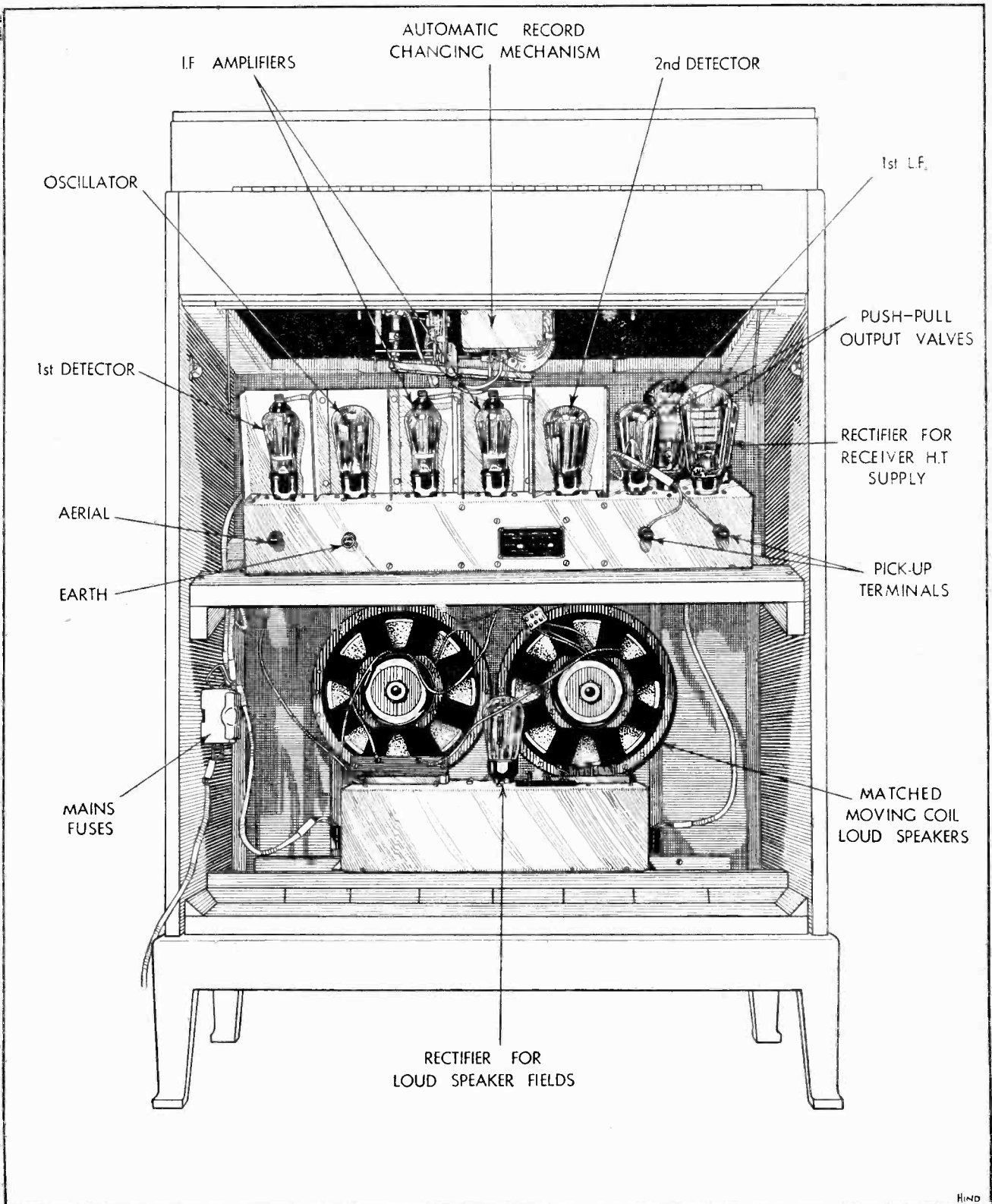

The R.G.D. "Supersonic" radio-gramophone (50-watt A.C. model) with the back panel removed.

A 21

R.G.D. "Supersonic" Radio-Gram.—

For the benefit of those who may not be familiar with the circuit, it may be stated briefly that there are in all seven stages. The aerial input circuit is of the band-pass type with "top end" coupling, and is connected straight to the grid of the first detector, a screen grid valve. The separate oscillator is ganged to the main tuning control and "padding"

and which ensures absolutely accurate tracking over both ranges.

The output from the oscillator is injected into the cathode lead of the detector, and the resulting beat frequency is passed to two intermediate frequency amplifiers of the variable-mu type coupled by tuned band-pass transformers. In the second detector true power grid conditions of rectification have been provided, and this

rard induction motor, and a Capehart automatic record-changer may be obtained as an extra.

The cabinet work calls for a special word of praise. It is of exceptionally solid construction, as befits an instrument incorporating two moving coil loud speakers, and it is evident that the same care and thought has been devoted to its design and finish as to the chassis

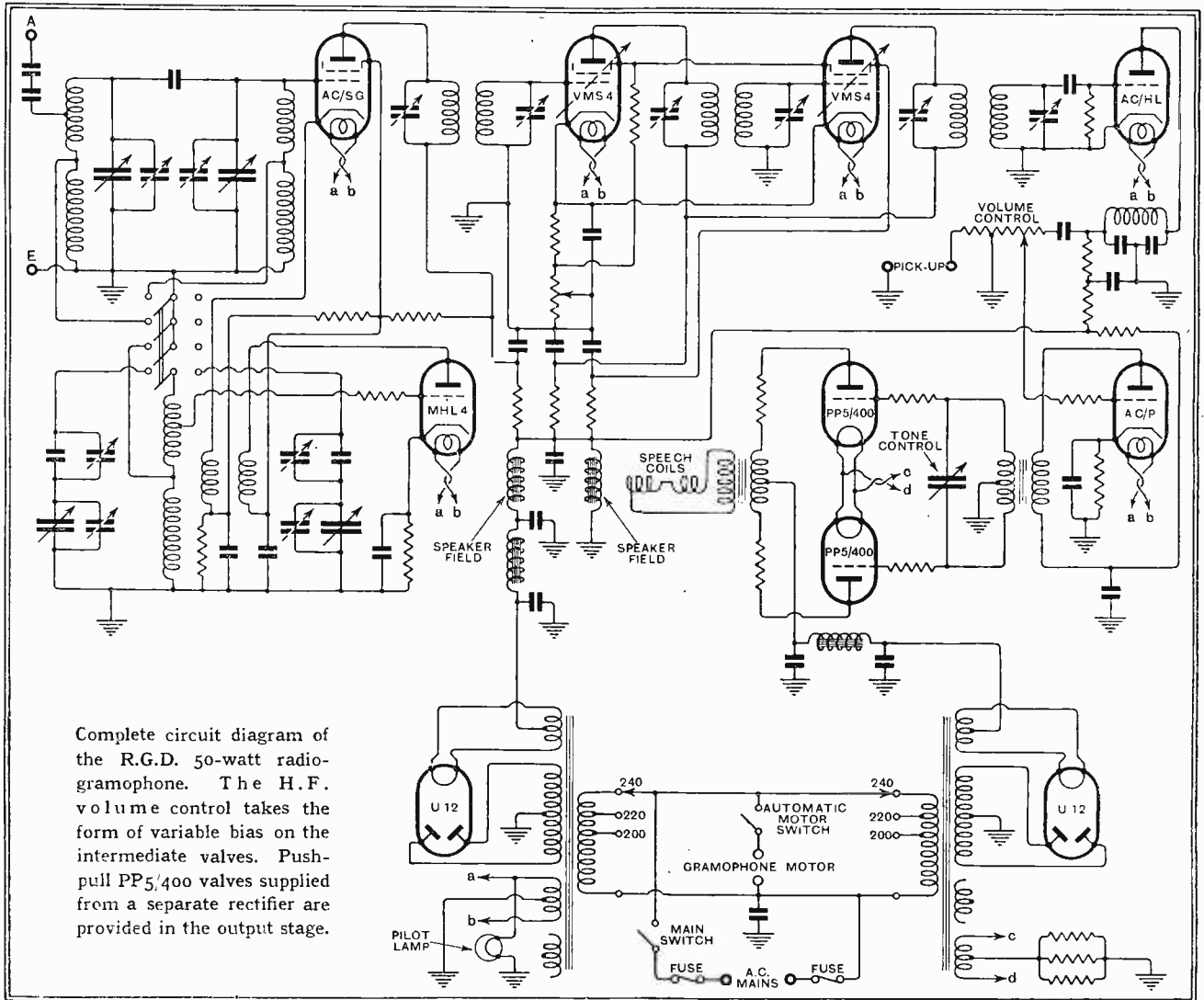

Complete circuit diagram of the R.G.D. 50-watt radio-gramophone. The H.F. volume control takes the form of variable bias on the intermediate valves. Push-pull PP5/400 valves supplied from a separate rectifier are provided in the output stage.

condensers complete with trimmers are used to obtain accurate alignment, at the required frequency separation, with the input band-pass filter. It is interesting to note that separate condensers are used for tuning the oscillator on long and short waves, a refinement which is permissible in a set of this character

stage is followed by a resistance-coupled amplifier before the push-pull output stage. The grid circuit of the first L.F. stage includes an ingenious "fader" volume control by means of which a perfectly silent transition from radio to gramophone and vice-versa can be made.

The specification includes a Gar-

which it houses. This is one of the few radio-gramophones in which the performance lives up to the impressive appearance of its cabinet.

Next Week's Set Review:—
FERRANTI CONSTRUCTORS' AMPLIFIER FOR A.C. MAINS.

The Truth about the Concert Studio.

LISTENERS, whose enjoyment of the programmes must always be the first consideration, have a right to learn the truth concerning the much-talked-of Concert Hall at Broadcasting House. Friends of the B.B.C. are now suggesting that this Hall was never intended to accommodate the National Symphony Orchestra, which (say they) requires a Queen's Hall or Royal Albert Hall to do it justice.

Pare the friends, they are wrong.

Platform Extensions.

In the current "B.B.C. Year Book" it is stated that, "owing to the enlargement of the B.B.C. Orchestra, it (the Concert Hall) will now seat exactly 751 when the full orchestra is performing." The italics are mine.

The full orchestra will never perform in the Concert Hall. It is good to know, however, that no efforts are being spared to accommodate as many players as possible. An extended platform has now been installed which permits "B" Section of the orchestra, consisting of 85 players, to give a very good account of itself. Section D (68 players) has already broadcast from the Hall on several occasions.

Too "Lively" Studios.

After a few weeks' experience in the new building, the engineers are now able to issue a very satisfactory report. Some of the studios, it appears, are almost too "lively," and are being damped down a little to avoid the empty corridor effect which a number of listeners have noticed.

"M.P.s" at Large.

Almost every day is now a red letter day at Broadcasting House, but June 7th, 8th and 9th should be picked out in gold. On these days Members of Parliament are to tour the place in relays, and the officials are expecting some frank criticism.

Probably the Effects Studio will arouse the greatest interest, back benchers always being on the look-out for new noises.

"Trade" at the Microphone.

IT is interesting to know that, so far as the Post Office is aware, "there is no truth in the statement" that the B.B.C. may have to resort to sponsored programmes. While this may absolve St. Martin's-le-Grand from any designs on the licence money, it does not clear the Treasury of such a charge. I understand that within the last few weeks a very strong movement has existed in Whitehall having as its object the retention by the Treasury of the whole of the licence monies, the B.B.C. being left to fish for itself among the eddying currents of commerce.

Misgivings in Portland Place.

I wish it were possible to state without a shadow of misgiving that everyone within the walls of Broadcasting House is opposed to the principle of trade shows

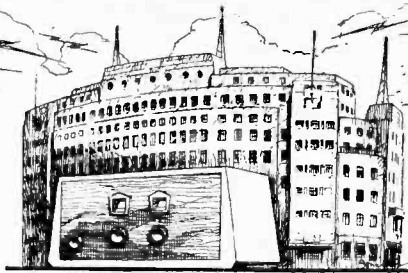

**BROADCAST
BREVITIES**

By Our Special Correspondent.

at the microphone. Unhappily, there is a leaning this way in some unexpected quarters. Although it would be wrong to say that there are two rival factions nowadays in the B.B.C.—one for and one against sponsored programmes—opponents of this type of programme have their moments of uneasiness.

Competitors Abroad.

With the new Luxembourg station at hand, offering widespread publicity for any firm which cares to pay the piper, and Dublin preparing similar facilities on almost as large a scale, it is not surprising that the B.B.C. is looking round in bewilderment, wondering how long it can retain its monopolistic grip on the British ether.

The Aldershot Tattoo.

ALDERSHOT Military Tattoo will be relayed this year on June 11th in the National programme. This annual function evokes an enormous budget of appreciations from listeners, and usually

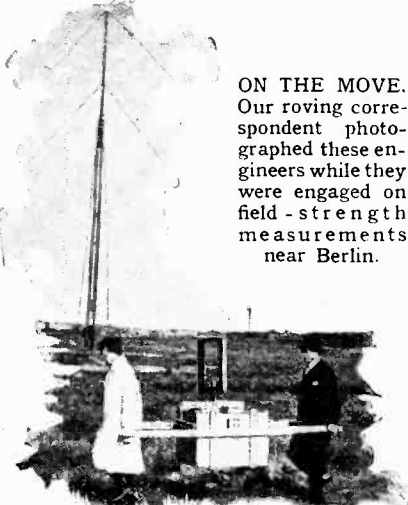

ON THE MOVE.
Our roving correspondent photographed these engineers while they were engaged on field-strength measurements near Berlin.

attracts vast numbers of visitors who, having heard excerpts on the wireless, decide to visit Aldershot and see the Tattoo performed.

Where Watchet Wins.

IN one respect at least, the new West Regional broadcasting station will probably beat its fellows. This is in the beauty of its surroundings. Three miles to the east of Washford Cross are the Quantock Hills, which at this end almost touch the Bristol Channel and extend southward to the valley of Taunton Deane and eastward to the Bridgwater territory. These hills will give a fine background to the station, for they are lofty and stand out in bold relief with their carpeting of grass, bracken and heather. Westwards from the station site can be seen Dunkery Beacon, Somerset's only mountain, and the Exmoor expanses.

If the correspondent who supplied this information gives a faithful picture, I should certainly award the beauty prize to Western Regional.

Throwing Over the Pick-up.

MR. CHRISTOPHER STONE will dispense with the electric pick-up for his recital of rare gramophone records on Monday next, June 6th. Instead, he will use an ordinary machine, which will play before the microphone, as was done in the very early days of broadcasting. The reason is that some very precious records from the collection of Mr. P. G. Hurst are to be used, and it is feared that a steel needle with an electric pick-up might possibly do some damage.

Listeners will hear, among others, the voices of Edward Lloyd, Battistini, Edouard de Reske, Albani, Calvé, and Melba.

A Day Outdoors.

SATURDAY afternoon, June 25th, will provide listeners with a succession of high lights in outside broadcasts. First an eye-witness account of the Test Match, England v. All India, by Howard Marshall, will be relayed from Lords Cricket Ground. A running commentary on the Shelsley Walsh Hill-climbing Trials follows; then a commentary on the sailing of M.V. *Georgie* will be relayed from Liverpool, via North Regional; next comes the popular annual event, a running commentary on the Royal Air Force Pageant from Hendon; and finally a commentary by Captain H. B. T. Wakelan and Colonel R. H. Brand on the All-England Lawn Tennis Championship meeting at Wimbledon.

This should be a record in "O.B." days

Why Engineers Go Bald.

EXTRACT from letter recently received at Broadcasting House: "I have filled the form up as good as I can but there one thing I would like to tell you when it is on the short wave it is so silent when it is not playing you can't tell it is on so it is all on the long wave."

CORRESPONDENCE

The Editor does not hold himself responsible for the opinions of his correspondents.

Correspondence should be addressed to the Editor, "The Wireless World," Dorset House, Tudor Street, E.C.4, and must be accompanied by the writer's name and address.

A Suggestion for the B.B.C.

THERE can be no doubts in the minds of most of us, after reading Mr. Hartley's interesting articles on broadcast reproduction, but that we must aim at least 30 to 9,000 as the minimum range for our receivers.

But there is one point that has not been touched upon yet—that is, how are we to know what our receivers are really giving us?

We may not consider that their performance is all that it ought to be, but few of us have access to apparatus that would enable us to give definite figures of their performance.

Cannot the B.B.C. give us a hand in this matter?

If they would occasionally broadcast a series of pure notes, say from 30 to 10,000 hertz, we should be able to form a better idea of what our receivers would and would not do.

I believe that there is a record available giving 30 to 7,000 hertz; an occasional broadcast of this would do to go on with, but the B.B.C. itself mentions 10,000 as a desirable upper minimum.

We should probably find that even those perfect receivers that we build ourselves were capable of slight improvement.
London, W.12. G. WEST.

Is 5,000 Cycles Enough?

AS there now appears to be a great deal of controversy as to the amount of high notes a set should reproduce, a few facts would not be out of place. First, my own opinion, is that a set incapable of reproducing above 5,000 cycles is not worth listening to. But what about the poor public? The words "frequency" and "cycles" convey practically nothing to them; they go into a shop, ask for some sets to be demonstrated, and should any of the sets incorporate a tone control the salesman invariably sets this to cut out the high notes, which were really not there in the first place. He does this because he admits that he prefers the depth of tone as well as the customer. That the customer likes this so-called depth of tone there can be no doubt. To give an instance:—

So time ago I held the very unimportant position of service engineer in the radio department of a great store. The buyer and head salesman of this department, who looked at you if harmonies were mentioned (knowing more about tobacco, and the only cycles he knew had booters), after interesting the customers, would demonstrate the tonal qualities of the set by turning the tone control to "Mello 'cello," a pleasant smile would appear on his face, the customer would say: "That's fine," and they would call it a sale.

It would then be my turn. I go with a colleague to install this set at the customer's own home, and after connecting everything up I would adjust the controls for the best possible reproduction the set was capable of giving, and as soon as I turned my back my colleague would make a dive for the tone control, turn it to "Mello 'cello," receiving a grateful smile from the customer for doing it.

All the foregoing, therefore, goes to prove that the average member of the public is not a judge of good reproduction and cannot appreciate it when he hears it. The public is being well catered for by the manufacturers.

Anybody *not* satisfied must either put up with it, do without altogether, or go to a sound specialist.

Bradford. A. SHACKMAN.

The 5,000-Cycle Cut-off and the Future.

PESSIMISTS who suggest that this limiting frequency will inevitably "truncate" the music of the future, as heard by the average man, and thus distort his musical taste, are very much to the fore lately. It may, however, be suggested that

they are not taking into consideration certain probable developments, any *one* of which is sufficient to upset their arguments entirely.

First, even if we admit that broadcasting will be the principal source of music, and that any extension above 5,000 cycles on the normal wavebands seems improbable in the near future, thanks to the selfishness of most of the national organisations, nevertheless even in this case the possibilities of the ultra-short waves should not be forgotten. Here there are practically no limitations as to width of channels, so that frequencies at least up to 15,000 can readily be dealt with, and the development of these waves will affect a very large proportion of listeners—all those, that is to say, who live in city areas, since broadcasting on these waves will not be economical for country broadcasting. Even for the country listener there is, however, hope from these waves, since when they take over a considerable proportion of the local broadcasting for cities at present done on the normal wavelengths, this band should become decidedly less congested than at present, and an extension of sidebands therefore possible.

But apart from this, there is hope also from gramophone music, especially as the newer rolled records (film, paper, or the like) replace the inconvenient discs. With such records there are no longer mechanical difficulties associated with the recording of the lower audible frequencies, nor does the reproduction of the higher ones bring with it the needle-scratch noises of the present systems; further, the objection of having to change the disc at short intervals is removed, as also the far more important one that the music has to be adapted to the playing time of the disc. If, into the bargain, these records cost only a fraction of present disc prices for the equivalent playing duration, it looks as though the gramophone will again become a very serious competitor to broadcasting as the purveyor of music to the average man, and therefore as the agency forming his taste.

And yet a third source of music must not be forgotten, the talkie, where the frequency limits are already very considerably wider than those of broadcasting or disc. More especially important are such films as those now being produced in Germany, recording good music as played by first-class orchestras. Here the music is the principal subject of the film, and as a result its reproduction, both as regards frequency limits and range of volume, is made as perfect as possible, even at the partial sacrifice (if necessary) of the visual image. The value of such films in forming musical taste, even if they are shown only as "overtures" to ordinary performances, can hardly be over-emphasised.

Finally, it must not be forgotten that the *interaction* of one source of music on the others is of very great importance. If, for example, the public begin to receive a better musical reproduction by film than by gramophone or by broadcasting, they will not long remain content with these, and thus the general standard will be forcibly raised.

La Ciotat, France.

R. RAVEN-HART.

100 Division or 180 Degrees?

IN view of the controversy that is likely to arise, at your behest, as to the merits or otherwise of the 100-division scale *versus* the 180-degree scale, I would like to state what I consider to be the only serious reason for standardising a scale with the higher reading; or even a *higher reading!*

When listeners calibrate their receivers, in particular on the congested medium wave-band, they invariably find, no matter what the condenser design, that on parts of the scale some of the stations are within half-degrees of each other, when accurately tuned in; whether they overlap on some receivers is apart from this subject.

In the region of Hilversum, for instance, unsatisfactory

recordings of dial readings might be taken, such as Turin 39 $\frac{1}{2}$, Hilversum 39 $\frac{3}{4}$, which is only one supposition that will likely be repeated often between 200 and 500 metres.

With the finer reading that would be supplied with the 200-degree, or rather division, scale, much of the fiddling over fractions would be done away with.

In fact, one would stand a very hopeful chance of registering whole numbers for most stations, which I am sure would have a certain usefulness, whereas I see nothing definitely in favour of the others.

S. CARL BUCKINGHAM.

London, N.W.6.

H.F. Push-pull.

THE letter appearing in your issue of May 4th from Mr. R. M. Sibbett, *re* H.F. Push-Pull Amplification, assumes that the idea is new, and the following facts may be of interest.

In 1924 I constructed a portable set on these lines, which, alas, was before the days of screened grid valves and before neutralising was widely known. This gave very stable results and formed quite an interesting receiver. I went farther than this, however; reflex circuits being then in vogue I was prompted to economise in valve current and utilise the two triodes as two L.F. stages in cascade. This I actually did, although the additional reflexing complications somewhat marred the merits of the arrangement.

I agree with Mr. Sibbett that a very stable and efficient H.F. stage, or stages, should be obtainable by applying push-pull to the H.F. amplifier.

LESLIE E. A. BOURN.

Ashford, Middlesex.

I WAS very much interested in the letter from your correspondent, R. M. Sibbett, in the issue for May 4th, and entirely agree with him as to the advantages accruing from the adaptation of H.F. push-pull.

I conducted a research on these lines some time ago, and results were so promising that I protected certain features, and later sent the Editor a diagram of a lay-out.

When I approached manufacturers, however, I found none of them interested, some looked askance at it, and others objected to the royalties on the extra valves. This led me to design and protect special valves with one filament and duplicate grids and plates, and other suitable arrangements, but it would appear that the innovation is a little in front of its time.

CHARLES BAXTER.

M.I.A.E., A.M.I.Mech.E., A.M.I.Min.E.

IN your issue of May 4th a correspondent, Mr. R. M. Sibbett, asks for information *re* push-pull circuits for H.F. amplification.

In this connection I may say that such a system has been developed by the United States Navy Department, and successfully used in the U.S. Navy for several years. The system is applicable both to transmission and reception, and works equally well in both cases.

An article describing the construction of an adaptation of this short-wave receiver for amateur use appeared in one of the American popular radio magazines about eighteen months ago. I do not recall which publication it was, but such information could doubtless be obtained by getting in touch with the Allen D. Cardwell Mfg. Corp., of Brooklyn, N.Y., which makes a special "split-stator" condenser (type 202E) for use in the above connection.

N. A. WOODCOCK.

Huddersfield.

Quality and Frequency Range.

IN your issue of May 4th Mr. H. A. Hartley makes the following statement: "A restriction of the frequency band is advocated only by those who cannot design for better performance, who, since they cannot see how to improve their apparatus, advise that apparatus should not be improved. Surely it cannot be 'in the best interests for future progress' that radio should be spoiled for the sake of the incompetents?"

As one who has on several occasions recently, in these columns and elsewhere, advocated the restriction of the frequency band to about 5,000 cycles for general purposes, I cannot fail to regard these remarks as a challenge, verging on the personal in character. To deal thoroughly with the matter would take up much

space, and therefore I shall state a number of facts and refrain as far as possible from comment.

(1) A receiver which is not designed at all will probably cover up to 10,000 cycles, perhaps more, purely by accident, but careful and precise design of a highly technical order is required to achieve a characteristic which is flat up to 5,000—or any specified limit—and then suddenly cuts off and stays cut off. Mr. Hartley might therefore as well lay it down as a law that driving through the streets at a safe pace is advocated only by those who cannot drive at a dangerous rate.

(2) "Why are radio sets made with a 5,000-cycle limit? I can see no other answer but—technical incompetence," says Mr. Hartley. Perhaps he is unaware that the frequency separation of stations is, if they keep strictly on their marks, 9,000 cycles, or by very special request in the case of London Regional, 11,000 cycles, and that this space has to be shared between two stations. In London—and therefore presumably within the service area of the London transmitters—a certain ordinary receiver, taken as an example, which is good enough to exclude modulation interference, causes even the uncritical listener considerable annoyance by carrier and sideband heterodyne, even though it cuts quite badly at the upper frequencies. A designed sharp cut-off is a necessary cure. Admittedly there are many cases in which the same result is secured more or less accidentally by the use of a loud speaker that cuts off. Is this how Mr. Hartley is able to use his wide frequency range amplifier?

(3) The B.B.C. gramophone transmissions are subject to a limit of approximately 5,000 cycles. The fact that these broadcasts invariably stand very high in ballots and other tests that are made to ascertain relative popularity seems incompatible with Mr. Hartley's contention that such a limit makes all speakers sound as if their mouths were filled with food (how Lewis Carroll!), that vaudeville would be consigned to eternal silence, etc., etc.

(4) According to Mr. Hartley (in his article on "Broadcast Reproduction") a 5,000-cycle limit spoils the whole of the oboe's compass, removes five-sixths of the violin, etc. Though not a trained musician, I personally have no difficulty in identifying all the instruments named almost as easily when broadcast from good records as when broadcast from a good concert hall, which is rather surprising if in the former case they have been "removed."

(5) While nobody would be so stupid as to deny that a switch-over from reception with a 5,000-cycle cut-off to one with a high limit reveals greater fidelity, in practice the number of people who would demand this, even after hearing it, would be negligible compared with the multitude who would instantly reject it because of the increased hiss, scratch, atmospherics, carrier and sideband heterodynes, any or all of which are more than likely to be noticeable. To insist on the wide compass is to strain at the gnat of harmonic loss and to swallow many camels that I could name.

(6) To descend to more sordid considerations, any company that adopted Mr. Hartley's policy in its designs would assuredly lose money by it, not because the public have a perverted craving for debased reception, but because they somewhat naturally prefer a very fair imitation of the original, unspoiled by extraneous items to perfect reproduction on a background—or perhaps foreground—of assorted interference. So regrettably necessary to business is the earning of profits that probably not even Mr. Hartley's badge of disgrace "Incompetent" will rouse the radio and gramophone manufacturers of the world to a sense of shame.

M. G. SCROGGIE.

London, S.E.19.

I AM not a scientist nor an engineer, but I cannot see the idea in favour of a "reproduction" which is not true.

The best radio music I have heard lacks most of the "life" and reality of the original—somewhat like a photograph.

If the "powers" decide to squeeze the symphony orchestra into the semblance of a mouth-organ I shall by-pass radio and fall back on the gramophone.

J. E. ROBERTS.

London, S.W.2.

IT seems to me that the controversy on the above subject is, to some extent, brought about by a misunderstanding as to the function of a broadcasting station. If we consider the studio, transmitter, and receiver as a specific entity, a device whereby sounds emanating from persons and objects in the studio are reproduced in the listener's home, then it is obvious that the

more perfect the reproducing process, the more efficient is that entity.

The regional stations of the B.B.C. provide service areas wherein the field strength of transmissions having a frequency range of at least 32-9,000 cycles is much greater, on the average, than that of any interfering transmission. There is, therefore, no reason why these transmissions should be received in a mutilated form. If the question of listeners outside the service areas is going to be brought up, then my answer is that they cannot be allowed to affect the issue at all. Broadcasting authorities concentrate on providing adequate service areas for their listening subscribers. It is the duty of technicians and manufacturers to provide apparatus to receive and reproduce these area transmissions as well as possible. Listeners outside the service areas know that they have no reliable service, and expect to suffer interference as a matter of course. They get it, too, whatever type of set be used, and they would get it if stations were separated by 90 k.c. instead of nine. Listeners inside the service areas have no right to expect interference-free transmissions from foreign sources, but they can have them with a receiver which reproduces up to 9,000 cycles. My own receiver and loud speaker have practically level response up to 10,000 cycles, and yet I can get Toulouse and Hamburg free from Midland and London Regionals. As Mr. Turner rightly points out, the 5,000-cycle people take it for granted that the receiver is to behave alike on all European stations, and wherever it is situated. To use Mr. Merdler's unctuous expression, "while the idealist may theorise, the practical man must act," and let him act to produce a receiver which does credit to the transmissions which can be received and not one which tries to get everything, receivable or otherwise.

Your leader of May 11th suggests that a receiver such as I possess must, of necessity, be costly. Actually, I spent £22 on it, and that with an L.S.6a output stage. I said in an earlier letter that it cost no more to make a good set than a bad one, and if manufacturers were possessed of loud speakers which would reproduce from 32-9,000 cycles without cut-off or resonance, they would be able to sell suitable sets at the same prices as those on the market to-day; very good reproduction would be commonplace, and not the unpurchasable commodity (so far as the regular trade is concerned) it is at the moment.

I cannot conclude without asking Mr. Merdler a few questions about his letter of May 11th. Would he accept a stalls seat for the price of a gallery ticket, and if not, why would he deny other people the opportunity of so doing? On what grounds does he assert that a restriction of the frequency range is in the interests of the many? Bearing in mind the fact that the majority of listeners are *inside* a service area, how does he reconcile this assertion with his statement a few lines farther on that receivers should be designed for the benefit of listeners *outside* the service area? Why should a transmitter be spoiled for the sake of people it was not intended to serve? Why, if he cannot receive frequencies higher than 5,000 cycles, should he label as fantastic the claims of those who can? And, finally, can he point out, in the whole history of the human race, a single instance where progress was arrested for the sake of "successful civilisation"?

H. A. HARTLEY.

Isleworth.

The Regional Scheme.

ON the completion of the Regional Scheme, that is, after the long-wave transmitter has been established at Droitwich with a power of 100 kilowatts, what precise degree of usefulness will it be possible to claim for the three medium-wave National transmitters at Brookmans Park, Moorside Edge, and Watchet? Can the B.B.C. give us *now* a reasoned argument justifying in the then existing circumstances the continued operation of these transmitters?

The radiation-curves published in the issues of *World Radio* of November 6th, 1931, and February 19th, 1932, would seem to support the following conclusions:—

(1) The effective range of the London National transmitter, the range, that is, within which it will provide a *stronger* signal than 5XX at Droitwich, will vary between twenty and thirty miles. Its average range, therefore, will be only twenty-five miles.

(2) The effective range of North National will vary between twenty-three and thirty-three miles, giving an average of twenty-eight miles. Manchester will get about twenty milli-

volts per metre from this transmitter, and 16 mV/m. from Droitwich.

(3) South of the Bristol Channel, the West National transmitter will have an average range of about 28 miles. North of the Channel, the range may be limited by a line drawn eastward from a point in Glamorganshire about 26 miles due north of Watchet to the mouth of the Wye, and a line drawn westward from the same point through Neath to the farther boundary of Carmarthenshire and thence to St. Gowan's Head. Bristol, one of the few centres of population in the Western region, will get 24 mV/m from Droitwich, and something less than this from West National, and will therefore fall outside the effective range of one of its two local transmitters.

(The service-area, in each case, it is clear, will be relatively insignificant in extent. The population of the London-National area I estimate to be $9\frac{1}{2}$ million, that of the North-National area $6\frac{1}{2}$ million, that of the West-National area about $1\frac{1}{2}$ million.)

(4) The long-wave transmitter will radiate the National programme over each of these three areas at an average signal-strength of 15 mV/m.

(5) The net utility of the three medium-wave transmitters will therefore consist in this; that they will each provide within a quite restricted range an average signal-strength superior by some 10 or 15 mV/m to the average 15 mV/m simultaneously obtainable from Droitwich 5XX.

But it is hardly necessary to analyse the position to see that it is going to be an extraordinary one. We shall have these three medium-wave transmitters each within 100 miles of the long-wave transmitter, and all four, using up between them four wavelengths and 250 kilowatts of power, will assiduously pump out the same programme. Though the long-wave transmitter will be relied upon to give an adequate service in districts as remote as Cornwall and Cumberland, it will not apparently deliver a signal of sufficient intensity in London, Manchester, or Cardiff.

Meanwhile, when listeners here in Newcastle or in Aberdeen complain of paltry treatment, they are always met with the bland assurance that, as far as their *obligations* to other areas and the scarcity of wavelengths at their disposal will allow, the B.B.C. are giving them the most efficient service possible. And at this moment, I suppose, work on the West National transmitter is proceeding apace.

K. M. C.

Newcastle-on-Tyne.

The Pick-up.

BEARING in mind that sound transmission and reproduction by electrical means is becoming more and more an exact science, and that apparatus can now be designed according to formulae and a very accurate assessment made of its probable behaviour, while fresh ideas and possible improvements may be investigated mathematically in the assurance that, in their materialisation, they will not depart appreciably from theory, it becomes all the more interesting to note that one little component in the midst of this orderly and amenable company has so far maintained an attitude of impish perversity as to have baffled all attempts to bring it into line with the rest. The gramophone pick-up evidently intends that never, so long as it remains a pick-up, will it submit to the indignity of complete scientific representation.

It is true that it has yielded to a certain amount of treatment, but one may almost say that it has done so only on its own conditions. It will lie quietly, and submit to mechanical analysis; it will dance a measure on a standard frequency record, and permit of an electrical investigation; but is this an expression of its real behaviour—its behaviour in its work-a-day job?

What is the relationship, if any, between a curve taken with a constant-frequency record, and the behaviour of the pick-up when actuated, for instance, by a record of the Philadelphia Symphony Orchestra? What is really happening when currents are being developed in the coils by an armature actuated at 100 cycles and 3,000 cycles; indeed, by "all sorts" of cycles, at the same time?

Most pick-ups show amplitude distortion below 200 cycles (which has even been referred to as the "providential rise"!). But what effect does this have on frequencies occurring concurrently? Are they subjected to distortion, or has the increased output of the pick-up at the lower frequencies no effect upon them?

I recently made so bold as to express some views on the subject of "informative advertising" in these columns, but

ny manufacturer who experiences difficulty in being as informative as one might wish about his pick-up has my full and unstinted sympathy. He may print its portrait, describe its size, mention its weight and its resistance, and tell us how many volts it will develop under certain conditions; but the title instrument, elusive, unconquered, and full of glee, gambols in the few fetters we may put upon it; and though we may say the dancer, can we call the measure?

And what does it all matter? I suppose it depends, as such things always do, upon one's point of view. There would appear to be two ways of looking at the question. One is to go and put a good modern record on a good modern reproducer, and say "That is the way this pick-up behaves under working conditions"; and one is bound to reply that it seems to be very well behaved indeed!

One might call this the "empirical method," and it is very pleasant and entertaining to apply. But can it get us very far? I suppose some would say that it can get us far enough for most purposes; but it is not a very helpful attitude to adopt, and is not very fruitful from the point of view of high achievement. The other method—the "rational" one—is concerned with

measurement, calculation, and computation, and a great deal of hard thinking. It is neither so pleasant to apply, nor are its results capable of being presented in so acceptable a manner; but it is the only method by which the present general excellence of reproduction has been attained, and by which further progress may be made. By its application, it may be supposed, the problem of the pick-up will eventually be solved; though who knows that, by that time, the whole system may not have undergone a change, pick-up and disc giving place to photo-cell and film, the frequency band widening out to a degree at present achieved only in the happiest of our dreams. (Would you, Sir, care to spend the rest of life hearing nothing above 5,000 cycles, if you were given the choice?)

I am afraid I have already had more than my fair share of space. May I end this letter by expressing the very sincere hope that anyone who may chance to read it, and who is interested in the matter, will give me some help with the puzzle? Such a discussion should surely be valuable, and you, Sir, are always generous in giving space on this potentially fruitful page!

Cheshire.

NORMAN P. SLADE.

THE "PRIMUSTATIC" LOUD SPEAKER.

READERS of this journal are already familiar with the principles underlying the operation of the electrostatic loud speaker, but hitherto few opportunities have occurred in this country of obtaining practical experience with reproducers of this type. The fact that the British-made "Primustatic" loud speaker, shown at Olympia last autumn, is now in production, is, therefore, an event of first importance, for recognition of the advantages of the electrostatic loud speaker is, in our opinion, long overdue. It is in the reproduction of the higher frequencies that the electrostatic loud speaker shows its superiority over other types. The extremely low inertia of the

very high frequencies, such as the jingling of keys, ringing of bells, etc., are most realistically reproduced, and we have seldom heard the characteristic qualities of string instruments so well rendered.

Measurements showed that there was a ready response to frequencies up to at least 15,000 cycles (the highest frequency available from the oscillator used). At the other end of the scale the output was well maintained down to 250 cycles, but fell off rapidly below 150 cycles. The bass response can be improved by experimenting with the matching between the loud speaker and output valve impedances, but the amplitudes which would be required in the bass to balance the excellent acoustic output in the upper register could not be obtained without rattling and possible damage to the diaphragm. Nevertheless, the response goes down low enough to give perfectly natural speech, and many people prefer the light and delicate quality which it confers to music. The connoisseur will no doubt make experiments with a view to obtaining the benefit of the bass response of a moving coil in conjunction with the exceptionally good performance of the "Primustatic" loud speaker in the reproduction of transients and high harmonics.

It is, however, advisable to work with voltages in the region of 200 volts, as with lower values there is a tendency to introduce second harmonic distortion at the lower frequencies.

Unlike loud speakers with inductive windings, the impedance falls with frequency, and this must be borne in mind when matching with the output valve. A special Ferranti tapped output choke is available for this purpose, and very full information regarding the output connections and the method of applying the polarising voltage from the H.T. supply to the receiver is contained in the instruction leaflet.

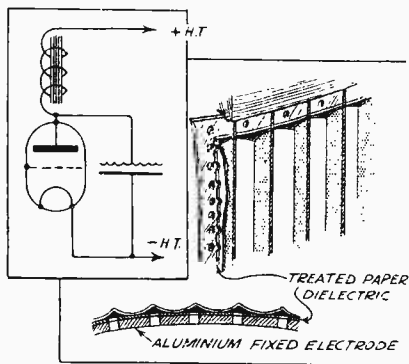

Constructional details and method of connecting the "Primustatic" loud speaker.

The design and arrangement of the perforated fixed plate and the fluted foil electrode have resulted in a degree of sensitivity somewhere between that of the moving coil and moving iron types of loud speaker. This has been obtained with polarising voltages of the order of 150 to 200 volts, which is considerably less than is required for previous electrostatic types.

The dimensions of the standard model are 21in. x 19½in. x 5½in., and the convex front was found to give far less focusing of the high frequencies than is usually the case with cone diaphragms. As a result it is sometimes difficult to tell from which direction the sound is emanating—a distinctive effect which is well suited to many types of transmission.

The makers are The Primus Manufacturing Co., Primus House, Willow Street, London, E.C.2.

like hand clapping and sounds requiring

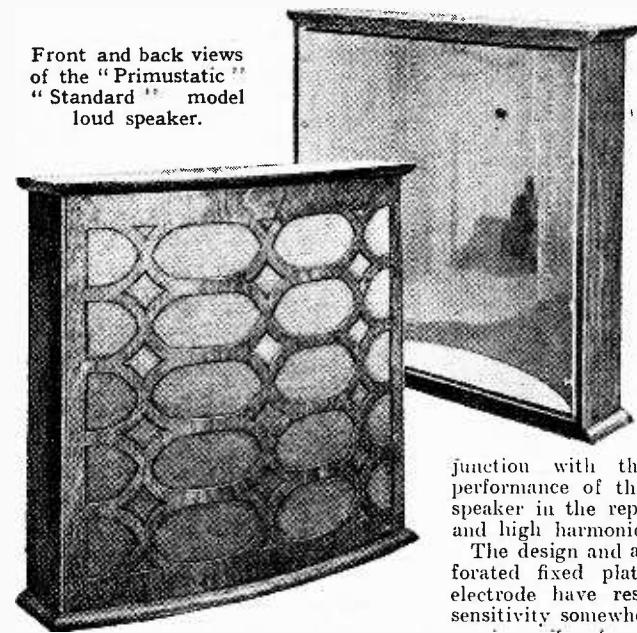

Front and back views of the "Primustatic" "Standard" model loud speaker.

the reproduction of transients in which the "Primustatic" excels. Complex noises

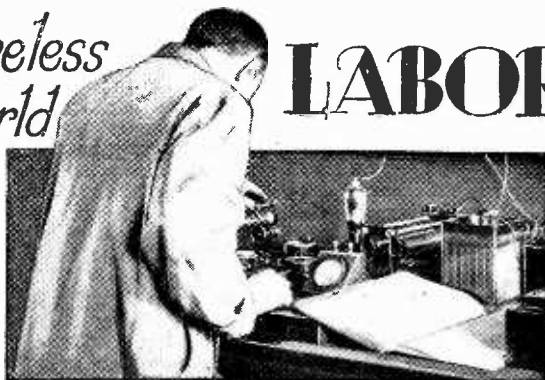
Wireless
World

LABORATORY TESTS

Review
of New
Radio
Products.**R. AND A. "CHALLENGER"
LOUD SPEAKER.**

This latest product of Reproducers and Amplifiers, Ltd., Frederick Street, Wolverhampton, maintains the reputation already established by this firm for the manufacture of high-grade loud speaker units of reasonable price. It is of the permanent magnet moving-coil type, and is fitted with a cadmium-plated cobalt-steel magnet of new design, giving a flux density of 6,800 lines per sq. cm. The cone diameter is 6½ in., and the overall diameter of the chassis 8½ in.

A low-resistance speech coil is employed, and the method of attachment to the diaphragm by means of a pressed-aluminium ring is particularly neat. Centring is effected by a three-legged spider attached to the centre pole-piece.

The performance of this unit is such that it merits discussion from an absolute standpoint and without regard to the very reasonable price asked. From the point of view of overall sensitivity it is slightly better than the average of its class, but, as in the R. & A. type 100 loud speaker, the reproduction in the bass below 100

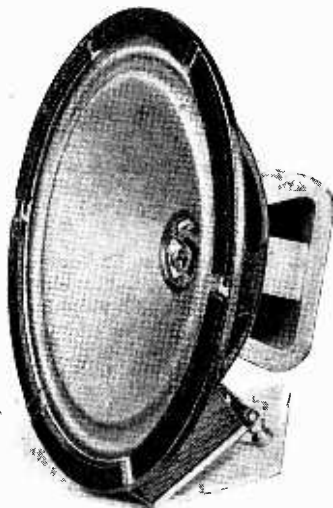

R. and A. "Challenger" permanent magnet moving-coil loud speaker including triple-ratio transformer.

cycles is quite definitely above the average. In the particular model tested the principal diaphragm resonance occurred at 88 cycles, but, instead of cutting off

sharply below the resonant frequency, as is usually the case, the output was found to be only 5 decibels down at 50 cycles. The 88-cycle resonance is not unduly pronounced, and, as a result of the well-maintained output down to 50 cycles, a full-bodied bass is obtained without "boom."

In the middle register between 250 and 1,000 cycles the output is slightly below the average level, but there is a rise from 1,500 cycles to a maximum at 3,500 cycles, and thereafter a slight falling off to 6,000 cycles, after which the cut-off is rapid. Before completely dying away, however, there is a subsidiary resonance at 9,000 cycles.

Reproduction of speech is natural and unforced, and the balance in music is exceptionally good for a loud speaker costing only 35s. This price includes a built-in transformer with ratios of 19, 33, and 44 to 1 for low- and medium-impedance output valves and pentodes.

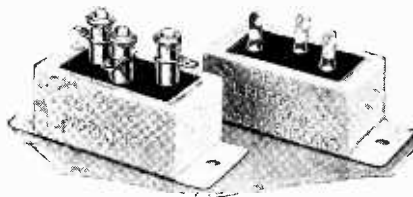

Peak "Buffer" condensers, compact units consisting of two 0.01 mfd. members.

PEAK "BUFFER" CONDENSERS.

Made by Wilburn and Co., 23, Bride Lane, London, E.C.4, these condensers are intended primarily for use in A.C. circuits, a typical example being between the anodes of the rectifying valve and the H.T. positive to stop modulated hum, while a condenser connected across the primary winding on the mains transformer will help to minimise background noise.

For the first-mentioned function the type 2,000 has been developed. This consists of two 0.01 mfd. condensers in one case tested at 2,000 volts D.C., and supplied either with terminals or with soldering tags, the prices being 3s. 3d. and 2s. 9d. respectively.

For the primary circuit two 0.001 mfd. condensers are adequate, and the Peak

type 1,000 provides these in one compact unit. They are tested at 1,000 volts A.C. and the price is 2s. 6d. The type 1,000 is made also as a 0.1+0.1 mfd. unit at the same price. In addition to the above there are many other uses for these extremely compact condensers.

o o o o

BULGIN PICK-UP AND TONE ARM.

The movement of this pick-up is interesting, in that laminated pole pieces are employed. These are graduated to minimise leakage, and ensure a high flux density in the air gap.

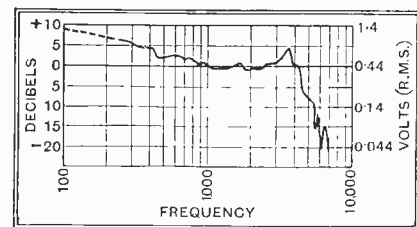

Output characteristic of the Bulgin pick-up. (H.M.V. loud needle).

The armature is of the conventional "half-rocker" type, and is damped by rubber pads at its upper extremity. In the particular specimen tested some difficulty was experienced in obtaining reliable readings below 250 cycles, as the needle would not follow the groove of the special frequency records, in which the pitch is much greater than that of ordinary records. However, sufficient evidence was obtained to show that the curve conforms to the best practice in that a rising characteristic is obtained towards the bass. A resonance between 3,500 and 4,000 cycles gives adequate brilliance in the upper register, while a fairly sharp cut-off above 5,000 cycles should prevent needle scratch.

The tone arm is artistically finished in Florentine bronze, and is provided with a counterbalance weight. Actually, the needle pressure is 4½ ounces. The pick-up head is set at the correct angle for accurate needle track alignment, and ball bearings provide a really

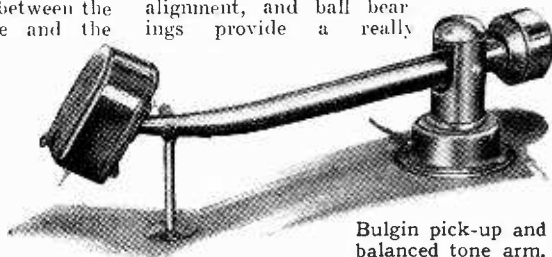

Bulgin pick-up and balanced tone arm.

efficient pivot for the tone arm. The price, complete with rest and mounting template, is 30s., and the makers are Bulgin and Co., Ltd., Abbey Road, Barking, Essex.

READERS' PROBLEMS

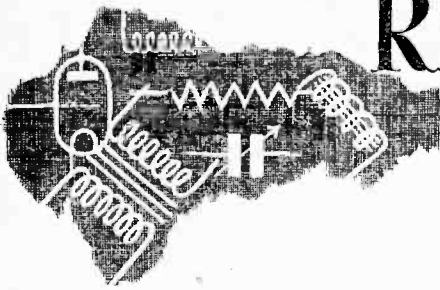

Substitute for Volume Control.

IT is well known that when speech is reproduced at greater strength than the original level it sounds unnatural and abnormally low-toned, even when a high-quality amplifier and loud speaker are employed.

This accounts for an effect which appears to have puzzled a correspondent, who has been doing some experiments with tone control. He notices that the reproduction of his receiver, so far as music is concerned, does not appear to require any correction, but speech is much more pleasing when deliberate attenuation of the bass register is introduced.

This effect is by no means uncommon, and some listeners, whose receivers are fitted with tone control, make a practice of reducing the lower register output when speech is being transmitted.

"D.C. Three" Voltage Adjustment.

IT should be made quite clear that the "Wireless World D.C. Three," described in the issue of this journal for March 16th, is designed for mains voltages of between 200 and 250 volts. Within these limits, the only alteration necessary to accommodate varying supply voltages is an appropriate tapping adjustment on the main resistance "mat" R_{11} . No changes whatever in the values of feed, decoupling, or bias resistance are required.

For pressures of considerably under 200 volts, the question is much more complicated, and those readers who are unfortunate enough to have low-voltage

THESE columns are reserved for the publication of matter of general interest arising out of problems submitted by our readers.

Readers requiring an individual reply to their technical questions by post are referred to "The Wireless World" Information Bureau, of which full particulars, with the fee charged, are to be found on the next page.

D.C. supplies should realise that good results can hardly be expected unless steps are taken to supplement the mains pressure, so far as the anode circuits are concerned. Correspondents who have raised this point are referred to page 377 of *The Wireless World* for April 13th, where a method of using an auxiliary H.T. accumulator battery was described.

Tone-control Transformers.

REFERRING to our description of the "Toco" variable tone-control transformer in *The Wireless World* of May 18th, a reader asks whether the published frequency response curves would still be attained if a transformer of this type were inserted directly in series with the anode of a detector valve of reasonably low impedance. Anode current would, of course, be kept within the limit stated in our descriptive review. Our correspondent is particularly anxious to know whether the inclusion of H.F. filtering devices is likely to impair the L.F. characteristics of the stage, and also asks

not retain a charge after being connected across the D.C. output terminals of the H.T. rectifier. All the other condensers produce a heavy spark when their terminals are short-circuited after charging. It is asked whether the smoothing condenser in question can be assumed to be faulty, and if so, what is the most probable nature of the defect?

As a result of these two tests, it may be concluded definitely that there is a serious fault. Failure to hold a charge may be due to a leakage, which need not of necessity be great enough to prevent the condensers working in a smoothing circuit, but the fact that insulation is good would indicate clearly that there is an internal disconnection.

All's Well.

AS a result of an accidental short-circuit across the bias resistor, a reader finds that the output valve of his "Power Radio-Gram" was operated for some minutes without any bias. The short-circuit was soon noticed and re-

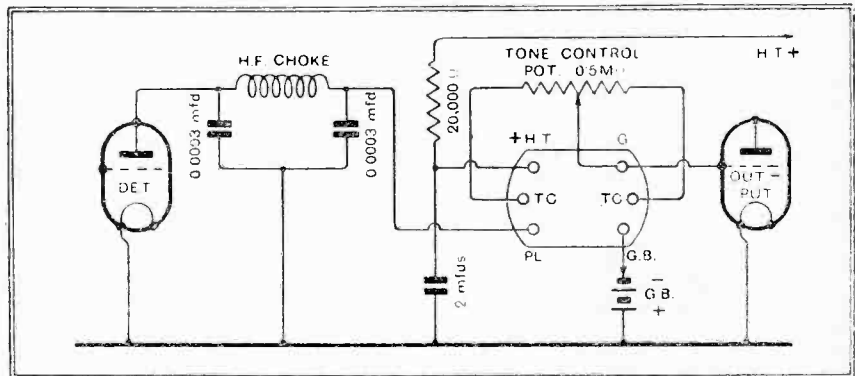

Fig. 1.—A "Toco" tone-control transformer, directly connected in the detector anode circuit. An H.F. filter is included, and component values are suggested.

for a circuit diagram showing the appropriate connections.

Although it is probably safest to operate the transformer in question in a "parallel feed" circuit, results are not greatly affected when the alternative method of direct connection is adopted. Similarly, the inclusion of an H.F. filter of normal design is unlikely to have any noticeable ill effects. We suggest that the apparatus should be wired as in Fig. 1.

Internally Disconnected Condenser.

IN an attempt to find the source of excessive hum in a mains-operated receiver, a reader has been testing all the smoothing and by-pass condensers; one of the former appears to have infinitely high insulation when tested with a battery and galvanometer, but it does

not retain a charge after being connected across the D.C. output terminals of the H.T. rectifier. All the other condensers produce a heavy spark when their terminals are short-circuited after charging. It is asked whether the smoothing condenser in question can be assumed to be faulty, and if so, what is the most probable nature of the defect?

As a result of these two tests, it may be concluded definitely that there is a serious fault. Failure to hold a charge may be due to a leakage, which need not of necessity be great enough to prevent the condensers working in a smoothing circuit, but the fact that insulation is good would indicate clearly that there is an internal disconnection.

Of course, there is the further possibility that the rectifying valve has been damaged, but the same automatic safeguard applies here also, and in any case the rectifier is normally operated with a large margin of safety.

Smoothing for D.C. Sets.

DIRECT-CURRENT supply systems vary enormously with regard to the amount of superimposed "ripple" and, as a consequence, it is hardly possible to specify a smoothing system that would be effective in all circumstances. Put another way, a smoothing system that can be depended upon to give satisfactory results with the worst kind of mains would be unnecessarily expensive for use when conditions are good; further, it would probably be responsible for an unduly high loss of H.T. voltage.

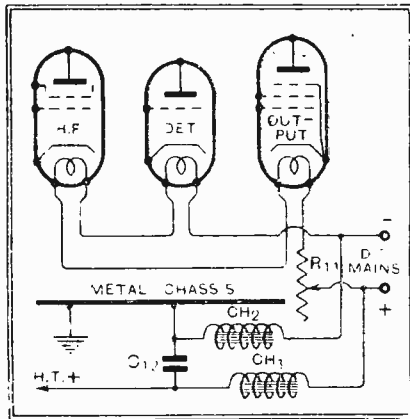

Fig. 2.—An extra smoothing choke (marked CH₂) added to *The Wireless World* D.C. 3 receiver.

For these reasons, most published designs for D.C. receivers include only enough smoothing for average conditions, and so the constructor who is unfortunate enough to have a bad supply must always consider the possibility of adding extra chokes and condensers.

All this is realised by a querist who proposes to make the "Wireless World D.C. Three" (described March 16th). Current derived from his mains is notoriously difficult to smooth, and he asks for information as to where an extra choke should be connected.

The best place for this addition will

probably be in the negative H.T. supply lead, as shown in Fig. 2, where this additional component is marked CH₂. Interconnections between the heaters, H.T. supply leads, and the metal chassis should be as shown; the negative heater lead should not be connected directly to the chassis as in the original set.

Loud Speaker Field as Smoothing Choke.

IT may be taken as a general rule that when the field winding of a moving-coil loud speaker is used as a smoothing choke the instrument should be mounted in close proximity to the set. At any rate, extreme caution should be used when long extension leads are proposed.

Requests have been received for information as to the maximum permissible length of these extension leads: it is not possible to lay down any hard-and-fast rule, but it is seldom that a length of 15 or 20 feet will be responsible for trouble.

Some of the questions relate specifically to the "Monodial" receiver, in which the loud speaker field is used for smoothing the H.T. feed current for all valves except the output stage. In the case of this particular receiver, an extension lead of the length suggested above should be quite safe.

Earthing Metallised Valves.

THE metal coating which is applied externally to many modern A.C. valves is connected internally to the cathode pin; a little thought will show that there is a risk of short-circuiting the grid bias supply by connecting the metallic coating directly to earth. The rule is that this should never be done when bias for the valve is derived from a resistor inserted in its cathode lead.

This may seem to run contrary to the experience of a reader, who states that incipient instability in his H.F. stage can only be checked by earthing the metal coating directly to the chassis: he realises that the valve is working without negative bias when this is done.

We fear that this cure for instability can only be considered as a rather

FOREIGN BROADCAST GUIDE.

CRACOW

(Poland).

Geographical position: 50° 4' N., 19° 55' E.
Approximate airline from London: 878 miles.

Wavelength: 312.8 m. Frequency: 959 kcs. Power: 1.5 kW.

Time: Central European (coincides with B.S.T.).

Standard Daily Transmissions.

10.00 B.S.T., sacred service (Sun.); 11.58, Time signal; Fanfare from St. Mary's Tower, news, then continuous broadcast to 19.45, main evening programme; 22.00, news, dance music. Mainly relays its entertainments from Warsaw and other Polish studios.

Announcers: Man and woman.

Call: *Hallo! Polskie Radjo Cracow* (pron.: *Krar-koof*).

Interval signal: Three notes or, when relaying Warsaw, a few bars from Chopin's *Polonaise* in F major.

All official announcements are preceded by the roll of a drum.

Closes down with the words: *Dobra noc, panstwo* (Good-night, Everybody) followed by French greetings and the National Anthem (*Dombrovski mazurka*).

Associated transmitters: Lodz, 235 m. (1,283 kcs.), 2.2 kW.; Poznan, 334.5 m. (896 kcs.), 1.9 kW.; Lvov, 380.7 m. (788 kcs.), 16 kW.; Katowice, 408.7 m. (734 kcs.), 10 kW.; and Warsaw, 1,411.3 m. (212.5 kcs.), 158 kW.

unsatisfactory palliative. No doubt stability is brought about by increased damping due to grid current when the valve is worked with a zero grid; in these circumstances, amplification and selectivity are both reduced, and we recommend that systematic tests should be made to locate the real source of grid-anode circuit coupling, which is at the root of the trouble.

"THE WIRELESS WORLD"

Information Bureau.

CONDITIONS OF THE SERVICE.

(1) THE service is intended primarily for readers meeting with difficulties in the construction, adjustment, operation, or maintenance of wireless receivers described in *The Wireless World*, or those of commercial design which from time to time are reviewed in the pages of *The Wireless World*. Every endeavour will be made to deal with queries on all wireless matters, provided that they are of such a nature that they can be dealt with satisfactorily in a letter.

(2) Communications should be addressed to *The Wireless World* Information Bureau, Dorset House, Tudor Street, E.C.4, and must be accompanied by a remittance of 5s. to cover the cost of the service. The enquirer's name and address should be written in block letters at the top of all communications.

(3) The fee of 5s. covers the reply to any wireless technical difficulty, but in special cases, where the enquiry may involve a considerable amount of investigation, an increased fee may be necessary. In such cases a special quotation will be made.

(4) Questions should be clearly written and concisely worded in order to avoid delay. Where enquiries relate to trouble experienced in receivers built to specifications in *The Wireless World* a complete account should be given of the trouble, and especially the symptoms.

(5) Where reference is made to published articles or descriptions of apparatus, the title of the article, the date of publication in *The Wireless World*, and the page reference number should be given, in order to facilitate reply.

(6) Full circuit diagrams, constructional details of apparatus, or values of components for home-designed receivers cannot normally be supplied, but circuit diagrams sent in with queries will be checked and criticised.

(7) Particular makes of components cannot, in general, be recommended, but advice will be given as to the suitability of an individual component for a particular purpose specified by the enquirer.

The Wireless World

AND
RADIO REVIEW
(21st Year of Publication)

No. 667.

WEDNESDAY, JUNE 8TH, 1932.

VOL. XXX. No. 23.

Editor : HUGH S. POCOCK.

Editorial Offices : 116-117, FLEET STREET, LONDON, E.C.4.

Editorial Telephone : City 9472 (5 lines).

Advertising and Publishing Offices : DORSET HOUSE, TUDOR STREET, LONDON, E.C.4.

Telephone : City 2846 (15 lines).

Telegrams : "Ethaworld, Fleet, London."

COVENTRY : Hertford St. BIRMINGHAM : Guildhall Bldgs., Navigation St.

MANCHESTER : 260, Deansgate. GLASGOW : 26B, Renfield Street, C.2.

Telegrams : "Cyclist, Coventry."
Telephone : 5210 Coventry.

Telegrams : "Autopress, Birmingham."
Telephone : 2970 Midland (3 lines).

Telegrams : "Diffe, Manchester."
Telephone : Blackfriars 4412 (4 lines).

Telegrams : "Diffe, Glasgow."
Telephone : Central 4957.

PUBLISHED WEEKLY.

ENTERED AS SECOND CLASS MATTER AT NEW YORK, N.Y.

Subscription Rates : Home, £1 1s. 8d. ; Canada, £1 1s. 8d. ; other countries abroad, £1 3s. 10d. per annum.

As many of the circuits and apparatus described in these pages are covered by patents, readers are advised, before making use of them, to satisfy themselves that they would not be infringing patents.

EDITORIAL COMMENT.

The Quality Controversy.

THERE appears to be no sign of abatement of interest in the subject of quality of reproduction and the extent to which the upper frequencies should be retained in transmission and reception in the aim to obtain a faithful representation of the original performance.

In this issue we publish important letters from Mr. P. W. Willans and from Mr. R. A. West, who was one of the original correspondents to cross swords with Mr. Hartley in connection with the demands made by him in his recent articles for retention of frequencies of a very high order in transmission and reception. Whatever else this correspondence may elucidate, it certainly serves to bring home to us the flexibility of the broadcast machine as a whole—the microphone, transmitter, receiver, and loud speaker—and indicates how easy it is by electrical methods to falsify the original performance in the process of transmission and reception.

Representatives of the B.B.C. at the recent discussion of the Institution of Electrical Engineers frankly admitted, in reply to a question put by Mr. Willans, that their transmitters erred on the side of giving a rising characteristic at the upper frequencies.

This flexibility of the broadcast machine renders it capable of peculiar effects. We wonder whether much of the bass response which formerly pleased listeners in the early days of moving-coil speakers was not a serious exaggeration of the original performance. Gramophone record reproduction was generally regarded as satisfactory, until Dr. McLachlan's "Novotone" indicated that substantial improvements were possible, and pick-ups were also designed to compensate for shortcomings of the record.

It has been suggested that, because of the flexibility which is possible with the transmitter, broadcasting

should put out transmissions with a frequency response other than straight-line. On this point we are disposed to consider that the proper attitude for the B.B.C. to adopt is to endeavour to give us the real thing with no boosting of any particular range of frequencies. It is for the designer of the receiver to see to it that his half dovetails with that of the transmitter. If once the frequency response of the transmitter is tampered with the task of the designer of a receiver becomes an impossible one, and the attainment of ideal reproduction will be farther off than ever.

Frequency Range—a Suggestion for the B.B.C.

ARTICLES and the large amount of correspondence recently appearing in *The Wireless World* on the subject of Quality and Frequency Range have prompted readers to revive the suggestion that the time has come when listeners require a means of checking the frequency response of their receivers at home, and the B.B.C., it is suggested, might transmit a series of pure notes of equal intensity at different points of the audio-frequency scale.

This should be a comparatively simple and yet most instructive experiment for the B.B.C. to carry out, and, in addition, if the engineering staff were to interest themselves in such a broadcast, it would be possible to transmit musical items demonstrating the importance of the upper frequencies and then repeat these items with varying degrees of "cut-off" so as to instruct the listener in the relative importance of reproduction of various bands in the audio-frequency spectrum.

We commend this suggestion to the B.B.C., and hope that they will find a means of conducting a transmission, or series of transmissions, of this nature.



The authors with their
5-metre equipment.

PRACTICAL 5-METRE WORKING

Amateur Transmission and Reception Tests.

By H. L. O'HEFFERNAN (G5BY) and S. G. MORGAN (G6SM).

MUCH interest has lately been evinced in the propagation and reception of ultra-short waves, which are generally taken to be those below 10 metres. It is not generally realised, however, that amateurs are permitted to work on a band of frequencies which extends from 56,070 to 59,930 kilocycles (5.35 to 5.005 metres), and the following account of the principles involved, the apparatus used, and the results obtained by the authors on this band since Christmas, 1931, is presented in the hope that it will encourage further investigation into the useful properties of these high frequencies. A great deal of progress has already been made by amateurs in the U.S.A. in this direction, and 5-metre networks are in operation all over the country.

It is more or less a matter of common knowledge that radio communication on short waves (i.e., below 100 metres) over distances in excess of about 100 miles is carried on by the refraction, or "bending back," towards the earth of a portion of the energy which is radiated skywards by a transmitter. This refraction is generally considered to be due to the ionisation of the upper atmosphere. The waves which are radiated horizontally from a transmitting station suffer rapid attenuation and absorption and soon fall below the strength necessary for consistent results. Waves, however, which are radiated

at angles slightly above the horizontal and up to a certain "critical" angle, are reflected earthwards; but those which impinge upon the lower surface of the ionised layer are either scattered in the upper atmosphere or else escape into space. The critical angle decreases as the wavelength is reduced, until we reach the vicinity of eight metres, when even the horizontal portion of the radiation strikes the ionised medium at an angle which is greater than the critical angle for that wavelength, and is therefore lost in outer space or dissipated in the upper regions of the atmosphere.

THE field open to amateur experimenters in the 5-metre region has attracted too little attention, despite the interest created in the "ultra-shorts" by recent commercial tests and those proposed by the B.B.C. In this article the authors give a first-hand account of tests with apparatus of their own construction, using a 5-metre transmitter on a car travelling at 50 m.p.h.

From this sketchy account of short-wave propagation it will readily be seen that signals of a wavelength lower than about eight metres are restricted, as far as is known at present, to what may be called a "visual" range—that is, signals will not be heard unless there is a comparatively clear air path between transmitter and receiver. This property, which has previously discouraged the use of

these wavelengths, now appears to be a highly desirable asset in view of the congestion of the other parts of the radio spectrum. For short-range working—up to a maximum of, say, twenty miles—these waves are an ideal medium because signals are confined within an area of roughly that radius, and cannot cause interference with similar services working on identical frequencies outside that distance.

Practical 5-Metre Working.—

Other advantages of the employment of a wavelength of the order of five metres are the simplicity of design and construction of the apparatus required and the small physical dimensions of the antenna systems used. This last factor is of great importance when contemplating the use of portable transmitters.

The generation and reception of these high frequencies is usually looked at askance by the average experimenter, but, as will be shown, these objects can easily be attained by the use of standard components and valves, provided that due regard is paid to what may seem minor details. The transmitter and receiver illustrated and described are those in use at G6SM, and similar gear is used at G5BY.

The Transmitter.

The type of transmitter that has been productive of the best results is illustrated below. The circuit diagram (Fig. 1) shows that a push-pull arrangement is used. This type of circuit offers many advantages, among which are the following:—

(i) The inter-electrode and associated capacities are in series across the grid and plate coils, and the attendant losses are therefore substantially less than those which would be occasioned by the use of one valve in a conventional oscillator.

(ii) The use of blocking condensers in the oscillatory circuits is obviated and consequent losses eliminated.

(iii) H.F. chokes, always a prevalent source of trouble, are almost unnecessary, those used as a matter of precaution being connected at points of minimum H.F. potential.

(iv) Symmetrical layout of the apparatus is greatly facilitated, and the simplicity of wiring and design are apparent from the photographs, the only wiring below the baseboard consisting of the filament and H.T. leads.

The valves used are two L.S.5s and, so far, they have shown no distress though being run sometimes for as long as eight hours continuously!

The grid leak is of the spaghetti type and runs from the H.F.



choke connected to the centre of the grid coil to the condenser spindle, and is located underneath the lead from the filament centre tap to the same point. Incidentally, it will be observed that the rotor bearings are not called upon to carry any current whatsoever. The

condenser is of the double stator type, each portion having the same capacity. Two separate condensers of identical design and ganged together could, if desired, be utilised instead.

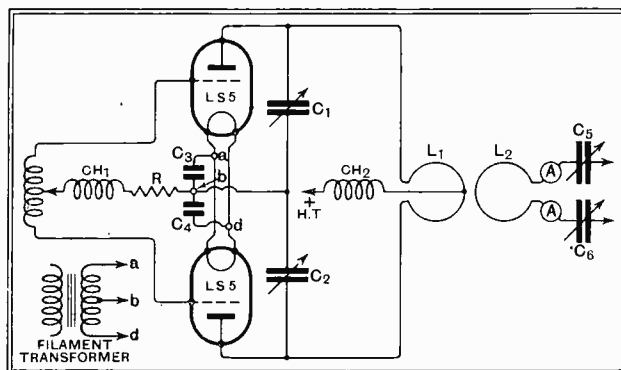

Fig. 1.—The push-pull transmitter circuit. $C_1, C_2 = 50$ micromicrofarads; $CH_1, CH_2 = 50$ turns of 32 D.S.C., $\frac{1}{2}$ in. dia.; $L_1, L_2 = 1$ turn 14 S.W.G., 5 in. dia.; $R = 10,000$ ohms; $C_5, C_6 = 250$ micromicrofarads.

The anode leads could, with advantage, be made a little shorter than those illustrated. The set was originally constructed for 40-metre work, but it works equally well on all the amateur bands.

The Antenna System.

From the preliminary remarks it will be seen that an antenna system is required which concentrates the majority of the radiated energy at a low angle to the surface of the earth. This condition is fulfilled by a vertical full-wave antenna of the dimensions and shape of Fig. 2 for working on 58 megacycles.

The current flowing in the two halves of the antenna must be in phase to secure the desired low angle radiation, and this end is attained by connecting a phasing coil in the middle. The feeder wires may be any odd

multiple of a quarter wavelength long (in this case one, three, five, etc., times approximately 4ft. 0.3in.). Both feeders must be of exactly the same length, and should preferably be as short and direct as possible without running too close to drain pipes, gutters, or other metallic objects.

This type of antenna has just been installed at G6SM, and experiments are at present in progress to determine its practical superiority over the other types which have hitherto been employed.

At G5BY (Croydon) a full-wave antenna, fed at the centre, with feeders one quarter wavelength long and rotatable about a horizontal axis, has been in constant

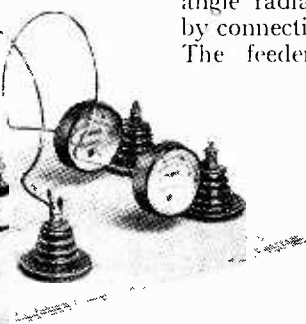

The transmitter, which employs a push-pull arrangement with LS5 valves. These have shown no sign of distress when run for eight hours continuously.

Practical 5-Metre Working.—

use, while at G6SM single and double wire matched impedance feed systems as used for 40-metre work have been excited on their harmonics. So far, the vertical arrangement of G5BY's antenna has proved the most successful, though it is anticipated that the system of Fig. 2 will yield far superior results.

The Receiver.

The receiver exclusively used has consisted of a

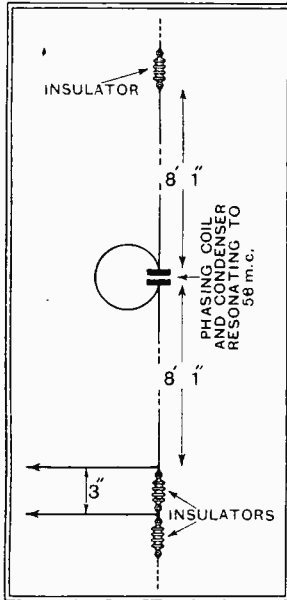

Fig. 2.—A suggested aerial arrangement for ultra-short waves.

receiver and worked on the super-heterodyne principle. It would be very easy to build a simple adaptor of this type for those who cared to do so.

The detector circuit (Fig. 3) seems rather unconventional. A study of the diagram will reveal that the tuning condenser is in series with the grid and plate coils across the grid to plate capacity of the valve. Its tuning effect is therefore very small, and ample separation of transmissions on adjacent frequencies is assured, although the capacity of the tuning condenser seems at first sight to be unduly large. All coils and wiring in the detector circuit should be made very rigid, as small changes in the various associated capacities will cause violent fluctuations in the reception of signals if the above precautions are not taken. The grid and anode leads must be as short as possible. The H.T. is fed via the H.F. choke to a point of fairly low H.F. potential on the anode coil so that the former component is a less important item than usual. Resistance control of regeneration is the only satisfactory method to adopt; other systems are usually prone to "floppy" reaction and bad tuning effects.

The voltage applied to the anode of the "quenching" valve will be found to be fairly critical. Almost

any type of low impedance valve is suitable for use in this position, and almost any type of low or medium impedance valve may be employed as a detector. It is advisable to mention at this point that it is essential to vary the number and dimensions of turns in the coils to suit the valve used, as these vary a great deal in their inter-electrode capacity. This is especially so in the case of valves such as the Mazda HL2 (to mention one that has been successfully tried), which has a metallised envelope. The valve used at the present time is a PM4DX.

Provided that it is not badly screened, there appears to be little advantage in using an aerial longer than eight feet for reception. For optimum range and results, however, it should be as high and as free from neighbouring obstacles as possible. On account of their small dimensions in comparison with the size of trees, buildings, poles, etc., these ultra-short waves suffer much absorption and scattering by such objects, and antennæ for both transmission and reception should therefore be placed as far away from them as possible.

Results.

Tests were first carried out with G5BY's transmitter and receiver. Inputs up to 45 watts have been used, but there seems little difference in results from the employment of from 10 watts upwards. Heising modulation was used, and sufficient modulation was available to modulate the carrier up to 100 per cent. if required. The full-wave current-fed antenna was utilised swung into a vertical position. The receiver was installed in a car with a roft. vertical antenna attached to a thin bamboo pole.

It was found that if the carrier wave was R3, using detector and low-frequency stage, the addition of the super-regenerative valve produced an R7 telephony

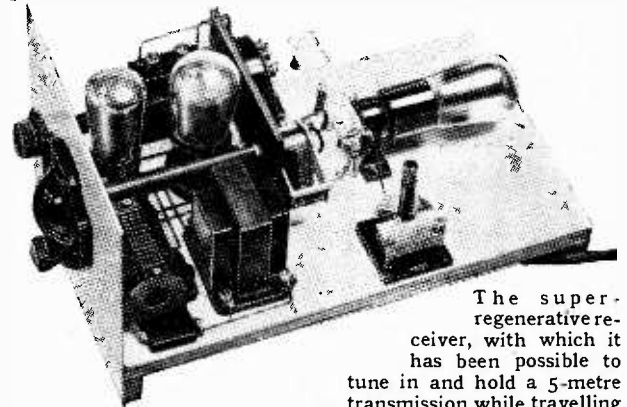

The super-regenerative receiver, with which it has been possible to tune in and hold a 5-metre transmission while travelling at speed in a car. A feature is the large amplification of telephony signals.

signal—giving some idea of the terrific gain obtainable when using this type of amplification. Definite screening by lamp standards and overhead tramway cables was soon observed, and signal strength varied enormously according to the amount of screening—hills, woods, and buildings, etc.—between the transmitter and receiver.

Practical 5-Metre Working.—

Moderately good telephony signals were received when six or seven miles distant from the transmitter and travelling at over fifty miles per hour—the engine being switched off and the car coasting, as otherwise the

and large-capacity condensers if desired. Up to three miles it was possible to obtain sufficient signal strength to overcome the interference caused by the ignition with the engine running.

The results mentioned were obtained with a horizontal 10ft. antenna strung between the front windscreen, and the back of the car. This yielded results superior to those obtained with the other vertical wire; besides exciting far less comment from surprised observers! Once when we were using this latter type of aerial, two small urchins enquired whether "guv'nor" was "fishin'," while one constable on point-duty waved us on as though he were under the impression that the Flying Squad was abroad!

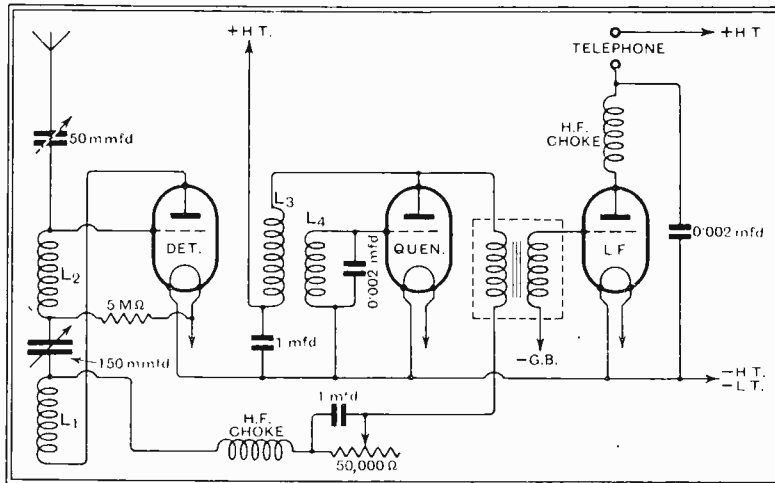

Fig. 3.—The unconventional detector circuit. H.F. chokes = 50 turns of 38 D.S.C., ½ in. dia.; L₁, L₂ = 8 turns 16 S.W.G., ½ in. dia.; L₃ = 1,500 turns of 38 D.S.C. on 1 in. core; L₄ = 800 turns of 38 D.S.C. on 1 in. core.

ignition system caused bad interference. Interference from the dynamo lighting was not so severe, and could be cured by the judicious placing of a few resistances

plane, so that a flight could be made to determine the maximum range which it is possible to obtain on this waveband.

Seven Years, and More.

"BY 1927 I had definitely come to the conclusion that mechanical methods such as that adopted by Baird and others were extremely limited, and I must confess that the results obtained by these methods greatly surpassed my expectations," remarked Mr. Robert W. Corkling in his lecture: "Seven Years' Experimental Research and Investigation of Television," given before the Television Society on May 11th. The lecturer exceeded the limits indicated by the title by giving a historical survey extending back to the year 1845. After a long and comprehensive review of the subject, Mr. Corkling declared that "we must all agree that television has not yet arrived," and indicated that he was devoting attention to the possibilities of eliminating a certain amount of mechanical detail by electro-chemical methods.

Hon. Secretaries: Mr. J. J. Denton, A.M.I.E.E., 25, Lisburne Road, Hampstead, London, N.W.3; Mr. W. G. W. Mitchell, B.Sc., "Lynton," Newbury, Berks.

From "Bread Board" to "Radio-gram."

THE layout of a wireless receiver is very often a source of perplexity to the amateur constructor, and many points which have to be taken into consideration were enumerated by Mr. E. H. Laister in a lecture before the last meeting of the North Middlesex Radio Society.

The lecturer briefly described the evolution of the domestic receiver of to-day from the "Bread Board" crystal set, and early valve sets studded with innumerable controls, to that modern article of furniture, the radio-gramophone.

Hon. Secretary: Mr. M. P. Young, 40, Park View, Wynchgate, N.21.

Conversion for Short Waves.

THE operation and general principles of the Elex Short-wave Converter were described by Mr. L. H. Fitzgibbon at a meeting of the Slough Radio Society on May 24th.

Hon. Secretary: Mr. G. H. Anderson, 58, Gloucester Avenue, Farnham Royal, Bucks.

CLUB NEWS.

Railway Radio Enthusiasts.

PAYMENT of subscriptions being the real criterion of the value of a club's membership toll, the Derby Railway Institute Radio Society can be said to occupy a satisfactory position, 36 of the members having paid their subscription.

The Society has spent a full and profitable season with lectures by leading personalities in the trade and amateur radio. During the session the Institute receiving set has been fitted with band-pass tuning and a new pentode.

Hon. Secretary: Mr. H. H. Dyer, Derby Railway Institute, L.M.S. Rly., Derby.

New Society's Progress.

THE many opportunities for distortion to occur while sound travels from the studio microphone to the loud speaker in the listener's home provided the theme for an admirable lecture given by Mr. J. C. Lee, G6JL, at a recent meeting of the Kettering Radio Society. Treating the subject in this novel manner, the lecturer was able to cover a wide field.

Other lecturers at the same meeting included "How It Works," by Mr. T. H. Hall, and "The Properties of the Selenium Cell," the latter (by Mr. Alan Hutchen) being accompanied by a demonstration using the cell as a burglar alarm, as a railway fog-signal control and automatic counter.

This new society is already flourishing, its membership nearing the hundred mark.

Hon. Sec.: Mr. R. Paukburst, 9, Shakespeare Road.

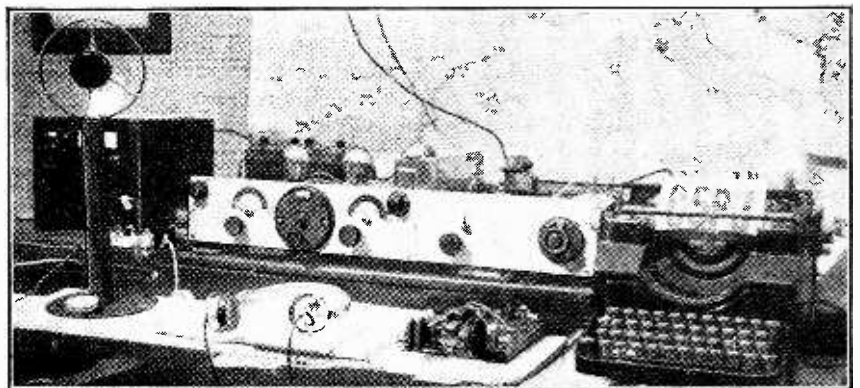

G5PJ is owned and operated by Mr. C. G. Phillips, at Northwood, Middlesex. The receiver is a standard battery-operated short-wave SG-V-1. To the left may be seen the monitor for listening to transmissions.

Lamp Resistances for D.C. Receivers

By F. E. HENDERSON, A.M.I.E.E.

(Technical Staff, The General Electric Co., Ltd.)

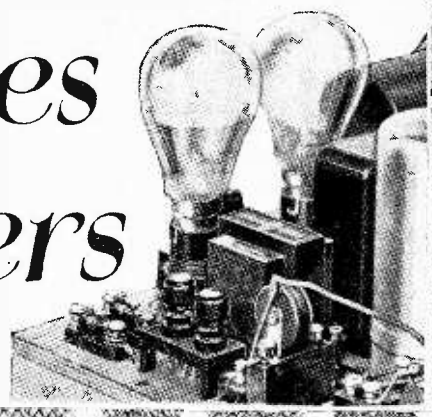

Some Advantages of the Metal Filament.

IN operating the new 0.25 amp. indirectly heated D.C. valves, the normal practice is for the filaments to be wired in series and the correct working current of 0.25 amp. obtained by insertion of a resistance of suitable value between the series filaments and the mains supply.

It is convenient and economical to use an ordinary electric lamp, as the whole or part of this external resistance and tests carried out on types of lamps suitable for this purpose have been conducted with interesting results. The indirectly heated D.C. valves used in the tests were the Osram 16 volt, 0.25 amp. series, and results of the tests refer to these valves.

In considering the use of lamps for voltage dropping resistances there are two distinct types of lamps from which to choose, namely, the carbon lamp and the metal filament lamp, and, as is well known, the temperature characteristics of these two types of lamp are entirely different. Fig. 1 shows the relation between change in resistance and current accompanying change in voltage across a carbon lamp. It will be seen that as the voltage rises the resistance gradually falls from a high value, while the current rises steeply. For a small percentage change in voltage there is quite a considerable change in current—a fact which is of importance, as will be seen later.

Temperature Characteristics of Metal and Carbon Lamps.

When we refer to Fig. 2, which is a graph showing a similar relation between change in resistance and current, with change in voltage across a metal filament lamp, marked differences between these two types of lamp are apparent, and it will be seen that in the metal lamp the rise in voltage causes an increase in resistance and, at the same time, the current change for

a given voltage change is much smaller than it was in the case of the carbon lamp.

Let us see how the use of one or other of these two types of lamps affects conditions when used in series with a set of valves for constant current working.

In the case of the carbon lamp there is a gradual rise in current as the lamp warms up. This effect, as has been previously described in *The Wireless World*, applies the heater current to the valves gradually, and is of advantage in this respect.

In the case of the metal filament lamp, there is an increase in voltage across the valves over the normal operating condition owing to the greater filament current during the period of heating, but when the current is steadied down to its correct figure of 0.25 amp. a very useful feature of the metal filament lamp comes into action.

Regulating Effect of the Metal Filament.

It will be seen, on comparing Figs. 1 and 2, that with the metal lamp in Fig. 2 there is comparatively small current change for a given voltage change, that is to say, ± 5 per cent. change in voltage indicates ± 3.6 per cent. change in current. On referring to Fig 1 for the carbon lamp, a similar change of 5 per cent. in volts indicates a

TABLE A.

Valve variation for $\pm 10\%$	With Carbon lamp.	With Tungsten lamp.
Voltage	+ 12.0% - 10.9%	+ 6.25% - 6.25%
Current	+ 12.4% - 12.0%	+ 7.2% - 7.2%
Wattage	+ 26.2% - 21.6%	+ 13.0% - 13.0%

Lamp Resistances for D.C. Receivers.—

change of ± 6 per cent. in current. In addition, the filaments of the particular valves used for the test have an opposite temperature characteristic to the metal lamp, and the use of this type of lamp, therefore, not only minimises the percentage current changes for fluctuating voltages, but actually tends to compensate for them, maintaining an extremely constant current of 0.25 amp. in spite of changes in mains voltage.

Fig. 3 shows clearly the effect of plus or minus 10 per cent. mains voltage variation.

From this graph we see that with the particular metal and carbon lamps used, each lamp passes exactly 0.25 ampere under the given conditions, and the voltage drop across each lamp at this current is 156 volts. This is because both the carbon and metal lamps were chosen to have the same wattage rating—other wattage lamps would, of course, produce different characteristics.

Under the set of conditions shown in Fig. 3 in which a receiver using four D.C. valves is assumed for the sake of argument, we shall then have the case of a voltage drop of $16 \times 4 = 64$ volts across the valves and of 156 volts across the lamp in series. Such a condition would apply with a mains voltage of $156 + 64 = 220$ volts (assuming no additional resistance) and can be taken to indicate a representative case.

As the current rises from zero we shall get an increase of voltage across the lamp up to 156 and across the four valves up to 64 until the steady state representing 0.25 ampere is reached.

In addition to the curve indicating change in current with voltage of the four valves in series, two further parallel curves can be added indicating a similar current change for a 10 per cent. rise and 10 per cent. fall respectively in mains voltage.

These parallels will cut the current voltage curves for the carbon and metal lamps at the points indicated, and it will be apparent that with the metal lamp a much smaller change in the current passing through the circuit occurs for a change of plus or minus 10 per cent. on the mean applied voltage, than would be the case if a carbon lamp were employed.

For the curves of Fig. 3 four 0.25 amp. D.C. valves were used in series with correct carbon and tungsten lamps. Under such conditions the mains fluctuation of ± 10 per cent. gives the variation shown in Table A in voltage, current and wattage of the valves.

The fact that the percentage variation in current is less than the percentage variation in voltage when using tungsten lamps compared with carbon is well known in the lighting industry, as it was one of the points in favour of the introduction of metal tungsten lamps in place of carbon lamps some years ago.

Switching Surges.

There is, of course, the point to be borne in mind that the use of the metal lamp imposes, as has been described, a surge in current during the period of heating on switching on. To investigate this point life tests have been conducted on a large number of valves of the Osram D.C. type under the most severe conditions, that is, with a small number of valves under conditions of repeated switching and with the filaments wired in series with a metal filament lamp from the high voltage mains supply. As these life tests have not shown any detrimental effects from the switching surges, it may be claimed that the use of the metal filament lamp in place of the carbon

lamp is satisfactory and offers a definite advantage in regulation to compensate for fluctuating mains supplies.

There is yet another point which is of importance,

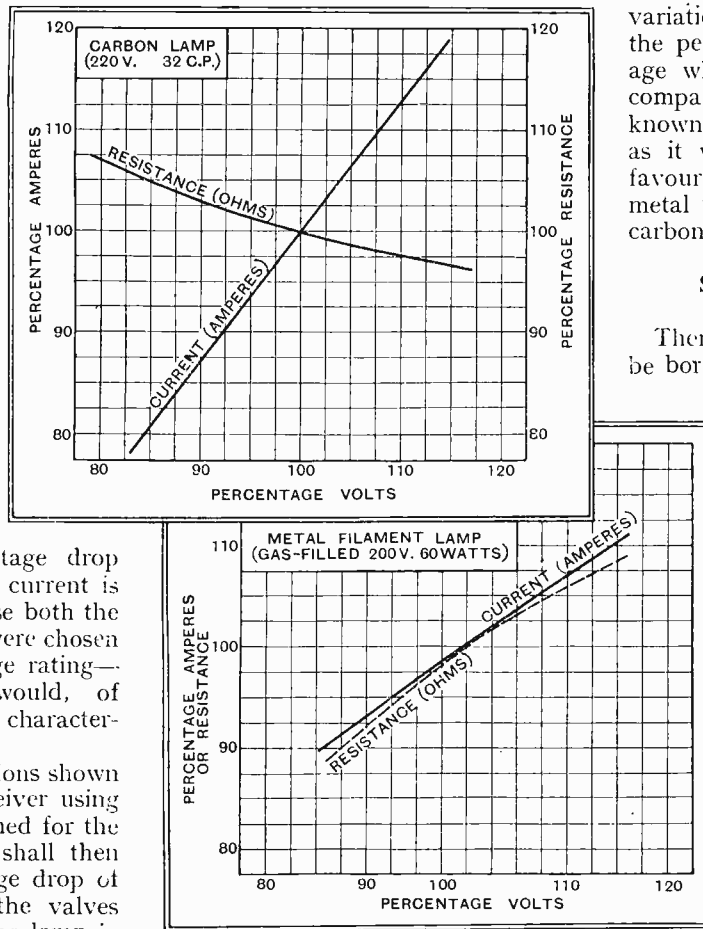

Fig. 1 (Top).—The relation between change in resistance and current when alteration in voltage is made across a carbon lamp.

Fig. 2 (Below).—Change in resistance and current in a gas-filled metal filament lamp. There is a considerable difference between this characteristic and that of Fig. 1.

TABLE B.

No. of valves (16 volt 0.25 amp.)	Typical lamp to be used—Osram Gas-filled.	
	Nominal Volts.	Nominal Watts.
1	220	60
2	210	60
3	200	60
	240	75
4	230	75
5	220	75
6	210	75
	250	100

Lamp Resistances for D.C. Receivers.—

and this is that with a metal lamp the heating time to enable the cathode to attain full electron emission is

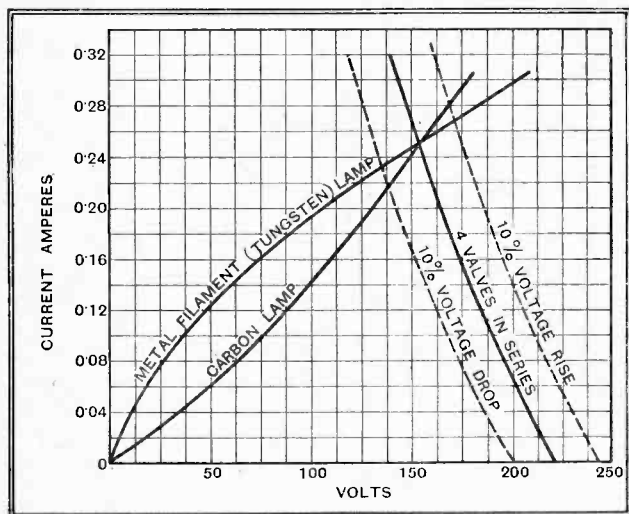

Fig. 3.—Curves showing the effect of plus or minus 10 per cent. mains voltage variation.

considerably less than if a carbon lamp were used. This may usually be considered an advantage, as it brings the set into operation in the minimum possible time after switching on.

Choice of Suitable Lamps.

In the particular type of D.C. valve under survey for these tests, the heater-cathode insulation is rated to withstand voltages up to 110 maximum which allows up to six such valves to be wired with filaments in series and cathodes virtually in parallel—a common practice in D.C. set design.

In order to give an indication as to suitable lamps, tests have been conducted on the basis of 200 volts D.C. supply, and Table B is given indicating suitable types of lamps to use with sets employing from one to six valves in series.

For supply voltages in excess of 200 a small subsidiary resistance of approximately 40 ohms for every 10 volts may be wired in series with the lamp.

It may also be borne in mind that all the lamps given in the above table are standard types of which replacements can easily be obtained.

NEW BOOKS.

The Outline of Wireless, by Ralph Stranger. Pp. 816+xvi, with 538 figures. George Newnes, Ltd., London, 1932. Price 8s. 6d. net.—The author, in his preface, frankly states that this book has been written for the benefit of "the busy man who has forgotten most of the stuff he learned at school and who cannot be bothered to remember his elementary science," and justly remarks that technical authors, as a rule, "do not write for those who do not know, but for those who do know already a good deal." This being the case, it is probable that the scientific expert would find much with which he may disagree, while the advanced mathematician will look in vain for pages written in his own peculiar symbolic language. Nevertheless, we think the book undoubtedly fulfils the purpose for which it was written

—to give the "man in the street" an outline of the elementary principles of wireless communication and of the general physical phenomena closely related to this subject. The writer, profiting by the experience gained when lecturing at L.C.C. technical evening institutes to men often tired after a hard day's work, illustrates his meaning by many homely analogies and colloquial interpolations which, though they may perhaps seem trivial to the serious scientific investigator, undoubtedly fulfil their purpose of arresting the attention of the tired or uninformed reader and of impressing facts upon his memory in an easy manner. Mr. Stranger starts with a brief account of the properties of matter and energy, including a very useful table of the main characteristics of the ninety-two chemical elements; the structure of the Atom and the functions of the electron; proceeding by easy stages through magnetism and electro-magnetism to wireless matters. If we must criticise from a technical point of view, we would suggest that the historical side is somewhat weak, as the work of Faraday is not mentioned. Maxwell is dismissed in one line, and no notice is taken of the pioneer work undertaken at Writtle in the early development of broadcasting in this country. Purists may also cavil at the almost exclusive use of "E.M.F." where "P.D." would seem more applicable. but, bearing in mind the avowed object of the book, we consider that it should certainly encourage the non-technical reader to take an intelligent interest in the science which affords so great a means of recreation for his leisure time.

W. H. M.

Wireless Receivers, the Principles of Their Design, by C. W. Outley, M.A., M.Sc. with a preface by O. W. Richardson, F.R.S. The fundamental principles involved in the design of wireless receivers (superheterodynes excepted), and with a useful bibliography giving references to articles on the subject which have appeared in *The Wireless Engineer*, *The Wireless World*, and other technical publications. Pp. 103+viii with 41 diagrams. Published by Methuen and Co., Ltd., London, price 2s. 6d. net.

"THE WIRELESS WORLD"**Information Bureau.****CONDITIONS OF THE SERVICE.**

(1) THE service is intended primarily for readers meeting with difficulties in the construction, adjustment, operation, or maintenance of wireless receivers described in *The Wireless World*, or those of commercial design which from time to time are reviewed in the pages of *The Wireless World*. Every endeavour will be made to deal with queries on all wireless matters, provided that they are of such a nature that they can be dealt with satisfactorily in a letter.

(2) Communications should be addressed to *The Wireless World* Information Bureau, Dorset House, Tudor Street, E.C.4, and must be accompanied by a remittance of 5s. to cover the cost of the service. The enquirer's name and address should be written in block letters at the top of all communications.

(3) The fee of 5s. covers the reply to any wireless technical difficulty, but in special cases, where the enquiry may involve a considerable amount of investigation, an increased fee may be necessary. In such cases a special quotation will be made.

(4) Questions should be clearly written and concisely worded in order to avoid delay. Where enquiries relate to trouble experienced in receivers built to specifications in *The Wireless World* a complete account should be given of the trouble, and especially the symptoms.

(5) Where reference is made to published articles or descriptions of apparatus, the title of the article, the date of publication in *The Wireless World*, and the page reference number should be given, in order to facilitate reply.

(6) Full circuit diagrams, constructional details of apparatus, or values of components for home-designed receivers cannot normally be supplied, but circuit diagrams sent in with queries will be checked and criticised.

(7) Particular makes of components cannot, in general, be recommended, but advice will be given as to the suitability of an individual component for a particular purpose specified by the enquirer.

UNBIASED

By
**FREE
GRID.**

had succeeded in getting, he declared that but for the foreign language he would have imagined he was still listening to the B.B.C. As a last resort he had come to me for help. My first thoughts were that his receiver was out of order, for he told me that he had had to return it to the manufacturers only once.

When I had accompanied him to his residence, however, and had handled the controls of the receiver, I speedily realised that somebody in the manufacturer's despatch department had blundered badly, the receiver being in absolutely first-class condition.

To cut a long story short, I spent Sunday with him, piloting him through the Continental ether; and, despite an unusual number of heterodynes, I succeeded in getting a good bag of programmes, comprising some of the world's finest music. But still his face preserved the same lachrymose and woebegone expression, and it was not until the evening was far spent and we struck a patch of unseemly hilarity—the sort the Montmartre Cafés used to indulge in a few years ago when the American tourist traffic was at its height—that his face began to lighten, and I realised what was wrong.

Apparently his idea of a Continental Sabbath was one of reckless abandon, and, after a careful cross-examination, he confessed, rather

shamefacedly, what he would expect to see if perambulating the streets of Paris on a fine Sunday morning. I could do little but advise him to pay a week-end visit to the Continent and to assure him that his set was working correctly. He still was disgruntled when I left him, however, and it occurs to me to wonder if the gaiety of Sunday programmes from abroad is not greatly overrated.

The gramophone concerts from Radio-Paris are all very well in their way, and are certainly a welcome diversion, but, frankly, if they were the only thing to be heard on the Continental ether on Sunday, I, for one, should never stray from the paths of righteousness as defined by the B.B.C. There are plenty of highly entertaining programmes, not of a high-brow character, to listen to from abroad, but listeners who buy a long-distance set in expectation of the gaiety which my friend anticipated are likely to be disappointed.

Can You Beat It?

I DO not suppose that anything could look more ridiculous than a notice posted up in a theatre by the management craving the indulgence of its patrons for any offence which might be caused to their susceptibilities by the Shakespearian epithets of the scene shifters, and yet a state of affairs fully as ludicrous as that exemplified in my homely analogy was revealed the other day by a notice exhibited in the radio department of a firm who appear otherwise to show no lack of keen business acumen.

I was passing through the department on my way to meet friends in another part of the building when I first saw the notice standing on the top of a radio-gramophone that was delivering the lunch-time restaurant music which, judging by the concomitant crackling and frying noises, emanated from a fish and chip establishment.

I give the notice herewith exactly as I copied it down: "PLEASE NOTE.—The crackling noises in this set are caused during the working of the store lifts."

How elevating!

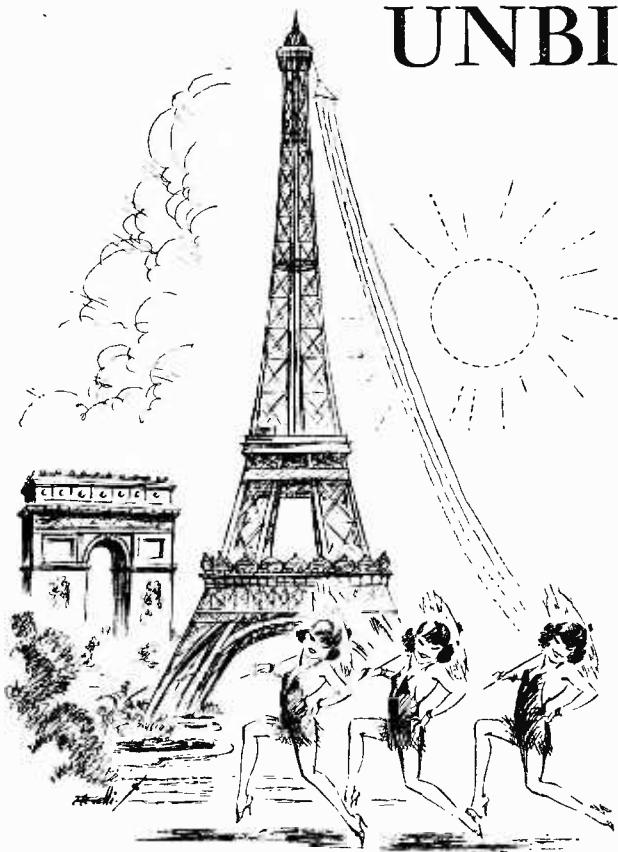

Sunday morning in Paris.

Those "Continental Sundays."

A MAN who alleged that he had been introduced to me at last year's local Flower Show called the other Sunday morning with an entirely new grievance. He had, so he said, spent a great deal of hard-earned cash in acquiring a long-distance receiver in order to escape from the B.B.C. into what he described as the joyous and care-free atmosphere of a Continental Sunday. Previously he had had a humble two-valve receiver, but, fired by the glowing picture painted by the Editor of the "Radio Corner" in his home-town newspaper of the joys that would be his if he reached across the Channel, he had spent more than he could afford in the pursuit of radio pleasure.

After struggling for a month, he had heard little but hoots and heterodynes; as for the few foreign programmes which he

NEWS of the WEEK.

Current Events in Brief Review.

Newspapers by Wireless.

THE wireless transmission of whole newspapers is brought a step nearer by the success of recent experiments carried out between Zurich and the Norddeutscher Lloyd express liner *Bremen* on its last voyage to New York. A system known as the "Radiotype" was employed to transmit pictures in the form of printing blocks, the method being described as "a combination of television and telephotography." Its sponsors are the Radiotype Company and the Debeg Radio Company of Berlin.

It is claimed that by means of the "Radiotype" it will soon be possible to transmit in the space of a few seconds over a great distance complete newspaper sheets ready to be printed. A short wave was used for the recent tests and complete success was attained in sending a poster of the Norddeutscher Lloyd express service over a distance of 2,500 miles.

Technical details of the invention are to be issued shortly.

Spain Talks to Europe.

EVERY Saturday, from 6 to 8 p.m. (G.M.T.), Spain broadcasts special programmes intended for all European countries. Transmissions are made from the Marconi station at Aranjuez (Madrid) on a wavelength of 30.4 metres. The directors, "Transradio Española," inform us that announcements are made in Spanish, English, and French, so short-wave listeners can be recommended to see what Spain has to say. It is understood that programmes are designed to give an idea of the artistic and intellectual life of Spain, and that for this purpose the finest artistes are being engaged.

A Notable Birthday.

THAT radio is no longer in its infancy is being borne out again and again these days by the occurrence of such happy anniversaries as that of Radio Instruments, Ltd. The company was founded in June, 1922. In a decade packed with activity there have been many notable high-lights. The firm began with the issue of the famous transformers, and a team of multi-valve receivers, including the seven-valve Console model with frame aerial, which was shown at the first Wireless Exhibition at the Horticultural Hall in 1922. The company's first multi-ratio transformer entered the market in 1926.

In ten years a family tree of radio sets has been built up, beginning with the Lyrian—the first table model receiver with loud speaker—in 1922, the Lyriante (portable) in 1924, the Interdyne, and the famous Madrigal range. The latest arrival is, of course, the R.I. Stenode.

Televising the Derby.

THE ideal of all television inventors—a public display on the cinema screen—was realised on Wednesday last at the Metropole, Victoria, London, where the Baird Company gave a television rendering of the Derby. Although the demonstration showed how much has still to be done before television has a definite entertainment value, a very large audience responded to the novelty of the occasion, obviously enjoying the spectacle of flying hoofs and surging crowds. The scene was portrayed on a screen divided into three "zones." Unfortunately these were unequally

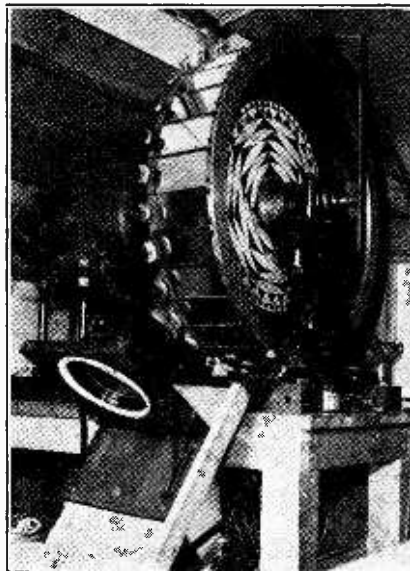

PUBLIC TELEVISION. One of the 30-mirror scanning drums used for the Baird television demonstration on Derby Day. The race was "witnessed" at the Metropole, Victoria.

illuminated, but they provided a sufficiently large area of view to give a recognisable picture. A certain amount of transverse flicker was noticeable.

The Eye in Television.

DR. W. D. WRIGHT, A.R.C.S., of the Physics Department, Imperial College of Science, will lecture on "The Eye: A Link in the Television Chain," at a meeting of the Television Society this evening (Wednesday) at 7 o'clock, at the University College, Gower Street, London, W.C.1.

The paper will deal with such features as persistence of vision, movements of the eye, contrast, colour, and distortion.

Eighteen Years in Amateur Radio.

MR. HIRAM PERCY MAXIM has been re-elected President of the American Radio Relay League for his nineteenth term, having held the position since he founded the League in 1914.

Ideas Famine in U.S. Radio.

LESS "ballyhoo" will be noticeable in the American radio trade during the 1932-1933 season, according to an observer in Washington. The radio dealers, who are victims of the prevailing depression, are now sober and cautious; they are suffering from a paucity of new designs, new wrinkles, and new gadgets in forthcoming models, a fact demonstrated by the tenor of the Chicago Show, which has just closed its doors.

Some idea of the depressed conditions prevailing in American radio may be gained from a study of the figures for the gross retail sales. The turnover of \$805,328,000 in the peak year of 1929 fell to \$500,591,000 in 1930 and \$309,270,000 in 1931. Oddly enough, the actual number of sales has been well maintained. In 1930 the total number of sets sold was 3,827,000, and in 1931 it was 3,420,000, but the financial gain was considerably less because fully half of the sets sold were of the midget type.

"Secret" Radio in U.S.

SECRECY has never been a strong point in radio, or at all events in amateur radio activities, but the American Radio Relay League has nevertheless revived the Royal Order of the Wolf Hong, which was originally organised in 1922 and numbered among its members many of America's leading amateurs. On May 21st last, new amateurs attending the Hudson Division Convention were inducted into the order by a number of mysterious rites "based on the traditional features of secret societies all over the world."

Heat-fed Radio Sets.

RADIO apparatus dispensing with external current or potential supply by providing a valve adapted to detect and amplify signals "merely under the influence of heat" has been invented by H. A. McIlvaine, of St. Charles, Ill., and patented at the U.S. Patent Office. McIlvaine was the patentee some years ago of a system of harnessing solar energy by the use of thermionic valves arranged on desert sands or other points where the sun's rays are most potent.

"The principle of generating the voltages for the B and C supply with tubes" says the inventor, "might some day be

applied also to generation of power from the sun; the deserts and mountain tops might be covered with giant tubes each having large amounts of electron evaporating from the sun's heat and light. These great beds of tubes would convert the sun's power into electricity, and this electricity could be stepped up with transformers and rectified with tubes; transmitted to our great cities as D.C.; changed to A.C. with thyratron tubes; stepped down with transformers and converted back into sunshine with large lamps of the mercury high-frequency type as covered in our patent."

Overcoming the Copyright Trouble.

MR. F. W. STRAW, a Colchester Marconiphone dealer, is to be congratulated on the way in which, at a recent demonstration, he avoided infringement of copyright. Instead of picking up the B.B.C. programmes, which would have constituted an illicit public performance of radio reception, he "tuned in" an imaginary broadcast programme from London consisting of gramophone records skilfully faded in and out at appropriate moments.

Radio Traffic Signals.

EVER since he stepped down from his Chair on the U.S. Federal Radio Commission, Mr. O. H. Caldwell has diffused original radio ideas with astonishing rapidity. His latest is concerned with the substitution of short-wave transmitters for the ordinary roadside signs

Voices Everywhere.
ACCORDING to a recent visitor to Leningrad, only in a very few parts of the city is it now possible to escape the sound of loud speakers. The task may be still more difficult in the near future, for no fewer than 32,000 loud

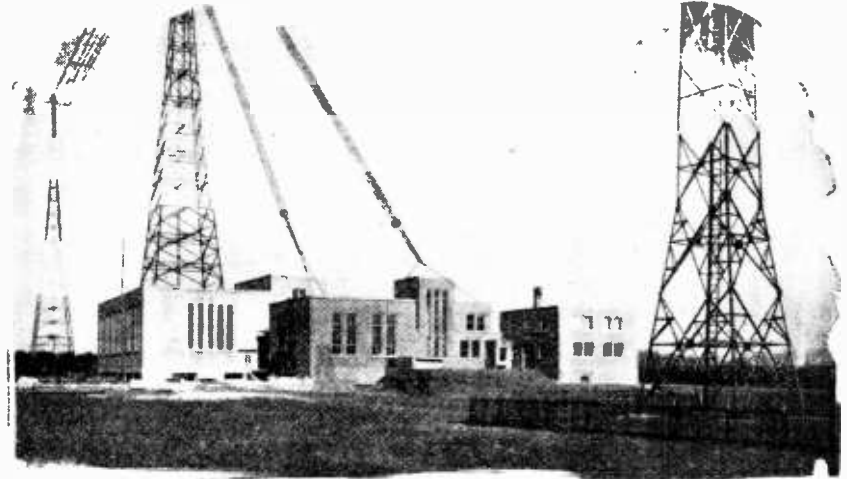

"RADIO-NATIONS." A glimpse of the station buildings and masts at Prangins, Switzerland. Already this official station of the League of Nations has played its part in international affairs, notably in the Sino-Japanese dispute. Steady communication has been maintained between Geneva and Shanghai and Tokyo.

speakers have been ordered by the authorities for installation in factories, workmen's clubs, and even in the streets.

Cathode Rays in Radio Research.
AMONG the new applications of the cathode ray tube demonstrated by the Slough Radio Research Station at the May soiree of the Royal Society was an automatic-release oscillograph for recording wave-forms of random transients.

The incidence of the transient was used to release a timing voltage which moved the spot horizontally across the screen in a controlled time-movement, thus delineating the wave-form of the transient, which could be photographed. The use of the oscillograph in visual direction-finding was also dealt with, while various photographic applications of the oscillograph were described and illustrated with cinema films. One film showed the reception at King's College of short-duration radio impulses sent out from the East London College. These records showed the reception of the ground ray with varying echoes, according to the number of times the signal pulse had travelled to and fro between earth and the upper layer.

Of special interest was the demonstration of a new circular time-base. In this case the spot was made to trace a circle from which the phenomena under observation caused radial deflections.

The oscillographs used in the demonstration were the new type of tube made by Messrs. A. C. Cossor, Ltd.

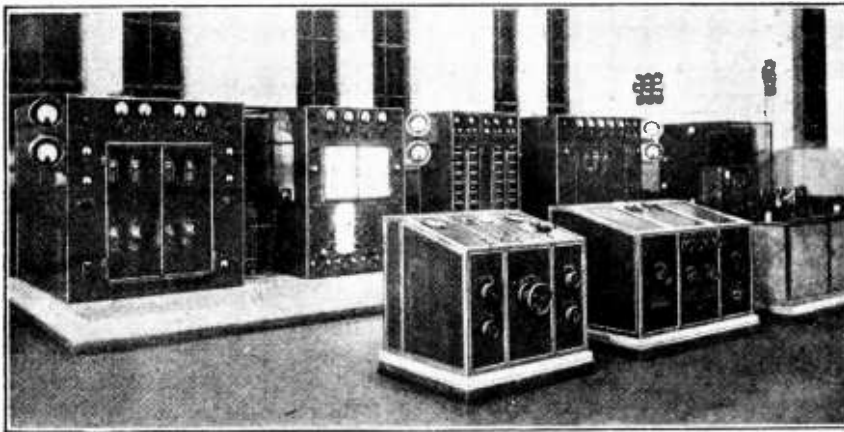

THE LEAGUE'S SHORT WAVES. The Marconi 20-kW. high-speed telegraph and telephone transmitter at Prangins. It is tuned permanently to four different wavelengths, any one of which can be instantly selected by switches.

for motorists. Assuming that in the future all motors will naturally be radio-equipped, he suggests that the car radio sets will be tuned to a fixed short wavelength used by permanent short-wave stations located at danger points on the route. These little stations would be operated by continuously played records; as a car passed through the zone of radio oscillations the driver would hear the warning, "Slow down, bad curve ahead"; or, "Speed limit, 20 miles an hour"; or any other messages the local authorities might want to deliver.

The "Monodial A.C. Super."

It is regretted that an unfortunate mis-statement has been allowed to appear with regard to the paper-dielectric condensers used in the "Monodial" receiver.

It should now be made quite clear that these components were all correctly described in the "List of Parts" which accompanied the published description, with the sole exception that the Dubilier L.S.B. condenser was stated to be of the "500-volt D.C. test" type; this should read "890-volt D.C. test."

Next, Please!

THE craze for miniature wireless sets of the matchbox or walnut-shell variety seems to recur at intervals. The latest claimant for honours in this direction is Mr. George Grammer, who, in the May issue of the American amateur magazine, "Q.S.T.," describes a "thoroughly workable" three-valve set occupying an aluminium box measuring 8½ x 6 x 6¾ in. Not only does it contain the receiver proper, but there is space for a three months' battery supply, headphones, plug-in coils and aerial and earth wires.

PRACTICAL HINTS AND TIPS.

AIDS TO BETTER RECEPTION.

ALTHOUGH a properly made earth connection to a main water-pipe is generally extremely effective from the point of view of receptive efficiency, it is now being realised that this form of connection,

as compared with a good buried earth-plate, is liable to increase the

Uncle Sam's Official "Earth."

general level of background noises due to electrical interference. This undesirable state of affairs is particularly likely to be noticed when the water-pipes also serve as a common earth return for other electrical circuits. For instance, the lighting or power supply, or even the telephone earth connection.

The ordinary small earth tube of commerce, though effective enough for ordinary needs, leaves a good deal to be desired, mainly because its area of contact with the ground is so small. Where extreme efficiency is desired, a connection to a large buried metal plate of several square feet in area is distinctly better, but the burying of such a plate is obviously an extremely laborious, and in some cases even an impracticable, task.

Those who think that their earth connections are susceptible to improvement may be interested in the details of an "official" American earth connection, for which a specification has been issued by the U.S. Bureau of Standards. The recommended procedure is to dig a hole one foot deep, and to place in it five pounds of rock salt. Water is poured in until the rock salt has dissolved, and then a metal tube or rod about one inch in diameter and eight feet long is driven into the ground through the centre of the hole, an electrical connection being made to its upper end. It is suggested that three or four of these earth connections may be joined in parallel in cases where the ground is abnormally dry. H. F. S.

IT is standard practice to obtain the necessary current for operating a thermal-delay H.T. switch from the H.T. transformer secondary which heats the filament of the rectifying valve. A consideration of

Delay-Action Switches.

Fig. 1 will show why this is done; the rectifier filament, and consequently its heating transformer, are at the same potential as the positive H.T. lead, in which the switch contact is inserted. Consequently, there is no appreciable risk of breakdown, in spite of the high voltages present. Even if a breakdown occurs its effects cannot be serious.

Occasionally, it happens that the rectifier L.T. winding of the power transformer is only just capable of supplying current for the valve; any additional load, such as that of the switch, would be responsible for a

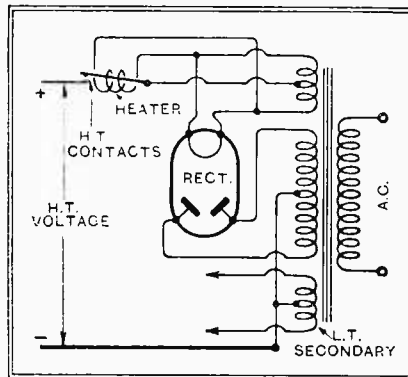

Fig. 1.—When a delay-action switch is connected in the usual manner, there is practically no risk of a breakdown of insulation between the heater and contact strip.

fall in voltage. In such cases there is a temptation to draw operating current for the switch from one of the other L.T. secondaries, which may well have a surplus output.

When the switch is in the positive H.T. lead, this procedure can hardly be advocated; as the diagram shows,

full H.T. voltage would then exist between the heater and the contact strip. True, a switch might withstand the application of such a high voltage under ideal conditions, but the margin of safety is not large, as clearances are small; and if moisture were present there might be a serious leakage.

If it is found essential to supply the switch current from any of the L.T. secondaries which feed the receiver valves, and not from the rectifier winding, it is better that the contacts should be inserted in the negative H.T. lead. H. F. S.

IN these days of variable-mu valves, the smoothing of the high-tension supply to the high-frequency stages need not be very thorough, since it is only by partial rectification that hum can be

The Last Traces of Hum.

superimposed on the carrier as modulation. The smoothing to the output valve also need not be very complete, because hum in the anode circuit of this valve receives no amplification before reaching the speaker.

We are therefore left with the conclusion that the detector valve requires a more completely smoothed anode-current supply than any other valve in the set. From this we may draw the very reasonable conclusion that if hum is due to the H.T. supply, the chances are that it is being caused by insufficient smoothing in the detector anode circuit.

Even now that power detection is becoming usual, detector valves do not eat up a very vast anode current, so that a choke to smooth the supply to such a valve may combine high inductance with quite reasonable bulk. If there is a low-frequency transformer of antique pattern stowed away in an odd corner of the junk-box, it may therefore be worth while to resurrect it and see if it will serve as a smoothing choke for the detector valve only. The primary was probably intended for an anode current of the order of that which it will be called upon to smooth, but if burnt out it may be that the secondary, though overloaded, will provide inductance enough to reduce the remaining hum to silence.

A. L. M. S.

PROGRAMMES FROM ABROAD



FRIDAY, JUNE 10th.

ALGIERS (363.3 metres); 13 kW.—7.15 p.m., Agricultural Report. 7.30, Songs from La Traviata (Verdi); Mireille (Gounod); Lohengrin (Wagner); Faust (Gounod); Cléopâtre (Massenet); Hamlet (Thomas). 7.55, News and Time. 8.0, Concert by the Station Orchestra; La Fête chez Thérèse (Hahn); Ballet Music from Ghismonda (Février); Serenade (Translatour); Ballet Music from Le Cid (Massenet); Pastorale d'été (Honegger); Norwegian Rhapsody No. 1 (Svendsen); Scènes Napolitaines (Massenet). 9.15, Recitations. 9.30, Dance Music from the Municipal Casino.

BARCELONA (Radio-Barcelona), Call EAUI (349 metres); 8 kW.—8.0 p.m., Trio Concert: Serenade, Amoroso (Doulvez); Selection from Die Walküre (Wagner); Minuet from Samson (Haudel). 8.30, Exchange Quotations, Request Gramophone Records, and Press Notes. 10.0, Chimes from the Cathedral, Weather Forecast, Exchange Quotations and Relay of Foreign Stations. 10.15, Concert by the Station Orchestra, followed by Programme of Modern Dance Music by the Demons Jazz Band. 11.0, Talk in Catalan by Adrian Gual. 11.30, Concert by the Vilalta Orchestra, relayed from the Café Espagnol. 1.0 a.m. (Saturday), Close Down.

BELGRADE (430.4 metres); 2.5 kW.—5.0 p.m., Orchestral Concert: Overture, La Dame Blanche (Boieldieu); Selection from Fedora (Giordano); Selection from The Little Dutch Girl (Kalman); Hofballtänze (Lanner). 6.55, Time and Programme Announcements. 7.0, Czech Lesson. 7.30, Recital of Yugoslavian Songs by Frau Boskovic-Agatonovic. 8.0, Sokol Talk. 8.30, Programme to be Announced. 10.30, News and Sports Notes. 10.50, Concert from the Imperial Hotel.

BERLIN (Königs Wusterhausen) (1,635 metres); 60 kW.—12 noon, Weather for Farmers. 12.2 p.m., Gramophone Concert of Variety Music, followed by Weather for Farmers. 12.55, Time Signal. 1.30, News Bulletin. 2.0, Gramophone Concert of Popular Music, relayed from Berlin (Witzleben). 3.0, Talk for Girls. 3.20, Weather and Exchange Quotations. 4.0, Educational Talk. 4.30, See Leipzig. 5.30, Talk: Risks run by Men of To-day. 6.0, Talk: The Middle Ages and the Unity of Western Civilization. 6.30, Talk on Economics. 6.55, Weather for Farmers. 7.0, See Berlin (Witzleben). 7.15, Talk for Dentists. 7.35, Talk for Workers, followed by Weather for Farmers. 8.0, Talk by Kurt G. Sell: What People are Talking About in America, relayed from America. 8.15, See Stuttgart. 9.15, See Berlin (Witzleben). 10.20, Weather, News, and Sports Notes. 10.30 (approx.), Dance Music from Berlin (Witzleben). 12.30 a.m. (Saturday), Close Down.

BERLIN (Witzleben) (419.5 metres); 1.5 kW.—5.50 p.m., Orchestral Concert from the Hotel Kaiserhof. 6.55, The Witzleben Station informs its Listeners. 7.0, Topical Talk. 7.10, Choral Concert: Nächtliches Ständchen (Nagler); Villanella alla napoletana (Donati-Hubmann); Folk Song, Der Tauber und die Täuberin (arr. Kirchl); Die Wetterpropheten (arr. Otto); Willkommen (Schotte); Spielmanns Ständchen (Mozart-Abert); Die Liebe gleicht dem April (Dürner). 7.30, Hints for the Week-end. 8.0, Talk by Kurt G. Sell: What People are Talking about in America, relayed from America. 8.15, See Breslau. 9.15, Concert conducted by Edwin Fischer; Soloist, Edwin Fischer (Pianoforte); Pianoforte Concerto in A (Bach); Concerto di chiesa in B flat (Felice dall'Abaco); Pianoforte Concerto in E flat (Mozart). 10.15, Hints for the Week-end. 10.20, Political Press Review, followed by Weather, News, and Sports Notes and Dance Music from the Eden Hotel. 12.30 a.m. (Saturday), Close Down.

BORDEAUX-LAFAYETTE (304 metres); 13 kW.—7.30 p.m., News Bulletin. 7.40, Educational Programme. 7.55, Lottery Results. 8.0, Advanced Spanish Lesson. 8.15, News Bulletin

and Weather Forecast. 8.30, Gala Concert organised by the Bordeaux Fair Committee. The Symphony Orchestra. Soloists: Mme. Saint-Val (Soprano), M. Raynal (Songs), and M. Barouk (Cello). Overture, Der Freischütz (Weber-Salabert); Concerto for Cello and Orchestra (Lalo); Symphony in C—the Jupiter (Mozart-Salabert); Symphonic Legend, La Forêt enchantée (d'Indy-Mouton); Bacchanale from Samson and Delilah (Saint-Saëns-Mouton). In the interval, Songs and Address by the President of the Bordeaux Fair Committee.

BRATISLAVA (279 metres); 14 kW.—7.0 p.m.—See Prague. 10.15, Programme Announcements and News. 10.20, Cigany Band.

BRNO (342 metres); 35 kW.—7.0 p.m., Popular Operatic Music. 8.0, See Prague. 10.15, News Bulletin. 10.20, See Prague.

BRESLAU (325 metres); 1.5 kW, and GLEIWITZ (253 metres).—4.30 p.m., Concert by a Bavarian Orchestra relayed from the Goldene Krone Cafe. 5.30, Weather for Farmers, and Book Review. 5.50, The Younger Generation—Prose by Willie Schäferdieck, with Introductory Talk and Commentary. 6.30, This will interest you—Surprise Programme. 6.50, Talk: Rock Gardens. 7.15, Weather for Farmers. 7.17, Concert of Popular Music on Gramophone Records. 7.55, Weather Forecast. 8.0, Talk by Kurt G. Sell: What People are talking about in America, relayed from America. 8.15, It must be a Waltz!—Concert by the Silesian Philharmonic Orchestra, conducted by Edmund Nick. Introductory Talk by the Conductor. 9.15, News Bulletin. 9.25, Extracts from The Maid of the Black Forest—Operetta in Three Acts (Jessel). 10.10, Time Signal, Weather Forecast, News Bulletin, Sports Notes and Programme Announcements. 10.30, Dance Music by the Station Orchestra, conducted by Franz Marszalek. In the interval at 11.10 (approx.), Weekly Sound News from the Deli Theatre. 12.0 Midnight (approx.), Close Down.

BRUSSELS (No. 1), I.N.R. (509 metres); 15 kW.—12 Noon, Light Music on Gramophone Records. In the interval at 12.30 p.m., Weather Report. 5.0, Orchestral Concert conducted by Charles Walpot: Paso doble, Melia (Calvette); Waltz, I love you (Waldteufel); Overture, The Nuremberg Doll (Adam); The Bells of St. Malo (Rimmer); The Phantom Brigade (Myddleton); Selection from Le Grand Mogol (Audran-Hubans); Waltz, Idylle Passionelle (Razigade); Potpourri, Hallo! Hallo! Hier Wien (Morena). 6.0, Gramophone Records; Hymne à la nuit (Rameau); Nocturne in E flat (Chopin); The Nightingale (Grétry). 6.15, Announcements. 6.30, Gramophone Records; Overture, Manfred (Schumann); Danse macabre (Saint-Saëns); Overture, 1812 (Tchaikovsky). 7.15, Announcements. 7.30, Music Review by Paul Gilson. 8.0, Orchestral Concert conducted by Jean Kumps; Soloist, Christiane Berlo (Songs); Overture, Phèdre (Massenet); Petite Suite (Debussy); Selection from Le Roi d'Ys (Lalo); Two Dances (Palla). 8.45, Talk by Albert Deveze. 9.0, Concert (continued); Ballet Music from Sylvia (Delibes); Songs; Minuet (Boccherini); Souvenir (Drlla); Tarantella (Filippucci); Songs; Viennese Waltz Suite (Gilson). 10.0, Le Journal Parlé. 10.10, Gramophone Concert; Waltz, The Wedding of the Winds (Hall); Tango (Cholla); Foxtrot, Sweet Summer Breeze (Vallee); Tango (Grothe); Foxtrot, You didn't

know the music (Coslow); Foxtrot, Sunshine and Shadows (Stamper); Foxtrot, Sweet Jennie Lee (Donabson); Foxtrot, Lazy Day (Postford); Foxtrot, Down by a Dutch Canal (Young); Tango, O Cara Mia (Brodszky); Foxtrot, Oh, Glory (Robin); Waltz (Strauss); Slow Foxtrot, I'd rather be a Beggar with you (King); Waltz from Gipsy Love (Lehár); Foxtrot, Roll on, Mississippi (West). 11.0 (approx.), Close Down.

BRUSSELS (No. 2), N.I.R. (338.2 metres); 15 kW.—Programme in Flemish. 12 Noon, Gramophone Concert. Selection from Miss Decima (Audran); Song of the Harz Canaries; Intermezzo and Waltz from Fedora (Giordano); Selection from A Waltz Dream (Oscar Straus). 12.30 p.m., Weather Report. 12.40, Concert (cont'd.); Selection from The Desert Song (Romberg); Ballet Music from Isoleine (Messenger). 1.0, Concert by the Station Trio. 5.0, Orchestral Concert conducted by Jean Kumps; Overture, The Barber of Bagdad (Cornelius); selection (Satte); Symphony in G (Haydn); Aria (Bach); Le Festin de l'Araignée (Roussel); Hungarian Dances (Brahms). 6.0, Gramophone Records of Popular Music. 6.15, Talk: The Van Eyck Brothers. 6.30, Gramophone Records; Suite from L'Arlesienne (Bizet); Overture, Tamulhäuser (Wagner). 7.15, Talk: The Cuckoo. 7.30, Radio Notes. 8.0, Orchestral Concert conducted by Franz André; March of the Diplomats (Souza); Overture, Orpheus in the Underworld (Offenbach); Pudding Potpourri (Morena); Popular Russian Songs; Romanian Dances (Borch); Sortie militaire (Faulx). 8.45, Programme on the Tenth Anniversary of the Flemish Tourist Society; Musical and Literary Selections. 9.30, Orchestral Selections. 10.0, Le Journal Parlé. 10.10, Concert by the Tea Room Orchestra; Overture, Morning, Noon, and Night (Suppé); Waltz, Ever or Never (Waldteufel); Symphonic Dances (Grieg); Foxtrot Fantasia, The Bird Fancier (Kochmann); Tango from Nina Rosa (Romberg); Selection from Véronique (Messenger); Waltz from Viennese Nights (Romberg); Rumba (Michaelov). 11.0 (approx.), Close Down.

BUCHAREST (394 metres); 12 kW.—4.0 p.m., Concert of Military Music. 5.0 p.m., News Bulletin and Time Signal. 5.10, Concert (cont'd.). 6.0, Talks on Philosophy and Religion. 6.40, Light Music on Gramophone Records. 7.0, Talk: The History of Music, with illustrations. 7.45, Choral Concert: César Franck. 8.45, News Bulletin.

BUDAPEST (550 metres); 18.5 kW.—Programme also relayed on 210 metres from 5.25 p.m. until close down. 5.25 p.m., Military Band Concert, conducted by Richard Francisay. 7.0, Stenography Lesson. 7.30, Topical Talk. 7.45, Concert by the Mándits Orchestra; Selection from Samson and Delilah (Saint-Saëns); The Legend of the Raven (Husza); Hortobágy (Stephanides); Auf der Wache (Dierig); By the Waters of Minnetonka (Liranco). 8.30, Gala Concert by the Szegedin Choral Society; The Legend of St. Elizabeth, Oratorio (Liszt). After the concert, Time Signal, Weather Forecast, and Concert by the Joska Racics Cigany Band.

COPENHAGEN (281 metres); 0.75 kW, and KALUNDBORG (1,153 metres); 7.5 kW.—12 Noon, Time and Chimes from the Town Hall. 12.2 p.m., String Ensemble Concert, conducted by A. Bendix from the Wivex Restaurant. 1.15, Educational Talk. 1.45-3.0, Interval. 3.0, Concert of Wind Instrument Music: March, El Capitan (Souza); Overture, Jean de Paris (Boieldieu); Largo from Xerxes (Handel); Selection from Carmen (Bizet); Selection from Tosca (Puccini); Waltz, Die Preiswerber (Fahrbach); March, Wein bleibt Wein; Readings; March from Fatimitza (Suppé); Waltz, The Blue Danube (Joh. Strauss); Torch Dance of the Brides of Kashtair from Feramors (Rubinstein); Selection from The Tales of Hoffmann (Offenbach); Der staar et Slot i Vesterled (Weyses); Dejlige Land (Danning); Coronation March from The Prophet (Meyerbeer). 5.0, Programme for Children. 5.40, Exchange and Fish Market Priests. 5.50, Talk by Franz Polke, Danish Burial Customs, followed by Song Recital by

Programmes from Abroad.—

Vilh. Michelsen. 6.20, German Lesson for Beginners. 6.50, Weather Forecast. 7.0, News Bulletin. 7.15, Time Signal. 7.30, Talk. 8.0, Chimes from the Town Hall. 8.2, Items by Per Knutzen. 8.10, Concert by the Schierbeck Vocal Trio. 8.30, William Fox: A Wall Street Tragedy (Johannes Becher). 9.15, Sonata in G Op. 96 for Pianoforte and Violin (Beethoven). 9.35, Reading. 10.0, News Bulletin. 10.15, Talk with Gramophone Illustrations: Spain in Dance and Song. 10.45, Dance Music from the Industri Restaurant. 12 Midnight (in the interval), Time and Chimes from the Town Hall. 12.30 a.m. (Saturday), Close Down.

DUBLIN, Call 2RN (413 metres); 1.2 kW, and **CORK (224.4 metres).—1.30-2.0 p.m.,** Time Signal, Weather Report, Stock Report, and Light Music on Gramophone Records. 6.0, Gramophone Records of Popular Music. 6.15, Programme for Children. 7.0, Gramophone Records of Variety Music. 7.20, News Bulletin. 7.30, Time Signal. 7.31, Talk on Gardening. 7.45, Talk: Bee-keeping. 8.0, Operatic Ballad Concert by the Station Sextet. May Busby (Soprano), H. Dunkerley (Baritone), and E. Hargreaves (Tenor). 9.0, Talk on Irish History. 9.30, Pianoforte Solos. 9.50, Variety Concert by Tony Reddin and Company. 10.30, Time Signal, News, Weather Report, and Close Down.

RECAMP (223 metres); 10 kW.—12 Noon, Gramophone Concert: Ca ne vait pas Paris (Ménichetti); Le Moulin de Maître Jean (Borel-Clerc); A Nogat (Mercier); Mon Coeur, attend (Cazaux); Prière Musicale (Ménichetti); Coquelicot (Borel-Clerc); Quand on aime on a toujours vingt ans (Moretti); Malgré moi (Harry Link). 12.30 p.m., First French News. 12.45, Concert: The Banner of Victory (v. Blon); Le Mistango (Bach, arranged Laverne); Tales from the Vienna Woods (Johann Strauss); Selection from Othello (Verdi); Au pays Limousin (Defrance); Tempo-Tempo (Dostal); The Flag of Liberty (Nowowiecki); A la Caserne (Bach, arranged Laverne); Gloire à Bueaud (Courtade). 2.0-7.30, Interval. 7.30, French Local News. 8.0, Second French News. 8.30, Listeners' Hour relayed from Le Havre. 9.30-11.0, Interval. 11.0, Hawaiian Band: Kiss me Goodnight, My Bluebird, Time Alone Will Tell, Somewhere in Old Wyoming. 11.15, Sentimental Songsters: Pianoforte Selection, Melodies of the Moment; Duets: (a) Put Your Loving Arms Around Me, (b) For the Sake of the Days Gone By; Pianoforte Selection, Popular Song Medley; Duets: (a) Kiss Me Again, (b) Goodnight, Sweetheart; Pianoforte Selection, Snatches of to-day's best tunes. 11.45, Banjo Quartet; Quartet: Darktoun Dandies; Two Solos: (a) Slick Fingers, (b) That Red-headed Frail; Quartet: Rumty-Tumty. 12 Midnight, Dance Music; Fox-trots: Always in All Ways, Elisabeth, Beyond the Blue Horizon; Waltz, You Will Remember Vienna; Fox-trots: You're Driving Me Crazy, I Bring a Love Song; Quick Step: Lady of Spain; Waltz: Balls, Picnics and Parties; Fox-trots: Happy Days, Me, It Always Starts to Rain; Waltz: Pagan Serenade; Fox-trots: Joey the Clown, Just One More Chance, Spring is Here, Kiss Me Goodnight. 12.57 a.m., IBC Goodnight Melody. 1.0 a.m. (Saturday), Close Down.

FRANKFURT (390 metres); 1.5 kW., and **CASSEL (246 metres).—12.0 Noon,** Concert by the Station Orchestra, conducted by Reinhold Merten. Part I: Unfamiliar Overtures. Les Deux Aveugles (Méhul). Rübzahl (Plotow). Graziella (Leococ). Part II: Unfamiliar Waltzes. Unsere Wiener Heeren (Ertl). Lippitzbacher Waltz (Koschat). Liebt er mich (Ertl). 12.50 p.m., News Bulletin and Weather Report. 1.0, See Langenberg. 2.0, News Bulletin. 2.10, Sponsored Concert. 3.0, Weather Report. 3.10, Time Signal and Agricultural Programme. 4.55, Economic Notes. 5.0, See Langenberg. 6.15, Economic Notes. 6.25, Programme in Celebration of the 90th Birthday of the Frankfurt Poet, Adolf Stoltze. Addresses by Adolf Stoltze and Paul Laven. Recitations by Lydia Lerner-Stoltze. 6.50, See Stuttgart. 7.15, Time Signal, Programme Announcements, Weather Forecast, and Economic Notes. 7.20, Talk: The 1932 Air Mail. 7.30-10.20, See Stuttgart. 10.20, Time Signal, Weather Forecast, News Bulletin, and Sports Notes. 10.45, Concert by the Station Orchestra, conducted by Walter Caspar. 12.0 Midnight (approx.), Close Down.

HAMBURG, Call HA (in Morse) (372 metres); 1.5 kW. Relayed by Bremen (270 metres); Flensburg (218 metres); Hanover (566 metres) and Kiel (232.2 metres).—6.0 p.m., Review of New Books about Goethe. 6.35 (from Kiel), Talk:

FRIDAY, JUNE 10th (cont.)

Social Insurance and the Protection of the Worker. 6.55, Exchange and Market Prices. 7.0, Topical Talk. 7.15, Weather Forecast. 7.20, Josef Marx and Gustav Mahler Song Recital. Thea Böhm-Linhard (Vocalist), Gerhard Maasz (Pianoforte), and Adolf Secker (Accompanist). Songs (Marx): (a) Regen, (b) Selige Nacht, (c) Lied eines Mädchens. Pianoforte Solo: Albumblatt (Marx). Songs (Marx): (a) Marienlied, (b) Japanisches Regenlied, (c) Venezianisches Wiegenlied. Pianoforte Solo: Impressionen (Paul Graener). Songs (Mahler): (a) Ich bin der Welt abhanden gekommen, (b) Ich ging mit Lust durch einen grünen Wald, (c) Wer hat dies Lied erdacht, (d) Aus... 8.0, See Berlin (Witzleben). 8.20, Goethe Concert. The Hamburg Philharmonic Orchestra, conducted by José Eibenschütz, the Norag Male Voice Choir, and Herbert Ernst Groh. A Faust Overture (Wagner). Eleucreigen from Faust, Part II, for Male Voice Choir and Baritone (Klose). A Faust Symphony (Liszt). 10.20 (from Hanover), Scherzo and Humoresque. Concert by the Humover Norag Orchestra, conducted by Otto Ebel von Sosen. Soloist: Willy Craney (Pianoforte). Humoresque (Levine). Humoresque (Vrenes). Scherzo in B flat minor for Pianoforte (Chopin). Allegretto grazioso quasi andantino (Brahms). Humoresque und Reigen (Regner). Pianoforte Solo: Eulenspiegelchen (Josef Haas). Scherzo, Sonnenkind und Wotekennan (Clemens). Humoresque (Sjögren).

HEILSBERG (276.5 metres); 60 kW., and **DANZIG (453.2 metres).—1.5 p.m.,** Orchestral Concert, conducted by Eugen Wilcken. March, Einzug der Hellebardiere (Blankenburg). Overture, Raymond (Thomas). Waltz from Gipsy Love (Lehar). Japanese Suite (Yoshitomo). Selection from William Tell (Rossini). Noch sind die Tage der Rosen (Baumgartner). An der Weser (Pressel). Waltz, Mon rêve (Waldteufel). Potpourri, Musikalische Neckereien (Warch). Weddigen Marsch (Büttner). 2.30, Advertising Notes with Gramophone Records. 3.30, Programme for Children. 4.0, Talk for Women. 4.30, Orchestral Concert, conducted by Eugen Wilcken. Overture, Jean de Paris (Boieldieu). Nocturne, Op. 19, No. 4 (Tchaikovsky). Valse lente (Chopin). Suite from A Midsummer Night's Dream (Mendelssohn). A Wedding Day on Troidhaugen (Grieg). Humoresque (Dvorak). Fantasia on the Works of Schumann (Schreiner). Hungarian Dances Nos. 1, 13, and 17 (Brahms). Military March (Schubert). 5.55, Book Review. 6.15, Agricultural Report. 6.25, Talk: Ninety Years of the Königsberg Gymnastics Society. 6.35, Talk: The Fight at Heilsberg 125 years ago. 6.55, Ernst Blasse recites his own Poems. 7.25, Trio in D minor, Op. 63 (Schumann). 7.50, Weather Report. 8.0, Talk by Kurt G. Sell: What People are talking about in America, relayed from America. 8.15, Concert of German Opera Music by Elsa Koch (Soprano), Alfred Bartolitsch (Tenor), and the Königsberg Opera House Orchestra, conducted by Werner Richter-Reichhelm. 9.15, See Berlin (Witzleben). 10.15, Weather, News, and Sports Notes.

HILVERSUM (296.1 metres); 20 kW (7 kW up to 4.40 p.m.).—6.25 to 9.40 a.m., Programme of the Workers' Radio Society (V.A.R.A.). 6.25 to 6.40 and 7.10 to 7.25, Gymnastics. 7.40, Gramophone Records of Variety Music. 8.40, Trio Concert. 9.40, Religious Programme by the Liberal Protestant Radio Society (V.P.R.O.). 9.55 to 11.40, V.A.R.A. Programme. 9.55, Recitations. 10.10, Trio Concert. 10.40, Talk for Women. 10.55, Concert (continued). 11.40 to 3.40 p.m., Programme of the Algemeene Vereeniging Radio Omroep (A.V.R.O.). 11.40, Orchestral Concert conducted by Nico Treep. Overture, Ten Maids and No Man (Suppé); Ballet Suite, Callirhoë (Chaminade); First Hungarian Rhapsody (Liszt). Gramophone Records of Variety Music. Selection from Lilac Time (Schubert-Berté). Waltz, La Hussarde (Ganne). Variations on: 's kommt ein Vogel geflogen (Ochs). Gramophone Records of Variety Music. March of the Dwarfs (Moszkovsky); Czardas (Monti); Marche solennelle (Tchaikovsky). 1.40, Talk for Schools. 2.10, Concert (continued). Limburg Folk Song (Altregio); Selection from Gasparone (Müllöcker); Waltz, Auge d'amour (Waldteufel); Hollywood March (Leopold). 2.40, Concert of Light Music relayed from the Hotel Atlanta, Rotterdam. 3.40 to 7.40, V.A.R.A. Programme. 3.40, Pianoforte Recital by Joh. Jong: The Moonlight Sonata (Beethoven); Waltz in A flat (Chopin). 4.10, Programme for Children. 4.40, Orchestral Concert conducted by Hugo de Groot.

Overture, Le cheval de bronze (Amber); Waltz from Polenblut (Nedbal); Selection from Manon (Massenet); Four Ballet Airs (Drigo). Gramophone Records of Variety Music. Waltz, Millionentanz (Fucik); Serenade (Widor); Caravane hindoue (Popy); Selection from Sylvia (Delibes). 6.25, Talk: Imperialism and the League of Nations. 6.45, Orchestral Concert (continued). 7.40 to 10.40, V.P.R.O. Programme. 7.40, Talk: Young People of To-day. 8.10, Symphony No. 1 in G Minor (Brahms) (on Gramophone Records). 8.40, Religious Address. 9.10, Quinet in B Minor (Brahms) (on Gramophone Records). 9.40, Religious Notes. 9.45, News Bulletin. 9.55, Recitations. 10.25, Gramophone Records of Variety Music. 10.40 to 11.40, V.A.R.A. Programme. Gramophone Records of Variety Music. 11.40 (approx.), Close Down.

HUIZEN (1,875 metres); 8.5 kW.—Programme of the Christian Radio Society (N.C.R.V.).—7.40 a.m., Bible Reading. 7.55 to 9.10, Gramophone Records of Variety Music. 10.10, Programme for Invalids. 10.40, Gramophone Records of Light Music. 11.40, Police Notes. 11.55, Concert. Overture, The Marriage of Figaro (Mozart); Song from The Marriage of Figaro (Mozart); Song from The Magic Flute (Mozart); Selection from Le Caid (Thomas); Selections (Mendelssohn); (a) Da liegt ich unter den Bäumen, (b) Wartend, (c) Spring Song, (d) Andes Maidenlied; Dem Andenken Beethovens (arr. Urbach); Zwei Königslieder (Reimann); Heidenröslein (Schubert); Das Zauberlied (Meyer-Hellmund); Le Credo du Paysan (Goublier); Selection from L'omnigetto (Verdi); Song from Simone Boccanegra (Verdi); Selection from The Mastersingers (Wagner). 1.40, Interval. 2.10, Gramophone Records of Variety Music. 2.40, Trio Concert. Trio Op. 1 No. 3 (Beethoven); Three Intermezzi Op. 116 No. 4, Op. 116 No. 6 and Op. 117 No. 3 (Brahms); Ilavnaise Op. 83 (Saint-Saëns); Three Preludes (Debussy); (a) Danseuses de Delphes, (b) Voiles, (c) Le vent dans la plaine; Poème Op. 25 (Chausson); Trio Op. 7 (Wolf-Ferrari). 4.40, Gramophone Records of Light Music. 5.10, Talk on Photography. 5.40, Talk. 6.10, Wireless Technical Talk. 6.40, Talk on Horticulture. 7.10, Police Notes. 7.25, Talk. 7.40, Musical Programme and Addresses relayed from the Educational Institute, Amsterdam. 9.40 (approx.), News. 9.50, Gramophone Records of Popular Music. 11.10 (approx.), Close Down.

KATOWICE (408 metres); 16 kW.—5.0 p.m., Concert by Professors of the Katowice Conservatoire of Music. 6.0, Talk by Casimir Simm. 6.20, Dance Music. 8.0, See Warsaw. 10.0, Dance Music. 11.0, Answers to Correspondents in French.

LAHTI (1,796 metres); 54 kW., and **HELSINKI (368.1 metres).—6.15 p.m.,** Programme for Children. 6.40, Pianoforte Recital relayed from Helsinki. 7.0, Talk. 7.25, Wind Instrument Quartet Selections relayed from Helsinki. 7.45, Recitations. 8.10, Orchestral Selections relayed from Helsinki. 8.45, News in Finnish and Swedish. 9.15, Military Music relayed from the Kappeli Restaurant. 10.0 (approx.), Close Down.

LANGENBERG (473 metres); 60 kW.—12 noon, Concert from Frankfurt. 12.50 p.m., Weather, News and Time Signal. 1.0, Concert conducted by Wolf. March from Sigurd Jorsalfar (Grieg); Overture, Tarandot (Lachner); Liebesliedwälder (Strauss); Selections from Das Nachtlager in Granada (Krentzer); Two Selections from the Suite Dresden China (Niemann); Russian Dance, Hopak (Moussorgsky); Festival Overture on the Theme U immer Treu und Redlichkeit (Hartung); Selections from Der Orlov (Granichstaedten). 2.30, Sponsored Gramophone Concert. 3.30, Economic Notes and Time Signal. 3.50, Programme for Children: Drawing and Painting. 4.10, Talk: The Feminist Movement. 4.20, Programme for Young People. 5.0, Concert by the Station Orchestra conducted by Kühn, and the Station Choir conducted by Zimmermann; Soloists, Heinz Jolles (Pianoforte) and Hans Wocke (Baritone); Pianoforte Concerto in E. No. 2 (d'Albert); Die Wallfahrt nach Kevelaer, for String Orchestra, Baritone and Harmonium (Friedland); Te Deum, for Mixed Choir and Orchestra (Wappenschmitt). 6.15, Review of New Books. 6.40, English Conversation. 7.0, Weather, Time, Economic and Sports Notes. 7.30, Talk on Employees' Insurance. 7.55, First General News. 8.0, Talk by Kurt G. Sell: What People are talking about in America, relayed from America. 8.20, From the Flute to the Kettle-drum, by Hans Ebert. 9.0, Concert of Chamber Music. 10.20, News, Sports and Miscellaneous Announcements. 10.40, Concert from a Café. 12 midnight (approx.), Close Down.

Programmes from Abroad.—

LEIPZIG (259 metres); 2 kW., and **DRESDEN (319 metres)—4.30 p.m.**, Concert by the Leipzig Symphony Orchestra conducted by Hilmar Weber: Ouverture zu einem ritterlichen Spiel (August Scharrer); Serenade for String Orchestra, op. 93 (Heinrich Hofmann); Entr'acte and Waltz from Intermezzo (Richard Strauss); New Slavonic Dances, Nos. 1 to 4, op. 72 (Dvorak). 5.30, Review of Books on Literatures of the World. 5.50, Economic Notes, Weather, and Time Signal. 6.0, Chinese Impressions (Max Tobby Scharara). 6.25, English Language Lesson. 6.50, Talk (to be announced). 7.0, Talk: Mozart's Marriage and the Fate of his Family. 7.30, Song Recital by Jessyka Koettrik (Contralto); Eugen Gottlieb-Hellmesberger at the Pianoforte, Scandinavian Folk Melodies: (a) The Rose in the Valley, (b) Cradle Song, (c) The Spring Breezes, (d) Shepherd Song from Hallingdal; Songs (Eugen Gottlieb): (a) Nun ist der letzte Tag erschienen, (b) An den Flieder, (c) Nocturne, Eva Waltz (Johann Strauss). 8.0, Talk by Kurt G. Sell: What People are talking about in America, relayed from America. 8.15, See Breslau. 9.15, Economic Notes. 9.25, The Clock—History, Literature, Interpretation, Report—a Radio Study (Josef Krahé). 10.25, News Bulletin. 10.35 (approx.), Concert by the Leipzig Symphony Orchestra conducted by Emil Loh: March, In Treue fest (Teiker); Isa Waltz from Der dumme August (Gfaller); Selections from l'Africaine (Meyerbeer); Siciliana in F, Op. 90, No. 3 (Schmalstich); Five O'clock Tea in the Dolls' House (Willy Rosen); Suite, The Flowers (Ludwig Siede); A B C Potpourri (Komzak); Waltz, Die letzten Tropfen (Kratzl). 12 midnight (approx.), Close Down.

LJUBLJANA (574.7 metres); 2.5 kW.—6.0 p.m., Quintet Concert. 7.0, French Lesson. 7.30, Talk for Women. 8.0, Talk for Sokols. 8.30, Programme from Belgrade. 10.30, Time and News.

LWOW (381 metres); 16 kW.—6.20 p.m., See Warsaw. 7.15, Miscellaneous Items and Racing Notes. 7.35, See Warsaw. 7.45, Talk by Marjusz Nowiwa. 8.0, See Warsaw. 10.0, Reading. 10.10, See Warsaw. 11.30 (approx.), Close down.

LYONS, La Doua (PTT) (465.8 metres); 1.5 kW.—7.0 p.m., Popular Music on Gramophone Records. 7.30, Radio Gazette for Lyons and the South-East. 7.45, Talk on the Occasion of Children's Week: School Hygiene. 7.52, Wireless Review. 8.0, Beauty Hints. 8.10, Pigeon Flying Report. 8.20, Tourist Review. 8.30, Concert organised by the Association Les Amis de la Doua, under the direction of Jean Witkovski; Soloists: Mme. Gaillard Farey (Violin), M. Dujols (Alto), J. Witkovski (Cello), M. Bridet (Oboe), and Mlle. Buisson (Pianoforte); Serenade for Violin, Viola and Cello (Beethoven); Audante for Oboe (Mozart); Sonata in F (Corelli); Romance for Oboe (Schumann); Sarabande, for Violin, Viola and Cello (Mannuel); Cor anglais, Solo from the third Act of Tristan and Isolde (Wagner); Romance sans paroles (Thurion); Two Popular Spanish Songs (Joquin Nin); Quartet for Pianoforte, Violin, Viola and Cello (Weber).

MADRID (Union Radio), Call EAJ7 (424.3 metres); 2 kW.—8.0 p.m., Chimes, Exchange Quotations, Market Prices, and Request Gramophone Records. 8.30 (in an interval), Educational Talk. 9.15, News Bulletin and Political Review. 9.30 to 10.30, Interval. 10.30, Chimes, Time Signal, and Political Review. 10.45, Symphony Concert on Gramophone Records: Overture: Fingal's Cave (Mendelssohn); Suite (Corelli); Persian Dances from Khovastelina. (Moussorgsky); Symphony No. 9 (Beethoven). 12.45 a.m. (Saturday), News Bulletin and Programme Announcements. 1.0, Chimes and Close down.

MORAVSKA-OSTRAVA (263.8 metres); 11 kW.—7.0 p.m., Brass Band Concert. 8.0, See Prague. 10.15, Programme Announcements and News Bulletin. 10.20, See Prague.

MOSCOW, Trades Union (1,304 metres); 100 kW.—6.30 p.m., Proletariat Radio Journal. 7.15, Programme for Young Communists. 8.0, Three Talks: (a) German—Answers to Correspondents, (b) Swedish—Soviet Foreign Politics, (c) French—Soviet Films.

MUNICH (533 metres); 1.5 kW. Relayd by Augsburg and Kaiserslautern (560 metres) and Nurnberg (239 metres)—4.5 p.m., Vocal and Instrumental Concert. Marianne Sondermann (Soprano), Theo Gutmann (Cello) and Mischa Rubasch (Pianoforte). Two songs for Soprano

FRIDAY, JUNE 10th (cont.)

and Pianoforte (Brahms): (a) Meine Liebe ist grün, (b) Dein blaues Auge. Two Soprano Solos, (Trunk): (a) Mir träumte von einem Königskind, (b) Unter Blüten. Sonata in D minor, Op. 36, for Cello and Pianoforte (Grieg). 4.40, Educational Talk. 5.50, Concert of Light Music, with Wireless Report in the interval, relayed from Furth. 6.15, Theatre Notes. 6.35, Talk: The Theatre in the Provinces. 6.55, Talk: Four Years as a Theatrical Agent. 7.15, Introductory Talk to the following transmission. 7.35, Ballo in Maschera (A Masked Ball), Opera in Five Acts (Verdi), relayed from the National Theatre. In the interval at 9.5, Announcements. 10.20, Time Signal, Weather Report, News Bulletin, Sports Notes and Traffic Report. 10.50, Talk by Kurt G. Sell: What People are Talking about in America, relayed from America.

OSLO (1,083 metres); 60 kW. Relayd by Fredrikstad (367.6 metres); Hamar (560 metres); Notodden (447.1 metres); Porsgrund (453.2 metres) and Rjukan (447.1 metres)—5.30 p.m., Popular Music on Gramophone Records. 6.0, French Lesson. 6.30, Norwegian Song Recital by Mme. Bertha Wang Halvorsen. 7.0, Weather Report and News Bulletin. 7.30, English Lesson. 8.0, Time Signal. 8.1, Dramatic Programme. 9.10, Talk: Wagner's Tristan and Isolde. 9.40, Weather Report and News Bulletin. 10.0, Topical Talk. 10.15, Talk: A Journey to Bremen. 10.45 (approx.), Close Down.

PALERMO Ente Italiano Audizioni Radiofoniche (542 metres); 3 kW.—5.30 p.m., Light Music and Dance Music. 6.30-8.0, Interval. 8.0, Announcements, Giornale dell' Enit, Agricultural Notes, Report of the Royal Geographical Society and Giornale radio. 8.20, Popular Music on Gramophone Records. In the interval at 8.30, Time and Announcements. 8.45, Orchestral Concert. Soloists: L. Landolfi (Pianoforte), S. Lojaccono (Violin). Naples, from Impressions d'Italie (Charpentier). Pianoforte Solos: (a) Gavotte in Rondo Form (Lully), (b) Sonata (Scarlatti), (c) Le tic-toc-toc (Copperin). Violin Solos: (a) Canzonetta (d'Ambrosio), (b) Andalusian Romance (Sarasate). Talk on Victor Hugo. Maskerade (Koringold). Pianoforte Solos (Martucci): (a) Romance, (b) Capriccio. Violin Solos: (a) Kaddisch (Ravel), (b) Gipsy Caprice (Kreisler), Baba-jaga (Liadov). After the Concert, Dance Music. 10.55 (approx.), Close Down.

PARIS (Eiffel Tower) Call FLE (1,445.7 metres); 13 kW.—Time Signals (on 2,650 metres) at 10.26 a.m. and 11.26 p.m. (preliminary and 6-dot signals). 6.45 p.m., Talk on the Theatre. 7.0, Le Journal parlé. 8.20, Weather Forecast. 8.30, Symphony Concert conducted by E. Flament, Suite of Six Pieces (Baeh-Woodhouse); Finale from the Quintet for Flute and Strings (E. Flament); Clarinet Solo: Canzonetta (Pierne); Selection from Ciboulette (Hahn-Salabert); Violin Solo; Selection from L'Amour masqué (Messager-Salabert). 9.30, Daniderff Concert. 10.0 (approx.), Close Down.

PARIS (Poste Parisien) (328.2 metres); 60 kW.—6.30 p.m., Sponsored Concert. 7.30, Light Music on Gramophone Records; News and Announcements. 8.0, Talk (to be announced). 8.30, Gramophone Records; Talk and Announcements. 8.45, Concert of French Songs by Music Hall Artists. 9.45, Dance Music on Gramophone Records. 10.45, News Bulletin. 10.50 (approx.), Close Down.

PARIS (Radio Paris), Call CFR (1,725 metres); 75 kW.—6.45 a.m., Physical Culture. 7.30, Weather and Physical Culture (continued). 7.45, Popular Gramophone Records. 8.0, News, Weather and Press Review. 12 noon, Jewish Address. 12.30 p.m., Woods and Forests; Gramophone Concert: The Coach in the Forest (Schaffer); The Mill in the Black Forest (Eilenberg); In the Virgin Forest (Alchansky); Morgenblätter (Johann Strauss); Sous bois (Staub); La Forêt qui chante (Charly); La voix des Chènes (Gaubert); The Forge in the Forest (Alchansky); Selection from L'Ataque du moulin (Bureau); In the Forest near the Lake: The Nightingale's Song (Zeller); Song of the Poplars (Doria); Sous la Feuillée (Thomé); Forest Murmurs from Siegfried (Wagner); Dans la Forêt normande (Evard); Waltz, Tales from the Vienna Woods (Johann Strauss); Selections from Lakmé (Delibes); The Hunter in the Forest; March of the Blacksmiths. In the intervals at 1.0, Exchange, News, and Weather; at 1.30, Exchange; and at 2.0, Exchange and Announcements. 3.45, Exchange and Market Prices. 6.30, Market Prices, Weather,

Agricultural Report, Talk, and Racing Results. 7.0, Talk on the French Colonies: Precious Stones of North Africa. 7.45, Commercial Prices and News. 8.0, Talk with Gramophone Illustrations, by M. Jacques Janin: Music and the Cinema. 8.30, News and Weather. 8.40, Gastronomic Review. 8.45, Poems in Prose (Baudelaire), with the collaboration of André Bacqué. In the interval at 9.15, Press Review and News.

PITTSBURGH (Westinghouse Electric) (KDKA) (306 metres); 25 kW.—9.0 p.m., Teaberry Baseball Scores. 9.5, Business News. 9.15, Rita Cavalieri (Soprano). 9.30, Pebeco Weather Report. 9.33, Market Reports. 9.45, Peabody High School a Capella Choir. 10.0, Teaberry Baseball Scores. 10.5, David Lawrence Dispatch. 10.10, KDKA Artist Bulletin. 10.12, Programme Announcements. 10.15, KDKA Kiddies' Klub. 10.30, The Singing Lady, from New York. 10.45, Little Orphan Annie, from New York. 11.0, Time Signal. 11.1, Temperature Report. 11.2, Who's News To-day. 11.7, Teaberry Sport Review. 11.12, Press News-Reeler. 11.15, KDKA Orchestra. 11.30, Royal Vagabond, from New York. 11.45, Literary Digest Topics, from New York. 11.59, Time Signal. 12 midnight to 3.30 a.m. (Saturday), New York Relay. 12 midnight, Popsodet Amos' n' Andy. 12.15, Esso Programme—Believe it or Not, by Ripley. 12.30, Stebbins Boys. 12.45, Billy Jones and Ernie Hare. 1.0, Nestlé's Programme. 1.30, Ivory Programme. 1.45, Sisters of the Skillet. 2.0, Friendship Town. 2.30, Amour Programme. 3.0, Whiteman's Pontiac Chieftains. 3.30, Love Songs and Waltzes. 3.45, Jean Wald's Orchestra. 4.0, Time Signal. 4.1, Teaberry Sport Review. 4.11, Temperature Report. 4.12, Weather Report. 4.15, Press and Last Minute News. 4.20, Lew Conrad and his Orchestra. 5.0, Cotton Club Orchestra, from New York. 5.15, Time Signal and Goodnight.

PRAGUE (488.6 metres); 120 kW.—5.45, Talk: The History of Religion in Bohemia. 5.55, Reading. 6.5, Agricultural Report and Market Prices. 6.15, Talk for Workers: Metallurgy. 6.25, German Transmission, News and Talks: (a) Important Inventions, (b) The Economic Crisis and the Future. 7.0, Relay of a Concert by the Czech Philharmonic Orchestra. 8.0, Cello Recital by Professor Ladislav Zelinka: Arpeggione Sonata (Schubert). 8.30, A Play (Lope de Vega). In the interval at 9.0, Time and News. 10.15, Miscellaneous Announcements. 10.20, Variety Music on Gramophone Records.

RADIO-SUISSE ROMANDE (SOTTENS) (403 metres); 25 kW.; **LAUSANNE (680 metres);** and **GENEVA (760 metres)—12.30 p.m.**, Time Signal from Neuchâtel Observatory. 12.31, Weather Report and News Bulletin. 12.40 (from Lausanne), Concert of Light Music on Gramophone Records. 1.0, Exchange Quotations. 1.5, Gramophone Concert (cont'd.). 1.45-5.0, Interval. 5.0, Time Signal from Neuchâtel Observatory. 5.1 (from Geneva), Programme for Women. 5.45, Concert by a String Orchestra, conducted by Robert Echenard. 7.0, Weather Forecast. 7.1 (from Lausanne), Sports Notes. 7.0 (from Lausanne), Report of the Swiss Automobile Club. 7.30 (from Geneva), Talk: The Work of the Disarmament Conference. 7.55, Announcements. 8.0 (from Lausanne), Recital of Italian Airs by Bruno Sarti (Tenor) and Ubaldo Russo (Baritone). 8.40, (from Geneva), La Journée des Cadeaux—Play in One Act (Blanchon). 9.20 (from Fribourg), Concert by the Landwehr Band, conducted by Gaimard. 10.0, Weather Forecast and News Bulletin. 10.15 (approx.), Close Down.

RIGA (525 metres); 15 kW.—6.0 p.m., French Lesson. 6.30, Latvian Lesson. 7.0, Weather Report. 7.5, Tchaikovsky Concert. Selection from Iolanthe. Songs, Suite. 8.0, News Bulletin. 8.20, Orchestral Concert. 9.0, Weather and News. 9.35, Variety Music. 10.30 (approx.), Close Down.

ROME, Call IRO (441 metres); 50 kW. Relayd by Naples (319 metres) and BR (25.4 metres)—8.15-8.30 a.m., Giornale Radio and Announcements. 12 Noon, Gramophone Records of Variety Music. 12.35 p.m., Weather Forecast. 12.45-2.0, Sextet Concert. Festival Overture (Keler-Bela); Musical Snuff Box (Nikolajevsky); Serenata Elena (Ruello); Intermezzo from Tieland (d'Albert); Bohemian Fantasia (Lattuada); Selection from The Blue Mazurka (Lehár); Bolero d'amore (Liga). In the intervals, Giornale Radio, Exchange, Time and Announcements. 4.45 (Naples), Talk for Women. 5.0, Exchange, Children's Radio Review. Giornale Radio and Announcements. 5.30,

Programmes from Abroad.—

Recital of Duets by Giuseppina Marciano (Soprano) and Clara Fioravanti Cinci (Mezzo-Soprano). Song (Schumann); Il ruscelletto (Benedetto Marcello); Cradle Song (Brahms); L'Eden (Falchi). 5.45, Instrumental Concert: Selection from Anima allegra (Vittadini). I promise you (Caster); Canzone d'amore (Leoncavallo). Selection (Mann). Selection from L'Arlesiana (Cilea). Com'è bella la vita (Bixio). 6.15, Giornale dell'Enit. 6.55 (Naples), Shipping and Sports Notes. 7.0, Agricultural Notes, Announcements, Giornale Radio and Press Review. 7.50, Gramophone Records of Variety Music. 8.0, Time, Announcements, and Report of the International Institute of Agriculture (in Italian, French, English, German, and Spanish). 8.30, Sports Notes and Announcements. 8.45, Police Band Concert, conducted by Andrea Marchesini. Selection from Le Maschere (Mascagni); Morning and Anitra's Dance, from Peer Gynt (Grieg); Selection from Tosca (Puccini). 9.30, A Comedy in One Act (de Croisset). 10.15, Concert (contd.): Selection from La Resurrezione di Cristo (Perosi); Polonaise (Chopin); Selection from the Second Act of Ero e Leandro (Mancinelli). Notes on Art. Rhapsody, Italia (Casella). 10.55, News Bulletin

SCHENECTADY (General Electric Company), (WGY) (379.5 metres); 50 kW. Relayed at intervals by **W2XAF** on (31.48 metres) and by **W2XAD** on (19.56 metres).—9.0 p.m., Decorating Notes from New York. 9.15, Ollie Yettru (Pianist). 9.30, Studio Ensemble. 9.50, News Items. 10.0, Stock Reports and Police Notes. 10.15, Skippy from New York. 10.30, The Success Doctor. 10.45, Chandu, the Magician. 11.0, Musical Programme. 11.24, Baseball Scores. 11.30, With Gray McClintock in the Canadian North-west. 11.45, Musical Programme. 12 Midnight (WGY only), General Electric Programme. 12 Midnight (W2XAF only), Stock Reports and News Items. 12.15 a.m. (Saturday), Weather Report. 12.16, New Kenmore Orchestra. 12.45, Trials of the Goldbergs, from New York. 1.0 (WGY only), Cities Service Concert, from New York. 1.0 (W2XAF only), International General Electric Programme. 1.30, WGY Farm Forum. 2.0, Cliquot Club Eskimos, from New York. 2.30, Pond's Programme from New York. 3.0, National Oration Society Programme, from New York. 4.0, Freddy Engel's Orchestra. 4.30, De Witt Clinton Orchestra. 5.0, Ralph Kirby (the Dream Singer), from New York. 5.5, Johnny Hamp's Orchestra, from New York. 5.30, New Kenmore Orchestra. 6.0 a.m. (approx.), Close Down.

SCHWEIZERISCHER LANDESENDER (BEROMÜNSTER) (459 metres); 60 kW.; BASLE (244.1 metres) and BERNE (246 metres).—12.20 p.m., Time Signal from Neuchâtel Observatory. 12.31, Weather Report and News Bulletin. 12.40, Concert by the Station Orchestra. 1.35, Weather Report and Exchange Quotations. 1.45-3.30, Interval. 3.30, Light Music on Gramophone Records. 4.30 (from Basle), Programme for Children. 5.0-6.30, Interval. 6.30 (from Basle), The Microphone—an Experimental Programme by Rudolf Kraege. 7.0, Time Signal, Weather Forecast, Automobile Report, Market Prices, and Sports Forecast. 7.30 (from Basle), Agricultural Talk. 8.0 (from Berne), Concert of Unfamiliar Works of Verdi, by the Station Orchestra and the Berne String Quartet; Soloists, André von Diehl (Bass) and Ernst Kappeler (Pianoforte). In the intervals, Talks on Verdi. 9.30, Weather Forecast and News Bulletin. 9.45, Cabaret Programme. 10.30 (approx.), Close Down.

STOCKHOLM, Call SASA (436 metres); 55 kW. Relayed by **Boden (1,229.5 metres); Göteborg (322 metres); Hörby (257 metres); Motala (1,348 metres); Östersund (770 metres) and Sundsvall (542 metres).—5.0 p.m.**, Light Music from **Sundsvall**. 5.45, Popular Music on Gramophone Records. 6.45, Recital of German Ballads of the Twelfth and Thirteenth Centuries by Erich Burger, with Harp accompaniment. 7.15, Weather Forecast and News Bulletin. 7.30, Talk on Photography. 8.0 (from **Sundsvall**), Military Band Concert conducted by Axel Eek. 9.0, Reading of Soldiers' Ballads. 9.30, 'Cello Recital by Roman Dukstulsky; Arioso (Bach); Après un rêve (Fauré); Pastorale (Couperin-Cassado); Minuet (Bocherini-Cassado); The Flight of the Bumble-bee (Rimsky-Korsakov). 9.45, Weather Report and News Bulletin. 10.0, Chamber Music Concert by the

FRIDAY, JUNE 10th (cont.)

Barkel Quartet; String Quartet in G, Op. 64, No. 4 (Haydn); String Quartet in F, Op. 18 (Stenhammar). 11.0 (approx.), Close Down.

STRASBOURG (345 metres); 11.5 kW.—11.30 a.m., Gramophone Concert of Classical and Light Music. 12.45 p.m., News in French and German. 1.0, Time Signal. 1.2, Gramophone Concert of Light Music. 2.0-3.0, Interval. 3.0, Concert relayed from Notre Dame, Paris, on the occasion of the Réfection des Grandes Orgues. 5.0, Literary Talk in French: Leconte de Lisle. 5.15, Orchestral Concert, conducted by Roskam: Colonial March, Vincennes (Wangermée); Valse des Blondes (Ganne); Madrigal (Van de Walle); Comedy Overture (Kéler-Béla); Selection (Wesly); Oriental Intermezzo, Tinkati (Neuds-Kalkmann); Selection from Die Puppenfee (Bayer); March, Regimentkind (Fucik). 6.0, Topical Talk in German. 6.15, Legal Talk in German. 6.30, Gramophone Concert: Rellets d'Allemagne (Fl. Schmitt); Villanelle (Dukas); Selection from Nina Rosa (Romberg); Adagio (Mirtovsky); Selection from Rosamunde (Schubert-Kreisler); Selections (Mayerl): (a) Mari-gold. (b) Robots; The Glow-worm Gavotte (Lincke); Czardas (Barthet); Le Cœur de Ninon (Becucci); Le Testament de Pierrot (Privas); Selections (Lehar) from (a) The Count of Luxembourg, (b) Gipsy Love; Selection (Gilbert); Sweet Jennie Lee (Donaldson). 7.30, Time Signal. 7.32, News in French and German. 7.45, Gramophone Concert: Song from Fortunio (Messenger); Intermezzo from L'Arlesienne (Bizet); Selection from La Basoche (Messenger); Moment Musical (Schubert); Mountaineer's Song (Joaquin Nin); Two Selections (Oberfeld-Ruyol); Sereade (Moszkovsky); Valse de Rêve (Locatelli); Küssen ist kein Sünd (Eysler). 8.30, Symphony Concert, conducted by Maurice de Villiers; Soloists: Mme. Biellmann (Soprano), M. Mourier (Baritone), M. Margulies (Tenor), and M. Halter (Pianoforte); The Coffee Cantata for Soprano, Baritone, and Tenor (Bach); Fantasia for Pianoforte, Choir and Orchestra (Beethoven); Third Symphony in D Minor (César Franck).

STUTTGART (Mühlacker) (360.5 metres); 60 kW.; and FREIBURG (570 metres).—10.0 a.m., Pianoforte Recital relayed from Mannheim: Pastorale and Capriccio (Searlatti); Sonata in D (Haydn); Variations on Schöne Minka (Weber); Ballade in G Minor (Chopin). 10.30 (from Freiburg), Talk for Schools. 11.0, Time Signal. Weather Report and News. 11.15, Sponsored Concert. 12 Noon, See Frankfurt. 12.50 p.m., Time Signal, Weather Report, News Bulletin, and Programme Announcements. 1.0, Concert from **Langenberg**. 1.55, News Bulletin. 2.0-2.15, Sponsored Musical Programme. 2.30, Advanced English Lesson. 5.0, Concert from **Langenberg**. 6.15, Time Signal, Weather Report, and Agricultural News. 6.25, Talk: It's the Same the Whole World Over—Reminiscences of a World Tour. 6.50 (from **Mannheim**), Medical Talk on Disinfection. 7.15, Time Signal, and Review of Coming Events in Esperanto. 7.30, Folk Songs of East Germany by Brunhilde Möckesch (Soprano) and Max v. Wistinghausen (Baritone). 8.0, Talk by Kurt Sell: What People are talking about in America, relayed from America. 8.15, Light Cavalry—Comic Opera (Suppé); 9.15, A Lesson in a School in 3,000 A.D.—Play (Schaaf); 10.20, Time Signal, Weather Report, News Bulletin, Programme Announcements, and Sports Notes. 10.45, See Frankfurt. 12 Midnight (approx.), Close Down.

TOULOUSE (Radiophonie du Midi) (385 metres); 8 kW.—5.0 p.m., Picture Transmission. 5.15, Exchange Quotations. 5.30, Hawaiian Guitar Solos. 5.45, First Suite from Peer Gynt (Grieg). 6.0, Orchestral Music. 6.15, Operatic Songs: Selections from The Prophet (Meyerbeer), Hérodiade (Massenet), Il Seraglio (Mozart), and The Magic Flute (Mozart). 6.30, Exchange and Racing Results. 7.0, Popular Concert. 7.20, News Bulletin. 7.45, Dance Music. 8.0, Selections by a Viennese Orchestra. 8.30, Sound Film Music. 8.45, Orchestral Selections: Marche Joyeuse (Chabrier); Wedding March (Lincke); Selection, Slavonic Dances (Dvorák). 9.0, Concert relayed from the Café des Américains. Light Music in the interval. 10.30, North African News. 10.45, Suite from L'Arlesienne (Bizet). 11.15, Popular Songs. 11.30, Symphony No. 7 for Orchestra (Beethoven). 12 Midnight, Weather Report and

Announcements. 12.5 a.m. (Saturday), English Concert. 12.30 (approx.), Close down.

TRIESTE (247.7 metres); 10 kW.—7.10 p.m., Quintet Concert: To Hamburg (Benatzky); Stenka Razin (arranged Goldmann); Invocazione (Senigaglia); Selection (Brodsky); In Campagna (De Micheli); E la Bimba Fuggi (Oneglia); Leggenda Marinara (Stocchetti); Bettina (Manoni). 8.0 till Close Down, See Turin.

TURIN (273.7 metres); 7 kW. Relayed by **Milan (331.5 metres), Genoa (312.8 metres), and Florence (500.8 metres).—6.45 p.m.**, Agricultural Notes and Report of the Royal Geographical Society; 7.5, Announcements. 7.10, Musical Selections: In a Persian Market (Ketelbey); Baci al Buio (De Micheli); Pattuglia Turca (Michaelis); Selection from The Girl in the Taxi (Gilbert). 7.30, Time, Announcements, and Gramophone Records of Variety Music. 8.0, Giornale Radio, Weather, and Gramophone Records of Variety Music. 8.55, Technical Talk. 9.0, Symphony Concert, conducted by Rito Selvaggi Talk in the interval. 11.0, Giornale Radio.

VATICAN CITY (Rome) (19.84 metres) (morning); and (50.26 metres) (evening); 10 kW.—11.0 to 11.15 a.m., Religious Information in German. 8.0 to 8.15 p.m., Religious Information in Italian.

VIENNA (517 metres), 15 kW. Relayed by **Graz (352.1 metres); Innsbruck (283 metres); Klagenfurt (453.2 metres); Linz (246 metres); and Salzburg (218 metres).—5.0 p.m.**, Concert by English Orchestras on Gramophone Records: The London Philharmonic Orchestra, conducted by Bruno Walter; Symphonic Poem, Don Juan (Richard Strauss); The Hallé Orchestra, conducted by Sir Hamilton Harty; Hungarian Dances, Nos. 5 and 6 (Brahms); London Symphony Orchestra, conducted by George Schneevogt; Norwegian Dance (Grieg); New Queen's Hall Orchestra, conducted by Sir Henry Wood; Danse macabre (Saint-Saëns); Bournemouth Orchestra: Overture, Zampa (Hérold); Regal Cinema Orchestra, conducted by E. Starkey; A Musical Jigsaw (Aston). 6.15, Report on Foreign Traffic. 6.30, Talk: The Joys of Camping with Collapsible Boats. 6.45, Sports Notes. 7.0, Talk by Paris Gütersloh. 7.30, Time Signal, Weather Forecast, and News Bulletin. 7.40, Pianoforte Recital by Viktor Ebenstein: Fantasia on two motives from Mozart's Marriage of Figaro (Liszt-Busoni); Polonaise-Fantasia (Chopin); Campanella (Liszt-Busoni). 8.10, Ludwig Fulda reads from his own Works, with introductory Talk by Ludwig Klünderberger. 8.40, Vienna on Holiday—Programme by the Otto Römisch Orchestra, Erika Heller (songs), the Mandl Quartet, Adalbert Vesely (Zither), and Rudolf Wallner (Pianoforte). 10.5, News Bulletin, Weather Forecast, and Announcements. 10.20, Dance Music by the David Mathé Orchestra, with Robert Etlinger and Wolfgang Ernst (Songs), relayed from the Hübner Kursalon.

WARSAW (1,411 metres); 120 kW.—11.58 a.m., Time Signal and Bugle Call from the Tower of St. Mary's Church, **Cracow**. 12.5 p.m., Programme Announcements. 12.10, Interval. 12.30, Press Review. 12.40, Weather Report. 12.45, Light Music on Gramophone Records. 2.0, Interval. 3.0, Economic Report. 3.10, Popular Music on Gramophone Records. 3.30, Report of the Polish Singers' Association. 3.35, Variety Music on Gramophone Records. 4.35, Hydrographic Report. 4.40, Talk. 5.0, Concert by the Academic Salon Orchestra, conducted by Karolini: March (Miller); Overture, The Caliph of Bagdad (Boieldieu); Angel's Prayer (Sawnow); Waltz, The Skaters (Waldteufel); Träumerei (Kratzer); Couiavienne (Karolini); Fox-trot (Pelc); Mazurka (Osmarsky); Oberek (Namyslowsky); Triumphant March (Karolini). 6.0, Talk, relayed from **Cracow (312.8 metres)**. 6.20, Dance Music relayed from **Lwow**. 7.15, Miscellaneous Items. 7.35, Radio Journal. 7.45, Foreign Agricultural Press Review relayed from **Wino (563 metres)**. 7.55, Programme Announcements. 8.0, Symphony Concert from the Studio. The Philharmonic Orchestra, conducted by E. Mlynarsky; soloist, Cas. Wikomirsky ('Cello); Overture (Moniuszko); Concerto for Cello and Orchestra (Maklakiewicz); Symphony No. 2 in D (Brahms). 8.55, Talk on Palestine. 9.50, Radio Journal. 9.55, Aviation Weather Report. 10.0, Dance Music. 10.40, Sports Notes. 10.50, Dance Music.

Programmes from Abroad.—

ALGIERS (363.3 metres); 13 kW.—7.15 p.m., Instrumental Concert. 7.55, News and Time Signal. 8.0, Concert (continued). 8.30, Request Gramophone Records.

BARCELONA (Radio-Barcelona), Call EAJI (349 metres); 8 kW.—7.0, Programme for Children, followed by Trio Concert and Picture Transmission. 8.30, Exchange Quotations, Request Gramophone Records, and News Bulletin. 10.0, Chimes from the Cathedral, Weather and Exchange Quotations. 10.5, Gramophone Concert of specially selected records. 11.0, Orchestral Concert of Music by Juan Manen, relayed from the Orfeó Gracienc Concert Hall. 1.0 a.m. (Sunday), Close Down.

BELGRADE (430.4 metres); 2.5 kW.—4.0 p.m., Request Concert of Variety Music on Gramophone Records. 5.0, Saxophone Recital. 5.30, Recital of Yugoslavian Songs by Herr Rasa Radenkovic. 6.55, Time and Programme Announcements. 7.0, Radio Talk. 7.30, The Second Trio, Op. 72, for Pianoforte, Violin, and Cello (Godard). 8.10, Talk on the following transmission. 8.20, Die Wahrsagerin (The Soothsayer), Operetta (Jenko). 10.20 (approx.), News and Cigány Music from the Rudnicanin Restaurant.

BERLIN (Königs Wusterhausen) (1,635 metres); 60 kW.—12 Noon, Weather for Farmers. 12.2 p.m., Gramophone Concert of Chamber Music, followed by Weather for Farmers. 12.55 p.m., Time Signal. 1.30, News Bulletin. 2.0, Gramophone Concert of Dance Music, relayed from Berlin (Witzleben). 3.0, Talk: The Graf Zepelin. 3.30, Weather and Exchange. 3.45, Talk for Women. 4.0, Talk. 4.30, See Hamburg. 5.30, Health Talk. 5.50, Talk: Prospects in Pomerania. 6.5, Weekly Music Review. 6.30, Legal Talk. 6.55, Weather for Farmers. 7.0, Elementary English Lesson. 7.30, The Quiet Hour, followed by Weather for Farmers. 8.0, See Vienna. 10.0, News and Dance Music from Berlin (Witzleben). 12.30 a.m. (Sunday), Close Down.

BERLIN (Witzleben) (419.5 metres); 1.5 kW.—4.5 p.m., Orchestral Concert from the Blüthner Hall, Magdeburg. Overture, Das goldene Kreuz (Brüll). Selection (Massenet). Homage March from Sigurd Jorsalfar (Grieg). Selections from Peer Gynt (Grieg): (a) Morning, (b) Anitra's Dance. Torch Dance of the Brides of Kashmir (Rubinstein). Selection from Le Postillon de Longjumeau (Adam). Waltz, Das Leben ein Tanz (Joh. Strauss). Overture, Morning, Noon and Night (Suppé). Viennese Folk Music (Kozzak). Johann Strauss Operetta Potpourri (Schlögel). Kaiserwalzer (Joh. Strauss). 6.0, The Narrative of the Week. 6.25, Song Recital by Maria Hussa (Soprano). Songs (Mozart): (a) Als Luise die Briefe ihres ungetreuen Liebhabers verbrannte, (b) Der Zauberer, (c) Die Verschweigung. Songs (Weber): (a) Heimlicher Liebe Pein, (b) Die gefangenen Sänger, (c). Die freien Sänger. Songs (R. Strauss): (a) Sie wissen's nicht, (b) Einkeller, (c) Cécilie. 6.50, Labour Market Report. 6.55, The Witzleben Station informs its Listeners. . . . 7.0, Topical Talk. 7.10, Health Talk. 7.35, Talk on Furniture. 7.45, Anthos reads from his own Works. 8.0, See Vienna. 10.0, Weather, News, and Sports Notes. 10.15 (approx.), Dance Music from the Summer Festival of the Association for Germans Abroad, in the Südende Park Restaurant. 12.30 a.m. (Sunday), Close Down.

BORDEAUX-LAFAYETTE (304 metres); 13 kW.—6.30 p.m., Radio Journal. 8.0, News, Exchange Quotations, and Lottery Results. 8.5, Sports Notes. 8.10, English Lesson. 8.25, News Bulletin and Weather Report. 8.30, Concert of Popular Music on Gramophone Records. 9.0, Two One Act Comedies: (a) Le Chevalier Canepin (Duvernois), (b) Burglary (Delamare).
BRATISLAVA (279 metres); 14 kW.—7.0 p.m., See Prague. 10.15, Programme Announcements. 10.20, See Moravská-Ostrava.

BRNO (342 metres); 35 kW.—7.0, See Prague. 10.15, News Bulletin. 10.20, See Moravská-Ostrava.

BRESLAU (325 metres); 1.5 kW., and **GLEIWITZ (253 metres);**—4.0 p.m., Concert of Light Music by the Station Orchestra, conducted by Franz Marszalek. 5.0, Carl Lange reads from his own works. 5.35, Talk: Is the Film Censor a Hindrance to the Production of Artistic Films? 6.0, Musical Programme by Joseph Witkovsky. 6.25, Talk: Silesia's Most Beautiful Parks. 6.50, Weather for Farmers. 6.55, Concert of Light Music by the Station Orchestra, conducted by Franz Marszalek; Waltz, Fesche Geister (Eduard Strauss); Country Dance (Chab-

SATURDAY, JUNE 11th.

rier); Fantasia, Dream Pictures (Lumbye); Selection from Die drei Wünsche (Ziehrer); March, Frohsinn (Hauschild). 7.35, Weather Forecast. 7.37, This will interest you! Surprise Programme. 8.0, See Vienna. 10.0, Time Signal, Weather Forecast, News Bulletin, Sports Notes, and Programme Announcements. 10.30, Dance Music from Vienna. 12.0 midnight (approx.), Close Down.

BRUSSELS (No. 1), I.N.R. (509 metres); 15 kW.—5.0 a.m., and at hourly intervals throughout the day: Pigeon Flying Report. 12 noon, Concert by the Max Alexys Orchestra. In the interval at 12.30 p.m., Weather Report. 5.0, Dance Music from the St. Sauveur Palais de Danse. 6.15, Talk: Occupational Diseases of Coal-Miners. 6.30, Gramophone Records: Offenbach Potpourri (Urbach); Marche des Camélias (Volant); Milonga . . . Porque lloras? (Cadicamo); Melodious Memories (Finck); Goodnight, Sweetheart (Noble); Ne coupe pas Mademoiselle (André-Sah); Grieg Potpourri (Urbach); Selection from Le Pré-aux-Clères (Hérod); March on Themes from Les Huguenots (Meyerbeer). 7.15, Talk: The Economic Situation in Europe.—The Oslo Convention. 7.30, Literary Review. 8.0, Chamber Music by the Cécilia Trio: MM. Bouquet (Violin), Turc (Cello), and A. Dufour (Pianoforte); Trio in G, No. 5 (Mozart); Trio in D Minor (Arensky). 8.45, Talk: Georges Marlow—A Belgian Author, with Readings from his Works. 9.0, Gramophone Records: Selections from Frederica (Lehar). 9.5, La Folle Journée—One Act Comedy (Mazaud). 9.45, Gramophone Records: Selection from La Chanson de Fortunio (Offenbach); Le Temps des Lilas (Chausson); La Maison grise (Messager); L'eau qui court (Georges). 10.0, Le Journal Parlé. 10.10, Concert by the Max Alexys Orchestra, relayed from the Ancienne Belgique. 11.0 (approx.), Close Down.

BRUSSELS (No. 2), N.I.R. (338.2 metres); 15 kW.—Programme in Flemish.—5.0 a.m., and at hourly intervals throughout the day, Pigeon Flying Report. 12.0 noon, Concert by the Tea Room Orchestra. In the interval at 12.30 p.m., Weather Report. 1.0, Gramophone Concert of Popular Music. 5.0, Orchestral Concert conducted by Franz André; March, Metropol (Lincke); Overture, Pique Dame (Suppé); Waltz, Potpourri (Fétras); Rumanian Airs (Dauber); Spanish Pieces (Granados); Czardas for Violin (Monti); Pieces for Two Pianofortes and a Drum; Selection from The Geisha (Jones); Faded Summer Love (Baxter); By the Sycamore Tree (Gillespie). 6.0, Gramophone Records: Selections from Moses in Egypt (Rossini-Paganini); Minuet (Boccherini); Caprice No. 9 (Paganini-Reuter); Gavotte (Gluck-Planté); Potpourri of Old French Songs. 6.15, Talk: The Poet Hendrik Van Veldeke. 6.30, Gramophone Dance Music: Tango, Por la Pinta; Parade of the Minutes; Pearl of Hawaii; Tango, Milonga . . . Porque lloras?; Blue Again; Waltz, Entr'acte; Slow Foxtrot, By the River Sainte Marie; Scottish Dance, First Kiss; Tango-Blues, Enchantment; Foxtrot, Sweetness; Saxophone Solo: Waltz, Inspiration. 7.15, Talk. 7.30, Cinema Notes. 8.0, Orchestral Concert conducted by Franz André. Soloist: M. Leener (Songs), and M. Fischer (Cello); March (Strauss); Potpourri, Quintessence (Morena); Waltz, Moonlight on the Alster (Fétras); Flemish Songs; Foxtrot Potpourri on The Gypsy Princess (Kálmán). 8.45, Humorous Items. 9.0, Concert (continued): Bohemian March (Filippucci); Carnival (Siede); Polka for Flute; Rossignolet (Bades); Czardas (Mietels); Selections from Rip van Winkle (Planquette); Songs, Cello Solos: (a) Berceuse de Jocelyne (Godard), (b) Arlequin (Popper). Down Beside a Dutch Canal; You Try Somebody Else; In a Little Old Italian Garden; Got the Bench; Got the Park; Anatole prend le Métro (Pense). 10.0, Le Journal Parlé. 10.10, Concert by Max Alexys and his Orchestra relayed from the Ancienne Belgique. 11.0 (approx.), Close Down.

BUCHAREST (394 metres); 12 kW.—4.0 p.m., Concert of Light Music and Rumanian Music by the Sibiceano Orchestra. 5.0, News Bulletin and Time Signal. 5.10, Concert. (contd.). 6.0, Talks on History and Geography. 7.0, Light Music by the Station Orchestra; Selection (Stolz); Selection from The White Horse Inn (Benatzky). 8.0, Talk (to be announced). 8.15, Concert of Rumanian Music by the Luca Orchestra. 9.0, News Bulletin.

BUDAPEST (550 metres); 18.5 kW.—Programme also relayed on 210 metres from 6.30 p.m. till Close Down. 5.0 p.m., Concert by the Karl Bura Cigány Band. 6.0, Programme by Béla Révész. 6.30, Sponsored Gramophone Concert. 7.30, Answers to Correspondents. 8.0, See Vienna. 10.0, Time Signal and Weather Report. 10.5, Concert by the Eugen Farkas Cigány Band relayed from the Café Spolarich.

COPENHAGEN (281 metres); 0.75 kW., and **KALUNDBORG (1,153 metres);** 7.5 kW.—12 Noon, Time and Chimes from the Town Hall. 12.2 p.m., String Ensemble Concert, conducted by Max Skalka, relayed from the Hotel d'Angleterre. 2.0 to 2.30, Interval. 2.30, Gramophone Concert; Elisabeth Rethberg: Song from Il re pastore (Mozart); Michael Gittowsky: Song from The Huguenots (Meyerbeer); Franz Völker: Santa Lucia (Gordigiani); Comedian Harmonists: In einem kühlen Grunde (Glück); Willy Fritsch: Two Songs from Ronny (Kálmán); Florence Oldham: If they ever had an income tax on love (Washington and Monaco); Nils Jacobsson: Salta biten (Wüter); The Boswell Sisters: An evening in Caroline (Donaldson). 3.0, Programme for Children. 3.30, Orchestral Concert, conducted by Launy Gröndall; Soloist: Kay Abrahamson (Vocalist); Overture: Halka (Moniuszko); Fantasia on Workers' Songs (Eini Reesen); Tango (Albéniz); Ballet Suite (Heinrich); Finale from the Second Act of Linda di Chamounix (Donizetti); Songs: (a) Two Songs from White Horse Inn (Benatzky), (b) Mona Lisa (Stolz), (c) Two Songs (K. N. Andersen); Polonaise (Glazounov); Aria from The Creation (Haydn); Perpetuum mobile (Joh. Strauss); Waltz from The Man with the Three Wives (Lehar); Six Country Dances for Strings (Mozart); Six Melodies by Bellman (arr. A. Söderman); Gallop, Casino (Rasmussen); 5.40, Exchange and Fish Market Prices. 5.50, Talk in English: Cambridge. 6.20, French Lesson. 6.50, Weather Forecast. 7.0, News Bulletin. 7.15, Time Signal. 7.30, Talk. 8.0, Chimes from the Town Hall. 8.2, Orchestral Concert, conducted by Emil Reesen; Soloist: Marie Bundezen (Vocalist); Overture: Le Postillon de Longjumeau (Adam); Waltz: Morgenblätter (Joh. Strauss); Selection from Mam'zelle Nitouche (Iffery); Six Songs; Selection from La Fille de Madame Angot (Lecocq); Selections (Lumbye): (a) Polka, Britta, (b) Mazurka, Columbine; Reel from Livjagerne paa Amager (V. Holm). 9.0, Reading. 9.25, Bellman Song Recital by Alf Gildsig, with Introductory Talk; Systra hören min musik; Träd fram du nattens gud. Liksom en herdinna; Om ödet mig skull skicka; Skrattra mina barn och vänner; Bölan sig nindrar för. 9.55, Orchestral Concert of Modern Operetta Music; March from Der liebe Augustin (Fall); Selection from Un bon garçon (Yvain); Foxtrot from Der lachende Dreibund (Benatzky); Waltz from Phi-Phi (Christine); Selection from No. No, Nanette (Youmans); March from Bacchanalian Nights (Granichs-täden). 10.45, News Bulletin. 11.0, Dance Music from the Lodberg Restaurant; In the interval at 12 Midnight, Time and Chimes from the Town Hall. 12.15 a.m. (Sunday), Close Down.

DUBLIN, Call 2RN (413 metres); 1.2 kW., and **CORK (224.4 metres);**—1.30 to 2.0 p.m., Time Signal, Weather Report, Stock Report, and Popular Music on Gramophone Records. 7.20, News Bulletin. 7.30, Time Signal. 7.31, Gaedhlig. 7.45, Talk on Opera. 8.0, Lurline—Opera (Wallace); The Augmented Station Orchestra; Station Opera Chorus and Soloists. 10.30, Time Signal, News, Weather Report. 10.40, Weekly Sports Review, by Seamus Lavery, and Close Down.

FECAMP (223 metres); 10 kW.—12.0 noon, Gramophone Concert. 12.30, First French News Bulletin. 12.45, Concert—Selection (Lehar); Chez le Docteur (Bach, arr. Laverne); Voices of Spring (Johann Strauss); Le Clairon (André); Indian March (Selleniel); Overture, Egmont (Beethoven); Selection from The Count of Luxembourg (Lehar); Le Baptême des Zolaux (Bach, arr. Laverne); Czardas (Grossmann); Le Cor (Féglér); Les Fiancées de Rosborden (Goguillot). 2.0 to 7.30, Interval. 7.30, French Local News. 8.0, Concert organised by Tour de Garde. 8.45, Concert organised by Le Haut Parleur; Aux Boris des Tapes (Clairludé); Mlade III (Marc Hély and Camus); Chanson du Mirillon (Hermet); Carolina Moon (Burke and Davis). 9.0, Second French News Bulletin. 9.15, Concert—The Love Waltz (Heymann); Selection, La Fille de Madame Angot (Lecocq); Un Pen d'Amour (Silésu); César Jongleur (René Sarvil); Le Fanion de la Victoire (Courtaud); Du

Programmes from Abroad.—

bist das süsseste Madel der Welt (Heymann); Poupée Valsant (Poidini); César chez les Fantomes (René Sarvil); Quand Madelon (Robert). 11.0, Scottish Ballad Concert—March of the Cameron Men; Johnnie Cope; Ae fond Kiss; Green Grow the Rashers O' Loch Lomond; Kirkconnell Lea; The Diel's awa'; When the Kye Come Home. 11.40, Songs with Pianoforte Selections; Pianoforte Selection, Medley. Two Songs (a) You've Got to Laugh at Care, (b) Sweet Temptation; Pianoforte Selection, When the Circus Comes to Town; Two Songs, (a) I've Got One Arm Around Mary, (b) Who Cares? 12.0 midnight, I.B.C. Light Orchestra: The Song is Done; Call Me, Darling; Titania; Two Songs. (a) Trees, (b) Linda; Kiss Me Again; Singing to the Song Bird; My Heart Sings a Broken Melody; Two Songs, (a) I'm Through With Love, (b) Just One More Chance; Souvenir d'Ukraine; Grasshoppers Dance; Musette; An Old Violin; When its Sleepy Time Down South; The Clock is Playing; Roses from the South; At the Temple Gates. 1 a.m., Washington Comedy Four—Transatlantic Humorous Vocalists. 1.30, Film Fans, Back to Gay Parade, from "The Brat"; I wou'er if you will Remember, from "The American Prisoner"; Cooking Breakfast for the One I Love, from "Be Yourself"; Waiting at the End of the Road, from "Hallelujah"; More Than You Know, from "Great Day"; You Are My Heart's Delight, from "The Land of Smiles." 2.0, Dance Music; Foxtrot, Sweetheart; Just You, Just me; All of Me; Marianne; Waltz, Dance Away the Night; Foxtrot, Lonesome Little Doll; That's What I Think about You; That's When I Learned to Love You; Moonshine is Better than Sunshine; Ifigh and Low; Waltz, There'll Never be Another Mary; Foxtrots, Body and Soul; With a Song in My Heart; Waltz, Go to Bed; Foxtrot, Mamsie; Waltz, Goodnight and Pardon, Madam. 2.57, I.B.C. Goodnight Melody. 3.0 a.m. (Sunday), Close Down.

FRANKFURT (390 metres); 1.5 kW., and **CASSEL (246 metres).—5.0 p.m.**, Concert by the Philharmonic Orchestra, conducted by Bruno Hartl; Overture, Samori (Vogler); Symphony in C (Weber). 6.15, Economic Notes. 6.25, Talk arranged by the Frankfurt Zeitung. 6.50, Time, Programme Announcements, Weather, and Economic Notes. 7.0, Coblenz Evening—Descriptive Pieces on Gramophone Records. 8.0, See **Vienna**. 10.0, Programme to be announced. 10.20, Time, Weather, News, and Sports Notes. 10.45, See **Munich**. 12 midnight (approx.). Close Down.

HAMBURG, Call HA (in Morse); (372 metres); 1.5 kW.—Relayed by **Bremen (270 metres); Flensburg (218 metres); Hanover (566 metres);** and **Kiel (232.2 metres).—4.30 p.m. (from Hanover)**, Concert from Bad Nenndorf—The Spa Orchestra, conducted by Ernst August Bürger; Overture, Prince Igor (Borodin); Ballet Music from La Gioconda (Ponchielli); Selection from The Girl from the Golden West (Puccini); Selection from Frasquita (Lehar); Ballet Suite (Popy); Waltz, Traumideale (Fueck); Toreh Dance (Meyerbeer). 6.0, Talk: The Olympic Games. 6.30 (from **Bremen**). Talk: The People, Government, and Administration of Siam. 6.55, Exchange and Market Prices. 7.0, Topical Talk. 7.15, Weather Forecast. 7.20, Variety Programme. 8.0, See **Vienna**. 10.0, News Bulletin. 10.20, Dance Music from the Haus Sieglar.

HEILSBURG (276.5 metres); 60 kW., and **DANZIG (463.2 metres).—11.30 a.m.**, Johann Strauss Concert by the Little Orag Orchestra conducted by Eugen Wilcken; Overture, Cagliostro in Wien; Kaiserwalzer; Thermen-Walzer; Overture, Karneval in Rom; Selection from The Gipsy Baron; Waltz, The Blue Danube; Overture, Eine Nacht in Venedig. 1.20 p.m., News Bulletin. 1.30, Gramophone Concert of Operatic and Light Music. 2.30-3.30, Interval. 3.30 (from **Danzig**) Handwork for Children. 4.0, Orchestral Concert, conducted by Eugen Wilcken; Attila Marsch (Fueck); Rakoczy Overture (Köler-Bela); Selections (Richter); (a) Schwarzwälder Spieluhr, (b) Aufzug der Holzpuppen; Ballet égyptien Suite No. 1 (Luigini); Waltz from Drei alte Schachteln (Kollo); Selection from Tosca (Puccini); Intermezzo, The Butterfly (Schlenck); Intermezzo, Gaukler im Orient (Lindemann); Wiener Operetten-Revue (Rohrecht). 5.30, Relay from **Bischofsburg** of the Demonstration of the Ernuld Workers' Catholic Society. 6.0, Programme Announcements. 6.10, Programme Announcements in Esperanto. 6.15, Agricultural Market Prices. 6.20, World Market Prices. 6.30, Talk: The Work of the Red Cross. 6.55, Weather Report. 7.0, An East Prussian Evening in Hirschfeld.

SATURDAY, JUNE 11th (cont.)

6.0, See **Vienna**. 10.0 (approx.), News and Dance Music from **Berlin (Witzleben)**. 12.30 a.m. (Sunday), Close Down.

HILVERSUM (296.1 metres); 20 kW. (7 kW. up to 4.40 p.m.).—6.25-9.55 a.m., Programme of the Workers' Radio Society (V.A.R.A.). 6.25-6.40 and 7.10-7.25 a.m., Physical Culture. 7.40, Variety Music on Gramophone Records. 8.40, Quintet Concert. 9.40, Religious Programme by the Liberal Protestant Radio Society (V.P.R.O.). 5.55, Concert; Songs to the Lute by G. Dumont, Quintet Selections and Recitations by K. Bakker. 11.40, Septet Concert, conducted by Is. Eyl, with Variety Music on Gramophone Records: One Step, O Pimpinella (Benatzky); The Wedding of the Winds (Hall); Tango, Ihr könnt es nicht verbieten, dass die Sonne scheint (Benatzky); Popular Gramophone Music: Duet from Boris Godounov (Monssorgsky); Bacchante from The Seasons (Glazomov); Potpourri, Lasst Schlager sprechen (Dostal); Selections from The Magic Flute (Mozart); Makin' faces at the Man in the Moon (Rich); Variety Gramophone Music; Potpourri of Tyrolese Music (Fetras); Zigeunersehnsucht (Niklas-Kempner); Dance (Sullivan); Schenk mir einen Tango, Manuela (Engelberger); Light Music on Gramophone Records; Potpourri, Minutenspiele (Rubach); March, Hoppla jetzt komm ich (Heymann). 1.25-1.40 p.m., Interval. 1.40, Talk. 1.55, Talk with Gramophone Illustrations: The Songs of the Maories. 3.15, Concert by a Mandoline Orchestra, conducted by J. Kok; March from Boccaccio (Suppé); Chanson triste (Tchaikovsky); Toréador et Andalous (Rubinstein). 3.25, A Radio Play (Awertschenko). 3.40, Mandoline Concert (continued); Waltzes (Johann and Joseph Strauss); Salut d'amour (Elgar); March, Es muss bald wieder Frühling sein (Winston). 3.54, Sports Talk. 4.10, Chamber Music Concert; Guitar Solo, Variations and Sarabande (Gauthier); Minuet for Oboe and Guitar (Bach); Tocatta for Guitar (Goffert); Aria for Oboe and Guitar, So oft ich meine Tabakspfeife (Bach). 4.40, Programme for Children. 5.40, Concert by the De Wielewaal Choir, conducted by P. Tiggers; Die Stund ist da (Haydn); Am Bach (Haydn); Jucholla, frent euch mit mir (Schein); Der Kühle Maien (Schein). 5.55, Programme for Young Socialists. 6.10, Concert (continued). 6.25, Weekly Review. 6.40, Quintet Concert. 7.10, Variety Programme; L. Davids (Talk and Songs), Leo Fuld (Songs), Johan Jong (Organ), the V.A.R.A. Dramatic Society, Teun de Klepperman (Topical Talk), the V.A.R.A. Orchestra, conducted by Hugo de Groot, the Amsterdam Quintet, and Hems by A. de Vries; in the interval at 10.40, News and Football Report; after the programme, Variety Music on Gramophone Records. 11.40 (approx.), Close Down.

HUIZEN (1,875 metres); 8.5 kW.—Programme of the Catholic Radio Society (K.R.O.). 7.40-8.55 a.m., Gramophone Records of Variety Music. 9.40, Instrumental Concert. 11.10, Religious Address. 11.40, Police Notes. 11.55, Sextet Concert conducted by Piet Lustenhouwer; Paso doble, Ein deutsches Madel (Reisfeld); Du-Du-Du (Stolz); Waltz, Golden Rain (Waldtenfel); Marionetten Brautzug (Rathke); Potpourri of Old Popular Dances (Renaus-Lustenhouwer); Fräulein Laura (Röter); Im Wandel der Zeiten (Morena); Das wär herrlich (Benatzky); Waltz, Wine, Woman, and Song (Strauss); Sonne der Südde (Wied); In meinem kleinen Paddelboot (Katt). 1.25-1.40 p.m., Interval. 1.40, Gramophone Records of Variety Music. 2.10, Programme for Children. 3.40, Swimming Lesson. 4.10, Light Music on Gramophone Records. 5.10, Talk on Sport. 5.25, Gramophone Records of Variety Music. 6.0, Journalist Review. 6.20, Gramophone Records of Light Music. 6.50, Talk by Dr. Max Jansen. 7.10, Police Notes. 7.25, Gramophone Records of Variety Music. 7.40, Radio Cabaret by the K.R.O. Orchestra, Mme. Fientje de la Mar (Recitations) and the Cavellis (Accordion). 8.40 (in an interval), News. 10.40, Gramophone Concert of Variety Music. 11.40 (approx.), Close Down.

KATOWICE (408 metres); 16 kW.—5.0 p.m., Light Music. 6.0, Talk by Léon Ferencovics. 6.20, See **Warsaw**. 7.45, Talk on Sports. 8.0, Concert of Light Music. 10.5, See **Warsaw**. 10.50, Dance Music.

LAHTI (1,796 metres); 54 kW., and **HELSINKI (368.1 metres).—6.15 p.m.**, Talk. 6.40, Orchestral Selections; Waltz, Dolores (Waldtenfel);

Serenade (May); Czardas (Grossman). 7.0, Talk. 7.20, Dramatic Programme. 8.0, Song Recital. 8.15, Orchestral Selections from (a) The Little Dutch Girl and (b) The Bayadere (Kálmán). 8.45, News in Finnish and Swedish. 9.15, Military Music, relayed from the Kappeli Restaurant. 10.0 (approx.), Close Down.

LANGENBERG (473 metres); 60 kW.—12 (noon), Concert from **Frankfurt**. 12.50 p.m., Weather and News, and Time. 1.0, See **Stuttgart**. 2.35, Sponsored Gramophone Concert. 3.30, Economic Notes and Time Signal. 3.50, Programme for Children. 4.20, Talk: Through the Rhineland and Westphalia—on the Moselle. 4.40, English Lesson. 5.0, Concert. 6.10, A Radio Report from the Dog Show in the Westfalenhalle, Dortmund. 6.30, Talk on Taxation Questions. 6.50, Talk: The Future of East Germany. 7.10, Weather, Time, Economic and Sports Notes. 7.20, Radio Notes. 7.30, Talk: The Problems of Free Will. 7.55, First General News. 8.0, Variety Programme with the Station Orchestra conducted by Breuer. 10.5, News Bulletin, Announcements and Sports Notes. 10.30, Dance Music from **Berlin (Witzleben)**. 12 (midnight), Gramophone Dance Music. 1.0 a.m. (Sunday), Close Down.

LEIPZIG (259 metres); 2 kW., and **DRESDEN (319 metres).—5.0 p.m.**, Concert by the Weissenfels Municipal Orchestra, conducted by Ernst Schwassmann; Festouverture (Hugo Hartung); Auf der Wanderschaft (August Klughardt); Two Selections (Schmalstich); (a) Die Glocken von Saint Cyr, (b) Schmetterlingsreigen; Three Spanish Dances (Moszkowski); Selections from Frederica (Lehar); March, Vom Rhein der Wein (Lincke); Gondoliera (Frauz Ries); Latenständchen (Reinhold Wismar); Tanzszenen (Martin Richter). 6.30, German Lesson. 6.50, A Modern Dictionary. 7.0, Talk: What is South-West Africa like? 7.30, Concert by the Chemnitz People's Choir, conducted by Willy Steffen; Hoffnung (Robert Kahn); Two Selections (Karl Thiessen); (a) Aufmunterung, (b) Hochzeitslied; Folk Song, Drei Laub auf einer Leinwand (arr. Karl Thiessen); Folk Melody of 1500, Schöne Maruschka; Two Selections (Palestrina); (a) Stiefel cervus, (b) Sanctus, from the Missa Papae Marcelli. 8.0, See **Vienna**. 10.5, News Bulletin, followed by Dance Music. 12 midnight (approx.), Close Down.

LJUBLJANA (674.7 metres); 2.5 kW.—6.30, Gymnastic Course. 7.0, English Lesson. 7.30, Topical Talk. 8.0, Balalacha Concert. 9.0, Song Recital. 10.0, Time and News. 10.15, Light Music.

LWOW (381 metres); 16 kW.—4.5 p.m., Orchestral Concert of Light Music, conducted by Tadeusz Serebinsky. 4.35, Talk. 4.40, Orchestral Concert (continued). 5.0, See **Warsaw**. 6.0, Talk: Apricots. 6.20, See **Warsaw**. 7.15, Miscellaneous Items and Light Music on Gramophone Records. 7.35, See **Warsaw**. 7.45, Talk: Twenty-four hours in a Model Viennese Reformatory. 8.0, See **Warsaw**. 10.50, Radio Serenade for June—Musical and Literary Programme presented by Viktor Butzynsky. 11.10, See **Warsaw**. 12.0 midnight (approx.), Close Down.

LYONS, La Doua (PTT) (465.8 metres); 1.5 kW.—7.0 p.m., Popular Music on Gramophone Records. 7.30, Radio Gazette for Lyons and the South-East. 7.50, Horse-racing Report. 8.0, Medical Talk. 8.10, Fire Report. 8.20, Esperanto Report and Fire Station Report. 9.0, Concert of Songs; soloists: M. Pichard, M. Buisson, Mme. Lysiane Doriani, M. Maurice Darbou, Mme. Jane Dubois; Serenade from Don Giovanni (Mozart); Si tu le veux, brune Lison (Callet); Covatina, from Romeo and Juliet (Gounod); Le Petit Navire (Missa); Aria from the Messiah (Handel); Pieces by M. Maurice Darbou; Pieces by Mme. Jane Dubois; Stances (Flegler); Selection from L'Ombre (Plotow); Selection from The Damnation of Faust (Berlioz); Two Airs from Alceste (Gluck); Duet: La Source (Massenet); Duet: La Fontaine (Reyer).

MADRID (Union Radio), Call EAJ7 (424.3 metres); 2 kW.—8.0 p.m., Chimes; Market Prices; Technical Talk and Request Gramophone Concert. 9.15, News Bulletin. 9.30-10.0, Interval. 10.0, Linguaphone French Lesson. 10.30, Chimes, and Time Signal. 10.45, Selections from Musical Comedies; (a) La Verbena de la Paloma (Bréton); (b) The Count of Luxembourg (Lehar). 12.45 a.m. (Sunday), News Bulletin. 1.0 a.m., Chimes and Close Down.

MORAVSKA-OSTRAVA (263.8 metres); 11 kW.—7.0 p.m., See **Prague**. 10.15, Programme Announcements and Theatre Guide. 10.20, Variety Programme.

SATURDAY, JUNE 11th (cont.)

Programmes from Abroad.—

MOSCOW, Trades Union (1,304 metres); 100 kW.—6.30 p.m., Proletariat Radio Journal. 7.15, Programme for Young Communists. 8.0, Talk in German and English: Soviet Foreign Politics. 9.55, Time. 10.0, Talk in Spanish: The Armed Rising in Kronstadt, 1905.

MUNICH (533 metres); 1.5 kW. Relayed by Augsburg and Kaiserslautern (560 metres); and Nürnberg (239 metres).—5.0 p.m., Concert by the Station Orchestra, conducted by Karl List; Soloist, Siegfried Borries (Violin); Overture, Martha (Flotow); Andante con moto from the Symphony in C (Schubert); Concerto in G minor for Violin and Orchestra (Brahms); Waltz Fantasia (Glinka); Perpetuum mobile (Ehrentzberger); Hungarian Dances, Nos. 1 and 2 (Brahms). 6.15, Palatine Programme. 6.30, In the Grand Manner—Song and Ballad Sequence by the Station Choir, conducted by Eduard Zengerle; Soloists: Else Laupmann (Contralto), Richard Staab (Pianoforte), and Kurt Horwitz (Recitations). 7.15, Wireless News. 7.30, Two Radio Potpourris by the Small Station Orchestra conducted by Erich Kloss, Mely-Schulte-Molitor (Soprano), Friedl Wilhelm (Soprano), Otto Hiel (Tenor), and Karl König (Tenor). 1.—Potpourri of Operetta Music. 11.—Old and New Airs from Sound Films. 8.25, Bavarian Programme, relayed from Regen. 9.30 (from Nürnberg), The Nürnberg Amazons—Farce in Three Acts in Nürnberg Dialect (Lelmann). 10.20, Time Signal; Weather Forecast; News Bulletin and Sports Notes. 10.45, Dance Music by the Radio Five, with Alexander Laszlo. 12.0 Midnight (approx.), Close Down.

OSLO (1,083 metres); 60 kW. Relayed by Fredrikstad (367.6 metres); Hamar (560 metres); Notodden (427.1 metres); Porsgrund (453.2 metres); and Rjukan (427.1 metres).—6.15 p.m., Programme of National Music: Recital on the Hardanger Fiddle by Jørgen Tjønstad. 6.45, Talk on Economics. 7.0, Weather Report and News Bulletin. 7.30, Talk. 8.0, Time Signal. 8.1, Concert by the Station Orchestra, conducted by Hugo Kramm; Overture, La belle Héloïse (Offenbach); Selection from Mignon (Thomas); Norwegian Wedding March (Sandby); Selection from Dinorah (Meyerbeer); Andalusian Romance (Sarasate); Waltz, Roses of the Orient (Ivanovic); Tyrolean March (Dreyer). 9.10, Reading. 9.40, Weather and News Bulletin. 10.0, Topical Talk. 10.15, Choral Concert. 10.45, Dance Music on Gramophone Records. 12.0 Midnight (approx.), Close Down.

PALERMO, Ente Italiano Audizioni Radiofoniche (542 metres); 3 kW.—5.30 p.m., Popular Music on Gramophone Records. 6.0, Programme for Children. 6.30-8.0, Interval. 8.0, Announcements, Giornale dell'Enit, Agricultural Report and Giornale Radio. 8.20, Popular Gramophone Music. In the interval at 8.25, Sports Notes. 8.30, Time and Announcements. 8.45, La casa inonorata—Operetta in Three Acts (Lombardo), Conductor: Miltelto. In the intervals, Review of New Books, and Variety Items. 10.55, News Bulletin.

PARIS (Eiffel Tower), Call FLE (1,445.7 metres); 13 kW.—Time Signals (on 2,650 metres) at 10.26 a.m. and 11.26 p.m. (preliminary and 6-dot signals).—6.45 p.m., Talk, with Musical Illustrations. 7.0, Le Journal Parlé. 8.20, Weather Forecast. 8.30, The Polish Jew—Play in Three Acts (Eckmann-Chatrian). 10.0 (approx.), Close Down.

PARIS (Poste Parisien) (328.2 metres); 60 kW.—7.0 p.m., Light Music on Gramophone Records, News and Announcements. 7.30, Sponsored Gramophone Concert. 8.30, Gramophone Records, Talk and Announcements. 8.45, Vocal and Orchestral Concert, Overture, A Night in May (Rimsky-Korsakov); Waltz from L'Enfant et les sortilèges (Ravel); Le Festin de l'Araignée (Roussel); Napoli, from Impressions d'Italie (Chabrier); Rhapsody in Blue for Pianoforte and Orchestra (Gershwin); Pastorale d'été (Honegger); Ballet, Callirhoé (Chaminade); Fête polonaise from Le Roi maigré lui (Chabrier).

PARIS (Radio Paris), Call CFR (1,725 metres); 75 kW.—6.45 a.m., Physical Culture. 7.30, Weather and Physical Culture (cont'd.). 7.45, Gramophone Records. Selection from Enlevez-moi (Gabaroche); Selection from L'haut (Yvain). 8.0, News, Weather and Press Review. 12.30 p.m., Gramophone Concert. Ça, c'est Paris (Padilla); C'est toi cheri, non seul amour (Hermitte); One Little Quarrel (Krier); Le Bal de la Reine (Paradis);

Selections from Nina Rosa (Romberg); Vagabond Song (Rimann); Adios Muchachos (Sander); Turkish Patrol (Michaelis); Tanakouva (Roubaud-Bernard); La Mousmé (Ganne); Selection (Eysler); Selection from The Czardas Princess (Kálmán); On the Garden Wall (Sarony); Gai Babillage (Avignon); Mi Madre (Cazes); Japanese Lantern Dance (Yoshitomo); Selection (Petrolida); Overture, Die Fledermaus (Johann Strauss). In the intervals, News and Weather. 3.0, Programme for Children. 3.45, Market Prices. 6.30, Market Prices, Weather, Agricultural Report, Talk, Exchange and Racing Results. 7.0, Talk arranged by the Union des Grandes Associations Françaises. 7.10, Technical Talk by Colonel Bourgoïn. 7.30, Elementary Book-keeping Lesson. 7.45, Latin Press Review, Commercial Prices and News. 8.0, Readings by André Bacqué; Fairy Stories. 8.30, News, Sports Notes and Weather. 8.40, Review by René Dorin. 8.45, Song Evening arranged by Dominique Bonnaud. In the interval at 9.15, Press Review and News.

PITTSBURGH (Westinghouse Electric) (KDKA) (306 metres); 25 kW.—9.0 p.m., Teaberry Baseball Scores. 9.5, Pebecco Weather Report. 9.7, Rhythmic Serenade, from New York. 9.30, Tales of the Pennsylvania State Police: Behind the Law. 9.45, Programme to be announced. 10.0, Teaberry Baseball Scores. 10.5, David Lawrence Dispatch. 10.10, KDKA Artist Bulletin. 10.12, Programme Announcements. 10.15, Roseyhits, by A. K. Rowswell. 10.30, Stories for Children, by Louise Guiraud. 10.45, Little Orphan Annie, from New York. 10.50, Temperature Report. 10.51, Weather Report. 11.0, Time Signal. 11.1, Temperature Report. 11.2, Who's News To-day. 11.7, Teaberry Sport Review. 11.12, Press News-Reeler. 11.15, Programme to be announced. 11.30, Lew Conrad and his Orchestra. 11.59, Time Signal. 12 Midnight, Pepsodent Amos 'n' Andy, from New York. 12.15, Sam Robin's Orchestra, from New York. 12.30, Sacred Songs. 1.0, Danger Fighters, from New York. 1.30, Dance with Countess D'Orsay, from New York. 2.0, Porto-Ricain: American Tobacco Programme, from New York. 2.30, The First Nighter, from New York. 3.0, Homey and Old Fashioned Quartet. 3.30, Twenty Fingers of Sweetness, from New York. 3.45, McCravy Brothers, from New York. 4.0, Time Signal. 4.1, Teaberry Sport Review. 4.11, Temperature Report. 4.12, Weather Report. 4.15, Press Last Minute News. 4.20, Messages to Explorers and Missionaries.

PRAGUE (488.6 metres); 120 kW.—5.45 p.m., Two Talks. 6.5, Agricultural Report. 6.15, Talk for Workers. 6.25, German Transmission. 6.30, Weekly Review. 6.40 (approx.), Vocal and Instrumental Concert. 7.0, Brass Band Concert. 8.0, Talk: Pictures of the Renaissance and the Baroque Period and Plastic Art. 8.15, Cabaret Programme. In the interval at 9.0, Time and News. 10.0, Time and News. 10.15, Miscellaneous Announcements. 10.20, See Moravská-Ostrava.

RADIO-SUISSE ROMANDE (SOTTENS) (600 metres); 25 kW.; **LAUSANNE (680 metres);** and **GENEVA (760 metres).—12.30 p.m.,** Time Signal from Neuchâtel Observatory. 12.31, Weather Forecast and News Bulletin. 12.40 (from Lausanne), Concert of Light Music on Gramophone Records. 1.0, Exchange Quotations. 1.5, Gramophone Concert (continued). 2.0-5.0, Interval. 5.0, Time Signal from Neuchâtel Observatory. 5.1 (from Lausanne), Ceremony in Honour of Baron Pierre de Coubertin, Honorary President of the Olympic Games, relayed from the University. Songs by the Union Choral Society Double Quartet. Address by the Representative of the State Council. Address by the Rector of the University. Address by the Representative of the Municipality. Songs by the Double Quartet. Address by M. de Ballet Latour. Address by M. Hirschy. Talk by M. de Coubertin. Songs by the Double Quartet. 7.0, Weather Forecast. 7.1 (from Geneva), Carillon and Bells from St. Peter's Cathedral. 7.10, Light Music on Gramophone Records. 7.30, Talk: The Week in International Politics. 7.55, Announcements. 8.0, See Vienna. 10.0, Weather Forecast and News Bulletin. 10.10 (from Montreux), Dance Music, relayed from Le Perroquet. 11.30 (approx.), Close Down.

RIGA (525 metres); 15 kW.—6.0 p.m., French Lesson. 6.30, Agricultural Talk. 7.0, Weather Report. 7.5, Dialogues (du Maupassant). 7.30 Song Recital. 8.0, News Bulletin. 8.20, Variety Music. 8.50, La Biche—Dialogue (de Maupas-

sant). 9.0, Weather and News. 9.15, Variety Programme. 9.35 (approx.), Dance Music. 11.0 (approx.), Close Down.

ROME, Call IRO (441 metres); 50 kW. Relayed by Naples (319 metres) and 2RO (25.4 metres).—8.15-8.30 a.m., Giornale Radio and Announcements. 12 (noon), Gramophone Records of Variety Music. 12.35 p.m., Weather Forecast. 12.45-2.0 p.m., Vocal and Instrumental Concert; Soloist, Maria d'Alba (Violin); Military March (Schubert); Poem, Ireland (Garofalo); Violin Solos: (a) Serenata al vento (Carteri) (b) Suitt d'amour (Elgar); Lake Como (Fauchey); Selection from Turandot (Puccini); Violin Solos: (a) Spanish Dance (Chaminade), (b) A Window in Seville (Dax), Clarion (Ferretto). In the intervals: Giornale Radio, Exchange, Time, and Announcements. 5.0, Exchange, Report of the Royal Geographical Society, Giornale Radio and Announcements. 5.15, Song Recital by Vera Nadia Poggio (Soprano); O del mio dolce ardor (Gluck); Aria from Norma (Bellini); Aria from Aida (Verdi). 5.45, Instrumental Concert: A Festival in Seville (Scasola); Barcarolle from Silvano (Mascagni); Selection (Culotta); Selection for 'Cello and Pianoforte: Chanson villageoise (Popper); Sarai la donna mia (de Vito). 6.15, Giornale dell'Enit. 6.25, Talk: Italian Provinces. 6.55 (Naples), Shipping and Sports Notes. 7.0, Atmospheric Signals, Lesson in Morse, Agricultural Notes, Giornale Radio and Press Review. 8.0, Time, Announcements, and Gramophone Records of Variety Music. 8.30, Sports Notes and Announcements. 8.45, Tannhäuser—Opera in Three Acts (Wagner). In the intervals: Review of New Books, and Talk: Actors of To-day. News after the Programme.

SCHENECTADY (General Electric Company) (WGY) (379.5 metres); 50 kW. Relayed at intervals by W2XAF (31.48 metres) and by W2XAD (19.56 metres).—9.0 p.m., Dollar Bill, from New York. 9.15, Alex Brassen's Orchestra, from New York. 9.45, Studio Ensemble. 10.15, Skippy, from New York. 10.30, Soloist, from New York. 10.45, Landt Trio, from New York. 11.0, Joe and Eddie. 11.15, Waldorf Astoria Orchestra, from New York. 11.30, American Trio. 11.45, De Witt Clinton Orchestra. 11.55, Baseball Scores. 12 midnight (W2XAF only), Stock Reports and News Items. 12 midnight (WGY only), De Witt Clinton Orchestra. 12.15 a.m. (Sunday), Weather Report. 12.15-1.15, New York Relay. 12.16, Laws that safeguard Society. 12.30, June Pursell in Popular Ballads. 12.45, The Goldbergs. 1.0, Bridge Lesson. 1.15, Bernard Silberg (Cellist). 1.30-4.30, New York Relay. 1.30, National Advisory Council in Radio on Education. 2.0, Drama K-7. 2.30, Club Valspar. 3.0, Lucky Strike Dance Hour. 4.0, De Witt Clinton Orchestra. 4.30, Hotel New Yorker Orchestra. 5.0, Ralph Kirbery (the Dream Singer). 5.5, Buddy Rogers and his California Cavaliers. 5.30, New Kenmore Orchestra. 6.0 (approx.), Close Down.

SCHWEIZERISCHER LANDESENDER (BEROMÜNSTER) (459 metres); 60 kW.; **Basle (244.1 metres) and Berne (246 metres).—12.30 p.m.,** Time Signal from Neuchâtel Observatory. 12.31, Weather Forecast and News Bulletin. 12.40, Variety Programme on Gramophone Records. In an interval at 1.15 (approx.), Talk on the Day's Events. 1.50-3.30, Interval. 3.30, Programme from Zürich. 4.30 (from Zürich), Talk: Provision for the Unemployed in Switzerland. 5.0 (from Zürich), Concert by the Zürich Accordion Society, conducted by G. Helbling. 5.30 (from Zürich), Health Talk. 5.50, Concert of Popular Music on Gramophone Records. 6.15 (from Zürich), Listeners' Quarter of an Hour. 6.20 (from Zürich), Talk: Opera and Operetta in 1932. 7.0 (from Zürich), Chimes. 7.15, Time Signal, Weather Forecast, and Market Prices. 7.30 (from Zürich), Musical Programme. 8.0, Selection from Les Saltimbanques (—) Opera (Ganne) on Gramophone Records. 8.15 (from Basle), Variety—Radio Play about Artists' Life in Modern Times (Hamik), 9.0, Dance Music by a Jazz Band, with Cabaret Turns in the intervals. 9.30, Weather Forecast and News Bulletin. 9.45, Dance Music (cont'd.). 11.0 (approx.), Close Down.

STOCKHOLM, Call SASA (436 metres); 55 kW. Relayed by Bodn (1,229.5 metres); Göteborg (322 metres), Hörby (257 metres), Motala (1,348 metres), Östersund (770 metres), and Sundsvall (542 metres).—4.0 p.m., Concert of Light Music. 5.0 (from Göteborg), Programme for Children. 5.30 (from Sundsvall), Cabaret Programme. 6.15, Popular Music on Gramophone Records. 7.15, Weather Forecast and

Programmes from Abroad.—

News Bulletin. 7.30, Talk on Geological Maps. 8.0, Programme of Old-time Dance Music by Knut Esbjörnson's Orchestra. 8.45 (from Göteborg), Provincial Programme. 9.45, Weather Forecast and News Bulletin. 10.0, Dance Music by Georg Ender's Orchestra. 11.0 (approx.), Close Down.

STRASBOURG (345 metres); 11.5 kW.—11.30 a.m., Gramophone Records of Light Music. Suite Carnavalesque (Thomé). Selection from Mireille (Gounod); Selection from The Queen of Sheba (Lehár); Tartuffe (Molière); Robots (Mayer); Jota Aragonesa (Sarasate); Rondo, Choral and Dance (Liadov); Dance of the Hours from La Gioconda (Ponchielli); Wohin (Schubert); Minuet (Schubert); Selection from Le Roi malgré lui (Chabrier); Slavonic Dance (Chabrier); Pête Polonoise (Chabrier). 12.45 p.m., News in French and German. 1.0, Time. 1.2, Gramophone Concert (continued): Overture, Preciosa (Weber); Sonata in A Major (Mozart); Fantaisie impromptu (Chopin); Mazurka in B Flat (Chopin); Selection from Le Petit Duc (Lecocq); Mississippi (Boyer); Reviens (Fragson); Prelude à l'après-midi d'un Faune (Debussy); Selection (Grotti); Es-tu fidèle (Molle-Mussner). 2.0, Talk in French: The Monetary System. 2.15, Dance Music on Gramophone Records: Endierno; Polla; Chez ma chérie; Sing you Sinners; Looking at You; Let me Sing; Je vous suis; Navigation Scolaire; Bye, Bye, Blues; I Need You; Batida nocturna; Buen amigo; This is Love; Vis ta vie; You're Simple Delight; C'est la grande vie; Espana; A Sevilla muchachos. 3.45, Musical Talk in French with Illustrations: Bach's Recitative Style. 4.0, Gramophone Concert: Selection from Madame Butterfly (Puccini); Selection from The Merry Widow (Lehár); Les hommes ne mentent jamais (Borel Clerc); St. Catherine (Bose); Tango della stella (Lazarro); Torna a Sorrento (Curtis); Polka (Bussion); Charme de fleurs (Fontana); Beneath Your Balcony (Klein). 4.45, Banking Talk in French. 5.0, Dance Music: One Step, Petit amie du Jour; Fox-trot, High and Low; Slow Fox-trot, Dreamy and Blue; Waltz, Il est Charmant; Fox-trot, Rain on the Roof; Fox-trot, Lo and Behold; Tango, Carmelita; Fox-trot, Lovebound; Slow Fox-trot, A Faded Summer Love; Waltz, Wiener Blut (Johann Strauss); Fox-trot, O Bella Donna; Slow Fox-trot, Lang ist es her; Tango, Cara dura; Fox-trot, Open Your Window; Fox-trot, You are the Melody; Paso doble, Saragoza (Krier). 6.0, French Lesson in German. 6.15, Agricultural Talk in French. 6.30, Orchestral Concert, conducted by Maurice de Villers: Pastoral Suite (Scassola); Waltz (Brahms); Festival Overture (Leutner); Selection from Manon (Massenet). 7.30, Time Signal. 7.32, News in French and German. 7.45, Orchestral Concert (continued): Florentine March (Kueck); Spanish Rhapsody (Richardy); Overture, Czar and Carpenter (Lortzing); Selection from Rose Marie (Friml); Three Dances (German); March (Rosey). 8.45, Concert by the Municipal Orchestra relayed from the Restaurant de l'Orangerie: Overture, La Princesse Jaune (Saint-Saëns); Meditation on a Bach Prelude (Gounod); Suite from Sylvia (Delibes); Overture, Mignon (Thomas); Serenade (Moszkovsky); Rustle of Spring (Sinding); Violin Solo: Prelude to Le Déluge (Saint-Saëns); Hungarian Rhapsody No. 2 (Liszt). 10.30, Dance Music from the Savoy. 12 Midnight, Close Down.

STUTTGART (Mühlacker) (360.5 metres); 60 kW; and **FREIBURG (570 metres);**—11.0 a.m., Time and Weather. 11.15-11.30 a.m., Sponsored Concert. 11.45, Sponsored Concert (continued). 12 noon (in the interval), Weather. 12.20 p.m., Gramophone Concert of Variety Music. 12.50, Time and News. 1.0, Concert by the Stuttgart Philharmonic Orchestra; Soloists: Hermann Lingor (Tenor), and Hermann Colzelmann (Baritone); Selections (Mozart). (a) Overture, Don Giovanni. (b) Baritone Solo from Don Giovanni. (c) Minuet from the Symphony in E Flat, (d) Baritone Solo from Il Seraglio; Ballet Music from William Tell (Rossini); Tenor Solo from The Hermit's Bell (Maillart); Dance of the Sylphs from The Damnation of Faust (Berlioz); Tenor Solo: Flower Song from Carmen (Bizet); Coronation March from the Prophet (Meyerbeer); Fantasia, Rumania (Michaelov); Dir sing' ich mein Lied (Lehar); Fox-trot (Fred Coofs); Song and Tango (Allan Gray); Paso-doble (Ricardo); Fox-trot, Frühling heisst Liebe (Sherman); Waltz, Es führt kein anderer Weg zur Seligkeit (Heymann); Tango, Kleine Elisabeth (Rosen); Waltz Potpourri, Altherliner Leierkasten (Leuschner);

SATURDAY, JUNE 11th (cont.)

Quick-step, Was Schenkst du mir dann? (Gröthe). 2.30, Reading of Poems by Gottfried Keller and Conrad Ferdinand Meyer. 3.0, Song Recital by Marta Weber-Neubek: Die schwarze Laute (Möhlendorf); Songs (Kaun), (a) Weiss Nicht, woher ich gekommen, (b) Wenn's Abend ward; Songs (Wendland). (a) Die Treppe im Mondlicht, (b) Tanz der Götter; Songs (Trunk), (a) Ein Brief, (b) Frühlingssonne; Songs (Bleyle), (a) Abendlied, (b) Erster Schnee, (c) Dem Unbekannten Gott, (d) Schweifen, O Schweifen. 3.30, Programme for Children. 4.30, Concert by the Concordia Choral Society relayed from Laupheim: Songs (Knab), (a) Wir Bauern, (b) Ein Brotliab, (c) Dir, Dir Jehova will ich Singen (Grasselius); Sacred Song (Bach and Georg Schumann); Trinitatisfest (Schlöter); Ruf an Sankt Raphael (Othegeven); Russian Folk Song (Lendvai). 5.0, See Frankfurt. 6.15, Time and Sports Notes. 6.25 (from Freiburg), Talk: Fifty Years of the St. Gotthard Railway. 6.50, Time and Weather. 7.0, See Frankfurt. 8.0, See Vienna. 10.15, Time and News. 10.45, Concert from Munich. 12 Midnight, Gramophone Concert of American Dance Music. 12.30 a.m. (Sunday), Close Down.

TOULOUSE (Radiophonie du Midi) (385 metres); 8 kW.—5.0 p.m., Picture Transmission. 5.15, Exchange Quotations. 5.30, Popular Songs. 5.45, Opera Music: Selections from The Damnation of Faust (Berlioz); Overture, Philémon et Baucis (Gounod); Overture, The Huguenots (Meyerbeer). 6.0, Orchestral Selections. 6.15, Songs from Operas: Selection from The Tales of Hoffmann (Offenbach); Don Giovanni (Mozart); and Il Trovatore (Verdi). 6.30, Exchange and Racing Results. 6.45, Concert: Narcissus (Nevin); Chanson triste (Tchaikovsky); Trio (Goldman); Trio in B Flat (Haydn). 7.0, Accordion Music. 7.15, Popular Songs. 7.30, News Bulletin. 7.45, Dance Music. 8.0, Selections by a Viennese Orchestra. 8.30, German Lesson. 8.35, Sound Film Music. 8.45, Orchestral Selections: La Habanera (Laparra); Prelude to Le roi malgré lui (Chabrier). 9.0, Selections from Tosca—Opera (Puccini). 10.0, Selections by an Argentine Orchestra. 10.15, Military Music. 10.30, North African News. 10.45, Orchestral Music. 11.0, Concert: Tout est permis quand on rêve (Heymann); Avoir un bon copain (Heymann); Pans Angelicus (Franck); Lehar Potpourri; Evening in the Black Forest; The Tram; Selection from Manon (Massenet); Frère Jacques (Raiter); Route ta bosse (Bétové); Le clochard (Scott); Wedding Procession in Lilliput (Translatour); March; Waltz, Künstlerleben (Johann Strauss); Waltz, Wiener Blut (Johann Strauss); O Sole mio (Di Capua); Parade of the Tin Soldiers (Jessel). 12 midnight, Weather Report and Announcements. 12.5 a.m. (Sunday), English Concert. 12.30 (approx.), Close Down.

TRIESTE (247.7 metres); 10 kW.—7.5 p.m., Quintet Concert: Signora o signorina? (Apollonio); Mia piccola bambola (Montaguini); Campana (Di Lazzaro); Brezza notturna (Bonelli); Selection from The Czarevitch (Lehár); Ronda brasiliana (Escobar); Pataky e Patuku (Crosti). In the interval at 7.25 p.m., French Lesson on Gramophone Records. 8.0 till Close Down. See Turin.

TURIN (273.7 metres); 7 kW. Relayd by Milan (331.5 metres), Genoa (312.8 metres), and Florence (500.8 metres)—6.45 p.m., Agricultural Notes. 7.0, Announcements. 7.5, Musical Selections: Fior d'Andalusia (Pennati-Malvezzi); La campanella (Ranzato); Selection from La gran via (Valverde); Ruthenian Dance (Mignone). 7.30, Time, Announcements, and Gramophone Records of Variety Music. 8.0, Giornale Radio and Weather. 8.15, Musical Selections. 8.35, Talk: Events and Problems. 8.50, Concert of Chamber Music: Trio for Clarinet, Viola, and Pianoforte (Mozart); Harp Solos. 9.50, Review of New Books. 10.0, Variety Programme. 11.0, Giornale Radio, followed by Dance Music from the Flischetteria Toscana, Milan. 11.55, News Bulletin.

VATICAN CITY (Rome), (19.84 metres) (Morning), and (50.26 metres) (Evening); 10 kW.—11.0 to 11.15 a.m. Religious Announcements in different Languages. 8.0 to 8.15 p.m., Religious Information in Italian.

VIENNA (517 metres); 15 kW. Relayd by Graz (352.1 metres); Innsbruck (283 metres);

Klagenfurt (453.2 metres); Linz (246 metres); and Salzburg (218 metres)—1.45 p.m., Song Recital from Francesco Merli on Gramophone Records: Drinking Song from "Cavalleria rusticana" (Mascagni); Air from "La Gioconda" (Ponchielli); Aria from "Aida" (Verdi). 3.0, Time Signal, Weather Report, and Exchange Quotations. 3.20, Talk, illustrated with Gramophone Records: Famous Viennese Opera Singers of Bygone Times. 4.0, Talk: Understanding and Treatment of Animals. 4.30, Adventures, told by Herbert Patera: Smuggling Expeditions and Explorations in Primitive Forests. 5.0, Concert of Light Music by the Johann Wilhelm Ganglbauer Orchestra and the Strohmeier-Kemeter quartet. Soloists: Mizzi Starecek and Rudi Hermann (Dnets), and Willy Boskovsky (Violin); March (Kronegger); Overture, "Der Waldmeister" (Johann Strauss); Violin Solo, Liebes-Serenade (Ganglbauer); Songs, (a) Ja, so a Walzer (Fiebich), (b) Mir bleib'n uns're herrlichen Weanstadt treu (Schima), (c) Unser Wean (Kastner); Der verliebter Faun (Kellner); Descriptive Piece, En Carriole (Ourdine); Songs: (a) Beim Thury-huckl wart' ich heut' auf dich (Domanig-Roll), (b) In mir singt es und klingt es von Wiener Music (Fiebich), (c) Geh' ma, Geh' ma (Köbl); Waltz, Backfischerl (Zielner); Potpourri of Marches (Komzak); March, Austria (Schieder). 6.45, Talk with Gramophone Records: The Mountain Folk of the Caucasus. 7.15, Topical Talk. 7.45, Time Signal, Weather Forecast, and Programme Announcements. 8.0, Soldiers Songs and Military Music of Three Centuries, by a Military Band of 200 players and Soldiers' Choir (500 strong); Part I—The Eighteenth Century; Conductor: Anton Mader; Soldiers' Song for Choir: Prinz Eugen, der edle Ritter; March of the Walloons, for Orchestra (Asbth); Choral Item: General Landon rückt an; Grand March (Haydn, arr. Mader). Part II—Nineteenth Century; Conductor: Moritz Thann; Choral Items: (a) Oesterreich über alles, and (b) Kriegseid (Lipavsky); Orchestral Selections: (a) Wellington's Victory (Beethoven), (b) Einzugs-marsch (Walch); Part III—Items conducted by Gustav Gaigg; Choral Items: (a) The 10th Battalion at St. Lucia, and (b) Radetzky Kommandier; Orchestral Selections: (a) Traite und Zapfenstreich (Leonhardt), (b) Lagermarsch (Zaverthel); Part IV—Twentieth Century; Conductor: Josef Richter; Choral Items: (a) Der gute Kamerad, (b) Lied der Kaiserjäger (Mühlberger); Orchestral Selections: (a) Generalmarsch (Mahr), (b) Festmusik mit Fanfaren (Richter). 10.0, News Bulletin, Weather Forecast, and Announcements. 10.15, Dance Music by the Charly Gandriot Jazz Band with Dario Medina (Songs), relayed from Hübners Park Hotel.

WARSAW (1411 metres); 120 kW.—11.58 a.m., Time Signal and Bugle Call from the Tower of St. Mary's Church, Cracow. 12.5 p.m., Programme Announcements. 12.10, Interval. 12.30, Press Review. 12.40, Weather Report. 12.45, Light Music on Gramophone Records. 2.0, Interval. 3.0, Economic Report. 3.10, Popular Music on Gramophone Records. 3.30, Announcements. 3.40, Programme for Children. 4.5, Light Music on Gramophone Records. 4.35, Hydrographic Report. 4.40, Review of Periodicals. 5.0, Concert of Light Music by the Station Orchestra, conducted by Josef Oziminsky; March (Stelzig); Phantom Melody (Kettelbey); Potpourri of Finnish Airs (Hermann); Gavotte (Ganglbauer); Im Märchenwald (Ganglbauer); Waltz: Dorischwalben aus Oesterreich (Josef Strauss); Fantasia on Slavonic Themes (Leuschner); Torch Dance (Meyerbeer). 6.0, Talk relayed from Lwow. 6.20, Concert of Chamber Music from the Cristal Restaurant. 7.15, Miscellaneous Items. 7.35, Radio Journal. 7.45, Agricultural News. 7.55, Programme Announcements. 8.0, Concert of Light Music by the Station Orchestra, conducted by S. Navrot; Soloists: A. Janovski (Flute), M. Moszkovsky (Trumpet); Overture: Morning, Noon and Night (Suppé); Intermezzo from Naila (Delibes); Flute Solo: Waltz from La Traviata (Verdi-Popy); Waltz from Eva (Lehar); Serenade, Anima (Lincke); Trumpet Solos; Spanish Dances Nos. 2 and 5 (Moszkovsky); Waltz: España (Waldeufel); Gallop (Johann Strauss); Mazurka (Namyslowsky). 8.55, On the Horizon. 9.10, Announcements. 9.50, Radio Journal. 9.55, Weather Report. 10.0, Interval. 10.5, Chopin Pianoforte Recital by J. Smidowicz; Rondo in E Flat, Op. 16; Three Mazurkas, Op. 63: (a) in B Flat, (b) in F Minor, (c) in C Sharp Minor; Waltz in C Sharp Minor, Op. 64; Waltz in A Flat, Op. 42. 10.40, Sports Notes. 10.50, Dance Music.

LABORATORY TESTS ON NEW RADIO PRODUCTS.

MARCONIPHONE MODEL 136 LOUD SPEAKER.

In these days when the majority of new moving-coil loud speakers making their appearance on the market are of the miniature permanent magnet type it is interesting to be reminded of the performance of the larger types from which they have been developed. In the middle and upper registers the smaller type is well able to hold its own, but it undoubtedly suffers in the bass below 150 cycles by comparison with units having larger diaphragms. The small unit relies on a resonance just above or below 100 cycles to simulate bass response, whereas in the larger types the output

Actually, the sound output increases steadily below 300 cycles until the diaphragm resonance at 60 cycles is reached. Above 300 cycles there is also an increase up to 2,000 cycles, after which the output is maintained to 3,500 cycles and is followed by a drop to the 300 cycle level at 4,500 cycles. Above this frequency there is a rapid cut-off. As a result, the reproduction is free from background noise on radio reception and needle scratch on records.

The new type of cabinet is pleasing to the eye and the curved sides give rigidity which minimises box resonance. An output transformer adjustable to all types of output valves in current use is a standard item of the specification.

The price is £8 10s. and the makers are The Marconiphone Co., Ltd., 210-212, Tottenham Court Road, London, W.1.

WEARITE MAINS TRANSFORMERS.

A range of mains transformers designed for use with the three standardised types of rectifying valve now available has just been introduced by Wright and Weaire, Ltd., 740, High Road, Tottenham, London, N.17. The T.21A model is the smallest of the range and will be used with an "A" type rectifier. It has three secondary windings, one rated at 250-0-250 volts R.M.S., and two giving 4 volts each. One 4-volt winding supplies the rectifier filament, while the other provides filament current for the A.C. valves; the maximum load being 4 amps. The primary winding is tapped to suit supplies of 200, 220, and 240 volts at 40 to 100 cycles per second.

Although the transformer is reasonably small in size, the core contains sufficient iron to assure a satisfactory performance. There is negligible rise in temperature, even after a prolonged run, and the volt-

load equivalent to that of three valves across the spare 4-volt winding. The L.T. voltages were substantially correct, the filament winding giving 4.05 volts, and the other 4.1 volts. The price of this model is 25s.

The transformer for the "B" type rectifier is slightly larger in size, since it is required to give a higher output voltage, namely, 350-0-350 volts at 120 mA., while the rectifier filament in this case consumes 2.5 amps. The other L.T. winding gives a maximum of 4 amps., and the price of

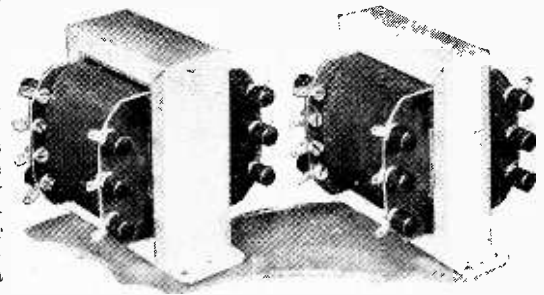

Wearite "A" and "B" type mains transformers.

the T.21B model, as it is styled, is 27s. 6d.

We understand that a "C" type transformer will shortly be available.

BULGIN TOGGLE SWITCHES.

Despite their small size these miniature toggle switches are quite capable of handling up to three amps. of current at 250 volts, and as the make-and-break action is rapidly executed they are quite suitable for use as a master switch in an all-mains receiver. The model S.102 is a single circuit make-and-break model and at 1/3 represents good value.

The body of the switch is a neat bakelite moulding completely enclosing the tinned phosphor-bronze contacts, while the insulating medium consists of specially treated non-hygroscopic fibre. Fixed to the body is a small plate carrying the make-and-break mechanism, also the single-hole fixing bush.

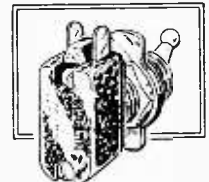

Bulgin single circuit make-and-break toggle switch.

In this particular design the moving contact wedges between the two fixed contacts, and as the action is of a wiping nature maintains the contact surfaces quite clean and bright.

There is another switch of similar design in which the moving contact closes two circuits alternately; this is styled the model S.103, and could be employed as a radio-gramophone switch.

o o o o

S. Smith and Sons (Motor Accessories), Ltd., Cricklewood Works, London, N.W.2, announce that the address of their Scottish agent, Mr. G. M. Smith, is Horse Shoe Chambers, 21, Drury Street, Glasgow, C.2. Telephone number Central 5382.



The latest Marconiphone permanent magnet loud speaker (Model 136).

energy can be more evenly distributed in the bass and it is even possible to arrange for a rising characteristic towards the lower limit by fixing the principal diaphragm resonance in the vicinity of 50 cycles.

These qualities are well exemplified in the Marconiphone Model 136 permanent magnet moving-coil loud speaker. Its sensitivity is comparable with mains en-

Regulation curves of the D.C. and A.C. output from Wearite Model T.21A mains transformer.

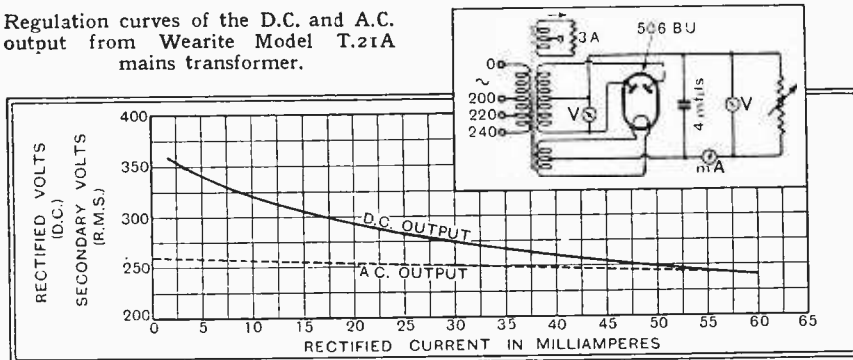

gineer models of equivalent size and the breadth and fullness of the reproduction in the bass is very satisfying to the ear.

age regulation is quite good. The D.C. output, using a Cossor 506 B.U. full-wave rectifier, is 240 volts at 60 mA. with a

Tone Correction and Distortion.

By

N. W. McLACHLAN, D.Sc., M.I.E.E., F.Inst.P.

The Important Effect of Harmonics.

THERE are two salient ways of defining selectivity, one might satisfy the mathematical mind, the other is understood by everyone.

The average person is satisfied with the selectivity of a receiver if he can listen in comfort to Timbuckthree when Timbucktwo is transmitting a few yards away, the frequency separation being a few kilocycles. The public wants results—that is what they are willing to pay for—and nothing else counts. Consequently the acid test of selectivity is clean reception of a large number of stations under all kinds and conditions of service. It is common experience in life that when we overdo things, somehow the price has to be paid. If we construct a receiver of ultra-selectivity, there is a price to be paid somewhere; something is forfeit to the god of selectivity, the fetish of searching the ether—like looking for a needle in a haystack. And the price is paid in quality. Now this is where someone steps in to assist the bankrupt listener. The latter—in the hands of the receiver—has been denuded of the upper audio frequencies, which are so essential in imbuing speech and music with finesse and qualities of interpretation. How can he know whether his loud speaker is talking Dutch or Sanskrit if the essence of the speech is lacking?

Into the arena steps a friend in need equipped with "wise saws and modern instances" who undertakes to better this sad state of affairs. Producing magic from his inner consciousness in the form of a correction or tone control circuit, he conceives wire wound on a laminated metal core, a thermionic valve and all the rest of it. Give this to the receiver and all will be well. But will it! The whole thing depends upon what the receiver thinks about the matter. In other words, it might be necessary to find out something about the receiver before trying out the new device on it.

Controlling Resonance Frequency.

Some years ago I was confronted with a problem in tone correction combined with considerable voltage amplification.¹

¹ *The Wireless World*, page 193, August 28th, 1929; *Electrician*, December 6th and 13th, 1929.

The correction necessary was greater than that required in the most selective radio receiver.

A special amplifier with several correction stages was built for the job in hand. When a uniform voltage at all frequencies was applied to the grid of the first valve, the voltage on the grid of the next valve gradually increased with the frequency as shown in Fig. 1. At a certain frequency the voltage was a maximum and then fell away. The maximum value corresponded to the resonance of the secondary winding of the transformer. This could be controlled by a small variable condenser connected across the secondary. It will be observed that the resonance frequency is outside the upper speech frequency, namely, 2,500 cycles per second.

What Happened to a Sine Wave.

The complete amplifier consisted of several such units, usually having different resonant frequencies, followed by a straight power amplifier with resistance-capacity coupling, and an attenuator for varying the strength of the output. One of the tests for an amplifier of this nature is to determine the degree of correction which it applies to the incoming signals. Actually, of course, the whole contraption is a distorting or anti-distorting network, whichever one prefers to call it. However, before measuring the degree of correction due to the apparatus, it is imperative to see whether a certain form of distortion arises in connection with pure sine waves. This is known as a linearity test. A sine wave is applied to the grid of the first valve. If the amplification at each stage is linear, the

sine wave will emerge from the power valve in its virgin state.

In the particular instrument under consideration it was decided after its assembly to make a rough linearity test to discover how the land lay. A local oscillator having a good wave form was got going and a frequency of 200 cycles applied at the input to the amplifier. The output from the latter was taken to an oscillograph, so that one could see what had happened to the sine wave in its passage through the correction amplifier. Personally, I have never seen anything quite like it. The nearest approach would be a dog's hind leg! Of

WHEN any modulated radio-frequency wave is amplified, and the sidebands attenuated by highly selective tuning circuits, it is important when restoring the upper audio frequencies by tone correction, that the detector should have a linear characteristic. Should harmonics be developed in the valve circuits, distortion may be serious, especially if the degree of tone correction is high. This article forms a valuable contribution to the technique of tone correction.

Tone Correction and Distortion.—

course this was annoying, bewildering, and certainly disconcerting. As the frequency was raised, the input voltage meanwhile remaining constant, the veil gradually lifted, and ultimately the sun shone on a good sine wave. The problem then presented itself, was it the amplifier after all?

Having reduced the input voltage at 200 cycles and found that the resemblance to canininity still persisted—the face at the window so to speak—the input was stopped, and a telephone receiver used for listening purposes. Apart from the customary valve noise nothing abnormal was scented. But when a small input from the oscillator was used the noise increased perceptibly. This was obviously due to the oscillator, although it had never shown up previously in any tests which were made on other kinds of apparatus.

Each stage of the amplifier was tested separately and found satisfactory. The next step was to test the oscillator for harmonics. Small amounts of harmonics were detected, but nothing which in the ordinary way would be regarded as serious.

Even the Eleventh Harmonic Dangerous.

To digress for a moment, suppose we consider the amplification curve for the complete receiver, and for simplicity, assume it is the same as that of an instrument with three stages like Fig. 1. The resulting curve is found by multiplying each ordinate in this figure by itself twice. Thus, when $f=1,000$ cycles the amplification for one stage is approximately 10, so that for three stages it is one thousand. The ratio of the amplification at 2,200 cycles to that at 200 cycles is approximately 3,000. Now suppose that our input wave, whose fundamental frequency is 200 cycles, has a trace of the 11th harmonic, i.e., 2,200 cycles. Let the trace amount to 1-60th per cent., then since the amplification ratio of

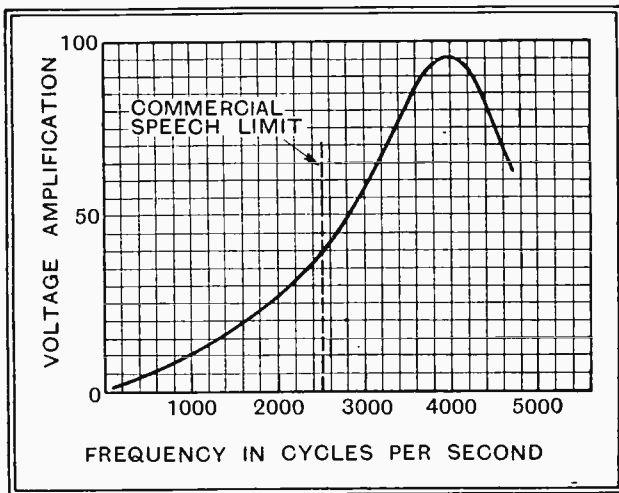

Fig. 1.—Characteristic curve for one correction stage of audio frequency.

tortion of the original sine wave is due, not to any defect in the amplifier, but to the fact that owing to the much greater magnification of the high than the low frequencies, any harmonics are exaggerated enormously. The degree of purity of the original sine wave would

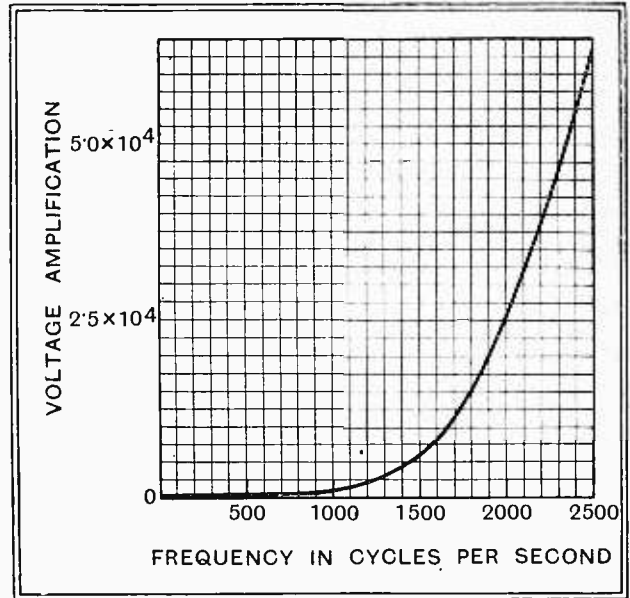

Fig. 2.—Characteristic curve for three correction stages of audio frequency up to 2,500 cycles.

have to be very much higher than that in ordinary use to emerge unscathed from such an amplifier. The noise due to the oscillator can be explained in like manner, but it so happened that in the case cited above the valve was rather noisy.

Linear Rectifier Essential.

Now we are in a position to answer the query formulated at the beginning of this article, namely, when correcting devices are added to a wireless set, does everything fit into the piece without objection? Let us consider a typical case of tone correction. We have very highly selective radio-frequency circuits prior to the detector or rectifier. Thereafter we have a tone-correcting device which amplifies the high frequencies much more than the lower frequencies. In this way we offset the cutting of the sidebands due to the radio-frequency circuits. The latter, of course, amplify the low frequencies at the expense of the high. The complete device is consequently something like adding two wrongs to make a right. In the radio circuits wrong is done, whilst in the audio circuit this wrong is righted amid great penitence. In the process, however, the signals may have a rough passage and may be put to considerable inconvenience. This is what we want to discover.

We have already seen that if the input to a highly correcting device is slightly impure the output is very impure. The frequencies we chose for illustration were 200 and 2,200 v., but in a radio receiver the frequencies range from 30 to 10,000. As a simple case take a

Tone Correction and Distortion.—

30-cycle note and imagine the amplification of the tone-correcting device to be proportional to the frequency. Then at 300 cycles any 10th harmonics in the 30-cycle note will be magnified tenfold, whilst at 3,000 cycles the magnification will be 100 fold. The problem arises, therefore, as to where this distortion of the original acoustic wave form is likely to occur. It can occur at the transmitter, but that is not under consideration at the moment. We are left with the receiver. For simplicity the influence of cross-modulation, etc., will be left out of account, and our attention will be directed to the rectifier. If an incoming modulated wave is not rectified linearly the result after a moderate degree of tone correction may contain as much upper register as the original speech or music. This would be mainly due to alien frequencies created by the interaction of the rectifier and the tone correction circuit. If the reader has understood the foregoing argument he will have no difficulty in following this important deduction. Consequently in any system where modulated radio frequency is rectified and then tone corrected, it is absolutely essential that the rectifier should have a linear characteristic.

If the degree of tone correction is very large and the

rectifier linear, any distortion of the original speech or music due to non-linear valves or circuits at the transmitter will be magnified in proportion to the degree of tone correction. In building and operating circuits of this nature the reader should be on his guard lest the rejuvenated sidebands be merely amplified harmonics of the lower frequencies. In view of all the articles on rectification which have appeared from time to time in *The Wireless World*, the reader should have no difficulty in seeing that "anode bend" is to be boycotted. Some data on this subject were given by H. L. Kirke during a discussion on selectivity at the I.E.E.¹ In the receiver tested by him there was a preponderance of the second harmonic, and this is absolutely fatal to good quality.

In this brief outline of the problem of tone control and possible distortion arising therefrom, there is no intention of scaring the reader. The subject has to be ventilated sooner or later, and it is better to be wise before than after an event. It is intended that the possibilities of distortion should not be absent from the mind of the experimenter, and that he shall not be under any delusion regarding a brilliant upper register when this can so easily be faked by the receiver.

¹ *The Wireless Engineer*, April, 1932.

THE HOWE BOX BAFFLE.

Eliminating Resonance with Absorbent Slag Wool.

IT is common knowledge that in order to obtain full radiation of the lower frequencies from a loud speaker diaphragm some form of baffle is necessary to prevent short-circuiting of the pressure waves generated by the back and front surfaces of the diaphragm. Generally a large flat baffle board is employed, but, as was shown by the data given on page 376 of the April 13th issue, a flat baffle assumes unmanageable proportions for domestic use when its size is increased to the point where it becomes really effective. This difficulty is largely overcome by constructing the baffle in the form of an open-backed box, keeping the distance from the edge of the diaphragm to the back edge of the box the same as in the flat baffle. Unfortunately, this method, while equivalent in efficiency as a baffle, introduces a serious resonance, due to internal reflection of the sound waves in the cavity of the box. The frequency at which resonance occurs depends, of course, on the dimensions of the box, but in general it is of the order of 150.

In the Howe box baffle made by F. McNeill and Co., Ltd., 52, Russell Square, London, W.C.1, box resonance is eliminated by lining the interior with absorbent slag wool, the lining being graduated in thickness and kept in position by stretched canvas. The results are equivalent, if not better, than those obtained with a flat baffle of the same area, for the box construction gives greater rigidity than a plane board of similar thickness. It is interesting to note that the foregoing considerations, combined with the advantage of compactness, have decided the B.B.C. engineers to adopt

this type of baffle for the majority of the loud speakers installed at Broadcasting House.

Comparative laboratory tests have convinced us of the soundness of this method. A moving-coil loud speaker was chosen with a reasonably uniform acoustic output between 50 and 500 cycles, and an estimate of the output was made (a) with a plane 7-ply baffle measuring 3ft. x 3ft.; (b)

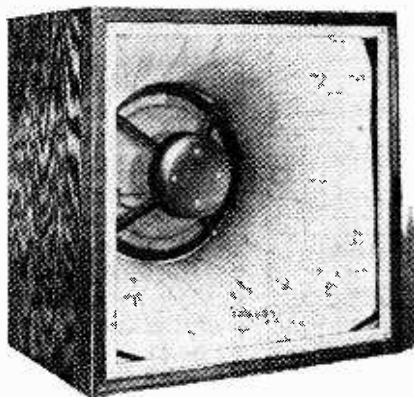

The Howe box baffle, the interior of which is lined with sound-absorbent material.

with an unlined box baffle of equivalent area; (c) with the same box lined with slag wool as shown in the accompanying photograph. The unlined box gave a well-defined resonance of about 12 decibels at 160 cycles, of which there was

no trace in tests (a) and (c). In other respects the performance was the same under all three sets of conditions, at least as far as could be judged by ear.

There can be no doubt, therefore, that the Howe box baffle gives a performance at least equal to that of a thick flat baffle without the disadvantages of unsightliness and bulk.

SPECIAL FILM FOR TELEVISION PURPOSES?

Television transmissions from cinematograph films, from the Berlin-Witzleben station, have brought out the fact that very strongly contrasted films are required for this purpose. When a film with strong contrasts is made by the ordinary methods, much detail is liable to be lost, however carefully the emulsion is chosen. Dr. F. Noack, the well-known German writer on wireless subjects, sends us from Berlin a suggested way out of this difficulty. He proposes that use should be made of the process worked out by Nolte for ordinary photography, which had already been applied successfully to printing purposes. It consists in taking two photographs, one in bright light and the other in dull; the first photograph brings out the detail in the dark parts, the second favours the light parts. The two are superimposed and the working copy taken from the combination. If applied to cinematograph films, the resulting film should be ideal for television purposes. A simple way of carrying out the principle is to use one lens only, combined with a mirror or prism system so that the image is focused on two films running side by side at the same speed. Screens in front of the films produce the effect of bright and dull illumination respectively.

BROADCAST

By Our Special Correspondent.

New Name for B.B.C.?

THE British Broadcasting Corporation is a nice name, but who knows when it will be changed to something grander and more comprehensive? The fact that B.B.C. methods have won a victory in Canada, where a Broadcasting Corporation on British lines is very shortly to be set up, suggests that the first link has been forged in a broadcasting chain which may include the whole Empire.

B.E.B.C.?

Who knows but what, in ten years time, those smart commissionaires outside Broadcasting House will bear on their hats the letters "B.E.B.C."—the "British Empire Broadcasting Corporation"?

Sir John Reith's Future.

The idea is not so fantastical as may appear. I understand that there is a strong feeling within Broadcasting House that broadcasting throughout the Dominions would gain immensely in power and prestige by some form of unification.

Sir John Reith can scarcely be accused of lacking ambition, yet it seems certain that he will never quit the broadcasting stage for other spheres of activity.

This being so, I predict that great things will happen within the next few years.

Get There First.

HERE is a private "tip" for readers of *The Wireless World* who wish to attend the first public performance in the large concert studio at Broadcasting House. This will probably be given in September, but at the moment the staff is without plans regarding the manner in which the public shall be admitted. In other words, no list of invitations has yet been compiled, and readers therefore have an excellent opportunity to create such a list by sending in their applications now.

Free Admission.

It is, of course, possible that a charge may be made for admission—at the Edinburgh headquarters moneys so received go to charity—but I understand it is still likely that the B.B.C. may maintain the system of free admission, as has always been done in the case of vaudeville broadcasts.

At any rate, it would be worth while to "book" a seat now.

New Wavelength Tests in the North.

SCOTTISH listeners will have to wait two or three months before the introduction of the National transmissions from Falkirk on 288.5 metres. In the meantime, however, Newcastle and Aberdeen, which also work on this common wavelength, will carry out some little tests on their own account to find wavelengths which will not be interfered with. On June 17th an experimental

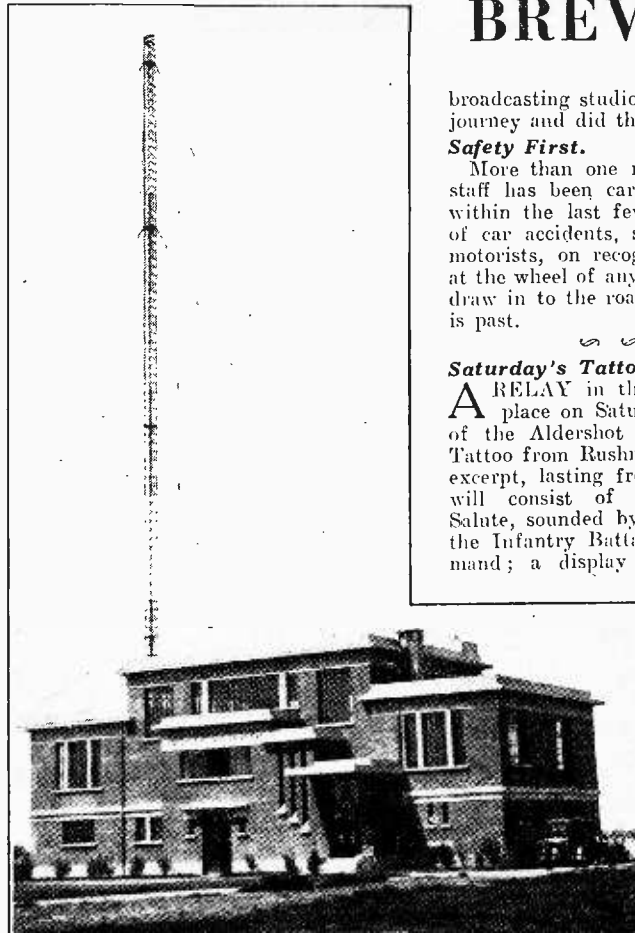

THE NEW VOICE. Poste Parisien, with its new 60-kW. transmitter has achieved European fame in the last few weeks. The wavelength is 328.2 metres.

transmitter will be launched in Aberdeen, using a wavelength of 214.3 metres, and a week later Newcastle will make a similar experiment on 211.3 metres.

Comfort for Aberdeen.

Aberdonians and Novocastrians are already accustomed to sudden wavelength changes, but it seems quite possible that some of the canny listeners in the North will find difficulty in plumbing the wavelength depths with their existing coils.

Aberdeen has one consolation: what it loses in metres it gains in kilocycles.

Vaudeville on the Road.

IT has often been asked whether A. J. Alan, the only mystery man connected with British broadcasting, is really human. I am sorry to say that the answer has been supplied in a rather unfortunate manner by the news that he has recently been much shaken and bruised in a motor accident. Nor is "A. J." the only road victim associated with broadcasting. Only the other day four members of the "Roosters" party had a bad car smash—Charles Harrison is still in hospital—and a few days ago Clapham and Dwyer also bit the dust in a road accident while on the way to the

BREVITIES.

broadcasting studio; they completed their journey and did their turn.

Safety First.

More than one member of the B.B.C. staff has been carrying temporary scars within the last few weeks as the result of car accidents, so I really think that motorists, on recognising a B.B.C. man at the wheel of any car they meet, should draw in to the roadside until the danger is past.

Saturday's Tattoo Broadcast.

A RELAY in three sections will take place on Saturday next, June 11th, of the Aldershot Command Searchlight Tattoo from Rushmoor Arena. The first excerpt, lasting from 9.35 to 10.05 p.m., will consist of Retreat and General Salute, sounded by the massed bugles of the Infantry Battalions, Aldershot Command; a display by a Brigade of the

Royal Horse Artillery, with musical accompaniment by the massed dismounted bands; and Beating Tattoo by the massed drums and fifes of fourteen battalions of the Aldershot Command.

Massed Bands on the March.

The second excerpt, from 10.25 to 10.38 p.m., will consist of the music played by the massed bands of the Command while marching and counter-marching.

The third excerpt, from 11.35 to 11.50 p.m., is the Grand Finale, all troops taking part in the Tattoo march on to the arena with bands playing.

The Truth About the Applause.

BECAUSE this item concerning the B.B.C. comes from America—to be precise, Washington—why should we doubt its authenticity? Anyway, here is an item circulated to the American Press by an agency in Washington: "Clackers aren't needed in radio studios to furnish backgrounds of applause for performers. The British Broadcasting Corporation uses the Blatterphone, the German recording device on which it records notable broadcasts for future reference, whenever clapping, foot stamping, and laughter are needed."

FERRANTI Constructors' Amplifier for A.C. Mains

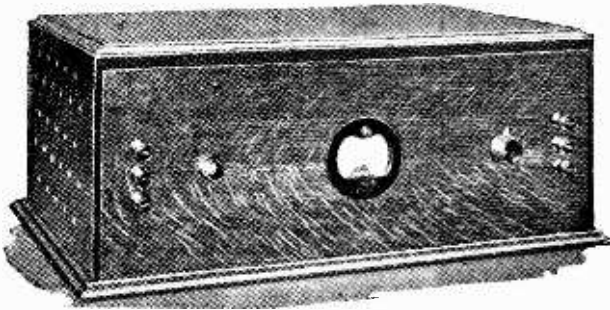

Model A.C.6. Three-stage L.F. Amplifier giving a Large Power Output.

AT no period in the history of the gramophone has high-grade reproducing apparatus been more necessary than at the present time, for with all the leading gramophone companies adopting electrical recording it is but reasonable to assume that to obtain the best possible results a somewhat similar method must be utilised for reproduction. Thus we find the L.F. amplifier, forming part of a broadcast receiver, called upon often to perform this function, and, within the limitations imposed by the nature of the apparatus and the power-handling capabilities of the output stage, it discharges its duty quite satisfactorily. Where, however, larger outputs are required, or better reproduction than is possible with the apparatus available, it is necessary to look elsewhere for a suitable amplifier.

The special models designed by Ferranti, Ltd., Hollinwood, Lancs, are, therefore, of particular interest, for, unlike the majority of similar apparatus now current, these models are obtainable in kit form for home construction. Since this firm has always been a staunch supporter of the push-pull method of amplification it is but natural that an amplifier of this style should figure in its models, of which the A.C.6 is probably the most interesting.

Good Response Curve.

It is operated entirely from the alternating-current supply mains and embodies three amplifying stages, all transformer coupled, while the last stage consists of two L.S.5A. valves working in push-pull. The maximum undistorted power output is approximately 6,250 milliwatts. It might seem at first that an amplifier giving such a generous output would be unsuitable for normal home use, but where really good-quality reproduction is the principal concern there are some good and sufficient reasons justifying the inclusion of a large power output stage. This applies not only to the amplifier

FEATURES.

General: Three-stage L.F. amplifier for gramophone reproduction. Maximum undistorted output 6,250 milliwatts. A.C. operated. Constructors' model.

Circuit: First stage parallel-fed transformer, second stage direct-fed transformer with push-pull output. Milliammeter for measuring all anode currents. Safety switch and main fuses. Input volume control.

Price: Complete kit of parts, approximately £25 including valves, but excluding cabinet.

Makers: Ferranti Ltd., Hollinwood, Lancashire.

we are dealing with here, but to every broadcast receiver. There should be sufficient latitude in the permissible grid swing at the output stage to take care of occasional loud passages, or overloading will occur. If small power valves are fitted, either distortion must be tolerated during these passages or the volume control adjusted to give a lower mean output level than is really desirable.

Should the A.C.6 amplifier be used as part of a broadcast receiver, for which purpose it would seem well suited, a slight modification to the input would be desirable, as it would be best to utilise the first valve as the detector. With modern valves the output from a detector stage is quite considerable, and two L.F. amplifiers are ample for all normal purposes. Incidentally, some difficulty might arise in stabilising a receiver embodying more than two low-frequency stages.

Turning to the circuit diagram, it will be noticed that quite a number of interesting features have been embodied. Although transformer couplings are adopted throughout, the first transformer is parallel fed and, in addition, has a resistance connected across its secondary winding. This arrangement functions as a compensat-

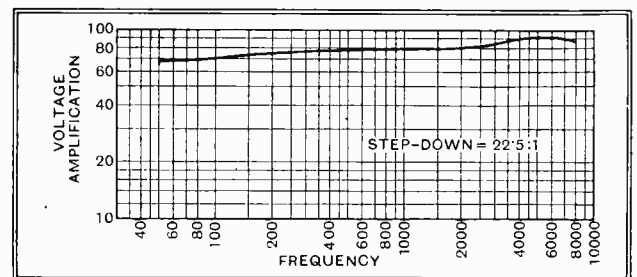

Overall response curve of the Ferranti A.C.6 constructors' amplifier.

ing stage, and alone would over-emphasise the bass, but in conjunction with the other stages gives a good overall characteristic, the amplification being sensibly constant over the whole range of audible frequencies.

POWER AMPLIFIER FOR HOME CONSTRUCTION.

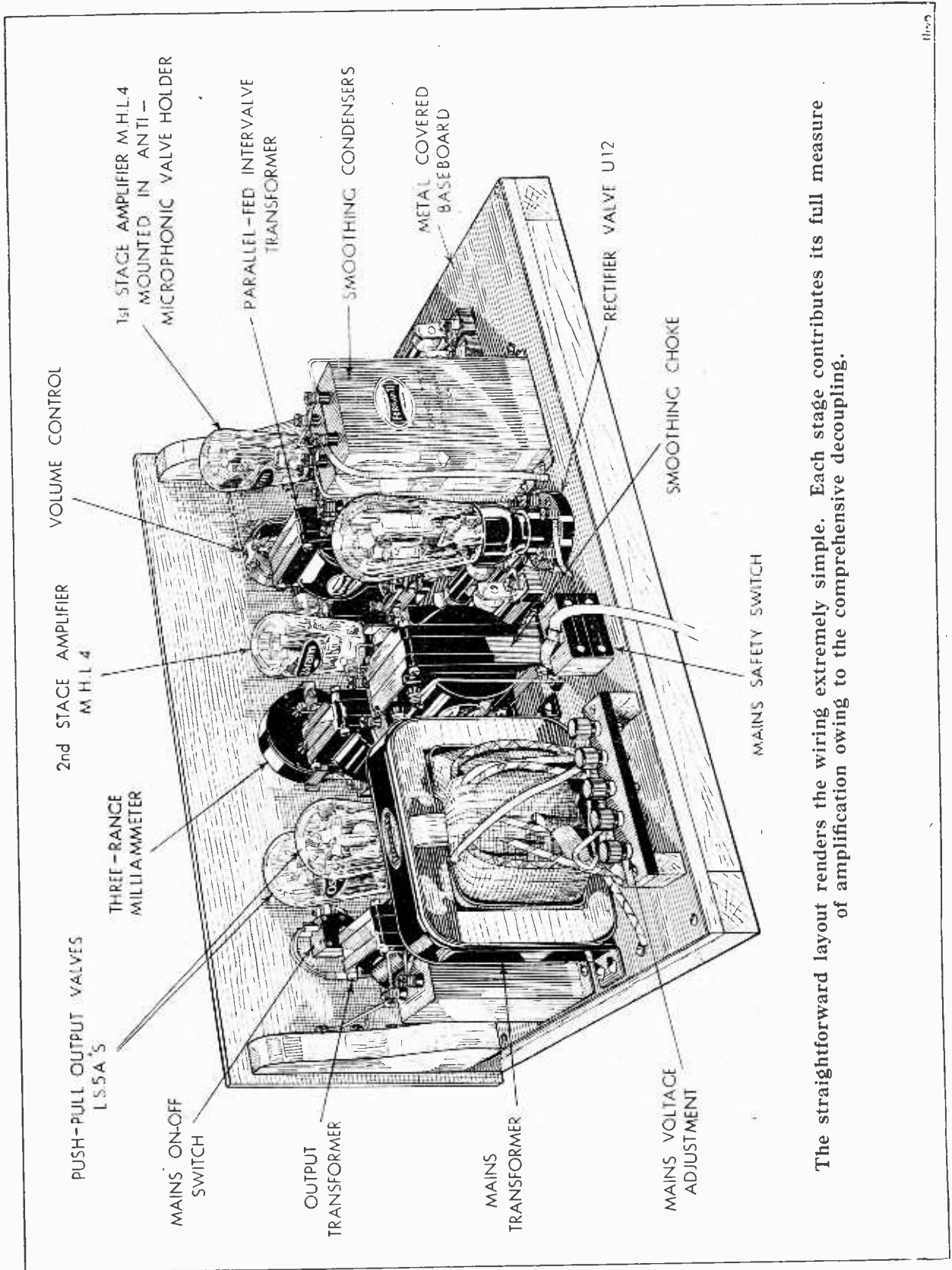

The straightforward layout renders the wiring extremely simple. Each stage contributes its full measure of amplification owing to the comprehensive decoupling.

Ferranti Constructors' Amplifier for A.C. Mains.--

Control of volume is effected at the input end by connecting a 50,000-ohm potentiometer across the gramophone pick-up terminals. If the input leads are unduly long they should be screened, and it might be advantageous to embody the volume control in the turntable unit.

The high resistance inserted between the grid of the first valve and the negative lead is included as a safety measure when the volume control is on the turntable unit, for, should the input leads come adrift or be disconnected without first switching off the mains supply, the valve might suffer damage due to interrupting the grid-bias circuit. It does not affect, in any way, the characteristics of the pick-up device, since the resistance is large compared with that of the volume control. The first valve is mounted on a lightly sprung holder,

thereby enabling such components as intervalve transformers and chokes to be mounted near to the main transformer without coming within its external field. This is a fruitful cause of hum, in the elimination of which strange positions often have to be found for the affected components.

An output transformer is essential to obtain the correct balance of impedances between the push-pull output stage and the loud speaker. Where low resistance loud speakers are favoured the Ferranti OPM6C transformer will generally be suitable, but where the high-resistance models are to be used satisfactory matching should be possible with the OPM1C transformer.

Included in the circuit is a milliammeter embodying a three-way switch, by the aid of which the meter can be inserted into the anode circuit of each of the valves

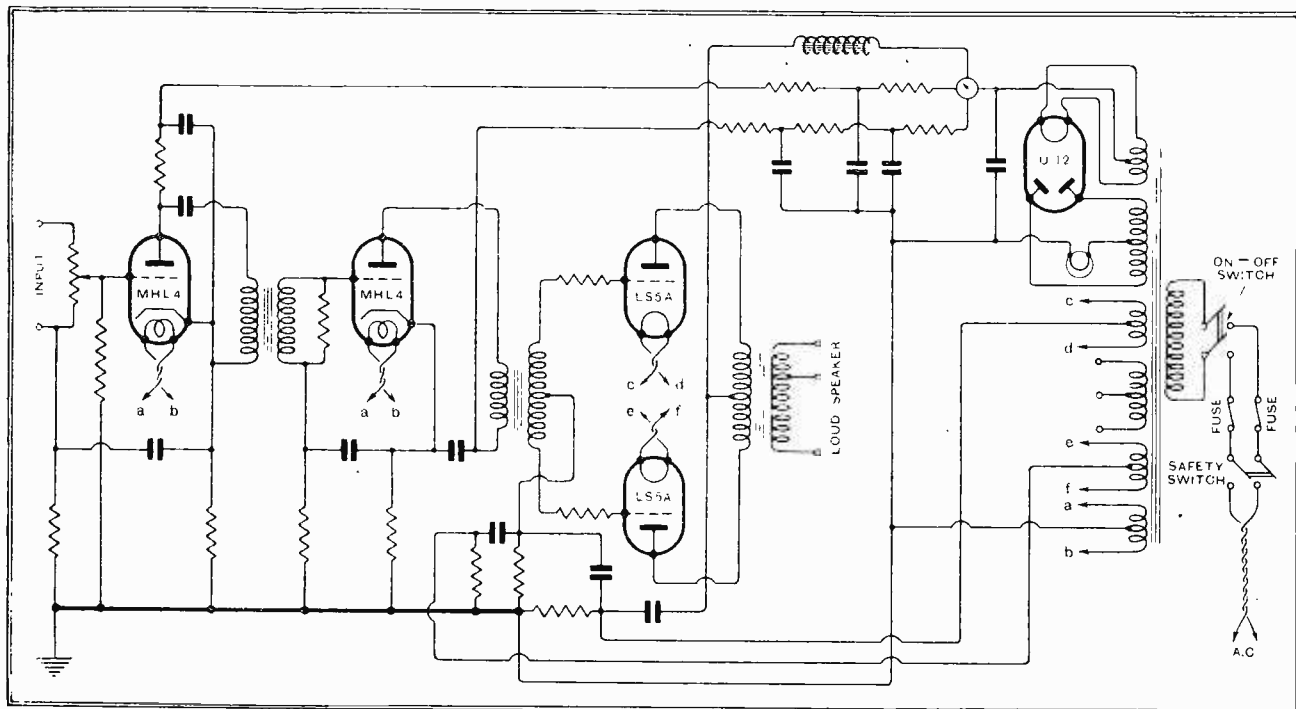

Complete circuit diagram. One among many interesting features is the provision of separate filament windings for the push-pull valves, each with its own grid bias resistance to avoid damage in the event of failure of one valve.

without which trouble might be experienced from microphony, and its inclusion is essential for the satisfactory operation of the amplifier.

Another interesting feature is the provision of separate filament windings for the two push-pull valves, and, in addition, each has its own grid-bias resistance. These are not included for the purpose of matching the two valves, but as a precautionary measure taken to assure that in the event of one valve failing the other will not suffer damage through inadequate grid bias.

At first sight the mains transformer might seem unduly large for an amplifier of this power, but the component is of a somewhat special type, all windings being sectionalised to a far greater degree than usual, and earthed screens are interposed between the sections. The aim is to minimise the extent of the external field,

in turn for the purpose of checking the anode current to ascertain that the valve is operating correctly. Further, this meter serves also as a check for overloading, although so far as this function is concerned it need be applied only to the last stage, for overloading will occur here sooner than in the earlier stages. The instrument is a standard Ferranti moving-coil meter, reading 0-12, 0-12, and 0-120 mA. respectively on the three ranges.

There is little that need be said here regarding the construction of the amplifier, for this is so straightforward that the wiring diagrams and instructions contained between the covers of their publication W.513, which deals exclusively with the various models of these amplifiers, provides all the necessary information. The cabinet advised can, of course, be modified to suit indi-

Ferranti Constructors' Amplifier for A.C. Mains.—

vidual requirements, but it would be very unwise to deviate from the published layout and disposition of the components. Whatever type of cabinet is used, however, arrangements should be made to incorporate the special safety switch which intercepts the mains supply when the amplifier is withdrawn from its protecting cabinet. It must be remembered that the total voltage given by one of the secondary windings approximates 1,000 volts A.C., and unpleasant results are likely to follow in the event of an accidental shock. Provided the instructions are adhered to this possibility need never arise.

The first test made with the amplifier was to take the overall characteristic, omitting the loud speaker, but including the output transformer, for if the curve is substantially linear the acoustic output will then be governed by the qualities of the loud speaker and the characteristic of the gramophone pick-up used. From the nature of the curve here reproduced it will be seen that there are no grounds for adverse criticism; on the contrary, it is exceptionally good, and the greatest deviation from the mean level, taken at 1,000 cycles,

occurs at 50 cycles where the output is about 3 decibels lower. At 100 cycles the output is 0.8 decibels below the mean level, while the slight rise at the upper end of the frequency scale—between 4,000 and 7,000 cycles—represents an increase of 1.2 decibels only.

The mean overall amplification, measured from the grid of the first valve to the anode of the output valves, is 1,755 times. Thus with the average type of gramophone pick-up the volume control must be backed off to a considerable extent, otherwise the output stage will be overloaded and distortion will occur. The high amplification afforded by the amplifier, together with its good response characteristic, renders it particularly useful for laboratory and experimental work where very small input voltages have to be dealt with, or, conversely, where a large power output is required. For example, it will prove entirely satisfactory for amplifying the exceedingly small voltage changes when experimenting with photo-electric cells, or it would serve as the amplifier for television experiments, to mention but two of the numerous additional functions for which the A.C.6 amplifier is so well suited.

Letters to the Editor.

The Editor does not hold himself responsible for the opinions of his correspondents.

Correspondence should be addressed to the Editor, "The Wireless World," Dorset House, Tudor Street, E.C.4, and must be accompanied by the writer's name and address.

"The Wireless World Two."

I FEEL that I should like to express my appreciation of "The Wireless World Two."¹ I have had this set in operation since December last, and I consider it to be the ideal small set for the reception of home, and occasionally the more powerful foreign, programmes. It is very inexpensive in upkeep, and inherently stable, even with an old battery.

I am using it with a small permanent magnet moving-coil speaker, and the quality and sensitivity are all that could be desired with the type of circuit, while the selectivity is sufficient to separate the locals definitely, with an 80ft. aerial, even in this difficult area.

Noticing a hint in a later issue of *The Wireless World*, I tried substituting a small capacity (approximately 0.00005 mfd.) preset condenser in place of the more normal 0.0002 mfd. grid condenser, and a small increase in selectivity has resulted, without any decrease in sensitivity.

Thanking you for an exceptionally good set.
Kenton, Middlesex. D. A. DAWSON.

An Appreciation.

ON behalf of this Society, I congratulate your paper on attaining its majority. Long may it prosper, long may it keep the esteem of discriminating wireless people.

Writers in your Correspondence columns have often sung your well-deserved praises, and have so covered your merits that they leave little to be said. One point has been missed, a very important point. Allowing for technical excellence, a good policy, and Free Grid, this special point is one of the reasons why your paper is beloved. I refer to the make-up. It speaks honesty, cleanness, reliability, sane common sense. You do not cover your pages with blobs of black-faced type—several columns, sensational headings in heavy type, or continue thirty lines of an article on another page of the same issue. Anyone looking at *The Wireless World* for the first time, without reading it, knows it is respectable by its appearance. And why has nobody mentioned the very fine work done by your artists? The appropriate

drawings and photographs worked into the titles of important articles, the clear circuits and wiring diagrams, and the particularly fine drawings of your own receivers and the receivers which you review. Every credit is due for this work, and the manner in which it reflects the downright thoroughness of your policy. I feel that someone should thank you from this point of view.

The Newcastle Society has now finished its weekly meetings until next session. Field days will be organised during the summer months. Various radio societies have claimed through your columns to be the oldest in the country. This society was founded in January, 1910, and has carried on ever since. We still have two members who were at the first meeting. Our present membership is 127, and at a public meeting which we held this session we had an attendance of 2,135. In view of your own twenty-first birthday, it would be interesting to know which is the oldest society.

Wishing you continued success.

WILLIAM W. POPE.
Hon. Secretary,
Newcastle-upon-Tyne Radio Society.

Broadcast Reproduction.

I HAVE been watching with great interest the spirited manner in which Mr. Hartley has been belabouring his opponents in the frequency controversy and I feel a certain disappointment that his latest blow, directed at my head, should have demolished nothing better than a man of straw. I refer to the last paragraph of his letter in your issue of May 25th in which he quotes and comments upon certain remarks of mine at the recent I.E.E. discussion.

If he refers again to the report on the discussion he will find that my contention as to the possibility of cutting top at the receiver was based upon the exaggeration, admitted by the B.B.C. engineers, of a certain range of upper frequencies at the transmitter. I regarded this as of advantage to the broadcasting art as a whole, inasmuch as it enabled the effect of interfering carrier waves to be reduced at the receiver, and I expressed a hope that, whatever good fortune the B.B.C.

¹ See *The Wireless World*, October, 28th, 1931.

engineers might obtain in producing microphones of uniform response, they would still transmit on a rising average characteristic in order to enable receiver designers to gain the advantage of using a falling characteristic.

Turning to the general question of fidelity I feel that while it is obviously of importance to attempt to improve results in all possible ways, there is at the moment a grave danger of your readers being misled into thinking that most of the imperfections of present day reproduction are due to the absence from the acoustic output of the frequency range from 5-10 kc. The fact that these frequencies have value is beyond dispute but so also is the need for selectivity in present day receivers and these two demands are competitive with each other. It is only when one reads, as in recent correspondence, of "exact reproduction," "each partial in its correct proportion," and so forth, that one begins to realise the tendency to treat the whole broadcasting chain from microphone to loud speaker as a whole translating device having a response characteristic like an amplifier. The plain fact is that there is no such thing as a response characteristic under practical conditions. We can measure the relations between the electrical quantities of the system and make them as uniform with frequency as we please, but if we demand that the sound pressure in each of our two ears shall be the same at any instant of time as if we were located near the studio microphone we are indeed "crying for the moon."

If Mr. Hartley happens by chance to be unfamiliar with the demoralising effects of acoustic interference upon the best-intentioned response characteristic, I would recommend him to try the experiment of exciting his loud speaker with a sine wave current of continuously variable frequency and measuring the effect upon a microphone located where he is accustomed to listen. I may say for the benefit of your readers that arbitrary fluctuations, in the ratio of 10:1 for a variation of a few cycles of frequency, and critical with the position of the microphone, are a commonplace occurrence. The effects of the varying absorption of different rooms you have already referred to in your recent Editorial. Another most potent cause of barely avoidable distortion is the fact that the response characteristic of both microphones and loud speakers vary according to the direction of the incident or emitted sound and we can thus never be certain what are the operating conditions at any moment. The engineering approach to the subject is by a consideration of average conditions and provided these are taken with a very large pinch of salt they form a most useful basis of constructive criticism, but no more. Exact reproduction (apart from binaural systems) is an impossible ideal, and we have to fall back upon aesthetic standards as our ultimate criterion.

From this point of view we are in a better position to consider the question propounded by Mr. West and echoed by Mr. Hartley—"what is it that the ordinary listener with a reasonably good set has been listening to?" My answer is that it is a reasonably effective presentation of the transmitted sound which contains in it most of the elements of aesthetic value existing in the original. If this were not the case it is inconceivable that broadcasting could have attained its present popularity or given such real satisfaction to genuine lovers of music.

In considering the range of frequencies to be transmitted therefore, I find myself at issue with Mr. Hartley and others of his way of thinking in so far as they consider that questions of fidelity of reproduction should be referred to an arbitrary technical criterion. The only possible standard is the satisfaction of the senses of the listener, and on this point nobody is in a position to lay down the law for others, nor is it necessarily those who are least musical who are most tolerant of a defective upper register. To apply this principle to one concrete case, namely, pianoforte reproduction, I would venture a personal opinion that this instrument gains to a negligible degree only by an extension of the frequency range, although it is extremely susceptible to distortion from other causes.

Turning to future developments, I agree heartily with the point of view of the B.B.C. engineers in taking steps to provide an extension of the frequency range for those who wish to take advantage of it. I would urge them to consider transmitting on a rising average-frequency characteristic, as I believe this is one of the ways in which a basic improvement in com-

munication can be obtained, and I suggest very strongly that they study the polar characteristics of their microphone: as it may well be that a reduction in directional distortion will be of benefit even over the limited range of frequency at present available. I do not feel that the extended frequency range will cause much increase in interference with neighbouring receivers, at any rate not of an avoidable character, and the provision of the necessary frequency band in the transmitter can thus at the worst do no harm. At the same time I must reiterate my view that an increase of the frequency range in receivers is incompatible with the present demand on the part of the public for selectivity that the present limited frequency range is not the only, nor even the most potent cause of distortion in present day reproduction and that since absolute realism is unattainable, aesthetic value is the standard by which we must judge results.

P. W. WILLANS.

I HAVE no desire to waste valuable space in your columns in wordy warfare with Mr. Hartley; but as he has occupied three-quarters of a column trying to show that I am "not so sound"—whatever that may mean—perhaps you will allow me a few lines in reply.

The point of my criticism was and is that by emphasising the large range of harmonics and upper partials sounded by musical instruments and the voice, he certainly gives the impression to those who have not previously studied the subject—that a receiver which does not reproduce at a reasonable level all musical frequencies up to at least 10 kc., seriously distorts both music and speech and a limit of anything like 5 kc. is not worth listening to. I repeat my opinion that this is a considerable *distortion* of the facts. Perhaps I may mention some of the bases of my opinion which has not been hastily formed. Among these are (1) The work of various physicists and experimenters. These have shown among other things, that the intensities at which frequencies over 5 kc. are normally transmitted by instruments and voices are very low indeed. Some physicists are of the opinion that the "timbre" of instruments is more concerned with "tone-formers" than with the upper partials which Mr. Hartley makes so much of. Some who have worked with gramophones consider that such an instrument which cuts off at 5 kc. rather than 4 kc. must be considered a luxury. (2) Personal experience of myself and friends (not entirely unmusical) with an ordinary moving-iron loud speaker and a simple set, both designed four or five years ago—coupled with the frequency response reports of various loud speakers published from time to time in *The Wireless World* (see one example in the issue of May 25th). I might add that I do *not* consider that *any* loud speaker which cuts off at 5 kc. is good enough, or that we should not aim at anything more. That is another matter.

Woolwich

R. A. WEST, A.M.I.E.E.

(Elect. Eng. Branch, M. College of Science).

5,000 Cycles.

A CORRESPONDENT criticises writers on the subject of the loud speaker for calling it a musical instrument—and, almost in the same drop of ink, heaps scorn on it as a reproducer; so, presumably, he regards it as neither. In that event he might leave those of us who do get some enjoyment within 5,000 cycles (or much less, on the average, whether from our musical instrument or reproducer) to wallow in the lack of musical quality we achieve—at least, until a receiver has been produced which will accept the additional 5,000 (or so) cycles without the inevitable concomitant beauties of heterodynes or mixed programmes so necessary to true musical appreciation—or until some genius induces the spectrum authorities to polarise every second transmitter. After all, there are plenty of puddings besides treacle; and not all of us insist upon liqueur brandies for the enjoyment of a meal.

I wonder what fare your "Monodial A.C. Super" provides for the enthusiasts whose letters appear next but one before that of "W. C. F."? 5,000 cycles, indeed. How dare they!

Armagh, N. Ireland.

JOHN A. PEEL.

WIRELESS ENCYCLOPEDIA

No. 17

Brief Definitions with
Expanded Explanations.

HIGH-FREQUENCY RESISTANCE. That property of an electric circuit by virtue of which energy is dissipated when a high-frequency current passes. Its numerical value in ohms is defined as the ratio of the power absorbed in watts to the square of the R.M.S. current in amperes.

RESISTANCE is usually referred to as one of the *constants* of the electric circuit, but this only applies under conditions of fixed current and temperature. The resistance offered by a circuit to high-frequency alternating currents may be many times greater than that offered to direct current, the difference depending on both the frequency of the current and the nature of the circuit. In the usual sense resistance is a physical property of the conductor carrying the current and may be regarded as a kind of frictional resistance to the motion of the electrons comprising the current. When a current is driven through a conductor against the resistance, energy is consumed and converted into heat.

In stating that the A.C. resistance of a circuit is greater than its D.C. resistance it must not be taken that a comparison is being made between *impedance* in the one case and resistance in the other; it is an increase in the actual resistance that occurs. For instance, one ampere of A.C. through a given circuit will generate more heat per second than one ampere of direct current in the same circuit.

Sources of Energy Loss.

If P watts is the power or rate at which energy is consumed in a circuit when the current is I amperes (R.M.S. value), the effective resistance of the circuit is $R = P/I^2$ ohms. Now, in general electrical engineering practice resistance is conceived

as the property of a circuit by virtue of which heat is generated within the conductors themselves when a current is flowing; but, in radio-frequency engineering the resistance is computed from the total power consumed, whether the energy is dissipated within the conductors or elsewhere.

A high-frequency tuning coil may be cited as an example where any kind of energy consumption represents a loss, and the effective resistance of the coil is the number which, when multiplied by the square of the current, gives the total loss.

In a high-frequency circuit there are several sources of energy loss contributing to the effective high-frequency resistance. Among these are: (a) the heat losses in the conductors themselves due to their actual or "ohmic" resistance, (b) energy transferred to neighbouring closed circuits through the medium of mutual induction, (c) losses in the insulating materials used in conjunction with the circuit, (d) energy radiated into space in the form of ether waves, (e) losses in any iron or other magnetic materials within the magnetic field of the circuit.

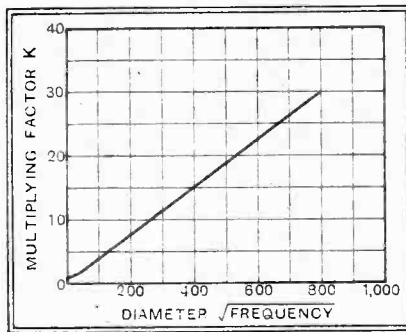

The curve enables the H.F. resistance of round straight wires to be determined from the D.C. resistance by multiplying the latter by the factor K. The wire diameter is in cms., and the frequency in cycles per second.

Apart from the incidental losses (b) to (e), inclusive, the ohmic resistance of the conductor itself varies with the frequency of the current. With D.C. the current is uniformly distributed within the conductor, and this is also very nearly true for

alternating currents of low frequency in their conductors. But when a high-frequency current flows in a solid conductor it is no longer uniformly distributed over the cross-sectional area. Actually the greater portion of the current flows near the surface of the conductor, the central part carrying only a relatively small proportion. This effect is referred to as *skin effect*, because at very high frequencies practically the whole of the current is concentrated near the surface of the conductor in a thin layer.

D.C. and A.C. Resistance.

The reason why high-frequency currents are driven towards the outer surface of a conductor is that the alternating magnetic field set up "in circles" in and around the conductor generates electromotive forces which strengthen the current near the surface and weaken it near the centre. Now, the heat generated by a current in a conductor is least when the current is uniformly distributed, and therefore the concentration of current at the outer surface results in greater losses for a given current, and so the resistance is increased.

The ratio of A.C. resistance to D.C. resistance for a solid round conductor increases as the frequency is raised, and, as the diameter of wire is increased, the ratio depending on the product of the diameter of the wire and the square root of the frequency. In the figure a curve is given showing the factor by which the D.C. resistance must be multiplied to give the A.C. resistance for various values of diameter \times $\sqrt{\text{frequency}}$, the diameter being in centimetres and the frequency in cycles per second.

Next Week's Set Review:—

REGENTONE
ALL-ELECTRIC A.C.
3-VALVE RECEIVER.

READERS' PROBLEMS.

THESE columns are reserved for the publication of matter of general interest arising out of problems submitted by our readers.

Readers requiring an individual reply to their technical questions by post are referred to "The Wireless World" Information Bureau, of which full particulars, with the fee charged, are to be found on page 596.

Short-circuited Grid Bias.

ALTHOUGH the low-potential end of the tuning coil which precedes a grid detector may almost invariably be earthed, the same rule does not hold good when the succeeding valve is negatively biased to act as an amplifier, or when the coil in question forms part of a band-pass filter with "bottom-end" capacity coupling. In these cases, a short-circuit will be imposed across the grid bias, the filter coupling condenser, or perhaps both.

This seems to be responsible for a puzzling effect observed by a correspondent, who has built the "Battery V.M. Three"; he states that the volume control potentiometer works according to plan on the long-wave band, but it is quite inoperative when medium waves are being received.

This is an almost certain indication that the ganged switch control rod, when at one end of its travel, introduces a short-circuit across both the filter coupling condenser and the source of variable grid bias for the H.F. valve; the fault should not be a difficult one to trace.

Rotary Converters.

WE are asked by a reader who has a low-voltage (110 volts) direct current supply, whether it would be practicable to install a D.C.-to-A.C. rotary converter in an outhouse, with the object of avoiding annoyance from the noise of the machine. Our correspondent seems to be in doubt as to whether the long connecting lead between the converter and the receiver is likely to be responsible for hum.

No trouble whatever should be experienced on account of the long leads in this case. We advise, however, that the wiring should be done as carefully as that of the electric supply. As the consumption of A.C. current—and consequently the voltage lost in the leads—will not be high, it will probably be convenient to use twin lead-covered cable, of reasonably heavy gauge, for the purpose.

Wattage Rating and Current Capacity.

IT is asked how the wattage dissipated in a fixed resistance of known value may be calculated in order to determine whether the resistor is suitable for a certain position in a receiver.

To make this calculation, it is necessary to know the current passing through the resistance as well as its ohmic value. Given this information, the number of watts dissipated is ascertained by multiplying the square of the current (in amperes) by the resistance (in ohms).

Electric Light Switches.

IN reply to a reader who asks what can be done to his receiver to prevent annoying clicks being heard in the loud speaker when the house-lighting switches are operated, we can say with some confidence that the answer is "nothing." In practice, interference of this sort must always be eliminated at the source.

We suggest that the switches should be overhauled, and in particular that their contacts should be cleaned. Arcing at the contacts, due to a slow-acting break mechanism, is often responsible for radiation, and a spot of light oil applied in the right place will often improve matters.

Screened Reaction Wire.

WHEN unconventional receiver "lay-outs" are attempted, it is often found that the wiring of the reaction control condenser is somewhat of a

as the set works satisfactorily when this wire is removed. He asks whether it would be permissible to screen the live reaction lead, and also wishes to know whether a serious loss of high notes is to be expected as a result of thus adding capacity in the detector anode circuit.

Screening of the reaction lead should prove entirely satisfactory in this case, and there is no need to fear a loss of high notes. Provided that a screened conductor of reasonably low capacity is employed, the total added capacity is most unlikely to exceed some 20 micro-mfds., which is probably negligible in comparison with the other capacities already existing in the circuit.

Monodial Interconnections.

AS the power-supply equipment and output stage of the "Monodial A.C. Super" is built as a separate unit, quite apart from the receiver proper, it will be obvious that this set lends itself quite readily to operation in conjunction with an existing amplifier, or with the output stage of an existing local-station receiver. A number of readers have asked questions on this subject, and the apparent uncertainty which exists in some cases on the method of interconnection may best be dispelled by means of a schematic diagram which shows the various inputs which the "Monodial" receiver unit requires, and also how the output of the set is arranged. These details are shown in Fig. 1.

A consideration of the diagram will show that the receiver unit requires a low-tension current of 5 amps. A.C. at 4 volts for the heaters, in addition to 200

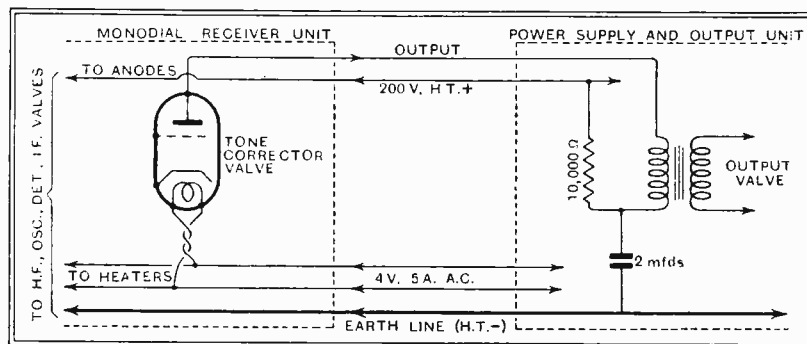

Fig. 1.—External connections between the "Monodial" receiver unit and a combined power-supply and output unit.

problem. This is particularly likely to be true when an "H.F." set with an abnormally great back-to-front dimension is constructed, as the reaction lead will be carrying amplified H.F. energy, which may cause undesirable interaction when it is passed in close proximity to the input grid circuit.

This has been found out by experience by a reader who has just constructed a receiver of the "deep and narrow" type to fit into an existing piece of furniture. Instability is evident, and its cause has finally been traced to the reaction lead,

volts for the anode circuits. This high-tension supply must be smoothed, as the existing smoothing circuit is included in the power unit. An H.T. consumption of 50 milliamps at the voltage given must be legislated for.

With regard to output, the "Monodial" receiver unit ends abruptly, so to speak, at the anode of the tone-correcting valve, from which corrected and slightly magnified L.F. impulses are available for application to any suitable output stage; the necessary coupling device must be included in the output unit.

The Wireless World

AND
RADIO REVIEW
(21st Year of Publication)

No. 669.

WEDNESDAY, JUNE 22ND, 1932.

VOL. XXX. No. 25.

Editor: HUGH S. POCOCK.

Editorial Offices: 116-117, FLEET STREET, LONDON, E.C.4.

Editorial Telephone: City 9472 (5 lines)

Advertising and Publishing Offices: DORSET HOUSE, TUDOR STREET, LONDON, E.C.4.

Telephone: City 2846 (15 lines).

Telegrams: "Ethaworld, Fleet, London."

COVENTRY: Hertford St. BIRMINGHAM: Guildhall Bldgs., Navigation St.

MANCHESTER: 260, Deansgate

GLASGOW: 26B, Renfield Street, C.2.

Telegrams: "Cryolist, Coventry."
Telephone: 5210 Coventry.

Telegrams: "Autopress, Birmingham."
Telephone: 2970 Midland (3 lines)

Telegrams: "Hiffe, Manchester."
Telephone: Blackfriars 4412 (4 lines).

Telegrams: "Hffe, Glasgow."
Telephone: Central 4857.

PUBLISHED WEEKLY.

ENTERED AS SECOND CLASS MATTER AT NEW YORK, N.Y.

Subscription Rates: Home, £1 1s. 8d.; Canada, £1 1s. 8d.; other countries abroad, £1 3s. 10d. per annum.

As many of the circuits and apparatus described in these pages are covered by patents, readers are advised, before making use of them, to satisfy themselves that they would not be infringing patents.

EDITORIAL COMMENT.

The B.B.C. Report.

THE fifth annual report of the British Broadcasting Corporation for the year 1931 has just appeared. The report constitutes an interesting record of steady progress, and brings home the variety and importance of the service which broadcasting renders to-day.

In connection with a previous report we had occasion to criticise the atmosphere of self-satisfaction which permeated the document, and it is particularly gratifying to find that no such accusation can be levelled at the annual report just issued. It constitutes a statement of fact, with explanations here and there; but references of a type to which we previously took exception are noticeable by their absence.

It is natural to find that the wavelength situation is referred to in this report, and, from the point of view of our readers, this is, perhaps, the most interesting section. It is stated that, with a view to ameliorating the wavelength situation, a number of international technical meetings have been held at which the Corporation has been represented, and certain changes have been effected in the wave plan to remove the major cases of interference; but it is indicated that the question of European broadcast wavelengths in general is not likely to receive full attention until after the world conference of all wireless matters which is being held in Madrid this autumn. Presumably, therefore, we may anticipate that, following upon Madrid, the broadcasting authorities in Europe will get together and tackle their own particular problem in detail.

There are many rumours current at the present time in regard to this question of wavelength distribution, but readers, we think, should disregard them, for it is inconceivable that there can be any real foundation

for projects of reallocation of wavelengths until after the conference at Madrid and a special broadcasting conference later have taken place.

The Modern Straight Five.

ARTICLES and correspondence in *The Wireless World* recently indicate the keen interest of the public in the question of quality of reception, and some correspondents have even had the temerity to question the adequacy of the frequency range transmitted by the B.B.C.

We cannot expect to be able to reproduce at our loud speakers a better frequency range or better quality than is transmitted, but we can take it that if all receivers did full justice to the quality put out by the B.B.C. we should have progressed a long way in the right direction. Seeing how great is the interest in and importance of good-quality reception, a receiver described in this issue—"The Modern Straight Five"—should make a special appeal. This set has been designed, putting quality before all other considerations, but retaining a degree of selectivity adequate to ensure that quality will not be marred by mutual interference of transmitters.

A feature of interest in connection with this set is that the output stage has been designed on very generous lines, and has been made as a separate unit which is interchangeable with "The Wireless World Monodial A.C. Super" recently described. Many enthusiastic readers who have constructed the Monodial Super have expressed the wish to have a more generous output stage, and the present design will meet their requirements, in addition to supplying the "Modern Straight Five" with an output worthy of its aspirations in the matter of quality of reproduction.

THE MODERN

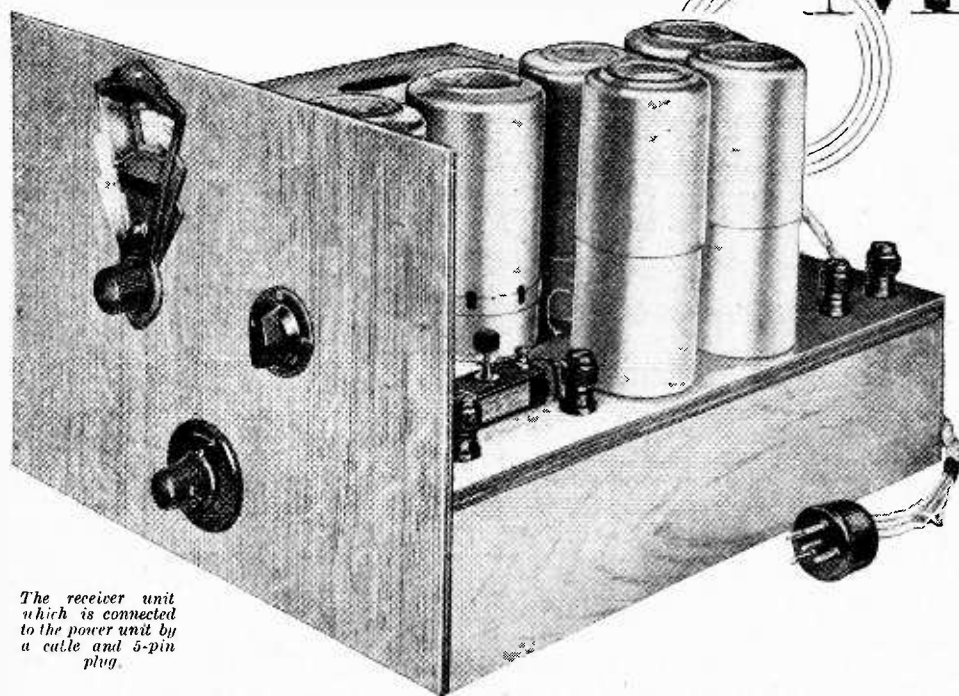

The receiver unit which is connected to the power unit by a cutie and 5-pin plug.

A Long-range Receiver with Two Variable-mu H.F. Stages.

By W. I. G. PAGE, B.Sc.,

In this connection it should be noted that the output stage has been designed specially with a view to its being employed with the Monodial A.C. Super¹, and that for this purpose no modification whatever is needed either to the Monodial receiver unit or to the Modern Straight Five unit. Those who favour the superheterodyne type of receiver, therefore, but who like a

THE straight type of receiver can always depend upon a faithful band of adherents who, carefully weighing the pros and cons, consider that the reliability of this form of set, together with its superlative quality of reproduction and freedom from valve hiss, more than compensate for some lack of selectivity as compared with the superheterodyne. And, in addition, they recall the fact that the straight set can boast an easily understood technique.

"The Modern Straight Five" has been designed throughout to give high-quality reproduction from the majority of British and Continental stations, as well as from gramophone records, and to possess a degree of selectivity that will ensure adequate freedom from interference. Reference to the circuit diagrams will show that the set has two variable-mu H.F. stages followed by a power grid detector, which in turn is linked by a transformer to a high-voltage output valve capable of delivering to the loud speaker nearly 6 watts undistorted A.C. energy. A two-unit method of construction has been adopted, partly because this simplifies the actual work involved, but chiefly because the output stage and mains equipment are then available for use with other receivers.

large output stage should use this power unit with the Monodial receiver, instead of the power unit originally specified.

Preceding the first H.F. valve is a band-pass filter of constant peak separation, the two component circuits of which are coupled by a common capacity C_2 and negative mutual inductance formed by the link circuit. This pre-selector tends to keep the selectivity substantially constant over the waveband, and is certainly more efficient than either a simple common capacity or inductance coupling. In order to provide a conductive path between the grid and cathode of the valve, a 1,000 ohms resistance R_1 is connected across C_2 , while the aerial is joined to the first tuned circuit through the 0.0001 mfd. compression type condenser C_1 .

The coupling between the two H.F. stages is by the well-known tuned-anode method, with the anode connection tapped well down the tuned circuit in order to obtain a maximum of selectivity and to promote stability. The voltage developed across the tuned circuit is passed to the grid of the next valve through

FEATURES OF

"THE MODERN STRAIGHT FIVE."

An A.C. mains receiver with two variable-mu H.F. stages followed by power-grid detector and transformer coupling. Output stage capable of delivering about 6 watts (A.C.). Single-dial control of four tuned circuits including constant peak band-pass filter. Tapped tuned-anode coupling.

Totally screened coils and valves, together with metal-covered baseboard, ensure stability.

¹ See *The Wireless World*, dated April 13th and 20th, 1932.

STRAIGHT FIVE

Embodies
the Most Advanced
Practice in "Straight"
Design.

and W. T. COCKING.

the 0.0005 mfd. condenser C_6 and a conductive path to earth is provided through the 0.5 meg. leak R_{10} . In order that a minimum of components may be used in the assembly, and to obtain a maximum of screening, both this condenser and resistance are included in the coil base, and are therefore contained within the normal coil screen. The coupling between the second H.F. and the detector valves is by means of a similar arrangement, but in this case the coupling condenser C_9 has a value of 0.0001 mfd. and the grid leak R_{11} a resistance of 0.25 meg., values well suited to power-grid detection.

The detector is of the now standard power-grid type, and is provided with the usual H.F. filter, comprising an H.F. choke and a 0.002 mfd. condenser C_{12} , in its anode circuit. It is transformer-coupled to the output valve by means of a component having a step-up ratio of 3.5-1, and the operating conditions are, therefore, adjusted so that the maximum signal output from the valve on deep modulation is about 10 volts peak. The H.T. supply for this stage is taken from the 200 volts (nominal) line through the 10,000 ohms decoupling resistance R_{17} (Fig. 2), and the usual 2 mfd. decoupling condenser C_{13} is shunted to earth.

It will be noted that the anode current of the AC/HL detector is passed through the primary of the AF5 transformer, and that no parallel-feed system is employed. This circuit has been adopted, first, because it is simple, and secondly, because the decoupling of the grid of the PP5/400 valve can be carried out efficiently; furthermore, there need be no fear of loss of bass register, as the primary inductance exceeds 90 henrys with the steady D.C. feed, which does not rise above 6.5 mA. under no signal conditions.

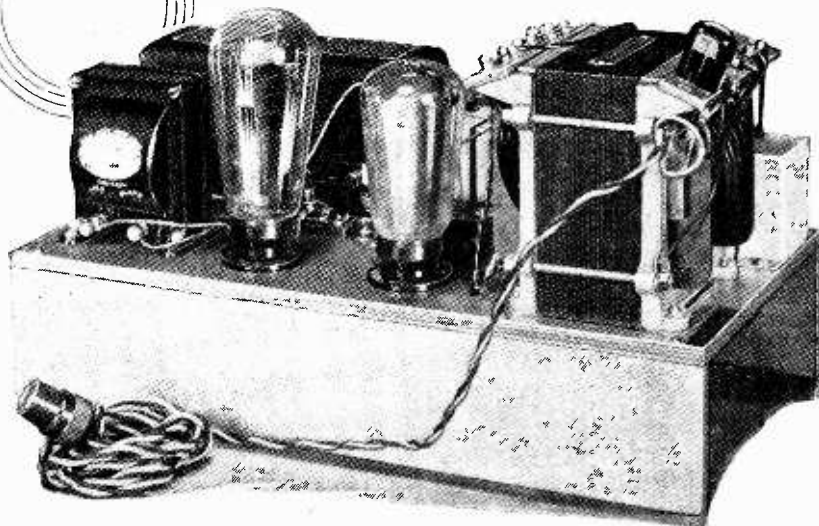

The power unit, which is suitable without modification to follow the Mouvinal A.C. Super receiver.

When gramophone records are being reproduced, the detector valve must act as an amplifier, so that bias is provided by voltage drop along the 1,000 ohms resistance R_{11} , shunted by the 1 mfd. condenser C_{11} . A simple make-and-break switch S_1 in the detector grid circuit connects the pick-up in circuit, and an unusual feature is the mechanical linking of this switch with the waverange switch, so that a single knob controls the change from medium to long waves and from radio to gramophone.

A further simplification to the controls is afforded by the mechanical linking of the radio and gramophone volume control potentiometers and the mains on-off switch. The radio control consists of the 5,000 ohms potentiometer R_9 acting to vary the bias of the H.F. stages, while the gramophone control is a 50,000 ohms potentiometer R_{16} connected across the pick-up. The sliders of these controls are mounted on a common spindle so that they are operated simultaneously; furthermore, when the control is fully rotated to the position

of minimum volume, a cam presses over the mains switch and cuts off the power supply to the receiver. In this way the total of the panel controls to fulfil all the usual functions is reduced to the very minimum number—namely, three.

To ensure a smooth and linear control of acoustic output both on radio and gramophone, the two ganged

MORE SPECIAL FEATURES OF THE SET.

Three controls only. (1) Tuning control with illuminated dial. (2) Ganged volume controls consisting of two graded track potentiometers for radio and gramophone, respectively, linked to mains on-off switch which is operated at minimum volume position. (3) Waveband switch with intermediate position for gramophone reproduction.

Loud speaker field in smoothing circuit.

Features of interest include automatic thermal delay switch to safeguard condensers from high voltages, special circuit to prevent parasitic H.F. oscillations in the output stage and earthed metal screen around primary of mains transformer to stop modulated hum and mains background noise.

The Modern Straight Five.—

potentiometer volume controls have graded tracks, and it is essential to connect the resistance elements in the correct way. In the case of the radio control the end of the track at which the resistance changes least for a given radial movement of the slider should be connected to earth. For gramophone reproduction a similar track connection is made to earth, but as an increase of volume in this case is obtained as the slider moves away from earth the resistance strips of each volume control are mounted in such a way that the graded tracks are in opposite directions.

The screening of the components in the H.F. amplifier is particularly complete, for not only is each coil and each variable condenser section totally enclosed in a metal container, but a new type of valve screen with closed top is employed around the two variable- μ

the cathodes themselves are maintained at earth potential to H.F. currents by the 0.1 mfd. non-inductive by-pass condensers C_3 and C_7 . The screen-grid and anode circuits are decoupled by the 600 ohms resistances R_5 , R_6 , R_7 , and R_8 , in conjunction with the 1 mfd. condensers C_4 , C_8 , C_9 , and C_{10} . The positive H.T. line has a nominal potential of 200 volts, so that the screen grids are fed from the usual potentiometer arrangement consisting of the 10,000 ohms resistance R_{13} , the 7,500 ohms resistance R_{12} , and the 5,000 ohms volume control potentiometer R_9 . Provided that the potential of the H.T. line remains reasonably constant, therefore, the screen voltage will follow its normal small variation of from some 65 volts to 80 volts with the variation of the volume control.

The attainment of a constant anode potential, however, is by no means simple in a case such as this where the

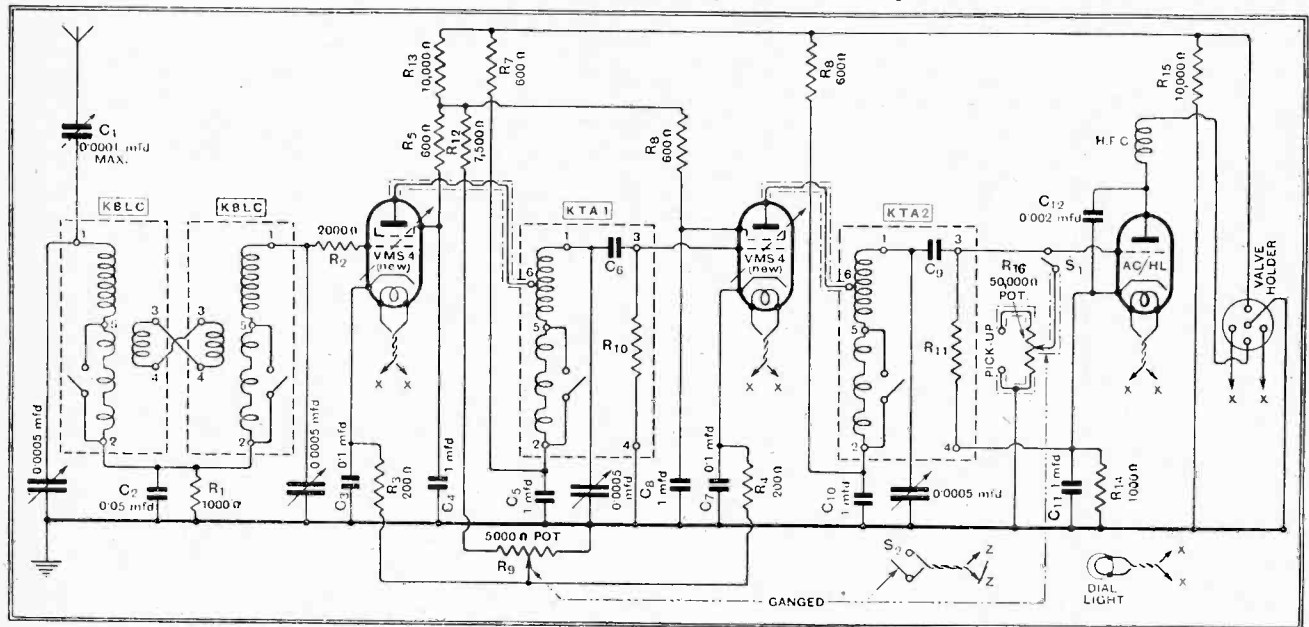

Fig. 1.—Circuit diagram of the receiver unit. C_1 , pre-set condenser 0.00005 to 0.0001 mfd; C_2 , mica dielectric; C_3 , C_4 , C_5 , C_6 , C_7 , C_8 , C_9 , C_{10} , C_{11} , non-inductive type; C_6 , R_{10} and C_9 , R_{11} , are contained within the coil bases and are supplied with them. R_1 , R_2 , R_{14} , metallised 1-watt resistances; R_9 , R_{16} and S_2 , ganged on one spindle; waverange switch and S_1 linked together; R_{15} , 10-watt resistance.

valves. It has long been felt that in the case of a 2-H.F. set the projecting anode terminal of the screen-grid valve is a potential source of unwanted coupling. The new² type VMS4 valves, having a mutual conductance of 2.4 mA./volt, are used in the receiver, and their bulbs should be non-metallised. Earthed metal sleeving is employed over the leads to the two pick-up terminals, also for one lead to S_1 and for both anode connections of the variable- μ valves—the latter being brought out of the slots at the bottom of the valve screens. To ensure stable amplification when the volume control is at its maximum position a non-inductive resistance R_2 of 2,000 ohms is connected to the grid of the first valve.

Before proceeding to discuss the details of the L.F. circuits and mains equipment, the feed circuits to the H.F. valves are worthy of some attention. The minimum bias is provided in the usual way by the resistances R_3 and R_4 of 200 ohms in the V.M.S.4 cathode leads, while

supply from the mains rectifier is at a high voltage. At first glance it appears merely that we should have to insert a resistance in the supply to drop the voltage to the required value, and this would be perfectly feasible were it not for the fact that the current drawn by the H.F. valves varies with the setting of the volume control. There are two ways of overcoming the difficulty—a variable resistance can be connected to the H.T. supply and ganged to the volume control so that the variation of load is compensated for,² or we can make the total standing current through the feed resistance so high that the variation of anode current is negligible in comparison.

The latter method has been adopted in this receiver as being the simpler. The total feed current for the H.F. stages, the detector, and the potentiometer and

² See article in last week's issue entitled "Variable- μ Valves—Operating Voltages of the New Types."

WIRING PLAN OF BASEBOARD AND UNDER-BASEBOARD OF RECEIVER UNIT.

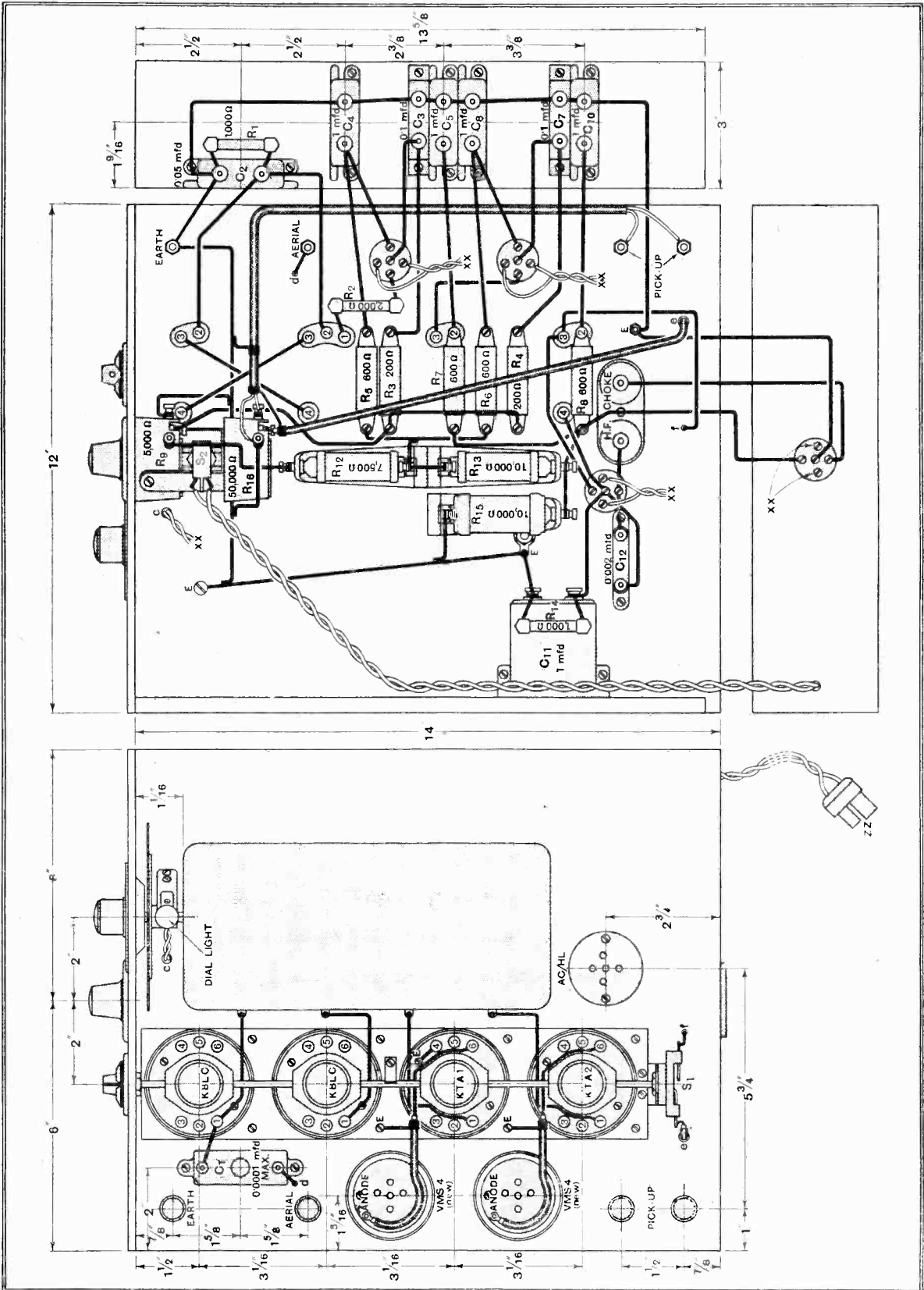

All decoupling equipment and resistance feeds are housed beneath the baseboard. Screened leads are used for the pick-up terminal connections, the anode leads, and one lead to the gramophone-radio switch.

The Modern Straight Five.—

stabilising resistance is 50 mA., with the volume control at maximum, and 40 mA. with the volume control at minimum. The H.T. supply is at 435 volts, and is taken through a 5,000 ohms resistance, made up of the 2,500 ohms resistance R_{23} and the 2,500 ohms speaker field. The voltage drop is 250, and the anode potential of the H.F. stages is 185 volts with maximum volume.

When this control is rotated to the position of minimum volume, the current falls to 40 mA., and so the potential of the H.T. line rises to 235 volts. The H.F. valves, however, are now biased negatively by some 50 volts, so that their actual anode potential is still about 185 volts. At a setting of the volume control midway between maximum and minimum, the anode potential reaches its maximum value of about 210 volts. The valves and screen potentiometer, of course, do not take sufficient current to make the total of 50 mA., so this is obtained by the use of the 10,000 ohms resistance R_{15} (10-watt type) shunted across the H.T. line.

In this way substantially constant anode and screen grid potentials are obtained from a high voltage source without the complication of ganged resistance controls, which would need special tapering of the resistance elements for perfect operation. The sole disadvantage of the scheme used is a somewhat increased current supply, but this is of little moment in a set already well within the rating of a class C rectifier.

In next week's issue constructional details and hints on operation will be given.

For the convenience of readers constructing the Modern Straight Five, full-sized blue prints of the complete layout and wiring diagrams appearing in this and next week's issue are available from the publishers at 1s. 6d. post free.

LIST OF PARTS.

After the particular make of component used in the original model, suitable alternative products are given in some instances.

RECEIVER.

- 1 Variable condenser, 4-gang, with dust cover (British Radiophone)
- 1 Dial for above with pilot lamp attachment (British Radiophone)
- 1 Set of 4 coils; 1 pair KBLC ganged to KTA1 and KTA2 and gramophone switch (Colvern)
- 2 VSC valve screens (closed top) (Colvern)
- 1 Semi-fixed condenser, 0.0001 mfd. max. (Formo-Densor "F")
- 4 5-pin Valve holders, under-baseboard type (Eddystone)
- 1 Binocular H.F. choke (Climax, Type CH271)
- 1 Twin volume control with graded tracks, 5,000 ohms and 50,000 ohms, with mains on-off switch (Wright and Weaire)
- 2 Wire-wound resistances, 200 ohms (Varley "Tag" type)
- 4 Wire-wound resistances, 600 ohms (Varley "Tag" type)
- 1 Wire-wound resistance, 7,500 ohms, and holder (Varley "Popular" type)
- 1 Wire-wound resistance, 10,000 ohms, and holder (Varley "Popular" type)
- 1 10-watt Power resistance, 10,000 ohms, and holder (Varley type EP42)

- 2 Metallised resistance, 1,000 ohms, 1 watt (Dubilier)
 - 1 Metallised resistance, 2,000 ohms, 1 watt (Dubilier)
 - 2 Fixed condensers, 0.1 mfd., paper (non-inductive) (T.C.C., type 50)
 - 1 Fixed condenser, 0.05 mfd., mica (Dubilier, Hydra.) (T.C.C., type 25A)
 - 5 Fixed condensers, 1 mfd., non-inductive (Dubilier, Hydra.) (T.C.C., type 50)
 - 1 Fixed condenser, 0.002 mfd. (Dubilier, Hydra.) (T.C.C., type 34)
 - 1 Venesta "Plymax" baseboard, 14in. x 12in. x 3/16in. (Peto Scott)
 - 2 5-pin Plugs (Dublin, P3)
 - 1 Twin connector (Belling-Lee)
 - 1 5-way Battery cable, 30in. (two conductors to carry 6 amps.) (Harbros.) (Bulgin, type W.W.)
 - 1 6-volt 0.1 amp. Pilot lamp (Bulgin)
 - 4 Ebonite shrouded terminals: aerial, earth, pick-up, pick up (Belling-Lee, type B)
 - Screened sleeving (Lewcos, Goltone, Harbros)
 - 1 Plywood panel, 12in. x 9 1/2in. high x 3/16in. (Peto Scott)
 - Screws, Wire, flex, sleeving, wood, etc.
 - Valves: 2 VMS4 (new type) (non-metallised) Osram, Marconi.
 - 1 A. 11L (metallised) Mazda
 - 1 6d V Mullard (new type) Marconi and Osram M14, Cosor 41MH.
- (Approximate cost without valves, £9.)

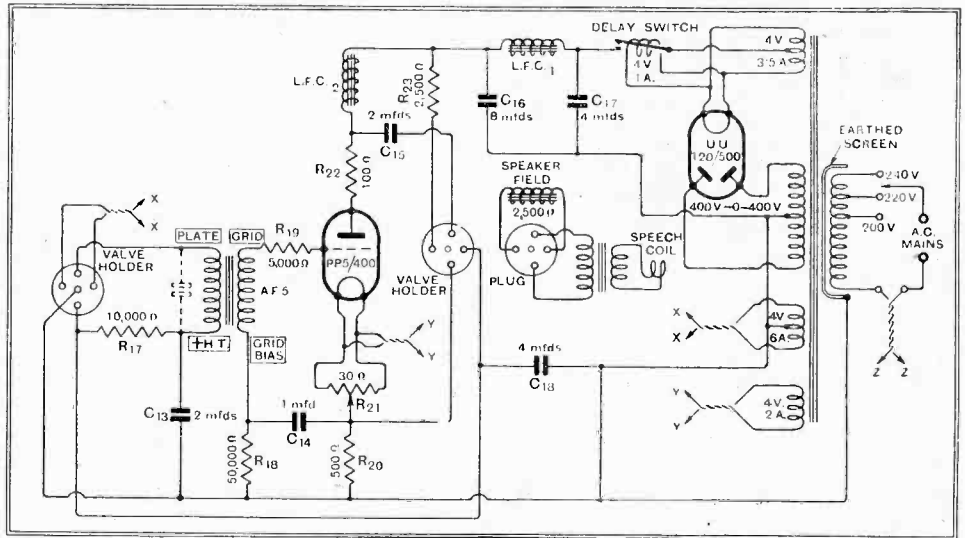
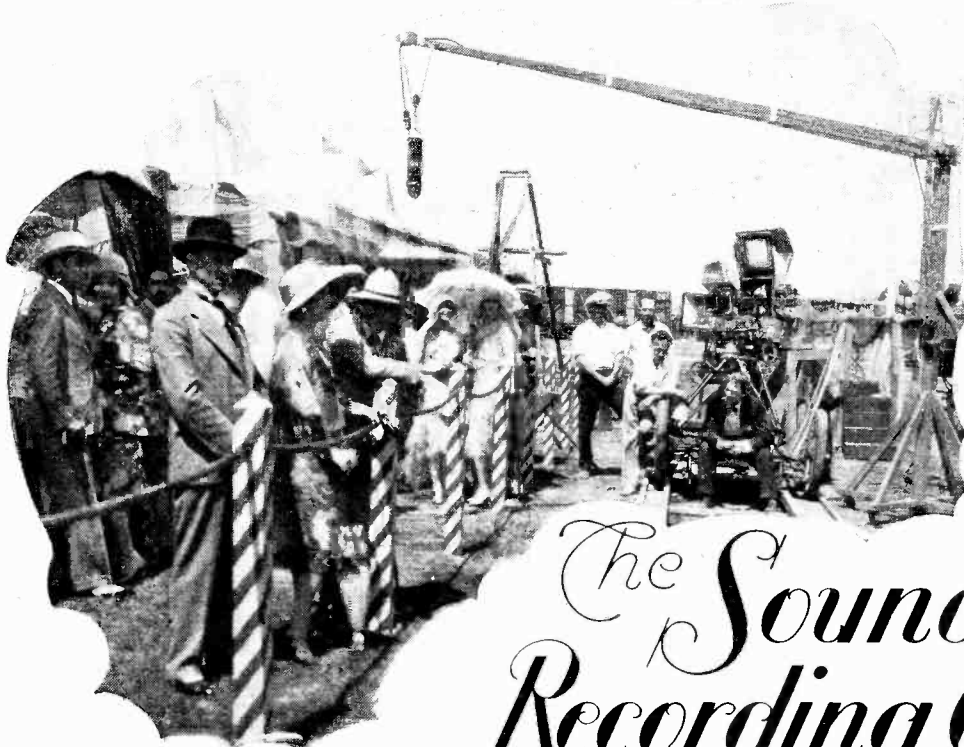

Fig. 2.—The power unit. R_{17} , R_{18} , R_{19} , R_{22} , metallised resistances 1-watt type; R_{20} , 3-watt resistance; R_{23} , 10-watt resistance; C_{15} , C_{16} , C_{17} , C_{18} , 1,500-volt D.C. test.

Power Unit.

- 1 Mains transformer; primary with earthed screen, secondary windings 400-0-400, 4 v. 6 amps., e.t.; 4 v. 3.5 amps., e.t.; 4 v. 2 amps. (Parmeko)
 - 2 L.F. Smoothing chokes, 28/14 henrys (R.I., type DY11)
 - 1 L.F. Transformer, 3 1/2 to 1 (Ferranti, AF5)
 - 1 Thermal Delay switch (Varley, type EP17)
 - 1 Potentiometer, 30 ohms (Claude Lyons, Hum Dinger)
 - 1 10-watt Power resistance, 2,500 ohms, and holder (Varley, type EP38)
 - 1 Metallised resistance, 100 ohms, 1 watt (Dubilier)
 - 1 Metallised resistance, 5,000 ohms, 1 watt (Dubilier)
 - 1 Metallised resistance, 10,000 ohms, 1 watt (Dubilier)
 - 1 Metallised resistance, 50,000 ohms, 1 watt (Dubilier)
 - 1 Metallised resistance, 500 ohms, 3 watts (Dubilier)
 - 4 5-pin Valve holders, under-baseboard type (Eddystone)
 - 4 Fixed condensers, 4 mfd., 1,500 v., D.C. test (Peak)
 - 1 Fixed condenser, 2 mfd., 1,500 v., D.C. test (Peak)
 - 1 Fixed condenser, 1 mfd., 500 v., D.C. test (T.C.C., type 65)
 - 1 Fixed condenser, 2 mfd., 500 v., D.C. test (Dubilier.) (T.C.C., type 65)
 - 1 5-pin Plug (Bulgin, P3)
 - 2 H.T. Safety sockets (Belling-Lee)
 - 1 Venesta ("Plymax") baseboard, 16in. x 8 1/2in. x 3/16in. (Peto Scott)
 - Screws, wire, flex, sleeving, lamp-holder adaptor, wood, etc.
 - Valves: 1 UU120/500 (Mazda)
 - 1 6d V Mullard (new type) Marconi and Osram M14, Philips 1561, Six-Sixty SSW120/500.
 - 1 PP5/400 (Mazda).
- (Approximate cost without valves, £10.)
- Cabinet: The London Super Cabinet Company, 35/37, Wadson Street, Cambridge Road, London, E.2. (12in. x 12in. wooden panel supplied.)



Outdoor work with microphone and camera. By courtesy of "Film Weekly."

Part II.
Variable
Density Systems:
Reducing
Ground Noise.

By
W. H. O. SWEENEY.

The Sound Recording Camera

TURNING now to variable-density recording, the system evolved by Western Electric may be found in use at the B. and D. studios, Elstree.

This method uses constant light and a variable slit. A photograph of the recorder is shown on the next page. The film is drawn from the top magazine by the sprocket S_1 , and passed round the recording sprocket S_2 . This sprocket, which engages only twenty perforations of the film, is driven through a mechanical filter composed of a three-point, star-shaped driving member acting through compression springs. This filter ensures that the sprocket shall have a uniform angular velocity, which would result in the linear motion of the film past the light being kept constant. The flywheel forming part of the filter is so balanced that the angular velocity is kept constant to one part in a thousand. After leaving the recording socket, the film is drawn into the lower take-up magazine by the sprocket S_1 .

The light system is seen to consist of a light source, a condenser, a light valve, and an optical system for focusing the image of the valve on to the film. The system is represented diagrammatically in Fig. 3, and the light valve is shown in more detail in Fig. 4. Like the R.C.A. vibrator, it consists of a duralumin tape, looped and suspended in a plane at right angles to a magnetic field. This tape, which is 6 mils in width and 0.5 mil thick, is stretched over two insulated bridges, the

distance between the two limbs being 1 mil. They lie just over the top edge of a slab of metal which forms part of the armature of an electro-magnet, and are separated from it by 3 mils. In the edge of this metal slab is a slot, measuring 8 mils wide by 256 mils long. This slot tapers out to the back of the slab, where it measures 204 mils by 256 mils. With the whole assembly complete, the valve is seen to consist of a slit, 1 mil by 256 mils, its sides lying in a plane at right angles to the lines of force, and centred over the air gap in the electro-magnet. When speech

TWO distinct methods are employed to record sound by the variable density of the film. In one system a constant light source requires the use of a variable slit to control the amount of illumination reaching the photo-electric cell; in another system, the slit is of constant width, fluctuating light being obtained by a gaseous discharge tube.

currents are applied to the loop, and the electro-magnet energised, the limbs open and close in sympathy with the current alternations. The natural frequency of the system is about 8,500 cycles. From Fig. 3 it will be seen that the light from the lamp (an 18-amp. projection lamp) is focused on to the plane of the valve. The valve in operation is opening and closing in sympathy with the signal currents. The image of the varying opening is focused, with a 2-1 reduction, on to the film. The length of the image on the film is 128 mils, and, under a condition of

no modulation, is $\frac{1}{2}$ mil wide. At 100 per cent. modulation the image varies from zero to 1 mil in width. The amount of light reaching the film is constantly varying, resulting in a track similar to that in the right-hand strip in Fig. 1 (see last week's issue). The power necessary to produce 100 per cent. modulation is

The Sound Recording Camera.—

of the order of 100 milliwatts. Inside the sprocket S_2 is a photo-electric cell, and, as will be seen from Fig. 3, a portion of the light falling on the film—4 per cent.—is transmitted through, and falls on the cell. The consequent variations in output of the cell are amplified, and when reproduced by means of a loud speaker are used as a check on what is actually getting on the film. In Western Electric recording the sound-picture

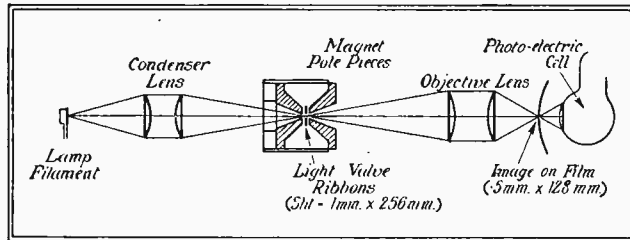

Fig. 3.—The optical system in the Western Electric method of variable density recording.

cameras are all controlled by the "Interlock" system. Selsens Motors, controlled by a master motor, are used for driving the individual units. In this way synchronism between the various machines is certain. Practically all other recording systems use synchronous 3-phase motors, whose speed depends on the frequency of the supply. Using these motors, the only factor likely to produce errors in synchronising will be voltage drop on the line, resulting in "hunting."

Varying Light Source Method.

The other variable-density system is that used by Fox Movietone. Here, as has been stated, a slit of constant width is employed, while the light varies in intensity. Thus, as the film moves past the beam, the varying intensity of the incident light produces a track of varying density. The light-emitting device is known as the "Aeolight," and is a gaseous discharge tube, which varies the amount of emitted light in sympathy with the speech currents applied to it. The tube has two elements—a nickel anode, and a looped cathode, coated with barium and strontium. When the Aeolight is filled with an inert gas such as helium, and a sufficient voltage applied to its terminals, it glows, and the amount of light emitted is proportional to the polarising voltage. In recording, a D.C. voltage is applied to the tube, which causes enough light to be emitted to give a certain exposure of the track,

corresponding to a condition of no modulation. When speech currents are applied, the light emission of the Aeolight varies on either side of the steady condition, which results in the track receiving exposures above and below the no-modulation figure. Contrary to the practice in other systems, an optical system is not used for the purpose of focusing the light on to the film. Instead, a quartz slit is used in contact with the emulsion, and the light shines through this on to the film. The slit is composed of a slab of quartz, 0.2in. square by 20 mils thick, coated with silver. Engraved right through the silver is a line 0.8 mil thick, which is covered by a second piece of quartz, 1 mil thick at the part opposite the slit. The slit is positioned with respect to the film by mounting it in a special floating metal shoe, which has the same radius as the recording sprocket. This shoe is mounted on the Aeolight holder in such a way that, when the assembly is complete, the light shines through the slit and its quartz protection on to the film at the correct point. The sound camera itself utilises one sprocket only, which draws the film through the camera. This sprocket is driven through the customary mechanical filter. The recorder is driven by a motor interlocked with the rest of the system, similar to the method adopted by Western Electric.

The difference between Aeolight and light-valve recorded tracks is a purely photographic one, depending

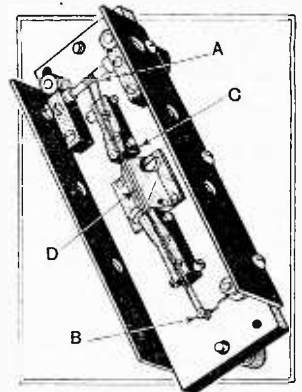
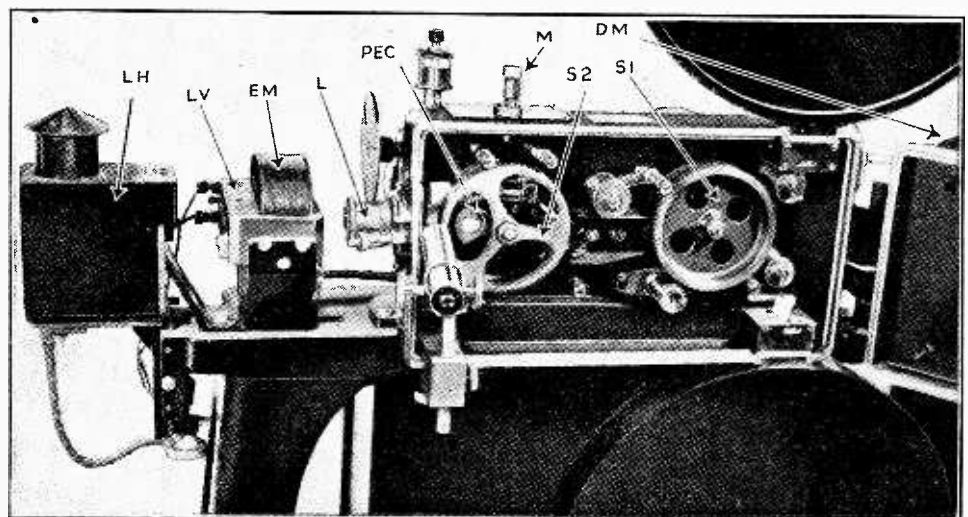

Fig. 4.—The Western Electric light valve. A=windlasses for adjusting tension; B=tension pulley; C=positioning clamps for spacing ribbons; D=portion of armature, containing slot, through which light enters to the ribbons.



The Western Electric recorder, as used at the British and Dominions studio at Elstree. S1=main sprocket; S2=recording sprocket; PEC=photo-electric cell; M=marker; L=lens system; EM=electro-magnet; LV=light valve; LH=light housing; DM=driving motor.

The Sound Recording Camera.—

entirely on the portion used of the Hurter and Driffeld curve, and a discussion of that difference would hardly come within the scope of *The Wireless World*.

The question of "ground noise" has not, so far, been mentioned. Ground noise may be defined as the unwanted, and often unavoidable, background which is the almost inevitable result of a comparatively long amplifying sequence, followed by a recording direct on to film. This background, accompanying the reproduction of the recorded sound, may be due to one or more of several causes. Set noise, valve noise, A.C. pick-up, or dirt on the track all contribute their quota to the ground noise. It is the obvious aim of the recording engineer to eliminate it as much as possible, for it follows that the higher the ground-noise level the more restricted will be the available range between the loudest sound it is possible to record and the least.

Reducing "Ground" Noise.

The loudest depends on the width of the film which is available for use as a sound track. The least is governed by the amount of ground noise present. If the ground noise can be reduced to a figure equal to or less than that of the theatre in which the sound is being reproduced, the reduction may be regarded as satisfactory.

Valve noise, set noise, and system noise, due to pick-up, can be practically eliminated by careful design and maintenance. Ground noise due to dirt is not easy to eliminate, as, however careful the technicians may be in handling the film, a small proportion of dirt is inevitable. It will be obvious that the greater the proportion of light area of track the greater will be the effect of dirt. Dirt, being opaque, will show up against a clear transparency. This fact has led to the invention of a piece of apparatus known as the ground-noise reduction amplifier and shutter. Developed in the R.K.O. studios in Hollywood, and handled by R.C.A. Photophone, it is only applicable to variable-area recording. In a variable-area track it will be obvious that the useful part is the serrated edge. The remainder is serving no useful purpose, as it is the *rate of change* of area which counts, not the quantity of exposed track. In the illustration, Fig. 1a, the track shown is the original negative. This is printed to form a positive when it is combined with the picture.

Thus where the image is now black it will be white in practice. Thus the greater the area of black in the negative the greater will be the area of white in the positive. This would obviously be unsatisfactory from the point of view of ground noise.

The object of the ground-noise reduction apparatus, or "squeeze-track," as it is known in the industry, is to reduce the proportion of clear track. This is achieved by inserting a light moving vane or shutter between the moving-light beam and the track. This shutter is operated by the amplified and suitably treated signal currents, and moves approximately in accordance with them. It is positioned so that it masks the light at the base of the track, and follows the general shape of the envelope. When correctly adjusted it just clears the peaks, so that the outline of the wave-form is allowed to reach the film, and nothing else. Owing to the inertia of the vane it obviously cannot vibrate at the speech frequencies, but moves in accordance with the modulation level. An examination of the left-hand track in Fig. 1 will show that the base line of the track is not a straight line, spaced from the edge of the film a distance of 278 mils, as would be the case of a standard track, but assumes an undulating form, so gradual that the resultant frequency is considerably below the level of audibility.

This undulating line moves away from the edge of the film at high modulation levels, and nearer to it at low levels. Thus, in the positive, at low levels, a very small area of clear track is found, which reduces the ground noise and permits the range of recorded sound to be increased considerably at the lower extremity. Using this apparatus, and with ordinarily careful working, a range of about 50 db. should be possible.

BOOK RECEIVED.

How to Become a Radio Amateur (2nd edition), giving instructions to the beginner on learning the Morse code, constructing a simple short-wave receiver and transmitter, operating procedure, etc. Although written primarily for American amateurs, the greater part is equally applicable to Great Britain, and constitutes a useful introduction to the more advanced "Radio Amateur's Handbook." Pp. 29, with 18 illustrations and diagrams. Published by the American Radio Relay League, Inc., West Hartford, Conn., U.S.A., price 25 cents, and obtainable in Great Britain from Mr. F. T. Carter, Flat A, Gleueagle Mansions, Streatham, for 1s. 6d. post free.

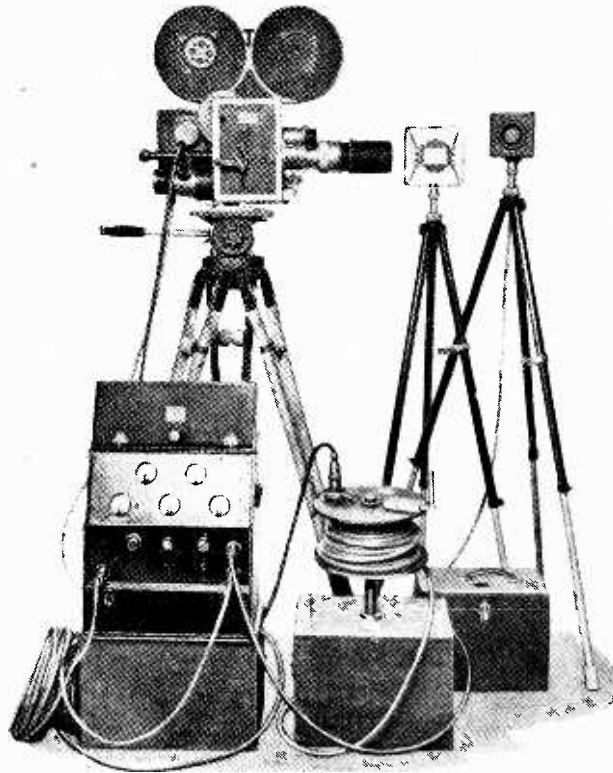

The British Acoustic combined film and recording camera for news-reel work. Note the portable amplifier, battery box and connecting cable. The sound is recorded on the same strip of film as the picture.

UNBIASED

+ + + + + By FREE GRID

*How I Invented the
Radio-Gramophone.*

WHILE waiting up late one night—or perhaps I should say early one morning—last week with a couple of friends for a special American broadcast, I was involved in a discussion as to who was the inventor of the radio-gramophone. I immediately laid claim to the distinction. In the absence of evidence to the contrary, I firmly believe that I have a right to it if by the phrase "inventor of the radio-gramophone" is meant the first person to use the low-frequency portion of a receiver for the reproduction of gramophone records and the first person to accommodate both turntable and wireless equipment in the same cabinet.

One of my friends doubting my word, we had a great routing out of my old diaries, and it was found that the wireless part of my outfit was built in the early part of 1921 when I was sojourning in New York for some weeks, the main purpose of the set being the reception of the De Forest station, which at that time was operating from Broadway on a wavelength of 1,400 metres. Returning to England later that year with the set, I happened to notice in a shop window—even the name of the shop was mentioned in the diary—an ordinary acoustic gramophone with a strange bulge in the tone arm.

It was revealed to me on diving into the shop that the instrument was made by the Sterling Telephone Co., a very well-known firm of those days, and that the bulge contained an ordinary carbon button microphone to which, the salesman said, I might attach a war surplus note magnifier and reproduce my records through a loud speaker as an alternative or as an addition to reproduction through the ordinary internal horn. I bought the instrument at once, and before long I had both gramophone and set mounted in a large cabinet complete with a change-

over switch; although the quality was atrocious and I suffered from the inconvenience of having to listen to the direct acoustic output of my gramophone simultaneously with the loud speaker output of the same record, I remember that I was mightily pleased with my effort and it was the pride of my heart for some months. It is on these grounds, as I explained to my friends, that I make the claim of being the inventor of the radio-gramophone.

I regret to say that my doubting friend, although accepting the accuracy of my diaries, still does not believe me to be the pioneer.

But I have resolved to convince him, and as evidence of my determination I hereby offer in all seriousness a free lunch to the first person

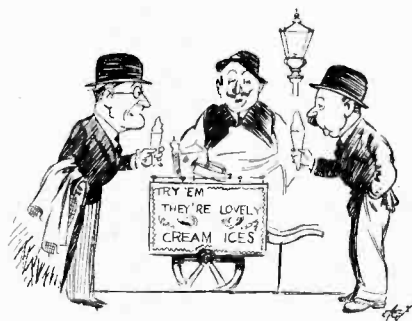

A free lunch.

who can bring forth documentary proof of the existence of any radio-gramophone prior to the autumn of 1921, when mine first appeared.

Crowd Psychology.

FINDING myself several leagues away from my wireless set about twenty minutes before the broadcasting of a national event some little time ago (the Editor informs me that it would be bad journalism to say definitely that it was the Derby, since that event is now very stale news), I barged into a large departmental store and hurried up to the radio department, where I found that a goodly crowd had already assembled. I was fortunate enough to take up my stance next to a

voluble gentleman who evidently understood racing from A to Z, and was anxious for all those within ear-shot to know it.

As three o'clock came and went, the constant ringing of the telephone by people who evidently did not know that the race invariably starts late became a source of annoyance to those of us who were attempting to listen to the commentator's preliminary remarks. Our voluble friend went up several points in my estimation by advising the harassed salesman at the telephone to place the instrument in front of the loud speaker of the American all-mains receiver which was in operation at the far end of the room. This was done, and to show his gratitude the salesman came over to our side of the room and switched on a mains transportable in our vicinity so that we might hear better.

Immediately there were protests from all sides as the speech became unintelligible, due to the fact that the voice from the portable seemed to be lagging a fraction of a second behind that from the American set at the other end of the department. The offending portable was then switched off, and the voluble gentleman at once attempted to add to his laurels by assuming the mantle of a radio expert. The whole trouble, he explained, was due to the fact that the first receiver was some 30ft. nearer to Epsom than the portable! Naturally I immediately butted in in order to explain that the transmission did not emanate from Epsom but from Brookmans Park, and that in any case the radio time lag would be quite unappreciable as it would amount to only $1/32,736,000$ th part of a second.

I was just about to attempt to explain away the phenomenon by a dissertation on acoustic peculiarities when my hat was pushed down over my eyes and I was unceremoniously hustled out of it by the crowd, leaving the voluble one triumphant. It appeared that, in my enthusiasm for radio, I had failed to notice that during my extemporaneous lecture the race had started; I had thus unwittingly incensed my companions, whose coarse minds were evidently incapable of aspiring to any greater height than the details of a sordid horse race.

PROGRAMMES FROM ABROAD



FRIDAY, JUNE 24th.

ALGIERS (363.3 metres) 13 kW.—7.30 p.m., Concert of Old Dance Music. 7.55, News and Time Signal. 8.0, Schumann Concert. 9.15, Songs from Opera. 9.30, Dance Music, relayed from the Municipal Casino.

BARCELONA (Radio-Barcelona Call EAJI (349 metres)): 8 kW.—8.0 p.m., Trio Concert, Berceuse (Delmas); Selection from Debutante (Saint-Saëns); Minuet, Clair de Lune (Lauré); Schmetterlingspiele (Leopold). 8.30, Exchange Quotations; Request Gramophone Records and News. 10.0, Chimes, Weather, Market Prices, Exchange Quotations and Relay of Foreign Stations. 10.15, Orchestral Concert: March (Wiga-Winston); Waltz, Frühling, wie bist du so schön (Lincke); Sarabande (Klass); Gavotte (Klass); Selection from Boris Godounov (Moussorgsky). 11.0, Literary Programme: Blasco Ibañez—Talk and Reading. 11.15, Argentine Programme by Pili Canete. 11.40, Orchestral Concert from the Café Español. 1.0 a.m. (Saturday) Close Down.

BELGRADE (430.4 metres); 2.5 kW.—5.0 p.m., Concert by the Station Orchestra, March (Rendla); Overture, Aus meiner Heimat (Binicki); Selection, Wenn du singst, denke an mich (Sedlacek); Selection from A Waltz Dream (Oscar Strauss); Romantic Suite (Arnandola). 6.5, Time Signal and Programme Announcements. 6.10, Czech Lesson. 6.40, Talk for Sokols. 7.20, Introductory Talk. 7.30, See Vienna. In the interval at 9.0 (approx.) News Bulletin and Sports Notes. After the Programme, Dance Music, relayed from the Moskva Café.

BERLIN (Königs Wusterhausen) (1,635 metres), 60 kW.—12 noon, Weather for Farmers. 12.2, p.m., Gramophone Concert of German Regimental Marches, followed by Weather for Farmers. 12.55, Time Signal. 1.30, News Bulletin. 2.0, Gramophone Concert of Music by Schubert from Berlin (Witzleben). 3.0, Talk for Girls. 3.30, Weather and Exchange Quotations. 3.40, Programme for Children. 4.0, Educational Talk. 4.30, See Leipzig. 5.30, Talk: German Plants and their Uses. 6.0, Talk: Pirates of Yesterday and To-day. 6.30, Talk: What is the meaning of a Moratorium? 6.55, Weather for Farmers. 7.0, Topical Talk. 7.15, Talk for Veterinary Surgeons. 7.35, Talk for Workers, followed by Weather for Farmers. 8.0, Talk by Kurt G. Sell: What People are talking about in America, relayed from America. 8.15, See Leipzig. 10.30, Weather, News and Sports Notes. 10.35, See Berlin (Witzleben).

BERLIN (Witzleben) (419.5 metres); 1.5 kW.—4.30 p.m., Chamber Music; Novelties for Pianoforte Trio (Gade); Selections (Puccini): (a) Chrysanthemum; (b) Two Minuets for String Quartet; Selection for Pianoforte Trio from the Suite in Dance Form (O. Straus); Wiegenlied (Osten-Sacken); Polka for String Quartet (Kopylov); Silhouettes for Two Violins and Pianoforte (Juon). Adagio and Rondo for Pianoforte Quintet (Schubert). 5.35, Talk: The Younger Generation. 6.5, Talk on Aquatic Sports. 6.30, Talk: Walther Rathenau. 6.55, The Witzleben Station informs its Listeners. 7.10, Review of New Books. 7.20, 'Cello Concerto in C Op. 20 (D'Albert), by the Station Orchestra, conducted by Bruno Seidler-Winkler. 7.50, Labour Market Report. 7.55, Talk: Hints for the Week-end. 8.0, Talk by Kurt G. Sell: What People are Talking About in America, relayed from America. 8.20, Variety Programme. 9.10, Orchestral Concert, conducted by Hans Oppenheim; Comedy Overture (Busoni); Serenade for Small Orchestra (Thomas); Selection from The Taming of the Shrew (Zither); Overture, Neues vom Tage (Hindemith). 10.0, Weather, News, and Sports Notes. 10.20, Talk: Prohibition in America. 10.45, (approx.) Orchestral Concert from the Blüthner Hall, Magdeburg; Overture, Rosamunde (Schubert); Ballet Suite (Gluck-Mottl); Serenade (Haydn); Selection from The Bartered Bride (Smetana); Polonaise from Eugen Onegin (Tchaikovsky); Waltz from Die

Kaiserin (Fall); Serenade (Mozskovsky); Waltz, Roses from the South (Joh. Strauss).

BORDEAUX-LAFAYETTE (304 metres); 13 kW.—7.30 p.m., Announcements. 7.40, Educational Talk. 7.55, Lottery Results. 8.0, Advanced Spanish Lesson. 8.15, News Bulletin and Weather Forecast. 8.30, Concert by the Area Symphony Orchestra and the Palestrina Choir: Soloist, Mlle. Chauveaubourdil (Vocalist); Overture, Ruy Blas (Mendelssohn-Salabert); Symphonic Poem, Cleopatra (Pierne); Sur le Lac (Godard-Salabert); Choral Selections: (a) Hymn to the Night (Rameau); (b) Mignone (Bordogni); Two Songs: (a) Song from Manon (Massenet); (b) Jacqueline's Song from Fortunio (Messager); Second Symphony (Beethoven); Choral Selections: (a) La sérénade d'hiver (Saint-Saëns). (b) Vivat (Carlier); Song from Hamlet (Thomas); Selection from Tannhäuser (Wagner-Mouton).

BRATISLAVA (279 metres); 14 kW.—6.45 p.m., Sports Notes. 7.0, See Prague. 8.0, See Brno. 10.15, Programme Announcements and News Bulletin. 10.20, See Prague.

BRESLAU (325 metres), 1.5 kW., and **GLEIWITZ (253 metres)**.—7.10, Weather for Farmers. 7.15 (approx.), Gramophone Concert: Selection from Eva (Lehar); Selection from Gasparone (Müllöcker); Selection from Der arme Jonathan (Müllöcker); Delirienwalzer (Jos. Strauss); Caprice on Themes from Die Fledermaus (Joh. Strauss); Selection from The Geisha (Jones); Overture, Im Reiche des Indra (Lincke). 7.55, Weather for Farmers. 8.0, Talk by Kurt Sell: What People are Talking about in America, relayed from America. 8.15-10.20, See Stuttgart. 10.20, Time, Weather, News, Sports Notes and Programme Announcements. 10.50, Sports Talk for Amateurs. 11.0, Weekly Sound News from the Deli-Theater. 11.15, Orchestral Concert from Magdeburg. 12.30 a.m. (Saturday), Close Down.

BRNO (342 metres); 35 kW.—7.0 p.m., See Prague. 8.0, A Comedy in Three Acts (Smaek). 10.0, See Prague. 10.15, News Bulletin. 10.20, See Prague.

BRUSSELS (No. 1) I.N.R. (509 metres); 15 kW.—12 Noon, Gramophone Records: Overture, Mariana (Wallace); Danse mauresque (Vidal); Selection from The Girl in the Taxi (Gilbert); Selection (Yarnio); Entry of the Gnomes (Pierne); Selection (Ellenberg); Mosaic (Zimmer); The Sacred Hour (Kettelbey); Pandanguillo (Turina). 1.0 p.m., Le Journal Parlé. 1.10, Gramophone Concert: Ma Poupée chérie (de Séverac); Selection (Moar); Selection from Boccaccio (Suppé); Aria from Les Noces de Jeanette (Massé); La Sérénade (Tosti); Airs for Saxophone from Frederica (Lehar); Selection; Serenade (Braga); Selection from La Traviata (Verdi); Overture, Orpheus in the Underworld (Offenbach). 5.0, Concert by the Hescu Orchestra relayed from the Kursaal, Chaudfontaine. 6.15, Gramophone Concert: Quartet in C (Grieg); Waltz in C Minor for Violin (Chopin); Amours-nous (Gounod); Symphony in C (Beethoven); Clair de Lune (Fauré); La Capricieuse (Elgar); Song (Chabrier); Selections from The Love for the Three Oranges (Prokofiev). 7.15, Talk: How to Understand the Weather Report. 7.30, Music Review by Paul Gilson. 8.0, Orchestral Concert conducted by Franz André. Soloist: M. Bonaventure (Violin); March (Blankenburg);

Arabian Intermezzo (Krüger); Selection from Show Boat (Kern); Songs by White Johnson; The Little Things in Life (Berlin); Der Nachtigall in Fliederbusch (Krome); Andalusian Romance for Violin (Sarasate); Potpourri (Schuman). 8.45, Recitations of his own Poems by Cocteau on Gramophone Records. 9.0, Concert (continued): Polka (Johann Strauss); Waltz (Kozák); Theme in the Classic Style (Ochs); Conte chinois (Dorson); Fox-trot, I Don't Know Why (Tark); Fox-trot, I've Just Got Eyes for Susie (Lewis); Tango, Innocenza (Conraut); Selection for Two Pianofortes; Clarinet Solo, Sitting at a Table laid for Two (Leslie). 10.0, Le Journal Parlé. 10.10, Concert by the Hescu Orchestra relayed from the Kursaal, Chaudfontaine. 11.0 (approx.), Close Down.

BRUSSELS (No. 2) N.I.R. (338.2 metres); 15 kW.—Programme in Flemish. 12 Noon, Trio Concert: Wedding March of a Doll (Leococ); Waltz, Brune ou blonde (Waldeufel); Suite, Trianon (Lachaume); Wiegienlied (Schumann); Le rouet de grand'maman (Gillet); Selections from The Damnation of Faust (Berlioz); Orientale for Violin (Cui); Russian Songs for 'Cello (Lalo); Serenade (Pierne); Waltz, from Das Lied ist aus (Stolz); Pasodoble, Amaranina (Lucchesi). 1.0 p.m., Le Journal Parlé. 1.10, Gramophone Concert: Hungarian Comedy Overture (Keler-Béla); Song without Words (Mendelssohn); Waltz from The Love Parade (Schertzing); Parody on the Second Rhapsody (Liszt-Ferry); The Spanish Beggar (Orth); Sons les toits de Paris (Moretti-Ferry); Waltz, Honolulu Moon (Lawrence); Tonerá (Sjöberg); Triumphal Polka (Krüger); Andante religioso (Thomé); Selection from White Horse Inn (Benzáky-Krome). 5.0, Orchestral Concert, conducted by Franz André: Overture, William Tell (Rossini); Selection from Les Dragons de Villars (Maillart); Waltz, The Blue Danube (Johann Strauss); Instrumental Solos; Ballet Music from Cinderella (Massenet); Jazz Fantasia on Faust (Gounod); Romanian Dances (Bach); Slavonic Dances (Dvorák). 6.0, Light Music on Gramophone Records. 6.15, Talk. 6.30, Gramophone Concert: Selections from Der Rosenkavalier (Richard Strauss); Aria from Prince Igor (Borodin); Orientale (Albéniz); Ombrà leggiera (Meyerbeer); March of the Little Tin Soldiers (Pierne). 7.30, Radio Notes. 8.0, Songs from Viennese Operettas by Mlle. I. De Kenkeleire and Mm. K. Loentier and Edgard De Pont. 9.0, Concert by the Cecilia Choral Society, conducted by Louis de Vocht. Soloists: Acl Van Beveren (Baritone), Mme. Dejen and Mme. De Backer. 10.0, Le Journal Parlé. 10.10, Concert by the Hescu Orchestra relayed from the Kursaal, Chaudfontaine. 11.0 (approx.), Close Down.

BUCHAREST (394 metres); 12 kW.—4.0 p.m., Concert by the Station Orchestra: March, El Capitan (Souza); Waltz, Estudiantina (Waldeufel); Overture, Peter Schmol (Weber); Selection from Turandot (Puccini); Slavonic Dance No. 15 (Dvorák). 5.0, News Bulletin and Time Signal. 5.10, Concert (contd.): Selection from The Rose of Stamboul (Leo-Fall); Waltz, España (Waldeufel); Ballet Music from The Demon (Rubinstein). 6.0, Educational Programme. 6.40, Popular Music on Gramophone Records. 7.0, Saxophone Recital of Modern Music. 7.20, Dramatic Programme. 8.15, Song Recital by M. Fauy Petresco (Baritone); 8.45, News Bulletin and Close Down.

BUDAPEST (550 metres); 18.5 kW.—Programme also relayed on 210 metres from 6.45 p.m. to Close Down. 5.0 p.m., Concert by the Jancsi Farkas Gíányi Band. 6.0, Farewell Speech to the Hungarian Representative of the Olympiad. 6.15, Talk: Society Life in Budapest in the Past Century. 6.45, Concert by the Virányi Salon Orchestra: Academic Overture (Brahms); Children's Airs from Ruralia Hungarica (Dohnányi); Intermezzo (Poldini); Danse macabre (Saint-Saëns); Sarazenek (Horváth); Milanese Serenade (Chorin); English Waltz (Szabo-Guy). 7.35, Talk. 8.0, Song and Pianoforte Recital by Sári Hir (Pianoforte) and Imre Molnár (Songs); Pianoforte Solos: (a) Prelude

Programmes from Abroad.—

(Chopin), (b) Concert Etude (Rubinstein); Old Hungarian Songs (arr. Kern); Pianoforte Solos; (a) S villa (Granados), (b) Polonaise in E (Liszt); Hungarian Folk Songs; Pianoforte Solos (Liszt); (a) Ricordanza, (b) Campanella; Old Hungarian Folk Songs. 9.0, News Bulletin. 9.15, Dance Music on Gramophone Records. 10.10, Weather Report. 10.45, Concert by the Lajos Kiss Cigany Band, from the Gellert Hotel.

COPENHAGEN (281 metres); 0.75 kW., and **KALUNDBORG (1,153 metres);** 7.5 kW.—11.0 a.m., Weather Forecast. 11.10, Angling Notes. 12 (noon), Town Hall Chimes. 12.2-2.0 p.m., Concert from the Wivex Restaurant. 3.0, Wind Instrument Concert, conducted by Johannes Andersen: March, Traditionskompagniet (Blume); Overture, Raymond (Thomas); Waltz, Die Hydropathen (Gungl); Entr'acte and Barcarolle from The Tales of Hoffmann (Offenbach); Selection from La j'etais roi (Adam); Parade March from Fredericus Rex (Roland); Reading (Schwanenflugel); March, Sangesbrüder (Richter); Ballet Music from Elverhøj (Kuhlau); Maritana-Waltz (Dellinger); Scene from Martha (Flotow); Selection from Orpheus in the Underworld (Offenbach); Montebello-March (Zalatoe). 5.0, Programme for Children. 5.40, Exchange and Market Prices. 5.50, Talk: Flowers and Insects. 6.20, Elementary German Lesson. 6.50, Weather and News. 7.15, Time Signal. 7.30, Talk: Some Light on the International Labour Crisis. 8.0, Town Hall Chimes. 8.2, Programme to be announced. 8.10, Pictures of Old Russia, by Dr. Alexander Tchumakov (Balalaika, Guitar and Accordion) and Alexei Heyermans (Balalaika); Scenes from a Festival at a Manor, for Balalaika and Guitar, (a) Grandmother's Waltz, (b) Grandmother's Song, (c) Gavotte (Gossec); Scenes from a Festival at the Czar's Court, (a) Parade from the Time of Peter the Great, for Accordion and Balalaika, (b) Bayard's Song for Balalaika and Guitar, (c) The Court Fool's Musical Jest, for Two Balalaikas. 8.45, A Midsummer's Eve Play (Adam Oehlenschläger), Music by Emil Reesen. 10.0, News Bulletin. 10.15, Concert of Light Orchestral Music, conducted by Emil Reesen: Overture, Gri-Gri (Lincke); Selection from Iolanthe (Sullivan); Waltz from Sleeping Beauty (Tchaikovsky); Russian Dance (de Teye); Andalousie (Delmas); Selections from the Chinese Rhapsody (Gabriel-Marie); The French Army's March into Tonkin (Desormes). 11.0 (approx.), Close Down.

DUBLIN, Call 2RN (413 metres); 1.2 kW., and **CORK (224.4 metres)—**1.30-2.0 p.m., Time Signal, Weather Forecast, Stock Report and Light Music on Gramophone Records 3.0, General Meeting (In Irish), relayed from the Theatre Royal. 6.0, Popular Music on Gramophone Records. 6.15, Programme for Children. 7.0, Gramophone Concert of Variety Music. 7.20, News Bulletin. 7.30, Time Signal. 7.31, Talk on Gardening. 7.45, Talk. 8.0, Mass Meeting of Women in Phoenix Park. 10.30, Time Signal, News, Weather Forecast and Close Down.

FEKAMP (223 metres); 10 kW.—12 noon, Gramophone Concert: Rhapsodie Orientale (Ter Abramoff); Excelsior (Marenco); Youme (Loyraux); It is To-day (Erwin); Les Armes Reluisant aux Soleil (Ter Abramoff); La Valse des Matelots (Loyraux); Selection (Erwin). 12.30 p.m., First French News Bulletin. 12.45, Concert: Song of the Volga Boatman; Thais (Pastschenko); Selection from The Merry Widow (Lehar); Selection from Lucia de Lammermoor (Donizetti); Selection from Orpheus in the Underworld (Offenbach); Dans le bois sombre (Pastschenko). 2.0-7.30, Interval. 7.30, French Local News. 8.0, Second French News Bulletin. 8.15, Report by the French Wireless Agricultural Society. 8.30, Listener's Hour, relayed from Le Havre. 9.30-11.0, Interval. 11.0 till Close Down, Programme in English. 11.0, Concert of Light Music by the I.B.C. Light Orchestra (Section B), conducted by Herbert Foster: Phyllis Dundy (Contralto); Waldteufel Memories (arr. Finck); Songs: (a) My Lover (Yellen), (b) I Like to do Things for You (Ager); The Wedding of the Rose (Jessel); Songs: (a) On the Sunny Side of the Street (Fields), (b) Exactly Like You (McHugh); Selection from On With The Show (arr. Somers). 11.30, Memories of Shows; The Film Fans with the Ibcians; Tunes from the Talks; Songs: (a) Just Like In A Story Book, from High Society Blues, (b) All Alone Monday, from The Cuckoos, (c) Painting the Clouds, from Gold

FRIDAY, JUNE 24th (cont.)

Diggers of Broadway; Orchestra, Happy Feet, from The King of Jazz; Songs: (a) Waiting at the End of the Road, from Hallelujah, (b) Any Time's the Time, from Paramount on Parade, (c) Dance Away the Night, from Married in Hollywood; Orchestra: The Silver Screen Medley. 12 midnight, Concert, Dance Music. 12.30 a.m., Concert, Dance Music by the Renis Revellers. 12.57, I.B.C. Goodnight Melody. 1.0, Close Down.

FRANKFURT (390 metres); 1.5 kW., and **CASSEL (246 metres)—**1.0, Pucik Concert by the Station Orchestra, conducted by Reinhold Merten: Florentine March; Overture, Marinarella; Waltz, Donausagen; Die lustige Dorfschmiede; Slow Waltz, Kleinsian Hours; Overture, St. Hubertus; Waltz, Frühlingsbotschaft; March, Fanfarenlänge. 2.0, News Bulletin. 2.10, Sponsored Gramophone Concert. 3.0, Weather Report. 3.10, Time and Economic Notes. 5.0, Concert from Munich. 6.15, Economic Notes. 6.25, Talk: Gutenberg and the Art of Printing. 6.50, See Stuttgart. 7.15, Talk, by Lina Cornhill-Dechent. 7.25, Time Programme Announcements, Weather and Economic Notes. 7.30-10.20, See Stuttgart. 10.20, See Berlin (Witzleben). 11.0, Time Weather, News and Sports Notes. 11.20, Recital from Stuttgart. 12 midnight (approx.), Close Down.

HAMBURG, Call ha (in Morse) (372 metres); 1.5 kW.—Relayed by Bremen (270 metres), **Flensburg (218 metres), Hanover (566 metres), and Kiel (232.2 metres)—**5.55 p.m., Organ Recital by Erwin Zillinger, relayed from the Schleswig Cathedral; Prelude and Fugue in G (Buxtehude); Variations on Unter der Linden grüne (Sweetland); Air in C minor (Weckmann); Legende, Op. 51, No. 7 (Raasted); Organ Chorals (Kickstat); (a) Die goldne Sonne, (b) Himmlerist der Sonne Schein; Theme and Variations in A minor, Op. 53 (Raasted). 6.35 (from Hanover), Programme for Workers. 6.55, Exchange Quotations. 7.0, Topical Talk. 7.15, Weather Forecast. 7.20 (from Kiel), Willi Kroger in a Pianoforte Recital of Jazz Music. 8.0, Talk, by Kurt Sell: What People are talking about in America, relayed from America. 8.15, Letters—A Humorous Radio Sequence (Müller-Pörster). 9.0 (from Hanover), Symphony Concert by the Dresden Philharmonic Orchestra, conducted by Walter Stöver, relayed from Bad Pyrmont. Soloist: Gustav Havemann (Violin): Overture, A Midsummer Night's Dream (Mendelssohn); Violin Concerto in A minor, Op. 88 (Juon); Symphonic Poem, Don Juan (Richard Strauss). 10.0, News Bulletin. 10.20 (from Hanover), Vivat Academia!—A Göttingen Programme.

HEILSBURG (276.5 metres); 60 kW., and **DANZIG (453.2 metres)—**1.5 to 2.30 p.m., Orchestral Concert, conducted by Eugen Wilcken: Festival Overture (Lortzing); Lamentation (Bortkiewicz); Hearts and Flowers (Czibulka); Fantasia on Grieg Music (Urbach); Waltz, Rheinsagen (Hohmann-Webau); Lyric Suite (Lindner); Variations in the Style of Modern Masters; Es kommt ein Vögel geflogen (Recktenwald); Potpourri, Drei Striüsse (Lindemann); Silber-Tango (Maus); Dort, wo die Wälder grün (Brodsky). 2.30, Sponsored Programme. 3.30, Talk for Women: Helping Children to become happy people. 4.0, Review of Books. 4.30, See Leipzig. 5.30, Talk: Precious Stones. 6.0, Gramophone Records of Variety Music. 6.15, Agricultural Market Prices. 6.25, Talk: Men and their Philosophy of Life. 6.50, Orchestral Concert, conducted by Eugen Wilcken: Overture, Giovanna d'Arco (Verdi); Florentine Serenade (Franchetti); Waltz from the First Suite (de Micheli); Selection from La Favorita (Donizetti); Overture, Norma (Bellini); Srenata d'Amalfi (Beccce); Selection from La cena delle beffe (Giordano). 7.50, Weather Forecast. 8.0, Talk by Kurt G. Sell: What they are talking about in America, relayed from America. 8.15 (from Danzig), The Passionate Ego—A Radio Sequence from the Time of Heibel (Alfred Müller). 9.20, Announcements. 9.25, Concert of Esthonian Music. Soloists: Paula Neumann-Puuse (Soprano) and Olav Roots (Pianoforte). Introductory Talk and Commentary by Leenart Neumann. Four Esthonian Folk Songs. Eight Esthonian Folk Melodies as Children's Pieces for Pianoforte (Pats); Four Esthonian Songs: (a) Primula veris (Late), (b) Youth (Ludig),

(c) She came (Saar), (d) Red Apple Blossom (Tubin). Talk. Song: My Song re-echoes in the Grove (Saar). 10.20 (approx.), Weather, News, and Sports Notes.

HILVERSUM (296.1 metres); 20 kW (7 kW up to 4.40 p.m.)—6.25 to 9.40 a.m., Programme of the Workers' Radio Society (V.A.R.A.). 6.25 to 6.40 and 7.10 to 7.25, Gymnastics. 7.40, Gramophone Records of Variety Music. 8.40, Septet Concert. 9.40, Religious Programme by the Liberal Protestant Radio Society (V.P.R.O.). 9.55 to 11.40, V.A.R.A. Programme. 9.55, Recitations. 10.10, Septet Concert. 10.40, Talk for Women. 10.55, Concert (continued). 11.40 to 3.40 p.m., Programme of the Algemeene Vereeniging Radio Omroep (A.V.R.O.). 11.40, Time Signal. 11.41, Orchestral Concert conducted by Nico Treep—Overture, Vert-Vert (Offenbach); Serenade (Schubert); Selections from La Bohème (Leoncavallo); Alle Humpelmänner tanzen (Lindemann); Waltz of the Butterflies (Prini); Gramophone Records of Variety Music; Waltz, Lotoshumen (Ohlsen); Selection from Schön i t die Welt (Lehar); Potpourri, Streiflichter (Morena). 1.10 p.m., Radio Report on the Annual Assembly of the Dutch Society for Industry and Commerce, relayed from Haarlem, Addresses by Prof. G. J. W. Bruins, Prof. J. R. Slotemaker de Bruine and Prof. J. A. van Hamel. 2.10, Gramophone Records of Variety Music. 2.40, Concert of Light Music. 3.40 to 7.40, V.A.R.A. Programme. 3.40, Pianoforte Recital—Spanish Suite (Albeniz). 4.10, Programme for Children. 4.40, Orchestral Concert conducted by Hugo de Groot—March, Groot Rotterdam (Schooteneyer); Waltz, Kirmesse am Rhein (Dreissen); Dutch Peasant Dances (Siep); Chimera (Siep); A Dutch Mill (Heykens); Waltz, Return (Schouten); Des pays lointains (Kriens); Potpourri (Ciére); March, Parody (Grit). 5.40, Gramophone Records of Variety Music. 5.55, Concert (continued)—Hungarian Comedy Overture (Kéer-Béla); Selection from Polnische Wirtschaft (Gilbert); Selection from L'ac Time (Schubert-Berté). 6.25, Talk for Students. 6.40, Concert (continued)—Selection from Cavalleria Rusticana (Mascagni). 7.0, Organ Recital—Cœur brisé (Gillet); Bahillage (Gillet); La lettre de Manon (Gillet); Entr'acte Gavotte (Gillet); The Melody of Love (Kaper-Jurmann). 7.20, Concert (continued)—Ballet from Faust (Gounod). 7.40 to 10.40, V.P.R.O. Programme. 7.40, Talk: Young People of To-day. 8.10, Quartet Concert—First Quartet in B flat for Two Violins, Viola and Cello (Mozart). 8.40, Talk. 9.10, Concert (continued)—Second Quartet in E flat, Op. 125 (Schubert). 9.40, Religious Notes. 9.45, News Bulletin. 9.55, Talk. 10.25, Gramophone Records of Variety Music. 10.40 to 11.40, V.A.R.A. Programme. Gramophone Records of Variety Music. 11.40 (approx.), Close Down.

HUIZEN (1,875 metres); 8.5 kW.—Programme of the Christian Radio Society (N.C.R.V.). 7.40 a.m., Bible Reading. 7.55, Variety Music on Gramophone Records. 9.10 to 10.10, Interval. 10.10, Programme for Invalids. 10.45, Popular Music on Gramophone Records. 11.40, Police Notes. 11.55, Vocal and Instrumental Concert. Soloists: J. Plemper (Baritone), H. Hermann (Violin), H. v. d. Horst, Jun. (Cello), and Mme. R. A. v. d. Horst-Bleekrode (Pianoforte)—Overture, Tancred (Rossini); Three Dutch Songs (Bastians); Russian Airs (Moussorgsky); Two Songs (Moussorgsky); Barcarolle (Tchaikovsky); Aria from The Messiah (Handel); Aria from The Seasons (Haydn); Moment Musical (Schubert); Military March (Schubert); Four Dutch Songs (Röntgen); Selection from Il Seraglio (Mozart). 1.40 to 2.10, Interval. 2.10, Instrumental Concert. G. Beths (Violin), F. Visscher (Violin and Viola), P. Halsema (Pianoforte)—Sonata in D (Corelli); Sonata in B Flat (Handel); Trio in E Flat (Mozart); Allemande (Searlatti); The Cuckoo (Daquin); Berceuse (Chopin); Etude in A Flat (Chopin); Three Songs (MacIowell). (a) To a Wild Rose, (b) In the Autumn, (c) To a Water Lily; La fille aux cheveux de lin (Debussy); Pavane pour une Infante défunte (Ravel); Malaguena (Albeniz); Duet in E Flat, Op. 3 (Sporh); Suite, Op. 71 (Mozskovsky). 4.10, Variety Music on Gramophone Records. 4.40, Talk for Young Stamp Collectors. 5.10, Variety Music on Gramophone Records. 5.40, Talk. 6.10, Wireless Technical Talk. 6.40, Talk. 7.10, Police Notes. 7.25, Talk. 7.40, Orchestral Concert conducted by F. Schuurman—Overture. Poet and Peasant (Suppé); Glow Worm Idyll (Lincke); Selection from I Pagliacci (Leoncavallo); Waltz from A Waltz Dream (Oscar Straus); Selection from The Geisha (Jones); Overture, Orpheus in the Underworld (Offenbach). 8.40, Talk and Concert (continued)—Overture, The Merry Wives of Windsor (Niola); Frühlingserwachen (Bach); Humoresque (Dvorak); Two Polonaises (Mosz-

Programmes from Abroad.—

kovsky); Waltz (Strauss); Selection (Fueik). After the Concert—Popular Gramophone Music. 11.10 (approx.). Close Down.

KATOWICE (408 metres); 16 kW.—5.0 p.m., Orchestral Concert. 6.20, Dance Music. 8.0, Symphony Concert, conducted by Valère Berdiayev. 10.5, Light Music on Gramophone Records. 11.0, Answers to Correspondents in French.

LAHTI (1,796 metres); 54 kW. Relayed by **HELSINKI (368.1 metres)**—6.15 p.m., Programme for Children. 6.35, Harp Recital relayed from Helsinki. 7.0, Talk. 7.25, Song Recital by Georg Malmsten. 7.35, Recitations. 8.15, Concert by the Station Ensemble, relayed from Helsinki. 8.45, News in Swedish. 9.0, News in Finnish. 9.15, Light Music, relayed from the Kappeli Restaurant. 10.0 (approx.), Close Down.

LANGENBERG (473 metres); 60 kW.—12.10 p.m., Concert from Stuttgart. 12.50, Weather, Announcements, and Time Signal. 1.0, Concert, conducted by Wolf. Tambour Marsch (Ehrke); Waltz: The Wedding of the Winds (Halt); Overture: Nebuchadnezzar (Verdi); Mazurka and Folk Dance (Thomas); Cockney Suite (Ketelbey); Selections from The Tales of Hoffmann (Offenbach); Witches' Dance (MacDowell); Selection from The Maid of the Black Forest (Jessel). 2.30, Sponsored Gramophone Concert. 3.30, Economic Notes and Time. 3.50, Handwork Lesson. 4.20, Programme for Children. 5.0, Concert, conducted by Wolf; Soloist: Adolf Erlenwein (Tenor); Overture: His Life for the Czar (Glinka); Waltz, Hofballtänze (Lammer); Heitere Suite (Schaalstich); Tenor Solos: (a) Melody (Rubinstein); (b) Kleine Sorge um den Weg (Raff); (c) Kein Meister fällt vom Himmel (Wolf); (d) Die nimmersatte Liebe (Wolf); (e) Song from Jessonda (Spohr); Extase (Bizet); Selection from The Dubarry (Millock-Mackeben). 6.20, Book Review. 6.40, Talk on Ticino. 7.0, Weather, Time, Economic Report, and Sports Notes. 7.15, Topical Talk. 7.30, Talk: The Bank Crisis of 1931 and its Settlement. 7.55, News Bulletin. 8.0, Talk by Kurt G. Sell: What People are talking about in America, relayed from **America**. 8.15, Concert, conducted by Wolf; Overture: Genoveva (Schumann); Waltz: Il mio tesoro (Beucchi); Symphonic Poem: From the Fields and Groves of Bohemia (Smetana); Three Spanish Dances Nos. 3, 4, and 5 (Moszkovsky); Selections from L'Africaine (Meyerbeer); Romance: My Heart (Pata). 9.0, Opera buffa—a Sequence on Gramophone Records, with Commentary. 10.5, News Bulletin. 10.45, Concert from Stuttgart. 12 Midnight, Close Down.

LEIPZIG (269 metres); 2 kW.; and **DRESDEN (319 metres)**—4.30 p.m., Concert by the Dresden Philharmonic Orchestra, conducted by Rolf Schröder. Overture and March from Turandot (Weber); Contre-tänze (Beethoven); Selections from Der Evangelinkam (Kienzl); Arcadian Suite Op. 76 (Scharwenka); Gallop, Ein Treffer (Kral). 5.30, Review of Books on Music. 5.50, Economic Notes, Weather and Time. 6.0, Talk, with Pianoforte Illustrations: Children's Songs. 6.25, English Lesson. 6.50, Programme to be announced. 7.0, Talk: German Films Abroad. 7.30, Talk: Wagner's Music. 8.0, Talk by Kurt G. Sell: What People are Talking About in America, relayed from **America**. 8.15, The Rhinegold—Opera (Wagner), relayed from the Opera House, Dresden. 10.30, News Bulletin. 10.40 (approx.), Concert by the Leipzig Symphony Orchestra, conducted by Hilmar Weber. Selections from Der Rosenkavalier (Richard Strauss); Overture, Peter Schmolli (Weber); Selections from Die Prinzessin von Tragant (O. Strauss); Waltz, Fraulichbeund leben (von Blon); Selections from Wie einst im Mai (Kollo). 12 Midnight (approx.), Close Down.

LIUBLJANA (574.7 m.); 2.5 kW.—6.0 p.m., Quintet Concert. 7.0, French Lesson. 7.30, Talk on Economics. 8.0, Talk for Sokols. 8.30, See **Vienna**. 10.30, Time, News, and Light Music on Gramophone Records.

LWOW (381 metres); 16 kW.—7.15 p.m., Miscellaneous Items. 7.35, See **Warsaw**. 7.45, Talk. 8.0, See **Warsaw**. 11.30 (approx.), Close Down.

LYONS, La Doua (PTT) (465.8 m.); 1.5 kW.—7.0 p.m., Concert of Light Music on Gramophone Records 7.30., Radio Gazette for Lyons and the South-East. 8.30, See **Strasbourg**.

MADRID (Union Radio) (Call EAJ7) (424.3 metres); 2 kW.—8.0 p.m., Chimes, Exchange,

FRIDAY, JUNE 24th (cont.)

Market Prices, and Request Gramophone Concert. In an interval at 8.30, Educational Talk. 9.15, News Bulletin and Political Review. 9.30, to 10.30, Interval. 10.30, Chimes, Time Signal, and Political Review. 10.45 (approx.), Symphony Concert, on Gramophone Records. Overture, Carnival (Dvorak); Ballet (Rameau); Second Rhapsody (Liszt); Symphony No. 1 (Beethoven); Selection from The Fire Bird (Stravinsky). 12.45 a.m. (**Saturday**), News Bulletin. 1.0, Chimes and Close Down.

MORAVSKA-OSTRAVA (263.8 metres); 11 kW.—7.0 p.m., See **Prague**. 8.0, See **Bрно**. 10.15, Programme Announcements and Theatre Guide. 10.20, See **Prague**.

MOSCOW, Trades Union (1,304 metres); 160 kW.—6.30 p.m., Proletariat Radio Journal. 7.15, Programme for Young Communists. 8.0, Talk in German, Swedish, and French: The Work of Young Communists. 11.0 (approx.), Close Down.

MUNICH (533 metres); 1.5 kW.; relayed by **Augsburg and Kaiserslautern (560 metres)** and **Nürnberg (239 metres)**—5.0 p.m., Orchestral Concert, conducted by Erich Kloss: Overture, Die Schuldigkeit des ersten Gebotes (Mozart); Ballet Suite from Prometheus (Beethoven); Oehsenmenuetz (Haydn); Fantasia, Ein Denkmal für Franz Liszt (Morena); Waltz, Hofballtänze (Lammer); Selection from Gipsy Love (Lehar); March from Indigo and die vierzig Räuber (Joh. Strauss). 6.15, Time, Weather, and Agricultural Report. 6.25, Talk: Europe To-day and Tomorrow. 6.45, Talk: A Journey Across the Sahara. 7.5, Talk: The Wends—a Great People in Germany in Former Days. 7.25, Chamber Music on Gramophone Records. 8.0, Talk by Kurt G. Sell: What People are Talking About in America, relayed from **America**. 8.20, Midsummer Festival. 9.0, Orchestral Concert, conducted by Karl List. Soloists, Elizabeth Hallstein (Coloratura Soprano) and Giacinta della Rocca (Viola): Overture, La Belle Hélène (Offenbach); Song from The Tales of Hoffman (Offenbach); Selection from Manon Lescaut (Puccini); Song from La Traviata (Verdi); Concerto for Viola and Orchestra (Forsythe); Aquarellen Walzer for Soprano and Orchestra (Joh. Strauss); Florentine March (Fueik). 10.0, Dialogue: Ideals and Illusions. 10.20, Time and News.

OSLO (1,083 metres); 60 kW.; relayed by **Fredrikstad (367.6 metres)**; **Hamar (560 metres)**; **Notodden (447.1 metres)**; **Porsgründ (453.2 metres)** and **Rjukan (447.1 metres)**—11.30 a.m., Programme on the 25th Anniversary of the East Norwegian Society for the Blind, relayed from the University Hall. 5.30, Popular Music on Gramophone Records. 6.0, English Lesson. 6.30, Concert of Popular Music by a Saxophone Quintet. 7.0, Announcements, Weather and News Bulletin. 7.30, Recitations. 8.0, Time Signal. 8.1, Talk (to be announced). 8.30, Second Act of Tristan and Isolde—Opera (Wagner), relayed from the National Theatre. 9.40, Weather and News Bulletin. 10.0, Topical Talk. 10.15, Concert by a Workers' Choir, relayed from **Christian-sand (235.5 metres)**.

PALERMO (542 metres); 3 kW.—5.30 p.m., Popular Music on Gramophone Records. 6.30 to 8.0, Interval. 8.0, Announcements, Radio Giornale dell'Enit, Agricultural Report, Report of the Royal Geographical Society, and Giornale radio. 8.20, Gramophone Records of Light Music. In the intervals at 8.30, Time and Announcements. 8.45, Concert: Clara Bentivegna (Violin), Marisa Bentivegna (Pianoforte), and A. Ginzaga (Soprano), Violin Solo, Ciaccona (Vitali); Pianoforte Solos, (a) Pastorale (Orelli-Godovsky), (b) Tambourin (Rameau-Godovsky); Soprano Solos, (a) Sera estiva (Bolzano), (b) Song from La Traviata (Verdi); Violin Solos, (a) Largo (Veracini-Corti), (b) Tempo di minnetto (Pugnani-Kreisler). Talk: Through the Streets of Old Palermo. Pianoforte Solos, (a) Liebestraum (Liszt), (b) Hungarian Rhapsody (Liszt); Soprano Solos, (a) Se tu m'ami (Pergolesi), (b) Aria from Linda di Chamounix (Donizetti); Violin Solos, (a) Aria in D (Morasca), (b) Caprice No. 2 (Paganini-Kreisler). 10.0, Concert of Variety Music. 10.55, News Bulletin.

PARIS (Eiffel Tower) Call FLE (1,445.7 metres); 13 kW.—Time Signals (on 2,650 metres) at 10.26 a.m. and 11.26 p.m. (preliminary and 6-dot signals)—6.45, Theatre Notes. 7.0, Le Journal Parlé. 8.20, Weather Report. 8.30, Orchestral Concert, conducted by Edouard

Flament; Soloist: Elisabetha Cotrus (Pianoforte); Suite in A for String Quartet (Flament); Toccata for Pianoforte (Enesio); Overture, La farce du cuvier (Dupont); Romanian Rhapsody for Pianoforte (Sibianu); Two Romanian Dances (Alfano-Gauwin); Pianoforte Solos (Golestan); (a) Fusul (b) La fantâna; Overture, Ruslan and Ludmilla (Glinka-Salabert). 9.30, Variety Programme, arranged by Henri Laverne. 10.0 (approx.), Close Down.

PARIS (Poste Parisien) (328.2 metres) 60 kW.—6.30 p.m., Sponsored Concert. 7.30, News Bulletin and Parliamentary Review. 7.45, Light Music on Gramophone Records. 8.20, Talk on the Theatre. 8.30, Journal Parlé and Announcements. 8.45, Vocal and Orchestral Concert: Overture, Morning, Noon and Night (Suppé); Waltz, Sourire du matin (Thomé); Selection from Die Fledermaus (Johann Strauss); Second Quartet for two Violins, Viola and Cello (Borodin); Ballet, Sleeping Beauty (Tchaikovsky); Sérénade florentine (Godard); Selection from The Count of Luxembourg (Lehar); Elegy (Rachmaninov); Selection from La Princesse de Trébizonde (Offenbach); Waltz (O. Strauss); March of the Tin Soldiers (Pierné). 10.45, News Bulletin. 10.50 (approx.), Close Down.

PARIS (Radio Paris) (1,725 metres) 75 kW.—6.45 a.m. Physical Culture. 7.30, Weather and Physical Culture (continued). 7.45, Light Music on Gramophone Records. 8.0, News, Weather and Press Review. 12 Noon, Jewish Address. 12.30, Gramophone Concert—The Countryside. Song of the Swiss Neatherds; La Chanson des bies d'or (Ibria); Butterfly (Zoubalov); The Little Church (Delmet); La Laitière et le Pot au lait (La Fontaine); La source (Hasselmanns); Chante, Chemineau (Persiani-Jourdan-Bommer); The Warblers; Chanteleere (Rostani); Les Biches (Poulenc); Shepherd's Song from Mirella (Gounod); The Bulls (Dupont); Waltz, Morgenblätter (Johann Strauss); Les Cigales (Chabrier); The Village (Frémine); The Apple Trees (Frémine); Semaillies (Goublier); Paysage (Lahn); Liac (Doelle); La Procession (Frank); Die schöne Müllerin (Schubert). In the intervals at 1.0, Exchange, News and Weather, at 1.30, Exchange, and at 2.0, Exchange and Announcements. 3.45, Exchange and Market Prices. 6.30, Market Prices, Weather, Agricultural Report, Talk and Racing Results. 7.0, Talk: Precious Stones in Darkest Africa. 7.45, Commercial Prices and News. 8.0, Talk by Paul Landormy with Gramophone Illustrations: Handel. 8.30, News and Weather. 8.40, Gastronomic Review. 8.45, Le Labeur et ses Enfants—Play (Tristan Bernard) with address by the Author. 9.15, Press Review and News. 9.30, Gramophone Concert: Spanish Caprice (Rimsky-Korsakov); The Field Marshal (Moussorgsky); Symphonie sur un chant montagnard français for Pianoforte and Orchestra (d'Indy); Overture and Selections from Le Bourgeois Gentilhomme (Richard Strauss).

PITTSBURGH, Westinghouse Electric (KDKA) (306 metres); 25 kW. Relayed by **W8XK** on 48.86 metres and 25.25 metres.—9.0 p.m., Teaberry Baseball Scores. 9.5, Business News. 9.15, Rita Cavalieri (Spanish Soprano). 9.30, Pebeco Weather Report. 9.33, Market Reports. 9.45, Programme to be announced. 10.0, Teaberry Baseball Scores. 10.5, David Lawrence Dispatch. 10.10, KDKA Artist Bulletin. 10.12, Programme Announcements. 10.15, KDKA Kiddies' Klub. 10.30, The Singing Lady, from New York. 10.45, Little Orphan Annie, from New York. 11.0, Time Signal. 11.1, Temperature Report. 11.2, Who's News To-day. 11.6, Teaberry Sport Review. 11.11, Press News-Keeler. 11.14, Bulova Weather. 11.15, Westinghouse Musical Maids. 11.30, Royal Vagabonds, from New York. 11.45, Literary Digest Topics in Brief, by Lowell Thomas, from New York. 11.59, Penzoiil Time. 12 Midnight to 3.45 a.m., New York Relay. 12 Midnight, Pepsodent Amos 'n Andy. 12.15 a.m. (**Saturday**), Royal Vagabonds. 12.30, The Stebbins Boys. 12.45, Billy Jones and Ernie Bare. 1.0, Nestle's Programme. 1.30, Ivory Programme. 1.45, Sisters of the Skillet. 2.0, Friendship Town. 2.30, Armour Programme. 3.0, White-man's Pontiac Chieftains. 3.30, Love Songs and Waltzes. 3.45, Programme to be announced. 4.0, Penzoiil Time. 4.1, Teaberry Sport Review. 4.11, Temperature Report. 4.12, Bulova Weather Report. 4.15, Press Last-Minute News Flashes. 4.20, Lew Conrad and his Orchestra. 5.0, Cotton Club Orchestra, from New York. 5.15, Penzoiil Time and Goodnight.

PRAGUE (488.6 metres); 120 kW.—6.15 p.m., Popular Music on Gramophone Records. 6.25, Transmission in German; News Bulletin and

Programmes from Abroad.—

Talks. 7.0, Recital of Popular Songs by J. Pospisil. 7.20, Dvorak Pianoforte Recital by Prof. Herman; Mazurka Op. 56, No. 2; Spring Song, Op. 85; Minuet, Op. 28, No. 2; Silhouette Op. 8, No. 6; Humoresque in F sharp; Elegy, Op. 12; Silhouette, Op. 8, No. 10; Waltz, Op. 54. 7.45, Talk on Hygiene. 8.0, See **Berno**. In the interval at 9.0, Time Signal, News Bulletin, and Sports Notes. 10.15, News, Theatre Notes, and Programme Announcements. 10.20, Violin Recital of Light Music by Stefan Frenkel.

RADIO-SUISSE ROMANDE (SOTTENS) (403 metres); 25 kW.; Lausanne (680 metres) and Geneva (760 metres).—5.0 p.m., Time Signal from Neuchâtel Observatory. 5.1 (from Geneva), Programme for Women. 5.45, Concert by a String Orchestra, conducted by R. Echenard. 7.0, Weather Forecast. 7.1 (from Geneva), Talk on Sports. 7.20 (from Geneva), Report of the Swiss Automobile Club. 7.30 (from Geneva), Talk: The Disarmament Conference. 7.55, News Bulletin. 8.0 (from Geneva), Radio Review. 8.15, See **Vienna**. 10.15, Weather and News. 10.30 (approx.), Close Down.

RIGA (525 metres); 15 kW.—5.30 p.m., Talk on Old Riga. 6.0, Concert of Popular Music. 7.0, Weather Forecast. 7.3, Talk on St. John's Eve. 8.30, Concert by the Station Orchestra, conducted by Lovre Mataczic. In an interval at 9.0, Weather Forecast. 9.30, Dance Music. 11.0 (approx.), Close Down.

ROME, Call 1R0 (441 metres) 50 kW.—Relayed by Naples (319 metres) and ZRO (25.4 metres).—8.15 to 8.30 a.m., Giornale Radio and Announcements. 12 noon, Variety Music on Gramophone Records. 12.35 p.m., Weather Forecast. 12.45, Sextet Concert. Suite, Girandola (Allegrà); Malesh (Risgallah); Due chitarre (Ferraris); Selection from Primavera (Pietri); Romance (Tchaikovsky); Camulita (Sarrochi). A Summer Night on the Rhine (Fetras); Querida mia (Borsatti). In the intervals at 1.15, Giornale Radio and Exchange, and at 1.30, Time and Announcements. 2.0 to 4.45, Interval. 4.45 (from Naples), Talk for Women. 5.0, Exchange, Children's Journal. Giornale Radio and Announcements. 5.30, Soprano Song Recital by Maria Landi. Emigranti (Maruzzi); Notte orientale (De Lucia); Song from Suzanne's Secret (Wolf-Ferrari); Song from Il piccolo Marat (Mascagni). 5.45, Variety Music. 6.15, Giornale dell'Ente. 6.55 (from Naples), Shipping News and Sports Notes. 7.0, Agricultural Report, Announcements, Giornale Radio and Press Review. 7.50, Gramophone Records. 8.0, Time, Announcements, and Agricultural Notes (in Italian, French, English, German, and Spanish). 8.30, Sports Concert, conducted by Rito Selvaggi. Soloist: Tito Rosati (Cello); Sixth Symphony in E Minor (Torelli); Overture in C (Foroni). Talk on Evelina Paoli; Cello Solos (a) Romance (Rubinstein), (b) Serenata (Rossini), (c) Tempo di danza (Squire); Intermezzo from Adrienne Lecouvreur (Gilea); Intermezzo from I quattro rusteghi (Wolf-Ferrari); Dance of the Hours, from La Gioconda (Ponchielli). After the Programme, Giornale Radio.

SCHENECTADY, General Electric Company (WGY) (379.5 metres); 50 kW. Relayed at intervals by W2XAF on (31.48 m.) and by W2XAD on (19.56 m.).—9.0 p.m., Decorating Notes, from New York. 9.15, Ollie Yettru (Pianist). 9.30, Studio Ensemble. 9.50, News Items. 10.0, Stock Reports and Police Notices. 10.15, Skippy, from New York. 10.30, The Success Doctor. 10.45, Chandu, the Magician. 11.0, Musical Programme. 11.24, Baseball Scores. 11.30, With Gray McClintock in the Canadian Northwest. 11.45, Lady Fingers. 12 midnight (WGY only), General Electric Programme. 12 midnight (W2XAF only), Stock Reports and News Items. 12.15 a.m. (Saturday), Weather Report. 12.16, New Kenmore Orchestra. 12.45, The Goldbergs, from New York. 1.0 (WGY only), Cities Service Concert, from New York. 1.0 (W2XAF only), International General Electric Programme. 1.30, WGY Farm Forum. 2.0, Clicquot Club Eskimos, from New York. 2.32, Pond's Programme, from New York. 3.0, Young Artists' Light Opera, from New York. 4.0, Freddy Engel's Orchestra. 4.30, De Witt Clinton's Orchestra. 5.0, Ralph Kirbery, the Dream Singer, from New York. 5.5, Hotel New Yorker Orchestra, from New York. 5.30, New Kenmore Orchestra. 6.0 (approx.), Close Down.

SCHWEIZERISCHER LANDESENDER (BEROMUNSTER) (459 metres); 60 kW.. BASLE (244.1 metres), and BERNE (246 metres).—

FRIDAY, JUNE 24th (cont.)

12.28 p.m., Time Signal from Neuchâtel Observatory. 12.30, Weather Report and News Bulletin. 12.40, Concert by the Station Orchestra. 1.35, Weather Report and Exchange Quotation. 1.45 to 3.30, Interval. 3.30, Concert of Chamber Music on Gramophone Records. 4.0, Viennese Songs on Gramophone Records. 4.30 (from Berne), Programme for Children. 5.0, Weather Report. 5.5 to 6.30, Interval. 6.30 (from Berne), Talk on Nature Study: The Habits of Fish. 7.0, Time Signal, Weather Forecast, Market Prices, Tourist Bulletin and Sports Notes. 7.10 (approx.), Variety Music on Gramophone Records. 7.30 (from Berne), Agricultural Talk. 8.0 (from Berne), Introductory Talk to the following Transmission. 8.15, See **Vienna**. 10.15 (approx.), News Bulletin.

STOCKHOLM, Call SASA (436 metres); 55 kW. Relayed by Boden (1,229.5 metres), Göteborg (322 metres), Hårbý (257 metres), Motala (1,348 metres), Östersund (770 metres), and Sundsvall (562 metres).—11.0 a.m., Divine Service. 3.0 p.m., Relay from the Scandinavian Temperance Congress at Hälsingborg (231 metres): Address by the Crown Prince Gustavus Adolphus. 4.0, Popular Music on Gramophone Records. 5.0, Weather Forecast. 5.5, Variety Programme. 5.30, Reading. 6.0, Divine Service. 7.15, Weather Forecast and News Bulletin. 7.30, The Wedding at Ulfåsa—Play (Frans Hedberg), Music by Söderman. 8.45, Orchestral Concert. 9.45, Weather and News Bulletin. 10.0, Modern Dance Music. 11.0 (approx.), Close Down.

STRASBOURG (345 metres); 11.5 kW.—11.30 a.m., Gramophone Concert of Opera and Light Music. 12.45 p.m., News in French and German. 1.0, Time Signal. 1.2, Gramophone Concert (continued). 2.0 to 4.45, Interval. 4.45, Literary Talk in French: Leconte de Lisle. 5.0, Concert of Classical Music relayed from Montpellier (286 metres). 6.0, Topical Talk in German. 6.15, Talk in German: Mortgages. 6.30, Gramophone Concert: Italian Caprice (Tchaikovsky); Chinese Serenade (Siede); Japanese Lantern Dance (Yoshihomo); Zigeunerweisen (de Sarasate); Overture, Coriolanus (Bretoven); Puccini Potpourri; Selection from The Pearl Fishers (Bizet); Jota, Nana (Falla); Singing in the Bath tub (Margidson). 7.30, Time Signal. 7.32, News in French and German. 7.45, Gramophone Concert of Light Music. 8.30, Monsieur de la Palisse—Opéra-bouffe in Three Acts (Claude Terrasse). 10.30 (approx.), Close Down.

STUTTGART (MUHLACKER) (360.5 metres); 60 kW., and **Freiburg (570 metres)**.—11.15 to 11.30 a.m., Sponsored Music. 11.45, Sponsored Music. 12 noon (from Freiburg), Concert of Music from Forgotten Operas by the Freiburg Concert Orchestra, conducted by Richard Fried: Overture, Der Edelknecht (Kreutzer); Selections from Die drei Pintos (Weber); Overture, La Sirène (Anher); Fantasia on Motives from Chevalier Jean (Joucières); Overture, Casanova (Lortzing). 12.50 p.m., Time, Weather, News, and Programme Announcements. 1.0, See **Frankfurt**. 1.55, News Bulletin. 2.0 to 2.15, Sponsored Music. 2.30 to 3.0, Advanced English Lesson. 4.0, Orchestral Concert from Wildbad. Conductor, Hermann Escherich: March, Salut au printemps (Monton); Overture, Die Geschöpfe des Prometheus (Beethoven); Prelude and Scherzo (Bach-Abert); Waltz from Das Puppenmädchen (Fall); Selection from Tosca (Puccini); Russian Dance, Trepak (Dreyshock). 5.0, Concert from Munich. 6.15, Time, Weather, and Agricultural Notes. 6.25, Talk: Is Technique a Curse? 6.50 (from Freiburg), Medical Talk: Swimming. 7.15, Time, Weather, and Programme Announcements in Esperanto. 7.30 (approx.), The Potash Mines in Buzingen—Radio Pictures. 8.0, Talk by Kurt G. Sell: What People are talking about in America, relayed from America. 8.15, South German Wind-Instrument Music—Concert by the Stuttgart Philharmonic Wind Instrument Orchestra. 9.15, Le cantatrice villane (The Village Singers). Comic Opera (Valentino Fioravanti) (arr. Arthur Haelsig). 10.20, Time, Weather, News, Programme Announcements, and Sports Notes. 10.45 (from Mannheim), Cello and Pianoforte Recital. Soloists: Walter Kötscher (Cello) and Frieda Kötscher-Behrendt (Pianoforte): Suite for Cello and Pianoforte (Busoni); Sonata in A for Cello and Pianoforte (Beethoven): Jazz Music on two Pianofortes. 12 midnight (approx.), Close Down.

TOULOUSE (Radiophonie du Midi) (385 metres); 8 kW.—6.30, Exchange Quotations and Horse Racing Results. 6.45, Orchestral Selections from (a) Rip van Winkle (Plauquette), and (b) The Czardas Princess (Kálmán). 7.0, Three Waltzes (Rebrecht). 7.15, Spanish Songs. 7.50, News Bulletin. 7.45, Songs from (a) The Barber of Seville (Rossini), (b) Lakmé (Delibes), (c) The Marriage of Figaro (Mozart), and (d) Les Dragons de Villars (Mailart). 8.0, Orchestral Selections. 8.15, Chansonnettes. 8.30, Orchestral Selections from Romeo and Juliet (Berlioz). 8.45, Accordion Solos. 9.0, Concert from the Café des Américains. 10.30, North African News. 10.45, Dance Music. 11.15, Light Music. 11.30, Orchestral Selections—Mascarade (Lacôme); Le couronnement de la muse du peuple (Charpentier). 12 midnight, Weather and Announcements. 12.5 a.m. (Saturday), Light Music. 12.30 a.m. (approx.), Close Down.

TRIESTE (247.7 metres); 10 kW.—7.10 p.m., Quintet Concert—Spagnolita (Piovano); A Little Love (Eislmann); Selection from Polen'nit (Nedbal); Serenata d'amore (Amadei); May Song (Blume); Lehár Potpourri (Ilhuby); Tramonto (Pennati-Malvezzi); Tarantella d'Amalfi (De Nardis). 8.0 till Close Down, See **Turin**.

TURIN (273.7 metres); 7 kW.—Relayed by Milan (331.5 metres), Genoa (312.8 metres), and Florence (500.8 metres).—7.10 p.m., Concert. Soloist: Professor Baiardo (Violin)—Vodka (Sadun); Gipsy Dance for Violin (Tivadar-Nachez); Ronda misteriosa (Ranzato); Tyrolean Festival (Krome). 7.30, Time and Announcements. 7.31, Light Music on Gramophone Records. 8.0, Giornale Radio, Weather and Light Music on Gramophone Records. 8.25, Wireless Talk. 9.30, A Comedy in Three Acts. After the Comedy—Variety Music on Gramophone Records. 11.0, Giornale radio.

VATICAN CITY (Rome) (19.84 metres) Morning; and (50.26 metres) Evening; 10 kW.—11.0 to 11.15 a.m., Religious Information in German. 8.0 to 8.15 p.m., Religious Information in Italian.

VIENNA (517 metres); 15 kW. Relayed by Graz (352.1 metres); Innsbruck (283 metres); Klagenfurt (453.2 metres); Linz (246 metres); and Salzburg (218 metres).—5.0 p.m., Orchestral Concert: Overture, The Mikado (Sullivan); Waltz from Wiener am Nil (Klein); Potpourri, Verdis Triumphe (Weninger); Song from Das Schwalbennest (Granichstaedten); Song, Onvre tes yeux bleus (Massenet); Song, Traum durch die Dämmerung (Richard Strauss); Violin Solos: (a) Valse triste (Vecey), (b) Staccato Serenade (Gustav Macho); Selection from The Flower of Hawaii (Abraham). 6.10, Report on Foreign Traffic. 6.25, Talk on Sport. 6.40, Weekly Physical Culture Review. 6.55, Talk by Felix Rosche. 7.20, Concert by the Ghibelline University Choir: Gaudeamus igitur; Innsbruck, ich muss dich lassen; Songs of the Sixteenth Century (arr. Hans Heinz Scholtzys): (a) Was trach ich auf der hende, (b) Wir zogen in das Feld; Alt-Heidelberg (Lachner) (arr. Wagner-Schönkirch); Der Prager Studenten Wanderschaft; Vagantentelied (Heinrich Rietsch); Die Fährndung (Hermann Hutter); Hallali-Hallalo (Döring); Deutsches Freiheitslied (Engelsberg). 7.50, Time, Weather and Programme Announcements. 8.0, Talk by Kurt G. Sell: What People are talking about in America, relayed from America. 8.15, Der liegende Holländer (The Flying Dutchman)—Opera in Three Acts (Wagner). 9.35 (in an interval), News. 10.45, Dance Music from Hühners Parkhotel, Schönbrunn.

WARSAW (1,411 metres); 120 kW.—12.5 p.m., Programme Announcements. 12.10, Press Rev. 12.20, Interval. 12.40, Weather Report. 12.45, Light Music on Gramophone Records. 1.25, Interval. 1.35, Popular Music on Gramophone Records. 2.10, Interval. 3.0, Economic Report. 3.10, Light Music on Gramophone Records. 3.30, Announcements. 3.35, Popular Music on Gramophone Records. 4.35, Hydrographic Report. 4.40, Talk: The Rhythm of Life. 5.0, Concert of Light Music by the Rózewicz Orchestra. 6.0, Astronomical Talk; relayed from **Cracow (312.8 metres)**. 6.20, Dance Music. 7.15, Miscellaneous Items. 7.35, Radio Journal. 7.45, Agricultural Talk, relayed from **Wino (563 metres)**. 7.55, Programme Announcements. 8.0, Symphony Concert by the Warsaw Philharmonic Orchestra, conducted by Berdiajev. Soloist, J. Kaminsky (Violin). Symphony in G Minor (Mozart); Concerto for Violin and Orchestra in C. No. 1 (Haydn); Petite Suite (Stravinsky); Scheherazade (Rimsky-Korsakov); Introduction to Act III of Lohengrin (Wagner). In the interval, Topical Talk. 9.50, Radio Journal. 9.55, Weather and Police Notes. 10.0, Dance Music. 10.40, Sports Notes. 10.50, Dance Music.

SATURDAY, JUNE 25th.

rogrammes from Abroad.—

ALGIERS (363.3 metres); 13 kW.—7.30 p.m., Music. 7.55, News and Time Signal. 8, Song Recital. 8.20, Saxophone and avian Guitar Selections. 8.30, Request concert of Gramophone Records.

BARCELONA (Radio-Barcelona) Call EAJ1 (49 metres); 8 kW.—7.0 p.m., Programme for children. 8.30, Exchange Quotations, Request Gramophone Records and News. 10.0, Chimes, Feather, and Exchange Quotations. 10.10, Orchestral Concert; Paso-doble, Sevilla canta Ibarra; Selection from La Picarona (Alonso); Waltz, Anita (Courtious); Danza de los velos (Berardi); Andante (Berardi); Escena de la fienra (Berardi). 11.0, Extracts from Opera n Gramophone Records. 1.0 a.m., (Sunday), Close Down

BELGRADE (430.4 metres); 2.5 kW.—4.0 p.m., Concert by the Station Orchestra; March (Antrejevic); Overture, Kostana (Krstic); Persian Suite (Ruhmstein); Waldeslustern (Czibulka); Berceuse (Jarmefeldt); Selection from Lilac Time (Schubert-Berte). 7.50, Introductory Talk to the following Relay. 8.0, See Zagreb. In the interval at 9.30 (approx.), News Bulletin. After the Programme, Dance Music, relayed from the Gradjevinska Kasina Restaurant.

BERLIN (Königs Wusterhausen) (1,635 metres); 60 kW.—12 noon (approx.), Weather for Farmers. 12.5 p.m., Gramophone Concert of Operetta Music, followed by Weather for Farmers. 12.55 p.m., Time Signal. 1.30, News Bulletin. 2.0, A Cabaret on Gramophone Records, relayed from Berlin (Witzleben). 3.0, Talk: A Journalist Travels as a Steward on the Sleeping Car of the Orient Express. 3.30, Weather and Exchange. 3.45, Talk for Women. 4.0, Talk: The Serial Story and the Reader. 4.30, See Hamburg. 5.30, Health Music Review. The Teeth. 5.50, Talk. 6.5, Weekly Music Review. 6.30, Talk on Wilhelm Busch. 6.55, Weather for Farmers. 7.0, English Lesson. 7.30, The Quiet Hour, followed by Weather for Farmers. 8.0, See Frankfurt. 10.20, See Berlin (Witzleben). 12.30 a.m. (Sunday), Close Down.

BERLIN (Witzleben) (419.5 metres); 1.5 kW.—4.5 p.m., Military Band Concert, relayed from the Seeterrassen Strandhalle Restaurant, Oranienburg. 6.0, Agricultural Talk. 6.15, Talk. 6.35, Technical Talk. 6.50, Labour Market Report. 6.55, The Witzleben Station informs its Listeners. 7.0, Topical Talk. 7.10, Song Recital by Lula Mysz-Gmeiner; Wechselbild zum Tanze (Reichardt); Jedem das Seine (Mattiessen) and Grete (Mattiessen); Jedem das Seine (Mattiessen); Hopak (Monssorsky); Songs from Galgenrieden (Graener); (a) Der Nachtschelm und das Siebenschwein, (b) Gespenst, (c) Palmström, (d) Das Huhn, (e) Der Mond, (f) Philantropisch. 7.35, The Narrative of the Week. 8.0, Orchestral Concert, conducted by Hermann Schulze-Wittenberg; Overture, Morning, Noon and Night (Suppé); Waltz from A Waltz Dream (O. Strauss); Selection from The Tales of Hoffmann (Offenbach); Polonaise No. 1 in A (Chopin); March, Wien bleibt Wien (Schrammel); Boston Waltz, Poranek (Lindsay-Thiemer); Potpourri, From the Rhine to the Danube (Rhode); Habsburg Marsch (Kral). 9.0, News and Sports Notes. 9.10, Variety Concert, relayed from the Kurhaus, Bad Homburg. 10.20, Weather, News, and Sports Notes. 10.30 (approx.), Dance Music. 12.30 a.m. (Sunday), Close Down.

BORDEAUX - LAFAYETTE (304 metres); 13kW.—6.30 p.m., Radio Journal. 8.0, Announcements, Exchange, and Lottery Results. 8.5, Sports Notes. 8.10, Advanced English Lesson. 8.25, News Bulletin and Weather Forecast. 8.30, Popular Music on Gramophone Records. 9.0, Les Jours du Foyer—Comedy in Three Acts (Maurice Hennequin).

BRATISLAVA (279 metres); 14 kW.—8.0 p.m., Programme for Children. 7.0, See Prague. 10.15, Programme Announcements. 10.20, See Moravska-Ostrava.

BRESLAU (325 metres); 1.5 kW.; and **GLEIWITZ (253 metres)**.—5.45, Concert by the Station Orchestra, conducted by Franz Marszalek; Suppellihsionen (Michaelov); Polka-Potpourri (Lindemann); Casaren-Marsch (Heinecke); Dutch Fisher-Girls (Fresco); Slow Foxtrot, Jonny, wenn du Geburtstag hast (Holländer); Selection from Für eine schöne Frau (Goetze); Foxtrot, The Sphinx (King and Warren); Foxtrot Fantasia, The Watermill (Evans); Potpourri, Walzertrümpe (Robrecht); Potpourri, Lassst Schläger sprechen (Dostal). 8.0, Weather for Farmers.

8.5, Topical Talk. 8.30, White Horse Inn—Comedy (Oscar Blumenthal and Gustav Kadelburg). 10.0, Time, Weather, News, Sports Notes and Programme Announcements. 10.30, Dance Music from Berlin (Witzleben). 12 Midnight (approx.), Close Down.

BRNO (342 metres); 35 kW.—7.0 p.m., See Prague. 10.15, News Bulletin. 10.20, See Moravska-Ostrava.

BRUSSELS (No. 1) I.N.R. (509 metres); 15 kW.—12 Noon, Concert by Max Alexys and his Orchestra. 1.0 p.m., Le Journal Parlé. 1.10, Concert (continued). 4.15, Programme for the Opening of the Medical Congress in the presence of Her Majesty the Queen, relayed from the Palais des Academies. Address by the Minister for the Interior, Professor Balthazard, Dean of the Faculty of Medicine of Paris, and others. 5.0, Trio Concert: Overture, Czar and Carpenter (Lortzing); Symphonie Poem, Erotica (Grieg); Ich liebe dich (Grieg); Selection from L'enfant prodige (Debussy); La lune qui danse (Aubry); Romance for Violin (Svendsen); Selection from The Drum Major's Daughter (Offenbach); The Broken Melody, for Cello (Van Bienen); Chanson d'Arlette (de Tave); Tango, Lorito (Santis); Waltz, Dorothy (Robert); Tarantella (Calindi). 6.0, Gramophone Records: Overture, Iphigenia in Aulis (Gluck); Ballad and Polonaise (Vieuxtemps). 6.15, Talk: Great Belgian Painters of the Nineteenth Century; Felicien Rops. 6.30, Gramophone Records: Overture, The Flying Dutchman (Wagner); Menuet des Follets et Valse des sylphes (Berlioz); Petite Suite (Debussy); Dance of the Seven Veils, from Salome (Richard Strauss). 7.15, Talk: Publishing the Works of Old Belgian Authors. 7.30, Literary Review. 8.0, Li feye de Djardin—Play (Derche) from the Trianon Walloon Theatre, Liège. 8.45, Answers to Correspondence. 9.0, Orchestral Concert, conducted by Charles Walpot. Soloists: José Pierre (Soprano) and Armand Crabbe (Baritone), of the Scala, Milan; March, Sortie militaire (Faulk); Overture, The Gipsy Baron (Johann Strauss); Josef Strauss Potpourri (Faubach); Baritone Solos, In a Camp of the Ancient Britons (Ketelby); Soprano Songs, Fragan Potpourri (Salabert). 10.0, Le Journal Parlé. 10.10, Concert (continued): Une fête a Aranjuez (Demerseman); Amaryllis, or The Shepherd's Kiss—Choral Ballet in One Act (Maurage), The Orchestra and Choir, conducted by Charles Walpot; Sound Film Potpourri (Salabert). 11.0 (approx.), Close Down.

BRUSSELS (No. 2) N.I.R. (338.2 metres); 15 kW.; Programme in Flemish.—12 noon, Concert by the Tea Room Orchestra. 1.0 p.m., Le Journal Parlé. 1.10, Concert (continued). 5.0, Orchestral Concert, conducted by Charles Walpot: March, The Cadets (Souza); Waltz from Die geschiedene Frau (Fall); Overture, The Merry Wives of Windsor (Nicola); Au village (Gillet); Selection from A Waltz Dream (Oscar Strauss); Memories of Lucerne (von Blon); Ballet russe (Luigini). 6.0, Gramophone Concert: Siegfried Idyll (Wagner); Prelude to Lohengrin (Wagner); Selection from Boris Godounov (Monssorsky); Spanish Songs (Falla); Overture, Rienzi (Wagner). 7.15, Talk: The Black Forest. 7.30, Film Review. 8.0, Gramophone Records: Italian Serenade (Wolf); Ronde Burlesque (Schmitt). 8.15, Georges Comteine Commemoration Programme. 9.0, De Vlasgaard, Opera (Vander Meulen); the Orchestra conducted by Arthur Meulemans; in the interval Le Journal Parlé.

BUCHAREST (394 metres); 12 kW.—4.0 p.m., Concert of Light Music and Romanian Music by the Sibicane Orchestra. 5.0, News Bulletin and Time Signal. 5.10, Concert (continued). 6.0, Educational Programme. 6.40, Light Music on Gramophone Records. 7.0, Viennese Music by the Schrammel Quartet. 7.30, Humorous Programme. 7.45, Concert of Romanian Music by the Lucea Orchestra. 8.45, News Bulletin and Close Down.

BUDAPEST (550 metres); 18.5 kW.—Programme also relayed on 210 metres from 4.0-4.45 and from 6.45 to Close Down.—6.0 p.m., Concert by the First Budapest Zither Association, conducted by Stefan Bundschuh. 6.45, Gyoni Commemoration Programme. 7.30, Song Recital by Nikolaus Matuskas, accompanied by Georg Kosa (Pianoforte); Orange (Kosa); Two Songs (Bartok); Two Hungarian Songs (Kodaly); Air (Szabados); Song (Dohnányi); To a Rose (Molnar); Song (Lányi); Air

(Kiszely). 8.0, An Operetta Zerkovitz. After the Operetta, News and Announcements, followed by Concert by the Eugen Farkas Cigany Band, relayed from the Café Spolarich.

COPENHAGEN (281 metres); 0.75 kW., and **KALUNDBORG (1,153 metres);** 7.5 kW.—11.0 a.m., Weather Forecast. 11.10, Angling Notes. 11.20 (from the Esbjerg Studio), Opening of the Danish Fishing Industries Exhibition in Esbjerg; Addresses and Music. 12.30-2.0 p.m., Concert from the Bellevue Strand Hotel. 2.30, Gramophone Records of Variety Music. 3.0, Programme for Children. 3.30, Concert by the Radio Orchestra, conducted by Launy Gröndahl, soloist, Pauli Jensen (Violin); Overture in E minor (Schubert); Myrtle Waltz (Johann Strauss Sen.); Ballet Music from Idomeo (Mozart); Selection from The Tales of Hoffmann (Offenbach); Entry of the Guests into the Wartburg, from Tannhäuser (Wagner); Violin Solos: (a) Minuet (Porpora-Kreisler); (b) Romance (Svendsen); (c) Concert Polonaise No. 2 (Wieniawsky); Overture Eurynthe (Weber); Tambourin, Minuet and Gigue from Céphale et Procris (Grétry); Waltz, Neu-Wien (Johann Strauss); Mimmet and Rondo from the Divertissement in D (Mozart); March and Selection from The Queen of Sheba (Gounod). 5.40, Exchange and Fish Market Prices. 5.50, Talk: National Types as seen through the Eyes of Foreigners—the Frenchman as seen by the Swede. 6.20, French Lesson. 6.50, Weather and News. 7.15, Time Signal. 7.30, Talk: Lassenius Kramp. 8.0, Town Hall Chimes. 8.2, Reading (Josef Maria Frank). 8.30-12 midnight, A Radio Ball for the Older Generation. 8.30, Dance Music: Kongemøde March (Olfert Jerspersen); Waltz, Seje og ad Aaen; Amalie-Polka (Jensen); Mazurka, La Scandinave (Ganne); Sekstur; Waltz, Lustige Brüder (Vollstedt); Polka, Wienerkreuz; Japanese Gallop (Möller). 9.10, Recital of Dance Songs. 9.25, Dance Music (contd.): March, Kinderlieder (Ziehner); Souvenir-Mazurka (Waldteufel); Les Lanciers (Mikel); Fingerpolka; Waltz, Lysistrata (Linke); Træddallehus-Polka (Iversen); March Festspiel (Blankenburg). 10.5, News Bulletin. 10.20, Dance Music (contd.): Mazurka from Der Bettelstudent (Müllöcker); Britta-Polka (Lumbye); Amelie Vals (Lumbye); Kontrasejre; Polka, Den lille Cohu (Eindöshofer); Valse lente, Quand l'amour meurt (Crémienc); Mirella (Munich-Lassen); Storfryd Alexander-March (Lumbye). 11.5, Recital of Old Songs. 11.20, Dance Music: Waltz, Donauwellen (Ivanovic); Polka, Hoch im Norden (Fahrbach); Spanish Mazurka, Madrileña; Tivoli Schottische (Gottschalksen); Caecilia Waltz (Lumbye); Danish Tatoo; Førgangen Nat. Champagne Gallop (Lumbye). 12 midnight, Town Hall Chimes and Close Down.

DUBLIN, Call 2RN (413 metres), 1.2 kW., and **CORK (224.4 metres)**.—12 Noon, Children's Day. Solemn Pontifical High Mass in Phoenix Park. 7.20, News Bulletin. 7.30, Time Signal. 7.31, Talk (to be announced). 7.45, Gaelic Hike. 8.0, Special Programme for Congress Week. 10.30, Time Signal, News, Weather Forecast, and Close Down.

FEGAMP (233 metres); 10 kW.—12 noon, Gramophone Concert. 12.30 p.m., French News Bulletin. 12.45, Concert Selection from Rose Marie (Friml); Kadubec (Yvain); Selection from The Magic Flute (Mozart); Selection from Les Dragons de Villars (Maillart); Selection from The Merry Widow (Lehar); Selection from Manon (Massenet). 2.0-7.30, Interval. 7.30, French Local News. 8.0, Concert offered by Tour de Garde. 8.45, Concert offered by Le Haut Parleur: La Voix de son Maître (Courtade); Nina (Pensio); Rustle of Spring (Sinding); Au fond du Square (Bach). 9.0, Vocal Concert by the Pupils of Mme. Jeanne Mallard; M. Petit (Pianoforte), Mme. Crass (Violin) and M. Morris (Comedian). 10.0, Interval. 11.0 till Close Down, Programme in English. 11.0, The Piano Synopaters (J. and A. K. Lee). 11.30, The I.B.C. Light Orchestra (Section B), conducted by Herbert Foster, and Studio Artistes: Memories (Waldteufel); Selection from The Gipsy Princess (Kaiman); Songs: (a) Go Home Again (Towers); (b) If They Had an Income Tax on Love (Washington); Melodies of the Moment (arr. Connelly); Duets: (a) Crystal Gazing (Rickards); (b) Moonshine (Leslie). 12 midnight, Through the Cotton Belt, another I.B.C. Tour. 1 a.m., Concert, Vocal and Orchestral: Over the Waves (Kosas); Waltz, Gold and Silver (Lehar); Snacks in Bars (Ezerer); Songs: (a) Little White Lies (Donaldson); (b) You are the Melody (Henderson); Raspberries (Hubert); You'll Die if you Worry (Damerell). 1.30, Concert: Lovin' You the Way I Do (Morrison);

Programmes from Abroad.—

Overnight (Connelly); More Than You Know (Elsen); I'm Walking in the Sun (King); Flying Stunts (arr. Foster); Selection from the Gypsy Princess (Kalmán); Songs: In Apple Blossom Time (Tobins), They'll All Be There But Me (Kalm). 2.0, Dance Music by Roy Lick's Columbians. 2.57, I.B.C. Goodnight Melody. 3.0, Close Down.

FRANKFURT (390 metres), 1.5 kW., and CASSEL (246 metres).—1.0, Concert by the Station Orchestra conducted by Walter Kaspar: Grillenbanner-Marsch (Komzak); Overture to an Operetta (Lincke); Waltz, Life and Love (Fall); Selection from Die Bayadere (Kalmán); Waltz from Wäschermädln (Raimann); March on Motives from Der Natursänger (Eysler); Waltz, Wiener Extrablätter (Translateur); Selection from Der Tenor der Herzogin (Künneke); Schneidige Reiter—March on Motives from Die beiden Husaren (Jessel); Ich bin dir gut—Waltz on Motives from Jabuka (Joh. Strauss); Overture, Berlin, wie es weint und lacht (Conradi). 2.0 (in an interval), News Bulletin. 2.40, Sponsored Gramophone Concert. 3.20, Weather Report. 3.25, Time and Economic Notes. 3.30 Handwork for Children. 4.50, Economic Notes. 5.0 See Stuttgart. 6.15, Economic Notes. 6.25, Announcement of a Competition for Listeners. 6.35, Talk: The Industrial Position of North America. 7.0, Time, Programme Announcements, Weather, and Economic Notes. 7.5, A Picture of the Town of Wiesbaden. 8.0, Variety Programme from the Bad Homburg Kurhaus. 10.20, Time, Weather, News, and Sports Notes. 10.45, Music from Berlin (Witzleben). 12 Midnight (approx.), Close Down.

HAMBURG, Call ha (in Morse) (372 metres), 1.5 kW., Relayed by Bremen (270 metres), Flensburg (218 metres), Hanover (566 metres), and Kiel (232.2 metres).—4.30 p.m., Concert of Overtures and Fantasias by the Little Norag Orchestra conducted by Horst Platen: Overture, The Black Domino (Auber); Selection from Lucia di Lammermoor (Donizetti); Overture, A Masked Ball (Verdi); Selection from Le Tribut de Zamora (Gounod); Overture, Tancred (Rossini); Selection from the Lady of the Rose (Gilbert). 5.30 p.m., Talk for Women. 5.35, (from Hanover), Talk on the Beauties of Germany: The District round the Weser. 6.0, Variety Programme. 6.35, Talk: Women as Manual Workers. 7.0, Topical Talk. 7.15, Weather Report. 7.20, T. W. Elbertzagen reads from His Own Works. 8.0, See Munich. 10.0, News Bulletin. 10.20, Wordly Wisdom in Popular Songs—Concert by the Small Station Orchestra, conducted by Gerhard Maasz. Soloists: Erna Kroll-Lange, Gertrud Stocks, Erwin Bolt, and Bernhard Jakschalt. (a) Baby, wenn du mairig bist, du, du! (Spoliansky); (b) Schlaf, mein Liebling (Bolt). Sound Precepts: (a) Lass dir Zeit, alles mit Gemütlichkeit (Fall); (b) Was der Onkel Doktor sagt, das soll man immer tun (Egen). The School of Experience: (a) Wenn du denkst der Mond geht unter; (b) Sieben Sterne hat der grosse Bär (Gertler). Young Love: (a) Mit der Liebe soll man nicht scherzen; (b) Küssen ist keine Sünd' (Eysler). Engagements: Nimm dich in act vor blonden Frauen (Holländer); (c) Treu muss man sein (Grothey). Marriage: (a) Einmal möchte ich was Nürrisches tun (Léhar); (b) Er soll dein Herr sein (Müllöcker). Parting: Wenn du mir mal nicht mehr treu bist (Streit); (b) Warum denn weinen, wenn man ausmändergeht. The Old Love: (a) Good-night from Victoria and Her Hussar (Abraham); (b) Glücklich ist, wer vergisst (Johann Strauss). 11.20, Dance Music, relayed from the Siegler Cafe.

HEILSBURG (276.5 metres), 60 kW., and DANZIG (453.2 metres).—11.30 a.m., Concert by the Königsberg Opera House Orchestra, conducted by Werner Richter-Reichhelm—Overture, Russian and Ludmilla (Glinka); Selection from Jenfa (Janacek); Three Variations on a Theme by Tchaikovsky for String Orchestra (Arensky); Intermezzo (Edmund Niek); Mozartiana (Tchaikovsky); Suite (Järnefeldt). 1.5 to 2.30 p.m., Gramophone Concert—Selection from La Bohème (Puccini); Oriental Suite (Poppy); Second Potpourri of Rheinländer (Kernbach); Xylophone Solo, Der Carneval von Venedig (Krüger); Alt-Berlin im Tempo der Zeit (Holländer); Think of Me (May); Uebermütige Zeeher (Meysel); Selection (German); Wir satzen am sonnigen Morgen (Sturm); March, Gruss an Deutschen Söhne (Berud). 3.30 (from Danzig), Programme for Children. 4.0, Talk: Why an Aviation-Advertisement Week? 4.10, Talk: Fifty Years of the Brinland Peasants Association. 4.30, Concert of National Dances by the Orag Orchestra, conducted by Eugen Wilcken—Norwegian Dances

SATURDAY, JUNE 25th (cont.)

Nos. 1, 2 and 4 (Grieg); Russian Dances Nos. 1, 2, 3 and 5 (Bortkiewicz); Austrian Dances (Pachernegg); Slavonic Dances Nos. 16 and 18 (Dvorak); Hungarian Dances Nos. 6, 3 and 5 (Brahms); Spanish Dances Nos. 1, 2, 4 and 3 (Moszkovsky); Dutch Clog Dance (Lortzing); German Dances (Mozart). 5.10 (in an interval) (from Danzig), Film Notes. 6.0, Programme Announcements for the Coming Week. 6.10, Programme Announcements in Esperanto. 6.15, Agricultural Market Prices. 6.20, International Market Report. 6.30, Monthly Review. 6.55, Concert by the Königsberg Blind Male Voice Choral Society. Conductor: Otto Dahms—O Schutzgeist alles Schönen (Mozart); Frühlingslied (Schumann); Frühlingsmorgen (Aht); Das alte Lied (Kirchl); Rheinlied (Hilowede); Das deutsche Volkslied (Weinberger); Horch, was kommt (arr. Hegar); Spinn, spinn (arr. Schauss); Serenade (arr. Neuhauer); Uebermut (arr. Wohlgenuth). 7.25, Talk by Waldemar Baumgart: South African Reminiscences. 7.55, Weather Forecast. 8.0, See Frankfurt. 10.20 (approx.), Weather, News, Sports Notes and Dance Music from Berlin (Witzleben). 12.30 a.m. (Sunday), Close Down.

HILVERSUM (296.1 metres); 20 kW (7 kW up to 4.40 p.m.).—6.25 to 9.40 a.m., Programme of the Workers' Radio Society (V.A.R.A.). 6.25 to 6.40 and 7.10 to 7.25 a.m., Physical Culture Lesson. 7.40, Gramophone Records of Light Music. 9.40, Religious Programme by the Liberal Protestant Radio Society (V.P.R.O.). 9.55 till Close Down, V.A.R.A. Programme. 9.55, Variety Programme. 11.40, Septet Concert with Gramophone Records of Variety Music. 12.40 p.m., Organ Recital—American Patrol (Meacham); Tesoro mio (Becucci); Overture, Frau Luna (Lincke); Si vous l'aviez compris (Denza); When it's sleep time down South (René); Temptation Rag (Lojze); Gramophone Records of Light Music; Potpourri, Hallo, hallo hier Wien! (Morena). 1.40, Interval. 1.55, Talk. 2.10, Quintet Concert—Miniature Overture, The Merry-makers (Coates); Valse triste (Sibelius); Serenata di baci (de Micheli); Suite, At the Circus (Armandola). 2.40, Sports Talk. 2.55, Concert (continued)—Waltz, Accelerationen (Strauss); Serenade (Pierné); Dance of the Derivishes (Bendix); Selection from The Barber of Seville (Rossini); Gramophone Records of Light Music; Four Indian Love Lyrics (Woodford-Pinden); Parade im Kindergarten (Bendix); Canzone della cavalletta (Amadei-Weninger); Intermezzo from Cavalleria Rusticana (Mascagni); Violin Solos, (a) Zapateado (de Sarasate), (b) Kickin' the Cat (Venuti); Gramophone Records of Light Music; Sound Film Music (arr. Cohen). 4.40, Programme for Children. 5.40, Septet Concert—Overture, Prince Carnival (Schreiner); Waltz, Die Berge die sind meine Heimat (Birkhofer); Potpourri, Extravaganzen (Morena); Tango, El Malero (de Caro); Foxtrot, Say it with a Ukelele (Conrad). 6.10, Weekly Review. 6.25, Concert (continued)—Selected from Manon Lescaut (Puccini); Waltz, Meine Liebe blüht alle Jahre auf's Neu (Salter); Paso-doble, Flame of Desire (Dazar); Potpourri of Popular Songs. 6.55, Address. 7.10, Concert (continued)—Waltz, Wienerblut (Joh. Strauss); Im Prater blüh'n wieder die Bäume (Stolz); Waltz, Das muss ein Stück vom Himmel sein (Hexmann); Potpourri, Wiener Bohème (Uhl). 7.40, Variety Concert. Topical Talk. Orchestral Selections: (a) March, Im Zigeunertager (Oscheit); (b) Waltz, Nights of Gladness (Anellife); (c) Selection from La Fille de Madame Angot (Lecoq); (d) American Patrol (Meacham); (e) Motor March (Rosey); Henri Marechal in his Repertoire; Orchestral Selections: (a) March, New York (Padilla); (b) Waltz, Was Blumen träumen (Translateur); (c) Song Potpourri, Die Welt im Lied (Intrator); Henri Marechal in his Repertoire. Orchestral Selections: (a) Comedy Overture (Kéler-Béla); (b) You are my Heart's Delight (Léhar); (c) Aufzug der Stadtwache (Jessel); (d) Selections from Der Juxbaron (Kollo). 9.55, News, Football Results, and Announcements. 10.10, Dance Music. 10.55, Gramophone Records of Variety Music. 11.40 (approx.), Close Down.

HUIZEN (1,875 metres); 8.5 kW.—Programme of the Catholic Radio Society (K.R.O.). 7.40 a.m., Gramophone Records of Light Music. 8.55, Interval. 9.25, Running Commentary on the International T.T. Races at Assen. 10.10, Gramophone Records of Popular Music. 10.40, Religious Address. 11.10, Police Notes. 11.25,

Running Commentary (contd.). 12.10 p.m., Sextet Concert; Tägliche Musik (Mackeben) Bleib' mir treu (Love); Schatzwalzer (Strauss); Selection from Faust (Gounod); Sinnbild (Lincke); Fantasia on the Works of Delibes (Urbach); Ein Lied aus meiner Heimat (Kaper); That tender melody (v. Lindern). 1.10, A Visit to the Submarine O.14 at Helder. 2.0, Running Commentary on the T.T. Races (contd.). 2.40, Programme for Children. 3.40, Swimming Lesson. 4.10, Gramophone Records of Light Music. 4.20, Running Commentary (contd.). 4.55, Popular Song Recital from Arkenham. 5.55, Concert; Overture: Falrendes Volk (Leuschner); Butterflies (Heykens); Chant sans paroles (Tchaikovsky); Minnet in G (Beethoven); Im Wandel der Zeiten (Morena); Zigeunerselnsucht (Kempper); Glinka - Juwelen (Urbach); Japo - Nialserie (Chapuis); Potpourri, Eisblumen (Leuschner); Pösterwalzer (Lammer); Finale. 6.50, Talk. 7.10, Police Notes. 7.25, Songs by the Comedian Harmonists on Gramophone Records. 8.25, Songs to the Lute and Pianoforte. 8.40, News Bulletin. 8.55, Orchestral Concert; Potpourri, Für alle (Dostal); The Knight of the Hobby Horse (Evans); Waltz; Potpourri (Robrecht); 9.25, Humorous Talk. 9.40, Concert (contd.); Potpourri, Hoch das Bein (Leuschner); Oriental Suite, An den Ufern des Nils (Platen); Erstes Rheinländer Potpourri (Kernbach); Potpourri, Zum Tanz (Kernbach). 10.25, Talk. 10.40, Concert (contd.); Waltz from Gipsy Love (Lehar); Angelus de la mer (Gouldier); Selection from Les Cloches de Corneville (Planquette); Waltz: La Gitana (Bucalossi); The Caravan (Bayer); Waltz: Ever or Never (Walldtfehl); Eins, zwei, drei . . . die ganze Kompagnie (Reisfeld). 11.40 (approx.), Close Down.

KATOWICE (408 metres); 16 kW.—5.0 p.m., Orchestral Concert. 6.0, Talk. 6.20, Concert of Light Music and Dance Music. 7.45, Sports Notes. 9.10, Concert of Light Music. 10.5, Recital of Chopin Music by Leon Borunsky. 10.50, Light Music and Dance Music.

LAHTI (1,796 metres); 54 kW., Relayed by HELSINKI (358.1 metres).—5.0 p.m., Talk on the Agricultural Exhibition. 5.50, News in Finnish. 5.59, Time Signal and Weather Forecast. 6.10, News in Swedish. 6.15, Talk (to be announced). 6.35, Accordion Recital. 6.55, Talk. 7.15, Song Recital by Hellin Kahila. 7.35, Dramatic Programme. 8.5, Concert by the Station Ensemble. 8.45, News in Finnish. 9.0, News in Swedish. 9.15, Light Music by the Orchestra of the Kappeli Restaurant. 10.0 (approx.), Close Down.

LANGENBURG (473 metres) 60 kW.—12 noon, Gramophone Concert: The Milan Scala Orchestra: Overture, William Tell (Rossini); The Philadelphia Symphony Orchestra: The Nutcracker Suite (Tchaikovsky); Marek Weber and his Orchestra: Ballet Music from Undine (Lortzing); The Berlin Opera House Orchestra: Quadrille from The Prophet (Mayerbeer). 12.50 p.m., Weather, Announcements and Time. 1.0, Concert from Frankfurt. 2.30, Gramophone Concert of Popular Music. 3.30, Economic Notes and Time Signal. 3.50, Programme for Children. 4.20, Talk on Touring in the Rhineland and Westphalia—From Arnsburg to Brilon. 4.40, English Lesson. 5.0, Mandoline Concert with Walter Schneiderhan (Violin); Selections (Bey-siegel: (a) March, Treue Freunde; (b) Waltz, Herbstweisen; (c) Intermezzo, Beim Kaffeeklatsch. Violin Solos: (a) Humoresque (Dvorak); (b) Kubelk-serenade (Drda); (c) Polichinelle (Kreisler); Serenata d'amore (Cerni); Paraphrase on O solo mio (Oscheit); The Cadet March (Souza); Violin Solos: (a) Mitternachts-glocken (Kreisler); (b) Spanish Serenade (Chaminade); (c) Introduction and Tarantelle (Sarasate); Sei grüsst mein schönes Sorrent (Hein); Waltz, Liebestraum (Czibulka); March, Neues Leben (Goebel). 6.15, Talk: Women and Aquatic Sports. 6.40, Talk. 7.0, Weather, Time, Economic Report and Sports Notes. 7.10, Talk for Workers. 7.30, Talk on Catholicism. 7.55, News Bulletin. 8.0, See Munich. 10.0, News Bulletin. 10.45, Concert, conducted by Wolf. 12 midnight, Jazz Music. 1.0 a.m. (Sunday), Close Down.

LEIPZIG (259 metres) 2 kW and DRESDEN (319 metres).—5.0 p.m., Concert by the Leipzig Symphony Orchestra, conducted by Hilmar Weber. Soloist Edith Schmidt (Soprano): Spring Overture, Op. 15 (Goetz); Four Songs (Schubert); (a) Fischer-Weise; (b) Die Liebe hat gelogen; (c) An die Nachtigall; (d) Rastlose Liebe. Serenade in C Op. 14 (Fuchs); Selection from The Queen of Spades (Tchaikovsky); Three Songs (Grieg);

Programmes from Abroad.—

SATURDAY, JUNE 25th (cont.)

a) Eros; (b) Vom Monte Pincio; (c) Ich liebe ich; Waltz, Gebirgskinder (Ziehrer); Selections from Eine Nacht in Venedig (Joh. Strauss). 3.30, German Lesson. 6.50, A Modern Dictionary. 7.0, Talk for Parents. 7.30, Concert by the Leipzig Concertina Orchestra, conducted by Paul Frey; Festklänge Ouverture (Frey); Intermezzo, Jupiter's Garden (Eugene); Gavotte. Herz und Herz (Latann); Die kleine Patrouille (Siede); Selection from Ermينو (Rossi-Werlé); Ecosaisés Schubert-Werlé. Folk Melody, Ich habe mir eines erwählt (arr. Werlé). 8.0, Variety Programme from Frankfurt. 10.20, News, followed by Dance Music from Berlin (Witzleben). 12 midnight, Close Down.

LJUBLJANA (547.7 m.) 2.5 kW.—6.30 p.m., Gymnastic Lesson. 7.0, English Lesson. 7.30, Talk on Philosophy. 8.0, Duets from Opera. 8.45, Mandoline and Guitar Recital. 9.30, Quintet Concert. 10.0, Time, News and Light Music.

LWOW (381 metres); 16 kW.—7.15 p.m., Miscellaneous Items. 7.35, See Warsaw. 7.45, Literary Talk. 8.0, Concert by the Serenade Mandoline Orchestra, conducted by M. R. Malewsky. 11.30 (approx.), Close Down.

LYONS (France) La Doua (PTT) 644 kc./s (465.8 metres); 1.5 kW.—Transmits at intervals from 8 a.m. 7.0 p.m., Concert of Popular Music on Gramophone Records. 7.30, Radio Gazette for Lyons and the South-East. 8.30, Programme relayed from Paris (Ecole Supérieure) (447.1 metres).

MADRID (Union Radio) Call EAJ7 (424.3 metres); 2 kW.—8.0 p.m., Chimes, Market Prices, and Request Gramophone Concert. 9.15, News Bulletin. 9.30-10.30, Interval. 10.30, Chimes, Time Signal, and Selections from Musical Comedies. (a) La Alegria de la Huerta (Chueca) and (b) The Merry Widow (Lehar). 12.45 a.m. (Sunday), News Bulletin. 1.0 a.m., Chimes and Close Down.

MORAVSKA-OSTRAVA (263.8 metres); 11 kW.—7.0 p.m., See Prague. 10.15, Programme Announcements and Theatre Guide. 10.20, The Queen's Collar—Comedy in One Act with Music (Hradecky).

MOSCOW, Trades Union (1,304 metres); 100 kW.—6.30 p.m., Proletariat Radio Journal. 7.15, Programme for Young Communists. 8.0, Talk in German and English: A Builder's Work. Talk in Spanish: Soviet Foreign Politics.

MUNICH (533 metres); 1.5 kW. Relayd by Augsburg and Kaiserslautern (560 metres) and Nurnberg (239 metres)—5.0 p.m., Orchestral Concert conducted by Karl List. Soloist, Andre Krenelhauff (Tenor). Overture, Masaniello (Auber); Waltz for String Orchestra (Tchaikovsky); Four Sonnets of Michelangelo Buonarroti, for Tenor and Orchestra, Op. 14a (Kundgraber); Daghestan Suite (Reiter); Selection from The Daughter of the Regiment (Donizetti); Erinnerungen an Lannet (Schrammel); March, Tren bewahrt (Benzinger). 6.15, Talk for Girls. 6.45, Concert by the Station Choir and String Orchestra. Soloists, Margot Leander (Soprano), Willy Stuhlfauth (Violin), and Gustav Schoedel (Organ). In Ewigkeit, for Mixed Choir, Strings, Harp, and Organ (Schalit); Largo for Violin and Organ (Hänssel); Selection, Motet, for Soprano and Mixed Choir a-capella (Schubert); Fantasia and Fugue on the Theme B.A.C.H. (Liszt). 7.25, Wireless Notes. 7.40, Talk with Gramophone Illustrations: Scandinavian Folk Music. 8.0, Variety Programme. 10.20, Time and News. 10.45, Concert from Langenberg. 12 Midnight (approx.), Close Down.

OSLO (1,083 metres); 60 kW. Relayd by Fredrikstad (367.6 metres); Hamar (560 metres); Notodden (447.1 metres); Porsgrund (453.2 metres); and Bjukan (447.1 metres). 3.0 p.m., Relay of the Tenth Scandinavian Youth Reunion at Akerhus Castle. 5.15, Programme for Children. 6.15, Programme of National Music by Trygve Kunna (Vocalist) and Eilvind Groven (Hardanger Fiddle). 6.45, Talk on Economics. 7.0, Announcements, Weather and News Bulletin. 7.30, Talk (to be announced). 8.0, Time Signal. 8.1, Concert by the Station Orchestra, conducted by Hugo Kramm; Overture, The Merry Wives of Windsor (Nicolaï); Potpourri of Music by Schubert (arr. Urbach); Torch Dance (Meyerbeer); The Slave (Lalo); Malagena (Razizade); Blaklokker (Liljefors); Nordfartak (Olsen); Ritornel (Olsen); Potpourri Streifflechter (Morena); Waltz, Frühlingstimmen (Johann Strauss); Die Wasche

Parade kommt (Eilenberg); Gallop (Axt); March, Mit Siegespalmen (Blankenburg). 9.40, Weather and News Bulletin. 9.45, Topical Talk. 10.15, Sketch. 10.45, Dance Music on Gramophone Records. 12 Midnight (approx.), Close Down.

PALERMO (542 metres); 3 kW.—5.30 p.m., Variety Music on Gramophone Records. 6.0, Programme for Children. 6.30-8.0, No Transmission. 8.0, Announcements, Radio Giornale dell'Enit, Agricultural Report and Giornale radio. 8.20, Gramophone Records of Light Music. In the intervals at 8.25 Sports Notes and at 8.30, Time and Announcements. 8.45, A Waltz Dream—Operetta in Three Acts (O. Straus). In the intervals, Book Review and Announcements. 10.55, News Bulletin.

PARIS (Eiffel Tower) Call FLE (1,445.7 metres); 13 kW. Time signals (on 2,650 metres) at 10.26 a.m. and 11.26 p.m. (preliminary and six-dot signals)—6.45 p.m., Talk on the Theatre: Music and Words. 7.0, Le Journal Parlé. 8.20, Weather Report. 8.30, Two Plays: (a) Voix intimes—Radio Scenario (Valin). (b) The Chicago Farmer—Comedy in Two Acts (Timothy) after Mark Twain. 10.0 (approx.), Close Down.

PARIS (Poste Parisien) (328.2 metres); 60 kW.—7.0 p.m., News Bulletin and Parliamentary Review. 7.15, Sponsored Gramophone Concert. 7.45, Talk on the Events of the Week. 8.0, Topical Talk. 8.20, Talk on Music. 8.30, Le Journal Parlé and News Bulletin. 8.45, Concert of French Songs by Music Hall Artists. 10.0, Dance Music on Gramophone Records. 12.0 midnight (approx.), Close Down.

PARIS (Radio Paris) (1,725 metres); 75 kW.—6.45 a.m., Physical Culture. 7.30, Weather and Physical Culture (continued). 7.45, Light Music on Gramophone Records. 8.0, News, Weather and Press Review. 12 noon, Gramophone Concert. Les Deux amis (Magnen); Voici mon Cœur (Crémieux-Varene); L'amour de ma vie (Bosc-Marinier); The Little Café (Whiting); La Fontaine et Carouet (Letorey); Je suis à la mode (Avignon); Selection (Erwin); Eternel Printemps (Popy); L'âme des violons (de Buxeuil-Fèvre); The Puppets (Raïter); Tu m'as juré (Lenoir); Grock, in his Musical Sketch; The Bird and the Fountain (Silesu); Arab Tales (Danou); Selection from Les Saltimbanques (Ganne); Mary Ann (Silver); La Feria (Lacombe); Place Blanche (Melé). In the intervals, News and Weather. 2.0, Gala Programme on the occasion of the Gramophone Congress, relayed from the Comédie des Champs Elysées. The Station Orchestra, conducted by Georges Grécount, Soloist: M. Dorin (Songs). After the Concert, Market Prices. 6.30, Market Prices, Weather, Agricultural Report, Talk, Exchange and Racing Results. 7.0, Talk arranged by the Union des Grandes Associations Françaises. 7.10, Technical Talk by Colonel Bourgoing. 7.30, Elementary Book-keeping Lesson. 7.45, Latin Press Review, Commercial Prices and News. 8.0, Talk by Lugne Poe. 8.30, News, Sports Notes, and Weather. 8.40, Review by René Dorin. 8.45, Revue arranged by the Cartoonist Moriss, with the Collaboration of Mlle. Gisèle Parry. 9.15, Press Review and News. 9.30, Excerpts from La Bohème—Opera (Puccini) on Gramophone Records.

PITTSBURGH, Westinghouse Electric (KDKA) (306 metres); 25 kW. Relayd by W8XK on 48.86 metres and 25.25 metres.—9.0 p.m., Saturday Matinee, from New York. 9.30, Tales of the Pennsylvania State Police: Behind the Law. 9.45, Programme to be announced. 10.0, Teaberry Baseball Scores. 10.5, David Lawrence Dispatch. 10.10, KDKA Artist Bulletin. 10.12, Programme Announcements. 10.15, Rosehills, A. K. Rowswell. 10.30, Stories for Children by Louise Guirand. 10.45, Little Orphan Annie, from New York. 10.50, Temperature Report. 10.51, Weather Report. 11.0, Time Signal. 11.1, Temperature Report. 11.2, Who's News To-day. 11.6, Teaberry Sport Review. 11.11, Press News-Reeler. 11.14, Bulova Weather Report. 11.15, Programme to be announced. 11.30, Lew Conrad and his Orchestra. 11.59, Pennzoil Time. 12 midnight, Pepsodent Amos 'n Andy, from New York. 12.15 a.m. (Sunday), Dance Masters, from New York. 12.30, Sacred Songs. 1.0, Danger Fighters, from New York. 1.30, Dance with Countess D'Orsay, from New York. 2.0, Goldman Band, from New York. 2.30, The First

Nighter, from New York. 3.0, Homey and Old-fashioned. 3.30, Twenty Fingers of Harmony, from New York. 3.45, McCravy Brothers, from New York. 4.0, Pennzoil Time. 4.1, Teaberry Sport Review. 4.11, Temperature Report. 4.12, Bulova Weather Report. 4.15, Press Last-minute News. 4.20, Messages to Explorers. 5.0, Lew Conrad and his Orchestra. 5.30, Pennzoil Time and Good Night.

PRAGUE (488.6 metres); 120 kW.—6.25 p.m., Transmission in German. News Bulletin and Talk. 7.0, Brass Band Concert, conducted by Benés. 8.0, Concert by the Czech Philharmonic Orchestra, conducted by Parik, relayed from the Prague Town Hall: Sokol Hymn (Seber); Sokol Overture (Kubín); Yugoslavian Rhapsody, Op. 60 (Bendl); Slovak Suite (Smatek); Gavotte (Jirák); Furiante (Kricka); Waltz (Provažník); Dance Suite from an Operetta (Moór); March of the Yugoslavian Sokols. 9.0, Time Signal and News Bulletin. 10.0, Time Signal, News Bulletin, Sports Notes, and Announcements. 10.15, Theatre Notes and Programme Announcements. 10.20, See Moravská-Ostrava.

RADIO-SUISSE ROMANDE (SOTTENS) (403 metres); 25 kW.—LAUSANNE (680 metres), and GENEVA (760 metres)—5.0 p.m., Time Signal from the Neuchâtel Observatory. 5.1, Orchestral Concert, conducted by Robert Echenard. 6.0 (from Geneva), Dance Music. 7.0, Weather Forecast. 7.1 (from Geneva), Chimes from St Peter's Cathedral. 7.10 (from Geneva) Gramophone Records of Variety Music. 7.31 (from Lausanne), Review of International Politics. 7.55, News Bulletin. 8.0, Orchestral Concert, conducted by Robert Echenard. 8.55 (from Lausanne), Baritone Song Recital by M. Perreux, Mme. Perregaux, at the Pianoforte. 9.20 (from Lausanne), Concert of Rural Music by the Vouzris Orchestra of Vevey. 10.0, Weather Forecast and News. 10.10 (from Montreux), Dance Music from Le Perroquet. 11.30 (approx.), Close Down.

RIGA (525 metres); 15 kW.—5.0 p.m., Concert of Popular Music. 6.0, Talk on China. 6.30, Song Recital of Lithuanian Music by Robert Vizbulis. 7.0, Talk on Agriculture. 7.30, Popular Concert by the Station Orchestra, conducted by Lovre Matacziez; Overture, Carnival (Dvorak); First and Eighth Slavonic Dance (Dvorak); Second Hungarian Rhapsody (Liszt); Dances from Prince Igor (Borodin); Hungarian Dances (Brahms); Waltz from Der Rosenkavalier (Richard Strauss); Selection from Rosamunde (Schubert); Waltz, The Blue Danube (Johann Strauss).

ROME, Call 1RO (441 metres); 50 kW. Relayd by Naples (319 metres) and 2RO (25.4 metres)—8.15-9.30 a.m., Giornale Radio and Announcements. 12 Noon, Gramophone Records of Variety Music. 12.35 p.m., Weather Forecast. 12.45, Sextet Concert, Soloist: Maria d'Alba (violin); Notti spagnole (Antco); Ma belle qui danse (Van Westerhoff-Billi); Serenata sarda (Can); Violin solos—(a) Serenata napoletana (Sgambati). (b) Cavatina (Raff). (c) Caprice (Vescey). Selection (Czeruovitch); La maja (Gabriel). In the intervals at 1.15, Giornale Radio and Exchange, and at 1.30, Time and Announcements. 2.0-5.0, Interval. 5.0, Exchange, Report of the Royal Geographical Society, Giornale Radio, and Announcements. 5.15, Reading. 5.30, Soprano Song Recital by Margherita Cossa: Songs (Schumann): (a) Song, (b) Der Nussbaum, (c) Frühlingnacht, (d) Widmung. 5.45, Variety Music, Leggenda esotica (Nani); Intermezzo, Sui irati (Gragnani); Mi hermosa (Staffelli); Prelude to Act I of William Katerini (Masegni); Intermezzo, Festa al villaggio (Billi); A Honey-moon (May). 6.15, Giornale dell'Enit. 6.25, Talk: Through Sicily. 6.55 (from Naples), Shipping News and Sports Notes. 7.0, Atmospheric Signals, Lesson in Morse, Agricultural Report, Giornale Radio, and Press Review. 8.0, Time, Announcements, and Gramophone Records of Variety Music. 8.30, Sports Notes and Announcements. 8.45, "The Cricket on the Hearth," Opera in Three Acts (Zandonai). In the intervals, Book Review, Talk and News.

SCHENECTADY, General Electric Company (WGY) (379.5 metres), 50 kW. Relayd at intervals by W2XAF (31.48 metres) and by W2XAD (19.56 metres)—9.15 p.m., Alex Drassein's Orchestra, from New York. 9.45, The Studio Ensemble. 10.15, Skippy, from New York. 10.30, Soloist, from New York. 10.45, Breen and de Rose, from New York. 11.0, Joe and Eddie. 11.15, Waldorf-Astoria Orchestra, from New York. 11.30, American Trio. 11.45, DeWitt Clinton Orchestra. 12 Midnight (WGY only): Baseball Scores. 12 Midnight (W2XAF only): Stock reports and News Items. 12.5 a.m. (Sunday), DeWitt Clinton Orchestra. 12.15.

Programmes from Abroad.—

Melody Trail, from **New York**. 12.45, The Goldbergs, from **New York**. 1.0, Bridge Lesson from **New York**. 1.15, Bernard Silberg, Cellist. 1.30, National Advisory Council in Radio on Education. 2.0, Drama K-7, from **New York**. 2.30, Club Valspar, from **New York**. 3.0, Lucky Strike Dance Hour from **New York**. 4.0, DeWitt Clinton Orchestra. 4.30, Hotel New Yorker Orchestra, from **New York**. 5.0, Ralph Kirbery (Dream Singer), from **New York**. 5.5, Buddy Rogers and his California Cavaliers, from **New York**. 5.30, New Kenmore Orchestra. 6.0 (approx.), Close Down.

SCHWEIZERISCHER LANDESENDER (BEROMUNSTER) (459 metres); 60 kW.; **BASLE** (244.1 metres); and **BERNE** (246 metres).—12.28 p.m., Time Signal from Neuchâtel Observatory. 12.30, Weather Report and News Bulletin. 12.40, Variety Music on Gramophone Records. In an interval at 1.15 (approx.), Topical Talk. 1.50, Weather Report and Exchange Quotations. 2.0, 3.30, Interval. 3.30, Songs of Work on Gramophone Records. 4.30 (from **Basle**), Programme for Workers. 5.0 (from **Basle**), Accordion Concert. 5.30 (from **Basle**), Talk: Here and There in the South of France. 5.50, Music from Sound Films, on Gramophone Records. 6.15 (from **Basle**), Wireless Notes. 6.30 (from **Zürich**), Talk on Psychology. 7.0 (from **Zürich**), Chimes. 7.15, Time Signal, Weather Forecast, and Agricultural Prices. 7.30, Popular Music on Gramophone Records. 8.0 (from **Basle**), Popular Concert by the Basle Orchestral Society, conducted by Gottfried Becker. Soloists, Erica Frauscher (Soprano) and Salvatore Salvati (Tenor). 9.30, Weather Forecast and News Bulletin. 9.45, Dance Music on Gramophone Records. 11.0 (approx.), Close Down.

STOCKHOLM Call **SASA** (436 metres); 55 kW.; relayed by **Boden** (1,229.5 metres); **Göteborg** (322 metres); **Hörby** (257 metres); **Motala** (1,348 metres); **Ostersund** (770 metres) and **Sundsvall** (542 metres).—2.0 p.m., Celebrations of the 350th Anniversary of the Town of Hudiksvall, relayed from Hudiksvall Church. 4.0, Concert of Light Music: Potpourri, From A to Z (Geiger); Tango, Lola (Collazo); Fox-trot, Auf Wiedersehen, my Dear (Hoffmann); Hymn to the Sun (Rimsky-Korsakov); Waltz from Gipsy Love (Léhar); Selection from The Flower of Hawaii (Abraham). 5.5, Programme for Children. 5.30, Popular Music on Gramophone Records. 6.30, Reading. 7.0, Song Recital by Valborg Beer. 7.15, Weather and News Bulletin. 7.30, Talk (to be announced). 8.0, Variety Programme. 9.15, The Engagement—Comedy (Alexis Kivi). 9.45, Weather and News. 10.0, Concert of Old Dance Music, by the Boden Quintet. 11.0 (approx.), Close Down.

STRASBOURG (345 metres); 11.5 kW.—11.30 a.m., Gramophone Concert of Opera and Light Music. 12.45 p.m., News in French and German. 1.0, Time Signal. 1.2, Gramophone Concert (continued). 2.0, Literary Talk in French: Marierey. 2.15, Gramophone Concert of Light Music. 3.15-3.45, Interval. 3.45, Illustrated Talk on Music. 4.0, Dance Music on Gramophone Records. 4.45, Legal Talk in French. 5.0, Orchestral Concert, conducted by Roskam: March, Peace and Liberty (Darf); Waltz, Among the Roses (Petras); Aubade printanière (Lacoube); Overture, Les Salignanques (Ganne); Mosaic on Adam (Urbach); Serenade, Il bacio (Michele); Selections from the Album pour mes petits amis (Piermé), (a) La Veillée de l'ange gardien, (b) Sérénade du Collier de saphir, (c) Marche des petits soldats de plomb, Selection from Les Mousquetaires au Convent (Varney). 6.0, Talk in French: Cartography. 6.15, Agricultural Talk in French. 6.30, Orchestral Concert, conducted by Maurice de Villers: Overture, Il sogno di Scipione (Mozart); Chant sans paroles (Tchajkovsky); Song from Prince Igor (Borodin); Spanish Dances from La vida breve (Fallá); Song from La Mule de Pedro (Massé). Salut d'amour (Elgar); May (Hahn); Song, Au bras de l'aimé (Levadé); Selection from Tosca (Puccini); Russian March (Joh. Strauss). 7.30, Time Signal. 7.32, News in French and German. 7.45, Dance Music. 8.30, Concert by the Municipal Orchestra, relayed from the Orangerie Restaurant; Overture, Zampa (Hérold); Waltz, Les Patineurs (Waldteufel); Suite, Mascaratte (Lacôme); Overture, Fra Diavolo (Auber); Salut d'amour (Elgar); Entr'acte from La Colombe (Gounod); Dances from Lakmé (Delibes); Military March, Op. 51, No. 1 (Schubert). 10.30, Dance Music from the Savoy. 12 Midnight (approx.), Close Down.

STUTTGART (Mühlacker) (360.5 metres); 60 kW.; and **FREIBURG** (570 metres).—11.15-

SATURDAY, JUNE 25th (cont.)

11.30 a.m., Sponsored Music. 11.45 a.m., Sponsored Music. 12 noon, Weather Forecast. 12.5 p.m., Sponsored Music. 12.20, Recital of German Folk Dances sung by the Members of the Charlottenburg Academy of Music (on Gramophone Records), followed by Selection of Marches. 12.50, Time, Weather, News, and Programme Announcements. 1.0, See **Frankfurt**. 2.30, Songs by Karl Jentsch (Baritone): Four Songs (Richard Trunk): (a) An mein Weib, (b) Blaublümlein, (c) Vor Akkon, (d) Ecce homo; Monologue from Rigoletto (Verdi). 2.50, Accordion Recital by Teo Monaruzzi: March, Junge Kameraden (Schweitzer); Waltz, Faschingszauber (Reiter); Wiener Fiaker (Gustav Pick); March, Wiener Humor (Schraummel). 3.30, See **Frankfurt**. 4.30, Choral Concert, conducted by Ernst Gäcke: Meeresstille und glückliche Fahrt (Buck); Marienbildnis (Kämpf); Auf ewig (Herrmann); Ich hör' ein Siechlein rauschen (Heinrich); Der Tauber (Wohlge-muth); Rothaarig ist mein Schätzelein (Kiehl). 5.0, Orchestral Concert, conducted by Gustav Görlich: Soloists: Charlotte Massenbourg (Soprano) and Renate Lang (Cembalo); The Brandenburg Concerto No. 2 in F for Cembalo and Orchestra (Bach); Andante (Fisch); Concerto for Cembalo and Orchestra (J. Chr. Bach); Romance from La Gioconda (Ponchielli); Aria from Debora e Jaël (Pizzetti); Programme of Old Dance Music. 6.15, Sports Notes. 6.20, Talk: Swabian Rifle Club Meetings. 6.35, See **Frankfurt**. 7.0, Time and Weather. 7.5-10.20, See **Frankfurt**. 10.20, Time, Weather, News, and Programme Announcements. 10.45, Dance Music from **Berlin** (Witzleben). 12.30 a.m. (Sunday), Close Down.

TOULOUSE (Radiophonie du Midi) (385 metres); 8 kW.—5.15 p.m., Songs from Opera: Arias from Manon (Massenet); Cavalleria Rusticana (Mascagni); Werther (Massenet); and Mignon (Thomas). 5.30, Orchestral Selections. 5.45, Operetta Music: Selections from Frederica (Léhar); The Merry Widow (Léhar); and A Waltz Dream (Oscar Straus). 6.0, Recital of Chansonnettes. 6.15, Military Music. 6.30, Exchange Quotations and Horse Racing Results. 6.45, Orchestral Selections. 7.0, Sound Film Music. 7.15, Instrumental Selections. 7.30, News Bulletin. 7.45, Selections by an Argentine Orchestra. 8.0, Operetta Music: Selections from (a) Die geschiedene Frau (Fall), (b) Gipsy Love (Léhar), and (c) No. No. Nanette (Youmans). 8.15, Light Music. 8.20, Orchestral Selections: Selection (Robrecht); Tango, Dajos Bela (Mutishimo); Tango (Ravera); Waltz (Strauss); The Polar Star (Waldteufel); Potpourri (Jessel); Potpourri (Léhar). 9.0, Selections from Hérodiade (Massenet). 10.0, Orchestral Selections. 10.30, North African News. 10.45, Accordion Solo. 11.0, Concert: Beau ciel de Pau; Literary Item: Selection from Cyano de Bergerac (Rostand); Le tango du chat (Raiter); L'embouteillage (Bach-Laverne); Les roses blanches (Raiter); Selection from Carmen (Bizet); Cocktail Parisien (Bach-Laverne); Ma Normandie (Berat); si l'on ne s'était pas connus (Parès-Van Parys); C'est pour mon papa (Oberfeld); Selection from The Magic Flute (Mozart); Le raccommodeur de faïence (Solér); Le P'tit Quinquin (Desrousseaux). 12 midnight, Weather and Announcements. 12.5 a.m. (Sunday), Concert of Light Music. 12.30 a.m. (Sunday), Close Down.

TRIESTE (247.7 metres); 10 kW.—7.5 p.m., Quintet Concert: Selection (Sieczynski); Invocation (Manno); Selection (Erwin); Canto d'amore (Petrelli); O Paul (Kaper); Selection from Halo America (Loube); Vieno a te (Gaudiosi); Trümpferi (Schubert); In the interval at 7.25, French Lesson on Gramophone Records. 8.0, till Close Down, see **Turin**.

TURIN (273.7 metres); 7 kW. Relayd by **Milan** (331.5 metres), **Genoa** (312.8 metres), and **Florence** (500.8 metres).—7.5 p.m., Concert: Selection (Sousa); Selection from The Czarevitch (Léhar); Tzigana (Frontini); Piccola (Amadei). 7.30, Time and Announcements. 7.35, Variety Music on Gramophone Records. 8.0, Giornale Radio and Weather. 8.20, Concert: Selection from La petite Mariée (Lecoq); The Children's Thé Dansant (Schmidt); Mascheroni Potpourri Grottesca (Vittadini). 8.45, Talk: Events and Problems. 9.0, Variety Programme; Review of New Books in the interval. 11.0, Giornale Radio and Dance Music. 11.55, News Bulletin.

VATICAN CITY (Rome) (19.84 metres) (Morning), and (50.26 metres) (Evening); 10 kW.—11 to 11.15 a.m., Religious Announcements in Different Languages. 8.0 to 8.15 p.m., Religious Information in Italian.

VIENNA (517 metres); 15 kW. Relayd by **Graz** (352.1 metres); **Innsbruck** (283 metres) **Klagenfurt** (453.2 metres); **Linz** (246 metres) and **Salzburg** (218 metres).—5.0 p.m., Concert by the Johann Wilhelm Ganglberger Orchestra; Soloist: Joska Soprony (Saxophone), and Willy Baskovsky; The Star-Spangled Banner (Sousa); Overture: Die Heizenmäucher (Korolani); Romance in G (Beethoven); Saxophone Solos: (a) Hungarian Dance (Rudy Widoft), (b) Raganullin Romeo (Paul White-man), (c) Nur ein Mädchen gibt es auf der ganzen Welt, (d) Czardas, Allegro; Waltz: Pesche Geister (Eduard Strauss); Tango (Sieczynsky); Polka for Piccolo (Wagner); Potpourri, Was wir lieben (Ganglberger); Vöslaher Marsch (Ludwig Werba). 6.40, A Report on the Industrial Position of Austria. 6.50, Topical Talk. 7.10, Talk: The Creative Artist and Modern Times. 7.20, Cello Recital by Josef Schuster (Cello); Sonata in F (Cesarini); Adagio and Allegro (Haydn); Adagio (Böcherini); Song without Words (Mendelssohn); Intermezzo (Vivaldi); Butterflies (Hamilton Harty); Sicilienne (Faure); Flight of the Bumble Bee (Rimsky-Korsakov). 7.55, Time, Weather, and Programme Announcements. 8.10, Die goldne Meisterin—Operetta in Three Acts (Eysler). 9.45 (in an interval), News. 10.30, Dance Music: Fox-trot, Swanee Stomp; Slow Fox-trot, Du mußt mir lügen; Fox-trot, A Long Time Ago; Waltz, Wenn du willst; Fox-trot, In meinem kleinen Padelboot; Potpourri—Rund um Robert Stolz; Fox-trot, Ruf mich an, blondes Baby!; Tango, Eine viertel Stunde spanisch; Rumba, Kennst du die Melodie; Fox-trot, Tiger Rag; Waltz, Ich hol' dir vom Himmel die Sterne; Fox-trot, Ein nettes, kleines Fräulein; Tango, Liebe; Tango, Zwei himmelblaue Augen; Fox-trot, Wenn in blauer nacht; Fox-trot, Lieblich, mach' dem Fenster auf. Was kann so schön sein. Sag' mir mal Schmeckli auf spanisch.

WARSAW (1,411 metres); 120 kW.—11.58 a.m.—Time Signal and Bugle Call from the Tower of St. Mary's Church, Cracow. 12.5 p.m., Programme Announcements. 12.10, Press Review. 12.20, Interval. 12.40, Weather Report. 12.45, Light Music on Gramophone Records. 1.25, Interval. 1.35, Popular Music on Gramophone Records. 2.10, Interval. 3.0, Economic Report. 3.10, Variety Music on Gramophone Records. 3.30, Announcements. 3.40, Programme for Children, relayed from **Lwow**. 4.5, Light Music on Gramophone Records. 4.35, Hydrographic Report. 4.40, Review of Periodicals. 5.0, Concert by the Station Orchestra, conducted by Josef Oziminsky: Overture, Light Cavalry (Suppé); Waltz from Der Rosenkavalier (Richard Straus); Fantasia, from the Old and New World (Dvorak); Norwegian Bridal Procession (Grieg); Trümpferi (Schumann); Dance of the Fisher Girls (v. Blum); March of the Dwarfs (Moszkovsky); Selection from the Barber of Seville (Rossini); Torel Dance (Meyerbeer). 6.0, Talk. 6.20, Light Music and Dance Music. 7.15, Miscellaneous Items. 7.35, Radio Journal. 7.45, Agricultural Notes. 7.55, Programme Announcements. 8.0, Concert of Light Music by the Warsaw Philharmonic Orchestra, conducted by S. Navrot. Soloist: M. Gabriel (Soprano); Overture, Ophelus in the Underworld (Offenbach); Czardas, from Countess Maritza (Kálmán); Song from Schön ist die Welt (Léhar); Gipsy March (Filipucci); Waltz from The Dollar Princess (Fall); Songs: (a) I know I love you (Dan), (b) Aliou (Maklakiewicz), (c) Air (Léhar); Selection from The Geisha (Jones); Two Polish Songs. Evening on the Banks of the Neva (Meyer-Heimund); Potpourri of Polish Songs (Osmausky); Gallop, Prestissimo (Waldteufel); March (Kozlowsky). In the interval, Reading. 9.50, Radio Journal. 9.55, Weather Report. 10.0, Interval. 10.5, Pianoforte Recital of Chopin's Music, by L. Borunsky. Nocturne in F sharp; Ballade in F minor; Etudes (a) in C sharp minor, Op. 10, (b) in G sharp minor, Op. 25, (c) in C minor, Op. 25; Mazurka in D, Op. 33; Scherzo in C sharp minor. 10.40, Sports Notes. 10.50, Dance Music.

ZAGREB (Yugoslavia) (307 metres); 0.75 kW.—7.35 p.m., Reports. 8.0, Les Noes Villageoises Ballet, with Songs (Stravinsky) and Petroushka—Ballet (Stravinsky), relayed from the National Theatre. In the interval, News and Weather Forecast.

Freestone Radio-Gramophone.

5-valve Superheterodyne
Radio - Gramophone for
A.C. Mains.



An unusual cabinet design.

more than sufficient to fill a room of average size. However, there is a separate volume control for the gramophone.

The cabinet is designed on bold and severely simple lines, unrelieved by ornamentation, but the workmanship is excellent, and it is very substantially made. First impressions are that the cabinet is somewhat large for the apparatus it contains, as there is considerable waste space inside, but on further consideration one is led to conclude that any reduction in size might well impair the general effect. The dimensions have been well chosen, for as a whole the cabinet is exceedingly well proportioned.

A feature of considerable interest is the accessibility of every part. The motor board is not located in a sunk well, which seems to be the accepted practice, but falls flush with the top of the cabinet when the lid is raised. This is hinged at the back, so giving easy access to the electric motor and also to the dial-illuminating lamp. Below the motor board is a fixed partition, the main function of which is to protect the receiver chassis should oil drip from the motor bearings.

A large compartment, taking up about half the total area of the cabinet, is provided for housing the Rola loud speaker and the mains equipment. In addition, there are two fuses, mounted on porcelain, and a switch for interrupting the mains supply. Sockets are fitted on the left-hand side of the cabinet for attachment of the aerial and the earth leads, together with a special insulated two-pin connector for the mains supply. The back and the sides of this compartment are acoustically open.

Little need be said here regarding the superheterodyne chassis, since this was described fully in *The Wireless World* dated February 3rd, 1932; it will suffice to say that the performance is possibly a shade

FEATURES.

General.—Five-valve superheterodyne chassis. A.C. operated. Electric gramophone motor. Rola loud speaker. Single-dial tuning.

Circuit.—Band-pass input filter with screen-grid first detector. Variable-mu I.F. amplifier, followed by screened-grid second detector with a pentode output valve.

Controls.—(1) Single-dial tuning. (2) Wave-change switch. (3) Input volume control for radio. (4) Gramophone volume control. (5) Radio-gramophone switch. (6) Mains switch.

Price.—38 guineas.

Makers.—V. E. Freestone and Co., Ltd., 102, Wembley Hill Road, Wembley, Middlesex.

better than the original model, which is to be expected, in view of the changes in the L.F. amplifier referred to above. The quality of reproduction both on radio and gramophone is excellent. There are no noticeable resonances, the higher frequencies being well in evidence, and speech is crisp, while the bass

FOR some years makers of special motor car bodies, Freestone and Co., Ltd., have now turned their attention to the production of high-grade radio-gramophones, and the experience gained in building superior coachwork will undoubtedly prove of considerable advantage in their new venture. Attractive appearance, first-class workmanship, and meticulous attention to details, both in the cabinet work and in the assembly of the electrical equipment characterise their work.

The model submitted for test certainly exhibits these features, for it is housed in a handsome oak cabinet, and embodies the Haynes A.C. Superheterodyne receiver. A few modifications have been effected in the low-frequency amplifier to afford a slight increase in amplification mainly for gramophone reproduction, since two valves only are used for this function. The volume is ample for all normal purposes, and, indeed, is now

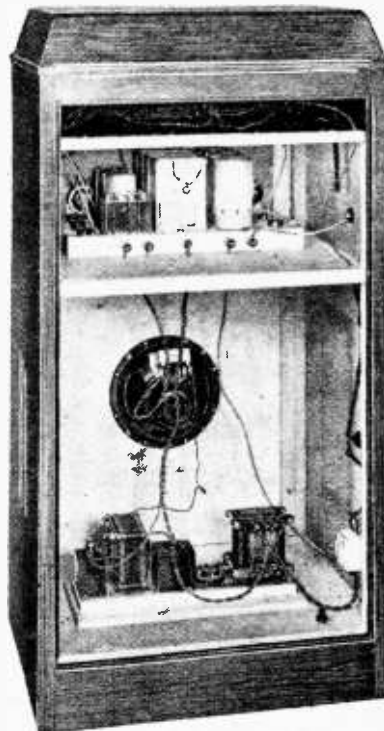

The generous area allotted to the speaker compartment is a feature of the assembly.

Freestone Radio-Gramophone.—

response is adequate to afford a well-balanced output.

Mains hum is only just audible, and there is no interference from the gramophone motor. Before the actual recording on the record is reached a trace of needle-scratch is heard; otherwise the set is particularly free from background noises. With an amplifier giving an adequate high-note response a little scratch is inevitable.

When reproducing gramophone matter the radio volume control—located on the extreme left—must be set to the minimum volume position, for if the receiver is tuned to a powerful broadcast station the transmission is audible even with the change-over switch set for gramophone reproduction.

To sum up, the Freestone superheterodyne radiogramophone is a carefully prepared instrument; the chassis has been adjusted, somewhat modified, and fitted to a special cabinet having sundry refinements. It should appeal strongly to those requiring an instrument with a performance above the average and selling at a reasonable price.

A "SHOCKING" PICK-UP.

IN order to prevent interference arising from the brushes of a gramophone motor from being heard in the loud speaker, it is quite a common practice to "earth" the main body of the motor through a condenser to one side of the mains, as at *a* in the illustration, or to bridge the mains by a pair of condensers and to connect the motor framework to the junction of the two, as in *b*. Either scheme is excellent as an interference-preventer, for the mains have a capacity large enough to make an excellent earth from the point of view of the disturbances, but either, if too carelessly

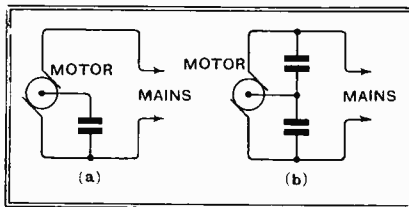

Either of the arrangements shown is quite commonly used to prevent interference from the motor.

applied, may introduce the possibility of getting some unexpected shocks.

It must be remembered, in tracing the cause of these, that it is usual to earth the tone-arm carrying the pick-up; if, therefore, the edge of the turntable is touched when lowering the pick-up on to the record, one has excellent opportunities of ascertaining, by direct personal separation, whether the motor is or is not earthed from the point of view of the alternating-current mains.

One side of the mains, in most cases, is earthed, the other being "live" to the extent of the supply voltage. If, with the single condenser, the main to which it is taken happens to be the earthed side, all is well. If it is not, then on completing through the body the circuit across to the earthed pick-up arm one is placing oneself, in series with the condenser, across the mains. Since a condenser of reasonable size (say 1 to 4 mfd.) will

offer far less impedance to the flow of 50-cycle current than does the human body, the voltage actually received is the major portion of the supply voltage.

By reversing the mains plug in its socket the lead which the condenser is taken becomes the earthed side and no more shocks will be felt. But it is safer, and usually just as efficacious, to connect the motor box direct to earth, and to put the condenser straight across the mains.

Where two condensers are used the motor and turntable are poised (assuming the condensers to be equal in capacity) at a potential half-way between that of the two mains. In most cases this will mean that a shock of half mains voltage will be felt if contact is simultaneously made with the turntable and an earthed point no matter which way round the plug is inserted in its socket. Occasionally, as in the writer's case, a house is wired up with "outers" only, the two mains having equal and opposite potentials to earth. In such a case the twin-condenser scheme may be used with perfect safety, as the motor is automatically held at earth potential.

With direct-current mains it might be thought that the condensers might be connected in any way that happened to be convenient, since they are completely insulated against the flow of direct current. In practice, however, much the same chances of shock arise, though in this case the shock can be due only to the charging current of the condenser. Those who have inadvertently discharged condensers of high capacity through their persons will probably be willing to agree that even such a momentary shock can be very disconcerting.

A. L. M. S.

THE MAGNIFICATION OF THE TUNED CIRCUIT.

ARISING from a recent article, "The Magnification of the Tuned Circuit," there has been some correspondence dealing with the relationship between *m* and other quantities in terms of which the characteristics of the tuned circuit may be described. The following table may be of interest in this connection.

- If : *f* = Frequency
- L* = Inductance of coil.
- r* = Equivalent series resistance of tuned circuit.
- m* = Magnification.
- R* = Dynamic resistance at resonance (or Tuned Impedance).
- F* = Power factor.
- δ = Decrement.

Quantity.	Defined as :	In Terms of :			
		<i>m</i>	<i>R</i>	<i>F</i>	δ
<i>m</i>	$\frac{2\pi fL}{r}$	—	$\frac{R}{2\pi fL}$	$\frac{1}{F}$	$\pi \delta$
<i>R</i>	$\frac{4\pi^2 f^2 L^2}{r}$	$2\pi fLm$	—	$\frac{2\pi fL}{F}$	$\frac{2\pi^2 fL}{\delta}$
<i>F</i>	$\frac{r}{2\pi fL}$	$\frac{1}{m}$	$\frac{2\pi fL}{R}$	—	$\frac{\delta}{\pi}$
δ	$\frac{r}{2fL}$	$\frac{\pi}{m}$	$\frac{2\pi^2 fL}{R}$	πF	—

A. L. M. S.

JEWELS OF THE WEEK.

Current Events in Brief Review.

Talking in Millions.

MORE than two and a quarter million pounds was subscribed by the listening community in licence fees during the year ended March 31st last. In the House of Commons last Wednesday Mr. Graham White, Assistant Postmaster-General, stated that £299,444, or ten per cent. of the total collected, had been retained by the Post Office. The payment to the B.B.C., which was based on the wireless licence revenue for the previous year, amounted to £1,225,709.

At the R.A.F. Display.

A SPECIAL mobile wireless station will be operating at Hendon on Saturday next to control the movements of aircraft coming from various stations for the Royal Air Force Display. The spectacle promises to be every whit as enthralling as in previous years; wireless will, of course, play a prominent part, while the enjoyment of the watching crowds will be enhanced by the use of an elaborate public address system operated by the Marconiphone Co. The B.B.C. are also installing apparatus to broadcast certain items of the Display.

An Interference Museum.

A RADIO Chamber of Horrors in which visitors will be shown apparatus causing interference with broadcast reception together with corrective devices was opened on Monday last in the Haus des Rundfunks, Berlin. We understand that the exhibition will be permanent, so that British visitors to Berlin will be well advised to take the opportunity of seeing this interesting collection.

Rival Radio Shows in Paris.

PARIS is threatened with a glut of radio shows this year. In addition to the official exhibition of the Radio Manufacturers' Association, there is to be a smaller exhibition, international in scope, to be sponsored by an independent minority of manufacturers who are not satisfied with the policy of the parent body. This rival show will be distinguished by the initials "S.N.I.R.," which is pronounced "sneer"; but this, according to our Paris correspondent, has no special significance.

French Hopes Revived.

FRENCH listeners are renewing their hopes for the establishment of a regular broadcasting system as a result of the appointment as Postmaster-General of M. Queuille, who is expected to "rule the waves" so long as the present Government holds power. He is keenly interested in wireless as was shown when, as Minister of Agriculture, he initiated, in 1927, a vast project for the employment of radio in rural districts to check the exodus of the country population to the towns.

Cradle Radio.

ALAN T. MARGO, of Forterville, California, is unusually modest in restricting his claim to that of being the youngest licensed radio amateur in the United States; we should imagine he is the youngest in the world. Now only 9½ years of age, Alan has passed his Government radio operators' licence examination, and duly received his station licence from the Federal Radio Commission. He is the owner and operator of station W6FZA. He is able to receive international morse at 15 words per minute, and thus exceeds the Government requirement of five words per minute. His talents are evidently hereditary, for his father, we learn, was operating a spark transmitter while at school in 1910.

Wireless in Patents.

WIRELESS has been well represented in the applications for patents during 1931, according to the report of the Controller General of Patents, Designs and Trade Marks, issued on June 8th. Inventors seem to have concentrated on securing selectivity without sacrifice of quality, but much attention has also been given to short-wave arrangements and the redistribution of broadcast programmes by landlines. In television, efforts have been directed to the replacement of apertured scanning discs by other scanning means such as reflectors, moving arcs and cathode rays.

Listen for Messages from the Stratosphere.

WE learn that Professor Picard, whose daring balloon trip to the upper atmosphere last year is still fresh in the public mind, is about to undertake a similar trip. This time, however, he will prudently take a radio transmitter of 50 watts power, intending to send messages in morse on a wavelength of between 40 and 80 metres.

Dog as Receiver.

THE possibility that the work of wireless set designers in the last few years has been wasted is suggested by the news that Frederick the Great, a great dane living in New Jersey, U.S.A., operates as an ideal radio receiver. When the wireless aerial is fastened to the dog's tail and the headphones are clipped to the neck, excellent reception, it is stated, can be obtained from the local broadcasting station.

While a minute examination of the animal's anatomy would be necessary to determine what method of detection is involved, we would hazard the guess that the dog is a diabetic subject. Our early experiments with lump sugar proved its

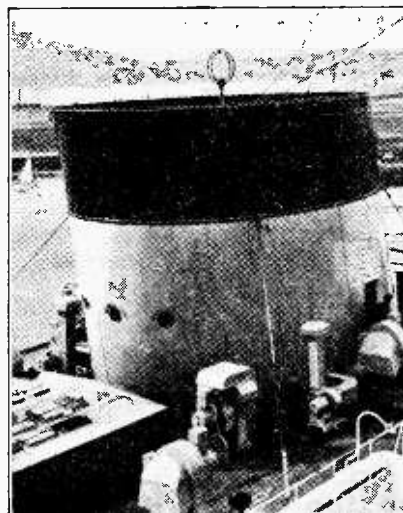

FIND THE RADIO. — The unique feature of the Marconi installation in the new White Star liner "Georgic" is that it is located in a dummy funnel. Note the D.F. aerial.

efficacy as a rectifier, and lacking further information we are forced to the regrettable conclusion that the dog's body contains an overdose of sugar.

Government Broadcasts in Germany.

THE German Government has commandeered the broadcasting service to the extent of decreeing that a daily half-hour between 6.30 and 7.30 p.m. shall be available, if necessary, for official announcements. Hitherto the Government has made only a very limited use of the microphone.

Our Berlin correspondent understands that the broadcasters will not be responsible in any way for Government transmissions, and that international arrangements for programmes may possibly be interfered with. It is likely, however, that international courtesy will be observed, and it is hardly probable that the German Government would make use of a broadcasting station to disseminate unfriendly propaganda.

In view of the approaching Reichstag election on July 31st, the various political parties, which number over a score, will probably each be given a chance to broadcast during the official period. The Communist party has been debared the use of the microphone.

Listeners Only.

IT is often debated whether performers at the microphone are themselves listeners and whether they are thus able to put themselves in the shoes of the man at the receiver. So far as Spain is concerned, the question is cleared up by a new regulation which enacts that no one may act or sing or speak before the broadcast microphone unless he can show that he has paid his wireless listening fee and has owned a receiver for more than three months.

WIRELESS ENCYCLOPEDIA

No. 18

HIGH-FREQUENCY TRANSFORMER. An arrangement of two coils or windings on a suitable former, with fixed inductive coupling between them, for the purpose of transferring high-frequency oscillations from one circuit to another; in particular for coupling two thermionic valves in cascade.

A HIGH-FREQUENCY transformer consists essentially of two coils magnetically coupled together, that is, possessing mutual inductance. The primary winding is the one which receives electrical power, and the secondary the one which gives out electrical power.

The commonest function of a high-frequency transformer is the coupling in cascade of the valves of a high-frequency amplifier. The primary winding L_1 is connected in the anode circuit of the first of two valves to be coupled, and the secondary winding L_2 is tuned by a variable condenser C_2 and connected between the grid and cathode of the succeeding valve in the manner shown by Fig. 1. The direct current feed to the anode of the first valve passes through the primary winding of the transformer, but, since there is no iron in the magnetic field, this does not in any way affect the action of the transformer. For this reason the intervalve circuit of Fig. 1 can be replaced by the equivalent A.C. circuit of Fig. 2.

If E_0 is the signal voltage applied to the grid of the first valve, and μ is the amplification factor of the latter, then an alternating voltage of μE_0 will, in effect, be set up in the anode circuit, this being in series with the internal A.C. resistance R_a of the valve. Consequently, in the equivalent A.C. circuit of Fig. 2, the source of E.M.F. drives an alternating current round the closed loop, including the primary winding of the transformer and the A.C. re-

sistance of the high-frequency valve.

The alternating current in the primary winding causes an E.M.F. to be induced in the secondary winding, this E.M.F. being proportional to the frequency and to the mutual inductance for a given value of current. Since the secondary winding is tuned to resonance, the oscillating current produced in it will be given by Ohm's law, being the ratio of the induced E.M.F. to the resistance, because the coil reactance is just balanced or neutralised by the condenser reactance at the resonant frequency. If the resistance of the secondary circuit is low, the oscillations will attain considerable strength and set up a correspondingly large (amplified) voltage across the condenser C_2 .

The stage gain in volts depends on the ratio of primary to secondary turns, the H.F. resistance of the secondary circuit, the A.C. resistance of the valve, and the amplification factor. The stage gain is the ratio of the input voltage at the grid of the second valve to that at the first. For maximum stage gain

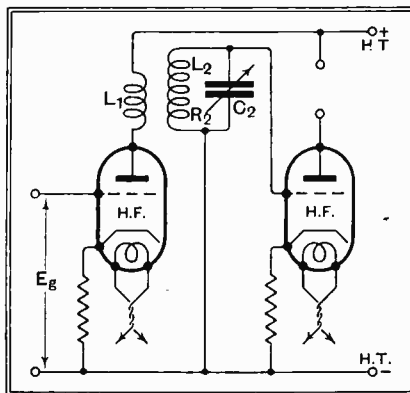

Fig. 1.—Circuit diagram showing how two valves are coupled in cascade by a high-frequency transformer.

with a given amplifying valve there is an optimum turns ratio which can be calculated. It will be obvious that, just as the primary current generates an E.M.F. in the secondary winding, so also will the very much larger secondary oscillating current generate an E.M.F. back into the primary winding. When the secondary is tuned to resonance

Brief Definitions with
Expanded Explanations

it happens that the E.M.F. induced into the primary is just in phase with the primary current, and its effect enormously to increase the apparent primary resistance.

This effective increase of primary resistance completely swamps the original primary impedance which may therefore be ignored in calculating the best turns ratio. Now R_2 and X_2 are the secondary circuit

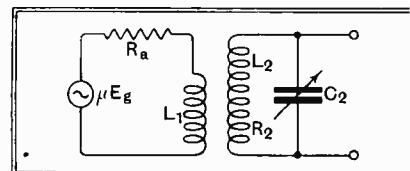

Fig. 2.—Equivalent A.C. circuit to the intervalve circuit of Fig. 1.

resistance and reactance respectively, and N is the primary to secondary turns ratio, the apparent gain in primary resistance is approximately $N^2 X_2^2 / R_2$ ohms. Further, maximum power output in the anode circuit occurs when the load resistance is made equal to the internal A.C. resistance of the valve, and this is the condition for maximum voltage output across the secondary circuit, for with a tuned circuit the voltage across it is greatest when the power consumed is greatest. Consequently, for maximum stage gain $N^2 X_2^2 / R_2 = R_a$, or $N = (\sqrt{R_2 R_a}) / X_2$ for the turns ratio.

Of course, X_2 depends on the wavelength, and so the formula applies to one wavelength or frequency only; but if a wavelength at the middle of the desired tuning range is chosen, the variation of stage gain on either side will be negligibly small.

WIRELESS ENCYCLOPEDIA No. 13.
(Ganging of Tuned Circuits.)

On page 458 of May 4th issue it was stated in the last paragraph of the centre column that equal angles of rotation of the condensers produced equal changes of wavelength with coils of different inductances. This, however, is not true for square-law condensers as stated, but only for condensers obeying an exponential law and when there are no stray capacities. With this type of condenser the logarithm of the capacity is proportional to the deflection. With equal inductances any type of variable condenser is suitable if the stray capacities are balanced.

PRACTICAL HINTS AND TIPS.

PARASITIC oscillation is most common in an output stage, here it manifests itself as an almost complete cessation of signals, combined with a very heavy increase in node current. The oscillations are probably taking place at a frequency determined by the inductance of the wires running to grid and plate, with interelectrode and other stray capacities acting as tuning condenser.

Parasitic Oscillation.

In the case of an output valve, which is not in any event expected to deal with high-frequency currents, the cure is based on the well-known "grid-stopper." A non-inductive resistance of about 5,000 ohms is connected, right up against the valve-holder, to the grid of the valve, in series with the signal-path (Fig. 1). The combination of this

AIDS TO BETTER RECEPTION.

with high-frequency signals, so that a resistance filter, while effective in checking the oscillation, might lead to a considerable drop in signal strength. A choke, consisting of ten or fifteen turns of wire wound to shape round a pencil, and then slipped off its temporary "former," may be connected between grid and grid-condenser. Its impedance to signals of normal wavelength is far too low to matter, but it is generally perfectly effective in checking the parasitic oscillation.

A choke of this kind may also be used in the output stage if no suitable resistance is to hand, but it will usually be found that the resistance provides a more certain cure, and so should be used whenever the conditions of the circuit make it possible to do so.

IT is not always easy to find a convenient electrical connection for an electric clock. Unless one happens to be fortunate, it may be that the nearest available mains supply point is at a considerable distance from the position in which it is desired to mount the clock.

Electric Clocks.

As an alternative to the mantelpiece of convention, the radio receiver, if mains-operated, and particularly if it is of the large cabinet type, seems to offer a solution of this difficulty. Those of us who use our sets to best advantage are always concerned with time in relation to programmes, and so are making continual reference to the clock. Further, it follows that the question of an electrical connection to the set has already been solved, and by fitting the clock in the position advocated no additional trouble in this respect will be experienced. All that is necessary is to wire the clock across the mains input to the receiver, taking care that it is on the "live" side of the on-off switch.

It is interesting to note that a Ferranti clock, specifically intended for so mounting, has now been produced. The instrument is fitted with special clamps, by means of which it may be secured to panels with thicknesses of between $\frac{3}{16}$ in. and $\frac{3}{8}$ in. It should obviously be mounted in such a position that the setting and starting knobs at the back are reasonably accessible.

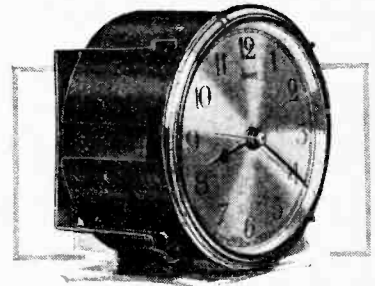

A Ferranti synchronous electric clock, specially designed for panel mounting.

STRIP resistors, of the type where the resistance wire is wound on a narrow strip of insulating material, are deservedly popular. Space may often be saved by mounting a number of these resistors on a pair of screws with spacing washers between the units, as they are generally provided with fixing holes which are insulated from the resistance element. It should be remembered that, so far as the higher ohmic values are concerned, the wire used is extremely fine, and so it cannot be expected to withstand rough handling.

Short-circuited Resistors.

There is a tendency for strip resistors to bend or buckle as a result of the normal rise in temperature which takes place in operation, and this should be borne in mind, either when mounting the resistors in the manner suggested above, or more particularly when they are mounted on and parallel to a metal screen or chassis. Sufficient spacing should be allowed to preclude all possibility of a short-circuit taking place in the event of warping.

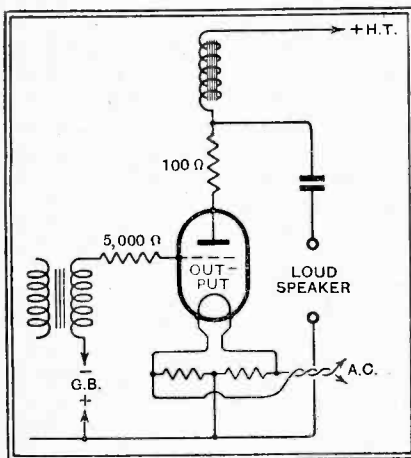

Fig. 1.—Connections of grid and anode H.F. stoppers in an output stage.

resistance with the grid-filament capacity of the valve makes a fairly effective filter preventing high-frequency voltages from developing on the grid. Additional safety may be had by connecting a similar type of resistance, of only about 100 ohms directly up against the anode terminal to act as an anode-circuit filter.

When oscillation of this type occurs in a detector stage, the cure is different. This valve has to deal

Broadcast Brevities.

By Our Special Correspondent.



A "RADIO" ORGAN. Poste Parisien broadcasting station is installing a thermionic valve-operated organ of the Givellet-Couplex type. The instrument in the photograph is in regular use at a church in Villemomble, near Paris.

The Scots Who Wrote.

OF the 595 letters which had reached the B.B.C. by Wednesday, June 15th, on the subject of reception from the new Falkirk station within an eighty-mile service area, 215 registered entire satisfaction. Correspondents who were not completely happy over the change-over numbered ninety-five.

Beyond the Service Area.

Only five listeners have complained that they are now hindered in the reception of foreign stations. A number of letters received from places outside the eighty-mile radius have had to be dealt with separately, as the information they contain is considered of secondary interest.

What pleases the B.B.C. most of all is the fact that not one letter suggests that the station is a failure. On this point the engineers certainly have something to crow about, for, though the average Scot can be a model of politeness, he can also express his opinions in pungent language and, if the occasion warrants it, he does not hesitate to do so.

The Swing of the Pendulum.

The tacit rivalry between Edinburgh and Glasgow on artistic matters has always found a focus point in broadcasting, and it is interesting to see that Edinburgh has now regained the ascendancy with the opening of the Falkirk transmitters.

Loud and long were the cries in "Auld Reekie" when Glasgow was honoured with a main station in 1925, while the historic capital had to content itself with a relay. I am told that at one time many Edinburgh citizens refused to listen to anything that came from Glasgow.

Centre of Scottish Broadcasting.

Edinburgh is now the centre of Scottish broadcasting, and the headquarters in Queen Street are undergoing appropriate changes to cope with the increased responsibility. The control room, when finished, will be second only in size to that at Broadcasting House.

B.B.C. Television.

ON or about Monday, July 18th, Baird television programmes will be given from Broadcasting House under the auspices of the B.B.C. The contract which is about to be signed between the Corporation and Baird Television, Ltd., will run to March, 1934, and may, of course, be renewed.

Television apparatus is now being installed in Studio BA on the basement floor.

Midland Regional for Vision?

Sight and sound transmissions will be a regular feature from 10.30 p.m. onwards, and it is probable, I learn, that the Midland Regional transmitter will be used for the vision side of the programme, thus affording new opportunities to listeners in the provinces.

Just now Post Office engineers are preparing suitable landlines to the north.

Hygienic Wassail.

IT must now be rather difficult for the Advisory Committee on Spoken English to find words on which they have not already made a pronounciatory ruling. However, a few more have been scratched up for debate at the next meeting and, whether we like them or not, here they are: Beret, camellia, carouse, defeatist, demise, dilatory, directional, hygienic, miscellany, oboe, prophecy, prophesy, rentier, robot, stanchion, wassail.

In the meantime announcers may carouse and wassail in any dialect they please.

Summer School for Talks Enthusiasts.

THE "Summer School" habit is growing. From July 23rd to August 6th the second National Summer School is to be held at New College, Oxford, under the auspices of the Central Council for Broadcast Adult Education, for the special benefit of the leaders of talks groups. The aim is to give group leaders confidence in undertaking what is undoubtedly a responsible task in stimulating interest among talks students. The ideal talk group leader acts as chairman without usurping the authority of the unseen speaker—not too easy a job unless the leader has imagination and the ability to say the right thing at the right time or maintain silence.

Broadcasting Five Hundred Voices.

THE microphone will be severely tested on June 26th, when a special choir of five hundred men and boys will provide the music at the Solemn Pontifical High Mass from Phoenix Park, Dublin to be relayed in the National programme. The celebrant will be the Cardinal Legate and the motet "Painis Angelicus" will be sung by Count John McCormack.

More Ridgeway Parades.

PHILIP RIDGEWAY returns to the microphone on July 19th, with a new programme under the old title of the Ridgeway Parade. On that date it will be heard by National listeners, and will be repeated by the "Regionals" on July 20th.

"My Life," by C. B. Cochran.

ONE of the most arresting life stories in the "Rungs of the Ladder" series should be that which Mr. C. B. Cochran will contribute on June 27th. Mr. Cochran's career is more than that of a super-showman; as the man who brought to English audiences such a varied assortment of attractions as Delysia, Hackenschmidt, Florence Mills, the Chauve Souris, Eugene O'Neill, the Guitrys, Max Reinhardt, and a host of other great performers, he ranks as an artist among the showmen of the world.

Polyglot Programme.

THE Columbia Broadcasting System of America has its own international problems. The other evening Tito Guizar, a young Mexican tenor whose mother is Italian and whose father is French, sang a German song in English. The orchestra was conducted by a Russian who later sang an English song in German.

The Portland Peninsula.

THE new diversion at Broadcasting House is to watch from a high window important and dignified members of the staff negotiating the death trap created by the network of busy crossings in front of the main entrance. Broadcasting House is a peninsula almost surrounded by taxi-haunted traffic channels. Danger lies in the fact that there are several methods of approach. The irresponsible make for the lamp standard at the top of Upper Regent Street, clinging there till it is safe (as they think) to sprint across to the comparative security of the pavement. But announcers and others whose lives are precious hug the Queen's Hall, then creep crab-like across the steps of All Soul's Church, and make the final dive carefully and prayerfully.

But why not a footbridge?



EMPIRE BROADCASTING

An Outspoken Opinion from Kenya

By R. L. MANN.

I AM away on the fringe of the Empire in East Africa and I have just had that exhilarating experience of listening-in to the Empire News Bulletin from G5SW.

To say that I am disappointed is to put it very mildly. Much has been written about G5SW, and much more might have been written! Oft was I tempted to rush into print on this matter, and up to the present I have refrained; but, like the moth at the candle, I have at last succumbed. I am not a newcomer to radio, for I have twiddled the knobs ever since the days when I twiddled the catwhiskers, and I still have happy memories of the days when four of us split up two pairs of 'phones to listen to the divine Melba broadcasting from the same G5SW; and to-night, as I listened, I thought of those days, and I presume that G5SW still has those same generators, for there is a modulation in the carrier wave like a Ford car in low gear, and, though the oscillator is now, perhaps, crystal-controlled, I feel sure that old man Rip Van Winkle still has virtual control.

I am British, and perhaps phlegmatic, and I hardly know how to put my thoughts into words without being abusive. I have no wish to be rude, but it seems so strange to think that England, the pioneer of wireless, is now the nonentity, the banana skin.

5,000ft. Up, but . . .

My "listening-in post" is not set in a congested suburb of a big city where aerials jostle one another like spider webs in a wine cellar, where the shriek of reaction in agony kills all but the loudest signals. No! I am not there. I am on top of the world. I am 5,000ft. above sea-level, and the nearest house is several miles away. I have an ideal listening post such as all may envy. When I tune in I hear the uttermost parts of the world, not because I am clever; not that, but by reason of my position. I hear Moscow, built last year, I think, with her two- to three-hundred kW. output. Willy nilly, one must hear that. I hear Milan, Rome. I hear France, with her splendid new S.W. station built especially for the benefit of her colonies. Not one station, but two. One directional N. and S., the other E. and W., with a total of four wavelengths, so that every colony might have every chance of good reception. Stations with a punch in them, and one so close to G5SW that one must have a good set to tune it out. Then I hear an automatic

Morse which seems to work night and day like a hive of mammoth bees; and then comes a *harmonic* of Moscow, the giant Bolshie, *louder and clearer* than G5SW on its own wave. Then, whilst I split the divisions of the dial into decimal points, I steal through, whilst holding my breath, to get my lover, G5SW; but should I over-shoot by the fraction of a hair's breadth I run into another Morse automatic. In any case, almost without exception, I have that constant background of Morse, which saps one's concentration.

Is this our much-vaunted link with the Empire? Is this the best that Britain can offer her sons across the sea? Is this the outcome of the Colonial Conference?

I saw in the Press that those in authority were huffed or annoyed because they did not get any telegrams of congratulation on the new service. The apathy is more eloquent than the praise.

The Business Point of View.

Speaking personally, I tune in to G5SW out of sheer sentiment; the programme value is not worth a dime. I get better programme value from Manitoba, and Oaklands, California. It sounds like swank to talk about these far-distant stations, but I do not imagine for one instant that I am anything more than a mere novice; but what I do say is: If I get these stations—I think I have logged sixty—why on earth should G5SW be so consistently bad? I have heard it clear and strong; but if I hear G5SW clear, then every other station is clearer. You may say this is a dead spot; but I have tried in very many parts of this vast continent, and I can truthfully say that it has been consistently bad and, as a programme, has little or no value. You have probably heard other and opposite reports? So have I. I am quite willing to admit that I am critical, but I am fair. Why should G5SW be inferior to Moscow? or France? or Rome? or any other station that is noted for being superior? It costs money, I know. I don't pay anything toward the others, yet these stations dominate the world. On the other hand, I have a hundred pounds' worth of wireless apparatus; and every grid leak was purchased from Britain. Somebody made a little profit on that! One firm, I believe, declared a hundred per cent. dividend. It should, I think, be part of the policy of these firms to see that the British Empire Station leads the way; not for my selfish pleasures. Oh, no! But, if you like, from a purely business point of view. There should

Empire Broadcasting.—

be no more of this "Experimental Station" bosh. Britain should have a station worthy of Britain, or say no more about it.

Knowing as I do that *The Wireless World* takes a real interest in Empire Broadcasting, I make the following suggestions:—

Invite your Overseas readers to state:

(1) Which stations they hear, putting them in order of strength and programme value, with special reference to G5SW.

(2) Ask all home readers to forward the questionnaire to a friend oversea.

(3) Ask all the directors of Overseas Broadcasting Stations if they ever rebroadcast G5SW, and, if not, Why?

When you get their answers remember that they have the finest wireless technology and the most up-to-date wireless apparatus in the country they represent, and their considered verdict as to the programme value of G5SW is not to be confounded with that of the amateur hearing dear old Chelmsford for the first time through the wrack and the wraith of the ether, and is so joyed that he must write to the daily Press about it.

CORRESPONDENCE.

The Editor does not hold himself responsible for the opinions of his correspondents.

Correspondence should be addressed to the Editor, "The Wireless World," Dorset House, Tudor Street, E.C.4, and must be accompanied by the writer's name and address.

100 Division or 180 Degrees?

SURELY the question of a 100 or 180 scale must depend on the size of the drum or dial. In most cases the 180° scale on the old form of condenser dial had only 90 markings or divisions (an undesirable arrangement, I think), and this led to the introduction of the 100 division scale. Drums are now getting larger, and this makes the scale more open, thereby accentuating the difficulty of accurate reading, complained of by Mr. Buckingham in his recent letter.

Why not, therefore, adopt the 100 division scale for all sizes and with the larger ones, if not all, *add a vernier*? The objection that some might not understand the vernier would be met by marking a distinctive arrow or other sign on the zero graduation of the vernier, thereby clearly indicating this as the pointer against which to read the scale when ignoring the vernier. Anyway, an article in your valuable paper would soon show the keen amateur how to use this aid to accurate receiver calibration.

London, S.W.7.

W. I. BAGOT,

Commander R.N.

A Suggestion for the B.B.C.

I AM fully in agreement with your correspondent Mr. G. West, who suggests in your issue of June 1st, 1932, that the B.B.C. would perform a very useful service by transmitting a series of pure notes. I wrote to the Corporation some months ago with this request, pointing out that such a transmission would be of the greatest interest to experimenters, and that it would, perhaps, at the same time open the eyes of the general public to the poor results which they were obtaining. To this letter the B.B.C. replied as follows:—

"The suggestion which you raise . . . has already been given serious consideration. We have decided not to radiate such a transmission at present, because it would be extremely misleading to the listening public, besides being somewhat difficult to do really scientifically.

"You will appreciate that certain types of loud speaker will

respond to a note of, say, two C's below middle C, though actually they will not reproduce much below, say, middle C. This is owing to the fact that some loud speakers reproduce overtones of an ultra bass note without the fundamental frequency being present, and are, in consequence, thought some to be satisfactory."

This reply is, I think, most unsatisfactory, for it would appear that the B.B.C. are refraining from making such a transmission in order to bolster up the inefficiencies of some type of commercial apparatus. Their action is surely all against progress, and I can only hope that the ventilation of the subject in your columns will cause them to reconsider their decision.

London, N.4.

M. G. K. BUTLER

The Monodial Super.

I SHOULD like to congratulate and thank *The Wireless World*, and Mr. W. T. Cocking, the designer, for the "Monodial A.C. Super." Its selectivity and range are, of course, what one would expect from a modern superhet., but the quality of its reproduction far transcends anything that I previously had imagined. A friend of mine, himself not unknown in radio circles, was amazed at its wonderful quality, and stated that it far surpasses that afforded by a most expensive radio gram of a famous make that he possesses.

The set has been housed in a "Beaufort" radiogram cabinet made by Messrs. W. and T. Lock, Ltd., of Bath. This has been solidly made and superbly finished, and provides a most handsome and much-admired home for the one superlative wireless receiver, the "Monodial A.C. Super."

Pook's Hill, Hove.

GEOFFREY E. PEACHEY

Re Frequency Response.

THE controversy which is raging with such fury on the subject of frequency response seems, at the moment, to have neglected one extremely important aspect.

I presume that those who have expressed such strong views wish to establish a standard to which any receiver worthy of the name must conform. This being the case, I am sure many correspondents have not given adequate consideration to the economic side of the question. This week one correspondent seems to indicate that it costs no more to produce a set with a flat characteristic from 32 cycles to 9,000 cycles than it does a representative modern receiver.

While I have made no definite calculations, I should not be surprised to find that a receiver with the suggested long flat characteristic would cost anything from 25% to 50% more than an ordinary set. I do not know how many of your correspondents have actually measured the frequency characteristics of contemporary individual components, or even a complete receiver, but those who have some idea of the characteristics of modern apparatus must realise that existing apparatus and circuit arrangements would be, for the most part, quite useless.

It is obviously possible to produce a receiver with a long flat characteristic, but complete redesign of almost everything would be necessary, and this could not be achieved without adding very appreciably to the production cost.

I feel that no one but a designer or an engineer actually realises that every penny or fraction of a penny is of such vital importance, and every additional cycle in each direction means an increase in the selling price.

I do not wish to express an opinion as to the advisability of a full or curtailed frequency response, as there are obviously points in favour for either system. At the same time, those who argue the matter to a finality, if such is ever reached, would do well to bear in mind the vitally important factor to which I have referred, as the economic basis is the ultimate deciding factor.

PAUL D. TYERS.

Watford, Herts.

NEXT WEEK'S SET REVIEW:
COLUMBIA RADIO-GRAMOPHONE
Model 603 for A.C. Mains.

WIRELESS WORLD

**Manufacturers'
New Products.**

D.C. MAINS RESISTANCES.

Cordo Electrical Products, Ltd., 68, Victoria Street, Westminster, London, S.W.1, has recently introduced a range of voltage-dropping resistances for the heater supply of D.C. mains sets. The model submitted for test was intended for use with three 16 volt 0.25 ampere type valves, and had tappings for 200 volts to 250 volts mains.

The total resistance was found to be almost exactly 800 ohms, giving a drop of 200 volts at 0.25 ampere, and so was just right for 250 volts mains, while suitably spaced tappings allowed the correct current with mains down to 200 volts.

As might be expected, the resistance runs quite hot, but the temperature rise after a prolonged run was by no means excessive, and the perforated metal protecting cover ensures adequate ventilation. The change of resistance with temperature is negligible, for a measurement of the resistance when the component was hot showed that an increase of only 10 ohms had taken place.

The component has a maximum diameter of 3½ in., and stands 6¾ in. high over-

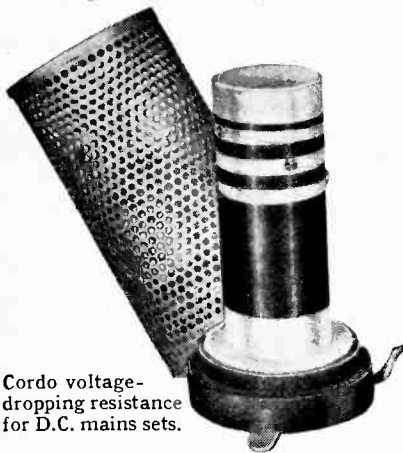

Cordo voltage-dropping resistance for D.C. mains sets.

all, including the metal cover. The tapped unit is priced at 9s. 6d., and can be confidently recommended for use in receivers such as the "Wireless World" D.C. III, in which its small dimensions allow it to be readily fitted.

**MAGNUM SHORT WAVE ADAPTOR.
Model T.**

This adaptor consists of a short-wave detector unit which is connected to the broadcast receiver by a flexible lead terminating in a four-pin plug which is inserted into the detector valve holder. The valve, having previously been removed, is then inserted into the holder on the short-wave adaptor.

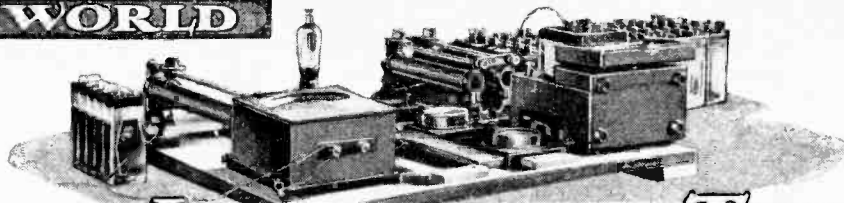

LABORATORY TESTS

No additional batteries are required, the H.T. and L.T. for the detector being supplied by the receiver through the flexible cable, and it is suitable either for use with battery- or mains-operated sets.

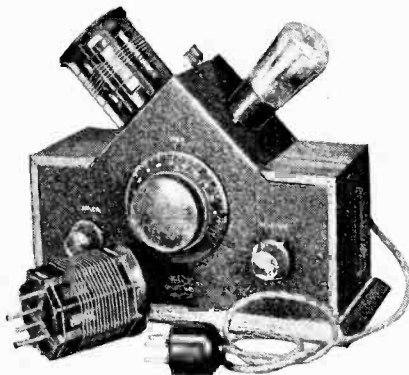

Magnum short-wave adaptor for use with battery- and mains-operated sets.

If used in conjunction with a super-heterodyne receiver, the plug connector must be inserted into the second detector valve holder as it is necessary to use only the L.F. amplifying portion of the broadcast set.

With the unit connected up, all controls on the receiver can be ignored as the tuning is carried out with the special short-wave condenser embodied in the adaptor. There are three controls in all, the tuning condenser occupying the centre position, while on the right is the reaction control and on the extreme left is the aerial coupling condenser. The function of this control is to adjust the aerial coupling for best results at all parts of the waveband, and it serves, also, to shift resonant peaks in the aerial circuit which damp out the oscillation and prevent the reaction control functioning correctly.

Two coil units are available wound on six-pin plug-in formers of skeleton construction, and these were found to be quite efficient. With the lowest range coil the waveband covered was from 17.5 metres to 41 metres, while the other coil extended the range to 83.5 metres. There is ample overlap between the two coils as the second unit tuned down to 34.7 metres.

Reaction is perfectly smooth over the whole wave range, being entirely free from backlash, and there is no trace of threshold howling at any part of the scale.

The makers are Burne-Jones and Co., Ltd., Magnum House, 296, Borough High Street, London, S.E.1, and the price is 39s. 6d., which includes one coil unit covering the 40-80-metre range. The additional coil costs 3s.

A complete list of the principal short wave stations, giving wavelengths and hours of working, will be found on the last page of the instructional leaflet. This should prove exceedingly useful.

THE "RIPPER" CONE.

This cone has been produced by Messrs. C. G. Johnstone, 154, Southwark Bridge Road, London, S.E.1, for those amateurs who wish to experiment with home-constructed moving-iron loud speaker movements. The choice of the material for this cone would appear to be a happy one, for the weight and texture of the paper give good reproduction of the bass without impairing the efficiency in the upper register. Frequency tests showed that the lowest notes produced by the average moving-iron unit are reproduced without loss, while the high-frequency response extends well above 6,000 cycles.

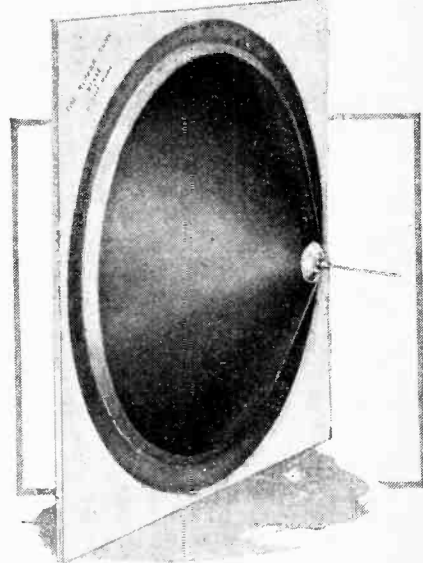

The Ripper cone unit for portable sets and home-constructed loud speakers.

The "Ripper" cone is made in three sizes, viz., 14 x 14 in. and 12 x 12 in. at 1s. 9d. each, and 10 x 10 in. at 1s. 3d. The latter model should be specially suitable for portable sets.

PROGRAMME ALARM WATCH.

There are numerous occasions when an alarm watch can be exceedingly useful, for if one's whole attention is given to a particularly involved problem time passes with startling rapidity. Apart from its application to business as an aural reminder of the hour of an important appointment, it will prove invaluable as a warning that a broadcast item of particular interest to the listener is due to commence.

The special alarm watches, obtainable from A. Arnold and Co., 122, St. John Street, Clerkenwell Road, London, E.C.1. will be found ideal for this purpose, for in addition to being excellent timepieces, they embody an alarm mechanism which gives adequate warning without being embarrassingly loud. These watches are fitted with a 30-hour lever movement and guaranteed for three years, and the price is 25s.

This firm make, also, a neat stop-watch fitted with a dial graduated in one-fifth seconds. It has a 30-hour movement also, and the price is but 10s. 6d. The stop lever is conveniently located on

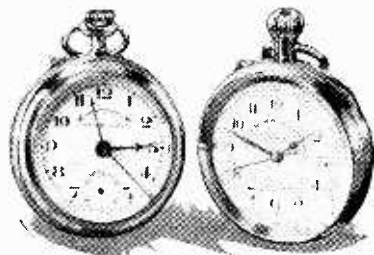

Arnold alarm watch and stop watch; the latter graduated in one-fifth seconds.

the side of the case and is instantaneous in its action. A neat wristlet model of the stop-watch is available at 15s.

INEXPENSIVE WIRELESS FURNITURE.

That inexpensive radio cabinets, even of the type for housing a complete radio-gramophone, can be attractive pieces of furniture is well exemplified by two specimen cabinets submitted for examination by the London Super Cabinet Co., 35-37, Wadeson Street, Cambridge Road, London, E.2.

The radio-gramophone model will accommodate a receiver measuring 13in. wide by 14in. deep, and allows for a panel measuring 7in. high. The panel opening is partially closed by an ornamental vignette having an aperture 12in. by 6in. for the controls.

The gramophone compartment is fitted with a loose motor board measuring 18½in. by 14in., and has an overall height of 4½in. It is closed by a hinged lid which opens to an angle of about 45 degrees. The loud speaker compartment occupies the lower half of the cabinet, and allows ample space for the accommodation of the mains equipment or batteries, as the case may be.

The cabinet is quite light, being made of comparatively thin wood, but the

workmanship is good, and the price is 39s.

A small pedestal cabinet suitable for housing a wireless set, loud speaker, and



Inexpensive wireless furniture made by London Super Cabinet Co.

mains equipment is available at the very attractive price of 19s. It is fitted with a baseboard measuring 16in. x 9in., and will accommodate a panel 7in. high. This model has a polished oak top, and measures 36in. high overall.

FERRANTI A.F.10 TRANSFORMER.

This intervalve L.F. transformer has been introduced especially to meet the needs of those requiring an inexpensive component but capable of a reasonably good performance. That the Ferranti designers have attained their object in this respect is exemplified by the good performance curve obtained with this transformer when used in a straightforward circuit employing general purpose valves.



Ferranti A.F.10 L.F. transformer.

Our tests were made with the transformer connected in the anode circuit of a valve whose A.C. resistance is some 14,000 ohms. With a view to simulating the conditions obtaining in a practical case the steady D.C. passing through the

primary was adjusted to 1.5 mA., and which conditions the maximum amplification afforded by the stage attained a very satisfactory figure of eighty time being sensibly constant at this level between 600 cycles and 5,500 cycles.

At 100 cycles the amplification falls to 25 times, which is equivalent to a reduction of about 10 decibels as compared with the highest level attained. Regarded from the acoustic point of view this is quite a tolerable reduction.

Taking into consideration the price of this component, which sells at 5s. 6d., the performance is exceptionally good. With no D.C. flowing the primary inductance is 34 henrys; with 2 mA. of D.C. it falls to 26.5 henrys, while with 5 mA. the inductance is maintained at the satisfactory figure of 20 henrys. The step-up ratio is 1:3.

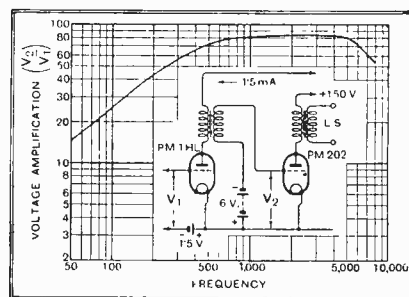

Voltage amplification-frequency curve of Ferranti A.F.10 transformer.

The makers are Ferranti, Ltd., Hollinwood, Lancs.

ALUMINIUM CHASSIS FOR SINGLE-DIAL SUPERHET.

The Peto Scott Co., Ltd., 77, City Road, London, E.C.1, announce that they have taken over the entire stock of aluminium chassis made by W. H. F. Radio Service, 23, Whitton Dene, Isleworth, Middlesex, for the Single-dial Super Het. receiver. These chassis are exceptionally well made and accurate in every detail, and are available with or without valve-holders, the prices being 10s. 6d. and 7s. 6d. respectively. They were reviewed in *The Wireless World* dated February 10th last.

STONE CORRECTION.

Readers interested in this important new development in receiver design will find an abundance of interesting technical information in a new booklet entitled "True Tone Control," issued by the Multitone Electric Co., Ltd., 95-98, White Lion Street, London, N.1. Arguments for the adoption of tone control in general broadcast reception, and also in the reproduction of gramophone records, are very lucidly advanced, and very full information relating to the electrical characteristics and circuit connections of the Multitone transformer are given.

LOEWE TYPE LR50 PICK-UP.

In reviewing this component in the May 25th issue, the price was given in error as 33s. It should be noted that the correct price is 33s. 6d.

READERS' PROBLEMS.

THESE columns are reserved for the publication of matter of general interest arising out of problems submitted by our readers.

Readers requiring an individual reply to their technical questions by post are referred to "The Wireless World" Information Bureau, of which full particulars, with the fee charged, are to be found on the next page.

Flash-lamp Battery for L.T. Supply.

A QUERIST who is making a light two-valve portable set proposes to feed the filaments of the series-connected 2-volt valves from a 4½-volt flash-lamp battery. He asks what value of voltage-reducing resistance will be necessary.

At first sight it would appear that a 5-ohm resistor should be inserted in series with the filaments and the battery, in order to absorb the surplus half-volt. We are assuming, of course, that the valves are standard specimens consuming 0.1 amp. But it must be remembered that flash-lamp batteries cannot be expected to maintain their full rated voltage on load, and, when delivering the comparatively heavy current of 0.1 amp., this will fall almost immediately to about 4 volts. This is precisely what is required for the valves when connected in series, and in practice it is found quite satisfactory to operate them without any external resistance.

Variable Condenser Connections.

IN a recent paragraph in the "Hints and Tips" section of *The Wireless World*, it was stated that each rotor section of a ganged tuning condenser must sometimes be directly earthed in order to avoid instability. The expression "earthed" was used in its wider sense; in certain cases the safest plan is to make a direct connection between the low-potential end of each tuning coil and the rotor of that section of the tuning condenser which is shunted across it. In this way the undesirable transference of H.F. energy from one circuit to another is often avoided.

We recommend this plan to a correspondent who has applied literally the remedy for instability which was suggested in the paragraph in question. As a result of doing this the instability from which his receiver is suffering has been reduced to a much narrower waveband, but is not entirely cured. Instead of joining each section of the rotor to the nearest "earth" point, we recommend him to connect them direct to the coils.

Pentode Anode Current.

THE anode current of a pentode valve is largely influenced by the voltage applied to its screen; but it would appear that those who are more accustomed to dealing with triode valves are inclined to ignore this point.

For instance, a correspondent submits the circuit diagram of his three-valve receiver, with a complaint that the pentode consumes rather less than half its rated anode current. Quality of reproduction is poor, and the maximum volume attainable without obvious distortion is extremely small.

The diagram shows that a feed resistance of abnormally high value is inserted between the positive H.T. line and the pentode screen terminal; almost undoubtedly this is responsible, and we suggest that the feed resistance should be reduced to 5,000 ohms. Indeed, our reader might go further, and as the H.T. supply voltage from his eliminator is obviously on the low side, he might apply the full voltage to both anode and screen without exceeding the maker's rating to any appreciable extent.

A Legitimate Risk.

REFERRING to the use of delay-action H.T. switches, the benefits of which were discussed in *The Wireless World* for May 25th, a reader suggests that if low-voltage condensers are fitted in the early

The point here is that the delay action switch does afford a very material increase in the margin of safety. Even if the occurrence mentioned by our readers took place, it does not of necessity follow that the low-voltage condensers would be damaged; although they may be unable to withstand high voltages for long periods, the momentary application of an excessive pressure is unlikely to do any harm.

In reply to his question as to how this risk may be obviated, we suggest that light fuses should be inserted in the rectifier anode lead. This procedure will admittedly not prevent a condenser breakdown, but it will remove the possibility of other consequent damage.

The moral of this is that it is wise to avoid an interruption in the output anode circuit during the time that high-tension voltage is applied to the set as a whole.

A Car Set.

A QUERIST who intends to construct a 1-v-1 set for use in his car wishes to feed the valves from the 6-volt starting and lighting battery. To economise in current, and also in the interest of safety, it is proposed to join the filaments in series.

Our correspondent, being accustomed to the more normal form of parallel connection, is at a loss to know where the grid circuits of the different valves should be "returned"; he also gives a list of

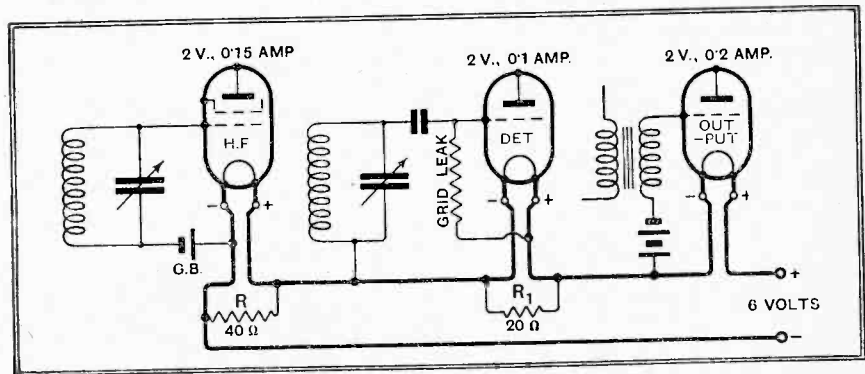

Fig. 1.—Method of feeding valve filaments from a 6-volt car battery.

stages of a receiver, the risk of damage to these condensers is not entirely avoided by the use of the safety devices in question. If, for example, the anode circuit of the output valve were interrupted, a considerable H.T. voltage rise would take place in an A.C. receiver, and, in a practical case quoted by our correspondent, the voltages applied to some of the condensers might well exceed their normal rating.

All this cannot be denied, but we would urge that in few spheres of activity is it possible to obviate all risk of doing damage to the component parts of an electrical or mechanical device through the application of excessive strains or stresses.

the valves to be used, and asks what value of shunting resistance must be connected across the filament of the H.F. and detector valves in order to absorb the surplus current. These valves have a lower filament current rating than the output valve.

These questions can most helpfully be answered by giving a skeleton circuit diagram (see Fig. 1). Positive and negative filament terminals of each valve are indicated, as we find that it is with regard to this detail that uncertainty generally exists. Grid circuits are always returned to the negative filament of the associated valves, except in the case of a grid detector.

Disappearing Bass.

A READER who has constructed a local-station quality receiver is perturbed by the fact that reproduction of the lower register tends to disappear almost entirely when volume is reduced to a low level. He submits a circuit diagram of his receiver, and asks us to say whether anything could be done to avoid this loss of bass.

When the proportional reproduction of high or low notes is affected by operation

of the volume control, one suspects at once that this device is of incorrect design, and in consequence is acting as a tone control, as well as a regulator of intensity. But the arrangement used by our correspondent is thoroughly sound; if anything, it would tend to "cut" the high notes when set towards the minimum position, but not to any serious extent.

We have come to the conclusion that the effect is a normal one; the loud speaker may be partly to blame, and also the human ear is very much less sensitive to low-frequency impulses than to those of higher periodicity. As a result, when the general volume level is greatly reduced a point may be reached where the low notes are quite inaudible.

The Wireless World INFORMATION BUREAU.

Conditions of the Service.

(1) THE service is intended primarily for readers meeting with difficulties in the construction, adjustment, operation, or maintenance of wireless receivers described in *The Wireless World*, or those of commercial design which from time to time are reviewed in the pages of *The Wireless World*. Every endeavour will be made to deal with queries on all wireless matters, provided that they are of such a nature that they can be dealt with satisfactorily in a letter.

(2) Communications should be addressed to *The Wireless World* Information Bureau, Dorset House, Tudor Street, E.C.4, and must be accompanied by a remittance of 5s. to cover the cost of the service. The enquirer's name and address should be written in block letters at the top of all communications.

(3) The fee of 5s. covers the reply to any wireless technical difficulty, but in special cases, where the enquiry may involve a considerable amount of investigation, an increased fee may be necessary. In such cases a special quotation will be made.

(4) Questions should be clearly written and concisely worded in order to avoid delay. Where enquiries relate to trouble experienced in receivers built to specifications in *The Wireless World* a complete account should be given of the trouble, and especially the symptoms.

(5) Where reference is made to published articles or descriptions of apparatus, the title of the article, the date of publication in *The Wireless World*, and the page reference number should be given, in order to facilitate reply.

(6) Full circuit diagrams, constructional details of apparatus, or values of components for home-designed receivers cannot normally be supplied, but circuit diagrams sent in with queries will be checked and criticised.

(7) Particular makes of components cannot, in general, be recommended, but advice will be given as to the suitability of an individual component for a particular purpose specified by the enquirer.

Selectivity: Real and Apparent.

IT is asked whether the addition of an H.F. stage to a high-quality local-station set, consisting of a detector followed by two resistance-coupled L.F. stages, will bring about a large increase in selectivity. Our correspondent states that at present he can only just separate his local twin stations.

By adding an H.F. amplifier, an enormous gain in sensitivity would, of course, be obtained, and at the same time the real selectivity of the set should also be increased. But the *apparent* selectivity might well be actually reduced, since the increase of sensitivity would probably be considerably greater than the increase of real selectivity.

The advisability of adding an H.F. stage in the circumstances described by our correspondent is debatable; in order to avoid interference from distant stations he might conceivably find it necessary to narrow down the band of frequencies to which his receiver will at present respond, with possibly a noticeable falling-off in the quality of reproduction. The opinion is widely held that a short-range set is best for "quality" reproduction of local stations.

Stray Coupling.

A CONSTRUCTOR of the "Power Radio-Gram" finds that signal strength is increased when the coupling condenser CC, which serves to link the two elements of the H.F. input filter, is disconnected. He asks us what may be deduced from this effect, and whether it indicates a fault in the components or wiring.

It seems certain in this case that there is excessive stray coupling between the component circuits. This may be due to the adoption of a different lay-out from that described, or to an incorrect method of wiring. Care should be taken to isolate the primary and secondary circuits as much as possible, and the wiring should be run in such a way that large inductive loops are avoided. It is a matter of some importance that the relative position of the coils, and also the dimensions of the screening plate, should follow the original design fairly closely.

There is an additional possibility that the coupling condenser used by our corre-

spondent has too high a minimum capacity, or that it is mounted in such a way that there exists excessive stray capacity between its connecting leads.

Diode Damping.

IT is a fact that the diode detector has a bad reputation for causing flat tuning, the opinion being generally held that it damps the circuit across which it is connected. This was true enough with regard to the method of using two-electrode detection which was popular a few years ago, but the modern arrangement, of which the various aspects have been discussed at length in recent issues of this journal, is almost entirely free from this shortcoming.

A well-arranged diode detector is responsible for a load of something between a quarter- and a half-megohm, which is quite negligible when we are dealing with small coils of the type at present in general use.

FOREIGN BROADCAST GUIDE.**GLEIWITZ**

(Germany).

Geographical position: 50° 17' 40" N.
18° 38' 30" E.

Approximate airline from London: 820 m.

Wavelength: 253 m. Frequency: 1,184 kcs. Power: 5 kW.

Time: Central European (coincides with B.S.T.).

Standard Daily Transmissions.

06.00 B.S.T., Relays Breslau. physical exercises; 06.15, relay of concert from "liner" at Hamburg (Sun.); or from Breslau; 08.15, morning concert, then continuous broadcasts until 17.00, concert, talks; 19.15, weather and news; 20.00, main evening programme; 22.30, news, etc.; dance music usually relayed from Berlin.

Opening and Interval Signal: Metronome (80 beats per minute).

Announcer: Man. German language only used.

Opening Call: *Achtung! Achtung! Hier sind die Schlesischen Sender Breslau und Gleiwitz*; during intervals, *Hier Schlesische Funkstunde*. Closes down with the words: *Meine Damen und Herren, wir beschliessen unsere heutige Sendung mit dem Deutschlandslid (Ladies and Gentlemen, we close down with the German National Anthem [Deutschland ueber Alles]) followed by Breslau und Gleiwitz wuenschen Ihnen eine recht gute Nacht. Vergessen Sie aber nicht Ihre Hoch und Aussenantennen zu erden. Meine Damen und Herren. Gute Nacht* (Breslau and Gleiwitz wish you a very good-night. Do not forget to earth your [outside] aerials Ladies and Gentlemen, Good-night.)

Associated transmitter: Breslau, 325 m. (923 kcs.), 1.5 kW. (later, 60 kW.).

The Wireless World

AND
RADIO REVIEW
(21st Year of Publication)

No. 670.

WEDNESDAY, JUNE 29TH, 1932.

Vol. XXX. No. 26.

Editor : HUGH S. POCOCK.

Editorial Offices : 116-117, FLEET STREET, LONDON, E.C.4. - - - Editorial Telephone : City 9472 (5 lines).

Advertising and Publishing Offices : DORSET HOUSE, TUDOR STREET, LONDON, E.C.4.

Telephone : City 2846 (15 lines).

Telegrams : "Ethaworld, Fleet, London."

COVENTRY : Hertford St. BIRMINGHAM : Guildhall Bldgs., Navigation St. MANCHESTER : 260, Deansgate. GLASGOW : 26B, Renfield Street, C.2.

Telegrams : "Cyclist, Coventry."
Telephone : 5210 Coventry.

Telegrams : "Autopress, Birmingham."
Telephone : 2970 Midland (3 lines).

Telegrams : "Hiffe, Manchester."
Telephone : Blackfriars 4412 (4 lines).

Telegrams : "Hiffe, Glasgow."
Telephone : Central 4857.

PUBLISHED WEEKLY.

ENTERED AS SECOND CLASS MATTER AT NEW YORK, N.Y.

Subscription Rates : Home, £1 1s. 8d. ; Canada, £1 1s. 8d. ; other countries abroad, £1 3s. 10d. per annum.

As many of the circuits and apparatus described in these pages are covered by patents, readers are advised, before making use of them, to satisfy themselves that they would not be infringing patents.

Two Wireless Papers in One.

WITH the publication of next week's issue of *The Wireless World* a very important change is introduced.

We have, for some weeks past, included a certain amount of information relating to programmes from abroad, but with next week's issue this feature will be extended so as to include full programmes from all the foreign stations for the complete week. Thus the paper will become what is, in fact, two papers in one, but the price will remain the same. In order to accommodate the programmes the paper will be greatly enlarged.

To enable us to publish the programmes from Sunday to Saturday, inclusive, it has been found necessary to alter the publishing day from Wednesday to Friday, so that your next copy will be dated Friday, July 8th, and will be on sale on that day. The change has been made to coincide with the commencement of a new volume, Volume XXXI.

Interest in Foreign Listening.

We are confident that this new feature will be welcomed by our readers, all of whom are interested in the reception of distant transmissions, and by combining this additional information with all the features of *The Wireless World* of the past the appeal of the paper will be greatly extended. We realise that there may be some readers, as, for instance, those resident abroad, to whom the programmes will not be of the same value, but these readers will have the satisfaction of our assurance that the character and quantity of articles to which they have been accustomed in the past will be unaffected by the change, and the cost of the paper is to remain the same.

A bigger *Wireless World*, with a wider appeal, must inevitably react to the advantage of all readers, for it enables the paper to be improved and the service to the reader extended in every direction.

Tell Your Friends.

We hope that we may look to all those who are our present readers to assist us in our enterprise by letting their friends know about the change. Those whose general interest in wireless hitherto may not have been sufficient to make them regular readers of the paper will now find that the programme feature, even by itself, is of vital interest to them, and they will now have a complete wireless journal in addition.

We shall, as in the past, welcome letters from our readers with suggestions, especially in regard to new features or articles which they would like to see included in the paper in its new form.

A New Portable.

IN this issue we announce a new receiver, "The Autotone Portable," which will be fully described next week. This receiver is a portable designed on exceptionally simple lines, yet capable of an extremely good performance. The Autotone principle is well known to our readers, as it was first embodied in a receiver described in this journal some time ago. The present portable model has several special features, and the somewhat elaborate primary adjustments originally required are entirely eliminated by employing a self-contained frame aerial instead of outside aerials of varying loads.

Practical Transformer Construction

Design Data for Transformer to Feed H.T.8 Rectifier.

THE particular Westinghouse rectifier for which the transformer described here has been designed, possesses a number of interesting features for, unlike the majority of rectifying devices, it provides a D.C. output voltage considerably in excess of the A.C. input. This is achieved by making use of the voltage doubling circuit, with the result that a modest 210 volts A.C. enables over 250 volts of smoothed D.C. to be obtained at a load of some 60 mA. Since it is unnecessary to provide a winding giving a high A.C. voltage, the secondary winding can consist of cotton-covered or silk-covered wire without rendering the component too bulky. Ample space will be available, also, for the filament windings, of which two are provided in the present case.

COMPLETE constructional details of a mains transformer suitable for feeding one of the most popular Westinghouse metal rectifiers—the H.T.8—are given in this article. The instrument is designed for a three- or four-valve set, and considerable attention is given to metal shielding of the primary winding.

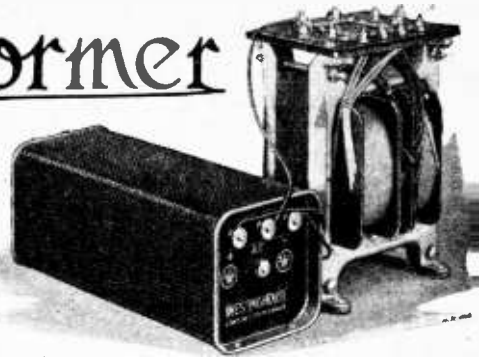

By H. B. DENT.

One of the four-volt windings is designed to carry four amps. maximum, while the other is limited to one amp., being intended to supply a directly heated output valve. But there is no particular reason why the

second L.T. winding should not be designed to deliver a heavier load to meet some special requirement. As originally planned, the total output under full load condition will amount to 45 watts, and as a core of generous size has been chosen, both the copper and iron losses are small, resulting in a reasonably efficient component, so that the total input when fully loaded is only a shade over 50 watts.

By contenting ourselves with a lower efficiency factor and cutting the insulation to the bare minimum, it would be possible to reduce the size of the transformer

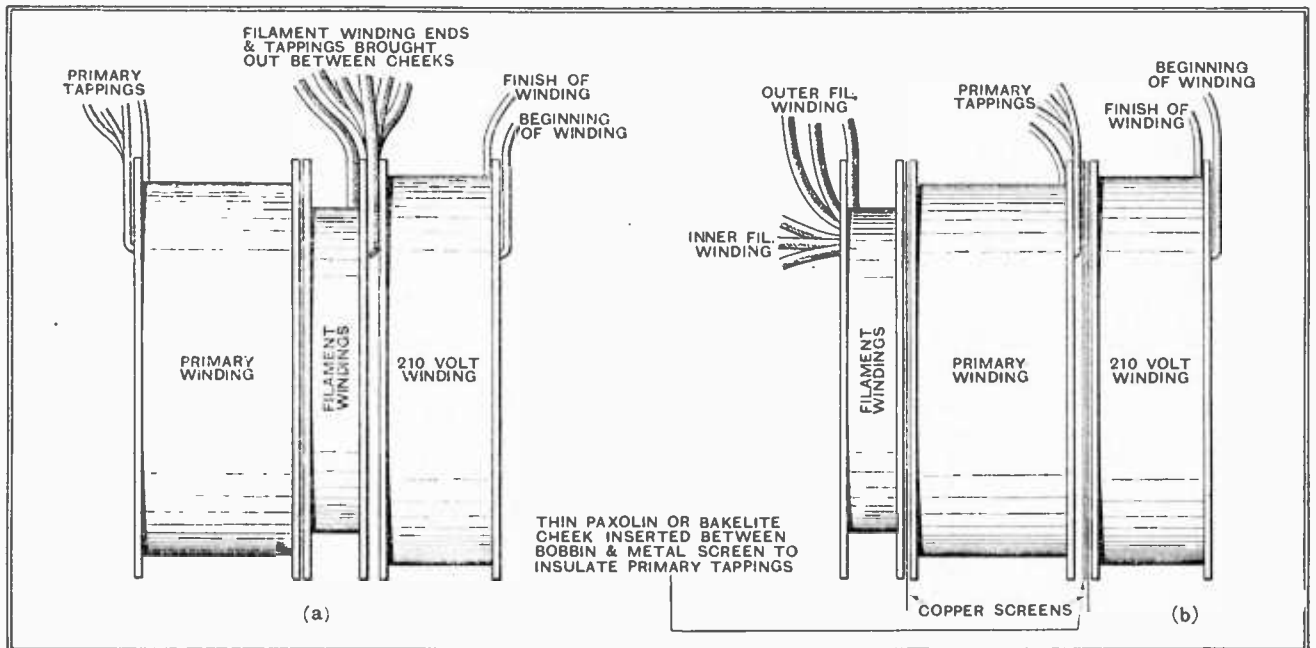

Fig. 1.—Disposition of the bobbins on the core when (a) screening plates not employed and (b) screens are interposed between the windings.

Practical Transformer Construction.—and consequently the cost of materials. The actual saving, however, will be very small, and seems hardly justified, since reliability is the all-important factor and justifies the expenditure of a few extra shillings. Each winding is carried on a separate bobbin; D.C.C. wire of adequate size is used throughout, so that the constructional work is reasonably simple and, most important of all, good insulation is assured.

Winding Details.

The core consists of six dozen pairs of Stalloy No. 33 stampings, giving a cross section of approximately 1.5 sq. in. of iron. Sound Sales, Ltd., supplied the bobbins, also the special aluminium end-clamps and bolts. The bobbins are not identical, but vary in length according to the space taken up by each coil; that carrying the primary measures 1½ in. long, while the 210-volt secondary is wound on a bobbin ¾ in. long. Both filament windings are accommodated on one bobbin, since there is negligible potential difference between them, and adequate inter-coil insulation can be obtained by winding on a few layers of Empire cloth. This bobbin measures ½ in. long. Overall dimensions are given in every case.

The primary can be wound either to suit the particular supply voltage or tapplings provided to accommodate it to various supply conditions, the latter course being favoured in the present case. It should

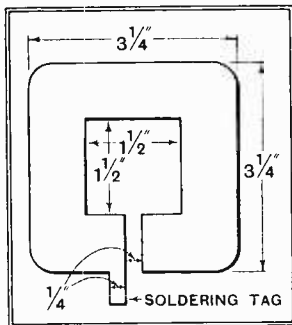

Fig. 2. — Dimensional drawing of the copper screening plates.

be mentioned in passing that this design is based on the assumption that the supply frequency is of the order of 50 cycles per second.

In all, 1,440 turns of No. 28 D.C.C. wire constitute the primary, and tapplings are brought out at the 1,200th turn and 1,320th turn, enabling the transformer to be used on supplies of 200, 220, and 240 volts. As there may be some difficulty in positioning accurately the holes in the side cheeks to pass the tapplings, it is suggested that a slot about 3/8 in. deep be cut with a hacksaw and the tapplings brought out through this.

For the 210-volt secondary winding, 1,250 turns of No. 30 D.C.C. wire are required, and although this

is somewhat in excess of the theoretical number—the transformer is designed on a basis of six turns per volt—it is necessary to compensate for the voltage drop due to the D.C. resistance of the wire, so that the potential will be correct on full load.

Each of the filament coils have 26 turns; No. 18 D.C.C. wire being used for the 2-amp. winding, while No. 22 D.C.C. will suffice for the 1-amp. coil. Both can be centre tapped, which calls for a little skill in handling such thick gauge wire as No. 18 S.W.G. These tapplings are not essential, for the same effect can be achieved by connecting a variable resistance, such as a "Humdinger," across the filament circuit.

The ends and the tapplings should be brought out through slots cut in one end-cheek of the bobbin. Two slots spaced ¼ in. apart will suffice, and these should extend to within about 1/8 in. of the bottom of the winding space. They must be wide enough to accommodate the thick wire. As mentioned above, a few layers of Empire cloth will serve to insulate the two filament windings.

A simple coil winder will be very useful when constructing the primary and secondary coils, but the filament bobbin is best wound by hand. To give some support to the filament bobbin, and prevent it collapsing while the turns are put on, a simple former consisting of two wooden end-cheeks and a centre piece can be made, the whole being held together by a short length of 2BA screwed rod with nuts either side.

The primary requires about 3/4 lb. of No. 28 D.C.C., while 1/2 lb. of No. 30 D.C.C. suffices for the H.T. secondary. Quite a small quantity of No. 18 D.C.C. and of No. 22 D.C.C. meet the needs of the filament coils, and 1/4 lb. of each will be ample.

We must now decide on the order in which to assemble the finished bobbins and consider what refinements can be introduced to improve the performance of the transformer. Recent developments favour an earthed screen between the primary winding and the other coils as a means of reducing background noise. On the other hand, it has been

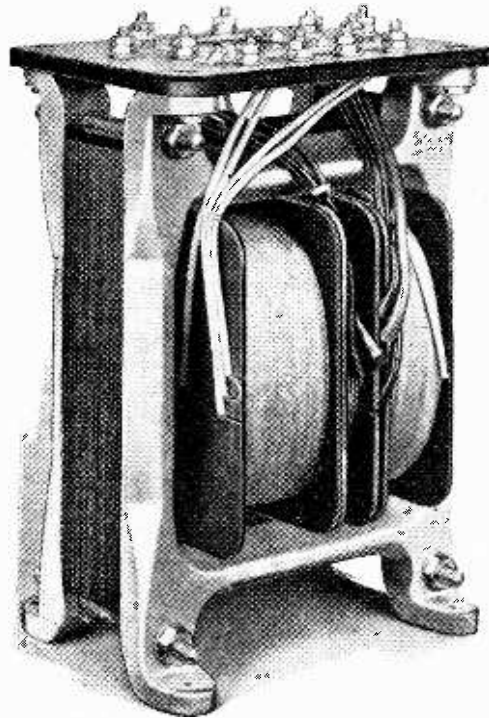

This view of the finished transformer clearly shows the method of bunching the leads to achieve a neat appearance.

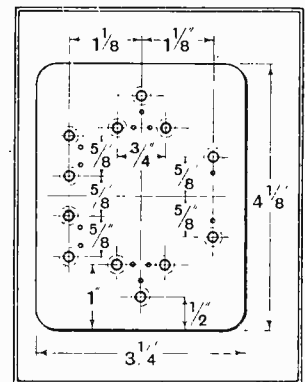

Fig. 3.—Drilling details of the terminal plate.

Practical Transformer Construction.—

found that sandwiching the filament bobbin between the primary and H.T. secondary windings reduces background noise considerably, for the filament winding then has a shielding effect as its centre point is earthed. This scheme is adopted in the transformer illustrated here.

Should it be decided to use metal screens to shield the primary then a slight rearrangement can be effected with advantage, for by transferring the filament bobbin to the outside position easy access is given to its various leads. The disposition of the bobbins is given in Fig. 1, where (a) shows the arrangement when the filament coils serve as a screen and (b) the suggested modification when screening plates are used. The screens can be cut from thin sheet copper to the size and shape shown in Fig. 2.

The Copper Screen.

These screens must not form a complete loop or each would then be equivalent to a short-circuited turn and heavy currents will circulate with possible damage to the transformer. Nor should they touch the core stampings at any point which might lead, also,

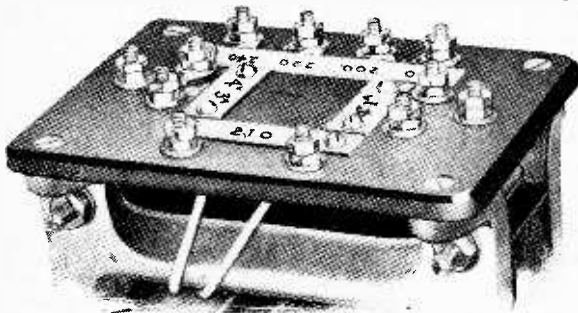

Enlarged view of terminal plate showing method of fixing voltage indicating strips.

to the formation of a short-circuited turn when the soldering tag is connected externally to the clamps.

A thin cheek of paxolin, or other suitable insulating material, must be inserted between the metal screen and the primary bobbin where the tappings pass through to prevent the insulation on the wire being chafed. If the bobbins are arranged as depicted in the drawing one insulating cheek only will be required, since the other face of the primary bobbin butts against a plain cheek remote from that where the leads pass through.

The core stampings can now be assembled, during which process the "T" and the "U" pieces are inserted from alternate ends so that the butt joints do not all fall in line. The core space is completely filled and the stampings packed tightly, for if the bobbins are loose after the core is clamped it may give rise to a little mechanical hum.

It remains now only to provide a terminal plate which might quite well be mounted on top of the transformer as this imparts to the finished product a neat and workmanlike appearance. Its size and drilling details for the various terminals are given in Fig. 3, but the four

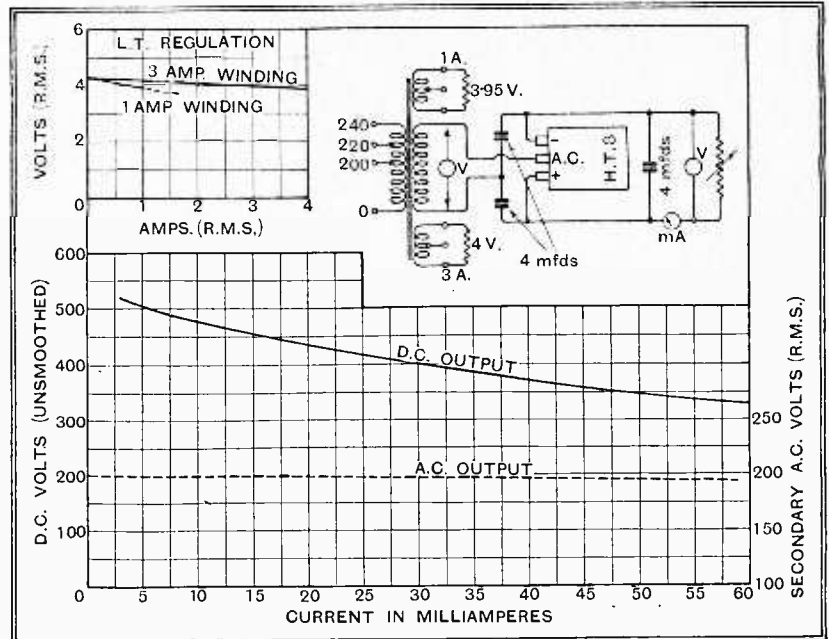

Fig. 4.—Output regulation curves taken under load conditions for the transformer dealt with in this article.

corner fixing holes have been omitted as these should be marked after tightening the core clamps. The leads from the various windings are brought up through the small holes adjacent to each terminal hole and the wires anchored to their respective terminals by small nuts.

The terminals might well consist of 4BA screws $\frac{1}{2}$ in. long with the heads countersunk into the underside of the ebonite or paxolin plate. As a means of identifying the various terminals small strips of cartridge paper can be prepared with the voltages marked in ink and glued in position. An alternative method of fixing which has much to commend it is to cut from non-inflammable celluloid strips of the same length and width as the paper tabs and fix them to the terminal plate by small 6BA screws, the screws passing through both the celluloid and the paper.

The generous core size and ample copper area of the windings contributes in no small measure to the good regulation shown on the graph. The H.T. secondary A.C. voltage falls 2.5 per cent. only on full load, while the L.T. voltages are well regulated; the 4-amp. winding showing exactly 4 volts at 3 amps. and but a shade less with 4 amps. flowing. Even with a 1-amp. load the output does not rise above 4.3 volts. The 1-amp. winding shows a shade under 4 volts when the transformer is delivering its full load. This is too near to its marked value to be improved by compensating turns, as one extra turn only would raise the output 0.16 volt, being three times the present deviation from the nominal value. In no case does the L.T. voltage rise to a level likely to damage the valves.

THE MODERN STRAIGHT FIVE

Design of the Power Unit.

Hints on Construction and Operation.

By W. I. G. PAGE, B.Sc., and W. T. COCKING.

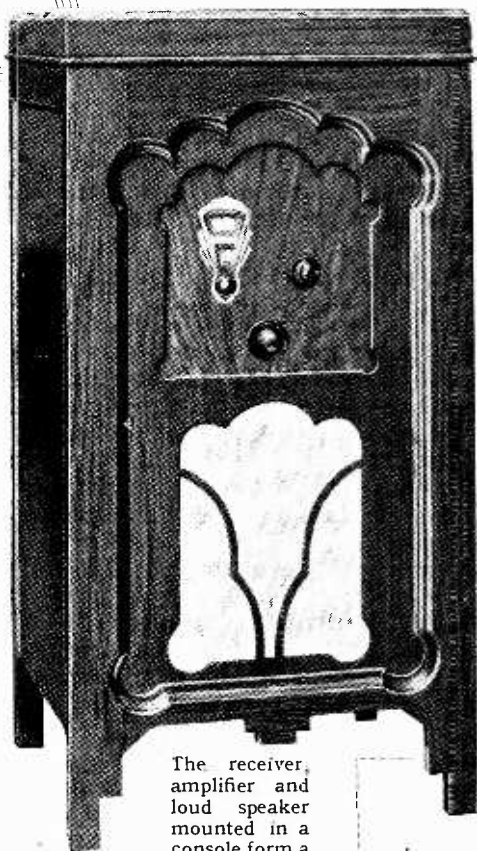

The receiver, amplifier and loud speaker mounted in a console form a self-contained equipment.

IN the previous article the separate receiver unit was described in detail and attention was paid to the method in which the voltage feed to the screening grids of the variable- μ valves was kept practically constant. Some sort of compensated potentiometer network was found to be necessary as otherwise the screen volts changed wildly and the amplification at high frequency was accompanied by a number of undesirable rectification phenomena. That the feed included in this receiver is satisfactory was proved by a series of readings on a voltmeter which imposed a load of only a few micro-amperes; the potential difference between screen and cathode of each VMS4 valve varied only a few volts above and below 72 as the bias volume control was adjusted from zero to maximum.

It now remains to describe the separate power unit and to give some hints on the construction and operation of the receiver as a whole. In designing a mains power amplifier with a high overall amplification such troubles as hum, parasitic oscillations at high frequency, back-

ground noise from the mains and motor-boating may occur, to mention a few only of the possible worries which beset the designer. In addition to avoiding these, each valve and its associated coupling circuit must be so arranged as to introduce the very minimum of amplitude (waveform) and frequency distortion. As there is practically no side-band cutting, tone correction is not necessary.

An output valve capable of delivering between 5,000 and 6,000 milliwatts undistorted A.C. energy to the speaker has been chosen because it is felt that in a large room music will sound "live" and like the real thing, being rendered at about the original volume level. If the receiver is to be used in a smaller room where the greater volume level is overpowering the output can be reduced to any desired degree by means of the variable-mu control, and there is then the advantage that signals are only occupying a very small part of the "straight" in the valve characteristic.

Circuit of the Power Unit.

The power unit is of the simplest possible construction, the principal components being attached to a "Plymax" metal covered baseboard raised by means of two wooden battens so that the decoupling resistances and condensers can be housed underneath. The output circuit of the receiver unit and the in-

put of the power unit are wired to valve-holders and interconnection is afforded by means of a length of 5-membered cable with a 5-pin plug at each end. Similar pins (that is, anode to anode, etc.) in the plugs must be wired together and the different colours used for the insulation of each member should prevent wrong connections from being made.

As explained in last week's article, the detector anode current is fed through the L.F. transformer primary—an arrangement which at once permits efficient decoupling of the grid circuit of the PP5/400 valve and, incidentally, decreases the number of components required. The output of the L.F. transformer is fed to the grid of the last valve via the "grid stopper" R_{13} . This non-inductive resistance of 5,000 ohms, which,

ALTHOUGH the selectivity will be found adequate, quality of reproduction has been placed before all other considerations in the design of this receiver, the description of which is included in the accompanying article. A generous output stage capable of delivering nearly 6 watts speech is incorporated in order that the volume of reproduced sound may bear a close relation to that in the broadcasting studio.

Modern Straight Five.—

together with R_{22} of 100 ohms in the anode circuit, prevents parasitic oscillations at high frequency, must be

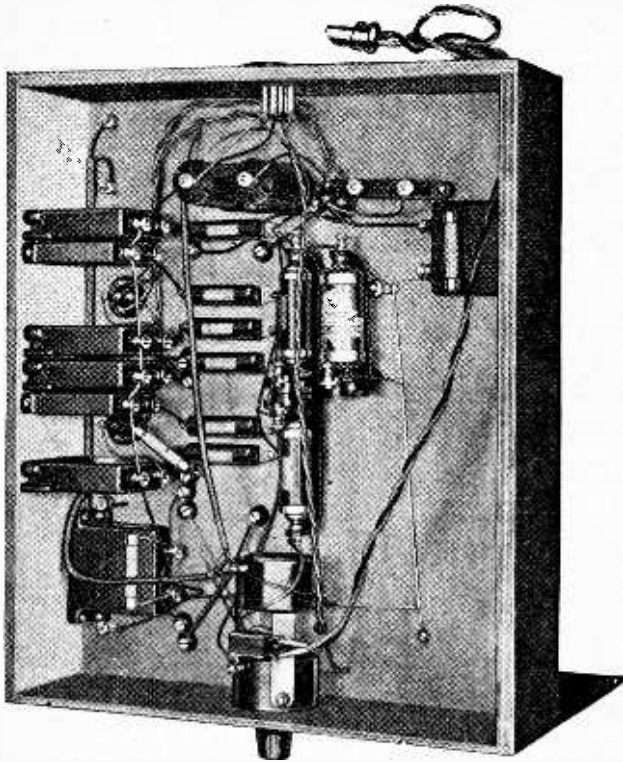

The decoupling components and constant-voltage feed network of resistances are housed beneath the baseboard in the receiver unit.

connected very close to the valve-holder terminals, for it is generally assumed that the inductance of the grid and plate leads in conjunction with the valve inter-electrode capacities form an undesirable resonance circuit of ultra-short wavelength.

The filter R_{18} , C_{14} decouples the grid circuit and provides a low-resistance path back to cathode for speech frequencies. At 50 cycles the impedance is about 3,000 ohms, whereas that through the alternative path R_{18} is 50,000 ohms at all frequencies. Self-bias for the PP5/400 is obtained from the voltage drop across the resistance R_{20} through which the anode current of this valve returns. With an applied voltage of 400 the anode current is 63 mA. and the necessary bias of 32 volts is obtained from a resistance

the value of which should be $32/0.063$ ohms = 508 ohms. This figure is made up of R_{20} of 500 ohms (3-watt type) and of the effective resistance of R_{21} , which is $7\frac{1}{2}$ ohms or a quarter of the total resistance of 30 ohms, the two halves being in parallel.

There is a conventional choke-filter circuit LFC₂ and C_{15} , the resistance of the former being but 260 ohms, causing the loss of only a few volts with 63 mA. anode current. The leads to the speaker field, which is included in the H.T. positive smoothing circuit, and the speech coil connections are twisted together, making a 4-membered cable the ends of which are joined to a 5-pin plug, the centre contact not being used.

The Thermal Delay Switch.

Little comment concerning the eliminator is needed. The mains transformer is provided with an earthed screen which effectually shunts away H.F. disturbances in the supply—in fact, this expedient is a better preventive against certain forms of background noise than any centre-tapped buffer condensers. The leads ZZ are taken to the mains switch, which is brought into action at the minimum position of the spindle of the dual volume control. About 2 ft. of twin lighting "flex" are needed in the case of the "Modern Straight Five," but if the power unit is coupled to the receiver chassis of the "Monodial A.C. Super," the leads ZZ are not required and the safety sockets which have been attached to the terminal strip of the mains transformer can be short-circuited.

To economise in the size of by-pass condensers a thermal delay switch has been included in the H.T. positive line. This component is sent out by the manufacturers with the contact points adjusted so that the circuit is closed one minute after the set is switched on. By this means high voltages are avoided in the early stages of the receiver while the valve cathodes are warming up, and it is, therefore, only necessary to use 1,500

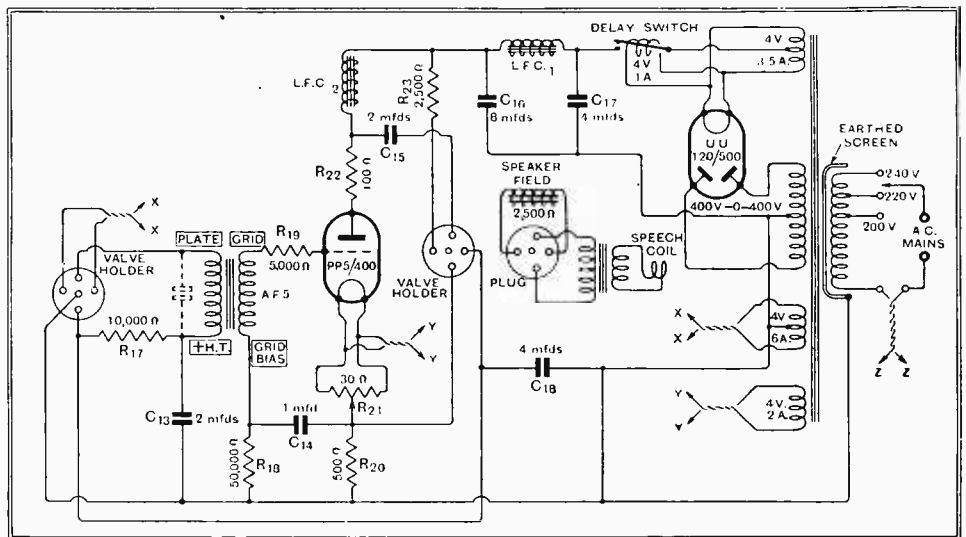

Circuit diagram of the power unit. The leads XX from the valve-holder must carry 6 amps. when the unit is used after the "Monodial A.C. Super" and 3 amps. with the present receiver.

Modern Straight Five.—

volt D.C. test condensers for C_{13} , C_{16} , C_{17} , and C_{18} . The bi-metal strip of the delay switch is heated by a small wire-wound element consuming one ampere at 4 volts which is fed from the same transformer winding as the filament of the UU120/500.

The receiver is intended to be used with a moving-coil loud speaker with energised field and no attempt should be made to press into service a permanent-magnet type unless a high-inductance choke of 2,500 ohms D.C. resistance is made to replace the field. In order that the speaker should be electrically suitable and of correct physical dimensions for the cabinet specified in the list of parts the following values should be noted. The field must have a D.C. resistance of 2,500 ohms capable of giving sufficient flux density with $4\frac{1}{2}$ to $6\frac{1}{2}$ watts dissipation and the speech coil should be connected to an input transformer with a suitable winding to match the PP5/400 valve. The speaker should be able to handle without distress 5,000 milliwatts A.C. energy, and the overall depth from the front of cone to back of the "pot" must not exceed $5\frac{3}{4}$ inches.

The Rola speaker type F.2500, Epoch E.8 (2,500 ohms), Magnavox type DC.142 "L," Rothermel type RC.2500 (these four have hum-bucking coils to eliminate the last traces of hum); and the Baker E10 mag chassis (2,500 ohms field) have all been found suitable for building into the self-contained equipment. If, however, an external speaker is preferred, rather more massive types can be used with even a larger margin of safety in respect of overload.

The general constructional work is simple and straightforward. Starting with the receiver unit, the ganged condenser assembly and the unit of four coils, together with gramo-radio switch, should be mounted first. To ensure stability these two key components should be earthed in a number of places. The panel should next be fitted to the baseboard and the three controls secured, after

which the valve holders and screening cans must be attached. The wiring above and below the baseboard can be followed easily by referring to the large plans and photographs; care being taken that the coil terminal extension pillars which project vertically downwards do not short-circuit to earth.

When building the power unit the first component to install is the mains transformer, as it has the greatest

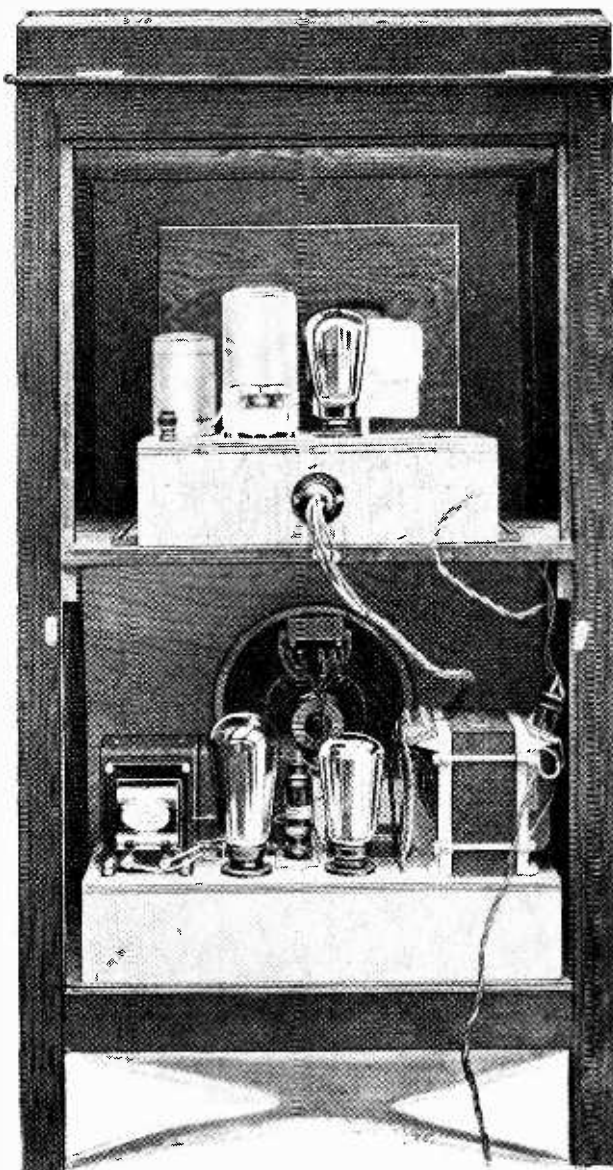

The cabinet with back removed, showing the disposition of the receiver, amplifier and loud speaker. To cover the aperture in this cabinet a wooden panel measuring 12in. x 12ins. is necessary for the receiver.

number of connections. The Parmeko product actually used necessitates that the primary and secondary of the L.F. transformer be in the exact position shown, as it has been very carefully orientated for minimum hum. Should a mains transformer of another make be chosen the A.F.5 transformer must be temporarily wired with long flexible leads and, when the receiver is undergoing initial tests, moved about until hum is negligible. With a number of the mains transformers the primary electrostatic screen is internally earthed to the frame; with others a lead from the screen is taken to a terminal, in which case a separate connection to earth must be made.

When the wiring has been completed and signals have actually been received, the first adjustment to make is the ganging of the four tuned circuits. It will be seen that the end vanes of all the tuning condenser members are split, but no attempt should be made to bend these sections as this will upset the matching, which has been carried out with great care at the factory. The final ganging is effected by trimmers which are changed in value by means of a screwdriver. The trimmer on the first condenser tuning the input circuit of the constant peak filter must be fully unscrewed and left in this position as the ganging of this circuit is carried out by altering the capacity of C_1 —the aerial series condenser.

It is first necessary to tune in a fairly loud station between 260 and 200 metres and to set the volume level rather low. Next adjust C_1 and the three trimmers on the two intervalve couplings and the secondary of the

GENERAL LAYOUT OF COMPONENTS AND WIRING PLAN OF POWER UNIT.

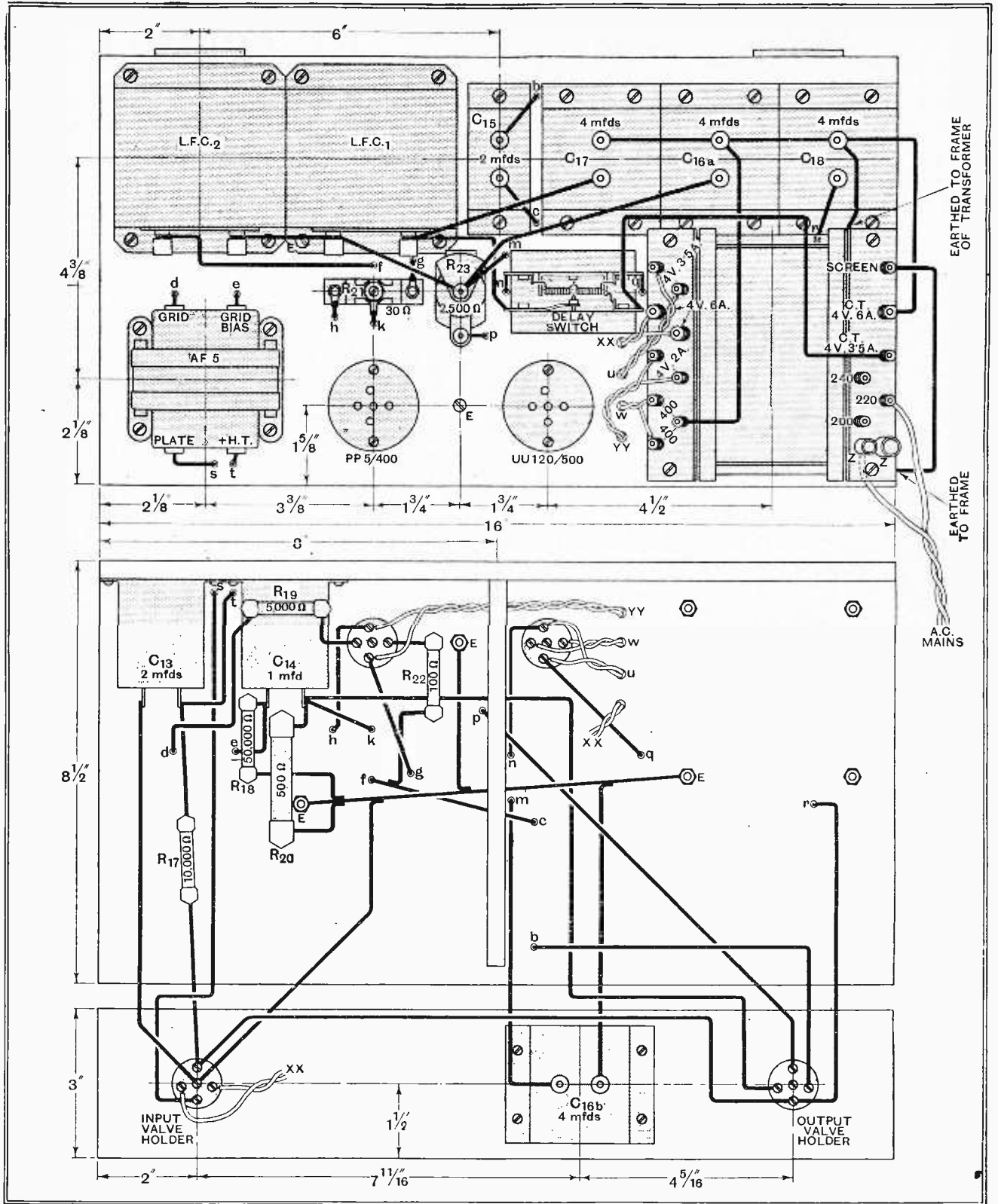

The condenser C_{16} of 8-mfd. capacity is made up of two 4-mfd. condensers in parallel shown as C_{16a} and C_{16b} . The delay switch gap should only be adjusted if after switching on there is considerably less than one minute's interval before the contacts close.

Modern Straight Five.—

filter respectively until there is maximum response. Now choose another station of low wavelength which can only be heard with the volume control set at maximum and readjust the trimmers as before. This will have the effect of balancing the circuits for incidental regeneration. Once the ganging is properly done at low wavelengths it will be found to hold over the scale on both wavebands.

Regarding the three controls; that on the left is the single tuning dial (illuminated), the right-hand knob changes the circuits from long to short waves with an intermediate position for gramophone reproduction, while the lower control increases volume on either radio or gramophone when it is rotated in a clockwise direction. Extreme anti-clockwise rotation opens the mains switch.

When tested the receiver gave a good account of itself. More than fifty British and Continental stations are available to provide a programme of entertain-

ment value. Selectivity is high enough to ensure interference-free reception of all worth-while stations except in the case of a transmission of small frequency separation from the local station, when the set is used in the wipe-out area of the latter.

The background is particularly silent, no hum being audible at a distance of 2 ft. from the moving-coil loud speaker. This can be accounted for by the liberal smoothing equipment provided and by the absence of rectification in the H.F. stages. In the event of any individual receiver having too loud a background of hum it is most likely due to wrong orientation of the L.F. transformer or to faulty adjustment of the potentiometer R₂₁.

This receiver is available for inspection by readers at the Editorial Offices, 116, Fleet Street, London, E.C.4.

For the convenience of readers constructing the Modern Straight Five, full-sized blue prints of the complete layout and wiring diagrams appearing in this and last week's issues are available from the publishers at 1s. 6d. post free.

In Next Week's Issue

The "Autotone" Portable

A Sensitive Tone-Corrected Three-Valve Portable

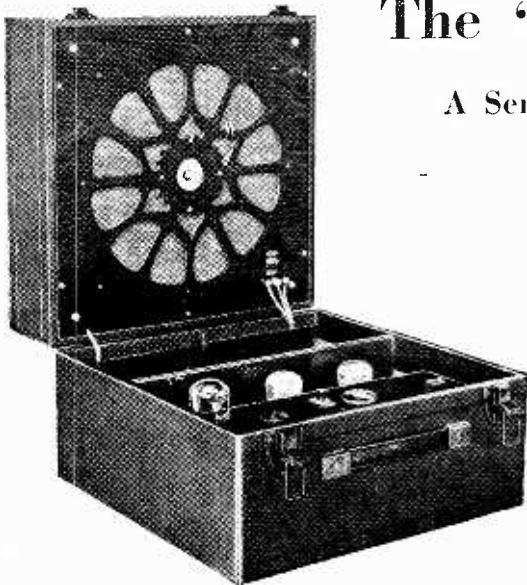

The "Autotone" principle of reception, when applied to a portable employing a frame aerial, is capable of giving an exceptionally good performance in the matter of range, selectivity, and quality, combined with economy in initial outlay and running costs.

Only three valves are necessary (det. and 2 L.F.), and it will be seen from the "List of Parts" below that, although nothing has been skimped, the total cost, including valves and batteries, is under £9. The current taken from the H.T. battery is 6 mA., and one of the many interesting features of the design is the incorporation of automatic grid bias. This effectively prevents overbiasing as the H.T. battery runs down, and tests have shown that good quality is maintained down to 50 volts H.T.

Constructional details and full particulars of the receiver will appear in next week's issue.

LIST OF PARTS.

After the particular make of component used in the original model, suitable alternative products are given in some instances.

- | | | | |
|--|------------------------------|--|-----------------------------|
| 1 Suitcase cabinet | (Camco "Riverside") | 1 Loud speaker unit | (Lissen "Solenoid" LN.5073) |
| 3 4-pin Valve holders | (Lissen Rigid Type) | (Ormond, Six-Sixty, Telsen.) | |
| 1 Tone control transformer, type 4/1 | (Multitone) | 1 Cone diaphragm, 10in. diameter | (Bulgin S.22) |
| 1 Tone control potentiometer | (Multitone) | (Benjamin, Goltone, Graham Farish, Igranic, Lewcos, 154, Southwark Bridge Road, London, S.E.1.) | |
| 1 Universal "Transcoupler" | (Bulgin) | 1 Push-pull switch "On-off" | (Bulgin S.22) |
| (Benjamin "Transfeeda.") | | 1 Push-pull 3-way switch "High wave—Low wave" | (Bulgin S.36) |
| 3 Metallised resistances, 250 ohms, 1 watt | (Dubilier) | (Benjamin, Graham Farish, Gripso, Junit, Lissen, Lotus, Melbourne, Ormond, Ready Radio, Sovereign, Telsen, Wearite.) | |
| 1 Metallised resistance, 50,000 ohms, 1 watt | (Dubilier) | 5 Wander plugs, "Midget" type | (Bellling-Lee) |
| 1 Metallised resistance, 500,000 ohms, 1 watt | (Dubilier) | (Clix, Eelex.) | |
| 2 Resistances, 20,000 ohms, spaghetti type | (Tunewell) | 3 Rigid sockets | (Clix, Type No. 15) |
| (Bulgin, Goltone, Graham Farish, Igranic, Lewcos, Magnum, Ready Radio, Sovereign, Telsen, Varley.) | | 2 Spade terminals | (Clix) |
| 1 Slow motion variable condenser, 0.0005 mfd. with dial | (Ormond R.426) | (Bellling-Lee, Eelex.) | |
| (Burton, Formo, Polar, Simplicon, Telsen, Utility, Wavemaster.) | | Metal braided twin flex | (Lewcos) |
| 1 Slow motion differential reaction condenser, 0.0002 mfd. | (Ormond R.190) | (Goltone.) | |
| (Burton, Formo, Polar, Simplicon, Telsen, Utility, Wavemaster.) | | Quantity of No. 22 D.C.C. wire and 28 D.S.C. wire, tinned copper wire, Systoflex, screws, flex, etc. | |
| 1 Fixed condenser, 2 mfd., centre tapped | (Ferranti Type C.2.C) | H.T. battery, 108 volts "Blue Triangle" | (Exide No. H.1018) |
| 2 Fixed condensers, 2 mfd. | (Ferranti Type C.2) | Unspillable accumulator, 2 volt | (Exide P03) |
| (Dubilier, Formo, Franklin, Hydra, Loewe, Savage, Sound Sales, T.C.C., Telsen, Wego.) | | VALVES. One Cossor 220PA, | Two Cossor 210 H.F., |
| 1 Fixed condenser, dry electrolytic, 50 mfd. | (T.C.C. Type 501) | or One Marconi LP2, | Two Marconi HL2, |
| 1 Fixed condenser, mica, 0.0001 mfd. | (Dubilier No. 610) | or One Osram LP2, | Two Osram HL2, |
| (Ferranti, Formo, Graham Farish, Hydra, T.C.C., Telsen.) | | or One Mullard PM2A, | Two Mullard PM HL. |
| 1 H.F. choke | (McMichael Binocular Junior) | (Approximate cost including valves and batteries, £8 15s.) | |

WIRELESS ENCYCLOPEDIA

No. 19

HYSTERESIS (Magnetic). The name for the phenomenon that the relationship between the magnetising force and the resulting magnetisation is different for increasing values of magnetising force than for decreasing values in the case of iron and its alloys.

HYSTERESIS LOOP. The graph showing the relationship between the degree of magnetisation of iron (and its alloys) and an alternating or pulsating magnetising force, the complete graph forming a closed loop.

THE degree of magnetisation or magnetic flux density produced in a given iron magnetic circuit depends chiefly on the product of amperes and turns of the magnetising coil, that is, on the ampere-turns. In a closed magnetic circuit of uniform cross-sectional area the magnetic flux density produced is given by a law akin to Ohm's law for the electric circuit, being the ratio of magnetomotive force to reluctance, where the magnetomotive force (M.M.F.) is 0.4π times the ampere-turns, and the reluctance is the ratio of the mean length of the magnetic circuit in centimetres to the permeability or "magnetic conductivity" of the iron. Denoting the reluctance by R , the flux density B is given by $B = \frac{M.M.F.}{R}$ gauss (or lines per sq. cm.), which is similar to the law $I = \frac{E.M.F.}{R}$ for the electric circuit. M.M.F. is expressed in gilberts.

The magnetomotive force per centimetre length of the magnetic circuit is referred to as the magnetising force (H) of the coil, and is 0.4π times the ampere-turns per cm., being expressed in gilberts per cm. For instance, if a coil of 100 turns is wound on an iron ring whose mean circumference is 30 cms., the magnetising force of the coil, with a current of 2 amperes flowing, is $0.4\pi \times \frac{2 \times 100}{30} = 8.38$ gilberts per centimetre.

If the iron ring is unmagnetised to start with (no residual magnetism), and the magnetising force H is gradually increased, the magnetic flux density B rises in the manner shown by the graph of Fig. 1, rising rapidly at first and then more gradually. This graph is referred to as the magnetisation curve or saturation curve of the iron. The ratio of B to H gives the permeability for any particular value of B , and the point in the curve where the bend is sharpest is referred to as the saturation point.

But if now the magnetising force were to be gradually reduced from the maximum value reached, back to zero, the flux density would not fall according to the curve already obtained for increasing values of H ,

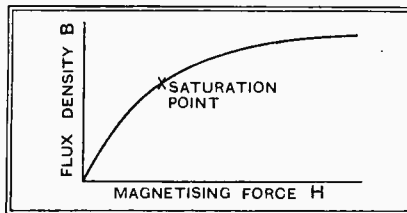

Fig. 1.—Curve showing the general form of magnetisation curve of iron.

but according to a new curve above that for increasing values; and when the magnetising force is removed altogether by switching off the current, the iron retains a considerable amount of residual magnetism. The effect is shown by the top right-hand portion of Fig. 2, where the broken line curve represents the rise of flux density as the magnetising force is raised from zero to OA with the iron initially unmagnetised (being the same as the curve of Fig. 1), whereas the curve BC gives the values of B as the magnetising force is again reduced to zero. It is this lagging effect which is called hysteresis.

To reduce the magnetism to zero the magnetising force has to be given the negative value OD by reversing the current. By increasing H still further in the negative direction to the value OA' , equal and opposite to the value OA , the flux density varies according to the curve DB' to the same maximum value as before, but in the reverse direction.

Then, on changing the magnetising force once more from OA' to OA , the degree of magnetisation follows the curve $B'C'D'B$, which is exactly the same shape as $BCDB'$, and the closed loop so formed is called the hysteresis loop.

From the foregoing it follows that

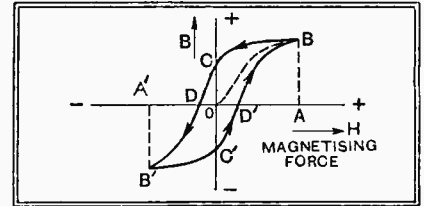

Fig. 2.—Hysteresis loop obtained with an alternating magnetomotive force.

when an alternating current is passed through the magnetising coil the magnetism will pass through a cycle of values represented by the hysteresis loop for each cycle of the alternating current. In practice, the loop for each succeeding cycle does not become identical with the previous one until several cycles have passed.

As a result of hysteresis, heat is generated in the iron, and the energy lost per second in this way is known as hysteresis loss, being usually expressed in watts. The energy lost per cycle is proportional to the area enclosed by the loop, and is given in ergs per cubic centimetre of iron by $1/4\pi$ times the loop area. The

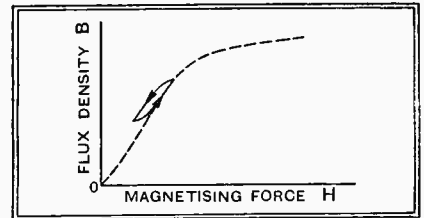

Fig. 3.—Showing the nature of the hysteresis loop obtained with a fluctuating but unidirectional magnetising force.

width of the loop increases rapidly as the iron is magnetised beyond saturation, and so to keep hysteresis losses down low values of maximum working density must be used.

When the magnetising force fluctuates between two limits in the same direction, hysteresis still occurs, and its nature is indicated by Fig. 3. A very common instance is that of a low-frequency transformer with the primary winding carrying both D.C. and A.C.

NEWS OF THE WEEK.

Current Events in Brief Review.

America at Madrid

THE American representatives may play a dominating rôle at the International Radio Telegraph Conference which opens in Madrid on September 3rd. It is not generally remembered that President Hoover himself, as Secretary of Commerce, headed the American delegation and was Chairman of the same International Conference when it was held in Washington in 1927. President Hoover is now choosing the delegates who will visit Madrid.

Major-General Charles M. Saltzman, Chairman of the Federal Radio Commission, will probably lead the party. The amateurs will be represented by K. B. Warner and Hall M. Segal, of the American Radio Relay League.

A hope is expressed that more channels of the ether may be made available for North American, as well as European, broadcasting services.

The rumour has recently been current in America that the Conference might be postponed on account of unsettled political conditions, but there now seems no doubt that the event will take place as scheduled.

The Radio-gramophone War.

THREE recently issued gramophone records in France bear the inscription, "Broadcasting Forbidden."

Stunt Broadcasts

THE German broadcasting authorities are, perhaps, more resourceful than any others in Europe in securing stunt items for the programmes.

Stuttgart is planning for the autumn a running commentary of an airship voyage, the commentator being a passenger on the craft. During the trip from Stuttgart via Geneva and Marseilles to Barcelona he will give his account through a short-wave transmitter, the signals being picked up and relayed from the high-power station at Mühlacker.

France, too, is becoming more enterprising in regard to "O.B." events; arrangements have been made for a running commentary from the footplate of the locomotive on the express from Paris to Rouen. The account will be given on a Sunday in the near future.

Super Valve Tests in U.S.

KDKA, Pittsburgh, is continuing its tests on from 50 to 400 kilowatts after midnight (5 a.m. B.S.T.), while WGY, Schenectady, is also experimenting on high power, ranging from 50 to 200 kilowatts.

The Pittsburgh tests are conducted with the experimental call-sign W8XAR on 980 kilocycles, and the WGY tests with the call-sign W2XAG on 660 and 790 kilocycles.

Both stations are concentrating on the development of new high-power transmitting valves.

Papal Representative at Madrid.

THE Vatican will be represented at the Madrid Conference. Father Gianfranceschi, the Director of the Papal short-wave station, will be one of the delegates. As our Turin correspondent remarks, Father Gianfranceschi will attend in his technical capacity; as a Jesuit he might have difficulty in obtaining admittance into Spain!

Radio for Olympic Athletes.

AN amateur radio station is to keep athletes at the Olympic Games at Los Angeles in touch with their relatives and friends all over the world. The public-spirited youth who has undertaken this service, free of all cost to the athletes, is William A. Lippmann, Jun., owner of station W6USA. Lippmann has found an excellent transmitting site on a hill within "Olympic Village," and from here he will transmit private telegrams in the usual manner, to be relayed by any amateur who chances to hear them.

A Portuguese B.B.C.?

PORTUGAL is now making up for lost time. After ten years of comparative indifference to broadcasting, new interest has been awakened by the project for the opening of the new 20-kW transmitter at Lisbon. During the last three days of May a Listeners' Conference, held in the capital, proved a great success. Problems dealing with Portuguese broadcasting were discussed, and, according to our Lisbon correspondent, the British system of broadcasting was held up as a model to be followed by the Portuguese Post Office.

Have You Heard Bari?

THE Marconi broadcasting station at Florence has a twin at Bari, which began tests on Monday, June 20th, on a wavelength of about 280 metres.

At present the transmissions are experimental, and the official opening will probably not take place until the end of October.

Black Monday in Italy.

MONDAY, July 4th, has been fixed by the Italian postal authorities as the last day on which broadcast pirates will be tolerated. A ruthless pirate hunt will then begin.

Loud Speakers in Hotels.

ITALY'S national committee of hotel proprietors and tourists has concluded a contract with the broadcasting authorities, fixing privileged licence fees for loud speakers used in hotels.

The same question might be worthy of attention in this country, where, it is to be hoped, many foreign tourists will this summer find their way into hotels all over Britain.

And, while on the subject of licence fees, would it not be as well to raise the question of loud-speaker quality? The time may easily come when foreign tourists will judge a country by its loud speakers, in which case we fear that Britain would be likened to the curate's egg.

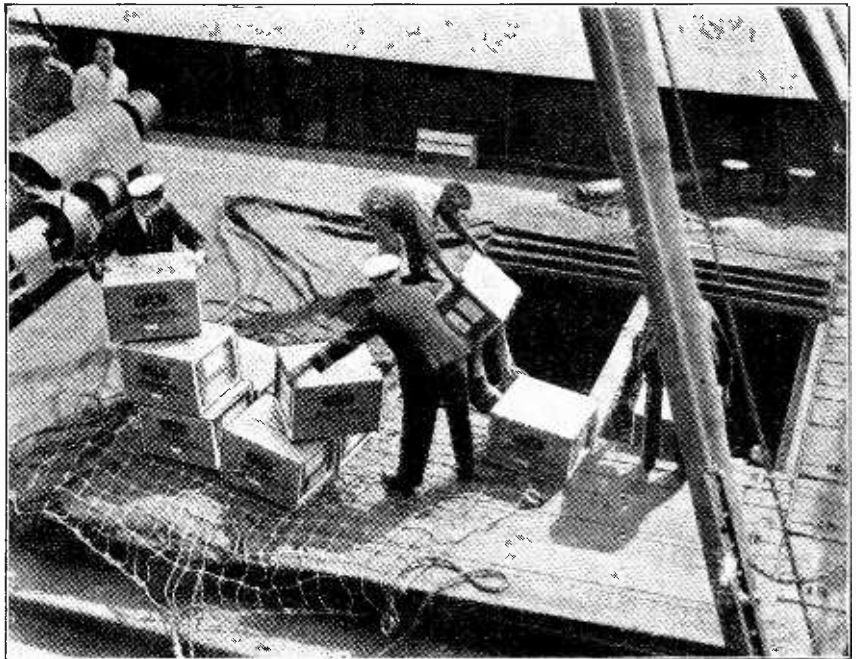

EKCO MAKE MARITIME HISTORY. The first consignment of goods ever to leave Southend Pier comprised 200 "Ekco" receivers bound for Newcastle. Even the ship's officers lent a hand.

Laboratory Tests

ON NEW RADIO PRODUCTS.

FRANKLIN RESISTANCES AND CONDENSERS.

Small resistance rods that can be bridged across condensers or suspended on the wiring are much in demand now since they occupy very little space, and, furthermore, simplify the process of wiring. Those made by the Franklin Electric Co., Ltd., Franklin House, 150, Charing Cross Road, London, W.C.2, are comparable in size with the average grid-leak resistance, yet they are rated to dissipate two watts.

A wide range of values is available, and up to 500,000 ohms the price is 1s. 4d. each, while higher values cost 1s. 8d. each. The specimens tested were found to be in close agreement with their marked values, the measured resistance of a 100,000-ohm rod being within 1 per cent., while a 50,000-ohm sample was 2.6 per cent. high only. These rods are provided with metal end-caps and long connecting wires.

A range of tubular condensers, provided, also, with long connecting leads, and made in all the usual sizes from 0.00005 mfd. to 0.01 mfd., will be found

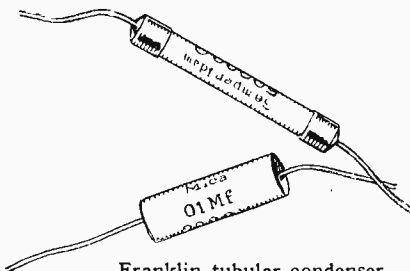

Franklin tubular condenser with mica dielectric and 2-watt resistance rod.

very useful when space is strictly limited, or where it is more convenient to loop the condenser between components rather than fix it rigidly to the baseboard. These are exceedingly compact and very light; for example, a 0.01 mfd. size with mica dielectric measures 1in. long by $\frac{1}{8}$ in. diameter, and costs 1s. 6d. With paper dielectric the price is 8d. only, and this type is tested at 1,500 volts D.C. The mica model is tested at 2,000 volts. Some of the mica specimens tested were as close as 3 per cent. to the marked value. The smaller capacities ranging from 0.00005 mfd. to 0.0005 mfd. cost but 6d. each.

WEARITE SCREENED H.F. CHOKE.

Of the many new components introduced recently by Wright and Weaire, Ltd., 740, High Road, Tottenham, London, N.17, the screened H.F. choke is of particular interest, for the present-day vogue for compact receivers has necessitated complete screening of all com-

ponents included in the high-frequency circuits. The Wearite choke has the added advantage of small size; the base measures 1 $\frac{1}{2}$ in. x 1 $\frac{1}{2}$ in., and the overall height is but 2 $\frac{1}{2}$ in.

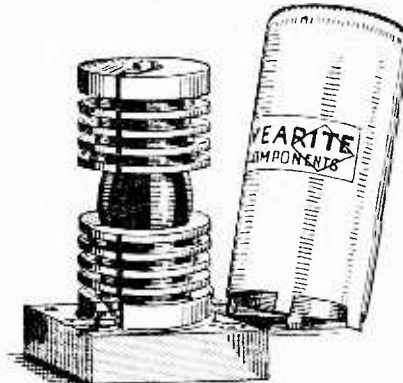

Wearite H.F. choke with aluminium case removed.

Despite its diminutive size, the inductance is adequate for all purposes, and when tested in a receiver it performed its allotted function in a perfectly satisfactory manner. When fitted in a detector circuit it enabled smooth reaction to be obtained over both medium and long broadcast wavebands, and was quite satisfactory even in a short-wave receiver. The makers' claims that this choke has an effective range of from 15 to 2,500 metres is fully substantiated by our tests.

The earthing tag for the aluminium case is brought out to a small eyelet concentric with one of the fixing holes, so that when the choke is mounted on a metal chassis, the fixing screw serves also to earth the metal container. The price is 3s. 6d.

AERIALITE AERIAL WIRE.

This is a new style of aerial wire suitable either for indoor or outdoor use, and consists of a core made up of seven strands of No. 24 S.W.G. hard-drawn copper wire enclosed in a thick insulated covering impregnated to render it waterproof.

Aerialite aerial wire for indoor or outdoor use.

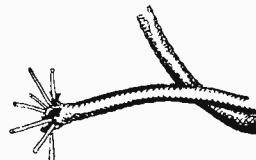

In view of the exceptionally good insulating properties of the covering, there is no particular need to employ the orthodox style of insulators, even for outdoor use. In large cities and in coastal districts where atmospheric impurities are

more likely to cause deterioration of the insulation than elsewhere, small insulators might be employed solely as a precautionary measure. The overall size of the cable is quite small, and it is extremely light, imposing little strain on the supports.

When erecting an indoor aerial the wire can be attached to the picture rail by means of the special cleats, of which various styles are now obtainable from most dealers.

Aerialite can be employed also for the earth lead where an insulated conductor is required to make connection to a distant earthing point.

Sold in cartons containing 50, 75, or 100 feet, the price is 1s. 6d., 2s. 3d., and 3s. respectively. Supplies are obtainable from the Aerialite Co., 10, Amber Street, Shudehill, Manchester.

BECKER RADIO SWITCHES.

Special radio switches designed on similar lines to the ordinary wall-type switches and embodying identical mechanism are now obtainable from Geo. Becker, Ltd., Ampere Works, Wembley Park, Middlesex, for inclusion in wireless receivers and associated equipment. They are particularly suitable for use as mains switches, since they are designed to handle high voltages and comparatively heavy currents.

The samples tested are rated at 4 amps. and have a snap-action make-and-break movement.

The body of the switch consists of a bakelite moulding, and all parts normally exposed are completely insulated. Phosphor-bronze spring contacts having a self-cleaning action are fitted, the design being such that they will stand up to hard wear without going out of

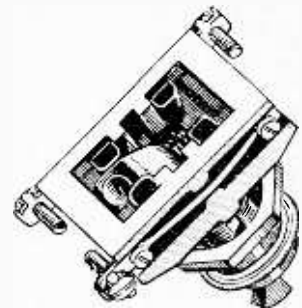

Becker snap-action radio-gramophone switch.

adjustment. A large-diameter single-hole fixing bush is provided, and there is a back nut, in addition to the milled locking ring, which enables the switch to be mounted on panels of various thicknesses.

A single-pole make-and-break switch suitable for including in the mains lead, and styled the model 460, costs 1s. 10d., while the single-pole change-over type, model 461/R, intended for use as a radio-gramophone switch, costs 2s. This type has a reasonably low capacity, and thus is quite suitable for incorporating in radio-frequency circuits.

PROGRAMMES FROM ABROAD



FRIDAY, JULY 1st.

ALGIERS (363.3 metres); 13 kW.—7.30 p.m., Selections of Popular Music. 7.55, News and Time Signal. 8.0, Recital of Chopin Music. 9.0, Songs from Opera and Operetta. 9.30, Dance Music, relayed from the Municipal Casino.

BARCELONA (Radio-Barcelona), Call EAJI (349 metres); 8 kW.—8.0 p.m., Trio Concert: Pensée d'Automne (Massenet); Selection from A Masked Ball (Verdy); Elegy for Cello (Vidaury); Melody (Ackermans). 8.30, Exchange Quotations, Request Gramophone Records, Sports Notes, and Press News. 10.0, Chimes, Weather Forecast, Exchange and Market Prices, and Relay of Foreign Stations. 10.15, Concert by the Station Orchestra; Soloist: Jarque (Violin); Waltz: For Ever and Ever (Greenbank); Selection from Madame Butterfly (Puccini); Entr'acte from Ghismonda (Février); Der Erlkönig (Schubert); Violin Solo: Romance in G (Beethoven); Pasodoble, Margarita (Rinaldi). 11.0, La del sor del Parral—Musical Comedy in Two Acts (Soutullo-Vert). 1.0 a.m. (Saturday), Close Down.

BELGRADE (430.4 metres); 2.5 kW.—6.55 p.m., Time Signal and Programme Announcements. 7.0, Gramophone Records of Variety Music. 7.20, Talk. 8.0, Recital of Operetta Arias by Milka Mielch; A Sketch of Spalat (Tjardovic); The Spanish Nightingale (Fall); Goal (Pordes); The Gipsy Princess (Kálmán); Natascha (Pordes); The Gipsy Baron (Johann Strauss). Where the Lark sings (Lehár). The Gipsy Princess (Kálmán), O Little Florany (Tjardovic), Polenbit (Nedbal). 8.30, An Opera (on Gramophone Records). 10.30, News and Sports Notes. 10.50, Orchestral Concert; Third Suite (de Michel); Waltz Serenade: To Thee (Czibulka); Barcelona (Grünfeld); Indian War Dance from the Ballet Far from Denmark (Lumbye).

BERLIN (Königs Wusterhausen), (1,635 metres); 60 kW.—12 Noon, Weather for Farmers. 12.2 p.m., Symphony No. 2 in D (Brahms) on Gramophone Records, followed by Weather for Farmers. 12.55, Time Signal. 1.35, News Bulletin. 2.0, Gramophone Concert of Music by Bruckner and Mahler, relayed from Berlin (Witzleben). 3.0, Talk for Girls. 3.30, Weather and Exchange Quotations. 3.40, Programme for Young People. 4.0, Talk: Is there a Justification for Portraits? 4.30, Concert from Leipzig. 5.30, Talk: The Inheritance of Byzantium. 6.0, The Fight between David and Goliath—a Biblical Pianoforte Sonata (Kullmau) with Introductory Talk. 6.30, Talk: The Economic Crisis. 6.55, Weather for Farmers. 7.0, Topical Talk. 7.15, Talk for Doctors. 7.35, Talk: The Proletarianisation of Actors, followed by Weather for Farmers. 8.0, See Munich. 9.35, Concert relayed from London. 10.30, See Berlin (Witzleben). 12.30 a.m. (Saturday), Close Down.

BERLIN (Witzleben), (419.5 metres); 1.5 kW.—4.30 p.m., Orchestral Concert, conducted by Alfred Brox: Overture: Bastien und Bastienne (Mozart); Waltz: Die Werber (Lanner); Minnet (Golzoni); Stunden in Lied und Tanz (Pagel); Romance (Schmidt-Kick); Gavotte (Gossec); Abendlandschaft (Hilvorsen); Liebes freud (Kreiser); Honnage March (Grieg). 5.35, Tales by Doktor Ueberall. 5.55, Review of New Books. 6.5, Oskar Baum reads from his own Works. 6.25, Hint for the Week-end. 6.55, The Witzleben Station Informs its Listeners. 7.0, Topical Talk. 7.10, Folk Song Recital by Franz Baumann. 7.40, Labour Market Report. 7.45, Orchestral Concert of Modern Music, conducted by Franz Schreker; Partita for Full Orchestra, Op. 14 (Gmeindl); Symphonic Music in One Movement (Jakubenas). 8.35, Hints for the Week-end. 8.40, Romantic Programme. 9.25, News and Sports Notes. 9.35, Military Band Concert, relayed from London. 10.30, Weather, News, and Sports Notes. 10.40 (approx.), Dance Music from the Delphi Palast. 12.30 a.m. (Saturday), Close Down.

BORDEAUX-LAFAYETTE (304 metres); 13 kW.—7.30 p.m., News Bulletin. 7.40, Medical

(Collins); Selection from Cydalise et le chèvrepié (Pierné); Waltz, Bonsoir m'amour (Lombardo-Luck); Venezia—Roma—Napoli—Popular Italian Song Potpourri; Selection from The Nothing-doing Bar (Milhaud); Selection (Birch); Perpetuum mobile (Johann Strauss). 8.45, Talk: Comte Louis de Lichtervelde—a Belgian Author. 9.0, Concert, conducted by Toussaint de Sutter, relayed from the Kursaal, Ostend. 10.30, Le Journal Parlé. 10.4, Dance Music from the Kursaal, Ostend.

BRUSSELS (No. 2) N.I.R. (338.2 metres); 15 kW.—12.0 noon, Programme in Flemish: Tannhauser—Acts One and Two (Wagner) on Gramophone Records. In an interval at 1.0, Le Journal Parlé. 5.0, Concert of Light Music by the Station Orchestra, conducted by M. André. 6.0, Concert of Popular Classical Music on Gramophone Records. 7.15, Talk. 7.30, Talk: What there is to see in Nature. 8.0, Concert by the Station Symphony Orchestra, conducted by M. Meulemans. Soloist: J. Vermeulen (Songs); Overture, Anacreon (Chernobin); Three Songs (Schubert); Otsenmennett (Haydn); Largo (Handel); Rondo (Beethoven); Abendlied (Schumann); Military March (Schubert). 9.0, Orchestral Concert relayed from the Casino, Knocke. Soloist: Mlle. Piette (Songs). 10.30, Le Journal Parlé. 10.40, Concert of Popular Music on Gramophone Records. 11.0 (approx.), Close Down.

BUCHAREST (394 metres); 12 kW.—4.0 p.m., Concert of Light Music and Romanian Music by the Sibiccano Orchestra. 5.0, News Bulletin and Time Signal. 5.10, Concert (continued). 6.0, Educational Programme. 6.30, La Bohème—Opera in Four Acts (Puccini), on Gramophone Records; News in the intervals.

BUDAPEST (550 metres); 18.5 kW. Also relayed on 210 metres from 7.15 p.m.—12 Midnight. —5.30 p.m., Concert: Soloists: Renée Sándor (Pianoforte), Stefi Sebő (Songs); Arnold Rákos (Violin), Kornelia Palko (Pianoforte), and Georg Kosa (Pianoforte); Sonata in C (Mozart); Adagio (Kodály); Malaguena (Albeniz); Caprice (Vecsey); Aria from Il Seraglio (Mozart); Aria from The Marriage of Figaro (Mozart); Hungarian Romanian Song (Bartok); Andante (Tartini); Serenade (d'Ambrosio); Polonaise (Wieniawsky); Aria from The Barber of Seville (Rossini); Lied (Loewe); March (Prokofey). 6.45, Talk: Carrara Marble. 7.15, Concert of Light Music. 8.15, Akl Miklos—Play after the Novel by Mikszáth (Siklössy); in the intervals, News and Weather. 10.10, Concert by the Joska Radios Cigány Orchestra from the Hotel Jägerhorn. 12 Midnight (approx.), Close Down.

COPENHAGEN (281 metres); 0.75 kW. and **KALUNDBORG (1,153 metres);** 7.5 kW.—12 Noon, Time and Chimes from the Town Hall. 12.2 p.m., String Ensemble Concert, conducted by Einar Jensen, relayed from the Hotel d'Angleterre. 2.0-3.10, Interval. 3.10, Reading. 3.30, Orchestral Concert relayed from the Wivex Restaurant. 5.0-5.40, Interval. 5.40, Exchange and Fish Market Prices. 6.20, Talk: Heredity and Environment. 6.50, Weather Forecast. 7.0, News Bulletin. 7.15, Time Signal. 7.32, Talk on Denmark. 8.0, Chimes from the Town Hall. 8.2, Programme by Per Knutzon. 8.10, Overture Suite in A for Cembalo (Telemann). 8.20, Introductory Talk to the following Transmission. 8.30, My Sister and I—Musical Play in Two Acts (Benatzky), relayed from the Betty Nansen Theatre. 10.50, News Bulletin. 11.5, Dance Music from Nimb's Restaurant. In the interval at 12 Midnight. Time and Chimes from the Town Hall. 12.30 a.m. (Saturday), Close Down.

DUBLIN, Call 2RN (413 metres); 1.2 kW., and **CORK (224.4 metres);** —1.30-2.0 p.m., Time Signal, Weather Forecast, Stock Report and Light Music on Gramophone Records. 6.6, Popular Music on Gramophone Records. 6.15, Programme for Children. 7.0, Variety Concert on Gramophone Records. 7.20, News Bulletin. 7.30, Time Signal. 7.31, Gardening Talk. 7.45, Talk. 8.0, The Station Sextet. 8.20, Contralto Solos by Mabel Homes. 8.30, Traditional Fiddle Recital by Cavanagh. 8.45, Songs and Stories

Talk. 7.55, Lottery Results. 8.0, Advanced Spanish Lesson. 8.15, News Bulletin and Weather Forecast. 8.30, A Comedy.

BRATISLAVA (279 metres); 14 kW.—7.0 p.m., See Prague. 9.0, Orchestral Concert, conducted by Dyk. Soloist: Zoubek (Violin). 10.0, See Prague. 10.15, Programme Announcements and News Bulletin. 10.20, Concert of Popular Music relayed from the Elisabeth Café.

BRESLAU (325 metres); 1.5 kW., and **GLEIWITZ (253 metres);**—6.30 p.m., Weather for Farmers. 6.35 (approx.), Concert of Dances by Josef Strauss, conducted by Franz Marszalek: Quick Polka, Feuerfest; Waltz, Mein Lebenslauf ist Lieb und Lust; Polka Mazurka, Arm in Arm; Waltz, Spährenklänge; Polka Mazurka, Frauenherz; Waltz, Aquarellen; Quick Polka, Eingesendet; Waltz, Dorfchwalben aus Oesterreich. 7.55, Weather for Farmers. 8.0, Magie im Hinterhaus—a Radio Play (Hans Reimann and Bruno Manuel). 8.50, News Bulletin. 9.0, Violin Recital by Stefan Frenkel: Concertante Tango (Moritz); Seven Pieces from Der Dreigroschenoper (Weill-Frenkel); Boston and Allegro capriccioso from the Petite Suite, Op. 12 (Frenkel); My Homeland (Smetana); Melody (Niek-Frenkel); Perpetuum mobile (Ries). 9.35, Military Band Concert from London. 10.30, Time, Weather, News, Sports Notes, and Programme Announcements. 10.45, Talk: A Visit to an Animal Nursery in the Zoo. 11.0, Dance Music from Berlin (Witzleben). In an interval from 11.25 to 11.40, Weekly Sound News from the Gloria-Palast. 12.30 a.m. (Saturday), Close Down.

BRNO (342 metres); 35 kW.—7.0 p.m., Concert by a Military Band relayed from the Josefovsky Restaurant. 10.0, See Prague. 10.15, News Bulletin. 10.20, See Prague.

BRUSSELS (No. 1) N.I.R. (509 metres); 15 kW.—12 noon, Trio Concert: España Cani (Marquina); Premières tendresses (d'Ambrosio); Chanson triste (Tchaikovsky); Gavotte for Violin (Gossec); Selection from Madame Butterfly (Puccini); Intermezzo for Cello (Granados); Nocturne from Cocorico (Ganne); The Stolen Kiss (Dearly-Leslie); Selection from Lohengrin (Wagner); Ma poupée chérie (de Sévécac); Bells across the Meadows (Ketelby); Ballet égyptien (Luigini). 1.0 p.m., Le Journal Parlé. 1.10, Gramophone Concert of Italian Music: Overture, Don Pasquale (Donizetti); Aria from La Favorita (Donizetti); Selections from Norma (Bellini); Overture, Sicilian Vespers (Verdi); Aria from The Girl of the Golden West (Puccini); La Campanella (Liszt-Paganini); Prologue to I Pagliacci (Leoncavallo); Overture, The Secret Marriage (Cimarosa). 5.0, Concert conducted by Arthur Meulemans: Overture from Printemps de la Vie (Mouton); Suite from L'Arlésienne (Bizet); Berceuse de Jocelyn (Godard); Selections from Thaïs (Massenet); Extase (Ganne); Waltz Suite from La Fille de Madame Angot (Lecocq); Ballet Music from Lakiné (Debüsses). 6.0, Gramophone Concert: Rigoletto Paraphrase (Verdi-Liszt); D'une Prison (Hahn); Marche joyeuse (Chabrier); Prelude to Lohengrin (Wagner); Prelude to Boris Godunov (Monssorsky); Spanish Songs (Balla); Overture, Rienzi (Wagner). 7.15, Talk: The Matches played by the Belgian National Football Team, 1931-1932. 7.30, Music Review by Marcel Poot and Talk on Pigeon-Flying. 8.0, Orchestral Concert, conducted by Franz André: Foxtrot, Cuckoo in the Clock

Programmes from Abroad.—

by Fay Sargent. 9.0, Talk on Irish History. 9.30, The Station Sextet. 9.45, Variety Programme. 10.30, Time Signal, News, Weather Report, and Close Down.

FECAMP (223 metres); 10 kW.—12 Noon, Gramophone Concert. Waltz (Offenbach); Miss Lisa (Emer); Selection from Paganini (Lehar); Chonchita (Matéo); Liebeslieder (Strauss); Béguin-Béguine (Emer); Selection from L'Amour masqué (Messenger); Pooling Me (Knight). 12.30, First French News Bulletin. 12.45, Concert; Selection from Sigurd (Reyer); The Trout (Schubert); Selection from I Pagliacci (Leoncavallo); Selection from La fille de Madame Angot (Lecocq); Selection from Mignon (Thomas); Invitation to the Waltz (Weber); Lachen und Weinen (Schubert); Selection from Cavalleria Rusticana (Mascagni); Selection from Thais (Massenet); La vie antérieure (Duparc). 2.0-7.30, Interval. 7.30, French Local News. 8.0, Second French News Bulletin. 8.15, Report by the French Wireless Agricultural Association. 8.30, Listeners' Hour, relayed from Le Havre. 9.30-11.0, Interval. 11.0 till Close Down, Programme in English by the I.B.C. 11.0, Concert by the I.B.C. Light Orchestra (Section A), conducted by John English, with T. Cragen (Xylophone); Siciliana (Schmalstich); Erstes Walzer (Robrecht); Xylophone Solos: (a) Marionette (Gaston), (b) Carnival of Venice (Benedict); The Rose Beetle goes a-wooing (Armandola); Dancing Dolls (Poldini); Xylophone Solos: (a) Looping the Loop (Gaston), (b) Tarantella (Byng). 11.30, Concert; Mother in Ireland (Griffin); Ireland, Mother Ireland (Loughborough); My Irish Song of Songs (Sullivan); Ständchen (Heykens); In the Still of the Night (Berwick); Rose of Killarney (Ball); Just an old refrain (Wynn); Ideale (Tosti). 12 Midnight, Concert; Dance Music by the Renis Revellers; Lady, play your mandoline; On a Chocolate Box; Maybe it's love; Bella Donna; Roamin' through the Roses; Sing Holly, Go Whistle, hey hey; There's a good time coming; Drink, brothers, drink. 12.30 a.m., Dance Music by the I.B.C. Solos; Milly; Cupid on the Cake; Moanin' for you; My heart belongs to the Girl; Just like in a story book; Chant of the Jungle; High Society Blues; What have I done? 12.57 a.m., I.B.C. Good-night Melody. 1 a.m., Close Down.

FRANKFURT (390 metres); 1.5 kW., and CASSEL (246 metres).—12 Noon, Orchestral Concert, conducted by Reinhold Merten; Soloists: Ludwig Theiss (Organ) and Rose Stein (Harp); Three Pieces for String Orchestra (Purcell); (a) Allendale, (b) Sarabande, (c) Cebell; Concerto for Harp and Organ (Handel); Toccata for Organ (Kaminsky); Selections from the Serenade for String Orchestra (Ludwig Scriba); (a) Allegro ma non troppo, (b) German Dance, (c) Theme with Variations. 12.50 p.m., News and Weather. 1.0, Gramophone Concert of Light Music. 2.0, News Bulletin. 2.10, Sponsored Gramophone Concert. 3.0, Weather Report. 3.10, Time and Economic Notes. 4.55, Economic Notes. 5.0, Concert from Munich. 6.15, Economic Notes. 6.25, Talk. 6.50, See Stuttgart. 7.15, Time, Programme Announcements. Weather, and Economic Notes. 7.30-10.0, See Stuttgart. 10.0, Street Arabs—Improvisation (Paul Laven). 10.20, Time, Weather, News, and Sports Notes. 10.45, Gramophone Concert; Two Songs from The Tales of Hoffmann (Offenbach); Polka from Barbe Bleue (Offenbach); Pianoforte Solo, A Carnival in Vienna—on Themes by Johann Strauss; Song from Die Landstreicher (Ziehrer); Song from The Merry Widow (Lehár); Overture, Im Reiche des Indra (Lincke); Duet from The Count of Luxembourg (Lehár); Song from The Geisha (Jones); Italian and Spanish Intermezzo from Casanova (Johann Strauss); Potpourri, Ein Souper bei Suppe (Morena); Song from Marietta (Oscar Straus); Selection from A Waltz Dream (Oscar Straus). 12 Midnight (approx.). Close Down.

HAMBURG Call ha (in Morse) (372 metres); 1.5 kW. Relayed by Bremen (270 metres); Flensburg (218 metres); Hanover (566 metres), and Kiel (232.2 metres).—6 p.m. (from Bremen), Heinrich Rahmeyer reads from his own works. 6.35, Awarding the Brinckman Prize—a Relay from Rostock University. 6.55, Exchange and Egg-Market Prices. 7.0, Topical Talk. 7.15, Weather Report. 7.20, The Fire Bird—Ballet (Stravinsky), for the Composer's Fiftieth Birthday. 7.50, Wayfaring Songs, Concert by the Station Quartet; Soloists: Ernst Lottorf (Songs) and Werner Rafael (Recitations); Ger-

FRIDAY, JULY 1st (cont.)

hard Maasz at the Pianoforte; Pianoforte Solo: Wandervogel (Kaun); Songs: (a) Wandern lieb ich für mein Leben (Hugo Wolf), (b) Heimweh (Hugo Wolf); Recitation: O Sonnensegen (Karl Henckell); Quartet Selections: (a) Folk Song, Wenn Gott will rechte Gunst erweisen, (b) Folk Song, Das Wandern ist des Müllers Lust; Recitation: Auf der Höhe (Karl Henckell); Pianoforte Solo, Die Vögelin schweigen (Kaun); Recitation: Das Tal der Blumen (Karl Henckell); Quartet Selections: (a) O Taler weit, o Höhen (Mendelssohn), (b) Wohlauf, die Luft geht frisch und rein (Becker); Recitation: Vor Sonnenuntergang (Karl Henckell); Songs: (a) Sonntags am Rhein (Schumann), (b) Wohlauf noch getrunken (Schumann); Pianoforte Solo: Herberge, from Waldszenen (Schumann); Recitation: Ostseewellen (Karl Henckell); Wanderrast (Müller-Ilartmann); Recitation: Aus dem Leben eines Taugenichts (Eichendorff); Quartet Selection: Vorwärts, in die blaue Ferne. 9.0 (from Hanover), Dance Melodies from the South—Concert by the Hanover Station Orchestra, conducted by Otto Ebel von Sosen; Romanian Folk Dances (Bela Bartok); Serbian Melodies (Hans Gal); Hungarian Czardas, Hullanzo Balaton (Huhay); Russian Dances (Bortkiewicz); La Foulane (Paul Fauchey); Sicilian Tarantella (Mercier); Spanish Dances (Granados); Spanish March, Marcha Zaragoza (Ortega). 10.0, Time, Weather, News, and Announcements. 10.20, Concert from the Hotel Reichshof.

HEILSBURG (276.5 metres) 60 kW., and DANZIG (453.2 metres).—1.5 p.m., Gramophone Concert; Selection from Il Trovatore (Verdi); Nocturne (Chopin); Overture: The Thieving Magpie (Rossini); Grossmütterchen und Grossväterchen (Langer); Overture: Wiener Frauen (Lehár); Circassian Taktow (Machts); Tenor Solos (a) O Sole mio (di Capua), (b) La Paloma, (Yradier); Mit allen Schikanen (Thiele); Elégie (Massenet); Faust Waltz (Gounod); Zigeunersucht (Niklas-Kempner); Torch Dance, No. 1 (Meyerbeer); Irene (Dazar-Benoit); Was wir ich ohne euch (Lehár); Tenor Solos (Lehár): (a) Immer nur lachen, (b) You are My Heart's Delight; Grand Historical March Potpourri (Kaiser). 2.30, Sponsored Gramophone Concert. 3.45, Talk for Women. 4.15, Concert by the Little Orag Orchestra, conducted by Eugen Wilcken; Overture: The Barber of Bagdad (Cornelius); Hungarian Dances Nos. 1, 13 and 17 (Brahms); Invitation to the Dance (Weber); Rhapsody No. 4 (Liszt); Selection from Die Königsinder (Humperdinck); Three Military Marches (Schubert); Ständchen (Richard Strauss); Two Selections (Mendelssohn): (a) Spinnlied, (b) Frühlinglied, Prelude to the Third Act of The Cricket on the Hearth (Goldmark).—5.35, Herr von Beethoven in der Sommerfrische—Radio Play for Young People (Emma Schiller). 6.15, Agricultural Prices. 6.25, Talk: Aviation in East Germany. 6.50, Song Recital by Käthe Coranda Laechelin, Das Veilchen (Mozart); Three Songs (Schumann): (a) Jasminstrauch, (b) Die Lotoblume, (c) Schneeglöckchen; Two Songs (Schubert): (a) Heideröslein, (b) Nachtvögel; Es hat die Rose sich beklagt (Robert Franz); Es weht um mich Narzissenduft (Brahms); Rosmarin (Humperdinck); Lilac (Rachmaninov); Lied der Knospen (Menzel). 7.20, Mandoline and Guitar Concert: Festibel-Reveille (Poland, Jun.), Waltz, Fiori di Prato (Sartori); Wilhelminen-Gavotte (Ritter); Intermezzo, Gnomenschliche (Rhode); Tango, Alma Andalusia (Dimasi); March, Vita mandolistica (Kok). 7.55, Weather Report. 8.0, Liche im Lärm—a Radio Play (Dymion); Music by Johannes Hanneemann. 9.0, (from Danzig), Danzig—Königsberg—Two Towns one Civilization IV. 1750. 9.20, Concert by the Rathshof Workers' Mixed Choir, conducted by Erwin Feustel, Three Sixteenth Century Choral Selections: (a) Mein Freud allein in aller Welt (Heinrich Isaac), (b) Song (Peter Marini), (c) Song (Baldassare Donati); Three German Folk Songs: (a) Maienzelt bannet Leid (arr. Karl Lütge), (b) Mein Herz hat sich geseilet (arr. Wilhelm Witzke), (c) Es ritten drei Reiter zum Tore hinaus (arr. Othegevaer); Two Dutch Children's Songs. 10.10, Weather, News and Sports Notes.

HILVERSUM (announced HUIZEN) (296.1 metres); 20 kW. (7 kW. up till 4.40 p.m.)—Programme of the Catholic Radio Society (K.R.O.). 7.40-8.55 a.m., Gramophone Records of Variety Music. 9.40, Gramophone Records of Variety Music. 11.10, Pro-

gramme for Hospitals. 11.40, Police Notes. 11.55, Trio Concert: March, Sparta (Jakma); Potpourri of Waltzes (Robrecht); Donna Vatrana (Köpping); Selection from The Gipsy Princess (Kálmán); A Wedding in Lilliput (Translauteur); Waltz, Adoration (Jakma); Melody, Spanish (Moon); In a Chinese Temple Garden (Kettelbey); Lolita (Buzzi-Pegcia); Potpourri, Fünf Uhr Tee bei Stolz (Dostal); March, Schön ist das Leben (Heymann). 1.25 p.m., Gramophone Records of Variety Music. 2.0, Organ Recital from the Café Hollandais at The Hague; Prelude in C Sharp Minor (Rachmaninov); Largo from the New World Symphony (Dvorak); Pierrette (Chaminade); Petite Pastorale from Mother Goose (Ravcl); Bergers et Bergères (Godard); Valse romantique (Heinecke). 2.20, Gramophone Records of Variety Music. 2.30, Organ Recital (contd.); Parla (Tosti); Gipsy Melodies (Borganov); Nola (Arndt); Toccata (Boëllmann). 2.50-3.10, Interval. 3.10, Vocal and Instrumental Concert. Pianoforte Selections: (a) Allegro in E Flat (Scarlatti), (b) Allegro vivace in B flat (Scarlatti); Pianoforte Solos (Albéniz): (a) Prelude, (b) Tango, (c) Malaguena, (d) Serenade. Two Selections (de Sévécac): (a) Ou l'on entend une vieille bolte à musique, (b) Valse romantique. Songs. Gramophone Records of Variety Music. Songs. Two Intermezzos (Brahms). Three Waltzes (Chopin); (a) In A flat, op. 63, (b) In D flat, op. 64, (c) In G Sharp Minor, op. 64. 5.10, Gramophone Record; Selection from The Barber of Seville (Rossini). 5.40, Talk on Valkenburg by the Mayor of Valkenburg. 6.0, Gramophone Records of Variety Music. 6.20, Agricultural Talk. 6.40, Talk by M. van Gelder. 7.10, Police Notes. 7.25, Gramophone Records of Variety Music. 7.40, Orchestral Concert, conducted by Johan Gerritsen. Soloists: G. Mermelen (Violin), Johan Vogtschmidt (Cello), H. Wesseling (Viola), and Willy François (Pianoforte); Overture, Le printemps de la vie (Mouton); Concerto No. 3 in A for Cembalo and String Orchestra (Rameau); Duet for Violin and Cello (Beethoven); Prelude, La damoiselle émue (Debussy); Concerto for Viola and String Orchestra (Wesseling); Prelude to the Fourth Act of Carmen (Bizet); Suite from L'Arlésienne (Bizet); Overture, The Italian Girl in Algiers (Rossini); Selection from Othello (Verdi); Three Woodland Dances (Haines); Selection from The Gipsy Barons (Strauss). 8.40 (in an interval), News. 10.40, Gramophone Concert of Variety Music. 11.40 (approx.), Close down.

HUIZEN (announced HILVERSUM) (1,875 metres); 8.5 kW.—6.25-9.40 a.m., Programme of the Workers' Radio Society (V.A.R.A.). 6.25-6.40 and 7.10-7.25, Gymnastics. 7.40, Gramophone Records of Variety Music. 9.40, Religious Programme of the Liberal Protestant Radio Society (V.P.R.O.). 9.55-11.40, V.A.R.A. Programme. 9.55, Recitations. 10.10, Septet Concert. 10.40, Recitations. 10.55, Concert (contd.). 11.40-3.40 p.m., Programme of the Algemene Vereniging Radio Omroep (A.V.R.O.). 11.40, Time Signal. 11.41, Concert by the Little Wireless Orchestra, conducted by Nico Treep; March, Entry of the Boyards (Halvorsen); Ballet Music from Undine (Lortzing); Selection from La Mascotte (Audran); Ballade (Gillet); Gramophone Records of Variety Music; Waltz, Always or Never (Waldteufel); Dreams (d'Ambrosio); Tyrolean March (Dreyer); Nachtigall im Fliederbusch (Krone); Berceuse de Jocelyn (Godard); Gramophone Records of Variety Music; Heinzelmännchens Hochzeit (Köpping); Valse des blondes (Ganne); Canto amoroso (Sammartini); Kirschblütenfest (Dieker); March, The North Star (Grit); 1.40 p.m., Talk. 2.10, Concert by the Wireless Chamber Orchestra conducted by G. Hagemes; March, Montmartre (Lehar); The Sun (Ackermans); Two Slavonic Dances (Dvorak); Serenata napoletana (Rivelli); Overture, Die Landstreicher (Ziehrer); Waltz, (Konzak); Selection from Countess Maritza (Kálmán); Gramophone Records of Variety Music; Indian Ballet from Lakmé (Delibes); Taquinerie (Demaret); Cantilène d'amour (Delmas-Popy); Waltz, Très jolie (Waldteufel). 3.40-7.40, V.A.R.A. Programme. 3.40, Gramophone Records of Variety Music. 4.10, Programme for Children. 4.40, Quintet Concert with Organ Solos. 6.35, Address. 6.50, Concert (contd.). 7.40-10.40, V.P.R.O. Programme. 7.40, Religious Programme. 8.10, Pianoforte Recital from the Twenty-four Preludes, op. 29 (Chopin). 8.40, Religious Talk. 9.10, Pianoforte Recital (contd.); Four Selections (Debussy): (a) Danseuses de Delphes, (b) Les Collines d'Anacapri, (c) La fille au cheuveux de lin, (d) Minstrels; Two Selections (Albéniz); (a) Evocations, (b) El Puerto; Spring (Milhaud); The Juggler

Programmes from Abroad.—

(Toch). 9.40, Religious Notes. 9.45, News Bulletin. 9.55, Recitations. 10.25, Gramophone Records of Variety Music. 10.40, Gramophone Records of Popular Music. 11.40 (approx.), Close Down.

KATOWICE (408 metres); 16 kW.—6.20 p.m., Dance Music Programme. 7.45, Talk. 8.0, Symphony Concert. 9.10, Concert. 10.5, Dance Music. 11.0, The Letter Box in French.

LAHTI (1,796 metres); 54 kW.; relayed by Helsinki (368.1 metres); Programme in Swedish.—5.15 p.m., Programme for Children. 6.45, Talk (to be announced). 7.15 (from Helsinki), Concert by the Station Ensemble. 7.45, Recitations by Ebba Jacobson-Lilius. 8.10 (from Helsinki), Concert by the Station Ensemble; Selection from La Juive (Halévy); Melody (Hahn); Arabesque (Debussy); Waltz from Gretta Green (Guiraud). 8.45, News in Finnish. 9.0, News in Swedish. 9.15, Light Music from the Kappeli Restaurant. 10.0 (approx.), Close Down.

LANGENBERG (473 metres); 60 kW.—12 Noon, Concert from Frankfurt. 12.50, Weather Report, News Bulletin, and Time Signal. 1.0, Orchestral Concert, conducted by Wolf: March, Fahnentrug (Lehnhardt); Overture, La part du diable (Anber); Italian Caprice (Tchaikovsky); Waltz, On the Green Narenta (Komzak); Polonaise (Dvorak); Selection from Mareike von Nyttwegen (d'Albert); Two Alsatian Peasant Dances (Merkling); Selection from The Bird Fancier (Zeller). 2.30, Sponsored Gramophone Concert. 3.30, Economic News and Time Signal. 3.50, Handwork for Children. 4.20, Programme for Children. 5.0, Violin and Pianoforte Recital by Erich Hammacher (Pianoforte) and Otto Noethe (Violin); Andante with Variations for Pianoforte (Haydn); Sonata for Violin and Pianoforte (Mozart); Polonaise in D, Op. 89, for Pianoforte (Beethoven); Sonata for Violin and Pianoforte (Zeller); Two Descriptive Pieces from Pictures in Westphalia for Pianoforte (Nellius); Three Pianoforte Pieces (Weber). 6.0, Topical Talk: Modern Youth and the Pathos of Tradition. 6.20, Talk on Social Hygiene. 6.40, English Conversation Lesson. 7.0, Weather Report, Time Signal, Economic Notes and Sports Forecast. 7.15, Topical Talk. 7.30, Talk on the State and Industry. 7.55, News Bulletin. 8.0, Talk with Gramophone Illustrations: Curiosities and Remarkable Performances on Gramophone Records. 8.30, Concert by the Aachen Kurhaus Orchestra, relayed from Bad Aachen. Conductor, Peter Hammers. Festival Overture (Leutner); Selection from Tiedland (d'Albert-Paepek); Emperor Waltz, The Kaiser (Johann Strauss); Ballet Music from La Gioconda (Ponchielli); Selection from The Gipsy Princess (Kalmán). 9.35, Wind Instrument Concert, relayed from London. 10.35, News Bulletin and Sports Notes. 10.50, Dance Music by Harry Blum and his Band, relayed from the Rheinterrasse Rodenkirchen. 12 Mid-night (approx.), Close Down.

LEIPZIG (259 metres); 2 kW.; and **DRESDEN (319 metres);**—4.30 p.m., Concert by the Leipzig Symphony Orchestra, conducted by Hilmar Weber: Overture, Christoffeln (Pfitzner); Suite for String Orchestra and two Horns, Op. 48 (Rinkens); Tarantella (Liszt); Irish Rhapsody in A (Victor Herbert); Concert Waltz in E (Moszkovsky). 5.30, Review of Scientific Books. 5.50, Economic Notes, Weather and Time. 6.25, English Lesson. 6.50, A Modern Dictionary. 7.0, Talk: The Human Laugh, with Gramophone Illustrations. 7.30, Concert by the Dresden Philharmonic Orchestra, conducted by Joseph Gustav Mraczek: Overture, The Taming of the Shrew (Goetz); Minuet and Scherzo from the Serenade in D, Op. 9 (Robert Fuchs); Selection from Die drei Pintos (Weber); Swedish Dances (Max Bruch); Probekuss-Walzer (Millöcker); Am Lagerfeuer (Siede); Overture, Banditenstreichle (Suppe); Selection from Bruder Straubinger (Eysler); Bavarian Ländler (Daxenberger); March, Germania (Keil). 9.0, Economic Notes. 9.10, Von Spitzeln und Detektiven—Radio Play (Gustav Hermann). 10.10, News Bulletin. 10.20 (approx.), Instrumental Concert. Introductory Talk: The Two Hundred and Fiftieth Anniversary of the Death of Buxtehude. Sonata in D for Viola, Gamba and Cembalo (Buxtehude); Two Sonatas for Cembalo (Scarlatti), (a) in G, (h) in D; Piece de clavecin from the Concerto No. 4 in B flat for Cembalo, Violin and Gamba (Rameau). 11.30 (approx.), Close Down.

LJUBLJANA (574.7 metres); 2.5 kW.—6.0 p.m., Quintet Concert. 7.0, Reading. 7.30, Programme for Women. 8.0, Humorous Pro-

FRIDAY, JULY 1st (cont.)

gramme. 8.30, Programme from Belgrade. 10.30, Time, News, and Light Music on Gramophone Records.

LOWO (381 metres); 16 kW.—7.15 p.m., Miscellaneous Items. 7.30, Racing News. 7.35, See Warsaw. 7.45, Talk. 8.0, See Warsaw. 8.55, Talk on the Polish Countryside. 9.10, See Warsaw. 11.30 (approx.), Close Down.

LYONS, La Doua (PTT) (465.8 metres); 1.5 kW.—7.0 p.m., Concert of Classical Music on Gramophone Records. 7.30, Radio Gazette for Lyons and the South-East. 8.30, See Strasbourg.

MADRID (Union Radio), Call EAJ7 (424.3 metres); 2 kW.—8.0 p.m., Chimes, Exchange, Market Prices and Request Gramophone Concert. In an interval at 8.30, Talk. 9.15, News Bulletin and Political Review. 9.30 to 10.30, Interval. 10.30, Chimes, Time Signal, and Political Review. 10.45 (approx.), Orchestral Concert on Gramophone Records. Overture, Der Freischütz (Weber); In the Steppes of Central Asia (Borodin); Danse Macabre (Saint-Saëns); Third Symphony (Brahms); Nights in the Gardens of Spain (Falla); Dance from La Vida Breve (Falla). 12.45 a.m. (Saturday), News Bulletin and Programme Announcements. 1.0, Chimes and Close Down.

MORAVSKA-OSTRAVA (263.8 metres); 11 kW.—7.0 p.m. to 10.0, See Prague. 10.15, Programme Announcements and Theatre Guide. 10.20, See Prague.

MOSCOW, Trades Union (1,304 metres); 100 kW.—6.30 p.m., Communist Journal. 7.10, Orchestral Concert. 8.0, Programme to be announced. 9.55, Time Signal and Close Down.

MUNICH (533 metres); 1.5 kW. Relayed by Augsburg and Kaiserslautern (560 metres), and Nürnberg (239 metres)—6.15 p.m., Time, Weather, and Agricultural Notes. 6.25 (from Nürnberg), Talk: In a Youth Hostel. 6.55, Talk: The Frankfurt-am-Main Choral Society. 7.10, Gramophone Records of Variety Music. 7.35 (from Nürnberg), Talk: German Art and Piety during the Thirty Years' War. 8.0, Concert by the Wireless Orchestra, conducted by Hans Winter. Soloist: Wolfgang Ruoff (Pianoforte); Petite Suite (Debussy); Concerto for Pianoforte and Orchestra (Ravel); Three Nocturnes for Orchestra (Debussy); (a) Nuages, (b) Fêtes, (c) Sirènes. 9.35, Concert from London. 10.30, Time, Weather, News, Sports Results, and Traffic Notes.

OSLO (1,083 metres); 60 kW. Relayed by Fredriksstad (367.6 metres); Hamar (560 metres); Notodden (447.1 metres); Porsgrund (543.2 metres) and Rjukan (447.1 metres).—5.30 p.m., Popular Music on Gramophone Records. 6.30, Talk: Is Opera an Old Form of Composition. 7.0, Announcements, News and Weather Forecast. 7.45, Running Commentary on the Football Match, Sweden v. Norway, relayed from Gotenburg. 8.45, Concert by the Station Orchestra, conducted by Hugo Kramm: Overture, Die Fledermaus (Johann Strauss); Japanese Suite (Yoshitomo); Retournons à la Valse (Freudenthal); Salut d'Amour (Elgar); Potpourri of Popular Melodies (Ganglberger); 9.40, Weather and News Bulletin. 10.0, Topical Talk. 10.15, Song Recital by Gunner Graerud (Tenor). 10.45 (approx.), Close Down.

PALERMO (542 metres); 3 kW.—5.30 p.m., Variety Music on Gramophone Records. 6.30-8.0, No Transmission. 8.0, Announcements, Radio Giornale dell'Unit, Agricultural Notes, Report of the Royal Geographical Society and Giornale Radio. 8.20, Popular Music on Gramophone Records. In the interval at 8.30, Time and Announcements. 8.45, Concert, Kimi Misiti (Pianoforte), Carducci (Tenor), Lojaco (Violin) and Sistina Lojaco (Violin); Pianoforte Solos (Debussy): (a) Réverie, (b) Arabesque; Tenor Solos: (a) Non m'amai più (de Curtis), (b) Song from Le Villi (Puccini); Sonata in G Minor for Violin (Tartini); Tenor Solos from (a) Mefistofele (Boito) and (b) Isabeau (Mascagni); Talk; Pianoforte Solos: (a) Sognidillo (Albeniz), (b) Guomenreigen (Liszt); Violin Solos: (a) Legend (Wieniawsky), (b) Spanish Dance (Falla). 10.0, Variety Concert. 10.55, News Bulletin.

PARIS (Eiffel Tower), Call FLE (1,445.7 metres); 13 kW.—Time Signals (on 2,650 metres) at 10.26 and 11.26 p.m. (preliminary and 6-dot signals).—6.45 p.m., Le Journal Parlé. 8.20,

Weather Report. 8.30, Programme for Children. 9.5, Alsace-Lorraine Concert; Soloists: M. Bruniau (Clarinet) and M. Marchesini (Cello) and Edouard Flament (Pianoforte); Trio, Soirs d'Alsace (Widor); La Fête au Village Lorrain (de Boisdeffre); Jour de Fête à Strasbourg (Brun); Scènes alsaciennes (Massenet); Marche Lorraine (Ganne). 10.10 (approx.), Close Down.

PARIS (Poste Parisien) (328.2 metres); 60 kW.—6.30 p.m., Sponsored Gramophone Concert. 7.30, News Bulletin and Parliamentary Review. 7.35, Concert of Light Music on Gramophone Records. 8.20, Talk on the Theatre. 8.30, Radio Journal and Announcements. 8.45, Vocal and Orchestral Concert: Overture, Le Paradis de Mahomet (Planquette); Vendredi from Pièces à danser for Pianoforte (Repertz); Selection from La Navarraise (Massenet); Gipsy Dance from Henry VIII (Saint-Saëns); Suite carnavalesque (Thomé); Selection from Passionnément (Messager); Waltz, Cornflowers and Poppies (Waldteufel); Selection from The Grand Duchess of Gerolstein (Offenbach); Orchestral Suite from I Pagliacci (Leoncavallo); Selection from Les Noces de Jeannette (Masse); Danse grecque (Ganne); March, Washington Post (Sousa). 10.45, News Bulletin. 10.50 (approx.), Close Down.

PARIS (Radio Paris), Call CFR (1,725 metres); 75 kW.—6.45 a.m., Physical Culture. 7.30, Weather and Physical Culture (continued). 7.45, Gramophone Records: Jeux d'eau (Ravel); Popular Spanish Suite (Falla); Tango (Albeniz-Kreisler). 8.0, News, Weather and Press Review. 12 noon, Jewish Address. 12.30 p.m., Symphony Concert on Gramophone Records: Symphony No. 7 (Beethoven); La Forêt (Caplet); Selection from The Damnation of Faust (Berlioz); Finale from The Twilight of the Gods (Wagner); Noël (Gerard Pérois); Le promenoir des anants (Debussy); Eglogue (Rabaud). In the intervals at 1.0, Exchange, News and Weather at 1.30; Exchange, and at 2.0, Exchange and Announcements. 3.45, Exchange and Market Prices. 6.10, Review of New Books: Marie des Angoisses (Prévost). 6.30, Market Prices, Weather Agricultural Report, Talk and Racing Results. 7.0, Gramophone Records of Variety Music. 7.45, Commercial Prices and News. 8.0, L'étrange pari (The Strange Wager), Radio Play (Renaud). In the intervals at 8.30, News, Weather and Gastronomic Review, and at 9.15, Press Review and News. 9.30, Cavalleria Rusticana, Opera (Mascagni), on Gramophone Records by the cast of the Scala, Milan, conductor, Lorenzo Molajoli.

PITTSBURG, Westinghouse Electric (KDKA) (306 metres); 25 kW. Relayed by WBXK on 48.6 metres and 25.25 metres.—9.0 p.m., Teaberry Baseball Scores. 9.5, Business News. 9.15, Programme to be announced. 9.30, Pebecco Weather Report. 9.33, Market Reports. 9.45, Programme to be announced. 10.0, Teaberry Baseball Scores. 10.5, David Lawrence Dispatch. 10.10, KDKA Artist Bulletin. 10.12, Programme Announcements. 10.15, KDKA Kiddies' Klub. 10.30, The Singing Lady, from New York. 10.45, Little Orphan Annie, from New York. 11.0, Time Signal. 11.1, Temperature Report. 11.2, Who's News Today. 11.6, Teaberry Sport Review. 11.11, Press News Reeler. 11.14, Weather forecast. 11.15, Westinghouse Musical Maids. 11.45, Programme to be announced. 11.59, Pennzip Time. 12 Mid-night to 3.45 a.m. (Saturday), New York relay. 12 Midnight, Pepsodent Amos 'n Andy. 12.15 a.m. (Saturday), Royal Vagabonds. 12.30, The Stebbins Boys. 12.45, Billy Jones and Emie Hare. 1.0, Nestle's Programme. 1.30, Ivory Programme. 1.45, Sisters of the Skillet. 2.0, Friendship Town. 2.30, Armour Programme. 3.0, Whiteman's Pontiac Chieftains. 3.30, Love Songs and Waltzes. 3.45, Programme to be announced. 4.0, Pennzip Time. 4.1, Teaberry Sport Review. 4.11, Temperature Report. 4.12, Bulova Weather Report. 4.15, Press Last Minute News Flashes. 4.20, Lew Conrad and his Orchestra. 5.0, Cotton Club Orchestra, from New York. 5.15, Pennzip Time and Good-night.

PRAGUE (488.6 metres); 120 kW.—6.25 p.m., German Transmission: News Bulletin and Talk on German Saints. 7.0, Concert of Popular Songs, relayed from the Settlers' Club. 8.30, Relay of the Zhorov Celebrations. 9.0, Time Signal. 9.2, Concert of Music by Blind Composers. 10.0, Time, News, and Sports Notes. 10.15, Theatre Guide and Programme Announcements. 10.20, Concert of Popular Music on Gramophone Records.

Programmes from Abroad.—

RADIO-SUISSE ROMANDE (Sottens) (403 metres); 25 kW.; **LAUSANNE** (680 metres); and **GENEVA** (760 metres).—5.0 p.m., Time Signal from Neuchâtel Observatory. 5.1 (from Geneva), Programme for Women. 5.45, Orchestral Concert, conducted by Robert Echenard. 7.0, Weather Forecast. 7.1 (from Lausanne), Talk on Sports. 7.20 (from Lausanne), Report of the Swiss Automobile Club. 7.30 (from Geneva), Talk: The Disarmament Conference. 7.55, News Bulletin. 8.0 (from Geneva), Dramatic Programme. 8.30 (from Geneva), Concert by the Genevan Mandoline Society. 9.15 (from Lausanne), Songs of the Seasons Concert, by the St. Paul's Parochial Choir, conducted by A. Porchet. 10.0, News and Weather. 10.15 (approx.), Close Down.

RIGA (525 metres); 15 kW.—4.30 p.m., The Valkyries—Opera (Wagner). 6.30, Talk on Latvian History. 7.0, Weather Forecast. 7.3, Talk: A Latvian in Scandinavia. 7.30, Concert of Popular Music by the Station Orchestra, relayed from Bulduri, Conductor: Arvids Parups. In an interval, at 8.25, News Bulletin. 9.0, Weather Forecast. 9.30, News Bulletin. 9.40, Gramophone Concert of Popular Music. 10.10 (approx.), Close Down.

ROME, Call 1RO (441 metres); 50 kW. Relay by **NAPLES** (319 metres) and **ZRO** (25.4 metres).—8.15 to 8.30 a.m., Giornale Radio and News. 12 Noon, Variety Music on Gramophone Records. 12.35 p.m., Weather Forecast. 12.45, Sextet Concert; Soloist: Umberto Spironello; American Fantasia (Myddleton); Versailles (Buchsblinder); Violin Solos: (a) Hindu Song (Rimsky-Korsakov), (b) Scherzo (Ferrata); Romantique Rhapsody (Carabelli); Selection from The Gipsy Baron (Johann Strauss); Violin Solo: Souvenir de Moscow (Wieniawski); Selection from Eleonora (Guerrieri); In the interval at 1.15, Giornale Radio and Exchange, and at 1.30, Time and Announcements. 4.45 (from Naples), Programme for Women. 5.0, Exchange, Programme for Children, Giornale Radio and News. 5.30, Soprano Song Recital by Vera Nadia Poggioli; La morte del trovatore (Sangiacomo); Aria from Edgar (Puccini); La lavandaia di S. Giovanni (Tommasini); Ghitane (Guarnieri). 5.45, Concert: The Picador (Patacchini); Selection from Fedora (Giordano); Selection (Elka); Oriental Vision (Bece); Three Soldiers (Escobar). 6.15, Giornale dell'Unit. 6.55 (from Naples), Shipping and Sports Notes. 7.0, Agricultural Report, Announcements, Giornale Radio and Press Review. 7.50, Variety Music on Gramophone Records. 8.0, Time, Announcements, and Report of the International Institute of Agriculture (in Italian, French, English, German and Spanish). 8.30, Sports Notes and Announcements. 8.45, L'appuntamento in cielo—Radio Comedy in Four Acts (Mazzolotti). 10.40, Orchestral Concert: Intermezzo from Manon Lescaut (Puccini); Suite: Jeux d'enfants (Bizet). 10.55, News Bulletin.

SCHENECTADY, General Electric Company (WGY) (379.5 metres); 50 kW. Relay at intervals by **W2XAF** (31.48 metres) and **W2XAD** (19.56 metres).—9.0 p.m., Decorating Notes, from New York. 9.15, Ollie Yettru (Pianist). 9.30, Talk. 9.45, Studio Ensemble. 9.50, News Items. 10.0, Stock Reports and News Items. 10.15, Skippy, from New York. 10.30, The Success Doctor. 10.45, Chandu, the Magician. 11.0, Musical Programme. 11.24, Baseball Scores. 11.30, With Gray McClintock in the Canadian North-West. 11.45, Lady Fingers. 12 Midnight, General Electric Programme. 12 Midnight (W2XAF only), Stock Reports and News Items. 12.15 a.m. (Saturday), Weather Report. 12.16, New Kenmore Orchestra. 12.45, The Goldbergs, from New York. 1.0 (W2XAF only), International General Electric Programme. 1.0 (WGY only), Cities Service Concert, from New York. 1.30, WGY Farm Forum, from New York. 2.0, Clicquot Club Eskimos, from New York. 2.30, Pond's Programme, from New York. 3.0, Young Artists Light Opera Company, from New York. 4.0, Palms Orchestra. 4.30, DeWitt Clinton Orchestra. 5.0, Ralph Kirbyer (Dream Singer), from New York. 5.5, Hotel Pierre Orchestra, from New York. 5.30, New Kenmore Orchestra. 6.0 (approx.), Close Down.

SCHWEIZERISCHER LANDESSENDER (BEROMUNSTER) (459 metres); 60 kW.; Basle (244.1 metres) and Berne (246 metres).—12.25 p.m., Time Signal from Neuchâtel Observatory. 12.30, Weather and News. 12.40, Orchestral Concert. 1.35, Weather and Exchange Quota-

FRIDAY, JULY 1st (cont.)

tions. 1.45 to 3.30, Interval. 3.30 (from Basle), Quartet Concert. 4.30 (from Basle), Programme for Children. 5.0, Weather Report. 5.2 to 6.30, Interval. 6.30 (from Basle), Talk: Optics. 7.0, Time, Weather, Market Prices, Tourist Report, Sunday Sports Announcements, and Gramophone Records of Popular Music. 7.30 (from Basle), Talk: Radio in the Service of Agriculture. 8.0, Orchestral Selections. 8.20 (from Berne), Folk Song Recital—Songs arranged by K. Grunder. 8.45, L'âbig Schueh—Dialect Play (H. Wagner). 9.30, Weather and News. 9.45 (from Berne), Eine kleine Nachtmusik (Mozart) by the Schiffmann String Quartet. 10.30 (approx.), Close Down.

STOCKHOLM, Call SASA (436 metres); 55 kW. Relay by **Boden** (1,229.5 metres); **Göteborg** (322 metres); **Hörby** (257 metres); **Motala** (1,348 metres); **Ostersund** (770 metres) and **Sundsvall** (542 metres).—5.5 p.m., Concert of Swedish Music. 5.30, Talk. 6.0, Popular Music on Gramophone Records. 7.0, Report on the International Football Match (Norway v. Sweden), relayed from Göteborg. 7.15, Weather and News Bulletin. 7.9, Football Report (contd.). 8.45, Violin Recital of Swedish Music by Charles Barkel. 9.25, Sports Talk. 9.45, Weather and News. 10.0, Report on the Chess Tournament in Karlskrona. 10.5, Concert of Operetta Music by a String Orchestra; Selection from The Bird Fancier (Zeller); Waltz from Frasquita (Lehar); Selection from Der Geiger von Lugano (Gilbert); Tango (Benatzky); Waltz from The Arabian Nights (Johann Strauss); Selection from Zigeunerprimas (Kálmán). 11.0 (approx.), Close Down.

STRASBOURG (345 metres); 11.5 kW.—11.30 a.m., Gramophone Concert of Opera and Light Music. 12.45 p.m., News in French and German. 1.0, Time Signal. 1.2, Gramophone Concert (continued). 2.0-4.45, Interval. 4.45, Literary Talk in French. 5.0, Orchestral Concert, conducted by Roskam: Marche sportive (Poppy); Waltz, Sphärenklänge (Jos. Strauss); Simple aveu (Thomé); Overture, Casanova (Lincke); Selections (Razigade), (a) Papillons crépusculaires, (b) Lontanetta; Selection from Les Saltimbanques (Ganne); Waltz, Coeur viennois (Erwin); Selections (Rimsky-Korsakov), (a) Hymn to the Sun, (b) Indian Dance. 6.0, Topical Talk in German. 6.15, Legal Talk in German. 6.30, Gramophone Concert: Polovtsian Dances (Borodin); Barcarolle from The Tales of Hoffmann (Offenbach); Démande et Réponse (Coleridge-Taylor); Ne Gоворите; Spi Moia; Petchalnaia; Chinese Serenade (Sléde); Japanese Lantern Dance (Yoshiotomo); Selections (Bernard), (a) Le Million, (b) Nous sommes seuls; Selections (Albeniz), (a) Tango de España, (b) Granada; I'm Satisfied with You (Nelson); He's my secret passion (Young). 7.30, Time Signal. 7.32, News in French and German. 7.45, Gramophone Concert of Light Music. 8.30, Die Teresina—Operetta in Three Acts (O. Strauss). 10.30 (approx.), Close Down.

STUTTGART (MUHLACKER) (360.5 metres); 60 kW.; and **FREIBURG** (570 metres)—10 a.m., Arias by Glück and Handel (on Gramophone Records); Aria from Armide (Glück); Aria from Rinaldo (Handel); O del mio dolce ardor (Glück); Il Pensieroso (Handel); Aria from Orpheus (Glück); Aria from Julius Caesar (Handel). 10.30 (from Mannheim), Talk for Schools. 11.0, Time, Weather and News. 11.15-11.30, Sponsored Programme on Gramophone Records. 11.45, Sponsored Programme on Gramophone Records. 12 Noon, See Frankfurt. 12.50 p.m., Time, Weather, News and Programme Announcements. 1.0, Yodelling Songs (on Gramophone Records); Grüss di Gott, mein liab Schwagerin (Reverelli); Folk Song, Steyrer Madl; In Lauterbach (Edler); Kirta is (Reverelli); Die Fischerbüttin (Kronegger); Mei Leibjodin. Instrumental Selections in the Interval. 1.55, News Bulletin. 2.0-2.15, Sponsored Programme on Gramophone Records. 4.0 (from Freudenstadt), Orchestral Concert: Overture, Peter Schmall (Weber); Waltz, Liebeslieder (Johann Strauss); Serenata d'Amalfi (Bece); Baci al buio (Micheli); Dubnuscha—Potpourri of Russian Gipsy Romances (Schirmann); Czardas (Nicklas-Kempster). 5.0, Concert from Munich. 6.15, Time, Weather and Agricultural Notes. 6.25, Talk: Luise Dumont. 6.50, Medical Talk. 7.15, Time, Weather, and Programme Announcements in Esperanto. 7.30, An Alsatian Dialect Programme: Choral Selection, An mein

Elsass; Poems (Jean Sebas); Alsatian Peasant Dances (on Gramophone Records); Short Stor. (Carl Klaus); Songs with Pianoforte (Aloy Braun); Alsatian Peasant Dances; Folk Song for a Choir; A Radio Scene; Potpourri of Alsatian Folk Tunes for Soloists, Choir, and Piano forte. 8.30, Concert by the Stuttgart Philharmonic Orchestra, conducted by Hermann Scherchen: The Second Symphony (Johann Schelbi); Overture, Orpheus in the Underworld (Offenbach); Abendblätter (Offenbach-Senger); Tänzerische Suite for Jazz and Augmented Orchestra (Kinneke). 10.0, See Frankfurt. 10.20, Time, Weather, News and Programme Announcements. 10.45, Gramophone Concert of Opera and Dance Music. 12 Midnight (approx.), Close Down.

TOULOUSE (Radiophonie du Midi) (385 metres); 8 kW.—7.0, Light Music. 7.15, Sound Film Music. 7.30, News Bulletin. 7.45, Selections by a Viennese Orchestra. 8.15, Songs from Opéra-Comique: The Barber of Seville (Rossini), and Les Dragons de Villars (Maillart). 8.30, Military Music. 8.45, Accordion Music. 9.0, Concert relayed from the Café des Américains. 10.30, North African News. 10.45, Overture, Patrie (Bizet). 11.0, Popular Songs. 11.15, Songs from Operas. 11.30, Instrumental Concert: Trio No. 2 (Mozart); Septet (Saint-Saëns). 12 Midnight, Weather Report. 12.5 a.m. (Saturday), English Music. 12.30 a.m. (approx.), Close Down.

TRIESTE (247.7 metres); 10 kW.—7.5 p.m., Quintet Concert: Made in Italy (Ripp); Parata di bambole (Serra); Suda (Berner); Mai? (Valini); Le Tambourin (Rameau); Selection from The Duchesse of Chicago (Kaiman); Tutto si perdona (Leux); Bassifondi (Innocenzi). 8.0 till Close Down, See Turin.

TURIN (273.7 metres); 7 kW. Relay by **Milan** (331.5 metres), **Genoa** (312.8 metres), and **Florence** (500.8 metres).—7.5 p.m., Variety Concert: Overture, Heinkelkehr aus der Fremde (Mendelssohn); Verschmähte Liebe (Lincke); Suite campestre (Amadei). 7.30, Time Signal and Announcements. 7.31, Light Music on Gramophone Records. 8.0, Giornale Radio, Weather Report, and Popular Music on Gramophone Records. 8.40, Wireless Notes. 8.45, Cello Recital by Benedetto Mazzacurati. In the interval, Talk by Giuseppe Villaroel. 9.30, Comedy in One Act. 10.0, Flute Quartet Music. 10.30, Dance Music. 11.0, Giornale Radio.

VATICAN CITY (19.84 metres) (Morning), and (50.26 metres) (evening); 10 kW. 10.11.15 a.m., Religious Information in German. 8.0-8.15 p.m., Religious Information in Italian.

VIENNA (517 metres) 15 kW.—Relayed by **Graz** (352.1 metres); **Innsbruck** (283 metres); **Klagenfurt** (453.2 metres); **Linz** (246 metres) and **Salzburg** (218 metres).—6.5 p.m., Report on Foreign Travel and Tourist Traffic. 6.20, Talk by Philipp Wolny: A Watery Death. 6.35, Sports Notes. 6.50, Talk: Foreign Travel and Crime. 7.10, Time Signal, Weather Forecast and Programme Announcements. 7.20, Eysler Concert: Grète Holm (Songs) and the Composer (Pianoforte); Song: Air from Bruder Straubinger; Pianoforte Solos: (a) Kissen ist keine Sünd, from Bruder Straubinger. (b) Besuch im Puppenheim; Song from Das Glücksschweinchen; Pianoforte Solos: (a) Song from Die Schütz-entiesel, (b) The First Spring Day; Song, Air from Der Frauenfresser; Pianoforte Solos: (a) Air from Der lachende Ehemann, (b) Little Viennese Waltz. 7.50, Mass in B-flat (Haydn)—The Creation Mass, by the Choir of the Schotten Church, the Maria Hilf Boys' Choir, and Members of the State Opera Orchestra, Conductor, Amand Figlhuber; Soloists: Erika Rokyta (Soprano), Luise Gruber (Contralto), Georg Maikl (Tenor), and Elemen von John (Bass); Programme relayed from the Schotten Church in commemoration of the 125th Anniversary of the Founding of the Church Schools. 8.45, Readings. 9.15, News Bulletin, Weather and Announcements. 9.35, Concert relayed from London. 10.30, Dance Music on Gramophone Records.

WARSAW (1,411 metres); 120 kW.—3.10, Variety Music on Gramophone Records. 3.30, Announcements. 3.35, Popular Music on Gramophone Records. 4.35, News. 4.40, Talk. 5.0, Concert by a Mandoline Orchestra, conducted by A. Szczeglow. 6.0, Talk on Africa, relayed from Cracow (312.8 metres). 6.20, Dance Music. 7.15, Miscellaneous Items. 7.35, Radio Journal. 7.45, Press Review, relayed from Wilno (563 metres). 7.55, Programme Announcements. 8.0, Symphony Concert by the Warsaw Philharmonic Orchestra, conducted by Gregoire Fiteberg; Soloist, Eric Khar (Violin). 9.50, Radio Journal. 9.55, Acronautical Weather Report. 10.0, Dance Music. 10.40, Sports Notes. 10.50, Dance Music.

Programmes from Abroad.—

ALGIERS (363.3 metres); 13 kW.—7.30 p.m., Talk: Travelling in Alsace. 7.45, Songs. 7.55, News and Time Signal. 8.0, Symphony Concert. 8.30, Request Concert of Gramophone Records.

BARCELONA (Radio-Barcelona) Call EAJI (349 metres); 8 kW.—7.0, Programme for Children, followed by Trio Concert and Picture Transmission. 8.30, Exchange Quotations, Request Gramophone Records and Press Notes. 10.0, Chimes, Weather Forecast, and Exchange and Market Prices. 10.15, Concert by the Station Orchestra: March, Bravura (Blankenburg); Selection from The Land of Smiles (Lehar); Pavane pour une Infante défunte (Ravel); Bohemian Dance (Godard); Waltz, Birds and Butterflies (Courtinoux); Song of Independence (Rabaud); Prelude (Casademont). 11.15, Selection from an Opera on Gramophone Records. 1.0 a.m. (Sunday). Close Down.

BELGRADE (430.4 metres); 2.5 kW.—6.55 p.m., Programme Announcements. 7.0, Talk (to be announced). 7.30, Concert by the Station String Quartet: Quartet in G (Schubert). 8.10, A Comedy. 8.50, Light Music on Gramophone Records. 9.15, See Prague. 10.0, News Bulletin. 10.20, Concert by the Station Orchestra: Overture, Rienzi (Wagner); Ballet Suite from Sylvia (Delibes); Lagoon Waltz (Johann Strauss). 11.0, Concert of Cigány Music, relayed from the Kudicann Restaurant.

BERLIN (Königs Wusterhausen) (1,635 metres); 60 kW.—12 Noon, Weather for Farmers. 12.2 p.m., Variety Music on Gramophone Records, followed by Weather for Farmers. 12.55, Time Signal. 1.35, News Bulletin. 2.0, Dance Music on Gramophone Records, relayed from Berlin (Witzleben). 3.0, Talk: The Problem of Speed in Aviation. 3.30, Weather and Exchange Quotations. 3.45, Talk for Women. 4.0, Talk: Giuseppe Garibaldi, the Italian Liberator. 4.30, Concert from Hamburg. 5.30, Health Talk. 5.50, Talk: Fifty Years of Kiel Week. 6.5, Talk on Music with Gramophone Illustrations, Igor Stravinsky. 6.30, Talk on Ludwig Richter, Wilhelm Busch, and Heinrich Zille. 6.55, Weather for Farmers. 7.0, Talk: Causality and Probability. 7.30, Talk: The Question of Miracles, followed by Weather for Farmers. 8.0, See Langenberg. 10.45, Weather, News and Sports Notes, followed by Dance Music from Berlin (Witzleben).

BERLIN (Witzleben) (419.5 metres); 1.5 kW.—4.5 p.m., Orchestral Concert, conducted by Eugen Sonntag: Overture, The Secret Marriage (Cimarra); Eine Nacht auf dem Kahlenberg (Mousorgsky); Tanzwalzer (Busoni); Petite Suite, Op. 43 (Cui); Scherzo, Irrlichter und Kobold (Hofmann); Selection from Die toten Augen (D'Albert); Egyptian Dance from Djamilah (Bizet); Slavonic March (Tchaikovsky); Slovakian Suite (Novacek); Wedding Waltz (Dohnanyi); Norwegian Rhapsody No. 1 in B Minor (Svendsen). 6.0, Reading of Aphorisms. 6.15, Talk: A German Student in France. 6.35, The Narrative of the Week. 6.55, The Witzleben Station informs its Listeners. . . . 7.0, Topical Talk. 7.10, Song Recital by Theodor Scheidl (Baritone). Songs (Trunk): (a) Vor Akkon, (b) Stilles Lied, (c) An mein Weib, (d) Abendlied; Ruhetal (Schoeck); Die Mainacht (Brahms); Songs (R. Strauss): (a) Morgen, (b) Heimkehr, (c) Freundliche Vision, (d) Ach weh, mir unglücklichem Mann. 7.40, Talk on Sports. 7.55, Labour Market Report. 8.0, See Langenberg. 10.45, Weather, News, and Sports Notes. 10.45 (approx.). Dance Music. 12.30 a.m. (Sunday), Close Down.

BORDEAUX-LAFAYETTE (304 metres); 13 kW.—7.15 p.m., News, Exchange Quotations, and Weather Forecast. 7.20, Sports Notes. 7.25, English Lesson. 7.40, News Bulletin and Weather Forecast. 7.45, Popular Music on Gramophone Records. 8.15, Relay from The Grand Theatre: Overture, The Marriage of Figaro (Mozart); The Barber of Seville—Opera (Rossini).

BRATISLAVA (279 metres); 14 kW.—7.50, See Brno. 8.5, See Prague. 10.15, Programme Announcements and News Bulletin. 10.20, See Prague.

BRESLAU (325 metres); 1.5 kW., and GLEIWITZ (253 metres)—6.0 p.m., Talk: Modern Spanish Philosophers. 6.25, This will interest you—Surprise Programme. 6.45, Weather for Farmers. 6.48, Concert by the Station Orchestra, conducted by Franz Marszalek: Overture, Acteon (Auber); Poème d'Extase (Bullerian); Abendstimmung (Juel-Frederiksen); Rocooco Gavotte. The Bells of Saint Cyr (Schmalstich);

SATURDAY, JULY 2nd.

Selection from Polenblut (Nedbal); Florentine March (Fucik). 7.30, Weather Forecast. 7.31, Topical Talk. 8.0, See Langenberg. 10.45, Time Signal, Weather Forecast, News Bulletin, Sports Notes, and Programme Announcements. 11.10, Dance Music from Berlin (Witzleben). 12.0 Midnight (approx.), Close Down.

BRNO (342 metres); 35 kW.—7.50, Talk: Sunbathing. 8.5, See Prague. 10.15, News Bulletin. 10.20, See Prague.

BRUSSELS (No. 1) I.N.R. (509 metres); 15 kW.—12 Noon, Viola Recital by Charles Foidart: Concerto (Mozart); Berceuse (Fauré). 12.30, p.m., Gramophone Records: Oriental Suite (Popy); Spanish Serenade (Bizet); Carnival Overture (Dvorák). 1.0, Le Journal Parlé. 1.10, Gramophone Concert: Overture, Die schöne Galathée (Suppé); Au ruisseau (Goyens); Selections from Brummel (Hahn); Waltz, My Queen (Bucalossi); Selection (Marcy); Selection from Samson and Delilah (Saint-Saëns); Minuet (Paderewsky); Essai au Piano (Grock); Violin and Pianoforte Selection (Grock); Overture, La Dame blanche (Boieldieu). 5.0, Orchestral Concert, conducted by Franz André: Parisian Carnival March (Popy); Italian Melodies (Löhr); Selections for Two Pianofortes; Selection from Le Grand Mogol (Audran); Violin Solo, Scènes napolitaines (Massenet); Foxtrot (Schertzingler); Waltz, Together (de Sylva and Brown). 6.0, Siegfried Idyll (Wagner), on Gramophone Records. 6.15, Talk on Goethe. 6.30, Gramophone Records: Symphony No. 2 in D (Beethoven); Au bord d'une source (Liszt); The Ride of the Valkyries (Wagner). 7.15, Talk: Contemporary Youth. 7.30, Literary Review and Hints on Floriculture. 8.0, Symphony Concert, conducted by Arthur Meulemans: Two Spanish Dances (Granados); Slovene Dances (Felber); Two Norwegian Dances (Grieg); Two Flemish Dances (Blockx); Two Russian Dances (Mousorgsky); Dances villageoises (Grétry); Hungarian Dances (Brahms). 8.45, Walloon Programme, on Gramophone Records. 9.0, Concert, conducted by Franz André: Waltz, España (Waldteufel); Rhapsody No. 14 (Liszt); Waltz from Faust (Gounod); Saxophone Solos: Selection from Show Boat (Kern); Dance Music with Vocal Refrains. 10.0, Le Journal Parlé. 10.10, Dance Music relayed from the Kursaal, Ostend. 11.0 (approx.), Close Down.

BRUSSELS (No. 2), N.I.R. (338.2 metres); 15 kW. Programme in Flemish.—12 Noon, Concert by Max Alexys and his Orchestra. 1.0 p.m., Le Journal Parlé. 1.10, Concert (continued). 5.0, Orchestral Concert, conducted by Meulemans; Prelude to Parsifal (Wagner); Selections from The Miracle (Humperdinck); Selection from The Italian Girl in Algiers (Rossini); Ballet Music from Carmen (Bizet); Selections from Les Dragons de Villars (Maillart); Ballet Music from Hérodiate (Massenet); March from The Prophet (Meyerbeer). 6.0, Gramophone Records; Overture, Iphigenia in Aulis (Gluck); Ballade and Polonaise (Vieuxtemps). 6.15, Reading of Poems by Eugen Bosschaerts. 6.30, Gramophone Records: Overture, The Flying Dutchman (Wagner); Mennet des Follets (Berlioz); Petite Suite (Debussy); Dance of the Seven Veils from Salome (Richard Strauss). 7.15, Talk: The Migrations of Fels. 7.30, Agricultural Talk. 8.0, Dichterliche—Song Cycle (Schumann), sung by Colette Chabry. 8.30, Gramophone Records. 8.45, Recitations. 9.0, Concert, conducted by Toussant de Sutter, relayed from the Kursaal, Ostend. 10.30, Le Journal Parlé. 10.40, Dance Music from the Kursaal, Ostend. 11.0 (approx.), Close Down.

BUCHAREST (394 metres); 12 kW.—4.0 p.m., Concert by the Station Orchestra: March Potpourri (Blankenburg); Waltz, Bad'ner Mäd'ln (Komzák); Potpourri, From Gluck to Wagner (Schreiner); In a Monastery (Rodin); Selection from The Pearl Fishers (Bizet); Nocturne (Tchaikovsky). 5.0, News Bulletin and Time Signal. 5.10, Concert (continued). Serenade in F Minor (Mario Tamenghi); Symphonic Poem, Danse macabre (Saint-Saëns); Selection from The Circus Princess (Kalman); March, Frisch voran! (Blankenburg). 6.0, Educational Talk. 6.20, Popular Music on Gramophone Records. 7.0, Musical-Saw Solos by Gaby Popesco. 7.20, Dramatic Programme. 8.0, Concert of Romanian Music by the Luca Orchestra. 9.0, News and Close Down.

BUDAPEST (550 metres); 18.5 kW. Also relayed on 210 metres from 6.30 p.m.—12 midnight.—5.0 p.m., Concert by the Eugen Pertis Cigány

Orchestra. 6.0, Answers to Correspondence. 6.30, Gramophone Dance Music. 7.30, Concert by the Workers' Choir, conducted by Elemet Petranyi; Soloist: T. Torök (Pianoforte); Waltz, The Blue Danube (Johann Strauss); Hungarian Folk Songs; Aria from Ernani (Verdi). 8.15, Concert by the Piano Humorists Mocsányi and Lakos. 8.55, Sports Notes. 9.0, Military Band Concert, conducted by Richard Fricssay; Overture, The Italian Girl in Algiers (Rossini); Elisabeth Waltz (Fricssay); Suite from Peer Gynt (Grieg); Piccolo Solo (Kling); Perpetuum mobile (Riesz-Fricssay); Spanish Serenade (Jarai); Valse lente (Jarai); Pöt-pourri, An meine Freunde (Komzák). 9.45, Talk. 10.30, Weather, Time, News, and Concert by the Bela Kiss Cigány Orchestra from the Hotel Gellert. 12 Midnight (approx.), Close Down.

COPENHAGEN (281 metres); 0.75 kW; and KALUNDBORG (1,153 metres); 7.5 kW.—12 Noon, Time and Chimes from the Town Hall. 12.2 p.m., String Ensemble Concert, conducted by A. Bendix, relayed from the Wivex Restaurant. 2.0 to 2.30, Interval. 2.30, Gramophone Records of Light Music. 3.0 to 3.30, Interval. 3.30, Orchestral Concert, conducted by Walther Meyer-Radon. Soloist: Ellen Methling (Vocalist); Overture, The Caliph of Baghdad (Boieldieu); Waltz, Künstlerleben (Joh. Strauss); Chanson Louis XIII et Pavane for Strings and Wood Wind Instruments (Couperin); Selection from The Mikado (Sullivan); Overture, Donna Diana (Reznicek); Valse triste (Sibelius); Polka from Die Fledermaus (Joh. Strauss); Songs (Lange-Müller): (a) Det skumrer over Bolge, (b) Vinden den flyver i Verden ud, (c) Yderst i Slaebet det lette. Songs (Grieg): (a) Vaaren, (b) Du fatter ej Bolgernes evige Gang, (c) Efteraarstormen. Comedy Overture, Nordisk Sæterrejse (Gade); Aften (Sinding); Three Pieces from the Suite ancienne (Halvorsen); Waltz from Coppélia (Delibes); Gollywog's Cake Walk (Debussy); Festival March from Romeo and Juliet (Gounod). 5.40, Exchange and Fish Market Prices. 5.50, Talk in French: The Influence of Molière on the Danish Theatre. 6.20, Talk on Denmark. 6.50, Weather Forecast. 7.0, News Bulletin. 7.15, Time Signal. 7.30, Talk for Tourists: Veile and the Surrounding Country. 8.0, Chimes from the Town Hall. 8.2, Dance Music by Famous Composers. Orchestral Concert, conducted by Walther Meyer-Radon. Selections from the Water Music (Handel): (a) Hornpipe, (b) Minuet, (c) Loure; Oclsenmennett (Haydn); Three German Dances (Mozart); Four Contredances (Beethoven); Three Viennese Dances (Beethoven). Selections (Schubert): (a) Polonaise, (b) German Dance, (c) Military March, Invitation to the Dance (Weber). 8.45, Variety Programme by Louis Prell's Instrumental Ensemble, Chr. Schroder (Readings), and Marie Bundesen (Vocalist). Reading, March, Alagazam (Holzmann); Waltz in A (Dvorák); Notre doux réve (Ackermans); Cossack Song (Czernek); Pasodoble, Ein deutsches Mädel (Reisfeld); Songs from Sound Films; Waltz Barcarolle, Nielsen (Meyer-Illumund); Divertissement, En Gaité (Fillipecci); Serenade, Bel Giorno (Grit); Rocooco Gavotte, Petite Marquise (May); Stelzenläufer (Murzilli). 10.15, News Bulletin. 10.30, Concert (continued). Melody Caprice (Squire); Pour un baiser (Tosti); Serenade (Metra); Ay, Ay, Ay (Perez-Freire); Arlequinade (Ganne); Spanish Serenade, Salamanca (Grit); Foxtrot, Heut bin ich gut aufgelegt (Jurmam-Kaper); Violin Solo, Caprice (Oldenburg-Poulsen). 11.0, Dance Music from the Ritz Restaurant. In the interval at 12 midnight, Chimes from the Town Hall. 12.15 a.m. (Sunday), Close Down.

DUBLIN, Call 2RN (413 metres); 1.2 kW; and CORK (224.4 metres)—1.30 to 2.0 p.m., Time Signal, Weather Report, Stock Report and Light Music on Gramophone Records. 7.20, News Bulletin. 7.30, Time Signal. 7.31, Readings from The Exploits of Brigadier Gerard (Conan Doyle). 7.45, Gaedhige. 8.0, The Augmented Station Orchestra. 8.30, Soprano Solos by Lena Munro. 8.45, Traditional Fiddle Recital. 9.0, Baritone Solos by T. Keane. 9.15, The Augmented Station Orchestra. 9.30, Contralto Solos by Florrie Ryan. 9.45, Pianoforte Solos by A. Healy. 10.0, Orchestral Selections. 10.30, Time Signal, News, Weather Report, and Close Down.

FECAMP (223 metres); 30 kW.—12 noon, Dance Music. 12.30, First French News Bulletin. 12.45, Concert: March of the Grenadiers (Schertzingler); Alsace et Lorraine (Tavoux); Que ne peut-on rêver toujours (Goublier); Le grand retour de chasse; II

Programmes from Abroad.—

est une femme (Mauprey); Selection from Madame Pompadour (Fall); Dream Lover (Schertzing); Navarre (Barat); Un tango dans tes bras (Jekyll); The Popy; Tell Me You Love Me (Stolz). 2.0-7.30, Interval. 7.30, French Local News. 8.0, Concert offered by Tour de Garde. 8.45, Second French News Bulletin. 9.0, Concert: Kawakan (Kealakai); If You Knew What I Knew (Heintz); Selection from Les petites Michu (Messager); Solveig's Song (Greig); Ah, les bruits de Paris (Raiter); Dancœur Mondaine (Heymann); My Inula Love Mon Village au trois couleurs (Heintz); Selection from The Tales of Hoffmann (Offenbach); Un petit oiseau chante dans le tilleul (Eberlé); Rosalie est partie (Raiter); The Road of Happiness (Heymann). 10.0, Smoking Concert: Je suis Coiffeur (Pingault); Je n'oserai plus faire ça (Gaboroché); C'est à boire qu'il nous faut; Oh! Titan (Rawson); Over the Garden Wall (Sarony); La vigne au vin; Tout pour Oscar (Rawson); Ma mère m'a mariée; Mon Pote (Bologne); Michte (Cazaux); Vous êtes mon béguin (Cazals); La fille de Parthenay; O! Pan de Chine (Rawson); Tout autour du moulin (Chantrier); Elle a des pieds en dedans (Prevost); Passant pour Paris. 11.0 till Close Down, Programme in English by the I.B.C. 11.0, Concert: Tom Bowling (Hibdin); Sea Shanties; (a) Drunken Sailor, (b) Shenandoah, (c) Rio Grande, (d) A-Roving; Larboard Watch (Williams); Rocked in the Cradle of the Deep (Knight); Shipmates o' Mine (Sanderson); Four Jolly Sailormen (German); Three for Jack (arr. Foster); The Sea Road (Somers); Announcement on behalf of Spink and Son, Ltd., of London. 11.45, The Novelty Quartet: Lonely Troubadour (Klenner); Ready for the River (Burke); The Sun is at my Window (Mayer); My Fate is in Your Hands (Waller). 12 midnight, The Midnight Derby, with a running commentary specially broadcast from the course. 12.30 a.m., Concert of Dance Music by the Renis Revellers: Laughing at the rain; My Temptation; Let's Get Friendly; Ninety-nine Out of a Hundred; Oh Rosalita; Good Friends; Ten Cents a Dance; When Your Hair Has Turned to Silver. 1.0, The Lowbrows in New Comedy numbers; Music Hall Favorites (Parts 1 to 4); Memories for the Fireside (Parts 1 and 2); Sitting on a Five-Barred Gate; Topsy-turvy talk; Songs made famous by Harry Champion; Songs made famous by Mark Sheridan; Songs made famous by Gus Elen; We all go Oo-ha-ha together; Sing Hully, Go Whistle; Ain't Got Nobody; Saint Louis Blues. 2.0, Dance Music by Roy Lick's Columbia: After Your Kiss; Any Time's the Time to Fall in Love; Songs of Swanee; Sweeping the Clouds Away; A Bench in the Park; Exactly Like You; Happy Feet; On the Sunnyside of the Street; Gypsy Melody; Hallelujah; If I Had a Girl Like You; The Harbour of the Heart; Let Me Sing and I'm Happy; Meet me in my Dreams Tonight; Harmonica Harry; One Mad Kiss. 2.57, I.B.C. Goodnight Melody. 3.0, Close Down.

FRANKFURT (390 metres), 1.5 kW., and **CASSEL (246 metres)**.—3.30 p.m., Programme for Young People; Der Talisman—Fairy Opera in Two Acts (Klages), relayed from **Bad Krennach**. 4.30, See **Stuttgart**. 4.55, Economic Notes. 5.0, See **Stuttgart**. 6.15, Economic Notes. 6.25, Talk: Gustavus Adolphus and the Churches. 6.50, Talk: The Economic Situation of the Nations—South America. 7.10, Time; Programme Announcements; Weather and Economic Report. 7.15, The Sixth Centenary Celebrations of the Town of St. Wendel, relayed from St. Wendel. 7.45-10.35, See **Stuttgart**. 10.35, Time, Weather, News, and Sports Notes. 10.45, Orchestral Concert, conducted by Walter Caspar; March from Die Schützenlied (Eysler); Overture, Das Veilchenmädchel (Hilmesberger); Waltz, Soldatennieder (Gungl); Jubelfeier-Polonaise (Kramar); Potpourri of German Folk Songs, Aus deutschen Gauen; Waltz, Der Liebesbote (Ivanovici); Polka Mazurka, Postscriptum (Müllöcker); Fremdenführer-Quadrille (Ziehler); Potpourri, Von Wien durch die Welt (Hruby); March, Freiwillige vor (Stefan Neumann); Waltz, Leben und Lieben (Fall); Frankfurt Radio March (Stefan Neumann). 12 Midnight (approx.), Close Down.

HAMBURG, Call ha (in Morse), (372 metres); 1.5 kW. Relayd by **Bremen (270 metres)**, **Flensburg (218 metres)**, **Hanover (566 metres)**, and **Kiel (232.2 metres)**.—4.30 p.m. (from **Hanover**), Orchestral Concert from **Bad Nenndorf**;

SATURDAY, JULY 2nd (cont.)

Conductor, Ernst August Bürger; Overture, Lodoiska (Chernibini); Selection from Hérodiade (Massenet); Ballet des parfums (Popy); Faust-Walzer (Goumud); Selection from Der Zigeunerprimas (Kalmán); Waltz from Ritter Pasman (Joh. Strauss); Selection from The Goldsmith of Toledo (Offenbach); Turkish March from The Ruins of Athens (Beethoven). 6.0, Talk for Countrywomen. 6.5 (from **Hanover**), Talk: Handicrafts and German Export Trade. 6.30, Talk: Germany and the Philippines. 7.0, Topical Talk. 7.15, Weather Report. 7.20, Concert, by a Mandoline and Guitar Orchestra, conducted by Walter Schuchardt, and the Station Quartet; Selection from Boccaccio (Suppé); The Norag Quartet: (a) Untreu (Fr. Gluck), (b) Love's Enchantment (Zuccalmaglio); Czardas, Milena (Maciocchi); Waltz, Tramonto (Sartori); Quartet Selections: (a) Italian serenade (Hugo Jünst), (c) Wat is en Kuss (Scheffler); March, Junges Blut (Blum). 8.0, See **Langenberg**. 10.45, Time, Weather, Sports Notes and Announcements. 11.5, Dance Music from the Haus Sieglar.

HEILSBERG (276.5 metres), 60 kW., and **DANZIG (453.2 metres)**.—11.30 a.m., Concert by the Little Orag Orchestra, conducted by Eugen Wilcken; Overture, Pièdre (Massenet); Canzonetta (Bocherini); Waltz, Bei uns z'haus (Johann Strauss); Selection from The Bartered Bride (Smetana); Ballet Divertissement (Blättermann); Der erste Brief (Reggov); Liebeständchen (Wilcken); Rhapsody No. 9 (Franz Liszt); Selection from The Last Waltz (Oscar Straus). 1.5-2.30 p.m., Gramophone Concert; Third Movement from the Pianoforte Trio, Op. 66 (Mendelssohn); Overture, The Hermit's Bell (Maillart); Song and Duet from Madame Butterfly (Puccini); First Movement from the Pianoforte Concerto in E Minor, Op. 11 (Chopin); Serenade (Heykens); Tenor Solos: (a) Rocooco Love Song (Meyer-Helmund), (b) Das Zauberkind (Meyer-Helmund); Selection from The Mikado (Sullivan); Kaddish and Ghetto (Stravsky); Potpourri, Offenbachiana (Offenbach-Urbach); March, Soldatenblut (Blon). 3.30, Programme for Children. 4.0, Concert by the Little Orag Orchestra, conducted by Eugen Wilcken; March, Die Wachtparade (Blankenburg); Waltz from Die Kaiserin (Fall); Overture, Pique Danie (Suppé); Puppel-Intermezzo (Stede); Intermezzo, Einzug der Schneekönigin (Noack); Selection from Czar and Carpenter (Lortzing); March, Friedensglocken (Urbach); Slavonic Rhapsody (Volpatti); Pianoforte Solos: Stransiana (Erich Börschel); Overture, Nakisir Hoehzeit (Lincke); Selection from Der Mann mit den drei Frauen (Lehár); Fliegermarsch (Urbach). 5.0 (in an interval) (from **Danzig**), Film Notes. 6.0, Programme Announcements for the Coming Week. 6.10, Programme Intelligence in Esperanto. 6.15, Agricultural Market Prices. 6.20, International Market Report. 6.35 (from **Danzig**), Talk on Economics: The Problem of Booms. 7.0, Ermland Honour. 7.25, Organ Recital of German Baroque Music; Preambulum in C Minor (Praetorius); Choral Prelude: Dies sind die heiligen zehn Gebot (Schreim); Toccata in C (Froberger); Partita on Du Friedeürst, Herr Jesu Christ (J. B. Bach); Short Masses for Organ (Bach): (a) Kyrie, Vater in Ewigkeit, (b) Christe, aller welt Trost, (c) Kyrie, Gott heilig-er Geist. 8.0, Weather Forecast. 8.5 (from **Danzig**), Variety Programme. 10.5 (approx.), Weather, News, and Sports Notes. 10.45 (approx.), Dance Music from Berlin (Witzleben). 12.30 a.m. (Sunday), Close Down.

HILVERSUM (announced HUIZEN) (296.1 metres); 20 kW. (7 kW. up till 4.40 p.m.).—Programme of the Catholic Radio Society (K.R.O.) 7.40-8.55 a.m., Gramophone Records of Variety Music. 9.40, Gramophone Concert of Variety Music. 11.10, Religious Address. 11.55-1.25 p.m., Sextet Concert: Overture, Der Bittelstudent (Müllöcker); Waltz, A Thousand and Nine Nights (Johann Strauss); Minuet from the Quintet, op. 23 (Bocherini); Selection from Lilac Time (Schubert-Berté); Xylophone Solos: (a) Tell Fantasia (Krieger), (b) Klapperschlangen (Krüger); Potpourri, Für alle (Dostal); Valse buhette (Drigo); Potpourri, Vom Rhein zur Donau (Rholde); March, The Carnival Maid (Snyder). 1.25, Interval. 1.40, Gramophone Records of Variety Music. 2.10, Programme for Children. 3.40, Programme arranged by the H.I.R.O. 4.40, Gramophone Records of Variety Music. 5.10, Esperanto Notes.

5.25, Gramophone Records of Variety Music 5.50, Journalist Review. 6.10, Gramophone Records of Variety Music. 6.50, Talk. 7.10, Police Notes. 7.25, Sports Talk. 7.40, Variety Programme. 10.40, Gramophone Records of Variety Music. 11.40 (approx.), Close Down.

HUIZEN (announced HILVERSUM) (1,875 metres); 8.5 kW.—6.25-9.40 a.m., Programme of the Workers' Radio Society (V.A.R.A.). 6.25-6.40 and 7.10-7.25 a.m., Physical Culture Lesson. 7.40, Gramophone Records of Variety Music. 8.40, Trio Concert. 9.40, Religious Programme by the Liberal Protestant Radio Society (V.P.R.O.). 9.55 till Close Down, V.A.R.A. Programme. 9.55, Variety Programme. 11.40, Septet Concert: March, Perpetuum mobile (V. Blon); Waltz, Badner Madin (Komzak); The Rose-Beetle Goes A-wooing (Armandola); Gramophone Records of Variety Music; Hawaiian Memories (Armandola); Toréador et Andalouse (Rubinstein); Tango, Por ti (Sentis); Babilage (Gillet); Variety Music on Gramophone Records; Waltz, Donauwellen (Ivanovici); Parlez-moi d'amour (Lenoir); Fox-trot, Wenn ein kleiner Zufall will (Jurmänn); Gramophone Records; Saxophone Solo, Trumbology (Trumbauer); Piazza del Popolo (Frederiksen); Das muss ein Stück vom Himmel sein (Heymann); Variety Music on Gramophone Records; Potpourri, Lasst Schlager sprechen (Dostal). 1.25 p.m., Interval. 1.40, Dialogue by P. Voogd and J. Gregoot. 1.55, Trio Concert: March, A nous (Brookhouse); Waltz, Wienerblut (Joh. Strauss); Overture, The Magic Flute (Mozart); Sous ta fenêtre (Lacharme); Gavotte, Mignonette (Brookhouse); Selection from Tannhäuser (Wagner-Alder); Tango, Fernando; Tango, Hast du gesagt. 2.25, Sports Talk. 2.40, Concert (contd.): Violin Solo; Cello Solo; Potpourri, Das Beste vom Besten (Dostal); An revoir (Brookhouse). 3.19, Concert by a Children's Choir. 3.55, Topical Talk. 4.10, Chamber Music. 4.40, Programme for Children. 5.40, Choral Concert. In the interval at 5.55, Talk. 6.10, Literary Talk. 6.40, Grüninger Programme—Talks, Recitations, and Music. 7.40, Variety Concert. 10.40 (approx.), News and Football Results, followed by Variety Music on Gramophone Records. 11.40 (approx.), Close Down.

KATOWICE (408 metres); 16 kW.—7.15 p.m., Talk. 10.5, Chopin Concert. 10.50, Dance Music.

LAHTI (1,796 metres); 54 kW. Relayd by **Helsinki (368.1 metres)**.—6.15 p.m., Talk (to be announced). 6.40, Concert by the Station Ensemble: Selection from La Traviata (Verdi); Waltz, Sommernacht (Söderström); Selection (Atterberg); Humoresque (Aulin). 7.10, Talk in Finnish. 7.30, Song Recital by Elias Kyander. 7.55, Dance Music by the Station Ensemble. 8.45, News in Finnish. 9.0, News in Swedish. 9.15, Light Music, relayed from the Kappell Restaurant. 10.0 (approx.), Close Down.

LANGENBERG (473 metres); 60 kW.—12.55 p.m., Weather Report, News Bulletin and Time Signal. 1.0, Concert, conducted by Wolf; March, Jugendfrühling (Blankenburg); Waltz from Die Fäschingsfee (Kalmán); Overture: The Bohemian Girl (Balfe); Potpourri of Wagner's Operas, Reminiscences of Bayreuth (Morena); Im wogender Ahrenfeld (Dransmann); Murrelndes Lüttchen (Jensen); Melodies from Offenbach's Operettas (arr. Conrad); Petite Suite for Orchestra, Jeux d'enfants (Bizet); Potpourri, Major and Minor (Schreiner). 2.35, Variety Concert on Gramophone Records. 3.30, Economic Notes and Time Signal. 3.50, Programme for Children. 4.20, Talk on Gardens. 4.40, English Lesson. 5.0, Concert by the Dortmund Zither Circle; Soloists: Berger (Soprano) and Hoersch (Tenor); Festival March (Grünwald); Gypsy Procession through the Woods (Höffe); Soprano Solos: Three Folk Songs; Tenor Solos, Löns Songs (Gabriel); Duets: (a) Ein Schäfermädchen weidete (Folk Song), (b) Die Auserwählte (arr. Seidler-Winkler); Concert Overture, No. 2 (Svoboda); Concert Waltz, Lockende Sirenen (Kollmaneck). 6.0, Talk: Three Small Excursions from Cologne into the Mountains. 6.20, Programme for Women. 6.40, Talk: Language as a Creative Factor. 7.0, Weather Report, Time Signal, Economic Report, and Sports Notes. 7.15, Wireless Hints for Everybody. 7.30, Talk on the State and Industry. 7.55, News Bulletin. 8.0, Public Variety Concert for the benefit of Needy Artists; The Small Station Orchestra, conducted by Leo Eysoldt, Harry Blum and his Orchestra, Choirs and Soloists. 10.30, News Bulletin and Sports Notes. 10.45, See **Frankfurt**. 12.0 Midnight, Dance Music. 1.0 a.m. (Sunday), Close Down.

SATURDAY, JULY 2nd (cont.)

Programmes from Abroad.—

LEIPZIG (259 metres); 2 kW., and **DRESDEN** (19 metres).—5.0 p.m., Orchestral Concert, conducted by Wilhelm Schmidt; Ballet Overture (Lincke); Selections from Hans Everigt (Ohlsen); Symphonic Dances Op. 64 (Jrieg); Selections from Die lustigen Nibelungen J. Strauss); Im Spielwarenladen (Jessel); (Tondnacht am Rheinsberger See (von Blon); Tarch: Linzer Buam (Drescher). 6.30, Germannesson. 6.50, Topical Talk. 7.0, Talk on World Problems. 7.30, Reinhold Becker Programme by Margarete Janda (Contralto) and Iellmuth Schaefer (Pianoforte); Songs (a) 'Frost der Nacht, (b) Stimme im Dunkeln, (c) 'Jinnal im Leben naht das Glück, (d) 'Aeresabend; Pianoforte Solos: (a) Walther von der Vogelweide, (b) Das Schloss am Meer; scene from Frauenlob. 8.0, Old and New Dance Music by the Leipzig Symphony Orchestra, conducted by Hilmar Weber, and Kurt Blachmann's Dance Band; Talk: Polonaise: Five Hundred Thousand Devils (Graben-Hoffmann); Waltz: The Blue Danube (Joh. Strauss); Foxtrot: Mädel so bist du (Brodzsky); Tango: Es kann dein Glück sein (Halleperein); Foxtrot (Brown); Polka: Papa-Mama (Bayer); Ist das nicht chic? (Heuberger); Waltz: Mon rêve (Waldteufel); Rumba, Für dich singe ich meine schönsten Lieder (Brodzsky); English Waltz: Es führt kein ander Weg zur Seligkeit (Heymann); Foxtrot (Lecuna); Mazurka, Die Emanzipierte (Jos. Strauss); Selections (Joh. Strauss): (a) Quadrille from Die Fledermaus, (b) Waltz: Wienerblut; Pasodoble, Du hast das Feuer im Blut (Bewit); Tango: Two Heavenly Blue Eyes (Raymond); Slow Foxtrot (Warren); Gallop, Ein Treiler (Kral); Foxtrot: Das Jägerhütchen (Myers); English Waltz: Was kann so schön sein, wie deine Liebe? (Brodzsky); Foxtrot: Natascha (Margulies); Polka: Die strammen Trompeter (Munkelt); Waltz from Eva (Lehar); Foxtrot: Was ist das (Harris); Tango: Was ich von dir weiss, kleine Elisabeth (Rosen); Foxtrot (Donaldson). 10.5, News Bulletin. 10.15 (approx.), Dance Music. 12 Midnight (approx.), Close Down.

LJUBLJANA (574.7 metres); 2.5 kW.—3.30 p.m., Gymnastics Course. 7.0, English Lesson. 7.30, Topical Talk. 8.0, Concert by the Zarfa Orchestra. 9.0, Song Recital. 10.0, Time, News and Light Music.

LWOW (381 metres); 16 kW.—7.15 p.m., Miscellaneous Items. 7.35, See Warsaw. 7.45, Talk: Film Stars. 8.0, See Warsaw. 12 Midnight (approx.), Close Down.

LYONS La Doua (PTT) (465.8 metres); 1.5 kW.—7.0 p.m., Popular Music on Gramophone Records. 7.30, Radio Gazette for Lyons and the South-East. 8.30, See Bordeaux-Lafayette.

MADRID (Union Radio) Call EAJ7 (424.3 metres); 2 kW.—8.0 p.m., Chimes, Market Prices, and Request Gramophone Records. 9.15, News Bulletin. 9.30-10.30, Interval. 10.30, Chimes. Time Signal, and Selections from Musical Comedies, (a) La Corte de Fardon (Lieg) and (b) La Reina Mora (Serrano). 12.45 a.m. (Sunday), News Bulletin. 1.0, Chimes and Close Down.

MORAVSKA-OSTRAVA (263.8 metres); 11 kW.—8.5, See Prague. 10.15, Programme Announcements and Theatre Guide. 10.20, See Prague.

MOSCOW Trades Union (1,304 metres); 100 kW.—5.30 p.m., Communist Journal. 7.10, Orchestral Concert. 8.0, Programme to be announced. 9.55, Time Signal and Close Down.

MUNICH (533 metres); 1.5 kW.; relayed by Augsburg and Kaiserslautern (560 metres) and Nürnberg (239 metres).—6.15 p.m., Programme for Young People. 7.0, Songs from Greece, by Ernst Konrad Haase (Bartone), with Commentary. 7.25, Wireless Notes. 7.40, Talk: The Local History Museum in Bavaria. 8.0, Orchestral Concert, conducted by Karl List. Soloists, Else Bartl (Soprano), Grete Jörn (Soprano), Otto Hillerbrand (Tenor), and Karl König (Tenor); Overture, Gri-Gri (Lincke); Waltz, Brüderlein fein (Fall); Intermezzo, Rendezvous (Aletter); Selection from Countess Maritza (Kálmán); Weiber-Marsch (Lehar); Volksliederchen und Märchen (Komzak); The Wedding of the Winds (Hall); Sang und Klang—Potpourri for Soloists, Choir, and Orchestra (Morena). 9.20, The Tyrolese Eagle and the Bavarian Lion—Variety Programme. 10.20, Time, Weather, News and Sports Notes. 10.45, Orchestral Concert, conducted by Reinhold Merten, relayed from Frankfurt. 12 Midnight (approx.), Close Down.

OSLO (1,083 metres); 60 kW.; relayed by Fredrikstad (367.6 metres); Hamar (560 metres); Notodden (447.1 metres); Porsgrund (453.2 metres); and Rjukan (447.1 metres).—5.15 p.m., Programme for Children. 6.15, Hardanger Fiddle Recital of National Music, and Talk by Johan Austbø. 6.45, Talk on Economics. 7.0, Announcements, Weather and News Bulletin. 7.30, Talk. 8.0, Time Signal. 8.1, Concert by the Station Orchestra, conducted by Hugo Kramme. Soloist, M. Simon Edvardsen (Vocalist); Overture, Ruy Blas (Mendelssohn); Selection from The Flying Dutchman (Wagner); Aria from Mephistopheles (Boito); Aria from Manon Lescaut (Puccini); Waltz from Der Rosenkavalier (Richard Strauss); Song from Countess Maritza (Kálmán); You are my Heart's Delight, from The Land of Smiles (Lehar); Polpourri, Hallo Budapest! (Pecsi-Prichystal). 9.10, Recitation. 9.40, Weather and News Bulletin. 10.0, Topical Talk. 10.15, Concert by a Male Voice Choir. 10.45, Dance Music on Gramophone Records. 12 Midnight (approx.), Close Down.

PALERMO (542 metres); 3 kW.—6.0 p.m., Programme for Children. 6.30-8.0, Interval. 8.0, Announcements, Radio Giornale dell'Unit, Agricultural Report and Giornale radio. 8.20, Gramophone Records of Popular Music. In the intervals at 8.25, Sports Notes; and at 8.30, Time and Announcements. 8.45, Ave Maria (Bettinelli). In the intervals, Book Review and Announcements. 10.55, News Bulletin.

Paris (Eiffel Tower) Call FLE (1,445.7 metres), 13 kW. Time Signals (on 2,650 metres) at 10.26 a.m. and 11.26 p.m. (Preliminary and 6-dot Signals).—6.45 p.m., Le Journal Parlé. 8.20, Weather Forecast. 8.30, Three One-act Comedies: (a) Passez muscade! (Le Marquis de Montferrier), (b) En lisant Sherlock Holmes (René Berton), (c) La Solution élégante (Delamare and Thévanne); Wireless Notes in the interval.

PARIS (Poste Parisien) (328.2 metres), 60 kW.—7.0 p.m., News Bulletin and Parliamentary Review. 7.5, Light Music on Gramophone Records. 7.15, Sponsored Gramophone Concert. 7.45, Talk by Maurice Bourdet: The Event of the Week. 8.0, Topical Talk. 8.20, Talk on Music by Louis Schneider. 8.30, Radio Journal and News. 8.45, Concert of French Songs by Music Hall Artists. 10.0, Dance Music on Gramophone Records. 12.0 midnight (approx.), Close Down.

PARIS (Radio Paris) Call CFR (1,725 metres), 75 kW.—6.45 a.m., Physical Culture. 7.30, Weather and Physical Culture (continued). 7.45, Light Music on Gramophone Records. 8.0, News, Weather, and Press Review. 12 noon, Gramophone Concert; Selection from Scarmanche (Messenger-Street); Ballet Music from La Patrie (Paladilhe); Poubie (Lenoir); Dream of Love after the Ball (Czibulka); Sur les bords de la Seine (Scott); Miss Columbia (Marecau); Selection (Granchistæden); The Unknown Singer (Sylviano); Marguerite douloureuse au rouet (Zabel); The Czekoo (Daquin); Reviens (Fragon-Christine); Entr'acte Waltz (Hirschmann-Yatove); Bouton d'or (Pierné-Yatove); Ton sourire (Catherine); Selection from La vie parisienne (Offenbach); Le Train Fatal (Borel-Clerc); Selection from The Czarevitch (Lehar); Partir avec vous (Borel-Clerc); Sous la Porte St. Martin (Cazels and Leardy); Selection (Nerim); Suite Carnavalesque (Thomé); Le Pas d'armes du Roi Jean (Saint-Saëns); Garde-moi (Yvain). In the intervals, News and Weather. 3.0, Programme for Children. 3.45, Market Prices. 6.30, Market Prices, Weather, Agricultural Report, Talk, Exchange and Racing Results. 7.0, Talk, arranged by the Union des Grandes Associations françaises. 7.10, Talk by Colonel Bourgoin. 7.30, Variety Music on Gramophone Records. 7.45, Latin Press Review. Commercial Prices and News. 8.0, Reading of Poems by Alfred de Musset. 8.30, News and Sports Notes. 8.40, Review by Jean Rieux. 8.45, Film portrayed in Song (Boyer) with the Collaboration of the Composer, Jane Pierly and M. Marjal. In the interval at 9.15, Press Review and News.

PITTSBURGH, Westinghouse Electric (KDKA) (306 metres), 25 kW.; relayed by W8XK on 48.86 metres and 25.25 metres.—7.30 p.m., The Happy Dollar Play, by E. B. Stimpson. 7.40, Radio Debuts. 8.0, Radio Troubadours, from New York. 8.30, Hello Marie, from

New York. 8.45, Fireside Singers, from New York. 8.53, Teaberry Baseball Scores. 8.58, Pebecco Weather Report. 9.0, Saturday Matinée, from New York. 9.30, Tales of the Pennsylvania State Police, Behind the Law. 9.45, Programme to be announced. 10.0, Teaberry Baseball scores. 10.5, David Lawrence Dispatch, 10.10 KDKA, Artist Bulletin. 10.12, Programme Announcements. 10.15, Roseybits, by A. K. Rowswell. 10.30, Stories for Children. 10.45, Little Orphan Annie. 10.50, Temperature Report. 10.51, Weather Report. 11.0, Time Signal. 11.1, Temperature Report. 11.2, Who's News To-day. 11.6, Teaberry Sport Review. 11.11, Press News-Reeler. 11.14, Weather Forecast. 11.15, Programme to be announced. 11.30, Vincent Lopez and his Orchestra, from New York. 11.59, Pennzip Time. 12 Midnight, Pepsodent Amos 'n Andy from New York. 12.15 a.m. (Sunday), Dance Masters, from New York. 12.30, Sacred Songs, 1.0, Danger Fighters, from New York. 1.30, Dance with Countess d'Orsay, from New York. 2.0, Goldman Band, from New York. 2.30, The First Nighter, from New York. 3.0, Programme to be announced. 3.15, Homey and Old Fashioned. 3.30, Twenty Fingers of Harmony, from New York. 3.45, McCravy Brothers, from New York. 4.0, Pennzip Time. 4.1, Teaberry Sport Review. 4.11, Temperature Report. 4.12, Bulova Weather Report. 4.15, Press Last Minute News. 4.20, Messages to the Far North. 4.30, Roseybits, by A. K. Rowswell. 4.45, Messages to the Far North (cont.) 5.0, Lew Conrad and his Orchestra. 5.30, Pennzip Time and Goodnight.

PRAGUE (488.6 metres); 120 kW.—6.25 p.m., German Transmission; Talk with illustrations—Orchestral Instruments. 7.50, See Brno. 8.5, Brass Band Concert, conducted by Milinsky. 9.5, Relay of the Federal Congress of Sokols from the Smetana Hall of the Municipal House. 10.0, Time, News, and Sports Notes. 10.15, Theatre Guide and Programme Announcements. 10.20, Uncle Kropal comes to the Congress in Prague—a Radio Comedy.

RADIO-SUISSE ROMANDE (SOTTENS) (403 metres); 25 kW.; Lausanne (680 metres), and Geneva (760 metres).—5.0 p.m., Time Signal from Neuchâtel Observatory. 5.1, Orchestral Concert, conducted by Robert Echenard. 6.0 (from Geneva), Dance Music. 7.0, Weather Forecast. 7.1 (from Geneva), Chimes from St. Peter's Cathedral. 7.10 (from Lausanne), Song Recital by Mme. Plomb. M. Moser at the Pianoforte. 7.30 (from Lausanne), Talk: The Week in International Politics. 8.0 (from Geneva), Ruy Blag. 8.10, Orchestral Concert, conducted by Robert Echenard. 9.5 (from Geneva), Monologues. 9.25 (from Lausanne), Country Music. Accordion Duets and Tyrolese Songs with Accordion accompaniment. 10.0, News and Weather. 10.10 (from Geneva), Dance Music relayed from the Moulin Rouge. 11.30 (approx.), Close Down.

RIGA (525 metres); 15 kW.—6.30, Talk by Captain Bernhard. 7.0, Weather Report. 7.3, Agricultural Talk. 7.30, Concert of Viennese Music by the Station Orchestra, conducted by Lovro Matacic; Overture, Rosamunde (Schubert); Waltz, Tales from the Vienna Woods (Johann Strauss); Waltz, Wiener Kinder (Johann Strauss); Waltz, Dorfschwalben aus Oesterreich (Joseph Strauss); Overture, Die Fledermaus (Johann Strauss); Overture, The Gipsy Baron (Johann Strauss); Waltzes (Johann Strauss): (a) Neues Wien, (b) Wienerblut, (c) Roses from the South, (d) Wine, Woman, and Song. 8.25 (in an interval), News Bulletin. 9.0, Weather Forecast. 9.40, Dance Music. 11.0 (approx.), Close Down.

ROME, Call 1RO (441 metres); 50 kW. Relayed by Naples (319 metres), and 2RO (25.4 metres).—8.15 to 8.30 a.m., Giornale Radio and News. 12 noon, Gramophone Records of Variety Music. 12.35 p.m., Weather Forecast. 12.45, Sextet Concert. Soloist: Paolo Leonori ('Cello); Hallo, America! (Lubbe); Serenata (Cacciali); Hungarian Dance No. 7 (Brahms); 'Cello Solos: (a) Chants russes (Lalo); Allegro spiritoso (Senallé); Selection from The Girl in the Taxi (Gilbert); Vito, for 'Cello (Popper); Spanish Fantasia, Per le vie di Siviglia (Lattuada); Flirt primaverale (Martelli). In the intervals at 1.15, Giornale Radio and Exchange, and at 1.30, Time and Announcements. 5.0, Exchange, Report of the Royal Geographical Society, Giornale Radio and Announcements. 5.15, Reading. 5.30, Tenor Song Recital, by Giulio Moroni: La ritrosa (Brogi); Madonna Fiorentina (Billi); La tua villa (Tirindelli). 5.45, Variety Concert: Spanish Dance, Seguidilla (Frontini); Selection from The Dance of the Dragonflies (Lehar); Invocation

Programmes from Abroad.—

(Manno); Selection (Llossas); Signore (Lethner). 6.15, Giornale dell'Enit. 6.55 (from Naples). Shipping Report and Sports Notes. 7.0, Atmospheric Signals, Morse Lesson, Agricultural Notes, Giornale Radio and Press Review. 8.0, Time, Announcements, and Light Music on Gramophone Records. 8.30, Sports Notes and Announcements. 8.45, La rondine (The Swallow) Opera (Puccini); Conductor, Riccardo Santarelli. Choirmaster, Emilio Casolari. In the intervals, Review of New Books and Talk. News after the Opera.

SCHENECTADY General Electric Company (WGY), (379.5 metres); 50 kW. Relayed at intervals by **W2XAF** (31.48 metres) and **W2XAD** (19.56 metres).—7.0 p.m.-9.45, New York Relay. 7.0, Rice String Quartet. 7.30, Symphonic Matinée. 8.0, Merry Madcaps. 8.30, Chautauqua Opera Hour. 9.0, Matinée Gems. 9.30, Soloist. 9.45, Studio Ensemble. 10.15, Skippy, from New York. 10.30, Soloist, from New York. 10.45, Musical Programme, from New York. 11.0, Joe and Eddie. 11.15, Waldorf-Astoria Orchestra, from New York. 11.30, American Trio. 11.45, DeWitt Clinton Orchestra. 12 Midnight, Baseball Scores. 12 Midnight (W2XAF only), Stock Reports and News Items. 12.5 a.m. (Sunday), DeWitt Clinton Orchestra. 12.15, Musical Crossroads from New York. 12.45, The Goldbergs, from New York. 1.0, Bridge Lesson. 1.30-4.0, New York Relay: 1.30, National Advisory Council in Radio on Education. 2.0, Drama K-7, from New York. 2.30, Musical Programme. 3.0, Lucky Strike Dance Hour. 4.0, De Witt Clinton Orchestra. 4.30, Hotel New Yorker Orchestra, from New York. 5.0, Ralph Kirbyer (Dream Singer), from New York. 5.5, Buddy Rogers and his California Cavaliers, from New York. 5.30, New Kenmore Orchestra. 6.0 (approx.). Close Down.

SCHWEIZERISCHER LANDESENDER (BEROMUNSTER) (459 metres); 60 kW.; **BASLE** (244.1 metres), and **BERNE** (246 metres).—12.28 p.m., Time Signal from Neuchâtel Observatory. 12.30, Weather and News. 12.40, Gramophone Concert of Variety Music; Talk in the interval. 1.50, Weather and Exchange Quotations. 1.55-3.30, Interval. 3.30 (from Zürich), Trio Concert. 4.0 (from Zürich), Talk for Workers. 4.30 (from Zürich), Concert by the Edelweiss Accordion Club. 5.0 (from Zürich), Talk: An Argument with Stay-at-homes. 5.30, Weather Report. 5.32-6.30, Interval. 6.30 (from Zürich), Talk: Rudolf von Habsburg, as portrayed in Contemporary Anecdotes. 7.0, (from Zürich), Chimes from the Zürich Churches. 7.15, Market Prices. 7.20 (approx.). (from Zürich), Wireless Notes. 7.30, Time and Weather. 7.32, Gramophone Records of Light Music. 8.0 (from Zürich), Popular Programme by Alfred Huguenberger (Readings in Dialect); the Zürich Municipal Orchestra, conducted by G. B. Mantegazzi, and the Hard Yodelling Club. 9.30, Weather and News. 9.45, Dance Music on Gramophone Records. 11.0 (approx.). Close Down.

STOCKHOLM, Call SASA (436 metres); 55 kW. Relayed by **Boden** (1,229.5 metres); **Göteborg** (322 metres); **Hörby** (257 metres); **Motala** (1,348 metres); **Ostersund** (770 metres), and **Sundsvall** (542 metres).—4.0 p.m., Technical Talk. 4.20, Concert of Light Music; Overture, Die Felsenmühle (Reissiger); Waltz (Lincke); Two Elegiac Pieces (Petersen); Selection from Faust (Gounod); Tango, Jamaica (Reisfeld-Egen); Potpourri (Geiger). 5.15, Programme for Children, relayed from Göteborg. 5.45, Gramophone Records of Variety Music. 6.45, Talk. 7.15, Weather and News. 7.30, Programme of Old Dance Music, relayed from **Halmsstad**. 8.15, Choral Concert. 8.45, Accordion Recital. 9.0, A Radio Revue. 9.45, Weather and News. 10.0, Radio Report on the Chess Tournament at Karlskrona. 10.5, Dance Music. 11.0 (approx.). Close Down.

STRASBOURG (345 metres); 11.5 kW.—11.30 a.m., Gramophone Concert of Classical and Light Music. 12.45 p.m., News in French and German. 1.0, Time Signal. 1.2, Concert, relayed from **Bordeaux Lafayette**. 1.50, Gramophone Records. 2.0, Talk in French. 2.15, Gramophone Concert of Light Music. 3.15-3.45, Interval. 3.45, Talk on Music with Illustrations: The Pianoforte Style of Mozart. 4.0, Dance Music on Gramophone Records. 4.45, Talk in French. 5.0, Dance Music. 6.0, Talk for Tourists in French. 6.15, Horticultural Talk in French. 6.30, Orchestral Concert, conducted by Maurice De Villers; The Nutcracker Suite (Tchaikovsky); Cello Solo: Après un rêve (Fauré); Selection from La Juive (Halévy);

SATURDAY, JULY 2nd (cont.)

Bacchanale from Samson and Delilah (Saint-Saëns); Danse persane (Giraud); Joyeuse marche (Chabrier). 7.30, Time Signal. 7.32, News in French and German. 7.45, Extracts from Carmen—Opera (Bizet). 8.45, Il Barbiere di Siviglia (The Barber of Seville); Opera (Rossini), relayed from the Grand Theatre, Bordeaux. 10.30, Dance Music from the Savoy. 12 Midnight (approx.). Close Down.

STUTTGART (Mühlacker) (360.5 metres); 60 kW.; and **FREIBURG** (570 metres).—10.0 a.m., Sonata for Saxophone and Pianoforte, Op. 25 (Hans Brehme). 10.30 (from Mannheim), Programme for Schools. 11.0, Time, Weather, and News. 11.15, Festival Programme on the Seventy-Fifth Anniversary of the Württemberg Academy of Music, relayed from the Liederhalle. 12 Noon, Weather Forecast. 12.5, Sponsored Programme on Gramophone Records. 12.20, Gramophone Concert. Overture, Alessandro Stradella (Flotow); Aria from The Barber of Seville (Rossini); Invitation to the Dance (Weber-Berlioz); Serenade (Richard Strauss); Two Selections (Ducasse): (a) Le Joli Jeu de Furet, (b) Petite Suite; Polonaise (Chopin); Serenade (Mozzkovsky); Two Selections from Aida (Verdi); Cello Solo, Serenata (Pierne); Indian Suite (Lüling); Potpourri on Goldne Liebe (Benatzky). 12.50, Time, Weather, News, and Programme Announcements. 1.0, Concert from Munich. 2.0, Mouth-Organ Recital, Bismarck-Marsch; Die Post im Walde (Schäffer); Mignonetten—Ouvverture (Baumann); Song from The Gipsy Baron (Johann Strauss); Overture, William Tell (Rossini); March, Weidmannsheil (Reckling). 2.30 (from Freiburg), Wesendonek Songs (Wagner), by Bertha Gunderloh (Soprano); Der Engel; Träume, Schmerzen, Steh still, Im Treibhaus. 3.0 (from Karlsruhe), Cornet Quartet Concert, Das ist der Tag des Herrn (Kreutzer); Caprice (Bordèse); Das Bild der Rose (Reichardt); Märchen (Komzak); Arabella (Kiesler); Des Jägers Abschied (Mendelssohn); Folk Song, Das stille Tal. Gute Nacht (Baldamus). 3.30, See Frankfurt. 4.30 (from Mannheim), Concert by the Flora Quartet, conducted by Friedrich Gellert. Madrigal, An einen Bächlein (Walrent, arr. Nagel); Minnelied (Adam de la Halle, arr. Schreiber); Das Ringeln (Wilhelm Nagel); Folk Song, Grossmutter will tanzen (arr. Ludwig Baumann); Wandern in Mai (Gellert); Mädels mach' kein böses Gesicht (Franziskus Nagler); Mit der Fiedel mit dem Liedel (Friedrich Gellert); Tanzlied (Doehert); English Waltz (Leo Ascher, arr. Josef Drexler); Wandervogel (Jesse Greer, arr. Ray Brown). 5.0, Orchestral Concert, conducted by Gustav Görlich. Soloists: Gerda Baumann (Soprano) and Max von Wistinghausen (Baritone); overture, The Marriage of Figaro (Mozart); Soprano Solo from Der Wallfenschmid (Lortzing); Entr'acte Music from Rosamunde (Schubert); Duet from Don Giovanni (Mozart); Champagne Song from Don Giovanni (Mozart); Bauernmarsch (Fall); Waltz, Rheinsagen (Homan-Webau); Two Songs for Soprano (Taubert): (a) Der Vogel im Walde, (b) Ich muss nun einmal singen; Waltz, Gold and Silver (Lehár). 6.15, Time, Weather, and Sports Notes. 6.25, Technical Talk. 6.50, Talk: Careers closed to Students. 7.15, Time and Weather. 7.20, See Frankfurt. 7.45, From Hamburg to Vienna—A Musical Trip by the Station Orchestra, conducted by Gustav Görlich. Soloist: Anton Maria Topitz (Tenor). 8.40, Festival Concert by the Württemberg High School of Music, on its Seventy-fifth Anniversary. The Orchestra, conducted by Carl Wendling, with K. Bosch-Möckel (Violin); Concerto for Violin and Orchestra (Beethoven); Overture, Eryanthie (Weber). 9.35, A Cabaret, from the Catacomb, Berlin. 10.35, Time, Weather, News, and Programme Announcements: 10.50, Concert from Frankfurt. 12 Midnight, Dance Bands of World-wide Reputation—Gramophone Concert. 12.30 a.m. (Sunday), Close Down.

TOULOUSE (Radiophonie du Midi) (385 metres); 8 kW.—5.15 p.m., Orchestral Selection. 5.30, Operatic Music; Selection from Samson and Delilah (Saint-Saëns) and Fra Diavolo (Auber). 5.45, Sound Film Music. 6.0, Classical Music for Orchestra; Selection from Rosamunde (Schubert); Mazurka in C (Chopin); Mazurka in B Minor (Chopin). 6.15, Accordion Solos. 6.20, Racing Results and Exchange Quotations. 6.45, Operetta Music; Good-night and Pardon Madame from Victoria

and Her Hussar (Abraham); Waltz from T Gipsy Baron (Strauss); Selection from Counte Maritza (Kálmán). 7.0, Orchestral Musi Dream Waltz (Millöcker); Selection from E (Lehár); Mother Goose Parade (Bréau); Val bleu (Margis). 7.15, Spanish Songs. 7.3 News Bulletin. 7.45, Accordion Solos. 8. Military Music. 8.15, Melodies from Opéra Comique: Rosina's Aria from The Barber of Seville (Rossini); Aria from Tosca (Puccini) Aria from Manon (Massenet). 8.30, Orchestra Music: Hurra! die Musik kommt (Zimmer) Selection from Il Seraglio (Mozart). 8.4 Selections by a Viennese Orchestra. 9.0, Extracts from The Barber of Seville (Rossini) 10.0, Accordion Solos. 10.15, Popular Songs 10.30, North African News. 10.45, Orchestra Selections. 11.0, Request Concert. 12 midnight, Weather and Announcements. 12.5 a.m. (Sunday), English Music. 12.30 a.m. (approx.). Close Down.

TRIESTE (247.7 metres); 10 kW.—7.5 p.m., Quintet Concert: Old Man Dance (Ferraris); Air (Caslar); Ricordi di Semmering (Lakke); Serenata inutile (Appollonio); Il ritratto di papa (Mignone); Potpourri, Eishlumen (Leuschner); Gita alpestre (Nucci); Quel che è fatto è fatto (Telo). In an interval at 7.25, French Lesson on Gramophone Records. 8.0 till Close Down, see Turin.

TURIN (273.7 metres) 7 kW. Relayed by **Milan** (331.5 metres), **Genoa** (312.8 metres), and **Florence** (500.8 metres).—7.5 p.m., Concert of Popular Music: Selection from The Marriage of Figaro (Mozart); Il Sogno (Catalini); Marionette (Ferraris). 7.30, Time Signal and Announcements. 7.35, Light Music on Gramophone Records. 8.0, Giornale Radio, Weather Report and Popular Music on Gramophone Records. 8.30, Topical Talk. 8.45, Variety Programme. In the interval, Book Review. 10.0, Dance Music relayed from the Luna Park Lido, Milan. In the interval at 11.0, Giornale Radio. 12.0 midnight, News Bulletin.

VATICAN CITY (19.84 metres) (Morning) and (50.26 metres) (Evening); 10 kW.—11.0-11.15 a.m., Religious Announcements in Different Languages. 8.0-8.15, Religious Information in Italian.

VIENNA (517 metres); 15 kW. Relayed by **Graz** (352.1 metres); **Innsbruck** (283 metres); **Klagenfurt** (453.2 metres); **Linz** (246 metres); and **Salzburg** (218 metres).—4.0 p.m., Dedication of the Haydn Memorial Organ at Hainburg. Dedication of the Organ, with Address by the Bishop. The Hainburg Church Choir: Du bist's dem Ruhm und Ehre göhrt (Haydn). Handing-over of the Organ to the Church Authorities. Prelude in E flat (Bach); Song, In nomine domini (Haydn); Organ Solos by Karl Mätzl: (a) Benedictus (Reger), (b) Fantasia on Grosser Gott. 5.0, Orchestral Concert. 6.40, Talk: Pictures from the Alps. 7.5, Topical Programme. 7.35, The Day-book of one who vanished (Leo Janacek) by Georg Markl (Tenor), Gertrude Rünger (Contralto), Sophie Mumteum (Soprano), Julie Waldek (Contralto), Luise Brix (Contralto), and Dr. Paul Amadeus Pisk (Pianoforte). 8.15, Time, Weather, Programme Announcements, and Sports Notes. 8.30, Benefit Concert by the Austrian Conductors' Union, relayed from the Zögernitz Casino. 10.0, News and Weather. 10.15, Uigány Concert from the Hotel Gellert, Budapest.

WARSAW (1,411 metres); 120 kW.—12.45, Popular Music on Gramophone Records. 1.25, Interval. 1.35, Light Music on Gramophone Records. 2.10, Interval. 3.0, Economic Report. 3.10, Variety Music on Gramophone Records. 3.30, Answers to Correspondents on Military Questions. 3.40, Programme for Children. 4.5, Music for Children. 4.35, Announcements. 4.40, Review of Periodicals. 5.0, Selections from Operas, by the Station Orchestra conducted by Josef Oziminsky. Selections from (a) The Queen of Spades (Tchaikovsky), (b) Hansel and Gretel (Humperdinck), (c) Halka (Moniuszko), (d) Tosca (Puccini), (e) Martha (Flotow). 6.0, Divine Service, relayed from **Wilno** (563 metres). 7.0, Sacred Music on Gramophone Records. 7.15, Miscellaneous Items. 7.35, Radio Journal. 7.45, Agricultural Report. 7.55, Programme Announcements. 8.0, Concert of Light Music by the Warsaw Philharmonic Orchestra, conducted by S. Navrot. Soloist: S. Zulez (Baritone). 8.55, In an interval: Feuilleton: On the Horizon. 9.50, Radio Journal. 9.55, Aeronautical Weather Report. 10.0, Interval. 10.5, Chopin Pianoforte Recital by Eust. Horodysky: Fantasia in F minor—Two Preludes: (a) in A flat, No. 26, (b) in G, Op. 10, No. 7; Mazurka in F minor, Op. 7; Waltz in A flat, Op. 64; Nocturne in E. Op. 62.

BROADCAST BREVITIES.

By Our Special Correspondent.

How We "Sustain" America.

I HAVE made the interesting discovery that our American cousins seem to be rather more attracted by our broadcast programmes than we are by theirs. The recent exchanges between the B.B.C. and the Columbia Broadcasting System of America were a frank and open arrangement, shouted from the housetops, but British listeners may not be aware that both the National and Columbia chains in U.S. now make a regular practice of "tapping" 5SW.

Why Hiram is Lucky.

These borrowed excerpts are used in "sustaining" periods, i.e., those portions of the day when no advertiser has bought time on the air, but which must nevertheless be filled with music or speech if listeners are not to lose interest in the stations.

From eight o'clock onwards on any of these summer evenings Hiram K. Yellowhammer, of Okla., O., may be enjoying the B.B.C.'s Wireless Military Band with as much gusto as John Smith, of Balham; with *more*, perhaps, for Hiram gets it without paying a licence fee!

Pay It With Music!

I think this is quite a happy arrangement provided that our Transatlantic cousin recognises his indebtedness. If he can be persuaded to look at things in the right light, the B.B.C. could render a national service by liquidating war debts with music.

Squads of B.B.C. musicians could play in relays throughout the twenty-four hours, clearing off the debt at the rate of a few million dollars a day.

British Programmes for Germany.

The Wireless Military Band, besides being popular with Americans, has a large following on the Continent. On July 1st the band's evening broadcast will be relayed to German stations at Königswusterhausen, Stettin, Magdeburg, Breslau, Gleiwitz, and to Langenberg and Munich with their respective relays. All the Austrian stations will also participate.

Canada, Too.

Canadians are attentive listeners to the B.B.C. broadcasts. To-morrow (Thursday) Canadian stations will relay all the speeches at the Dominion Dinner in London. H.R.H. the Prince of Wales will be the principal speaker.

That "Secret" Charter.

IT is difficult to pick holes in the so-called "Secret Charter" of the B.B.C. All that it amounts to is the insertion of a special clause in the Charter by Mr.



"THE QUALITY OF MERCY IS NOT STRAINED." An actress at the Munich broadcasting station in the rôle of Portia.

Atlee, the P.M.G. in the late Labour Government, enabling the Corporation to realise some of the capital invested in trustee securities as a Sinking Fund *if required for the purpose of capital expenditure.*

The B.B.C. is not breaking on its reserves for its day to day expenditure.

Money Pouring into Portland Place.

No one need lie awake o' nights worrying over the finances of the B.B.C. Against the £150,000 sacrifice to the Treasury during the current financial year, the B.B.C. can count upon an additional £100,000 from the increase in licences since December last, when the total issued amounted to 4,301,754. On May 31st—five months later—the total had risen to 4,699,367, an increase of nearly 400,000, from which the Corporation receives approximately five shillings per licence.

Where Is That Saturation Point?

It looks as if the five million figure will be easily reached before the end of the year.

And yet we were already beginning to ask if the "saturation point" was near in 1928!

Talkie Producer's Broadcast Sketch.

ADRIAN BRUNEL, playwright, film producer, journalist, and broadcaster, has written a comedy sketch entitled "Good Morning, Boys," which will be given in the London Regional vaudeville programme on July 4th. He was responsible for the first British "talkie," "Elstree Calling," and his silent pieces include "The Constant Nymph," "The Vortex," and "The Man Without Desire." His microphone adaptation of his own stage play, "Till To-morrow," was one of the B.B.C.'s recent successes.

Half-holidays Sacrificed?

IT would be difficult to find a more optimistic body than the Central Council for School Broadcasting, yet even this body, in a newly issued pamphlet, "Some Problems of School Broadcasting," sounds a doubtful note. Speaking of teachers who view broadcasting in a sceptical light, the Council remarks: "They (the teachers) will find it . . . difficult to believe that an unseen personality may so enthral a child that he may wish to come back to school on a half-holiday rather than miss a single lesson from a favourite broadcast teacher." I should share the teachers' difficulty.

The Voice from Outside.

The booklet discusses four main questions, namely, (1) What shall be broadcast to schools? (2) Who is to broadcast to schools? (3) How should broadcast lessons be used in schools? (4) Why are not more schools taking broadcast lessons? Each is discussed in a candid and common-sense manner. Half the value of school broadcasting, it would appear, resides in what must be recognised as "broadcasting personality." "A fresh voice coming from the outside, informed and enlightened by a type of experience other than that which is common to the teachers in the school, may sow intellectual seed in the soil of certain young minds which may prove ultimately to be of very great value."

Broadcasting a Parliament.

FOR the third year in succession the quaint Tynwald ceremony will be made available to North Regional listeners by means of a running commentary on July 5. The Tynwald is the parliament of the Isle of Man, and has a contentious history of nearly a thousand years. It is only exceeded in antiquity among the parliaments of Europe by the Icelandic assembly known as Althing.

In Honour of France.

IT has been the practice of the B.B.C. to broadcast on July 14th of each year a programme on the subject of France, for this day is the National Feast Day of France. This year the programme is emanating from Scotland, though it will be broadcast on the National wavelength. It is entitled "The Auld Alliance," and is based upon the traditional friendship existing between the ancient kingdoms of Scotland and France. The programme consists of narration, sketches, and music. Plentiful use has been made of music, and of the remarkable similarity between the popular French tunes and the Scottish country dances. The programme is written by Moray McLaren, and the music arranged by John Gough.

Rungs in G. B. S.'s Ladder.

I FANCY that George Bernard Shaw's contribution to the "Rungs in the Ladder" series will contain something a little more startling than we have yet heard. His eventful career could probably be better described as clambering up the greasy pole. The date? July 11th.

COLUMBIA

Four-valve Combined Receiver and Electric Gramophone for A.C. Mains.

THE circuit specification of the receiver embodied in the Columbia Model 603 radio-gramophone places it definitely in the category of long-range receivers, for of the four valves it includes two are employed as high-frequency amplifiers. Yet despite the exceptional sensitivity available, when the occasion demands, it is always under perfect control and there is no difficulty whatsoever in handling the receiver in close proximity to a powerful broadcast station. Simplicity of operation is, perhaps, one of its most attractive features, as there are three controls only and their respective functions are soon mastered.

By means of mechanical couplings each control is made to serve two or more functions; for example, the wave-change and radio-gramophone switches are operated by one knob having three well-defined positions. The volume-level adjustment serves for both radio and gramophone, and in addition embodies the mains on-off switch. The tuning control operates all three condensers simultaneously through a reduction drive and a phosphor-bronze band, which, being anchored both to the drum on the condenser spindle and to the driving mechanism, precludes any possibility of slip or backlash. There is an illuminated dial, calibrated in wavelengths, and with separate scales for each waveband.

A particularly robust and well-made induction-type electric motor is fitted, which, together with the gramophone pick-up and the moving-coil loud speaker, are of Columbia design. An automatic stop embodied in the turntable unit switches off the motor supply when the record is played. The maximum volume obtainable from the gramophone is more than sufficient for normal domestic use, but it is often



FEATURES.

General.—Four-valve receiver chassis for operating with external aerial and earth or mains aerial. Wavelength calibrated scales. Moving-coil loud speaker and induction-type electric motor. For A.C. supplies from 190 to 250 volts at 40 to 60 cycles.

Circuit.—Two screen-grid H.F. valves. Transformer couplings. Grid detector followed by parallel-fed L.F. transformer and pentode output valve. H.T. from full-wave rectifying valve. Provision for external loud speaker.

Controls.—(1) Single-knob tuning. (2) Wave-change and radio-gram switch. (3) Combined volume control and mains switch.

Price.—10 Guineas.

Makers.—The Columbia Graphophone Co., Ltd., 98/108, Clerkenwell Road, London, E.C.1.

convenient to have an excess available, since the instrument may be called upon occasionally to provide dance music in a large room or small hall, as the case may be.

The quality of reproduction, both on radio and gramophone, is excellent; the built-in moving-coil loud speaker has a good response characteristic, is free from noticeable resonances, and does full justice to the well-balanced electrical circuits.

RADIO-GRAMPHONE.

Model 603.

Despite the presence of the pentode the upper register does not obtrude but is present in correct proportion, while the bass is well in evidence, and, as a whole, the reproduction is a very faithful replica of the original, whether this be broadcast or gramophone.

Mains hum is possibly most noticeable by its absence, for with the receiver tuned to a silent part of the waveband, if such can be found, since the receiver is particularly sensitive even to distant transmissions, it is audible only within a foot or two of the loud speaker fret. In this respect the Model 603 is especially satisfactory on both wavebands, and on the gramophone side the increase is so slight as to pass unnoticed unless one's attention is directed to it.

Reception of distant stations is particularly good, the sensitivity on the long waveband, in particular, being most noticeable even when using quite a short outdoor aerial; indeed, one of any considerable length might prove far from an advantage close to a powerful broadcast station. A short indoor aerial was found extremely effective with this model, giving an adequate number of alternative programmes. Provision is made for using the mains as an aerial if desired, which, in the majority of cases, will provide adequate volume from the local station, and, under favourable conditions, gives a choice of a few Continental programmes.

The four stages in the receiver are arranged so that two function as high-frequency amplifiers, coupled by specially designed H.F. transformers. A single tuned circuit only is included between the aerial and the first valve, but, as there are three tuned circuits in all, this need not give rise to speculation regarding inadequate selectivity.

The aerial is loosely coupled to the input circuit, the same order of coupling being maintained on the long waveband by the inclusion of an additional loading coil. Two

LONG-RANGE RECEIVER WITH TWO H.F. STAGES.

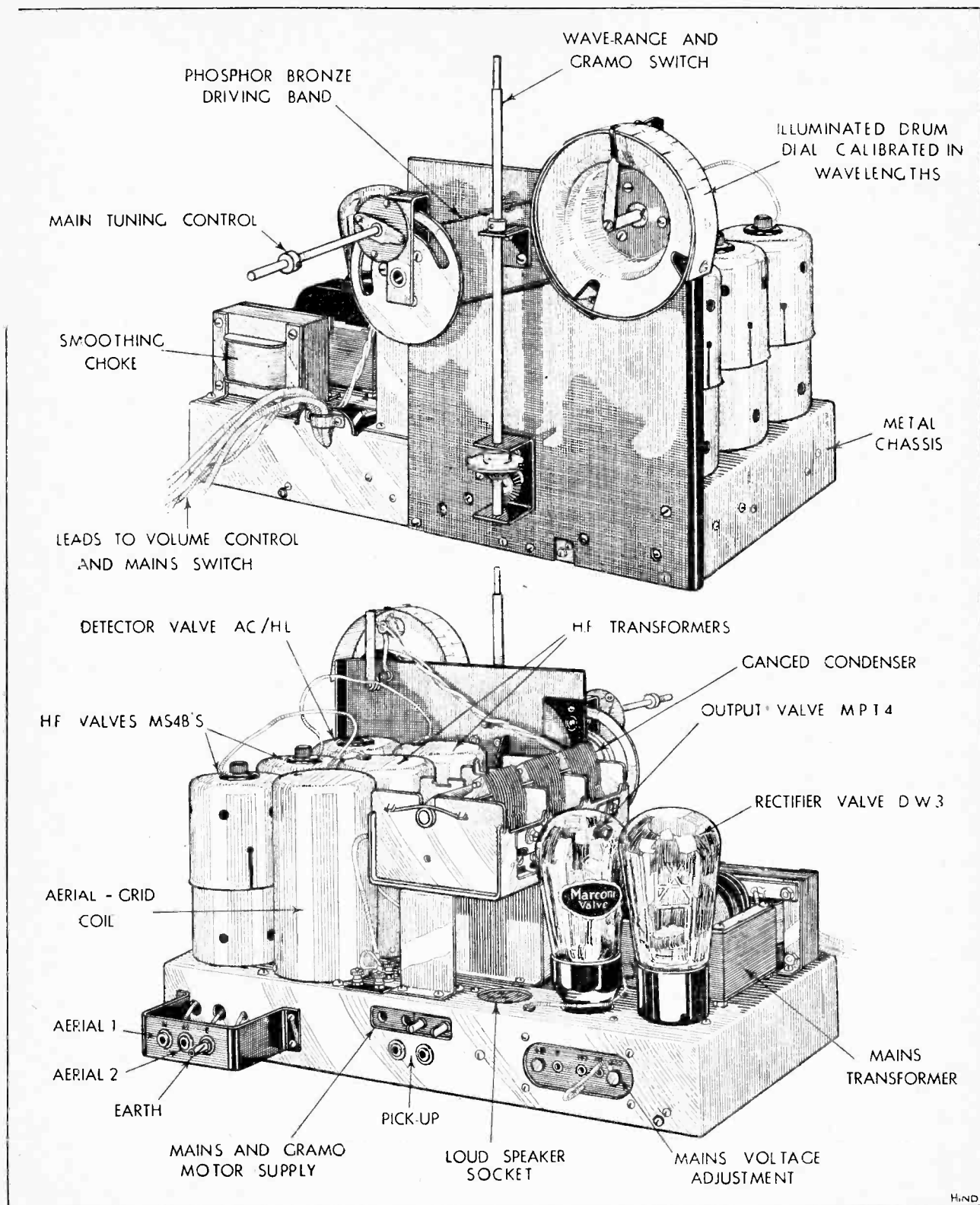

Two views of the chassis. Simplicity of operation is a feature of this instrument.

A 31

Columbia Radio-Gramophone.

aerial connections are provided, the one going direct to the aerial coil while the other interposes a small series condenser. With indoor aerials the direct connection should be used, but if an outside aerial of average length is available the lead may be attached to the alternative connection, since it enhances the selectivity but detracts little from the range, as the sensitivity is maintained still at a very high level.

A reaction circuit is not included, but self-oscillation can be incited by turning the volume control to the full maximum position. This control takes the form of a high-resistance potentiometer, which on the radio side is so connected that it controls the grid bias for the two H.F. stages, but, when using the gramophone, is switched into the pick-up circuit

small terminals are provided on the chassis for the attachment of an external loud speaker, but if advantage is taken of this the instrument used must be of the low-resistance type, since these terminals are connected to the secondary winding on the output transformer.

All stages are carefully decoupled, a very necessary precaution in any modern set, but essential in a receiver of this type where there are two high-frequency stages. High tension is provided by a full-wave rectifying valve and a single L.F. choke of high inductance, in conjunction with condensers of large capacity, constitute the smoothing equipment. The arrangement is particularly effective, for there is a very slight trace only of mains hum.

Although an instrument of this type naturally appeals primarily to

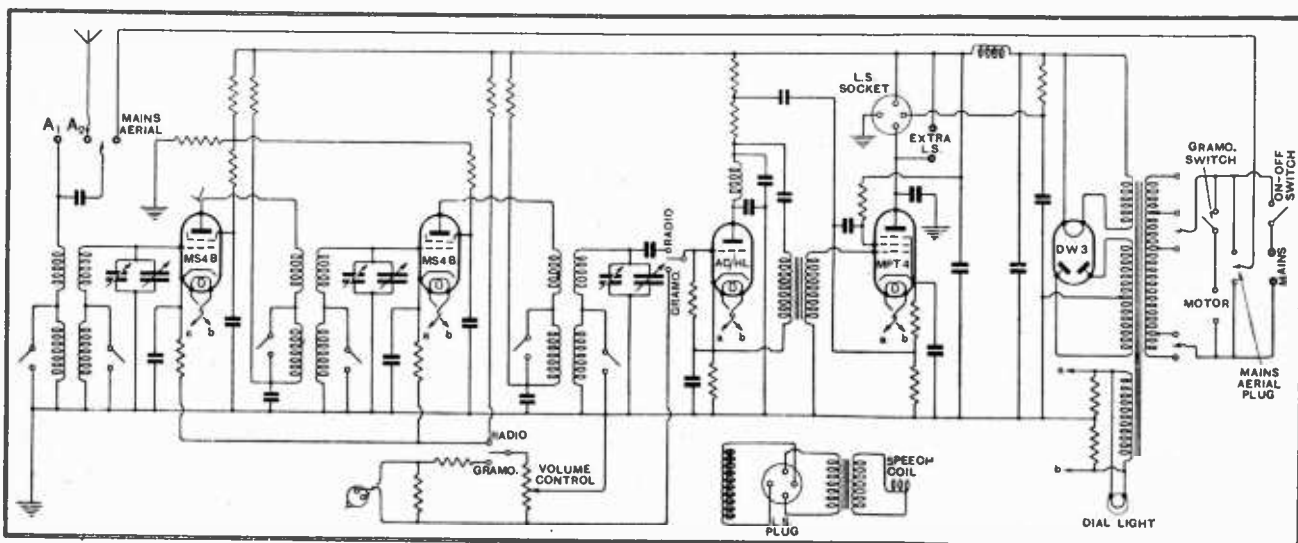

Full circuit arrangement of the Columbia Radio-Gramophone Model 603. An ingenious control of volume for radio or gramophone is included.

and serves to control the input to the detector. This valve is automatically converted into an amplifier during the switching process, a small negative bias being applied.

Following the detector is a parallel-fed intervalve L.F. transformer, working into a pentode output valve, which is transformer-coupled to a low-resistance loud speaker. This is one of the energised type, the field winding being connected in shunt with the main H.T. supply, but with a small resistance interposed to adjust the current to the correct value. Two

the ear, its fine qualities do not rely solely upon this sense, for it is equally attractive to the eye, being housed in an exceptionally well-made cabinet of pleasing design. Two control knobs only are visible; the third, together with the scale aperture, is accommodated on the enclosed motor board, where it falls most convenient to the eye when standing in front of the receiver.

Both in appearance and performance the Model 603 fully exemplifies those fine qualities which have always been a feature of Columbia products.

entire sound or discriminate between the different instruments.

The Society's meeting on June 20th was devoted to short-wave work, arrangements being made for a special message to be transmitted to the Society on short waves.

Hon. Secretary: Mr. R. Pankhurst, 9, Shakespeare Road, Kettering.

Hunting a Roaming Transmitter.

SOME dozen cars were used in an exciting radio hunt held by the Slade Radio Club, of Erdington, Birmingham, on June 5th. The quarry was the transmitter G2AK fitted on the car of Mr. C. H. Young. No fewer than five parties succeeded in finding the transmitter, the winner being only a minute ahead of the runner-up. The experience of one competitor created amusement. He had forgotten to change his set from long waves to short and consequently for a few miles after setting out he was tracking down Daventry 5XX! The Society is discussing the proposal for a transmitter hunt between midnight and breakfast time.

Hon. Secretary: 110, Hillaries Road, Gravelly Hill, Birmingham.

CLUB NEWS.**New Headquarters.**

THE Radio and Television Society have moved into new and more commodious quarters at The Hut, Lonsdale Road, Barnes S.W.13, which is a few minutes' walk from Barnes Bridge Station on the Southern Railway. Hon. Secretary: Mr. G. E. Edwards, 48, Tager Road, Richmond, Surrey.

New Yorkshire Society.

AT Rawmarsh, near Rotherham, a Radio Society and Short-Wave Club has been formed with a membership of about 39. Meetings are held at the Haugh Road Senior School on alternate Thursdays at 7 p.m. New members are cordially invited, and particulars of the Society may be had from the Hon. Secretary, Mr. J. J. Holton, 7, Osburton Street, Rawmarsh.

How Sounds are Produced.

SEVERAL members of the Northampton Radio Society were visitors at the meeting of the Kettering Radio and Physical Society on June 6th, when Mr. B. Kew lectured on "How Sound is Reproduced." Mr. Kew described in a vivid way, with graphical illustrations, how the compound sound of an orchestra was built up, and how the ear was able to pick up the

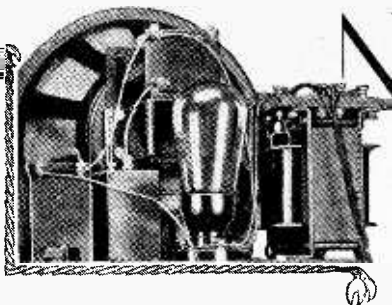

NEW PENTODE OUTPUT CIRCUIT

By L. G. A. SIMS, Ph.D., A.M.I.E.E.

Low-Frequency Power Compensation.

THE pentode output stage differs from that of the power triode by several interesting peculiarities which arise from the high and variable resistance of the pentode. For example, there is the practice of matching the pentode to a load of much smaller impedance than its own nominal impedance, and of placing a resistance and small condenser across the load in order to maintain roughly the same overall-load impedance at all frequencies. Thus, if *The Wireless World* "Valve Data Sheet" be consulted, it will be found that optimum

load values are quoted for all pentodes, and, though it is not the practice to show the pentode resistances because of their variability, it may be taken that the optimum load values are in all cases below the average nominal resistances of the pentodes to which they apply. Again, the makers' instruction leaflets usually contain suggestions for suitable resistance-condenser combinations to employ across the load, together with special warnings as to the undesirability of tampering with the output circuit whilst the pentode is in operation on account of the high peak voltages which may be produced.

Readers who wish to recall in detail the reasons for the above will find them dealt with in various past articles in these pages, but the author would refer them particularly to an article early in 1929,¹ in which some of the practical aspects of pentode loading were dealt with for the first time. The subject of the present article developed as a result of earlier experiments upon the pentode which are described in that article.

It is sufficient now to recall that there is an important fundamental difference between the output circuit

conditions for the pentode and the triode, which can be indicated diagrammatically, as in Figs. 1 and 2, where a skeleton output circuit, consisting of the internal resistance of the valve in series with a resistance to represent the load, is shown for the pentode and triode respectively, the relative values of the resistance in each case being indicated very approximately by their lengths in the diagram. The valve resistance is marked R_v , and that of the load R , and it is seen that, whilst the pentode works with a comparatively low load resistance, the case of the triode is just the opposite, as its load is comparatively great.

It is here pointed out for the first time that a very considerable improvement in bass response can be effected by the use of quite a small capacity in the choke filter output circuit of a pentode. A condenser of about one-eighth of the usual capacity is made to resonate with the output choke at low frequencies and a circuit very similar to that of the parallel-fed L.F. transformer results. The resonance is damped out by the low impedance of a triode but remains almost unaltered by the high pentode impedance. Many practical examples of the arrangement are outlined.

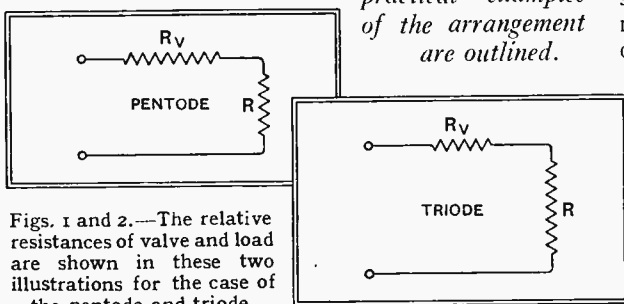

Figs. 1 and 2.—The relative resistances of valve and load are shown in these two illustrations for the case of the pentode and triode.

Condenser Values.

Now, in practice, R_v and R may be coupled together in any one of three different ways: (1) directly, as shown; or (2) by means of an output transformer; or (3) by means of a choke-condenser unit. A little mathematical analysis shows that the last case, namely, that of the choke-condenser output, is affected in a very marked manner by the relative values of R_v and R when a pentode is used as the output valve.

Stated briefly, the output from the pentode at low frequencies can be increased very greatly by the presence of the coupling condenser, whereas the triode output is not affected in the same way.

It is at present common practice to use an output coupling condenser of capacity 2 microfarads indiscriminately with both types of valve. This value is specified presumably because it has always been satisfactory with the triode. But the fact is that both mathematics and experiment show that a smaller value of condenser leads to a greater output at low frequencies from the pentode, though, in accordance with popular belief, it reduces the output of the triode.

¹ See "The Pentode and Power Amplification," L. G. A. Sims, *The Wireless World*, Vol. 24, No. 490, January, 1929.

New Pentode Output Circuit.—

Figs. 3 and 4 will make this clearer. Fig. 3 shows two experimental curves taken with a typical modern triode output valve at a frequency of 50 cycles per second. It is seen that the power delivered by the

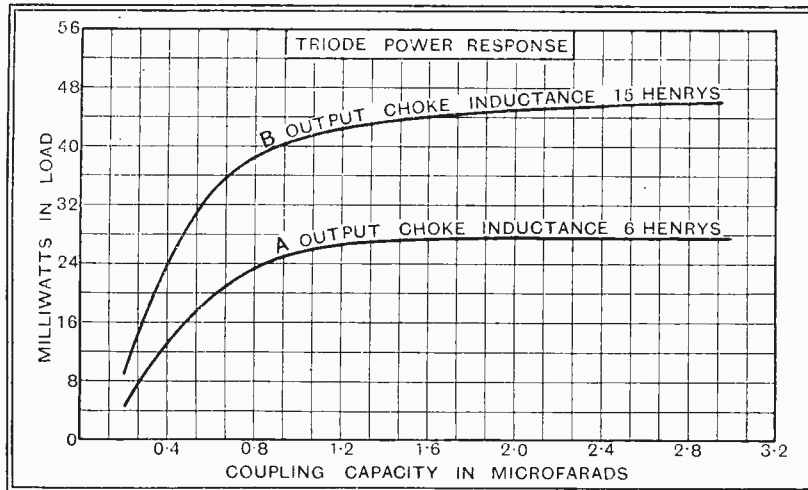

Fig. 3.—With a triode the power output is changed very little when the choke filter condenser is increased from one to three microfarads. The valve used was a P.240 type and the frequency 50 cycles per second.

valve increases steadily as the capacity is increased and that a 2 microfarad condenser is entirely satisfactory, though, if anything, unnecessarily large. But a reduction to 1 microfarad, though practicable, would be suggested only from the viewpoint of economy in the cost of the condenser, not from any advantage in power output.

But Fig. 4 shows a quite different result. The curves in this figure relate to a typical pentode. It is clear that a 2 microfarad coupling condenser gives much less power output than one of about 0.3 microfarad.

This result is demonstrated again in a very practical manner by the curves of Fig. 5. Here the power response curve of the same pentode is plotted from experimental results taken over a range of frequencies between 50 cycles per second and 6,000 cycles per second. The lower curve refers to the power output using a standard commercial choke-condenser unit containing a 2 microfarad condenser. The upper curve shows the result of reducing the coupling condenser to the value of 0.25 microfarad.

So far as the author is aware, this peculiarity of the pentode power stage has not previously been pointed out. It is a direct result of the special load conditions which, as is now well known, have to be employed with the pentode in order to avoid anode-voltage peaks and distortion of output.

Careful measurements show that the

use of what we may now call "Critical Capacity coupling may compensate the low-frequency power response to almost any desired degree. For example provided that the coupling choke has a fairly high inductance, the normal droop in the low-frequency response (see Fig. 5, lower curve) may be either raised to the extent that the curve becomes almost perfectly straight from, say, 50 cycles per second up to the high audio frequencies, or, if desired, may be converted into a hump thereby tending to compensate for deficiency in the bass response of the loud speaker.

Since the critical value to be employed in any given case may differ somewhat according to the other components in use in the circuit, it is necessary to examine such differences, and, in the present instance, this is best accomplished by further experimental curves. For example, if Fig. 6 represents the essential components of a pentode output stage, the equivalent circuit for which is given by Fig. 7, we have to know how the critical value of capacity is affected by changes in the load impedance, by the choke tapping point T_1 , T_2 , or T_3 , to which the condenser and load are connected, by the inductance of the choke and by different pentode internal resistances.

Effect of Load Impedance.

Fig. 8 shows curves of 50-cycles power plotted against change of coupling capacity for two widely different values of load, other conditions being kept constant. Curve A relates to a load consisting of a

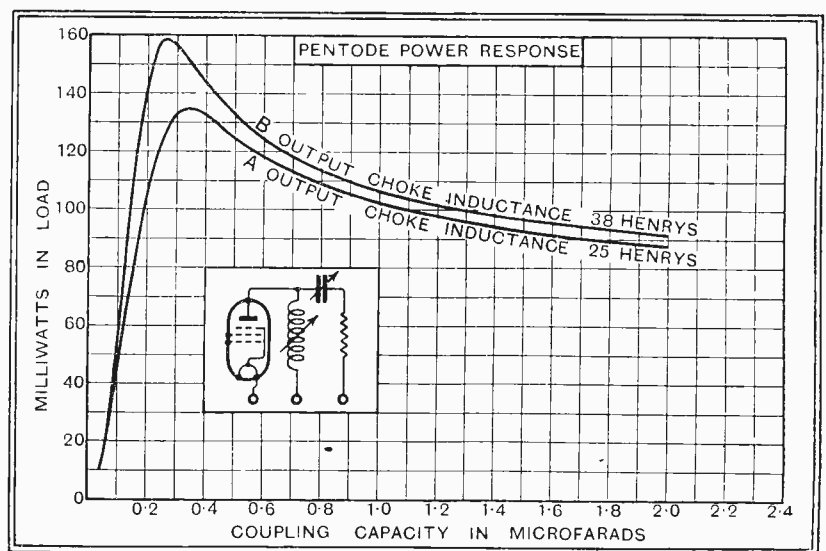

Fig. 4.—Quite an appreciable drop in power output results from an increase of capacity from 0.3 to 2 mfd. in the choke-filter condenser in the case of a pentode (valve used PT.240 and frequency 50 cycles).

w Pentode Output Circuit.—

istance of 10,000 ohms and curve B to one of 750 ohms. The curves show that the critical capacity is not affected by this very large variation in load conditions, though the percentage increase of power at the critical value of capacity is very much greater for

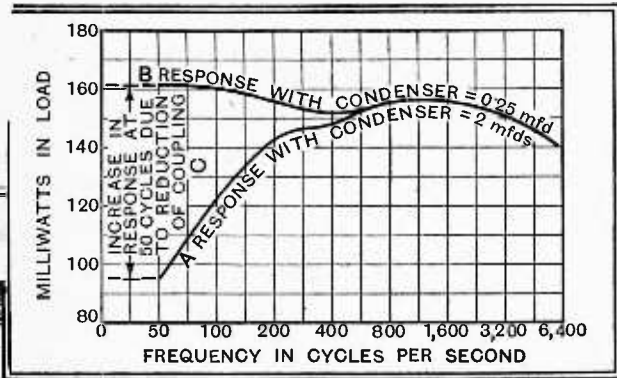

Fig. 5.—Curves showing the marked improvement in bass response when using an 0.25 mfd. coupling condenser as compared with a 2.0 mfd. condenser in a pentode output circuit

the low resistance. Now, the loud speaker is, of course, the most usual form of load, and this has a variable impedance which is lowest at the low frequencies, so that the critical capacity would seem to be particularly effective if used in a practical output stage.

The curves so far dealt with have all shown a capacity of about 0.25 to 0.4 microfarads for 50 cycles per second, and it is well to review the cases taken in order to see what has been covered. Fig. 4 showed that changing the choke inductance from about 25 henrys to about 40 henrys changed the critical capacity from about 0.35 microfarads to about 0.25 microfarads, whilst Fig. 8 showed that changes in the load resistance did not affect the value of capacity at all. But all these curves related to a tap ratio of unity, that is, to the tapping position T_1 in Fig. 7. What modification will be introduced by connecting to positions such as T_2 and T_3 ?

Fig. 9 provides the answer to this question, for it shows curves plotted for different taps on the coupling choke. If these curves be examined it will be found that the critical capacity value varies according to the square of the tapping ratio. Thus, for example, with a centre-tapped choke the capacity

will be four times as great as with a plain untapped choke because the tap ratio of the former is two, and so on. This simple relationship is very convenient.

Tapping ratios greater than about 3 to 1 are mainly used with low-resistance moving-coil loud speakers, and the curves of Fig. 9 teach that, in this case, a well-designed output transformer is to be preferred to a choke-condenser unit as the value of condenser required in the latter increases alarmingly as the tap ratio goes up—see, for example, the curve for the modest ratio of 3 to 1, where 3.6 microfarads is necessary for maximum power, and the usual 2 microfarads is then much too small.

We have now only to examine curves showing the

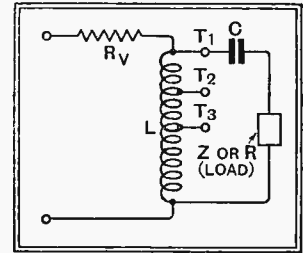

Fig. 7.—The equivalent electrical network of Fig. 6.

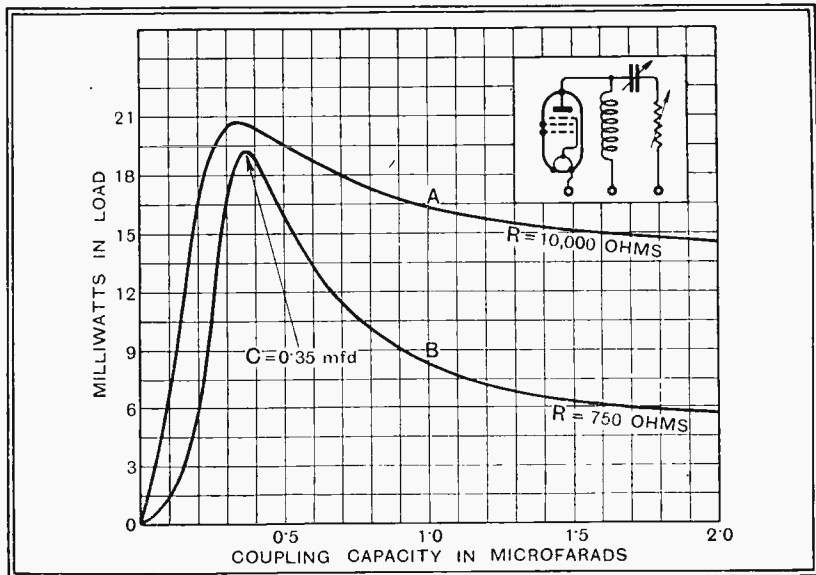

Fig. 8.—Curves A and B show how change of load affects the output when the condenser capacity is altered. The output at "critical capacity" in both cases is the highest.

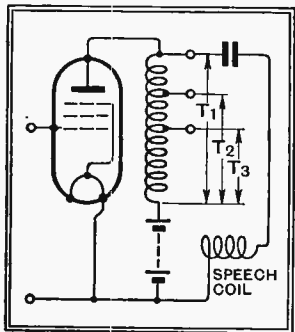

Fig. 6.—Conventional pentode circuit with tapped output choke.

effect of changing the pentode and of using an actual loud speaker in place of a resistance as a load. Both these cases are included in Fig. 10, where curves for three different pentodes working into a modern inductor-dynamic loud speaker are shown, an untapped choke being used. It will be seen that changing the pentode has practically no effect upon the critical capacity value, which in this case was about 0.25 microfarad, whilst the presence of an actual loud speaker accentuates rather than diminishes the effect we are dealing with. The possibility of this was foretold earlier in the article. (It should be stated that the volt input to the different pentodes in this test was not the same in each case. This was necessary because of their different amplifying properties in order to avoid too

New Pentode Output Circuit.—

great divergences between the curves. It does not affect the capacity values.)

This completes the examination of all the variable quantities in the circuit so far as space permits in the present article, and, to summarise results, it may be said that the value of the critical capacity for a given frequency is practically independent of all the circuit components except the choke. The inductance of the latter, if of the normal value of about 30 to 40 henrys, causes small changes above and below 0.3 microfarad for the frequency of 50 cycles per second. The ratio of the choke tap may cause large changes which, however, are proportional to the square of the ratio.

Condenser-fed Transformer.

It should be clear that, although the treatment of the case has been based upon a frequency of 50 cycles per second, this is in no sense a fundamental frequency. The same arguments apply throughout the low-frequency band, and therefore, if any small capacity of the order 0.3 microfarad is used as an output coupling, it will tend to compensate the low-frequency response, being, however, particularly effective at one frequency. Thus a condenser of capacity 0.1 microfarad will compensate most strongly in the region of 100 cycles per second. On the other hand, larger capacities will tend to compensate at still lower frequencies than 50 cycles, but the compensation is weaker. So long as a pentode is in use compensation in some degree will occur with

a wide range of capacity values,² but the most valuable effects from the point of view of correction of the deficiencies of the normal response curve are given by capacities of the order 0.3 microfarad, and this value

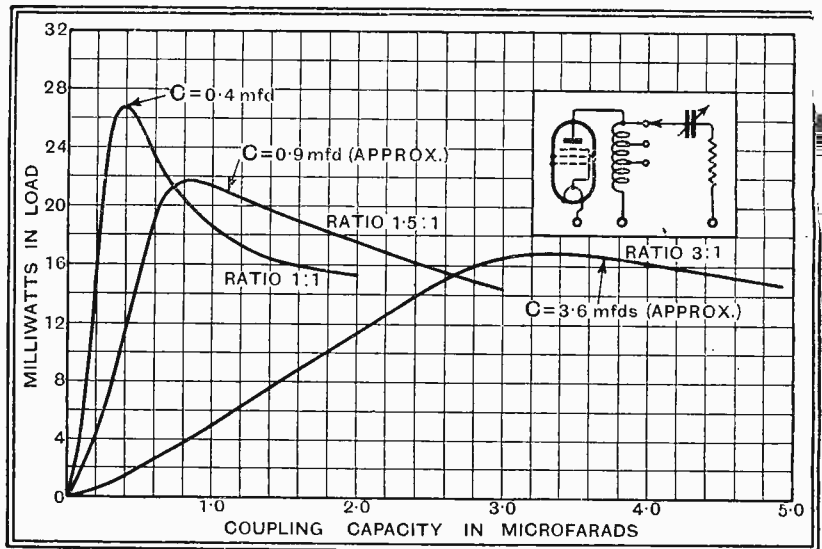

Fig. 9.—The effect of changing the choke tapping (or auto-transformer ratio) is shown by the curves. Frequency 50 cycles per second.

is recommended for trial—or the correct multiples of it where the tap ratio is not unity.

Now, although the treatment so far given relates to choke-condenser coupling particularly, why not apply it to the output transformer also, provided that its ratio is not so great as to call for the use of an unduly large condenser? The output choke, whether tapped or not, is, after all, a transformer of the special type known in power engineering as an "auto-transformer."

A theory which applies to the output choke will therefore apply equally well to the output transformer, and a condenser inserted in series with the load on the secondary side of such a transformer will increase the power delivered, especially if the condenser has the critical value as defined above. This gives a means of increasing the bass response of a poor output transformer. For example, Fig. 11 shows the output from 50 cycles per second to 1,600 cycles per second of a 1.5 to 1 output transformer whose bass response was not too good. The lower curve relates to the transformer as designed, and the upper one is a repetition, with a condenser of capacity 0.8 microfarad in series on the secondary side. This was

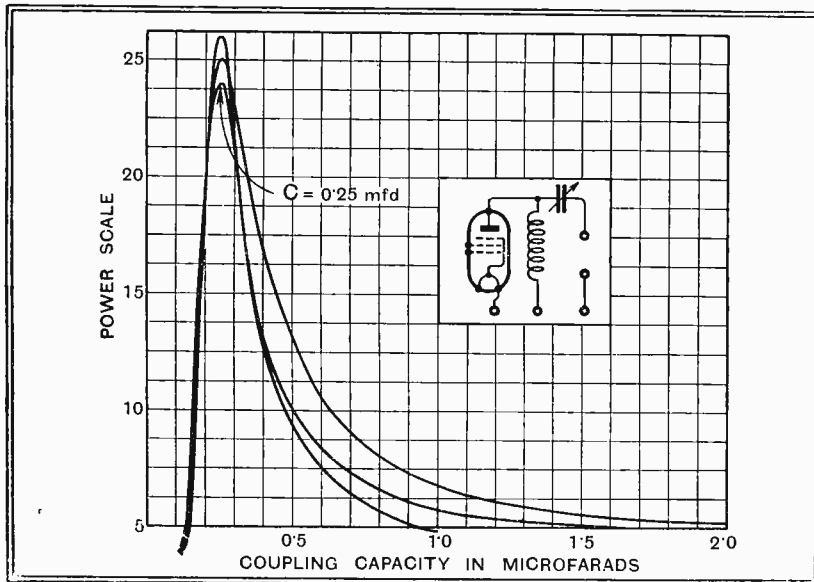

Fig. 10.—With an untapped choke and three modern pentode output valves the above curves speak eloquently of the effect on power output of the "critical capacity."

² Even with the triode a coupling condenser may give a slight power increase, but there is no value which will either completely compensate or over-compensate the response curve at any point in the bass register, and strictly it is in this special respect that the pentode differs.

ew Pentode Output Circuit.—

the critical capacity for 50 cycles per second, and if we divide it by the square of the transformer ratio we obtain a value which is in line with the results obtained upon untapped output chokes. It is seen that the presence of the condenser increases the power at 50 cycles by about 70 per cent. The increase would have been much greater had the transformer had a larger primary inductance.

This is a point of further interest—output transformers usually have less primary inductance than output chokes because there is less room inside for a large primary winding. But this is all the more reason to experiment upon applying bass compensation by the use of critical capacity. Fig. 12 shows the power-capacity curve for a pentode and output transformer, with capacity added in the secondary winding, working into a loud speaker. The normal transformer power level is indicated by a dotted line.

In conclusion, the author would say that his own experiments upon the subject outlined in the article have necessarily been confined more to laboratory measurements than to aural experiments upon receivers reproducing broadcast, but such trials as he has been able to make of "critical capacity" coupling in conjunction with speech and music seem entirely favourable

changes, and it would be very helpful to have the opinion of amateurs who care to apply the principle in their receivers and note carefully the results. A few condensers of capacities 0.05 and 0.1 microfarad which

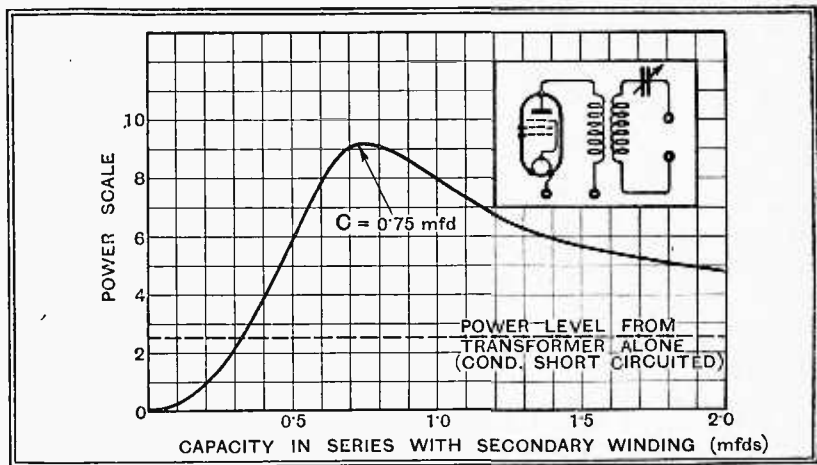

Fig. 12.—Power-capacity curve for pentode transformer output working into a speaker load.

can be connected in parallel step by step would make an ideal test equipment. For the rest, a pentode and a good-quality choke and loud speaker (capable of reproducing the low bass register) are all that is necessary. The usual high-note filter across the speaker will not affect the experiment adversely, but it is desirable to switch off the pentode during alteration of the circuit.

**“The Wireless World” Information Bureau.
CONDITIONS OF THE SERVICE.**

(1) THE service is intended primarily for readers meeting with difficulties in the construction, adjustment, operation, or maintenance of wireless receivers described in *The Wireless World*, or those of commercial design which from time to time are reviewed in the pages of *The Wireless World*. But every endeavour will be made to deal with general wireless queries.

(2) Communications should be addressed to *The Wireless World* Information Bureau, Dorset House, Tudor Street, E.C.4, and must be accompanied by a remittance of 5s. to cover the cost of the service. The enquirer's name and address should be written in block letters at the top of all communications.

(3) The fee of 5s. covers the reply to any wireless technical difficulty, but in special cases, where the enquiry may involve a considerable amount of investigation, an increased fee may be necessary. In such cases a special quotation will be made.

(4) Questions should be clearly written and concisely worded in order to avoid delay. Where enquiries relate to trouble experienced in receivers built to specifications in *The Wireless World* a complete account should be given of the trouble, and especially the symptoms.

(5) Where reference is made to published articles or descriptions of apparatus, the title of the article, the date of publication in *The Wireless World*, and the page reference number should be given, in order to facilitate reply.

(6) Full circuit diagrams, constructional details of apparatus, or values of components for home-designed receivers cannot normally be supplied, but circuit diagrams sent in with queries will be checked and criticised.

(7) Particular makes of components cannot, in general, be recommended, but advice will be given as to the suitability of a component for any particular purpose.

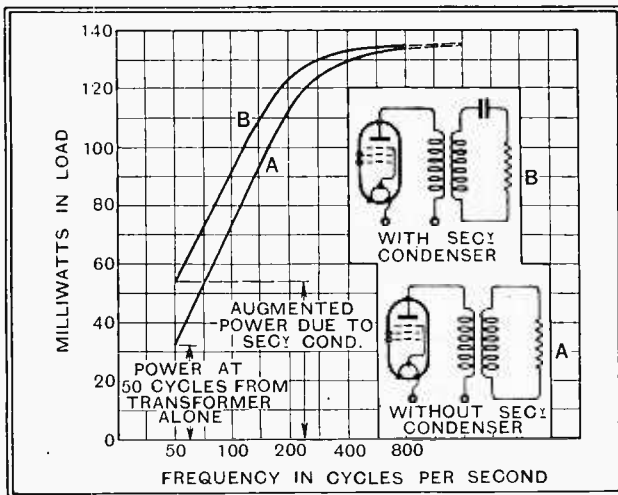

Fig. 11.—The effect on bass response of including appropriate capacity in output transformer circuit.

to its use. Moreover, there seems no theoretical reason why this should not be so. Loud speakers differ greatly, but even in those cases where the low-frequency response is not strikingly improved by the much smaller condenser, due to the characteristic of the speaker and of the human ear, at least an economy in condenser cost may be found possible. The "phase" relations in the region of the critical condition undergo rather violent

Nuts to Crack.

Instructive Problems and their Solution.

THE present series has been started by *The Wireless World* for the benefit of readers who like to work out little problems for themselves and be sure that the results they obtain are correct. At frequent intervals wireless problems are presented, and in the following instalment the answers are given with the methods of working them out, and hints on possible points of difficulty. Problems 51 and 52 have been previously given, and below the answers appear, whilst another set of problems is included this week for treatment in the next instalment.

QUESTION 51.—With constant grid bias of -1.5 volts, simultaneous values (v_a, i_a) of anode volts and milliamps for a certain valve are given as (75, 0.7), (100, 1.9), (125, 3.1), (150, 4.5). What will be the volts on the anode when the latter is connected through 50,000 ohms to 250 volts positive H.T., and what current will pass?

Answer—115 volts; 2.7 mA. (approx.).

This question is most conveniently answered by drawing a graph: really not at all a difficult business if some squared paper is handy. The figures given enable us to plot the characteristic curve of the valve for the constant grid bias of -1.5 volts; in less technical language, we are going to draw a picture of the relationship between the anode volts v_a , and the anode current, i_a , when the grid bias is maintained constant at -1.5 volts.

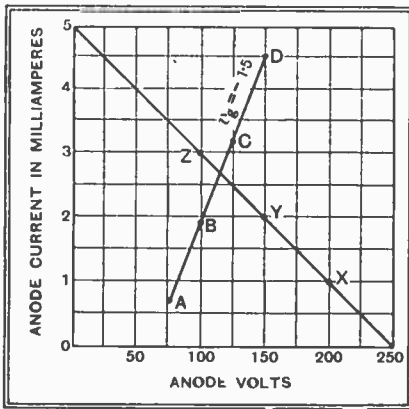

Showing how working values of anode current and anode voltage may be graphically determined in resistance-coupled amplification.

If, as in the figure, we take vertical lines to represent values of i_a , while horizontal lines represent values of v_a , we can plot the four points A, B, C, D, whose (v_a, i_a) values correspond to those of the bracket numbers given. We may join these points by a smooth line which, in this case, is almost straight. This line is the characteristic for $v_g = -1.5$; to save confusion this value should be attached to it as shown, for naturally other values of v_g will have other characteristics.

From this curve much information about the working of the valve may be obtained. For instance, if the current passing were 4 mA., we should see at a glance that the corresponding anode voltage would

actually be round about 140 (provided always that $v_g = -1.5$).

The same drawing may now be used in a very interesting and convenient way to show the relation between the loading resistance in the external anode circuit and the working voltage on the anode. We know, of course that, since there is always a steady or "mean" current flowing in the anode circuit, there must be a drop in potential across this resistance. In other words, the anode end of the resistance is at a lower potential than that connected to the H.T. source. In the case here considered the resistance of 50,000 ohms is connected to 250 volts positive H.T. If a mean current of 1 mA or 0.001 A. were to flow through it, the potential drop would be $IR = 0.001 \times 50,000$, or 50 volts, so that the potential of the other or anode end would be 200 volts. Again, if 2 mA. were to pass through it, the anode potential would similarly be only 150 volts; if 3 mA., 100 volts, and so on. Let us mark these points as X, Y, Z on the diagram. Obviously, they lie on a straight line passing through 250 volts and zero current. Now, any point on this line gives the anode potential when the current flowing through the resistance is known. But the other (valve) characteristic gives the anode potential when the current flowing through the valve is known. Now, since the current in the valve and the current in the resistance are the same, it does not need a Sherlock Holmes to see that there is one point on both lines which shows the same current, viz., the point of their intersection. This point, therefore, gives the working values for both i_a and v_a when the valve is connected to that particular resistance and that particular value of H.T. volts (and also, of course, for the particular value of grid bias used).

From an inspection of our diagram we readily see that at this point v_a is 115 volts, while the anode current is 2.7 mA. (approx.).

QUESTION 52.—What are (a) the D.C. resistance, (b) the A.C. resistance and (c) the anode power dissipation of the valve at the working point of the previous question?

Answer—(a) 42,600 ohms; (b) 20,800 ohms; (c) 310.5 milliwatts.

At the working point in question the mean P.D. between filament and anode is 115 volts, while the current flowing is 0.0027 A. The D.C. resistance of the valve

is, accordingly, given by $R = \frac{E}{I} = \frac{115}{0.0027} = 42,600$

ohms. This figure is, of course, of practically no importance whatever, since in actual working it is the response of the valve to A.C. that is of chief interest. The A.C. resistance is given in thousands of ohms by

the fraction $\frac{\delta E}{\delta I}$ where δI is the increase of anode

current in mA. consequent upon the small increase δE in anode volts, the grid volts being held constant. To find the A.C. resistance of the above characteristic at the working point, we may consider the small stretch of the curve between B and C on which this point lies. The difference δE between the voltage values at B and

is 25 volts; the difference δI in the corresponding current values is 3.1-1.9, or 1.2 mA.

Hence, A.C. resistance = $\frac{25}{1.2}$ thousands of ohms =

20,800 ohms (approx.).

Finally, the anode power dissipation is given in milliwatts by the product anode volts \times anode milliamperes at the working point, i.e., anode dissipation = $15 \times 2.7 \text{ mW.} = 310.5 \text{ mW.}$

As a check on this we may use the relation—Anode dissipation = $I^2 R$ watts, where I = mean anode current in amps, and R is the D.C. resistance of the valve as found above. Anode dissipation = $(0.0027)^2 \times 42,600 \text{ W.} = 0.3105 \text{ W.}$

NEXT SERIES OF PROBLEMS.

QUESTION 53.—A battery eliminator is capable of supplying 18 mA. at 240 volts, and 10 mA. at 260 volts. A portable receiver to be used with it takes 2 mA. for H.F. and det. valves, and 10 mA. for power valve, all at 150 volts. What series resistance would be required to absorb the surplus voltage of the eliminator, and what is the D.C. power expended in it?

QUESTION 54.—If a potentiometer of 50,000 ohms is connected directly between the eliminator terminals for use with a S.G. valve, what will be the altered value of the series resistance required in the above question?

QUESTION 55.—By means of an input potentiometer the power output of a certain amplifier can be varied between 0.1 watt and 10 watts. What is the power range in decibels?

NUTCRACKER.

BOOKS RECEIVED.

Wiring Systems. by L. M. Waterhouse, A.M.Inst.C.E., M.I.E.E., containing detailed descriptions and helpful suggestions relating to the installation of modern wiring systems for the electrical equipment of buildings. Pp. 172, with numerous illustrations and 4 pages of squared paper. Published by Gee and Co. (Publishers), Ltd., London. Price 5s., or in Pocket Edition 3s. 6d.

The New Zealand Radio Guide and Call Book, 1932, containing a brief history of broadcasting in New Zealand, numerous articles on technical subjects and servicing, list of broadcasting stations of the world, including short-wave stations, and various tables and useful data. Pp. 160, with numerous illustrations and diagrams. Published by Radio Publishing Company of New Zealand, Ltd., Wellington, N.Z. Price 2s. 6d.

Willing's Press Guide, 1932, giving alphabetical and geographical lists of all London and provincial newspapers and periodicals; Dominion, Colonial, and foreign publications, with the addresses of their London offices; classified list of technical and trade papers; reporting and news agencies, and other valuable information concerning all kinds of periodicals. Pp. 498+xii. Published by Willing Service, London. Price 2s. 6d.

Televisone, Radiovisone, Theoria, Pratica, Dati Costruttivi, by Arturo Castellani. The theory and practice of television. Pp. 326, with 202 illustrations and drawings, and 15 sheets of diagrams and working drawings. Published by Ulrico Hoepli, Milan. Price 28 lire.

Les Machines a Courants Continus, by R. Langlois-Berthelot, with preface by P. Janet. The theory, design, control, and application of continuous-current dynamos and motors. Pp. 289+xiv, with 195 diagrams. Published by Gauthier Villars and Cie, Paris. Price 75 francs.

Les Unites Electriques, by J. Sudria, with preface by M. A. Blondel. A text-book for students giving the definitions of the various units and formulae required in electrical problems, with eleven typical examination questions and their solutions. Pp. 86. Published by Librairie Vuibert, Paris. Price 10 francs.

Das Buch Der Ansager, by Hans S. von Heister, containing the portraits and short biographical notes of the announcers of the principal broadcasting stations of the world (the B.B.C. announcers prefer, perhaps wisely, to remain anonymous). Pp. 103. Published by Rothgiesser und Diesing A.G., Berlin. Price RM. 4.50.

COSSOR CATHODE RAY OSCILLOGRAPH.

IN view of the increasing importance of the Cathode Ray Oscillograph in research and development work, it is gratifying to note that British manufacturers are at last turning their attention to the production of special tubes of this type. The latest oscillograph to make its appearance on the British market is made by A. C. Cossor, Ltd., Highbury Grove, London, N.5, and is of the Braun tube type, with certain important improvements. For instance, decreased conductance of the deflector plates is secured by extending the anode in such a way as to collect nine-tenths of the return space charge in the tube, which would otherwise flow to the deflector plates.

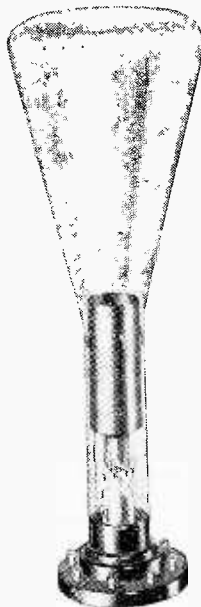

The oscillograph will operate with high-tension voltages as low as 300, the maximum safe voltage being 3,000. Other characteristics of the tube are as follows:—

Filament Current	0.7 to 1.1 amps.
Filament Voltage	0.4 to 0.5
Gun Voltage	350 to 3,000 (relative to
Shield Voltage	0 to -200 } filament.
Gun Current	10 to 200 microamps.
Capacities (inclusive of socket):—	
Each deflector plate to gun	6.0 μ F. approx.
Each deflector plate to	
opposite plate	1.5 μ F. approx.

The price of the Cathode Ray Tube, including sockets, is £7 10s., and two types are available, A for visual observations, and B for photographic records. A very compact and informative booklet (B15), dealing with the properties and

applications of the Cossor Cathode Ray Oscillograph, is obtainable on application, and should prove of interest not only to works laboratories, but also to advanced amateur experimenters.

SPECIAL ANNOUNCEMENT
TWO PAPERS IN ONE AT THE SAME PRICE

Next week's issue will contain detailed foreign programmes for the full week combined with all the features of "The Wireless World" of the past. The paper will be greatly enlarged and will be published in future on Friday.

ON SALE FRIDAY, JULY 8TH

TH**E**SE columns are reserved for the publication of matter of general interest arising out of problems submitted by our readers.

Readers requiring an individual reply to their technical questions by post are referred to "The Wireless World" Information Bureau, of which full particulars, with the fee charged, are to be found on page 681.

No Suitable Valves.

A NUMBER of readers have asked us to suggest modifications to the circuit of the "Monodial A.C. Super," in order to adapt it for use with indirectly heated D.C. valves. It is feared that at the present moment it is impossible to comply with their wishes; the set depends largely for its efficiency on the use of variable- μ valves, and these valves have not yet been added to the D.C. range of any manufacturer.

Superheterodyne Radiation.

A CONSCIENTIOUS reader, who has built a superheterodyne receiver embodying principles recently described in these pages, is afraid that it may be causing interference to his neighbours by radiation. His fears are founded on the fact that a beat note is produced in another receiver, installed in the same room as the "superhet," when the tuning of the latter set is varied.

This is not a conclusive test for radiation from the aerial. It is probable that the beat note is reproduced in the second receiver by direct interaction from the superheterodyne oscillator circuit; this form of interaction is almost inevitable, and should do no harm, as it is confined to the immediate vicinity of the set, and is not radiated by the aerial.

Useless Components?

A READER has discovered that when the grid decoupling resistance of the output stage of his mains-operated receiver is short-circuited there is no obvious change in the working of the set; contrary to his expectations, motor-boating does not take place, and there are no signs of incipient L.F. instability. Logically enough, he questions whether the decoupling resistance and condenser are superfluous components.

It should be borne in mind that although the primary object of decoupling is to stop motor-boating—an audible indication that the valves are in a state of self-oscillation—it also has other uses. Without it, a serious amount of L.F. reaction may be present, with the result

READERS' PROBLEMS

that the proportional amplification of certain bands of frequencies is over-accentuated. Further, the absence of grid decoupling in a modern set may introduce an appreciable loss in the lower register, due to a "reversed reaction" effect. There is also the question of smoothing, as the decoupling condenser and resistance in conjunction often play an important part in this respect.

In the Wilds.

A READER living in British East Africa is in difficulties with regard to the charging of his L.T. accumulator. No source of current is available, and so he proposes to charge the accumulator—a single cell—from his 6-volt car accumulator, which is in good condition and apparently capable of providing much more current than is needed for its normal functions. Information is requested as to the appropriate form of connection, and also the resistance necessary to limit the charging current to 1 ampere.

As has already been pointed out in this journal, the use of a car battery for charging L.T. cells is quite practicable, although, if a regular practice is made of doing so, extra care must be taken to see that the battery is well maintained, and is relieved of all avoidable loads.

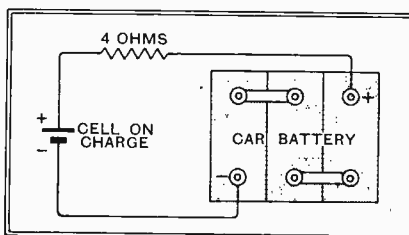

Fig. 1.—Charging a single-cell L.T. accumulator from a car battery.

Connections will be as in Fig. 1; it should be noted that the positive terminal of the source of charging current is connected to the positive terminal of the battery through the resistance. The latter should have a value of 4 ohms, and, of course, must be capable of passing the necessary current without undue heating.

Cathode Circuit Biasing.

IT is generally known that, unless suitable decoupling devices are included, a loss of bass takes place when a valve is biased by means of a resistor in its cathode lead. This loss is due to a reversed reaction effect, and is most pronounced in the lower frequencies, for the reason that the usual 2-mfd. condenser, which is shunted across the bias resistor, is relatively less effective as a by-pass at these frequencies. Low-note attenuation due to a bias resistor in series with the cathode of an L.F. valve may be avoided by increasing the shunt capacity to a sufficiently high value.

Realising this, a reader asks whether a published design could safely be modified by replacing a 2-mfd. paper condenser, originally specified as a shunt across the bias resistor, by one of the new T.C.C. low-voltage dry electrolytic condensers with a capacity of 25 mfd. The object in doing this, of course, is to improve the reproduction in the low register.

In all probability this alteration would be a safe one, but it must be remembered that, in preparing the original design, the loss of bass, which undoubtedly takes place at this point, may have been compensated for by an increased proportional amplification of these frequencies elsewhere in the set. There is also the question of instability and hum; decoupling devices, for instance, tend to become less effective as the frequency with which the amplifier is dealing is reduced, and so there is a risk that motor-boating might become evident as a result of making the proposed change.

In another letter the question of using electrolytic condensers as shunts across bias resistors is approached from a different angle. It is asked whether the condenser will have to withstand any greater voltage than that assumed by calculation to be developed across the resistor for bias purposes.

Except in untoward circumstances, the voltage across a by-pass condenser in this position is not likely to rise to any serious extent. Even if the eliminator voltage reaches a high value during the time that the indirectly heated valves are warming up to their work, the cathode circuits are isolated from the H.T. supply by the high internal resistance possessed by the valve when it is cool. The working conditions of these condensers is not, in this respect, comparable with those of condensers used for by-pass purposes in anode circuits.

FOREIGN BROADCAST GUIDE.

BEZIERS

(France).

Geographical position: 43° 21' N.; 3° 13' E.

Approximate air line from London: 573 miles.

Wavelength: 219.9 m. Frequency: 1364.1

kcs. Power: 1.5 kw.

Time: Greenwich Mean Time (France adopts B.S.T.).

Standard Daily Transmissions.

20.15 B.S.T., news; concert; 21.00, talk; 21.30, concert; 21.45, dance music (Sat.).

Announcer: Man.

Call: *Allo! Allo! Ici Radio Béziers* (pron: *Bay-zee-aye*).

Interval signal: Crowing of a cockerel.

Closes down with usual French good-night greetings followed by *La Marseillaise*.