

CONSTANT SELECTIVITY. TESTS ON PICK-UPS.

The Wireless World

AND RADIO REVIEW

4^D

The Paper for Every Wireless Amateur

Wednesday, April 2nd, 1930.



TELSEN
L.F. TRANSFORMERS

Radio's Choice

Have acquired a world-wide reputation for Quality and Value. Built by Specialists in Transformer construction they have set a Quality of Performance above reproach. Your Set will work better with a Telsen Transformer - - - - Fit one now!

TELSEN ELECTRIC CO. LTD.
Miller Street, Birmingham.

Radiogrand 12/6
Ratios 3-1 and 5-1
Radiogrand 7-1 Ratio 17/6.



MUCH IMITATED
CLAROSTAT

NEVER EQUALLED

REDUCED PRICES

POWER TYPES now 13/6
STANDARD " 9/6
VOLUME " 7/6

Send for 36 pp. illustrated Booklet FREE

CLAUDE LYONS LTD.
76, OLDHALL ST. LIVERPOOL.

B.A.T.
750 WATT
Q.M.B. SWITCH

This miniature switch comfortably breaks 3 Amprs at 250 Volts cannot be equalled for H.F. L.F. H.T. L.T. circuits, Etc., often specified by the "Experts."



ONLY 2/6 EACH

HYDRA

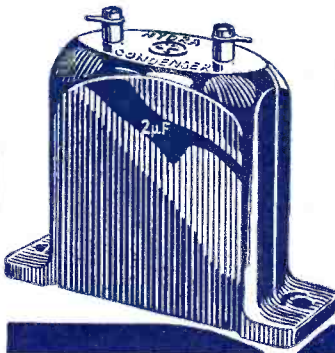

Many a condenser has been "made" by advertising, but when the necessity for an outstanding condenser arose—necessity made Hydra.

LOUIS HOLZMAN,
37, Newman Street, London, W.1.
Telephone: Museum 2641.

BurTON

SELF-LOCATING

VALVE
HOLDER

1/- each



Pentode -Valve - Holders 1/6 each

Patent No. 316708

MANUFACTURED BY C. F. & H. BurTON

PROGRESS WORKS WALSALL, ENG.



IF YOUR SUPPLY MAINS ARE D.C.

You can use an A.C. All Electric Receiver
By Employing The M.L.—D.C. to A.C.

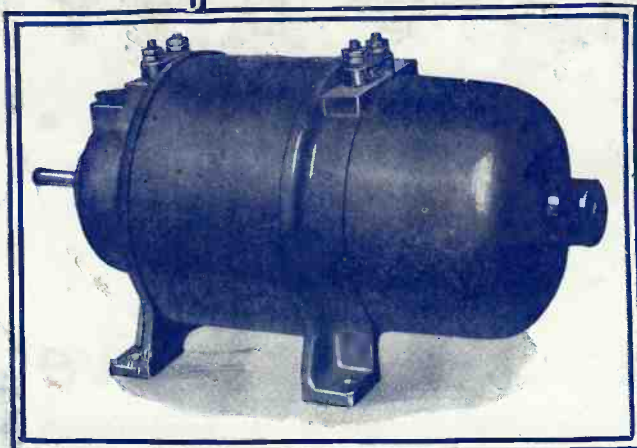

ROTARY TRANSFORMER

Can be supplied
to run from
any Voltage
12-250 V.D.C.

*Recommended and
used by*

Philips Radio,
Marconiphone,
Kolster-Brandes,
Burndept, Etc.

40 WATT Model
£13-0-0
85 WATT Model
£19-0-0

M-L MAGNETO SYND. Ltd., Radio Dept., COVENTRY.
Telephone: 5001.



HIGH QUALITY AND WIDE VARIETY

PARMEKO apparatus is excellently designed and constructed from the finest materials. There is a PARMEKO Choke and Transformer for every circuit featured in the technical Press, besides all kinds of other mains apparatus.

If you need anything made to specification, send us details for a quotation. This work is a speciality of ours.

*Write for price list of
Wireless Mains Apparatus.*

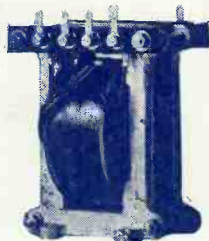

PARTRIDGE & MEE Ltd.,

26, DOVER STREET,
LEICESTER.

74, New Oxford Street,
LONDON, W.C.1.

Get the Experts to Advise You:—

The R.G.D. Radiogramophone



For the highest possible quality and tone for both radio and record, with ample volume, incorporating the latest developments in moving coil speaker; operates entirely from electric mains, A.C. any voltage, or D.C. 200 volts or over.

Mahogany Oak
£80 £75

Place your order now to ensure delivery and we shall be pleased to supply literature on application.

The Radiogramophone Development Co.,
St. Peter's Place, Broad Street, Birmingham.

A GREATER POWER . . . OUTPUT THAN ANY OTHER A.C. POWER VALVES!

! and twice as sensitive



The only way to improve a set fitted with Mazda A.C./S.G. and A.C./H.L. valves is to use a Mazda A.C. Power valve in the output stage.

These valves are indirectly heated, so that freedom from hum is completely assured.

The A.C./P. valve combines a large power handling capacity with great sensitivity. It is roughly twice as sensitive as the ordinary filament valve, and thus its use doubles the sensitivity of the set.

Where more power output is required an A.C./P.1. valve should be employed.

PRICES	AC/HL	-	15/-
	AC/P	-	17/6
	AC/P1	-	17/6
	AC/SG	-	25/-

The Amazing

MAZDA VALVES



THE EDISON SWAN ELECTRIC CO., LTD.,
Radio Division,
1a, Newman Street, Oxford Street, W.1.
Branches in all Principal Towns.

EDISWAN

V.30.

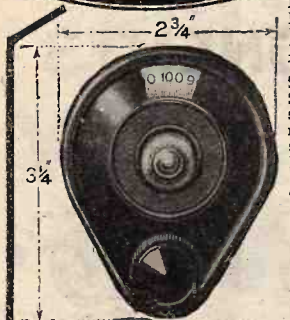

MECHANICALLY PERFECT. POSITIVE BRASS CONTACT drive on SOLID BRASS SCALE ensuring smooth movement with absolutely NO BACK-LASH. ROBUST in Construction and Trouble Free.

PRICE **3/-**

THERE IS ONLY ONE GENUINE

FORMO-DENSOR



Length 2 1/2 in.
Width 1/2 in.

F. Max. .0001 Min. .000005 **2/-**
G. Max. .0003 Min. .000025 **2/-**
H. Max. .001 Min. .001 **3/-**

THE FORMO CO., CROWN WORKS, CRICKLEWOOD LANE, N.W.2.

'1930" LOG (MID-LINE) CONDENSER

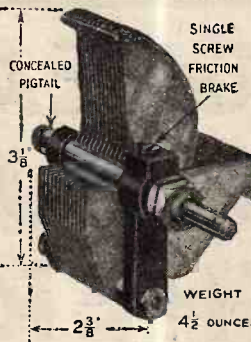

In four Capacities:

- .0005
- .00035
- .00025
- *.00015

4/6

each.

WEIGHT 4 1/2 OUNCES
*Double spacing of vanes for Ultra Short-wave work.

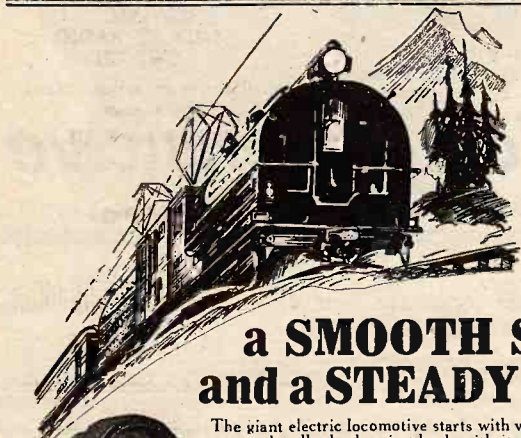

a **SMOOTH** Start and a **STEADY** Pull



The giant electric locomotive starts with velvet smoothness and pulls the heaviest loads with steady, unflinching power. It's all a matter of proper control. The increased sensitivity of your radio demands the S-m-o-o-t-h control that only Centralab can give. Noiseless, free of inherent sputtering—self-inflicted static. For smooth, quiet, velvety radio reception your radio must be CENTRALAB equipped.

Write for free booklet, "Volume Controls, Voltage Controls, their uses."

Centralab

THE ROTHERMEL CORPORATION LTD.,
24, Maddox Street, London, W.1.
Phone: MAYFAIR 0578/9.

WIRELESS
DIRECTION FINDING
and **DIRECTIONAL RECEPTION**

(1927)

By R. KEEN, B.Eng. (Hons.)

Second Edition: Revised and Enlarged.

THIS volume deals with the principles of the subject and the constructional details of direction-finding installations, and includes some information concerning aircraft installation. It describes the principles of Direction and Position Finding in this country in such a way that the subject may be grasped easily by engineers tackling this field of wireless work for the first time. Numerous photographs and diagrams are included

Price 21/- net. By post 21/9.

From leading booksellers or direct from the Publishers:

ILIFFE & SONS LIMITED,
Dorset House, Tudor Street, London, E.C.4.

w.w.68

WHY BUY FOREIGN VALVES?

-BRITISH VALVES ARE CHEAPER!
BRITISH MADE AND GUARANTEED

For any and every circuit, including SCREENED GRID and "WIRELESS WORLD" Sets.

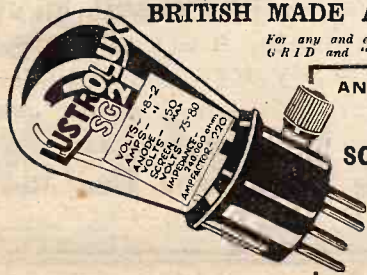

AN OUTSTANDING SUCCESS—
The S.G.2
SCREENED GRID
VALVE

Proved, Tested and Adopted by all. A Splendid Valve. Try one.
2 volts **15/-** each.
only

"A" Type.

2, 4 & 6 volts	H.F. L.F. R.C. POWER	5/- Each
----------------	----------------------	----------

OUR LATEST—"Super" Type, Pipless.

2, 4 & 6 volts	H.F. L.F. R.C. POWER	5/- Each 7/- Each
----------------	----------------------	----------------------

ALL RING VALVES REPAIRED. Price as follows:—

QUICK
L.F. H.F. R.C. - 5/3
Power Valve - - 6/3
Screened Grid - 11/3
ORIGINAL CHARACTERISTICS GUARANTEED

From your Dealer or Direct—

LUSTROLUX

Lower House Mills, West Bollington, Nr. MACCLESFIELD.
Scottish Agent: Messrs. Bothwell Elec. Co., 54, Edginton Street, Glasgow.

Ltd.

Mention of "The Wireless World," when writing to advertisers, will ensure prompt attention.

A2



RELIABLE IGRANIC COMPONENTS

You can purchase an
IGRANIC

GUARANTEED COMPONENT
TO REPLACE ANY
COMPONENT IN ANY SET.

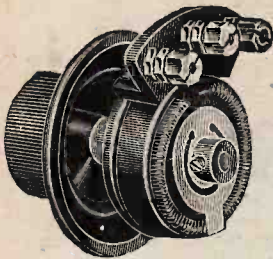

**IGRANIC
"MEGOSTAT"
VOLUME CONTROL.**

Made in 4 sizes: 50,000 ohms,
500,000 ohms, 1 megohm,
5 megohms.
Price 6/-

IGRANIC Components include
Transformers, Variable Condensers,
H.F. Chokes, L.F. Chokes, High
Resistance, Low Resistance, Potentiometers,
Tuning Coils, Knobs
and Dials, etc.

*If your Dealer cannot supply you, please
write at once to Dept. U.310,*



**IGRANIC
MIDGET RADIO
SWITCH.**

Definite in action, sound
electrical contact.

Price 1/6 & 1/8

IGRANIC ELECTRIC CO., LTD., 149, Queen Victoria Street, London.



A Simple Circuit

for a battery eliminator for A.C. Mains

which will give 120 volts, 20 m.a. D.C., sufficient for the majority
of modern 3-valve sets (excluding those using pentode valves).

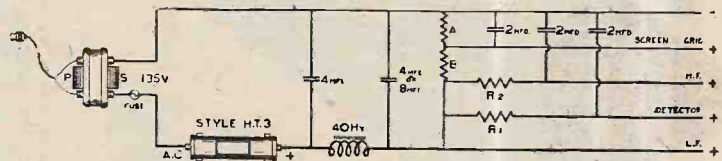

Price 21/-

Full particulars of this and other
circuits are given in our 32-page
book "The All-Metal Way, 1930."
Send a 2d. stamp for a copy.

THE WESTINGHOUSE METAL RECTIFIER TYPE H.T.3

is used in this circuit. This rectifier has nothing
in it to wear out—no filaments, moving parts,
or chemicals, and consequently does not require
periodical replacement.

The Westinghouse Brake & Saxby Signal Co. Ltd.,
82, York Road, King's Cross, London, N.1.

With more selective tuning a *desirability.*

K.C. CONDENSERS are a necessity

K.C. CONDENSER

Tuning is velvet smooth and free from backlash. With knob, dial and slow-motion device, '0003 or '0005 **12/-**
Without knob, dial or slow-motion device, '0003 or '0005 **8/-**

K.C. DRUM CONTROL CONDENSERS

With drum Control and slow-motion device, '0003 or '0005 **15/6**
Triple K.C. each condenser '0003 or '0005 **38/6**
Triple K.C. Combinations of '0003 and '0005 **40/-**



If you have any difficulty in obtaining Dubilier products write to us direct, giving the name and address of your dealer.

MIDGET CONDENSER

A small variable condenser for panel mounting, '0005, '0001 or '0002, **5/6**

DUBILIER VARIABLE CONDENSERS

We shall be pleased to see you at our **STAND** 466, Main Hall Gallery, Ideal Home Exhibition, Olympia.

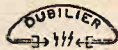

Dubilier Condenser Co. (1925), Ltd., Ducon Works, Victoria Road, N. Acton, London, W. 3.

USE THIS BATTERY FOR LOW TENSION IT WILL LAST LONGER, SAVE MONEY



A modern 3, 4 or 5 valve set, economical in current, can be run for weeks or months on one charge if a large capacity battery be used of special type capable of standing for long periods without harm when more or less discharged. Of this type cells of the Exide "D" series are supreme. They provide more burning hours in relation to cost than any other battery. Their differently shaped terminals can be identified even in the dark. A metal carrier is included.

Exide

THE LONG LIFE BATTERY

- Type DTG, 20 amp. hrs. 4/6 per 2 volt cell.
- Type DFG, 45 amp. hrs. 8/6 per 2 volt cell.
- Type DMG, 70 amp. hrs. 11/- per 2 volt cell.
- Type DHG, 100 amp. hrs. 14/6 per 2 volt cell.

For an absolutely steady H.T. supply use the Exide WH Battery. It will help you to separate the regional stations Obtainable from Exide Service Stations and all reputable dealers. Exide Service Stations give service on every make of battery.

EXIDE BATTERIES, Clifton Junction, Manchester. Branches: London, Birmingham, Bristol, Glasgow.

J 15

"CLARKE'S ATLAS"

ALL-MAINS UNITS

convert any Set into an All-Mains Set without any alterations whatever

WITHOUT any alterations whatever to your present Set, providing you have Electric Light in the home, the new "ATLAS" ALL-ELECTRIC Units will provide from the Mains all the High and Low Tension supply necessary for your Set at a cost of a few pence per month, and make your Set equivalent to an expensive ALL-MAINS SET. Combining H.T. Battery Eliminator and Low Tension Trickle Charger these Units incorporate the Westinghouse Metal Rectifier and have no moving parts, no liquids and no valves, and are absolutely foolproof and guaranteed for twelve months.

Model A.C. 86

(illustrated) for Alternating Current, provides 3 H.T. Tappings—one fixed of 150 Volts and two variable, 0/100 Volts and 0/120 Volts respectively, and gives output of 150 Volts at 30 m/A. On the Low Tension side, facilities are provided for maintaining the charge of either 2-, 4-, or 6-Volt Accumulators.



Price 10/- down and nine monthly easy instalments, or

CASH PRICE £8-15-0

Model A.C. 84X. This is a cheaper Model suitable for any Set requiring up to 15 m/A output, and provides two fixed H.T. Tappings of 90 and 120 Volts respectively, and one variable of 0/100 Volts. The Trickle Charger on this Model provides for maintaining the Charge of 2-Volt L.T. Accumulators only. Price 10/- down and 6 monthly easy instalments, or

CASH PRICE £6-17-6

Can be obtained from any good Wireless Dealer.

Ask your Dealer for Folder No. 49, or POST THIS COUPON TO-DAY in unsealed 1/2d. stamped envelope.

Messrs. H. Clarke & Co. (M/cr.) Ltd. (Dept.-3), Atlas Works, Old Trafford, Manchester.
Please forward Folder No. 49, along with particulars of your easy payment scheme.

NAME

ADDRESS

Please use BLOCK LETTERS. W.W.3

"TILTRACK"

Registered Trade Mark
Patent-STEEL STORES System



is an over-rated pastime and unprofitable. Then why waste time and money losing your goods in old-fashioned wooden stores when "TILTRACK" found steel stores enable goods to be stored where they can be in minimum time with minimum trouble?

THE "BENCHRACK" (Tiltrack Principle)

A real help for storing small parts such as Terminals, Nuts, Washers, Insulators, etc. Made to stand on the work bench, it enables all small parts needed for the job in progress to be stored where they are immediately to hand. All the trays are tilted so that the parts stored can be seen at a glance, and the front faces of the trays are rounded so that the smallest parts can be swept up the slope with the fingers of one hand. Each tray is provided with patent hinging partitions which can be moved quickly to make larger or smaller compartments. Being so accessible these racks greatly facilitate stock taking and being all steel there is no danger of fire. The Experimenter will do his job much quicker and with greater pleasure, and the Factory will save many pounds per year by installing this Benchrack.

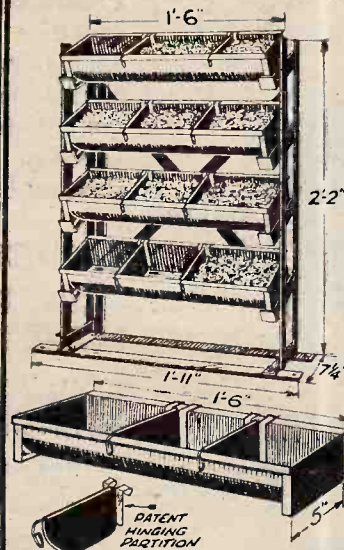

30/-
F.O.R.

"TILTRACK JUNIOR"

This all-steel rack is designed to hang against a wall or other convenient position, and is a most excellent rack for storing small parts. It is supplied complete with white canvas protective cover to keep out the dust. All the trays are tilted and have movable partitions.

30/-
POST FREE.

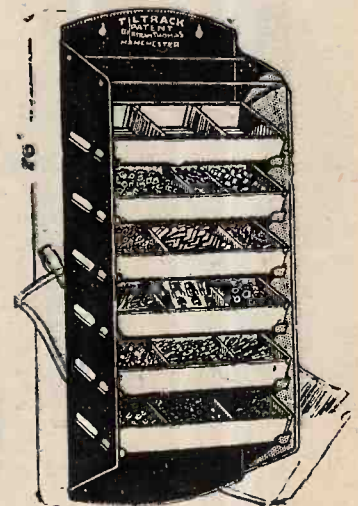

THERE ARE MANY MORE TYPES OF "TILTRACK."
WRITE FOR LISTS.

Particulars from Manufacturer & Patentee:— **Worsley Street, Hulme, MANCHESTER.**
BERTRAM THOMAS,
London Office & Showroom:—28, Victoria Street. S.W.1.

HEAR HOW GOOD YOUR SET CAN BE



Type 2016
Price
£2.10.0



Type 2007
Price
£5.5.0



Type 2013
Price
£14.14.0



MAKE the most of your radio receiver by using it in conjunction with a Philips Loudspeaker and Battery Eliminator. Philips Loudspeakers give the most perfect reproduction, while Philips Battery Eliminators ensure the utmost efficiency. They eliminate all trouble caused by battery voltage-drop, and the expense of renewing rapidly wasting batteries.

LOUDSPEAKERS

- Philips Loudspeaker, Type 2007. Price - - £5.5.0
- Philips Seven-Cornered Loudspeaker, Type 2016. Price - - £2.10.0
- Philips Moving Coil Loudspeaker, Type 2013 (for use with Philips de Luxe 4-valve All-Electric Receiving Set, Type 2511). Price £14.14.0
- Philips Loudspeaker, Type 2019. Price - - £5.10.0

PHILIPS BATTERY ELIMINATORS

- Type 3009. For A.C. Mains. Price - - £5.15.0
- Type 3002. For A.C. Mains. Price - - £5.10.0
- Type 3005. For D.C. Mains. Price - - £3.17.6

For 10/- down you may have any of these Battery Eliminators on Philips Hire Purchase System.



Type 3009
Price
£5.15.0



Type 3002
Price
£5.10.0

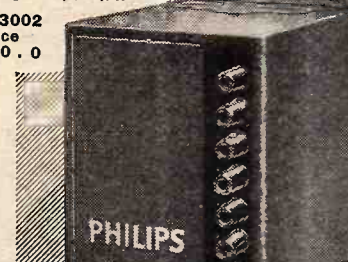

Type 3005
Price
£3.17.6

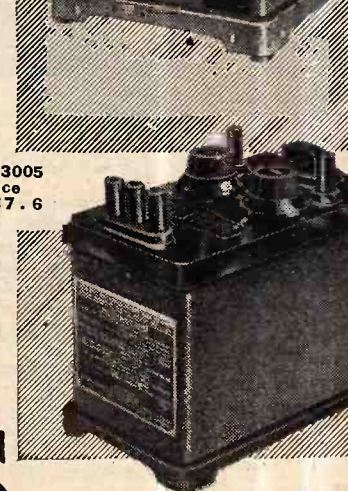

PHILIPS ALL-ELECTRIC RADIO

Made by the manufacturers of the famous Philips All-Electric Radio Receivers, Argenta Lamps and Neon Signs.

PHILIPS LAMPS LTD., PHILIPS HOUSE, 145, CHARING CROSS ROAD, LONDON, W.C.2.

Mention of "The Wireless World," when writing to advertisers, will ensure prompt attention.

The Wireless World

AND
RADIO REVIEW
(18th Year of Publication)

No. 553.

WEDNESDAY, APRIL 2ND, 1930.

VOL. XXVI. No. 14.

Editor : HUGH S. POCOCK.
Assistant Editor : F. H. HAYNES.
Editorial Offices: 116-117, FLEET STREET, LONDON, E.C.4
Editorial Telephone : City 9472 (5 lines).
Advertising and Publishing Offices :
DORSET HOUSE, TUDOR STREET, LONDON, E.C.4.
Telephone: City 2847 (13 lines). Telegrams : "Ethaworld, Fleet, London."
COVENTRY: Hertford Street.
Telephone: 3210 Coventry.
BIRMINGHAM: Guildhall Buildings, Navigation Street.
Telegrams : "Autopress, Birmingham." Telephone: 2970 and 2971 Midland.
MANCHESTER: 260, Deansgate.
Telegrams : "Hilfe, Manchester." Telephone: 8970 City (4 lines).
GLASGOW: 101, St. Vincent Street, C.2.
Telegrams : "Hilfe, Glasgow." Telephone: Central 4857.

PUBLISHED WEEKLY.
Subscription Rates : Home, £1 1s. 8d. ; Canada, £1 1s. 8d. ;
other countries abroad, £1 3s. 10d. per annum.
Entered as Second Class Matter at New York, N.Y.
As many of the circuits and apparatus described in these pages are covered by patents, readers are advised, before making use of them, to satisfy themselves that they would not be infringing patents.

CONTENTS OF THIS ISSUE.

	PAGE
EDITORIAL VIEWS	349
CAPACITY COUPLED FILTERS. BY A. L. M. SOWERBY	350
PRACTICAL HINTS AND TIPS	354
GRAMOPHONE PICK-UPS TESTED (CONCLUDED)	356
CURRENT TOPICS	363
WIRELESS THEORY SIMPLIFIED. PART XXV. BY S. O. PEARSON	364
BROADCAST BREVITIES	367
THE D'ORSAY EFFECT. BY D'ORSAY BELL	368
READERS' PROBLEMS	371

EIGHTEENTH YEAR OF PUBLICATION.

THIS month *The Wireless World* enters upon its eighteenth year of publication, the journal having first appeared (then as a monthly) in April, 1913, and incorporating the *Marconigraph*, the first issue of which was dated two years earlier. We believe that we include amongst our readers of to-day quite a number who can well remember the first issues of what then was the only wireless paper published in the world.

Wireless has gone through many changes during the life of *The Wireless World*, and the revolution of broadcasting introduced it to a vast circle of new readers, but still the basic policy of the paper has remained faithful to the original conception of the journal, when with the first issue it was announced that it was to be the medium for the interchange of ideas concerning the further scientific and commercial development of wireless telegraphy, and that, whilst the magazine was to be popular, the information which it would print would compel the attention of the scientist.

WIRELESS TRANSMISSION OF POWER.

AT the time of writing these notes the name of the Marchese Marconi has appeared in most of the daily newspapers of the world associated with the subject of transmission of power by wireless. From his yacht "Elettra," at Genoa, a signal was sent out which served to operate a relay which, in turn, closed switches and so turned on the electric lamps illuminating an exhibition in Sydney, N.S.W., 11,000 miles away. Though there was no novelty in the method of performing this operation, and certainly no invention connected with it, yet it was an interesting enough demonstration in its way had it been left at that. But the incident has been described as a demonstration of the transmission of power; though it has no more claim to be so described than has the transmission of any wireless signal which provides the means at the receiving station of operating a telephone or a loud speaker, or any other electrically controlled device which may be substituted.

Before the valve and before the crystal, the earliest form of detector of radio waves, the coherer, was employed in a wireless receiving set, so that when influenced by a wireless signal transmitted from a distance the coherer served to close a local circuit and could ring a bell or operate some other electrical device.

Remote control of machinery by wireless, as, for instance, directing a ship or switching on and off a wireless receiving set, are accomplishments which have been well known for many years. The distance over which this can be done does not in itself constitute novelty, because it is merely a question of the signal reaching its destination.

After the conclusion of the experiment the Marchese Marconi is quoted as having said, "It is particularly important because it points the way to a future day when there will be no electric wires, and all current of electric power will be transmitted directly through the air in any direction and quantity desired."

We fail to see that there is any real connection between this experiment and the question of the possibility of some day being able to transmit power without the aid of wires. There is, as far as we can visualise to-day, no vestige of evidence to indicate that the transmission of power by wireless will ever be a practical possibility, far less a commercial reality, and a statement such as that which we have quoted above, unsubstantiated by any scientific evidence, is unfair to the illustrious name with which it has been associated, and misleading to the public.

Capacity Coupled Filters

Keeping the Selectivity
Constant
at all Wavelengths.



By
A. L. M. SOWERBY, M.Sc.

IN a recent article there was a discussion of that type of band-pass filter in which the coupling between the two component coils consisted either in placing them near to one another (coupling by mutual inductance) or by making a small auxiliary inductance common to the two circuits. These two possible arrangements are shown at (a) and (b) in Fig. 1.

In the article referred to¹ it was shown that the characteristic variation of the high-frequency resistance of the tuned circuit with wavelength made it possible to build a filter in which the separation between the two peaks of the resonance curve was substantially constant over the whole tuning range of the receiver without introducing the necessity of varying the coupling between the two coils when retuning the filter to a new wavelength. Resonance-curves of two typical filters, both alone and in conjunction with other tuned coils, were given to illustrate the point.

Inductance-coupled filters of the type there discussed, therefore, provide a very suitable means of ensuring that the high-frequency side of the set shall not cut out, at any wavelength, the side-bands of a received transmission, and that music and speech shall, therefore, not be denuded of the high notes and overtones that in speech provide clarity and naturalness, and in music enable individual instruments to be distinguished and recognised. For a receiver primarily designed for short-range reception from a limited number of high-power transmitters—a "local-station receiver" under the Regional Scheme, for example—the inductance-coupled filter therefore has a very valuable application.

The requirements just detailed are primarily concerned with the shape of the peak of the resonance curve, which

must be more or less flat if it is to transmit equally the whole band of frequencies radiated by the station to which it is desired to listen. To pick out one or two or three high-power stations, well separated in wavelength from one another, is not so exacting a requirement that it is necessary to pay any very excessive attention to the selectivity of the receiver, so that for this purpose the fact that the inductively coupled filter is incapable of giving any approach to constant selectivity over the whole of its tuning range is a matter

not of the greatest importance.

It is an inevitable property of any circuit in which tuning is performed by means of a variable condenser that the selectivity is much higher at the upper end of its wave-range than at the lower. In Fig. 2 are shown the resonance curves of a single small coil for two wavelengths towards the ends of its tuning range, and it is painfully obvious from these that at 225 metres selectivity is practically non-existent.

This extreme lack of selectivity at the shorter wavelengths is due to two causes acting together. To begin with, the selectivity of a tuned circuit depends on the

ratio of capacity to inductance. When tuning is carried out by means of a variable condenser, the inductance remains constant over the whole wave-band, and the capacity alone alters, being nine times as great at 600 metres as it is at 200. This particular source of varying selectivity can to a large extent be combated, as in some American receivers, by using a variometer as the tuning element in place of, or in conjunction with, a variable condenser. The

variometer, however, has a whole series of special disadvantages of its own, so that it is by no means a complete cure.

The remaining source of bad selectivity at the lower end of the tuning range is to be found in the fact that

AN article by the author giving a detailed description of the characteristics of the inductance coupled filter appeared recently in these pages. It was shown that this type of tuned circuit provides a means of preventing sideband cutting so that speech shall be natural and overtones shall not be lost. Selectivity, however, becomes poor at the lower end of the tuning scale and we have to turn to the capacity-coupled filter which is lucidly described in the accompanying article for a solution of the problem.

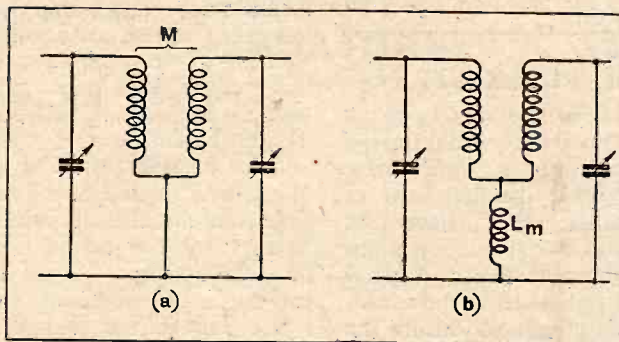

Fig. 1.—Types of inductively coupled filters. In (a) the coupling is by mutual inductance, indicated by M . The fields of the two coils are allowed to interact. In (b) the main coils are screened from one another, but coupling is provided by making the small inductance L_m common to both tuned circuits. Compare this with Fig. 4.

¹ "The Selectivity of Coupled Coils," *The Wireless World*, February 26th, 1930.

Capacity Coupled Filters.—

the high-frequency resistance of a tuned circuit, including the usual components, such as valve-holders and valves that have to be connected in parallel with it, is enormously higher for short waves than for long. The tuned circuit to which refer the curves of Fig. 2 has an equivalent resistance of only $5\frac{1}{2}$ ohms at 550

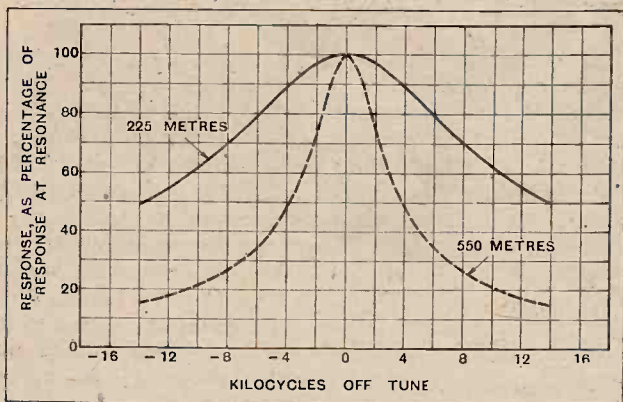

Fig. 2.—Resonance curves, at 550 and 225 metres of average tuned circuit incorporating a good solid-wire coil. The coil is 2in. diameter, having 80 turns of No. 26 D.C.C. The inductance is 200 microhenrys.

metres, but this figure rises to 20 ohms at 225 metres. With this value of resistance in circuit it is inevitable that the selectivity of the circuit should be very low.

Shortcomings of Inductance-coupled Filter.

When two such coils as this are embodied in an inductively coupled filter in such a manner as to give a more or less constant separation of the two peaks of the double-humped resonance curve, the top of the curve is naturally broad at the shorter wavelengths, owing to the flat tuning of the individual coils, while at the longer wavelengths the resonance curve has its peak artificially broadened by the filter effect. Nevertheless, the natural selectivity of the two tuned circuits still shows itself in the form of a very rapid falling away of the curve outside the two humps. The two resonance curves of Fig. 3, which refer to an inductively

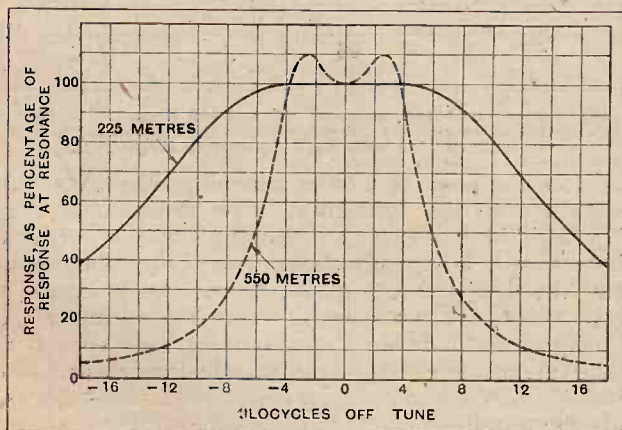

Fig. 3.—Resonance curves, at 225 and 550 metres, of an inductively coupled filter made up of two good solid wire coils, coupled by 2.5 microhenrys. The coils are as described under Fig. 2.

coupled filter designed for constant peak-separation over the bulk of its tuning range, emphasise the manner in which the selectivity characteristics of the single tuned circuits are retained in the completed filter.

Thus, although the side-bands of the station actually being received are well looked after by the inductively coupled filter at all points in the wave-range, yet if a receiver embodying such a filter is used for the reception of distant stations on wavelengths not far removed from those of powerful local transmitters, it will be noticed that the selectivity of the set, as judged by its ability to cut out stations some twenty kilocycles away from that to which it is tuned, is much greater at the upper end of the tuning range than at the lower.

In a nutshell the filter differs from the individual tuned circuits only in its ability to deal more faithfully with a narrow band of frequencies immediately surrounding the official carrier frequency of the station to which it is tuned, while offering a selectivity, as against interference, practically identical with that of the same number of tuned circuits used normally in cascade.

How the Capacity-coupled Filter Works.

If we wish to design a filter of such a type that it will tend to hold the selectivity more nearly constant, we have to turn to the capacity-coupled filter, the simplest form of which is shown in the circuit of Fig. 4. In this diagram the condenser C_m is common to both the tuned circuits, and therefore provides a coupling between them.

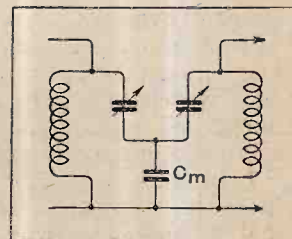

Fig. 4.—A capacity-coupled filter, using the condenser C_m , common to both tuned circuits, as the coupling between them. This is the circuit of all the capacity-coupled filters referred to in the text.

If a high-frequency voltage is induced into the first coil, from, say, a small primary connected to an aerial, it will cause a current to flow round the first tuned circuit, which is made up of the coil, the first tuning condenser, and the coupling condenser, C_m , all in series. In flowing through these three components the current will set up a voltage across each. The voltage developed across C_m will cause a current to flow in the second tuned circuit, for C_m is a part of this also. If C_m is large, its impedance will be low, and the voltage introduced into the second tuned circuit will be small. We then have weak, or "loose," coupling between the two tuned circuits. If, on the other hand, the capacity of C_m is small, it will have a higher impedance, so that a greater voltage will be developed across it and introduced into the second circuit. This represents the case of close, or "tight," coupling.

It is to be observed that the closeness of the coupling is primarily dependent on the impedance of the coupling condenser, rather than upon its capacity alone, and as, further, a fixed capacity offers greater impedance to currents of low frequency than to those of high, the voltage developed across C_m , and so communicated from the first circuit to the second, will be greater on the longer wavelengths than on the short. From the point

Capacity Coupled Filters.—

of view of the operator of the set, a coupling condenser which is left unchanged when the set is retuned may be said to provide "fixed coupling" (and in the present article the phrase "fixed coupling" is used with that meaning), but in the strict electrical sense the coupling automatically varies itself, with or without our approval, every time the tuning of the receiver is altered.

As a result of the tighter coupling at the long-wave end of its range, the resonance curves of a filter with a fixed capacity as the coupling element have their two peaks well separated at longer wavelengths, but as the filter is tuned to lower and lower wavelengths, the peaks approach more and more closely to one another, and may finally coalesce into the single peak that we associate with tuned circuits in cascade. The wavelength at which this coalescence takes place, if it occurs at all, depends upon the value of the coupling condenser chosen and upon the inductance and resistance of the tuned circuits concerned.

Calculating Peak Separation.

The necessary value of coupling condenser to provide suitable coupling between the two halves of the filter, provided that these are identical, can be calculated from the formula:²

$$\text{Peak separation (cycles)} = \frac{\sqrt{\frac{I}{\omega^2 C_m^2} - r^2}}{2\pi L}$$

where $\omega = 2\pi \times$ frequency, in cycles per second.

L = inductance of each of the coils, in henrys.

r = equivalent series resistance of each tuned circuit at the frequency being dealt with.

If we take, as a suitable coil for the construction of a filter, a two-inch coil, wound with eighty turns of No. 26 d.c.c. wire giving an inductance of 200 microhenrys,³ we find that the values of C_m required to give a peak-separation of 10 kilocycles at various wavelengths are as follows:

Wavelength. (Metres.)	Capacity of C_m . (Microfarads.)
550	0.0256
475	0.0215
400	0.0172
350	0.0140
300	0.0096
275	0.0086
250	0.0070
225	0.0054
200	0.0036

It is quite clear from these figures that, however cunningly we may select our coupling condenser there is no hope whatever of keeping the peak-separation constant throughout the whole wave-band.

The next step is to find the peak-separation at various wavelengths that will be given by various coupling capacities. In the table that follows this is done, the three capacities chosen being approximately those which pro-

vide a peak-separation of 8 kilocycles at 550, 425, and 300 metres.

Wavelength. (Metres.)	Peak Separation in Kilocycles.		
	$C_m=0.025$ mfd.	$C_m=0.0186$ mfd.	$C_m=0.010$ mfd.
550	8.2	11.7	22.8
475	6.4	9.6	19.4
400	3.8	7.1	15.9
350	—	4.6	13.2
300	—	—	8.4
275	—	—	4.6
250	—	—	—

It will be seen that in all three cases the two separate peaks characteristic of a filter-circuit disappear altogether at some wavelength towards the middle of the range, so that from this point down to the shortest waves that can be tuned in the filter acts much like two tuned circuits arranged normally in cascade, and separated by a valve so that they cannot react upon one another.

A clearer notion of what these figures imply in the way of resonance curves can be had from a consideration of the curves of Figs. 5 (a) and 5 (b), which give the resonance curve of the filter in which $C_m=0.0186$ mfd. at four selected wavelengths. At some wavelength between 300 and 400 metres the two humps meet and become one, and at all wavelengths below this the two circuits composing the filter are too loosely coupled to show the double hump.

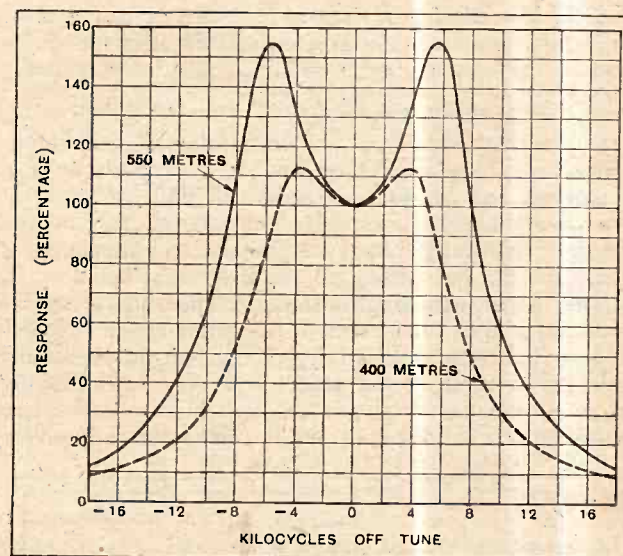

Fig. 5 (a).—Resonance curves at 400 and 550 metres of a filter consisting of two of the 200-microhenry coils described in the text, coupled by a fixed capacity of 0.0186 mfd.

From the point of view of retaining side-bands, this tendency of the resonance curve to become more "peaky" at the shorter wavelengths is not very serious, because with a carefully chosen value of coupling capacity the disappearance of the humps can be made to take place at a wavelength where the naturally flat tuning of the individual circuits is in itself enough to take care of the side-bands to an extent sufficient for all but the most critical. From the point of view of keeping the selectivity of the filter approximately constant, the disappearance of the humps is a positive advantage. Inspection of the outer edges of the curves of Figs. 5 (a)

² This formula, together with much other information used in this article, is derived from E. A. Uehling, *Proceedings of the Radio Club of America*, November, 1929.

³ See "Size versus Efficiency of Small Coils," *The Wireless World*, January 29th, 1930.

Capacity Coupled Filters.—

and 5 (b) will reveal that at all wavelengths from 250 to 550 metres a station removed in frequency by 18 kilocycles from that being received will be heard as interference at a loudness varying between 9 and 13 per cent. of its loudness when deliberately tuned in. This represents very good constancy of selectivity as against interference removed in frequency by this amount from the required station.

Curves plotted on a "straight" scale, as in Figs. 5 (a) and 5 (b), are very useful for showing the peaks of the resonance curve, and for exhibiting the selectivity in the immediate neighbourhood of the peaks. Unless drawn on an impossibly large scale, however, they cannot give any useful idea of the response of the circuit to signals considerably removed in frequency from those to which the circuit is tuned. For this purpose a logarithmic scale is very much better suited.

(To be concluded.)

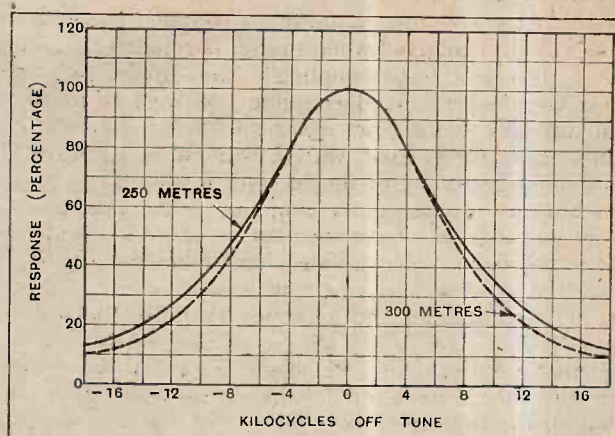

Fig. 5 (b).—Resonance curves at 250 and 300 metres for a filter as described under Fig. 5 (a).

The "Call Book."

The March issue of the Radio Amateur Call Book has now been published, and copies may be obtained from Mr. F. T. Carter, Flat A, Gleneagle Mansions, Streatham, price 4s. 6d., post free. The lists of amateur transmitters in all parts of the world have been carefully revised and brought up to date. In particular, the British list has been thoroughly overhauled and improved by weeding out the stations whose owners have given up their licences. When it is realised that the only official list of British amateurs is that kept, in the strictest confidence, by the G.P.O. and that any published list can only be compiled with the aid of individual transmitters, the labour entailed in constantly correcting the record of "G's" and especially in obtaining information from those who are no longer working, will be appreciated. Among other noteworthy features of the new edition is the revised list of Argentine stations.

We would recommend interested readers to apply early to Mr. Carter, if they require copies, as we know the December issue was quickly out of print.

o o o o

International Congress of Short-wave Amateurs.

The International Congress, to which reference was made on page 242 of our issue of March 5th, will be held in Antwerp from July 12th to 14th next. Amateur transmitters from all the five continents are cordially invited. Various problems relating to the properties of short waves will be discussed, and lectures are promised by leading experimenters. Detailed information may be obtained from the General Secretary of the Managing Committee, M. Arthur Respen (ON 4HV), 15, Plaine de Malines, Antwerp.

Among the many subjects set down for discussion is the general status of amateurs, the services they have rendered in the past, and those they hope to render in the future; a plan of campaign to be adopted at the Madrid Conference in 1932 will also be considered.

8 7

TRANSMITTERS' NOTES.

The organisers of the Congress evidently intend that it shall be a social as well as a technical success. The formal meetings will be held in the morning from 9.30 to 12.30, and visits to the World's Fair, museums and other places of interest are to be arranged for the afternoons.

The Antwerp Congress will be followed by a visit to the Liège Exhibition on July 15th and 16th, and the proceedings will conclude with a dinner in Brussels on July 18th at 2 p.m. We understand that a special reduction in railway fares will be allowed to the delegates and free tickets to the Exhibition.

o o o o

International Short-Wave Club.

An International Short-Wave Club has been formed in Klondyke, Ohio, U.S.A., with the object of exchanging information among short-wave amateurs, sending out bulletins, answering questions, etc. Mr. Arthur J. Green, the President of the club, sends us a copy of its bulletin for February 10th, from which we gather that it consists at present mainly of listeners who are anxious to get into touch with European amateurs willing to send them information concerning short-wave stations of interest on this side of the Atlantic. The subscription to the International Short-Wave Club is \$1 per annum, and communications should be addressed to the Secretary, Box 713, Klondyke, Ohio, U.S.A.

o o o o

Regular Short-Wave Transmissions.

Mr. Green also sends us particulars of a few stations transmitting regularly, which may be of interest to British listeners:—
 HRB, Tegucigalpa, Honduras, on 49.95 metres, broadcasts on Tuesdays, Thursdays and Saturdays, 02.15 to 05.00 G.M.T., and is installing a new transmitter which should enable its signals to be heard in England.

HKT, Bogota, Columbia, on 48.5 metres, about 4 nights a week at 01.00 to 04.00 G.M.T.

Both these stations send in Spanish. VE9CL, Winnipeg, Canada, on 52.4 metres, taking the place of CJRX on 25.6 metres.

VE9AT, Drummondville, Canada, on 47.5 metres.

These two stations broadcast at about 01.00 G.M.T.

FZS, Saigon, Indo-China, working with FW, Sainte Assise, on 16.4 metres at about 18.00 G.M.T.

NRH, Costa Rica, on 30.8 metres, and VRY, Georgetown, British Guiana, on 43.86 metres, are increasing their power and should soon be heard in England.

o o o o

Short-Wave Workers.

Mr. George Brown (G5BJ), 62, The Ring, South Yardley, Birmingham, wishes to form a group of amateurs in Birmingham and district interested in short-wave working, and asks those who are willing to collaborate to communicate direct with him.

o o o o

New Call-Signs and Stations Identified.

G2LW F. H. Lawrence, 36, Earlsthorpe Road, London, S.E.26. (Change of address.)

G2XB (ex 2AUH), J. Browne, "Kenilworth," Beaufort Road, Ashton-under-Lyne.

G2XV G. A. Jeapes, 2, Salisbury Villas, Station Road, Cambridge. (Change of address.) Transmits on 40-metre band, telephony on Sunday mornings; 20-metre band, C.W. telegraphy, evenings and early mornings; 10-metre band, C.W. mid-day to early evening Sundays only. Reports will be welcomed.

G5JK L. R. Harper, "The Knoll," Bieldside, Aberdeen. (Change of address.)

G5SV M. F. Somerville, 13, Elm Park Mansions, Park Walk, Chelsea, S.W.10.

G6GL (ex 2BH1), G. R. Lee, 25, Boundary Road, West Kirby, Cheshire.

G6SK E. D. Sykes, Jnr., 12, St. Roberts Road, Knaresborough.

G6TG R. Harris, Berwick St. John Rectory, Shaftesbury, Dorset. (Change of address.)

2ARU E. J. Thomas, High Street, Cwmgrwrach, near Neath. (Change of address.)

2BIK H. M. Arnold, Dorney Cottage, Wittering Lane, Heswall, Cheshire.

2BIX A. C. Jones, 167, Plymouth Street, Merthyr Tydfil, Glam.

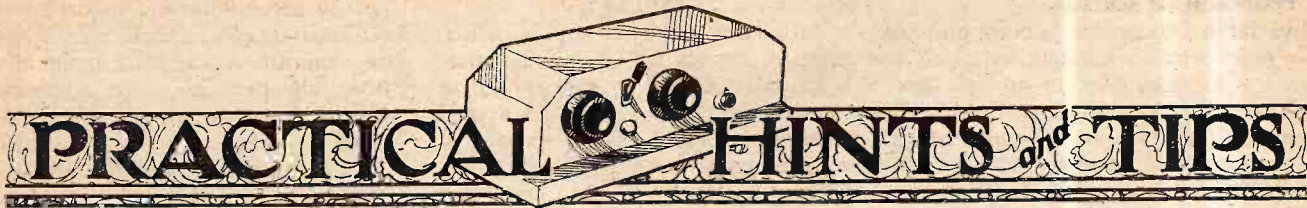

PRACTICAL HINTS and TIPS

Simplified Aids to Better Reception.

THROTTLE REACTION WITH H.F. AMPLIFICATION.

THE throttle-controlled Hartley circuit, with "mid-point" loading for long-wave reception, has long been a favourite with readers of this journal. One should always hesitate before acclaiming any particular reaction device as being definitely superior to its competitors, but, without suggesting that this arrangement has any magic properties, it may be stated that it has proved itself to be extraordinarily effective in practice. It is the fashion nowadays to deprecate too great a dependence on reaction as an aid to sensitivity; this may be right enough, but the fact remains that long-distance reception is most easily, and above all cheaply, attained when full use is made of a smoothly controllable system of feed-back.

An illustration of what can be done in this direction is provided by the "Everyman Portable" (*The Wireless World*, April 18th, 1928), in which the particular cir-

cuit under discussion was first included. This little self-contained detector-L.F. set, without any H.F. amplification, and in spite of the infinitesimal pick-up of its almost ridiculously small frame, is quite capable of receiving Continental stations after dark.

The throttle-controlled reaction circuit under consideration happens to lend itself especially well to use in combination with an H.F. amplifying stage. It is possible to use it as a simple tuned-anode intervalve coupling, but, to avoid the various minor difficulties inherent in this system of transferring energy from valve to valve, it is to be recommended that the claims of the alternative "parallel-feed" or "tuned-grid" method should be considered. It is certainly much less likely to give rise to trouble, particularly when the anodes are fed from a main supply.

A diagram showing an intervalve coupling of this latter kind is given in Fig. 1. For the benefit of those who are unfamiliar with

throttle-controlled circuits it should be said that the medium-wave tuned-grid inductance $L(a)$, $L(b)$ consists of a single coil, of which the winding is broken at its centre point. In this "break" is inserted the long-wave loading coil L_1 , with its centre point connected to the earth line. A switch, which must be of the "three-point" type now produced by several manufacturers, is arranged to short-circuit the long-wave coil when it is not required.

Oscillations fed back from the anode *via* the feed condenser F.C. are passed back to "earth" through one half of the tuned coil, which thus acts as a reaction winding. The actual proportion of energy thus fed back to the grid depends on the relative capacities of F.C. and of the reaction control condenser R.C. If the latter is large it will offer a path of low reactance and will deflect energy from the reaction circuit; thus it will be seen that this control condenser does not operate in the normal manner, and that reaction effects are increased as its capacity is *reduced*.

Now for a few practical details. The "split" coil $L(a)$, $L(b)$ may have 60 to 70 turns of No. 24 D.C.C. (depending on the capacity of the tuning condenser C_1) as a continuous winding except for a break of about $\frac{1}{8}$ in. at the centre, where the ends are taken out for external connection. Ready-made coils of the "Dimic" type are equally suitable. For a loading inductance, L_1 , an ordinary commercial centre-tapped coil (about No. 200) will do.

If a fixed condenser is used for reaction feed (F.C.) its capacity should not exceed 0.0005 mfd. For this purpose it is very convenient to substitute a semi-variable condenser with a maximum capacity of 0.0001 mfd. The reaction condenser should be of 0.0005 mfd., but, with

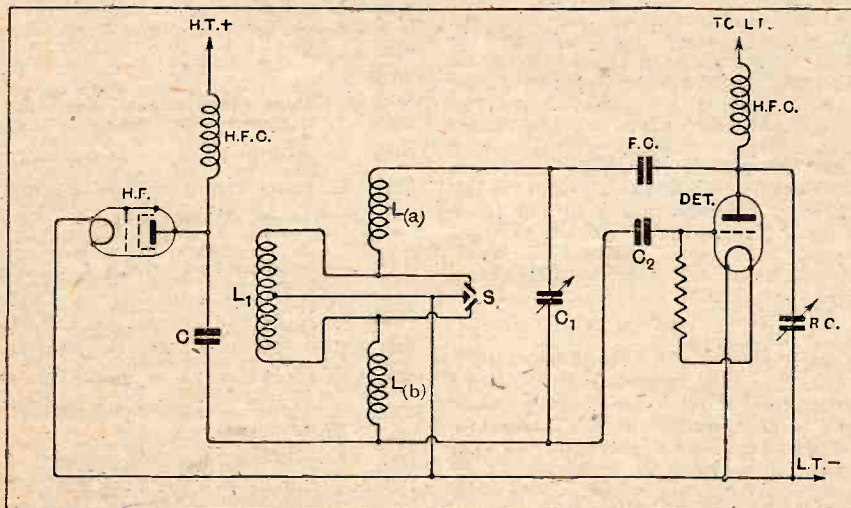

Fig. 1.—Parallel-feed H.F. amplifier with screen grid valve. The throttle-controlled Hartley circuit provides good reaction control and simple waveband switching.

Practical Hints and Tips.—

variable feed, a maximum of 0.0003 mfd. is enough.

The blocking condenser C may be of the usual value in a circuit of this kind (0.0002 to 0.0005 mfd.). C₂ is the normal detector grid condenser.

The usefulness of "centre-loaded" circuits is not confined ex-

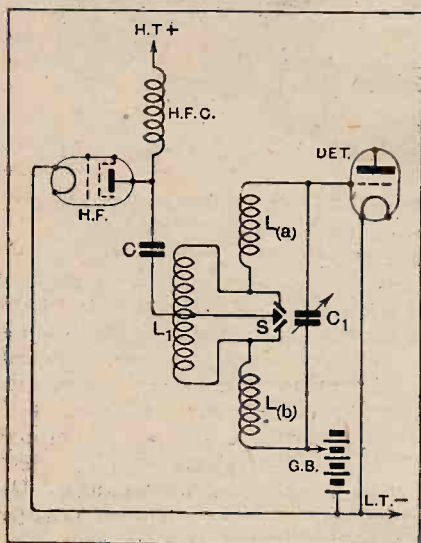

Fig. 2.—A tuned grid circuit, without reaction. By adopting mid-point loading, a centre-point connection is retained on both wavebands without complication of switching.

clusively to sets in which reaction plays an important part. It is now generally admitted that "parallel-feed" H.F. couplings offer no advantages over transformers beyond allowing of a simpler form of waveband switching; this simplicity is apt to disappear if the coils are "good" enough—and sometimes if metallic screening is bad enough—to make it necessary to "tap down" the anode-feed connection for long-wave reception. In order that the feed connection may be transferred to an appropriate point on the long-wave coil it may be essential, when using the conventional circuit, to provide a double-pole change-over switch. Here the principle of inserting the loading coil at the mid-point of the medium-wave inductance comes to our help, as it allows us to use a very simple switch for wave-changing in all cases where a centre-tapped connection happens to be suitable for the two wavebands.

H.T. REGULATION.

Although modern valves when used in modern circuits are not particularly exacting in the matter of anode voltage—always provided they get enough—it is a matter of some importance that the pressures applied to H.F. screening grids and to detectors (particularly of the anode-bend type) should be both well maintained and of approximately the right value. It is for this reason that we find a tendency, in designing mains-fed sets, to use a potentiometer for controlling these voltages, rather than a series-absorbing resistance.

Continuously variable potentiometers are to be advocated for controlling screening grid voltage, where fairly high accuracy is needed; this is partly because it is surprisingly difficult accurately to estimate the values of resistances for a fixed potentiometer unless one has access to several measuring instruments. These two types of potential dividers are shown respectively in Fig. 3 (a) and (b), from which it will be seen that the resistance element is joined directly across the main terminals of the eliminator.

The first task is to decide upon the total resistance required. As a rough-and-ready rule, it may be said that the potentiometer should consume at least four times as much current as the circuit fed from it; an average value for a screening grid is about 0.75 milliamp. (0.00075 amp.), so the resistance should pass 3 milliamps. (0.003 amp.). By dividing the voltage to be applied across the potentiometer by this current we can arrive at a suitable resistance value for it (in ohms). Taking these figures, and assuming an eliminator output voltage of 150, we get $150 \div 0.003$, giving 50,000 ohms as the total resistance. This is a value that is commercially available, and, in practice, it will be found suitable in the great majority of cases.

Still referring to the variable potentiometer (diagram 3 (a)), it will hardly be necessary to point out that the voltage fed to the external circuit through the sliding contact B will decrease progressively from the full pressure delivered by the eliminator to zero as this contact is moved from A towards C.

Fixed potentiometers, made up of two resistances connected in series (see diagram 3 (b)) are generally rather cheaper, and are adequate where exact regulation is unimportant. The combined resistance of the elements R and R₁ are determined in exactly the same way as in the case of the variable potentiometer, but the voltage fed to the external circuit will depend on the relationship between the two resistors. If no current were consumed it would be a simple matter to estimate the relative resistance values, as the voltage at the junction point would be determined by simple proportion; with 150 volts applied, as before, across the potentiometer, and with resistors of 25,000 ohms each, a pressure of 75 volts would exist. In practice, however, some current is always flowing through the feed circuit, and so an adjustment must be made by subtracting the voltage absorbed in resistance R. In the case under consideration we have assumed that consumption will amount to 0.75 milliamp. (0.00075 amp.), and the

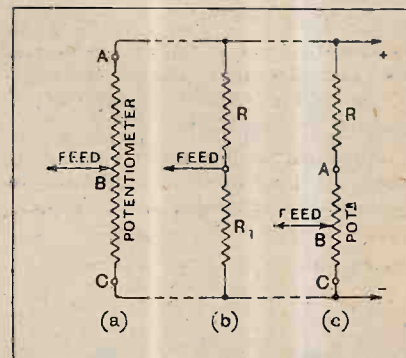

Fig. 3.—Potentiometers for anode current feed: continuously variable, fixed and semi-variable types are shown.

lost voltage is determined by multiplying this current by the value of the resistance, which is 25,000 ohms. This gives us 18.75 volts, which must be subtracted from the input voltage of 150 before the arrangement can be considered as a simple potential divider.

Where it is desired to avoid the possibility of applying full eliminator voltage, or where it is not convenient to use a variable potentiometer of the full resistance needed, a fixed voltage-limiting resistance may be connected in series, as shown at R in Fig. 3 (c).

Gramophone Pick-ups Tested

Measured
Frequency
Characteristics.

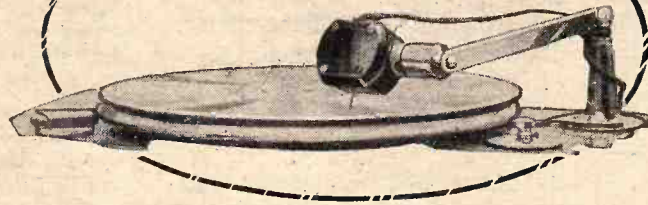

Notes on Record Wear
and
Constructional Details.

THE frequency characteristic of an electrical gramophone pick-up is of first importance in judging its merits. From a long series of laboratory tests these characteristics have been prepared in respect of the best-known pick-ups and forms a reliable guide to the choice of a suitable type.

It will be observed that the characteristics possess marked irregularities, and in judging the seriousness of the peaks it is pointed out that a variation in sound intensity of 25 per cent. is only just appreciated by the average listener. Owing to the limitations in reproducing the bass brought about by the pitch of the groove on the gramophone record, a rising characteristic below 250 cycles is desirable. Reference is made in these tests to the weight of the pick-up and its ability to follow the groove at the lower frequencies, which reveals in many cases the best operating conditions bearing in mind the need to avoid excessive record wear. Constructional details of the magnetic system and the method of damping show the present-day tendencies in pick-up design.

(Continued from page 328 of last week's issue.)

GRAWOR.

The tone arm of this model incorporates a volume-control potentiometer, which was set at maximum for the purpose of taking the characteristic. It will be observed that the pick-up shows reluctance to follow the standard frequency records below 200 cycles, but the ratio of the mass of the pick-up to the flexibility of the reed is such that no extra pressure is required to produce the maximum output until the movement actually starts to

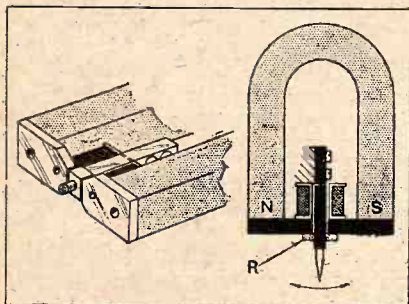

Grawor.

chatter. Of course, in playing ordinary records, it is probable that no chattering would be observed, as the standard frequency records employ a much greater pitch of groove. Apart from a group of resonances between 2,500 and 3,500 cycles, the characteristic is good, and these latter resonances would be only just perceptible to the ear. The output is measurable up to 7,000 cycles.

A differential magnet system is employed, and the reed armature is clamped to a lug formed on the moulded carcase of the unit. A swivel mounting facili-

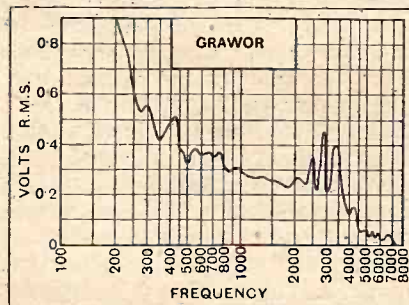

Tested with H.M.V. half tone needle.

tates the removal of needles, and the general finish is excellent.

Price, with tone arm and volume control, 45s.

Henry Joseph, 11, Red Lion Square, London, W.C.1.

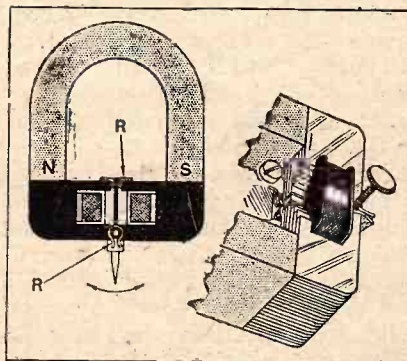

Harlie.

HARLIE.

The movement is of the differential armature type, and an interesting feature is the arrangement of the pole-piece laminations in echelon. The characteristic is above the average, and the resonance at 2,900 cycles is not sufficiently marked to cause serious trouble.

A spring tensioning device is provided to vary the needle pressure, but with this slackened right off to give the greatest pressure available extra weight was still

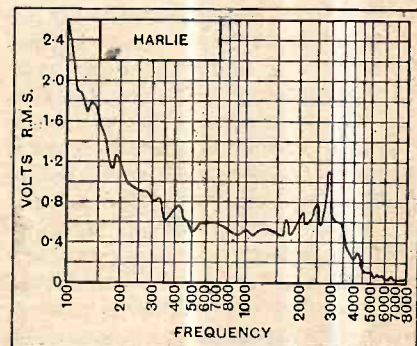

Tested with H.M.V. half tone needle.

required to obtain accurate readings below 325 cycles. Record wear is not excessive, and no difficulty is experienced in following standard records down to 100 cycles. A volume control is incorporated in the tone-arm pivot, and this was set at maximum while taking the characteristic.

Price, with tone arm and volume control, 37s.

Harlie Bros., Balham Road, Lower Edmonton, London, N.9.

Gramophone Pick-ups Tested.—
HEGRA.

This pick-up can be placed in the best half-dozen from the point of view of the frequency characteristic, which shows an upward tendency at the correct point in

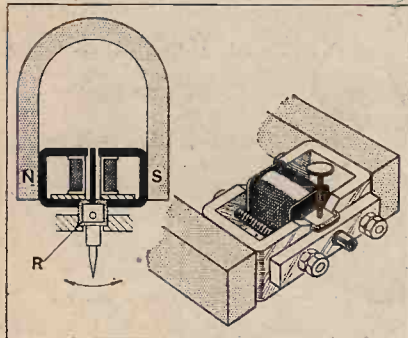

Hegra.

the lower register, and maintains a constant average level up to 3,000 cycles. Above this frequency the output decreases, but not sufficiently rapidly to deprive the upper register of its proper significance. The weight is somewhat low in relation to the stiffness of the movement, and

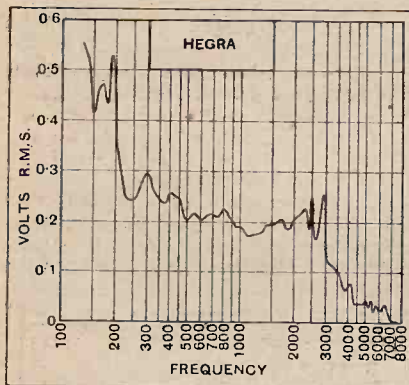

Tested with H.M.V. half tone needle.

extra pressure was required to obtain suitable readings below 425 cycles. The record wear is, however, satisfactory, and readings were obtained down to 130 cycles. Price, 35s.

Geo. Becker, Ltd., 39, Grafton Street, Tottenham Court Road, London, W.1.

o o o o

HELIOS (GRASSMAN).

An interesting feature of this component is the provision of a mica inspection window, through which it is possible to see that the armature is properly centred and that the air-gap is free from dust particles. The tone arm which carries the volume control and pedestal is rather too short for satisfactory needle track alignment.

A good output of the order of 0.6 R.M.S. is obtained, and the characteristic rises steadily below 1,000 cycles. Although numerous irregularities were ob-

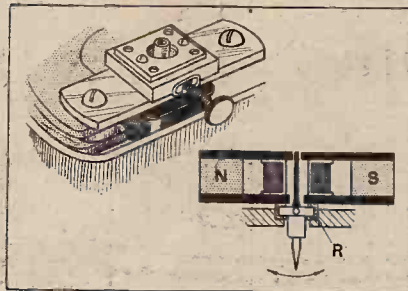

Helios.

served, none of these is important apart from the one at 2,500 cycles. Above this frequency the output falls steadily to a cut-off point at 5,000 cycles.

The needle pressure in relation to the stiffness of the armature movement is satisfactory, and no extra pressure was

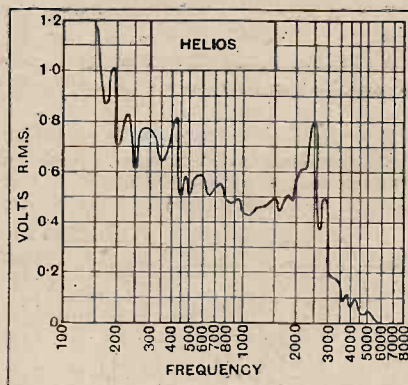

Tested with H.M.V. half tone needle.

needed to obtain accurate readings at any point on the curve. Price, with tone arm and volume control, 42s.

Rotor Electric, Limited, 2-3, Upper Rathbone Place, London, W.1.

o o o o

IGRANIC SUPER PHONOVOX.
This latest product of Igranipacient is completely redesigned both

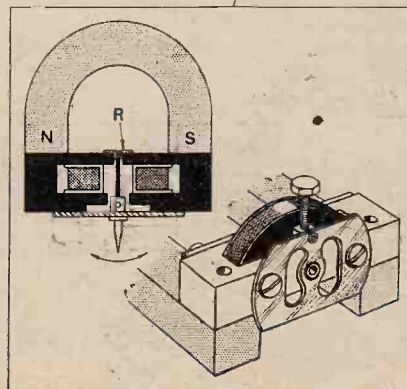

Igranipacient Super Phonovox.

as regards the mechanical arrangement of the pick-up mechanism and also the tone-arm mounting.

The tone arm is of channel section and is provided with a balance weight, while the pick-up itself is hinged to facilitate the fitting of needles. It should be noted that the pick-up is exactly in line with the tone arm, so that the tracking errors are greater than they might be.

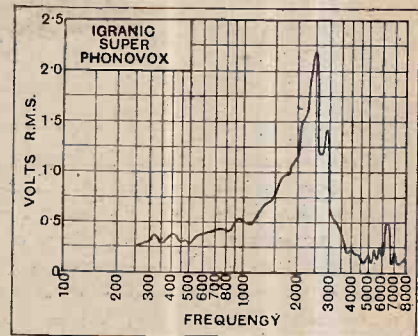

Tested with H.M.V. half tone needle.

In the new model the mass of the armature has been considerably reduced, and a novel centring device in the form of a thin paxolin "spider" is employed. Adjustable damping is provided by rubber blocks at each side of the upper extremity of the reed.

In spite of the reduction in the mass of the armature, however, the principal resonance is rather low. It would be possible to raise the frequency of resonance by increasing the pressure of the damping pads and so increasing the restoring force, but this would result in increased record wear. Already there is a tendency to jump the groove on the standard records at 250 cycles, though in fairness it is only right to state that this effect is not noticeable on ordinary records in which the amplitude is considerably less.

Price, with tone arm, 42s.

The Igranipacient Electric Co., Ltd., 149, Queen Victoria Street, London, E.C.4.

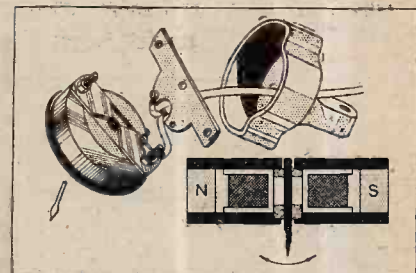

Lissen.

LISSEN.

The principal interest attaching to this pick-up is that it is one of the few representatives of the needle-armature type. A four-pole magnet system is provided; the needle is embedded in rubber

Gramophone Pick-ups Tested.— between the pole-pieces, and itself carries the magnetic flux and performs the function of the armature. A small

year. A tubular iron armature was introduced to reduce weight, and is mounted between a 4-pole magnet system. The pick-up, although light in weight, will

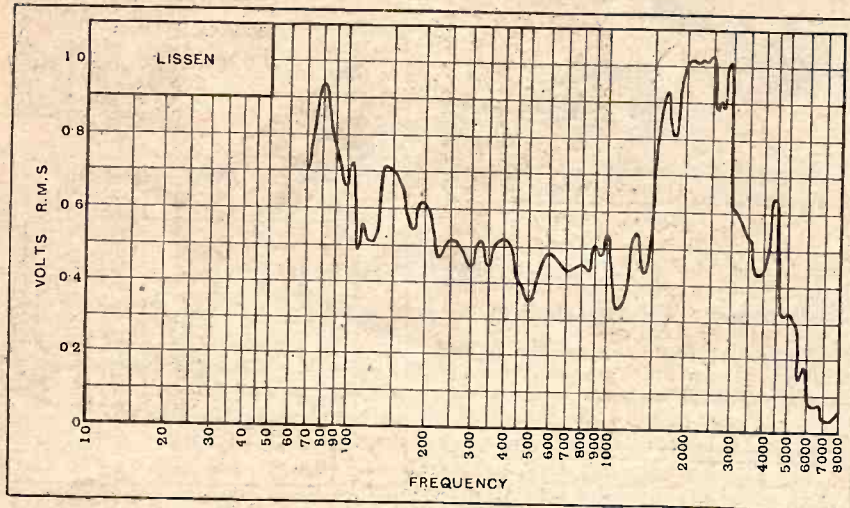

Tested with Columbia Spearpoint needle.

metal bush is inserted in the rubber tube at the lower end to prevent wear through repeated insertion and withdrawal of needles.

As might be expected, the pick-up is very light on records, and no difficulty was experienced in obtaining readings down to 70 cycles on standard records without any additional needle pressure being required. The curve is characterised by numerous minor irregularities, and a general raising of the output between 1,500 and 3,000 cycles. As might be expected in view of the small inertia of the needle armature, the high-frequency response is good. It is also interesting to note that the voltage output, in spite of the small dimensions of the armature, is comparatively high, being of the order of 0.5 volt.

Spearpoint needles are recommended, and these may be turned at various angles to provide variations in the general level of the output. Price 30s.

Lissen, Limited, Lissenium Works, Worple Road, Isleworth, Middlesex.

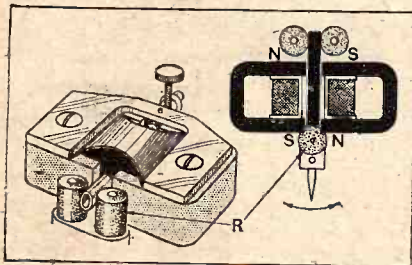

Loewe.

LOEWE.

Little, if any, alteration has been made to the design of this pick-up since last

follow the standard records down to 130 cycles without extra pressure, and an average output of the order of 0.3 volt R.M.S. is obtained up to 2,500 cycles.

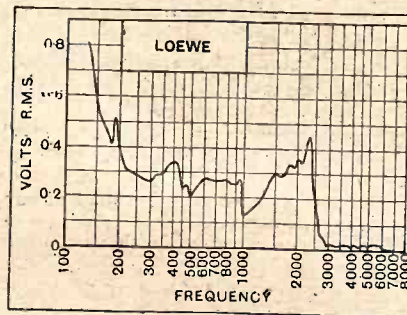

Tested with H.M.V. half tone needle.

The high frequency cut-off takes place virtually at 3,000 cycles, though there is a measurable output up to 6,000 cycles. Price 18s. 6d.

The Loewe Radio Co., Ltd., 4, Fountainayne Road, Tottenham, London, N.15.

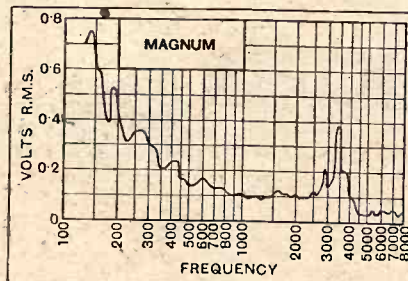

Tested with H.M.V. half tone needle.

MAGNUM.

This unit has been entirely redesigned since last year, and is now perfectly satisfactory from the point of view of record wear. A very good characteristic was obtained, with a satisfactory increase in the bass, and a resonance at 3,400 cycles, which will have the effect of giving brilliance to the upper register without causing objectionable resonances (3,400 cycles is equivalent to the top note of the piano). Taking the performance as a

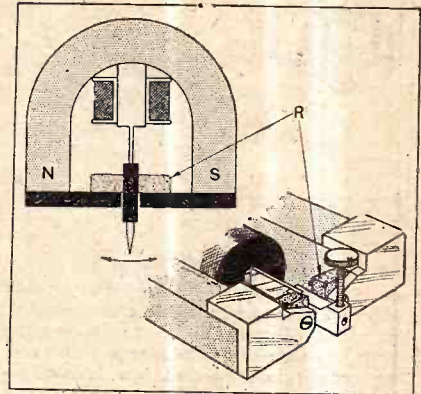

Magnum.

whole this pick-up may be placed among the best half-dozen. Price 35s.

Burne-Jones and Co., Ltd., 288-296, Borough High Street, London, S.E.1.

o o o o

MARCONIPHONE.

The characteristic of this component may well serve as a model to designers of gramophone pick-ups. Over the middle band of frequencies from 250 to 2,500 cycles a constant output of approximately

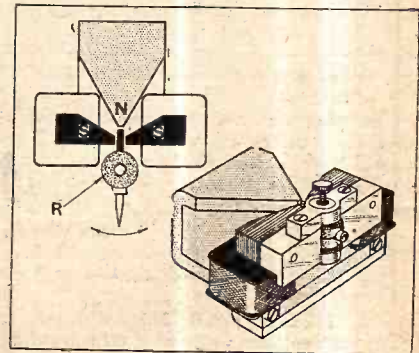

Marconiphone.

1.5 volts is maintained. Below 250 cycles there is a gradual rise to 70 cycles, and then a more rapid increase of output to 30 cycles, which adequately compensates for the restriction in amplitude of the lowest frequencies recorded. In the upper register a resonance occurs in the region of 3,500 to 6,000 cycles, depending on the needle used. As this resonance is outside



Gramophone Pick-ups Tested.—

the range of fundamental frequencies used in music, it serves the useful purpose of giving a rising characteristic in the upper register, which compensates for deficiencies in the amplifier system.

Throughout the tests no trace of record wear could be detected, and no tendency to jump the groove was observed until a frequency of 25 cycles was reached. The weight of the pick-up, and consequently the needle pressure, is above the average, and in our opinion this is a desirable feature. Failure to follow the record at low frequencies is in most cases due to too light a needle pressure. A further advantage of a massive pick-up is that tone arm resonances are considerably reduced. In the Marconiphone instrument no trace of tone-arm vibration could be detected.

The armature is of exceedingly small dimensions, and whilst being adequately damped is capable of developing large amplitudes. As will be seen from the

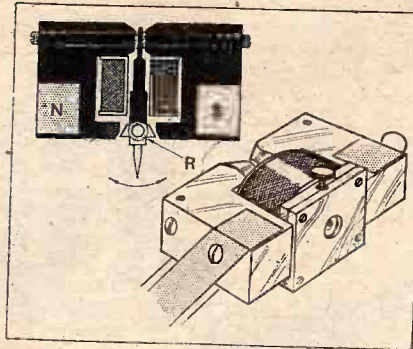

Melrope.

The pick-up is fairly massive, but extra pressure was required to produce accurate readings below 325 cycles. Actually readings were taken down to 150 cycles, though some of these are not shown on the curve. The output of 150 cycles was 1.84

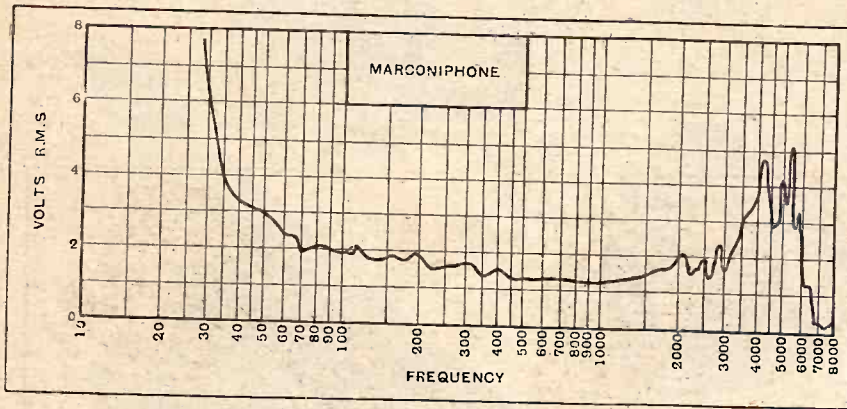

Tested with H.M.V. loud tungstyle needle.

diagram, the magnet system is unconventional, three pole-pieces being employed—one at the top of the reed and the remaining two at the sides. The tone arm is provided with a detachable counter-balance, and is set at the correct angle for accurate needle track alignment. An interesting feature is the provision of a third terminal for earthing the metal parts of the tone arm

Price, with tone arm, 63s.

The Marconiphone Co., Ltd., 210-212, Tottenham Court Road, London, W.1.

o o o o

MELTROPE.

This comparatively new instrument is characterised by an extraordinarily good output in the bass. It will be seen that from 350 cycles downwards the increase in the output is very rapid, and this quality should prove useful in correcting for amplifiers or loud speakers which are deficient in the lower register. Above 350 cycles the output falls steadily until 6,800 cycles is reached, at which point the volts developed could not be measured with accuracy. It will be observed that the entire characteristic is free from serious resonances.

volts R.M.S. The record wear is satisfactorily small, and the pick-up is specially recommended where good output in the lower register is required.

Price, with tone arm, 50s.

Amplifiers, Ltd., Billet Road, Walthamstow, London, E.

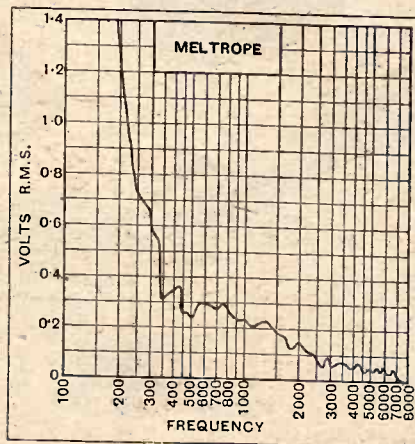

Tested with H.M.V. half tone needle.

PHILIPS.

In view of the fact that no attempt has been made to achieve accurate needle track alignment, it is rather surprising that the length of the tone arm in this model should be only 7 inches. This has the effect of considerably increasing tracking errors. An 8-pole differential magnet system is employed, and, in spite of the small dimensions of the permanent magnets, a considerable output is obtained. The output is characterised by a very distinct

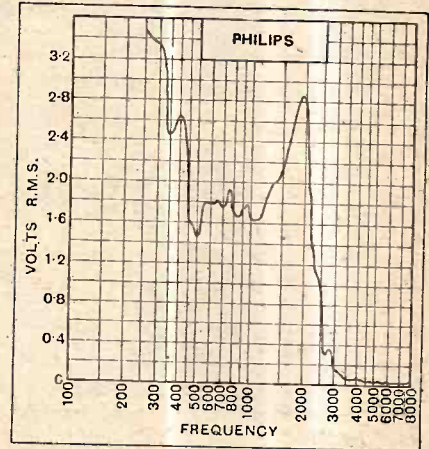

Tested with H.M.V. half tone needle.

cut-off, starting at 2,000 and finishing at about 3,000 cycles. In spite of the fact that the mass of the pick-up is above the average, in order to obtain an accurate reading, the needle pressure had to be increased below 425 cycles, and no further readings could be taken below 250 cycles.

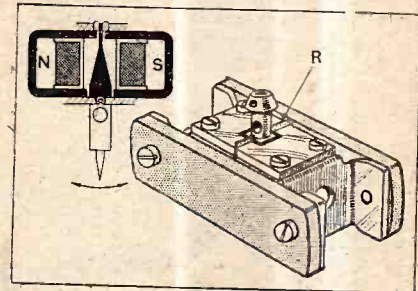

Philips.

The outfit is completed by a volume control and all necessary leads and plugs, the whole being presented in a tasteful velvet-lined cabinet. Price 90s.

Philips Lamps, Ltd., Philips House, 145, Charing Cross Road, London, W.C.2.

R.G.D.

This pick-up has already been reviewed in the pages of this journal (January 29th, 1930). While the output at low frequencies is somewhat below the average, the characteristic curve is level from 250 to 1,000 cycles, after which there is an increased output between 1,500 and 4,500 cycles. Brilliance in the upper

Gramophone Pick-ups Tested.—

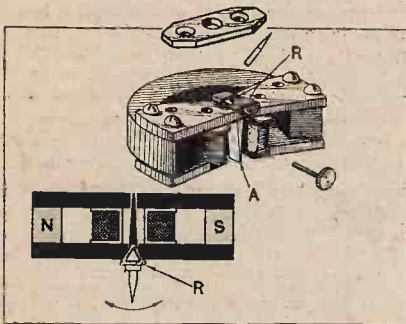

R.G.D.

register is therefore the outstanding feature of the performance, and the pick-up should prove useful in correcting for over-emphasis of the bass where this occurs either in the amplifier or the loud speaker. Record wear is satisfactory, and the general design of the tone arm is neat and of small overall height.

Price, with tone arm, 60s.

The Radio Gramophone Development Co., 7, St. Peter's Place, Broad Street, Birmingham.

Test reports on the following gramophone pick-ups appeared in last week's issue:—

Bear, Blue Spot, Bowyer-Lowe, B.T.H. (Ediswan), Burndept, Brown No. 2, Brown No. 3, Celestion, Detex, Edison Bell, Efesca, Electramonic, Electravox (Amplion), Elka, Graham Farish.

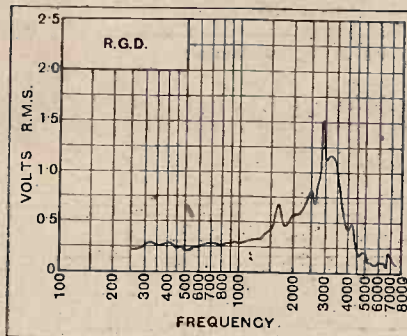

Tested with H.M.V. half tone needle.

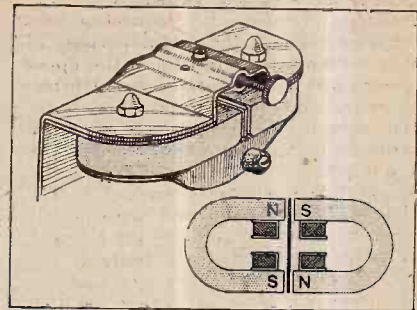

Truvox.

TRUVOX.

The unit comprises a four-pole differential movement with double permanent magnets. The movement is fairly heavily damped, and the lower limit for following the standard frequency records is 150 cycles. For accurate readings, extra needle pressure is required below 375 cycles.

An interesting feature is the provision of an adjustable angle between the pick-up and the tone arm, for obtaining correct track alignment. The tone-arm pivot takes the form of a gimbal univer-

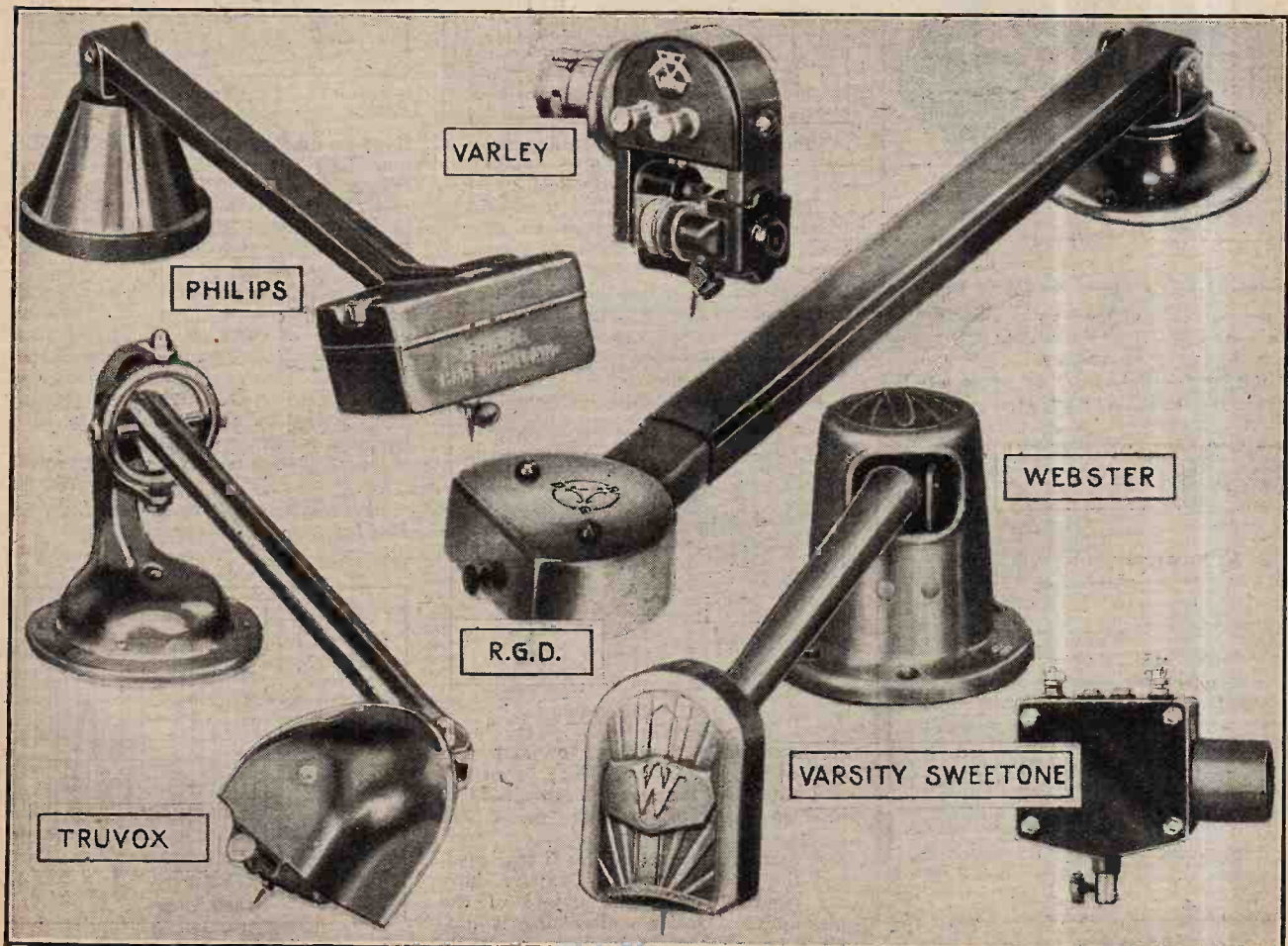

Gramophone Pick-ups Tested.—

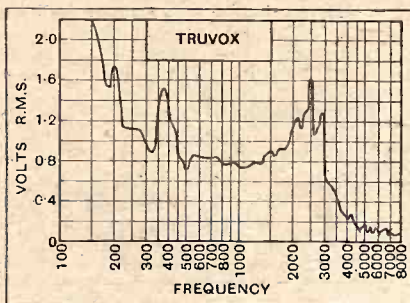

Tested with H.M.V. half tone needle.

sal, joint, which provides movement in all directions.

Price, with tone arm, 42s. 6d.

Universal Gramophone and Radio Co., Ltd., Ryland Road, Kentish Town, London, N.W.5

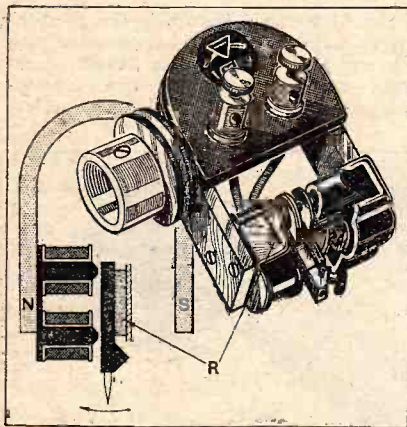

Varley.

VARLEY.

Although the vibrating mass of the armature and its associated mountings

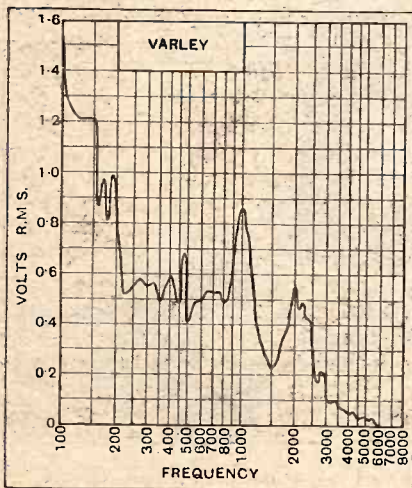

Tested with H.M.V. half tone needle.

is comparatively high, the damping is well distributed, and permits considerable freedom of movement. As a result the record wear is negligible, and the pick-up follows the standard frequency records with ease down to 100 cycles. With ordinary records, of course, in which the amplitude at low frequencies is considerably less, this pick-up should have no difficulty in reproducing notes down to 50 cycles, and the trend of the curve shows that adequate correction will be obtained for the restriction in amplitude which normally takes place below 250 cycles on the ordinary record. The D.C. resistance of the windings is 2,000 ohms, and the inductance at 1,000 cycles is approximately 1 henry.

Price 37s. 6d.

Varley (Olive Pell Control, Ltd.), Kingsway House, 103, Kingsway, London, W.C.2.

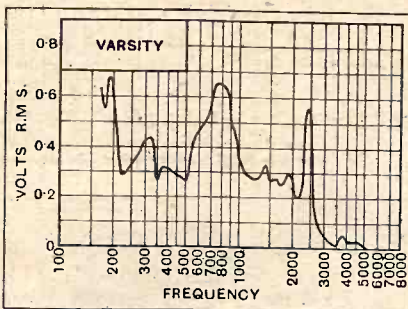

Tested with H.M.V. half tone needle.

VARSITY "SWEETONE."

This is a well-finished component, which is being marketed at an attractively low price. It gives an adequate output up to 2,750 cycles, and there are two resonances in the characteristic at 800 and 2,400 cycles respectively.

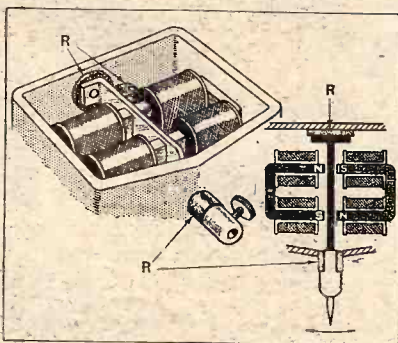

Varsity "Sweetone."

Evidence of a tendency to jump the groove below 200 cycles was observed, and extra pressure was required to produce accurate readings below 325 cycles.

A four pole magnet system is employed, and the reed is unusually massive, having regard to the light weight of the pick-up as a whole. Damping is provided by a rubber bush where the needle

holder passes through the metal case of the unit.

Price, 10s. 6d.

M. A. Frost, 54, Clerkenwell Road, London, E.C.1.

WEBSTER.

The design of this pick-up has not been altered appreciably since it was reviewed last year in the pages of this journal. The model tested was provided with a volume control in the tone-arm support, which was set at maximum while taking the characteristic. Tungstyle needles are recommended, and with

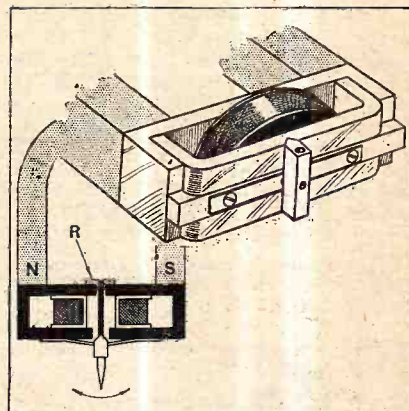

Webster.

these an average output of 1 volt R.M.S. may be expected. The characteristic rises steeply from 500 cycles downwards, and a noticeable resonance was recorded in the vicinity of 3,000 cycles. Nevertheless, a measurable output is obtained up to 8,000 cycles.

The solid tone arm ensures an adequate needle pressure, and, as might be expected under these conditions, the pick-up followed the groove extraordinarily well, and showed very little sign of record wear. No additional pressure was required to obtain the correct reading at any point on the curve.

Price, with tone arm and volume control, 77s. 6d.

The Rothemel Corporation, Ltd., 24, Maddox Street, London, W.1.

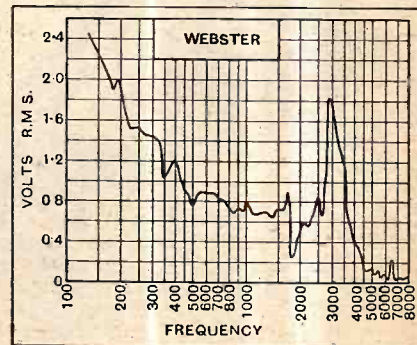

Tested with H.M.V. loud tungstyle needle.

THE TRUTH ABOUT THE EXPERIMENT.

"The Senator merely pressed a key on his yacht and a small current went into the ether, where it grew stronger and stronger until when it reached Sydney it was capable of switching on the lights of the Exhibition."—*Daily Mirror*.

Many problems should be solved by this newly discovered relationship between distance and signal strength.

HIGH POWER FROM THE RIVIERA.

"Radio Côte-d'Azur," the well-known broadcasting station at Nice, will shortly launch out on a new career with a minimum power of 25 kW., probably increasing to 50 kW.

FOR THE FAIR SEX.

The female penitentiary at Barcelona has been equipped with a central radio receiver, together with a loud speaker for each group of cells.

HUNGARIAN POLICE WIRELESS.

A wireless network is being planned for the Hungarian Police Department, with a central transmitter at Budapest and 120 receivers installed at various local stations.

MAINS SETS CAUSE A SLUMP.

The sudden popularity of mains-operated receivers in Germany is reported to have produced a slump in the ordinary battery models, prices of which have been reduced by 30 per cent.

GERMAN WIRELESS FOR CHINA.

The German Telefunken Company has secured a contract for the erection at Nanking of one of the most powerful wireless stations in the world. Chinese engineers are to proceed to Germany to study modern radio methods.

DEMONSTRATING RADIO-GRAMOPHONES.

The latest in radio-gramophones are included in the H.M.V. Hall of Music at the Ideal Home Exhibition, Olympia, London. Frequent demonstrations are given.

BRIGHTENING THE TALKS.

The "radio barber" has made his appearance at the Lyons broadcasting station, his function being to "shave" local celebrities at the microphone. During the process the barber and his victim discuss local news and gossip.

FADING FREAKS IN A COAL MINE.

Coal mining to music is the prospect suggested by interesting tests carried out in the Camerton Pit, Somersetshire, on March 18th with a Burndept portable receiver. The set, which incorporates a screen grid valve, detector and two stages of L.F., picked up 5XX while on the surface, but ceased to function immediately the cage began to descend. At the bottom of the shaft, some 1,000 feet below the surface, 5XX was again tuned in at about half normal strength, though full strength was secured by a slight adjustment to the H.F. condenser. London Regional came in strongly, both with the frame aerial in the set and with an exter-

Current
Topics

Events of the Week
in Brief Review.

nal aerial, but was more stable with the former. A curious fading effect was observed, London Regional "disappearing" completely at intervals of 15 seconds. On the other hand, no trace of fading was observed on the transmission of Radio Toulouse, which was received at very good strength.

B.B.C. BOAT RACE TRANSMITTER.

The transmitter which the B.B.C. will use in describing the Boat Race has been designed as a quality instrument, and range is sacrificed in consequence, the effective range being of the order of five miles. The transmitter is housed in two separate cases, one of which contains the drive and power magnifier and the other the modulator and sub-control. It normally works on a low wavelength, and for this

wavelength the aerial circuit is tuned with a variometer. The rest of the circuit follows more or less standard practice. The H.T. is supplied by a generator, battery driven, which gives an output of from 1-1,200 volts. This part of the equipment is in duplicate, and the two machines, together with the necessary regulating resistances and change-over switches, form a complete unit. On some occasions one machine supplies the plate voltage to the drive and magnifier and the other the plate voltage to the modulator, and for this reason each of these components has its own smoothing circuit. The input to the modulator panel comes from a speech amplifier fed by the usual Reisz microphone.

One of the most important features of the transmitter is the earthing arrangement, and many experiments have been carried out to secure the best possible system consistent with steady tuning of the aerial circuit.

The aerial is limited, both as regards size and effective height, the latter being a 12ft. maximum on account of bridges.

The checking of the transmitter during the race will be carried out with a small local receiver, which has a rectified current meter to indicate maximum signal strength without distortion.

TOO GOOD TO MISS.

An unforeseen possibility in regard to train wireless is suggested by a cartoon in a French contemporary. A passenger wearing headphones is seen proffering his ticket to an inspector. "But, Sir," says the inspector, "you have passed your station." "Never mind," retorts the passenger. "Give me a supplementary ticket to the terminus; this programme is too good to miss."

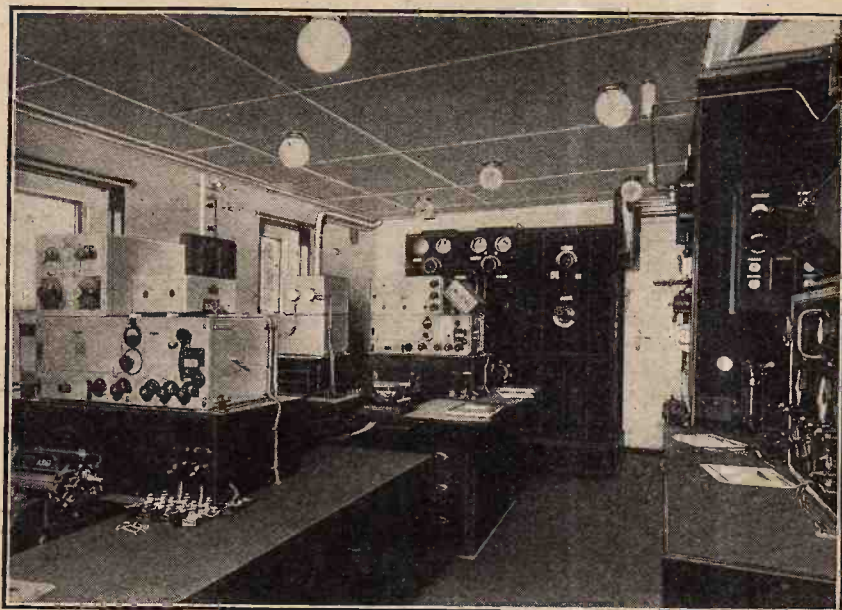

WIRELESS ON THE "EUROPA." A general view of the wireless cabin on the fastest Atlantic liner. Three transmitters, for long, medium and short waves, are installed, together with a direction finder and three receivers covering the entire band of useful wavelengths. Four motor lifeboats also carry transmitters and receivers.

Part XXV.—Coupled Aerial Tuning (*continued*).

By S. O. PEARSON, B.Sc., A.M.I.E.E.

(Continued from page 309 of the issue dated March 19th, 1930.)

IT now remains to summarise the conclusions reached, in the two preceding instalments of this series, with regard to the mutual effects on each other of the untuned aerial circuit and the tuned secondary circuit of the so-called aperiodic aerial system of tuning, where the aerial circuit is inductively coupled to the secondary coil, and then to consider how the selectivity, signal strength and tuning are affected when the degree of coupling between the aerial and secondary coils is varied. The general circuit arrangement is repeated here in Fig. 1.

In the first instance it was found that the tuned secondary circuit produced a large apparent increase in the resistance of the primary circuit, being given by equation (2) of Part XXIV. But there is no change in the reactance of the primary circuit when the secondary is tuned to resonance.

It was then shown that both the resistance and the inductive reactance of the secondary circuit are affected by the untuned primary circuit. First, the resistance is apparently increased by a relatively small percentage compared with that in the primary circuit, the value of the apparent increase depending on the impedance and actual effective resistance of the aerial circuit according to equation (3) of Part XXIV. Secondly, the effective reactance of the secondary coil is changed by an amount depending on the aerial circuit impedance and on the resultant reactance in the aerial circuit, the extent of the change being given by equation (5) of the previous part. It will be remembered that a preponderance of condensive reactance in the aerial circuit results in an increase of inductive reactance in the secondary coil, and vice versa.

The change of reactance in the secondary circuit appears to be more real than apparent, because to maintain resonance the setting of the tuning condenser has to be changed as the coupling between the coils is varied. Actually, the condenser tunes the combination of secondary coil and inductively coupled aerial to resonance.

On the other hand, the resistance of the secondary does not appear to be actually changed because, for oscillations of constant amplitude, the current is still given by dividing the E.M.F. induced into the coil L_2 by the actual effective resistance R_2 . Nevertheless, any decrease in the amplitude of the oscillations will involve the transfer back to the primary circuit of some of the stored oscillating energy in the secondary; and so as regards *damping* there is actually an increase in the equivalent resistance. Now, when telephony is being received the amplitude of the high-frequency oscillations is varying continually according to the low-frequency modulation, and hence the apparent increase of secondary resistance will show its effect as an increase of damping or decrease of selectivity.

When an unmodulated "carrier" wave is being received there is a steady flow of energy from the aerial circuit to the secondary, just sufficient to compensate for the losses in the secondary circuit due to the actual effective resistance R_2 ; but when the wave is modulated there is a transfer of energy backwards and forwards between the primary and secondary circuits, over and above that already mentioned, caused by the fluctuations of *stored energy* in the magnetic and electrostatic fields of the secondary circuit, and it is in terms of this transient energy only that an increase of secondary circuit resistance becomes apparent. These facts lead to the important conclusion that for determining the voltage magnification in the circuit only the actual secondary resistance R_2 must be taken into account, whereas in computing the selectivity the apparent increase of resistance must also be included.

Power Factor of Aerial Circuit.

It must be remembered that even in the case of the unmodulated carrier the effect of the secondary resistance on the primary circuit has been taken into account when calculating the value of the aerial current I_1 . Although the secondary circuit has the effect of reducing the aerial current, this does not mean that the power picked up by the aerial is decreased, because increase

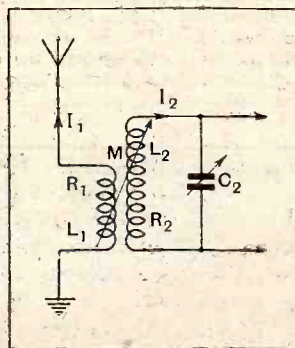

Fig. 1.—Tuned circuit coupled to untuned aerial. The numerical values are: $R_1 = 40$ ohms; $R_2 = 15$ ohms at 300 metres and 10 ohms at 500 metres; $L_1 = 20$ microhenrys; $L_2 = 200$ microhenrys. The aerial inductance is 10 microhenrys and its capacity 0.0002 mfd. The mutual inductance M is variable.

Wireless Theory Simplified.—

of resistance in that circuit results in a higher power factor. It can be shown that in any circuit where the reactance is fixed and the resistance variable the power for a given applied voltage is greatest when the resistance is made equal to the reactance. In the original example given, the effective resistance of the aerial circuit alone was 40 ohms and its impedance 608 ohms, the power factor being therefore $\frac{R_1}{Z_1} = \frac{40}{608} = 0.066$ only. With the tuned circuit coupled to the aerial coil the

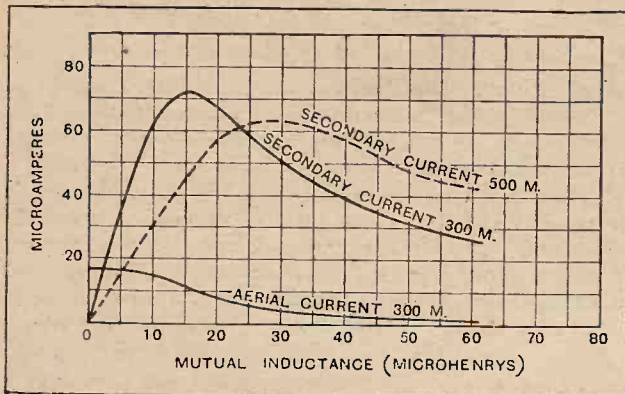

Fig. 2.—Curves showing how the currents in primary and secondary circuits depend on the mutual inductance between the coils. Maximum secondary current occurs when $2\pi fM = \sqrt{Z_1 R_2}$.

apparent resistance was 1,690 ohms and the apparent impedance 1,795 ohms under the stated conditions of coupling. This gives a power factor of 0.94, so that although the current was found to have been reduced nearly three times, the power factor was increased over fourteen times, resulting in nearly five times the power!

Effect of Coupling on the Signal Strength:

There is apparently a prevalent belief that the signal strength will be greatest when the coupling between the aerial and secondary coils is tightened to the maximum extent possible; but this is not the case. For a given ratio of primary to secondary inductance there is one particular value of the mutual inductance M for which the current in the secondary tuned circuit will be a maximum at any one wavelength, and, assuming constant secondary effective inductance, the voltage developed across the secondary coil is proportional to this current. Thus the signal strength will be greatest for that mutual inductance which makes the power in the secondary circuit a maximum.

The secondary current is given by $I_2 = \frac{X_m I_1}{R_2}$, where $X_m = 2\pi fM$ ohms. It is therefore not only proportional to the mutual inductance, but to the primary current also. Now it was shown that in effect the primary resistance, and hence the impedance, is greatly increased by the presence of the tuned circuit, and therefore as the coupling is tightened the primary current is reduced. It follows then that as the mutual inductance between the coils is increased by bringing them

closer together the factor X_m is an increasing one and I_1 is a decreasing one, and so I_2 will have a small value at each end of the range and reach a maximum at some intermediate point.

The values of the primary and secondary currents have been calculated for the circuit of Fig. 1 by the methods already explained, for various values of mutual inductance between the coils, ranging from zero to 60 microhenrys. The circuit constants are given in the inscription under Fig. 1, and the signal voltage picked up by the aerial was taken as 10 millivolts at a frequency of 1,000 kc. per second (wavelength=300 metres). The maximum mutual inductance which it is possible to obtain theoretically is that which gives a coefficient of coupling of 100 per cent. between the coils, and this occurs when $M = \sqrt{L_1 L_2}$, which in this case is $M = 63.25$ microhenrys.

The calculated current values have been plotted as graphs and are shown by the full-line curves of Fig. 2, from which it will be seen that the aerial current starts from a maximum value of 16.5 microamps. and falls to about 1 microamp. as the mutual inductance is increased from zero to 60 microhenrys. The secondary current, on the other hand, rises rapidly from zero and reaches a maximum value when the mutual inductance is about 15 microhenrys. The broken-line curve gives the values of secondary current when the wavelength is 500 metres and the secondary resistance is 10 ohms (as the frequency is lowered the H.F. resistance of a coil diminishes, and 10 ohms was chosen as a probable value for a coil having 15 ohms at 300 metres). It will be noted that a tighter coupling is required for maximum current at the higher wavelength, namely, about 29 microhenrys.

In determining the secondary current it was assumed that the tuning condenser had been adjusted to give resonance after each adjustment of the coupling, this being necessary because the effective reactance of the secondary coil changes as the coupling is varied. The apparent change of inductive reactance at 300 metres for various values of M is shown by the upper curve of Fig. 3, the apparent increase being proportional to the square of the mutual inductance as shown by

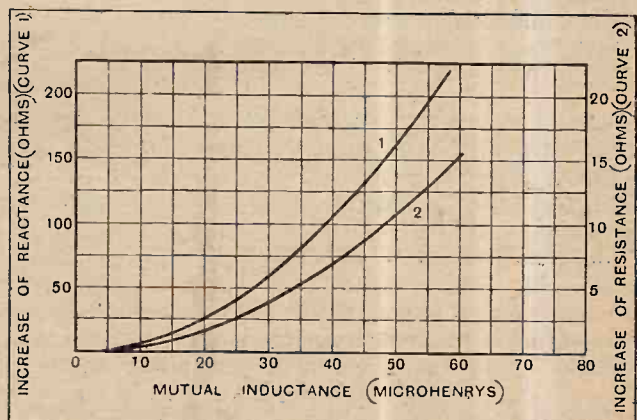

Fig. 3.—Curve (1) shows the apparent increase of inductive reactance and curve (2) the apparent increase of resistance in the secondary circuit for various values of mutual inductance when the wavelength is 300 metres.

Wireless Theory Simplified.—

equation (5) of the previous part. A curve obeying this law is called a parabola.

Conditions for Maximum Signal Strength.

Referring again to Fig. 2, it is seen that at 300 metres the maximum secondary current is nearly three times as great as that which occurs with the maximum coupling. It can be shown that the highest value of resonant secondary current occurs when the mutual reactance X_m is made equal to the square root of the product of the primary impedance and the secondary resistance, that is when $X_m = \sqrt{Z_1 R_2}$ ohms. At 1,000 kc. the impedance Z_1 of the aerial circuit was

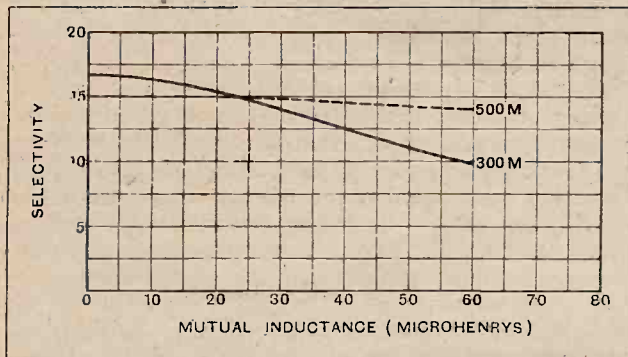

Fig. 4.—Curves showing how the selectivity depends on the mutual inductance at wavelengths of 300 metres and 500 metres.

found to be 608 ohms, and R_2 is given as 15 ohms. Thus for maximum current in the closed circuit we have $X_m = \sqrt{608 \times 15} = 95.5$ ohms, and since $X_m = 2\pi fM$, we get $M = \frac{95.5}{2\pi \times 10^6} \times 10^6 = 15.2$ microhenrys, in agreement with the curve.

Since for an untuned aerial circuit the resultant reactance X_1 is large compared with the resistance, the impedance Z_1 will be almost equal to the reactance, and very little error will be introduced by using the reactance instead of the impedance when calculating the critical value of M required to give maximum secondary current.

The expression then becomes

$$M = \frac{\sqrt{X_1 R_2}}{2\pi f} \text{ henrys} \dots \dots \dots (1)$$

When the secondary current is greatest the power in the secondary circuit will be a maximum. Now the secondary power is given by $I_2^2 R_2$, or by $I_1^2 R_1'$, where R_1' is the apparent increase of primary resistance, its value being $R_1' = \frac{X_m^2}{R_2}$ ohms; therefore as the coupling is varied R_1' will change and, as explained before, the power in a circuit of fixed reactance and variable resistance is greatest when the resistance is made equal to the reactance. So for maximum secondary power we must have $R_1' = X_1$, whence $\frac{X_m^2}{R_2} = X_1$, or $X_m = \sqrt{X_1 R_2}$ ohms, which is the same as equation (1) above if we divide each side by $2\pi f$. This is only approximately

true because the primary resistance has been neglected.

The actual signal voltage output from the secondary circuit is given by the product of effective secondary inductive reactance and the current. Now, owing to the fact that the effective coil reactance also varies as the coupling is changed, it follows that the voltage across the circuit will not reach the maximum value for quite the same value of mutual inductance as that required for maximum current. But since the percentage change of reactance is quite small when the coupling is loose (it is only just over 1 per cent. when $M = 15$ microhenrys) we are justified in assuming that the maximum signal strength occurs when the secondary current is greatest.

Overall Voltage Magnification.

Having found that maximum secondary current at 300 metres occurs when the mutual inductance is 15.2 microhenrys, we can find the maximum overall voltage magnification possible with this circuit and compare it with that obtained when the coupling is tightened to the greatest extent. The maximum current is 72 microamps. and the effective coil reactance is $2\pi fL_2 + X_2'$. From the upper curve of Fig. 3 we find that when $M = 15.2$ microhenrys the apparent increase of reactance is $X_2' = 15$ ohms. Thus the total effective reactance is $1,257 + 15 = 1,272$ ohms, and the voltage across the circuit is $1,272 I_2 = \frac{1,272 \times 72}{1,000} = 91.5$ millivolts. The voltage picked up by the aerial is 10 millivolts, and so the overall magnification under optimum conditions is 9.15 times at 300 metres.

For a very tight coupling, say, when $M = 50$ microhenrys, the secondary current (from Fig. 2) is 31.5 microamps. and the increase of secondary reactance (from Fig. 3) is 162 ohms, giving a total effective reactance of 1,419 ohms. The voltage output is then $1,419 \times 0.0315 = 44.7$ millivolts, the step-up effect being thus only 4.47, or about half the optimum value. These figures emphasise the importance of the degree of coupling on the signal strength obtained.

Effect of Coupling on Selectivity.

As regards selectivity we know from the outset that it will be a maximum for the secondary circuit by itself, that is, when there is no coupling between it and the aerial, and that the selectivity will become less as the coupling inductance is increased from zero, because this results in an apparent increase of secondary resistance.

As explained on page 23 of January 1st issue, the selectivity number is given by $\frac{1}{5R_2} \sqrt{\frac{L_2}{C_2}}$, which reduces to $\frac{2\pi fL_2}{5R_2}$. Hence with the aerial uncoupled the selectivity would be $\frac{1,257}{5 \times 15} = 16.8$. As the coupling between the coils is tightened the effective reactance and effective resistance of the secondary coil are both increased, the apparent change being given by the curves of Fig. 3 for various values of mutual inductance.

It will be instructive to calculate the value of the

Wireless Theory Simplified.—

selectivity number when the signal strength is greatest, that is, when $M=15.2$ microhenrys. From the curves we find that the increase of reactance is 15 ohms and the increase of resistance 1 ohm, giving a total effective reactance of 1,272 and resistance 16 ohms. The selectivity number is therefore $\frac{1,272}{5 \times 16} = 15.9$, which is only 5.3 per cent. less than the maximum that is attainable.

When the mutual inductance is increased to 50 microhenrys the effective reactance becomes 1,419 ohms and the effective resistance 25.7 ohms, yielding a selectivity

of $\frac{1,419}{5 \times 25.7} = 11$. In the same way the selectivity numbers have been calculated for intermediate values of M at 300 metres, the results being shown by the full-line curve of Fig. 4. The broken-line curve shows the values obtained at 500 metres with the same coils, the assumption being made as before that $R_2=15$ ohms at 300 metres and 10 ohms at 500 metres. It will be noted that at the higher wavelength the selectivity is very little affected by the degree of coupling between the coils. This is mainly due to the fact that the ratio of secondary to primary inductance is high, its value being 10. (To be continued.)

Licence Secrets Disclosed.

For the first time in British broadcasting history the Post Office has disclosed secrets concerning licence figures. The B.B.C. has always been anxious to know how the listening population is distributed up and down the country, but until last week it was necessary to rely on guess-work.

o o o o

Low Figures from Scotland.

The Post Office has now supplied Savoy Hill with a list showing the number of licensees in each county. The figures are startling.

The whole of Scotland contains only 195,000 licensees, as compared with 541,000 in the London Postal District alone. In the provinces, Lancashire, with 304,000, is well ahead of its nearest rival, Yorkshire, which boasts a quarter of a million.

o o o o

The Truth About Rutland.

Wales contains a fifth of London's figure, and Northern Ireland has only 30,000.

Surrey, Middlesex, and Kent are assisted by London's overflow, but counties without a powerful local station, such as Northumberland, Herefordshire, Norfolk, and Suffolk, have failed to produce a large army of listeners. As might be expected, Rutland secures the booby prize with just over a thousand licensees.

o o o o

Hint to Programmé Compilers.

These figures should be valuable to the B.B.C. in framing programmes for the National as distinct from the London Regional transmitter.

Lancashire and Yorkshire together contribute as much licence revenue as London, so people who grumble because the National programme sometimes includes concerts from Liverpool and Manchester do not appreciate the facts.

o o o o

Discounting the Pirates.

By the way, the B.B.C. has been cynically advised not to be guided by the Post Office figures, dealing as they do with licences, not listeners. To which the B.B.C. can reply that the programmes are not arranged for pirates.

Pirates are requested to communicate with the G.P.O. to facilitate the preparation of statistics.



By Our Special Correspondent.

Brookmans Park in Italy.

High praise for London National comes from a friend in Northern Italy. Using an H.F. (tuned anode) det. and 1 L.F. set at Venice, he finds that the 261-metre station comes in strongly with very little fading.

o o o o

5XX, the Foreigners' Favourite.

Tributes from Continental listeners have also been received at Savoy Hill, but recent correspondence shows that 5XX remains the foreigners' darling. Apparently 5XX romps in in France, Holland, and Germany as Hilversum does here.

FUTURE FEATURES.

- National (261 and 1554 metres).
- APRIL 8TH.—De Courville's Hour (6).
- APRIL 9TH.—"The Enchanted Island," an operetta by Richard H. Walthew.
- APRIL 11TH.—"His Past Life," a play by Tyrone Guthrie.
- APRIL 12TH.—Running commentary on Oxford v. Cambridge Boat Race.
- London Regional.
- APRIL 6TH.—Concert relayed from Albert Hall.
- APRIL 8TH.—"Any Rags?" a Saga of Syncopation.
- APRIL 9TH.—Old Folks' programme.
- APRIL 10TH.—"The Apostles" (Elgar), relayed from Worcester Cathedral.
- Midland Regional.
- APRIL 7TH.—A Percy Fletcher programme.
- APRIL 12TH.—Musical comedy programme.
- Cardiff.
- APRIL 12TH.—"Labels," a "travel" programme.
- Manchester.
- APRIL 7TH.—Programme commemorating the birth of William Wordsworth.
- Glasgow.
- APRIL 12TH.—"The Glen is Mine," a comedy by John Brandane.
- Belfast.
- APRIL 8TH.—"Blackpool."

A Compliment from France.

The French are great admirers of the long-wave Daventry. A few days ago a journalist representing one of the leading Paris newspapers visited Savoy Hill to study Daventry's programme methods, assuming that 5XX is Britain's principal station and that its programmes are relayed to the smaller stations, such as Brookmans Park. It is said that a portrait of Capt. Eckersley slipped off its hook.

o o o o

Percy Pitt's "Diversion."

Hurriedly summoned from an undress rehearsal a few days ago, Percy Pitt left the studio minus collar and tie to discover a moment later that he was the hero of a presentation ceremony presided over by Sir John Reith. The staff's tribute was a gift of silver plate in appreciation of Mr. Pitt's services as Music Director since the very early days of broadcasting.

o o o o

No Alternative.

The alternative programme scheme continues to bewilder. Why was Lord Hewart's lecture broadcast from every B.B.C. station? True, it was described as a "National Lecture," and thoroughly deserved a large audience, but the Regional scheme exists to provide alternatives. With all respect for Law, Ethics, and Legislation, can one imagine that the speech of the Lord Chief Justice was intended for light-hearted social gatherings? Yet every night England is seething with such gatherings. Of course, there is always the gramophone.

o o o o

Ballooning to Sweden.

The Swedish Programme which National listeners are to hear on April 10th will be an epic in sound. It will convey impressions of one of the most modern of European countries, gathered on a balloon journey. The pilot is Lance Sieveking.

o o o o

New Scottish H.Q.

As I was able to predict last week, the Scottish B.B.C. staff have found an Edinburgh home in Queen Street. Certain structural alterations are necessary to the building, which was formerly the Queen's Hall, but it is expected that the new headquarters will be ready for occupation by the end of next month.

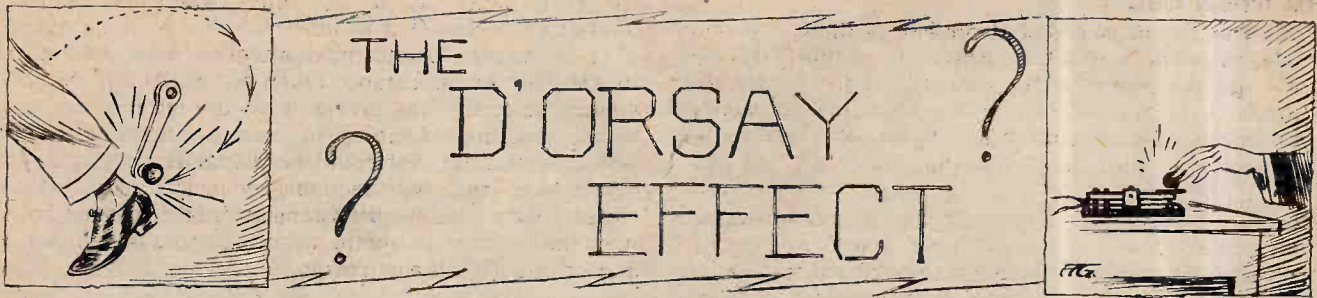

Birth of Radio Telekinetics.

By D'ORSAY BELL, M.A.

THE great human family, to which so many of my readers belong,¹ has always had a weakness for labelling any newly revealed oddity on the part of Nature as the "So-and-so Effect," So-and-so being the man who first came across it. Wireless telegraphy, and all its subsidiary arts, simply teems with such Effects. The Joule Effect, for instance—one of the most venerable: christened years before Wireless was dreamed of, but still hale and hearty. How funny our valves would look without the Joule Effect: with their filaments heated, perhaps, by little methylated spirit lamps—for the Joule Effect, of course, is that a current i flowing through a resistance R produces an amount of heat proportional to i^2R .

A Prehistoric Polar Diagram.

Polar diagrams of aerials are nowadays the most commonplace things. About the first ever plotted was obtained by means of a combination of the Joule Effect and another old dug-out, the Peltier Effect (by which, incidentally, you can now recharge your accumulator if you are far from mains and dynamos). In those days Wireless research was always like either a circus or like a Heath Robinson picture, and this particular bit of research was like both. A mast about 6ft. high was stuck up, carrying one end of an aerial wire roof-t. long; someone held the other end (with an insulator in between if he remembered it) and ran round in a circle with the wire as a radius. He would stop at regular intervals while someone else sparked the fixed end of the wire to earth, by an induction coil, unless—in the excitement of running round—the radius vector had (a) pulled the mast down, (b) torn the nominally fixed end of the wire out of its terminal, or (c) upset the portable accumulators driving the induction coil. The spark-produced signals were received on a

vertical aerial about half a mile away and taken to a short, very fine piece of resistance wire, in which they produced the Joule Effect; the heat produced warmed up a tiny thermo-junction swinging (at the end of a wire loop) very close to the resistance wire, and by the Peltier Effect generated a current in this loop. The loop lay between the poles of a powerful magnet, and this current made it twist itself according to the amount of the current, and therefore according to the strength of the received signal. In this way the polar curve of the rotating transmitting aerial was plotted. It was, of course, the now démodé "figure-of-eight" diagram, with the backward loop much smaller than the forward one, and quite respectable minima at about 120° . A poor thing compared with the modern "beam," but some accomplishment, I can tell you, in those days when every other type of aerial gave a monotonous uniformity all round—like a B.B.C. programme.

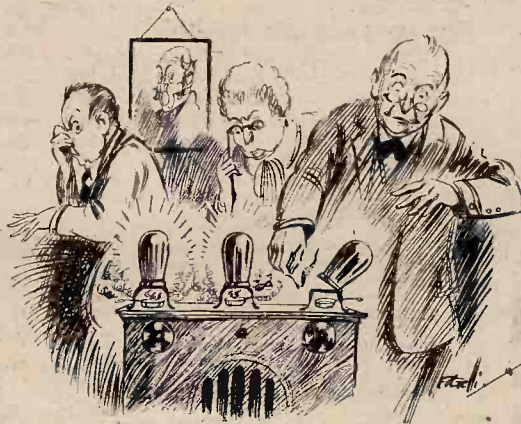

How funny our valves would look. . . .

1845—and Still Going Strong.

In 1845 Faraday discovered his "Effect"—that he could rotate the polarisation plane of a light ray by passing it through a magnetic field; nothing much has been done about it; it has just kept quietly to itself, waiting for Wireless to come to its present stage of development. And now it recalls itself to our attention and explains very beautifully certain puzzling facts recently observed in the propagation of wireless waves—certain curious changes in polarisation as these waves pass through the earth's magnetic field, and also the intriguing, worrying feeling, vaguely felt ever since the first days of long-distance Wireless, but hardly acknowledged as reasonable, that it is harder to establish communication in an East-West direction than in a North-South direction. Not only that, but it lends itself to us to form an electro-magnetic relay by which we can change variations in radio signals into variations in a ray of light—a thing badly needed nowadays for picture telegraphy, television, and the "talkies."

¹ Cribbed, I fear, from Mr. Chesterton (1904).

The D'Orsay Effect.—

As a matter of fact, just at present all the best people use another effect—the Kerr Effect—to obtain that light-relay action. Kerr, by the way, has the very unusual distinction (I am not sure it is not unique) of having *two* effects named after him; to avoid muddle the second one is called the "Kerr Phenomenon," and consists of the fact that, if a ray of light is reflected from the pole of a magnet, its plane of polarisation is rotated. Probably someone, sometime, will make use of this, but I have not heard of any such application. But I like the sound of the "So-and-so Phenomenon"; I am not at all sure that I shall not change the title of this article to "The D'Orsay Phenomenon." In fact, I will mention a circumstance at the end which rather suggests that this would be the *mot juste*. Meanwhile, I am afraid we must skip over many pleasant Effects—including the attractively named Johnsen-Rahbek Effect—and come at once to

The D'Orsay Effect.

This important but little-known effect was discovered in 1919. The discoverer was experimenting with a small transmitting circuit for a power input of about 20 watts. Its valve was officially known, I believe, as an LTr, but people acquainted with Peter Pan hailed it at once as "Slightly." It was slightly soft, slightly hard—in fact, slightly queer—but then so were many valves in those days. Its H.T. was provided by a little D.C. high-voltage dynamo, such as is used in the testing instrument called a "megger"; this was hand-driven through a lot of very substantial gearing and a handle like a grindstone's, and to get it to give about 25 milliamps at 800 volts meant turning that handle like—well, with considerable effort. The circuit was connected to a little aerial about 20ft. long and to an earth.

At the historical moment of which we are writing something in the usual Heath Robinson lash-up required adjustment, and the discoverer had just risen from his handle-grinding crouch in order to make this adjustment. While thus occupied he was startled and pained by a violent blow on the foot. The next step in the research was to raise the foot and apply massage, at the same time taking notice of any circumstances which might account for the effect observed—or, rather, felt. It was seen that the grindstone handle, which had been left, naturally, in some casual position, was now pointing towards the earth's centre—in which position it had impacted against the foot.

While the discoverer was attempting to reconcile the obvious first idea—that the heavy handle had fallen by its own weight from near the top of its stroke to the bottom—while he was trying to reconcile this with his

absolute certainty, the fruit of bitter experience, that it required more than that to move the durned thing even on open circuit, his horrified attention was suddenly attracted by the appearance taken on by Slightly, who, without warning, was giving a good imitation of an electric bowl-fire. Leaping to save its life by disconnecting everything that could be disconnected, the discoverer was struck with redoubled violence on the knee—after which act the grindstone handle continued for about one minute to rotate wildly, bolshevistically, in contradiction to human reason.

The Birth of Radio Telekinetics.

The orgy ceased as suddenly as it had begun; the handle came to rest, the valve recovered its normal, more or less respectable, appearance; the discoverer, after a few moments' strenuous brainwork, left the building, entered a neighbouring one, and made certain enquiries. He emerged again, accompanied by a distinguished engineer whose face wore a pleasant but slightly sceptical smile.

After posting him in the front row of the stalls, as it were, the discoverer walked to the door and shouted an agreed signal to the other building; thereupon, the key controlling a 1½ kW. transmitting circuit in that second building was pressed—just as it had been pressed two or three times during the past quarter of an hour—energy flowed into the aerial connected to that circuit, a tiny fraction of it crossed the ether to the little aerial belonging to the 20-watt circuit, flowed

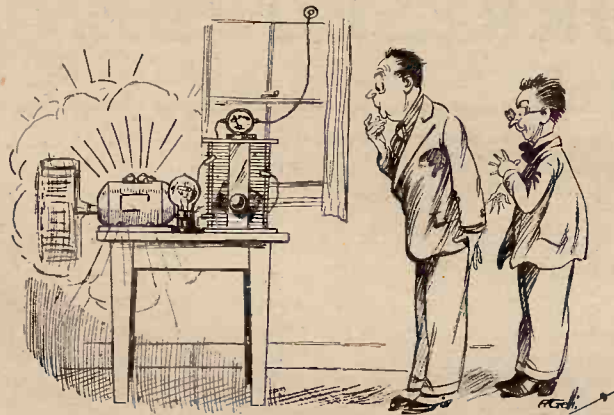

The world's first demonstration of Radio Telekinetics.

down, and excited Slightly to a state of pink activity, passed on into the high-speed, high-voltage dynamo, which suddenly found itself converted into a motor—and with a gradually dropping jaw and bulging eyes the distinguished engineer beheld the grindstone handle move slowly, get up speed . . . and the world's first demonstration of Radio Telekinetics was in full swing. . . . True, the transmitting station had about 1½ kW. power, the distance between the aerials was not very great, and the power received merely drove a handle round and round. But, on the other hand, the power lost in the gearing was considerable. A man turning a handle is supposed to be able to accomplish about one-tenth of a horse-power and keep it up for ten hours; it would be a strong and brave man who could keep that grindstone handle going for ten hours. Presumably, therefore, Slightly was gallantly providing something like 40 or 50 watts; no wonder it got pink in the plate in doing so. Again, there was no question of the energy being directed from one aerial to the other, no kind of "beam" effect; and Esau has found (with very short waves) that the amount of energy required to give a fixed strength of signal over a fixed distance is divided by 12 by the use of a reflector at

The D'Orsay Effect.—

the transmitting end, or by 150 if a reflector is added at the receiving end also. So that if these modern refinements had been available the demonstration could have been much more sensational.

The D'Orsay Phenomenon.

I said I would tell you why the above title might be considered an improvement. Now, it happened that the distinguished engineer who formed that first audience was the right-hand man of a still more distinguished engineer—an engineer so distinguished, in fact, that if I were to call him a . . . if I were to say that he erred in his statements, half the amateurs in the world would faint with horror at the sacrilege. Three years after the events' chronicled the discoverer of the D'Orsay Effect learned from a mutual friend that this great man had pronounced the verdict that the D'Orsay Effect

had never occurred; that he had proved it, mathematically and graphically, to be impossible, and that he attributed the rumours to the fact that the events—such as they were—took place after luncheon. A pleasantly sweeping statement; unfortunately, his whole argument was based on an error of fact in connection with the type of circuit used.¹ Still I think, after all this, that the title "Phenomenon" is justified.

One last word: as regards the importance of the subject, a little bird tells me that one of the big Wireless firms is seriously thinking to-day—eleven years later—of plunging into a demonstration of radio telekinetics. We shall see. I don't believe they will get half as much excitement and amusement as we got out of ours.

¹ Put tersely, the circuit was *not* a top-feed one: the XA1, using the MT5 valve, was top feed, but the circuit here used was a precursor to this and used bottom feed.

CORRESPONDENCE.

The Editor does not hold himself responsible for the opinions of his correspondents.

Correspondence should be addressed to the Editor, "The Wireless World," Dorset House, Tudor Street, E.C.4, and must be accompanied by the writer's name and address.

D.C. TO A.C.

Sir,—During the change-over in Edinburgh the officials have come into contact with so many "mugs" who have paid varying sums toward new apparatus that they have become blasé. "Enquirer" can easily change their attitude by reference to a clause in the powers granted to them by the Electricity Commissioners of Savoy Court, Strand, W.C.2, dated June 17th, 1927, as follows:—

"Unless otherwise agreed, the Corporation shall, at their own expense, carry out the necessary alterations to customers' existing apparatus to suit the altered system and pressure, or pay to each consumer injuriously affected such sum as may be agreed upon, or, in default of agreement, as may be determined by an Arbitrator appointed on the application of either party, by the Ministry of Transport, as the reasonable cost incidental to the change of supply (including compensation for any loss or damage incurred in consequence of the alteration), the expenses to be borne as the Arbitrator directs."

The increasing use of the mains for wireless reception and accumulator charging is not to be lightly flouted by these officials, whose only concern is the economical change for the credit of their department. An uncompromising attitude should be adopted and admittance to the premises refused until the apparatus is duly replaced.

OHM SWEET OHM!

Edinburgh.

QUALITY AND THE LISTENER'S SET.

Sir,—I have read Mr. J. L. Greateorex's remarks in the March 12th issue of *The Wireless World*, in which he states that the B.B.C. are wasting time and money in improving transmitting conditions, owing to the poor quality available from the "average" set.

It would, of course, be impossible to estimate the number of listeners with (1) bad sets, (2) average sets, (3) good sets, and (4) super sets, but I feel sure that there must be thousands of listeners who own the well-known types of "Kit" sets, which give excellent quality (an L.S.5A valve is *not sine qua non* of quality, Mr. Greateorex!), and there would be far more sufferers than Mr. Greateorex imagines if the B.B.C. left their transmissions in a bad state.

Progress is the aim of the present day even more than ever. It is inevitable that we must progress, otherwise the world would be in a state of chaos. If the B.B.C. had stopped improving their transmissions, say three years ago, what would have happened? It is hard to say, but manufacturers of wireless

apparatus would have been forced to close down; it would have been useless for them to go on improving their goods because of the "average" transmissions. *The Wireless World* has done much to bring receivers up to their present excellent state; it was, I think, *The Wireless World's* one aim—quality. Does Mr. Greateorex, then, think the journal wasted its efforts? Surely not.

With regard to the last paragraph of Mr. Greateorex's letter, the efforts of the B.B.C. may be set at naught by the average set, but once they (the B.B.C.) stop improving until absolute finality is reached, I am afraid it will be the licence numbers which will be set at "nought."

I have no doubt that *The Wireless World* will still continue its excellent efforts towards the goal of perfection, whether the average set is in the majority or not.

Barnard Castle.

F. W. ARMSTRONG.

MIDLAND PROGRAMMES.

Sir,—A perusal of the current *Radio Times* shows that under the new grouping of programmes listeners in the South are to have at least two, and often three, different programmes, whereas listeners in the North are to have only 5XX and the Northern Group.

As the Northern Group and the Manchester programmes consist to a very large extent of landline relays of the National programmes, the Northern listener is practically dependent on one programme only, as the London Regional and the Midland Regional fade to such an extent as to be negligible for intelligent listening.

I suggest that every one of your readers who sees this letter should send a postcard to the B.B.C. asking that instead of the Northern Group and the Manchester station relaying the National programme they should relay either the London Regional or the Midland Regional, thus ensuring a definite alternative programme to Northern listeners.

Individual communications to the B.B.C. have proved to be of no avail, but concerted action by all Northern listeners may have some effect.

A petition by this club some years ago resulted in the erection of the Writtle station, the pioneer of broadcasting in this country, and an attack on similar lines may remind the B.B.C. that there are listeners in the North as well as in the South who want an alternative programme, and encourage them to fill in the interval which must elapse until the new Pennine Regional station is completed.

LOUIS J. WOOD,

March 11th, 1930.

Hon. Sec., Halifax Wireless Club.

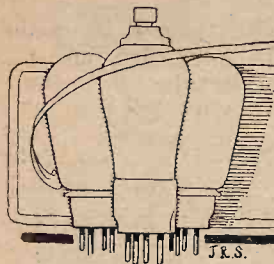

READERS' PROBLEMS.

"The Wireless World" Supplies a Free Service of Technical Information.

The Service is subject to the rules of the Department, which are printed below; these must be strictly enforced, in the interest of readers themselves. A selection of queries of general interest is dealt with below, in some cases at greater length than would be possible in a letter.

Comparative Selectivity.

I live at a distance of about twelve miles from Brookmans Park, and, as you will readily understand, have been forced to consider the rebuilding of my present receiver, which consists of a detector followed by two L.F. amplifiers.

If possible I should like to use no more than one H.F. stage, but suppose that, in order to receive a fair number of foreign stations without interference from the local twin stations, it will be better to have two stages. Will you give me a few words of advice on this matter?

K. F.

In assessing the selectivity of a receiver, it would perhaps be better to take into account the number of its tuned circuits rather than the number of its H.F. amplifying stages. For instance, many modern "1 H.F." receivers have a two-circuit aerial tuner, while designers of "2 H.F." sets are reluctant to make this addition to a receiver that is already considerably more complex than the other. Consequently, we find that these receivers generally have the same number of tuned circuits, and so it is to be anticipated that their relative selectivity will be approximately the same. Actually, however, the "1 H.F." set may have a better performance (in the matter of

eliminating local interference) than the other receiver.

If you have decided to limit yourself to three tuned circuits it would perhaps be as well for you to adhere to your original plan, and to make up a set with a single H.F. stage; but if a multiplicity of dials is not objected to, you might consider a four-control set with two high-frequency amplifiers and an input filter.

Drastic Measures.

The H.F. amplifier (single stage, screen grid) of my newly built receiver is quite stable on the long waveband, but uncontrollable oscillation is produced as the dials come into tune over the majority of the medium broadcast tuning range. I have tried the expedient of removing turns from the transformer primary, but signal strength falls off rather more than I could wish when sufficient turns are taken off. I have come to the conclusion that the trouble is due to inadequate screening: to improve matters in this respect would be difficult in my own case, and I have decided to try the rather drastic expedient of neutralising, following the plan adopted in the case of the "Record III" (described in your issues of September 4th and 11th, 1929).

Will you please give me a diagram showing how neutralising may be applied to the medium-wave coupling only? It should be stated that waveband switching is included, both primaries and secondaries of the transformer being connected in series with a short-circuiting switch.

W. L. T.

It is possible to devise a balancing scheme in the manner shown in Fig. 1, but it is quite likely that this addition, though it will probably effect a cure on the medium band, will introduce instability on the long wavelengths. Trouble of this kind is generally traced to the transference of energy between plate and grid circuits via the lead between the neutralising condenser and the grid of the H.F. valve. Difficulties of this sort may generally be overcome by breaking this lead by a switch (marked S in our diagram), but sometimes it will be found necessary to make arrangements for complete removal of the connecting wire.

For information regarding the neutral-

ising coil N (which may have about two turns) we would refer you to the published description of the receiver which you mention (the "Record III"). The important question of the direction of the

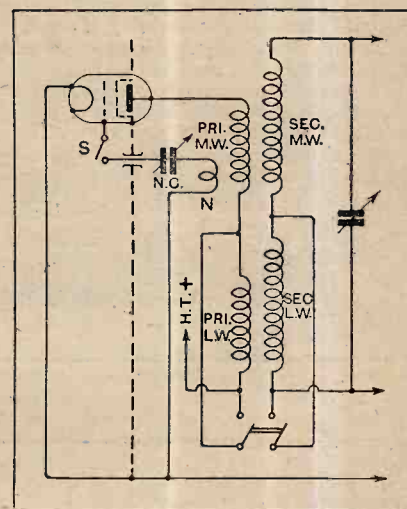

Fig. 1.—H.F. intervalve coupling with neutralising for the medium waveband.

various windings on the transformer is, we think, made quite clear in a published reply that appeared in the "Readers' Problems" section of our issue for November 20th, 1929.

Choosing a Circuit.

Do you consider that the "Wireless World" S.G. Regional receiver would be suitable for use at a distance of approximately fifty miles from Daventry? Transmissions from other stations will not be required, or, at any rate, their reception at full strength will not be normally expected.

R. J.

This receiver should be well suited to your requirements, but perhaps its overall magnification is rather greater than is strictly necessary. The three-valve receiver described in the issue of March 19th would be rather more economical, and its sensitivity should be ample. As usual, in giving this answer, we assume that receiving conditions are normal.

RULES.

(1.) A query must be accompanied by a COUPON removed from the advertisement pages of the CURRENT ISSUE.

(2.) Only one question (which must deal with a single specific point) can be answered. Letters must be concisely worded and headed "Information Department."

(3.) Queries must be written on one side of the paper, and diagrams drawn on a separate sheet. A self-addressed stamped envelope must be enclosed for postal reply.

(4.) Designs or circuit diagrams for complete receivers or eliminators cannot ordinarily be given; under present-day conditions justice cannot be done to questions of this kind in the course of a letter.

(5.) Practical wiring plans cannot be supplied or considered.

(6.) Designs for components such as L.F. chokes, power transformers, complex coil assemblies, etc., cannot be supplied.

(7.) Queries arising from the construction or operation of receivers must be confined to constructional sets described in "The Wireless World"; to standard manufactured receivers; or to "Kit" sets that have been reviewed.

An Extra H.F. Unit.

It has been noticed that on several occasions your contributors have deprecated the addition of an extra H.F. unit to an existing receiver, particularly when this receiver already includes H.F. amplification. I take it that this attitude cannot be justified if the extra unit is completely screened, and that if this precaution is taken it is quite impossible that the combined set and unit when connected together should exhibit any greater tendency towards self-oscillation than if they were working separately.

If this reasoning is correct, or, indeed, if you think that the idea is practicable, will you please give me the circuit diagram of a "tuned grid" H.F. amplifier to be made as a unit?

N. P. R.

It is not quite correct to say that the addition of an H.F. unit, even though it may be completely screened, is unlikely to bring about instability. Although magnetic and capacitive interaction between the circuits may be completely obviated by this screening, it must not be forgotten that in practice both unit and receiver are fed either from the same batteries or from the same eliminator, and any internal resistance in either source of supply will act as a form of coupling between the various valves that go to make up the complete receiver.

By paying attention to the isolation of the various feed circuits—which means in practice the fitting of decoupling resistances and condensers—it is possible to

achieve something like the ideal state of affairs, and it should become possible to add an H.F. unit without risk. We give in Fig. 2 the circuit diagram of such an arrangement, which should be applicable to a number of sets. The intention is that the output lead of the unit marked A should be connected to the normal aerial terminal of the receiver; it will be realised that in certain cases it will be necessary to modify the normal aerial coupling arrangements of the receiver in order that a sufficiently large proportion of the H.F. energy developed across the H.F. choke may be transferred to the tuned grid coil.

o o o o

How Loud Speakers Affect Current Consumption.

I have two loud speakers, and have noticed that the anode current passed by the last valve is reduced by about 5 milliamps when one of them is connected, as compared with the current flowing when the other is in circuit. Is it normal that this very considerable change should take place?

D. G. F.

The ohmic resistances of commercial loud speakers vary within wide limits, and in practice values of 300 or 400 ohms up to 2,000 ohms are found. A resistance in the order of the last-mentioned figure is comparable with that of a modern low-impedance super-power valve, and consequently it is not to be wondered at that anode current falls very considerably when a winding of this value is connected in the anode circuit.

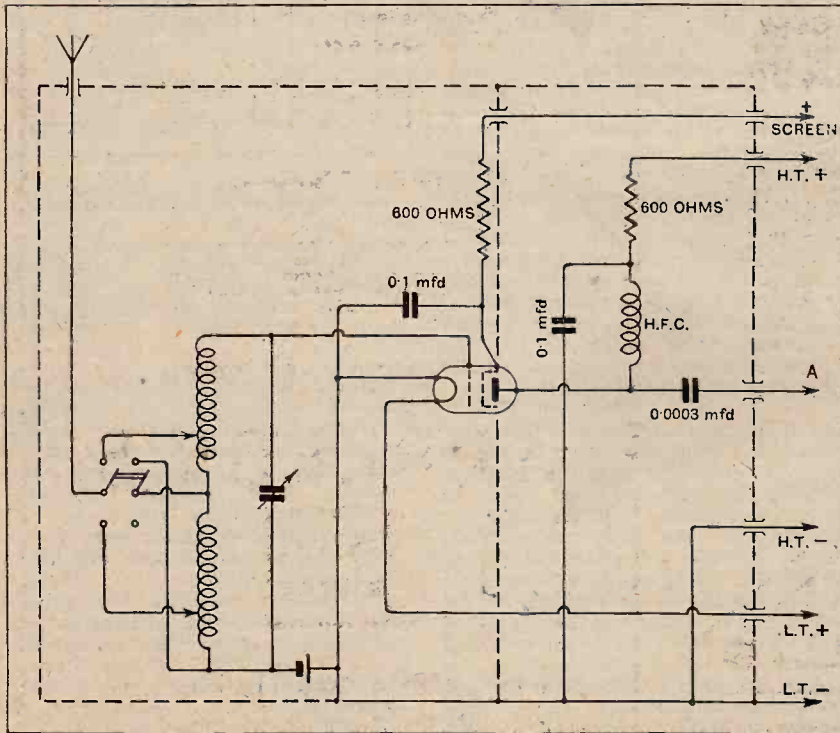

Fig. 2.—A shielded and "decoupled" H.F. unit for adding to an existing receiver.

FOREIGN BROADCAST GUIDE.

MUNICH

(Germany).

Geographical Position : 48° 9' N. 11° 33' E.
Approximate air line from London : 565 miles.

Wavelength : 533 m. Frequency : 563 kc
Power : 1.5 kW.

Time : Central European (one hour in advance of G.M.T.).

Standard Daily Transmissions.

05.45 and 06.30 (G.M.T.) physical exercises and gramophone records (ex. Sun.); 10.05 news; 11.00 (Sun.) concert; 11.30 gramophone records; 13.00 news and weather; 15.00 or 15.30 concert; 16.30 approx. main evening programme (Sunday 19.00); 20.54 (Monday) dancing lesson; 21.20 last news, weather, etc., followed by late dance music (ex. Tuesday, Thursday and Friday).

Works throughout the day from 05.45 G.M.T. Interval Signal :

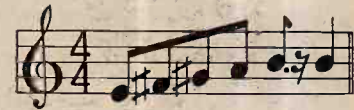

Man announcer. Call: *Hier die Bayrischen sender München, Nürnberg, Kaiserslautern und Augsburg.*

All announcements in the German language only.

Closes down with German National Anthem, played to the melody of the Old Austrian Hymn (Haydn).

Headphones and D.C. Mains.

I have been told that it is not safe to use headphones attached to a receiver fed with anode current from D.C. mains through an eliminator. Will you please give me your opinion on this subject, and also say whether any safety measures can be adopted in order to obviate risk? G. W. P.

We certainly agree that it is unwise to connect headphones directly in the anode circuit of a valve deriving its H.T. supply from D.C. mains. In such cases it is always to be recommended that the 'phones should be connected either through a double-wound transformer or through a choke filter arrangement of the type in which a condenser is placed on each side of the output terminals.

Time Signals.

Can you tell me of any publication giving a comprehensive list of Time Signals and Direction Finding Stations throughout the world? G. R. B.

This information, together with lists of Wireless Fog Signals, Weather Bulletins, etc., etc., is contained in "The Admiralty List of Wireless Signals," prepared by the Hydrographic Department of the Admiralty, and sold by J. D. Potter, 145, Minories, London, E.1, at the price of 6s. 6d.



**THE
NEW
"MAGNET
DYNAMIC"
SPEAKER**

**HEAR
ONE FOR
YOURSELF**

THE new Hegra "MAGNET DYNAMIC" Loud-speaker embodies a totally new construction, in which unique principles of design are employed. The quality of reproduction is astounding, being equal to that of a moving coil, and yet no field energising current is required. It will handle with ease an input up to 4 watts. It costs no more than the ordinary cone type loud-speaker, but will give sufficient volume to fill a large hall. All over the country this new speaker has met with tremendous success. Ask your dealer to demonstrate one. You will be astonished at its clear, powerful reproduction. Ideal for radio gramophones and all mains receivers—for small or powerful sets.

**CHASSIS FORM (as illustrated) £2-16-0
IN POLISHED WALNUT CABINET £5-10-0**



**OBTAINABLE
FROM ANY
DEALER**

M.C. 4

BY REQUEST

AT the request of a large number of customers, we are recommencing our part exchange service, with certain modifications to meet modern conditions, in order that the standard which it is believed is expected of this business may be maintained. Our future activities will be confined to articles the value of which is worthy of the financial consideration of our clients.

We can supply and accept in

PART EXCHANGE

only the reputable makes of the following apparatus:

- Receivers (Domestic & Portable).
- Radio-Gramophones.
- Loud Speakers (Cone & Moving Coil).
- Cone Units and Chassis.
- Battery Eliminators and Mains Equipment.
- Battery Chargers.
- Pick-ups and Carrier Arms.
- Electric Gramophone Motors.
- H.F., L.F. and Power Chokes.
- Condensers (Variable and Smoothing).
- Measuring Instruments (High Grade)
- L.F. Transformers.

In view of the difficulty of making definite offers for material that we have not inspected, it is suggested that apparatus tendered for part exchange should be forwarded to us for valuation.

Terms of Business :

A minimum of 50% of the value of an order is payable in cash. Should the part exchange allowance exceed 50% of the total value of new requirements, the difference will be credited against future orders. Material may be deposited against a credit note, which may be utilised at a later date. Only apparatus in good condition can be accepted in part exchange.

Buy Quality with Economy through

APPLEBY'S



The Originators of Radio Part Exchange,
CHAPEL STREET, MARYLEBONE, N.W.1.

(4 minutes from Oxford Street, London.)
Phone: Paddington 8828 (3 lines).

Such beautiful Tone!

Here is the new No. 100 Cradle, the latest addition to the Squire Range.

Modern speaker design is tending steadily in the direction of free edge cones, particularly for small cones whose duty it is to reproduce the higher frequencies.

The Squire No. 100 has a free edge small cone and we can emphatically state that the reproduction afforded is the finest yet.

The beautiful tone and ample volume obtainable when this Cradle is used in conjunction with any reputable make of unit is truly wonderful.

It is equally responsive on all frequencies.

Ask your dealer to demonstrate one, or in case of difficulty write to us direct.

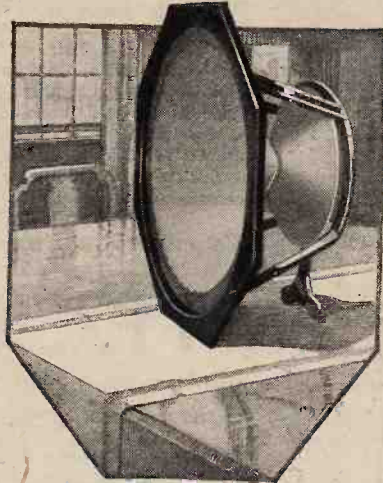

Price, inclusive of Cones and Octagonal Front, 28/6. Price of the two Cones supplied complete—riveted together—with metal washers attached and packed in box, 6/6.

FREDERICK

SQUIRE LTD.

10, Leswin Place, Stoke Newington, N.16.

Telephone: Clissold 0334.

M.C.2

DICTIONARY of WIRELESS TECHNICAL TERMS

(1926)

Compiled by S. O. PEARSON, B.Sc., A.M.I.E.E.,
and issued in conjunction with
"THE WIRELESS WORLD."

THIS volume contains definitions of terms and expressions commonly used in wireless telephony and telegraphy and is intended to serve as a guide to all those interested in wireless who come across, from time to time, unfamiliar words in their reading. In such cases the **DICTIONARY OF WIRELESS TECHNICAL TERMS** proves of very great use and value. It is well illustrated, and cross-referenced to enable the required information to be rapidly obtained.

PRICE 2/- NET

By Post 2/2

From leading Booksellers or direct from the Publishers:

ILIFFE & SONS LTD., Dorset House, Tudor Street,
London, E.C.4.

W.W.43

NO WAVE TRAPS

20 Stations in 5 minutes at
Loud-speaker Strength

BY USING THE
NEW PATENTED

Tapped Model D.A.T.3.

DUAL COIL



15/-

Tunes from 200-2,000 metres

Amplifies as a transformer, thus producing more volume. Simple Detector L.F. Receivers can now compare with the latest Screened Grid Sets.

Bullphone Tapped Aperiodic Six-Pin SELECTIVE COILS

will also separate the National and Regional Stations.

Short Wave 4/6 Long Wave 5/6

Send for our Free Lists and Circuits—

BULLPHONE LTD. (Dept. W.W.)
38, HOLYWELL LANE, LONDON, E.C.2

The AMATEUR³ PHOTOGRAPHER & CINEMATOGRAPHER

Incorporating "THE NEW PHOTOGRAPHER"



—for
All Camera Users!

Every camera user can get more pleasure out of photography and better results by reading "The Amateur Photographer" regularly.

The "A.P." caters for all photographers, including beginners and advanced workers, and contains Lessons for Beginners; Free Criticism of Readers' Prints; Answers to Queries; Regular Competitions and a weekly Art Supplement of particular interest to pictorial workers.

Every Wednesday 3D.

ILIFFE & SONS LTD.

Dorset House, Tudor Street, London, E.C.4

W.W.37.

Mention of "The Wireless World," when writing to advertisers, will ensure prompt attention.

MISCELLANEOUS ADVERTISEMENTS.

NOTICES.

THE CHARGE FOR ADVERTISEMENTS in these columns is :

12 words or 1 s. 2/- and 2d. for every additional word.

Each paragraph is charged separately and name and address must be counted.

SERIES DISCOUNTS are allowed to Trade Advertisers as follows on orders for consecutive insertions, provided a contract is placed in advance, and in the absence of special instructions the entire "copy" is repeated from the previous issue : 13 consecutive insertions 5% ; 26 consecutive, 10% ; 52 consecutive, 15%.

ADVERTISEMENTS for these columns are accepted up to **FIRST POST** on **THURSDAY MORNING** (previous to date of issue) at the Head Offices of "The Wireless World," Dorset House, Tudor Street, London, E.C.4, or on **WEDNESDAY MORNING** at the Branch Offices, 19, Hertford Street, Coventry ; Guildhall Buildings, Navigation Street, Birmingham ; 260, Deansgate, Manchester ; 101, St. Vincent Street, Glasgow, C.2.

Advertisements that arrive too late for a particular issue will automatically be inserted in the following issue unless accompanied by instructions to the contrary. All advertisements in this section must be strictly prepaid.

The proprietors retain the right to refuse or withdraw advertisements at their discretion.

Postal Orders and Cheques sent in payment for advertisements should be made **& Co.** payable to **ILIFFE & SONS Ltd.**, and crossed **Notes being untraceable if lost in transit should not be sent as remittances.**

All letters relating to advertisements should quote the number which is printed at the end of each advertisement, and the date of the issue in which it appeared.

The proprietors are not responsible for clerical or printers' errors, although every care is taken to avoid mistakes.

NUMBERED ADDRESSES.

For the convenience of private advertisers, letters may be addressed to numbers at "The Wireless World" Office. When this is desired, the sum of 6d. to defray the cost of registration and to cover postage on replies must be added to the advertisement charge, which must include the words Box 000, c/o "The Wireless World." Only the number will appear in the advertisement. All replies should be addressed No. 000, c/o "The Wireless World," Dorset House, Tudor Street, London, E.C.4. *Readers who reply to Box No. advertisements are warned against sending remittance through the post except in registered envelopes ; in all such cases the use of the Deposit System is recommended, and the envelope should be clearly marked "Deposit Department."*

DEPOSIT SYSTEM.

Readers who hesitate to send money to unknown persons may deal in perfect safety by availing themselves of our Deposit System. If the money be deposited with "The Wireless World," both parties are advised of its receipt.

The time allowed for decision is three days, counting from receipt of goods, after which period, if buyer decides not to retain goods, they must be returned to sender. If a sale is effected, buyer instructs us to remit amount to seller, but if not, seller instructs us to return amount to depositor. Carriage is paid by the buyer, but in the event of no sale, and subject to there being no different arrangement between buyer and seller, each pays carriage one way. The seller takes the risk of loss or damage in transit, for which we take no responsibility. For all transactions up to £10, a deposit fee of 1/- is charged ; on transactions over £10 and under £50, the fee is 2/6 ; over £50, 5/-. All deposit matters are dealt with at Dorset House, Tudor Street, London, E.C.4, and cheques and money orders should be made payable to Iliffe & Sons Limited.

SPECIAL NOTE.—Readers who reply to advertisements and receive no answer to their enquiries are requested to regard the silence as an indication that the goods advertised have already been disposed of. Advertisers often receive so many enquiries that it is quite impossible to reply to each one by post.

"WIRELESS WORLD" INFORMATION COUPON

This Coupon must accompany any Question sent in before

APRIL 9th, 1930

For Particulars of Free Service, see Rules on page 371.

B&J

ALL WIRELESS WORLD COILS

1630 EVERYMAX

FOUR	£7/3 set
KIT SET, Coils with Switches	45/- set
NEW KILOMAG	45/- set
RECORD III	45/- set
FOREIGN LISTENERS 4 B.P.O.	20/- set
METAL CABINETS	5X 37/6 set
51" DRUM DIALS with Escutcheons	35/6 to 45/3

B&J. Wireless Co.

2, 3, & 4, Athelstane Mews, Stroud Green Rd., N.4

Archway 1695

VOX-VERITAS

BRITISH MADE
New C.V Model

MOVING COIL LOUDSPEAKER

is different!

—and it is just that little difference which makes *all* the difference between an ordinary moving coil loudspeaker and a reproducer of pure music.

Fullness of tone, absolute quality, a ready response to the highest and lowest frequencies with entire freedom from "boom."

That is "VOX-VERITAS"
—the True Voice.

Ask your dealer for a demonstration or write to us for descriptive pamphlet.

VOX-VERITAS

12, Union Court, Old Broad St., London, E.C.2

6 volt '8 amp. or
D.C. mains, any voltage,
£2.10.0

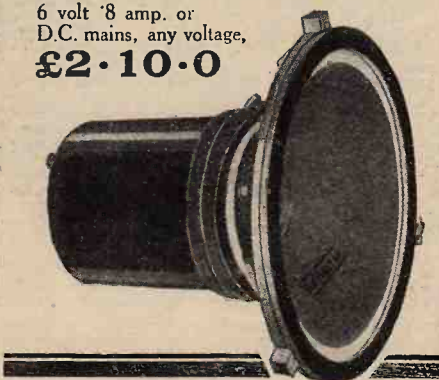

"WIRELESS WORLD" COILS

Record III 40/-, Ideal Homes 35/-, and all other types. Also slotted formers supplied unbound 5/- each.

Individual attention, satisfaction guaranteed.

E. W. MITCHELL & SONS,
HOLMROOK, Cumberland.

IMPORTANT NOTICE.

Owing to the Easter Holidays, the issues of "THE WIRELESS WORLD" dated April 16th and April 23rd must be closed for press earlier than usual.

The MISCELLANEOUS ADVERTISEMENTS for insertion in those issues can be accepted up to the following times :—

Issue of April 16th
FIRST POST WEDNESDAY, April 9th.

Issue of April 23rd,
FIRST POST TUESDAY, April 15th.

RECEIVERS FOR SALE.

SCOTT SESSIONS and Co., Great Britain's Radio Doctors.—Read advertisement under Miscellaneous. [0264]

HIRE a McMichael Portable Set, by day or week, from Alexander Black, Wireless Doctor and Consultant, 55, Ebury St., S.W.1. Sloane 1655. [0328]

STEREOPHONIC Couplers!—Latest talkie super models, many in use, wonderful reproduction; type B super £5/5 A super £3/15; trade supplied.—Bonavia-Hunt, 96, Broadhurst Gardens, N.W.6. [8798]

BURNDIPT Super Het 7-valve De Luxe Model, 1929 (all wave), 6-volt and 120-volt Exide heavy type accumulators, loud-speaker and 'phones, packed and carriage paid; twenty-five pounds.—Box 5446, c/o *The Wireless World*. [8933]

ELSTREE Six, in oak cabinet, fitted with Oram valves and first class components throughout; 14 guineas, or others.—Blake, Square, Kelso. [8917]

COMPLETE, famous Puda Six, handsome oak console, 4ft. high; great sacrifice, £18, or nearest offer.—21a, Sutton Buildings, Plough Rd., S.E.16. [8902]

BARGAINS.—National portable (less valves), £7; Lissen binocular coils, 4/-; Lewcos screened coils, 4/-; Keystone reaction condensers, 2/-, all perfect.—Davies, Aeron House, Tregaron. [8898]

BARGAIN.—4-valve screened grid portable Vauxhall receiver, complete, excellent loud-speaker; cost £16/10, no reasonable offer refused.—Apply H. Jewelowski, Hills Hotel, Prince's Sq., W.2. [8897]

SOLODYNE 5-valve Receiving Set, in solid mahogany case, with full instructions for use; £7, or offer.—Colonel Spaight, Shortfield House, Frensham, Surrey. [8892]

D.C. Mains Receiver, 3 valves (H.F., detector, and Pentode), provision for gramophone pick-up, only first class components used, moving coil speaker, perfect quality; £17.—R. North, 11, Palace St., S.W.1. Victoria 2942. [8814]

BERCLIF D.C.2 All Mains Receiver, 200 to 250 volts D.C.; price £14/10; with valves and royalties, suitable for M.C. speaker; particulars free; trade inquiries specially invited.—Simmonds Bros., Shireland Rd., Smethwick. [8734]

YOUR Old Receiver or Components Taken in Part Exchange for New; write to us before purchasing elsewhere, and obtain expert advice from wireless engineer of 25 years' professional wireless experience; send a list of components or the components themselves and we will quote you by return post; thousands of satisfied clients.—Scientific Development Co., 57, Guildhall St., Preston. [0226]

SUPER Selective 6v. Set, speaker daylight reception all European stations, long and short wave Dimio coils, handsome cabinet, complete with Marconi valves, Elite H.T. 180 volts accumulators, Celestion speaker; nearest £16; heard after 7.—2, Green Lane, New Eltham, S.E. Eltham 1654. [8961]

CLEARANCE of Stocks, guaranteed as new.—Marconiphone 5-valve portable, complete, £15 (listed £18/10); Pye Presentation Two, complete, £9 (listed £12); Brandes 3-valve, £5/5, including valves (listed £7/5); also greater bargains in speakers, components, gramophone records; write for list; goods sent per deposit system.—Box 5443, c/o *The Wireless World*. [8911]

MARCONI 5-valve Portable, 2 months old, perfect; £11.—Atkinson, 28, Montague St., Russell Sq., W.C.1. [8942]

FARADAX Portable, guaranteed perfect working order, December model, used for demonstration purposes only, case slightly soiled, £8 (16 guinea model); Marconiphone set contained 2-valve set and speaker, perfect condition, in one unit, shop soiled only, list £12/12, £5; Standard 3-valve, snip, £4.—Stanley Radio Co., King's Stanley, Glos. [8950]

MAGNIFICENT 8-valve Receiver, famous English maker, snip case portable, both as new; cheap.—Room 693, 66, Chancery Lane, W.C.2. [8955]

EPOCH
MOVING COIL SPEAKERS
Have captivated the Whole World.
Sales still going up by leaps
and bounds.

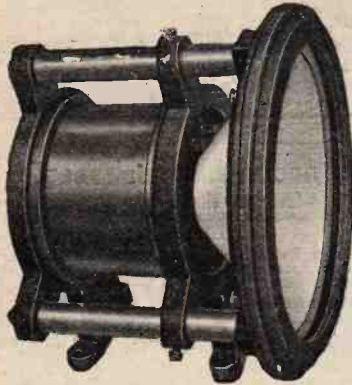

The Masterpieces of Loud-speaker design.

(See loud-speaker column, p. 12.)

Send for descriptive booklet W53 or call
and have a demonstration.

EPOCH RADIO MANUFACTURING CO., LTD.,
3, Farringdon Avenue, London, E.C.4.

PAREX



Bakelite
Drum Dials
with Escutcheons:

5/6

(from stock).

Cabinets, Coils, Valve Holders, etc., for
New Kilo-Mag 4 and 1930 Everyman 4.

IDEAL HOME RECEIVER

Special Screen and Panel 17/6.
Set of 3 Coils as specified 45/-.

Order direct
from

E. PAROUSSI,

10, Featherstone Buildings, High Holborn, W.C.1

'Phone: Chancery 7010.

**STOP CARRYING THAT
BATTERY ABOUT.
CHARGE IT
YOURSELF.**



All you have to do is to connect up
your Batteries and switch on. It
charges one to six Cells, i.e., 2 to 12
Volts at 1 1/2 amps. without requiring
attention of any kind.

It is guaranteed against defects
for 12 months.

You Save Money by using this
Charger.

The price complete with
Valves ready for use is only **45/-**
State Voltage of your supply mains
when ordering.

SAVOY UNITS, 30 City Road, London, E.C.1
Telephone: Clerkenwell 6610.

Receivers for Sale.—Contd.

HALCYON 1930 New Screened Grid Four, leather
case: £12.—Below.
MICHAEL 1930 New Screened Grid Four, leather
case.—Below.
KOLSTER BRANDES 1930 Screened Grid Four,
leather case.—Below.
ANY Trial of the Above: portable sets taken in part
payment.—'Phone: Sloane 9077. H. Passmore,
8, Grosvenor Gardens Mews (North), Victoria, London,
S.W.1. [8966]
IGRANIC Neurosonic Sevep, complete with valves,
battery box, Celestion L.S., frame aerial; best
offers.—Box 5459, c/o *The Wireless World*. [8971]
3-VALVE Set, Exide batteries, 220v. Trickle charger,
speaker, £6; also quantity accessories.—Bryant,
2, South Ridgway Place, Wimbledon. [8972]
1930 National Portable, splendid tone, almost new,
£10; also 4-valve screen grid R.S.G.B. short
wave receiver, world reception on indoor aerial, £12/10;
owner going abroad.—Berrington, 5a, Belle Vue
Parade, Wandsworth Common, S.W.17. [8981]

ACCUMULATOR HIRE.

DON'T Buy Accumulators or Dry Batteries, join our
C.A.V. low- and high-tension accumulator hire
service, the largest and best in London; better and
cheaper reception with no trouble; regular deliveries
within 12 miles of Charing Cross; no deposit, payment
on each delivery or by quarterly subscription; over
10,000 satisfied users; explanatory folder post free;
'phone or write to day.—Radio Service (London), Ltd.,
105, Torrington Av., N.W.5. 'Phone: North 0623-4, 5. [8751]

BATTERIES.

WET H.T. Replacements.—Sacs (capped or un-
capped), highest grade, No. 1, 10d. per doz.; No.
2, 1/9 per doz.—See below.
ZINCS—Best quality (wired), No. 1, 8d. per doz.;
No. 2, 9d. per doz.; orders valued 5/- carriage
paid, otherwise 6d. for postage.—British Battery Co.,
Clarendon Rd., Watford, Herts. [0258]
TWO Exide H.T. Batteries W.J.10, each 80 volts
2.5 amps., perfect condition, little used; £3 the
lot.—Apply "Bansra," Colnbrook, Bucks. [8893]
60-VOLT Batteries; 4/11, post free.—A. Percy,
Manufacturers' Agent, Auchenhove, Kilbirnie,
Scotland. [8988]

CHARGERS AND ELIMINATORS.

CHEBROS—Chebros for all types of transformers
and chokes, high grade instruments at a very
moderate price; enquiries invited.—Chester Bros., 244,
Dalston Lane, London, E.8. [5290]
TANTALUM and Liumion for A.C. Rectifiers; for
inexpensive chargers; blue prints for H.T. and L.T.,
1/- each; Liumion electrodes, 2-3 and 5-8 amps.—Black-
well's Metallurgical Works, Ltd., Garston, Liverpool. [8298]
ELIMINATOR Kits.—Transformers, choke, condensers,
valve holder, resistance, insulated terminals, and
wiring diagram; 25/- complete; 20 milliamps at 120
volts; send for list.—Pel-Ectric Radio, Garden St.,
Sheffield. [8618]

PHILIPSON'S Safety High Tension Battery Elim-
inators.

10/- Down and the Balance in Easy Monthly
payments secures the finest high tension
supply available.

PHILIPSON'S Safety Eliminators are Guaranteed for
12 Months.

PHILIPSON'S Safety Eliminators are the Cheapest
to Install and the Cheapest to Run; prices:
Model A.C.5 £4/17/6, A.C.7 £3/17/6, complete with
full wave, rectifiers; D.C.4 37/6, D.C.5. 45/-.

ALL Models Obtained for 10/- Deposit; take advan-
tage of this and get constant high tension imme-
diately.

WRITE for Our Booklet, "Radio Power" to
Phillipson and Co., Ltd., Radio Engineers, Astley
Bridge, Bolton. 'Phone: 2038. Grams: Safety, Bol-
ton. Est. over 50 years. [0318]

MAINS Transformers, and chokes; list on request.—
C. F. Gibbs, Pennygate, Spalding. [8845]

ZAMPA H.T. Eliminator Kit, comprising rectifying
unit (incorporating transformer, condensers, West-
inghouse H.T.3), necessary condensers, choke, terminals,
baseboard, etc., output 120 volts at 20 m.A., complete;
45/-; 7 days' approval against cash; other Zampa kits
and transformers on request.—Mic Wireless Co., Market
St., Wellingborough. [8857]

EKCO C2A All-power Eliminator for A.C., new, in
perfect condition; £6.—Greenhalgh, 18, Opeshaw
St., Bury, Lanes. [8928]

ATLAS Eliminator, as new, 200-250v., D.C. mains,
output 120v., fixed and variable; cost £3/15,
would accept 25/-.—Meyer, Woodside, Oriental Rd.,
Woking. [8979]

COSMOS Mains Transformer, primary 95-115v.,
tapped, output 250-0-250v., 4v. heater winding;
25/-.—41, Portland Rd., Oxford. [8978]

240 A.C. Charger, output 2a.; 50/-.—Blakeney,
13, Crescent, N.W.2. [8958]

"RED DIAMOND"

THE RECOGNISED DETECTOR
FOR ALL CIRCUITS USING
CRYSTAL RECTIFICA-
TION.



RD 40

2/-

By Insured
Post 2/3 or
2/0 with shield.
Can be mounted
on brackets or
through panel. Once set
always ready. Not affected
by vibration. Each one is tested
on broadcast before despatch, and is perfect.

"RED DIAMOND"
Pull & Push SWITCHES

As mentioned in T.W. of 12/3/30,
Robust Construction. Definite "on" and
"off" positions. No shaking. By
Perfect contacts. Large Insured
terminals for easy fitting. Post
RD39 Battery 1/3 1/6



RD38 Change Over (2 Terminals) 2/- 2/3
RD37 Three Point (4 Terminals) 1/6 1/9
Ebonite Bushes for all purposes kept
in stock.

TRADE MARK



Of all high-class Radio
Dealers or Sole Makers:

JEWEL PEN CO., Ltd.

(Radio Dept. 44), 21-22, Great
Sutton St., LONDON, E.C.1.

BONA FIDE TRADERS' GUIDE.

Send for our comprehensive Illustrated List
QUICK SERVICE. QUICK SERVICE..

THE QUALITY HOUSE.

PERSEUS MFG. CO., LTD. (Dept. W.W.),
BRANSTONE RD., BURTON-ON-TRENT.

BAKELITE ADAPTORS

with moulded-in contacts, suitable for
Eliminators, All Mains Sets, Radio
Gramophones, etc.

TURNOCK'S MOULDINGS,
41, High Street, Aston, BIRMINGHAM.

**METAL
CABINETS**

for
EVERYMAN

KILOMAG 4, RECORD 3,
Complete with base and finish 47/6.
Plain cabinet without base 27/6.
FOREIGN LISTENERS 4 (set of 4) 18/6.

W. H. PARKER, Sheet Metal Worker
Back Autumn Terrace
LEEDS. Tel: 52859

POWER CHOKES

guaranteed
twelve months,
substantially built, for smoothing
circuits
in eliminators dealing with currents
100 to 300 milliamperes,
inductance 30 henries,
8/6 post free.

REPAIRS

to any make
of L.F. Transformer,
Loudspeaker or Headphones.
All repairs dispatched within
48 HOURS—TWELVE MONTHS' GUARANTEE
with each repair. 4/- Post Free. Terms to Trade.

TRANSFORMER REPAIR CO.

Dept. W.,
214, High Street, Colliers Wood, London, S.W.19.

Mention of "The Wireless World," when writing to advertisers, will ensure prompt attention.

Chargers and Eliminators.—Contd.

SAVAGE'S Specialise in Wireless Power from the Mains, reliable apparatus at reasonable prices.

SAVAGE'S Transformers Laminations and Bakelite Bobbins; intending home constructors should write for list.

SAVAGE'S Reliable Smoothing Condensers, 1,000 volt D.C. test, 1 mfd., 2/-; 2 mfd., 3/-; 4 mfd., 5/3; 500 volts D.C. test, 1 mfd., 1/6; 2 mfd., 2/3; 4 mfd., 3/9.

SAVAGE'S Super Smoothing and Output Chokes, many types available, write for list.

SAVAGE'S Mains Transformers for Westinghouse H.T. 4 Unit 18/6; A.3, 17/6; A.4, 20/-.

SAVAGE'S Mains Transformers for Westinghouse H.T. 4, with additional winding, 4 volts, 3 amps.; 23/-.

SAVAGE'S Mains Transformer V.T.31 200-0-200-volts 60 milliamperes 2+2 volts 2 amps., 2+2 volts 3 amps., 28/-.

SAVAGE'S Mains Equipment for New Foreign Listeners Four Transformer N.F.L.4, 33/-; smoothing choke C.32G, 20/-; output choke C.32/0, 20/-.

SAVAGE'S Mains Transformers and Power Chokes are Carefully and Individually Constructed from First Class Materials with an Exceptionally Generous Margin of Safety.

SAVAGE'S, 146, Bishopsgate, London, E.C.2. 'Phone: Bishopsgate 6998. [8474]

FOR Sale, Philips A.C. H.T. mains unit, 200v. 50c., only used one month; £4/10, or near offer, cost £5/10.—Call any evening after 6 o'clock, or write, Perry, 77, Fernhead Rd., Maida Hill, W.9. [8959]

FOR Sale, Tungar rectifier, 200v. 50c. A.C. input, 14v. 3a. output. £2/15; 200v. to 600v. and 6v. transformer, 15/-; also smoothing chokes, Zenith resistances, and various other gear; send for list.—Disimore, 15, Cameron Rd., Seven Kings. [8956]

ATLAS Eliminator, 200-240-volt A.C. mains, H.T. tappings, 2 variable, 0-100, 0-122 volts, 1 fixed, 180 volts, L.T. 4 volts 4 amps. for A.C. valves, G.B. for power valve, new condition; cost £11, accept £5/15, including valve.—Brookes, Rivington, Compstall Rd., Romiley, Cheshire. [8939]

ELIMINATORS—Let us fit an eliminator, D.C. or A.C., to your set; all mains a speciality; our representative will call, under no obligation, and supply estimates.—Melville and Murdoch, 257, Lewisham High Rd., S.E.4. [8944]

CABINETS.

ARTCRAFT Radio Cabinets are Britain's Best Value. [0313]

DIGBY'S Cabinets.—Table models in solid oak and mahogany; from 11/6 to 71/-.

DIGBY'S Cabinets, fitted with Radion or Resiston ebonite if required.

DIGBY'S Cabinets.—Pedestal model, with separate battery components; from 56/- to £12.

DIGBY'S Cabinets Made to Customers' Own Designs.

DIGBY'S Cabinets.—Write for new 16-page art catalogue.—F. Digby, 9, The Oval, Hackney Rd., E.2. 'Phone: Bishopsgate 6458. [0128]

ARTCRAFT Radio Cabinets are Britain's Best Value. [0311]

CABINETS for All Requirements.—F. W. Ramsey, 63, Shaftesbury St., London, N.1. Clerkenwell 7139. [8155]

ARTCRAFT Radio Cabinets are Britain's Best Value. [0309]

WIRELESS Boxes, solid oak, new, polished, 16-10-5, 3/- each; frets, 1/-.—Bell, 119, Arlington Rd., Camden Town. [8905]

ARTCRAFT Radio Cabinets are Britain's Best Value. [0310]

KAY'S Cabinets, the greatest range of pedestal cabinets in the kingdom; original creative designs at prices 50% lower than elsewhere; quotations for specials by return; delivery at short notice guaranteed.

RADIOGRAM Cabinets.—A variety of really practical and exclusive models from 60/-; illustrated lists free.

H. KAY, Wireless Cabinet Manufacturer, Mount Pleasant Rd., London, N.17. 'Phone: Waltham-stow 1626. [8963]

ARTCRAFT Radio Cabinets; Britain's best value; lowest prices consistent with highest quality; illustrated list free from actual manufacturers.—Arterait Co., 156, Cherry Orchard Rd., Croydon. 'Phone: Croydon 1981. [0040]

IT Will Amaze You, this new mahogany piano finished loud speaker cabinet of unique and elegant design, value and appearance out of all proportion to the price; 37/6, carriage paid; money back guarantee.—Buckland, 18, Howe St., Derby. [8949]

COILS, TRANSFORMERS, ETC.

TRANSFORMERS and Chokes for Battery Eliminators.—Chester Bros., 244, Dalston Lane, London, E.8. [8652]

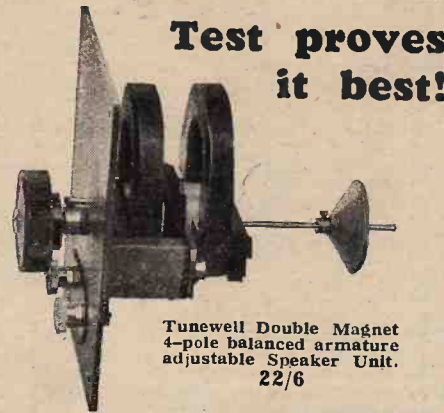

Tunewell Double Magnet 4-pole balanced armature adjustable Speaker Unit. 22/6

Read the following extract from the recent "Wireless World" Test Report:—

... The response is remarkably uniform from 300 to 6,000 cycles. Below 300 there is a reduction, but there is a definite response down to 50 cycles. ... The general effect is very pleasing, and we have no hesitation in placing this unit in the highest class. ... The sensitivity is above the average. ...

Hear this new Tunewell Speaker Unit—its tone is amazing and it handles enormous power without rattle or distortion.

From your dealer or address below. Price 22/6

Complete Speaker, in large domed or square oak cabinet, 14 inch cone. Price 59/6

Send for List.

Brookmans By-Pass wave-trap coils, complete with fixing brackets, 3/3 each

Tunewell "Cut-out" 10/6

New dual range coil for Reinartz circuits. X-tapped on both high and low waves. Super-selective. 10/6

Tunewell Transformer. Ratios 3 to 1 and 5 to 1. 12/6

TURNER & CO.,
54, Station Road, New Southgate, N.11.

DOMINION VERNIER DIALS 2/6

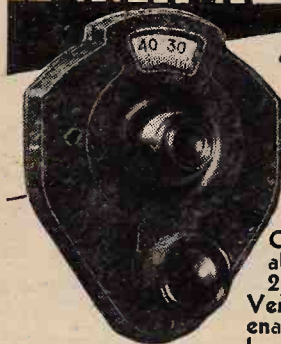

Only Brownie's ability to produce 2,000 Dominion Vernier Dials a day enables them to keep the price as

low as 2/6. Hear this special non-backlash design (for fine tuning) and the splendid finish (smooth black or beautifully grained mahogany bakelite) coupled with the low price, makes the Dominion Vernier Dial a real radio bargain.

BROWNIE WIRELESS COMPANY (G.B.) LIMITED, NELSON STREET WORKS, LONDON, N.W.1

BROWNIE WIRELESS

Coils, Transformers, Etc.—Contd.

600 ohms Decoupling Resistances, specified for new Kilo-Mag Four; 1/6 each, post free.—Groves Brothers.

120 and 1,000 ohms Resistances for new Foreign Listeners Four; 1/6 each, post free.—Groves Brothers.

SCREENING Boxes for Foreign Listeners Four, selectivity units, etc.; 6/- each, post free.—Groves Brothers.

NEW Kilo-Mag Four Coils, 37/6 set, Kilo-Mag slotted formers, 12/6 set; 1930 Everyman Four formers, 8/6 set; kit set formers, 10/6 set; all post free; trade supplied.—Groves Brothers, St. Mary's Place, Shrewsbury. [8757]

RADIOGRAPH—"Wireless World" Coils, Record III, 35/-; New KiloMag Four, 33/-; S.G. Regional, 37/6; kit set, 45/-; 1930 Everyman Four, 42/6.

RADIOGRAPH—Litz wire, 9/40, 1/6; 27/42; 2/6 dozen yards; Redfern's deep ribbed or Beool tube, 5d. per inch, slotting 1/6 extra.—Station Rd., Handsworth, Birmingham. [8856]

LEWCO'S Binocular Coils, long wave, B.A.C.20 and L.B.S.P.20; 6/6 and 12/6; nearly new.—Dick, Alvechurch, Worcestershire. [8926]

LEWCO'S Q.A.T. and Q.S.P.; 25/6; as new.—Cooper, Baskley, New Milton, Hants. [8930]

BERCLIF Coils, the standard of excellence, for all "Wireless World" receivers; latest lists post free; trade supplied, all quantities.—Simmonds Bros., Shireland Rd., Smethwick. [8735]

FOUR Matched Silver Marshall Superhet. Transformers, 3 No. 210 and 1 No. 211; £3.—Box 5460, c/o The Wireless World. [8970]

COILS for the Ideal Home Receiver Wound to Specifications; price 25/-.—Box 5461, c/o The Wireless World. [8969]

DYNAMOS, ETC.

M-L Motor Generator, new and unused, input 210 volts D.C., outputs 575 volts, 200 m.a., and 5.5 volts 5.5 amps. D.C.; listed £32/10, what offers?—91, Penywin Rd., Cardiff. [8921]

GRAMOPHONES, PICK-UPS, ETC.

GARRARD Double-spring Motor, new, unused; 25/-; stamp.—18, Wellington Rd., E.17. [8859]

RADIOGRAPH—Pick-up, with valve adaptor, 18/- complete; approval.—Station Rd., Handsworth, Birmingham. [8855]

B.T.H. Pick-up Straight Arm, guaranteed perfect; 24/-.—Young, 55, Frances St., Battersea, S.W.11. [8935]

B.T.H. Pick-up, with tone arm, complete, new last November, good condition; 25/-.—Box 5399, c/o The Wireless World. [8903]

BURNDYPT, 12/6; Brown No. 2, with adaptor, 13/6; both perfect.—Gay, 7, St. Matthew's Av., Surbiton.

B.T.H. Electric Gramophone Motor, cost £6/6, is new and in perfect condition; £3/15.—Greenhalgh, 18, Openshaw St., Bury, Lancs. [8929]

ADRIAN Pick-up, with volume control, light, sensitive, 15/6; B.T.H. pick-up amplifier, complete, 21/-; c.o.d.; guaranteed.—4, Brecon Rd., Handsworth, Birmingham. [8976]

B.T.H. 1930 Pick-up (with arm), unused; 25/-.—B. O. Priestley, 74, Aberdeen Rd., Highbury, London, N.5. [8973]

IGRANIC Phonovox Pick-up, adapter, volume control, leads, complete; £1.—Robus, 24, Newton Rd., Tunbridge Wells. [8948]

B.T.H. Pick-up, with tone arm, new type; 25/-.—Willoughby, 164, Clonmore St., Southfields, S.W.18. [8947]

LOUD-SPEAKERS.

BAKER'S SELHURST RADIO 36-page Booklet, "Sound Advice is Yours for the Asking"; write now for new edition; see displayed advertisement on page 12. [0231]

VIBRO-SKIN Special Leather for Fixing the Diaphragm of the Moving Coil Loud Speaker; price 2/- per piece 11in. square, 1/6 per piece 9in. square; post free; cash with order.—The Alder Leather Co., 3, Southwark St., S.E.1. Tel.: Hop 4448. [0330]

MOVING Coil Magnet Pots, ready machined, complete with coil former; 4/6; ex stock, genuine bargain; 7 days' approval against cash.—Mic Wireless Co., Market St., Wellingborough. [8858]

PERARDUA Moving Coil Reproducers.—These superlative instruments may be obtained for 15/- down, balance by 5 equal monthly payments; cash prices, 230-volt D.C., £3/3; 6-volt, £3.—R. Vevers, 4, York Rd., Maidenhead. [8872]

ALUMINIUM Cone Chassis, to take Blue Spot, suitable for baffle fixing, 10/-; Telsen Ace, 5-1 transformer, 4/-.—41, Priory Rd., West Bridgford, Notts. [8894]

AMPLION Lion Table Cabinet Model, oak case, new condition; £4.—Wood, 17, Hythe Rd., Worthing. [8906]

BUILD THE "NEW FOREIGN LISTENER'S FOUR"

Complete kit, including ready wound Transformer £16

Ready wired and tested, including Valves, Coils, and Royalty paid £25

The price includes P.M.24A Valve. 15/- less if P.625 Valve is required.

Any parts supplied separately as required.

Detailed lists of parts, including a list of Short Wave Stations and other interesting literature, on request.

BURNE-JONES & CO., LTD.,

"MAGNUM" HOUSE, 296, BOROUGH HIGH STREET, LONDON, S.E.1.
TELEPHONE: HOP 6257/8.

SEND TO-DAY FOR OUR FREE 36-PAGE BOOKLET "SOUND ADVICE."



Now installed at the London Hippodrome

PERFECT RECEPTION FOR MUSIC LOVERS

BAKER'S
Selhurst
RADIO

Offices: 89, Selhurst Rd., S. Norwood, S.E.25.
Works: 42, Cherry Orchard Rd., E. Croydon.

Super Power Moving Coil Speaker.

CABINETS
KABILOK
OF DISTINCTION

If you are requiring a cabinet for that receiver, loud-speaker or radio gramophone, send first for the **KABILOK CATALOGUE** which contains a splendid selection of cabinets.

Free on request

W. & T. LOCK LTD.
ST. PETER'S WORKS BATH.
LONDON: 11, Red Lion St., W.C.1.

METAL CHASSIS IDEAL HOME RECEIVER

Complete with all holes drilled and baseboard **13/6** Carr. Paid.
S.G. Short Wave III small screening box for H.F. valve **2/6** Carr. Paid.

J. BURDEN AND SON,
Sheet Metal Workers, **ALCESTER.**

Loud-Speakers.—Contd.

EPOCH Moving Coil Speakers are Masterpieces, designed and produced by master engineers.

EPOCH Moving Coil Speakers are the Standard by which other Speakers are Compared.

EPOCH Moving Coil Speakers are in Use in many Editorial Offices.

EPOCH Moving Coil Speakers are in Use in several Famous Laboratories.

EPOCH Moving Coil Speakers are in Use in many Broadcasting Stations.

EPOCH Moving Coil Speakers are in Use by most Prominent Musicians.

EPOCH Moving Coil Speakers Bring Unbounded Joy to Thousands upon Thousands of Homes.

EPOCH Moving Coil Speakers, the only Speakers that give clear, uncoloured reproduction.

EPOCH Moving Coil Speakers do Render Speech Perfectly and Music Correctly.

EPOCH Moving Coil Speakers Provide the Perfect Illusion of the Artist's Presence.

EPOCH Moving Coil Speakers Represent the Finest Intrinsic Value ever Offered.

EPOCH Moving Coil Speakers are Guaranteed for a year, but last for ever.

EPOCH Moving Coil Speakers bring the Grand Concert out of the most Modest Set.

EPOCH—You can hear a hundred Moving Coil Speakers, but Epoch is different.

EPOCH—If you own the best set, only by Epoch can you confirm it.

EPOCH—Away with the tin can and cracked banjo reproduction, and install an Epoch.

EPOCH—Away with the drumminess, droniness and huskiness of the average Moving Coil Speakers.

EPOCH—The clearest, sharpest, cleanest reproduction—a marvel of accuracy and beauty.

EPOCH Moving Coil Speaker Models from £2/10 to £30.

EPOCH Moving Coil Speakers.—Models for every requirement and taste.

EPOCH Permanent Magnet Moving Coil Speakers.—Nine models from £3/15.

EPOCH Permanent Magnet Moving Coil Speakers Require no Mains or Batteries.

EPOCH Permanent Magnet Speakers are more Sensitive than most Energised Moving Coil Speakers.

EPOCH Energised Models are the Finest ever put on the market.

EPOCH Super Cinema Speaker has Created the Biggest sensation for many years.

EPOCH Super Cinema Model is many times, as Sensitive as the so-called Supers.

EPOCH Super Cinema Speakers give Enormous Volume from a 1-watt Amplifier.

EPOCH Super Cinema Speakers are used on many 100-watt Amplifiers and never "rattle."

EPOCH Super Cinema Model is Standard on several Talkie Equipments.

EPOCH Super Cinema Model is already in use in over 200 Cinemas.

EPOCH Super Cinema are the only Moving Coil Speakers used in Large Theatres, unaided.

EPOCH Super Cinema Speakers provide alone the Upper as well as the Lower Register.

EPOCH—Other Moving Coil Speakers require the help of exponential horns to provide depth.

EPOCH—A list of many prominent cinemas using the Speakers supplied on request.

EPOCH Speakers are not Made of Tin or Aluminium Stampings, but are sound, solid, engineering jobs.

EPOCH Heartily Invite Comparison, on all counts, with any make, regardless of price or claims.

EPOCH—Don't accept our quality claims without verification, but don't accept any other maker's either.

EPOCH—Order one for 7 days' approval, and test with a switch-over; the only real test.

EPOCH Moving Coil Speakers may be heard in our Demonstration Room Daily.

EPOCH—Our demonstration room is in the heart of London.

EPOCH—Its accessibility has been studied for the convenience of callers.

EPOCH—If you cannot call, write for booklet W.9.3, and approval terms.

EPOCH RADIO MANUFACTURING Co., Ltd.,
Tarrington Av. (near Ludgate and Holborn Circuses), Phone: Central 1971. [8983]

STUPENDOUS!

A recent advertiser in "THE WIRELESS WORLD" writes as follows:

"As the results from my advertisement in 'The Wireless World' were stupendous, I shall be glad if you will cancel my advertisement in next week's issue as I am cleared out.

I might add that 'The Wireless World' is the best journal I have read."

W. F. Macbeth,
"Bramar,"
Ballymena, Ulster.

w.w.3g.

So Many Replies!

A recent advertiser in "THE WIRELESS WORLD" writes as follows:

"I HAVE received so many replies to my advertisement in 'The Wireless World,' which appeared under a Box Number that I am sending herewith stamps to the value of 6d. as further payment towards your postage expenses. Thanking you for the quick despatch of all replies."

R. W. CAPEWELL,
52, Chapel Terrace,
Trent Vale,
Stoke-on-Trent.

W.W.88.

Loud-Speakers.—Contd.

EPOCH 9 Speaker, D.C. model, Pentode coil, perfect condition; £3/5.—Box 5441, *c/o The Wireless World*. [8908]

MASSIVE Loud-speaker, powerful unit, cabinet lin. solid inlaid mahogany, 26x28x14, handsome appearance and tone; £4/10.—W. A. Searle, 29, Robinson Rd., London, E.2. [8925]

NEW Magnavox R4 Moving Coil Speaker, in perfect condition; £4/10.—Greenhalgh, 18, Openshaw St., Bury, Lancs. [8927]

SUPERTONE Mahogany Cabinet Loud-speakers, perfect tone, stupendous volume; 35/-; trade enquiries invited.—Supertone Reproducers, 97, Thomas St. Bristol. [8794]

MAGNAVOX Moving Coil Speakers, 1929 6-volt models, never been used, in original cases; 3 guineas.—Wilburn and Co., 23, Bride Lane, Ludgate Circus, E.C.4. [8884]

MOVING Coil Speaker, large cabinet, 6v. acc., perfect tone; heard appointment after 7; 7/0.—2, Green Lane, New Eltham, S.E. Eltham 1654. [8960]

PUBLIC Address Loud-speaker Horns (prov. patented), for moving coil loud-speakers, as supplied to the B.T.H. and Ediswan Cos.—G2VM, 27a, Bridget St., Rugby. [8975]

AIR-CHROME, 4-guinea chassis, new, moving coil quality; 57/6.—Brookes, Rivington, Compstall Rd., Romley. [8940]

SENIOR R.K. Reproducer, with built-in rectifier, 200-240-volt, unused and in original packing; £9.—Bowden, 2c, Park Rd., Hampton Hill. [8986]

TRANSMITTERS.

CHEBROS. Chebros. Chebros transformers and chokes of all descriptions, special transformers for transmitting and modulation; chokes a speciality; enquiries invited.—Chester Bros., 244, Dalston Lane, London, E.8. [5240]

VALVES.

AMPLIFIER Valve.—If you require power you cannot do better than one of these:—

FILAMENT Volts 6, plate volts 400 (maximum), grid bias 84 volts (approx.), impedance 800 ohms, amplification factor 3.8, mutual conductance 4.35 m.a./volts; price £5/10; see article "The Wireless World," 24th July, 1929, then send to North London Valve Co., Ltd., 22½, Cazenove Rd., Stoke Newington, London, N.16. [8808]

LOUDEN Valves (British), unused, 6-volt, half price, 3/3; ditto, bright emitters, 4½-volt, 1/9; c.o.d.—Thorburn, 14, Reid St., Morpeth. [8985]

COMPONENTS, ETC., FOR SALE.

BELLING-LEE Panel Fittings are designed to give an expert finish to any home-constructed set; catalogue post free.—Belling and Lee, Ltd., Queensway Works, Ponders End, Middlesex. [0018]

WESTON Model 301, milliameters, ammeters, and voltmeters, 21/- each; hot wire ammeters 0-1 amps., 4/-; 0-0.5 amp., 3/-; instrument repairs and alterations; send for list.—The Victa Electrical Co., 47, High St., Battersea, S.W.11. Established 1910. [8626]

EXPERIMENTER Has a Large Number of Various Components for Disposal, all in perfect order; send for list.—Gay, 7, St. Matthew's Av., Surbiton. [8895]

ALL Good as New; Blue Spot minor chassis, 4/6; Wate's universal double cone, 5/6; Lewcos wave trap, 4/6; Lewcos Reinartz, transcoil, 550 metres, 3/-; Lewcos 6-pin base, 1/-; Reinartz aerial coil, 2,000 meters, 2/-; Dubilier R.C. unit, 3/6; Igranite gramo. pick-up, 10/-; Magnum H.F. choke, 3/6; Varley wire wound res., 80,000 ohms, and holder, 5/-; G.E.C. volume control, 1 meg., Clarostat volume control, 2 meg., Mullard P.M.1 valve, new, 4/-; lot for £2/5.—Aves, 8, Newport Rd., Stafford. [8899]

THREE S.M. Dials, H.F. choke, J.B. neutralising condenser, 1/- each; 200v. to 4v. 4a. filament transformer, £1; 3 Cosmos A.N.P. coils and bases, 5/- each; 4 Cosmos A.C./G., 7/6 each; Cosmos A.C./R., 8/6; 2 rectifying valves, 7/6 each.—14, Alexandra Rd., South Norwood. [8901]

MATEUR'S Surplus.—All as new; Crossley Merola pick-up, with tone arm and self contained volume control, 20/-; chrome loud-speaker, with Tefag 4-pole unit, 30/-; Blue Spot Major chassis, 10/-; R.I. gen-purpose transformer, 8/-; D.E.5, 4/-; B11, 5/-; Mazda 215, 15/-; Marconi pick-up, 55/-; central lab., 400 ohms, 5/-; 2,000 ohms, 5/-; full list on application.—B.M.P.X.J.N., London, W.C.1. [8910]

R.I. Varley Automatic Tone Arm and Pick-up, 40/-; set of 4 Berclif coils (long, short waves) for Lode-stone and Touchstone receivers, 30/-; W.M. Signal Booster screen grid H.F. amplifier (long, short waves), with S.G.215 valve, 40/-.—"Grange View," Ross Rd., South Norwood. [8916]

INEXPENSIVE—PUBLIC ADDRESS and SPEECH & MUSIC TRANSMISSION—MICROPHONE—

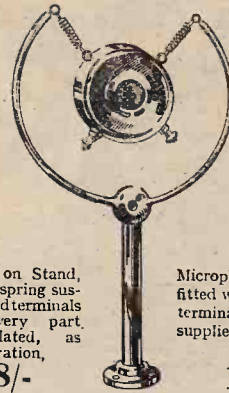

Complete on Stand, 10" high, spring suspension and terminals fitted, every part nickel-plated, as illustration, **18/-**

Microphone only, fitted with hooks and terminals, springs supplied, all nickel-plated, **12/6**

This thoroughly efficient Microphone has been especially designed for use with small Valve Amplifiers, or in connection with Wireless Sets which are adapted to work from a Gramophone Pick-up. When connected to two or three L.F. Stages, through a Microphone Transformer, this Microphone is GUARANTEED to transmit speech and music without distortion and with ample volume to fill a large hall.



Microphone Transformer,

special design to obtain best possible results from sensitive Microphones when connected to Valve Set, or Valve Amplifier; best Transformer for clear speech with volume, speech and music transmission. Public Address Microphones, etc.; Prim. and Sec. terminals; full directions for use of Microphone and diagrams of connections free. Goods by return post **6/-**—**FREDK. ADOLPH, Actual Maker, PHONE: Maseum 5329.** 27, Fitzroy Street, London, W.1.

'Layerbill'

Every inch of space is used in making the famous Columbia "Layerbill" battery. The result—concentrated power from top to bottom and an electrical capacity half as great again as any other battery in the world of the same type and size. Not a single soldered connection. **25/-**

Also No. 4780. 60 Volts. For multi-valve sets. 20/-
No. 4755. 93 Volts. specially recommended for portables. 18/-

by **Columbia** RADIO BATTERIES

J. R. MORRIS, Imperial House, 15, Kingsway, London, W.C.2.
Scotland: J. T. Cartwright, 3, Cadogan St., Glasgow.

Components, Etc., For Sale.—Contd.

AS New, few hours test only; Mazda P220, 8/6; Mazda 215 S.G., 15/-; Cossor R.C.410, 4/-; Dario S.P. 4v. 4/-; Amplion A.U.4 horn unit, as new, 15/-.—77, Hartland Rd., N.W.6. [8920]

WIRELESS Components for Sale; cheap.—Apply 316, Portobello Rd., W.10, after 7 o'clock. [8924]

EXPERIMENTER'S Surplus.—Ferranti A.F.5, 20/-; O.P.4C, 12/6; mains transformer P8, 10/-; B.T.H. 15-1; B.T.H. stand microphone, £3; Marconi pick-up, as new, £2; Celestion, 10/-; 2 Lotus variable condensers, 0.00035, 2/6 each; 2 P225A H.L.610, 4 D.E.L.610, 5/- each, 25/- the lot.—A. Fitzbrown, Hunt's Cross, Liverpool. [8932]

CRYPTO Charger, 200v. 50 cycles, output 8 and 16 volts, 5 amps., perfect condition, £5/15; Graham Farish 3-valve unit, 6/-; Watmel choke transformer, 6/-; 6-pin coils, 2/3 each; various wire wound resistances, E.B. 1/6 each; Varley 200,000 and holder, 5/-; Lissen O.P. choke, 3/6; volume control, 2/-; Universal motor, with worm gear (D.C. or A.C.), including resistance, suitable for gramophone, 27/6; stamp reply.—105, Hunslet Hall Rd., Leeds. [8934]

RADIO HOUSE, HUDDERSFIELD, issues the Reliability Wireless Guide, which will be sent post free upon request by Messrs. J. H. Taylor and Co., 15, Macaulay St., Huddersfield. [7823]

PART Exchange.—See our advertisement under Receivers for Sale.—Scientific Development Co., 57, Guildhall St., Preston. [0228]

MATEUR Clearing Surplus Offers 1 Sifam, 4 Suprecision milliameters, various ranges, Sifam double range voltmeter, all as new, 17/6 each; 3 unused Cossor 4-volt R.C. valves, 5/- each; Ferranti A.F.4 transformer, unused, 9/-.—2, Green Lane, New Eltham, S.E. Eltham 1654. [8962]

B.T.H. Pick-ups and Tone Arms (cranked), 30/2 each; Dubilier transformers, type 640, 0.003 mid., 1/- each—G2VM, 27a, Bridget St., Rugby. [8974]

MAZDA AC/SG, 18/6; AC/HL, 11/6; 2 AC/PIs, 13/- each; all unused; B.T.H. output transformer, 1-1, 10/-; 2 utility D.F.D.T. switches, 2/6 each; Lewcos 6-pin B.A.C.5, B.A.C.20, 3/- each; P.M.6D, 5/-; S625, 5/-; postage extra.—Lomax, c/o Newman, Dashwood Rd., Alford, Lincs. [8919]

COMPONENTS Lent on Hire.—Details from Alexander Black, Wireless Doctor, 55, Ebury St., S.W.1. Sloane 1655. [0329]

WEARITE Foreign Listener Coils, both bands, 39/6; Radielle A.C. transformer, 27/6; all new.—Needler, 857, Holderness Rd., Hull. [8984]

CLEARANCE—Bolt dynamos, volts 12, amps. 12. C.A.V. dynamo, volts 8, amps. 6, quick sale, 35/-; Browns P.Q. type public address loud-speaker horns and flares, excellent condition, 11/6; Gammont speech amplifier, £5; ex Government heterodyne wave-meters, 8/6, ohmmeter, 35/-; portable voltmeters, teak cases, 17/6; Marconi ¼ K.W. transformers, 22/6; new Burnedpt Ethophone IV, 4-valve receivers, mahogany cabinets, sacrifice, £5/10.—J. B. Humphreys and Co., 23, College Hill, Cannon St., London, E.C.4. [8982]

BANKRUPT Stock.—Have secured another 30 push-pull amplifiers, as advertised in last week's issue, at 37/6 each, carriage paid.—Franks, 42a, St. George's St., Cannon St. Rd., London, E.1. Phone: Royal 8546. [8977]

ATLAS Eliminator, A.C.16 input, 200-250 volts, output 150v. 30ma., £3; Loewe pick-up, 10/-; Blue-spot 66K, and Major chassis, 25/-; pair Music Magnet coils, 9/-, all guaranteed as new.—Briggs, Carlton Rd., Shilley. [8954]

VARLEY Deal Wave Regional Aerial Coil, 10/6; Varley Nicore 1 transformer, 13/6; Sifam M.C. milliammeter, 0-20, 12/6.—Jolly, 25, Hamilton Rd., London, W.4. [8953]

VALVES—Two B.T.H. B4, three D.E.5B, two D.E.5, one P.M.c. 5/- each condensers, Bowyer-Loewe triple gang, 0.0005, 15/-; Cylind 0.00115 and 0.0005, 5/- each; three Peto-Scott neodyne condensers, 2/- each; Indigraph dial, 2/-; condition perfect.—Seath, 4, Maida Vale Cottages, Island Rd., Sturry. [8952]

VARLEY Antinovos (3), 4/6 each; H.F. choke, 4/6; Mullard Permacone, 14/-; R.I. 6 terminal transformer, 15/-; Iye 32 henry choke, 9/-; Heayberd mains transformer, 210v. input, 200v. output, 10/-; ditto smoothing choke, 50 henry, 100ma., 10/-; also Amplion Lion L.L.14, oak, as new, £9 model, accept £5/15.—Blunt, 4, Grove Park, Redland, Bristol. [8951]

CELESTION C24 Chassis, guaranteed, listed £14, accept £8; Oldham H.T. charger, type A.C.H.1, listed 45/-, as new, £1.

16 HART 10 Volt H.T. Accumulators, 3,000 actual, good condition; listed 9/3 each, accept 3/6 each, or £2/10 the lot.—Taylor, 74, The Mint, Ry. [8946]

6V. 55 Exide 10/-; Brown No. 2 pick-up, adapter and Watmel arm, 17/-; Cossor 610 H.F. 4/6.—Ackaman, 722, Chester Rd., Stretford, Manchester. [8938]

MARCONI 2-stage Amplifier, mahogany, 50/-; Marconi pick-up, with arm, £1; P.M. 24 pentode, 15/-; P.M.25B, 10/-; Marconi D.E.H.610, 6/6; Ferranti 0-50 milliammeter, 17/6; 500wcos binocular coils, 6/-; all as new.—Eve, 65, Balsall Heath Rd., Birmingham. [8937]

PERMANENT POWER AT THE COST OF 3 DRY BATTERIES

Our 2C. Standard model as illustrated, for D.C. mains, is suitable for any type of set (100-250 Volts, 45-50 M. Amps.).

PRICE £2-5-0. For very bad D.C. mains specify Model E.W.15 with three 15M. Amps. specially suitable for valve sets. Complete with Westinghouse Metal Rectifier. PRICE £3-10-0.

For A.C. mains specify Model E.W.15 with three 15M. Amps. specially suitable for valve sets. Complete with Westinghouse Metal Rectifier. PRICE £3-10-0.

SUPREMUS H.T. ELIMINATORS



SUPREMUS SPECIALITIES LTD.
 118, HIGH STREET, ERDINGTON, B'HAM
 Northern Agents: THE CHORLTON METAL CO.
 18, Amber Street, Manchester.

"Where did that one come from?"



Type "R" 3d.
 also Type "B" 6d.
 and Type "M" 4d.

Even when their heads are engraved terminals are apt to be very muddling—if the tops come off. The tops of Belling-Lee terminals cannot possibly come off—one of the many advantages to be gained by using these excellent little products. Ask your dealer, or send to us for FREE Belling-Lee Handbook "Radio Connections."

BELLING-LEE FOR EVERY RADIO CONNECTION

Asst. of Belling & Lee, Ltd., Queensway Works, Ponders End, Middlesex.

The VOLUVERNIA

VOLUME CONTROL

Resistance 0 to 4 meg. For Radio Receivers or Gramophone Amplifiers. Smooth and silent in operation. Can be used with metal panel if desired.

6/9

GAMBRELL RADIO LTD., 6, Buckingham St., Strand, London, W.C.2.

Mention of "The Wireless World," when writing to advertisers, will ensure prompt attention.

MISCELLANEOUS.

ALEXANDER BLACK.
 THE Original Wireless Doctor, will call (London and Home Counties) and cure your set.

CONSULTATIONS by Appointment Without Obligation, sets installed, maintained, and brought up to date, gramophone pick-ups, eliminators, and Webson moving coil speakers demonstrated; purity reproduction specialists.

55, Ebury St., Victoria, S.W.1. Sloane 1655. [0277]

CALIBRATE Your Set With the C.D.E.S. Calibration Chart; 8d., post free.—C.D.E.S., 98, Cherry Orchard Rd., Croydon. [8612]

REPAIRS to all Types of Receivers; London area; expert advice.—F. D. Armitage, 4, Willow Av., Uxbridge. [8698]

SCOTT SESSIONS and Co., Great Britain's Radio doctors, officially approved as wireless repairers by Radio Society of Great Britain and Wireless League; old sets of every type repaired, rebuilt, modernised; send set for immediate quotation.

SCOTT SESSIONS and Co.—New sets constructed with your or our components, guaranteed finest workmanship; we specialise in "The Wireless World" circuits; remember, we have satisfied customers throughout the British Isles and in three Continents; if you so desire, we will design and construct high grade apparatus to suit your special circumstances for quality, range and selectivity.—Tel.: Tudor 5326. Muswell Hill, London, N.10. [0262]

FAIR Isle Jumpers.—For high class goods at wholesale prices, apply Pottingers, Hannovoe, Lerwick. [8889]

PATENT AGENTS.

PATENTS and Trade Marks, British and foreign.—Gee and Co. (H. T. P. Gee, Member R.S.G.B. and A.M.I.R.E.), 51-52, Chancery Lane, London, W.C.2. 'Phone: Holborn 1525. [0001]

KING'S PATENT AGENCY, Ltd., 146a, Queen Victoria St., E.C.4.—Free advice and handbook on patenting inventions and registering trade marks; registered agent with 43 years' experience. [0002]

REPAIRS.

SCOTT SESSIONS and Co., Great Britain's radio doctors; read advertisement under Miscellaneous column. [0263]

GUARANTEED Repairs by Experts.—Loud-speakers, headphones, cone units, pick-ups, any type, re-wound, remagnetised, and adjusted, post free 4/-; transformers, from 4/-.—Howell, 91, Morley Hill, Enfield, Middlesex. [7882]

REPAIRS Returned Post Free, and to ensure satisfaction send remittance after approval of same.—Leeds Wireless Repair Service.

LOUD-SPEAKERS, headphones, re-wound to any resistance and remagnetised, 3/-; transformers re-wound, 4/-; Blue Spots, Triotrons and 4-pole units, 4/6; work guaranteed.—Leeds Wireless Repair Service, 5, Boston Place, Green Rd., Leeds. [8945]

WANTED.

A.F.S.C. O.P.M.1C, Ferranti meters, all ranges, standard clarostats.—Paul, Theatre Royal, Blyth. [8931]

HEADPHONES.—Brown's 8,000 ohms, perfect condition.—Johnson, 23, Southwood Rd., Ramsgate. [8904]

WANTED, Marconi phone short wave adapter, model S24, also short wave model 34.—Redway, Point, Exmouth. [8900]

WANTED, demonstrators and canvassers for portables.—Box 5465, c/o The Wireless World. [8957]

SET Coils, Cockaday's L.C.27, Hammerlands 0.000275 dual condenser.—Box 5464, c/o The Wireless World. [8941]

PORTABLE Wireless Sets Bought for Cash, any condition.—Box 5466, c/o The Wireless World. [8967]

CAPACITY Bridge, measuring 0.00001 mfd. upwards; approval and accuracy essential.—BM/ZLME, W.C.1. [8964]

EXCHANGE.

WE Will Accept Your Surplus Apparatus (making you a high allowance) in Part Payment for Any New Apparatus; your enquiry will be dealt with promptly.—Bostock and Stonnill, 1, Westbourne Terrace, S.E.23. [8923]

WHAT Offers in Exchange for Coventry Eagle Motor Cycle, 2 1/2 h.p., or sell, nearest offer £12.—Repath, Down-Thornhill, near Plymouth. [8918]

A Shoal of Requests!

A recent advertiser in "THE WIRELESS WORLD" writes as follows:

"I feel I ought to inform you how successful my small advertisement was in "THE WIRELESS WORLD" of December 25th. Even before I had seen it myself I had received a shoal of requests of all descriptions. Practically everything was sold."

Martin Woodroffe,
 Westington,
 Chipping Campden,
 Gloucester.

W.W.9r.

"Could have been sold over a dozen times!"

A recent advertiser in "THE WIRELESS WORLD" writes as follows:

"You may be pleased to know that the coils I advertised in 'THE WIRELESS WORLD' could have been sold over a dozen times.

"They were sold first post here on Thursday morning, and I had applications for them for a fortnight after."

W. A. Pelly,
 Pierhead,
 Eastbourne.

W.W.9r.

Exchange.—Contd.

WANTED, good short wave receiver, complete, in exchange for Titan Three, in cabinet, and Underwood portable typewriter, both new condition.—Box 5442, c/o *The Wireless World* [8909]

FINANCIAL PARTNERSHIPS.

PARTNER Required, capital £300-£500, half-share well established business East end of London, wireless, electrical, gramophone, and accumulator service; would consider outright purchase as alternative.—Write Box 5444, c/o *The Wireless World*. [8914]

SITUATIONS VACANT.

WIRELESS Operating Appointments Assured; short qualifying course, day, evening; fees payable after appointment for boarding students; Morse classes.—Manager, Wireless School, 21, Manor Gardens, London, N.7. Archway 3694. [8121]

RADIO Sales Department.—Wanted, young man, age 17-20, some technical knowledge essential.—Write, stating salary required, etc., to London Electric Wire Co., Church Rd., Leyton Dept. T.F.M. [8912]

ENGINEERS Required Immediately for Sound Reproduction Section, only those with actual experience of talking equipment need apply.—The B.T.H. Co., Ltd., Construction Department, Rugby. [8987]

WIRELESS Services.—The Premier Telegraph College in the British Isles (established 34 years) gives a sound training to all students, with assured positions on qualification. Fees are not disguised under expensive board-residence scheme. 44 students out of a total of 47 obtained qualifying wireless certificates at first attempt in the last seven Government examinations.—Apply for prospectus, Dep. W, The London Telegraph Training College, Ltd., Morse House, Earl's Court, S.W.5. [8943]

SPLENDID Opportunity for a Smart Young Man, thoroughly experienced in retail sales, must furnish good references, very attractive prospects of advancement to a man with ability.—Call 11-12 a.m., Polchars, 98, High St., S.E.8. [8936]

SUDAN Government Posts and Telegraphs Department require the services of a Wireless Inspector in the Engineering Branch. He should be a trained electrical engineer, well up in modern wireless practice and have had military training, preferably with experience as a N.C.O. Age 23 upward, single man preferred. Pay £E.300-£E.324 per annum on two years' probation, after which permanent service may be offered (£E.1=£1 Os. 6d.). Strict medical examination. Free second class passage. Full particulars on application in writing to The Controller, Sudan Government London Office, Wellington House, Buckingham Gate, S.W.1, marking the envelope "Wireless Inspector." [8913]

SITUATIONS WANTED.

YOUNG Man, 21, desires situation connected radio, first class P.M.G., 3 years' operator leading shipping company, excellent education, student B.I.E.T., keen interest modern radio developments, excellent references.—Box 5445, c/o *The Wireless World*. [8915]

MANUFACTURERS.—Radio engineer (21), 8 years' experience, factory, test, talkie's, sales, desires progressive position.—W. Salt, A.M.I.R.E., City and Guilds (Radio), 5, Coverdale Rd., Lancaster. [8922]

RADIO Engineer (23) desires change to reliable post, technical and practical experience of manufactures of quality, including mains, radio-grams, and P.A. equipment.—Box 5463, c/o *The Wireless World*. [8965]

YOUNG Man, keen, well educated, desires post as salesman, electrical and wireless firm; moderate salary.—Mulholland, 16, Meredyth Rd., Barnes. [8980]

KEEN Young Man seeks Position Laboratory Assistant, good theoretical and practical knowledge radio, neat bench worker.—Box 5462, c/o *The Wireless World*. [8968]

BOOKS, INSTRUCTION, ETC.

"THE Wireless Manual" (new 1930 edition), by Captain Frost, is an ideal non-technical book full of up-to-date facts about wireless development, choice of set, how to use your own set, etc.; illustrated; 5/- (post 5/4), of a bookseller, or Pitman's, Parker St., Kingsway, W.C.2. [8178]

STEP by Step Wireless; a complete course of the theory of electricity in relation to the practical design of wireless apparatus, eliminators, circuits, etc., with extracts from a designer's notebook, giving up-to-date practical application; issued weekly, send 1/- p.o. for first 4 weeks.—Clifford Pressland, A.M.I.E.E. Eng., Dept. W.W., Hampton-on-Thames. [0195]

FREE: Inventor's Guide on Patents.—T. A. A., 253 (W), Gray's Inn Rd., London, W.C.1. [6375]



A Handful of good points



PRECISION INSTRUMENTS

The J.B. "Tiny" Condenser combines the most expert workmanship with many ingenious features of design—all in an area little more than that of a matchbox. The extreme neatness and lightness make the "Tiny" particularly useful for Portables and wherever space is restricted. Its Ball Bearings, Pigtail Connection and thorough insulation are other points which speak for the efficiency of its design. Supplied complete with knob, pointer and scale and fitted with Slow Motion, ratio 8-1.

J.B. "TINY" CONDENSER:		PRICES:	
.0005	10/-	.0003	9/6
.0002	9/-	.0001	8/6

Advertisement of Jackson Bros., 72 St. Thomas' Street, London, S.E.1. Telephone: Hop 1837.

FREE! 6d. Book

An interestingly written and well-illustrated 35-page book on Condensers. Invaluable to the radio enthusiast and should be in the hands of every set constructor and owner. Published at 6d., but sent Free and most free to all readers of "The Wireless World" for 1d. stamp. Write Dept. W.,



WINGROVE & ROGERS Ltd.
188-9, Strand, London, W.C.2.

METAL Cabinets



Precisely to specification and sealed with Tubular Brass Gauze, for ALL "WIRELESS WORLD" SETS
Oak Base and Oak Finish 57/6 complete
Mahogany 63/-
Oak Base and Imitation Leather 63/-
Metal Container and Copper Screens, less woodwork 42/3
COILS, DRUM DIALS AND ESCUTCHEONS to "W.W." Specification.
1930 Everyman Four 47/6 per set
NEW Kiloma; IV - 45/-
Record III - 45/-
Wave Trap - 10/3
2 1/2" Drum Dials with Escutcheons 5/6 each.
RIGBY & WOOLFENDEN,
Sheet Metal Workers,
Millnrow Road, ROCHDALE. 'Phone 2943

ELECTRADIX

We have the Biggest Stock of Radio Apparatus, Laboratory Instruments, H.T. and L.T. Dynamos and Motors, Experimental and Laboratory Gear in this Country.

Immediate delivery from stock to any part of the World. Call and inspect or send addressed envelope for list. Tell us your wants and we will offer something suitable.

ELECTRADIX RADIOS,
218, Upper Thames Street, E.C.4.

City 0191. Electradix, Cent, London.

BOOKS on WIRELESS

Write for complete list to
ILIFFE & SONS LTD.,
Dorset House, Tudor St., London, E.C.4.

INDEX TO ADVERTISEMENTS.

	PAGE		PAGE		PAGE
Abbey Radio	16	Gambrell Radio Ltd.	14	Philips Radio	6
Adolph, Fredk.	13	Graham Farish Radio	16	Radiogramophone Development Co.	Cover ii
Appleby, E. Hetherington	7	Hegra	7	Rigby & Woollenden	15
B. & J. Wire-ess Co.	9	Holzman, L.	Cover i	Rothermel Corporation, Ltd. (Centralab)	2
Baker's "Selhurst" Radio	12	Igranic Electric Co., Ltd.	3	Savoy Units	10
Bayliss, William, Ltd.	Cover iii	Jackson Bros.	15	Squire, Fredk., Ltd.	8
Belling & Lee, Ltd.	14	Jewel Pen Co. Ltd.	10	Supremus Specialities, Ltd.	14
Brownie Wireless Co. (G.B.), Ltd.	11	Lock, W. & T., Ltd.	12	Telsen Electric Co., Ltd.	Cover i
Bullphone, Ltd.	8	Lustrolux, Ltd.	2	Thomas, Bertram	5
Burden, J., & Son	12	Lyons, Claude, Ltd.	Cover i	Transformer Repair Co.	10
Burne-Jones & Co., Ltd. (Magnum)	12	Mitchell, E. W. & Sons	9	Turner & Co.	11
Burton, C. F. & H.	Cover i	M-L Magneto Synd., Ltd.	Cover ii	Turnock's Mouldings	10
Clarke, H., & Co. (Mcr.), Ltd.	5	Morris, J. R.	13	Vox-Veritas	9
Dubilier Condenser Co. (1925), Ltd.	4	Mullard Wireless Service Co., Ltd.	Cover iv	Westinghouse Brake & Saxby Signal Co., Ltd.	3
Edison Swan Electric Co., Ltd.	1	Parker, W. H.	10	Weston Electrical Instrument Co. Ltd.	16
Electradix Radios	15	Paroussi, E.	10	Wilkins & Wright, Ltd.	
Epoch Radio Mfg. Co., Ltd.	10	Partridge & Mee, Ltd.	Cover ii	Wingrove & Rogers, Ltd.	15
Exide	4	Perseus Manf. Co.	10		
Formo Co.	2				

Weston sets the world's standard



Model 528, Pocket Size A.C. Tester

A small and reliable instrument essential to maintain accuracy and efficiency in Voltage control. The sensitivity is remarkably high, 6 m.a. for 600 volts with self-contained resistance. The Scale is very legible and the damping excellent. This instrument is capable of continuous service at full load.

Prices from £3. 10. 0 to £4. 15. 0

WESTON
ELECTRICAL INSTRUMENT CO., LTD.

15, Great Saffron Hill, London, E.C.1

Write for your copy of "Radio Control," which explains simply the electrical operation of a radio set. Sent free on receipt of a postcard addressed to:—



H.F. and G.P. .. 6/-
Super Power .. 7/-

Ask your Dealer for Particulars

Abbey Radio, 47, Victoria St., London S.W.1. Phone Victoria 3914

The valve with the **NEW COLLOIDAL FILAMENT COATING** Representing the latest development of radio technique

Better than wire wound



The "Ohmite" MOULDED ANODE Resistance hermetically sealed in Bakelite. Noiseless and efficient. Negligible self-capacity so that the high notes are retained. Also fitted with terminal ends.

All values, 1,000 to 500,000 Ohms.
2/3 each. **GRAHAM FARISH** BROMLEY — KENT.

The Yachting World

and Motor Boating Journal
The Leading British Yachting Journal

"THE YACHTING WORLD" deals with yachts and boats of all types and tonnages, whether on the sea or inland waters. Every aspect of yachting and motor boating is covered in an attractive and interesting manner.

Every Friday 6D.

ILLIFFE & SONS Ltd., Dorset House, Tudor St., London, E.C.4

BAYLISS

Superior Quality Power Transformers
and Chokes for the Mains from 35/- each
—to Customers' Requirements.

BAYLISS ROTARY CONVERTER

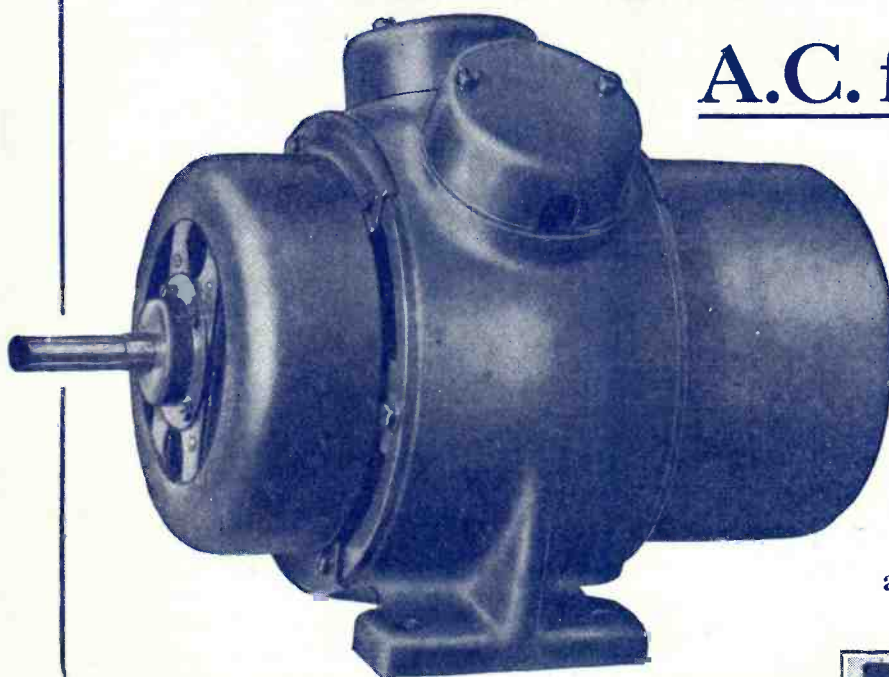

A.C. from D.C.

Load 400 Watts.

ANY Input.
ANY Output.

PRICE

£12 . 10 . 0

For Audio
Amplifiers
and General Purposes.

Also Dynamos,
Motor Generators, etc.
for all purposes.

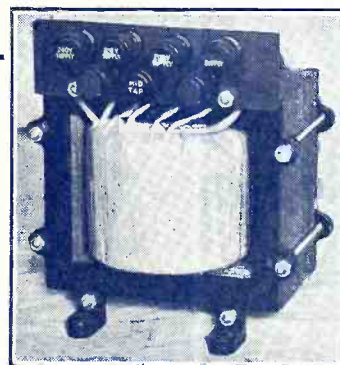

WILLIAM BAYLISS LTD.

Contractors to the Admiralty, War Office, Colonial Governments, etc.

**Sheepcote Street
BIRMINGHAM**

Telephone :
Mid. 1409.

Telegrams :
"Drawbench, B'ham."



VOLUME

In radio there's volume *and* volume—one a discordant blare which strangely enough is often allowed to continue until chance gives an opportunity of comparison, the other, a clear, undistorted magnification of sound. It's the output loudspeaker valve that makes the difference. Only by the use of the correct type of valve—in this case a Mullard Pentone—can you get the most of the best out of your receiver.

Ask for these type numbers from your dealer.

PM 22
2 volt.

PM 24
4 volt.

PM 26
6 volt.

Mullard

THE MASTER VALVE

Advt. The Mullard Wireless Service Co. Ltd., Mullard House, Charing Cross Road, London, W.C.2.

Printed for the Publishers, LILFEE & SONS LTD., Dorset House, Tudor Street, London, E.C.4, by The Cornwall Press Ltd., Paris Garden, Stamford Street, London, S.E.1.

Colonial and Foreign Agents:
 UNITED STATES—The International News Co., 131, Varick Street, New York. FRANCE—W. H. Smith & Son, 248, Rue Rivoli, Paris; Hachette et Cie, Rue Réaumur, Paris.
 BELGIUM—W. H. Smith & Son, 78, Marche aux Herbes, Brussels. INDIA—A. H. Wheeler & Co., Bombay, Allahabad and Calcutta. SOUTH AFRICA—Central News Agency, Ltd.
 AUSTRALIA—Gordon & Gotch, Ltd., Melbourne (Victoria), Sydney (N.S.W.), Brisbane (Queensland), Adelaide (S.A.), Perth (W.A.), and Launceston (Tasmania).
 CANADA—The American News Co., Ltd., Toronto, Winnipeg, Vancouver, Montreal, Ottawa, St. John, Halifax, Hamilton; Gordon & Gotch, Ltd., Toronto; Imperial News Co., Toronto, Montreal, Winnipeg, Vancouver, Victoria. NEW ZEALAND—Gordon & Gotch, Ltd., Wellington, Auckland, Christchurch and Dunedin.

NEW FLAT DIAPHRAGM LOUD SPEAKER.

The Wireless World

AND RADIO REVIEW

The Paper for Every Wireless Amateur

4^D

Wednesday, April 9th, 1930.

"EKCO-ELECTRIFY" YOUR RADIO

Write for Free Booklet on "All - Electric Radio."



E. K. COLE, Ltd., Dept. W, "Ekco" Works, Leigh - on - Sea.

PLUG IN - THAT'S ALL!

FIRST- BECAUSE OF THE FILAMENT

Mullard
THE - MASTER - VALVE

AWARDED THE CERTIFICATE OF THE INSTITUTE OF HYGIENE FOR QUALITY AND PURITY

Superfine Quality

Trelleborgs

GUARANTEED PURE EBNONITE

25% REDUCTION ON RETAIL PRICES

120000 VOLTS PER M.M.
National Physical Lab. Report

TRELLEBORG EBNONITE WORKS, LTD., Union Place, Wells Street, W.x

STILL ON TOP!

Blue Spot

BLUE SPOT 66K UNIT

25/-



**THE NEW
16 PAGE
NOVOTONE BOOKLET**

tells you how to obtain
REALISM FROM RECORDS

"The Wireless World" says:—
"There can be no doubt that anyone who has heard the Novotone demonstrated . . . would, from that time onwards, cease to be satisfied with gramophone reproduction by ordinary methods."

To Users of Electrical Pick-ups:—
Until you have used a Novotone you cannot realise how great have been your losses in reproduction.
Why not enjoy absolute realism which only the Novotone can give you?

GET YOUR COPY NOW. CALL FOR DEMONSTRATION.

**GAM-BRELL RADIO
GRAMOPHONE**

NOVOTONE MODEL.

The Novotone is incorporated in this famous Radio-Gramophone and gives to it the power of reproducing records with a fidelity and realism otherwise impossible to obtain.

Price	Price
D.C. Mains, 69 Gns.	A.C. Mains, 80 Gns.
in Oak Cabinet.	in Oak Cabinet.
Mahogany 71 Gns.	Mahogany 82 Gns.

Illustrated Literature on request.



GAMBRELL RADIO LTD.,
6 Buckingham St., Strand, London, W.C.2.

Mention of "The Wireless World," when writing to advertisers, will ensure prompt attention.

**RECTIFYING
VALVES**



For :
Reliable H.T. Supply
Dependability
Long Life
High Efficiency
Output easily varied
and smoothed

The rectifier that has stood
the greatest of all tests—
TIME.

Made by the manufacturers of
the famous Argenta Electric
Lamps and Fittings, All-
Electric Radio Receivers, and
Neon Signs.

**PHILIPS
RECTIFYING VALVES**

PHILIPS LAMPS LTD., PHILIPS HOUSE, 145, CHARING CROSS ROAD,
LONDON, W.C.2.

R.V.3

And when the British PERTRIX PATENT DRY BATTERY was opened —

A PERTRIX BATTERY



—after it had been in use for 8 months, there was not the slightest sign of corrosion. In the Pertrix battery there is

NO SAL-AMMONIAC

That explains its amazingly long life.

Now look at the illustration of the ordinary sal-ammoniac battery. See the thick white deposit for yourself.

That is what chokes the life out.

Buy a Pertrix and you will obtain clear, silent reception, and a life, in many cases, as much as 80% longer.

You can also obtain Pertrix batteries for your flash lamp. Write for leaflet 'B,' which will give you full particulars of all types.



A SAL-AMMONIAC BATTERY

SAVE EXPENSE WITH PERTRIX.

There is no "crackle" when using a Pertrix battery. That is why you can use it until it has *entirely* run down. Use it in conjunction with your next new Pertrix in order to boost the voltage. You will find that two Pertrix batteries last as long as three of the ordinary type because you can use *all* the power in a Pertrix.

PRICES						
STANDARD.		★ Discharge 12 milliamps			GRID BIAS.	
Volts	Size in inches.	L.	B.	H.	s.	d.
60	5 1/8	6 1/2	3 1/8	8	0	9 1 6
100	8 3/8	6 1/2	3 1/8	13	0	12 2 3
120	10 3/8	6 1/2	3 1/8	15	6	15 2 9

WHAT A LIFE!



PERTRIX LTD., BRITANNIA HOUSE, 233, SHAFTESBURY AVENUE, LONDON, W.C.2. **EXIT SAL-AMMONIAC**

**THIS NEW REGENTONE COMBINED UNIT
MAKES ANY SET ALL-ELECTRIC
— EVEN A PORTABLE**

*It fits Inside
any Portable*

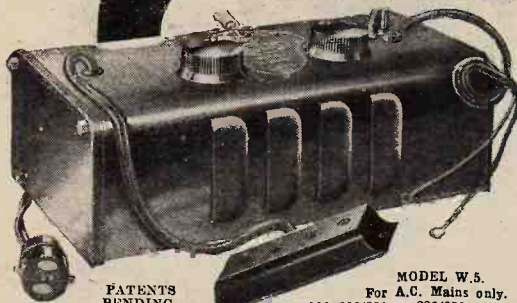

PATENTS
PENDING.
DESIGN
REGISTERED.

MODEL W.5.
For A.C. Mains only.
100, 200/220, or 230/250 volts.
40/100 cycles. Incorporates Westinghouse Metal Rectifier on H.T. and L.T. side. H.T. Output: 120 volts at 15 m.a. H.T. Tappings: 2 variables (one S.G.) and one power. L.T. Trickle Charger for 2, 4- or 6-volt accumulators. Size 9 in. x 5 in. x 3 1/2 in.

—and it is equally suitable for all popular 2-, 3-, and 4-valve Receivers. H.T.—absolutely ripple free; L.T. Accumulators always fully charged; special design for sensitive receivers—all this in a handsome earthed metal case small enough to fit inside any Portable. Westinghouse Metal Rectifier incorporated on H.T. and L.T. side. Guaranteed for 12 months. Dependable — trouble-free, low initial cost—negligible running **£5:17:6** costs.

Stand No. 437. Ideal Home Exhibition.
March 24th—April 17.



Write for particulars and FREE ART BOOK LET "Radio from the Mains."

Ask your Dealer for demonstration or call at our London Showrooms.



REGENT RADIO SUPPLY CO. 21, Bartlett's Buildings, Holborn Circus, London, E.C.4. Telephone Central 8745 (3 Lines)

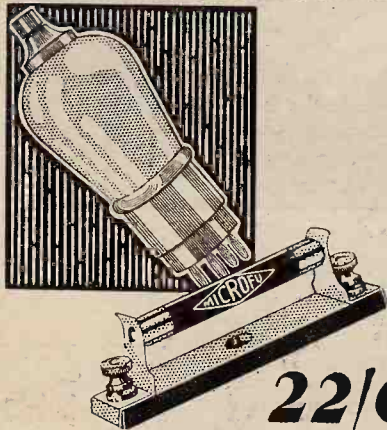

**22/6
saved!**

Save your Valves. It's the easiest thing in the world to connect your H.T. Battery to your L.T. terminals—the easiest thing in the world to blow your valves—an expensive pastime. If you'd rather be sure than sorry fit a 'Microfite'—it will blow as soon as the current is excessive; it blows in 1/1000th part of a second. And 2/9 is not a lot to pay for safety. Remember! it is made by T.C.C., the very hall-mark of reliability.



Advt. Telegraph Condenser Co. Ltd., Writtle Farm Rd., N. Acton, London W.3.

PAILLARD
ELECTRIC INDUCTION MOTOR
IDEAL FOR RADIOGRAMS.
Causes No Interference.

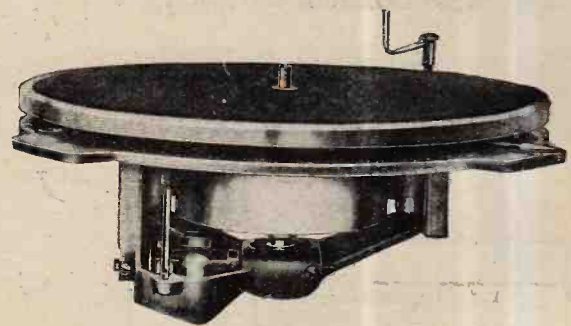

(For alternating current only.)
Type 1201, for 100 to 130 volts.
Type 1203, for 200 to 250 volts.
7 1/2 in. x 5 1/2 in. x 5 1/2 in.

NO Belt. Resistance, Brushes, Commutator Sparks, Noise or Hum in Speaker.
SIMPLE, SILENT, ACCURATE, ROBUST, COMPACT.
Equipped with 12-inch Turntable covered with velvet, and Automatic Brake and Cut-Out.

£4.17.6

with unit plate as illustrated. (Without unit plate £4.19.0)

APOLLO GRAMOPHONE Co., Ltd.,
4/5, Bunhill Row, LONDON, E.C.1.

Mention of "The Wireless World," when writing to advertisers, will ensure prompt attention.

The BRITISH better-service BATTERY

You'll get better service from your Ediswan H.T. battery—longer life—more even discharge—and a wonderful freedom from background noises, thus ensuring a sparkling, lifelike quality of reproduction that will be the envy of your friends.

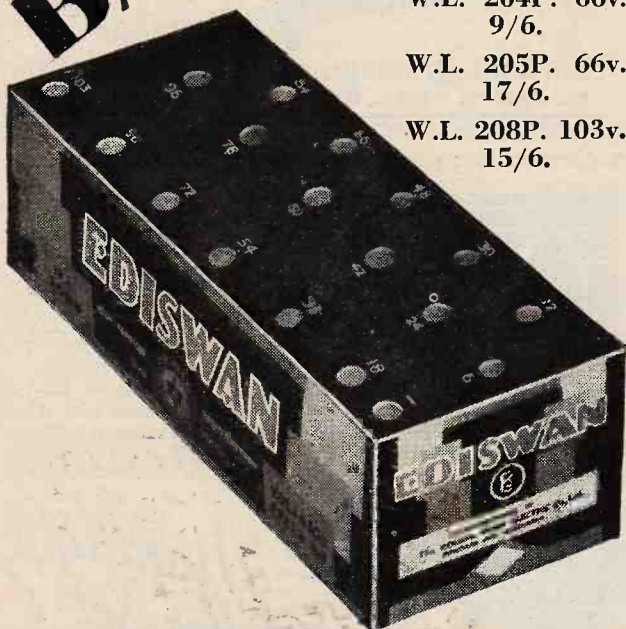

W.L. 204P. 66v.
9/6.

W.L. 205P. 66v.
17/6.

W.L. 208P. 103v.
15/6.

EDISWAN DRY BATTERIES



THE EDISON SWAN ELECTRIC CO., LTD.,
123/5, QUEEN VICTORIA STREET, LONDON, E.C.4.
Showrooms in all the Principal Towns.

B.57.

Heat Insulation Conserves Energy! in the Mazda H.L. 210



All filament supporting hooks in the Mazda H.L. 210 are coated with a heat insulating substance which retains the valuable heat in the places where it can do the most good instead of leaking away down the supports as is the case of most makes of valves. These filament supporting hooks render the valve—sensibly non-microphonic and it is thus ideal for use in portable and similar receivers. For full details see catalogue—free on application.

MAZDA PRICE 10/6 RADIO VALVES



THE EDISON SWAN ELECTRIC CO., LTD.,
Radio Division,
1a, Newman Street, Oxford Street, W.1.
Showrooms in all the Principal Towns.

EDISWAN V.26



COMPONENTS THAT WILL LIVE

BEHIND the perfect tone of radio that will live—VARLEY RADIO—you will find Varley Components, every one an answer to a modern radio problem.

Varley Components have proved their performance in thousands of sets in homes all over the country. They have special features in design which place them ahead of any others you can buy to-day.

Varley Components lend their better quality of design and performance to your set, giving it long range, selectivity and perfect tone—radio that is a picture of life itself.

Use them; they are the foundations on which is built *radio that will live*. Send for the Section of the Varley Catalogue in which you are interested.

SECTION A gives full particulars of 2- and 3-valve All-Electric Receivers, Radio Gramophones, Gramophone Pick-up and Auto-arm.
SECTION B and C deals with H.F. Choke, Regional Coils, Bi-duplex Resistances, Rheostats, Potentiometer, R.C. Couplers and Anti-Mobos.
Details of Nicore Transformers, Output, Push-Pull Input and Output Transformers, Push-Pull, L.F., and Constant Inductance Chokes are given in SECTION D, whilst Section E deals with Power Transformers, Standard, Dual and L.T. L.F. Chokes, Constant Inductance Chokes, and Power Potentiometers.

STAND No. 440
IDEAL HOME EXHIBITION
MARCH 24th — APRIL 17th.



Advertisement of Oliver Pell Control, Ltd., Kingsway House, 103 Kingsway, London, W.C.2. Telephone: Holborn 5303.

Get the Experts to Advise You:—
The R.G.D. Radiogramophone



For the highest possible quality and tone for both radio and record, with ample volume, incorporating the latest developments in moving coil speaker; operates entirely from electric mains, A.C. any voltage, or D.C. 200 volts or over.

Mahogany Oak
£80 £75

Place your order now to ensure delivery and we shall be pleased to supply literature on application.

The Radiogramophone Development Co.,
St. Peter's Place, Broad Street, Birmingham.

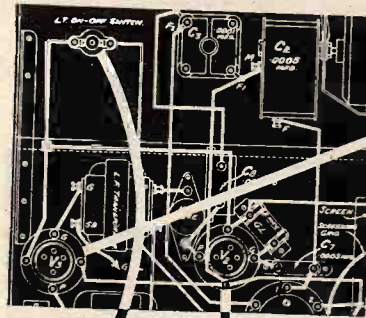

VIBROLIDER.
The self-aligning feature ensures positive contact with all 4-pin valves.

1/6



ROTARY SWITCH.
An effective alternative to the push-pull type. All insulated and with indicating dial.

1/9

★ Write for illustrated leaflets on all products.



CLEARER TONE.
The original anti-microphonic valve holder, often imitated, never duplicated.

Making a Better Set? - then include the Better Components

BENJAMIN

THE BENJAMIN ELECTRIC, LTD.,
BRANTWOOD WORKS, LONDON, N.17.

Mention of "The Wireless World," when writing to advertisers, will ensure prompt attention.



Gentleman:
"Excuse me Madam
would you mind if
I smoked a . . .

Player's
Please

Lady:
Certainly not, I'll
have one with you."



P.C.C.821

THE
 **WESTINGHOUSE** 
METAL RECTIFIER

STYLE A3
 FOR LOW TENSION

D.C. Output, 9 volts, 1 amp.

23/6

MADE IN ENGLAND BY

The Westinghouse Brake &
 Saxby Signal Co. Ltd.,
 82 York Road, King's Cross, London, N.1.

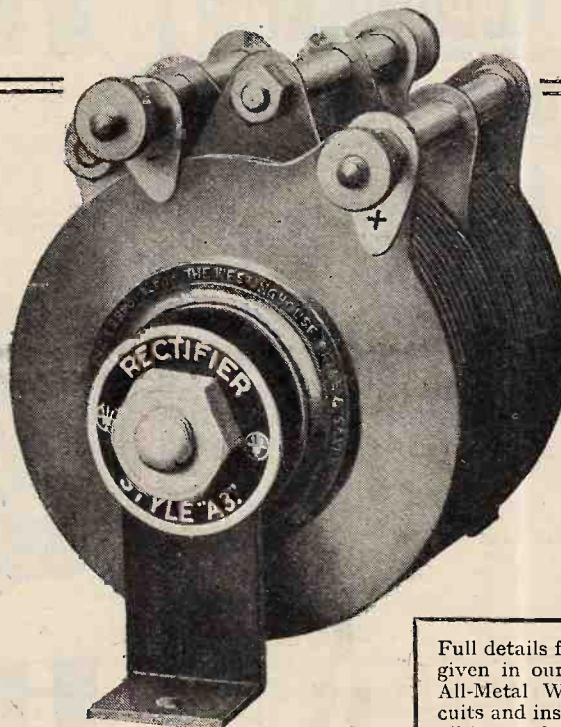

- NO FILAMENTS.
- NO CHEMICAL ACTION.
- NO MOVING PARTS.
- NO PERIODICAL REPLACEMENTS.

Full details for using this unit are given in our 32-page book "The All-Metal Way, 1930," with circuits and instructions for building all types of A.C. mains units, high and low tension.
 Send 2d. stamp for a copy.

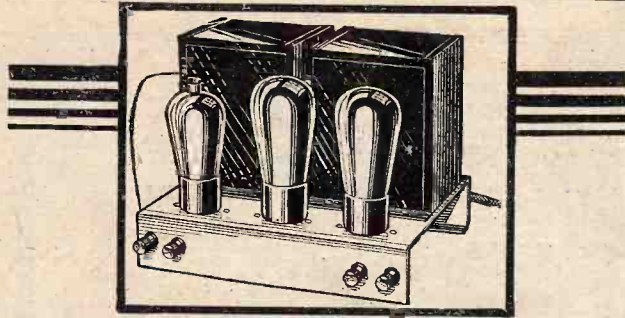

Watch for the New Electrad Loftin-White Direct Coupled Amplifier

The new Electrad Loftin-White direct coupled (plate to grid) A.C. amplifier will shortly be available. This new revolutionary system of amplification entirely dispenses with the use of transformers and resistances.

The Electrad Loftin-White amplifier employs one A.C. Screen Grid valve in the first stage followed by one power valve and one rectifier, the whole operated direct from A.C. mains. Utilising only two valves for amplification, tremendous volume is available with a frequency response, registering a practically flat curve from 30 to 7,000 cycles.

The new Loftin-White system will undoubtedly bring about a complete revision of accepted amplifier principles.

For 110 volt 50 cycle A.C., complete with valves ready to operate **£12 5s.**

For 220 volt 50 cycle A.C., complete with valves ready to operate **£12 5s.**

Write for further details.

THE ROTHERMEL CORPORATION LTD.,
24, Maddox Street, London, W.1.

Phone: MAYFAIR 0578/9.

VOKES ACCUMULATOR INDICATORS

Tell you the
exact state of
charge.



British Made
throughout.

**MINIATURE FLUSH MODEL FOR
WIRELESS PANELS.**

Similar to Illustration. Size as under.

DIA. 1 3/8" DIAL 1 1/16" DIA.

PRICE: For L.T. Batteries - **8/6**
 " H.T. " 90v. **9/6**
 " " " 150v. **11/-**
 " " " 200v. **12/6**

C. G. VOKES, Ltd., 95 Lower Richmond Rd., PUTNEY,
S.W.15.

Telephone: Patney 5851-2. Telegrams: Vokesaccess Put, London.

Use the **CAMCO** "MAJOR" Cabinet

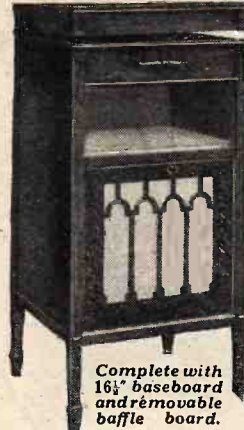

Complete with
16 1/2" baseboard
and removable
baffle board.

for your RADIOGRAM

This Cabinet provides ample space for your amplifier. It is soundly constructed and beautifully finished. Will take panels 18" x 7" or 18" x 8". Loud Speaker compartment is 18" x 18" x 16 1/2". Suitable for all popular circuits.

OAK - - £7:10:0
MAHOGANY £7:15:0

Call and see full range of
"Camco" cabinets at new
London showrooms.

CARRINGTON MANUFACTURING CO., Ltd.
New Showrooms, 24, Hatton Garden, Holborn, London, E.C.1

Telephone: Holborn 8202.

Factory: Camco Works, Sth. Croydon.

CA 3503

HYDRA

9 times out of 10—
the best method of
defence is attack—
the tenth time—in
a wireless set—it's
Hydra.

Nine times out of
ten you will find
Hydra condensers
in a Wireless set!

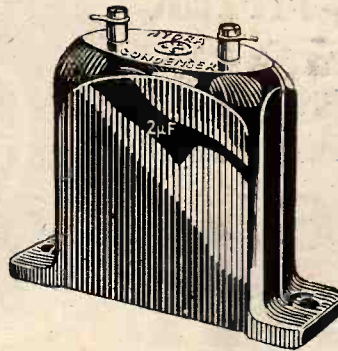

LOUIS HOLZMAN,
37, NEWMAN STREET,
LONDON, W.1.

Telephone: Museum 2641.

HYDRA

NO CONNECTIONS NECESSARY—

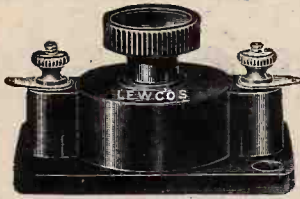

Lewcodenser, Type "O."
.0015 to .001 mfd.
Price 2/6 each.

Type "W."
.00002 .0002 mfd.
Price 2/6 each.



Patent applied for

Ref. AW5, 235-550 m.
AW20, 1000-2000 m.
Price 6/- each.
(For use with Standard six-pin and "Q" type coils.)

Binocular Type Absorption Wavetrap.
Ref. AW/BAC5.
AW/BAC20.
Price 10/6 each.

Send for Leaflet No. R. 60.

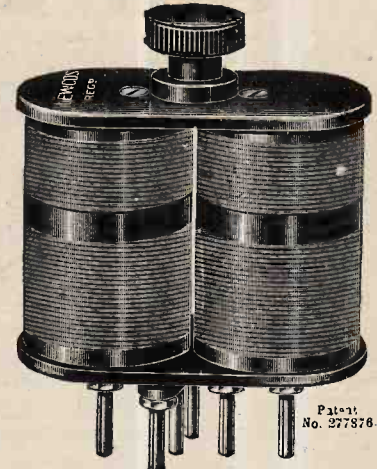

LEWCOS

REGD.

THE LONDON ELECTRIC WIRE COMPANY & SMITHS LIMITED, Church Road, Leyton, London, E.10. Trade Counter: Playhouse Yard, Golden Lane, E.C.1.

IF YOUR SUPPLY MAINS ARE D.C.



You can use an A.C. All Electric Receiver By Employing The M.L.—D.C. to A.C.

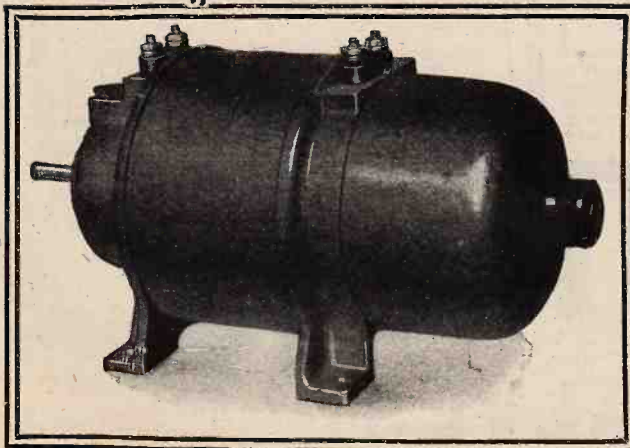

ROTARY TRANSFORMER

Can be supplied to run from any Voltage 12-250 V.D.C.

Recommended and used by

Philips Radio,
Marconiphone,
Kolster-Brandes,
Burndept, Etc.

40 WATT Model
£13-0-0
85 WATT Model
£19-0-0

M-L MAGNETO SYND. Ltd., Radio Dept., COVENTRY.

Telephone: 5001.

TO Amateur Constructors and Wireless Enthusiasts IMPORTANT

In presenting the new Triotron A.C. valves for your approval we feel we cannot do better than reproduce, for your information, the announcement we are inserting in the leading trade papers. We would draw your special attention to the last paragraph of this announcement.

A FEW STRAIGHT WORDS ABOUT INDIRECTLY HEATED A.C. VALVES.

Theoretically it should be easier to make an efficient A.C. Valve than a good Dark Emitter. It is easy, for instance, to get Amplification, but in order to get music instead of noise the emitting coating must have properties which depend on the most subtle research in Micro Chemistry.

The manufacture of the coating embodied in Triotron A.C. Valves is the secret of a scientific Master Mind. It cannot be analysed, it cannot be imitated.

Remember : A.C. Valves work direct from the Power Supply. No amount of advertising, no amount of salesmanship can minimise the severity of this test and the drastic consequences of filament failure.

Do not experiment with your customers ; give them the best that science has been able to produce.

Now Ready For Immediate Delivery.

Indirectly Heated A.C. Valves			Rectifying Valves		
TYPES		RETAIL PRICE	TYPES		RETAIL PRICE
S.C.N.4	Screened Grid	18/6 each	G.A.24	Full Wave	60 m/a
S.N.4	Super Detector and High Frequency	10/6 "	G.N.24	Full Wave	30 m/a
A.N.4	General Purpose	10/- "	G.N.14	Half Wave	30 m/a
W.N.4	Resistance Coupling	10/- "	<i>Full wave rectifier G.A.24 makes it possible to control the output H.T. voltage by the low tension voltage supplied to the filament.</i>		
Y.N.4	Low Frequency and Power	10/6 "			

WARNING Triotron A.C. Valves are of the very highest quality it is possible to buy. Insist on Triotron valves. Do not be put off by selling talk. Do not accept substitutes or be misled by phrases about other valves, such as "just as good," "even better," "last longer," etc. There is no better valve than Triotron and very few just as good—no matter what you pay.

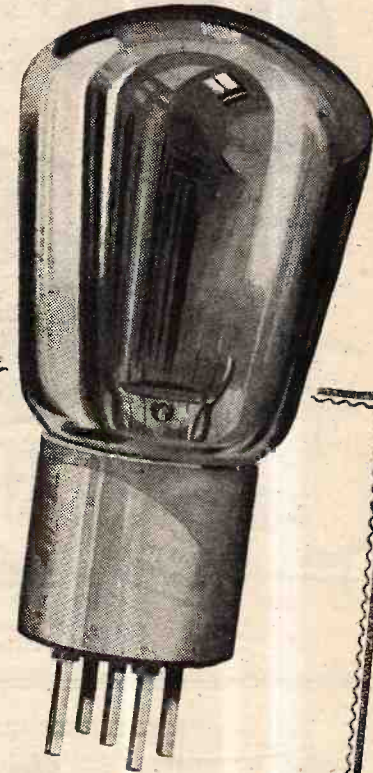

CHARACTERISTICS OF TRIOTRON A.C. VALVES

TYPE	W.N.4	A.N.4	S.N.4	Y.N.4
Purpose	Resistance Coupling	General Purpose	Super Detector and H.F.	L.F. and Power
Filament	Standard A.C. Heaters.			
Amplification Factor	45	28	22	8
Impedance Ohms	34,600	14,000	8,000	4,700

TRIOIRON A. C. VALVES

Apply to your local dealer. Any technical information desired will be supplied by:—
TRIOIRON RADIO COMPANY, LTD., 91, GREAT RUSSELL STREET, LONDON, W.C.1.

Telephone: Museum 1908.

Mention of "The Wireless World," when writing to advertisers, will ensure prompt attention.

The Wireless World

AND
RADIO REVIEW
(18th Year of Publication)

No. 554.

WEDNESDAY, APRIL 9TH, 1930.

VOL. XXVI. No. 15.

Editor: HUGH S. POCKOCK.
Assistant Editor: F. H. HAYNES.
Editorial Offices: 116-117, FLEET STREET, LONDON, E.C.4
Editorial Telephone: City 9472 (5 lines).
Advertising and Publishing Offices:
DORSET HOUSE, TUDOR STREET, LONDON, E.C.4.
Telephone: City 2847 (13 lines). Telegrams: "Ethaworld, Fleet, London."
COVENTRY: Hertford Street.
Telegrams: "Cyclist, Coventry." Telephone: 5210 Coventry.
BIRMINGHAM: Guildhall Buildings, Navigation Street.
Telegrams: "Autopress, Birmingham." Telephone: 2970 and 2971 Midland.
MANCHESTER: 260, Deansgate.
Telegrams: "Hiffe, Manchester." Telephone: 8970 City (4 lines).
GLASGOW: 101, St. Vincent Street, C.2.
Telegrams: "Hiffe, Glasgow." Telephone: Central 4857.

PUBLISHED WEEKLY.
Subscription Rates: Home, £1 1s. 8d.; Canada, £1 1s. 8d.;
other countries abroad, £1 3s. 6d. per annum.
Entered as Second Class Matter at New York, N.Y.
As many of the circuits and apparatus described in these pages are covered by
patents, readers are advised, before making use of them, to satisfy themselves
that they would not be infringing patents.

CONTENTS OF THIS ISSUE.

	PAGE
EDITORIAL VIEWS	373
A NEW MOVING COIL LOUD SPEAKER. BY R. W. PAUL AND B. S. COHEN	374
THE "N" DIAGRAM. BY W. A. BARCLAY	376
PRACTICAL HINTS AND TIPS	379
WAVEMETER SCALES. BY W. H. F. GRIFFITHS.	381
CURRENT TOPICS	384
CAPACITY COUPLED FILTERS (CONCLUDED). BY A. L. M. SOWERBY	386
NEW APPARATUS REVIEWED	392
BROADCAST BREVITIES	392
WIRELESS THEORY SIMPLIFIED. PART XXVI. BY S. O. PEARSON	394
CORRESPONDENCE	398
READERS' PROBLEMS	399

our slight services. We believe that the question has got so far as to have become the subject of a conference at the Colonial Office, and we cannot but think that, if the advantages which the Empire can expect to derive have been presented in their proper relation to the probable cost of the enterprise, a satisfactory decision will result from the Colonial Office deliberations.

Technically, we believe that short-wave broadcasting throughout the Empire has been a practical proposition for a very long time past, but it required that someone should stir the B.B.C. or, better still, that the urge should come from within, to develop a service on permanent lines. In our issue of October 23rd last year we besought the new Chief Engineer and his staff to show the same degree of enthusiasm for achieving results with a short-wave Empire broadcasting service as, on other wavebands, had already resulted in a success which has earned for British broadcasting a reputation second to none. Perhaps that little appeal may have had its effect; in any case, we would like to express our appreciation to whoever on the staff of the B.B.C. has taken the initiative in face of the very considerable amount of opposition which we feel convinced must have existed.

The material benefits resulting from a service should be apparent when it is realised that the Empire broadcasting service can be utilised to further the interests of inter-Empire trade.

Twenty-four Hour Programmes.

In order to give satisfaction it would seem essential that the short-wave broadcasting should be conducted at intervals throughout the twenty-four hours, since otherwise the transmissions will not take place at a time convenient for reception in all parts of the Empire. The maintenance of programmes at intervals throughout the twenty-four hours may at first sight appear to present a rather difficult problem, but recording of transmissions is a comparatively simple matter, and it should, we think, be possible to transmit repetitions of much of the daily programme matter from the short-wave station by means of records taken during the initial performance. Reception at long distances has not yet reached such a stage of perfection that listeners would be over-conscious of the difference between the broadcasting of original matter and repetitions which had been permanently recorded. By some such arrangement as this we foresee at least a temporary solution in maintaining microphone performances at intervals throughout the twenty-four hours.

EMPIRE BROADCASTING.

IS REAL PROGRESS BEING MADE ?

HERE are persistent rumours that at long last some definite attempt is being made to arrive at a basis on which to establish an Empire short-wave broadcasting station and guarantee its finance. Perhaps it is a fitting reward for our constant criticism at the delay that *The Wireless World* should be kept in the dark as to what is going on behind the scenes, even though we believe there can be no argument put forward which could question the title of *The Wireless World* as the originators and the persistent champions of a short-wave Empire broadcasting service.

However, we have no desire to seek credit for ourselves, and if the many pages which have been devoted to the subject in our issues for the past three years have contributed in some small measure towards arousing interest in the matter which will culminate in the definite establishment of a service, then we shall consider ourselves more than adequately rewarded for

A NEW *Moving Coil* Loud Speaker

Employing a Flat Rigid
Piston of Balsa Wood.

By R. W. PAUL, M.I.E.E., F.Inst.P.,
and B. S. COHEN, M.I.E.E.

THE instrument to be described is the outcome of a series of experiments in the construction of flat pistons, substantially rigid, yet light enough to operate effectively as pistons in loud speakers of the hornless type. After trying many materials in various combinations, most of which showed a tendency to shatter under prolonged vibration, Balsa Wood was adopted; the specific gravity is only 0.1 approximately, while the Young's Modulus of elasticity is 0.45×10^{11} along the grain. The velocity of propagation of sound along the grain is about twenty times the velocity of sound in air. Means were found for rendering the wood proof against the absorption of atmospheric moisture and, by the use of a non-hygroscopic adhesive, a disc

coil is made comparatively large; it is wound on a former of tissue paper, in the layers of which two thin copper strips are embedded to form the leads, and a flange is provided for cementing to the piston; the whole is bakelised into a rigid unit. After attachment to the piston the leads from the coil are brought through to the front of the latter, being soldered to a pair of terminal plates carried on the centring support. The coil, apart from

the diaphragm, weighs 5.5 grams. On the axis of the magnet is a hole, the front end of which is coned to fit a conical plug on which the moving system is carried; the outer end of this plug passes through a clearance hole in the piston, and has fixed to it two volutes, cut from thin duralumin sheet and placed about $\frac{1}{8}$ in. apart. On each side of the piston, and concentric with it, is a collar of balsa wood to which the outer rims of the volutes are attached. The system is thus free to move axially, but constrained from any lateral movement, while the volutes are so

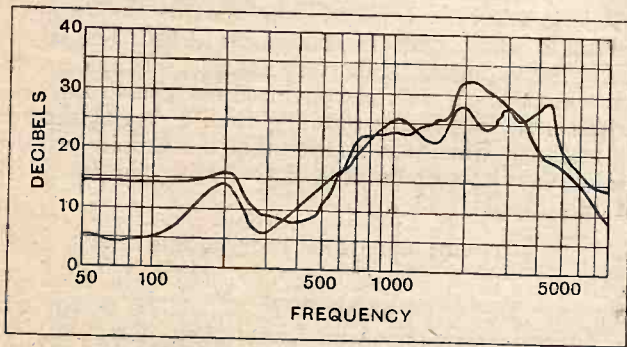

Fig. 1.—Response curves, using a Balsa piston of $11\frac{1}{2}$ inches diameter.

of the material may be stiffened with ribs so as to be free from any tendency to shatter.

In arriving at the design of the piston more than thirty types were constructed, frequency-amplitude characteristics being taken of each; finally, it was found best to arrange the ribs so as to divide the area of the disc into a number of asymmetrical areas roughly triangular in shape. The following are typical weights for pistons, exclusive of the moving coil, but including the centring device described later:—

Nominal diameter (inches)	8	10	$11\frac{1}{2}$
Radius (centimetres)	10	12.5	14.5
Weight (grams)	12	18	24

In order to distribute the force, as well as to add to the stiffness of the system, the diameter of the moving

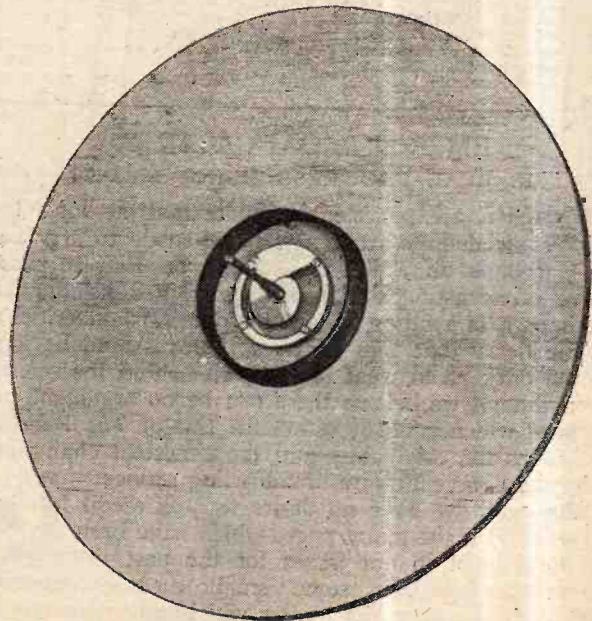
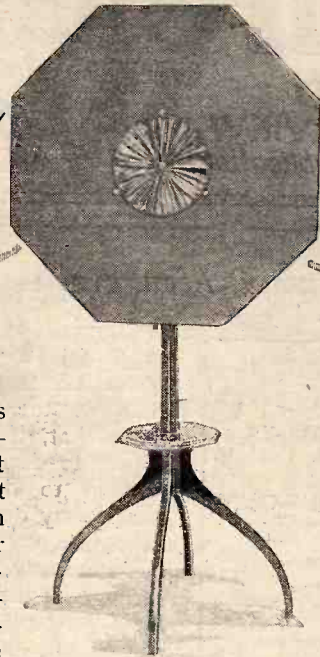

Rear view of piston with coil showing one volute and the centring plug.

A New Moving Coil Loud Speaker.—

designed as to exert a definite control or stiffness factor, arrived at by experiment. The weight of the centring device is about 2.2 grams, part only of which is associated with the moving system.

The front of the pot magnet is bevelled off so as to provide ample free space behind the piston; the area of the air-gap is 15 sq. cm., and the useful flux about 180,000 lines, produced by 2,400 ampere-turns. Accurate concentricity of the inner and outer poles is ensured by means of a brass distance-ring.

The magnet carries a spider with a baffle-ring which surrounds the piston without touching it; to assemble the moving element to its magnet it is only necessary to push the centre plug into position, it being impossible to scrape the coil in so doing; two pivoted contact arms, integral with the terminals, are then turned into the position which is shown in the illustration so as to make connection with the moving coil. The absence of any surround to the piston eliminates an element of instability, and the need for readjustment after prolonged use does not arise; moreover, the effect of a surround was shown, by experiment, to detract from the purity of reproduction. The front of the loud speaker may be covered with thin silk without any appreciable effect on the output.

Reference may be made to the observations, by skilled listeners, of the performance of the loud speaker. The bass response is pure, and entirely free from the "booming" common to instruments of the cone-type; speech articulation, as heard through the media of an electrostatic microphone and the loud speaker, is almost indistinguishable from the same voice heard direct. The notes of a piano are reproduced without alteration in pitch, while tests of a number of orchestral instruments showed faithful and "brilliant" reproduc-

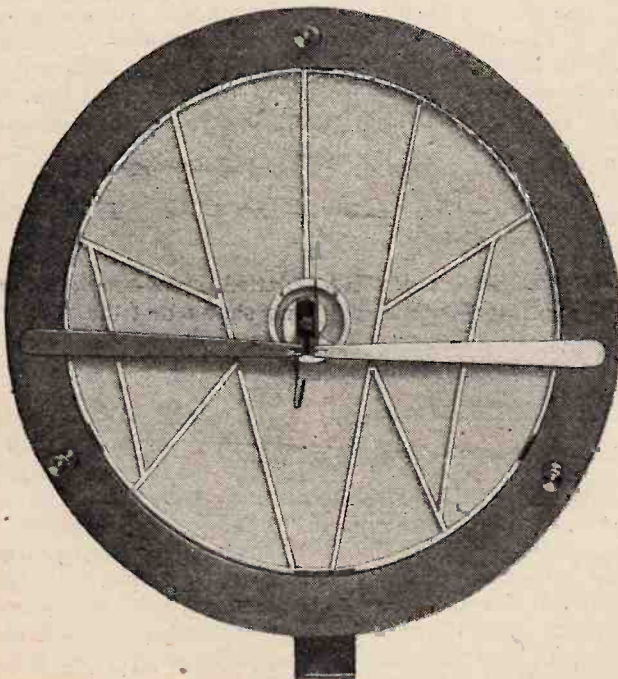

Piston mounted in magnet with contact arms in position.

A 11

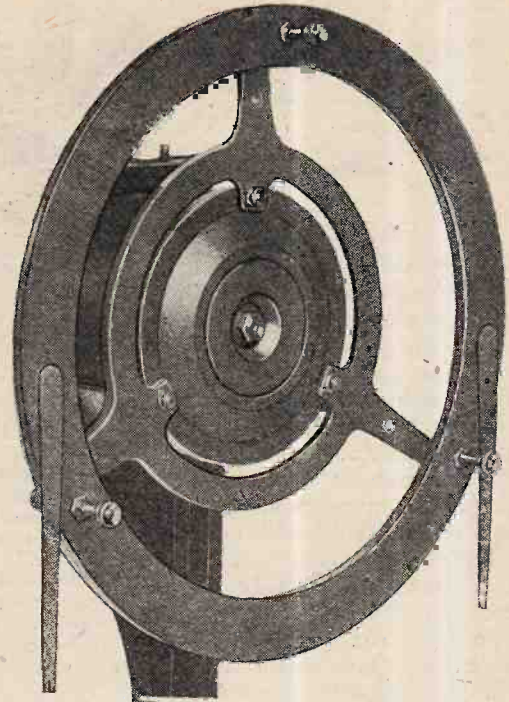

Electromagnet with baffle ring and socket for centring support.

tion. Typical curves are illustrated in Fig. 1; it will be seen that the response both at the lower and the upper ends of the audio range is exceptionally good.

This loud speaker¹ is adapted for fitting in a cabinet or fixing behind a baffle board; in the title illustration it is shown with its baffle mounted on a console.

¹ Patent No. 315,501.

VIBRATION IN GRAMOPHONE MOTORS.

ELABORATE precautions are frequently taken to overcome the possibility of electrical interference caused by electric gramophones being conveyed to the amplifier, but a trouble of importance connected with mechanical vibration is often overlooked.

In the running of certain types of motor, both electrical and mechanical, vibrations may occur of definite frequencies. These may be unnoticed whilst the record is playing, but are, nevertheless, present and interfere most seriously with the quality of reproduction. What actually occurs is that the vibration is carried up the spindle on which the turntable is mounted and the vibration of the turntable and record is conveyed to the needle. Usually, when it occurs, the vibration is of a low frequency and produces, especially in a moving-coil speaker, a kind of "dither," often of considerable amplitude. No amount of "cushioning" the mounting of the motor can overcome this trouble, unless it could be introduced in the mounting of the turntable. To ascertain if the trouble is present remove the turntable, and, with the motor running, place the needle of the pick-up so that it rests on some part of the framework of the motor adjacent to the spindle; then any "dithering" of the loud speaker diaphragm will be apparent to the ear, or, in extreme cases, even to the eye.

The 'N'-DIAGRAM

A New Method of Simplified Calculation.

By W. A. BARCLAY, M.A.

ONE of the most fundamental conceptions in wireless theory is that of utilising a given proportion of some available magnitude for some specific purpose. For example, in order to use a sensitive meter to measure high voltages, it is proper to include a series resistance in the circuit so that only a proportion of the total voltage is applied to the instrument. Again, when using resistance or choke-capacity coupling, only a proportion of the voltage generated by the valve is passed *via* the resistance or choke to the grid of the following valve. Other examples will no doubt readily occur to the reader. It is the object of this article to give a short account of a simple alignment diagram from which the amounts of such proportions may be read off at sight and without calculation.

Although the general employment of alignment diagrams is by now well understood by readers of this journal, the examples which have appeared from time to time in its pages have not been such as the reader could readily construct for himself. The diagrams now to be described will be found quite easy to draw by anyone who can provide a fairly large sheet of paper and a graduated ruler. Above all, no logarithms are required, though a table of squares will be of assistance.

It is proposed to call the diagram the "N-Diagram," on account of its shape. Although it is so easy both to use and construct, it has not yet—so far as the writer is aware—been utilised for those wireless purposes for which it seems so eminently adapted.

Series and Parallel Resistances.

Let us consider two resistances in series whose values are r_1 and r_2 ohms (see Fig. 1a). Then, if an E.M.F. of any value be applied across the two resistances in series, it is known that the proportion of the total E.M.F. which will exist across the resistance r_1 will be $\frac{r_1}{r_1 + r_2}$ of the whole.

Similarly, if we have two resistances, s_1 and s_2 in parallel (Fig. 1b), if a certain total current flow past the assemblage, the fractional current passing through the component s_1 will be $\frac{s_2}{s_1 + s_2}$ of the whole.

READERS of this journal will be well versed in the use of abacs, or alignment diagrams, which appeared as a series under the title of "Useful Data Charts." The accompanying figures—which it is proposed to call N-diagrams can easily be constructed by anyone possessing a graduated ruler, and provide a ready means of solving a large number of problems. It is believed that this is the first time the specific properties of this simple figure have been made available to wireless theory.

The N-Diagram.

Now let us construct the N-diagram shown in Fig. 2a. First draw the sloping diagonal line AB of any convenient length, and divided into 100 equal parts. These are numbered off in the direction A to B to represent percentages. (The chief values only are shown on the diagram.)

Next, draw the arms of the N, *i.e.*, the vertical parallel lines AC and BD. These lines, which may be produced at will to any required distance, are also graduated by equal divisions, the graduations representing ohms. The points A and B represent zero values on both arms of the diagram. The graduations may be set out to any scale, representing large or small values of resistance according to the requirements. The case shown in Fig. 2a

illustrates small resistances, values up to 5 ohms being shown on both AC and BD. It is important to notice that the scale to which these graduations are set out is entirely independent of the graduations on the diagonal, which latter occupy the same positions no matter what scale be chosen to set out the values of r_1 and r_2 .

The scale AC now represents values of the resistance r_1 of Fig. 1a, while the scale BD represents values of r_2 . If any particular values which may be assigned to these resistances be now joined by a straight line, it will be found that the joining line meets the diagonal in a point giving the value of the fraction $\frac{r_1}{r_1 + r_2}$

expressed as a percentage. Thus, if r_1 be 2.5 ohms, and r_2 be 4 ohms, the dotted index-line on Fig. 2a shows that the proportion of the applied voltage effective across r_1 is 38.5 per cent.

It will also be evident that by reversing the order of the graduations on the diagonal scale, a similar diagram may be made to estimate the proportional distribution of currents in the parallel network of Fig. 1b. Fig. 2b has been drawn for values of s_1 and s_2 up to 10,000 ohms, and the dotted index-line indicates the case for $s_1 = 6,000$ ohms, and $s_2 = 7,500$ ohms. It can clearly be seen from the diagram that the current through s_1 is 55.5 per cent. of the whole.

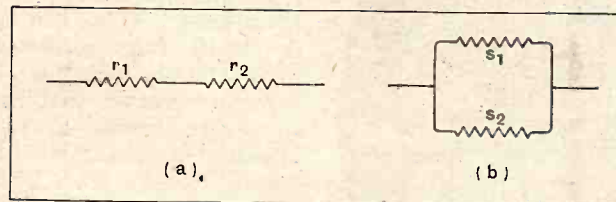

Fig. 1 (a).—Resistance in series. (b).—Resistance in parallel.

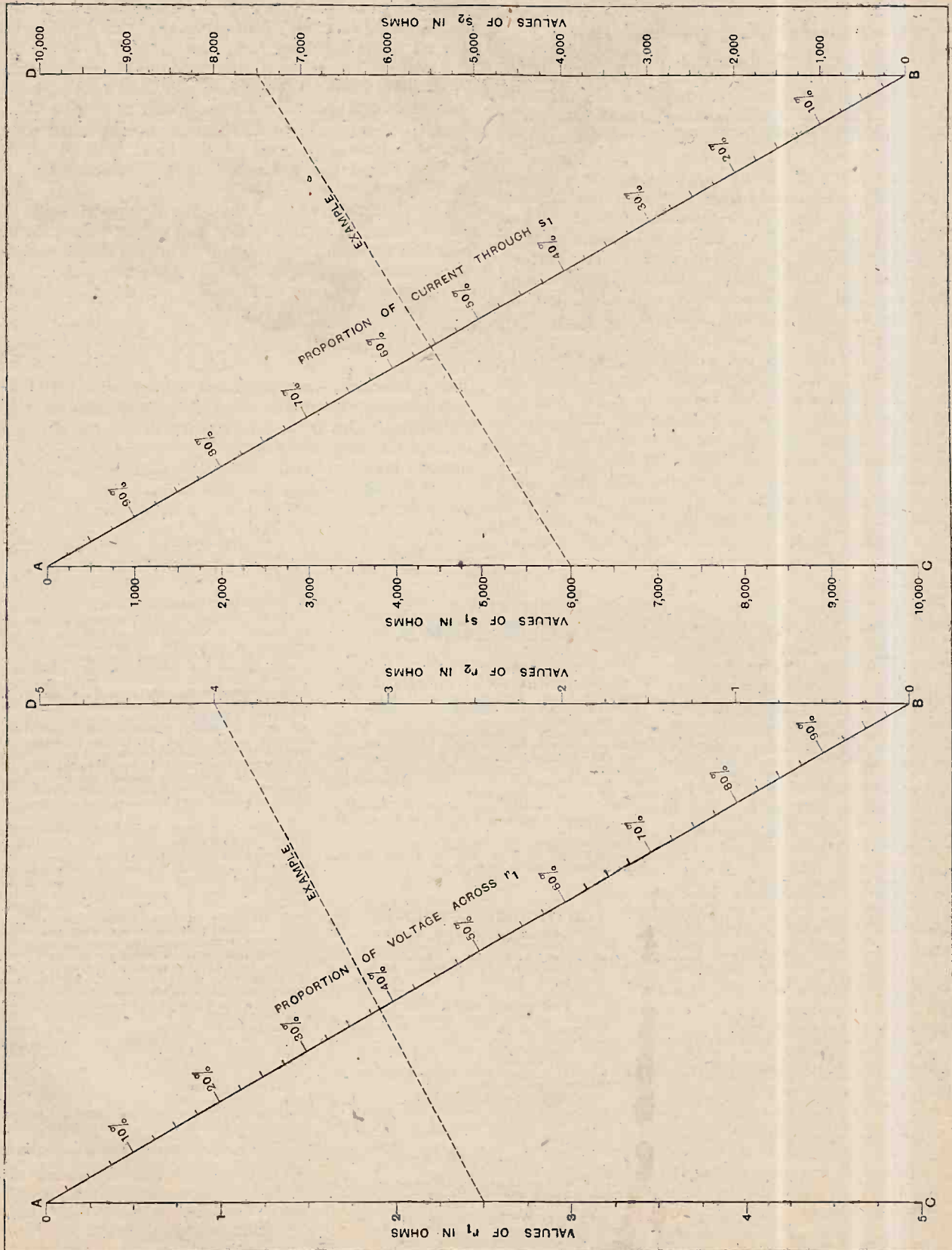

Fig. 2 (b).—The N-diagram for resistances in parallel.

Fig. 2 (a).—The N-diagram for resistances in series.

The "N"-Diagram.—

Components of Widely Differing Values.

The remarkable ease with which these diagrams may be drawn out renders them of particular service when the two component resistances do not differ markedly from each other in value. When, however, one of them is much larger than the other, two alternatives present themselves. Either one of the supporting scales must be made inconveniently long, or the value of the smaller resistance appears so near the angle of the N that the diagram is difficult to read. These difficulties may be readily surmounted—but at a cost, namely, the sacrifice of the conveniently even percentage graduations on the diagonal scale. The new scale on the diagonal will be unevenly graduated, but the diagram is, however, almost as simple to construct as before.

Suppose that one of our resistances, r_1 , is to be roughly of the order of ten times the magnitude of the other, r_2 . We proceed as before to draw out our figure N, this time, however, leaving the diagonal ungraduated. In this case the two vertical arms are first graduated, but not, as previously, to the same scale. The arm AC, which is to accommodate the large values of r_1 , should now be made to carry a scale the divisions of which are ten times closer together than those on BD, so that the larger values of r_1 are not now incon-

veniently remote. Again, it is important to note that the scales chosen may still have any values quite unrelated to each other, *i.e.*, the lengths between the graduations on AC need not necessarily be ten times as small as those on BD. Any convenient factor might have been chosen—for instance, one might be taken in units of an inch, while the other might be in centimetres. Herein lies one of the chief beauties of the method—the ease with which the scales may be selected.

Having thus graduated the upright supports with the useful values of r_1 and r_2 , the percentage values on the diagonal may now be filled in. For this it is necessary to perform a small calculation for each point. To ascertain the position of the point for, say, p per cent., we have the following equation:—

$$\frac{p}{100} = \frac{r_1}{r_1 + r_2} \dots \dots \dots (1)$$

Then, selecting any values of r_1 and r_2 which will make this equation true, we join these values on their respective scales by a line which will cut the diagonal line in the required point. The values of r_1 and r_2 selected must, of course, be such as will be found conveniently situated on the external supports. An example of the procedure will render it clearer.

(To be concluded.)

D.C. from A.C. Mains.

The various methods of using A.C. electric light mains to supply direct current for operating wireless receivers occupied the attention of members at the last meeting of the North Middlesex Radio Society. The speaker was Mr. S. A. Stevens, A.C.G.I., B.Sc. (Eng.), D.I.C., representing the Westinghouse Brake and Saxby Signal Co., Ltd.

Mr. Stevens gave special attention to the Westinghouse Metal Rectifier. The construction, characteristics, and operation of this type were fully described, with the aid of explanatory lantern slides, and suitable circuits and values were given for its various uses, including battery charging and the supply of H.T. and L.T. current.

The talk concluded with the exhibition of the Company's film, "Rectification."

Hon. Secretary, Mr. E. H. Laister, "Windsflowers," Church Hill, N.21.

Gramophone Problems.

Mr. Radford, of the Gramophone Company, gave an interesting and helpful talk on "sound" at a recent meeting of the Wembley Wireless Society, touching briefly on some of the problems which have to be overcome in the production of gramophone records. Members were fortunate in hearing many special records, which had been prepared to illustrate the various points in the lecturer's discourse.

Hon. Secretary, Mr. H. E. Comben, 24, Park Lane, Wembley.

Competitions Breed Enthusiasm.

The annual "competition" evening of the Bristol and District Radio and Television Society was held on March 21st at Bristol University. The exhibits, which included both broadcast and short-wave receivers, speakers, power transformers and battery eliminators, showed great ingenuity and a high standard of workmanship. Each entrant demonstrated his exhibit, giving a short account of the special points in design. Prizes were awarded on a ballot of the members present.

Hon. Secretary, Mr. S. T. Jordan, 1, Myrtle Road, Cotham, Bristol.

L.F. Amplifier Design.

The principles underlying the design of audio-frequency amplifiers were dealt with in a talk given by Mr. P. R. Thomas before the Croydon Wireless and Physical Society on March 17th.

CLUB NEWS.

The conditions necessary to obtain a large undistorted output from the final stage were discussed. Particular attention was drawn to the use of decoupling circuits for the prevention of low-frequency oscillation in amplifiers whose plate current supplies are drawn from an eliminator. The speaker emphasised the desirability of ensuring that the amplification should be reduced at frequencies lower than those which can be usefully reproduced.

Visitors are heartily welcomed to the Society's meetings, which are held at 5, Altyre Road, East Croydon.

Particulars may be obtained from the Hon. Secretary, Mr. H. T. P. Gee, of Staple House, 51-52, Chaucery Lane, London, W.C.2.

FORTHCOMING EVENTS.

WEDNESDAY, APRIL 9th.

Muswell Hill and District Radio Society.—At 8 p.m. At Tolington School, Tetherdown. Lecture: "The Function of the Condenser," by Mr. J. Eric Johnson (G2ZN).

THURSDAY, APRIL 10th.

Iford and District Radio Society.—At the Wesleyan Institute, High Road. Ordinary Meeting.

Kensington Radio Society.—At 8.30 p.m. At 20, Penycuik Road, Earl's Court. Lecture: "Screen Grid Valves," by the Marconiophone Co., Ltd.

MONDAY, APRIL 14th.

Newcastle-upon-Tyne Radio Society.—At 7.30 p.m. In the English Lecture Room, Armstrong College. Lecture: "The Moving Coil Speaker and its Amplifier," by Mr. F. Youle, B.Sc., A.C.G.I. (of the Marconiophone Co., Ltd.).

WEDNESDAY, APRIL 16th.

Golders Green and Hendon Radio Society.—At 8 p.m. At the Club House, Willifield Way, N.W.11. Lecture: "Metal Rectifiers," by Mr. F. A. Stevens, B.Sc., A.C.G.I. (of the Westinghouse Brake and Saxby Signal Co., Ltd.).

A Universal Gramophone Motor.

For his lecture before the Muswell Hill Society on March 19th, Mr. G. Parr, of Ediswan, brought along a large amount of apparatus, much of which was of quite recent development.

First of all the Ediswan battery-driven S.G. receiver was demonstrated, and excellent results were obtained using only a length of flex as an aerial! Next followed a description of the Universal gramophone motor, which can be run off A.C. or D.C., this arousing considerable interest, since doubt exists as to when the local D.C. mains are to be changed to A.C. The motor was demonstrated in conjunction with the B.T.H. pick-up working through the B.T.H. R.K. speaker. As a contrast to the latter, the Ediswan ridged cone assembly was on view.

o o o o

Television Explained.

In view of the sudden recrudescence of interest in television, the lecture given recently before the Muswell Hill and District Radio Society by Mr. H. Andrews, G2TA, was particularly opportune, dealing as it did with the first principles of that science. The lecturer dealt concisely yet explicitly with the whole process of transmission and reception from the scanning disc in the transmitter to the moving picture seen in the receiver. Various systems of modulating the transmitter with the television impulses were outlined and the importance of a dead steady carrier was emphasised, the advantages of a crystal-controlled transmitter being obvious in this connection.

Hon. Secretary, Mr. C. J. Witt, 39, Coniston Road, N.10.

o o o o

"Touring" Europe.

An excellent demonstration of radio and gramophone reproduction was given at the last meeting of the South Croydon and District Radio Society by its vice-president, Mr. George H. Tozer, using a receiver of *The Wireless World* "Everyman" type, used in conjunction with an electric pick-up and a coil-driven loud speaker.

Subsequently Mr. Tozer demonstrated the long-distance properties of his *Wireless World* "Exhibition Five," securing thirty stations in a brief "tour" of Europe.

Hon. Secretary, Mr. E. L. Cumbers, 14, Campden Road, South Croydon.



Simplified Aids to Better Reception.

ELECTRIFICATION BY INSTALMENTS.

THE purpose of this note is to offer a suggestion to those who are still dependent on batteries—at any rate, to some extent—for the energy necessary to operate their receivers, in spite of the fact that they have access to an A.C. supply.

As the upkeep costs of a high-tension battery represents the heaviest expenditure connected with wireless receiver maintenance, it is natural enough that the first step of those wishing to convert existing sets should be to install an H.T. battery eliminator. When this piece of apparatus has been persuaded to function in an altogether unexceptionable manner, one's thoughts naturally turn towards the L.T. battery; it may either be completely eliminated by fitting indirectly heated valves, or the trouble incidental to its periodical recharging at a service station may be avoided by investing in a small rectifying unit.

Neither of these alternatives is particularly cheap. If the first-mentioned plan is adopted various minor modifications to the receiver may possibly be called for, in order to compensate for the higher efficiency of A.C. valves, and in any case there may be a natural reluctance ruthlessly to "scrap" a set of perfectly good valves.

Fortunately, there is a simple and inexpensive, but apparently rather neglected, scheme whereby the load imposed on the L.T. battery may be lightened. It is in the nature of a more or less temporary expedient, but is none the less valuable for that reason.

In most simple receivers—and it is with the less ambitious type of set that we are here dealing—it will be found that the output valve consumes as much, or even more, filament current than do all the rest put together. This is particularly likely to be true where the popular two-

volt valves are used; in this range the better output valves take as much as 0.4 amp. This figure, added to perhaps 0.2 or 0.25 amp., brings the total up to rather more than the cheap type of "mass" cell can comfortably deliver. If arrangements can be made to feed the output valve directly from the mains, this difficulty will no longer arise, and even the smallest accumulator will be working well within its capabilities.

Although it is not possible to supply the filaments of ordinary directly heated valves with raw or unsmoothed A.C. throughout the whole set, there is no objection to applying this principle in the output stage. The necessary alterations are of the simplest nature, and practically the only extra apparatus required is a small transformer to step down the mains voltage to that of the valve. Extra consumption of this addition is altogether too small to manifest itself in the electric light bill.

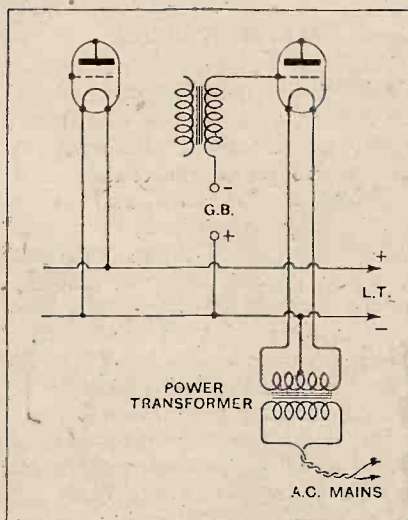

Fig. 1.—Step-down transformer used for supplying current to an output valve in a set where the remaining filaments are fed from an L.T. battery.

Transformers, specially made for this purpose, with a centre-tapped secondary winding, are to be recommended, but it is quite possible to use a bell-ringing transformer, as sold by electrical dealers for about five shillings, or even less. Naturally enough, one can hardly expect that cheap appliances of this kind should be entirely beyond criticism, but it seems that most of them are capable of delivering at least half an ampere continuously. To be on the safe side, light fuses (say, No. 42 gauge copper wire) should be inserted in each mains lead. Outputs are almost invariably rated at 3, 5 and 8 volts, a tapped secondary being provided. It cannot be assumed that these voltages are exact.

If the conversion in question is to be made with the help of a proper centre-tapped transformer, delivering the correct voltage, necessary alterations will be as shown in Fig. 1. It will be seen that the output valve filament terminals are disconnected from the L.T. bus-bars, and joined across the secondary, the mid-point tapping being linked to the common negative or "earth" lead. No other modifications are called for, beyond the obvious connection between transformer primary and mains; as a rule this pair of leads will be joined across the eliminator input terminals.

Where the transformer is not rated to deliver the right voltage, and is not provided with a centre tapping, it will become necessary to fit a rheostat and "artificial centre" potentiometer, as shown in Fig. 2. The resistance of the potentiometer is not of great importance, but it is as well to use a low value—in the order of tens of ohms—so that grid bias may not be upset by the voltage drop due to the passage of anode current through it. The purpose of this potentiometer is to prevent "hum" due to asymmetrical

Practical Hints and Tips.—

conditions in the grid return circuit. So far everything has been plain sailing, but we now come to a minor difficulty—but fortunately one that can be overcome without too much trouble. It has already been stated that the voltage marked on cheap transformer terminals cannot be depended upon to be accurate; further, the type of D.C. voltmeter customarily used will not read A.C. voltages, and so it is not immediately

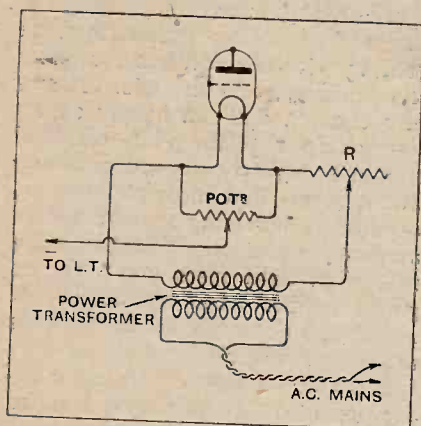

Fig. 2.—Adapting a cheap transformer for heating an output valve filament.

clear how the value of resistance R (Fig. 2) is to be determined.

A convenient method of procedure is to measure anode current, using the reading of a milliammeter to indicate whether filament temperature is correct. Before changing over to A.C. supply the current flowing under fixed operating conditions and with full filament voltage should be carefully noted. Next, a rough approximation of the ohmic resistance necessary at R should be made by dividing "volts to be absorbed" by "current taken by the valve (in amps.)." To allow some latitude a rheostat with a value at least 50 per cent. greater than indicated should be obtained. Having connected up the A.C. supply circuit, the rheostat should be adjusted carefully (starting from maximum) until anode current, as indicated by the milliammeter, is restored to its original value. Provided that operating conditions, including anode voltage and grid bias, are as before, it can be safely assumed that filament current is correct, and the rheostat may be finally locked in position.

SMOOTHING CHOKES.

In dealing with receivers that are particularly susceptible to stray and harmful interstage couplings, it is not unusual to find that separate smoothing must be provided in the associated eliminator for each individual anode circuit, or, at any rate, for the detector and each L.F. amplifier feed. When choosing a smoothing choke for the detector branch, one is seldom likely to err in using a higher inductance value than usual—say, 100 henrys or so. These chokes cost no more than those of the conventional type, and their inevitably high ohmic resistance is most unlikely to be a drawback in a circuit where something considerably less than the maximum available voltage is almost invariably required.

o o o o

AN UNSUSPECTED DANGER.

It is not unusual at the present time to use 2-volt screen-grid valves in conjunction with a 4- or 6-volt L.T. battery; this is due to the fact that some of the 2-volt H.F. amplifiers have characteristics that are unsurpassed in the higher voltages.

If the conventional method of connection for these valves is adopted—filaments in parallel, with a single series voltage-reducing resistance—it is fatally easy to over-run a valve by withdrawing one of them from its socket, thus allowing the voltage across the other to rise considerably.

o o o o

VALVES IN SERIES.

When two or more valve filaments are connected in series (see Fig. 3), the current that must flow is determined by that taken by the most extravagant valve in the chain. If it so happens that each and every valve consumes precisely the same current, no special precaution need be taken, beyond ensuring that the voltage applied across all valves is equal to the sum of their individual requirements.

But in practice the problem is generally rather more complicated, and if valves are carefully chosen with a view to their characteristics and functions, rather than with an eye to similarity of filament ratings, it will often be found that no two are precisely the same.

In such cases it becomes necessary

to shunt each filament, except that—or those—consuming maximum current, with a deflecting resistance (R_1 in Fig. 3).

Determination of the value of this resistance seems to have given rise to some perplexity among amateurs, but the whole matter is really very simple if one regards its task as that of carrying the surplus current, or, in other words, the difference in current between that taken by the valve itself and that which must flow through the chain. The resistance (in ohms) is then ascertained by dividing this difference in current (expressed as a fraction of an ampere) into the voltage at which the shunted valve filament is rated. This, of course, is merely a practical application of Ohm's law; in other words, $R = \frac{E}{I}$, where R is re-

sistance of the required shunt, in ohms; E , valve filament voltage; I , current to be passed through the shunt.

In the example given diagrammatically, the shunted valve consumes 0.1 amp. The current passing through the chain, as determined by the rating of the remaining valve, is 0.15 amp. Therefore, current to be passed through the shunt amounts to $0.15 - 0.1 = 0.05$ amp. Applying

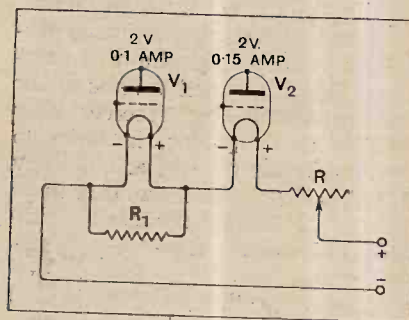

Fig. 3.—Valves in series. Filament characteristics of valves taken as an example in the text are indicated.

our formula, we find that the required resistance is $\frac{2}{0.05} = 40$ ohms.

Determination of the ohmic resistance of R is easily made by first adding together the individual filament voltages of each valve and then subtracting the sum from the total voltage applied. This gives "volts to be absorbed," which is then divided by current (in amps.) to be passed.

The most sensitive DETECTOR Valve on the market

**AND ABSOLUTELY
NON-MICROPHONIC**



The Amazing

MAZDA VALVES

The most efficient detector valve in the world, and absolutely free from hum.

The Mazda A.C./H.L. valve has been designed specially for anode bend and cumulative grid detection, the ideal for power detection.

Examine its characteristics and you will understand why it is so efficient.

CHARACTERISTICS.

Filament volts	4.0
Filament amps.	1.0
Amplification factor	25
Mutual conductance	2.6
Anode resistance (ohms)	13,500
Anode volts	200

MAZDA AC/HL PRICE 15/-



THE EDISON SWAN ELECTRIC CO., LTD.,
Radio Division,
1a, Newman Street, Oxford Street, W.1.
Branches in all Principal Towns.

EDISWAN

*Do not miss the Hall of Ideals
at the Ideal Home Exhibition.*

V.31

ALL ROUND THE WORLD FOR 27/-

READ THIS LETTER.
YOU WILL HAVE EQUALLY
SATISFACTORY SERVICE BY
SPECIFYING EVER READY
POPULAR POWER WHEN
NEXT BUYING A BATTERY

The Manager,
 The Ever Ready (Gt. Brit.) Ltd.

Dear Sir,
 I feel you should be acquainted with the following facts. On the 20th February 1929 I purchased a "Popular" Power" battery (60 volts) and have been using it in a three valve set (H.F:L.F: Power valves) with a similar circuit to the Mullard Master Three Star.

I have now taken the battery off as it has only just run down. The other 60 volt battery was bought in May last and still registers over 40 volts. We have the wireless on every evening for varying periods and on Sundays nearly all day. I have now purchased another battery, for one could hardly have cheaper entertainment at 27/- per year.

Should you wish to have the old battery kindly call at the above address.

Thank you for such a good product and wishing Ever Ready every success.

I am,
 Yours truly,

Letter
 Dated
 25.3.30.

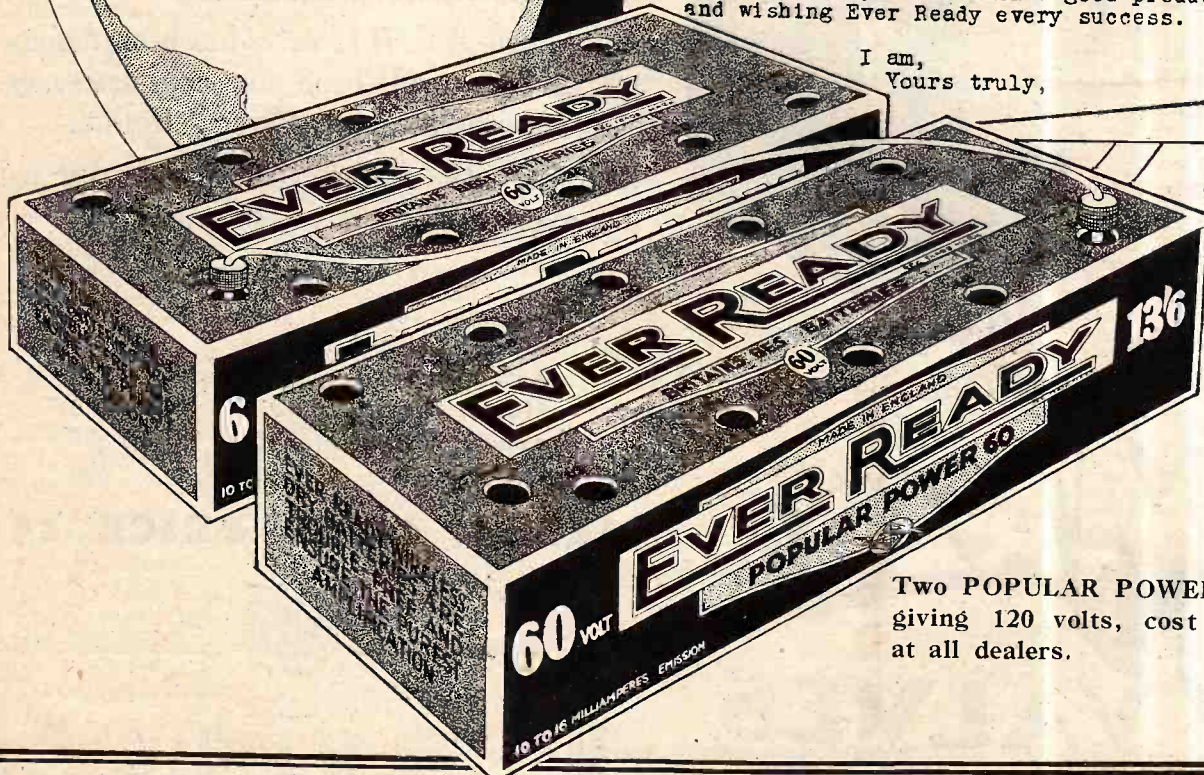

Two POPULAR POWER 60,
 giving 120 volts, cost 27/-
 at all dealers.

Send for List of Standard Sizes suitable for every set.
THE EVER READY CO. (GT. BRIT.) LTD., HERCULES PLACE, HOLLOWAY, N.7.

Mention of "The Wireless World," when writing to advertisers, will ensure prompt attention.

WAVEMETER SCALES

Choosing a Suitable Condenser Scale for an Accurate Wavemeter.

By W. H. F. GRIFFITHS, F.Inst.P., A.M.I.E.E.

WHEN considering the condenser scale for an accurate wavemeter the closeness to which easy reading is possible depends to some extent upon the fineness of the engraved lines of the dividing as well as upon the index and the circumferential dimension of the scale. The fineness of the engraved lines in turn depends upon the material from which the scale is made and upon the engraving process employed. Metal scales may usually be divided much more finely than those of insulating materials, and dividing with "knife" cutters is much more effective in producing fine lines than that by a rotary cutter engraving machine.

The limitation of scale-reading accuracy by the thickness of engraving is shown clearly by the magnified scale dials of Fig. 1. They are ordinary three-inch diameter dials the circumferences of which are separated into divisions of 2 degrees. The only difference between (a), (b) and (c) is the varying fineness of the engraving—the thickness of the lines being 0.02 inch, 0.01 inch and 0.007 inch respectively. The dial shown at (a) is typical of a large number of dials at present on the market, and that shown at (b) is a finely divided ebonite dial such as would be fitted to a commercial wavemeter of fair quality. The (c) dial represents fine dividing on metal.

Another dividing feature which should, perhaps, be mentioned here is that of the number of divisions into which the circumference of the scale should be split up. If the divisions are made too small, interpolation reading becomes more difficult owing to the fact that, as in the case of thickly engraved lines, the ratio of space between lines to the thickness of the lines themselves becomes too small. In other words, in order to gain the full advantage of finer subdivisions the lines separating those subdivisions must be made correspondingly finer. A rough rule which exists among instrument makers is that scale divisions should not be less than 1 mm., and for still further accurate subdivision a vernier should be employed. Working very roughly to this rule the following table has been made.

IN a previous article in this journal the author discussed the various electrical features which contribute to the accuracy of a wavemeter and gave curves by the aid of which one is enabled to design a resonant circuit for any required accuracy of wavemeter. Care must, however, be taken to ensure that the electrical accuracy of the design is not limited by inaccuracy of scale reading. Many wavemeters have scales so small that their overall accuracy is much less than that which would be justified by the design of their resonant circuits.

Scale Radius.	Finest Divisions.	Vernier to read to
1 to 2 inches	2°	0.2°
2 to 4 inches	1°	0.1°
4 to 6 inches	0.5°	0.05°

In order to determine the radius of scale which is necessary to enable readings of a certain accuracy to be made it must be assumed that even with fine line divid-

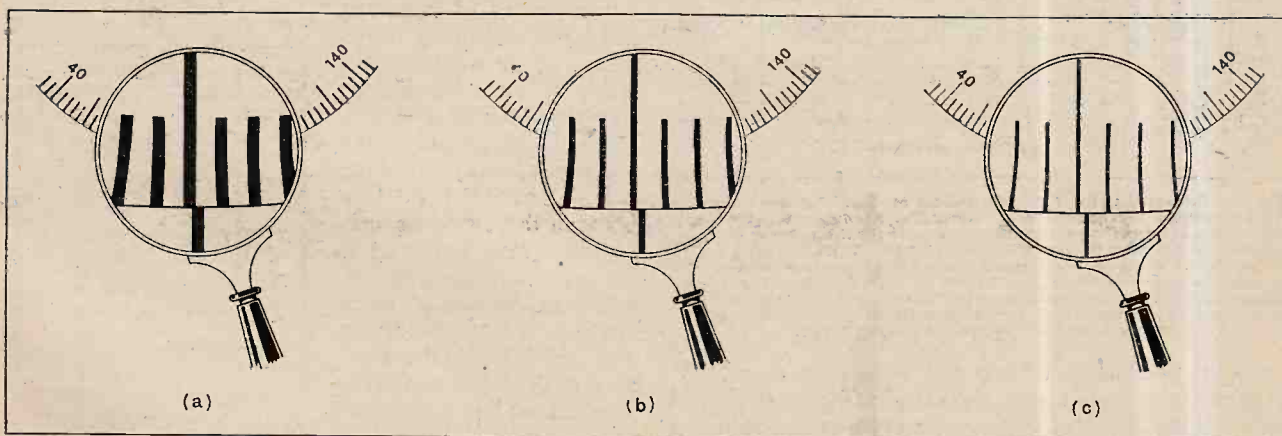

Fig. 1.—Magnified views of dials marked at every two degrees. The limitation of scale-reading accuracy by the thickness of engraving is clearly seen.

Each of these dials is shown set to 90.5° and, although this reading is quite easily seen in (c) dial, it is quite impossible to recognise the 0.5° in dial (a) owing to the difficulty of eliminating (by imagination) the thickness of the lines when interpolating.

ing it is not possible to estimate with certainty a scale reading to a closer accuracy than that corresponding to 0.01 inch of scale circumference, even when a vernier is employed. Upon this assumption expressions can be formed which will give the required scale radius in terms

Wavemeter Scales.—

of the accuracy desired of the wavemeter. These expressions will differ for wavemeters having variable condensers of different "laws" and are given below:—
Straight-line capacity condenser dial.

$$R = \frac{0.32 (\text{Capacity ratio} - 1)}{A}$$

Straight-line wavelength and straight-line frequency condenser dials.

$$R = \frac{0.64 (\sqrt{\text{Capacity ratio}} - 1)}{A}$$

Logarithmic law condenser dial.

$$R = \frac{0.73 (\log. \text{Capacity ratio})}{A}$$

In the above formulæ R is the scale radius in inches

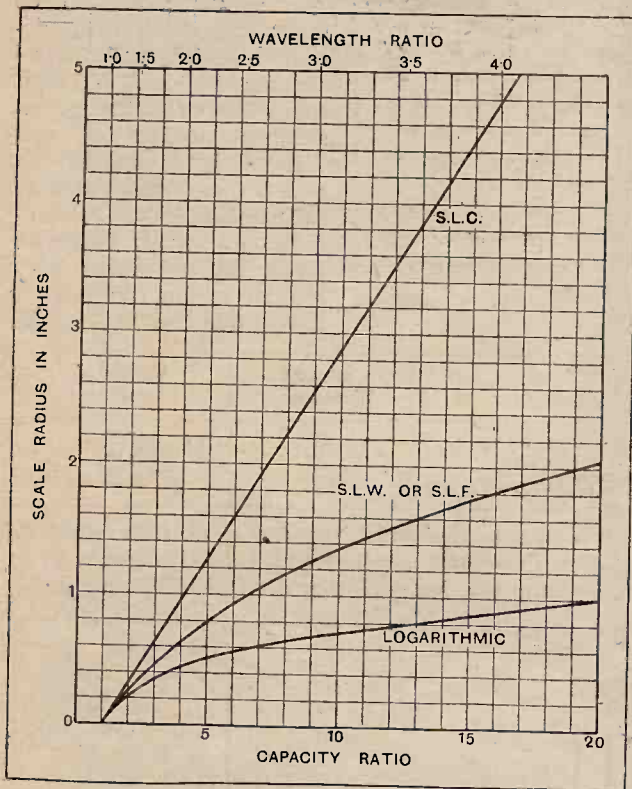

Fig. 2.—Curves showing the scale radius required for the variable condenser of a wavemeter of 1 per cent. accuracy for various ratios of maximum to minimum capacity or for the corresponding ratios of maximum to minimum wavelength. The curve S.L.C. is to be used when the wavemeter has a "straight-line capacity" variable condenser; the curve S.L.W. or S.L.F. when the condenser is of either the "straight-line wavelength" or "straight-line frequency" type and curve logarithmic when the condenser is of the "logarithmic law" type.

and A the percentage accuracy of wavelength required.¹ By capacity ratio is meant the ratio of the capacities of the variable condenser (when connected in the circuit of the wavemeter) with the moving plates "all in" and "all out." In these formulæ, and in the curves which follow, R should be increased by about 50 per cent. if the scale is to be coarsely engraved on ebonite; whereas, in

¹ The overall accuracy of the wavemeter should be used in these formulæ and not the accuracy of scale reading desirable, for a factor of safety of 2 has been allowed.

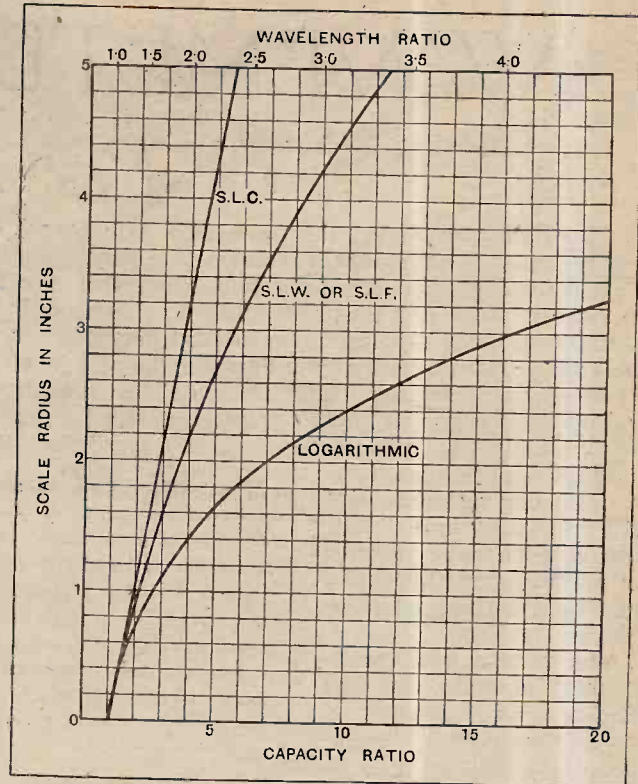

Fig. 3.—Curves showing the correct scale radius for the variable condenser of a wavemeter of 0.3 per cent. accuracy for various values of Cmax/Cmin or λmax/λmin.

scales of large radius engraved finely on metal, R may be somewhat less than that given by the formulæ or curves.

The curves of Figs. 2, 3 and 5 have been plotted to show at a glance the scale radius required for wavemeters of given accuracy. For a wavemeter of any accuracy intermediate between those for which the curves have been plotted simple proportion may be employed, for a wavemeter of, say, 0.5 per cent. accuracy obviously requires twice the scale radius of one having only 1.0 per cent. accuracy.

Smaller scale radii are required for condensers of the S.L.W. and S.L.F. type because they tend to open out that closed-up part of the scale which is obtained with an ordinary semi-circular plate condenser and which limits the accuracy of the latter type. The logarithmic law wavemeter scale requires an even smaller scale radius because it is characteristic of this type of condenser that the percentage scale openness is constant throughout the entire scale, there being no closed-up portions of the

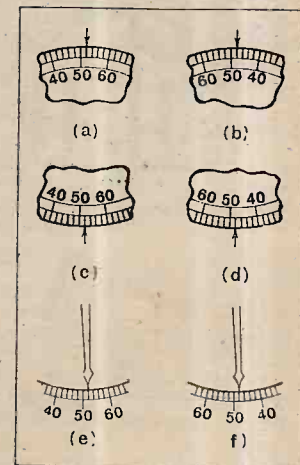

Fig. 4.—The right and wrong way of numbering the degrees of condenser dials. The scales of (b), (d) and (f) are incorrect and may cause errors to be made.

Wavemeter Scales.—

scale to limit the accuracy with which it can be read. Given a scale of the correct dimensions, the accuracy with which a variable condenser can be set to any given scale reading depends also upon the quality of the bearing employed. This important fact is often overlooked.

In order that the dial may be set precisely to any given value, it is necessary that the bearing shall be of sufficiently good quality to permit a uniform "crawl" throughout its whole movement. In other words, if a uniform force is applied to the dial it must not produce a series of short "jerks," because if the required value happens to correspond with the centre of such a jerk it is impossible to set to it. Anyone who has experienced the intensely annoying jumping of a condenser rotor past a required setting, first to one side and then to the other, will at once appreciate the necessity for attention to the bearing.

The circumferential dimension of the smallest readable estimated portion of the scale upon which the formulæ for scale radii were based was 0.01in. But in order that the scale may be read and set with this accuracy it is necessary to specify a smooth crawling angular movement of the rotor throughout the entire range of the condenser.

In conclusion it is thought advisable to draw attention to several incorrect methods of numbering the degrees of condenser dials. Of the scales shown in Fig. 4 (b), (d) and (f) are incorrect, and many errors occur through rapidly reading these scales in the usual left-to-right manner, as, for example, reading those shown at (b), (d) and (f), as 52° instead of 48°.

Again, for wavemeter work the dial (c) or the scale and pointer (e) are preferable to the dial (a) if mounted on a horizontal panel, because of the introduction of excessive extraneous earth capacity by bending the head and shoulders over the top of the wavemeter in order to read

the latter scale accurately. If the dial is mounted on a vertical panel, however, dial (a) is the more easily read.

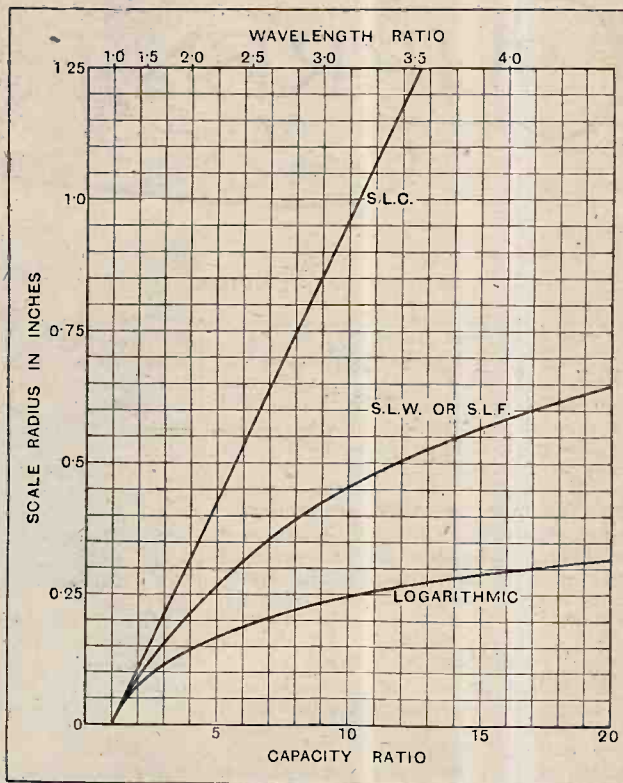

Fig. 5.—Curves showing the correct scale radius for the variable condenser of a wavemeter of 3 per cent. accuracy for various values of C_{max}/C_{min} or $\lambda_{max}/\lambda_{min}$. It should be noted that the scale dimensions read from this curve are those which will suffice theoretically, but it is, of course, unnecessary to reduce the scale radius below 1 inch.

Sainte Assise Stations.

We understand that the Cie Radio France no longer uses the call-signs FW3, FW4, etc. The short-wave stations at Sainte Assise are: FTA on 25.125 metres, FTB on 40.05, FTC on 14.25, FTD on 15.12, FTE and FTO on 16.44, FTF on 38.61, FTG on 43.92, FTH on 27.42, FTI on 27.72, FTJ on 18.45, FTK on 18.89, FTL on 30.15, FTM on 15.5, FTN on 24.46, FQE and FQO on 24.67, FRE and FRO on 15.45, FSE and FSO on 22.32 metres.

The letters E and O indicate the Eastern and Western projections respectively of beam stations. ○○○○

Hybrid Language.

We have, in time past, raised mild protests against the misuse of transmitters' abbreviations in written correspondence. This evil practice is, admittedly, not so prevalent in Great Britain as in America or, if we may judge by some of our foreign contemporaries, in France, where the mixture of French and "Ham Language" often has a quaint and curious effect and we note that "QSO" is raised to the dignity of a full-fledged verb with moods, tenses, par-

TRANSMITTERS' NOTES AND QUERIES.

ticsples, gerunds, and all other appurtenances—present indicative: Je QSOte, tu QSOtes, il QSOte, nous QSOtons, vous QSOtez, ils QSOtent. We presume it will make an official appearance in future French grammars, despite the lamentation of the grammarians over the importation of exotic words. Advanced mathematicians are said to think, not in words but in symbols, and possibly some amateur transmitters would have us believe that they are so wrapped up in their pursuits as to have lost the faculty of writing in their native language. ○○○○

Obituary.

We regret to record the death, at the early age of 22, of Mr. Mervyn Stanley Woodhams, whose transmitting station G6WO, at Rugby, was well known. In addition to being a wireless enthusiast, Mr. Woodhams was a canable musician,

and it was while playing the organ at Catthorpe Parish Church that he suddenly collapsed. ○○○○

French Short-waves.

The Radio Club de Toulouse transmits every Saturday from 20.30 to 22.00 G.M.T. on 49 metres. ○○○○

Spanish Amateurs.

In addition to the supplementary list of Spanish stations which we gave in our issue of Feb. 19, the following amateur transmitters have been licensed:—

- EAR 175 Radio Club Manresa, Picas 3, Mauresa.
- EAR 176 E. Figueras, Paseo Nacional 15, Barcelona.
- EAR 177 E. Altube, Nueva de la Estación 25, Valladolid.
- EAR 178 F. Pou, Joaquin Costa 22, Barcelona.

New Call-signs and Changes of Address.

- G 5DD A. Dodsworth, 145, Hyde Park Rd., Leeds.
- G 5FH L. H. Lee, Edendene, 25, Marion Rd., Smethwick, Staffs. (Change of address.) Telephone on 150 metres on Sunday mornings and below 40 metres at night during the week.
- G 5SR. S. Riisen, 192b, Fulham Palace Road, Hammersmith, W.6.
- G 6XN L. A. Moxon, Flat 1, 52, Hogarth Rd., S.W.5. (Change of address.)
- 2BJJ W. Mitchell, 12, Grauge Rd., Southport, Lancs.
- 2BPT A. I. Perkins, 127, St. Asaph Rd., S.E.4.

CURRENT TOPICS

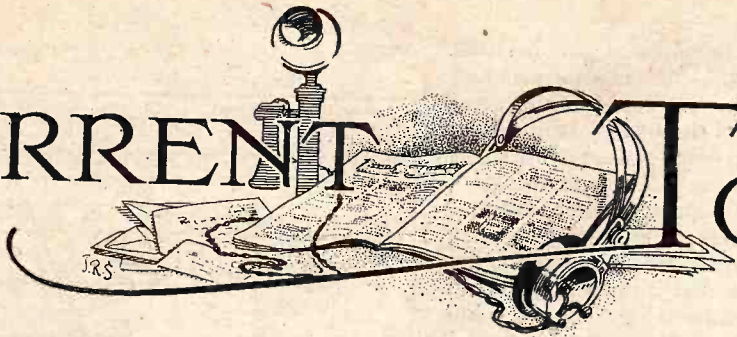

Events of the Week in Brief Review.

NEW USE FOR CRYSTAL SETS.

Crystal sets are to be installed on the gliders to be used by the newly formed Dorset Gliding Club. Their purpose will be to enable instructors to give advice to gliding pupils by means of a low-power short-wave transmitter.

○○○○

RADIO FOR RAILWAY SHUNTING.

Locomotives in the railway goods yard at Hamm, Westphalia, are now equipped with wireless receivers, shunting operations being directed from a central transmitter.

○○○○

WIRELESS ON TAP.

A shilling per annum for each wire crossing a thoroughfare is the fee which the Sheffield Corporation will probably require from Radio-by-Wire, Ltd., in respect of the wireless relay service which the company proposes to establish in Sheffield.

○○○○

RADIO FOR THE MASSES.

A radio propaganda campaign is reported to have been instituted by the

Russian Soviet. Specially equipped radio vans seating from 60 to 100 persons tour the villages, giving loud speaker demonstrations of reception from nearby broadcasting stations.

○○○○

WIRELESS IN FICTION.

The average fiction writer's obsession with the notion that Morse calls like SOS and CQD have a hidden meaning is once more illustrated, this time in the American journal *Sea Stories*, quoted by QST.

One of the authors writes: "Naturally I was reminded of the past when the SOS call was more of a novelty than it is to-day. SOS—Save Our Souls! It used to be CDQ (*sic*), which meant: Come damn quick!"

○○○○

CHEAPER FRENCH RADIO APPARATUS.

The reduction of the French luxury tax from 12 to 6 per cent. has led to a corresponding reduction in the price of radio material.

LUXEMBOURG WIRELESS SHOW.

A wireless exhibition is to be held at Luxembourg from June 8th-15th next under the auspices of the Association Radio-Luxembourg.

○○○○

WIRELESS WITHOUT WORRY.

A system of set maintenance after purchase has been inaugurated by the Paris firm, Radio-L.L. For a small annual fee the customer's wireless set is maintained in working order throughout the year.

○○○○

GOOD NEWS FROM ITALY.

Madame Quinn, a lady resident in Italy, is credited with a startling radio invention by the Italian journal, *Radio-corriere*, which states that she has produced a valve in which a broken filament can be instantly replaced, presumably without affecting the characteristics.

Until further news arrives we shall continue with our common or garden valves and trust to luck.

○○○○

GENERAL FERRIÉ.

A special Bill has been passed in the French Senate enabling General Gustav Ferrié, the famous wireless expert, to remain on the army active list although he has reached the age of retirement. General Ferrié is head of the French military wireless branch and president of the Radio-Telegraphic Experts' Committee of the League of Nations.

○○○○

BELGIUM AHEAD OF FRANCE.

French listeners are growing jealous of their Belgian neighbours, writes our Paris correspondent. The recent passage of three radio Bills through the Belgian Senate, creating a national broadcasting institution with a system of licences, definitely places France "in the shade" as the most backward of the European nations in the development of broadcasting. The projected French Broadcasting Bill is not expected to receive Parliamentary sanction until next year.

○○○○

ANTI-PIRATE WAR IN INDIA.

The Indian Government formally took over the broadcasting service on April 1st, paying £22,500 for the assets of the Indian Broadcasting Company. We understand that the Government contemplates special measures for attacking

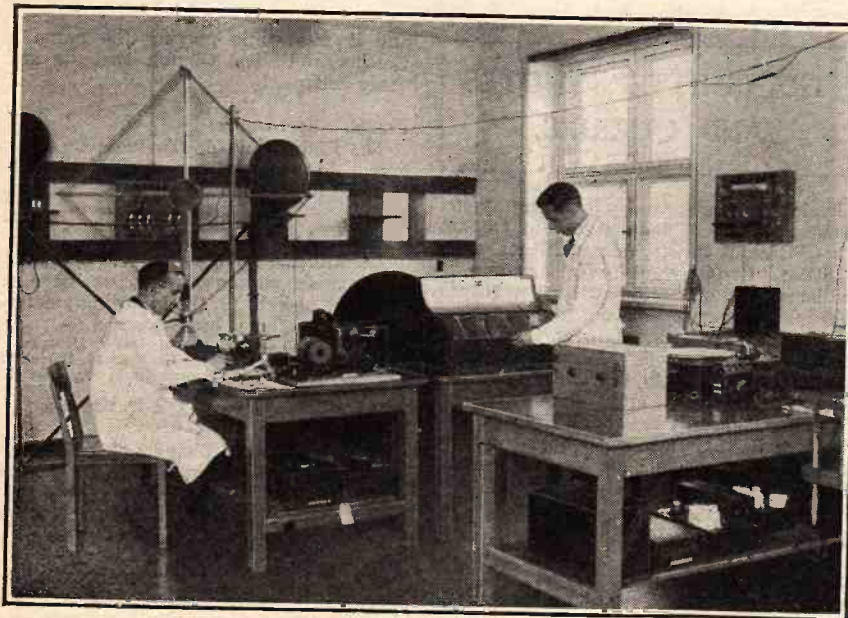

THE "N.P.L." OF GERMANY. The new Heinrich Hertz Institute in Berlin, as its name implies, concentrates on electro-magnetic wave research. The photograph shows the short-wave reception laboratory.

the "pirate" nuisance, which has hitherto been regarded as the main cause of the failure of Indian broadcasting.

PRIZES FOR SLEUTHS.

To put down "radio piracy," the Indian Radio Corporation, of College Street, Calcutta, offers twenty crystal sets of its own manufacture each month to listeners who give information leading to the detection of unlicensed sets. The champion sleuth for the month will receive a special prize of a three-valve set, mains- or battery-driven, complete with loud speaker.

"AS A THIEF IN THE DOCKS."

In an open letter to "Our Pirate Friends," the *Indian Wireless Magazine* includes the following poignant remarks:—

You say, you . . . simply did it out of fun. Friends, you have had enough of it, just get a licence. The Post Peons who calls at your place will carry word, and then all the fun will be in the Police Court. You stand as a Thief in the Docks and everybody laughing at your discomfiture. The lawyer's fees which you will have to pay will see you through licence fees for years, and in the end, whether a fine of Rs. 70/- or more—and perhaps Rigorous Imprisonment with nobody to cheer you when you enter the Jail or garland you when you come out. You will be no Martyr—but people will point at you and say "Thief," and still you will have to pay Rs. 10/- as licence fee. Friend, is it worth the game? A thousand times no.

LESS CASH TO SPARE.

The Radio Corporation of America report for 1929 shows a drop in available surplus for dividends, as compared with the figures for 1928. The surplus is \$15,892,000, as against \$19,834,000 in the previous year. The net operating income was \$182,137,000, an increase of \$82,511,000 over that of 1928.

OIL HUNTS BY WIRELESS.

All "responsible applicants" are to be granted wireless facilities for oil exploration in accordance with a definite policy recently adopted by the American Federal Radio Commission, which has now allotted five short-wave frequencies specially for the purpose.

The method employed by surveyors is to transmit a radio signal simultaneously with a subterranean explosion of dynamite. By measuring the time lag between the reception of the radio signal and the sound, it is possible to determine whether oil deposits exist in the territory between transmitter and receiver.

U.S. MUSICIANS GROWING NERVOUS.

Arguing for "the human rather than the mechanistic medium," the American Federation of Musicians is trying to persuade the Federal Radio Commission to restrict the periods during which broadcasting stations may transmit gramophone music in place of "living orchestras."

It is expected that the Commission will decline to accept any responsibility in the matter.



RADIO RESEARCH IN GERMANY. Another view of the Heinrich Hertz Institute, showing a room equipped for acoustic measurements. The walls are composed of asbestos.

HOW TO WIN A COIL-DRIVEN SPEAKER.

Among the many attractions at the "Ideal Home" Exhibition at Olympia is the chance of winning a Marconiphone moving-coil speaker, gramophone pick-up, or cone loud speaker.

These gifts are being offered by the Marconiphone Company as prizes in a simple competition. Every visitor to their demonstration hall in the Radio Section of the exhibition is invited to forecast the total number of persons who will have attended these demonstrations by the time the exhibition closes on April

17th. The visitor who guesses or comes nearest to the actual number as recorded by the company's officials will be able to select which of the three loud speaker models—battery, D.C., or A.C. mains-driven—he prefers. The value of the A.C. model is £12 12s.

The next successful competitor will be awarded a Marconiphone gramophone pick-up, value £3 3s., and the third prize-winner will receive a Marconiphone "Octagon" loud speaker, value £1 10s.

SMALL ADVERTISEMENTS.

With the approach of Easter, slight alterations are necessary in our printing arrangements. The latest date on which small advertisements can be accepted for *The Wireless World* of April 23rd is Tuesday, April 15th.

COSSOR DEPOT FOR LIVERPOOL.

Readers in Lancashire, Cheshire, and North Wales will be interested to learn that Messrs. A. C. Cossor, Ltd., have opened a branch establishment at 42, Paradise Street, Liverpool, for the distribution of Cossor valves and other products.

TAKING OUT A PATENT.

The mysteries associated with patent procedure are clearly explained in "Patents and Trade Marks," the 1930 edition of the brochure issued annually by King's Patent Agency, Ltd., of 146a, Queen Victoria Street, London, E.C.4. The book deals comprehensively with all the problems that are likely to perplex the inventor who seeks the protection of Letters Patent.

PORTABLE INTERFERENCE DETECTOR.

A "radio interference detector" which not only locates the source of disturbance but indicates more or less precisely what kind of apparatus is creating it, has been perfected by two engineers at the Iowa State College, writes an American correspondent.

The device has the appearance of an ordinary portable receiver, but includes an oscillograph which records the waveform of the intruding signal. The inventors hope to supply an interference detector to every municipal authority in the United States.

RADIO DATA CHARTS.

In the design of wireless receivers and associated apparatus a large number of calculations are involved, some of which are by no means simple and would ordinarily take up a great deal of time, even when tackled by those accustomed to working out such problems. By devising charts in the form of abacs it is possible to reduce to comparative simplicity the task of arriving at any required result.

The purpose of the book of "Radio

Data Charts," just issued by the publishers of *The Wireless World*, is to place in the hands of the designer of wireless apparatus a ready means of solving his problems without recourse to complicated formulæ and mathematics. By the use of the charts it is possible to tackle all the more familiar problems in radio receiver design, from such simple requirements as finding the relationship between inductance, capacity, and frequency,

right up to the design of high-frequency transformers and the estimation of stage gain with various types of couplings.

This book of "Radio Data Charts" is based on a series of charts originally published in *The Wireless World*, and now revised and amplified for publication in book form. The pages of the book are approximately the same size as the pages of *The Wireless World*, and the published price is 4s. 6d., or 4s. 10d. post free.

Capacity Coupled Filters

Overall Response Curves Showing Constant Selectivity.

By A. L. M. SOWERBY, M.Sc.

(Concluded from page 353 of previous issue.)

AT the end of the preceding instalment of this article it was stated that for certain purposes it is more convenient to plot a resonance curve to a logarithmic rather than to a "straight" scale. This statement, perhaps, needs a little justification.

If we look at any of the curves accompanying last week's instalment, we shall see that the vertical or "response" scale runs from 0 to 100. Working downwards, the distance from 100 to 10 occupies 90 per cent. of the scale, the distance from 10 to 1 occupies 9 per cent., and the distance from 1 to 1-10 occupies 0.9 per cent. This, at first sight, seems an eminently reasonable allocation of space—and so, for many purposes, it is. But a drop from 100 units to 10 sounds, to the ear, exactly like a drop from 10 units to 1; in each case the response is divided by ten. There is therefore a good

A listener who lives some distance from his nearest station is not likely to be troubled by interference from any transmitter that is not fairly close in wavelength to that which he is trying to receive. He will therefore be interested primarily in attaining reasonable selectivity at frequencies near that to which he is tuned, and will only be interested in assuring himself that the

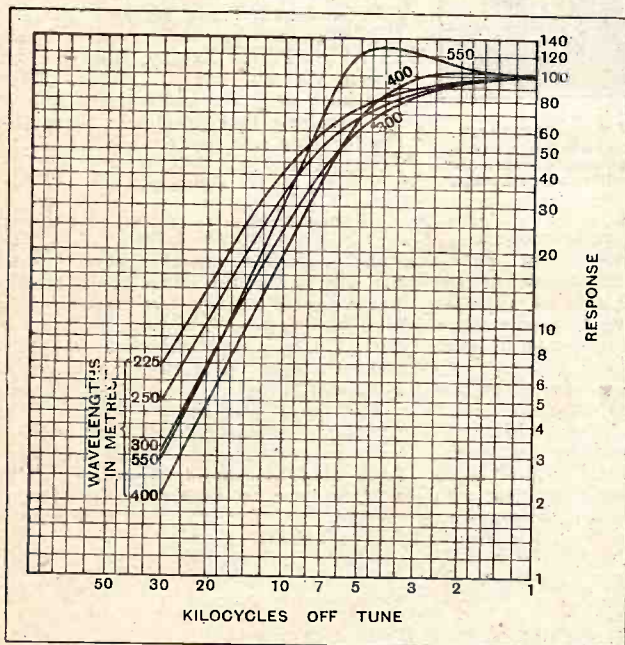

Fig. 6.—Resonance curves of capacity-coupled filter. The coupling capacity is 0.025 mfd.

reason for giving these two drops equal vertical distances on the curve. A glance at any of the diagrams included in this part will show that the logarithmic-scale does exactly this, while drawing out the bottom part of the scale so that it can be read to the same percentage accuracy as the upper part.

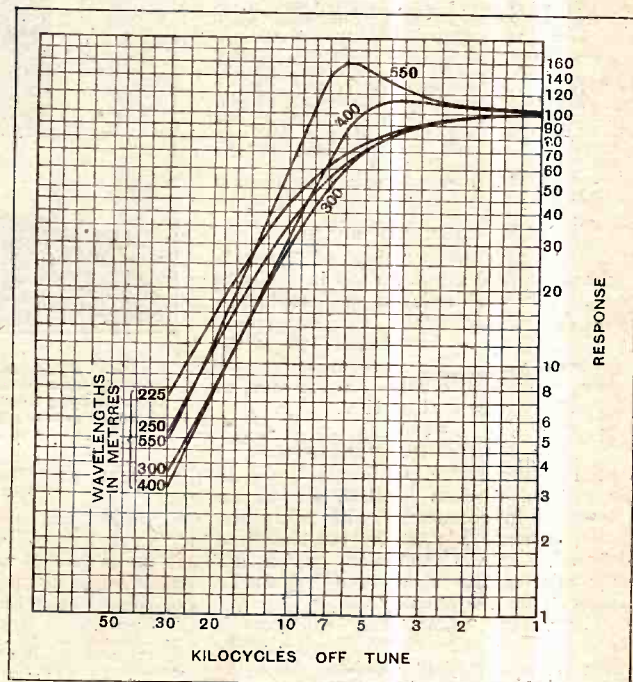

Fig. 7.—Resonance curves of capacity-coupled filter. The coupling capacity is 0.0186 mfd.

overall response-curve of his receiver falls to, say, five or six per cent. at 20 kilocycles from resonance. The logarithmic scale will thus offer him no special advantage over the simpler straight scale. The listener near a powerful station, however, who is in danger of hearing his local station "all over the dial" is more interested in persuading his resonance curve to fall to one-tenth of one per cent. at some 50 kilocycles, and will be compelled to focus his attention on the outlying parts of the curve, for which the logarithmic scale is essential.

With the idea of catering for all needs, the remaining curves accompanying this article are plotted on logarithmic scales.

In the three figures numbered 6 to 8 are plotted reson-

Capacity Coupled Filters.—

ance curves of filters made up in each case from a pair of the coils already described, and coupled by the three different capacities mentioned on the diagrams themselves. One of the diagrams (Fig. 7) repeats, to the logarithmic scale, the curves already given in Fig. 5; it is hoped that the opportunity of comparison between the two modes of presenting the same facts will enable those not familiar with the logarithmic scale to make more readily the transition from the one to the other. The logarithmic scale can never get down to zero, so that half only of the resonance curve can be plotted.

The curves for the three filters should be compared, not only with one another, but with the set of resonance curves of Fig. 9, which are those for the same two tuned circuits arranged in cascade, but not coupled.

The first and most noticeable point in the comparison is that the selectivity of all the filters is less than that of the cascaded circuits. This, of course, is the price that has to be paid for broadening the peak of the curves to prevent loss of side-bands. In the case of the filter with the weakest coupling (largest coupling condenser) the 225, 250 and 300-metre curves show almost the same selectivity, as judged by their height at 30 kc. from resonance, as the simple cascaded circuits. The selectivity at 400 metres has been reduced, by the broaden-

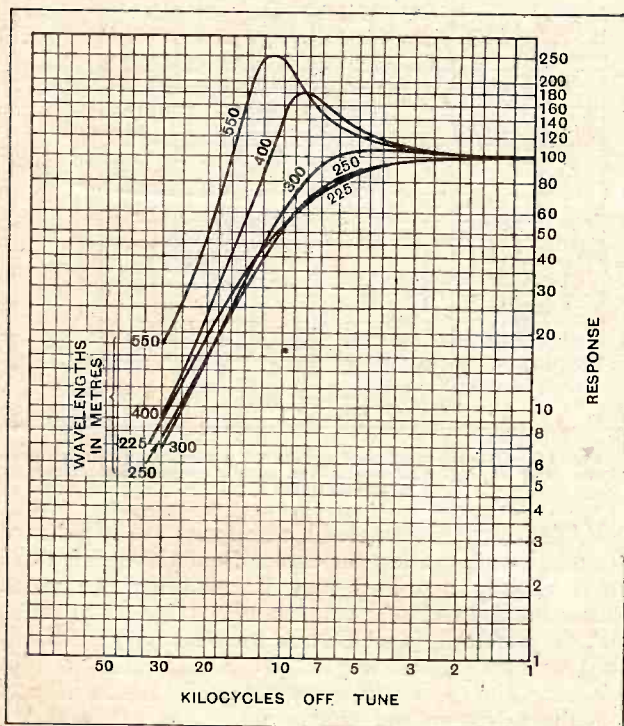

Fig. 8.—Resonance curves of capacity-coupled filter, the coupling capacity being 0.010 mfd.

ing of the curve, until it is very little greater than that at 300 metres, while the 550-metre curve has been pushed back so that at 30 kc. off tune it practically coincides with the 300-metre curve.

In the next filter, coupled by a slightly smaller condenser, the 225 and 250-metre curves are still almost

unchanged, but the broadening of the 300-metre curve is now perceptible even at 30 kc. from the peak. The 400-metre curve occupies much the same position that the 550-metre curve filled in the last filter, and the 550-metre curve is pushed back still farther, and lies now

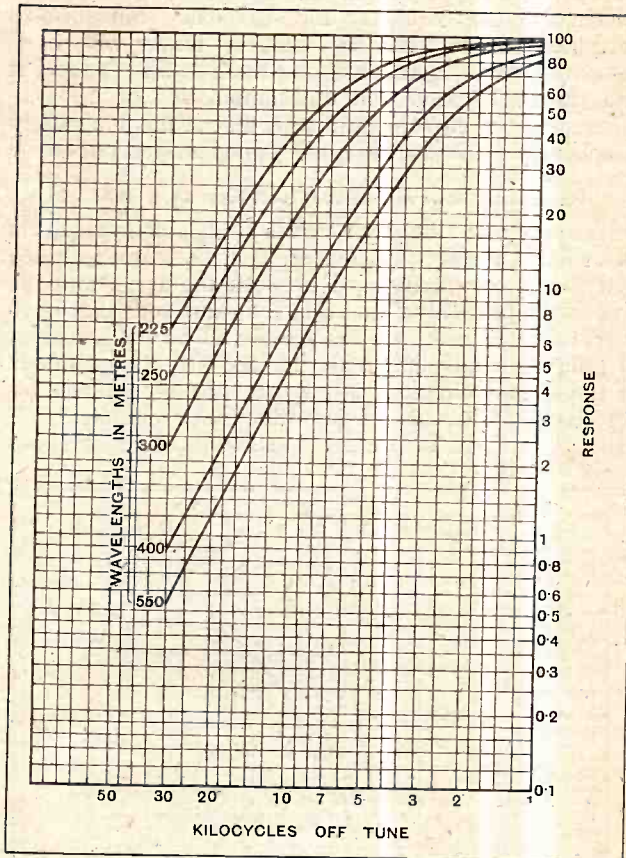

Fig. 9.—Resonance curves of two uncoupled tuned circuits. The coils are those of the filters of Figs. 6, 7 and 8, with which these curves should be compared.

on the 250-metre curve. This filter, considered by itself, offers about the nearest approach to constant selectivity that can be attained. Combined with this, the response at 5 kc. from resonance, which is usually taken to mark the limit of sidebands, does not fall below 70 per cent. at any wavelength. Two of these filters, each used to replace one of the usual single-tuned circuits in an ordinary receiving set, would provide as close an approximation to a perfect tuning system as one is likely to be able to find. The overall response curve of a receiver employing two of these filters is given, as a matter of interest, in Fig. 10. It may be added that a coupling condenser of 0.015 mfd. may quite well be substituted for the 0.0186 mfd. used for the calculation, without running the risk of upsetting the curves to any extent that could possibly be appreciated by the most critical ear.

In the third filter the process of development has gone a stage farther. The closer coupling has now almost reversed the normal order of selectivity at the different wavelengths; the 550-metre curve now shows the least

Capacity Coupled Filters.—

selectivity at 30 kc. from resonance. Moreover, its peaks, 22 kc. apart, are both too widely separated and too high to be satisfactory. This fault, however, may become a virtue if the filter is to be used, not as a unit by itself, but as part of the tuning system of a receiver which also uses ordinary high-frequency transformers or tuned anode coupling. These latter will have resonance curves somewhat like those of Fig. 9, and it will readily be seen that the combination of the 550-metre curve on this diagram with that of this too closely coupled filter will lead to quite a good overall curve.

Resonance Curves of the Receiver as a Whole.

Finally, some resonance curves applicable to receivers as a whole have been calculated. For these it is assumed that the filter will be used between the aerial and the grid of the first valve, and that the same coils that have been taken to make up the filters will be used, singly, as intervalve coupling with the ordinary tuned anode or tuned grid circuits. Allowance has been made for the damping introduced into the tuned circuits by a valve of A.C. resistance 200,000 ohms, which is about

the usual figure for the modern screen-grid valve. Using a single high-frequency amplifier, so that there is one tuned circuit in addition to the filter, the overall response curves are given in Fig. 11. It will be noticed that the filter-coupling recommended is that which was suggested as best for a set employing filters only; the single-tuned circuit, with valve damping, tunes so flatly that its introduction in series with the filter does not modify the resonance curves very seriously.

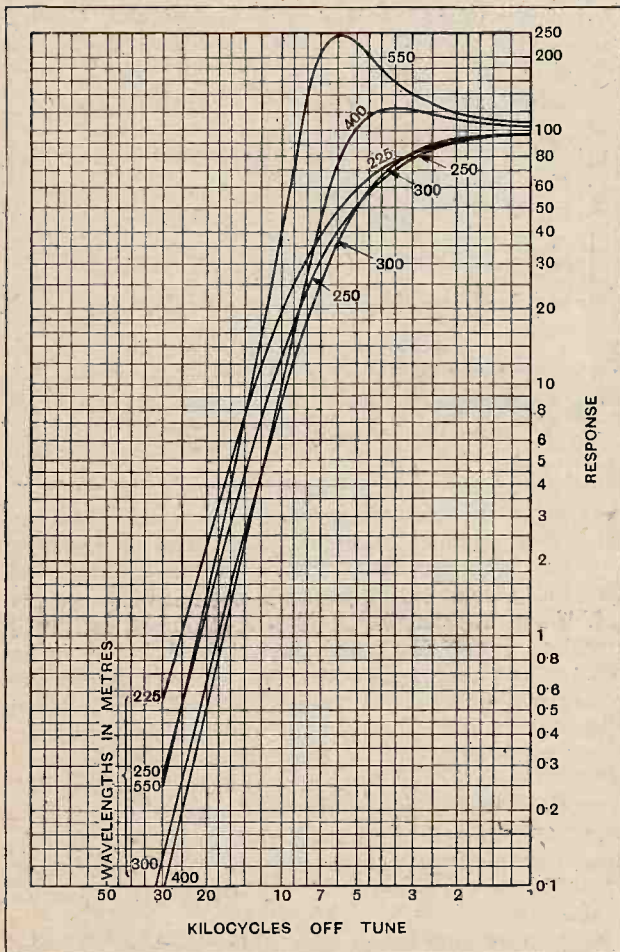

Fig. 10.—Overall resonance curves of a receiver embodying two filters, to the specification of Fig. 7, in cascade. This tuning system, as a whole, is exceptionally good from all points of view.

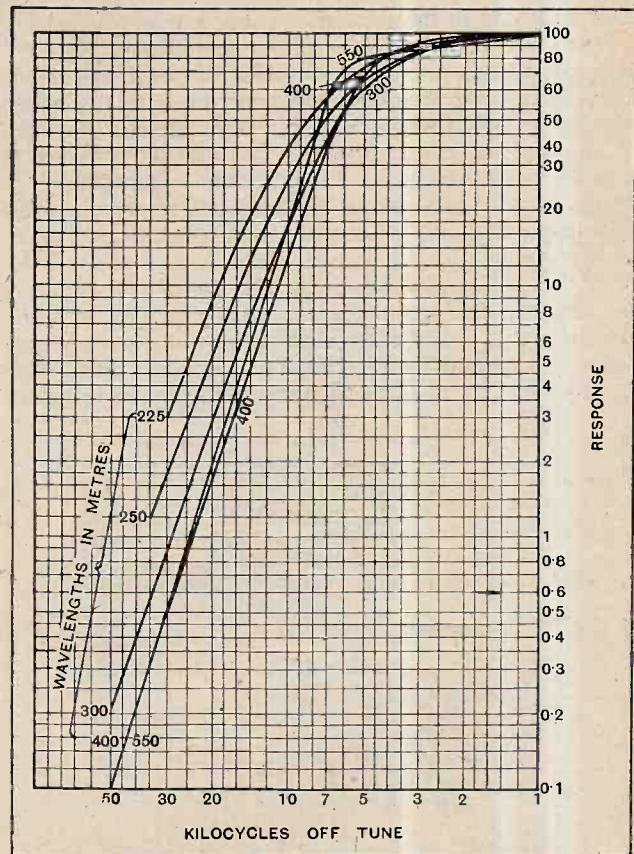

Fig. 11.—Overall resonance curves of a receiver embodying the filter of Fig. 7 in conjunction with a single tuned circuit of conventional type.

If, however, two single-tuned circuits are to be used in cascade with a filter, the choice from among the three filters already described may be made in two ways. Either the most closely coupled filter ($C_m=0.010$ mfd.) may be preferred, in which case the selectivity is reasonably constant over the waveband as a whole, as shown in Fig. 12. The disadvantage of this choice lies in the fact that the sidebands are sacrificed to some extent at the higher wavelengths, as the 550-metre curve shows, owing to the very wide separation of the peaks of the original filter at this wavelength. (Compare Fig. 8.) Alternatively, the less closely coupled filter for which $C_m=0.0186$ mfd. may be chosen, when the overall response becomes that shown in Fig. 13. Here the sidebands are very well retained at all wavelengths, but the selectivity is considerably higher at the upper end of the tuning range. If possible the two-stage high-frequency

Capacity Coupled Filters.—

amplifier should employ two filters and one tuned-anode circuit, thus giving overall curves very similar to those of Fig. 10.

Practical Considerations.

The curves that have been reproduced have all been determined by calculation, but it must not be overlooked that the work has throughout been based on the measured characteristics of the tuned circuits described. As a result, the curves are at least one step nearer the truth than any purely "theoretical" curves can be. It remains to consider what precautions should be taken to prevent them from becoming seriously altered in character when trying to realise them in a practical set.

First, the coupling between each pair of coils. It is essential that there should be no coupling other than

the two sets of fixed plates will tighten the coupling to a very considerable extent. Each filter should be tuned by a single knob, which must control both the condensers simultaneously. To make the ganging effective a "trimming" condenser will in most cases be needed in parallel with one or other variable condenser, and the

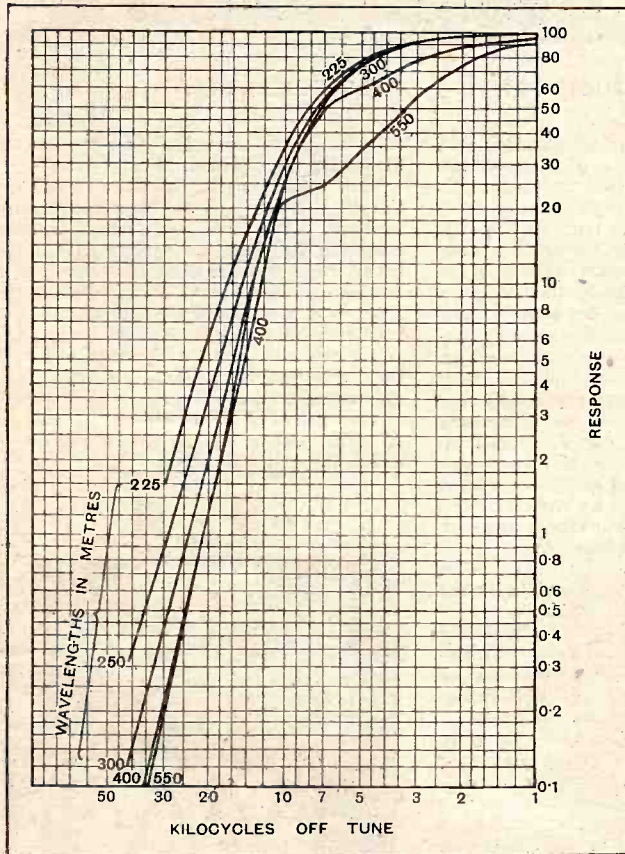

Fig. 12.—Overall resonance curves of receiver embodying the filter of Fig. 8 in conjunction with two tuned circuits of conventional design.

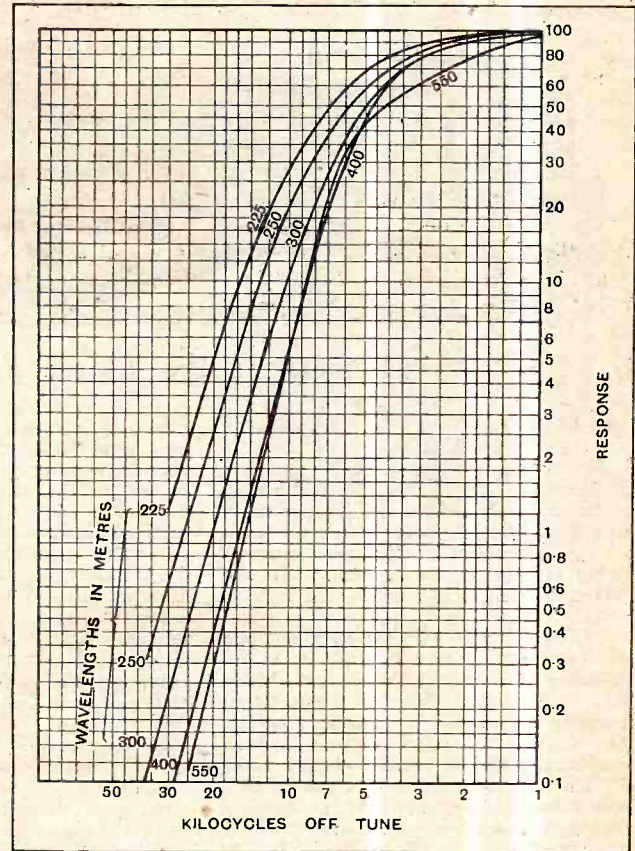

Fig. 13.—Overall resonance curves of receiver embodying the filter of Fig. 7 in conjunction with two tuned circuits of conventional design.

that provided by the coupling condenser, so that the two coils forming a filter *must* be screened from one another. Complete enclosure of the coils in metal boxes is, however, unnecessary; it will suffice if the two are placed in line with one another with axes at right-angles, and are separated by a sheet of earthed metal.

It is highly desirable that the tuning condensers should be placed on opposite sides of this screen, as a very small capacity of only a few micromicrofarads between

coils should, of course, be identical. If desired, the remaining tuned circuits of the receiver may also be controlled by the same knob, but the adoption of this more extended ganging is purely a matter of taste.

Since no allowance has been made for incidental reaction effects when calculating the curves, there must be almost perfect screening between successive stages in any receiver employing high-frequency amplification, and, in addition, the screen-grid valve chosen must have the lowest possible grid-plate capacity. For data on this point, *The Wireless World Valve Data Sheet* (Supplement to *The Wireless World*, December 4th, 1929) should be carefully consulted. The fullest success with any receiver containing a filter can never be attained with valves of high residual capacity.

Careful attention to these few points will ensure that the resonance curves of the completed set will differ but little from those that are predicted by calculation based on information derived from measurements made on the tuned circuits before they are actually built.

WIRELESS WORLD LABORATORY TESTS

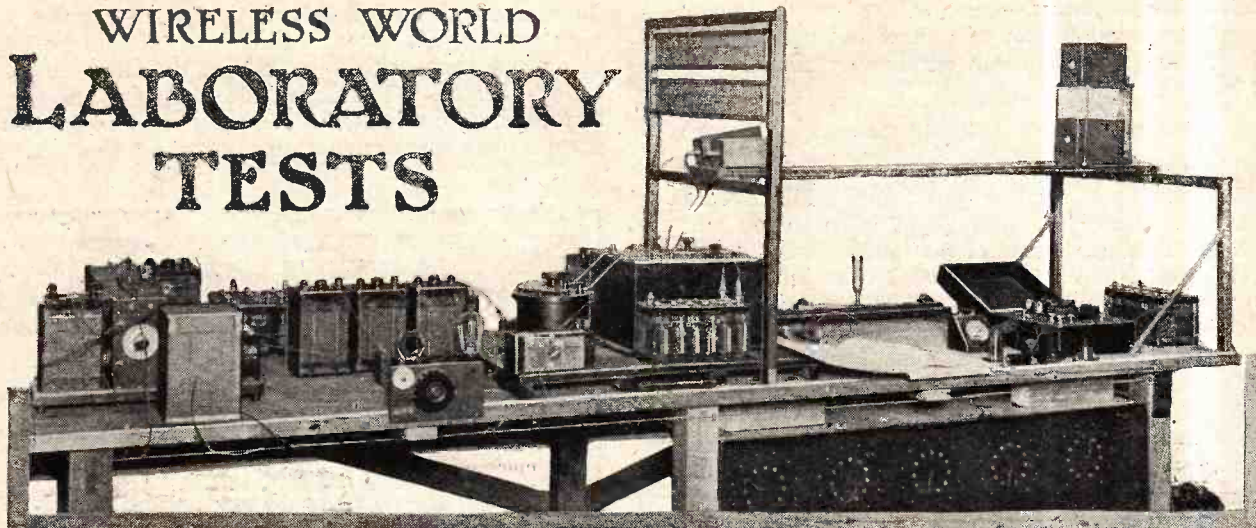

A Review of the Latest Products of the Manufacturers.

VARLEY DUAL-WAVE REGIONAL COILS.

There are two types of Varley Regional coils available—the B.P.3, an aerial-grid coil, and an H.F. transformer, styled the B.P.4. Both models are similar in appearance, and the same constructional features figure in each. It will suffice, therefore, to describe one only in detail.

The aerial unit consists of a medium wave coil wound as a solenoid on a 3in. diameter former, and mounted inside this, but spaced $\frac{1}{2}$ in. from it, is a sectional-wound coil for the long waves. The reaction winding is common to both wavebands, and is carried on the inner former. These coils are mounted on a hollow-moulded bakelite base, in which is accommodated the waveband switch.

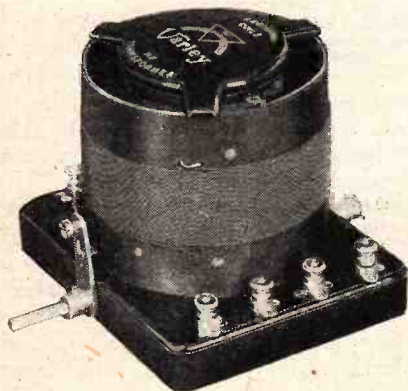

Varley dual-wave Regional coil with built-in waveband switch.

This is operated by rotary movement, and provision has been made to gang the switches, thereby enabling one knob to control two or more units. Multiplicity of control knobs on the panel is by this means avoided.

For medium wave reception the two

grid coils are connected in parallel, and the aerial attached to a tapping on the outside winding. When the switch is moved to the alternative position the long-wave coil only remains in circuit, and the aerial is changed over to a suitable tapping on this coil.

This arrangement appears to work very satisfactorily, as proved by some practical tests carried out with the samples submitted. When connected to an average-sized aerial and tuned by a 0.0005 mfd. condenser, the wave range covered by this coil was from 229 metres to 567 metres, and from 885 metres to 2,250 metres. Capacity control of reaction was employed, and this proved satisfactory over the entire range covered by the coil. The winding, and its relationship to the two coils, has been well proportioned.

Selectivity on the medium waveband is reasonably good, and comparable with the design of the unit, but where interference is particularly bad a very selective arrangement can be assembled by employing two aerial units carefully screened to preclude magnetic coupling, but linked together by a small variable condenser.

The secondary windings on the H.F. transformer are similar to the grid coils on the B.P.3 unit, but it carries in addition a primary winding designed for use with screen-grid valves. The primary is common to both wavebands. There is, also, a reaction coil. The wave range covered by this unit was from 227 metres to 556 metres and from 760 metres to 2,229 metres when tuned by a 0.0005 mfd. condenser.

The makers are Varley, Kingsway House, 103, Kingsway, London, W.C.2, and the price of the units is £1 1s. in each case.

o o o o

A NEW CABINET.

For those who prefer to combine a standard Philips type receiver and loud speaker in a single cabinet, an attractive container has recently been produced by

Messrs. John Moores & Company, Ravald Street Works, Salford, Manchester.

The accompanying illustration shows the cabinet designed to house the Philips receiver, Type 2511, with which is combined an Amplion loud speaker. On the cover, over the small control panel, is a station log. Absence of tuning dials in the front is a merit of the arrangement, but it is necessary to gain access to the ends of the receiver through the two side panels for both tuning in and adjusting the volume control.

The price of the cabinet in oak is £7 10s. Other models are available in mahogany and walnut.

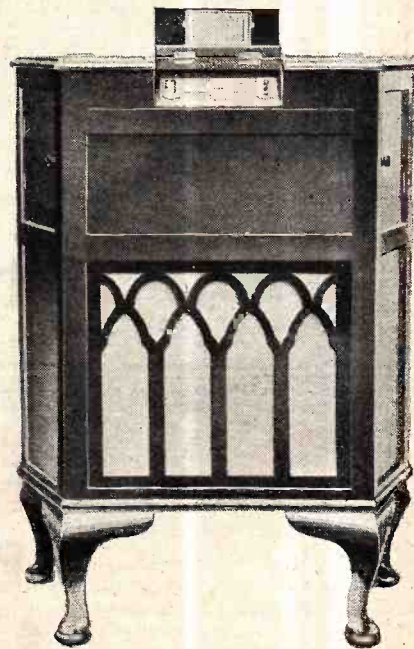

The Moores cabinet designed to combine a Philips receiver and Amplion loud speaker.

GAMBRELL MODULATED C.W. WAVEMETER.

The crowded nature of the ether, particularly on the medium broadcast waveband, precludes ready identification of foreign stations received, and, furthermore, hinders tuning-in to any one particular transmission that may be of especial interest to the listener at the time. With a view to overcoming these difficulties, Gambrell Radio, Ltd., Buckingham House, Buckingham Street, Strand, London, W.C.2, have placed on the market a modulated C.W. wavemeter which covers all wavelengths from 180 to 2,000 metres.

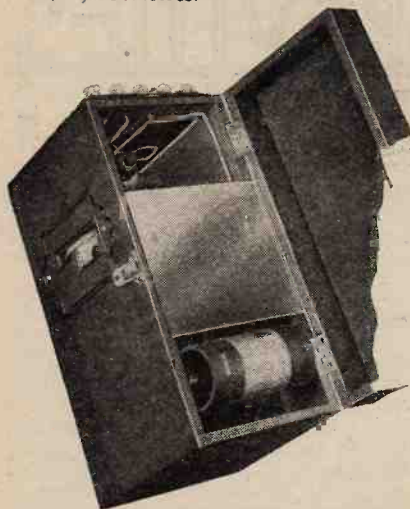

McLachlan modulated wavemeter and radio station finder, made by Gambrell Radio, Ltd.

The principle on which it operates is that of the negative resistance property of the screen-grid valve when the screen potential is of a higher order than that of the anode. The working grid is given a small positive potential by connecting it direct to the L.T. positive. Under these conditions the valve will oscillate if a reasonably low-loss tuned circuit is connected between the anode and the source of high tension.

In the Gambrell model, which, incidentally, is made to the patent specification of Dr. N. W. McLachlan, there is included, also, a modulating circuit which takes the form of an iron-cored inductance shunted by a condenser and interposed between the radio-frequency circuit and the H.T.+1 terminal. The constants of this circuit have been chosen to produce a low-frequency oscillation of 800 cycles. Thus there are two sets of oscillations, one of which is variable and the other fixed, so far as frequency is concerned.

Since many modern sets are not fitted with reaction circuits, they give no audible response to unmodulated signals, and an audible note is essential for tuning purposes. With such sets the 800-cycle note will be used for tuning, but where reaction is available tuning can be carried out by heterodyning the radio-frequency output from the wavemeter. With either method the degree of accu-

racy obtained is governed by the limitations imposed by the wavemeter condenser scale.

The indicator fitted does not permit reading to within much closer limits than half a division on the 180-degree scale. The calibration chart cannot be read to a greater accuracy than this, so, perhaps, there would be little gained by arranging for finer tuning on the condenser.

Some practical tests were made, using a laboratory standard wavemeter, and we found that with the Gambrell model set to 300 metres, according to its chart, the measured wavelength was 299 metres. A similar test at 400 metres gave a reading on the Laboratory standard of 398.5 metres.

The makers recommend 2 volts L.T., about 40 to 60 volts to H.T.+1 and about 100 volts to H.T.+2. The sample tested functioned best with 30 volts at H.T.+1 and 85 volts at H.T.+2. The L.T. was 2 volts. With these values the total current drawn from the H.T. battery was 6.6 mA.

The price of the wavemeter is £6 with coil and chart to cover 180 to 600 metres, the extra coil and chart to extend the wavelength from 600 to 2,000 metres costing £1.

o o o

LOEWE SMOOTHING CONDENSERS.

The Loewe Radio Co., Ltd., 4, Fountain Road, Tottenham, London, N.15, has recently introduced a range of large-capacity paper dielectric condensers for use in mains-operated sets, battery eliminators, and such other purposes where large-capacity condensers are specified. These are assembled in neat metal cases and tested to 500, 700, 1,000 and 1,200 volts D.C. The standard capacities range from 0.1 mfd. to 10 mfd.

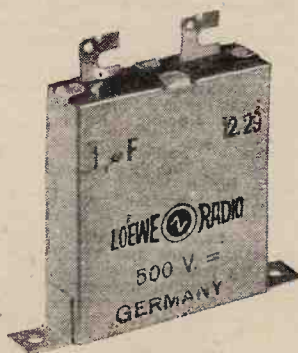

Loewe 500-volt D.C. test 1 mfd. paper dielectric condenser for use in mains sets and eliminators.

A sample of 1 mfd. condenser rated at 500 volts D.C. test was sent in for test. Its small size—it measured 1½ in. wide, 2 in. high and ½ in. thick—occasioned some doubt regarding its capacity to withstand the test voltage, but this was soon dispelled, as, although it was subjected to a pressure of 900 volts D.C., it showed no trace of leakage. Furthermore, it held its charge, as some considerable time after test a fat discharge spark could be obtained by shorting its lugs.

As the working voltage of a 500-volt test condenser is of the order of 200 volts D.C., the factor of safety of Loewe condensers is extraordinarily high, and they can be confidently recommended. The prices range from 1s. 2d. for a 0.1 mfd. to 11s. for a 10 mfd. size.

o o o

"PREMIER" L.F. TRANSFORMERS.

These transformers are made by the Premier Radio Co., 160, Aston Road, Birmingham, in 3:1 and 5:1 ratios, the price being 5s. 6d. in each case. The amplification afforded by the 3:1 model, when preceded by a 20,000-ohm-type valve, is a little below the average for a combination of valve and transformer of

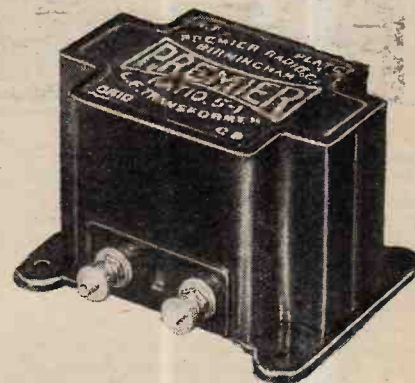

"Premier" L.F. transformer.

this ratio. It is reasonably uniform over the middle register, but tails off at each end of the audible scale. In orchestral music this is noticeable by a lack of bass, but it does not appear to affect the reproduction of speech. By using a valve of lower A.C. resistance to precede the transformer a better level was obtained, but the amplification of the stage was lowered.

The 5:1 ratio exhibited similar characteristics, and it was found that the best all-round results were given by employing a valve of about 8,000 ohms A.C. resistance to precede this component.

CORRECTIONS.

Owing to an unfortunate miscalculation, the current required for a full-scale deflection on the 150-volt range of the "Sifameter" reviewed on page 233 in our issue of February 26th last was given as 50 mA. As the D.C. resistance of this range is 5,200 ohms, a current of approximately 28 mA. only will be required for a full-scale reading.

o o o

In the test report on the Varley multi-volt transformer, published on page 306 in our issue of March 19th last, it was stated in error that the Westinghouse units R.4-2-1 and R.4-2-2 gave half-wave rectification. These models are, of course, bridge-connected, giving full-wave rectification, and have been designed especially for battery charging.

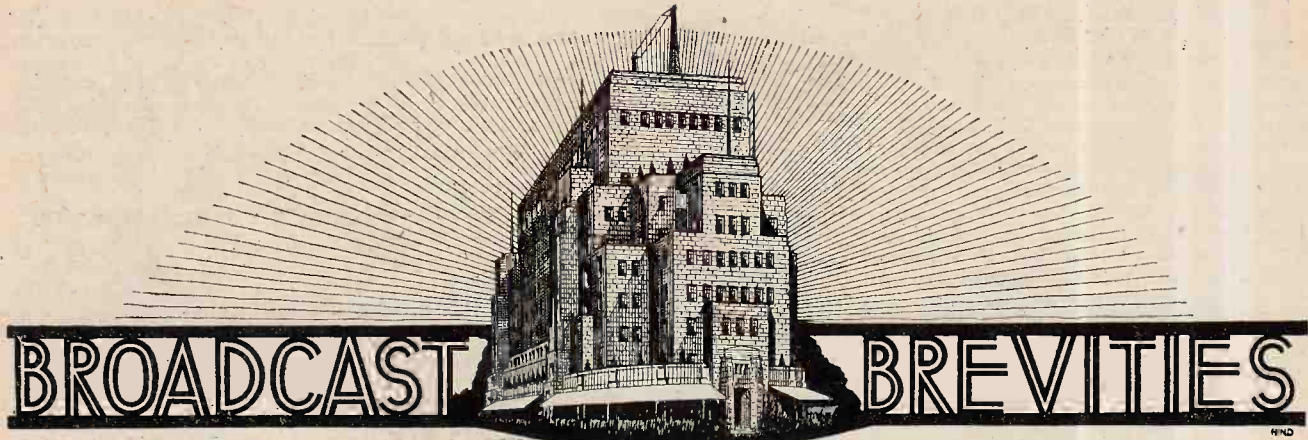

By Our Special Correspondent.

**5SW to Relay Boat Race.—Money for the Regional Scheme.—Midland Listeners in Trouble.—
B.B.C. and the F.A.—A Budget Broadcast.**

Boat Race Relay to the Empire . . .

It is good to learn that the running commentary on the Boat Race will also go out from 5SW. This is the first time that Colonial listeners have had a chance to hear what is undoubtedly one of the most vivid and satisfactory relays that the B.B.C. is able to stage.

o o o o

. . . And to Germany.

The Germans have always shown an extraordinary interest in the University Boat Race, and this year their enthusiasm is so great that arrangements are being made to relay the event to the more important broadcasting stations in the Fatherland.

o o o o

B.B.C. Finance.

Onlookers who wonder why the B.B.C. is so slow in developing this magnificent regional scheme will find an explanation in the financial statement contained in the Governors' Third Annual Report, soon to be submitted to the Postmaster-General. The B.B.C. is playing for time—and more money.

o o o o

An Interesting Report.

Although the number of licences continues to increase the proportion of income finding its way into the B.B.C. coffers is steadily declining, while that accruing to the Treasury and the Post Office is increasing. The approximate figures, which, I understand, will shortly be made public, show that for the year 1929 the Post Office is taking an additional £20,000 from the gross revenue (£1,470,000 in 1929 as against £1,307,000 in 1928).

The Treasury's share is £70,000 in excess of that for the previous year, i.e., £342,000 compared with £272,000 in 1928.

o o o o

The Share-out.

The licences in force at the end of last year reached a total of 2,956,736, which was 329,000 higher than the 1928 figure.

Actually, therefore, the increase in the licence revenue was £164,500, but the B.B.C.'s share in this increase will be only £72,000.

Where the Money Goes.

Since the Corporation was established at the beginning of 1927 the gross amount of wireless licence payments has been £3,969,000, of which Savoy Hill has received £2,617,000, the Treasury £856,000, and the Post Office £496,000.

o o o o

Regional Delays Explained.

With regard to the regional scheme, the total amount which the B.B.C. was able to place in the regional reserve fund at December 31st last was £300,000.

This is nowhere near the amount required for the completion of the scheme; in fact, I understand that until a fresh instalment rolls in from the Post Office

the B.B.C. can do little towards the erection of the Scottish Regional station at Falkirk.

o o o o

Payments Out of Revenue.

Most listeners will agree, however, that all new broadcasting projects should be paid for out of revenue. The B.B.C. Charter gives the Corporation power to raise a loan, but even if we assume that the necessary amount could be raised by these means, the payment of interest would fall on the shoulders of the listener.

The programmes already show signs that "economy" is being practised, as witness the recent broadcasting of Lord Hewart's speech from all stations and the increasing tendency to use London as a centre of mass production.

o o o o

Grief in Birmingham.

This policy of programme centralisation is a cause of growing concern in the provinces. At the moment the storm clouds are centred over Birmingham, where there is genuine grief at the probability that the Birmingham studio orchestra will be disbanded in the autumn. It is no consolation to Birmingham music lovers to know that the same fate threatens the studio orchestra at Manchester.

o o o o

A Mistaken Impression.

To add to the general grief, the impression has gained ground in Birmingham that the local studio is to disappear with the orchestra. I am assured at Savoy Hill that this is not so; under the regional scheme the existing studios in both Birmingham and Manchester will continue to provide a large amount of material by local artistes.

o o o o

Football by Instalments.

The rather undignified passage of arms between the B.B.C. and the Football Association having ended as unpleasantly as it began, the B.B.C. has decided to relay the Cup Final on the instalment system in the same manner as last year. There will be seven commentators, each of whom will be allotted eight minutes

FUTURE FEATURES.

National (261 and 1,554 metres).

APRIL 13TH.—Service relayed from St. Martin-in-the-Fields, with address by Rev. F. H. Gillingham.

APRIL 14TH.—"Diversions" (6).

APRIL 15TH.—Symphony concert relayed from the Queen's Hall.

APRIL 16TH.—Swedish National programme.

APRIL 17TH.—"The Son of Man," an Act of Devotion for Passiontide, by Lois Mary Shiner.

APRIL 18TH.—"Parsifal," relayed from the Queen's Hall.

London Regional.

APRIL 14TH.—"Now and Then," a contrasting feature programme.

APRIL 16TH.—Popular orchestral concert.

APRIL 17TH.—Instrumental concert.

APRIL 18TH.—Part of Bach's St. Matthew Passion, relayed from Leipzig.

Midland Regional.

APRIL 16TH.—"The Fourth Proposal," a Cotswold farce, by F. Morton Howard.

APRIL 17TH.—Concert by Worcestershire Association of Musical Societies, relayed from Public Hall, Worcester.

APRIL 19TH.—"The Dumbleton Fête and Gala," a Ballegorical Cantorio.

Gardiff.

APRIL 13TH.—Mozart programme relayed from the Town Hall, Maesteg.

Manchester.

APRIL 19TH.—"Spring Cleaning, or Gather ye Cobwebs While ye May," orchestral programme.

Glasgow.

APRIL 15TH.—"As Ithers See Us" (1), Dr. Berthold Wiesner.

at a microphone installed in a house adjoining the Wembley Stadium.

The Jazz Background.

The summary of the first half will be given by Mr. Derek McCulloch, and the entire game will be discussed by the last commentator, Captain H. B. R. Wakelan.

Last year the breathlessness of the speakers after their scramble from the Stadium made their remarks rather difficult to follow. This year no attempt will be made to give a continuous narrative; when each commentator has told his story a five minutes interval will follow in which we shall be able to digest his remarks to a jazz band accompaniment.

Those Musical Backgrounds.

Musical backgrounds are regarded as indispensable in American broadcasting. Recently a trio was employed by the American National Broadcasting Company to provide a suitable musical background to a talk on dressing up cold lamb. No doubt this provided a good opportunity for the bleating saxophone.

S.O.S.

It surprises me to learn that fewer than 50 per cent. of the S.O.S. messages sent out by the B.B.C. are successful. During 1929 the number transmitted was 881, of which 367 reached their objective. The fruitless calls numbered 475, while the results of 39 were unknown.

A Budget Broadcast.

Although most people are vitally interested in the Budget it would probably need superhuman endurance and concentration to listen by wireless to its recital in the House of Commons. A better way

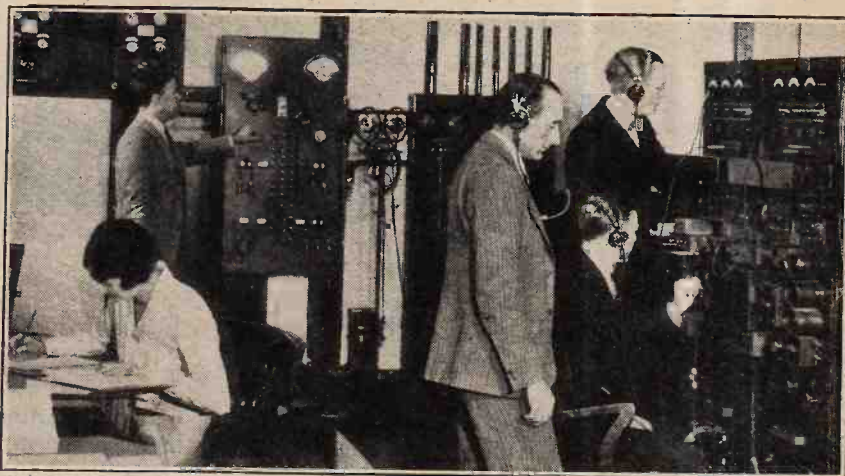

AN AMERICAN CONTROL ROOM. A busy scene in the control room of KPO, the American National Broadcasting Company's station at San Francisco.

has been discovered. On April 15th, the day following its presentation in the House, the Chancellor of the Exchequer will himself explain its intricacies to listeners who tune in to the National programme on that evening.

Cecil Lewis Again.

Mr. Cecil Lewis, former chief of programmes at Savoy Hill, has now returned from America, whither he went to produce plays for the National Broadcasting Company. "Lord Jim," "R.U.R.," and "Saint Joan" were some of the radio-dramas which he produced for the B.B.C., and he is resuming his work in this country with a radio adaptation of

"The Four Feathers," A. E. W. Mason's novel. This will be broadcast on May 8th.

Transmitter or Receiver?

"Has the B.B.C. been advertising a brand of grape juice?" was the question recently put to the organisers of the Children's Hour by an anxious parent whose little girl had petitioned him for some grape juice of the sort recommended by the B.B.C.

Urgent enquiries were instituted, and finally it was discovered that the child had been listening to a Greek play in which occurred the appeal: "Oh Great Zeus, hear us!"

The B.B.C. engineers insist that the fault was in the receiver.

A Cathedral Broadcast.

On Easter morning (April 20th) listeners will hear the service from Canterbury Cathedral.

"Proms." in the North.

Broadcasting makes another important contribution to musical history in the arrangement which has been arrived at between the B.B.C. and the Hallé Concert Society for a season of Northern Promenade Concerts in Manchester, Leeds and Liverpool during the summer months. So far as I am aware, this is the first opportunity given to Northern music lovers to taste the delights of "promenade" concerts as originated by Sir Henry Wood at the Queen's Hall.

A Famous Conductor.

The season will start on May 26th in the Free Trade Hall, Manchester, where performances will be given during two weeks. Liverpool audiences will have their opportunity of attending promenade concerts at the Philharmonic Hall from June 9th to 14th, and the final week of the season will be in the Leeds Town Hall from June 16th to 21st. Sir Hamilton Harty will be conducting throughout the season.

These promenade concerts will be used not only as contributions to the Northern English programmes, but also to the National and other transmitters.

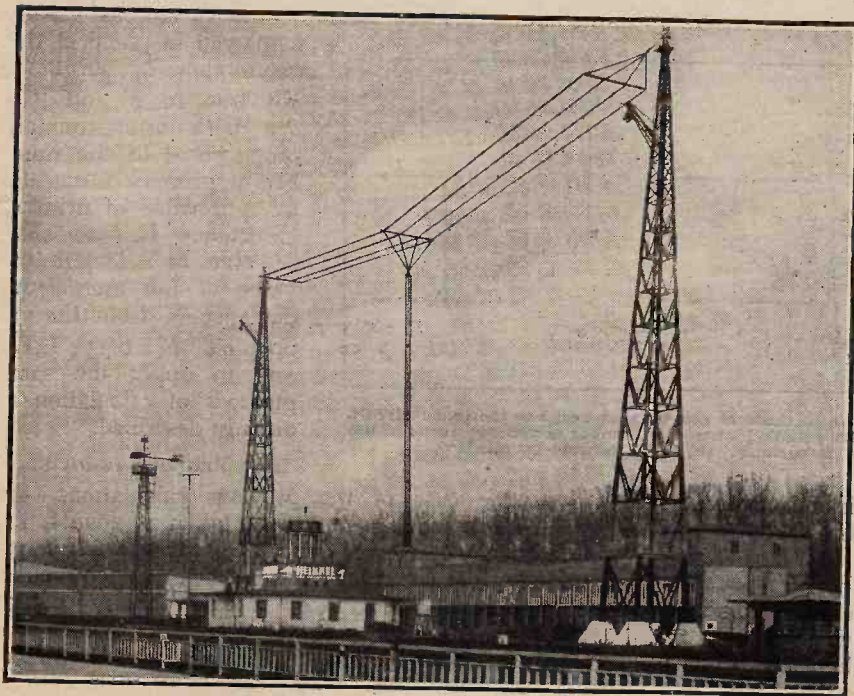

THE "CROYDON" OF GERMANY. The wireless station at the well-known Tempelhof aerodrome at Berlin. Messages from the Graf Zeppelin have been picked up by this station and relayed to German listeners.

WIRELESS THEORY SIMPLIFIED



By S. O. PEARSON,
B.Sc., A.M.I.E.E.

Part XXVI.—Further Details of Coupled Aerial Tuning.

(Continued from page 367 of previous issue.)

THERE are three methods which enable the selectivity to be altered in the case of coupled aerial tuning where the aerial circuit itself is untuned but inductively coupled to a tuned secondary circuit. These methods are (a) by varying the mutual inductance between the circuits, e.g., by means of a variocoupler; (b) by keeping a tight coupling and varying the ratio of primary to secondary turns, e.g., by means of tappings on the primary coil; and (c) by connecting a series condenser in the aerial circuit.

Detailed consideration has already been given to method (a) in which the primary and secondary inductance values were kept constant, and attention is now directed to method (b), which possesses a decided advantage from the mechanical point of view, in that no movable part is necessary. The primary and secondary windings are usually wound on the same former so that they are in fixed positions relatively to each other. Sometimes the primary turns are wound over the secondary turns with spacers between to keep the two windings separated radially by a tenth of an inch or so; or the primary turns may be wound in grooves sandwiched in between those carrying the secondary winding. A third arrangement is that in which the primary coil is wound at one end of the former, which carries both windings, a small separating space being left blank between them. The two windings should never be wound in contact with each other, even if well-insulated wire is used, as this results in a considerable amount of undesirable capacity coupling.

Primary Winding with Tappings.

In order to show the effect of changing the turns ratio of the primary and secondary coils, it will be most convenient to consider an arrangement where the primary is tightly coupled to the secondary. Either of the first two winding arrangements referred to above will conform to this condition.

It is unfortunate that there is no simple relationship between the number of turns in a coil and its inductance—the inductance depends on the shape and dimensions of the coil as well as the number of turns. And so we are forced in a theoretical consideration of this nature to find how the selectivity and signal strength vary in terms of the ratio of inductances of the coils rather than in terms of the ratio of turns. In the case of a practical measurement it would be easier to employ the latter ratio.

In the investigation to follow, it will be assumed that the primary inductance is the independent variable quantity, the inductance in circuit being varied by connecting the aerial to different tappings on the primary winding, as shown in the circuit diagram of Fig. 1 (a). We shall have to assume further that the coefficient of coupling is the same for all tappings, having a moderate value of, say, 35 per cent., so that $\frac{M}{\sqrt{L_1 L_2}} = 0.35$ throughout. With a narrow primary coil as usually

employed in practice, this assumption is substantially true, for M and $\sqrt{L_1}$ are both approximately proportional to the number of primary turns. So for any value of primary inductance L_1 , we shall be able to calculate the value of the mutual inductance M from the expression $M = 0.35 \sqrt{L_1 L_2}$, and to apply the same methods of calculation as already described.

Best Primary Inductance.

As in the case of the previous calculations, the secondary coil inductance will be taken as $200 \mu\text{H}$, the high-frequency resistance being 15 ohms at a frequency of 1,000 kc. per second, or a wavelength of 300 metres. Also, the aerial inductance = $10 \mu\text{H}$, capacity = 0.0002 mfd. and resistance = 40 ohms, as before.

We know from experience that for wavelengths of this order the aerial coil should consist of not more than ten or twelve turns, and therefore the change of reactance of this coil is not likely to make any appreciable

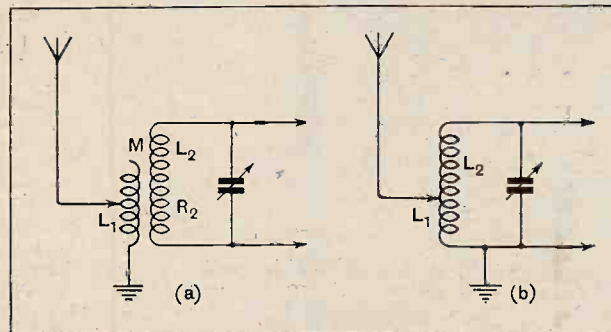

Fig. 1.—Two methods of coupling an aerial to the tuned circuit. (a) Inductive coupling where the number of primary turns in use is variable. (b) Direct or auto-coupling.

Wireless Theory Simplified.—

difference to the total aerial circuit reactance when the number of turns is varied over a limited range, chiefly because the aerial reactance is mainly condensive and large compared with the inductive portion.

For constant aerial reactance it was shown that maximum current occurs in the closed secondary circuit (which is tuned to resonance) when $X_m = \sqrt{X_1 R_2}$ ohms (approximately), or when the mutual inductance between

the coils is $M = \frac{\sqrt{X_1 R_2}}{2\pi f}$ henrys, where X_1 is the

resultant aerial circuit reactance. By assuming that X_1 remains fairly constant, we can apply the same method here for finding roughly the value of primary coil inductance which will give the greatest signal strength.

Without an aerial coil the aerial reactance works out to 734 ohms at 1,000 kc., and with a 20 μ H coil in series the total reactance becomes 610 ohms. The average value of X_1 over this range is thus about 670 ohms, and we can use this value for finding approximately the mutual inductance which will give the greatest signal strength, thus:—

$$M = \frac{\sqrt{670 \times 15}}{2\pi \times 10^6} \times 10^6 = 16 \mu\text{H}.$$

But $M = 0.35\sqrt{L_1 L_2}$, where $L_2 = 200 \mu\text{H}$, so that $0.35\sqrt{200 L_1} = 16 \mu\text{H}$, from which $L_1 = 10 \mu\text{H}$ approximately for maximum signal strength. If, then, we calculate the secondary currents for various values of primary coil inductance by the method fully explained in the previous part, and plot the results as a graph, the maximum point of the curve should occur when the primary coil inductance is about 10 μH .

Before we can proceed with the calculation on these lines, however, it is necessary to determine the value of the mutual inductance for each arbitrary value of aerial coil inductance. As an example, let us consider that the inductance L_1 of that portion of the primary coil which is in circuit is 15 μH . The mutual inductance will then be $M = 0.35\sqrt{200 \times 15} = 19.2 \mu\text{H}$, and the mutual reactance of the circuits will be $X_m = 2\pi f M = 120$ ohms. The total aerial circuit inductance is $L_1 + L_a = 25 \mu\text{H}$, giving a reactance of 157 ohms; the condensive reactance, as previously found, is -797 ohms. The resultant primary circuit reactance is therefore $157 - 797 = -640$ ohms. The apparent increase of primary resistance $R_1' = \frac{X_m^2}{R_2}$ is next found, and the calculation proceeds in exactly the same way, as explained in the previous part for the case of variable mutual inductance and fixed coil inductance.

The values of secondary current have been determined in this manner for primary coil inductance values ranging from zero to 60 μH , for wavelengths of 300 metres and 500 metres. As before, the signal voltage induced in the aerial was assumed to be 10 millivolts and the secondary circuit resistance 15 ohms at 300 metres and 10 ohms at 500 metres. The results are given by the curves of Fig. 2, the respective wavelengths being indicated on each.

These two curves show at a glance the important bearing the aerial coil inductance has on the signal strength, which is assumed to be proportional to the secondary current. At 300 metres the current reaches a maximum value when the primary inductance is about 10 μH —in agreement with the preliminary estimation above—and falls away rather rapidly for inductance values above 20 μH or so, and very rapidly between 5 μH and zero. On the other hand, at 500 metres the highest signal strength occurs for primary inductance values between 20 μH and 60 μH , the curve being very much flatter.

When the aerial coil consists of a winding without tappings, and therefore having fixed inductance,

the number of turns must be so chosen that a fair degree of signal strength is obtained over the whole of the tuning range—a compromise must be struck between the number of turns giving maximum signal strength at the shortest wavelength and the number required for the same condition at the longest wavelength. For the case under consideration the curves of Fig. 2 indicate that the best inductance value to choose would be about 23 μH . Now, from tables giving the inductances of coils of various diameters wound with a specified number of turns per centimetre, the necessary number of turns can be estimated. Such tables are found in *The Wireless World* Diary and in almost any wireless handbook. For instance, suppose the primary coil is to have a diameter of 8 cms: and to be wound with ten turns to the centimetre; then for 23 μH we should require thirteen turns. If the spacing between the turns is a little greater than 1 millimetre it would be better to use fourteen turns. (It is interesting to note that this was the number of turns chosen for the original "Everyman Four" receiver, which also had a 200 μH secondary coil.)

How the Selectivity is Affected.

The selectivity numbers have been computed for wavelengths of 300 and 500 metres over a primary coil inductance range from zero to 60 μH , and the respective results are shown by the curves of Fig. 3. The method of calculation is identically the same as that explained in last week's issue, and is therefore not repeated here.

With the chosen inductance value of 23 μH , the

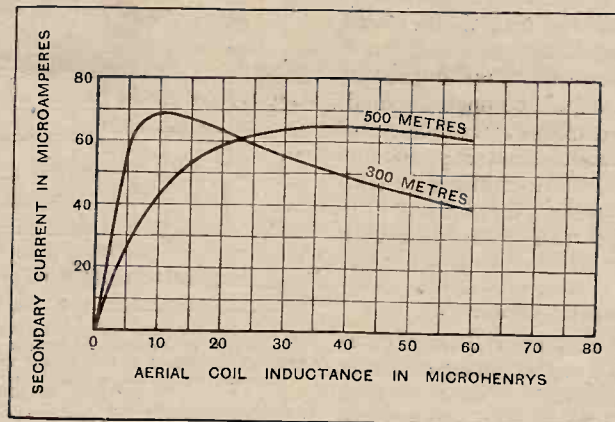

Fig. 2.—Curves showing how the signal strength depends on primary coil inductance, the coefficient of coupling $\frac{M}{\sqrt{L_1 L_2}}$ being constant.

Wireless Theory Simplified.—

selectivity happens to be the same for each of the wavelengths, but this is merely a coincidence. However, this figure is not much below the maximum possible, which shows that the 13-turn primary coil would be suitable from every point of view.

Auto-Transformer Coupling.

Instead of using a separate primary coil, the aerial is sometimes connected to a tapping on the main tuning coil, as shown at (b) in Fig. 1. With such an arrangement the theory and calculation are almost the same as that of circuit (a). Only a slight difference arises out of the fact that a few of the turns are common to both aerial and tuned circuits, and the vector sum of the two currents flows through these turns—it was pointed out on page 281 (Fig. 3) that these two currents are 90° out of phase. But since the aerial current is small compared with that in the closed circuit, practically no error will be introduced by assuming that the currents are flowing in separate windings, as in circuit (a), with the corresponding tightness of coupling; then all the foregoing arguments and calculations can be applied with equal effectiveness.

Series Condenser in Aerial Circuit.

It is usually recommended when an aerial tuning circuit is insufficiently selective that a condenser of about 0.0001 mfd. capacity should be connected in series with the aerial lead to the set. The main effect of such a procedure is greatly to increase the reactance and impedance of the aerial circuit. Now, it was shown that the apparent increase of secondary circuit resistance, in the case of magnetic coupling, is inversely proportional to the square of the aerial impedance and directly proportional to the aerial resistance (equation 3 of Part

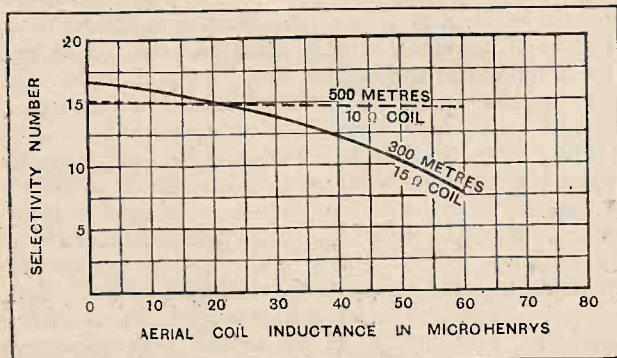

Fig. 3.—Curves showing how the selectivity is affected by changing the primary coil inductance.

XXIV). Since the reactance of an untuned circuit is large compared with the resistance, the impedance and reactance will be nearly equal, and from this it follows the apparent increase of secondary resistance is almost inversely proportional to the square of the aerial circuit reactance.

The selectivity is itself inversely proportional to the total apparent resistance of the secondary circuit, and therefore will be increased when the aerial circuit reactance is raised by the introduction of a series condenser.

As an example we can take a case in which the aerial and secondary circuits are rather too tightly coupled, with the result that the selectivity is impaired, although the secondary resistance might be reasonably low. In Part XXV calculations were made for a $20 \mu\text{H}$ aerial coil coupled by various degrees to a $200 \mu\text{H}$ secondary coil. With a mutual inductance of $60 \mu\text{H}$ between the coils, the selectivity number at 300 metres was found to be 9.83 as calculated on a 10 per cent. signal strength basis. This coupling is obviously much too tight, for by reducing the mutual inductance to $15.2 \mu\text{H}$, the

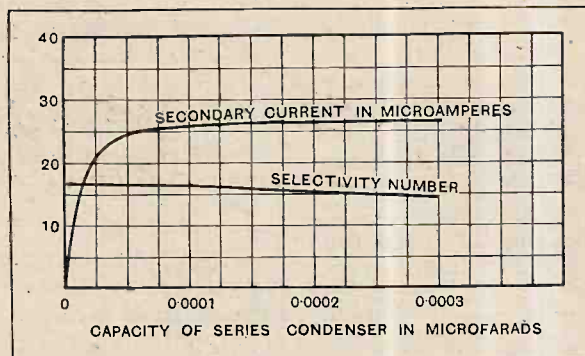

Fig. 4.—How the selectivity and signal strength are affected by the value of capacity in series with the aerial when the latter is tightly coupled to the tuned circuit. The selectivity is only 9.3 without the series condenser. The curves are for a wavelength of 300 metres.

value which gives maximum signal strength, the selectivity number increases to 15.9, as shown by the full-line curve of Fig. 4 of the previous part.

In the case then considered, the aerial capacity was 0.0002 mfd., or 200 micromicrofarads. Now, suppose that a condenser of 0.0001 mfd. capacity is connected in series with the aerial circuit so that its total effective capacity is reduced to 66.7 micromicrofarads. This causes the resultant aerial reactance to be increased from -606.5 ohms to $-2,201$ ohms, the inductive reactance of 188.5 having been taken into consideration in each case.

From this point the calculation is carried through step by step in exactly the same way as previously explained, and at the conclusion it is found that the selectivity has been increased from 9.83 to 16.35, a value even greater than that obtained with the optimum coupling without the added condenser.

The signal strength, on the other hand, is very little changed in this particular case by the inclusion of the aerial condenser. For instance, the secondary current was found to be 26.4 micro-amps. with a mutual inductance of $60 \mu\text{H}$ and without the added condenser in the aerial circuit. When the 0.0001 mfd. condenser is included, it is found that the secondary current is only slightly reduced to 25.8 micro-amps.

So, by adding the series condenser in the aerial circuit, the selectivity has been considerably improved without reducing the signal strength to any extent. But a word of warning will not be out of place here: This desirable state of affairs has only been achieved because the coupling between the aerial and secondary circuits was too tight for the particular wavelength in question, and,

Wireless Theory Simplified.—

due to this alone, the signal strength has already been reduced well below the figure which could have been obtained with optimum coupling. The series condenser thus has the effect of correcting the reduced selectivity, but at the same time it makes the already reduced signal strength slightly worse. When the aerial coil is loosely coupled to the secondary, the addition of a series condenser will make very little difference to the selectivity, as it is then already nearly equal to the maximum possible value.

At the longer wavelength of 500 metres, the series

condenser produces a much smaller improvement of selectivity, because it is already fairly good (the selectivity number was found to be 14 with a mutual inductance of 60 μ H), but in this case the signal strength is reduced to a more marked extent.

The curves of Fig. 4 show how the selectivity and signal strength depend on the value of the capacity connected in the aerial circuit for a wavelength of 300 metres, the other conditions being as stated above. It is evident that the value of the series capacity is by no means critical.

(To be continued.)

ECHOES FROM THE DEPTHS OF SPACE.

Results of French Expedition.

IN *The Wireless World* of November 28th, 1928, an account was given of the remarkable discovery of a Norwegian wireless amateur, Engineer Jørgen Hals, who reported that, when listening to the Dutch short-wave station PCJJ (Eindhoven), he had often heard echoes of a particular signal received several seconds after the arrival of the signal itself. Hals was quite familiar with the usual round-the-world echoes which arrive with spacing intervals of one-seventh of a second. The new type of echo he discovered was often delayed for many seconds after the original, and, in later experiments, he has observed echoes with a retardation of a minute or so.

Professor Störmer, to whom Hals first communicated this amazing discovery, put forward an equally amazing theory to account for the echoes. As far back as 1907 Störmer had investigated the paths of electrons shot out from the sun and deviated by the earth's magnetic field. He showed that such electrons would be bent round to form a kind of toroid situated at a great distance from the earth. Störmer's explanation of the echoes of long delay was that the wireless waves had penetrated the Heaviside layer and had shot out into space, ultimately to be reflected by the inner surface of this toroid of electricity.

The French Observations in Indo-China.

Since 1928 many attempts have been made in Europe to investigate these matters further. Professor Störmer has given an account of a series of special tests made from PCJ during which Dr. van der Pol, in Holland, and Professor Appleton, in this country, have confirmed the existence of the echoes. But the number of echoes heard in Europe are very small compared with the number observed during the French Solar Eclipse Expedition to Pulo-Condore (Indo-China) last year. An account of these results has recently been published by MM. J. B. Galle and G. Talon. These observers formed part of the expedition from the French Bureau des Longitudes sent out for astronomical observation last May. The eclipse took place at a time when Professor Störmer predicted that, according to his theory, conditions were very favourable for the reception of echoes.

A 25-metre transmitter on a steamship was used. This was situated at a distance of about three kilometres from the receiving station at Pulo-Condore. Special signals, spaced at intervals of a half-minute, were sent out, and the observers heard in the succeeding half-minute echoes with a retardation of from 5 to 25 seconds after the original signal. In the period between midday and 4 p.m. (local time) practically every signal was followed by an echo. Echoes were not found to have all the same characteristics. Some were long-drawn-out signals; some were very weak, and some were very strong, the intensity reaching as much as 30 per cent. of the original.

Strong daylight seemed to be the necessary factor for the production of echoes, for the number heard was found to diminish with the approach of sunset, and none was heard after 6 p.m. The echoes heard during the eclipse itself were specially interesting, for, although echoes were received satisfactorily both before and after the eclipse, it was found that *they disappeared entirely during the period of totality*. This result strongly confirms the view that strong sunshine seems to be necessary for the occurrence of the echoes. In a recent paper General Ferrié, the well-known French wireless pioneer, has discussed the French results in terms of Störmer's theory, and points out that it is not easy to see how the eclipse of the sun by the moon can affect the reflection of waves at a point which is supposed to be situated at a distance away many times that of the moon.

P. B.

INFORMATION SERVICE.

Under the rules of *The Wireless World* Information Service a coupon from the current issue should accompany each question sent in.

Whilst we will endeavour to deal with questions now on hand from readers who have omitted to enclose a coupon, yet preference must, of course, be given to those who comply with the rules. To ensure a prompt reply, questions must be brief. Delay in reply is inevitable when questions are long or involved.

CORRESPONDENCE.

The Editor does not hold himself responsible for the opinions of his correspondents.

Correspondence should be addressed to the Editor, "The Wireless World," Dorset House, Tudor Street, E.C.4, and must be accompanied by the writer's name and address

EMPIRE BROADCASTING.

Sir,—I am unable to contain myself any longer.

Last Monday I sat up till 12.30 a.m. (actually Tuesday morning) expressly to hear Chelmsford 5SW, our "British short-wave station." I was greeted by a talk on butterflies for half an hour and a French lesson for a further half-hour.

I tried the next day to get the midday broadcast from 12.30 to 1.30 G.M.T. (6 p.m. to 7 p.m. Indian Time), but, owing to the fact that our "British short-wave station" was operating on 25.53 metres in the middle of the day, I was mercifully unable to get anything. Half an hour later I tuned in to PHI on 16.88, and enjoyed two hours' faultless reception. I listen to PHI every night it operates.

Why on earth cannot someone wake up to the fact that there are other dominions and colonies besides Canada and Africa who would like to hear the London programme before 12.30 a.m. in the morning.

You, I know, have tried hard to remedy this damaging attitude, but I would be so bold as to suggest that the only method likely to meet with success is to make Chelmsford 5SW the subject of your editorial every week for six months. That may be impossible from your point of view, but even a small article would in the end have its effect. If your wireless contemporaries and the daily Press could be induced to take up the campaign, I feel sure you would not go unrewarded in your efforts.

Let us do something about it, anyway, or close the place down. It is only a sheer waste of money as it is.

Punjab, India.

T. MUNRO.

Sir,—After the broadcasting of the King's Speech at the opening of the Naval Conference I wrote to the B.B.C. and told them that, while I could only get 5SW's carrier on that date, the whole speech came through at L.S. strength from PHIL. I then suggested that the amount of red on the map of the world should be compared with the amount of whatever colour Dutch possessions are marked in, and that this study might be an incentive to give overseas listeners a better show.

If it is of any use to you in your propaganda to help British people abroad, you might publish the following extract from the B.B.C.'s reply dated February 10th, 1930:—

The B.B.C. is certainly responsible for 5SW, but it is an experimental station, and has never been regarded as anything else. In the year and a half's working, however, a vast amount of highly important technical information has been obtained as a result of these experiments, and a long report on the subject has been compiled here. This report is shortly to be the subject of conversation between the Colonial Office, Post Office and this Corporation. Future arrangements depend largely, one imagines, on finance, as the B.B.C. is not able to bear the cost of erection and maintenance of a permanent station of the nature required. The Dutch station to which you refer belongs to a commercial organisation and subserves its interests.

I admit that the finance part is difficult and that one ought to pay for what one listens to; but surely some sort of scheme can be devised to overcome this.

Lahore, India.

F. C. BOOTY.

THE WEHNELT OSCILLATOR.

Sir,—In the issue of March 5th of *The Wireless World*, over the signature "H. K." is described a method of generating H.F. oscillations by means of a modified Wehnelt interrupter. The author is evidently of the opinion that the Russian physicist, W. M. Shulgin, was the first to discover the possibility of using the Wehnelt interrupter as a H.F. generator. Both he and Mr. Shulgin seem, however, to have overlooked the fact

that in 1911 the German Dr. Arndt had described a similar arrangement. In the British patent No. 226/1916 Sidney George Brown has also described an arrangement for generating H.F. oscillations which, as a matter of fact, is a Wehnelt interrupter with reversed polarity. The mechanism of the operation has also been explained by Ludewig in the "Jahrb. d. drahtl. Tel.," 9, 1915. When the platinum wire is connected to the negative pole of the supply an arc is formed between the hot electron-emitting cathode and the cold anode, i.e., the surface of the diluted acid. We have, therefore, an asymmetrical arc which is known to be an excellent generator of H.F. oscillations.

The author (H. K.) is further of the opinion that it is impossible to generate H.F. oscillations with a Wehnelt interrupter connected in the normal way, i.e., the platinum point connected to the positive pole of the supply. However, in a paper published in the "Jahrb. d. drahtl. Tel.," 9, 1914, and later in a dissertation of 1917, I have shown that this is easily possible. The strength of the oscillations set up in a circuit across the Wehnelt interrupter is dependent on several factors, e.g., the self-inductance of the L.F. choke and the length of the platinum wire immersed in the acid. If the ratio C/L of the oscillating circuit is very low, a low damping decrement is introduced; for high values of this ratio, however, the Wehnelt interrupter behaves as a quenched spark so that in a secondary circuit oscillations of a very low decrement can be generated.

The Wehnelt interrupter used in this manner has, however, a very low efficiency compared with the efficiency achieved by reversing the polarity as described in your journal. With the latter method the oscillations are also almost undamped, but the rapid wearing off of the platinum wire is a serious drawback.

(DR.) G. ALB. NILSSON.

Lund, Sweden.

March 8th, 1930.

WIRELESS MUSIC.

Sir,—As the writer of *The Times* article quoted in your Editorial of March 19th, I venture to add that the most complete article on this subject is, I believe, that which I wrote for the *Musical Quarterly* (New York), January, 1930.

I should also like to say that in my opinion the important matter is not the limitations imposed on the composer by broadcast conditions (referred to in your last paragraph), but the entirely novel possibilities offered to him by wireless technique. These are simply dealt with in the article quoted, and in another (written in collaboration with a young English composer) at present under consideration by a leading British reviewer.

Compiègne, France.

R. RAVEN-HART.

"FFB."

Sir,—I am glad to see the letter of Mr. Hobday complaining of the interference caused by FFB's bad tuning.

This station is now the international radio nuisance; not only is his log. decrement nearly as bad as Xs, but he rubs it in by indulging in yarn-spinning and frequent CQ calls, which he declares to be on wavelengths of 300 to 800 metres, though this really means that there is a slight emphasis of radiation on the alleged wavelength.

Hour after hour he is blaring away at cross-Channel steamers and close-ups, as though they were off Crookhaven.

Any British operator who carried on thus would get his ticket jammed without much ceremony, and I am surprised that the French, who are renowned for their exquisite instrument work and engineering skill, should persist in retaining such a fit-up on their doorstep.

Let us hope that he gets a chopped CW set like some of the other French coast stations and GNF, OST, etc., in the near future.

Ashford, Kent.

WM. A. RICHARDSON.

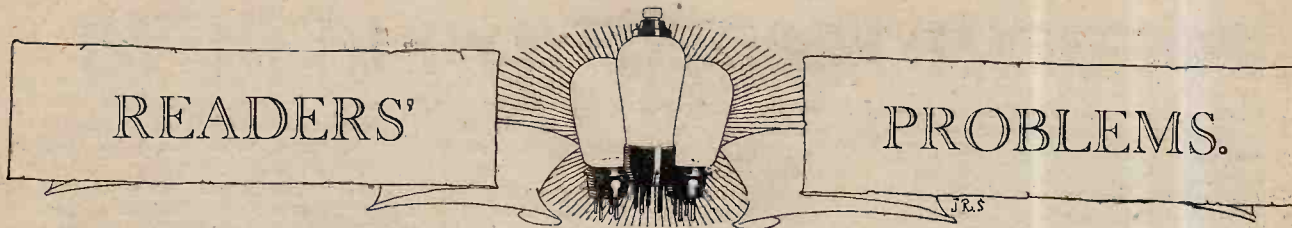

"The Wireless World" Supplies a Free Service of Technical Information.

The Service is subject to the rules of the Department, which are printed below; these must be strictly enforced, in the interest of readers themselves. A selection of queries of general interest is dealt with below, in some cases at greater length than would be possible in a letter.

A Point in Testing.

I have just finished building the "Wireless World Kit Set," but have so far been unable to obtain any signals, even on headphones, which are used for testing. The reaction control works normally, as a "plop" is produced when the condenser is advanced beyond a certain point, and a "breathing" sound is heard in the phones. Apart from this, the set seems to be quite "dead."

From this information, can you suggest where I should look for the trouble?
J. McE.

It seems fairly certain that from the grid circuit of the detector onwards your set is working properly, or, at any rate, that there is no complete disconnection. Consequently, it is logical to assume that the fault is located in the H.F. valve or one of the circuits associated with this valve. A more definite statement than this we cannot make without fuller information, but we think that systematic point-to-point tests of the H.F. and grid circuits should reveal the fault.

To confirm that both windings of the H.F. transformer are in order, you might try the effect of connecting the aerial through a 0.0001 mfd. fixed condenser to the flexible lead which normally connects to the anode terminal of the screen-grid valve. With this alteration, the set should work as a Det.-L.F. combination.

RULES.

- (1.) A query must be accompanied by a COUPON removed from the advertisement pages of the CURRENT ISSUE.
- (2.) Only one question (which must deal with a single specific point) can be answered. Letters must be concisely worded and headed "Information Department."
- (3.) Queries must be written on one side of the paper, and diagrams drawn on a separate sheet. A self-addressed stamped envelope must be enclosed for postal reply.
- (4.) Designs or circuit diagrams for complete receivers or eliminators cannot ordinarily be given; under present-day conditions justice cannot be done to questions of this kind in the course of a letter.
- (5.) Practical wiring plans cannot be supplied or considered.
- (6.) Designs for components such as L.F. chokes, power transformers, complex coil assemblies, etc., cannot be supplied.
- (7.) Queries arising from the construction or operation of receivers must be confined to constructional sets described in "The Wireless World"; to standard manufactured receivers; or to "Kit" sets that have been reviewed.

Power Transformer Failure.

After an accidental short-circuit was introduced across one of the secondary windings of my power transformer, the receiver failed to operate, and after carrying out tests I found that the primary winding (which is, of course, connected to the A.C. mains) had burnt out. Is not this rather unusual? It is understandable that the short-circuited winding itself should have failed, but it seems to me that the primary, which was not interfered with in any way, should have been quite unaffected by any rise in current.

This is by no means abnormal. Consideration will show that an increase in the current taken from the secondary winding of a transformer must be accompanied by an increased consumption from the mains; thus extra current must, of course, flow through the primary.

Very possibly the accidental short-circuit took place across a low-voltage secondary winding of thicker wire than that used for the primary, which would consequently be more likely to have been slightly weakened in the course of manufacture.

o o o o

Unwanted Absorption.

I have recently made a det.-2 L.F. self-contained portable, which works quite well—indeed, fully up to my expectations—when operated in its wooden framework, but gives very weak signals when inserted in its container, which is actually a fibre suit-case. Do you think that the trouble is due to dampness of the material of which the case is made, or is it altogether unsuitable as a container for a wireless receiver?

R. P. T.

Portable sets in fibre containers work quite well, and we do not consider that this material is really unsuitable. Most probably you will find that the edges of the case are bound with metal, which may form a more or less continuous loop, and so will have an effect comparable with that of a short-circuited turn in a frame aerial. If our assumption is correct, and you do not care to obtain another and more suitable container, we suggest that you should cut through the metal binding at a number of points with a hacksaw, in order to interrupt the continuity of the circuit.

An Anode Feed Potentiometer.

Since changing over from H.T. batteries to an eliminator, it has been noticed that my anode bend detector does not function in the same way as formerly; in particular, it seems that its bias adjustment is not nearly so critical, and that a different value of bias is required, although the anode voltage is calculated to be the same as previously.

I suppose that this is probably due to the fact that anode voltage must be changing in sympathy with changes in grid voltage, and have come to the conclusion that it will be best to fit a potentiometer feed. Will you please give me a diagram showing how this may be done? The detector is coupled to the L.F. amplifier through a transformer, and there is a combined voltage absorbing and decoupling resistance in series.

A. E. R.

The necessary alterations are indicated in Fig. 1, in which R and C show the normal anode feed resistance and decoupling condenser. R₁ is the extra resistance required to convert your existing arrangement from series feed to potentiometer feed.

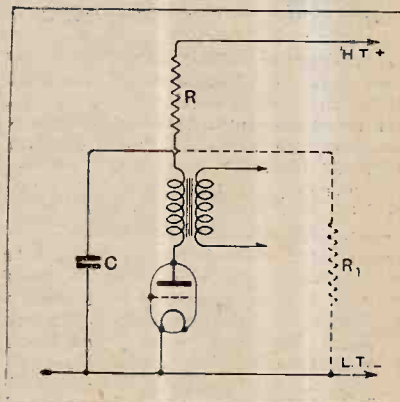

Fig. 1.—By adding an extra resistance, of which the connections are shown in dotted lines, a series feed resistance is made to serve as one of the elements of a fixed potentiometer.

The values of these resistances will depend on the voltage applied, etc., and in any case it will be necessary to reduce the present resistance of R.

Critical Adjustment of Grid Voltage.

My proposed receiver is on the lines of the "1930 Everyman Four," but A.C. valves are to be used throughout. It has been decided to retain the feature of potentiometer control for detector bias voltage, but I cannot see exactly how this may be done, as, of course, there will be no low-tension battery. Will you please make a suggestion, bearing in mind the fact that I propose to use battery bias throughout?

J. N.

We think that the arrangement shown in Fig. 2 is the simplest that can be devised in the circumstances. It seems probable that with the type of A.C. valve ordinarily used as an anode bend detector in a set of this kind, you will require from 4 to 6 volts negative bias, so it is recommended that a tapped bias battery (say of three cells) should be connected in series with a potentiometer connected across two dry cells, a switch being interposed in order to avoid wastage of these cells when the set is not in use.

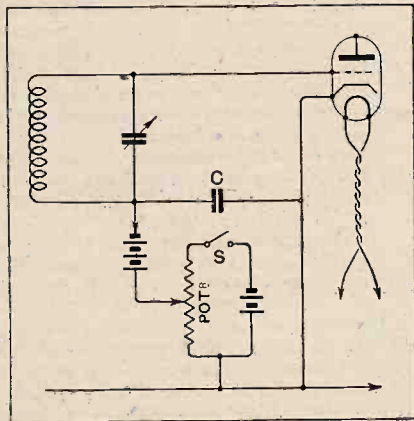

Fig. 2.—A potentiometer, in conjunction with a tapped battery, provides for continuous adjustment of detector bias.

If the potentiometer is of some 400 ohms resistance, the drain on the cells will in any case be small.

It is recommended that the large bypass condenser shown at C in our diagram should be fitted.

○○○○

Raw A.C. for Filaments.

I understand that it is quite possible to heat an output valve filament from A.C. mains through a step-down transformer, although this practice cannot be followed with regard to all the valves of a receiver. Is there any objection to supplying L.T. current to both L.F. valves of a 1-v-2 set from this source?

A. P.

This plan cannot be successfully applied to a receiver of conventional design using ordinary directly heated valves. Although the output valve filament may be fed with raw A.C., any attempt to supply the penultimate valve with unsmoothed current will result in the production of "hum."

Stability Essential.

I have recently added a separately tuned aerial circuit to my 1-v-2 receiver, but am afraid that I have not yet completely mastered its operation. In particular, I am puzzled by the behaviour of the aerial tuning condenser; there seems to be two settings of its dial which give loudest signals. At what is apparently the true resonance point between these two maxima there is a slight, but nevertheless definite, falling-off in intensity, accompanied by, it may be added, some improvement in quality. This is not "double humped" tuning in the ordinary sense, as aerial coupling is normally very loose, and any further reduction in coupling tends rather to accentuate the trouble than to cause it to disappear. Can you explain?

A. S. V.

Your description leads us to believe that your H.F. amplifier is not completely stable, and, before going any further, we strongly advise you to take pains to remove all possible causes of incidental reaction. This may bring about some falling-off in sensitivity, due to the loss of stray reaction, but the set will work in a much more definite manner.

The reason for the effect you describe is fairly clear; as the aerial condenser is moved to a position slightly "off resonance," loading due to the open circuit is reduced, very probably to a value less than that obtaining when it was originally operated with the usual aperiodic coupling; a natural consequence of this reduction in loading is that incidental reaction should again assert itself, and the receiver would naturally become apparently more sensitive.

This also accounts for the improvement in quality that you have noticed when the aerial circuit is exactly "in tune." When aerial loading is partially removed, the H.F. valve may be actually on the verge of self-oscillation, in which case quality would naturally be impaired.

○○○○

The "A.C. 3": Improving Selectivity.

I have never seen a statement in your journal to the effect that a loosely coupled and separately tuned aerial could be added to the "A.C. 3." Will you please say if there is any reason why this addition should not be made, and also refer me to a back number in which a suitable aerial tuning unit was described?

E. B. W.

There is no reason why a two-circuit aerial tuner should not be used in conjunction with any set having a properly stabilised H.F. amplifier, and, consequently, any of the various arrangements described from time to time in these pages could be added to your "A.C. 3." The "Wireless World Selectivity Unit," described in our issue of April 25th, 1928, would be suitable, while a somewhat simpler piece of apparatus discussed in *The Wireless World* for March 12th would also be effective, and has the advantage that it will operate on both medium and long broadcasting wavebands.

Litz Wire Complications.

Would it be possible to use litz for the secondaries of the medium-wave H.F. transformers in the "New Kilo-Mag Four"? If so, do you think that this alteration would be an improvement, particularly in increasing the range of the receiver?

G. L.

The transformers as specified provide almost as much magnification as can be obtained, and we can hardly endorse your proposed alteration. In the first place, to be worth while, the litz coils would be larger than those included in the set described, and this would involve re-arrangement of the components. Selectivity would be improved by using transformer secondaries of lower resistance, but a gain in this direction might be offset by a falling-off in high-note reproduction.

○○○○

H.F. Couplings for Portables.

I am aware that tuned anode H.F. couplings have disadvantages in a mains-fed receiver, but should think that the simplicity of this method might outweigh its drawbacks in a "2H.F." portable receiver with battery feed for the anodes. I am about to build a set of this kind, and should welcome a word or two of advice on the subject.

V. M. M.

We think that you would probably do better with transformer couplings. In designing a portable, no efforts should be spared to avoid all possible sources of interaction between stages; the particular kind of undesirable interstage reaction to which "tuned anode" sets are prone can be prevented by extensive decoupling, but only at the expense of lost voltage, which cannot always be spared in a self-contained set.

FOREIGN BROADCAST GUIDE.**RIGA**

(Latvia).

Geographical Position: 56° 57' N. 24° 3' E.
Approximate air line from London: 1,040 miles.

Wavelength: 525 m. Frequency: 572 kc.
Power: 3 kW.

Time: Eastern European (two hours in advance of G.M.T.).

Standard Daily Transmissions.

08.00 (G.M.T.) German church service;
09.15 Lettish church service (Sundays only); 10.35 weather; 15.00 concert followed by talks, etc.; 18.00 approx. weather and concert; 19.00 news and main evening programme; 20.00 weather; 21.00-22.00 dance music (ex. Thursday and Friday).

Interval Signal: metronome.

Lady announcer. Call: *Halui is Riga.*

Announcements are made in Lettish and German.

BY REQUEST

At the request of a large number of customers, we are recommencing our distribution and part exchange services, with certain modifications to meet modern conditions, in order that the standard which it is believed is expected of this business may be maintained. Our future activities will be confined to articles the value of which is worthy of the financial consideration of our clients.

We can supply and, if so desired, accept in

PART EXCHANGE

only the reputable makes of the following apparatus:

Receivers (Domestic & Portable).
Radio-Gramophones.

Loud Speakers (Cone & Moving Coil).

Cone Units and Chassis.

Battery Eliminators and Mains Equipment Components.

Battery Chargers.

Pick-ups and Carrier Arms.

Electric Gramophone Motors.

H.F., L.F. and Power Chokes.

Condensers (Variable, Reaction and Smoothing).

Measuring Instruments (High Grade)

L.F. Transformers.

Valves and Tuning Coils can be supplied but not accepted in part exchange.

In view of the difficulty of making definite offers for material that we have not inspected, it is suggested that apparatus tendered for part exchange should be forwarded to us for valuation.

Terms of Part Exchange Business:

A minimum of 50% of the value of an order, plus carriage charge where due, is payable in cash unless the value is below £1 when a minimum of 10/- is payable. Should the part exchange allowance exceed 50% of the total value of new requirements, the difference will be credited against future orders. Material may be deposited against a credit note, which may be utilised at a later date. Only apparatus in good condition can be accepted in part exchange.

Buy Quality with Economy through

APPLEBY'S



The Bank & Clearing House of Radio.
CHAPEL STREET, MARYLEBONE, N.W.1.

(4 minutes from Oxford Street, London.)

Phone: Paddington 8828 (3 lines).

R100 LOST IN FOG!



When R100 ran into dense fog on its recent third test flight, the Croydon and Pulham direction-finders gave the giant airship its bearings — through Marconi Valves. Another of the many important services in which Marconi Valves are relied upon. All Imperial Airways machines . . . all Trinity House beacon stations and lightships . . . most British passenger-ships . . . use Marconi Valves. For their wide range. For their dependability. For their long life. • In cases like these, when unfailing reliability is essential, men insist on Marconi Valves.

FIT MARCONI VALVES

TO YOUR RADIO SET



Give you clearer tone, greater volume, wider range. Cost not a penny more. Fit any set.

THE FIRST AND GREATEST NAME IN WIRELESS

For all technical information on valves, write to the MARCONIPHONE COMPANY LIMITED, 210-212 Tottenham Court Road, London, W.1

JUST PUBLISHED

RADIO DATA CHARTS

A SERIES OF ABACS

providing most of the essential Data required in Receiver Design.

By R. T. BEATTY, M.A., B.E., D.Sc.

Reprinted from "The Wireless World."

"Radio Data Charts" provides designers of wireless apparatus with a ready and convenient means of solving problems without having recourse to complicated formulæ and mathematics.

By the use of the charts it is possible to tackle all the more familiar problems in radio receiver design; such as, for example, finding the relationship between inductance capacity and frequency, and working out the design of high frequency transformers. All keen amateurs will appreciate this helpful book.

Price 4/6 net. By post 4/10.

From all leading booksellers or direct from the Publishers.

Published from the Offices of "THE WIRELESS WORLD."

ILIFFE & SONS LTD., Dorset House, Tudor St., London, E.C.4.

**DICTIONARY
of WIRELESS
TECHNICAL
TERMS**

(1926)

Compiled by S. O. PEARSON, B.Sc., A.M.I.E.E.
and issued in conjunction with
"THE WIRELESS WORLD."

This volume contains definitions of terms and expressions commonly used in wireless telephony and telegraphy and is intended to serve as a guide to all those interested in wireless who come across, from time to time, unfamiliar words in their reading. In such cases the **DICTIONARY OF WIRELESS TECHNICAL TERMS** proves of very great use and value. It is well illustrated, and cross-referenced to enable the required information to be rapidly obtained.

Price 2/- net. By Post 2/2

From leading booksellers or from the Publishers:

ILIFFE & SONS LTD.,

Dorset House, Tudor St., London, E.C.4.

W.W.48

Mention of "The Wireless World," when writing to advertisers, will ensure prompt attention.

WIRELESS

**DIRECTION
FINDING
and DIRECTIONAL
RECEPTION**

(1927)

By R. KEEN, B.Eng. (Hons.).

Second Edition: Revised and Enlarged.

THIS volume deals with the principles of the subject and the constructional details of direction-finding installations, and includes some information concerning aircraft installation. It describes the principles of Direction and Position Finding in this country in such a way that the subject may be grasped easily by engineers tackling this field of wireless work for the first time. Numerous photographs and diagrams are included.

Price 21/- net. By post 21/9.

*From leading booksellers or
direct from the Publishers:*ILIFFE & SONS LIMITED,
Dorset House, Tudor Street, London, E.C.4.

w.w.68

A40

MISCELLANEOUS ADVERTISEMENTS.

NOTICES.

THE CHARGE FOR ADVERTISEMENTS in these columns is :
12 words or less, 2/- and 2d. for every additional word.

Each paragraph is charged separately and name and address must be counted.

SERIES DISCOUNTS are allowed to Trade Advertisers as follows on orders for consecutive insertions, provided a contract is placed in advance, and in the absence of fresh instructions the entire "copy" is repeated from the previous issue : 13 consecutive insertions 5% ; 26 consecutive, 10% ; 52 consecutive, 15%.

ADVERTISEMENTS for these columns are accepted up to **FIRST POST ON THURSDAY MORNING** (previous to date of issue) at the Head Offices of "The Wireless World," Dorset House, Tudor Street, London, E.C.4, or on **WEDNESDAY MORNING** at the Branch Offices, 19, Hertford Street, Coventry ; Guildhall Buildings, Navigation Street, Birmingham ; 260, Deansgate, Manchester ; 101, St. Vincent Street, Glasgow, G.2.

Advertisements that arrive too late for a particular issue will automatically be inserted in the following issue unless accompanied by instructions to the contrary. All advertisements in this section must be strictly prepaid.

The proprietors retain the right to refuse or withdraw advertisements at their discretion.

Postal Orders and Cheques sent in payment for advertisements should be made **& Co.** payable to **ILIFFE & SONS Ltd.**, and crossed **Notes being untraceable** if lost in transit should not be sent as remittances.

All letters relating to advertisements should quote the number which is printed at the end of each advertisement, and the date of the issue in which it appeared.

The proprietors are not responsible for clerical or printers' errors, although every care is taken to avoid mistakes.

NUMBERED ADDRESSES.

For the convenience of private advertisers, letters may be addressed to numbers at "The Wireless World" Office. When this is desired, the sum of 6d. to defray the cost of registration and to cover postage on replies must be added to the advertisement charge, which must include the words Box 000, c/o "The Wireless World." Only the number will appear in the advertisement. All replies should be addressed No. 000, c/o "The Wireless World," Dorset House, Tudor Street, London, E.C.4. Readers who reply to Box No. advertisements are warned against sending remittance through the post except in registered envelopes ; in all such cases the use of the Deposit System is recommended, and the envelope should be clearly marked "Deposit Department."

DEPOSIT SYSTEM.

Readers who hesitate to send money to unknown persons may deal in perfect safety by availing themselves of our Deposit System. If the money be deposited with "The Wireless World," both parties are advised of its receipt.

The time allowed for decision is three days, counting from receipt of goods, after which period, if buyer decides not to retain goods, they must be returned to sender. If a sale is effected, buyer instructs us to remit amount to seller, but if not, seller instructs us to return amount to depositor. Carriage is paid by the buyer, but in the event of no sale, and subject to there being no different arrangement between buyer and seller, each pays carriage one way. The seller takes the risk of loss or damage in transit, for which we take no responsibility. For all transactions up to £10, a deposit fee of 1/- is charged ; on transactions over £10 and under £50, the fee is 2/6 ; over £50, 5/-. All deposit matters are dealt with at Dorset House, Tudor Street, London, E.C.4, and cheques and money orders should be made payable to Iliffe & Sons Limited.

SPECIAL NOTE.—Readers who reply to advertisements and receive no answer to their enquiries are requested to regard the silence as an indication that the goods advertised have already been disposed of. Advertisers often receive so many enquiries that it is quite impossible to reply to each one by post.

"WIRELESS WORLD" INFORMATION COUPON

This Coupon must accompany any Question sent in before

APRIL 16th, 1930

For Particulars of Free Service, see Rules on page 399.

B & J

ALL WIRELESS WORLD COILS
1830 EVERYMAN FOUR

KIT SET, Coils with Switches	47/6 set
NEW KILOMAG	45/- set
RECORD III	45/- set
FOREIGN LISTENERS 4 B.B.C.	50/- set
METAL CABINETS	5X 37/6 set
5" DRUM DIALS with Escutcheons	38/6 to 49/6
	5/3

B & J. Wireless Co.

2, 3, & 4, Athelstane Mews, Stroud Green Rd., N.4

Archway 1995

NEW MAGNAVOX 1929
MOVING COIL SPEAKERS

for £3-3-0 each

Original list price £8-0-0

Messrs. WILBURN & CO.,
23 Bride Lane, Ludgate Circus, E.C.4.,
have to offer by arrangement a limited number of the above instruments (without input transformer). These speakers are new and in the manufacturer's sealed cases. Field winding for 6 volts .65 amps.

Phone : Central 6994.
9 a.m. to 6.30 p.m. 1.30 p.m. Saturdays.

The 'SPRINGSREW'

A NEW CLIX WANDER-PLUG.

CLIX



CLIX

2d.

Red and Black. Engraved id. extra.

Ideal for portables, or where space is limited.

Write for the Clix leaflet.

LECTRO LINX, LTD. 254, Vauxhall Bridge Rd., London, S.W.1.

MAKE YOUR OWN
LINEN-DOUBLE-
DIAPHRAGM-SPEAKER

AT HOME - WITH THE



TWIN CONE KIT OF PARTS

NON-WARP ALL-STEEL CHASSIS 20 x 20 - PURE LINEN DIAPHRAGMS - BEAUTIFUL TONE - DOPE - RUBBER SIDES - SCREWS - ETC. - BUILT WITH A SCREW DRIVER - SUIT ANY POPULAR MOVEMENT.

SPECIAL TWIN-CONE DRESSING FOR ALL LINEN SPEAKERS

GREEN & FAULCONBRIDGE, LTD. POST FREE
11, Queens Road, COVENTRY.

IMPORTANT NOTICE.

Owing to the Easter Holidays, the next issue of "THE WIRELESS WORLD" (dated April 16th) is closing for press earlier than usual.

In accordance with the Notice that appeared last week, the latest date upon which Miscellaneous Advertisements could be accepted for the above issue was **FIRST POST WEDNESDAY, April 9th.**

For the issue of April 23rd, advertisements for these columns can be accepted up to **FIRST POST TUESDAY, April 15th.**

RECEIVERS FOR SALE.

SCOTT SESSIONS and Co., Great Britain's Radio Doctors.—Read advertisement under Miscellaneous. [0264]

HIRE a McMichael Portable Set, by day or week, from Alexander Black, Wireless Doctor and Consultant, 55, Ebury St., S.W.1. Sloane 1655. [0328]

STEREOPHONIC Couplers!—Latest talkie super models, many in use, wonderful reproduction; type B super £5/5 A super £3/15; trade supplied.—Bonavia-Hunt, 96, Broadhurst Gardens, N.W.6. [8798]

AMERICAN Fada Special 6-valve (drum dial), needs slight adjustment; 70/- carriage paid, no offers.—Box 5544, c/o The Wireless World. [9018]

5-VALVE Solodyne, cost £25, best components, with valves; £11, offers; apply before noon or by letter.—H. Norris, 92, Alberta St., Kennington, S.E.17. [9004]

POWERFUL Super 6-valve Set, built for quality, with large output high tension eliminator, 210 volts 50 cycles, 450 plate max., large new 6-volt Exide accumulator, a really high class set in every way; can be seen and heard by appointment; price £40.—Kidner, Burleigh House, West Heath Rd., N.W.3. [9003]

KOLSTER-BRANDES Portable, 4-valve, screened grid, only used a few times; retails at £18/18, what offers?—Finchley Radio and Sports Co., 9, Castle Court, Castle Rd., North Finchley, N.12. [9000]

A.C. Mains Amplifier, moving coil speaker, B.T.H. tone arm, pick-up, electric motor, complete; £25, or best offer.—Box 5538, c/o The Wireless World. [8996]

WIRELESS Portable Sets, with 5 Cossor new process valves, for 10 guineas; less than component cost; comparable with any set double this price; royalty paid; seen between 1 and 2 p.m., or particulars sent on receipt of stamped addressed envelope.—G. Hodgson, 53, Windsor House, Victoria St., Westminster. [8991]

BURNE-JONES 3-valve Universal, S.G. and P., with coils, 15-2,000 megohms, used demonstrations only, just overhauled by Burne-Jones; best offer to Morrison, 20, Queen's Gate, Glasgow. [8989]

FOR SALE.—Marconi Straight Eight I.S., etc., with accumulator; best offer secures.—41, The Avenue, Watford. [8993]

BERCLIF D.C.2 All Mains Receiver, 200 to 250 volts D.C.; price £14/10; with valves and royalties, suitable for M.C. speaker; particulars free; trade inquiries specially invited.—Simmonds Bros., Shireland Rd., Smethwick. [8734]

YOUR Old Receiver or Components Taken in Part Exchange for New; write to us before purchasing elsewhere, and obtain expert advice from wireless engineer of 25 years' professional wireless experience; send a list of components or the components themselves, and we will quote you by return post; thousands of satisfied clients.—Scientific Development Co., 57, Guildhall St., Preston. [0226]

GECOPHONE Victor Three, with valves, new; 90/-.—Seymour, 20, Foxholes Rd., Southbourne, Bournemouth. [8992]

BROOKMANS Three for Sale, or exchange 12x9 carpet or furniture.—18, Oakleigh Court, Edgware. Phone after 7: Colindale 6461. [9024]

EXCEPTIONAL Offer.—4 only, 3-valve sets, complete with valves, absolutely new, only £3/18/6; also Midget log. condensers, 4/- each; trade supplied.—M. Grundy and Co., 54, Clerkenwell Rd., E.C.1. Clerkenwell 3080. [9072]

BARGAIN.—Fada Special Six, with valves; £8 only.—6d, Castletown Rd., W.14. [9054]

SHORT Wave Set (new), 3-valve P.W., De Luxe coils; £5/10, or offer.—A. London, 23, Renfrew Rd., S.E.11. [9053]

5-VALVE Portable, new, complete; £10, cost double.—Bracey, Factory Sq., Streatham. [9039]

Receivers for Sale.—Contd.

MARCONIPHONE Screened Three, perfect, £7; Zenith 6-valve neutrodyne, £8; Marconiphone type 61, 3 S.G., 2 L.F., world's finest receiver, £18; all with valves; surplus components, write list.—2a, Salisbury Rd., Seven Kings, Essex. [9052]

PHILLIPS 4v. All-mains Receiver, A.C. 200v., list price £37/10, accept £26; also 4v. Ediswan all-mains transportable, A.C. 200-250 volts, list price £31/10, accept £22/10; both as brand new and calibrated reading for over 50 stations; two of the finest sets made; only reason for selling cash urgently required.—F. C. Holliday, Forest Hill, Roundhay, Leeds. [9045]

MARCONI Straight Eight, type 81, offers; Marconi 51B mains receiver, combined Rice-Kellog, £30; B.T.H. mains R.K. concert speaker, £30; all equal new.—Benson, 1, Vyvyan Terrace, Bristol. [9041]

ALL-ELECTRIC Radio Gramophone, for A.C. or D.C. mains, beautiful instrument; must sell, £25; seen any time.—55, Upper Court Rd., Epsom. [9037]

OSRAM Music Magnet, built last December, excellent condition; £6/10.—Bradley, Alcombe, Holden Av., North Finchley. [9036]

FADA Special 6-valve Receiver, with new valves; £4/10.—Ravaux, 8, Fairholme Rd., West Kensington. [9033]

BROOKMANS Four Coils, Wearite; 35/- set of 3.—Box 5559, c/o *The Wireless World*. [9061]

RADIO - GRAMOPHONES—Rhapsody-Twin Salon Grand Mains 6, mahogany, list £108, £45; Boudoir Grand Mains superhet 8, walnut, list £121, £40; Chairside Mains 5, mahogany, list £108, £35; portable radio-gramophones 5, leather, list £39, £12.—Liquidator, Reproduction, Ltd., 6, Dysart St., Wilson St., E.C.2. [9067]

EVERYMAN 4-valve, in beautiful walnut Console cabinet, all best parts, extraordinarily selective, both Brookman's stations cut out in few degrees of dial at Boves Park, price £15/15; also mahogany Console gramophone, latest model, quite new, cost £15/15, near offers.—Box 5537, c/o *The Wireless World*. [8995]

F. W. SMURTHWAITE, A.M.I.R.E., for high grade individually made radio apparatus of all kinds. Why buy mass production sets when I can design and manufacture one to meet your needs exactly? Every instrument is made under my supervision by highly skilled mechanics and personally tested and guaranteed by me.

ALL Mains Receivers, radio gramophones, etc., are a speciality of mine, for either A.C. or D.C. mains; details with pleasure.

A.C. Three—An outstanding all A.C. receiver in handsome mahogany or oak cabinet, has range sufficient to bring in all worth while foreign transmissions, is selective, and gives over 1,000 milliwatts undistorted power output, which is more than sufficient to work a moving coil speaker at good volume with perfect quality; examine the merits of this instrument against any competitive all electric set; price £25, complete with valves and royalty.

OVERSEAS Readers—For short wave reception I recommend the special 4-valve receiver with S.G. H.F. stage designed by the R.S.G.B.; this set is an immense advance on the conventional type of instrument, is much easier to tune, and has vastly greater power; price £21, complete.

RECONSTRUCTIONS, Repairs, etc.—If you have a set with good components in it, why not have it brought up to date? In many cases such sets can be rebuilt to equal new instruments at much less than new cost; your enquiries will receive my personal attention and unbiased advice.

SECOND-HAND Bargains—I have a very limited number of second-hand receivers for sale at bargain prices, all guaranteed in perfect order; please state type of receiver required, when I shall be glad to send details.

F. W. SMURTHWAITE, A.M.I.R.E., contractor to various boards of guardians, the B.B.C., etc.—Correspondence to 15a, Onslow Gardens, Wallington, Surrey, Works, Belmont Rd. Phone: 1982 Wallington. [9073]

BURDETT 5-valve Ethogrand, with valves and coils, £7/10; Marconi V2, 30/-; ditto, with amplifier, 50/-; carriage extra.—James Scott and Co., Radio Engineers, Dunfermline. [9033]

ACCUMULATOR HIRE.

DON'T Buy Accumulators or Dry Batteries, join our C.A.V. low- and high-tension accumulator hire service, the largest and best in London; better and cheaper reception with no trouble; regular deliveries within 12 miles of Charing Cross; no deposit, payment on each delivery or by quarterly subscription; over 10,000 satisfied users; explanatory folder post free; phone or write to-day.—Radio Service (London), Ltd., 105, Torrione Av., N.W.5. Phone: North 0623-4-5. [8751]

BATTERIES.

WET H.T. Replacements.—Sacs (capped or uncapped), highest grade, No. 1, 10d. per doz.; No. 2, 1/9 per doz.—See below.

ZINCS—Best quality (wired), No. 1, 8d. per doz.; No. 2, 9d. per doz.; orders valued 5/- carriage paid, otherwise 6d. for postage.—British Battery Co., Clarendon Rd., Watford, Herts. [0258]

TWO Exide H.T. Batteries W.J.10. each 80 volts 2.5 amps., perfect condition, little used; £3 the lot.—Apply "Bansra," Colnbrook, Bucks. [8893]

The Brilliant "GRASSMANN" Moving Coil Loudspeaker

Demonstrated FREE IN YOUR OWN HOME!



6 volt, 100 volt D.C., 240 volt D.C.
£4 - 17 - 6
240 volt A.C.
NO HUM model
£8 - 5 - 0

"Peter Grassmann" Moving Coil Speakers, Inductive Dynamic Units and Chassis, also Electrical Pick-up complete with Tone Arm and Volume Control, are obtainable from all good dealers.

Read what Mr. J. H. Reyner says about the "GRASSMANN" Moving Coil Speaker in the March issue of the "Wireless Magazine," then decide to hear this wonderful speaker on your own set in your own home. It costs you nothing to hear it, commits you to nothing. Just tell us which model you want to hear, and

Send your Retailer's Name and Address to

ROTOR ELECTRIC LTD., 2/3, Upper Rathbone Place, LONDON, W.1.

OVERSEAS READERS WE SPECIALISE IN OVERSEAS BUSINESS.

PARTS, SPEAKERS, ELIMINATORS OR COMPLETE SETS—Write and tell us exactly what you require and we will buy it for you. It is our business to select suitable apparatus and thus ensure satisfaction to the user. Payment may be made either through "The Wireless World" deposit system, see page 13, or direct to us.

THE OVERSEAS TRADING CO. 144, St. Vincent Street, GLASGOW. Scotland. Telegrams: "Tenacity," Glasgow.

BOOKS on WIRELESS

Write for complete list to LIFFE & SONS LTD., Dorset House, Tudor St., London, E.C.4.

CHARGERS AND ELIMINATORS.

CHEBROS—Chebros for all types of transformers and chokes, high grade instruments at a very moderate price; enquiries invited.—Chester Bros., 244, Dalston Lane, London, E.8. [5290]

TANTALUM and Liumion for A.C. Rectifiers; for inexpensive chargers; blue prints for H.T. and L.T., 1/- each; Liumion electrodes, 2-3 and 5-8 amps.—Blackwell's Metallurgical Works, Ltd., Garston, Liverpool. [18298]

ELIMINATOR Kits—Transformers, choke, condensers, L valve holder, resistance, insulated terminals, and wiring diagram; 25/- complete; 20 milliamps at 120 volts; send for list.—Pel-Ectric Radio, Garden St., Sheffield. [18618]

PHILIPSON'S Safety High Tension Battery Eliminators.

10/- Down and the Balance in Easy Monthly payments secures the finest high tension supply available.

PHILIPSON'S Safety Eliminators are Guaranteed for 12 Months.

PHILIPSON'S Safety Eliminators are the Cheapest to Install and the Cheapest to Run; prices: Model A.C.5 £4/17/6, A.C.7 £3/17/6, complete with full wave, rectifiers; D.C.4 37/6, D.C.5 45/-.

ALL Models Obtained for 10/- Deposit; take advantage of this and get constant high tension immediately.

WRITE for Our Booklet, "Radio Power" to Philipson and Co., Ltd., Radio Engineers, Astley Bridge, Bolton. Phone: 2038. Grams: Safety, Bolton. Est. over 50 years. [10318]

TRICKLE Chargers, A.C. mains, for 4- and 6-volt accumulators, output 0.5 amps., no upkeep; 16/6, carriage paid.—Benoit, 4, Manor Gardens, Gunnersbury Lane, London, W.5. [9011]

REGENTONE A.C. Model W2 Eliminator, input 200-250, used 3 weeks; cost £12, accept £9/5; excellent results; owner acquired all-electric receiver.—Box 5535, c/o *The Wireless World*. [8998]

SAVAGE'S Specialise in Wireless Power from the Mains, reliable apparatus at reasonable prices.

SAVAGE'S Transformers Laminations and Bakelite Bobbins; intending home constructors should write for list.

SAVAGE'S Reliable Smoothing Condensers, 1,000 volt D.C. test, 1 mid., 2/; 2 mid., 3/; 4 mid., 5/3; 500 volts D.C. test, 1 mid., 1/6; 2 mid., 2/3; 4 mid., 3/9.

SAVAGE'S Super Smoothing and Output Chokes, many types available, write for list.

SAVAGE'S Mains Transformers for Westinghouse H.T. 4 Unit 18/6; A.3, 17/-; A.4, 20/-.

SAVAGE'S Mains Transformers for Westinghouse H.T. 4, with additional winding, 4 volts, 3 amps; 23/-.

SAVAGE'S Mains Transformer V.T.31 200-0-200-volts 60 milliamps 2+2 volts 2 amps., 2+2 volts 3 amps., 28/-.

SAVAGE'S Mains Equipment for New Foreign Licensers Four Transformer N.F.L.4, 33/-; smoothing choke C.32G, 20/-; output choke C.32/U, 20/-.

SAVAGE'S Mains Transformers and Power Chokes are Carefully and Individually Constructed from First Class Materials with an Exceptionally Generous Margin of Safety.

SAVAGE'S, 146, Bishopsgate, London, E.C.2. Phone: Bishopsgate 6998. [8474]

M-L Anode Converter, 12v. in, 400v. out; £6.—Bell Radio, 205, Uxbridge Rd., W.13. [9028]

M-L Converter, 12 to 300 volts, in aluminium case, complete with smoothing equipment, few months old only, and definitely guaranteed perfect; open to makers' or any other examination; cost £12, accept £7/10.—F. W. Smurthwaite, A.M.I.R.E., 15a, Onslow Gardens, Wallington, Surrey. [9074]

DOUGLAS-MACKIE Petrol-electric Generator, with switchboard, 14 volts 30 amps., nominal rating, equal to new; £12 cash, no offers; an absolute gift.—Wheeler, "Greystones," Chalk Lane, East Horsley, Surrey. [9032]

DYNIC A.C. H.T. Eliminator, £3; Regentone, £3; Philips L.T. charger, £2/10; Ferranti trickle chargers, £1/10; carriage extra.—James Scott and Co., Radio Engineers, Dunfermline. [0335]

WESTINGHOUSE A4, 9 volts 2 amps, 30/-; H.T.3, 15/-; mains transformer, 14 volts 2 amps, 15/- (Rich and Bundy); 13.5 volts 2 amps, 10/- (Townsend); 135 volts 70 m.a., 11/-; 135 volts 70 m.a., 4 volts 4 amps, for A.C. valves, 16/-; 200 volts, 4 volt for valve eliminator, 9/-; Pye choke, 32 henrys, 9/-; all above are as new and for mains 220-230 volts.—Wright, 13, Ealdham St., Eltham, London. [9025]

CABINETS.

ARTCRAFT Radio Cabinets are Britain's Best Value. [0313]

DIGBY'S Cabinets.—Table models in solid oak and mahogany; from 11/6 to 71/-.

DIGBY'S Cabinets, fitted with Radion or Resistor ebonite if required.

DIGBY'S Cabinets.—Pedestal model, with separate battery components; from 56/- to £12.

DIGBY'S Cabinets Made to Customers' Own Designs.

DIGBY'S Cabinets.—Write for new 16-page art catalogue.—F. Digby, 9, The Oval, Hackney Rd., E.2. Phone: Bishopsgate 6458. [0128]

Mention of "The Wireless World," when writing to advertisers, will ensure prompt attention.

The LOTUS All-Mains :: Unit



**Converts an
Osram
"MUSIC MAGNET"
to an
ALL-ELECTRIC SET
with minimum trouble
and maximum effect**

In less than five minutes, by using the Lotus All-Mains Unit, you can turn your Music Magnet Receiver into All-Electric.

Make this change and effect a saving of nearly £4 a year, by dispensing with batteries.

Cash Price £7.7.0 (or 14/6 down and 11 similar monthly payments).

Send for full particulars.

*Made in one of the most modern
Radio Factories in Great Britain*

**GARNETT, WHITELEY & CO., LTD.,
Lotus Works, Mill Lane, Liverpool**

Cabinets.—Contd.

ARTCRAFT Radio Cabinets are Britain's Best Value. [0311]

CABINETS for All Requirements.—F. W. Ramsey, 63, Shaftesbury St., London, N.1. Clerkenwell [8155]

ARTCRAFT Radio Cabinets are Britain's Best Value. [0309]

WIRELESS Boxes, solid oak, new, polished, 16-10-5, 3/- each; frets, 1/-—Bell, 119, Arlington Rd., Camden Town. [8905]

ARTCRAFT Radio Cabinets are Britain's Best Value. [0310]

KAY'S Cabinets, the greatest range of pedestal cabinets in the kingdom; original creative designs at prices 50% lower than elsewhere; quotations for specials by return; delivery at short notice guaranteed.

RADIOGRAM Cabinets.—A variety of really practical and exclusive models from 60/-; illustrated lists free.

H. KAY, Wireless Cabinet Manufacturer, Mount Pleasant Rd., London, N.17. Phone: Walthamstow 1626. [8963]

ARTCRAFT Radio Cabinets; Britain's best value; lowest prices consistent with highest quality; illustrated list free from actual manufacturers.—Artercraft Co., 156, Cherry Orchard Rd., Croydon. Phone: Croydon 1981. [0040]

KILO-MAG Box, as specified, 18 gauge aluminium, no base; 30/-, or near offer.—Box 5541, *c/o The Wireless World*. [8997]

A LIMITED Number of Magnificent Radio-gramophone Cabinets, brand new, panel size 18in. x 7in., oak £6, mahogany £7; larger size, with double doors, panel 21in. x 8in., oak £11, mahogany £12/10; portable cabinets (suitcase type), 30/-; transportable (oak or mahogany), £2; cabinets with oval panel opening, suit 2- or 3-valve set, 17/6; carriage extra.—James Scott and Co., Radio Engineers, Dauferrmine. [0334]

COILS, TRANSFORMERS, ETC.

TRANSFORMERS and Chokes for Battery Eliminators.—Chester Bros., 244, Dalston Lane, London, E.8. [8652]

600 ohms Decoupling Resistances, specified for new Kilo-Mag Four; 1/6 each, post free.—Groves Brothers.

120 and 1,000 ohms Resistances for new Foreign Listeners Four; 1/6 each, post free.—Groves Brothers.

SCREENING Boxes for Foreign Listeners Four; selectivity units, etc.; 6/- each, post free.—Groves Brothers.

NEW Kilo-Mag Four Coils, 37/6 set, Kilo-Mag slotted formers, 12/6 set; 1930 Everyman Four formers, 8/6 set; kit set formers, 10/6 set; all post free; trade supplied.—Groves Brothers, St. Mary's Place, Shrewsbury. [8757]

RADIOGRAPH.—"Wireless World" Coils, Record III, 35/-; New Kilomag Four, 33/-; S.G. Regional, 37/6; kit set, 45/-; 1930 Everyman Four, 42/6.

RADIOGRAPH.—Litz wire, 9/40, 1/6; 27/42, 2/6 dozen yards; Redfern's deep ribbed or Beool tube, 5d. per inch, slotting 1/6 extra.—Station Rd., Handsworth, Birmingham. [8856]

BEROLIF Coils, the standard of excellence, for all "Wireless World" receivers; latest lists post free; trade supplied, all quantities.—Simmonds Bros., Shireland Rd., Smethwick. [8735]

FERRANTI O.P.3 (c), 15/-; O.P.2, 15/-.—K., 106, Kinfauns Rd., Goodmayes, Essex. [8058]

GRAMOPHONES, PICK-UPS, ETC.

RADIOGRAPH.—Pick-up, with valve adaptor, 18/- complete; approval.—Station Rd., Handsworth, Birmingham. [8855]

GAMBRELL Novotone; £3/10, or nearest offer.—Stainsby, Woolley, Hexham-on-Tyne. [9023]

MARCONIPHONE Latest Type Pick-up and Tone Arm; 40/-; guaranteed as new.—Geddes, Jeweller, Arbroath. [9006]

BARGAINS.—Gramophone set, Garrard motor, swan neck tone arm, latest sound box, 3 records, lot 30/-, cost double; J.B. dual gang 0.0005, 15/-; Ferranti B1 choke, 12/6; stamp list.—Cour, 40, Adelphi St., Preston. [9017]

GAMBRELL Novotone, £3; Burndep't needle armature pick-up, 25/-; as new.—Dobbie, Balvonie, Skelmorlie, Ayrshire. [9012]

B.T.H. Pick-up, with arm, latest type, perfect, only used temporarily; 25/-—White, "Fairview," South Eden Park Rd., Beckenham. [9034]

VARSITY Sweetone Pick-up; see "W.W." page 362.

THIS is a Well Finished Component, giving adequate output.

10/6 Retail; trade enquiries invited.—Frost, 54, Clerkenwell Rd., E.C.1. [9062]

THE FINEST HIGH GRADE REPRODUCER IN THE WORLD

SEND TO-DAY
FOR OUR FREE
36-PAGE BOOK-
LET "SOUND
ADVICE."



The Super Power Moving Coil Speaker—

THIS famous speaker has been installed in many of the world's best theatres, including THE LONDON HIPPODROME—a splendid testimony to its flawless reproduction and high efficiency.

HAVE YOU TRIED THE NEW LINEN DIAPHRAGMS?

As used in Baker's All Electric Receivers



Good reports are being received from all parts of the country.

Complete Diaphragm assemblies, comprising Floating Cone and leather suspension, accurately mounted on cardboard ring, fitted with moving coil and centring device 15/-

BAKER'S 'Selhurst' RADIO

Pioneer Manufacturers of Moving Coil Loud Speakers

Offices: 89, Selhurst Road, S. Norwood, S.E.25
Works and Demonstration Room:
42, Cherry Orchard Road, E. Croydon
Telephone: Croydon 1618

LOUD-SPEAKERS.

EPOCH Moving Coil Speakers are Masterpieces, designed and produced by master engineers.

EPOCH Moving Coil Speakers are the Standard by which other Speakers are Compared.

EPOCH Moving Coil Speakers are in Use in many Editorial Offices.

EPOCH Moving Coil Speakers are in Use in several Famous Laboratories.

EPOCH Moving Coil Speakers are in Use in many Broadcasting Stations.

EPOCH Moving Coil Speakers are in Use by most Prominent Musicians.

EPOCH Moving Coil Speakers Bring Unbounded Joy to Thousands upon Thousands of Homes.

EPOCH Moving Coil Speakers, the only Speakers that give clear, uncoloured reproduction.

EPOCH Moving Coil Speakers do Render Speech Perfectly and Music Correctly.

EPOCH Moving Coil Speakers Provide the Perfect Illusion of the Artist's Presence.

EPOCH Moving Coil Speakers Represent the Finest Intrinsic Value ever Offered.

EPOCH Moving Coil Speakers are Guaranteed for a year, but last for ever.

EPOCH Moving Coil Speakers bring the Grand Concert out of the most Modest Set.

EPOCH—You can hear a hundred Moving Coil Speakers, but Epoch is different.

EPOCH—If you own the best set, only by Epoch can you confirm it.

EPOCH—Away with the tin can and cracked banjo reproduction, and install an Epoch.

EPOCH—Away with the drumminess dropiness and huskiness of the average Moving Coil Speakers.

EPOCH—The clearest, sharpest, cleanest reproduction—a marvel of accuracy and beauty.

EPOCH Moving Coil Speaker Models from £2/10 to £30.

EPOCH Moving Coil Speakers—Models for every requirement and taste.

EPOCH Permanent Magnet Moving Coil Speakers—Nine models from £3/15.

EPOCH Permanent Magnet Moving Coil Speakers Require no Mains or Batteries.

EPOCH Permanent Magnet Speakers are more Sensitive than most Energised Moving Coil Speakers.

EPOCH Energised Models are the Finest ever put on the market.

EPOCH Super Cinema Speaker has Created the Biggest sensation for many years.

EPOCH Super Cinema Model is many times as Sensitive as the so-called Supers.

EPOCH Super Cinema Speaker give Enormous Volume from a 1-watt Amplifier.

EPOCH Super Cinema Speakers are used on many 100-watt Amplifiers and never "rattle."

EPOCH Super Cinema Model is Standard on several Talkie Equipments.

EPOCH Super Cinema Model is already in use in over 200 Cinemas.

EPOCH Super Cinema are the only Moving Coil Speakers used in Large Theatres, unaided.

EPOCH Super Cinema Speakers provide alone the Upper as well as the Lower Register.

EPOCH—Other Moving Coil Speakers require the help of exponential horns to provide depth.

EPOCH—A list of many prominent cinemas using the Speakers supplied on request.

EPOCH Speakers are not Made of Tin or Aluminium Stampings, but are sound, solid, engineering jobs.

EPOCH Heartily Invite Comparison on all counts, with any make, regardless of price or claims.

EPOCH—Don't accept our quality claims without verification, but don't accept any other maker's either.

EPOCH—Order one for 7 days approval, and test with a switch-over; the only real test.

EPOCH Moving Coil Speakers may be heard in our Demonstration Room Daily.

EPOCH—Our demonstration room is in the heart of London.

EPOCH—Its accessibility has been studied for the convenience of callers.

EPOCH—If you cannot call, write for booklet W.S.3, and approval terms.

EPOCH RADIO MANUFACTURING Co., Ltd., Farringdon Av. (near Ludgate and Holborn Circuses). 'Phone: Central 1971. [8983]

MAGNUM PICK-UP



Price 35/-

The efficiency of a Pick-up must be judged by its curve. Study this curve.

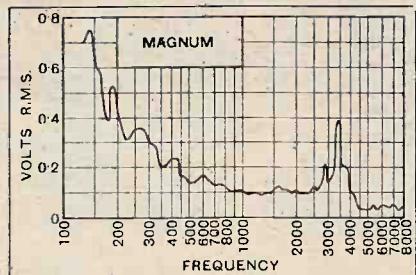

In the recent review of leading Pick-up Units, "Wireless World" states:— "... Taking the performance as a whole, this pick-up may be placed among the best half-dozen."

Full particulars, including pamphlet "Volume Controls and Dissolvers and How to Use Them," and a useful list of leading short wave stations free on request.

BURNE-JONES & CO., LTD., MAGNUM HOUSE, 256, Borough High Street, London, S.E.1. Telephone: HOP 6257 & 6258.

ESSENTIAL FOR MAINS RECEIVERS

Look at it—completely insulated, essential where high voltages are concerned—ample contacts—impossible to burn out valves. The first plug and socket in which both parts are engraved and entirely insulated when connected or disconnected. Engravings on both Plug and Socket make for easy connections.



Price 9d.

(Panel Portion 3d) (Flex Portion 6d.) Ask your dealer, or send to us for FREE Belling-Lee Handbook "Radio Connections."

BELLING-LEE FOR EVERY RADIO CONNECTION

Advertisement of Belling & Lee Ltd., Queensway Wks., Ponders End, Mdx.

EXACT TUNERS

250 to 2,000 metres.

No further coils are required, tuning is as simple as A.B.C., see "Wireless World," January 25th: "We can strongly recommend these tuners." Send postcard for particulars and Circuits FREE to

THE EXACT MANUFACTURING CO. Craft Works, Priory Place, COVENTRY.

Loud-Speakers.—Contd.

BAKER'S SELHURST RADIO 36-page Booklet, "Sound Advice is Yours for the Asking"; write now for new edition; see displayed advertisement on page 12. [0231]

VIBRO-SKIN Special Leather for Fixing the Diaphragm of the Moving Coil Loud Speaker; price 2/- per piece 11in. square, 1/6 per piece 9in. square; post free; cash with order.—The Alder Leather Co., 5, Southwark St., S.E.1. Tel.: Hop 4448. [0330]

PERARDUA Moving Coil Reproducers—These superlative instruments may be obtained for 15/- down, balance by 5 equal monthly payments; cash prices, 230-volt D.C. £3/3; 6-volt, £3.—R. Vevers, 4, York Rd., Maidenhead. [8872]

MAGNAVOX R5 200-250v. D.C. Field, £3/10; also R.K. junior, latest pattern, scarcely used, same field winding, £4/10; both absolutely perfect order; wanted R.K. Senior, latest, with A.C. equipment, 200 volts.—B.M./M.H.N.E., London, W.C.1. [9008]

SUPERTONE Mahogany Cabinet Loud-speakers, perfect tone, stupendous volume; 35/-; trade enquiries invited.—Supertone Reproducers, 97, Thomas St. Bristol. [8794]

DOUBLE Linen Speakers, 22in. square, mahogany or oak case, fret, wonderful tone; 28/6 cash with order.—Melodist Radio Co., 57, Sparsholt Rd., London, N.19. [9050]

R.K. Moving Coil, £3; 2 old M.C. speakers, £1 each; new moving coil speakers, 220v. A.C., £3; carriage extra.—James Scott and Co., Radio Engineers, Dunfermline. [0336]

6 GUINEA British-Thomson-Houston, Rice-Kellogg speaker, 6 volt; 4 guineas, carriage paid; write first; no offers.—37, Wilberforce Rd., Walton, Liverpool. [9044]

AMPLION Lion Chassis, 60/-; Celestion Woodroffe pick-up, 40/-; both as new.—F. R. C., Cowden Cross, Cowden, Kent. [9069]

TRANSMITTERS.

CHEBROS. Chebros. Chebros transformers and chokes of all descriptions, special transformers for transmitting and modulation; chokes a speciality; enquiries invited.—Chester Bros., 244, Dalston Lane, London, E.8. [5240]

VALVES.

AMPLIFIER Valve—If you require power you cannot do better than one of these:—

FILAMENT Volts 6, plate volts 400 (maximum), grid bias 84 volts (approx.), impedance 800 ohms., amplification factor 3.8, mutual conductance 4.35 m.a./volts; price £5/10; see article "The Wireless World," 24th July, 1929; then send to North London Valve Co., Ltd., 22½, Cazenove Rd., Stoke Newington, London, N.16. [8808]

TWO Osram P625A, 7/6 each; P.M.5, 3/6; B4, 3/6.—Hanson, Verwood, Dorset. [9007]

MULLARD P.M.24, perfect condition; 15/-—Box 5545, c/o The Wireless World. [9019]

MULLARD S4 Valve, as new, 10 hours use; 12/6.—H. Claricoat, 66, Archery Rd., S.E.9. [9001]

L.S.6A, £1; L.S.5A, 15/-; P625, 10/-; Mazda S.G.215, 15/-; H.L.210, 5/-; P220 power, 6/-; all as brand new.—P., 74, Aberdeen Rd., Highbury, N.5. [9056]

WIRE.

WIRE You Require; D.C.C., D.S.O., and enamelled, all sizes, coverings, stocked.—Frost, 54, Clerkenwell Rd., E.C.1. [9063]

COMPONENTS, ETC., FOR SALE.

BELLING-LEE Panel Fittings are designed to give an expert finish to any home-constructed set; catalogue post free.—Belling and Lee, Ltd., Queensway Works, Ponders End, Middlesex. [0018]

WESTON Model 301, milliameters, ammeters; and voltmeters, 21/- each; hot wire ammeters 0-1 amps., 4/-; 0-0.5 amp., 3/-; instrument repairs and alterations; send for list.—The Victoria Electrical Co., 47, High St., Battersea, S.W.11. Established 1910. [8626]

COMPONENTS Lent on Hire—Details from Alexander Black, Wireless Doctor, 55, Ebury St., S.W.1. Sloane 1655. [0329]

CLEARANCE—Bolt dynamos, volts 12, amps. 12, C.A.V. dynamo, volts 8, amps. 6, quick sale, 35/-; Browns P.Q. type public address loud-speaker horns and flares, excellent condition, 11/6; Gammont speech amplifier, £5; ex Government heterodyne wave-meters, 8/6, ohmmeter, 35/-; portable voltmeters, teak cases, 17/6; Marconi ¼ K.W. transformers, 22/6; new Burndept Ethophone IV 4-valve receivers, mahogany cabinets, sacrifice £5/10.—J. B. Humphreys and Co., 23, College Hill, Cannon St., London, E.C.4. [8982]

IRON Core, airspaced, H.F. choke, insures even choking; post 2/6.—Calton-Stewart, 28, St. Enoch Sq., Glasgow. [9016]

SUPERDYNE Unit, transforms your obsolete 2- or 3-valver into a powerful portable without extra valves.—Particulars, Ledsham, 297, King St., Hammer-smith. [9002]

Mention of "The Wireless World," when writing to advertisers, will ensure prompt attention.

**SENSITIVE
MICROPHONES
FOR
DEAF AIDS,
DETECTAPHONES,
PUBLIC ADDRESS,
AND FOR THE RELAYING OF
SPEECH & MUSIC
TO ANY DISTANCE.**

All descriptive Lists Free.

FREDK. ADOLPH, Actual Maker,
27 Fitzroy St., London, W.1. Phone: Museum 8329.

BROWNIE

10'6

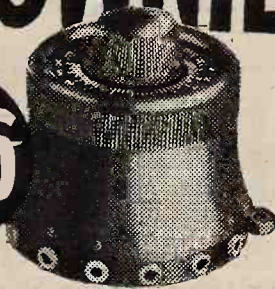

**SELECTIVITY UNIT
(WAVE TRAP & SELECTIVITY UNIT)**

Screen-Grid Selectivity with an ordinary set—that's what you get with the Brownie Combined Wave Trap and Selectivity Unit! Used as a wave trap, it immediately cuts out the interfering station: used as a selectivity unit, it provides razor edge tuning throughout the entire range. Its performance is amazing—yet it costs only 10/6! Your dealer will tell you all about it.

BROWNIE WIRELESS CO. (G.B.)
Ltd., Nelson St. Works, London N.W.1.

Components, Etc., For Sale.—Contd.

TWO Sparta 2v. Accumulators, 5/- each; Brown's A phones, 10/-; Sparta super H.T. battery (new), 6/6; 9 Igranite coils, 6/-—R. and S., 5, Prebend Row, Darlington. [9005]

R.I. Multi Transformer, 7/6; Dubilier 0.0003 variable inductor vernier dial, 8/6; R.I. resistance coupler, type A, 9/6; Dubilier resistance coupler, valve holder type 4/6; Mullard P.M.24 pentode, 7/6; 60-volt H.T. accumulator, 17/6; 30-volt H.T. accumulator, 7/6; H.T. charger, D.C., 9/6.—Sayers, 255, High St., Camden Town. [9013]

RADIO HOUSE, HUDDERSFIELD, issues the Reliability Wireless Guide, which will be sent post free upon request by Messrs. J. H. Taylor and Co., 15, Macaulay St., Huddersfield. [7823]

PART Exchange.—See our advertisement under Receivers for Sale.—Scientific Development Co., 57, Guildhall St., Preston. [0228]

A RADIO-GRAMOPHONE Manufacturing Company (in voluntary liquidation); parts offered for sale by order of the liquidator.

CALLERS ONLY.

ELECTRIC MOTORS B.T.H., 60/-; dual, 35/-; fittings G.E.C. Auto stop, 2/-; turntables, G.E.C. and B.T.H., 4/-; spring motor Collaro S.S., 12/6. Pick-ups: B.T.H. Gilt, 30/-; arm only, 2/6; Burndept. 10/- tone arms, 1/-; Transformers: R.I. 375v., 35/-; Pys 684, 15/-; 680, 8/-; McMichael semi aperiodic, 2/6. Valves: Osram L.S.5, 7/6; D.E.H.610, 5/-; D.E.8 H.F., 10/-; Cossor 610P, 6/-; 610 H.F., 5/-; Maxda P.X.650, 10/-; rectifier, Westinghouse H.T.1, 50/-; eliminator, Met-Vick L.T., 7/6; metal cases, 2/-; resistances, Bradleyohms, 3/6; Aerovox, 700 ohms, 2/-; Varley volume controls, 4/-; grid leaks, various, 3d.; fixed condensers, Hydra, 8 mid., 5/-; 1 mid., 1/6; T.C.C. 4 mid., 3/6; Dubilier 2 mid., 1,200v. test, 5/-; various, 6d.; Formodensers, 1/6. Switches: Wearite lever, 2/6; Lissen, P.P., 1/-, and others. Chokes: H.F., R.I., 4/6; Woodfull, 1/-; L.F., Rich and Bundy, 10/-; Accumulators: Exide W.H.10, 5/-; 3C.Z.6, 20/-; carriers, 2/6; panels, assorted, 1/- upwards; valve holders from 4d.; workshop tools, 5/-; tools, various; complete radio-gramophones (see under Receivers).

CALLERS ONLY.

L IQUIDATOR, Reproduction, Ltd., 5, Dysart St., Wilson St., E.C.2. [9066]

PHILIPS M.C. Loud-speaker 2049, with transformer, as new, £4; Philips H.T. unit, 3002, new, £3; Infradyne, America's wonder set, 10 valves, cost £40, as new, £15; Magnaformer, America's super set, 9 valves, as new, cost £40, £15.—J.C., 11, Garrick Close, Walton-on-Thames. [9048]

S TATIC Transformer by Foster Engineering Co., primary 200 volts, secondary 500-1,000-1,500-2,000 volts, mid tap, also 7 and 14 volt-tappings, £5; electric motor, 3h.p., 900 r.p.m., 200 volts, D.C., as new, £10; 2 0/50 Mullard transmitting valves, as new, £1/5 each; rectifying panel, with 2 valves and Western milliammeter, £1/15.—Moir, 46, Wisteria Rd., Lewisham, S.E. [9047]

DYNAMOS.—50v. 4a. charging dynamos, shunt wound, perfect, 35/-; 110v. 3a., ball bearing, 55/-; 20v. 8a., ball bearing, 40/-; 220v. 2a., 55/-; all perfect and ready for use.—Below.

MOTORS, 1/4h.p. to 1/2h.p., 110v., D.C., ball bearing, as new, 30/-; 220v. ditto, 50/-; 110v. D.C., 1/4h.p., shunt wound, 40/-; 1/2h.p., 110v. and 220v., D.C., 10/- each; new portable telephones, 20/-; wireless spark transmitting sets, 12/6; magnetic relays, 12/6; microphones, 2/-; microphone transformers, 2/6; earphones, 1/6; 1,000 ohm H.T. chokes, 1/-; P.O. relays, 6/6; lin. spark coils, 6/-; Ford ignition coils, 4/-; buzzers, 3/6; Morse keys, 3/6.—Below.

S TARTERS and Regulators, make good shunt regulators for dynamos, 2 amp. 7/6, 5 amp. 10/-, 8 amp. 12/6; all goods cash with order or c.o.d.; all letters answered; satisfaction guaranteed.—Galpin, Binfield Heath, near Henley-on-Thames. [9046]

FERRANTI A.F.5, 19/6; A.F.6, 22/-; O.P.M.1, 16/-; Marconiophone D.C.2 eliminator, 40/-; Lion chassis, 55/-; Megavox coils, pair 12/6.—Woodthorpe, 5, New St. Hill, E.C.4. [9064]

A MATEUR'S Surplus.—Gambrell Nerotone, 75/-; Ferranti M.C. speaker unit (new), £8/15; Burndept choke (40 h.), 12/6; two P625A, 8/6 each; two D.E.L.610, 5/- each; three Burndept super-het transformers, 25/-; one P.M.6D, 6/-; one A.F.5 transformer, 22/6; A.F.S.C. 26/-; various Burndept coils, 1/- each.—Snelgrove, Rosemount, Hursley Hill, Whitechurch, Som. [9070]

B.T.H. Rice-Kellog Moving Coil Speaker, 6 volt field, Junior model, £3; B.T.H. electric gramophone motor, with auto. stop and 12in. turntable, £3/10; Woodroffe-Celestion pick-up, as new, £2.—C. J. Diamond, 132, Griffin Rd., S.E.18. [9057]

FOR Sale.—Epoch 6-volt high resistance moving coil, 55/-; Philip's L.T. charger (£3/10 model), £2; T.C.C. electrolytic condenser, 8/-; A.C.P., 12/6; last 3 nearly new.—Munden, 9, Montague Place, Cotham, Bristol. [9031]

SURPLUS Components.—A.C. eliminator, H.T. accumulator, S.G. valves, etc.; stamp for list—103, Ullet Rd., Liverpool. [9030]

The heart of every set



Pentode 18/6
Screened Grid 15/6

General Purpose
and Power

5'6

Super Power 7/6

Let FOTOS fill this vital position! And give your set a chance to produce that quality of which it is capable.

Ask for

fotos
CONCERT VALVES
THE HEART OF EVERY SET

or write for descriptive Booklet B22
CONCERT RADIO & ELECTRICAL CO., LTD.
256/7, Bank Chambers, 329, High Holborn, W.C. ↑
Phone: Holborn 8667.

STOP CARRYING THAT BATTERY ABOUT. CHARGE IT YOURSELF.



All you have to do is to connect up your Batteries and switch on. It charges one to six Cells, i.e., 2 to 12 Volts at 1 1/2 amps. without requiring attention of any kind. It is guaranteed against defects for 12 months.

You Save Money by using this Charger.

The price complete with 45/- Valves ready for use is only 10/- State Voltage of you supply mains when ordering.

SAVOY UNITS, 30 City Road, London, E.C.1
Telephone: Clerkenwell 6610.

The Autocar EVERY FRIDAY, FOURPENCE

Components, Etc., for Sale.—Contd.

R.L. Transformer, 6-terminal, straight line, 15/-; Hagra 4-pole balanced armature unit, 13/6.—Smith, 67, Fairdene Rd., Coulsdon. [9043]

THE Following Slightly Used Components to Clear.—Master Three coil, 10/-; R.I. tuner, 17/6; Mullard Orgola coils, 11/- pair; set James Special Three coils, 12/6; Lotus Q.S.P. coil, 9/-; ditto Q.A., 7/-; Colvern T.R.2 coil, 7/-; Formo screen grid coils, 10/- pair; Ferranti screen grid H.F. kit, 18/-; set Eddy-stone short wave coils, 10/-; set Aero short wave coils, etc., listed 65/-, 25/-.

AMPLION B.A.2 Unit, 14/-; Blue Spot unit, 15/-; Brown V. unit, 15/-; Goodman P.G.3 cone and chassis, 21/-; White Spot chassis, 12/6; Blue Spot chassis, 9/-.

A.P.5C and O.P.3C, 42/- pair; pair R.I. Bi-Duplex heavy duty push-pull transformers, 35/-; R.I. resistance capacity units, 8/-; ditto Dubilier, 3/6; ditto Marconi, 3/6; Celestion C.14 speaker, cost £14/14; £7/15; Amplion L.18 power chassis, £5/10; ditto L.14, £4; pair P.M.26 valves, 14/- each; P.M.24, 14/-.

ALL Guaranteed; also many other components; send A list of requirements; carriage paid over 20/-.—Scientific Development Co., 57, Guildhall St., Preston. [9055]

AMPLION Lion, type L.C.41, in oak cabinet, just overhauled by makers, £5/10, or nearest; also P.M.256, H.L.610, P.M.14.—C.G. Tangye, Bromo, nr Stourbridge, Wores. [9051]

VOLTMETER, Weston 6-volt panel mounting, £1; Marconi U5, box unopened, 15/-; A.C.G. with holder, 8/6; 2 P.M.5X, 4/- each; Lotus remote control for eliminator, 15/-.—Mannheim Rd., Bradford, Yorks. [9042]

B.L. Screening Box, 3/-; Lewcos split primary aerial and 2 transformer coils, 550 metres, Magnum ditto, 2,000 metres, Lewcos C.A.C.5, 2/6 each; National dial 0-100-0, 2/6; P.S. neut. cond., 2/-; P.M.14 S.G., 12/6; 4D.X., 5/-.—Mearns, Methven Rd., Giffnock, Glasgow. [9035]

MISCELLANEOUS.

ALEXANDER BLACK.

THE Original Wireless Doctor, will call (London and Home Counties) and cure your set.

CONSULTATIONS by Appointment Without Obligation, sets installed, maintained, and brought up to date, gramophone pick-ups, eliminators, and Webson moving coil speakers demonstrated; purity reproduction specialists.

55, Ebury St., Victoria, S.W.1. Sloane 1655. [0277]

CALIBRATE Your Set With the C.D.E.S. Calibration Chart; 8d., post free.—C.D.E.S., 98, Cherry Orchard Rd., Croydon. [8612]

SCOTT SESSIONS and Co., Great Britain's Radio doctors, officially approved as wireless repairers by Radio Society of Great Britain and Wireless League; old sets of every type repaired, rebuilt, modernised; send set for immediate quotation.

SCOTT SESSIONS and Co.—New sets constructed with your or our components, guaranteed finest workmanship; we specialise in "The Wireless World" circuits; remember, we have satisfied customers throughout the British Isles and in three Continents; if you so desire, we will design and construct high grade apparatus to suit your special circumstances for quality, range and selectivity.—Tel.: Tudor 5326. Muswell Hill, London, N.10. [0262]

FAIR Isle Jumpers.—For high class goods at wholesale prices, apply Pottingers, Hamnavoe, Lerwick. [8889]

PATENT AGENTS.

PATENTS and Trade Marks, British and foreign.—Gee and Co. (H. T. P. Gee, Member R.S.G.B. and A.M.I.R.E.). 51-52, Chancery Lane, London, W.C.2. Phone: Holborn 1525. [0001]

PATENTS.

THE Owners of Patent No. 266655, relating to Identification Label for Insulated Conductors, and No. 220183, for Identifying Marker for Insulated Conductors, are desirous of negotiating with interested parties for the granting of licences thereunder on reasonable terms.—For information apply to Messrs. Lloyd Wise and Co., 10, New Court, Lincoln's Inn, London, W.C.2. [9065]

REPAIRS.

SCOTT SESSIONS and Co., Great Britain's radio doctors; read advertisement under Miscellaneous column. [0263]

REPAIRS Returned Post Free, and to ensure satisfaction send remittance after approval of same.—Leeds Wireless Repair Service.

LOUD-SPEAKERS, headphones, rewound to any resistance and remagnetised, 3/-; transformers rewound, 4/-; Blue Spots, Triolrons and 4-pole units, 4/6; work guaranteed.—Leeds Wireless Repair Service, 5, Boston Place, Green Rd., Leeds. [8945]

BONA FIDE TRADERS' GUIDE.

Send for our comprehensive Illustrated List QUICK SERVICE. QUICK SERVICE.

THE QUALITY HOUSE.

PERSEUS MFG. CO., LTD. (Dept. W.W.), BRANSTONE RD., BURTON-ON-TRENT.

METAL CABINETS

EVERYMAN FOR KILOMAG 4. RECORD 3. Complete with base and finish 47/6. Plain cabinet without base 27/6. FOREIGN LISTENERS 4 (set of 4) 18/6. W. H. PARKER, Sheet Metal Worker, Back Autumn Terrace, LEEDS. Tel: 52859

EELEX
WANDER PLUGS
Actual size, nickel plated, 6 colours. 2DW Standard size, 2DW or Midget, 2d. each.
Write for List X98.
J. J. EASTICK & SONS, 118 Bunhill Row, London, E.C.1

"TILTRACK"
Registered Trade Mark
Patent-STEEL STORES System
For the Wireless Experimenter, Factory, Factor and Retailer.
Full Particulars from Sole Manufacturer and Patentes:—
BERTRAM THOMAS, Worsley Street, Hulme, MANCHESTER.

MAKE A GRAMOPHONE AT

quartershop prices. Or buy Cabinets for Wireless. Order Set as shown. British spring motor. Velvet turntable, swan arm, metal soundbox, amplifier, needle cups, for £17 3 0 p.p., and build your own Cabinet. Portable Gramophones from 21/- Motors from 8/6. Lists free. 64 pp. Catalogue, Drawing and How to Make Gramophones, 3d.
REGENT FITTINGS CO. (W.O.), 120, Old Street, London, E.C.1.

METAL Cabinets

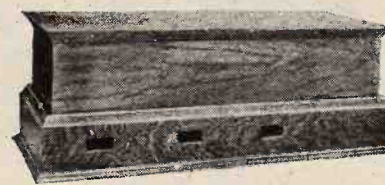

Precisely to specification and sealed with Tubular Brass Gauge, for ALL "WIRELESS WORLD" SETS
Oak Base and Oak Finish 57/6 complete
Mahogany 63/-
Oak Base and Imitation Leather 63/-
Metal Container and Copper Screens, less woodwork 47/6
COILS, DRUM DIALS AND ESCUTCHEONS to "W.W." Specification.
1930 Everman Four 47/6 per set
NEW Kilomags IV 45/-
Record III 45/-
Wave Trap 10/6
1 1/2" Drum Dials with Escutcheons 5/6 each.
RIGBY & WOLFENDEN, Sheet Metal Workers, Millnrow Road, ROCHDALE. Phone 2019

Repairs.—Contd.

GUARANTEED Repairs by Experts.—Loud-speakers, headphones, cone units, pick-ups, any type, rewound, remagnetised, and adjusted, post free 4/-; transformers, from 4/-.—Howell, 91, Morley Hill, Epsom, Middlesex. [7882]

WANTED.

WANTED, demonstrators and canvassers for portables.—Box 5465, c/o The Wireless World. [8957]

WANTED, petrol driven H.T. generator, 250 volts 3 amps (about); price and particulars.—F. S., 128, Lewisham Rd., London, S.E.13. [8994]

WANTED, 400-volt eliminator, 60 to 80 milliamperes, 40 cycles, with L.T. preferred, mains voltage 240; no rubbish entertained.—Phillips, 6, Cheapside, Spennymoor, Co. Durham. [9049]

WANTED, all types of electrical and wireless apparatus; purchased for cash; large quantities only.—Thompsons, 1, South St., Greenwich, S.E.10. Tel.: 1259 Greenwich. [0331]

WANTED, 1, 2, and 4 mfd. fixed condensers; cheap.—186, Normandy Rd., Handsworth, Birmingham. [9068]

"WIRELESS WORLD," giving original Kilomag Four.—Box 5558, c/o The Wireless World. [9060]

EXCHANGE.

WE Will Accept Your Surplus Apparatus (making you a high allowance) in Part Payment for any New Apparatus; your enquiry will be dealt with promptly.—Bostock and Stonnill, 1, Westbourne Terrace, S.E.23. [9015]

CRESCENT Multimeter, or 0-25 milliammeter for 0-50 milliammeter, or 2-volt valves.—Hanson, Ferwood, Dorset. [8853]

ICRANIC Dual Impedance Unit, 30/- new, for Ferranti A.F.3 or A.F.5; sell 17/6.—Head, Playden Cottage, Missenden, Bucks. [9040]

ATTWATER-KENT 5-valve Receiver, 2 H.F. D, 2 L.F., very selective, with valves, for folding reflex camera.—Tel.: Barnet 2727, London. [9038]

PART Exchange.—The best offers are made by the Northfield Radio Stores, 157, Northfield Av., West Ealing, Ealing 3666. [9027]

MAZDA A.C./S.G. Valve, unbroken sets, 15/-; "W.W." lit set, Mazda valves, S.P. batteries accumulator, £11, cost £16; Garrard No. 10a motor, 37/-, exchange portable.—Box 5562, c/o The Wireless World. [9071]

COMPONENTS Taken in Part Payment, brand new supplied guaranteed; any reasonable suggestion accepted; cash payment not always essential; state lowest price acceptable for your goods, and particulars of new required.—Byall's Radio, 182, Kennington Rd., London. [9075]

BUSINESSES & PROPERTY FOR SALE, TO BE LET, OR WANTED.

OLD KENT RD., S.E.—Capital shop and upper part, fine position for wireless trade; rent £150; premium £100; 12 years lease.—Apply C. C. and T. Moore, 113, Newington Causeway, S.E.1. [9009]

WIRELESS Business, main thoroughfare S.W. London, rent 25/-; price £40, stock at valuation, if desired.—Write 41, Merton Hall Gardens, S.W.20. [9022]

SITUATIONS VACANT.

WIRELESS Operating Appointments Assured; short qualifying course, day, evening; fees payable after appointment for boarding students; Morse classes.—Manager, Wireless School, 21, Manor Gardens, London, N.7. Archway 3694. [8121]

ENGINEERS Required Immediately for Sound Reproduction Section, only those with actual experience of talking equipment need apply.—The B.T.H. Co., Ltd., Construction Department, Rugby. [8987]

WIRELESS Services.—The Premier Telegraph College in the British Isles (established 34 years) gives a sound training to all students, with assured positions on qualification. Fees are not disguised under expensive board-residence scheme. 44 students out of a total of 47 obtained qualifying wireless certificates at first attempt in the last seven Government examinations.—Apply for prospectus, Dep. W, The London Telegraph Training College, Ltd., Morse House, Earl's Court, S.W.5. [8943]

PUBLICITY Manager.—Manufacturers of electrical and wireless components require an experienced advertisement layout writer, capable of taking charge of publicity department; no applications can be considered unless the following particulars are given, age, salary required, full details of experience, whether at present disengaged and samples of work.—Box 5479, c/o The Wireless World. [8990]

Mention of "The Wireless World," when writing to advertisers, will ensure prompt attention.

Situations Vacant.—Contd.

HULL EDUCATION COMMITTEE, Municipal Technical College. Department of Wireless Telegraphy.

WANTED, Instructor in Chief, must hold first class certificate of Postmaster General, possession of the City of Guilds Certificate in Radio-Communication an additional recommendation.

COMMENCING Salary £350 per annum; hours of duty 10 sessions or 30 hours per week.

APPLICATIONS, giving age and full particulars, should be forwarded by letter to the undersigned not later than Saturday, the 3rd May.—R. C. Moore, Director of Education, Education Offices, Guildhall, Hull, 31st March, 1930. [9021

JUNIOR Assistant for Radio Shop; must understand battery charging.—Apply 205, Uxbridge Rd., W. Ealing. [9028

SITUATIONS WANTED.

WIRELESS Operator, P.M.G. certificate, seeks land berth, long experience all classes radio work, sound theory of wireless and electrical engineering, design and construction broadcast receivers, etc.—Box 5546, c/o *The Wireless World*. [9020

YOUNG Man (27), disengaged, served apprenticeship electrical engineering, good draughtsman, possesses first class P.M.G. and other certificates, operating experience, interested radio.—Box 5536, c/o *The Wireless World*. [8999

EX-NAVAL-AIR Operator (30), 12 years shore, sea and air experience, new P.M.G., keenly interested theoretical and technical radio, desires situation, any capacity.—Blake, 279, Fawcett Rd., Southsea. [9026

TRANSMITTING Amateur (licence 7 years), with technical training London College, desires post with reputable firm handling or manufacturing radio or radio-gramophone apparatus, well educated, and of good appearance, willing to undertake service work in London or the Provinces if good prospects.—Box 5557, c/o *The Wireless World*. [9059

BOOKS, INSTRUCTION, ETC.

"THE Wireless Manual" (new 1930 edition), by Captain Frost, is an ideal non-technical book full of up-to-date facts about wireless development, choice of set, how to use your own set, etc.; illustrated; 5/- (post 5/4), of a bookseller, or Pitman's, Parker St., Kingsway, W.C.2. [8178

STEP by Step Wireless, a complete course of the theory of electricity in relation to the practical design of wireless apparatus, eliminators, circuits, etc., with extracts from a designer's notebook, giving up-to-date practical application; issued weekly, send 1/- p.o. for first 4 weeks.—Clifford Pressland, A.M.I.E.E. Eng. Dept. W.W., Hampton-on-Thames. [0195

FREE: Inventor's Guide on Patents—T. A. A., 253 (W), Gray's Inn Rd., London, W.C.1. [6373

For the Best in Radio

WILL-DAY LTD.

(THE BEST IN THE WEST)

19 LISLE STREET, LEICESTER SQUARE, LONDON, W.C.2

OPEN TILL 7 P.M.

WRITE FOR OUR CATALOGUE

POSTAGE 6d FREE TO CALLERS

Aluminium Cabinets and Screening Boxes.

All sizes to order.

Standard screening boxes 6" x 6" x 6" 5/- each, including baseboards.

YATES SUTTON LTD., Sheet Metal Workers, York Street, Leicester.

BAKELITE ADAPTORS

with moulded-in contacts, suitable for Eliminators, All Mains Sets, Radio Gramophones, etc.

TURNOCK'S MOULDINGS, 41, High Street, Aston, BIRMINGHAM.

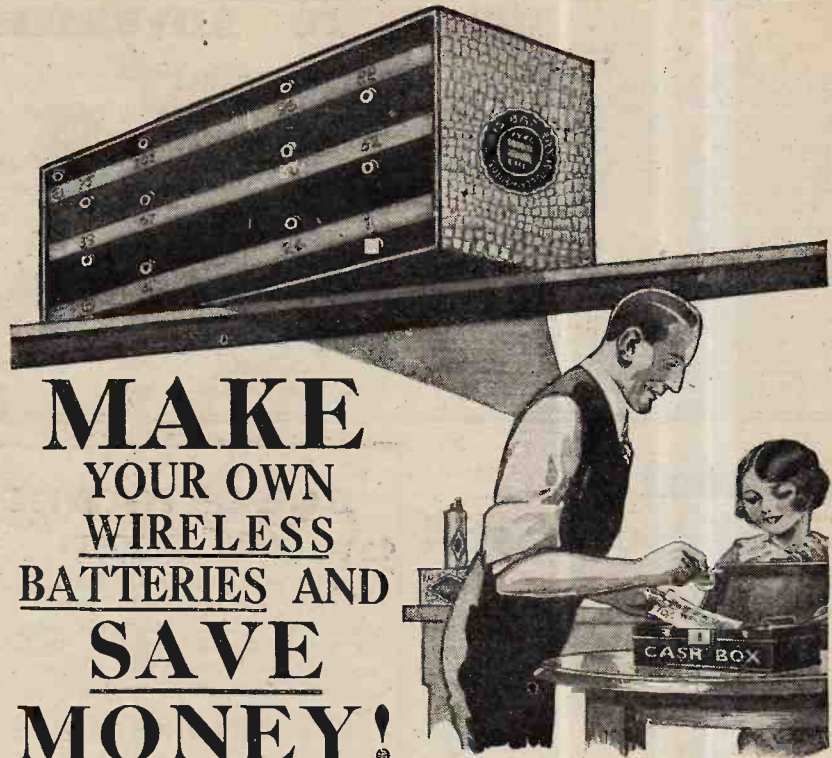

MAKE YOUR OWN WIRELESS BATTERIES AND SAVE MONEY!

WE GUARANTEE YOU PROFITS

Once you and your friends see how Highly Efficient our batteries really are, and how easily you can make batteries to equal the best you can buy, you and they will never want to use any other kind. Many "WIRELESS WORLD" readers who are now making our batteries find that repeat orders and new orders come in faster than they ever imagined; so fast, in fact, that sometimes the combined efforts of the entire family fail entirely to cope with the immediate demand. If, however, you are unable always to sell all you make we will buy sufficient of your output to Guarantee you a weekly profit, providing the same reaches the required standard of efficiency, which is easily attainable, and we undertake to continue your training FREE until that Standard is reached! Could anything be more definite or more fair?

BE UP AND DOING—TO-DAY!

It costs nothing to write for further particulars TO-DAY. Send the Coupon below and learn all about the Wonderful Opportunity that we offer you! The amount of money you can earn is only limited by the time you have to spare! Don't hesitate—you've nothing to lose but there may be a lot to gain by Acting Quickly.

You have made your own Wireless Set and saved money on it—and enjoyed it all the more because you did make it. Why not go a step further and make your own batteries and save money on them, too?

"Batteries?" you say. "Too technical." Not by any means. The work is easy and pleasant—it can be commenced on your kitchen table and it is so simple that the family can help. But where you will gain—and gain a lot—is in the fact that the batteries manufactured by our Patent Methods are far and away more efficient and longer-lasting than the average factory-produced article. This is proved by independent experts' tests. Besides, you will know there are no "defects" to let you down at critical moments.

You will find the work so fascinating that you may want to go further into this profitable business. Why not make your friends' batteries, too?

NO EXPENSIVE MACHINERY.

No previous knowledge or skill is necessary. No expensive plant or machinery is required. You need only simple hand tools and presses. Most of these you can make yourself at a very small cost. Very little instruction is necessary and we will give you that FREE.

MAKE YOUR FRIENDS' WIRELESS BATTERIES AND MAKE MONEY!

SEND THIS COUPON TO-DAY.

To Mr. V. ENGLAND-RICHARDS, THE ENGLAND-RICHARDS CO., LTD., 67, King's Lynn, Norfolk.

Sir,—Please send me at once, and FREE, full details as to how I can Make Money at home in my spare time. I enclose 2d. stamp for postage.

Print your name and address boldly in capital letters on a plain sheet of paper and pin this coupon to it.

"Wireless World," 9/4/30.

INDEX TO ADVERTISEMENTS.

Adolph, Fredk	PAGE 17	Green & Faulconbridge, Ltd.	PAGE 13	Regent Fittings Co.	PAGE 18
Appleby, E. Hetherington	11	Heyberd, F. C., & Co.	6	Regent Radio Supply Co.	2
Apollo Gramophone Co., Ltd.	2	Holzman, L.	Cover i.	Rigby & Woolfenden	18
B. & J. Wireless Co.	13	Hughes, F. A., & Co. Ltd.	13	Rothermel Corp., Ltd. (Electrad)	6
Baker's "Selhurst" Radio	15	Lectro-Linx, Ltd.	20	Rotor Electric, Ltd.	14
Belling & Lea, Ltd.	16	Lever, Eric J. (Trix.), Ltd.	7	Rowley, Thos., Ltd.	17
Benjamin Electric, Ltd.	4	Lisenin Wireless Co.	11	Savoy Units	2
British School of Engineering Tech.	Cover iii.	Lock, W. & T. Ltd.	17	Scientific Supply Stores	18
Brownie Wireless Co. (G.B.), Ltd.	17	London Electric Wire Co. & Smiths, Ltd.	11	Telegraph Condenser Co., Ltd.	18
Burne-Jones & Co., Ltd. (Magnum)	16	Marconiphone Co., Ltd.	7	Thomas, Bertram	20
Carrington Manf. Co., Ltd.	6	McMichael, L., Ltd.	7	Transformer Repair Co.	Cover i.
Celestion, Ltd.	Cover iii.	M.L. Magneto Synd., Ltd.	Cover i.	Trelleborgs Ebonite Works	8
Cole, E. K., Ltd.	Cover i.	Mullard Wireless Service Co., Ltd.	Cover iv.	Triotron Radio Co., Ltd.	19
Concertion Radio & Electrical Co., Ltd.	17	Ormond Engineering Co., Ltd.	14	Turnock's Mouldings	4
Day, Will, Ltd.	19	Overseas Trading Co.	18	Universal Gramophone & Radio Co., Ltd.	6
Eastick, J. J., & Sons	18	Parker, W. H.	18	Varley (Oliver Pell Control, Ltd.)	5
Edison Swan Electric Co., Ltd.	3 & 9	Paronssi, E.	18	Vokes, C. G., Ltd.	13
Electradix Radios	20	Perseus Manf. Co.	1	Westinghouse Brake & Saxby Signal Co., Ltd.	Cover iii.
England-Richards Co., Ltd.	19	Pertrix, Ltd.	Cover ii.	Wingrove & Rogers, Ltd.	15
Ever Ready Co. (G.B.), Ltd.	10	Phillips Lamps, Ltd.	5	Wilburn & Co.	13
Exact Manf. Co.	16	Playser's	20	Wilkins & Wright, Ltd.	Cover iii.
Gambrell Radio, Ltd.	Cover iii.	Potter, H. B., & Co., Ltd.	4	Wright & Weaire, Ltd.	19
Garnett, Whiteley & Co., Ltd.	15	Radiogramophone Development Co.	4	Yates Sutton Ltd.	19

A Shoal of Requests!

A recent advertiser in "THE WIRELESS WORLD" writes as follows:

"I feel I ought to inform you how successful my small advertisement was in "THE WIRELESS WORLD" of December 25th. Even before I had seen it myself I had received a shoal of requests of all descriptions. Practically everything was sold."

Martin Woodroffe,
Westington,
Chipping Campden,
Gloucester.

W.W.91.

ELECTRADIX

APRIL BARGAIN

List of Radio and Electrical Gear at fractional prices, ready. Send stamped envelope for full details. Will save you pounds. Biggest and Best stock in London.

ELECTRADIX RADIOS

218, Upper Thames Street, E.C.4.
City 0191. "Electradix, Cent, London."

POWER CHOKES

substantially built, for smoothing in eliminators dealing with currents 100 to 300 milliamperes, inductance 30 henries, 8/6 post free.

REPAIRS

to any make of L.F. Transformer, Loudspeaker or Headphones. All repairs dispatched within 48 HOURS—TWELVE MONTHS' GUARANTEE with each repair. 4/- Post Free. Terms to Trade.

TRANSFORMER REPAIR CO.

Dept. W.,
214, High Street, Colliers Wood, London, S.W.19.

"Could have been sold over a dozen times!"

A recent advertiser in "THE WIRELESS WORLD" writes as follows:

"You may be pleased to know that the coils I advertised in 'THE WIRELESS WORLD' could have been sold over a dozen times.

"They were sold first post here on Thursday morning, and I had applications for them for a fortnight after."

W. A. Pelly,
Pierhead,
Eastbourne.

W.W.92.



LISENIN

POSITIVE GRIP TERMINALS

(Patent 245,586)
Maintain their lead established five years since, and are acclaimed by the keen Radio experimenter as the ideal terminal. There is one for all radio connections. Write for descriptive leaflet. It's sent free to all "W.W." readers.

- Plugs and Sockets with 2 nuts 4d.
- Spade Ends 3d.
- Standard Wander Plugs 2d.
- Chubby Wander Plugs, for portable sets 2d.
- Pin Ends 2d.
- All Mains Socket and Plug 6d.

Don't forget Pos. Grips overcome unsightly frayed ends to leads. What a boon!
THE LISENIN WIRELESS COMPANY, SLOUGH, BUCKS.



PARFAIT

THE PERFECT EBONITE PANEL ONE QUALITY ONLY THE BEST

SUPPLIED IN SIX FINISHES: Matt, Semi-Polished Mahogany, Highly Polished Black, Cube Surface, Highly Polished Mahogany, Semi-Polished Black.
Stocked by most Wireless dealers. If any difficulty in obtaining locally, write for name of nearest stockist to:
H. B. POTTER & Co., Ltd., Station Buildings, ROCHDALE.

Mention of "The Wireless World," when writing to advertisers, will ensure prompt attention.

183

GUARANTEED

WEARITE

COMPONENTS

+YOUR TIME=BEST RESULTS—TROUBLE

MAINS TRANSFORMERS AND L.F. CHOKES

Type	Output.		Use.	Price.
T.2	4 v	5 a	For H.T. & L.T. For A.C. Valves Also U.5 Type Rectifier	37/6
	5.5 v	2 a		
	250 v	80 m/a		
T.3	135 v	50 m/a	For Westinghouse Rectifiers Styles H.T.3 & H.T.4	27/6
T.4	135 v	50 m/a	As T.3 with addition of wind- ings for A.C. Valve Heater	32/6
	4 v	5 a		
T.5	230 v	50 m/a	For Westinghouse Rectifier Style H.T.1, also A.C. Valve Heater Winding	32/6
	4 v	5 a		

CONSTANT INDUCTANCE L.F. CHOKES.

	Inductance (Henries)	Resistance (Ohms)	Current-carrying capacity.	Price.
H.T.2	20	35	75 m/a	21/-
H.T.3	40	850	50 m/a	21/-

Potentiometers, 200, 300 or 400 ohms. **2/6**
 Volume Controls, .25, .5, 1 or 2 megohms **4/-**
 To pass maximum 1 m/a.

Write for free illustrated lists:
WRIGHT & WEARE LTD.,
 740, HIGH ROAD, LONDON, N.17. Phone: Tottenham 3847/8.

all about

6d. BOOK FREE!



An interestingly written and well-illustrated 36-page book on Condensers. Invaluable to the radio enthusiast and should be in the hands of every set constructor and owner. Published at 6d., but sent Free to all readers of "The Wireless World" for 1½d. stamp. Write Dept W.

Two Famous "Polars"

POLAR "IDEAL"
 FAST AND SLOW MOTION TUNING
 CONDENSER.

Can be used in practically any circuit, and is scientifically designed to give a definitely wider tuning range. Smooth and silent action. Excellent for short or long wave work.

'0005, 12/6 '00035, 12/3 '0003, 12/-
 Phosphor-bronze balls 6d. extra.

POLAR "No. 3"
 DIRECT DRIVE TUNING CONDENSER

Excellent on all wavelengths. Smooth yet precise action. Constructed, like the "Ideal," of chemically cleaned hard brass.

'0005, 5/9 '00035, 5/7 '0003, 5/6
 Phosphor-bronze balls 3d. extra.
 Dial 1/- extra.

WINGROVE & ROGERS LTD.

188-9, STRAND, W.C.2. | MILL LANE, OLD SWAN, LIVERPOOL.

ENGINEERS!

Can't we get together?



All we ask is the chance to prove that you can earn £300, £400, £500 per year or more. Other men are doing it, and you can do the same

We have an unrivalled and world-wide organisation, waiting to help you whether you be novice or expert. If you wish for something more than a "bread and butter" job you owe it to yourself to investigate our Service.

Our handbook "Engineering Opportunities" has pointed the way to better things to over 20,000 of your fellows. It contains details of A.M.I.Mech.E., A.M.I.E.E., A.M.I.C.E., A.M.I.A.E., A.M.I.Struct.E. London Matric., C. & G., G.P.O., etc. Exams., outlines home study courses in all branches of Electrical, Mechanical, Motor and Wireless Engineering, and explains our unique guarantee of

NO PASS—NO FEE.

In a Brilliant Foreword Prof. A. M. Low shows clearly the chances you are missing. "Engineering Opportunities" and our advice are quite FREE. Don't neglect this offer—give vent to that "upward urge" and send a postcard NOW, stating Branch, Post or Exam. which interests you.

BRITISH INSTITUTE OF ENGINEERING TECHNOLOGY,
 387, SHAKESPEARE HOUSE, 29-31, OXFORD STREET, W.1.

Write for this Book today
IT'S FREE!

THE FIRST STEP WHICH HAS LED THOUSANDS TO SUCCESS



Today more than ever, the 4 years' old Celestion C.12 is recognised as Radio's Richest Voice.

The Celestion C. 12 is the one Loud-speaker which has withstood four years' competition and is actually selling today in increasing numbers.

See and hear it for yourself and you will realise why it is radio's greatest prize. Oak £5. 12. 6. Mahogany £5. 17. 6. Walnut £6. 6. 0. Hear also the new Celestion Z Models, from £7. 15 0

Write for interesting booklet, on sound reproduction and particulars of the new Celestion Electrical-Gramophone & Radio-Gramophone

CELESTION LTD., DEPT. C.,
 KINGSTON - ON - THAMES.
 London Showrooms: 106, Victoria St., S.W.1

CELESTION

The Very Soul of Music

THERE'S A PROUD REPUTATION BEHIND EVERY ORMOND PRODUCTION!

Designed to carry out their work faultlessly and smoothly, Ormond components reveal in every detail the highest standard in construction and design.

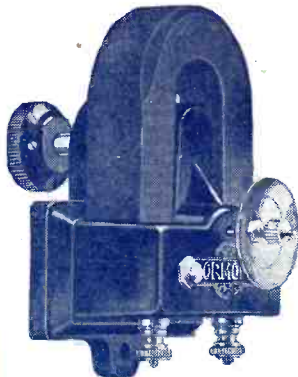

Four-pole Adjustable Units, fitted large Cobalt Magnet and beautifully polished bakelite cover. Price 12/6.

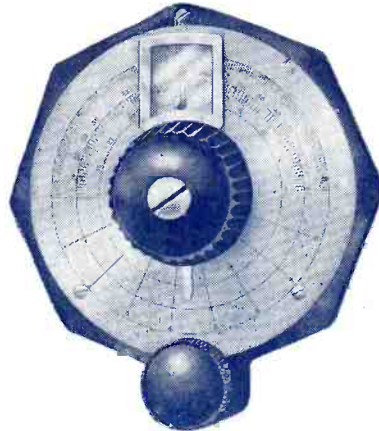

Duo Dual Indicator Dial. Operated either by direct drive from the central control knob or by the slow-motion drive. (Ratio 16-1). Price 6/-.

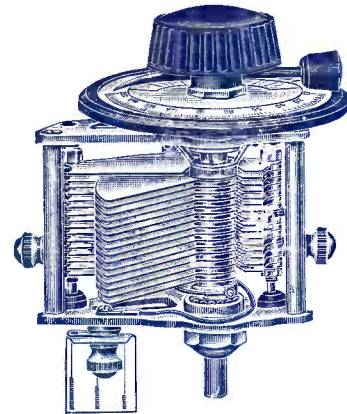

Small Logarithmic Condenser with Pointer Dial. Constructed mainly of Aluminium.

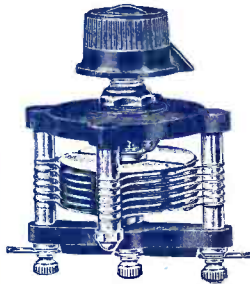

Differential Condenser. Insulation is provided between fixed and moving vanes, obviating all danger of short circuiting. One-hole fixing. Ideal for use as a reaction control. Price 4/-.



Fixed Condensers. Available in all the usual capacities. May be secured either direct to valve sockets or supported on the wiring. Prices from 7d. to 1/9.

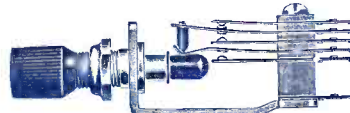

Jack Switch. Of entirely new design, brass frame, heavily nickel-plated, springs of nickel silver, the contacts being riveted in. The control contact is of the push-pull type. Prices from 2/9 to 4/6.

Two Point Push-pull Change Over Switch. Very robustly made, fitted with a moulded bakelite former. Can be mounted on a metal panel and insulated by means of the ebonite bush if necessary. Complete with knob terminals and soldering tags. One hole fixing. Price 1/6.

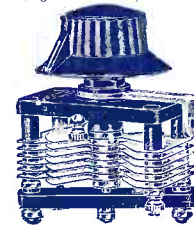

Midget Condenser. Can be mounted on panel or baseboard. Minimum Capacity, .000015 Mfd. Maximum Capacity, .0001 Mfd. Price 4/-.

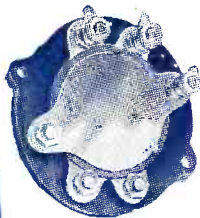

Three Electrode Fixed Condenser. Designed for use as the aerial coupling condenser. Insulation is provided between the vanes and capacity is approximately .0001 each half. Price 1/-.

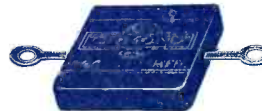

Chassis and Cone. Produced for use with the loud-speaker unit. Constructed of aluminium, 1 1/2 ins. in diameter with a cone of specially selected material. Price 7/6.

Large Chassis, 16 1/2 ins. in diameter, of similar construction. Price 11/6.

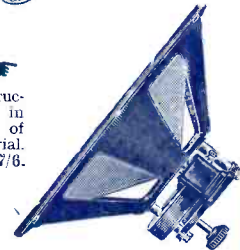

For Quality!

THE ORMOND ENGINEERING CO., LIMITED,
ORMOND HOUSE, Rosebury Avenue, LONDON, E.C.1.
Phone: Clerkenwell 5834/5/6 & 5844/5/6. Telegrams: "Ormondengi, Smith."

For Value!

EVERY SET ITS OWN WAVEMETER

The Wireless World

AND
RADIO REVIEW

The Paper for Every Wireless Amateur

Wednesday, April 16th, 1930.

4^D

BurTON

SELF-LOCATING

VALVE
HOLDER



1/- each

Pentode
- Valve -
Holders
1/6 each

Patent No.
316708

MANUFACTURED BY
C. F. & H. BurTON

PROGRESS WORKS
WALSALL, ENG.

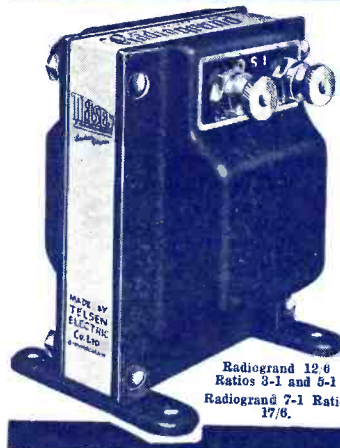

TELSEN
L.F. TRANSFORMERS

Radio's Choice

Have acquired a world-wide reputation for Quality and Value.

Built by Specialists in Transformer construction they have set a Quality of Performance above reproach. Your Set will work better with a Telsen Transformer - - - - Fit one now!

TELSEN ELECTRIC CO. LTD.
Miller Street,
Birmingham.

Radiogrand 12/6
Ratios 3-1 and 5-1
Radiogrand 7-1 Ratio
17/6.

VIVIDLY NATURAL RADIO WITH THIS SUPREME SPEAKER



If your set is old or new, large or small, the Ultra Air Chrome Speaker will give you radio with atmosphere, character, temperament and vitality. Vividly natural, playing, singing or talking, with perfect acoustic balance over the full compass of orchestra and voice. From all dealers.

50%

ULTRA
AIR CHROME SPEAKER

WITH THE DOUBLE LINEN DIAPHRAGM

ULTRA ELECTRIC LIMITED, 661, HARROW ROAD, LONDON, N.W.13.

McMICHAEL PORTABLE RECEIVER

22 GNS.

Point No. 4.

WORKMANSHIP.

Ten years of consistently high grade manufacture are reflected in the perfect workmanship displayed by this receiver.

Hear it at any high-class radio store or our London showrooms.

L. McMICHAEL LTD.,
Wexham Road, Slough, Bucks.
179, Strand, London, W.C.2.





It's firmly clamped

Unvarying capacity is positively assured with a Dubilier Mica Condenser. Take, for instance, the Type 610 Condenser illustrated—before the "element" is sealed into the moulded case it is tightly clamped, so that absolute constancy of capacity is ensured. This is just one example of the way in which Dubilier safeguard the efficiency of their Condensers—Condensers which have gained a world-wide reputation for absolute reliability.

DUBILIER MICA CONDENSERS

Type 610 (Horizontal) and Type 620 (Vertical). Test Voltage, 500 A.C.

·0005 to ·0009	2/6
·001 to ·006	3/-
·007 to ·009	3/6

Type B775, Tested at 500V. D.C.

Specially suitable for use in resistance-capacity coupled amplifiers, also where a condenser is required to withstand potentials of several hundred volts.

·01, 4/-; ·1, 8/6; ·5, 37/6.

Intermediate capacities at proportionate prices.

If unobtainable from your dealer, write direct to us giving his name and address. Dubilier Condenser Co. (1925) Ltd., Ducon Works, Victoria Road, N. Acton, London, W.3.

Ask your dealer for the Dubilier Booklet—
"A Bit about a Battery"—it's free.

Cleaver BC 2921F

- NO FILAMENTS.
- NO CHEMICAL ACTION.
- NO MOVING PARTS.
- NO PERIODICAL REPLACEMENTS.

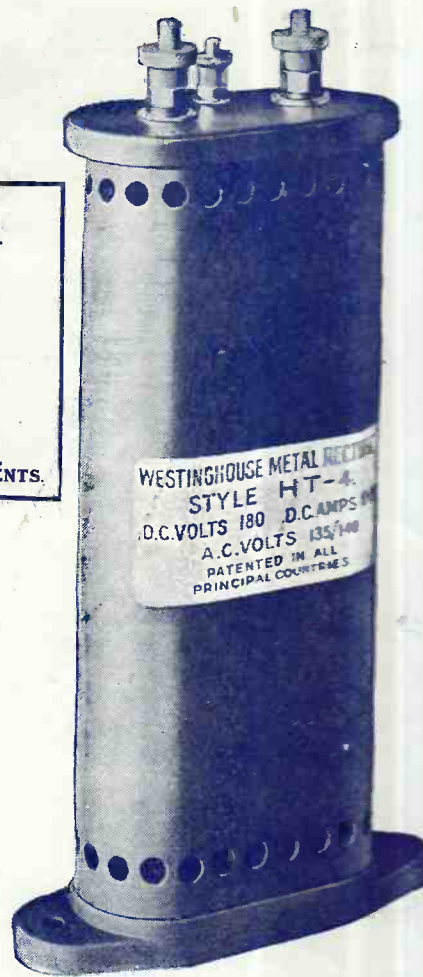

THE



METAL RECTIFIER

STYLE H.T.4

PRICE 37/6

D.C. output 180 volts 30 m.a. full wave, when used in the "Voltage Doubler" circuit.

Full details of this and other A.C. mains units circuits are given in our 32-page book, "The All-Metal Way, 1930."

Send 2d. Stamp for a Copy.

The Westinghouse Brake & Saxby Signal Co., Ltd.,
82, York Rd., King's Cross, London, N.1

THE BIG STRIDE FORWARD

in BATTERY PERFORMANCE



NEW design, new materials, new methods of construction all combine to make the performance of the Full O' Power Battery of outstanding merit.

The exclusive employment of seamless drawn zinc cylinders of exceedingly high purity—

- AVOIDS: corrosion.
- GIVES: larger output of current.
- ENSURES: longer service.
- GUARANTEES: maintenance of a high standard of efficiency over a long period.

No. 1210 SIZE - 60 VOLTS.

IT COSTS NO MORE!



IF YOUR SUPPLY MAINS ARE D.C.

You can use an A.C. All Electric Receiver
By Employing The M.L.—D.C. to A.C.

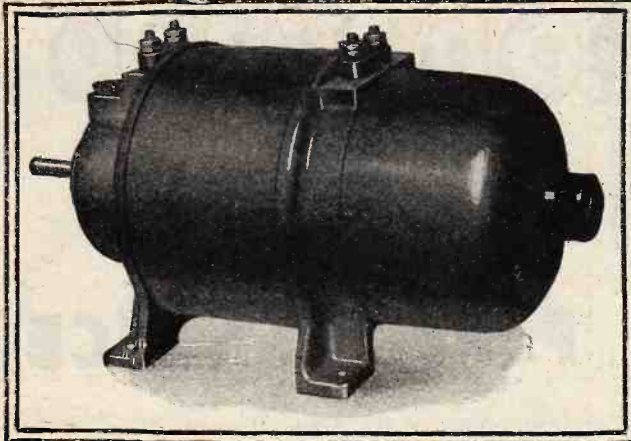

ROTARY TRANSFORMER

Can be supplied
to run from
any Voltage
12-250 V.D.C.

*Recommended and
used by*

Philips Radio,
Marconiphone,
Kolster-Brandes,
Burndept, Etc.

40 WATT Model
£13-0-0
85 WATT Model
£19-0-0

M-L MAGNETO SYND. Ltd., Radio Dept., COVENTRY.
Telephone: 5001.

THE TRANSFORMER FOR YOUR PORTABLE



Igranic "J" Transformer

IGRANIC TYPE "J" L.F. TRANSFORMER

See how small it is. Though it only weighs a few ounces, it is by far the best of its kind. Use it in your portable, and enjoy truly magnificent magnification. Rich bass and clear high notes. If you want the best results from your portable, get to know the Igranic range. Made in two ratios, 3 : 1 and 6 : 1.

PRICE 17/6



IGRANIC ELECTRIC CO., LTD.,
149, QUEEN VICTORIA STREET,
LONDON, E.C.4

Write for Lists to Dept. U.311.

COMPLETE FREEDOM FROM HUM WITH THE A.C./P.1.

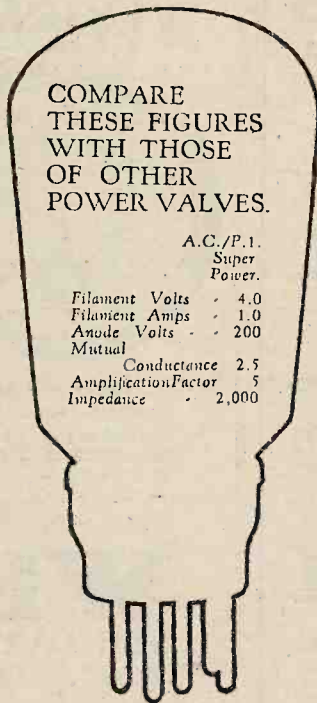

COMPARE
THESE FIGURES
WITH THOSE
OF OTHER
POWER VALVES.

	A.C./P.1.
	Super
	Power.
Filament Volts	- 4.0
Filament Amps	- 1.0
Anode Volts	- 200
Mutual	
Conductance	2.5
Amplification Factor	5
Impedance	2,000

The latest Mazda indirectly heated Power Valve is the A.C./P.1. It combines a very high power-handling capacity with great sensitivity, and, in addition, the use of the famous Mazda indirectly heated cathode ensures complete freedom from hum when this valve is used.

PRICE 17/6

The Amazing

MAZDA

ALL MAINS
VALVES



THE EDISON SWAN ELECTRIC CO., LTD.,
Radio Division,
1a, Newman Street, Oxford Street, W.1.
Showrooms in all the Principal Towns.

EDISWAN

V.34

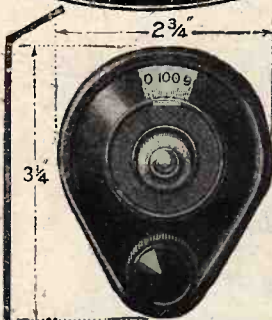

MECHANICALLY PERFECT. POSITIVE BRASS CONTACT drive by SOLID BRASS SCALE ensuring smooth movement with absolutely NO BACK-LASH. ROBUST in Construction and Trouble Free.

PRICE **3/-**

THERE IS ONLY ONE GENUINE **FORMO-DENSOR**



Length 2 1/2 in.
Width 1 in.

F. Max. .0001 2/- G. Max. .001 2/-
Min. .00005 Min. .0002
J. Max. .0003 2/- H. Max. .002 3/-
Min. .000025 Min. .001

THE FORMO CO., CROWN WORKS, CRICKLEWOOD LANE, N.W.2.

'1930' LOG (MID-LINE) CONDENSER

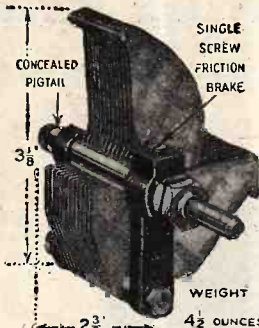

In four Capacities:

.0005
.00035
.00025
*.00015

4/6 each.

Double spacing of vanes for Ultra Short-wave work.

NO WAVE TRAPS

20 Stations in 5 minutes at Loud-speaker Strength



BY USING THE NEW PATENTED

Tapped Model D.A.T.3.

DUAL COIL

15/-

Tunes from 200-2,000 metres

Amplifies as a transformer, thus producing more volume. Simple Detector—L.F. Receivers can now compare with the latest Screened Grid Sets.

Bullphone Tapped Aperiodic Six-Pin SELECTIVE COILS

will also separate the National and Regional Stations.

Short Wave 4/6 Long Wave 5/6

Send for our Free Lists and Circuits—

BULLPHONE LTD. (Dept. W.W.)

38, HOLYWELL LANE, LONDON, E.C.2

Weston sets the world's standard

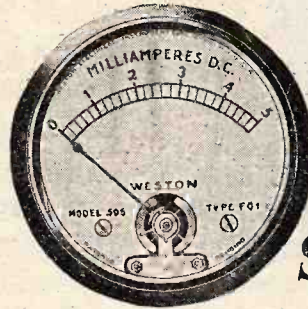

Our Model 506 MIL-AMMETER Panel Mounting type should be placed in the High Tension Circuit of the valve to ensure correct operation and to check distortion.

Prices £1 : 15 : 0—£2 : 15 : 0

WESTON

STANDARD THE WORLD OVER

Pioneers since 1888

WESTON ELECTRICAL INSTRUMENT CO., LTD., 15, Great Saffron Hill, London, E.C.1.

Sound in principle

SAYS THE

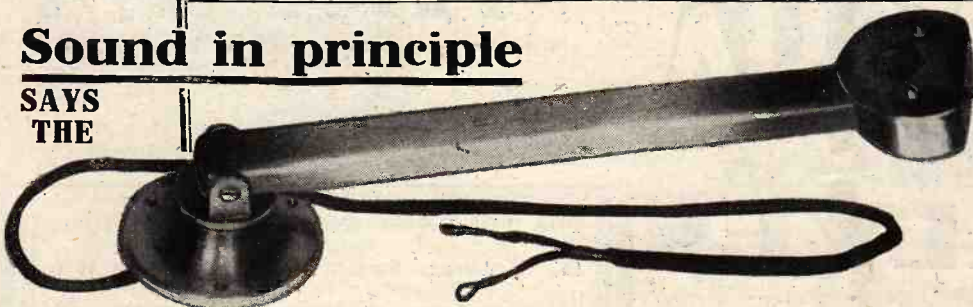

THE R.G.D. PICK-UP

is free from resonance. No tracking wear. Highly finished Pick-up in Bronze, Oxidised Silver. Specially constructed for the Coil-driven Speaker.

Price

£3 : 0 : 0

Post free.

"Wireless World."

THE RADIOGRAMOPHONE DEVELOPMENT CO., ST. PETER'S PLACE, BROAD STREET, BIRMINGHAM.

Mention of "The Wireless World" when writing to advertisers, will ensure prompt attention.



Don't kick the Dog.—The fault is yours. Why not store your Wireless parts in "Tiltracks," where they are instantly available when wanted? Wooden shelves are hopelessly out of date. "Tiltracks" save Time, Labour, and a tremendous amount of worry. They are real paying propositions to every Wireless Man, be he Experimenter or Manufacturer.

THE "BENCHRACK"
(Tiltrack Principle)

A real help for storing small parts such as Terminals, Nuts, Washers, Insulators, etc. Made to stand on the work bench, it enables all small parts needed for the job in progress to be stored where they are immediately to hand. All the trays are tilted so that the parts stored can be seen at a glance, and the front faces of the trays are rounded so that the smallest parts can be swept up the slope with the fingers of one hand. Each tray is provided with patent hinging partitions which can be moved quickly to make larger or smaller compartments. Being so accessible these racks greatly facilitate stocktaking and being all steel there is no danger of fire. The Experimenter will do his jobs much quicker and with greater pleasure, and the Factory will save many pounds per year by installing this Benchrack.

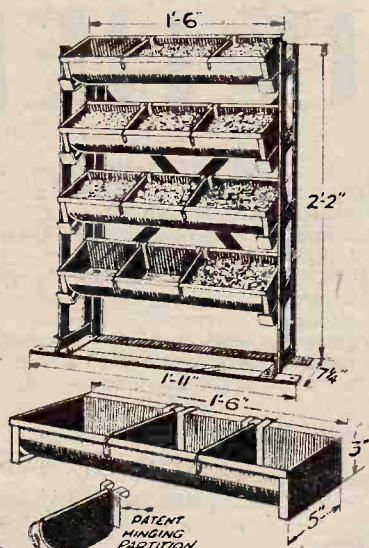

30/-
F.O.R.



"TILTRACK JUNIOR"

This all-steel rack is designed to hang against a wall or other convenient position, and is a most excellent rack for storing small parts. It is supplied complete with white canvas protective cover to keep out the dust. All the trays are tilted and have movable partitions.

30/- POST FREE.

THERE ARE MANY MORE STYLES OF "TILTRACKS." PLEASE SEND FOR LISTS.

Particulars from Manufacturer & Patentee — **BERTRAM THOMAS,** Worsley Street, Hulme, MANCHESTER.
London Office & Showroom — 28, Victoria Street. S.W.1.

USE THIS BATTERY FOR LOW TENSION IT WILL LAST LONGER, SAVE MONEY



Most sets only ask for a small current discharge from the low tension battery these days. For such sets the Exide "D" series provide more listening hours on one charge in relation to cost than any other battery.

Note the safety lid and the terminals, unmistakable as to polarity and completely free from leakage and corrosion.

Exide

THE LONG LIFE BATTERY

- Type DTG, 20 amp. hrs. 4/6 per 2 volt cell.
- Type DFG, 45 amp. hrs. 8/6 per 2 volt cell.
- Type DMG, 70 amp. hrs. 11/- per 2 volt cell.
- Type DHG, 100 amp. hrs. 14/6 per 2 volt cell.

For an absolutely steady H.T. supply use the Exide WH Battery. It will help you to separate the regional stations. Obtainable from Exide Service Stations and all reputable dealers. Exide Service Stations give service on every make of battery.

EXIDE BATTERIES

CLIFTON JUNCTION, NR. MANCHESTER
Branches at London, Birmingham, Bristol and Glasgow



TELEVISION IS HERE!

At last the greatest Radio achievement of the era—the Baird Televisor becomes a “home” proposition. Everyone has been eagerly awaiting the advent of this apparatus, at a reasonable price, and its coming heralds the commencement of the greatest radio boom in history.

The wonder of ordinary radio is now amplified by the additional wonder of the Baird Televisor. To *SEE* and *HEAR* is the expressed desire of everyone interested in radio, and only the Baird Televisor with its actual reproduction of every movement of living things can solve the problem. No laborious building up of “still” pictures can ever be more than experiment of limited interest. The Baird Televisor Home Reception Set *alone* can give permanent satisfaction.

Daily broadcasts both from the National and Regional Studios at Brookmans Park have been a feature since March 31st. The Baird Television Company has given great thought and care in producing a Kit of Parts bearing the BAIRD brand. This will interest the Home Constructor and experimenter, and will open up a new wonder to tax his ingenuity. Ample “Service” is arranged for. Prices for the complete Receiver and Televisor, Televisor only, and Kit of Baird branded parts will be sent on application to:—

THE BAIRD TELEVISION DEVELOPMENT
COMPANY, LTD.,

133, Long Acre, London, W.C.2.



the birth of a wonderful radio era

The Wireless World

AND
RADIO REVIEW
(18th Year of Publication)

No. 555.

WEDNESDAY, APRIL 16TH, 1930.

VOL. XXVI. No. 16.

Editor: HUGH S. POCKOCK.
Assistant Editor: F. H. HAYNES.
Editorial Offices: 116-117, FLEET STREET, LONDON, E.C.4
Editorial Telephone: City 9472 (5 lines).
Advertising and Publishing Offices:
DORSET HOUSE, TUDOR STREET, LONDON, E.C.4.
Telephone: City 2847 (13 lines). Telegrams: "Ethaworld, Fleet, London."
COVENTRY: Hertford Street.
Telegrams: "Cyclist, Coventry." Telephone: 5210 Coventry.
BIRMINGHAM: Guildhall Buildings, Navigation Street.
Telegrams: "Autopress, Birmingham." Telephone: 2970 and 2971 Midland.
MANCHESTER: 260, Deansgate.
Telegrams: "Hiffe, Manchester." Telephone: 8970 City (4 lines).
GLASGOW: 101, St. Vincent Street, C.2.
Telegrams: "Hiffe, Glasgow." Telephone: Central 4857.

PUBLISHED WEEKLY.
Subscription Rates: Home, £1 1s. 8d.; Canada, £1 1s. 8d.;
other countries abroad, £1 3s. 10d. per annum.
Entered as Second Class Matter at New York, N.Y.
As many of the circuits and apparatus described in these pages are covered by patents, readers are advised, before making use of them, to satisfy themselves that they would not be infringing patents.

CONTENTS OF THIS ISSUE.

EDITORIAL VIEWS	PAGE
DIELECTRIC PROPERTIES OF INSULATORS. BY W. H. F. GRIFFITHS	401
EVERY SET ITS OWN WAVEMETER. BY A. L. M. SOWERBY	402
CURRENT TOPICS	407
BROADCAST RECEIVERS. TRUPHONIC MELO GRANDE S.G. FOUR	411
WIRELESS THEORY SIMPLIFIED, PART XXVII. BY S. O. PEARSON	412
NEW APPARATUS REVIEWED	414
THE "N" DIAGRAM (CONCLUDED). BY W. A. BARCLAY	417
BROADCAST BREVITIES	418
READERS' PROBLEMS	422
	423

natives. It may be that the B.B.C. is under certain obligations already entered into which have made it impossible for them to modify the terms of their offer, but if that is so, then surely they might have explained that this was the situation, and so justified their seemingly obstinate attitude. As it is, they have certainly not earned the sympathy of the public in the dispute, and have, in our opinion, only accentuated what appears to be an arrogant attitude by the recent publication in their official organ, *The Radio Times*, of the correspondence which has passed between themselves and the Football Association. Nor do we think that they presented their own case any more forcibly by introducing the correspondence which they published with a paragraph calculated to appeal to public sentiment and having no bearing on the question at issue.

The B.B.C., because it enjoys an unassailable monopoly, appears to be drifting farther and farther from the position of being a public service. The vast majority of the listening public expected to participate in the Cup Final through the medium of broadcasting, and it would appear that had it not been for the broadminded attitude adopted by the Football Association in reopening negotiations, the B.B.C. would have been held directly responsible by the listening public for having destroyed their chances of participating in the event. This would have been the direct result of the adoption on the part of the B.B.C. of an attitude in their negotiations with the Football Association which so far they have made no attempt to justify in the eyes of the public.

o o o o

THE B.B.C. AND THE F.A.

SIR FREDERICK WALL, Secretary of the Football Association, is to be congratulated on having taken the first step in an endeavour to overcome the deadlock which had arisen in connection with negotiations between the Association and the B.B.C. for the broadcasting of the Cup Final.

The B.B.C., it will be remembered, offered to pay £100 to any charity named by the Football Association in return for facilities to broadcast a running commentary on the Cup Final. The Football Association adopted what we consider to be the reasonable attitude that, whilst they were ready to discuss terms under which facilities would be given to the B.B.C. to conduct the broadcast, they were not prepared to accept the principle that the terms should be dictated to them by the B.B.C. The B.B.C. rejoined that they could not, in any circumstances, depart from the terms of the offer which had been made, yet without giving any reasons why they were not prepared even to discuss any alter-

AN INTERESTING PATENT SITUATION.

IT has come to our notice that an interesting situation has arisen in connection with the licensing of manufacturers of wireless receivers under various patents. Since broadcasting began a general licence has been available from the Marconi Company, under which manufacturers made use of any of the Marconi Company's patents, these patents being generally considered to cover most of the circuits likely to be employed in receiver design. Now, however, Standard Telephones and Cables, Ltd., are offering to the British wireless manufacturer a licence to manufacture under more than sixty patents which they own, and the manufacturer may, we think, find himself in rather an embarrassing position when it comes to making the decision as to which licence to take, especially as a superficial inspection of some of the patents of the respective companies under which licences are offered suggest that there may be overlap and interlocking of subject-matter.

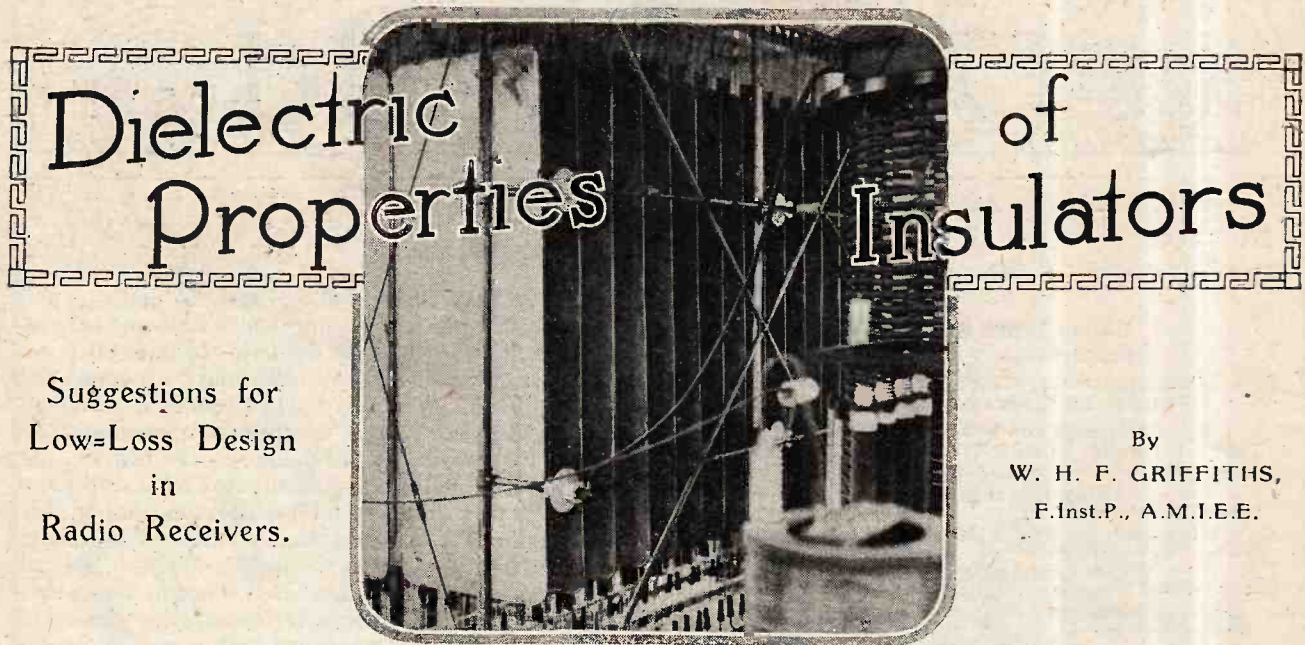

Suggestions for
Low-Loss Design
in
Radio Receivers.

By
W. H. F. GRIFFITHS,
F. Inst. P., A. M. I. E. E.

THE conductors used in radio apparatus are usually limited to the metallic elements and alloys which are readily worked by the wire manufacturer and instrument maker. The latter uses metals in such ample proportions that it usually matters not, within limits, what their conducting properties are. Copper is the only metal commonly used for high-conductivity purposes (except where great mechanical strength is required, when phosphor-bronze is substituted), and even the resistance-wire alloys are limited in number, and, in any case, have properties quite similar, well defined and well known. Fortunately, also, the difference in the conducting properties of metals tends to become less marked at radio-frequencies so that their selection¹ for ordinary apparatus requires but little consideration.

Insulating materials, on the other hand, are, literally, being invented every day, and one is never quite sure for what purpose they are particularly suited. This is largely due to the fact that, unlike metals which, if we again for convenience ignore permeability, have only one electrical property which is practically constant for all electrical and physical conditions; insulators have many independent electrical properties, all of which contribute to their resultant dielectric quality at radio-frequencies. Moreover, some of these contributing properties are variable with temperature and atmospheric humidity, and, adding to the

general complexity is the fact that the degree to which the various properties contribute to the resultant electrical quality of the material varies tremendously with frequency. An insulating property which is the chief cause of power loss in a material subjected to an alternating current of, say, 1,000 cycles per second, may be quite a negligible factor in the total power loss in that material at a radio-frequency of, say, 1,000,000 per second.

Electrical and Mechanical Properties.

Again, in the selection of an insulating material for any particular purpose the mechanical and thermal properties must receive consideration, since these properties vary tremendously in insulators, while in conductors they are of the same order.

The chief properties of insulating materials are enumerated below:—

1. Electric strength.
2. Volume resistivity or specific resistance.
3. Surface resistivity or surface leakage.
4. Permittivity.
5. Power-factor.
6. Moisture absorption.
7. Mechanical hardness and tendency to "cold flow."
8. Temperature coefficient of expansion.

The first five of these qualities are purely electrical, and the others are mechanical. Moisture absorption has been placed before the other mechanical properties because although not itself an electrical property it has a direct influence upon all those that are. Properties 7

THE selection of insulating materials suitable for the construction of the various components of a piece of wireless apparatus is much more difficult than the selection of conductors. While the conducting materials commonly employed are comparatively few and their properties well known, the insulating materials, both natural and synthetic, from which one has to select nowadays, are numerous and their properties obscure. In this article valuable data is given on the relative merits of a large number of insulators the dielectric properties of which are examined.

¹ If irons, steels and high permeability alloys are avoided.

Dielectric Properties of Insulators.—

and 8 are purely mechanical in nature and chiefly concern the rigidity and permanence of structure of the apparatus being constructed, although even these properties sometimes affect the electrical efficiency of apparatus.

Electric strength, although the first in the present list and usually the chief or only property given by the makers of insulating materials, is not of primary importance in the design of apparatus, except in condensers or transmitting apparatus, where insulating members are subjected to high electric strain. It is the author's intention, therefore, to pass over this property and, commencing with those of specific resistance and D.C. insulation, to endeavour to give the reader some truer idea of the real quality of a material than that which may be formed, using these, the only well-known qualities, as criteria.

The D.C. Quality of an Insulator.

Among the less advanced of amateurs the only very well-known property of an insulating material is its "insulation," by which is meant insulation resistance. One reason for this is, perhaps, the fact that it is the only quality which can be easily measured without special apparatus—the test being usually performed by a "Megger," or some such combination of D.C. generator and "ohmmeter." For very high quality insulating materials and apparatus constructed from them the ordin-

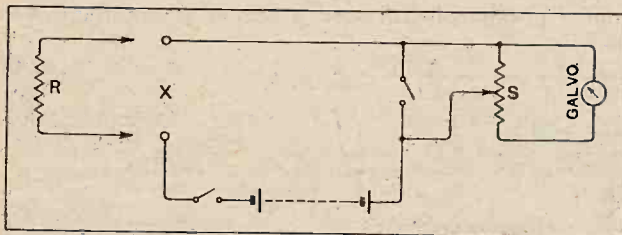

Fig. 1.—Diagram of connections for D.C. insulation test set.

ary testing set is too crude, and one has to resort to a well-insulated high-tension battery and a highly sensitive moving-coil galvanometer of the suspended type, which can be used to measure the infinitesimal current which flows past the test piece upon the application of the battery potential. The diagram of Fig. 1 shows the arrangement of such a test set. The shunt S provides various "multiplying powers" of the galvanometer deflections, and the whole circuit is calibrated by the substitution of a standard high-resistance R of known value for the insulation X being tested. Although insulations higher than about 50 to 100 megohms cannot be measured on a Megger, insulations of one million megohms can be measured with the ordinary simple test set described.

However the insulation resistance of a test piece is determined, the quantity that is actually being measured is the total current which flows from electrode to electrode (via the insulating material between them) upon the application of a given potential.

From the simple "Ohm's Law" relationship between current and voltage the resistance is thus known, but it

is better for the present purpose to regard the quantity being measured as the reciprocal of the resistance $\frac{1}{r}$ or conductance (of current), since the latter is directly proportional to the current which passes. But the conductance which is determined in measuring the "insulation" is that through the material as well as that over its surface. Thus it is seen that there are two components of insulation resistance, first, volume resistivity (which is really the quantity termed specific resistance in the case of conducting materials), and secondly, surface insulation.

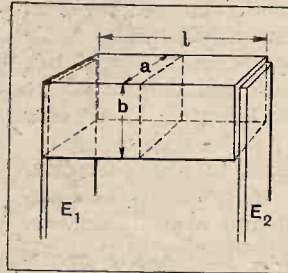

Fig. 2(a).—A test piece of insulating material. Both volume resistivity and surface insulation resistance are proportional to l but the volume resistivity is inversely proportional to the cross-sectional area $a b$ whereas the surface insulation is inversely proportional to $2a + 2b$.

In Fig. 2a is sketched a piece of insulating material between two electrodes E_1, E_2 , the length of the insulation path being l and the cross-sectional area of the piece being shown. The volume resistivity is proportional to the length of the path l and inversely proportional to the cross-sectional area $a b$. The surface insulation resistance is also proportional to the length of the path l , but is inversely proportional to total width of path $2a + 2b$. The dimensions a, b and l are not always so well defined as those of the insulating piece of Fig. 2a, as an examination of the insulating plate with two terminals of Fig. 2b will show. But the same law of insulation will apply so that it is evident that in order to increase the insulation between the terminals they must be placed farther apart, and the width of the plate at $p q$ must, if possible, be decreased.

Surface Leakage.

In most insulating materials the leakage over the surface is much greater than that through the actual material, but in some laminated materials such as, for example, bakelised paper panels, there is a good deal of leakage or conductance through the material in the direction of the laminae, especially after the material has been left for some time in a humid atmosphere. Because of this, a sheet of such material should never (for high insulation work) be drilled as one would drill an ebonite plate unless all the holes can be immediately sealed by a varnishing process similar to that employed by the makers as a finish.

In the homogeneous ebonites and good loaded ebonites, however, it is the surface leakage or surface conductance which determines the insulation between two metal pieces,

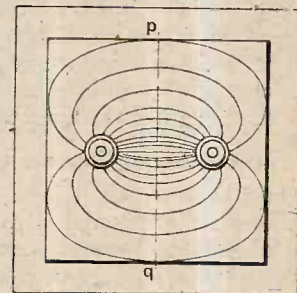

Fig. 2(b).—The effective dimensions of the insulation paths are not so well defined in this case as in Fig. 2(a)

Dielectric Properties of Insulators.—

and the extent of that conductance depends largely upon the nature of the surface. Rough and dirty surfaces conduct more readily than smooth, clean surfaces, and for this reason, for high insulation it is generally safer to polish the surfaces of these materials, although, as a matter of fact, freshly and smoothly papered matt-finished ebonite has a higher surface insulation (lower conductance) than polished ebonite, but the advantage is soon lost if the surfaces are allowed to become dusty.

It is obvious that some insulators, such as porcelain, must be highly glazed in order to preserve the insulation both through the material and over its surface. Glazing is, of course, particularly effective in preventing moisture absorption by an insulator and in preventing a continuous film of moisture over its entire surface. It is for this reason that glazed porcelain insulators are very suitable for outdoor use, as, for example, aerial insulators.

It has, the author believes, been stated that the insulation of a telegraph line mounted on porcelain insulators is actually improved by a shower of rain.

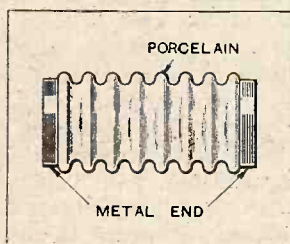

Fig. 3.—One method of increasing the effective length of surface leakage path of an insulator.

In some cases insulating materials which cannot be glazed are coated with varnish to seal an otherwise open surface and so form a more or less glazed skin on which the effect of a humid atmosphere is less serious. The impregnation of porous insulating materials with good electrical varnish is also resorted to as a preventive against moisture absorption.

The leakage conductance over the surface of an insulator can obviously be reduced by increasing the effective length of leakage path as shown in Fig. 3.

Alternating Current Losses in Insulators.

On a D.C. circuit it is seen that the loss of power in any insulating material is caused by a continuous leakage of current between two conductors, and that the extent of this leakage or conductance is determined by the value of a resistance r —the insulation resistance—which may be substituted for the insulator between the electrodes as shown in Fig. 4a. In the perfect (D.C.) insulator r would be infinity, the conductance zero, and there would be a complete break in the circuit, no electrical energy being transferred between the electrodes after a steady state had been reached at an interval after switching on. It is obvious that the same source of power loss exists under alternating current conditions, except that the effective value of r is not necessarily the same as in the D.C. case. But since the potential across the insulator is alternating, an alternating current will flow between the electrodes by virtue of the capacity which is formed between them. This current will be in addition to the current which leaks over the conducting paths on the surface of the insulator. The two currents which flow are quite different in relation to

the voltage which produces them, one, the capacity current, being 90° out of phase (leading) with the voltage between the electrodes, and therefore purely wattless, causing no loss of power, and the other, the leakage current, being in phase with the voltage, and therefore being the direct cause of power loss. A circuitual representation of this condition may be made by the substitution of the capacity C and resistance r for the insulator as shown in Fig. 4b.

Although for a constant voltage between the electrodes the current and, therefore, watts lost in r will be constant, irrespective of the frequency of the supply, the current through the capacity will increase proportionally with a raising of frequency. Therefore, although at low, or even at speech, frequencies the current through r may be appreciable compared with that through C , it becomes more inappreciable as the frequency is raised, until at radio frequencies, especially at high radio-frequencies, leakage currents become almost always negligible. In other words, insulation resistance need not be as high in radio-frequency apparatus as it is required to be in audio- or speech-frequency apparatus.

As an example of the relative unimportance of insulation resistance at high radio-frequencies, the case of a variable air condenser may be taken. An insulation resistance of 10 megohms (artificially introduced, if desired, by means of an external resistance of the grid-leak type), although practically negligible in its effect on the condenser at a frequency of 10^6 cycles per second (300 metres) will have a serious power-loss pro-

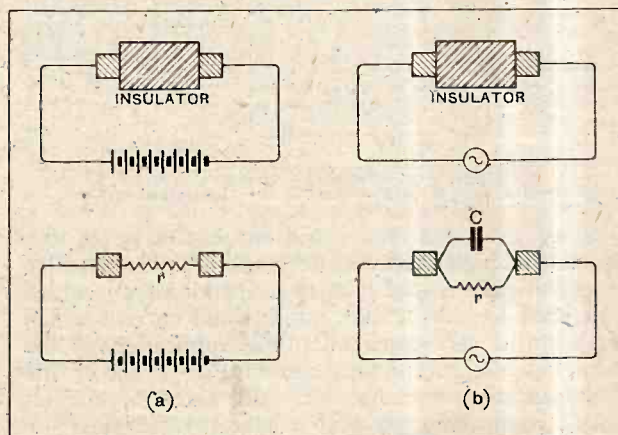

Fig. 4.—Showing an insulator in (a) direct-current and (b) alternating-current circuits. In the former case a resistance r may be substituted for the insulator whereas in the latter case it behaves as a capacity shunted by a resistance.

ducing effect at the lower radio-frequencies (20,000 metres), while at the mean frequency of speech (800 cycles per second) such a low value of insulation resistance will make the condenser intolerably bad. In other words, in order that the insulation resistance of an air condenser shall not contribute unduly to its losses it must be of the order of, say, 5 megohms at 300 metres, and 200 megohms at 20,000 metres, while at telephonic frequencies it should have an insulation resistance of at least 2,000 megohms.

Dielectric Properties of Insulators.—

It is seen, therefore, that although at audio-frequencies the loss due to insulation resistance may be serious if the surface leakage is great,² it is not the chief source of power loss at radio-frequencies, especially at those corresponding to the lower wavelengths below, say, 600 metres. Neither must it be thought that surface conductance is the *only* source of loss at audio-frequencies; it certainly is not, because if precautions are taken to preserve the surface insulation of an insulator at audio-frequencies, then the power loss in it is due largely to the same source as at radio-frequencies. It is due to the *dielectric* properties of the insulating material itself and occurs only by virtue of the fact that an alternating electric field passes through the material. Whenever a piece of insulating material is employed in the construction of alternating current apparatus, it is really forming the dielectric of a small-capacity condenser. Especially is this obvious in the case of wireless apparatus, because the numerous small condensers formed by

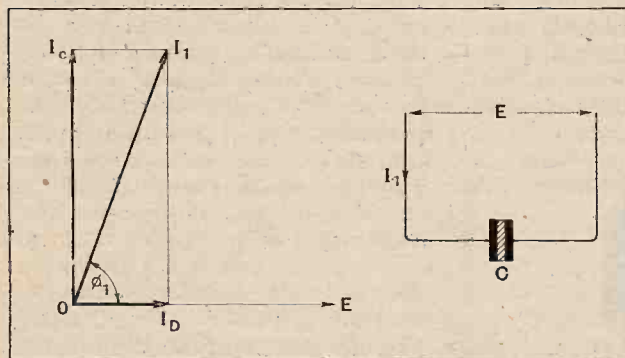

Fig. 5.—Vector diagram depicting the power loss in a condenser or piece of insulating material due to dielectric loss. The insulation resistance is assumed to be perfect (infinity). See also Figs. 6 and 7.

insulating materials are often appreciable compared with the total capacity in circuit. It is, perhaps, well known to the reader that unless the current through a condenser is exactly 90° out of phase (leading) with the voltage producing it, power is lost, and the cosine of the out-of-phase angle is termed the power factor of the condenser. The power factor or measure of power loss of a condenser may be due to three causes.

1. Due to a resistance in series with it.
2. Due to a resistance in parallel with it.
3. Due to a hysteresis loss, or absorption of power, in the material of which its dielectric is formed.

If the dielectric of the condenser is air the loss due to cause 3 is zero, because air is a pure dielectric medium no hysteresis loss occurring in it when an alternating electric field passes through it. But if the dielectric is formed from anything other than air, loss No. 3 occurs to an extent which is governed entirely by the nature of the insulating material. To every insulating material, therefore, can be assigned a figure which expresses quantitatively the amount of power loss which always occurs in it for a given voltage and at a given frequency. This figure is termed the power factor of the material, and

² As would be the case with unprotected surfaces, especially in a humid atmosphere.

is a function only of the nature of the material itself and is, of course, unaffected by the dimensions or shape of any particular specimen; that is to say, unaffected by the capacity of the condenser of which it is to form the dielectric.

Thus any condenser has a power factor not less than that of the material which forms its dielectric. Its power

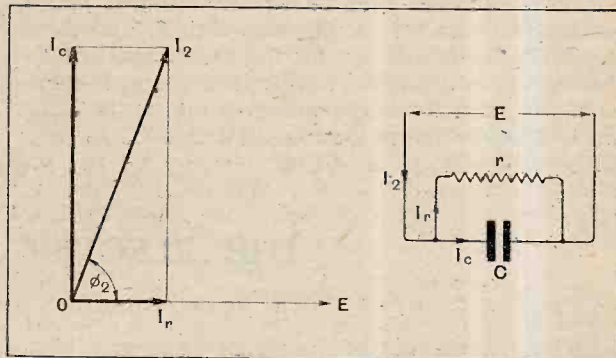

Fig. 6.—Vector diagram illustrating the power loss in a condenser or piece of insulating material due to faulty insulation only, the dielectric absorption of the material being assumed to be perfect (zero power-factor). See also Figs. 5 and 7.

factor may be augmented by that due to another cause; for instance, by that due to the shunt resistance of a faulty insulation, and in that case the power factor due to the latter cause is merely added arithmetically to that of the insulating material.

To those who possess a knowledge of simple vector diagrams³ the following method will help to show how these two components of power loss are added. Fig. 5 is the vector representation of a condenser having loss wholly due to the power factor of its dielectric material, which means that the in-phase components of its current I_D is found by constructing the vector $I_c = \omega CE$ leading E by 90°, and by completing the parallelogram from a knowledge of the phase angle ϕ_1 . This angle is the angle of which the power factor of the insulating material

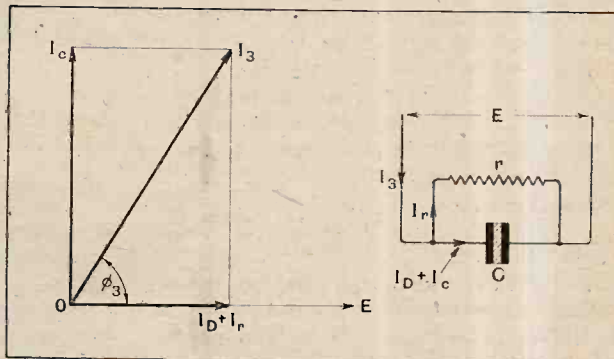

Fig. 7.—Vector diagram of a condenser in which the losses of Figs. 5 and 6 are both present. The resultant power-factor of the condenser is given by $\cos \phi_3 = \cos \phi_1 + \cos \phi_2$ if the angles are nearly 90° as is invariably the case in practice.

is the cosine. Upon the completion of the parallelogram the value of I_D is found, and it is this current which supplies the dielectric loss of the material.

³ The application of vector diagrams to capacity in A.C. circuits has recently been dealt with in this journal by S. O. Pearson, "Wireless Theory Simplified," December 11th, 1929.

Dielectric Properties of Insulators.—

In Fig. 6 the loss is due entirely to a parallel resistance r , which may be insulation resistance, the dielectric material of the condenser C being assumed to be so pure that its power factor is zero, as would be the case with air. In this case I_c is found and drawn as before, since the capacity of the condenser is unaltered, but I_r is found from Ohm's Law connecting E and r . This current is, of course, in phase with E , and therefore a complete knowledge for the construction of the parallelogram is available, the phase angle ϕ_2 is therefore known, and its cosine will give the power factor of the condenser due to the parallel resistance r .

In Fig. 7 is depicted vectorially the addition of the power factors due to the dielectric loss in the insulating material, $\cos \phi_1$, and that due to the leakage resistance r , $\cos \phi_2$.

I_D and I_r of diagrams 5 and 6 respectively are added arithmetically to obtain the total loss current which is in phase with E , the capacity current I_c will remain as before, and the resultant phase angle ϕ_3 will be found to be such that its cosine is approximately equal to the arithmetical sum of $\cos \phi_1$ and $\cos \phi_2$, provided that both are small values, say, less than 0.1, such as would be the case with all insulating materials with which one is, in practice, likely to deal.

(To be concluded.)

THE ELECTRIC GRAMOPHONE.

An Idea for Housing the Turntable and Pick-up.

PERHAPS one of the peculiar advantages associated with the use of an electric gramophone instead of a mechanical one is that the loud speaker can be put where you like and can be run on extension leads to different parts of the house if necessary. Another advantage is that it may be convenient to have the pick-up and turntable adjacent to the loud speaker and yet have the amplifier at some distance away, stowed, perhaps, in a corner out of sight. In any case, it is not always an advantage to arrange to house the pick-up, motor, amplifier, and loud speaker all in the same cabinet. Some people, too, prefer that wireless or electric gramophone apparatus should be unobtrusive and should not interfere with the general furnishing style of the room.

These observations must be the excuse for offering to fellow-readers of *The Wireless World* an illustration and description of an arrangement which has proved very satisfactory.

Old Work-table Modernised.

The cabinet illustrated will be recognised as an old-fashioned work-table which, in its original form, was fitted to hold cottons and thimbles, whilst the well in the centre was, presumably, meant to keep the undarned stockings out of sight. By removing all the fittings in the cabinet the well in the centre can be used to accommodate an electric or clockwork gramophone motor, and there is in most patterns of table similar to the one illustrated suffi-

cient area to allow a fairly long pick-up tone arm to be used. Ample space is also available for the fitting of an automatic trip switch to break the motor circuit on the completion

of the playing of a record, while containers can be provided for the needles. In the case of the particular cabinet illustrated it was found necessary to put a new octagonal rim on to the lid in order to raise it about 1½ in. and so allow sufficient clearance for the lid to be closed whilst a record was playing. By the substitution of another type of pick-up and tone arm, such, for instance, as the Burndept, which is much shallower, the necessity for raising the lid might have been avoided, but, in any case, the task is not an impossible one even if undertaken by an amateur carpenter. From many pick-ups it is possible to hear the playing of the record, and this, together with surface noise, renders the use of the lid over the record desirable.

Choice of Motor.

Tables of this type can be bought very cheaply in second-hand furniture shops, and, whilst being generally regarded as out of fashion for their original purpose, can be brought quite up to date again when converted as a radio gramophone. There are, of course, a number of other shapes and types of work-table having a well suitable for housing the motor, but this particular pattern seems to be the most convenient because of the area available for the turntable and pick-up. One has to select the type of motor rather carefully, as some makes are mounted in a framework which might prove too big to fit into the well of the table. A motor of the direct-drive type can be readily accommodated, as the spindle is central with the armature and the field magnet.



An old-fashioned work-table converted to a new use.

of the playing of a record, while containers can be provided for the needles. In the case of the particular cabinet illustrated it was found necessary to put a new

Every Set Its Own Wavemeter.—

set is tuned becomes steadily higher and higher, and that the relationship between the wavelength and the degree of enmeshment of the vanes can be plotted on squared paper as a smooth curve. Nevertheless, surprisingly few take the trouble to apply this simple fact in such a way as to arrive at a really complete calibration of their receiver. And yet one evening with the set, if one is armed with an up-to-date list of stations and a sheet or two of squared paper, will provide a calibration so complete that the set may be used as a very effective wavemeter, enabling any station whose wavelength is known to be tuned in at a moment's notice.

It may not be amiss to point out that without the squared paper the calibration of the set is rendered so difficult as to be next door to impossible.

The squared paper, or graph paper, as it is often called, can be obtained, either from stock or to order, of any good stationer,² and it is strongly recommended that the paper chosen be divided into centimetre and millimetre squares rather than inches and tenths. This preference for the metric system is not due to any feeling that it is more scientific and highbrow than the common inch, but arises merely from the fact that the millimetre is smaller than a tenth of an inch, giving a more minutely divided paper on which wavelengths are easier to read with accuracy.

The first step, before the calibration of the receiver is started, is to decide which of the tuning dials, if

condenser should be the one to be calibrated, since any variations in the aerial, or in the mode of coupling it to the set, will upset the calibration of the aerial circuit. With a two-dial set it will not be necessary to calibrate more than one dial, for when the settings of this are known it will be sufficient to adjust it to the required station and then to swing the remaining dial until that station is heard. With a three-dial set, incorporating either two stages of high-frequency amplification, or one stage in conjunction with a filter between aerial and the first valve, both closed-circuit condensers may be calibrated if desired, though if the user is thoroughly accustomed to the set one will usually be sufficient. Either may then be chosen in a set where reaction is not used; where reaction is incorporated it will generally be preferable to calibrate the dial controlling the circuit to which reaction is not applied.

Wavelength or Frequency?

In the case of a set of the detector-low-frequency type there is no choice; there is but one dial that can be calibrated. There will be no point in noting the settings of the reaction condenser, as the adjustment of this depends primarily on factors other than the wavelength of the station being received.

The proceedings are opened by marking along one edge of a sheet of the squared paper a scale of "Condenser Readings"—this will run from 0 to 100 or from 0 to 180, according to the graduations on the tuning dial. Along the other edge a scale of wavelengths from

200 to 600 metres, or of frequencies from 500 to 1,500 kilocycles, should be marked off, as in Figs. 1 and 2. The choice between wavelengths and frequencies depends largely on the preferences of each individual, but may also be decided by the type of tuning condenser in use. If this is of the straight line-frequency type the scale, for a first calibration at any rate, should be in frequencies, while a wavelength scale is preferable if the tuning condenser is of the square law, or straight line-wavelength variety. If the scale is made out as suggested, in either case the calibration curve should be a straight line over most of the range, which will help materially

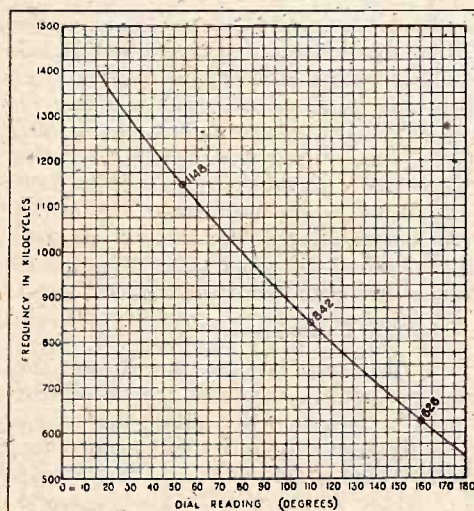

Fig. 1.—Preliminary curve drawn through the settings for three known stations. In this curve a frequency-scale is adopted in place of a wavelength scale. Either may be used, according to taste.

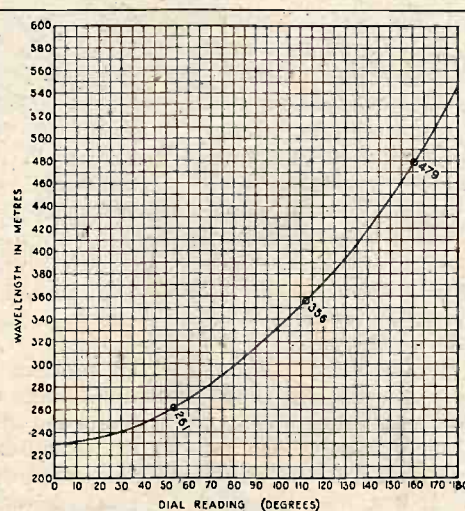

Fig. 2.—The first stage. The three marked points represent the Brookmans Park stations and 5GB (the Midland Regional). The curve shown was drawn through these three points, with no other guide, and was used as the foundation of the complete calibration, as described in the text.

there is more than one, should be taken as the standard of reference. The commonest type of set nowadays is perhaps that with a single stage of screen-grid high-frequency amplification followed by a grid-detector with reaction. In such a case the inter-valve tuning

in identifying stations while calibration is in progress. With a logarithmic condenser, either a wavelength scale or a frequency scale may be used indifferently; in neither case will the calibration curve be a straight line.

When the squared paper has had its scales marked out, the receiver is tuned in succession to all those stations that are heard regularly, and of whose identity there is no doubt. Let us assume that we are

² Londoners may like to know that Messrs. H. K. Lewis, of Gower Street, W.C.1, carry full stocks of squared paper of all types.

Every Set Its Own Wavemeter.—

Londoners, and that we can therefore tune in the two Brookmans Park transmitters and the Midland Regional. Each of these in turn is carefully tuned in, the tuning dial that we have decided to calibrate being adjusted with great care to give the absolute maximum of volume. Reaction, if it is applied to the circuit being calibrated, should be used to the fullest extent possible without causing the set to oscillate. If the set has a stage of high-frequency amplification it is probable that signals from the local station will be so powerful that it is impossible to find the exact tuning point; in such a case the aerial should be temporarily replaced by a short length of wire attached to the aerial terminal. In the case of a det.-L.F. set, where the aerial provides part of the tuning capacity of the circuit being calibrated, the full aerial must of course be retained.

The exact reading of the dial for each of these three stations must be noted, and the wavelength of the stations found, if it is not already known, by reference to the list of stations previously mentioned as a necessary part of the equipment. Three dots are then made on the squared paper with a finely pointed soft pencil—one dot for each station. In each case the dot is made at a point vertically above the dial-reading, and in a horizontal line with the wavelength or frequency of the station concerned.

We now have three points on the squared paper, and, if the suggested stations have been chosen, these three points are nicely spaced out over the paper. They will form the basis of our calibration curve, the general run of which they will outline. As a guide to the identification of other more-distant transmitters, a smooth curve should be drawn through these three points before proceeding farther.

Identification Becomes Easy.

After writing the last paragraph, the writer realised that a purely "armchair" article would not be as helpful as one written immediately after actually going through the process of calibrating a set. He therefore borrowed an unfamiliar receiver (actually a well-known portable) and proceeded to follow his own instructions. Figs. 1 and 2 therefore show two calibration curves drawn through the dial settings found, as just described for the two Brookmans Park transmitters and 5GB (the Midland Regional); in one a frequency-scale is adopted and in the other a wavelength scale.

The next step in calibrating the portable was to look for some of the more powerful foreign stations, and a

start was made on Rome. Its wavelength was found (from the list of stations in *World Radio*) to be 441 metres, and from the curve reproduced in Fig. 1, it was seen that the dial-reading would be 148 degrees—provided the curve was correct. At 148 degrees there was nothing to be heard, but on turning the dial backwards and forwards a trifle it was found that the loud speaker gave forth a stream of talk in a language very rich in vowels—maximum volume at 147 degrees. The language was not difficult to identify as Italian,

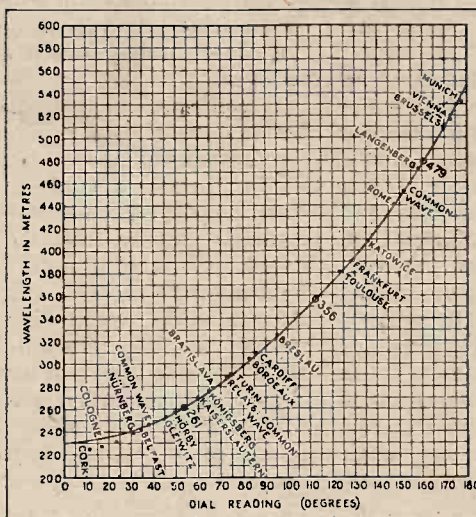

Fig. 3.—The second stage. The curve of Fig. 2, with the addition of a number of points found by tuning in various stations. Although the curve was substantially correct, it is now seen to require a little amendment in places.

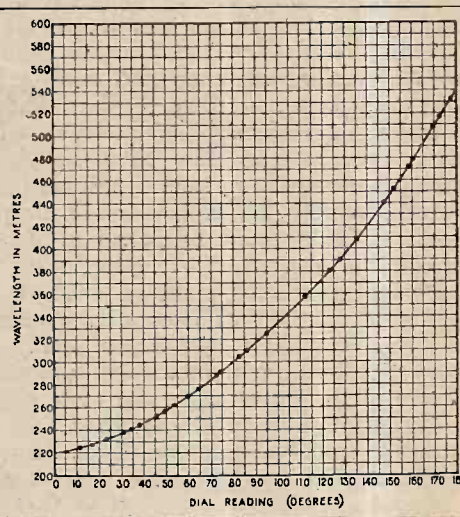

Fig. 4.—Final calibration curve of receiver, made by drawing a smooth curve through all the points found during the calibration.

although the writer does not know a single word of that tongue. In any case, Rome is listed as a 50-kilowatt station, and there was no other loud signal for six or eight degrees in either direction from the point at which Rome was expected. The dial-reading was therefore noted, and a dot was made on the squared paper to register 147 degrees as representing 441 metres. This new point was just a fraction off the curve, as will be seen by Fig. 3, which repeats the curve of Fig. 2 with the addition of the stations found during the process of calibration.

Langenberg was next tuned in in the same way, first finding the probable dial-reading (159) from the curve. It was actually heard at 158 degrees, and was identified by the fact that the language spoken was German, with which the writer is fairly conversant. In the same way Toulouse, Breslau, Turin, Bratislava, Katowice, and Vienna were tuned in; in every case they were found in the first place by the original curve, and the correctness of the identification was confirmed by the language spoken. The actual name of the station was heard in very few instances.

To those who have never attempted to calibrate a set in a really systematic manner it may appear that the evidence for the identity of the stations was very weak, but those who are familiar with the ways of curves will realise that if the station is correctly identified the point on the squared paper that expresses its

Every Set Its Own Wavemeter.—

wavelength must inevitably lie *exactly* on the smooth curve drawn through other like points for neighbouring stations. That is to say, the points for the various stations will mark out a perfectly smooth curve, free from humps and kinks, though it is more than likely that this curve will deviate a little from the rough curve of Fig. 2, which was drawn through the original three points only. If the point for any station lies off the curve, it is *perfectly certain that the station has been wrongly identified*. The only exception to this is a station working off its wavelength, but these are rare birds nowadays. If a station is identified beyond doubt—by hearing the announcer name it, for example—and *still* it does not fall on the curve, after taking the dial reading, the wavelength upon which it is actually working may be read off. On this evidence it would not be presumptuous to send a post-card to the station director demanding an explanation of his misbehaviour.

Some difficulty may be found in determining the curve at the shorter wavelengths, below 261 metres, since we have a fixed point on one side only of this region. It will be seen from Fig. 3 that the writer's first curve was a bit wild at this end. Fortunately, however, there are a number of "common waves" in this part of the wave-range, and since the various stations using these waves do not have their wavelengths controlled from a common source there are small deviations. Consequently, they all heterodyne one

another, giving rise to a noise which sounds rather like distant steamboat syrens welcoming the New Year. As a result of this effect, the common waves can be used as supplementary fixed points on the curve, being almost as easy to identify as Brookmans Park. By taking them in order, from 261 metres down, the curve in this region can be roughed out, and finally filled in by tuning in stations as already described.

The last step of all in the process is to transfer to a new sheet of squared paper all the points found, and to draw through them a final neat curve (as in Fig. 4) which includes every station found, and which forms the final and permanent calibration curve of the receiver.

It will be seen, then, that the method of calibration here suggested is a progressive one, for we start with three unmistakable stations, and use the curve that they outline as a guide to identifying further stations. Each station so found is at once a confirmation of the stations already identified, and a guide to finding others. Without the curve, each identification would be a separate process, independent of all the others, so that mistakes would be easy. With the curve, any mistake in identification becomes glaringly obvious, since the point in question does not lie on the curve. This check imparts such certainty to the calibration that when it is complete any desired station may be found, or any station tuned in may be identified, with the most perfect confidence.

Photo-Electric Cells. By Norman R. Campbell and Dorothy Ritchie. Sir Isaac Pitman & Sons, Ltd. 1929. 15s.

Since the advent of talking pictures and television in particular, the photo-electric cell has received extensive practical application, and this book dealing with both the theory and practical application of photo-electric cells will be welcomed by all who are interested in this subject.

The book is divided into three parts on the theory, use and application of photo-electric cells. The first part contains much useful data and information concerning the principles underlying photo-electric cell construction and the choice of photo-electric cells for special purposes.

The detection of photo-electric currents by electrostatic methods is described in the section on the use of photo-electric cells, which also includes descriptions of various methods of valve amplification of these currents.

Among the applications of photo-electric cells their use is described in connection with the measurement of luminous flux, illumination, colour and absorption which are illustrative of the value of the photo-electric cell for measuring purposes, and the allusion to the problem of grading articles points to its commercial utility.

o o o o

The Fundamentals of Radio. By Professor R. R. Ramsey. Ramsey Publishing Co., Bloomington, Indiana. 1929. \$3.50.

This book assumes an elementary knowledge of electricity such as a first-year University student may possess, and the

BOOKS REVIEWED
AND
BOOKS RECEIVED

subject is treated in the main without mathematics, though calculus has been introduced in a few sections.

The science and art of wireless is treated as far as 372 pages will allow, and the method of presentation remains on a fairly good level throughout, being somewhat reminiscent of Professor Morecroft's "Radio Communication." Though the book follows well-worn lines on the whole, it takes the lead in abandoning the method of plotting valve characteristics on a scale of grid volts v. plate current, and uses plate volts v. plate current instead. This method is the more useful one for all purposes, and it is to be hoped that it will be eventually adopted by English manufacturers.

The chapter on loud speakers is well written. It compares the theoretical and practical possibilities of magnetic, dynamic, inductor, and electrostatic speakers. Battery eliminators and filters are given a separate chapter, as is to be expected in view of the general use of mains-fed sets in America. R. T. B.

o o o o

The National Physical Laboratory, Collected Researches, Vol. XXI, 1929.—Containing 21 papers on recent research in matters connected with wireless, by Dr. D. W. Dye, R. M. Wilmotte, L. Hartshorn, C. E. Webb, Dr. R. L. Smith-

Rose, R. H. Barfield, F. Adcock, and J. Hollingworth. Pp. 448, with numerous illustrations and diagrams. Published by H.M. Stationery Office, price 22s. 6d. net.

o o o o

Cantor Lectures on Wind Instruments from Musical and Scientific Aspects.—A series of three lectures delivered before the Royal Society of Arts by E. G. Richardson, B.A., Ph.D., D.Sc., explaining the production of sound waves by wind eddies in various instruments, including the orchestral wood-wind and brass; organ flue pipes and reeds; and the Æolian harp, with brief descriptions of the nature and mechanism of different wind instruments. Pp. 38, with 18 illustrations. Issued by the Royal Society of Arts, London, price 2s. 6d.

o o o o

Riding the Airwaves with Eric Palmer, Junr.—An account of his experience in the working of an amateur transmitting station, told by a youthful American enthusiast in his own picturesque vernacular. Pp. 392, with 13 illustrations. Published by Horace Liveright, New York, price \$2.

o o o o

Report of the Radio Research Board, for the period ended March 31st, 1929. Including the General Report and Review of Investigation in the Propagation of Waves, Directional Wireless, Atmospherics, Standards and Measurements, Aerials, Amplifiers, Interference, Short Waves, and other subjects. Pp. 166, with frontispiece. Published by H.M. Stationery Office, price 3s. 6d. net.

THE UBIQUITOUS PIRATE.

During the last quarter 202 listeners in Germany were fined for using receivers without licences.

NOISY LOUD SPEAKERS.

Poplar is the latest borough to pass a bylaw prohibiting the use of loud speakers in public places in such a manner as to cause annoyance.

AN UP-TO-DATE LIBRARY.

A feature of the central library now being built at Burnley will be a room for broadcast reception. Patrons will be encouraged to listen to talks and other educational features.

PORTUGAL, THE LISTENER'S PARADISE.

Under a new decree issued by the Portuguese Minister of Commerce and Communications, wireless amateurs are permitted to listen without payment of any kind provided that their aerials do not cross a public thoroughfare or trespass on neighbouring property.

TOO EXPENSIVE?

Australia considers that a wireless talk with the Mother Country is too dear at £9 for three minutes, the figure originally suggested in regard to the projected telephone service *via* Rugby. According to a Sydney message, the Australian Post Office asks that the fee shall be £6.

HAVE YOU HEARD ITALY'S SHORT WAVE?

Tests are now being conducted with the Marconi short-wave beam transmitter, erected near Rome for the purpose of relaying the programmes of "Radio Roma" to the Italian Colonies and countries overseas. A wavelength of 25.4 metres is used, but provision is made for the alternative wavelength of 80 metres.

Favourable reports have already been received from India, Australia, South Africa, and the United States.

RADIO LINKS AMERICAN CONTINENTS.

Radio telephone service over the first two-way circuit linking the continents of South and North America was established on April 3rd by the Compania Internacional de Radio (Argentina) and the American Telephone and Telegraph Company, when the public telephones in Argentina, Chile, and Uruguay were connected with those in Mexico, Cuba, and the United States and Canada.

The wireless stations are at New York and Buenos Aires.

PICTURES BY BEAM.

Picture transmission and reception apparatus is *en route* to South Africa for installation at Kodak House, the headquarters of the South African Wireless Telegraph Company, Cape Town, with a view to the use of the beam system for the exchange of newspaper photographs and other illustrations. When the installation is completed tests will begin between Cape

Current
Topics

Events of the Week
in Brief Review.

Town and Radio House, London, the wireless headquarters of Imperial and International Communications, Ltd.

NEWSPAPERS BY WIRELESS.

Another interesting stage in wireless picture transmission was reached on April 3rd, when a short-wave station at Oakland, Cal., transmitted the entire front page of a Californian newspaper to a receiver in the G.E.C. laboratory at Schenectady, New York.

BROADCASTING STATIONS IN CITIES.

The twenty-two broadcasting stations in Buenos Aires have been served with notices to quit by the Argentine Government, a nine months' time limit being allowed in which they must find new quarters outside the city. The power used by these transmitters varies from 100 to 5,000 watts, several being private telephony stations, but the Government has decided that all must fall under the same ban if peace is to be restored.

The Argentine is yet another in the

long list of countries which are discovering that broadcasting stations are best situated away from large centres of population.

THE "ELETTRA" EXPERIMENT.

Readers will be interested to learn that Marchese Marconi has authorised *The Wireless World* to refute the reports attributing to him the remark that his experiment in transmitting a wireless signal to switch on the lights at the Electrical Exhibition in Sydney "points the way to a future day when there will be no electric wires and all currents of electric power will be transmitted directly through the air." Such a statement was not made by him and is obviously incorrect.

It will be recalled that in an editorial on the subject in the issue of April 2nd *The Wireless World* expressed the view that the alleged statement, unsubstantiated by any scientific evidence, was unfair to the illustrious name with which it had been associated.

LEIPZIG'S GRAMOPHONE CONCERTS.

Leipzig broadcasting station has a new studio which will be used solely for gramophone transmissions. Four electric gramophones are installed.

NEW AIR YACHT'S WIRELESS.

The new three-engined metal monoplane air yacht which has been constructed by the Supermarine Aviation Works for the Hon. A. E. Guinness is equipped with Marconi apparatus equivalent in power and range to the normal wireless installation on a sea-going vessel of 5,000 tons.

The transmitter and receiver are of the Marconi 1/2 kilowatt AD8 type, giving a telegraphy or telephony range up to 400 miles. A direction finder is included, and the equipment is completed with a broadcast receiver. The air yacht carries a crew of three and six passengers.



A RADIO RETREAT. The Chief Engineer of the Berlin broadcasting organisation photographed in the private laboratory at his home in the suburb of Zehlendorf. Envious amateurs in the district believe that this equipment will pick up any signal that is worth hearing from any part of the world.

BROADCAST RECEIVERS

IN designing a self-contained set with tuned H.F. amplification, the most difficult problem to be solved is that of stability. This is natural enough, in view of the fact that the H.F. circuit components must of necessity be mounted in close proximity to the frame aerial; as a consequence, the prevention of stray unwanted couplings, both magnetic and capacitative, always presents very real difficulties. Even though all due precautions may be taken against the more obvious forms of interaction, it generally requires great patience and ingenuity to trace and finally to clear away the various incidental couplings that may so easily upset the best laid plans.

The set under review is chiefly of interest because it is essentially of simple and straightforward design, without any "tricks" or adventitious aids to stability. It falls into the "transportable" or upright cabinet class of receiver; though intended rather to be moved from room to room than to accompany its owner on his excursions abroad, it is sufficiently light and compact to be taken wherever the need of the moment may dictate. The general specification is conventional, both with regard to layout and equipment. Dimensions are: Height, 18in.; width 15in.; depth, 8½in. The complete set weighs 34 lb. This is a battery model, the L.T. and H.T. supply units being, as usual, housed in the lower part of the cabinet. A cone-type loud speaker is mounted behind a grille having a silk fabric backing, and so the set is self-contained in the fullest sense of that expression.

The circuit comprises a screen-grid H.F. amplifying valve, coupled by the "tuned-grid" or "parallel-feed" method to a grid detector. Capacity-controlled reaction is provided between plate and grid circuits of this latter valve, which is followed by two transformer-coupled L.F. stages. The input and inter-valve circuits are tuned by a double "gang" condenser, operated

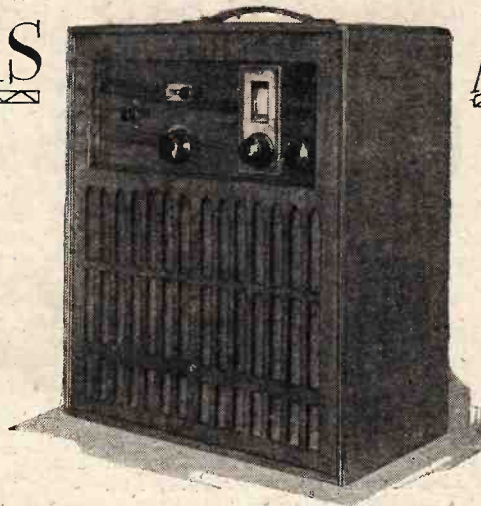

A Straightforward Portable Receiver with Single = knob Tuning.

TRUPHONIC Melo Grande S.C.4.

by a single knob, and so the set is suitable for manipulation by the totally unskilled.

This, in bare outline, describes the essential features of the receiver, but those who concern themselves with the finer points of portable set design will be interested in details. Starting at the input end we find that the frame aerial is switched on the simple "short-circuit" principle, medium- and long-wave sections being connected in series; both are carried on the wooden frame inside which all apparatus is assembled. The wave-changing switch is arranged to short-circuit the long-wave winding. A

trimming condenser, operated by a panel knob, is connected in parallel with the input section of the main tuning capacity. By-pass condensers are provided for screen and anode circuits of the H.F. valve, which works with a zero grid; this is quite permissible in view of the comparatively low anode voltage—108 volts maximum—that is applied.

The choke-feed system of the H.F. amplifier does not call for any particular comment; all anode circuit components, including the H.F. choke, tuned grid coils, tuning condenser, and feed and grid condensers, are contained in an aluminium screening box, into which the plate section of the H.F. valve is arranged to project. The detector valve is mounted in the same compartment, which also accommodates the small reaction control condenser. Medium- and long-wave

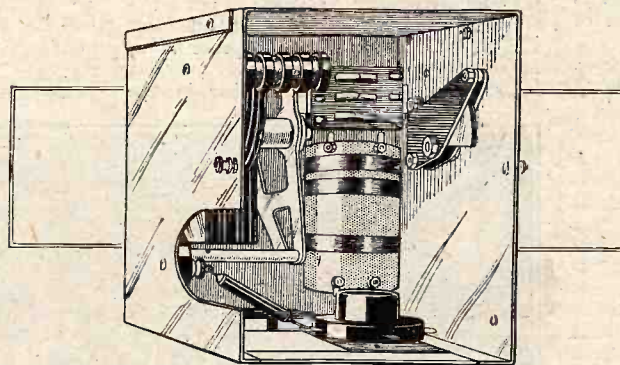

Layout of components inside the screening box.

grid coils are connected in series, wave-changing being effected by short-circuiting the latter.

Reaction control is a matter of some importance in a set of this type, and, to allow for exceptionally smooth adjustment, a tapped potentiometer is provided for the setting of detector grid bias. This connection is fixed by the manufacturers, and need not directly concern the user of the receiver.

An H.F. stopper, in the shape of a series resistance, is inserted in the grid circuit of the first L.F. valve.

Broadcast Receivers—Truphonic Melo Grande S.G.4.—

As already stated, both L.F. stages are coupled by transformers. Feed resistances, with the usual by-pass condensers, are inserted in series with the anodes of detector and first-stage L.F. valves, with the result that the inevitable increase, with age, of the internal resistance of the H.T. battery should not provoke undesirable L.F. reaction. The loud speaker is connected directly in series with the output valve anode; its armature setting with respect to the magnet pole pieces may be adjusted with the help of a screwdriver, for which a brass-bushed hole is fitted through the centre of the grille.

No special precautions are taken to prevent movement of the C.A.V. jelly-electrolyte accumulator cell or of the Hellesen 108-volt H.T. battery; these might well be provided with chocks or some other form of support to withstand rough handling in transit.

The receiver proper, in its rectangular wooden frame on which the frame aerial is wound, may readily be withdrawn as a unit from the container for examination, repair, or test. There is a turntable on the underside of the cabinet; this is a useful fitment, as directional effects are fairly well marked.

Externally, the set is nicely finished in a polished walnut container, as befits a piece of apparatus that is primarily intended for use in a living-room. The recessed control panel is of bakelised material with an external wood veneer.

Tests made under varying conditions would suggest that the average maximum range of reception from a high-power, medium-wave station in daylight is somewhere between 60 and 100 miles. Greater distances may be attained, but, generally speaking, only by applying considerably more reaction than is to be tolerated in the interests of quality. On the long waves range is considerably increased; under fair conditions several of the Continental stations can be depended upon to afford good signals.

It should be emphasised that the foregoing remarks apply only to daylight reception; on a good night numbers of distant transmissions are to be heard. The impression is formed that more H.F. amplification would be acceptable, particularly on the medium waveband, but the effectiveness of reaction control goes a long way towards masking any shortcomings in this direction. Adjustment of the feed-back condenser has commendably little effect on tuning, and its setting is reasonably constant on both wavebands.

The single-control tuning system is quite satisfactory, and in practice there is little need to touch the compensating condenser after it has once been correctly set, although a very slight readjustment is, strictly speaking, called for when passing from one waveband to the other.

It is fair to say that selectivity is well above the average standard, and is naturally vastly superior to that of a set with an aperiodic H.F. amplifier. Mutual interference, even between powerful twin stations, should easily be avoided at quite short distances without reducing input by taking advantage of directional reception as afforded by the frame aerial.

Low H.T. Consumption.

Quality of reproduction, without being exceptional, is fully up to the usual portable set standard, and is good when one takes into account the extremely modest H.T. consumption, which amounted to no more than 7 milliamperes in the case of the set tested! Operating voltages as fixed by the makers were applied; the low anode consumption is to a certain extent accounted for by the practice of slightly over-biasing the output valve, but a reduction in applied negative grid potential is hardly worth while.

These results are partly due to the loud speaker, of which the sensitivity is above the average. For best results, with regard both to quality and sensitivity, the armature of this instrument must be critically adjusted.

The set is made by Truphonic Radio, Ltd., of Truphonic House, Hanover Park, Peckham, London,

S.E.15, and is sold at 22 guineas, complete with all accessories.

o o o o

OUR INFORMATION SERVICE.

We would again draw our readers' attention to the conditions of *The Wireless World* Information Service. A coupon from the current issue should accompany each question sent in.

Whilst we will endeavour to deal with questions now on hand from readers who have omitted to enclose a coupon, yet preference must, of course, be given to those who comply with the rules, which are fully set out on page 423. To ensure a prompt reply, questions must be brief. Delay in reply is inevitable when questions are long or involved.

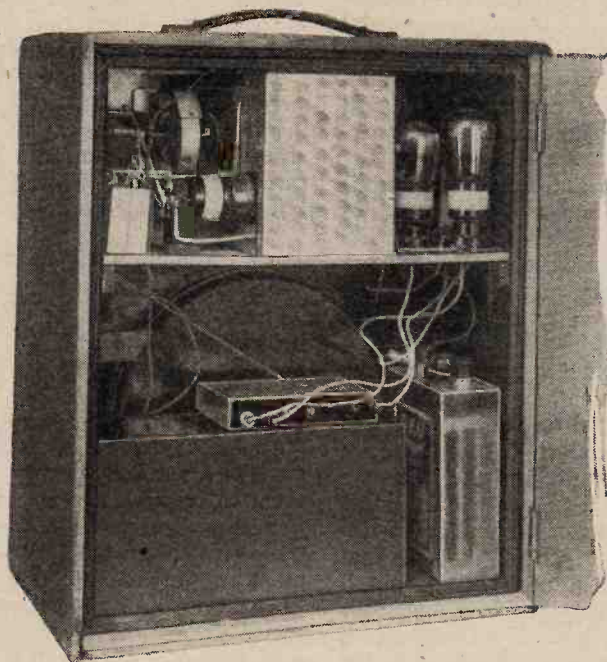

Interior view from the rear, showing mounting of the main components. The screening box back cover is removable.

WIRELESS
THEORY

SIMPLIFIED

By S. O. PEARSON,
B.Sc., A.M.I.E.E.

Part XXVII.—Sound Waves and Harmonics.

(Continued from page 397 of previous issue.)

IN dealing with A.C. circuits it has so far been assumed that the alternating currents and voltages have obeyed the simple sine law; that is to say, each of the quantities could be represented as a pure sine wave having a fixed frequency and constant amplitude. All definitions were given on this understanding, and all the relationships between voltage and current obtained for the various circuits were based on the assumption of constant frequency and unvarying amplitude. Now, in the transmission and reception of radio-telephony it will be shown that we have to deal in the main with alternating quantities whose amplitudes are varying with time, and the theory has to be extended to meet the new conditions, especially when applied to tuned circuits.

It has already been pointed out that high frequencies must be used for radio communication, because under such conditions only can a transmitting aerial be made to radiate a sufficiently large proportion of the power put into it from the generating plant, and the receiving aerial efficiency depends on the same conditions. Another reason why it is essential to use high radio-frequencies arises, as explained later, out of the fact that each transmitting station in effect monopolises, not a single frequency, but a band of frequencies whenever speech or music, or, in fact, any kind of intelligence, is being transmitted.

For European broadcasting on the medium wavelength band, radio-frequencies ranging from 600 to 1,500 kilocycles per second are employed, and on the longer wavelengths the frequencies used range from 155 kilocycles per second upwards.

The Range of Audible Frequencies.

The frequencies representing audible notes, on the other hand, lie within a limited band of comparatively low values, and are referred to as "audio-frequencies," or "low frequencies," to distinguish them from "radio-frequencies" or "high frequencies." The upper and lower limits of the audio-frequency range are not quite the same for all individuals, and depend on the intensity of the sound waves reaching the ear-drum. For ordinary speech the frequencies involved range from about 100 cycles per second to roughly 5,000 cycles per second. Intelligible speech can be transmitted on a much narrower band, as in the case of ordinary land-line telephony, but unless the full range of frequencies

is faithfully reproduced a certain aspect of the speaker's personality is lost, and this is fatal where broadcasting is concerned—interest on the part of the listener is soon lost when an effort is required to understand the speech.

In the case of musical performances such as orchestral works, etc., the whole of the audible-frequency range is involved, and this extends from about 16 cycles per second to 10,000 per second or more. Most young people can hear a frequency as high as 20,000 cycles per second, but cannot recognise it as having any definite pitch.

Modulating High-frequency Oscillations.

All these audio-frequencies, except perhaps the very highest, are too low for direct transmission; but even if the audible frequencies could be directly transmitted, it is obvious that any given district could be served by a single broadcasting station only, because every station would then have to operate over the same range of frequencies, and selection would be impossible. For these reasons a radio-frequency far above the audible range must be employed to act as a "carrier" of the low frequencies through the ether from aerial to aerial—the radio-frequency oscillations in the transmitting aerial must be "modulated" by some suitable method.

The function of the transmitting station is to convert sound waves into corresponding electrical vibrations of audio-frequency through the agency of the microphone, superimpose them in a suitable manner on a radio-frequency oscillation, and send out corresponding ether waves. The function of the receiver is to pick up a fraction of the energy represented by these ether waves, convert it back into electrical oscillations corresponding in form to those in the transmitting aerial, and then to separate out the low or audio-frequency components and to convert them once more to sound waves in the air.

Thus in tracing a message through all these stages from speaker to listener we should be concerned with the functioning of every component in both transmitter and receiver. But in such a series as this it is only necessary to consider those aspects of the subject which directly apply to reception. We are concerned in the first place with the nature of the waves to be received, and must therefore be familiar with the manner in which the high-frequency oscillations are modulated to enable the audio-frequency variations to be conveyed through space. This in turn requires some knowledge of the nature of the audio-frequency waves themselves.

Wireless Theory Simplified.—

The Meaning of Harmonics.

Sound waves in the air representing speech or music are extremely complicated, and it is essential that we should know how to deal with vibrations which at first appear to obey no laws at all except that for a sustained note each succeeding cycle of variations is identically the same as the preceding one. In the case of speech even this repetition of waveform does not occur, so for the time being we shall confine our attention to the consideration of a sustained note such as that produced by an organ pipe or a reed instrument emitting a note of constant intensity. The vibrations representing such a sound, whether mechanical or electrical, can be represented by a periodic wave of constant frequency, the sequence of variations over each succeeding cycle being identical. By frequency here is meant the number of complete sequences of variation occurring in one second.

Now, it can be proved that any periodic or alternating quantity, however complicated the waveform, can be resolved into a number of pure sine waves whose sum gives the complex wave in question. The most important of these component waves has a frequency equal to that of the actual wave and is called the *fundamental frequency*, and sometimes the first harmonic. All the remaining component waves are called *harmonics* and have frequencies higher than that of the fundamental. The frequencies of the harmonics are all exact multiples of the fundamental, or main, frequency; that is to say, each of the harmonic frequencies is exactly divisible by the fundamental frequency.

A harmonic whose frequency is twice as great as the

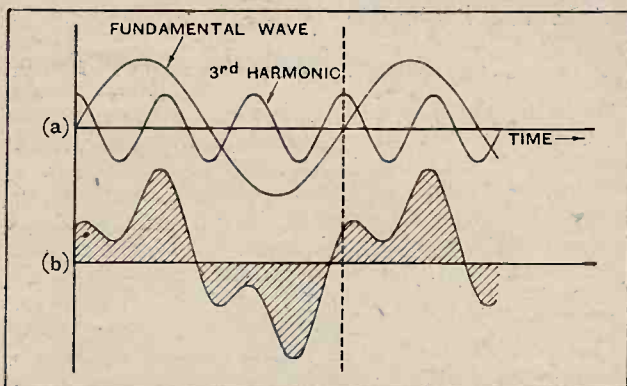

Fig. 1.—The complex wave at (b) is obtained by adding together the two sine waves shown at (a) where one has three times the frequency of the other and half the amplitude. Note that (b) is a periodic wave which repeats itself cycle by cycle. Any periodic wave can be resolved into a series of sine waves.

fundamental frequency is called the second harmonic,¹ one whose frequency is three times as great is called the third harmonic, and so on. The ratio of any harmonic frequency to the fundamental frequency is always a whole number.

Adding Sine Waves of Unequal Frequency.

The manner in which an irregular waveform can be resolved into a fundamental sine wave and a series

of harmonic sine waves will be most easily understood by first reversing the process and showing the effect of adding together graphically two or more sine waves whose frequencies are such that the lowest frequency chosen is exactly divisible into each of the others. For instance, in Fig. 1 (a) are shown two sine waves where one has three times the frequency of the other, or where one has a third of the wavelength of the other respectively, the one with the higher frequency thus being the third harmonic. The harmonic frequency usually has a smaller amplitude or peak value, and in

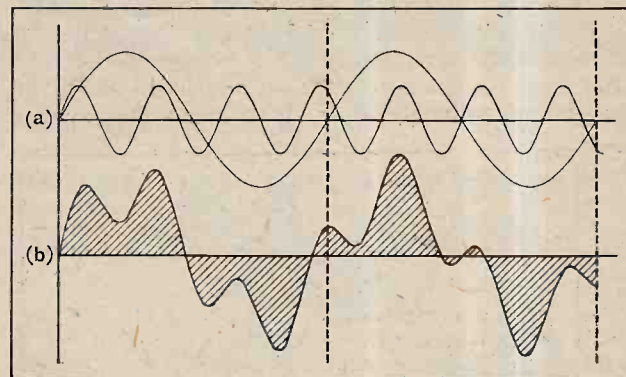

Fig. 2.—When the two sine waves (a) to be added together have frequencies whose ratio is not a whole number, the resultant wave is not a periodic one, as shown by curve (b). A sound wave represented by curve (b) would be heard as two distinct notes which might or might not form a discord, depending on the ratio of frequencies.

this instance the third harmonic has half the amplitude of the fundamental sine wave.

By carefully adding together the simultaneous values represented by the two sine curves of Fig. 1 (a) at various instants along the time base and plotting the sum as a new curve we obtain the more or less complex wave shown at (b). Thus if we had a sound wave, or the equivalent alternating current representing it, with an irregular shape such as that of curve (b) we should be justified in saying that this complex wave was equivalent to two sine waves such as those shown at (a). There is a process called "harmonic analysis," by which a complex wave can be resolved into its constituent fundamental sine waves and its harmonics.

The Effect of Phase Position.

If the higher frequency of the two sine waves to be added were not an exact multiple of the lower one, the resulting complex wave would not be a periodic one and could not possibly represent a sustained note—there would be no successive repetition of identical cycles of variation, and the one is therefore not a harmonic of the other. This is clearly shown by Fig. 2, where the ratio of the frequencies of the two waves added is not a whole number; the resulting complex wave is one which varies with time quite differently over two successive cycles of the larger sine wave of lower frequency. So here we have not a single note of a certain quality or timbre, as represented by

¹ Sometimes in music this is referred to as the first overtone

Wireless Theory Simplified.—

curve (b) of Fig. 1, but two distinct notes which are appreciated separately by the human ear.²

Reverting, then, to the case of the sustained note whose waveform repeats itself cycle by cycle, we must consider briefly what factors govern the shape of the resultant wave for a given fundamental sine wave and a given single harmonic, such as the third, as illustrated in Fig. 1 (a). It will be immediately obvious that the shape of the complex wave will depend on the relative amplitudes of the fundamental wave and the third harmonic—the smaller the amplitude of the harmonic wave compared with that of the fundamental the more nearly will the resultant wave approach to a pure sine wave, and vice versa.

But there is another factor on which the shape of the resultant wave depends, that being the relative

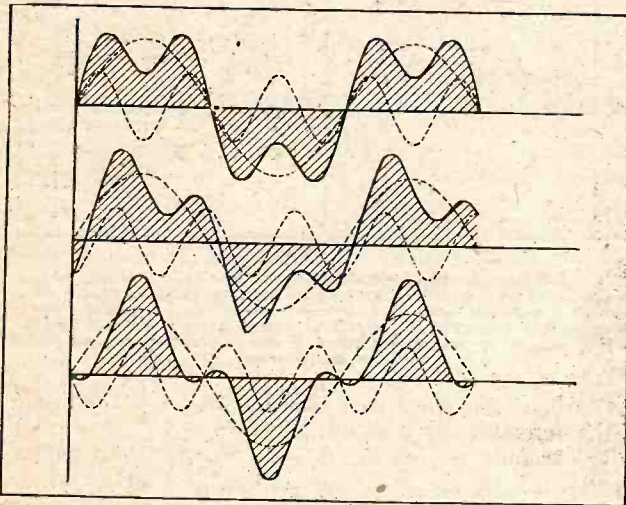

Fig. 3.—The resultant wave obtained by adding together a fundamental sine wave and a harmonic depends on the relative phase positions of the two sine waves. In each case the respective sine waves are the same as those of Fig. 1 (a).

phase positions of the two component sine waves. Thus two waves which have entirely different shapes may each be equivalent to the same fundamental and the same harmonic frequencies, the amplitudes of the latter also being the same for each case, so that the variation of waveform is merely due to the difference in relative phase positions. In order to make this important point clear the series of curves of Fig. 3 have been drawn for a fundamental sine wave and a third

² See article "How We Hear" in *The Wireless World*, December 11th, 1929.

Lissen, Ltd., Lissenum Works, Worples Road, Isleworth, Middlesex.—Illustrated folder describing the 2-valve "Lissenola" Regional receiver. The loud speaker and the batteries are accommodated in the cabinet, but an external aerial and earth connection is necessary. Also descriptive folder of a Regional Selector Unit.

Igranic Electric Co., Ltd., 149, Queen Victoria Street, London, E.C.—Descriptive folder of Igranic A.C.2 all-electric

Catalogues Received.

receiver; also leaflets describing the Midget Radio Switch and a 5-watt power amplifier stage for A.C. mains.

Peto-Scott Co., Ltd., 77, City Road, London, E.C.1.—Revised edition of their

harmonic of three times the frequency and half the amplitude of the fundamental wave, as in the case of Fig. 1 (a). Each line represents the resultant wave (shaded) for a different relative phase position between the sine waves added, the third harmonic wave having been moved along by a quarter of a cycle in each successive stage.

The Pitch and Quality of a Note.

A sustained note which has no harmonics, and is therefore represented by a pure sine wave, is called a *pure tone* in acoustics—it consists of the fundamental frequency only. Now, the pitch of a note on the musical scale is determined by its frequency. If the note is not a pure tone, but, as is usually the case, possesses harmonics, the pitch is determined by the frequency of the fundamental sine wave or "first harmonic." The distinctive quality of a note, however, called the timbre, is determined by the presence and prominence (amplitudes relative to that of the fundamental) of harmonics. For instance, the note of a violin could never be confused with that of a flute, even though each had the same pitch or frequency, the reason being that the vibrating violin string is very rich in powerful harmonics, whereas the vibrating air column in the barrel of the flute has very few harmonics which are relatively weak. Although the ear does not normally separate out the harmonics and recognise their individual pitches, the hearer is very sensitive to even the slightest change in timbre; for example, one can recognise the subtle difference between one violin and another due to some small difference in the relative amplitudes of the harmonics.

Necessity of Maintaining All Harmonics.

The foregoing remarks emphasise the importance of ensuring that, in a radio transmitter and receiver, all of the harmonics shall be maintained in their proper proportions to obtain a really good reproduction. Some of the harmonics may have such a high frequency that they cannot be actually recognised as having any definite relationship to the musical scale, but, nevertheless, their presence is necessary to maintain the correct timbre or quality. It follows, then, that the high-frequency oscillations in the aerial of the transmitter must be controlled in such a way that all the low-frequency notes, together with their harmonics, must be faithfully "carried"; and the knowledge that a complex low-frequency wave can be resolved into a series of pure sine waves enables the theory of modulation to be much more simply explained than would otherwise be the case.

(To be continued.)

"Easy Way Catalogue," containing a comprehensive list of proprietary receivers and accessories now obtainable on the system of deferred payments arranged by this firm.

o o o o

Pye Radio, Ltd., Paris House, Oxford Circus, London, W.1.—Illustrated leaflet of the Pye 25/C Portable Receiver. This, and other Pye sets, can now be purchased by deferred payments extending over a period of twelve months.

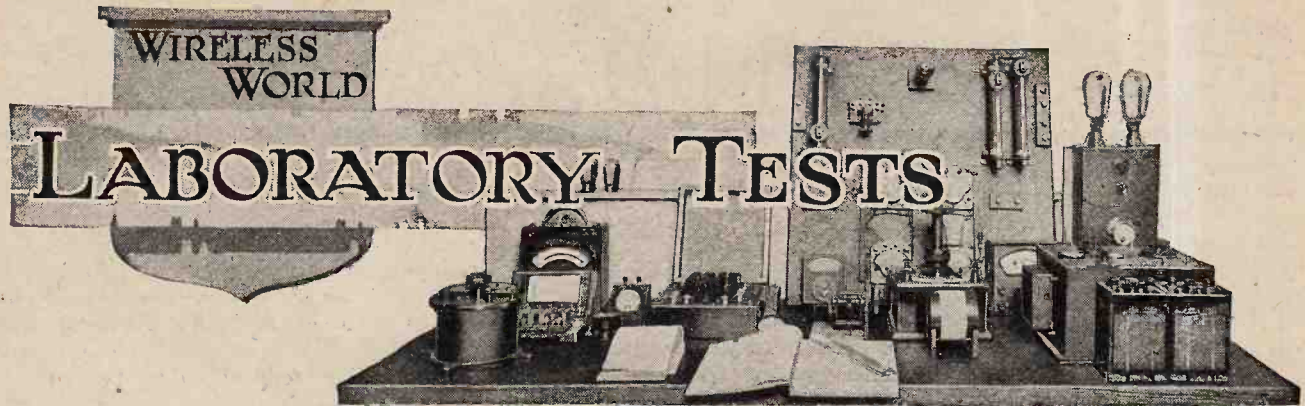

A Review of Manufacturers' Recent Products.

"FETIS" HIGH-RESISTANCE WIRE-WOUND POTENTIOMETER.

Although the total resistance is of the order of 30,000 ohms, the size of this component is surprisingly small. It measures slightly less than 2in. in diameter and occupies a depth of 1 inch behind the panel. The wire is wound on a fibre strip which is fixed to an aluminium spider-type centre carrying the single-hole fixing bush and the bearing for the moving arm. It is exceedingly light in weight and would be ideal for use in portable sets.

Tests showed that the component would carry a current of 20 mA. without becoming unduly hot; it is absolutely safe to pass 15 mA. through it, and we prefer to regard this as the maximum value for normal occasions. This would be equivalent to a difference in potential of 450 volts across its ends.

The movement is perfectly smooth and entirely free from "lumpiness." It is, also, electrically silent in action. Its

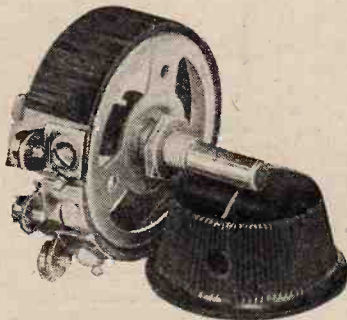

"Fetis" 30,000-ohm wire-wound potentiometer.

measured resistance was found to be 27,900 ohms. For control of volume or for the fine adjustment of screening grid volts, for instance, this component should find useful application.

The resistance is of foreign make and is marketed in this country by Messrs. Haw and Co., Ltd., 20, Cheapside, London, E.C.2. The price is 6s. 3d., including knob.

B 19

BULGIN MAINS SWITCHES.

Messrs. A. F. Bulgin and Co., 9, 10, 11, Cursitor Street, Chancery Lane, London, E.C.4, have recently placed on the market some specially designed switches, styled

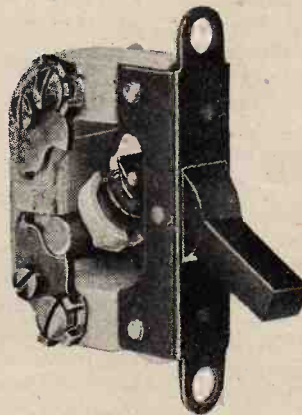

Bulgin "Competa" main switch.

"Competa" switches, in which the insulation is of a very high order. These are intended for use in mains-operated sets, power amplifiers, and battery eliminators where the voltages dealt with are of the order of 250, or higher. Two samples were submitted for test, one being a single-pole change-over switch assembled on a porcelain frame and having all "live" parts fully insulated from the operating lever. This switch is of the quick-break type, and is rated to carry 5 amps. at 240 volts. Its construction is such that it can be used, also, to make and break two separate circuits alternately. The price of this model, which is listed as No. S.55, is 3s.

The other sample, No. S.56, is a double-pole "on-off" switch, suitable for use as a master-switch in the supply leads and rated to carry 2 amps. at 240 volts. The body of this model is built up from strips of paxolin, but the moving contacts are isolated from the control lever by a small porcelain thimble. The price of this type is 3s. 6d.

CLARKE'S ATLAS RHEOGRAD.

This is a variable high resistance, of the compression type, having a nominal range of from practically zero resistance to 2 megohms. Its measured values were 175 ohms minimum and about 10 megohms maximum. Above 2 megohms the device is rather uncertain in action, and we prefer to regard this figure as being the maximum reliable value for practical purposes. Its principal applications are voltage control in battery eliminators, decoupling and voltage-reducing resistance in the anode circuits of valves demanding a lower H.T. than the maximum voltage. It is suitable, also, for use as a volume control connected across the primary of an intervalve transformer. Its usefulness is not restricted to these few rôles, since it can be employed wherever a high resistance is specified in a receiver.

It is rated to dissipate 10 watts, but we found that the component became hot when doing so; the temperature of the case being sufficiently high to soften ebonite slightly. It will be perfectly safe to dissipate this wattage if the device is mounted on a metal support or panel. When mounted on an ebonite panel, the maximum wattage that it will

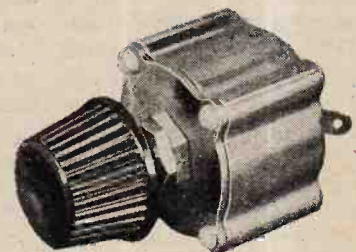

Clarke's "Atlas" Universal Rheograd.

handle, with a safe temperature rise, is of the order of 4 watts, which must be considered a liberal dissipation.

The makers are Messrs. H. Clarke and Co. (Manchester), Ltd., Atlas Works, Old Trafford, Manchester, and the price is 8s. 6d.

The 'N' Diagram

Calculating Stage Amplification in a Low-Frequency Amplifier.

By W. A. BARCLAY, M.A.

(Concluded from page 378 of previous issue.)

LET us construct an N-diagram which will interpret numerically the formula for the percentage magnification obtainable with resistance-capacity coupling. With the circuit of Fig. 3, where the impedance of the coupling condenser C is supposed negligible, and that of the leak R_G to be infinite, the percentage of the magnification factor μ_0 available at the grid of the following valve is $\frac{R}{R+R_0} \times 100\%$ where R_0 is the valve A.C. resistance and R is the external anode resistance. We shall consider R_0 as having all values from 0 to 50,000 ohms, and R as having all values up to ten times this amount, i.e., to 500,000 ohms.

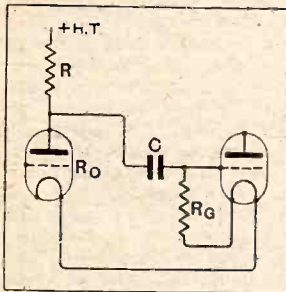

Fig. 3.—Conventional circuit for resistance-capacity coupling.

In Fig. 5 let the arms AC and BD of the N-diagram be graduated evenly for these amounts to represent values of R and R_0 respectively, using any convenient scales for the measurements. We are now ready to proceed with the graduation of the diagonal AB.

Let us find first the point on AB which will represent an actual magnification of

99 per cent. of μ_0 . Then from our formula (1)

$$\frac{99}{100} = \frac{R}{R + R_0} \dots\dots\dots (2)$$

It will be seen that if R had the value 99,000 ohms, while R_0 were 1,000 ohms, the equation would be satisfied. Therefore, if 99,000 on AC be joined to 1,000 on BD, the resulting line should meet the diagonal AB in the required point for 99 per cent. Unfortunately, in practice, things do not "pan out" as simply as that. The snag here is that the line when drawn meets the diagonal in an angle which is too acute for the precise determination of the point. We must, therefore, have recourse to a dodge; if the values of both R and R_0 were multiplied by some factor, the equation (2) would still hold, but the new values might occupy more suitable positions on the scales. We may select any arbitrary factor for this purpose: in the present case let us take, say, 5. This gives $R=495,000$ ohms, $R_0=5,000$ ohms. These values at once satisfy the formula and establish the position of the 99 per cent. point with precision. The subjoined table gives the run of corresponding values from 99 per cent. to 95 per cent., and shows how the values of R and R_0 may be chosen to run quite smoothly, so

that the plotting of the diagonal points becomes quite automatic.

Percentage Magnification p.	R.	R_0 .
99	495,000	5,000
98	490,000	10,000
97	485,000	15,000
96	480,000	20,000
95	475,000	25,000

As the values of R_0 become too large for convenience of plotting, the factor 5 may be reduced. Thus for 90 per cent. we have $\frac{90}{100} = \frac{90,000}{90,000 + 10,000}$. If we take the factor 3, this becomes $\frac{90}{100} = \frac{270,000}{270,000 + 30,000}$ so that $R=270,000$, and $R_0=30,000$ would be suitable values to take for this point.

The diagonal having thus been graduated, the diagram is now ready for permanent service, and will be found to supply a rapid and convenient answer to many general problems regarding the relative values of the resistance components in this form of coupling. For example, suppose it is desired to ascertain the value of anode resistance necessary to give 94 per cent. of the possible magnification when using this method with a valve of A.C. resistance 15,000 ohms. The answer is found by joining this value of R_0 to 94 per cent. on the diagonal scale, and producing to meet the scale of external anode resistance in the required value. This example is shown on Fig. 5 by the broken line, the value of resistance required being found to be 235,000 ohms.

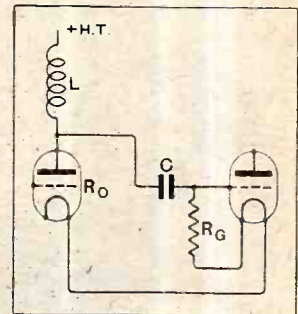

Fig. 4.—The choke-capacity coupled amplifier.

Application to Choke-capacity Coupling.

The principle of the N-diagram is easily extended to apply to more complicated problems. Take, for instance, the case of choke-capacity coupling as shown in Fig. 4. Here the anode resistance R of Fig. 3 is replaced by a choke of inductance L. At any specified frequency of f cycles per second, the reactance of the

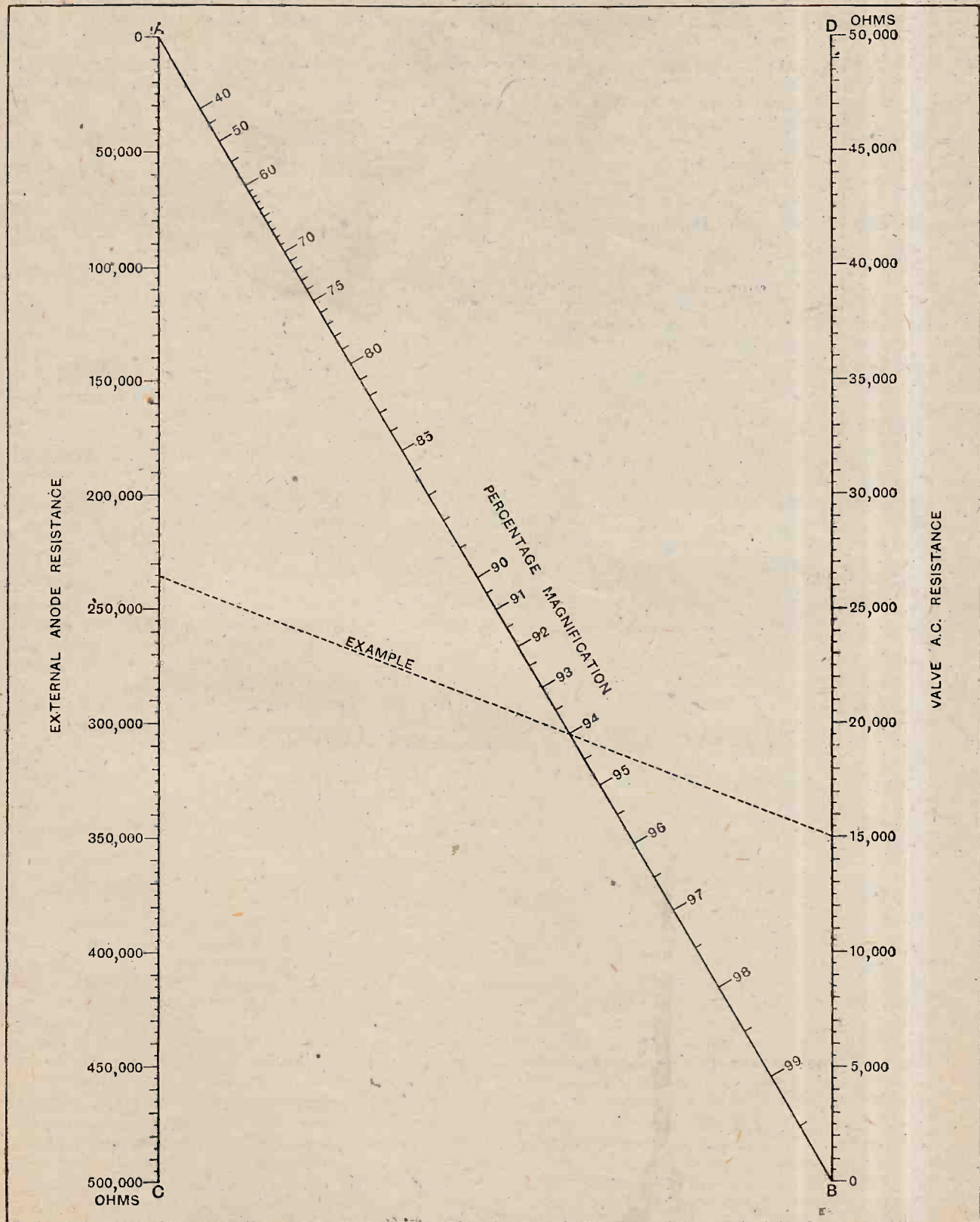

Fig. 5.—N-Diagram for resistance-capacity amplification.

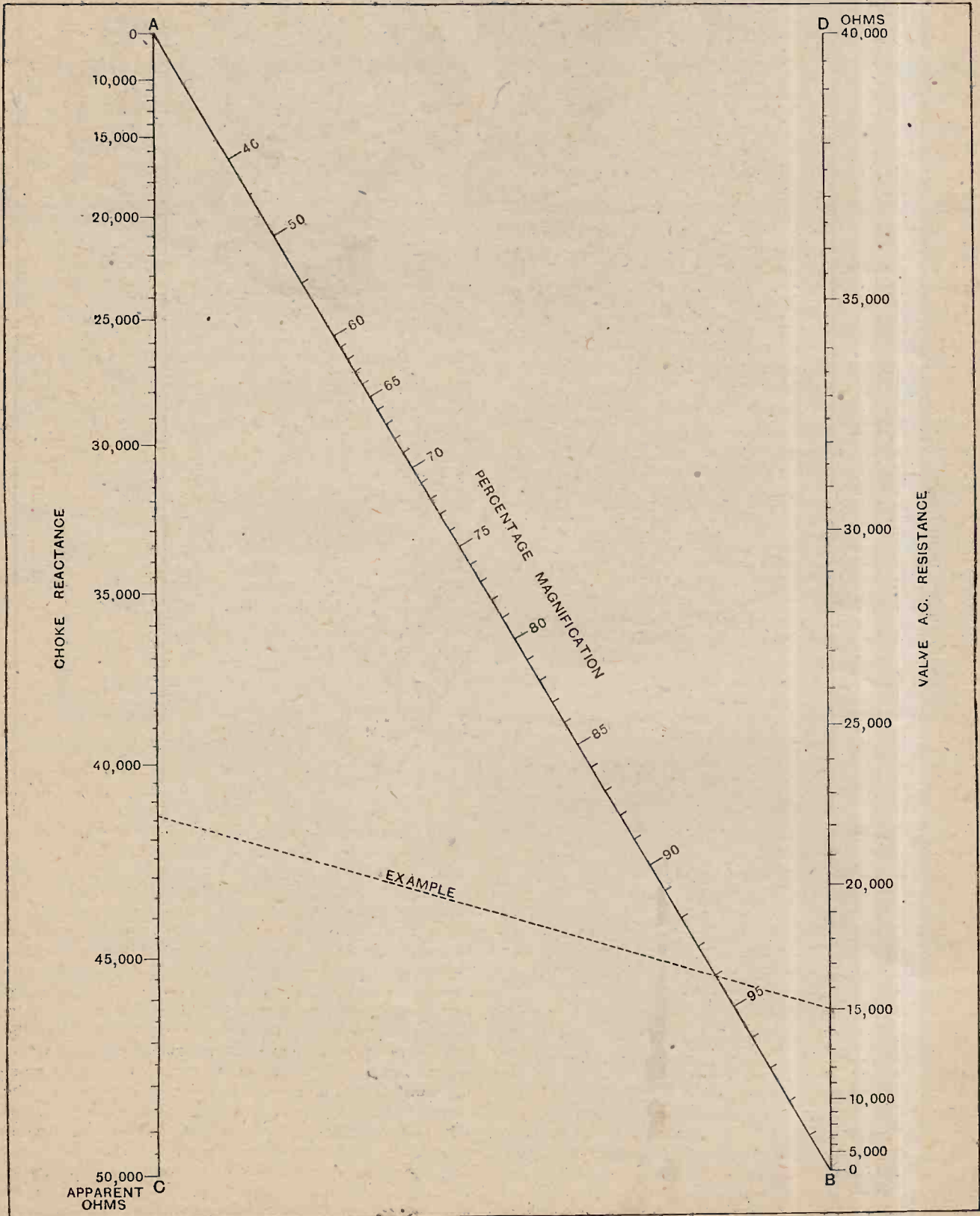

Fig. 6.—N-Diagram for choke-capacity amplification.

The N-Diagram—

choke is given by ωL apparent ohms, where $\omega = 2\pi f$. It is well known that, with the same assumptions as were made above regarding C and R_0 , the voltage amplification available at the grid of the following valve expressed as a percentage of μ_0 is given by

$$\rho = \frac{\omega L}{\sqrt{\omega^2 L^2 + R_0^2}} \times 100\% \dots\dots (3)$$

The numerical evaluation of this expression is always a tedious process; the construction of an N-diagram which is always available for its automatic solution will amply repay the labour expended upon it. The method of construction adopted for the chart shown in Fig. 6 follows the same general principles as in Fig. 5. The arms AC and BD are first graduated with the values of ωL and R_0 over the required ranges, but in this case the graduations follow a square law, *i.e.*, the distance of any graduation from the zero point of the scale is taken as proportional to the *square* of the value it is to represent. As before, the scales to which the markings are set out need not be the same. The arms AC and BD are here made to carry values of ωL up to 50,000 ohms, and values of R_0 up to 40,000 ohms respectively. The calculations necessary to obtain the positions of the diagonal points were obtained from formula (3), or as it may be rewritten, $\frac{\rho^2}{10,000} =$

$\frac{\omega^2 L^2}{\omega^2 L^2 + R_0^2}$ and need not be considered in detail. The selection of suitable values of ωL and R_0 to obtain the several percentage points is not, in reality, such a formidable task as it might at first sight appear, espe-

cially if use be made of a good table of squares, such, *e.g.*, as Barlow's.

Having obtained the completed chart of Fig. 6, we may use it to find the value of choke reactance which will give the same percentage magnification (94 per cent.) with the same R_0 (15,000 ohms) as we used in the previous example dealing with resistance amplification. The broken index-line on Fig. 6 shows that the necessary choke reactance will be 41,300 apparent ohms. It is interesting to note that this is a much smaller value than the 235,000 ohms found necessary for resistance coupling. If the frequency used is $f = 1,000$ cycles per second, the value of the choke L must therefore be $\frac{41,300}{2\pi \times 1,000}$ or 6.6 henrys.

Geometry of the N-Diagram.

It will be evident that in what has been said above we have been content to make use of the very remarkable properties of this figure without making any attempt to prove them. It is, really, by no means difficult to show that, when once a point on the diagonal scale has been fixed by means of any one pair of related values on the external arms, then the same diagonal point will connect every other pair of values on the external scales to which it is related by means of the given formula. The preliminary labour entailed in finding the positions of the diagonal points is thus very small when compared with the immense scope and utility of the completed diagram. The proof is, after all, a matter of pure geometry, and as such is omitted.

Finally, it should be said that in drawing out these or any similar charts, as large a scale as possible is recommended for the work.

DESIGNING THE DECOUPLING SYSTEM.

WE all remember the difficulties that beset the first attempts to employ the mains in place of a high-tension battery. Motor-boating and related phenomena were almost universal troubles in the homes of the experimenters.

The anode-feed scheme of decoupling, originated in the Ferranti laboratories, soon came to our rescue, and workable eliminators were built with a separate supply terminal for each valve of the set. Each terminal was isolated from all the others by a resistance-capacity filter, with the result that the receiver would work as well from the mains as from batteries.

As the first eliminators were designed to operate receivers for which batteries had previously been used, it was only natural that the decoupling components should be regarded as part of the eliminator rather than as part of the set. With the higher stage-gain that modern valves and modern receiver design have brought us, it is beginning to be found that in some cases at least it is essential to decouple the anode circuits from one another in the receiver itself, for if the signal currents are allowed to run all round the set, and out of it into the eliminator, hopeless instability is quite likely

to result. It is, in fact, necessary to complete the anode and grid circuits of each valve independently, using the shortest possible paths. High-frequency return leads especially should not emerge from their earthed screening boxes.

All Stages on a Single Potential.

There is therefore a good deal to be said for the newer practice, as adopted, for example, in such receivers as the "Record III" and the "New Foreign Listeners' Four," of incorporating the entire decoupling system in the set itself. The decoupling resistances are then so chosen that, with the same external voltage, each valve has the required working voltage on its plate. All the H.T. + points are then brought together, and the set has a single H.T. + terminal which can be fed from any hum-free supply of the correct voltage. The eliminator is simplified down to a smoothing circuit only (with rectifying arrangements added if A.C. mains are to be used). If built as a separate unit it contains no series resistances or potential dividers, and gives but one fixed output voltage from a single pair of terminals.

Broadcast Brevities

By Our Special Correspondent.

P.O. Detector Van at Work.—5SW and the Cup Final.—“Broadcasting House” on the Stage.

A Post Office Drama.

A gripping story of the adventures of the Post Office detector van during the recent campaign in Manchester is told in an official statement communicated to the B.B.C. Unfortunately the story has a sting in its tail.

o o o o

More Tactics than Tact.

Zero hour was unhappily chosen, coinciding as it did with the start of National Radio Week (January 13th), and it is quite on the cards that the spectacle of this official Juggernaut parading the streets scared off many prospective listeners. At the same time it is certain that many pirates were frightened into buying licences.

o o o o

Choosing Strategic Points.

Although some attempt was made to locate oscillating receivers by means of D.F. apparatus, the officials were bent on creating a moral effect among the unlicensed fraternity, and accordingly the van was stationed at strategic points where its foreboding aspect was likely to impress the greatest number of people.

o o o o

Making Their Flesh Creep.

A number of schools were visited. During lunch hours the terrifying vehicle was seen outside mills, factories, and business houses. On market days the van lay in wait in public squares. In the evenings it frequented the railway stations for the benefit of workers returning to the suburbs. It also turned up at football matches.

o o o o

A Sad Aftermath.

The results of the campaign were soon apparent behind the Post Office counters, and before the end of the month the P.M.G. was able to report that the number of new licences per week averaged an increase of 30 per cent. above the normal figure.

And then came February 14th, the date on which the van made its scheduled departure. Almost at once the licence figures declined. By the end of February the Post Office reported that the licence demand was back to normal.

o o o o

The Mixture as Before.

The B.B.C. are inclined to think that the temporary rise in the Manchester licence figures was largely attributable to the appeal of National Radio Week and its special programmes, but St. Martin's

le-Grand thinks otherwise. I understand that the P.O. engineers are now preparing tonic doses for a few other towns.

o o o o

The Cup Final Episode.

Now that the B.B.C. and the F.A. have come to terms over the broadcasting of the Cup Final the “O.B.” people at Savoy Hill find that they will have no use for the upstairs flat, complete with telephone, which had been hired for the use of the seven commentators.

The special arrangements made for broadcasting the match by instalments, including commentators' tickets of admission, their fees, and the rent of the flat, worked out at more than the £100 which the B.B.C. had offered for charitable objects in the event of a direct running commentary.

o o o o

5SW Again.

The broadcast from Wembley on April 26th will be carried out by Mr. George F. Allison, the well-known football expert, and will be sent out by all B.B.C. stations, including 5SW.

This will be the first time that the short-waver has broadcast a football match.

o o o o

The Imperial Broadcasting Project.

The increasing activity of 5SW will be very gratifying to all who believe in the

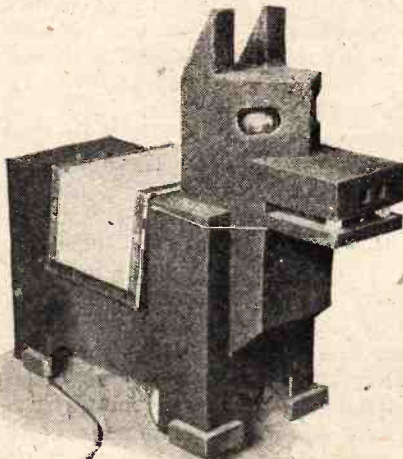

THE RADIO DOG. “Phil,” the creation of Philips Lamps Ltd., barks, wags his tail or rolls his eyes in response to signs from a flash lamp. His eyes are photo-electric cells and his “innards” include amplifying valves, relays and batteries.

future of Empire broadcasting, and it is to be hoped that the service which is being rendered will not be overlooked by the officials at the Colonial Office, who, as first reported in *The Wireless World*, are now discussing an Imperial broadcasting scheme.

o o o o

A Welcome Statement.

Meanwhile, since the ordinary listener has supplied the cash for the Chelmsford experiments, it would be a happy gesture if the B.B.C. were to issue a public statement showing the measure of success achieved by 5SW as revealed by listeners' reports from all parts of the world.

o o o o

B.B.C. Dance Band on the Stage.

Jack Payne and his B.B.C. Dance Band are as happy on the variety stage as in the Savoy Hill studio; in fact, some observers are wondering whether the attraction of the footlights may prove so strong that eventually the B.B.C. will have to seek a new dance leader.

o o o o

Loud Speakers in the Theatre.

Meanwhile Jack Payne's music hall appearances form an excellent advertisement for the B.B.C. The “turn” begins with dance music reproduced on loud speakers in the auditorium, the band being concealed behind a drop-curtain which bears an impressionist picture of the future “Broadcasting House” in Portland Place. With the rise of the curtain the band is vaguely seen through a mist of gauze. Then the fog lifts, the loud speakers are switched off, and the audience sees and hears the real thing.

The band appeared last week at the Palladium, London, and its next music hall engagement will be at the Newcastle Hippodrome on April 28th.

o o o o

“Elijah.”

The “Parsifal” evening on Good Friday marks the end of the B.B.C. winter season Symphony Concerts, and, excepting one occasion, the Queen's Hall will not again be used for broadcasting until the Promenade Concerts begin in August. The exception will be on May 23rd, when the B.B.C. National Chorus and Orchestra will combine in a performance of Mendelssohn's “Elijah.” Although one of the finest oratorios ever written “Elijah” demands a large orchestra and chorus, which it often fails to get.

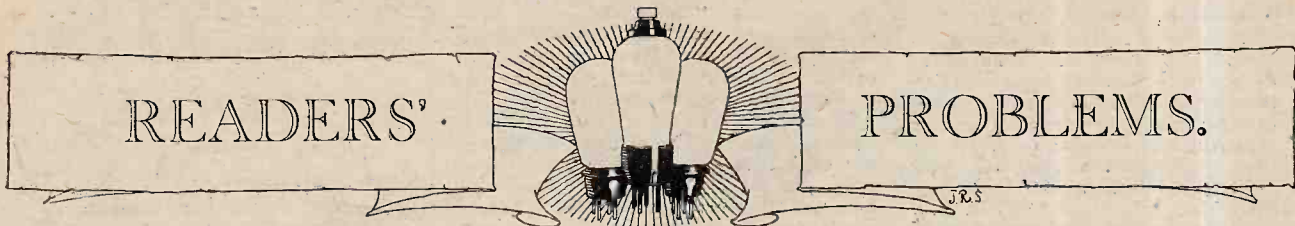

"The Wireless World" Supplies a Free Service of Technical Information.

The Service is subject to the rules of the Department, which are printed below; these must be strictly enforced, in the interest of readers themselves. A selection of queries of general interest is dealt with below, in some cases at greater length than would be possible in a letter.

Cathode Potentiometer.

I have just obtained one of the new low-resistance potentiometers, and am wondering whether there would be any advantage in fitting this component in place of the 400-ohm potentiometer and 0.005 mfd. condensers which are shunted across the I.T. winding of the power transformer in the "Record III."

In view of the low resistance of the potentiometer, I suppose that there would be no point in retaining the by-pass condensers.

M. L. S.

We presume that the potentiometer to which you refer has a resistance of some 10 ohms: this component should be entirely suitable, and the current consumed by it will be almost negligible when compared with that taken by the heaters of the three valves.

As you suggest, the low resistance of the potentiometer will probably render the by-pass condensers (C_{11} and C_{12} in the original circuit diagram) quite unnecessary, but there will be no objection in leaving them in position.

o o o o

A Breach of the Peace Averted.

I have lately been troubled by interference from oscillations on the wavelength of the "National" transmitter (261 metres), and am inclined to think that one of my near neighbours is the offender. I say this because I happen to know that his set (a rather out-of-date det.-2 L.F. affair) will not properly tune down to this wavelength, although signals of a sort are receivable. I rather suspect that, in order to increase strength, he has to use an excessive amount of reaction, and so is responsible for the interference. Do you think that I am likely to be correct in this opinion?

H. J. R.

We do not. If your neighbour's receiver cannot be tuned accurately to the wavelength of 261 metres, it is equally impossible that it should be capable of generating oscillations of a frequency giving an audible beat note with the carrier wave. Further, it is rather unlikely that any increase in signal strength of the 261-metre transmission will be brought about by applying reaction, as this will tend to sharpen up tuning and to reduce still further the intensity of signals of a frequency to which the circuit cannot be adjusted.

Aerial Tuner with Wave Switching.

If it is possible to modify the aerial tuning unit described in your issue of March 12th (in the article entitled "Local Station Interference") by adding waveband switching for the two wavelengths, will you please give me a diagram showing how this may be done?

M. R. M.

This is quite a simple matter, although in order to accommodate the two coils comfortably it may be necessary to use a rather larger screening box. A suggested

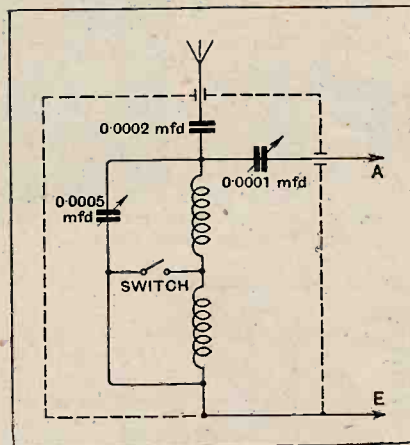

Fig. 1.—An aerial tuning unit with waveband switching.

RULES.

- (1.) A query must be accompanied by a COUPON removed from the advertisement pages of the CURRENT ISSUE.
- (2.) Only one question (which must deal with a single specific point) can be answered. Letters must be concisely worded and headed "Information Department."
- (3.) Queries must be written on one side of the paper and diagrams drawn on a separate sheet. A self-addressed stamped envelope must be enclosed for postal reply.
- (4.) Designs or circuit diagrams for complete receivers or eliminators cannot ordinarily be given; under present-day conditions justice cannot be done to questions of this kind in the course of a letter.
- (5.) Practical wiring plans cannot be supplied or considered.
- (6.) Designs for components such as L.F. chokes, power transformers, complex coil assemblies, etc., cannot be supplied.
- (7.) Queries arising from the construction or operation of receivers must be confined to constructional sets described in "The Wireless World," to standard manufactured receivers; or to "Kit" sets that have been reviewed.

method of connection is shown in Fig. 1, from which you will see that the two tuning coils are connected in series, one of them—the long-wave winding—being shunted by a short-circuiting switch.

o o o o

Inadequate Screening.

Will you please tell me if the method of construction exemplified in the "Ideal Home Receiver" ("Wireless World" March 19th) would be suitable for a set closely resembling the "1930 Everyman Four"? My object is mainly to reduce overall width by following the "double-deck" method of mounting the two tuned input circuit components.

F. S. A.

The screening afforded by this method of construction is adequate for an H.F. stage of medium gain, but is hardly enough for a set such as the "1930 Everyman Four," in which Litz-wound coils with exceptionally low losses are used.

If you wish to adopt this general scheme of construction, it would be essential completely to enclose the H.F. anode circuit components, and, to be on the safe side, it is to be recommended that the various joints of the sheet aluminium chassis should be "sealed" by interposing strips of gauze.

o o o o

Appropriate Action.

Can you suggest any cure for severe interference in the shape of crackling and humming noises, which has been definitely proved to emanate from a cinema at a distance of some twenty or thirty yards from my house?

My set is a four-valve self-contained portable, and so I am afraid it will be rather difficult to modify it. If this is so, do you think it would be worth while approaching the owners of the picture-house with a request that they should try to prevent radiation from their electrical appliances?

M. C. L.

A certain amount of interference may be obviated by using a centre-tapped frame, with the centre point connected to earth; this may or may not be easily applicable to your own receiver.

We strongly recommend that you should communicate with the B.B.C. and the Post Office authorities, giving a full description of the trouble, and stating your grounds for concluding that the interference really emanates from the cinema.

ANOTHER PHILIPS TRIUMPH



Philips Portable Radio
Type 2522. Price £27 10s.
Or £5 10s. deposit and ten
monthly payments of
£2 7s. 3d.

Once again Philips prove their supremacy in the design of modern radio receivers. This portable set, constructed on entirely new lines, gives an amazing performance, definitely surpassing that hitherto associated with portable radio receivers. A single thumb tuning control actuates a gauged condenser—two tuned circuits—which ensures easy reception and separation of the leading British and continental stations. The circuit includes a screened-grid H.F. stage, a steep slope detector, an L.F. stage and a pentode. When the cabinet

is closed the receiver is automatically switched off and cannot be used again until the cabinet is unlocked. Sockets are provided for an external aerial and earth and loud-speaker as desired. A connection is also provided for a gramophone pick-up. The cabinet is polished walnut, and is fitted with a turntable and waterproof cover. Price complete with valves, accumulator and batteries and waterproof cover, £27 10s. Hire Purchase Terms. Deposit: £5 10s., followed by 10 monthly payments of £2 7s. 3d.

PHILIPS PORTABLE RADIO

Made by the manufacturers of Philips All-Electric Radio Receivers, Argenta Electric Lamps, Commercial and Industrial Fittings, and Neon Signs.

Philips Lamps Ltd. - Philips House - 145 Charing Cross Road - London, W.C.2

B27 Advertisements for "The Wireless World" are only accepted from firms we believe to be thoroughly reliable.

Utility

CONDENSERS —for Value

All high-class dealers stock "Utility" Condensers—better value is unobtainable. The "Mite" illustrated offers maximum efficiency in a very small compass. It is designed on low loss principles and the centre spindle rotates on ball bearings. Perfect contact between spindle and single end plate is ensured by phosphor-bronze springs. A great space economiser and fully guaranteed. Send postcard for latest illustrated "Utility" List.

Wilkins & Wright Ltd.
Utility Works, Holyhead Road,
BIRMINGHAM.

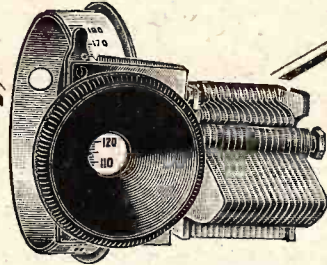

PRICES

Supplied at the following prices with 3" Vernier Dial:

Cat. No.	Cap.	Price
W.200	.0001	8/6
W.199	.0002	9/-
W.198	.0003	9/6
W.197	.0005	10/-

With Drum Dial (as illustrated):

Cat. No.	Cap.	Price
W.203	.0002	10/6
W.202	.0003	11/-
W.201	.0005	11/6

Also supplied as Ganged Units with or without Dials.

JOLLYS of WITTON, BIRMINGHAM Offer the following Radio Bargains

B.T.H. RK Moving Coil Speakers
fitted in all Amplifiers.

B.T.H. RK Amplifiers complete with Speakers,
etc., Senior and Junior models, all volt-
ages A.C. and D.C., from - £10 0 0

B.T.H. Panatropo Amplifiers with Speakers,
Junior and Senior models, all voltages
D.C. and A.C., from - £11 0 0

B.T.H. Transformers, 1-1, 10-1, 15-1, 8/6 each

B.T.H. Chokes, 30 henries, 100 milliamps,
10/6 each

B.T.H. Generators, input 200/250 volts D.C.,
output 475 volts 200 milliamps, D.C.,
£6 0 0

B.T.H. Generators, input 200/250 volts D.C.,
output 725 volts D.C., 200 milliamps,
£7 0 0

We have all spares in stock for the above. State your requirements.

Terms—Cash with order. Goods sent Carriage Paid within 150 miles.

JOLLYS, 410 & 416, Aston Lane, Witton, Birmingham.

WIRELESS DIRECTION FINDING and DIRECTIONAL RECEPTION

(1927)

By R. KEEN, B.Eng. (Hons.).

Second Edition: Revised and Enlarged.

THIS volume deals with the principles of the subject and the constructional details of direction-finding installations, and includes some information concerning aircraft installation. It describes the principles of Direction and Position Finding in this country in such a way that the subject may be grasped easily by engineers tackling this field of wireless work for the first time. Numerous photographs and diagrams are included.

Price 21/- net. By post 21/9.

From leading booksellers or
direct from the Publishers:

ILIFFE & SONS LIMITED,
Dorset House, Tudor Street, London, E.C.4.

DICTIONARY of WIRELESS TECHNICAL TERMS

(1926)

Compiled by S. O. PEARSON, B.Sc., A.M.I.E.E.
and issued in conjunction with
"THE WIRELESS WORLD."

This volume contains definitions of terms and expressions commonly used in wireless telephony and telegraphy and is intended to serve as a guide to all those interested in wireless who come across, from time to time, unfamiliar words in their reading. In such cases the DICTIONARY OF WIRELESS TECHNICAL TERMS proves of very great use and value. It is well illustrated, and cross-referenced to enable the required information to be rapidly obtained.

Price 2/- net. By Post 2/2

From leading booksellers or from the Publishers:

ILIFFE & SONS LTD.,
Dorset House, Tudor St., London, E.C.4.

Mention of "The Wireless World," when writing to advertisers, will ensure prompt attention.

MISCELLANEOUS ADVERTISEMENTS.

NOTICES.

THE CHARGE FOR ADVERTISEMENTS in these columns is:

12 words or less, 2/- and 2d. for every additional word.

Each paragraph is charged separately and name and address must be counted.

SERIES DISCOUNTS are allowed to Trade Advertisers as follows on orders for consecutive insertions, provided a contract is placed in advance, and in the absence of fresh instructions the entire "copy" is repeated from the previous issue: 13 consecutive insertions 5%; 26 consecutive, 10%; 52 consecutive, 15%.

ADVERTISEMENTS for these columns are accepted up to **FIRST POST ON THURSDAY MORNING** (previous to date of issue) at the Head Offices of "The Wireless World," Dorset House, Tudor Street, London, E.C.4, or on **WEDNESDAY MORNING** at the Branch Offices, 19, Hertford Street, Coventry; Guildhall Buildings, Navigation Street, Birmingham; 260, Deansgate, Manchester; 101, St. Vincent Street, Glasgow, C.2.

Advertisements that arrive too late for a particular issue will automatically be inserted in the following issue unless accompanied by instructions to the contrary. All advertisements in this section must be strictly prepaid.

The proprietors retain the right to refuse or withdraw advertisements at their discretion.

Postal Orders and Cheques sent in payment for advertisements should be made **& Co.** payable to **ILIFFE & SONS Ltd.**, and crossed **Notes being untraceable** if lost in transit should not be sent as remittances.

All letters relating to advertisements should quote the number which is printed at the end of each advertisement, and the date of the issue in which it appeared.

The proprietors are not responsible for clerical or printers' errors, although every care is taken to avoid mistakes.

NUMBERED ADDRESSES.

For the convenience of private advertisers, letters may be addressed to numbers at "The Wireless World" Office. When this is desired, the sum of 6d. to defray the cost of registration and to cover postage on replies must be added to the advertisement charge, which must include the words Box 000, c/o "The Wireless World." Only the number will appear in the advertisement. All replies should be addressed No. 000, c/o "The Wireless World," Dorset House, Tudor Street, London, E.C.4. *Readers who reply to Box No. advertisements are warned against sending remittance through the post except in registered envelopes; in all such cases the use of the Deposit System is recommended, and the envelope should be clearly marked "Deposit Department."*

DEPOSIT SYSTEM.

Readers who hesitate to send money to unknown persons may deal in perfect safety by availing themselves of our Deposit System. If the money be deposited with "The Wireless World," both parties are advised of its receipt.

The time allowed for decision is three days, counting from receipt of goods, after which period, if buyer decides not to retain goods, they must be returned to sender. If a sale is effected, buyer instructs us to remit amount to seller, but if not, seller instructs us to return amount to depositor. Carriage is paid by the buyer, but in the event of no sale, and subject to there being no different arrangement between buyer and seller, each pays carriage one way. The seller takes the risk of loss or damage in transit, for which we take no responsibility. For all transactions up to £10, a deposit fee of 1/- is charged; on transactions over £10 and under £50, the fee is 2/6; over £50, 5/-. All deposit matters are dealt with at Dorset House, Tudor Street, London, E.C.4, and cheques and money orders should be made payable to Iliffe & Sons Limited.

SPECIAL NOTE.—Readers who reply to advertisements and receive no answer to their enquiries are requested to regard the silence as an indication that the goods advertised have already been disposed of. Advertisers often receive so many enquiries that it is quite impossible to reply to each one by post.

"WIRELESS WORLD" INFORMATION COUPON

This Coupon must accompany any Question sent in before

APRIL 23rd, 1930

For Particulars of Free Service, see Rules on page 423.



ALL WIRELESS WORLD COILS
100% EVERYMAN
FOUR 47/8 set

KIT SET, Coils with Switches	45/- set
NEW KILOMAG	45/- set
RECORD III	45/- set
FOREIGN LISTENERS 4 B.R.C.	50/- set
	5XX 37/6 set

METAL CABINETS
5 1/2" DRUM DIALS with Escutcheons 38/3 to 46/3 5/3

B & J. Wireless Co.
2, 3, & 4, Athelstane Mews, Stroud Green Rd., N.4
Archway 1095

BUILD THE

"NEW FOREIGN LISTENER'S FOUR"

Complete Kit **£16**
Ready Wired and Tested.. **£25**
Lists on Application.

MAGNUM SCREENING BOXES FOR THE F.L. 4

6/- each inclusive of baseboards.

Particulars of the New Magnum Pick-up, Dissolvers and Volume Controls are now available.
Free on request.

BURNE-JONES & CO., LTD.

"MAGNUM" HOUSE, 296, BOROUGH HIGH STREET, LONDON, S.E.1.
TELEPHONE: HOP 6257/8.

METAL Cabinets



Precisely to specification and sealed with Tubular Brass Gauze, for

ALL "WIRELESS WORLD" SETS

Oak Base and Oak Finish	57/8 complete
Mahogany	63/-
Oak Base and Imitation Leather	63/-
Metal Container and Copper Screws, less woodwork	47/3

COILS, DRUM DIALS AND ESCUTCHEONS to "W.W." Specification.

1930 Everyman Four	47/8 per set
NEW Kilomag IV	45/-
Record III	45/-
Wave Trap	10/3
5 1/2" Drum Dial with Escutcheons	5/6 each.

RIGBY & WOLFENDEN,
Sole Mfrs. Works,
Millnrow Road, **ROCHDALE.** Phone 2918

USE POLAR THE MASTER CONDENSER

for
Selectivity and Wide Range
Write for free leaflet.

WINGROVE & ROGERS Ltd
188-9, Strand, London, W.C.2.



RECEIVERS FOR SALE.

SCOTT SESSIONS and Co., Great Britain's Radio Doctors.—Read advertisement under Miscellaneous. [0264]

HIRE a McMichael Portable Set, by day or week, from Alexander Bick, Wireless Doctor and Consultant, 55, Elmly St., S.W.1. Sloane 1655. [0328]

STEREOPHONIC Couplers!—Latest talkie super models, many in use, without reproduction; type B super £5/5 A super £3/15; trade supplied.—Bonavia Hunt, 96, Broadhurst Gardens, N.W.6. [8798]

5-VALVE Portable, new, complete; £10, cost double.—Bracey, Factory Sq., Streatham. [9039]

BURDEPT 5-valve Ethogrand, with valves and coils, £7/10; Marconi V2, 30/-; ditto, with amplifier, 50/-; carriage extra.—James Scott and Co., Radio Engineers, Danfermline. [0333]

McMICHAEL Super Range Portable Four, as new; £15, no offers.—Box 5645, c/o The Wireless World. [9101]

BARGAINS.—2-valve sets, oak cabinets, all-wave tuners; 52/6.—Whorton, Norton Canes, Stafford. [9100]

ORMOND Five Transportable, new Christmas, 1929, with valves £9/9, without £7/7; Bulgin 20 henries choke, 7/6; Marconi Ideal, 2-1, 15/-; quantity utility switches, 2/- each; 6-volt Mullard Pentode, 15/-; several P.M.6 and P.M.5X, half price; Pegasus and Lincone double diaphragms, 10/- each; everything guaranteed absolutely as new.—Cleimens and Taylor, Radio House, Pershore. [9094]

RECEIVERS.—One-valve Sterling, steel clad units with coil holders, 139/153, 15/-; valve, 3/6; Marconiphone 1-valve and detector, R.B.10, with valve, 17/6; 1-valve T.M.C., 17/6; valve, 3/6; 2-valve ditto, R.B.10, H.F. and L.F., enclosed in leatherette covered cabinet, 35/-; ditto, 2 L.F., 35/-; valves, 7/-; 2-valve Ediswan set, 35/-; 3-valve Efesca receivers, 200-2,000 m., 48/-; valves, 7/-; 3-valve R.A.F. Aircraft portable, 27/6; valves, 7/-; 3-valve Polar, H.F., det. and 2 L.F., vertical, polished mahogany, 70/-; valves, 14/-; 5-valve R.A.F. 10, with valves, oak American type cabinet, 80/-; Aircraft model, with valves, 60/-; ditto, without remote control, 40/-; R.A.F. 7-valve receiver amplifier, 60/-; Marconi No. 55 7-valve H.F. screened No. 39, 60/-; Power amplifiers for grammo. motors and Western Electric 2-valve, mahogany case, 45/-; Sterling ditto, 45/-; W.D. M.K.IV, 40/-; Sterling 1-valve, 15/-; Pantatrop for D.C. mains, 65/-; tone arms, 4/8; Fellows 3 and 4-valve sets, H.T. units, and chargers, 50% off list.—Electradix Radios, 218, Upper Thames St., E.C.4. [9089]

G.E.C. 3-valve All Mains A.C. Set, cost £23; B.T.H. senior model R.K. loud-speaker, model De Luxe, cost £40, new condition; what offers? Suitable for large hall.—F. Bond, 56, Kingsway, W.C.2. [9087]

ELSTREE Six, Exide H.T., Mullard valves, 6-valt Exide, Amplion speaker, in large cabinet with battery compartment; offers invited.—Brittain, 16, Puller Rd., Barnet, Herts. [9078]

EVERYMAN Four Screened Grid Circuit, mahogany case, Exide trickle charger and 108 volt batteries, 2 6-volt batteries; cheap; buying mains set; also 170 full scale pianola rolls.—Higgett, 232, Gloucester Terrace, W.2. [9127]

EVERYMAN Four, original model, absolutely to Mr. James' specification, first quality components, Cameo fall-front oak cabinet, with valves, as new; £5.—Box 945, c/o Browns, 39, Tothill St., S.W.1. [9126]

RADIOGRAM.—Improved Clarion three circuit, H.T. mains, easily separates Reg. and Nat., many stations on loud-speaker; demonstrations from 7 p.m.—93, Richmond Rd., Ilford, Essex. [9110]

FADA Radio 8-valve Receiver, latest type, gang control, in magnificent inlaid walnut console cabinet; this is a unique opportunity as this set has a wonderful performance and cost about £130; can be seen and tried by appointment; complete with all valves and large accumulators; offers considered.—F. W. Smurthwaite, A.M.I.R.E., 15a, Onslow Gardens, Wallington. Phone: Wallington 1982. [9109]

McMICHAEL Super Screened Four, perfect; list £36, £20, or offer.—Box 5655, c/o The Wireless World. [9106]

BERCLIF D.C.2 All Mains Receiver, 200 to 250 volts D.C.; price £14/10; with valves and royalties, suitable for M.C. speaker; particulars free; trade inquiries specially invited.—Simmonds Bros., Shireland Rd., Smethwick. [8774]

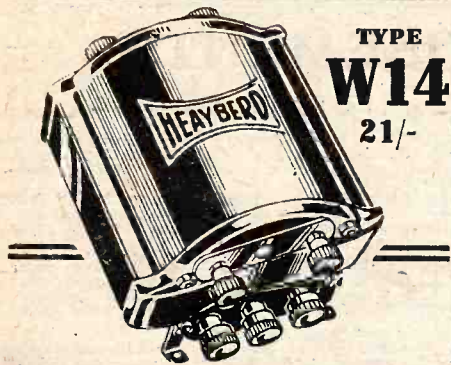

TYPE
W14
21/-

**Worth their weight
in GOLD**

All Heayberd Mains Transformers are built to give long and reliable service. The latest—Type W.14—is no exception. Neat in design and finish, efficient in operation—under any load—use this new Heayberd, with Westinghouse Metal Rectifiers, for all Mains Work. Price 21/-.
Ask your Dealer or write for complete list of types and prices.



POWER TRANSFORMERS

F. C. HEAYBERD & CO.
10, Finsbury Street, E.C.2.
Phone: Clerkenwell 7216.

Public Address System

by Standard Telephones and Cables Ltd. Comprising Power Amplifier, Microphones, Power Speakers, Valves and Spares.

Arranged for inputs from Microphone, Gramophone and Radio. This apparatus has only been in operation a short period, as a Band, Radio, Gramophone and Speech repeater and is for disposal due to changes in administration. Complete specification and details on request.

THE BRITISH RADIO MFG. CO.,
9, South Castle Street, Liverpool.

PAREX



**Bakelite
Drum Dials**
with Escutcheons

5/6

(from stock).

Cabinets, Coils, Valve Holders, etc., for New Kilo-Mag 4 and 1930 Everyman 4.

IDEAL HOME RECEIVER

Special Screen and Panel 17/6.
Set of 3 Coils as specified 45/-.

Order direct from

E. PAROUSSI,

10, Featherstone Buildings, High Holborn, W.C.1

Phone: Chancery 7010.

Receivers for Sale.—Contd.

YOUR Old Receiver or Components Taken in Part Exchange for New; write to us before purchasing elsewhere, and obtain expert advice from wireless engineer of 25 years' professional wireless experience; send a list of components or the components themselves, and we will quote you by return post; thousands of satisfied clients.—Scientific Development Co., 57, Guildhall St., Preston. [0226]

ACCUMULATOR HIRE.

DON'T Buy Accumulators or Dry Batteries, join our C.A.V. low- and high-tension accumulator hire service, the largest and best in London; better and cheaper reception with no trouble; regular deliveries within 12 miles of Charing Cross; no deposit, payment on each delivery or by quarterly subscription; over 10,000 satisfied users; explanatory folder post free; phone or write to-day.—Radio Service (London), Ltd., 105, Torriono Av., N.W.5. Phone: North 0623-4-5. [8751]

BATTERIES.

WET H.T. Replacements.—Sacs (capped or uncapped), highest grade, No. 1, 10d. per doz.; No. 2, 1/9 per doz.—See below.

ZINCS.—Best quality (wired), No. 1, 8d. per doz.; No. 2, 9d. per doz.; orders valued 5/- carriage paid, otherwise 6d. for postage.—British Battery Co., Clarendon Rd., Watford, Herts. [0258]

CHARGERS AND ELIMINATORS.

CHEBROS.—Chebros for all types of transformers and chokes, high grade instruments at a very moderate price; enquiries invited.—Chester Bros., 244, Dalston Lane, London, E.8. [5290]

TANTALUM and Lionium for A.C. Rectifiers; for inexpensive chargers; blue prints for H.T. and L.T., 1/- each; Lionium electrodes, 2-3 and 5-8 amps.—Blackwell's Metallurgical Works, Ltd., Garston, Liverpool. [8298]

ELMINATOR Kits.—Transformers, choke, condensers, valve holder, resistance, insulated terminals, and wiring diagram; 25/- complete; 20 milliamperes at 120 volts; send for list.—Fel-Ectric Radio, Garden St., Sheffield. [8618]

PHILIPSON'S Safety High Tension Battery Eliminators.

10/- Down and the Balance in Easy Monthly payments secures the finest high tension supply available.

PHILIPSON'S Safety Eliminators are Guaranteed for 12 Months.

PHILIPSON'S Safety Eliminators are the Cheapest to Install and the Cheapest to Run; prices: Model A.C.5 44/17/6, A.C.7 43/17/6, complete with full wave, rectifiers; D.C.4 37/6, D.C.5 45/-.

ALL Models Obtained for 10/- Deposit; take advantage of this and get constant high tension immediately.

WRITE for Our Booklet, "Radio Power" to Philipson and Co., Ltd., Radio Engineers, Astley Bridge, Bolton. Phone: 2038. Grams: Safety, Bolton. Est. over 50 years. [0318]

SAVAGE'S Specialise in Wireless Power from the Mains, reliable apparatus at reasonable prices.

SAVAGE'S Transformers Laminations and Bakelite Bobbins; intending home constructors should write for list.

SAVAGE'S Reliable Smoothing Condensers, 1,000 volt D.C. test, 1 mfd., 2/-; 2 mfd., 3/-; 4 mfd., 5/3; 500 volts D.C. test, 1 mfd., 1/6; 2 mfd., 2/3; 4 mfd., 3/9.

SAVAGE'S Super Smoothing and Output Chokes, many types available; write for list.

SAVAGE'S Mains Transformers for Westinghouse H.T. 4 Unit, 18/6; A3, 17/-; A4, 20/-.

SAVAGE'S Mains Transformers for Westinghouse H.T. 4, with additional winding, 4 volts, 3 amps.; 23/-.

SAVAGE'S Mains Transformer V.T.31 200-0-200-volts 60 milliamperes 2+2 volts 2 amps., 2+2 volts 3 amps., 28/-.

SAVAGE'S Mains Equipment for New Foreign Listeners Four Transformer N.F.L.4, 33/-; smoothing choke C32G, 20/-; output choke C32/0, 20/-.

SAVAGE'S Mains Transformers and Power Chokes are Carefully and Individually Constructed from First Class Materials with an Exceptionally Generous Margin of Safety.

SAVAGE'S, 146, Bishopsgate, London, E.C.2. Phone: Bishopsgate 6998. [8474]

**A Shoal
of Requests!**

A recent advertiser in "THE WIRELESS WORLD" writes as follows:

"I feel I ought to inform you how successful my small advertisement was in "THE WIRELESS WORLD" of December 25th. Even before I had seen it myself I had received a shoal of requests of all descriptions. Practically everything was sold."

Martin Woodroffe,
Westington,
Chipping Campden,
Gloucester.

W.W.gr.

STUPENDOUS!

A recent advertiser in "THE WIRELESS WORLD" writes as follows:

"As the results from my advertisement in 'The Wireless World' were stupendous, I shall be glad if you will cancel my advertisement in next week's issue as I am cleared out.

I might add that 'The Wireless World' is the best journal I have read."

W. F. Macbeth,
"Bramar,"
Ballymena, Ulster.

w.w.89.

Chargers and Eliminators.—Contd.

DYNIC A.C. H.T. Eliminator, £3; Regentone, £3; Philips L.T. charger, £2/10; Ferranti trickle chargers, £1/10; carriage extra.—James Scott and Co., Radio Engineers, Dunfermline. [0335]

EKO Eliminator Model, 2V.60. as new, £5/10, or best offer.—Collett, Uiverley Villas, Uiverley Rd., Oton. [9085]

FIXED Condenser Bargains.—Dismantled from bankrupt eliminator stock: Hydra 1,000 volt D.C. test, 1 mfd. 1/6; 2 mfd. 2/6; 4 mfd. large, 4/-; post free, cash with order.—Oliver, 325, Kennington Rd., London. [9098]

ZAMPA H.T. Eliminator Kit comprising rectifying unit (incorporating transformer, condensers, Westinghouse H.T.3.), necessary condensers, choke, terminals, baseboard, etc., output 120 volts at 20 m.a.; complete, 45/-; 7 days approval against cash; other Zampa kits and transformers on request.—Mic Wireless Co., Market St., Wellingborough. [9080]

RADIELLE Model K4, 200-250 A.C. output 150 volt 30 m.a., and variable tapping; cost £5/17/6, sell £2/15; brand new.—P. 74, Aberdeen Rd., Highbury, London, N.5. [9119]

CABINETS.

ARTCRAFT Radio Cabinets are Britain's Best Value. [0313]

DIGBY'S Cabinets.—Table models in solid oak and mahogany; from 11/6 to 71/-.

DIGBY'S Cabinets, fitted with Radion or Resistor ebonite if required.

DIGBY'S Cabinets.—Pedestal model, with separate battery components; from 56/- to £12.

DIGBY'S Cabinets Made to Customers' Own Designs

DIGBY'S Cabinets.—Write for new 16-page art catalogue.—F. Digby, 9, The Oval, Hackney Rd., E.2. 'Phone: Bishopsgate 6458. [0128]

ARTCRAFT Radio Cabinets are Britain's Best Value. [0311]

CABINETS for All Requirements.—F. W. Ramsey, 63, Shaftesbury St., London, N.1. Clerkenwell 7139. [8155]

ARTCRAFT Radio Cabinets are Britain's Best Value. [0309]

KAY'S Cabinets, the greatest range of pedestal cabinets in the kingdom; original creative designs at prices 50% lower than elsewhere; quotations for specials by return; delivery at short notice guaranteed.

RADIOGRAM Cabinets.—A variety of really practical and exclusive models from 60/-; illustrated lists free.

H. KAY, Wireless Cabinet Manufacturer, Mount Pleasant Rd., London, N.17. 'Phone: Walthamstow 1626. [8963]

ARTCRAFT Radio Cabinets are Britain's Best Value. [0310]

A LIMITED Number of Magnificent Radio-gramophone Cabinets, brand new, panel size 18in. x 7in., oak £6, mahogany £7; larger size, with double doors, panel 21in. x 8in., oak £11, mahogany £12/10; portable cabinets (suitcase type), 30/-; transportable (oak or mahogany), £2; cabinets with oval panel opening, suit 2- or 3-valve set, 17/6; carriage extra.—James Scott and Co., Radio Engineers, Dunfermline. [0334]

ARTCRAFT Radio Cabinets; Britain's best value; lowest prices consistent with highest quality; illustrated list free from actual manufacturers.—Artcraft Co., 156, Cherry Orchard Rd., Croydon. 'Phone: Croydon 1961. [0040]

COILS, TRANSFORMERS, ETC.

600 ohms Decoupling Resistances, specified for new Kilo-Mag Four; 1/6 each, post free.—Groves Brothers.

120 and 1,000-ohms Resistances for new Foreign Listeners Four; 1/6 each, post free.—Groves Brothers.

SCREENING Boxes for Foreign Listeners Four, selectivity units, etc.; 6/- each, post free.—Groves Brothers.

NEW Kilo-Mag Four Coils, 37/6 set, Kilo-Mag slotted formers, 12/6 set; 1930 Everyman Four formers, 8/6 set; kit set formers, 10/6 set; all post free; trade supplied.—Groves Brothers, St. Mary's Place, Shrewsbury. [8757]

'POPULAR' TRANSFORMER

Make your new set a better set with the Brownie POPULAR Transformer. Although it costs only 9/6, its purity of amplification gives a more vivid clarity of reproduction throughout the musical scale, while its sturdy British build ensures that once it is fitted the words "transformer troubles" can be eliminated from your list of worries.



BROWNIE WIRELESS CO. (G.B.) LTD., Nelson St. Works, London, N.W.1.

BROWNIE WIRELESS

LET A

"SUPREMUS"

H.T. ELIMINATOR DRIVE YOUR SET



B15 MODEL

PRICE 21/-

D.C. The B15 Model, giving 60 and 120 volts, 15 M/A. Price 21/-, as illustrated.

A.C. The Ero Model, giving 60 and 120 volts, 10 M/A. Price 65/-, complete with valve.

D.C. The C25 Model, with tapplings of 60, 120 and 150, 25 M/A. Price 32/6.

A.C. The E15, with tapplings of 60, S.G and 120, 15 M/A. Price 70/- complete
All models guaranteed 12 months. 24 models in stock.

Write for lists.

Valve or Westinghouse Rectification optional.

SUPREMUS SPECIALITIES LTD.,

118, HIGH STREET, ERDINGTON, B'HAM.

Northern Agents: THE CHORLTON METAL CO., 18, Amber Street, Manchester.

London Agent: P. H. SMEDLEY, 50, Richmond Road, Leytonstone, E.11.

Coils, Transformers, Etc.—Contd.

TRANSFORMERS and Chokes for Battery Eliminators.—Chester Bros., 244, Dalston Lane, London, E.8. [8652]

RADIOGRAPH.—"Wireless World" Coils, Record III, 35/-; New Kilomag Four, 33/-; S.G. Regional, 37/6; kit set, 45/-; 1930 Everyman Four, 42/6.

RADIOGRAPH.—Litz wire, 9/40, 1/6; 27/42, 2/6 dozen yards; Redfern's deep ribbed or Becol tube, 5d. per inch, slotting 1/6 extra.—Station Rd., Handsworth, Birmingham. [8856]

BERCLIF Coils, the standard of excellence, for all "Wireless World" receivers; latest lists post free; trade supplied, all quantities.—Simmonds Bros., Shireland Rd., Smethwick. [8735]

DYNAMOS, ETC.

MOTOR Generator, 230 volts D.C., direct coupled on bedplate, 65 volts 23 amps, with switchboard; lot £18/10.

GENERATOR, 2,000 volts 100 m.a., separate excitation, 25-50 volts, field regulator; cost £29, accept £12/10.

STATIC Voltmeter, Everlett Edgecombe, 3,000 volts; £2.—Mayer, Wickford. [9096]

GRAMOPHONES, PICK-UPS, ETC.

RADIOGRAPH.—Pick-up, with valve adaptor, 18/- complete; approval.—Station Rd., Handsworth, Birmingham. [8855]

UNIVERSAL Electric Gramophone Motor (Columbia) as new, £3/10; also Varley pick-up; offers 7-38, Florence St., Swindon. [9014]

COLUMBIA Gramophone, latest £8/10 model, £5; wanted, W.H.10 units, P625A.—73, Fairfax Rd., Hornsey. [9083]

NOVOTONE, £3/15; B.T.H. latest pattern pick-up, 32/6, both perfect; will accept £5 for both.—B.M/TNDS, London, W.C.1. [9097]

LOUD-SPEAKERS.

BAKER'S SELHURST RADIO 36-page Booklet, "Sound Advice is Yours for the Asking"; write now for new edition; see displayed advertisement on page 12. [0231]

VIBRO-SKIN Special Leather for Fixing the Diaphragm of the Moving Coil Loud Speaker; price 2/- per piece 11in. square, 1/6 per piece 9in. square; post free; cash with order.—The Alder Leather Co., 3, Southwark St., S.E.1. Tel.: Hop 4448. [0350]

PERARDUA Moving Coil Reproducers.—These superlative instruments may be obtained for 15/- down, balance by 5 equal monthly payments; cash prices, 230-volt D.C. £3/3; 6-volt, £3.—R. Vevers, 4, York Rd., Maidenhead. [8872]

R.K. Moving Coil, £3; 2 old M.C. speakers, £1 each; new moving coil speakers, 220v. A.C., £3; carriage extra.—James Scott and Co., Radio Engineers, Dunfermline. [0336]

AMPLION Lion Chassis, 60/-; Celestion Woodroffe pick-up, 40/-; both as new.—F. R. C., Cowden Cross, Cowden, Kent. [9069]

MOVING Coil Magnet Pots, ready machined, complete with coil former; 4/6, ex stock, genuine bargain; 7 days approval against cash.—Mic Wireless Co., Market St., Wellingborough. [9081]

6-VOLT 1/2 amp. M.C. Speaker, list £6, new last year, including transformer, 29/6; permanent magnet speaker, list £9/10, new last year, £3; 7 days approval against cash.—Brew, Pychley, near Kettering. [9082]

SHEFFIELD Magnate Moving Coil P.M. Speaker; a bargain, £4; call any evening.—98, Mandeville Rd., Enfield Wash, London, N. [9086]

LINEX Speakers, fit the Perfecta chuck extension for 100% results; 1/3; post free.—Douglas Briggs, Radio Engineer, Newport, Mon. [9124]

BLUE Spot 66K, White Spot, frame mounted push button, new, 35/-; Amplion A.R.19, oak, 25/-; 17, Marlborough Crescent, W.4. [9095]

B.T.H. R.K. Moving Coil Loud-speaker, Senior 1930, ridged cone, transformer, perfect condition; cost £8/5, £4.—237, Balfour Rd., Ilford. [9103]

The Secret of its PERFECT CONTACT

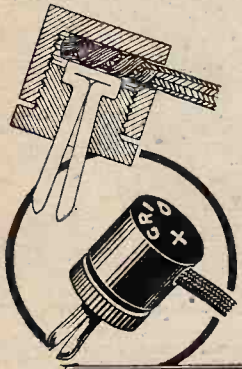

The Powerful Grip of the Belling-Lee Wander Plug and its adaptability to any size battery socket are due to the long prongs made of special spring metal. 15 Engravings, side entry. Wire, rubber and braiding firmly gripped.

Ask your dealer, or send to us, for FREE Belling-Lee Handbook, "Radio Connections."

Price 4d.

7-way Battery Cord with Belling-Lee Wander Plugs and Spade Terminals for Orgola and other sets, 5/9.

BELLING-LEE FOR EVERY RADIO CONNECTION

Advt. of Belling & Lee, Ltd., Queensway Works, Ponders End, Middlesex.

POWER CHOKES

substantially built, for smoothing circuits in eliminators dealing with currents 100 to 300 milliamperes, inductance 30 henries, 8/6 post free.

REPAIRS

to any make of L.F. Transformer, Loudspeaker or Headphones. All repairs dispatched within 48 HOURS—TWELVE MONTHS' GUARANTEE with each repair. 4/- Post Free. Terms to Trade.

TRANSFORMER REPAIR CO.

Dept. W., 214, High Street, Colliers Wood, London, S.W.19.

BAKELITE ADAPTORS

with moulded-in contacts, suitable for Eliminators, All Mains Sets, Radio Gramophones, etc.

TURNOCK'S MOULDINGS,

41, High Street, Aston, BIRMINGHAM.

Aluminium Cabinets and Screening Boxes.

All sizes to order. Standard screening boxes 6" x 6" x 6" 5/- each, including baseboards. YATES SUTTON LTD., Sheet Metal Workers, York Street, Leicester.

The VOLUVERNIA
VOLUME CONTROL
Resist. 0 to 1 meg. For Radio Receivers or Gramophone Amplifiers. Smooth and silent in operation. Can be used with metal panel if desired. 6/9

GAMBELL RADIO LTD., 6, Buckingham St., Strand, London, W.C.2.

Loud-Speakers.—Contd.

- EPOCH Moving Coil Speakers are Masterpieces, designed and produced by master engineers.
- EPOCH Moving Coil Speakers are the Standard by which other Speakers are Compared.
- EPOCH Moving Coil Speakers are in Use in many Editorial Offices.
- EPOCH Moving Coil Speakers are in Use in several Famous Laboratories.
- EPOCH Moving Coil Speakers are in Use in many Broadcasting Stations.
- EPOCH Moving Coil Speakers are in Use by most Prominent Musicians.
- EPOCH Moving Coil Speakers Bring Unbounded Joy to Thousands upon Thousands of Homes.
- EPOCH Moving Coil Speakers, the only Speakers that give clear, uncoloured reproduction.
- EPOCH Moving Coil Speakers do Render Speech Perfectly and Music Correctly.
- EPOCH Moving Coil Speakers Provide the Perfect Illusion of the Artist's Presence.
- EPOCH Moving Coil Speakers Represent the Finest Intrinsic Value ever Offered.
- EPOCH Moving Coil Speakers are Guaranteed for a year, but last for ever.
- EPOCH Moving Coil Speakers bring the Grand Concert out of the most Modest Set.
- EPOCH.—You can hear a hundred Moving Coil Speakers, but Epoch is different.
- EPOCH.—If you own the best set, only by Epoch can you confirm it.
- EPOCH.—Away with the tin can and cracked banjo reproduction, and install an Epoch.
- EPOCH.—Away with the drumminess, droniness and huskiness of the average Moving Coil Speakers.
- EPOCH.—The clearest, sharpest, cleanest reproduction—a marvel of accuracy and beauty.
- EPOCH Moving Coil Speaker Models from £2/10 to £30.
- EPOCH Moving Coil Speakers.—Models for every requirement and taste.
- EPOCH Permanent Magnet Moving Coil Speakers.—Nine models from £3/15.
- EPOCH Permanent Magnet Moving Coil Speakers Require no Mains or Batteries.
- EPOCH Permanent Magnet Speakers are more Sensitive than most Energised Moving Coil Speakers.
- EPOCH Energised Models are the Finest ever put on the market.
- EPOCH Super Cinema Speaker has Created the Biggest sensation for many years.
- EPOCH Super Cinema Model is many times as Sensitive as the so-called Supers.
- EPOCH Super Cinema Speakers give Enormous Volume from a 1-watt Amplifier.
- EPOCH Super Cinema Speakers are used on many 100-watt Amplifiers and never "rattle."
- EPOCH Super Cinema Model is Standard on several Talkie Equipments.
- EPOCH Super Cinema Model is already in use in over 200 Cinemas.
- EPOCH Super Cinema are the only Moving Coil Speakers used in Large Theatres, unaided.
- EPOCH Super Cinema Speakers provide alone the Upper as well as the Lower Register.
- EPOCH.—Other Moving Coil Speakers require the help of exponential horns to provide depth.
- EPOCH.—A list of many prominent cinema-using the Speakers supplied on request.
- EPOCH Speakers are not Made of Tin or Aluminium Stampings, but are sound, solid, engineering jobs.
- EPOCH Heartily Invite Comparison, on all counts, with any make, regardless of price or claims.
- EPOCH.—Don't accept our quality claims without verification, but don't accept any other maker's either.
- EPOCH.—Order one for 7 days approval, and test with a switch-over; the only real test.
- EPOCH Moving Coil Speakers may be heard in our Demonstration Room Daily.
- EPOCH.—Our demonstration room is in the heart of London.
- EPOCH.—Its accessibility has been studied for the convenience of callers.
- EPOCH.—If you cannot call, write for booklet W.S.3, and approval terms.
- EPOCH RADIO MANUFACTURING Co., Ltd., Farringdon Av. (near Ludgate and Holborn Circuses). Phone Central 1971. [8983

"Could have been sold over a dozen times!"

A recent advertiser in "THE WIRELESS WORLD" writes as follows:

"You may be pleased to know that the coils I advertised in 'THE WIRELESS WORLD' could have been sold over a dozen times.

"They were sold first post here on Thursday morning, and I had applications for them for a fortnight after."

W. A. Pelly, Pierhead, Eastbourne.

W.W.92.

So Many Replies!

A recent advertiser in "THE WIRELESS WORLD" writes as follows:

"I HAVE received so many replies to my advertisement in 'The Wireless World,' which appeared under a Box Number that I am sending herewith stamps to the value of 6d. as further payment towards your postage expenses. Thanking you for the quick despatch of all replies."

R. W. CAPEWELL, 52, Chapel Terrace, Trent Vale, Stoke-on-Trent.

W.W.88.

Mention of "The Wireless World," when writing to advertisers, will ensure prompt attention.

Loud-Speakers.—Contd.

PERMANENT Magnets for Moving Coil Loud-speakers, 35% cobalt steel, complete with positively centred moving coils, wound 1,500 turns, or to order; £2/10 each.—Duddles, 102, Cranford Lane, Heston, Middlesex. [9112]

SILK Gauze, finest quality, gold finish; 1/3 sq. ft.—Douglas Briggs, Radio Engineer, Newport, Mon. [9123]

SUPERTONE Mahogany Cabinet Loud-speakers, perfect tone, stupendous volume; 35/-; trade enquiries invited.—Supertone Reproducers, 97, Thomas St. Bristol. [8794]

VALVES.

P625A, nearly new, full emission; 10/-—98, Leish-Hall Rd., Leigh-on-Sea. [9091]

TRANSMITTERS.

CHEBROS. Chebros. Chebro's transformers and chokes of all descriptions, special transformers for transmitting and modulation; chokes a speciality; enquiries invited.—Chester Bros., 244, Dalston Lane, London, E.8. [5240]

COMPONENTS, ETC., FOR SALE.

BELLING-LEE Panel Fittings are designed to give an expert finish to any home-constructed set; catalogue post free.—Belling and Lee, Ltd., Queensway Works, Ponders End, Middlesex. [0018]

WESTON Model 301, milliameters, ammeters, and voltmeters, 21/- each; hot wire ammeters 0-1 amps., 4/-; 0-0.5 amp., 3/-; instrument repairs and alterations; send for list.—The Victoria Electrical Co., 47, High St., Batterssea, S.W.11. Established 1910. [8626]

COMPONENTS Lent on Hire.—Details from Alexander Black, Wireless Doctor, 55, Ebury St., S.W.1. Sloane 1655. [0329]

PHILIPS M.C. Loud-speaker 2049, with transformer, as new, £4; Philips H.T. unit, 3002, new, £3; Infradyne, America's wonder set, 10 valves, cost £40, as new, £15; Magnaformer, America's super set, 9 valves, as new, cost £40, £15.—J.C., 11, Garrick Close, Walton-on-Thames. [9048]

COILS.—Lewcocks C.T. 35, 60 (2), 75, 2/9 each, 10/- set; 150 (2), 200, 250, 300, 4/3 each, 20/- set; Burndopt 82, 82½, 83, 84, 85, 35, 50, 75, 2/6 each, 18/6 set; 100 (2), 150 (2), 300 (2), 400, 4/6 each; Ferranti A.F.3C, O.P.3C, 16/- each, 30/- pair.—Box 5578, c/o The Wireless World. [9076]

NOVOTONE, new, £4; Loewe pick-up and arm, 10/-; new M.L. converter, 12 to 300, type C.X., £4.—80, Victoria Rd., St. Austell, Cornwall. [9079]

EPOCH 66, 3 guineas; 180-volt Oldham super size H.T. and Peto Radford charger, £6/10.—Parry, Leavesden, Branch Hill, Hampstead. [9084]

120-VOLT Osglim and Holder, 5/-; 4 mfd., fixed, 3/6; 0.5 mfd. (2), ditto, 2/- each; Lissen R.C.C., 2/6; Utility 4-pole 2-way switch, 3/6; 4 large permanent magnets, 1/6 each; Ormand differential condenser, 2/6 (no dial); Osram D.E.R., 3/-; Mullard screen grid, 10/6; R.L. telephone transformer, 4/-; buzzer, 2/6; Lissen transformer, 3/6; ditto (make unknown), 2/6; milliammeter (15 milliamps), 3/6 (1 in. diameter face).—Lall, Thatched House, Broadstairs. By post only. [9090]

L.S.5.B., P.M.3, D.V.10, Raytheon B.H., B.L. rectifying unit, output 6v. 2½ amps., Sterling, phones, 10 W.J. 20v. Exides.—G.G.D.G., "Mon Desir", Borehamwood, Herts. [9099]

CELESTION-WOODROFFE Pick-up, £2; Igranite pick-up, 10/-, both as new; P.M.14, 17/6; P.M.4.D.X., 8/-; P.M.254, 10/6; few hours use only, guaranteed.—Mowhay, 4, Westbourne Crescent, W.2. Padd. 9639. [9104]

ONE Mazda A.C.S.G., 17/6; 1 A.C.H.L., 10/-; 2 A.C.P., 12/6 each; 1 U.U., 60-250, 14/-; 1 U., 75-300, 10/-; 1 B.T.H. pick-up and tone arm, 30/-; all unused; 1 Cosmos A.C.R. valve, few hours use, 7/6.—Box 5646, c/o The Wireless World. [9105]

SENSITIVE Microphone for Deaf Aids, detectaphones, public address work, and for the transmission of speech and music to any distance; all illustrated lists free.—F. Adolph, 27, Fitzroy St., London, W.1. [9122]

**SENSITIVE
MICROPHONES
FOR
DEAF AIDS,
DETECTAPHONES,
PUBLIC ADDRESS,
AND FOR THE TRANSMISSION
OF
SPEECH & MUSIC
TO ANY DISTANCE.**

All Illustrated Lists Free.

**FREDK. ADOLPH, Actual Maker,
27 Fitzroy St., London, W.1. Phone: Museum 8329.**



RADIO'S LATEST & BEST SURPRISE!!

Brand new! The TRIX All Mains Regional Portable Two! Complete with A.C. Valves, Loudspeaker and Frame Aerial. The set of the season! 15 Gns. Further details from the manufacturers.

ALL MAINS REGIONAL PORTABLE

Manufacturers: ERIC J. LEVER (TRIX) LTD., 8-9, Clerkenwell Green, London, E.C.1. Phone: Clerkenwell 3014/5.

Components, Etc., for Sale.—Contd.

FERRANTI A.C. Trickle Charger, perfect condition; 50/-.—Burnie, 24, Kenmare Place, Preston. [9077]

SELECTIVITY Units, ready ratio (20/-), 9/6; Harlie (12/6), 7/6; guaranteed unused; also Amplion cone, 10/-.—E. C., 8, Gleavon Rd., E.15. [9120]

P.M. Cone Speaker, type 2007, 45/-; Marconi moving coil, 6v., 55/-; Dual electric gramophone motor, universal, complete, £3; Lewcocks Q.A.T. coil, 8/6; Colvent dual, 8/6; Tritron, Loewe, Bullphone, cone units, 6/-; Amplion horn unit, A.R.67, 7/6; Watmel tuner, new type, 8/-; old type, 6/-; Philips 328 and 451 rectifier valves, 7/- each; Lissen 2v. Pentode, new, 9/-; Magnavox 25-1 transformer, 5/6; Magnavox 6v. pot wound, useful smoothing, 10/-; all perfect.—G. A. Ryall, 182, Kennington Rd., London [9118]

S4V and P.M.24, as new, full emission, 14/- each; 2 unmounted heavy duty L.F. chokes, 5/- each.—Box 5659, c/o The Wireless World. [9116]

L.S.5A, 15/-; A.C.P., 12/-; S4V, 16/-; P.M.3, 5/-—A. Maxley, 52, Shoot-up Hill, Cricklewood, London. [9113]

RADIO HOSE, HUDDERSFIELD, issues the Reliability Wireless Guide, which will be sent post free upon request by Messrs. J. H. Taylor and Co., 15, Macaulay St., Huddersfield. [7823]

PART Exchange.—See our advertisement under Receivers for Sale.—Scientific Development Co., 57, Guildhall St., Preston [0828]

MISCELLANEOUS.

ALEXANDER BLACK
THE Original Wireless Doctor, will call (London and Home Counties) and cure your set.

CONSULTATIONS by Appointment Without Obligation, sets installed, maintained, and brought up to date, gramophone pick-ups, eliminators, and Watson moving coil speakers demonstrated; purity reproduction specialists.

55 Ebury St., Victoria, S.W.1. Sloane 1655. [0277]

CALIBRATE Your Set With the C.D.E.S. Calibration Chart; 8d., post free.—C.D.E.S., 98, Cherry Orchard Rd., Croydon. [8612]

SCOTT SESSIONS and Co., Great Britain's Radio doctors, officially approved as wireless repairers by Radio Society of Great Britain and Wireless League; old sets of every type repaired, rebuilt, modernised; send set for immediate quotation.

SCOTT SESSIONS and Co.—New sets constructed with your or our components, guaranteed finest workmanship; we specialise in "The Wireless World" circuits; remember, we have satisfied customers throughout the British Isles and in three Continents; if you so desire, we will design and construct high grade apparatus to suit your special circumstances for quality, range and selectivity.—Tel.: Tudor 5326. Muswell Hill, London, N.10. [0262]

PATENT AGENTS.

PATENTS and Trade Marks, British and foreign.—Gee and Co. (H. T. P. Gee, Member R.S.G.B. and A.M.I.R.E.), 51-52, Chancery Lane, London, W.C.2. Phone: Holborn 1525. [0001]

KING'S PATENT AGENCY, Ltd., 146a, Queen Victoria St., E.C.4.—Free advice and handbook on patenting inventions and registering trade marks by registered agent with 45 years' experience. [0002]

REPAIRS.

SCOTT SESSIONS and Co., Great Britain's radio doctors; read advertisement under Miscellaneous column. [0263]

REPAIRS Returned Post Free, and to ensure satisfaction send remittance after approval of same.—Leeds Wireless Repair Service.

LOUD-SPEAKERS, headphones, rewound to any resistance and remagnetised, 3/-; transformers rewound, 4/-; blue Spots, Tritrons and 4-pole units, 4/6; work guaranteed.—Leeds Wireless Repair Service, 5, Boston Place, Green Rd., Leeds. [8945]

EPOCH

MOVING COIL SPEAKERS

Have captivated the Whole World.
Sales still going up by leaps and bounds.

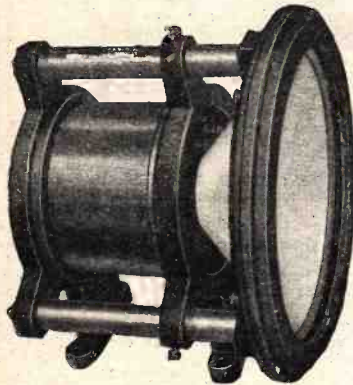

The Masterpieces of Loud-speaker design.

(See loud-speaker column, p. 12.)

Send for descriptive booklet W53 or call and have a demonstration.

EPOCH RADIO MANUFACTURING CO., LTD.,
3, Farringdon Avenue, London, E.C.4.



We have the Biggest Stock of Radio Apparatus, Laboratory Instruments, H.T. and L.T. Dynamos and Motors, Experimental and Laboratory Gear in this Country.

Immediate delivery from stock to any part of the World. Call and inspect or send addressed envelope for list. Tell us your wants and we will offer something suitable.

ELECTRADIX RADIOS,

218, Upper Thames Street, E.C.4.
City 0191. Electradix, Cent, London.

SEND TO-DAY FOR OUR FREE 36-PAGE BOOKLET "SOUND ADVICE."



Super Power Moving Coil Speaker.

The Finest High-grade Speaker in the World

PERFECT RECEPTION FOR MUSIC LOVERS

BAKER'S 'selhurst' RADIO

Offices: 89, Selhurst Rd., S. Norwood, S.E.25.
Works: 42, Cherry Orchard Rd., E. Croydon.

Repairs.—Contd.

GUARANTEED Repairs by Experts.—Loud-speakers, headphones, cone units, pick-ups, any type, re-wound, remagnetised, and adjusted, post free, 4/-; transformers, from 4/-.—Howell, 91, Morley Hill, Enfield, Middlesex. [7882]

WANTED.

WANTED: all types of electrical and wireless apparatus; purchased for cash; large quantities only.—Thompson, 1, South St., Greenwich, S.E.10. Tel.: 1259 Greenwich. [0331]

A.C. Kit Set, owner wants advice or assistance from similar owner.—Wallace, 21, Whalley Grove, Manchester. [9111]

WANTED, Marconi Ideal and Ferranti transformer.—Box 5660, c/o The Wireless World. [9117]

A.F.5 Transformers, 32h. Pyc. L.F. choke.—362, Leagrave Rd., Luton. [9121]

5-VALVE Suitcase Portable Set, in a good condition.—Write Ray-Rusz, 34, Windmill St., Tottenham Court Rd. [9088]

AGENCIES.

AGENCY Required, electrical, mechanical, wireless, large shipping connection, excellent opportunity British goods; International Exhibition opens this month.—W. Tenby, 10, Rue de L'Olivier, Antwerp. [9125]

EXCHANGE.

MULLARD A.C. Screen Grid and Pentode; exchange 4v. screen grid.—Roper, 4, Essex St., Forest Gate. [9093]

WE Will Accept Your Surplus Apparatus (making you a high allowance) in part payment for any new apparatus; your enquiry will be dealt with promptly.—Bostock and Stoumill, 1, Westbourne Terrace, S.E.23. [9114]

FINANCIAL PARTNERSHIPS.

ASERVING Officer of the Royal Air Force Desires a Partner for a Wireless Business which it is proposed to start during October, 1930, for the sale of high class components and sets, maintenance, etc., minimum capital, £1,000.—Box 5643, c/o The Wireless World. [9092]

SITUATIONS VACANT.

WIRELESS Operating Appointments Assured; short qualifying course, day evening; fees payable after appointment for boarding students; Morse classes.—Manager, Wireless School, 21, Manor Gardens, London, N.7. Archway 3694. [8121]

ENGINEERS Required Immediately for Sound Reproduction Section, only those with actual experience of talking equipment need apply.—The B.T.H. Co., Ltd., Construction Department, Rugby. [8987]

WIRELESS Services.—The Premier Telegraph College in the British Isles (established 34 years) gives a sound training to all students, with assured positions on qualification. Fees are not disguised under expensive board-residence scheme. 44 students out of a total of 47 obtained qualifying wireless certificates at first attempt in the last seven Government examinations.—Apply for prospectus, Dep. W. The London Telegraph Training College, Ltd., Morse House, Earl's Court, S.W.5. [8943]

PUBLICITY Manager.—Manufacturers of electrical and wireless components require an experienced advertisement layout writer, capable of taking charge of publicity department; no applications can be considered unless the following particulars are given, age, salary required, full details of experience, whether at present disengaged and samples of work.—Box 5479, c/o The Wireless World. [8990]

HULL EDUCATION COMMITTEE, Municipal Technical College, Department of Wireless Telegraphy.

WANTED, Instructor in Chief, must hold first class certificate of Postmaster General, possession of the City of Guilds Certificate in Radio-Communication an additional recommendation.

COMMENCING Salary £350 per annum; hours of duty 10 sessions or 30 hours per week.

APPPLICATIONS, giving age and full particulars, should be forwarded by letter to the undersigned not later than Saturday, the 3rd May.—R. C. Moore, Director of Education, Education Offices, Guildhall, Hull. 31st March, 1930. [9021]



From "The Amateur Photographer."

For Every User of a Camera!

Every camera owner can get more pleasure out of photography and better results by reading "The Amateur Photographer" regularly.

The "A.P." caters for all photographers, including beginners and advanced workers, and contains Lessons for Beginners; Free Criticism of Readers' Prints; Answers to Queries; Regular Competitions and a weekly Art Supplement of particular interest to pictorial workers.

The AMATEUR PHOTOGRAPHER & CINEMATOGRAPHER
—The Journal for Everybody with a Camera—

Every Wednesday 3d.

LIFFE & SONS LTD.,
Dorset House, Tudor Street, London, E.C.4.
W.W.37a.

Situations Vacant.—Contd.

WELL-KNOWN and Old-established Firm of Manufacturing and Consulting Radio Engineers Require Immediately, for their London sales offices, an efficient junior, must be proficient in shorthand-typewriting and general office routine, knowledge of electrical and radio general principles with ability to follow practical, also schematic circuits an advantage.—By letter, stating present situation, when free, age, and salary expected, to Box 5657, c/o *The Wireless World*. [9108]

SITUATIONS WANTED.

YOUNG Man (20), seeks situation as packer, assistant storekeeper, etc., experienced, capable.—Stacy, Stratton House, Kildoran Rd., Brixton. [9102]

SITUATION Wanted by Good Reliable Man, 30, 14 years' radio experience Royal Navy, excellent references, thorough knowledge fitting, testing, maintenance, batteries.—Box 5656, c/o *The Wireless World*. [9107]

WIRELESS Operator Seeks Shore Berth, long experience all classes radio work, sound technical knowledge, design and construction wireless receivers, etc., P.M.G. certificate.—Box 5658, c/o *The Wireless World*. [9115]

BOOKS, INSTRUCTION, ETC.

"THE Wireless Manual" (new 1930 edition), by Captain Frost, is an ideal non-technical book full of up-to-date facts about wireless development, choice of set, how to use your own set, etc.; illustrated; 5/- (post 5/4), of a bookseller, or Pitman's, Parker St., Kingsway, W.C.2. [8178]

STEP by Step Wireless; a complete course of the theory of electricity in relation to the practical design of wireless apparatus, eliminators, circuits, etc., with extracts from a designer's notebook, giving up-to-date practical application; issued weekly, send 1/- p.o. for first 4 weeks.—Clifford Pressland, A.M.I.E.E. Eng., Dept. W.W., Hampton-on-Thames. [0195]

FREE: Inventor's Guide on Patents.—T. A. A., 253 (W), Gray's Inn Rd., London, W.C.1. [6373]



How to sell a Portable!

For the sale or purchase of Portable or other Receivers use the Miscellaneous Columns of "The Wireless World." A recent advertiser writes as follows:

"I am very satisfied with the results obtained. The Portable set was sold the same day, and I had over twenty other replies, including prepaid Telegrams. I also had a large number of callers, and altogether am very pleased with the pulling powers of your valuable paper."

M. A. FROST,
54, Clerkenwell Road,
London, E.C.1

W.W.85

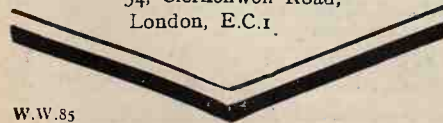

Two Clear Scales with Mirror for Accurate Reading
are on the **Dix-onemeter**

50/-



Only Six Terminals, but 50 Ranges!

The DIX-ONEMETER, of portable size to go in the pocket, but big enough to cover the whole range of D.C. electrical measurements. You can have multipliers to work from 50 micro-amps to 150 amps and 20 milli-volts to 2,000 volts. What other instrument to Brit. Elec. Standard Assn. Standard of Accuracy for First Grade meters is available at the price? None! A novice can use it as accurately as an expert. No switch to be accidentally turned with disastrous results, as each range has its independent multiplier and a safety button controls the moving coil.

DIX-ONEMETERS are now 50/- only, a remarkably small price for a meter worth £10 in comparison with others.

Latest Model. Mirror Double Scale, Moulded Base. The finest Precision Multi-Measuring instrument is the DIX-ONEMETER, the acknowledged Radio standard beloved by Expert and Amateur.

Test Booklet free.

ELECTRADIX RADIOS
218, Upper Thames Street, E.C.4

Telephone: City 0191.

BONA FIDE TRADERS' GUIDE.

Send for our comprehensive Illustrated List
QUICK SERVICE. QUICK SERVICE..

THE QUALITY HOUSE.

PERSEUS MFG. CO., LTD. (Dept. W.W.),
BRANSTONE RD., BURTON-ON-TRENT.

METAL CABINETS

for EVERYMA 7

KILOMAG 4. RECORD 3
Complete with base and finish 47/6
Plain cabinet without base 27/6
FOREIGN LISTENERS 4 (set of 4) 18/6

W. H. PARKER, Sheet Metal Worker,
Back Autumn Terrace,
LEEDS. Tel: 52859

INDEX TO ADVERTISEMENTS.

	PAGE		PAGE		PAGE
Adolph, Fredk.	15	Gambrell Radio, Ltd.	12	Radiogramophone Development Co.	4
Appleby, E. Hetherington	16	Heayberd, F. C. & Co.	10	Rigby & Woolinden	9
B. & J. Wireless Co.	9	Hegra		Rothermel Corporation, Ltd. (Centralab)	
Baird Television Development Co., Ltd.	6	Holzman, L.	16	Siemens Bros. & Co., Ltd.	1
Baker's "Selhurst" Radio	14	Igramic Electric Co., Ltd.	2	Squire, Fredk., Ltd.	Cover iii.
Belling & Lee, Ltd.	12	Jackson Bros.		Stratton & Co., Ltd.	16
British Radio Manufacturing Co.	10	Jolly, J. M.	8	Supremus Specialities, Ltd.	11
British School of Engineering Tech.	Cover iii.	Lever, Eric J. (Trix), Ltd.	13	Telsen Electric Co., Ltd.	Cover i.
Brownie Wireless Co. (G.B.), Ltd.	11	Lustroulox, Ltd.		Thomas, Bertram	5
Bullphone, Ltd.	4	McMichael, L. Ltd.	Cover i.	Transformer Repair Co.	12
Burne-Jones & Co., Ltd. (Magnum)	9	M.L. Magneto Synd. Ltd.	2	Turnock's Mouldings	12
Burton, C. F. & H.	Cover i.	Morris, J. R.		Ultra Electric, Ltd.	Cover i.
Dubilier Condenser Co. (1925), Ltd.	Cover ii.	Mullard Wireless Service Co., Ltd.	Cover iv.	Westinghouse Brake & Saxby Signal Co., Ltd.	Cover ii.
Edison Swan Electric Co., Ltd.	3	Parker, W. H.	15	Weston Electrical Instrument Co., Ltd.	4
Electradix Radios	14 & 15	Paroussi, E.	10	Wilkins & Wright, Ltd.	8
Epoch Radio Mfg. Co., Ltd.	14	Partridge & Mee, Ltd.		Wingrove & Rogers, Ltd.	9
Exide	5	Perseus Manf. Co.	15	Yates Sutton, Ltd.	12
Formo Co.	4	Philips Radio	7		

THE SERVICE OF THE APPLEBY

COUNTRY AND OVERSEAS ORDER SECTION

Devoted to the speedy supply of all the leading lines of radio equipment on the British Market, at Current List Prices, to customers in all parts of the World.

Complete Receivers, Speakers, Eliminators, Components and Kits of Parts. ("The Wireless World" Designs especially catered for).

Customers not having deposit accounts should remit sufficient to cover the cost and carriage of material. Any difference will be adjusted upon despatch. Drafts should be made payable to E. HETHERINGTON APPLEBY, and crossed a/c Payee.

Deposit Order Accounts may be opened with sums of £2 upwards. To facilitate transactions, deposit order accounts are recommended.

APPLEBY'S

"Where radio is sold differently—all the year round."

CHAPEL STREET, MARYLEBONE, LONDON, N.W.1.

Bankers: Westminster Bank Limited.

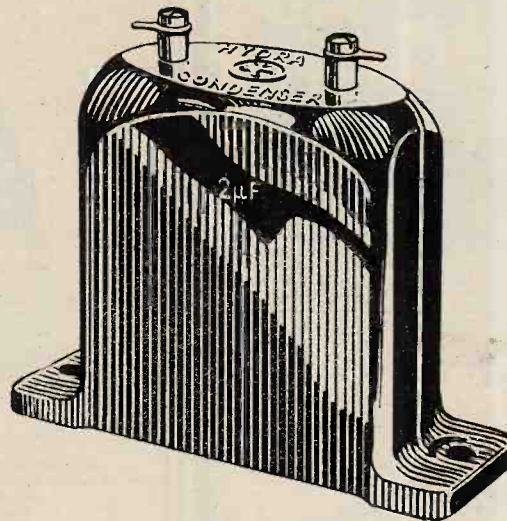

Promises may get friends but it's performance that keeps them. For years past Hydra condensers have been the friends of thousands.

LOUIS HOLZMAN, 37, NEWMAN ST., LONDON, W.1. Telephone: Museum 2641.

HYDRA

EDDYSTONE SHORT WAVE APPARATUS

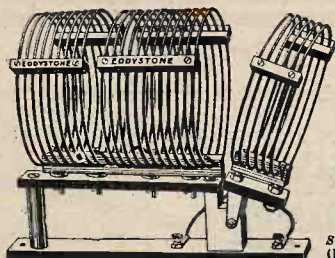

TYPE A.V. INDUCTANCE ASSEMBLY
This complete inductance unit for short wave reception consists of five interchangeable coils with mounting stand, the range from 18-90 metres being covered efficiently with a '00015' condenser. The arrangement makes use of aerial, grid and reaction coils; the first named being variable to prevent blind tuning spots. Wound with well-spaced turns, entirely open core and low loss banana-type mounting pins, the short wave performance of the coils is unequalled. Full circuit details enclosed. Extra B.C. coils can be supplied.

PRICE 20/- WITH STAND.
Send for complete list (W) of short wave apparatus.

Sole Manufacturers:
STRATTON & CO., LTD.,
BROMSGROVE STREET,
BIRMINGHAM.

London Service Depot:
WEBB'S RADIO ELECTRIC
STORES
164, Charing Cross Road, W.C.2.



The Yachting World and Motor Boating Journal

The Leading British Yachting Journal

"THE YACHTING WORLD" deals with yachts and boats of all types and tonnages, whether on the sea or inland waters. Every aspect of yachting and motor boating is covered in an attractive and interesting manner.

Every Friday 6D.

ILIFFE & SONS Ltd., Dorset House, Tudor St., London, E.C.4

"What a wonderful Speaker!!"

You will be saying the same when you have listened to the new Squire No. 100.

Modern speaker design is tending steadily in the direction of free edge cones, particularly for small cones whose duty it is to reproduce the higher frequencies.

The Squire No. 100 has a free edge small cone, and we can emphatically state that the reproduction afforded is the finest yet.

The beautiful tone and ample volume obtainable when this Cradle is used in conjunction with any reputable make of Unit is truly wonderful.

It is equally responsive on all frequencies.

★ Ask your dealer to demonstrate one, or in case of difficulty write to us direct.

FREDERICK

SQUIRE LTD.,

10, Leswin Place, Stoke Newington, N.16.

Telephone : Clissold 0334.

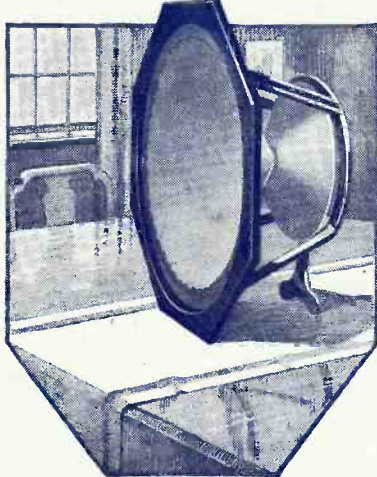

Price, inclusive of Cones and Octagonal Front - - - - 28/6
 Price of the two Cones, supplied complete, riveted together, with metal washers attached and packed in box 6/6

ENGINEERS!

Can't we get together?



All we ask is the chance to prove that you can earn £300, £400, £500 per year or more. Other men are doing it, and you can do the same

We have an unrivalled and world-wide organisation, waiting to help you whether you be novice or expert. If you wish for something more than a "bread and butter" job you owe it to yourself to investigate our Service

Our handbook 'Engineering Opportunities' has pointed the way to better things to over 20,000 of your fellows. It contains details of A.M.I.Mech.E., A.M.I.E.E., A.M.I.C.E., A.M.I.A.E., A.M.I.Struct.E. London Matric., C. & G., G.P.O., etc., Exams. outlines home study courses in all branches of Electrical, Mechanical, Motor and Wireless Engineering, and explains our unique guarantee of

Write for this Book today IT'S FREE!

NO PASS—NO FEE.

In a Brilliant Foreword Prof. A. M. Low shows clearly the chances you are missing.

"Engineering Opportunities" and our advice are quite FREE. Don't neglect this offer—give vent to that "upward urge" and send a postcard NOW, stating Branch, Post or Exam. which interests you.

BRITISH INSTITUTE OF ENGINEERING TECHNOLOGY,
 387, SHAKESPEARE HOUSE, 29-31, OXFORD STREET, W.1.

JUST PUBLISHED

RADIO DATA CHARTS

A SERIES OF ABACS

providing most of the essential Data required in Receiver Design.

By R. T. BEATTY, M.A., B.E., D.Sc.

Reprinted from "The Wireless World."

"Radio Data Charts" provides designers of wireless apparatus with a ready and convenient means of solving problems without having recourse to complicated formulæ and mathematics.

By the use of the charts it is possible to tackle all the more familiar problems in radio receiver design; such as, for example, finding the relationship between inductance capacity and frequency, and working out the design of high frequency transformers. All keen amateurs will appreciate this helpful book.

Price 4/6 net. By post 4/10.

From all leading booksellers or direct from the Publishers.

Published from the Offices of "THE WIRELESS WORLD."

ILIFFE & SONS LTD., Dorset House, Tudor St., London, E.C.4.

W.W.93

MR. ARKS acclaimed in the world

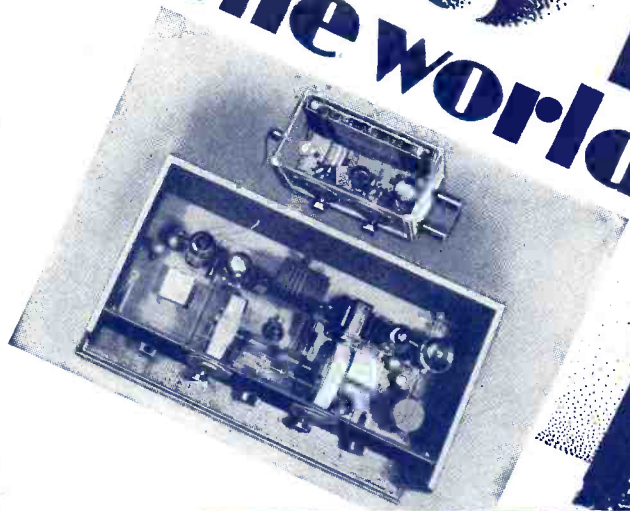

Mr. H. L. O'Heffernan (G5BY), of Croydon, Surrey, has been awarded first prize in the International contest organized by the American Radio Relay League to determine the World's best Amateur Radio Station. It is significant that Mullard Valves are used throughout the installation. You cannot go wrong by following the lead of this expert. Make it a Mullard Valve for every stage in your own receiver.

Mullard THE MASTER VALVE

Advt. The Mullard Wireless Service Co. Ltd., Mullard House, Charing Cross Road, London, W.C.2.

ARKS

Printed for the Publishers, LIFFE & SONS LTD., Dorset House, Tudor Street, London, E.C.4, by The Cornwall Press Ltd., Paris Garden, Stamford Street, London, S.E.1.

Colonial and Foreign Agents:

UNITED STATES—The International News Co., 131, Varick Street, New York. FRANCE—W. H. Smith & Son, 248, Rue Rivoli, Paris; Hachette et Cie, Rue Réaumur, Paris. BELGIUM—W. H. Smith & Son, 78, Marche aux Herbes, Brussels. INDIA—A. H. Wheeler & Co., Bombay, Allahabad and Calcutta. SOUTH AFRICA—Central News Agency, Ltd. AUSTRALIA—Gordon & Gotch, Ltd., Melbourne (Victoria), Sydney (N.S.W.), Brisbane (Queensland), Adelaide (S.A.), Perth (W.A.), and Launceston (Tasmania). CANADA—The American News Co., Ltd., Toronto, Winnipeg, Vancouver, Montreal, Ottawa, St. John, Halifax, Hamilton; Gordon & Gotch, Ltd., Toronto; Imperial News Co., Toronto, Montreal, Winnipeg, Vancouver, Victoria. NEW ZEALAND—Gordon & Gotch, Ltd., Wellington, Auckland, Christchurch and Dunedin.

SUPERHETERODYNE SHORT-WAVE ADAPTOR

The **Wireless** **World**

4^D

AND
RADIO REVIEW

The Paper for Every Wireless Amateur

Wednesday, April 23rd, 1930.



**FIRST-
BECAUSE OF
THE FILAMENT**

Mullard
THE MASTER VALVE

**No Batteries or Accumulators
Modern radio at its best**

Write for Free Book-
let on "All-Electric
Radio" and details of
Easy Payments to:-
E. K. COLE LTD.,
Dept. W,
"EKCO" Works,
Leigh-on-Sea.

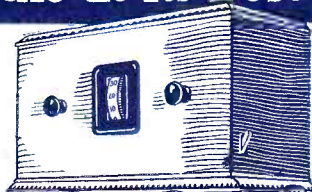

"EKCO" "EKCO-LECTRIC"
RECEIVERS
ALL POWER UNITS
H.T. and L.T. UNITS
FOR D.C. or A.C. MAINS

Utility **DIFFERENTIAL
CONDENSER**

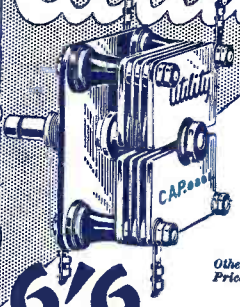

Stocked by all good dealers and the best value in a Condenser of this type that you can possibly obtain. The capacity is .0001 mfd. and the design provides smooth reaction at all points of the scale. Fully guaranteed for efficiency and finish by "Utility" — makers of the Dials, Condensers and Switches that experienced constructors always choose. Illustrated list free for a p.c.

Other Prices:
 '00015 7/-
 '0002 7/6
 '0003 9/8

WILKINS & WRIGHT LTD.,
"Utility" Works,
Holyhead Road, BIRMINGHAM.

6/6

ACCURACY

Licensed
under
design Reg.
No. 723271.

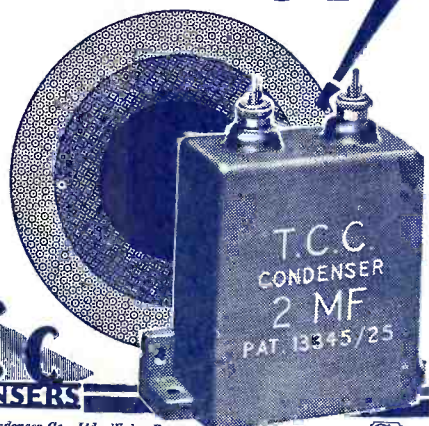

T.C.C.
CONDENSERS

Advt. of Telegraph Condenser Co., Ltd., Wales Farm

Road, W.3

MAZDA A.C. VALVES

will increase range and volume—and give you vastly improved quality

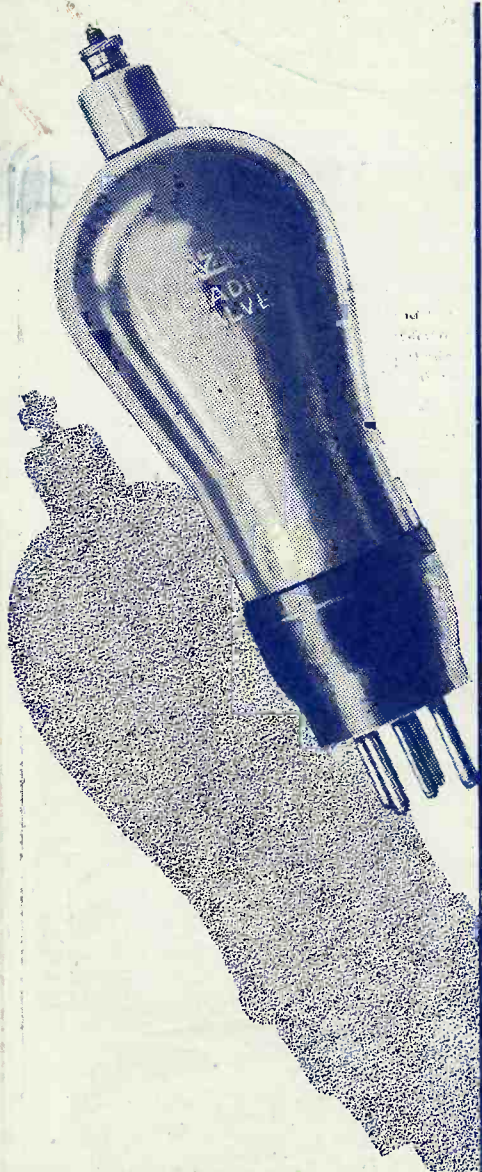

Over two years of constant research have made Mazda A.C. Valves the standard by which all indirectly heated valves are judged.

Compare the characteristics given below:—

	A.C./S.G. Screen Grid	A.C./H.L. Det.	A.C./P. Power.	A.C./P.1 Super Power.
Filament Volts	4.0	4.0	4.0	4.0
Filament Amps	1.0	1.0	1.0	1.0
Anode Volts	150	200	200	200
Screen Volts	60	—	—	—
Mutual Conductance	2.0	2.6	3.75	2.5
Amplification Factor	1,200	35	10	5
Impedance	60,000	13,500	2,650	2,000

The Amazing

MAZDA

ALL MAINS
VALVES

PRICES

AC/SG 25/-
AC/HL 15/-
AC/P 17/6
AC/P1 17/6



THE EDISON SWAN ELECTRIC CO., LTD.,

Radio Division.

1a, Newman Street, Oxford Street, W.1.

Branches in all the Principal Towns.

EDISWAN

V.32

Mention of "The Wireless World," when writing to advertisers, will ensure prompt attention.



**The McMichael 1930
SUPER RANGE FOUR
(Table Model)**

The ideal Receiver for the home where use of outdoor aerial or earth are not desirable. The Cabinet is of beautifully finished Walnut. The circuit is of the latest Screened Grid type, whilst a directional turntable and highly efficient frame aerial and earth ensure a wide range and powerful reception. This Receiver is absolutely self-contained but can be used in conjunction with an outdoor aerial if desired, in which case increase over the normal and truly remarkable range and volume is obtained.

Cash Price **26 Gns.**
(Including all equipment and Royalties.)



L.M. MICHAEL LTD

Manufacturers of Wireless and Scientific Apparatus
WEXHAM ROAD, SLOUGH, BUCKS.
Phone: Slough 441-442 Grams: Radiether, Slough
LONDON SHOWROOMS: 179, STRAND, W.C.2
(Telephone: Holborn 2466.)

Just as the plaintive melody of Syrinx (the beautiful nymph who turned to reeds) lured Pan to make his "pipes," so does every listener find fascination in the purity of reproduction which characterizes McMichael Radio Receivers.

**THE McMICHAEL 1930
SUPER RANGE PORTABLE FOUR**

A highly efficient Portable of handsome appearance. Fitted in a handsome furniture hide suitcase with patent locking clips this set is effective both for indoor or outdoor use.

Incorporating Screened Grid Amplification this Receiver is exceptionally powerful, reproducing the Broadcast Programmes with unsurpassed clarity and perfection.

Tuning is accomplished with unique ease, being controlled by a combined single-dial and volume control, whilst a simple switch-over from long to short waves is provided.

Although maintaining a high standard of perfection the set remains at an exceptionally low price whilst it is particularly economical on battery consumption.

Owing to the high degree of selectivity in this, and our other Screened Grid Portable Receivers, we are able to guarantee complete selectivity between all main B.B.C. stations under the new scheme of wavelengths, as recently proved by an actual test under the twin aerials at Brookman's Park, when both programmes were received separately without interference, and in addition a number of other British and foreign stations.

This test was made on a standard "Super Range Four" Receiver, under an independent Press observer, and was repeated at half-mile intervals with similar results.

Ask for a demonstration of this set at any high-class radio store, or call at our London Showrooms.

**CASH PRICE
22 GNS.**

(Including all equipment and Royalties).
or by our special
"Deferred Payments on
Hire Purchase Terms"
system, £5 down and 10
monthly payments of
£2.1.0.



THE CHASSIS

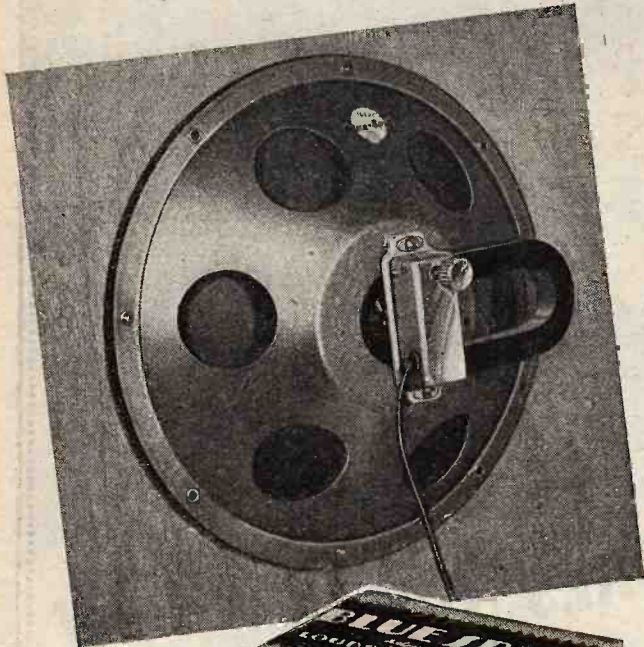

FOR THE 66K UNIT

Blue Spot 66K is the world's most famous unit and here is the Cone and Chassis that was specially designed for it.

Everyone knows the unit; soon everyone will know the Chassis.

In five minutes you can build yourself a speaker which for quality and sensitivity is unexcelled. Screw the unit to the chassis—the cone is already in position—connect up to your set and you will hear Blue Spot at its best.

66K Unit costs 25/- and is sold under guarantee.

The Chassis is sold in two sizes: The Minor, with 9½" Cone (as illustrated) costs 12/6; The Major, with 13" Cone, costs 15/-.

F. A. HUGHES & CO., LIMITED,
204-6 Gt. Portland St., London, W.1.

Phone: Museum 8630 (4 lines).

Distributors for Northern England, Scotland and North Wales

H. C. RAWSON (SHEFFIELD & LONDON) LTD.,
100 London Rd., Sheffield. (Phone: Sheffield 26006.) 22 St. Mary's
Parsonage, Manchester. (Phone: Manchester City 3329.)

VARLEY

A TRANSFORMER that will live

The Varley Push-Pull Output Transformer, like a part in a mighty machine, perfectly designed, certain of maintaining its efficiency for years to come, contributes to radio that lives and will live—VARLEY radio.

You can be confident that in your radio set the Varley Push-Pull Output Transformer will give you thousands of hours of efficient performance. Carefully tested, the halves of the split winding are exactly matched, to ensure very little risk of L.F. oscillation. For use after the largest super power valves, it is tapped to give two ratios for high and low resistance speakers.

It is a transformer that will live. Not for a matter of months but for years, this transformer will be playing its part in giving you better radio. It is a transformer of VARLEY quality.

PUSH-PULL OUTPUT TRANSFORMER (Double Ratio)	22/6
Royalty 1/6 extra	
HEAVY DUTY PUSH-PULL INPUT TRANSFORMER	23/6
Royalty 1/6 extra.	

Write for Section D of Varley Catalogue, which gives particulars of our Intervalve and Output Transformers and Chokes.



Advertisement of Oliver Pell Control Ltd., Kingsway House, 103, Kingsway, London, W.C.2. Telephone: Holborn 5303.

Mention of "The Wireless World," when writing to advertisers, will ensure prompt attention.

PATENTS STANDARD TELEPHONES AND CABLES LIMITED

Begin to announce that they are the owners of more than 60 patents relating to wireless broadcast receiving sets.

These include amongst many others:—

**Superheterodyne
Push-pull
Split Loop
Hartley Oscillator
Mains Receivers
Free Grid Bias
Gang Condensers
Volume Control with
Constant Impedance
Folded Exponential Horns**
and
(in conjunction with Electrical Research Products Inc.)
**Combined Gramophone
and Radio**

AND THAT they are willing to grant licences under these patents and future inventions of their own and their associated Companies to approved British manufacturers, who are invited to apply for further particulars and conditions to:—

STANDARD TELEPHONES & CABLES
ROOM 717, BUSH HOUSE, ALDWYCH, W.C.2



REALISM FROM RECORDS

New 16-page Booklet now ready.

"The Wireless World" says—

"There can be no doubt that anyone who has heard the Novotone demonstrated . . . would, from that time onwards, cease to be satisfied with gramophone reproduction by ordinary methods."

ELECTRIC PICK-UP USERS

do not know what they are missing due to the lower register not being cut in the record in its proper proportion.
This and more is put in by

The NOVOTONE

Write now for Free 16 p. Booklet W/1. Call for a Demonstration.

GAMBRELL RADIO LTD., 6, BUCKINGHAM ST., STRAND, W.C.2

THE GAM-BRELL VOLUVERNIA

THE PERFECT
VOLUME CONTROL

Perfectly graduated resistance from 0 to $\frac{1}{2}$ megohm.

Velvet-smooth and silent in operation.

Can be fitted to metal or insulating panels.

Ideal for Radio Receivers or Gramophone Amplifiers.

Price **6/9**

Write for Components
Booklet W/2.

REJECT INTERFERENCE !

**Local Stations Eliminated.
Distant Transmissions Separated
with the Lewcos Rejector Wavetrap.**

This component, the latest development of the Lewcos laboratories, can either be inserted in series with the aerial lead-in wire and employed as an ordinary Rejector Wavetrap, or where unscreened radiating coils such as standard six-pin or "Q" Coils are employed it may be used as an

absorption wavetrap. When used in the latter manner no connections are necessary.

Where extreme conditions necessitate it, a Rejector Wavetrap can be used in conjunction with an absorption wavetrap.

For further details write for leaflet R.60.

LEWCOS

REGD.

THE LONDON ELECTRIC WIRE
COMPANY AND SMITHS LTD.,
Church Road, Leyton, London, E.10.

Trade Counter:
7, Playhouse Yd., Golden Lane, E.C.1.

LEWCODENSER.

Type "O"—capacity '00015 to '001 mfd.
2/6 each.

Type "W"—capacity '00002 to '0002 mfd.
2/6 each.

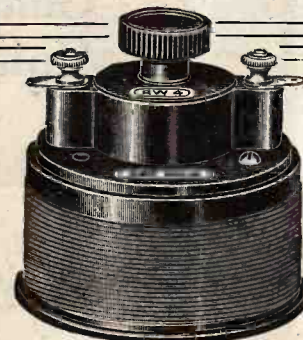

Rejector Wavetrap.
RW. 4, 235-425 metres.
Price 7/6 each.

Absorption Wavetrap.
AW. 5, 235-550 metres.
AW. 20, 1000-2000 metres.
Price 6/- each.





Gentleman:
"Excuse me Madam
would you mind if
I smoked a . . .

*Player's
Please*

Lady:
Certainly not, I'll
have one with you."



P. C. C. 821

D.C to A.C



If your supply mains are D.C. you can operate an A.C. All-Electric Receiver by using the



**D. C. to A. C.
ROTARY
TRANSFORMER**

Can be supplied to run from any voltage 12-250 V.D.C. 40 watt model £13; 85 watt model £19. Recommended and used by Philips Radio, Marconiphone, Burndept, Kolster-Brandes, M.P.A., Etc., Etc. Write for Pamphlet 596/1 which gives full details.

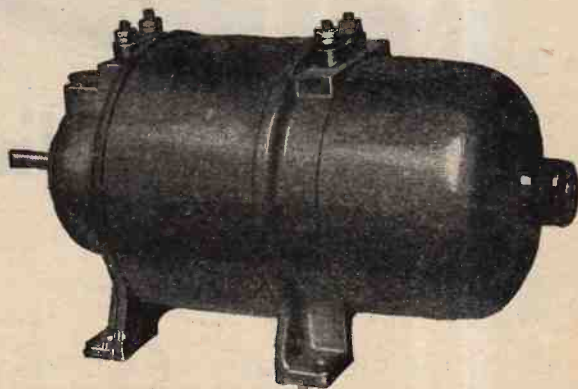

THE M-L MAGNETO SYND. LTD.,
Radio Dept., COVENTRY.
Telephone : 5001.



**I'm the most Powerful—
most Silent—
Challenge me if you will**

I'm



Write for list of Standard Sizes for every set, free from
EVER READY CO. (G.B.) LTD., 29, Hercules Place, Holloway, N.7

Mention of "The Wireless World," when writing to advertisers, will ensure prompt attention.

The Wireless World

AND
RADIO REVIEW
(18th Year of Publication)

No. 556.

WEDNESDAY, APRIL 23RD, 1930.

VOL. XXVI. No. 17.

Editor : HUGH S. POCOCK.
Assistant Editor : F. H. HAYNES.
Editorial Offices : 116-117, FLEET STREET, LONDON, E.C.4
Editorial Telephone : City 9472 (5 lines).
Advertising and Publishing Offices :
DORSET HOUSE, TUDOR STREET, LONDON, E.C.4.
Telephone : City 2847 (13 lines). Telegrams : "Ethaworld, Fleet, London."
COVENTRY : Hertford Street.
Telegrams : "Cyclist, Coventry." Telephone : 5210 Coventry.
BIRMINGHAM : Guildhall Buildings, Navigation Street.
Telegrams : "Autopress, Birmingham." Telephone : 2970 and 2971 Midland.
MANCHESTER : 260, Deansgate.
Telegrams : "Ilife, Manchester." Telephone : 8970 City (4 lines).
GLASGOW : 101, St. Vincent Street, C.2.
Telegrams : "Ilife, Glasgow." Telephone : Central 4887.

PUBLISHED WEEKLY.
Subscription Rates : Home, £1 1s. 8d. ; Canada, £1 1s. 8d. ;
other countries abroad, £1 3s. 10d. per annum.

Entered as Second Class Matter at New York, N.Y.

As many of the circuits and apparatus described in these pages are covered by patents, readers are advised, before making use of them, to satisfy themselves that they would not be infringing patents.

CONTENTS OF THIS ISSUE.

	PAGE
EDITORIAL VIEWS	425
SUPERHETERODYNE SHORT-WAVE ADAPTOR. BY H. B. DENT	426
NORDDEICH	431
RADIO MEASURING INSTRUMENTS. BY E. H. W. BANNER	432
CURRENT TOPICS	437
KIT CONSTRUCTORS' NOTES	438
BROADCAST BREVITIES	440
DIELECTRIC PROPERTIES OF INSULATORS—(CONCLUDED). BY W. H. F. GRIFFITHS	441
CORRESPONDENCE	444
READERS' PROBLEMS	445

THE PROBLEM OF SELECTIVITY.

THERE can be no question of the importance of selectivity as a factor in deciding the limit of the horizon in the development of radio communication, whether for point-to-point services or for broadcasting, so that any proposals which indicate the possibility of a contribution towards radio technique bearing on this problem deserve the closest attention.

For this reason, whilst declining to be stampeded into immediately accepting the claims which have been made for the circuit principle known as the Stenode Radiostat, and being still less prepared to throw overboard accepted theory as to the physical reality of side-bands, yet we have been keenly interested in the proposals which have been made, and from the first have approached the subject at least with an open mind.

The first practical demonstration of the apparatus did not go far enough to enable any definite opinion to be formed, either favourable or otherwise, but recently we have had the privilege of a private demon-

stration in London, as a result of which we are in a position to say that from the point of view of selectivity the apparatus as demonstrated to us clearly indicates the probability that in this circuit principle we have the evidence of a definite step towards overcoming some aspects of the problem of ether congestion.

We doubt very much whether any revolutionary modification of existing theory will be necessary in order to explain the operation of the new system; rather we would think it likely that the explanation of operation will serve only to clarify accepted theory.

So far as the demonstration which we were given is concerned, the degree of selectivity attained with the receiver was certainly of a very high order, and there seemed to be little difficulty in separating any given station from another under circumstances where, with an ordinary selective receiver designed for quality reception, heterodyning would have been experienced. It was interesting to observe that tuned to the carrier wave of a station it was necessary that that station should show no tendency to "wobble" on its wavelength if satisfactory reception was to result, this effect being due to the sharpness of tuning and the fact that the receiver is crystal-controlled. This observation implies that the Stenode receiver principle requires that the transmitter is crystal-controlled or otherwise maintains its carrier at a constant frequency; in other words, the Stenode principle would appear, at the moment, to be ahead of the present average standard of broadcast transmission.

Apart from this objection, we must also postpone the probability of a general application of the principle to broadcast receivers for some considerable time to come, in view of the apparent complication of the receiver, for the superheterodyne principle at present appears to be necessary in order to feed the signal to a circuit of predetermined frequency, controlled with a quartz oscillator. Since the principle of the Stenode involves accentuation of the fundamental frequency out of proportion to the higher frequencies, a frequency or tone corrector has to be employed in the final amplifier to satisfy the requirements of quality.

The principle should, no doubt, be applicable in the first place to point-to-point telephony or telegraphy where an extension of the number of channels for transmission is needed, and here we would anticipate satisfactory and useful service, provided that stability of the transmitter can be assured.

We are promised that it will be possible to give our readers a descriptive account of the apparatus.

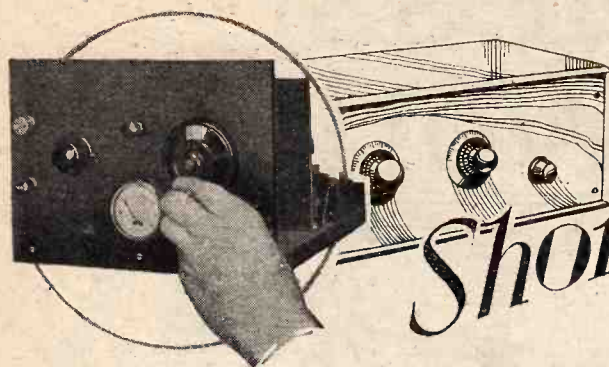

SUPERHETERODYNE Short-Wave Adaptor

A Separate Unit with Single Tuning Control Converting a Broadcast Set to a Short-wave Receiver.

By H. B. DENT.

PROBABLY it has occurred to some readers that if the broadcast set could be adapted easily for short-wave reception, much duplication of apparatus would be spared—to the financial benefit of all concerned. From the detector stage to the loud speaker a short-wave receiver is fundamentally the same as a broadcast set, and it is only in the pre-detector portion that any real difference exists. A receiver designed especially for short-wave reception can be used on the medium broadcast waveband—200 to 600 metres—provided arrangement was made for this when designing the set. Its usefulness cannot be said to extend much above 600 metres, as owing to the small capacity of the tuning condensers very large inductances, giving a high L/C ratio, will be required, so that unless provision is made to bring into use waveband filter circuits, the selectivity of the receiver will be inadequate to cope with the conditions obtaining on the higher wavelengths.

From time to time various schemes have been put forward to convert a broadcast set into a short-wave receiver, the general feature being the utilisation of the low-frequency amplifier in conjunction with a special short-wave detector unit. However, it is not proposed to enumerate, or criticise, these schemes here, but to point the way to another method which, hitherto, has not received much prominence. The method referred to is the super-sonic heterodyne principle, and this has been found particularly effective on the ultra-short wavelengths. Also, it scores

heavily over many of the alternative suggestions in that no modification whatsoever is required to the broadcast set. The receiver, however, must incorporate at least one stage of high-frequency amplification, and be capable of fairly selective tuning on the 1,000- to 2,000-metre waveband.

Having regard to present-day conditions of broadcasting, it is probably redundant to specify these conditions, since a set that does not comply with this specification is hardly entitled to be classed as a modern receiver.

The unit, which forms the subject of this article, is, therefore, a frequency changer, since its function is to convert all signals received to a longer wavelength, which is fixed and determined by the tuning of the broadcast set. Having initially adjusted the tuning controls to a suitable wavelength they can be ignored, as henceforth all tuning will be carried out on the short-wave unit. The high-frequency stages now become what is known as the intermediate amplifier in the orthodox super-heterodyne receiver.

The components required for the unit are mostly special short-wave parts, consequently there is no duplication of apparatus. Now super-sonic heterodyne receivers generally embody two main tuning controls: one for the aerial circuit and the other for the local oscillator. In the present case it has been found possible to combine these two functions in one circuit so that only one tuning control is required. The small variable condenser, seen mounted on the left of the tuning

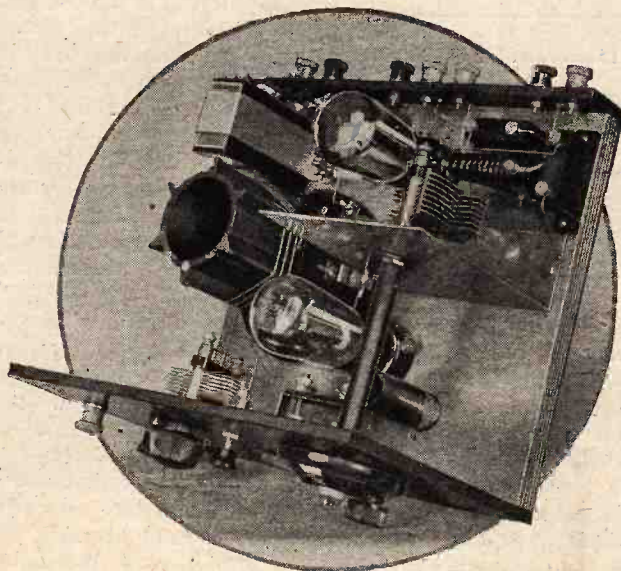

Plan view of the unit. The tuning condenser is mounted well back from the panel to prevent hand-capacity effects.

condenser, seen mounted on the left of the tuning

Superheterodyne Short-wave Adaptor.—

condenser in the illustrations, is to regulate the intensity of the locally generated oscillations and thereby keep the current drawn from the H.T. battery within reason-

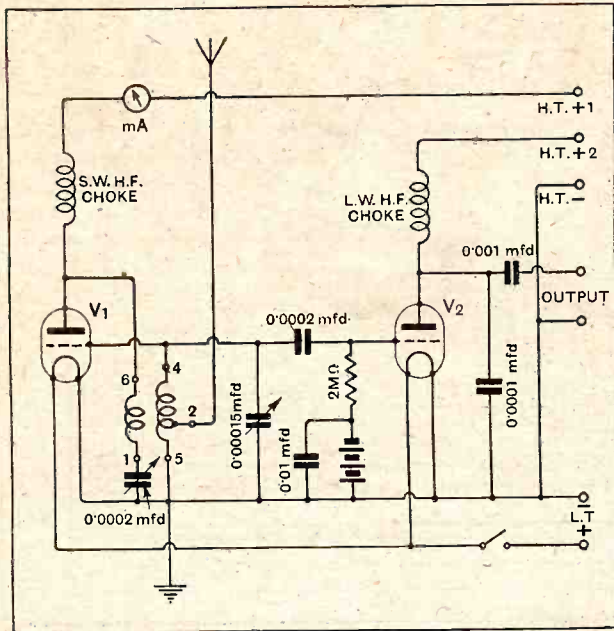

Theoretical circuit diagram. V_1 is the local oscillator and V_2 the detector.

able bounds. To facilitate this a milliammeter has been included in the anode circuit of the oscillator valve, as it was found in the early experimental stages that without a monitor of some description the drain on the H.T. battery often became 10 to 12 milliamps. when using a low-impedance valve. As this valve functioned quite well when drawing 2 to 3 milliamps. only, anything in excess is an unpardonable waste, and it will be found in time that the meter will more than justify its inclusion by the conservation in H.T. current made possible by its aid.

From the circuit diagram it will be seen that two valves are used; the function of V_1 is to produce the local oscillations which, when mixed with the received signals and rectified by V_2 , produce the beat frequency, or the long-wave signal, which is passed to the broadcast set. Under certain conditions it would be possible to arrange for one valve to perform this dual function, but experiments have shown that at the very high frequencies dealt with here considerable difficulty was experienced in obtaining uniformity of operation, even with valves of the same type and make. A very small difference in characteristics between one valve and another, such as would pass unnoticed on the ordinary broadcast waveband, is sufficient to necessitate modification to the reaction circuit. As it must not be assumed that every reader has

stocks of valves with which to experiment, the two-valve arrangement was adopted, as this afforded the greatest factor of safety.

The anode bend method of detection is favoured for V_2 , as this arrangement is more economical and serves our purpose quite as well as the leaky grid method, since we are not dealing with very small inputs. The extra 2 or 3 milliamps. that would be required might just as well be saved, as it is assumed that the batteries supplying the main set will be used for the short-wave unit. The extra burden imposed on these should be kept as small as possible, since in many cases dry-cell batteries of, perhaps, not too large a capacity will be called upon to supply the additional current.

The oscillator circuit is quite straightforward, and does not call for lengthy description. Best results were obtained by using a valve of the 10,000-ohm A.C. resistance type; any good L.F. class of valve in the 2-, 4- or 6-volt range will answer. Capacity feed is adopted and a short-wave H.F. choke used to deflect the oscillations through the reaction circuit.

How the Detector Functions.

The function of the valve V_2 is not quite such a straightforward job as that of an ordinary detector. The ordinary detector has fed into it high-frequency oscillations, and it passes on to the following stage the low-frequency component. In this case the detector receives high-frequency as usual, but passes on high-frequency oscillations also, so that we must connect in its anode circuit a component that will put up a high impedance to

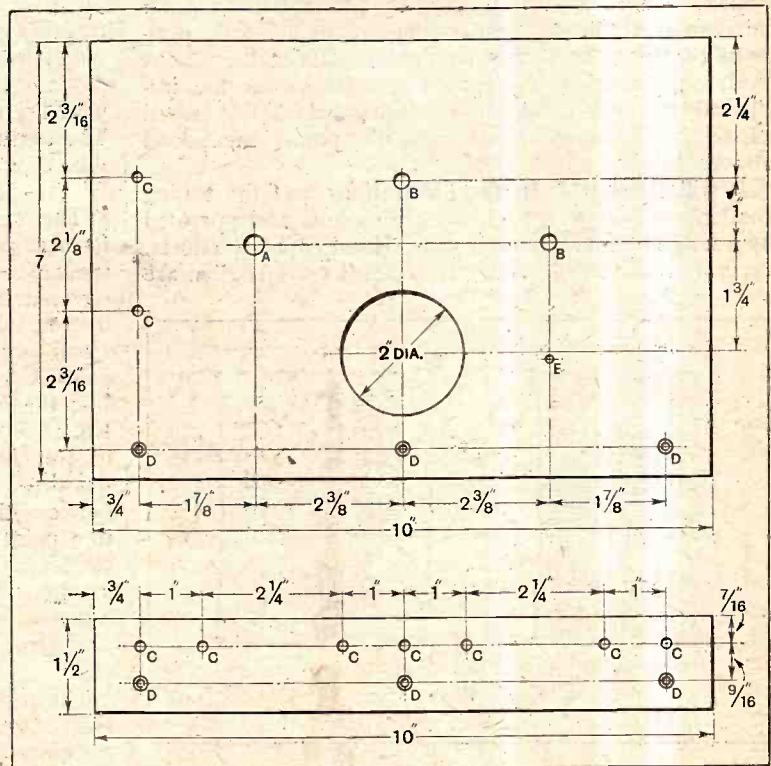

Details of the panel drilling and the terminal strip. A = $\frac{3}{8}$ " dia.; B = $\frac{1}{2}$ " dia.; C = $\frac{3}{8}$ " dia.; D = $\frac{1}{2}$ " dia. countersunk for No. 4 wood screws; E = $\frac{1}{2}$ " dia.

Superheterodyne Short-wave Adaptor.—

currents at radio-frequency. This condition can be met either by an H.F. choke or by a resistance, or by a tuned circuit. The last-mentioned would introduce an extra control without conferring any real benefit. As the detector valve recommended for V_2 is of the 20,000-ohm type with a good mutual conductance, preference will be given to the H.F. choke, as its low D.C. resistance might prove advantageous. The standard broadcast type is, of course, used since we are dealing with long-wave signals. The actual valve used for the detector was a Mazda H.L. 210, which has a conductance of 1.25 and proved to be very satisfactory.

The 0.0001 mfd. condenser connected between the anode and the L.T. negative of V_2 proved to be necessary to combat an anti-reaction effect that so damped the circuit that the oscillator ceased to function at certain positions of the tuning condenser. It was noticed that over a few degrees of the condenser dial the oscillator valve refused to function unless the capacity of the reaction condenser was increased to close on maximum. Elsewhere quite a small capacity sufficed to maintain oscillation. Knowing that a similar effect can be caused by aerial load, precautions were taken to keep the lead-in well away from the unit. The curves reproduced on the last page of this article illustrate the effect mentioned. Curve A was obtained by plotting the angular movement of the reaction condenser against scale divisions on the main tuning condenser without the 0.0001 mfd. condenser in circuit. Curve B shows the improved reaction condition obtaining when this small capacity is connected between the points mentioned above.

It will be seen from the illustrations that the tuning condenser is set well back from the panel and operated by a long ebonite extension rod. Hand capacity effects, very often so troublesome on the short wavelengths, are

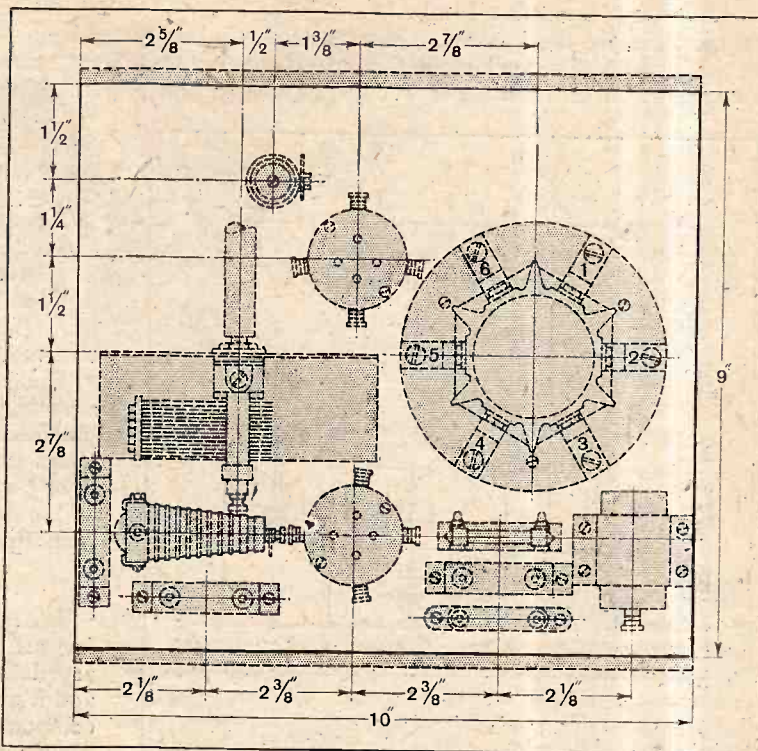

Disposition of the components on the wooden baseboard.

thus avoided. Fortunately it does not introduce any additional constructional work, as the condenser is supplied by the makers mounted on the aluminium plate, together with a detachable spindle 4in. long and provided with a brass spindle at the panel end to accommodate the dial. An enclosed pigtail makes contact with the moving vanes, so that it is noiseless in action. The outfit is made by the Formo Co.

Constructional Details.

The coils are wound on Becol six-ribbed ebonite formers fitted with side contacts and mounted on the special base supplied by the makers. The wavelengths covered by the two coils extend from 16 metres to 50 metres, and provide continuous tuning, as there is a small overlap between the two coils. One coil tunes from 16 to 31 metres and the other from 29 to 58 metres. For the lower range the grid coil has three turns of No. 18 S.W.G. tinned copper wire wound with a spacing of 1/4 in. between consecutive turns. The reaction coil has three turns also, and these are wound in the spaces between the turns of the grid coil. The aerial is tapped to a point on the grid coil one-sixth of a turn from the earth end. The second coil is wound in exactly the same manner, but in this case the grid winding consists of eight turns and the reaction coil has four turns only. The aerial tapping is made half a turn from the earth end.

The ranges mentioned above were obtained with the H.F. stages in the broadcast set tuned to 1,900 metres.

Before the initial tests are made the receiver should be carefully tuned to a "free" wavelength, somewhere between 1,500 and 2,000 metres. The aerial can then

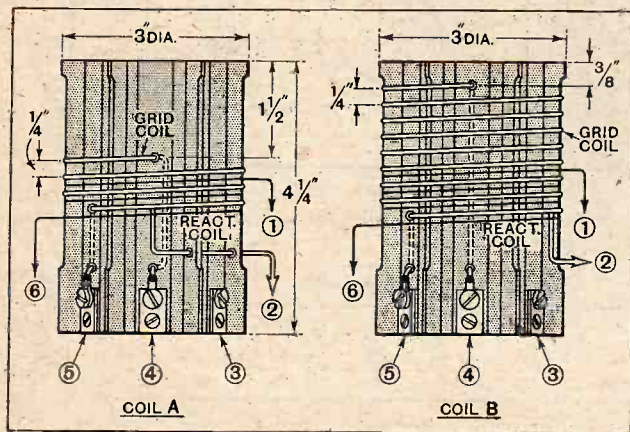

Details of the coils. The windings terminate at metal contacts located on the flats between the ribs. The lettering corresponds with that on the other drawings.

LIST OF PARTS.

1 Short-wave condenser outfit, 0.00015 mfd. (Formo).
 1 Vernier dial for above (Formo).
 1 Reaction condenser, 0.0002 mfd., with knob (Formo "Midget")
 2 Valve holders (Burton).
 1 H.F. choke (Eddystone).
 1 Short-wave H.F. choke (Igranic).
 1 Fixed condenser, 0.0002 mfd. (Dubilier No. 620).
 1 Fixed condenser, 0.0001 mfd. (Dubilier No. 620).
 1 Fixed condenser, 0.001 mfd. (Dubilier No. 620).
 1 Fixed condenser, 0.01 mfd. (T.C.C.).
 1 Grid leak, 2 megohm (Loewe).

1 Porcelain holder for grid leak (Bulgin).
 9 Terminals (Burton).
 1 Panel-mounting meter, 0/25 milliamps. (Wates).
 3 Cells, "O" size (Ever Ready).
 2 Ebonite formers, 6-ribbed with side contacts (Becol).
 1 Base for above.
 1 Ebonite panel, 10in. × 7in. × ¼in.
 1 Terminal strip, 10in. × 1½in. × ¼in.
 1 Baseboard, 10in. × 9in. × ¼in.
 1 On-off switch (Benjamin).
 Wire, screws, Sistoflex, etc.

Approximate cost

£4 0s. 0d.

In the "List of Parts" included in the descriptions of *THE WIRELESS WORLD* receivers are detailed the components actually used by the designer, and illustrated in the photographs of the instrument. Where the designer considers it necessary that particular components should be used in preference to others, these components are mentioned in the article itself. In all other cases the constructor can use his discretion as to the choice of components, provided they are of equal quality to those listed and that he takes into consideration in the dimensions and layout of the set any variations in the size of alternative components he may use.

be removed and attached to the aerial terminal on the short-wave unit. The terminals on the back of the unit may then be connected to their respective batteries. It is a good plan to use the same class of valves in the unit as fitted in the set, as this obviates the need for a separate L.T. accumulator. With a 20,000-ohm type valve in the detector position and an 8,000- to 10,000-ohm valve as an oscillator, H.T. + 1 terminal will require between 30 and 40 volts, and H.T. + 2 between 100 and 120 volts, according to the particular characteristics of V_2 . The output terminal connected to the 0.001 mfd. condenser must be connected to the aerial terminal on the receiver and

large capacity condenser must be connected between the low potential output terminal on the unit and the earth terminal on the receiver. The earth lead should be con-

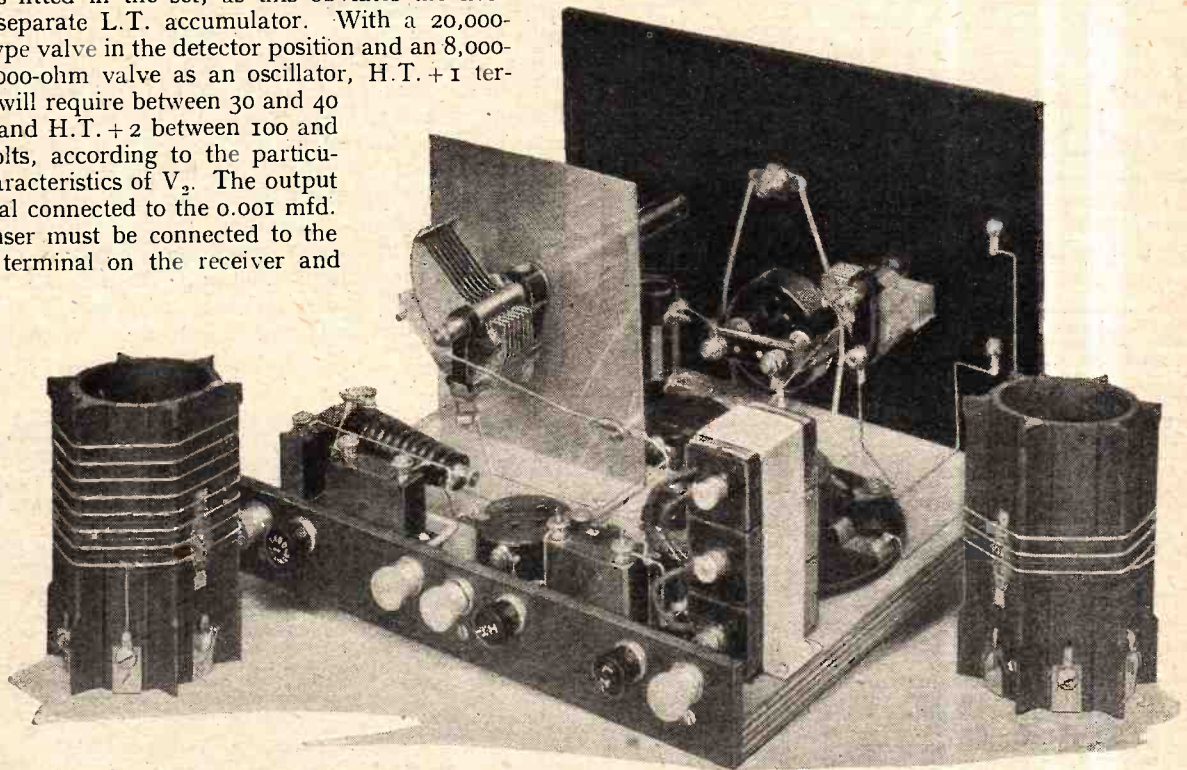

Rear view showing the method of mounting the long-wave choke and the grid biasing cells.

the other output to the earth terminal on the receiver. Since the batteries are common to both set and unit it is essential that the H.T. - and the L.T. - in the broadcast set should be at the same potential. The *Wireless World* sets follow this practice, but there are some receivers on the market in which the H.T. - is joined to the L.T. +. These points must be watched, and the reader should first assure himself that both negatives are common before connecting up the unit. If it is found that the H.T. - goes to the L.T. +, then a

connected to the earth terminal on the short-wave unit only and not to the broadcast set as well.

With the filament switch in the "on" position and the reaction condenser at minimum capacity, make a mental note of the current taken by the oscillator valve, as shown by the Wates' meter. Slowly increase the reaction condenser and note the setting at which oscillation commences. This will be indicated by an increase in the anode current. The best operating conditions will be when the anode current is about 1 to 2 milliamps. more

DAN Completes Its Quarter Century.

TO the world at large, and even to the majority of wireless enthusiasts, the name "Norddeich" means very little; to a select few, however, mention of this little outpost on the West coast of Germany summons up visions of the earliest days of amateur wireless activity. For it was the ability to receive the time signals and weather report from Norddeich (KND, subsequently KAV, and now DAN), at a satisfactory strength on a crystal set, that distinguished certain amateurs in the Edwardian period from the lesser members of the tribe who had to content themselves with the comparatively powerful transmissions from the Eiffel Tower.

To-day the station at Norddeich can boast five powerful transmitters, telephonic as well as telegraphic; but in 1905, when the Telefunken Company first installed the plant, a single transmitter working on the spark system sufficed to operate a service consisting of ship and shore traffic, weather bulletins and time signals. The functions of the modern Norddeich station include long-distance ship traffic, storm bulletins for vessels in

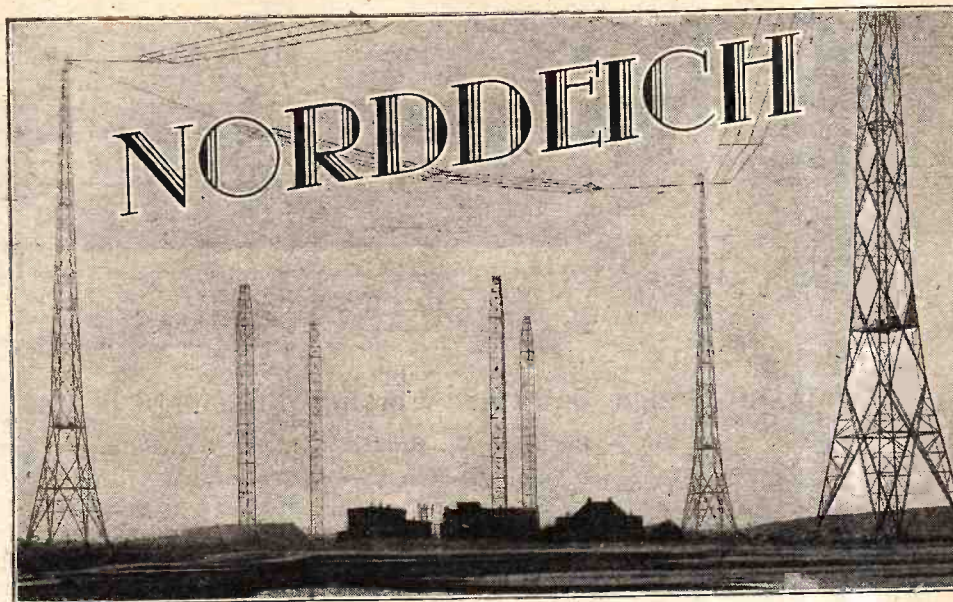

A general view of the station which helped to make amateur radio history in the days when transmitters were few.

the North Sea, a special service for the fishing fleets, and, on occasions, communication with aircraft. During the Atlantic flights of the "Graf Zeppelin" Norddeich was in almost continuous touch with the airship, sending and receiving weather reports and general information.

The Modern Equipment.

The present equipment comprises five transmitters—two of 20 and 10 kilowatts respectively for long waves; two of 5 kW. for medium wavelength working, and a short-wave set with a world-wide range, the last-named being a recent addition. The station keeps a continuous watch on 2,098 metres.

The telephony services are carried out on wavelengths of 1,649, 52.9, 36.0, 26.4, and 18.0 metres. The "studio" housing the microphone and low-power amplifiers is situated about three miles from the transmitter.

As the upper photograph shows, Norddeich occupies a commanding site. Its three tall, self-supporting masts are 400ft. in height, the others being some 260ft.

During the War Norddeich was principally used for naval messages, besides serving as a communications base for the raiding Zeppelins.

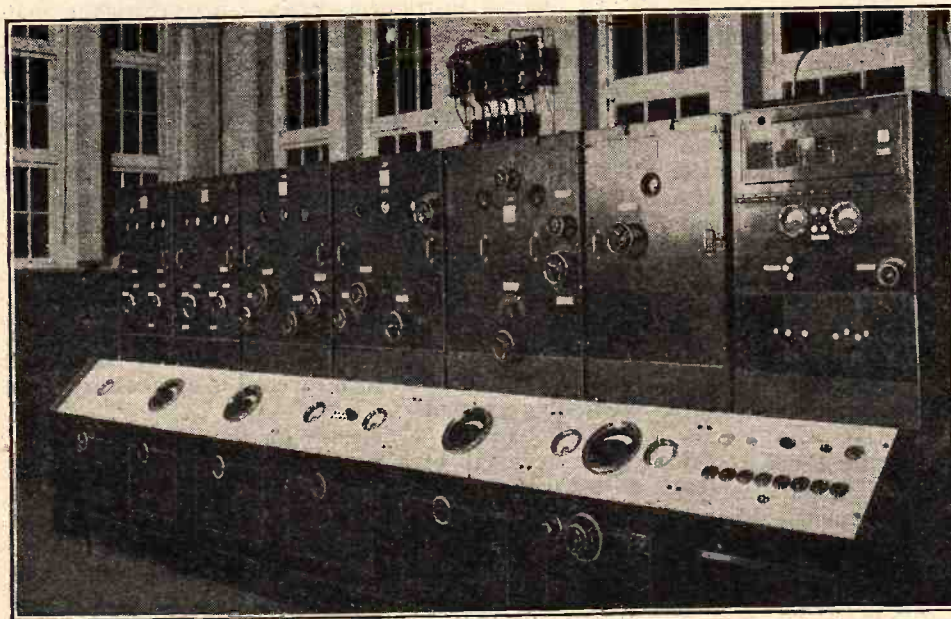

The Telefunken short-wave transmitter at Norddeich.

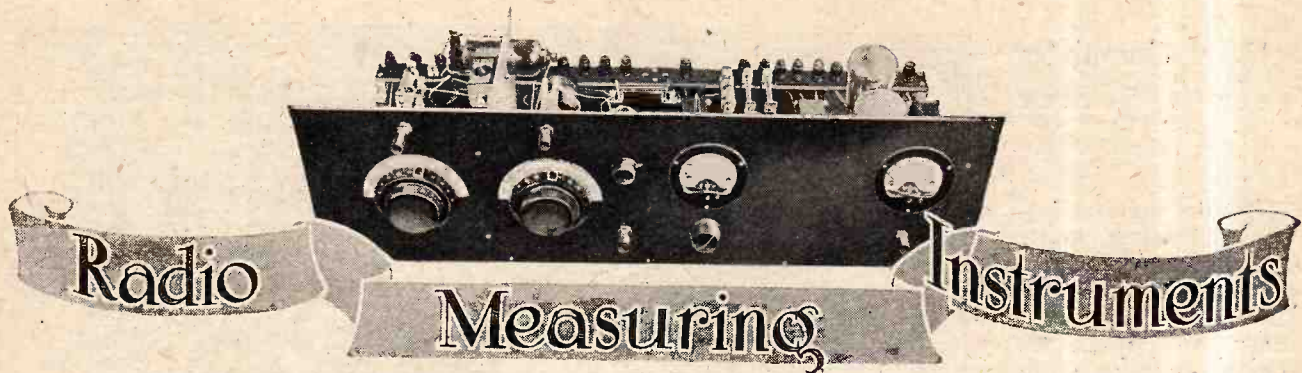

Points in Design and the Working Principles of the Various Types.

By E. H. W. BANNER, M.Sc., A.M.I.E.E.

(Instrument Department, Ferranti Ltd.).

It was said by a great scientist many years ago that progress depends on the discovery of to-day being measured to-morrow. This is particularly true in electrical work, especially radio, where discoveries and improvements are of frequent occurrence. To a serious radio amateur, electrical measuring instruments are indispensable, and as the types are so many and the detail points of design so important, it is necessary that, to be able to use a given instrument efficiently, the user must know the good and bad points of instruments, and, in addition, should be able to modify the range temporarily to suit a different job in order to use an instrument economically.

Four Types of Instruments.

Instruments considered include four general types usually met in radio work—moving-coil, moving-iron, thermal, and electrostatic. In addition, modifications peculiarly suitable for radio frequencies are included. The moving-coil instrument is essentially a direct-current meter; its scale is linear, or even throughout. The principle of its action is that a coil of wire carrying a current in the field of a magnet tends to move, and the construction is such that the movement is a rotation, the amount of which is shown by a pointer and scale. The moving coil is controlled by two springs, which also serve to conduct the current to be measured to the coil. Depending on the manner in which the coil is connected to the circuit, either amperes or volts may be read, and each of these of almost any magnitude which is not less than that required by the coil alone. Due to the presence of the permanent magnet this type of instrument is said to be polarised; and so polarity is of consequence or the instrument will tend to read reversed if the leads are not correctly connected.

Moving-iron instruments are generally cheaper than moving-coil of the same range and size, and this fact leads to their use on direct-current circuits, although they are generally inferior to moving-coil instruments for direct current. During the last few years, however, several moving-iron instruments have been marketed having as good an accuracy on direct current as on alternating current, but these instruments are generally

too large and expensive for radio experimental use.¹

Two general types of moving-iron instruments exist: one has a single moving iron which is attracted into a current-carrying coil, and the other has two irons in the coil which become similarly magnetised and repel each other; in each case the motion is rotational so that a pointer moves angularly over a fixed scale. Neither type has supreme advantages over the other.

Alternating-current Meters.

Thermal instruments depend on the heating properties of a current, and are sub-divided into two types, the thermo-expansion, or hot-wire, and the thermo-E.M.F. types. The hot-wire is now rather a back-number, and is little used in this country. Thermo-E.M.F. ammeters are on the increase, and are found to be more reliable and better able to withstand overloads than the old hot-wire ammeter.

All thermal instruments possess the advantage that they will measure alternating current of any ordinary frequency and any wave-form accurately, indicating the true root mean square value, and, provided also that their design is good, they will measure at any frequency, including radio-frequencies. For the highest frequencies, however, it must not be assumed that because an instrument is of the thermal type it is equally accurate for radio-frequencies as on low. Again, a well-designed thermal instrument will read correctly on direct current, but in some instruments this is not the case, and it will be found that if the polarity of the instrument is reversed, a different reading results. In general, a mean of these two readings will be correct for direct current, and such reversal is unnecessary with alternating current.

The hot-wire type depends for its action on the increase in length of a wire carrying current. The sag of this wire is made to operate a pointer, but the direct result of the heating is a linear motion which has to be translated to a rotational one to operate the pointer. It will be seen that a change of air temperature will affect the length of the working wire, so that it will

¹ "Moving-iron Instruments on D.C." *Electrician*, January 6th, 1928, p. 3.

Radio Measuring Instruments.—

not be independent of temperature, although usually some attempt is made to compensate for this.

Radio-frequency Meters.

Thermo-E.M.F. instruments depend for their action on the fact that a junction of dissimilar metals is a source of potential when the junction is heated relatively to the temperature of the rest of the circuit. In practice a junction of iron and "Eureka" is placed near to, or on, a wire which acts as a heater and carries the main current. The potential developed then operates a moving-coil millivoltmeter movement which is incorporated in the instrument case. With either type the heating wire usually has to be run at a reasonably high temperature to be efficient, which greatly reduces the limit of overload, often with disastrous results.

This type is now used almost exclusively for radio-frequency circuits, where neither of the two former types are of any use. However, great care is needed in the design to obtain an instrument which is truly independent of frequency at the extreme frequencies used in short-wave radio transmission. It will be seen that these instruments have no appeal to the amateur who receives only, but to the transmitter they are a necessity for measuring radiated current.

Electrostatic instruments are now less used than formerly, but a revival is setting in, as there are some measurements in radio work that can be made both accurately and simply by an electrostatic voltmeter. An electrostatic voltmeter is usually similar to a variable condenser, consisting of one or more moving and two or more fixed vanes, the movement being spring-controlled similarly to the other types. Also the

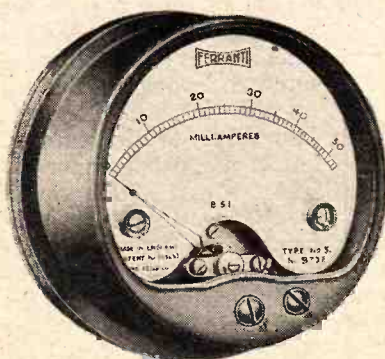

Fig. 1.—Moving-coil milliammeter showing the "girder" form of pointer construction.

mechanical design is usually such that a direct rotational movement is produced. It is often assumed, as for the thermal type, that an electrostatic voltmeter is independent of frequency, but this is not necessarily the case, the usual causes of error being due to stray capacities, somewhat similar to hand effects on a radio variable condenser when not efficiently screened, and also to the fact that at high radio frequencies the instrument capacitance may be greater than that present in the oscillatory circuit. It will be seen that as no current flows, excepting at radio frequencies, no power is consumed. This is of great importance, as it leads to a field of use where no other type can be used, with the exception of thermionic voltmeter, which will be described later.

Suppose the volt drop across a valve having a resistance or other load in series, or the drop across a

condenser in series with another condenser is required; if a voltmeter of any other type than electrostatic is used it will take a current in parallel with the valve or condenser, which will entirely upset the steady condition and so give a false reading. Another case is in measuring the grid voltage on a large valve; if the grid voltage is of the order of hundreds of volts it can be read directly on an electrostatic voltmeter, whereas, due to the current taken, other types are inadmissible. When used for testing an eliminator the true open-circuit voltage can be measured without imposing a load.

The relatively narrow scope of the electrostatic voltmeter is due to its limited range. The working force depends on the square of the applied voltage, so that for low voltages the working force is small, and robust instruments of full-scale range of less than about 1,000 volts are unusual, although some more or less delicate instruments deflect fully for about 100

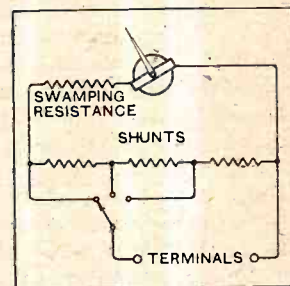

Fig. 2.—Circuit arrangement of multi-range ammeter using series connected shunts.

volts. With the exception of stray capacities, due to the case and other parts, these instruments also are independent of frequency and wave-form, except when used with short wavelengths; and so they are used to some extent as transfer instruments by calibrating with direct current and using to check alternating current voltmeters.

Limits of Accuracy.

There are certain points of design which are common to all instruments, and the principal of these will be given before considering the types in detail.

It is obvious that a long scale can be read and mentally sub-divided more accurately than a short scale. There is a limit, however, to which this can go which is set by the inherent accuracy of the movement itself. Suppose that in a certain instrument pivot friction, spring variation, and general mechanical construction limit the accuracy which can be attained by the instrument to 1 per cent. of full-scale deflection. If this instrument has a scale which is so long and finely divided that with a fine, knife-edged pointer it can be read with ease to 0.5 per cent., then such a reading is misleading, and not justified by the accuracy of the movement.

In general, the accuracies of instruments used by radio ammeters are between 1 and 2 per cent. of full-scale deflection, so that for such instruments the scale should be capable of being read to this accuracy also. Generally speaking, a scale length equal to the dial diameter gives the best results, and this is usually attained by a deflection of 110 to 120 degrees. Such a scale arc is usual in large instruments, but unusual in small ones, but the illustrations show Ferranti instruments in which this is actually carried out, and a 2½ in. diameter scale has a scale of 110 degrees and a length at the pointer tip of 2½ in.

There are so many points that can affect accuracy that only a few need be enumerated; others can be

Radio Measuring Instruments.—

readily brought to mind. Whatever the type of instrument a certain force is produced by the movement, which, if rotational, can be expressed as a torque tending to rotate the movement against its control spring. Generally speaking, the higher the torque the greater the accuracy, and, in considering what such torque should be, it is obvious that no one value can be given; it depends on the size of the instrument and the service expected, amongst other factors. The best and most satisfactory way to express the torque for any instrument is by the ratio of torque to weight of the moving parts, it being obvious that the larger the instrument the longer the pointer, and so the greater the weight. Besides the weight of the movement affecting the torque desirable for reliable indication, it will also affect the life of the instrument; the heavier the movement the greater the wear upon the jewels and pivots.

From this consideration it may be thought that the greater the weight the torque should increase at a faster rate, or that the criterion should be not torque/weight, but torque/weight to some power, this power being greater than unity. This leads to the expression that, for reliability of indication, the factor torque/weight $\times 1.5$ should be high.

The need for a high factor of torque/weight is chiefly on account of friction, which, although small in well-made instruments, cannot be negligible. As a result, there are certain minimum ranges which can be used with a double-pivoted instrument. Below these ranges either the Unipivot of R.W. Paul or the suspended type must be used. In the latter, as there is no pivot friction, extremely low values of current and voltage can be measured with reliability. The main limitation then becomes elastic strain in the suspension.

The ratio of torque to weight of movement is usually not less than $1/20$ for portable meters, and $1/10$ for switchboard instruments—the higher the value the better. In the instruments illustrated, where a $2\frac{1}{2}$ in. dial instrument has a $2\frac{1}{2}$ in. scale length, the ratio torque/weight is $1/8$, or 0.125, an unusually high figure, leading to permanency of accuracy, with the obvious exception of deliberate mechanical damage. Accuracy demands fine adjustment of jewels and pivots, so that the initial calibration will be maintained. It requires a mechanically strong movement, so that temperature effects, heat, overload and abuse will not lead to distortion or actual fouling.

Two general forms of damping are usual—magnetic and pneumatic; the former is found in moving-coil instruments, and the latter in moving-iron types. It is well known that a potential is induced in a conductor moving in the field of a magnet, which is proportional

in its value to the rate of cutting of the magnetic flux. If there is a closed circuit a current will flow, and in consequence will tend to retard the motion. In the moving-coil instrument the elements required for this form of damping are already there. There is a permanent magnet, and the moving coil is usually wound on a metal "former" for mechanical strength. In addition to this, the shunt of a milliammeter or ammeter forms an additional closed circuit with the coil, resulting in the fact that the damping of a moving-coil ammeter is rather better than that of a voltmeter. It will be observed that the damping is due entirely to the motion, so that no impedance is offered to the smallest change of torque due to altered current passing through the coil.

Ability to Withstand Overload.

In pneumatic damping a nearly closed chamber has a piston attached to the spindle and capable of movement inside the chamber, so that air pressure on the piston retards movement; like magnetic damping, no mechanical friction tends to prevent free motion.

Included in this is the ability to withstand overloads. All instruments are liable to unexpected overloads when a higher voltage or current than that of the range of the instrument is inadvertently connected. An instrument may fail in one or both of two ways on overloads—thermally and mechanically. The former is usually the case with a slowly applied and sustained overload, whilst the latter is due to a suddenly applied overload. With the exception of electrostatic voltmeters all instruments carry current, and for efficiency it is usual to design windings for an economical current-density. This means that any overload tends to warm the windings of an instrument unduly, and that a heavy overload will cause a burning-out of some part of the winding or springs. With a brief overload this is unusual, owing to the lag of the increased temperature due to the current, but in thermal instruments, where a part of the circuit is already at a high temperature for full-scale reading, such failure is common; particularly for the lower ranges and for the thermo-expansion type.

The second cause of failure is directly due to the increased force generated by the overload, and is usually manifested in a bent or smashed pointer.

It will be seen that good damping tends to reduce this cause of trouble, as the speed of travel of the pointer is retarded.

As the pointer is usually the part that suffers most, it is important to design a strong pointer, and the usual thin tubular pointer fitted to most instruments is deficient in this respect. A springy pointer is found to be the best suited to repeated overloads, and the

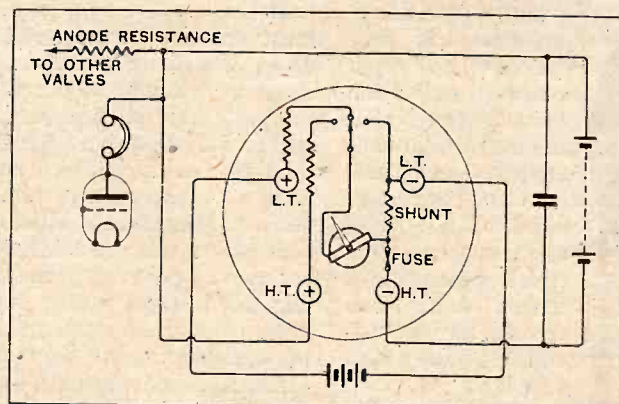

Fig. 3.—Combined multi-range voltmeter and milliammeter fitted with single-pole switch and suitable for connecting in the negative H.T. lead.

Radio Measuring Instruments.—

girder construction shown on the instrument in Figs. 1 and 5, amongst other illustrations, is extremely springy, and will stand a considerable overload without failure. Repeated overloads of 1,000 per cent. have no effect on the accuracy, and some instruments have been known to withstand a brief overload of 10,000 per cent., or one hundred times normal voltage. Robustness also includes the ability to withstand knocks and falls without loss of adjustment.

The force in a moving-coil instrument is proportional to the ampere-turns on the coil and the magnetic flux in the air gap in which the coil swings. The force multiplied by the radius of the coil gives the torque. For considerations of weight the radius should be kept small, and so it results that for the torque to be high, the coil ampere-turns and the flux should be a maximum. Generally, the ampere-turns range from about 0.1 to 2, being obviously less in a small instrument. The disadvantages of a high value are, that if the current is high the consumption of the instrument will be high, and for a larger number of turns the weight will be high, and will need a longer air gap in the magnet, which will result in the air gap flux being reduced. The magnet, however, should be as strong as possible, compatible with permanence. Tungsten-steel magnets are general, but lately cobalt-steel has come into use, and is adopted in the instruments shown in most of the figures.

Advantages of a Cobalt Steel Magnet.

To design a magnet for a given flux density, any good magnet steel may be used. Cobalt-steel has a higher value of "permanent magnetism," and also "coercive force," and so it is in general better where the strongest flux is required with a minimum volume of steel. A cobalt-steel magnet need be only about one-third the length of a tungsten-steel magnet, and about one-and-a-quarter times the area. However, as cobalt-steel is much more expensive, the smaller magnet costs more than the tungsten-steel, one has the advantage of the smaller bulk, and a somewhat better permanency with less "ageing."

The great advantage of a small but efficient magnet is that when installed in an instrument case there is ample room left for the accommodation of resistances and shunts. In this way small 2½ in. instruments may be made self-contained up to 500 volts.

The criterion for a good magnet is the factor

$$\frac{L_m}{A_m} \times \frac{A_g}{L_g}$$

where L_m is the length of the magnet,
 L_g is the length of the air gap,
 A_m is the area of the magnet,
 A_g is the area of the air gap.

This factor should be high. To take account of various magnetic materials the coercive force of the steel is multiplied by the above "safety factor," as it is termed; so that as cobalt-steel has a high coercive force the length of the magnet can be reduced and still be permanent. Lack of permanency is due to self-demagnetisation, which is caused by the action of the poles of a magnet on one another. The instruments shown have a figure of 13,300 for the "safety factor" multiplied by the coercive force.

The coil winding for an instrument is usually different for an ammeter than for a voltmeter. In the former the resistance should be kept low so that the millivolt drop across it can be low, whereas a voltmeter should take the smallest possible current from the circuit, particularly for such uses as battery eliminators where the output is limited. For this purpose it is generally accepted that one milliamperes for full scale is a reasonable value, whereas for ordinary work five milliamperes is not too

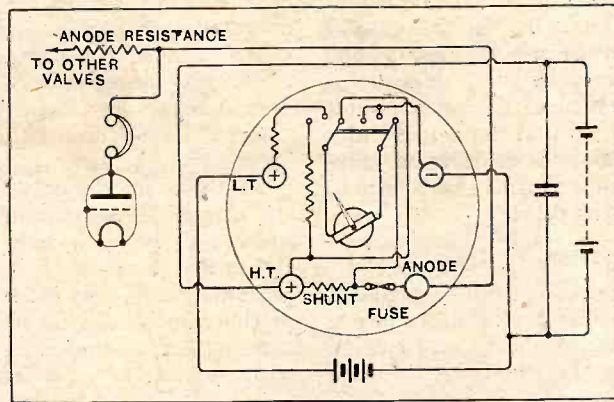

Fig. 4.—Multi-range voltmeter and milliammeter incorporating a double-pole switch so as to permit current readings to be taken in the positive H.T. lead.

much. On account of the strong magnetic flux in these instruments a winding for five milliamperes can have so few turns that the resistance is also low, resulting in the fact that a five-milliamperes winding, which is good for voltmeters, is equally suitable for shunted milliammeters and ammeters, as the overall voltage drop can still be kept down to the usual value of 75 millivolts.

This results in economy in that standard windings can be applied indiscriminately to voltmeters or ammeters, with the exception of the one-milliamperes winding. If this latter were used for ammeters the voltage drop would be about 150-200 millivolts, a figure which is rather high for a good instrument, although often of no real consequence for milliammeters.

The winding on the coil is of copper, having a fairly high-temperature coefficient of resistance. An unshunted milliammeter will have no error on account of temperature as the increased temperature will merely increase the volt drop. If a shunt is used, however, which will generally be of eureka or some other alloy of low-temperature coefficient of resistance, heating of the instrument will upset the proportion of current through the movement, unless the high-temperature coefficient of the copper is neutralised or swamped with eureka wire in series with it, the whole then having a low or negligible temperature coefficient. The "swamp," as it is termed, is adjusted usually to bring up the millivolt drop to 75, so that a swamp is necessary in order to add external shunts for any range, whilst if a plain unshunted movement is used there need be no swamp; but if such a winding is shunted externally, there will be an appreciable temperature error.

In a voltmeter the high series resistance acts as a

Radio Measuring Instruments.—

swamp, so that except for low-millivolt ranges the temperature error is quite negligible. In a multi-range ammeter there are several ways of connecting the shunts, and one of these is definitely better than the others, for when bad contacts occur at the switch, as is sure to happen in time to some extent, the calibration will be affected if this method is not adopted.

All the shunts are connected in series (Fig. 2), with all joints in the movement circuit soldered or otherwise solidly connected so that no alteration of reading due to variable contact resistance at the switch can occur. Any variable switch resistance alters the volt drop across the terminals, but not across the moving coil. The calculation of the shunts is somewhat more difficult, as for the lowest range the resistance of the other shunts is in series with the movement, so that the actual shunt drop will be greater than 75 millivolts in order to maintain 75 millivolts across the coil. Instead of a switch, a number of terminals may be used.²

Multi-range Meters.

The 75 millivolt, 5 milliampere winding detailed being equally suitable as a voltmeter or ammeter, it can be arranged for this purpose by means of a switch, and any number of ranges may be fitted. A common requirement for wireless receivers is an instrument to read anode current in milliamperes, anode volts and filament volts. Owing to the compact magnet in the instruments described, the case can be made to accommodate a switch as well as the shunt and two resistances, and various combinations of ranges can be provided. There are two alternatives in the measurement of anode current; if the current is measured in the negative lead a single-pole switch is sufficient, but if it is required to measure current in the positive lead then a double-pole switch becomes essential. This will be seen from Figs. 3 and 4. A specimen instrument is shown in Fig. 5.

It is often said that the scale of a moving-coil instrument is always evenly proportional, or linear. Whilst this is the case in theory, it presupposes that the magnet is perfectly homogeneous and free from small flaws, that the air gap is perfectly uniform, and that the springs are perfectly true in that the deflection is directly proportional to the torque. In practice slight departures from perfection are bound to occur, and so the scale may be not quite linear in consequence. If the scale is absolutely linear it may be a printed one made to fit all requirements, and if so it should be considered with suspicion.

When comparing instruments of different types and makes it must be remembered that the consumption, torque, etc., can be correctly compared only with

² For more details the reader is referred to a paper by the present author, "Increasing the Range of D.C. Measuring Instruments." *Experimental Wireless*, February, 1925, p. 291.

equal lengths of scales. Imagine a voltmeter of 200 ohms per volt resistance for a full-scale deflection. If this had a scale of half normal length, the apparent consumption would be halved, giving the impression that the resistance was 400 ohms per volt. The long scales shown on the illustrations are representative of good modern practice, so that when comparing the above factors the scale length must be taken into account. Generally, this feature is common to other types as well as moving coil.

Moving-iron Types.

Moving-iron instruments will be considered in less detail, as their use for wireless purposes is not so wide as is the case of moving-coil instruments. Cheap instruments are usually of this type, as they can be manufactured more cheaply than any other type.

In these instruments the torque is proportional to the square of the current and to the rate of change of inductance between zero and full-scale deflection. To the former term is due the "square law," or non-proportional scale, and the latter shows that the disposition of the iron should be such that the inductance of the winding is a minimum at zero and a maximum at full-scale deflection. The attraction type has, of course, one iron, and the repulsion type, two.

Electrically, there is no difference between the two, and, in general, the lowest ranges available are about 10 volts and 1 ampere, or, for smaller instruments, somewhat less. As a milliammeter or ammeter the consumption varies from about one-third to one voltampere for a small instrument, and for voltmeters more on account of the necessary swamping resistance.

It is sometimes stated that this type will read equally well on D.C. as on A.C., but this does not necessarily follow, as, unless the inductance is well swamped, there is bound to be a frequency error, and D.C. may be considered as A.C. of zero frequency.

For range changing, voltmeters may have added series resistance, but shunts are not permissible for ammeters unless there is a swamp in series with the coil, all this increasing the instrument volt-drop, which is more than that of a moving-coil instrument for the same range and size, with the exception of very high current ranges.³ Moving-iron voltmeters have a greater milliamperere consumption than moving-coil voltmeters of the same range. While it was stated that a moving-coil voltmeter of 5, or even 1, milliamperes is easy to produce, a good moving iron of about 100-200 volts range will require, perhaps, 20-50 milliamperes, and one or 10 volts about 100 milliamperes. In cheap instruments, of which there are many on the market, these figures are considerably exceeded.

(To be concluded.)

³ "Multi-range A.C. Instruments." *Elec. Rev.*, Aug. 19, 1927, p. 295, Aug. 26, p. 430, and Sept. 2, p. 397.

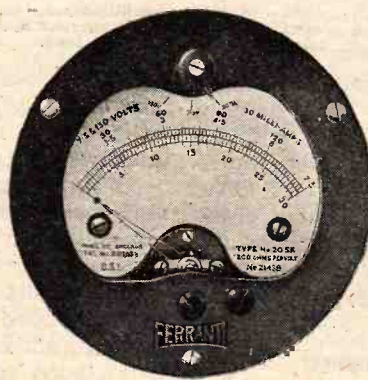
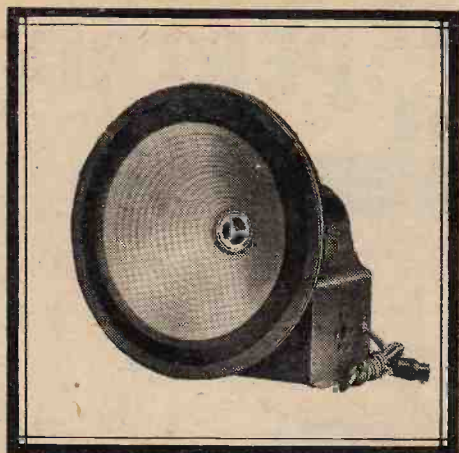

Fig. 5.—Combined pattern instrument arranged for reading L.T. and H.T. potentials and anode current.



Senior "R.K." Unit with A.C. Field Excitation.
 This "R.K." Unit has a 10in. corrugated cone with moving coil, having an impedance of 10-15 ohms at 50/4,000 cycles. The pot magnet is mounted in a pressed metal base, which also contains a mains transformer, Mazda U.U. 60/250 rectifier valve, and smoothing condenser for the supply of field current.
 Price £11/10/0.

The B.T.H. "R.K."—justly described as the world's finest reproducer—first appeared in 1926 and its advent created a new standard of reproduction.

Four years have elapsed since then, but still the "R.K." maintains its leadership.

The new range of models includes the 10in. cone "Senior," with or without built-in rectifier for use with A.C. mains supply, and the "Junior" with 6in. cone.

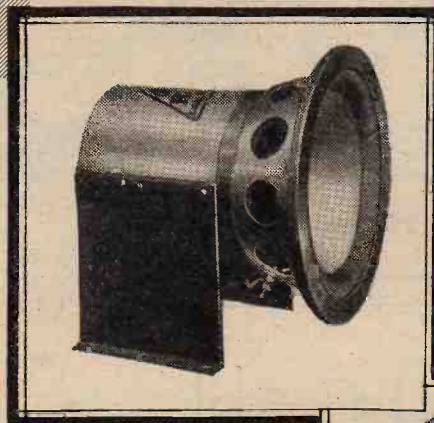

The Senior "R.K." Unit incorporates a 10in. corrugated cone with moving coil, having an impedance of 10-15 ohms at 50/4,000 cycles.
 Price £7/7/0.

The Junior "R.K." Unit has a 6 in. straight-sided cone with moving coil, having an impedance of 10-15 ohms at 50/4,000 cycles.

Price £6/6/0.

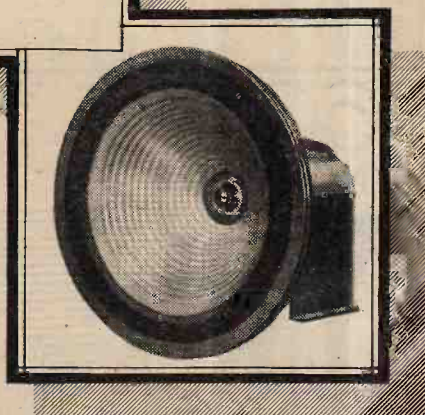

REPRODUCERS



B.T.H. "R.K." Reproducers are manufactured in Great Britain.

THE EDISON SWAN ELECTRIC CO., LTD.,
 Radio Division,
 1, Newman Street, Oxford Street, W.1.
 Branches in all Principal Towns.

EDISWAN

W68

You will hear it better with a **PERTRIX** PATENT DRY BATTERY

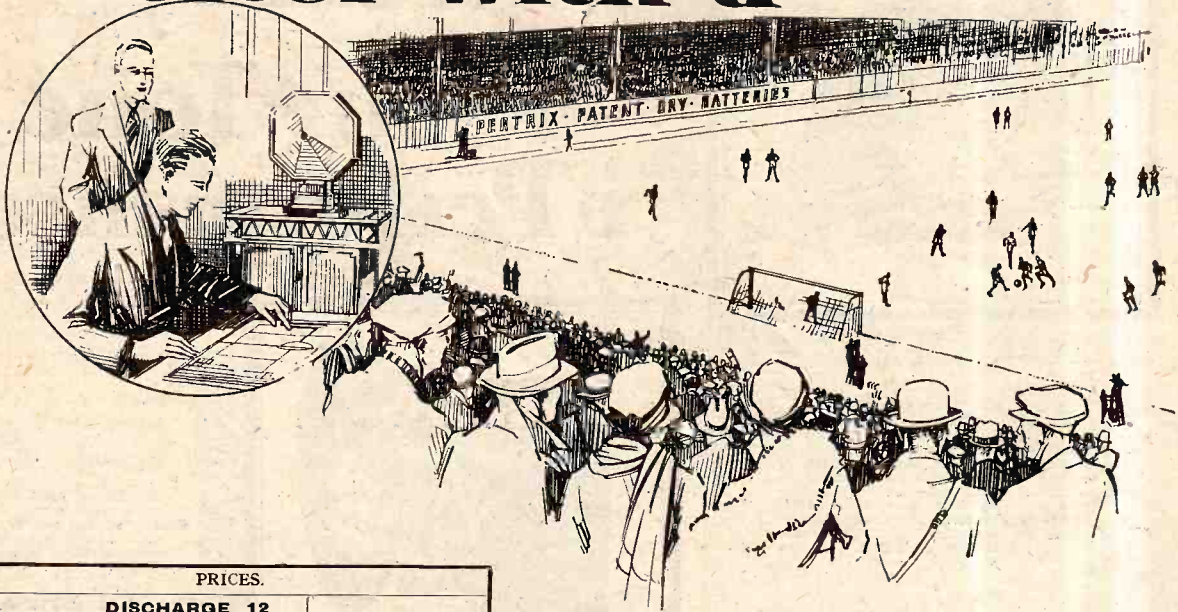

STANDARD.		DISCHARGE 12 MILLIAMPS.		GRID BIAS.	
Size in inches.					
Volts.	L. B. H.	s.	d.	Volts.	s. d.
60	5 1/2" x 6 1/2" x 3 1/2"	8	0	9	1 6
100	8 1/2" x 6 1/2" x 3 1/2"	13	0	12	2 3
120	10 1/2" x 6 1/2" x 3 1/2"	15	6	15	2 9

**60%
LONGER LIFE**

**What
a life!**

NO SAL-AMMONIAC



The **PENALTY** of using an ordinary sal-ammoniac battery is that you are unable to use all the power. As time **PASSES** the cells corrode internally and become choked long before the useful life of the battery is over.

TACKLE your H.T. problem by **SHOOTING** your old sal-ammoniac battery into a **CORNER**, and buying a new Pertrix.

You get more **KICK** and a life often as much as **80%** longer.

The **NET** result will be that you will use only two Pertrix batteries where you had three ordinary batteries before.

When you buy a Pertrix, you will then have reached the **GOAL** of perfect radio reception.

You can also obtain Pertrix batteries for your flash lamp. Write for leaflet "B," which will give you full particulars of all types.

PERTRIX PATENT DRY BATTERY

PERTRIX LTD.,
Britannia House, 233, Shaftesbury Avenue,
London, W.C.2.

Events of the Week

In Brief Review

CURRENT TOPICS

THE HAPPY INDUCEMENT.

A New York motor dealer recently offered a wireless set with every second-hand car.

o o o o

A NEW HORROR.

Doncaster listeners are complaining of a new form of interference to broadcast reception, caused by automatic traffic signals. The regularity of the "clicks" is said to intensify the irritation.

o o o o

AMERICAN TWO-WAY TELEVISION.

Two-way television in conjunction with ordinary telephones was demonstrated by the American Telephone and Telegraph Co. in New York on April 9th. According to a *Times* correspondent, speakers saw each other as if they were conducting a conversation with someone at an open window 10 to 12 feet away, although the actual separation was about three miles.

Dr. Frank Jewett, president of the Bell Telephone Laboratories, explained that the system employed was not yet commercially feasible.

o o o o

BUSINESS BEFORE PLEASURE.

Listeners to the Canadian National Railway's broadcasting station at Winnipeg have enjoyed some unusual "surprise items" of late in the form of verbal instructions given by a Canadian Government official to the Postmaster of the Hudson Bay Post at Cape Dorset, Baffin Island, relating to food supplied for an Eskimo village. By special arrangement, the Canadian Government makes use of the Winnipeg station for communication with Hudson Bay factors, who are equipped with portable broadcast receivers.

IRELAND AND TELEVISION.

In response to an appeal from the *Irish Radio News* for television experiments in Ireland, the Baird International Television Co. replies that it is considered that it would be in the best interests of television generally to confine experimental work to London until the results of the present dual transmissions can be known and utilised.

o o o o

RADIO SOCIETY OF GREAT BRITAIN.

"Recent Advances in the Construction of Condensers for Radio Circuits" is the title of a lecture to be given by a representative of the Telegraph Condenser Co. at a meeting of the Incorporated Radio Society of Great Britain at the Institution of Electrical Engineers, Savoy Place, W.C.2, on Friday next, April 25th. The lecture will commence at 6 p.m. (Light refreshments at 5.30.)

o o o o

SIAMESE PRINCE'S RADIO EXPLOIT.

H.R.H. Prince Purachatra of Siam, who is already well known as a radio enthusiast, has added to his laurels by communicating on short waves with Bangkok while homeward bound in the Red Sea on the M.S. "Fionia." The distance of 4,000 miles was covered by a Marconi A.D.19 transmitter, working on 46.5 metres, which the Prince had purchased during his European visit. The transmitter is valve-driven with 100 watts input.

GO-AHEAD BRAZIL.

All secondary schools in San Paulo, Brazil, have been equipped with mains-driven wireless receivers.

o o o o

A NEW EXCUSE.

To the long list of police court excuses offered by users of unlicensed sets must now be added that of a Sheffield pirate who said that he understood that a new set could be operated for one month without a licence.

o o o o

GRAMOPHONE SPRING UNITS.

We are asked by the Filograph (Parent) Company, Limited, to state that it has been decided not to proceed further with the project for manufacturing and selling gramophone motors with detachable spring units under British Letters Patent No. 318,711. This decision is the outcome of alleged prior anticipations cited by the German Patent Office.

o o o o

GOVERNMENT CO-OPERATION IN RADIO-TELEPHONY RESEARCH.

The question of radio research has been raised by the Earl of Clarendon in the House of Lords. Lord Clarendon asked the Government if they would give every possible facility to Imperial and International Communications, Ltd., for research and experimental work in connection with wireless telephony, explaining that his enquiry was prompted by the hope that the Post Office did not intend to obstruct the company's efforts to meet the competition of the American Telephone and Telegraphs Corporation.

Replying for the Government, Earl Russell promised that the company would have the co-operation not only of the Post Office, but of the Department of Scientific and Industrial Research, the only reservation being that co-operation should not extend to joining in commercial advertising.

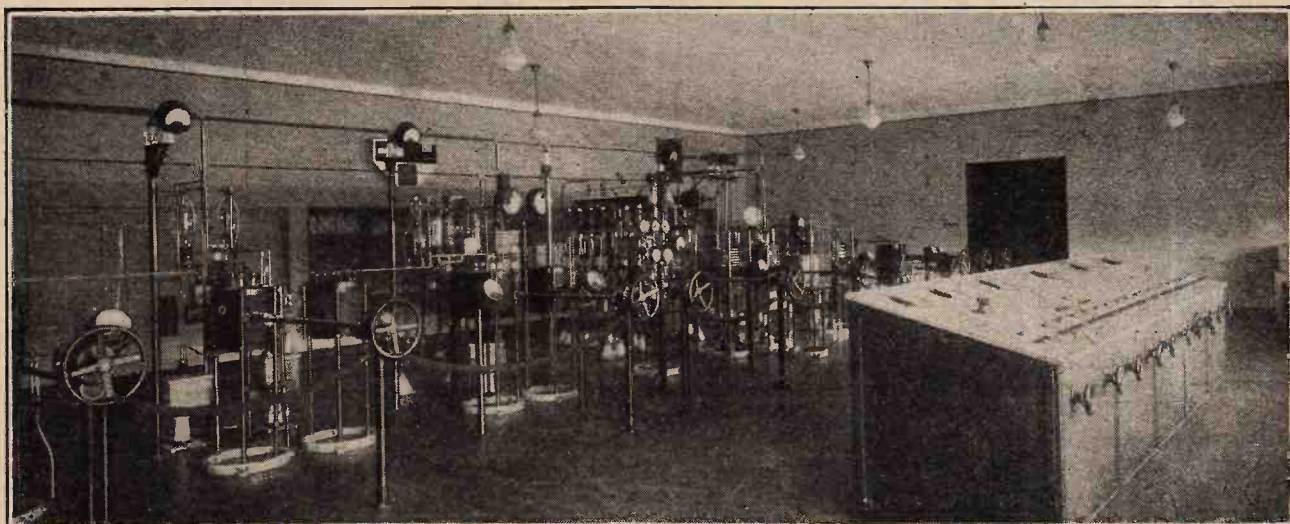

An interesting view of the control room of the Oslo broadcasting station.

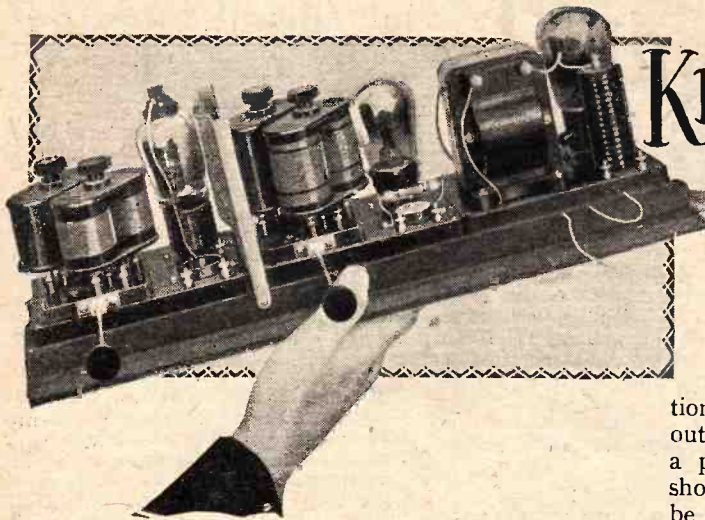

KIT CONSTRUCTORS' NOTES

Lewcos Three-valve Kit Assembly.

It would perhaps be more correct to describe this piece of apparatus as a receiver chassis than as a kit set. As sent out by its manufacturers, it is not in a form capable of immediately receiving signals, but can be made to do so simply by connecting three variable condensers, an on-off switch, and, of course, the usual batteries and aerial-earth system. The set is compact, and is particularly likely to appeal to those who wish to convert some piece of furniture, such as a bureau or cabinet, into a radio receiver with a minimum of trouble and expense. Alternatively, the chassis may be housed in an American-type cabinet of conventional design and standard dimensions, fitted with a front panel, for which drilling details are given by the makers.

An important feature is the provision of means whereby battery valves or indirectly heated A.C. valves may be used at will. If the latter are chosen, the set, in conjunction with an external H.T. eliminator, needs no batteries other than that for biasing the output stage.

The circuit arrangement is simple and straightforward, comprising an S.G. high-frequency amplifier, transformer-coupled to a grid detector with capacity controlled reaction between its plate and grid circuits. The single L.F. stage is coupled by a transformer of fairly high step-up ratio. These details are shown in the accompanying diagram, which indicates the connec-

tions for A.C. valves and a directly heated triode in the output position. This latter valve may be replaced by a pentode, and, indeed, it is recommended that one should be used where the necessary anode current can be supplied—as is almost invariably the case when energy is derived from the mains.

When a pentode is used, its screening grid terminal is normally connected by a short lead to a plug socket which picks up connection with the main H.T. positive feed. An economy in current may be effected by joining this screening grid terminal directly to a point giving a voltage rather lower than that applied to the anode.

It is not difficult to see how the necessary circuit alterations are almost automatically brought about when battery valves are substituted. Imagining that all the extra "cathode" connections are eliminated—as they actually are when four-pin valves are inserted in the holders—it will be appreciated that, as all grid-return

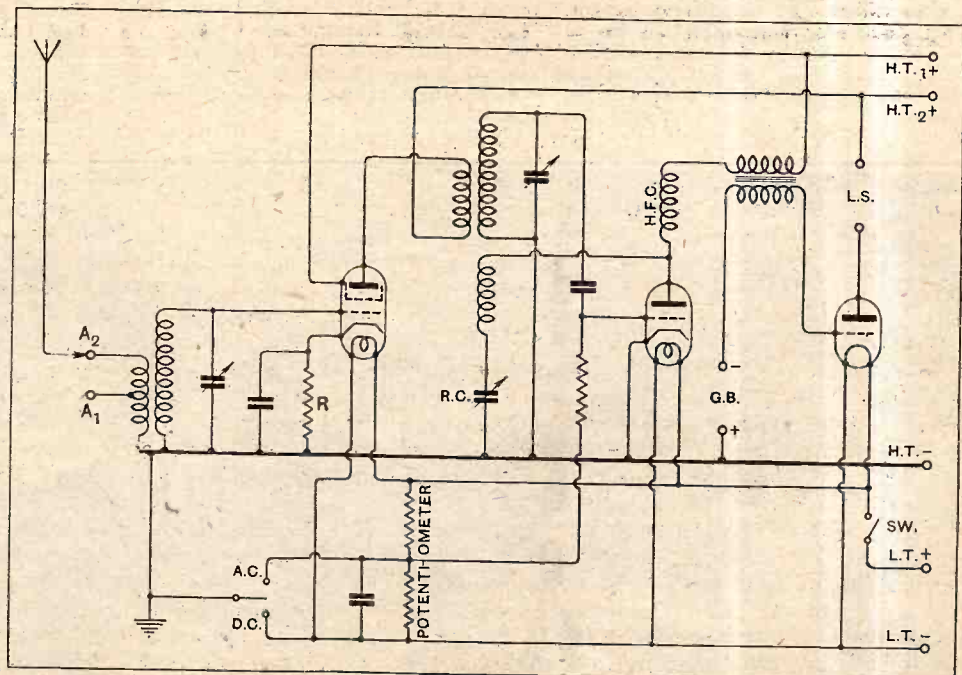

Complete circuit diagram, showing how the earth bus-bar may be changed over to provide appropriate cathode connections for either A.C. or battery L.T. supplies.

Kit Constructors' Notes.—

leads are taken to the H.T. negative bus-bar, the normal circuit is obtained merely by joining this "earth line" to the L.T. negative bus-bar by means of the change-over link provided, and which is indicated in the diagram. Under these conditions, the H.F. valve works with a zero grid, as the automatic bias resistance R is no longer in circuit. By virtue of its connection to the potentiometer *via* the grid leak, the detector grid now receives a positive bias equal to one-half of the L.T. battery voltage, instead of operating at zero, as it does with an A.C. supply.

From whichever source energy is derived, it is essential to see that the link referred to in the preceding paragraph is in the correct position. With an A.C. feed, the 4-volt L.T. output of the external power transformer is obviously joined across the receiver L.T. terminals, while the eliminator output is connected to the appropriate H.T. terminals.

quired to complete the set, and so it is unnecessary to make any soldered joints. There is a good deal of latitude as to the position of these extra parts with relation to the chassis, which measures about 18in. long, 5 $\frac{3}{4}$ in. deep, and 5 $\frac{1}{4}$ in. high overall.

The set was first tested with battery valves. It showed itself to have a good measure of selectivity, and, in London, there was no need to resort to any artifices or even to use the more selective aerial tapping in order completely to separate the twin local transmissions. Quality of reproduction was up to the standard to be expected of a "safe" receiver of this type, in which stray L.F. reaction is most unlikely to be present.

It is only to be expected that very small static coils such as those included should have a fairly high H.F. resistance, in spite of careful design, and so it was not surprising to find that the high-frequency gain was rather on the low side, a fair amount of reaction being necessary for reception of distant stations. This is not

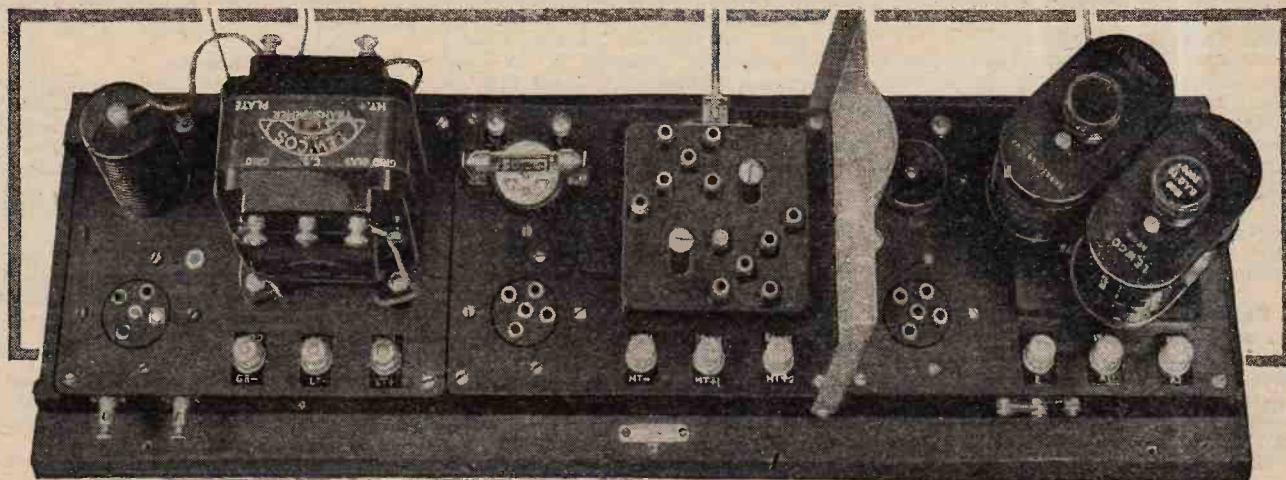

Plan view, showing carrier for H.F. transformers, which have been removed from their sockets.

Construction is on a modified "unit" system, components in the H.F. amplifier, detector, and L.F. circuits being mounted on separate moulded bakelite blocks; the three units are secured in line to a pair of wooden battens. Most of the wiring is on the underside of the blocks, and is concealed and protected by a wooden base below the battens.

Waveband changing is effected in an unusual way. Sockets for the medium- and long-wave coil assemblies are mounted on a sliding carrier, to the underside of which are fitted spring contacts which engage with fixed contacts on the base. Thus the appropriate aerial-grid and intervalve couplings are placed in circuit by moving the carriers bodily with their pairs of transformers; the necessary movement is transmitted through rods terminating in knobs which project through the control panel. The transformers are of the binocular "field-less" type, and are extremely compact. A small vertical screen is placed between them.

Terminals are fitted in convenient positions for connection of the various external components that are re-

altogether a matter of pure H.F. amplification, the question of detector action being involved. A glance at the circuit diagram will show that the rectifier anode circuit is not shunted by any by-pass capacity when the reaction condenser is at zero; under these conditions rectification efficiency is bound to suffer. Actually, this is not a serious drawback to distant reception, as reaction control is unusually smooth and constant.

As was to be anticipated, overall magnification was slightly increased when A.C. valves, with their inherently higher efficiency, were tried. The set still worked with complete stability under normal conditions, but self-oscillation was produced over a part of the tuning scale when a short length of wire was substituted for the full-length outside aerial. This tendency was readily checked by applying a screening grid voltage slightly below the optimum value, and in any case it must not be taken that the set is unsuitable for use with a short indoor aerial, as instability is only evident when the H.F. valve happens to be a particularly "hot" specimen.

BROADCAST

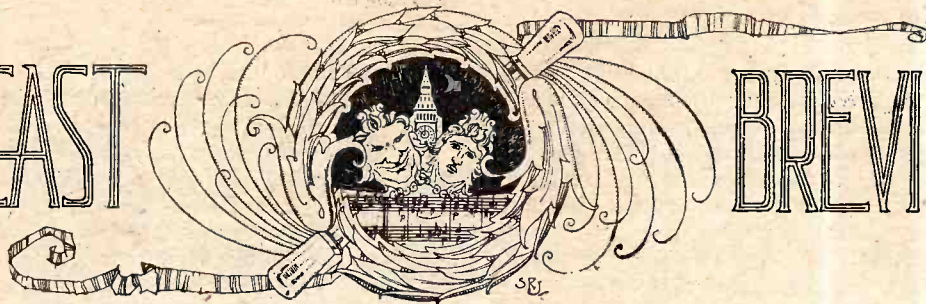

BREVITIES

By Our Special Correspondent.

News from 5SW.—Awaiting Dominion Response.—Licences in the Provinces.

News for the Empire.

Empire broadcasting is again in the limelight. By the time these lines are read it is probable that the inauguration of an experimental Empire news service from 5SW, Chelmsford, will have been announced, if not actually started.

Music Takes Second Place.

Hitherto, owing to copyright restrictions, 5SW has closed down during the news broadcasts from the ordinary B.B.C. stations. These silent intervals have sorely tantalised listeners abroad to whom news from home, however fragmentary, is as welcome as water in the desert.

It has now been recognised that even the finest music from the Mother Country does little to satisfy the real needs of the Dominions and Colonies.

A Daily Bulletin.

I understand that the new experiment is made possible by the co-operation of Reuter's Agency, which is arranging the preparation of a special bulletin to be broadcast at 6 p.m. every week-day from 5SW.

This progressive step is understood to be the outcome of the recent preliminary Conference on Imperial broadcasting held at the Colonial Office. The inclusion of news will immensely increase the value of the existing service, and will help to console our cousins abroad while awaiting the advent of the half-promised permanent Imperial broadcasting station.

Awaiting the Dominion Response.

Meanwhile it is hoped that this effort on the part of the Mother Country will meet with a suitable response from the Dominions. Only by the reception of reports can the success of the present experiment be judged; and the Dominions will not need to be reminded that the costly business of inaugurating a permanent service will be undertaken only if it is likely to fill a real demand.

A Vigorous Conductor.

Who is the most energetic musician in the world of broadcasting? Surely it would be difficult to find a more worthy claimant than Sir Henry Wood. During the Friday and Saturday preceding last week's broadcast performance of Mahler's Eighth Symphony Sir Henry conducted rehearsals lasting twenty-four hours. Each section of the orchestral

and vocal "machine," comprising 500 performers, was rehearsed separately—quite a terrific task at the end of a long musical season.

Another B.B.C. Chorus.

Massed choirs are not always successful from a broadcasting point of view, but no one will deny that the National Chorus under Stanford Robinson is an ideal microphone combination. I hear that the B.B.C. is now forming another chorus of a probationary kind, consisting of 100 voices, which will work independently of the National Chorus, but will fill vacancies in the latter as they occur.

Papal Broadcast Relay?

A B.B.C. relay of a speech by the Pope will probably take place on Sunday, June 29th, when, according to Rome reports, His Holiness will celebrate the Feast of St. Peter and St. Paul by a personal appearance at the microphone of the new Vatican City short-wave station.

Musical Control Pioneer.

Mr. L. Stanton Jefferies, one of the first broadcasters in this country, and one of the few members of the original staff

to remain at Savoy Hill, went to Leipzig to advise on the balance and control of the Good Friday performance of the St. Matthew Passion, part of which was relayed to London Regional.

Mr. Stanton Jefferies is in charge of the musical balance and control section at Savoy Hill.

How the Towns Listen.

Apropos the recent disclosure in these columns of the licence figures showing how the listening population is distributed up and down the country, some interesting figures have now reached me indicating the relative importance, from a wireless viewpoint, of the big towns and their surrounding postal districts.

Omitting London, with its army of over half a million, we find that Birmingham heads the list with 88,476. Manchester follows with 86,578.

Canny Dundee.

Here are a few more: Liverpool, 74,760; Leeds and Bradford, 70,194; Glasgow, 58,776; Sheffield, 41,345; Newcastle, 38,392.

Of the towns provided with relay stations Dundee contributes the smallest number of licences, viz., 11,356.

The Masts at Slaithwaite.

The 200-ft. masts at Brookmans Park would look rather puny against the three 500-footers which the Radio Communication Company are to erect at Slaithwaite for the Northern Regional transmitter. It seems that there are no height restrictions at Slaithwaite, aircraft not being so plentiful in that neighbourhood as in the northern suburbs of London.

A Bigger Service Area.

That the service area of the Northern Regional will be greater than that of the London and National stations is admitted by the B.B.C. engineers. In many respects this will have its advantages, but it will not simplify twin transmission separation in Manchester and Huddersfield, not to mention Slaithwaite.

For the Sleepless.

A friend who evinces no enthusiasm over the proposal of "physical jerks" broadcasting before breakfast, suggests that the B.B.C. would perform a more useful function by providing a midnight yawn service for sufferers from insomnia.

FUTURE FEATURES.

National (261 and 1,554 metres).

APRIL 27TH.—Operatic concert relayed from 11, Downing Street.

APRIL 28TH.—Opening night of Covent Garden Opera Season relayed from Covent Garden.

APRIL 30TH.—"Gianni Schicchi," a comedy by Puccini. ("Cavalleria Rusticana" Mascagni.)

MAY 1ST.—"Robin Hood," a play. London Regional.

APRIL 27TH.—Orchestral concert from Eastbourne.

APRIL 28TH.—"Cavalleria Rusticana" (Mascagni). "Gianni Schicchi," comedy by Puccini.

MAY 1ST.—"A Mad Mummer's Bright Dream," a May Day revel by Charles Brewer.

MAY 2ND.—Excerpt from Covent Garden opera.

MAY 3RD.—Rugby League Cup Final relayed from Wembley Stadium.

Midland Regional.

APRIL 27TH.—Light orchestral concert.

MAY 3RD.—Military Band concert. Manchester.

APRIL 29TH.—Programme of Jewish music. Glasgow.

APRIL 30TH.—Opening of the extension of offices and works of the India Tyre and Rubber Company, Inchinnan. Band concert, and speech by Right Hon. J. H. Thomas.

Dielectric Properties of Insulators

Methods of Reducing Power Loss.

By W. H. F. GRIFFITHS, F.Inst.P., A.M.I.E.E.

(Concluded from page 406 of previous issue.)

AS has been previously stated, every insulating material has associated with it a figure representing its power factor and to which the power loss which occurs in that material is proportional. When choosing an insulating material for a particular purpose in the construction of wireless apparatus, therefore, power factor should be regarded as the true criterion of electrical quality, especially if low-loss design is intended.

It is not strictly true, however, to say that the power loss is proportional to power factor only, for it depends also upon another quality, that of permittivity, better known, perhaps, as specific inductive capacity (S.I.C.) or dielectric constant.¹ The permittivity of a material is simply the ratio of the capacity of a condenser having a piece of that material for its dielectric to the capacity of the same condenser having an equal volume of air of the same dimensions for its dielectric. It follows that the permittivity of air is unity. Now the capacity of a condenser may be defined as the quantity of electricity which is required to raise the potential between its electrodes to a certain amount, and therefore the electric field passing through the dielectric of a condenser is proportional to its capacity. It follows that an increase of capacity due to an increase of dielectric permittivity will produce a proportional increase of dielectric loss due to the consequent increased field density. Because of this, the power loss in a condenser having a certain insulating material for its dielectric is proportional not only to the power factor of that material but also to its permittivity.

A study of the vector diagram of Fig. 5 in the first instalment of this article will, perhaps, make this more clear without resort to fundamental ideas. If the capacity current is proportional to the value of C, and

if this is doubled, due to a corresponding increase of permittivity, it will be at once seen that I_D , the loss-producing "in-phase" current, is also doubled, for, of course, the phase angle ϕ_1 is constant for the material because its cosine is a measure of its constant power factor.

It is hoped that the reader by now quite appreciates the fact that the power loss in any material is proportional to the product of its power factor and its permittivity, and a tabulation giving the power-loss factor for various materials in general use in the construction of wireless apparatus is therefore included on this page.

This table, in which the materials are given in order of freedom from power loss, should prove an extremely useful guide to the selection of insulating materials for

low-loss apparatus. The materials are grouped into three sections of almost perfect, good, and poor insulators; those of the latter group should be avoided in the construction of low-loss apparatus unless the designer is sufficiently skilled to avoid concentrated electric fields through them. The wonderful mechanical properties of bakelite, for example, can be made use of, even in low-loss apparatus, by judiciously disposing parts of this material.

The values in some cases are very approximate, since both the power factor and permittivity of a material may vary with frequency and with physical conditions. Although in some materials these quantities are considerably different at telephonic and radio frequen-

cies they do not, usually, vary greatly over small bands of frequency, and the figures given are approximately correct for the usual medium short wavelengths of, say, 100-1,000 metres, and may be used relatively at other frequencies.

The power factors and permittivities of some of these materials are increased considerably by their absorption of moisture when they are left for any length of time in a humid atmosphere, and measures should therefore be taken to avoid both excessive atmospheric humidity during the use of low-loss apparatus and the effect of

Insulating Material.	Power-loss Factor (Power Factor × Permittivity).
Silica-quartz	0.0005
Mica	0.0010
Micalex*	0.015
Pyrex	0.020
Ebonite (best)	0.025
Keramot**	0.050
Glass (average)	0.10
American Whitewood	0.15
Bakelite (dielecto)	0.20
Vulcanised Fibre	0.25
Badly loaded ebonite	0.30
Bakelite (Continental)	0.35
Various specimens of white materials often used as insulators	0.40 0.50 0.60

* At high radio-frequencies.

** A good loaded ebonite or ebonite loaded with minerals to harden the material and to increase its mechanical strength.

¹ The modern term is much more descriptive of the property, the latter of the two older terms being particularly misleading, for the property is by no means constant for a given material under varying conditions.

Dielectric Properties of Insulators.—

humidity upon such apparatus by suitable design. Particularly should the absorption of moisture by materials be prevented as far as possible by sealing their surfaces with a thin coating of a good electrical varnish, which imparts a hard and glossy finish, although almost the same effect can be obtained on some materials by polishing their surfaces. High temperature is another physical condition which increases the power loss in most insulating materials, but one hardly likely to be met with except in high-power transmitter work.

The Influence of Power-Loss Factor Upon Design.

A few examples in the use of the tabulation of inclusive power-loss factors in apparatus design will now be given.

As has been stated previously in this article, every piece of insulating material used in the construction of a piece of wireless apparatus may be regarded as the dielectric of a small condenser which is electrically in

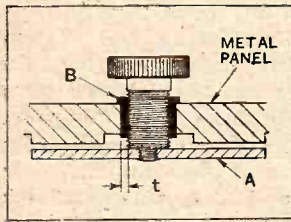

Fig. 8.—Illustrating the "dilution" of the dielectric loss in the insulating bush B by the pure air dielectric capacity between the plate A and the metal panel.

parallel with the main capacity of the apparatus, for in every wireless circuit there must be capacity, if only the self-capacity of an inductance coil. Usually, in low-loss apparatus the bulk of the circuit capacity is in the form of an air condenser, either variable or fixed, and the losses in the small insulator capacities of all the component parts of the circuit tend to render this air dielectric capacity impure. Viewed in another way, the losses in the various insulating materials are diluted by a much larger amount of pure air dielectric of the main condenser of the circuit. As an example, let a simple air condenser (Fig. 8) of, say, 90 micromicrofarads capacity be considered, and let the only insulating material employed to support the insulated plate A be the ebonite insulator B. If the capacity between the stem and the metal panel *through the insulator* is 10 micromicrofarads, then the power factor of the whole condenser is that of the insulator diluted ten times by the pure air capacity, in parallel with it. That is to say, the power factor of ebonite being 0.007, this figure must be divided by $90 + 10/10$ or 10, in order to obtain the power factor of the complete condenser resulting from the dielectric loss in its insulating bush, because the capacity in which the loss is occurring is only

a tenth of the total capacity on which the loss is effective. The power factor of the condenser will, therefore, be 0.0007.

It may be decided that, owing to a softening of the ebonite of this simple condenser or some other defect, it is desirable to substitute another insulating material more suitable, mechanically, for the purpose, say, Keramot. Upon referring to the table on the previous page it will be seen that the material to be substituted has a power-loss factor twice that of ebonite, and in order that the power loss shall not exceed that when ebonite was employed, it will be necessary, therefore, to halve the capacity of the

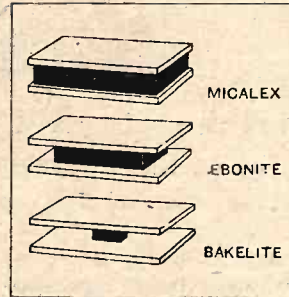

Fig. 9.—Showing the relative amounts of various insulating materials which are permissible if the dielectric losses between the pairs of metal plates are to be equal.

bush by making its radial thickness "t" twice its original dimension. If this dimensional alteration is effected, the power factor of the condenser will remain unaltered if the air capacity be slightly increased to make up for the smaller bush capacity, i.e., to bring the condenser again up to its original value of 100 micromicrofarads.

This example in the use of the table of relative power-loss factors can be used as a basis of low-loss design in a quantitative manner. The importance of the correct proportioning of the insulating material employed in low-loss apparatus is emphasised pictorially in Fig. 9, which shows the relative proportions of the insulators Micalex, ebonite and bakelite (Continental), permissible if the power loss is to be equal in all three cases. An even greater difference would, of course, be necessary between the best and worst materials included in the tabulation—a difference which would, in fact, be difficult to represent in this way.

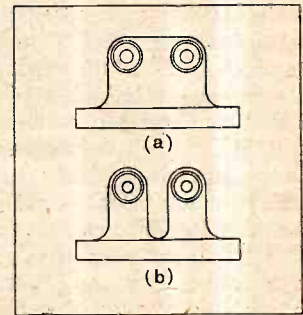

Fig. 10.—The dielectric loss between the terminals of the insulating moulding shown at (a) is reduced by reducing the capacity between them as at (b).

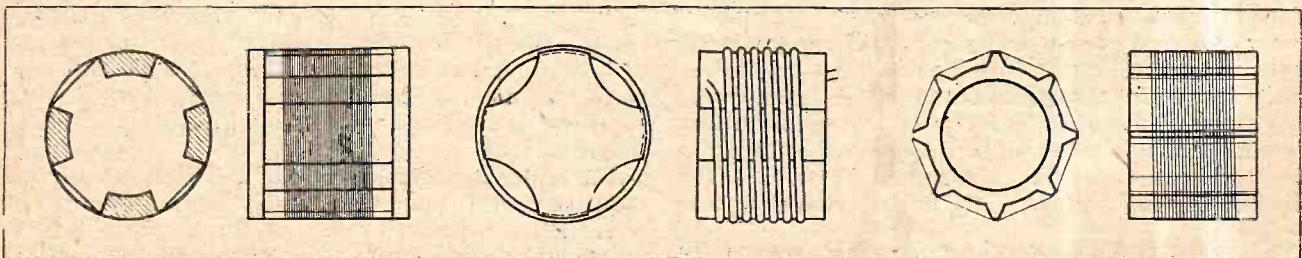

Fig. 11.—Various methods of reducing the dielectric loss in the insulating formers of inductances by the removal of superfluous material in close proximity to the actual conductor.

Dielectric Properties of Insulators.—

General Low-Loss Design Considerations.

Since the power factor of an insulator in any part of a circuit is diluted, as it were, by the main pure capacity of that circuit, it is immediately obvious that the larger the circuit capacity is made the less serious the loss in a given insulator becomes.

In some cases the main circuit capacity is either entirely formed by, or at any rate, augmented by, a fixed condenser of mica dielectric. It will be seen from the tabulation of power-loss factors, however, that mica is so free from dielectric loss compared even with the good materials that condensers, whose dielectric consists entirely of mica may, if properly constructed, be regarded as pure capacities for most wireless purposes. It is extremely fortunate that mica is both loss-free and laminar in structure, so that it may be split into uniform sheets of a thickness which makes a built-up fixed condenser an inexpensive proposition; no other material is at all suitable for this purpose.

In most cases where the framework of a piece of apparatus is of an insulating material of rather bad, or perhaps unknown, power-loss factor, the dielectric loss can be reduced by cutting away any superfluous material, especially that between metallic parts, between which a maximum potential difference exists. Fig. 10 illustrates such a case in which the insulating material is cut out from between the terminals in order to reduce the "loss capacity" between them.

The self-capacity of an inductance coil, although distributed in nature, and therefore difficult to conceive, may be a source of power loss to a circuit if the electric field between its adjacent turns passes through an insulating material of doubtful quality. In Fig. 11 methods are shown of reducing this source of power loss by removing superfluous material from the insulating former.

Another method of reducing the power factor of a piece of apparatus is that of screening its insulating material so that the electric field is prevented from passing through it. A simple case of this to serve as an illustration is shown in Fig. 12. It is the case of a variable air condenser in which the moving-plate system is made earthy and fitted with a screening disc to shield the fixed-plate system from stray capacities which would otherwise be introduced by the proximity of the hand during tuning. In Fig. 12a this shielding disc S is shown fitted to the top of the insulating panel E so that an electric field is permitted to pass through the latter from the fixed plate F, and contribute very considerably to the total loss of the condenser. If the shield is placed on the underside of the panel, as shown at S₁ Fig. 12b, the latter will be shielded from the field which exists between the moving and fixed-plate systems (except in the vicinity of the fixed-plate supports), and so the power factor of the condenser will be considerably improved.

The reader should be reminded of the possibility of considerable augmentation of power loss by a very poor

surface insulation, especially at the higher wavelengths and in telephonic frequency circuits. Therefore, although the chief object of the author in writing this article was to show that, in wireless apparatus, at any rate, the better-known surface leakage loss should be regarded as of secondary importance only, this source of loss should never be ignored entirely.

The Effect of Voltage and Frequency Upon Power Loss.

For the sake of simplicity, in dealing with the power loss which occurs in an insulating material, the effects of frequency and voltage have been omitted purposely.

The power loss in a condenser is $E I \cos \phi$, where E is the e.m.f. applied across it and the current passing through it at a given frequency, f, is

$$I = \frac{E}{\frac{1}{2\pi f C}} = 2\pi f C E.$$

Therefore, the power loss is $2\pi f C E^2 \cos \phi$.

It has already been shown that the power loss is proportional to the power factor $\cos \phi$ and also to C (for C is proportional to the permittivity of the dielectric material). These two quantities have been accordingly accounted for in the "power-loss" factor figures in the table given earlier. It is seen, however, that this

factor is only a measure of power loss for a given voltage E and at a given frequency f, for the total loss of power is dependent also upon these quantities as well as upon the qualities of the dielectric material.

Conclusion.

In conclusion there is, perhaps, just one other matter which for the sake of completeness should be mentioned here, although it is more relevant to condensers in general than to the dielectric properties of insulating materials. It is the connection between power factor and effective resistance of a condenser.

It was stated earlier that the power factor of a condenser was contributed to by series resistance, parallel resistance, and quality of material. It follows that the power factor of the dielectric material of any condenser² is augmented by series and parallel resistance to an extent which may be appreciable. In wireless work the losses of a condenser have to be added arithmetically to those of an inductance with which it is invariably to be associated in a resonant circuit. The losses of the inductance coil are collectively stated conveniently as effective (series) resistance at a given frequency, and it is therefore convenient also to collect the three forms of condenser loss into one quantity termed the effective series resistance. For this purpose it is therefore necessary to be able to convert the power factor of a condenser (due to its dielectric loss) and its parallel resistance into their equivalent series resistances, and expressions which enable either of these quantities to be expressed in these terms for any given frequency are given herewith.

² As diluted in the cases of variable and fixed air condensers explained previously.

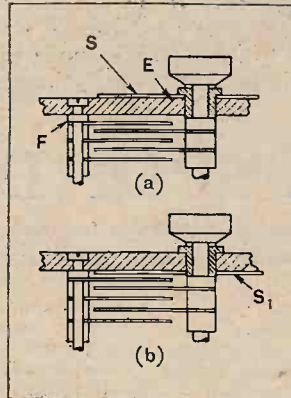

Fig. 12.—Reduction of power-factor of the variable air condenser shown at (a) by shielding the ebonite panel E from electric field by placing the screening disc S on the underside as at S₁ of sketch (b).

Dielectric Properties of Insulators.—

If R_s is the resistance in series with a condenser

R_p is the series resistance equivalent to a parallel resistance r , i.e., one which produces the same amount of power loss.

and R_ϕ is the series resistance equivalent to the power factor of the insulating material

then $R_p = \frac{I}{\omega^2 C^2 r}$ for condensers of fairly good quality such as are likely to be met with in practice.

$R_\phi = \frac{\text{Power factor of material}}{\omega C}$ for materials

likely to be met with in practice.

and the total effective resistance of the condenser

$$R = R_s + R_p + R_\phi.$$

R is a figure which can be added arithmetically to the coil resistance in order to find the total effective resistance of the resonant circuit. It should be noted that the units to be used in the above expressions are ohms and microfarads, and that $\omega = 2\pi f$.

CORRESPONDENCE.

The Editor does not hold himself responsible for the opinions of his correspondents.

Correspondence should be addressed to the Editor, "The Wireless World," Dorset House, Tudor Street, E.C.4, and must be accompanied by the writer's name and address.

"W.W." NO. 1.

Sir,—I still have a No. 1 copy of *The Wireless World* dated April, 1913, in excellent condition. The front cover is coloured, with a map of the world, a steamship, and six wireless masts, and 3d. monthly on it.

The advertisements are mostly of the big shipping lines. It would be interesting to know if there are any other readers in possession of a No. 1 copy. E. G. WRIGHT.
Eltham.

PICTURE RECEPTION.

Sir,—I read in the correspondence section of February 5th Mr. Wallace's opinion of the present system of Television. Would you, therefore, grant me a little of your precious room to point out to your correspondent the error of most of his statements?

In the first place, he suggests that wireless pictures are devoid of entertainment and education; from this, I gather, is meant "still pictures" of the Fultograph type.

I discussed the merits of these transmissions some time ago, and still feel sure that, to the serious experimenter, they afford considerable means of attaining some very useful data.

Mr. Wallace's idea of the present television system appears to be very vague when he says that it will be ten years before we can hope to have perfect reproduction, and that the scanning disc is impossible. If this, then, is his idea of the matter, I would suggest that he should endeavour to improve the present system instead of "heaving mud" at it.

When we consider the enormous strides made during the past two years in this particular branch of science, we cannot help feeling that the goal is not far distant.

Let us then summarise the state of affairs as they are at present with an unbiased mind.

Up to a short time ago the greatest difficulty to be overcome was that of synchronisation, viz., keeping both the transmitter and receiver discs in "step."

This has now been accomplished by means of the Magnetic Corrector.

The Photo Electric Cell, with its small "time-lag" and great sensitivity, has taken the place of Selenium.

The Neon Tube has been improved to such an extent that, altogether, the Televisor of to-day is not an empty dream, but a concrete fact, capable of producing images that are almost perfect.

This, then, being the case, it has occurred to me that Mr. Wallace's entry into the realm of television has been dogged by bad luck, or that he has not witnessed one of the demonstrations given in London during the last month or so, but is basing his knowledge on the experiments of early days, when the reproduced image of a pin looked more like a barrel than its real self.

One more point: the writer tells us that when a perfect system is evolved it will have to operate on a wavelength of below five metres.

This theory is grounded, I suppose, on the wide side bands required by the present apparatus, the wavelength being kept

low, so that it will not interfere with the B.B.C. programme. I think one might safely hope that long before that dreaded ten years is up we shall have the system confined to a band no wider than the average 10kW. station of to-day.

In conclusion, let me make it quite clear that I am in no way connected with the Television industry, but merely one who is deeply interested in the welfare of a new branch of science which, from a point of utility, knows no bounds.

Rhyl, N.W.

TREVOR R. LITTLE.

PHONES.

Sir,—Your contributor, "F. M. C.," on the subject of headphones, does not seem to have heard of Baldwin phones, which have been in use in America for many years, and are not unknown over here; they were used by Paul Godley for his first Transatlantic reception of amateur signals.

These phones have mica diaphragms driven by a balanced armature mechanism.

However, the ordinary type of headphone need not be so bad as "F. M. C." would have us believe; the response curves look bad enough, but are no worse than those of loud speakers which are considered quite good. L. J. VOSS.
Devon.

USE FOR OLD WIRELESS ACCUMULATORS.

Sir,—Many people up and down the country collect tinfoil and leadfoil from cigarettes and chocolates, etc., for their local hospital, but what about worn-out wireless accumulators and car-starting and lighting batteries, etc.? These weigh far heavier than tinfoil, and indeed a heavy old car-starting battery must represent at least a lifetime's work for anybody collecting tinfoil, and a small worn-out wireless accumulator a good many months of it.

The metal of accumulator plates contains a certain proportion of antimony which renders them considerably more valuable than ordinary scrap lead. At the same time worn-out accumulators are often only lumber, and people would be very glad to get rid of them. Also hospitals selling collections of old accumulators in quantities direct to the smelters would be able to obtain a far better price for them than anybody would be able to get for only one or two. It would thus be a very economical proposition to follow, in addition to benefiting the hospitals very considerably.

Of course, an old accumulator does not look such a nice gift to take to a hospital as a bright-looking ball of silver paper, but an old accumulator would be far more valuable, and a hospital is not built for show, but for strictly practical purposes. No doubt people would be pleased to organise collections of old accumulators in their district for the local hospital from time to time. With the millions of wireless users and the large number of motor cars in use, it seems to be an idea which would benefit the hospitals of the country to the extent of thousands of pounds in the aggregate if it were generally adopted, and who is not interested in hospitals? E. PICKWORTH FARROW, D.Sc.,
Vice-President of the Spalding-Johnson Hospital,

Limehurst, Spalding.

READERS'

PROBLEMS

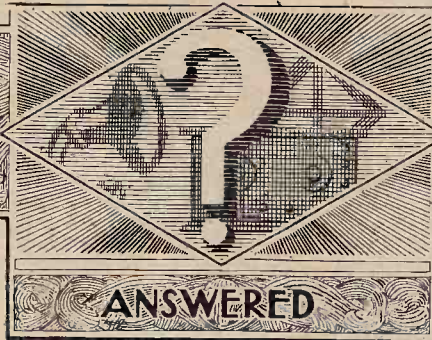

The Service is subject to the rules of the Department, which are printed below; these must be strictly enforced in the interest of readers themselves.

A selection of queries of general interest is dealt with below in some cases at greater length than would be possible in a letter.

"The Wireless World" Supplies a Free Service of Technical Information.

Testing for Interaction.

I am about to make up an experimental set with a capacity-coupled input filter, working on the lines suggested in your issue of April 2nd. As thorough screening is clearly necessary between the two inductances, I should be obliged if you would suggest a method whereby I can assure myself that magnetic interaction is not taking place.

H. C.

It should be an easy matter for you to obtain a very good idea of the extent of stray magnetic coupling between the two coils of the filter. All that you will have to do will be to short-circuit the coupling condenser, and then see whether it is possible to tune in any signals. If no signals can be received, or even if a near-by local station is heard, but only at greatly reduced strength, it can be assumed that screening is adequate.

If you make your test when the set is adjusted to receive a given transmission, it must not be imagined that an immediate cessation of signals when a short-circuit across the coupling condenser is introduced will indicate completely effective screening. By short-circuiting the condenser, a slight alteration in the capacity shunting each tuning coil is made, and this must be compensated for by readjustment of the tuning condensers.

Finally, you must not allow yourself to be misled by direct pick-up of powerful

local signals by the second tuned circuit of the filter.

o o o o

H.F. Transformer Construction.

I am about to try my hand at making an H.F. transformer of the section-wound type, in which the primaries are sandwiched between the subdivided secondary coils. As far as essentials are concerned, designs for couplings of this sort given in your journal will be followed. To avoid all risk of short-circuits between primary and secondary, I propose to insert strips of paxolin between the windings; is this likely to do any harm?

N. W. L.

We do not quite understand how the strips of paxolin are to be used; if it is intended completely to fill up the space between the primaries and secondaries with this material, then we definitely do not advocate your plan.

It should be emphasised that self-capacity between the primary and secondary windings of an H.F. transformer should always be kept as low as possible, and it is for this reason that in the best designs the dielectric material between them consists mainly of air. However, no great harm would be done by inserting narrow bars of insulating material at a few points in order to prevent accidental contact.

o o o o

Obviating a Possible Short-Circuit.

For H.F. amplification I use a neutralised triode, coupled to the detector by means of a transformer with interwound primary and balancing windings, the general design being that described in your journal in connection with the "Everyman Four" and other receivers of similar type. On several occasions a short-circuit has taken place between the two electrodes of the neutralising condenser, resulting in a burnt-out winding. Is it not possible to obviate the possibility of recurrence of this trouble by adopting a modified form of connection for the balancing coil? I seem to remember that you published information on this point some time ago.

R. B. R.

Burnt-out windings due to short-circuits in the neutralising condenser can easily be avoided by joining the low-potential

end of the balancing coil to the negative side of the H.F. valve filament instead of to the H.T. positive feed lead. Electrically, results are similar, or possibly even superior.

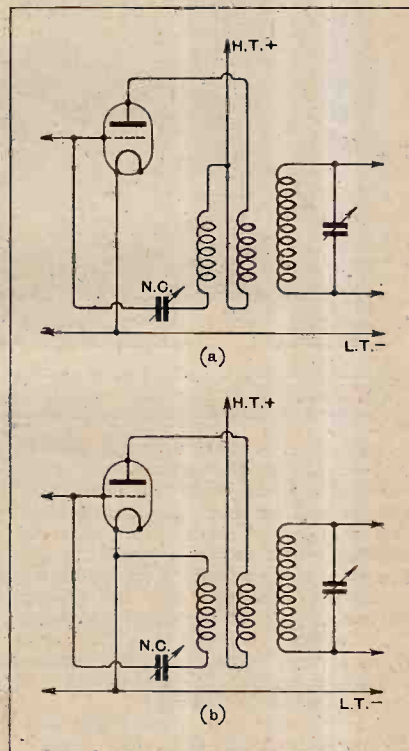

Fig. 1.—The conventional form of connection for a neutralised H.F. transformer (diagram (a)) compared with a method conferring immunity from burn-outs due to short-circuiting of the balancing condenser.

The two forms of connection are illustrated in Fig. 1, which shows the various coils which make up the neutralised couplings more or less in their relative positions.

To make the change, the bridging connection between the low-potential ends of the primary and neutralising windings of an "Everyman Four" type of transformer must be removed, and an extra lead taken from the latter point to negative filament, as indicated in diagram (b).

RULES.

- (1.) A query must be accompanied by a COUPON removed from the advertisement pages of the CURRENT ISSUE.
- (2.) Only one question (which must deal with a single specific point) can be answered. Letters must be concisely worded and headed "Information Department."
- (3.) Queries must be written on one side of the paper and diagrams drawn on a separate sheet. A self-addressed stamped envelope must be enclosed for postal reply.
- (4.) Designs or circuit diagrams for complete receivers or eliminators cannot ordinarily be given; under present-day conditions justice cannot be done to questions of this kind in the course of a letter.
- (5.) Practical wiring plans cannot be supplied or considered.
- (6.) Designs for components such as L.F. chokes, power transformers, complex coil assemblies, etc., cannot be supplied.
- (7.) Queries arising from the construction or operation of receivers must be confined to constructional sets described in "The Wireless World"; to standard manufactured receivers; or to "Kit" sets that have been reviewed.

Avoiding a Common Impedance.

(Referring to previous correspondence.)
You say that it is often necessary to provide entirely separate feeds for each anode circuit of a Det.-2 L.F. set having high-gain transformer-coupled stages, in order that eliminator reaction may be avoided: will you please give me a diagram showing how this principle may be applied to my own set? I am not quite clear whether a common smoothing circuit is permissible or not.

P. N.

In building an eliminator for a receiver of this sort, where, due to the high L.F. magnification provided by two transformer-coupled L.F. stages with modern valves, it is an extremely difficult matter to avoid incidental and harm-

this valve both hot and cold. Any falling-off which is observed when the filament is emitting will indicate the extent of grid circuit loading that is present. Obviously, it will be essential to ensure that input signal voltage remains constant while these measurements are being made.

Even if you cannot use a valve voltmeter, it is possible to form a good opinion of whether any loss is being introduced by measuring rectified anode current—still under constant input conditions, of course—first with normal connections and then with a really large by-pass condenser joined between anode and filament of the detector valve. If anode current rises very considerably when this extra by-pass condenser is added, it is shown definitely that grid circuit loading is taking place.

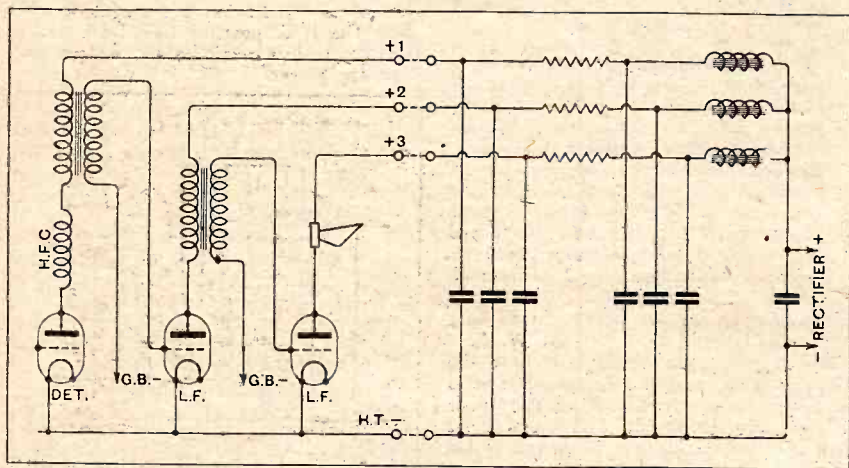

Fig. 2.—Individual smoothing circuits and voltage-reducing resistances for detector, 1st L.F., and output valves: connections between eliminator and receiver.

ful reaction, it is wise to avoid impedances common to all the anode circuits. To be on the safe side, we think you would do well to adopt the arrangement shown in Fig. 2, which provides a separate smoothing circuit for each anode supply.

You do not say whether your mains are A.C. or D.C., but this does not greatly affect our reply. If the supply happens to be "rough" D.C., it may be necessary to embody some of the refinements described in an article appearing in our issue of August 28th, 1929.

o o o o

Grid Circuit Loading.

I have been interested in articles dealing with loading of the grid circuit of an anode-bend detector by reverse reaction effects. This particular part of my own receiver has been designed, as far as possible, to minimise losses due to this cause, but I should like to know if there is any way of making a rough determination of the extent of loading that may remain.

G. B. H.

If you have access to a valve voltmeter, it will be easy to measure the reduction of grid voltage brought about by reverse reaction through the valve capacity; all that is necessary is to make measurements of signal voltage existing across the detector grid circuit with the filament of

Reaction Introduces Complications.

My "Wireless World Kit Set" is working quite well—indeed, very well on the upper part of its tuning range—but I am by no means satisfied that everything is as it should be. It seems that the reaction control circuit may be at fault, as when receiving at the lower end of the medium waveband it is essential to set it at minimum in order to prevent self-oscillation.

Do you think that this is due to my having used a condenser of different make (and also, I believe, of higher minimum capacity) than that specified for the original set as described?
E. C. P.

It is possible that your assumption is correct, but we are inclined to think it more likely that your H.F. amplifier is not completely stable, and we recommend that before going any farther you should reassure yourself on this point. To do so, all that is necessary is completely to disconnect the reaction control circuit, and then to see if the set is properly stable over the whole tuning range. If it is not, the H.F. amplifier should have attention before anything more is done. On the other hand, if there is no sign of self-oscillation, you will be able to conclude that the reaction system is at fault.

Difficulty in preventing self-oscillation may be due, as you say, to a reaction condenser with an excessively high minimum capacity, but we think this is rather unlikely, as there is normally a considerable margin.

Faults of this nature have been traced to a detector anode by-pass capacity (between plate and filament of the detector valve) with a capacity much less than specified. If the trouble still persists after checking this point, you are advised to remove a few turns from the reaction coil.

o o o o

Tracing Hum.

The amount of hum produced by my set (three indirectly heated A.C. valves) is more than I should wish, and in an attempt to get to the root of the trouble, I recently tried the experiment of short-circuiting grid and cathode of the detector valve. This produced almost complete silence, so I suppose it is logical to assume that the voltages giving rise to the hum are being in some way introduced into the detector-grid circuit.

Is it possible that direct magnetic induction should take place between the detector-grid coil and the A.C. power transformer, or possibly the A.C. wiring of the receiver?

G. H. H.

This is quite possible—indeed, it is a fruitful source of trouble in A.C. receivers. We suggest that you should try the effect of changing the relative positions of the coil and power transformer, and also make sure that your A.C. wiring is as nearly non-inductive as possible.

The use of a grid leak of rather lower value than usual is likely to help matters, and it is also worth while to try the effect of slightly more positive bias on the detector grid.

FOREIGN BROADCAST GUIDE.

BRUSSELS

(Belgium).

Geographical Position: 50° 11' N. 4° 22' E.

Approximate air line from London: 196 miles.

Wavelength: 509 m. Frequency: 590 kc.

Power: 1 kW.

Time: * Greenwich Mean Time.

* Belgium adopts British Summer Time.

Man announcer: Call: Allo! Ici Radio Belgique.

Opening Signal: Tuning note.

Announcements are made in French, and occasionally in Flemish.

Standard Daily Transmissions.

B.S.T. 17.00 and 18.00 concert; 18.30 gramophone records; 19.30 news; 20.5 main concert; 22.15 last news.

Usually closes down with a few bars of Belgian National Anthem: La Brabançonne.

RELIABILITY IN RADIO MEANS BENJAMIN

The popularity of Benjamin Radio Components is the outcome of best quality workmanship and faultless design. Complete absorption of vibration is obtained with the valve holders of Benjamin. Considerably lengthening the life of valves they are an inexpensive asset to any set. The rotary switch is new in design and adds to the appearance of the tuning panel as well as giving a definite indication of 'on' or 'off.'



5-Pin Valve Holder
For 5-pin valves with centre leg. In Bakelite, with one-piece springs, terminals and soldering tags 1/9

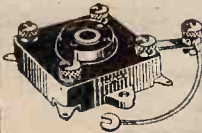

Pentode Valve Holder
The standard Clear-tone valve holder with flexible connection for attaching to terminal on pentode valves, 2/3



Vibrolder
One-piece Bakelite construction, with one-piece springs, self-aligning feature terminals and soldering tags 1/6



Rotary Switch
An effective alternative to the push-pull type. All insulated and with indicating dial.... 1/9

★NOTICE! PORTABLE-SET OWNERS

A new ball-bearing turntable, with folding legs, fitted with rubber buffers and smooth running ball-bearings. An inexpensive asset to any portable receiver. Price 7/6.

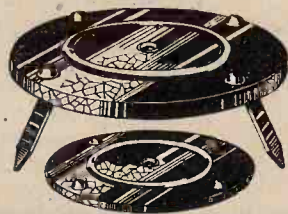

BENJAMIN

THE BENJAMIN ELECTRIC LTD.
BRANTWOOD WORKS, TOTTENHAM, N.17

'WARE ICEBERGS!



In mid-Atlantic. Wireless operator picks up urgent message from ice-patrol: "Icebergs on Liverpool-New York route!" At once, liner alters course. Disaster avoided, hundreds of lives saved from deadly peril... by warning received through Marconi Valves. Most British passenger-carrying ships use Marconi Valves. So do all Imperial Airways machines... whole Norwegian whaling fleet... all British broadcasting stations... Empiradio Beam Wireless... Metropolitan Police. For their dependability. For their wide range. For their long life. ● In cases like these, when unflinching reliability is essential, men insist on Marconi Valves.

FIT MARCONI VALVES TO YOUR RADIO SET



Give you clearer tone, greater volume, wider range. Cost not a penny more. Fit any set.

THE FIRST AND GREATEST NAME IN WIRELESS

For all technical information on valves, write to The MARCONIPHONE COMPANY LIMITED, 210-212 Tottenham Court Road, London, W.1

BETTER!

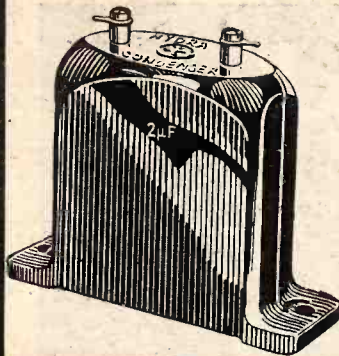

Better pass a danger once than to be always in fear.

Better still fit Hydra condensers now and never so much as worry.

HYDRA

LOUIS HOLZMAN
37 NEWMAN STREET, LONDON, W.1.
Telephone: Museum 2641.

PARFAIT

THE PERFECT EBONITE

SUPPLIED IN SIX FINISHES
Semi-Polished Black Semi-Polished Mahogany,
Highly Polished Black Highly Polished Mahogany
Matt Cube Surface

Obtainable from most wireless dealers.

Advertisement of H. B. Potter & Co., Ltd., Station Buildings, ROOHDALÉ.

The Yachting World

and Motor Boating Journal

The Leading British Yachting Journal

"THE YACHTING WORLD" deals with yachts and boats of all types and tonnages, whether on the sea or inland waters. Every aspect of yachting and motor boating is covered in an attractive and interesting manner.

Every Friday 6D.

ILIFFE & SONS Ltd., Dorset House, Tudor St., London, E.C.4

What the Pacific Engineering Laboratory Co. (U.S.A.) thinks of

EXPERIMENTAL WIRELESS

& The WIRELESS ENGINEER

"This is one of the best technical wireless journals we have read and we heartily recommend it to everyone."

MONTHLY 2s. 6d. net.

Subscription: 32s. per annum, post free.

ILIFFE & SONS LTD.,
Dorset House, Tudor St., London, E.C.4

W.W. 37

DICTIONARY OF WIRELESS TECHNICAL TERMS

(1926)

Compiled by S. O. PEARSON, B.Sc., A.M.I.E.E.
and issued in conjunction with
"THE WIRELESS WORLD."

This volume contains definitions of terms and expressions commonly used in wireless telephony and telegraphy and is intended to serve as a guide to all those interested in wireless who come across, from time to time, unfamiliar words in their reading. In such cases the DICTIONARY OF WIRELESS TECHNICAL TERMS proves of very great use and value. It is well illustrated, and cross-referenced to enable the required information to be rapidly obtained.

Price 2/- net. By Post 2/2

From leading booksellers or from the Publishers:

ILIFFE & SONS LTD.,
Dorset House, Tudor St., London, E.C.4.

W.W. 48

Mention of "The Wireless World," when writing to advertisers, will ensure prompt attention.

COMBINED H.T. UNIT WITH L.T. CHARGER

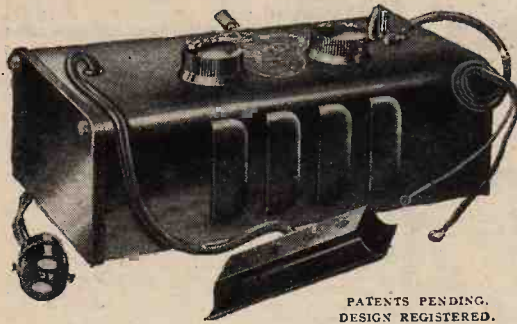

PATENTS PENDING.
DESIGN REGISTERED.

to fit inside any Portable

and suitable for all popular 2-3- & 4-valve receivers

Write for **FREE ART BOOKLET**
"Radio from the Mains."

For A.C. Mains only.
100, 200/220, or 230/250 volts. 40/100 cycles.
Incorporates Westinghouse Metal Rectifier on H.T. and L.T. side.
H.T. Output: 120 volts at 15 m.a. Size 9 in. x 5 in. x 3½ in.
H.T. Tappings: 2 variables (one S.G.) and one power.
L.T.: Trickle Charger for 2-, 4- or 6-volt accumulators.

PRICE

£5 17 6



For Radio from the Mains

REGENT RADIO SUPPLY CO. 21, Bartlett's Bldgs. Holborn Circus, London, E.C.4. Telephone Central 8745 (3 Lines)

JUST PUBLISHED

RADIO DATA CHARTS

A SERIES OF ABACS

providing most of the essential Data required in Receiver Design.

By R. T. BEATTY, M.A., B.E., D.Sc.

Reprinted from "The Wireless World."

"Radio Data Charts" provide designers of wireless apparatus with a ready and convenient means of solving problems without having recourse to complicated formulæ and mathematics.

By the use of the charts it is possible to tackle all the more familiar problems in radio receiver design; such as, for example, finding the relationship between inductance capacity and frequency, and working out the design of high frequency transformers. All keen amateurs will appreciate this helpful book.

Price 4/6 net. By post 4/10.

(39 CHARTS and more than 50 Diagrams.)

From all leading booksellers or direct from the Publishers.
Published from the Offices of "THE WIRELESS WORLD."

ILIFFE & SONS LTD., Dorset House, Tudor St., London, E.C.4.

W.W.93

MISCELLANEOUS ADVERTISEMENTS.

NOTICES.

THE CHARGE FOR ADVERTISEMENTS in these columns is:

12 words or less, 2/- and 2d. for every additional word.

Each paragraph is charged separately and name and address must be counted.

SERIES DISCOUNTS are allowed to Trade Advertisers as follows on orders for consecutive insertions, provided a contract is placed in advance, and in the absence of fresh instructions the entire "copy" is repeated from the previous issue: 13 consecutive insertions 5%; 28 consecutive, 10%; 52 consecutive, 15%.

ADVERTISEMENTS for these columns are accepted up to FIRST POST on THURSDAY MORNING (previous to date of issue) at the Head Offices of "The Wireless World," Dorset House, Tudor Street, London, E.C.4, or on WEDNESDAY MORNING at the Branch Offices, 19, Hertford Street, Coventry; Guildhall Buildings, Navigation Street, Birmingham; 260, Deansgate, Manchester; 101, St. Vincent Street, Glasgow, C.2.

Advertisements that arrive too late for a particular issue will automatically be inserted in the following issue unless accompanied by instructions to the contrary. All advertisements in this section must be strictly prepaid.

The proprietors retain the right to refuse or withdraw advertisements at their discretion.

Postal Orders and Cheques sent in payment for advertisements should be made **& Co.** payable to **LIFFE & SONS Ltd.**, and crossed **Notes being untraceable if lost in transit should not be sent as remittances.**

All letters relating to advertisements should quote the number which is printed at the end of each advertisement, and the date of the issue in which it appeared.

The proprietors are not responsible for clerical or printers' errors, although every care is taken to avoid mistakes.

NUMBERED ADDRESSES.

For the convenience of private advertisers, letters may be addressed to numbers at "The Wireless World" Office. When this is desired, the sum of 6d. to defray the cost of registration and to cover postage on replies must be added to the advertisement charge, which must include the words Box no. c/o "The Wireless World." Only the number will appear in the advertisement. All replies should be addressed No. 000, c/o "The Wireless World," Dorset House, Tudor Street, London, E.C.4. Readers who reply to Box No. advertisements are warned against sending remittance through the post except in registered envelopes; in all such cases the use of the Deposit System is recommended, and the envelope should be clearly marked "Deposit Department."

DEPOSIT SYSTEM.

Readers who hesitate to send money to unknown persons may deal in perfect safety by availing themselves of our Deposit System. If the money be deposited with "The Wireless World," both parties are advised of its receipt.

The time allowed for decision is three days, counting from receipt of goods, after which period, if buyer decides not to retain goods, they must be returned to sender. If a sale is effected, buyer instructs us to remit amount to seller, but if not, seller instructs us to return amount to depositor. Carriage is paid by the buyer, but in the event of no sale, and subject to there being no different arrangement between buyer and seller, each pays carriage one way. The seller takes the risk of loss or damage in transit, for which we take no responsibility. For all transactions up to £10, a deposit fee of 1/- is charged; on transactions over £10 and under £50, the fee is 2/6; over £50, 5/-. All deposit matters are dealt with at Dorset House, Tudor Street, London, E.C.4, and cheques and money orders should be made payable to Liffe & Sons Limited.

SPECIAL NOTE.—Readers who reply to advertisements and receive no answer to their enquiries are requested to regard the silence as an indication that the goods advertised have already been disposed of. Advertisers often receive so many enquiries that it is quite impossible to reply to each one by post.

"WIRELESS WORLD" INFORMATION COUPON

This Coupon must accompany any Question sent in before
APRIL 30th, 1930

For Particulars of Free Service, see Rules on page 445.

B&J

ALL WIRELESS WORLD COILS
1880 EVERYMAN'S

FOUR	47/3 set
NEW KILOMAG	45/- set
RECORD III	45/- set
FOREIGN LISTENERS 4 E.B.C.	40/- set
METAL CABINETS	5XK 37/6 set
54" DRUM DIALS with Escutechone	38/6 to 48/6

B&J. Wireless Co.

2, 3, & 4, Atheistane Mews, Stroud Green Rd., N.4
Archway 1695

The simplest, neatest aid to selectivity



Connect the new Belling-Lee Condenser Spade to your aerial lead. In every case it will greatly increase the selectivity, and in most cases it will entirely eliminate the unwanted station. This new idea combines a "0002 series aerial condenser" with a Belling-Lee clip-on Spade Terminal which ensures perfect contact.

Ask your dealer, or write to us, for Belling-Lee Handbook "Radio Connections."

only 2/6

Patent applied for.

BELLING-LEE
FOR EVERY RADIO CONNECTION

Advertisement of Belling & Lee Ltd.,
Queensway Works, Ponders End, Middlesex.

POWER CHOKES

guaranteed twelve months substantially built, for smoothing circuits in eliminators dealing with currents up to 300 milliampere, inductance 30 henries, 8/6 post free.

8/6

REPAIRS to any make of L.F. Transformer, Loudspeaker or Headphones. All repairs dispatched within 48 HOURS—TWELVE MONTHS' GUARANTEE with each repair. 4/- Post Free. Terms to Trade.

TRANSFORMER REPAIR Co.

Dept. W.,
214, High Street, Colliers' Wood, London, S.W.19.

FREE! 6d. Book

An interestingly written and well-illustrated 86-page book on Condensers. Invaluable to the radio enthusiast and should be in the hands of every set constructor and owner. Published at 6d., but sent Free to all readers of "The Wireless World" for 1d. stamp. Write Dept. W.

WINGROVE & ROGERS Ltd.

188-9, Strand, London, W.C.2.



RECEIVERS FOR SALE.

SCOTT SESSIONS and Co., Great Britain's Radio Doctors.—Read advertisement under Miscellaneous. [9264]

HIRE a McMichael Portable Set, by day or week, from Alexander Black, Wireless Doctor and Consultant, 55, Ebury St., S.W.1. Sloane 1655. [0328]

BURNDIPT 5-valve Ethrogrund, with valves and coils, £7/10; Marconi V2, 30/-; ditto, with amplifier, 50/-; carriage extra.—James Scott and Co., Radio Engineers, Dunfermline. [0333]

MULLARD S.G.P. Orgola Kit, 4-volt valves, less battery cords; £4; new Christmas.—Advertiser, 49, Leonard Rd., Hanley, Staffs. [9146]

PHILLIPS 7-valve 2511, all mains, A.C. 210, condition as new; £26; can be seen by appointment, S.W.16. district.—Letters to Box 5691, c/o The Wireless World. [9144]

OSRAM Music Magnet, complete kit, including valves, wiring diagram ready for home construction, also £5/5 Amplion loud-speaker; astonishing value for quick sale, inspection welcomed, £6.—Box 5690, c/o The Wireless World. [9143]

MULLARD Orgola, oak, makers' specification, less valves, £4; Amplion Lion, oak, £3; both perfect.—Eve, 65, Balsall Heath Rd., Birmingham. [9138]

S.G. 4v. Receiver, magnificent solid oak bureau, 4ft. high x 3ft. long, 18in. deep, complete with speaker and Exide H.T. and L.T. batteries; sacrifice, genuine bargain, cost £40, best offer.—Box 5663, c/o The Wireless World. [9128]

BERCLIF D.C.2 All Mains Receiver, 200 to 250 volts D.C.; price £14/10; with valves and royalties, suitable for M.C. speaker; particulars free; trade inquiries specially invited.—Simmonds Bros., Shireland Rd., Smethwick. [8734]

YOUR Old Receiver or Components Taken in Part Exchange for New; write to us before purchasing elsewhere, and obtain expert advice from wireless engineer of 22 years' professional wireless experience; send a list of components or the components themselves, and we will quote you by return post; thousands of satisfied clients.—Scientific Development Co., 57, Guildhall St., Preston. [0226]

OSRAM Music Magnet, S.G.3, 1930; £6/10.—Westcott, 77, Crowlands Av., Romford. [9172]

CRYSTAL Set and Marconi Headphones for Sale.—Apply Mrs. Fradeletto, 2, Clifton Hill, N.W.8. [9168]

EMPIRE Færia 5-valve Portable, only 13in. x 13in. x 8in., weight 20lb., brown leather case, metal corners, waterproof cover, excellent quality and range, condition as new; cost £25, best offer over £15.—Sankey, Albrighton, Wolverhampton. [9170]

MARCONI New 44 Receiver, latest model, with 2S.G. det. pentode valves, cost £23/10, accept £15/15, or exchange Marconi 55 portable, with cash; also Marconi M.C. speaker, in cabinet, D.O. mains, 75/-.—88, Mile End Rd., E.1. Phone: Bishopsgate 4593. [9166]

BURNDIPT Superhet, complete valves and 2 frames, £6; Futorgraph picture receiver, complete, £3; Magnavox M/C speaker, 6 volt, £3; many other parts cheap.—Coppin, 93, Mysore Rd., S.W.11. [9162]

ACCUMULATOR HIRE.

DON'T Buy Accumulators or Dry Batteries, join our C.A.V. low- and high-tension accumulator hire service, the largest and best in London; better and cheaper reception with no trouble; regular deliveries within 12 miles of Charing Cross; no deposit, payment on each delivery or by quarterly subscription; over 10,000 satisfied users; explanatory folder post free; phone or write to-day.—Radio Service (London) Ltd., 105, Torrington Av., N.W.5. Phone: North 0623 4-5. [8751]

BATTERIES.

WET H.T. Replacements.—Sacs (capped or uncapped), highest grade, No. 1, 10d. per doz.; No. 2, 1/9 per doz.—See below.

ZINCOS—Best quality (wired), No. 1, 8d. per doz.; No. 2, 9d. per doz.; orders valued 5/- carriage paid, otherwise 6d. for postage.—British Battery Co., Clarendon Rd., Watford, Herts. [0258]

CHARGERS AND ELIMINATORS.

CHEBROS—Chebros for all types of transformers and chokes, high grade instruments at a very moderate price; enquiries invited.—Chester Bros., 244, Dalston Lane, London, E.8. [5290]

TANTALUM and Lionium for A.C. Rectifiers; for inexpensive chargers; blue prints for H.T. and L.T., 1/- each; Lionium electrodes, 2-3 and 5-8 amps.—Blackwell's Metallurgical Works, Ltd., Garston, Liverpool. [8298]

DYNIC A.C. H.T. Eliminator, £3; Regentone, £3; Philips L.T. charger, £2/10; Ferranti trickle chargers, £1/10; carriage extra.—James Scott and Co., Radio Engineers, Dunfermline. [0335]

Mention of "The Wireless World," when writing to advertisers, will ensure prompt attention.

Wonderful Response!

A recent advertiser in "The Wireless World" writes:—

"I should like to inform you of the wonderful response to my advertisement in 'The Wireless World.' I have received no less than 20 applications for the Ferranti and Marconi Transformers and most of the other goods have been sold."

W. H. Trevett,
80, High Street,
Erith, Kent.

W.W.32.

EGYPT
NATAL
SOUTH AFRICA
MALTA

High Value!

"You will be pleased to learn that from my last advertisement in 'The Wireless World,' letters reached me from EGYPT, NATAL, SOUTH AFRICA, and goods were sold to a person residing in MALTA.

This undoubtedly proves the high value of your paper."

WILLIAM WINFIELD,
4, ARTHUR ST.,
HULL ROAD,
YORK.

W.W.33

Chargers and Eliminators.—Contd.

PHILIPSON'S Safety High Tension Battery Eliminators.

10/- Down and the Balance in Easy Monthly payments secures the finest high tension supply available.

PHILIPSON'S Safety Eliminators are Guaranteed for 12 Months.

PHILIPSON'S Safety Eliminators are the Cheapest to Install and the Cheapest to Run; prices: Model A.C.5 £4/17/6, A.C.7 £3/17/6, complete with full wave, rectifiers; D.C.4 37/6, D.C.5. 45/-

ALL Models Obtained for 10/- Deposit; take advantage of this and get constant high tension immediately.

WRITE for Our Booklet, "Radio Power" to Philipson and Co., Ltd., Radio Engineers, Astley Bridge, Bolton. 'Phone: 2038. 'Grams: Safety, Bolton. Est. over 50 years. [0318]

ZAMPA H.T. Eliminator Kit comprising rectifying unit (incorporating transformer, condensers, Westinghouse H.T.3), necessary condensers, choke, terminals, baseboard, etc., output 120 volts at 20 m.a.; complete, 45/-; 7 days approval against cash; other Zampa kits and transformers on request.—Mic Wireless Co., Market St., Wellingborough. [9080]

REGENTONE A.C. Model W4 Eliminator and L.T. Charger, as new; cost £14, accept £11.—Keech, Red Gables, Fleet, Hants. [9155]

HIGH-TENSION Eliminator, output 250v., 6 taps, 190 milliamp., 200-230v. A.C., as new, £5; linen double diaphragm speaker, 35/-.—H. R. H., "Hite," Sutton Common Rd., Sutton, Surrey. [9150]

MEGAVOX Eliminator (as specified "W.W." 12/12/28) A.C. 230-250, D.C. 200v. 100 m.a., Westinghouse, Ferranti, Pye components cost £13/10, write for full description, £8 or nearest offer; also Mullard 104v. A.C. power valve, new, 7/6.—Phillips, 7, Whitchurch Gardens, Edgware. 'Phone: 0493. [9145]

SAVAGE'S Specialise in Wireless Power from the Mains, reliable apparatus at reasonable prices.

SAVAGE'S.—Transformer laminations and Bakelite bobbins; intending home constructors should write for list.

SAVAGE'S.—Reliable smoothing condensers, 1,500 volt D.C. test, 1 mfd., 2/-; 2 mfd., 3/-; 4 mfd., 5/3; 500 volt D.C. test, 1 mfd., 1/6; 2 mfd., 2/3; 4 mfd., 3/9.

SAVAGE'S.—Super smoothing and output chokes, many types available; write for list.

SAVAGE'S.—Mains transformer for Westinghouse H.T.4 unit, with additional winding, 4 volts centre tapped 23 amps, 23/-; transformers for other Westinghouse units available.

SAVAGE'S.—Mains equipment for new Foreign Listeners Four, transformer N.F.L.4, 33/-; smoothing choke, C32G, 20/-; output choke C32O, 20/-.

SAVAGE'S.—Mains transformer B.T.4, 500-0-500 volts, 120 m. amps., 7½ volts 3 amps., 6 volts 3 amps., 4 volts 2 amps., 4 volts 1 amp., 4 volts 1 amp., all central tapped, specially developed for automatic bias; 57/6.

SAVAGE'S.—Mains transformers and power chokes are carefully and individually constructed from first class materials, with an exceptionally generous margin of safety.

SAVAGE'S, 146, Bishopsgate, London, E.C.2. 'Phone: Bishopsgate 6998. [9165]

CABINETS.

ARTCRAFT Radio Cabinets are Britain's Best Value. [0313]

DIGBY'S Cabinets.—Table models in solid oak and mahogany; from 11/6 to 71/-.

DIGBY'S Cabinets, fitted with Radion or Resistor ebonite if required.

DIGBY'S Cabinets.—Pedestal model, with separate battery components; from 56/- to £12.

DIGBY'S Cabinets Made to Customers' Own Designs.

DIGBY'S Cabinets.—Write for new 16-page art catalogue.—F. Digby, 9, The Oval, Hackney Rd., E.2. 'Phone: Bishopsgate 6458. [0128]

ARTCRAFT Radio Cabinets are Britain's Best Value. [0311]

CABINETS for All Requirements.—F. W. Ramsey, 63, Shattisbury St., London, N.1. Clerkenwell 7139. [8155]

ARTCRAFT Radio Cabinets are Britain's Best Value. [0309]

KAY'S Cabinets, the greatest range of pedestal cabinets in the kingdom; original creative designs at prices 50% lower than elsewhere; quotations for specials by return; delivery at short notice guaranteed.

RADIOGRAM Cabinets.—A variety of really practical and exclusive models from 60/-; illustrated lists free.

H. KAY, Wireless Cabinet Manufacturer, Mount Pleasant Rd., London, N.17. 'Phone: Walthamstow 1628. [8963]

VOX-VERITAS

BRITISH MADE
New C V Model

MOVING COIL LOUD SPEAKER is different!

—and it is just that little difference which makes all the difference between an ordinary moving coil loud speaker and a reproducer of pure music. Fullness of tone, absolute quality, a ready response to the highest and lowest frequencies with entire freedom from "boom." That is "VOX-VERITAS"
—the true Voice. Ask your dealer for a demonstration or write to us for descriptive pamphlet.



6 volt 8 amp. or
D.C. mains, any voltage,
£2-10-0

CORNER BAFFLE BOARDS Oak . . . 38/6 Mahogany . . . 42/-

The "Wireless World," Dec. 18th says:
"... a handsomely finished baffle."

VOX-VERITAS 12, Union Court, Old Broad St., London, E.C.2.

Aluminium Cabinets and Screening Boxes.

All sizes to order.

Standard screening boxes 6" x 6" x 6 5/8" each, including baseboards.

YATES SUTTON LTD., Sheet Metal Workers, York Street, Leicester.



For the Wireless Experimenter, Factory, Factor and Retailer,
Full Particulars from Sole Manufacturer and Patentes:—
BERTRAM THOMAS, Worsley Street, Hulme, MANCHESTER.

METAL CABINETS

for EVERYMAN

KILOMAG 4, RECORD 3
Complete with base and finish 47/6
Plain cabinet without base 27/6
FOREIGN LISTENERS 4 (set of 4) 18/6

W. H. PARKER, Sheet Metal Worker,
Back Autumn Terrace,
LEEDS. Tel: 52859



THREE REASONS WHY

You should buy a Lotus All Electric Receiver.

Because it is sufficiently sensitive to provide a wide range of home and foreign stations, yet selective enough to cut out unwanted local stations.

Because it is extremely easy to operate and exceptionally cheap to maintain—no batteries required.

Because its design and appearance are modern without being eccentric.

Lotus 3-valve S.G.P. All Electric Receiver. Price £21 cash or £1 19 9 down and 11 similar monthly payments. Also available as 3-valve S.G.P. Battery Model Receiver £13 15 0 cash and

3-valve S.G.P. Battery Model Kit £7 12 6 cash.

Both of which can be had on Hire Purchase Terms.

LOTUS ALL ELECTRIC RECEIVER

Gets the best reception.

You can hear these sets in your own home without obligation. Ask your radio dealer or write:—

Garnett, Whiteley & Co., Ltd., Dept. W.W.7, Lotus Works, Mill Lane, Liverpool.

Causton

Mention of "The Wireless World," when writing to advertisers, will ensure prompt attention.

Cabinets.—Contd.

A RTCRAFT Radio Cabinets are Britain's Best Value. [0310]

A LIMITED Number of Magnificent Radio-gramophone Cabinets, brand new, panel size 18in. x 7in., oak £6, mahogany £7; larger size, with double doors, panel 21in. x 8in., oak £11, mahogany £12/10; portable cabinets (suitcase type), 30/-; transportable (oak or mahogany), £2; cabinets with oval panel opening, suit 2- or 3-valve set, 17/6; carriage extra.—James Scott and Co., Radio Engineers, Dunfermline. [0334]

A RTCRAFT Radio Cabinets; Britain's best value; lowest prices consistent with highest quality; illustrated list free from actual manufacturers.—Arctcraft Co., 156, Cherry Orchard Rd., Croydon. Phone: Croydon 1981. [0040]

COILS, TRANSFORMERS, ETC.

600 ohms Decoupling Resistances, specified for new Kilo-Mag Four; 1/6 each, post free.—Groves Brothers.

120 and 1,000 ohms Resistances for new Foreign Listeners Four; 1/6 each, post free.—Groves Brothers.

SCREENING Boxes for Foreign Listeners Four, selectivity units, etc.; 6/- each, post free.—Groves Brothers.

NEW Kilo-Mag Four Coils, 37/6 set. Kilo-Mag slotted formers, 12/6 set; 1930 Everyman Four formers, 8/6 set; kit set formers, 10/6 set; all post free; trade supplied.—Groves Brothers, St. Mary's Place, Shrewsbury. [8757]

TRANSFORMERS and Chokes for Battery Eliminators.—Chester Bros., 244, Dalston Lane, London, E. 8. [8652]

GRAMOPHONES, PICK-UPS, ETC.

B.T.H. Pick-up, straight, perfect; 22/-.—May be heard 69, Whellock Rd., Chiswick. [9153]

VARLEY Pick-up, auto-arm, volume control, as new; £2.—196, Farebrother St., Grimsby. [9152]

B.T.H. Electric Gramophone Turntable, good condition, £3; also B.T.H. pick-up, with tone arm, £1.—8, Whitby Rd., Bradford. [9161]

EXPERIMENTER'S Surplus, all nearly new, all without tone arms, B.T.H., 19/6; Woodroffe, 25/-; Brown (£4 model), 19/6; Walmal tone arm, 4/6.—Box 5665, c/o The Wireless World. [9130]

B.T.H. Pick-up, with arm, new latest type; 25/-.—8, West Hill Av., Chapelallerton, Leeds. [9157]

LOUD-SPEAKERS.

BAKER'S SELHURST RADIO 36-page Booklet, "Sound Advice is Yours for the Asking"; write now for new edition; see displayed advertisement on page 12. [0231]

VIBRO-SKIN Special Leather for Fixing the Diaphragm of the Moving Coil Loud Speaker; price 2/- per piece 11in. square, 1/6 per piece 9in. square; post free; cash with order.—The Alder Leather Co., 3, Southwark St., S.E.1. Tel.: Hop 4448. [0330]

R.K. Moving Coil, £3; 2 old M.C. speakers, £1 each; new moving coil speakers, 220v. A.C., £3; carriage extra.—James Scott and Co., Radio Engineers, Dunfermline. [0336]

A MPLION Lion Chassis, 50/-; Celestion Woodroffe pick-up, 35/-; both as new.—F. R. C., Cowden Cross, Cowden, Kent. [9069]

MOVING Coil Magnet Pots, ready machined, complete with coil former; 4/6, ex stock, genuine bargain; 7 days approval against cash.—Mic Wireless Co., Market St., Wellingborough. [9081]

6-VOLT 1/2 amp. M.C. Speaker, list £6, new last year, including transformer, 29/6; permanent magnet speaker, list £9/10, low last year, £3; 7 days approval against cash.—Brew, Pychley, near Kettering. [9082]

L INEN Speakers, fit the Perfecta chuck extension for 100% results; 1/3; post free.—Douglas Briggs, Radio Engineer, Newport, Mon. [9124]

S ILK Gauze, finest quality, gold finish; 1/3 sq. ft.—Douglas Briggs, Radio Engineer, Newport, Mon. [9123]

B ROWN P.Q. Speaker for Sale; list price £12/12, accept £3; as new.—9, High St., Ealing, W.5. [9132]

MOVING Coil L.S., high resistance, for 6v. accumulator, in handsome cabinet; bargain, £2.—Keogh, Red Gables, Fleet, Hants. [9156]

A MPLION A.B.6, oak, as new, £3; Hypermu, 12/6, or exchange R.K. moving coil, cash adjustment.—Pollard, 69, All Hallows Rd., Bristol. [9151]

W HITE Lambskin Leather, specially for diaphragms, 12in. square; 1/6, post free.—Harris, 89, London Rd., Kettering. [9148]

OVERSEAS READERS WE SPECIALISE IN OVERSEAS BUSINESS.

PARTS, SPEAKERS, ELIMINATORS OR COMPLETE SETS

Write and tell us exactly what you require and we will buy it for you. It is our business to select suitable apparatus and thus ensure satisfaction to the user. Payment may be made either through "The Wireless World" deposit system, see page 12, or direct to us.

THE OVERSEAS TRADING CO.
144, St. Vincent Street, GLASGOW, Scotland.
Telegrams: "Tenacity," Glasgow.

HAVE YOU TRIED THE "SPRINGSREW" YET?

This New "Clix" Wander Plug embodies the "Clix" greatly improved form of resilience. It is variable, and having a solid end, is non-collapsible. This is important because the usual spiral type plug soon buckles and collapses.

Proc. Pat. Regd. Design.

The **SPRINGSREW** gives strong, spring contact, has self-cleaning surfaces.

Wiring is simple, and the horizontal insulator is a space saver.

LECTRO LIX LTD.
254, Vauxhall Bridge Rd., S.W.1

2d.
Engraved 1d. extra.
Solid End.

EXACT TUNERS

250 to 2,000 metres.

No further coils are required, tuning is as simple as A.B.C. see "Wireless World," January 25th: "We can strongly recommend these tuners." Send postcard for particulars and Circuits FREE to

THE EXACT MANUFACTURING CO.
Croft Works, Priory Place, COVENTRY.

Electrically sealed

METAL CABINETS

Complete with Base for 1930 Everyman Four, New Kilmag Four, and W.W. Record III. Jacobean Finish.

TERMS: CASH WITH ORDER Price 57/6.

RIGBY & WOOLFENDEN, SHEET METAL WORKERS.
MILNROW RD., ROCHDALE.

The **VOLUVERNIA**

VOLUME CONTROL

Resist. 0 to 1 meg. For Radio Receivers or Gramophone Amplifiers. Smooth and silent in operation. Can be used with metal panel if desired.

6/9

GAMBRELL RADIO LTD., 6, Buckingham St., Strand, London, W.C.2

5/6

General Purpose
and Power
7/6 Super Power

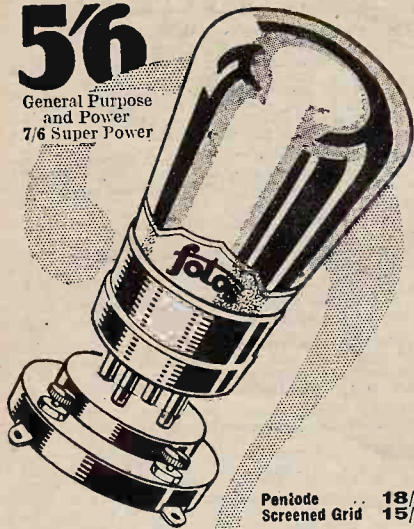

Peniode 18/6
Screened Grid 15/6

What valves in your holders

Good reception depends chiefly on your valves. Tone, volume, selectivity—all are determined by your valves. What are yours?

are they

Trade
Mark.

fotos
CONCERT VALVES

THE HEART OF EVERY SET

Ask your dealer for FOTOS or write
for Descriptive Booklet B23.

CONCERTON RADIO & ELECTRICAL CO. LTD.
256-7, Bank Chambers, 329, High Holborn, W.C.1.
Phone: Holborn 8667.

ELECTRADIX

APRIL BARGAIN LIST
of Radio and Electrical Gear
at fractional prices ready.
Send stamped envelope for
full details. Will save you
pounds. Biggest and Best
Stock in London.

ELECTRADIX RADIOS,
218, Upper Thames Street, E.C.4.
City 0191. Electradix, Cent, London.

The Autocar

EVERY
FRIDAY,
FOURPENCE

Loud-Speakers.—Contd.

EPOCH Moving Coil Speakers are Masterpieces, designed and produced by master engineers.

EPOCH Moving Coil Speakers are the Standard by which other Speakers are Compared.

EPOCH Moving Coil Speakers are in Use in many Editorial Offices.

EPOCH Moving Coil Speakers are in Use in several Famous Laboratories.

EPOCH Moving Coil Speakers are in Use in many Broadcasting Stations.

EPOCH Moving Coil Speakers are in Use by most Prominent Musicians.

EPOCH Moving Coil Speakers Bring Unbounded Joy to Thousands upon Thousands of Homes.

EPOCH Moving Coil Speakers, the only Speakers that give clear, uncoloured reproduction.

EPOCH Moving Coil Speakers do Render Speech Perfectly and Music Correctly.

EPOCH Moving Coil Speakers Provide the Perfect Illusion of the Artist's Presence.

EPOCH Moving Coil Speakers Represent the Finest Intrinsic Value ever Offered.

EPOCH Moving Coil Speakers are Guaranteed for a year, but last for ever.

EPOCH Moving Coil Speakers bring the Grand Concert out of the most Modest Set.

EPOCH.—You can hear a hundred Moving Coil Speakers, but Epoch is different.

EPOCH.—If you own the best set, only by Epoch can you confirm it.

EPOCH.—Away with the tin can and cracked banjo reproduction, and install an Epoch.

EPOCH.—Away with the drumminess, droniness and huskiness of the average Moving Coil Speakers.

EPOCH.—The clearest, sharpest, cleanest reproduction—a marvel of accuracy and beauty.

EPOCH Moving Coil Speaker Models from £2/10 to £30.

EPOCH Moving Coil Speakers.—Models for every requirement and taste.

EPOCH Permanent Magnet Moving Coil Speakers.—Nine models from £3/15.

EPOCH Permanent Magnet Moving Coil Speakers Require no Mains or Batteries.

EPOCH Permanent Magnet Speakers are more Sensitive than most Energised Moving Coil Speakers.

EPOCH Energised Models are the Finest ever put on the market.

EPOCH Super Cinema Speaker has Created the Biggest sensation for many years.

EPOCH Super Cinema Model is many times as Sensitive as the so-called Supers.

EPOCH Super Cinema Speakers give Enormous Volume from a 1-watt Amplifier.

EPOCH Super Cinema Speakers are used on many 100-watt Amplifiers and never "rattle."

EPOCH Super Cinema Model is Standard on several Talkie Equipments.

EPOCH Super Cinema Model is already in use in over 200 Cinemas.

EPOCH Super Cinema are the only Moving Coil Speakers used in Large Theatres, unaided.

EPOCH Super Cinema Speakers provide alone the Upper as well as the Lower Register.

EPOCH.—Other Moving Coil Speakers require the help of exponential horns to provide depth.

EPOCH.—A list of many prominent cinemas using the Speakers supplied on request.

EPOCH Speakers are not Made of Tin or Aluminium Stampings, but are sound, solid, engineering jobs.

EPOCH Heartily Invite Comparison, on all counts, with any make, regardless of price or claims.

EPOCH.—Don't accept our quality claims without verification, but don't accept any other maker's either.

EPOCH.—Order one for 7 days approval, and test with a switch-over; the only real test.

EPOCH Moving Coil Speakers may be heard in our Demonstration Room Daily.

EPOCH.—Our demonstration room is in the heart of London.

EPOCH.—Its accessibility has been studied for the convenience of callers.

EPOCH.—If you cannot call, write for booklet W.S.3, and approval terms.

EPOCH RADIO MANUFACTURING Co., Ltd., Farringdon Av. (near Ludgate and Holborn Circuses). Phone: Central 1971. [8983]

IN DEMAND EVERYWHERE

WRITE FOR
FREE 36-
PAGE BOOK-
LET NOW.



The Super Power
Moving Coil Speaker
INSTALLED AT THE
LONDON HIPPODROME
AND LEADING CINEMAS.

Read what others say:

THE EXPERT COMMITTEE
OF "THE GRAMOPHONE":—

"IN a well-matched combination it is the most efficient speaker we have yet tested. The reproduction with this speaker is extremely good on all kinds of music as well as on speech. It is brilliant and forceful right through the scale."

"VOX":—

"THE Speaker is the most sensitive we have yet tested—it gives excellent quality and adequate volume with quite low powered sets and yet it will handle large inputs very effectively."

Obtain a Baker's on 14 days' approval. A comparative test will immediately convince you.

ALL BRITISH.

Demonstrations daily.

BAKER'S
'Selhurst'
RADIO

Pioneer Manufacturers of Moving Coil
Loud Speakers

Offices: 89, Selhurst Road, S. Norwood, S.E.25
Works and Demonstration Room:
42, Cherry Orchard Road, E. Croydon
Telephone: Croydon 1618

Loud-Speakers.—Contd.

LQUIDATOR'S Clearance—250 speakers; 6/- each, carriage forward, or c.o.d. black crystaline finish, 25in. high, 14in. flare, weight 7½lb., splendid condition and tone; special prices for quantities.—Westall, Kenilworth Rd., St. Annes-on-Sea, Lancs. [9157A]

SUPERTONE Mahogany Cabinet Loud-speakers, perfect tone, stupendous volume; 35/-; trade enquiries invited.—Supertone Reproducers, 97, Thomas St. Bristol. [8794]

PERARDUA Moving Coil Reproducers.—These superlative instruments may be obtained for 15/- down, balance by 5 equal monthly payments; cash prices, 230-volt D.C. £3/3; 6-volt, £3.—R. Yevers, 4, York Rd., Maidenhead. [9169]

PICTURE RECEIVER APPARATUS.

TELEVISION.—Scanning discs, Neon tubes, experimental models made.—John Salter, Member Television Society, Featherstone Buildings, Holborn, W.C. [9154]

TRANSMITTERS.

CHEBROS. Chebros. Chebros transformers and chokes of all descriptions, special transformers for transmitting and modulation; chokes a speciality; enquiries invited.—Chester Bros., 244, Dalston Lane, London, E.8. [5240]

VALVES.

BRAND New 4-pin M.H.4; 10/6.—H. Grimmer, 34, Tottenham Close, Kenton, Middlesex. [9149]

AMPLIPLIER Valve.—If you require power you cannot do better than one of these:—

FILAMENT Volts 6, plate volts 400 (maximum), grid bias 84 volts (approx.), impedance 800 ohms, amplification factor 3.8, mutual conductance 4.35 m.a./volts; price £5/10; see article "The Wireless World," 24th July, 1929, then send to North London Valve Co., Ltd., 22½, Cazenove Rd., Stoke Newington, London, N.16. [9142]

COMPONENTS, ETC., FOR SALE.

BELLING-LEE Panel Fittings are designed to give an expert finish to any home-constructed set; catalogue post free.—Belling and Lee, Ltd., Queensway Works, Ponders End, Middlesex. [0018]

WESTON Model 301, milliameters, ammeters, and voltmeters, 21/- each; hot wire ammeters 0.1 amps., 4/-; 0.05 amp., 3/-; instrument repairs and alterations; send for list.—The Vieta Electrical Co., 47, High St., Battersea, S.W.11. Established 1910. [8626]

COMPONENTS Lent on Hire.—Details from Alexander Black, Wireless Doctor, 55, Ebury St., S.W.1. Sloane 1655. [0329]

SENSITIVE Microphone for Deaf Aids, detectaphones, public address work, and for the transmission of speech and music to any distance; all illustrated lists free.—F. Adolphe, 27, Fitzroy St., London, W.1. [9122]

PERFECT.—Valves, P.M.14, 12/6; P.M.5, 5/-; P.M.4D, 5/-; Cossor R.C.410, 4/-; Dario S.P.4v., 2, 4/- each; Amphion A.U.4 horn unit, new, 10/-.—77, Hartland Rd., N.W.6. [9134]

WEBSTER Pick-up Meltrope Tone Arm, perfect order, guaranteed, 40/-; Marconi output transformer, 10/-.—Pearce, Huntingrove, Crawley. [9136]

ATLAS A.C.16 Eliminator, new, £3; Lewcos coils, pair split primary, aerial, 5/-; ditto, binocular, 6/-; valves, S.G.610, 10/-; L.F.607, 5/-.—Briggs, Carlton Rd., Shipley. [9137]

230v. Transformer, 300+300, 7½, 6v., 25/-; M.L. motor, on base, with L.T. choke, 60v. 4.7 amps., £2; Fellowes A.C. L.T. charger, 12/6; Bowyer Lowe superhet transformers and coupler, £1; Baker's A.C. speaker, wound for 8v., less diaphragm, £1; Polar Four, with valves, remote control, long or short raves change over, beautiful mahogany cabinet, as new, £5; 2 All-wave Four H.F. transformers and base, 10/-; foreign listeners transformer, 25/-.—W. P. Roberts, 49, Orrell Lane, Bootle. [9139]

H.F. Chokes, dual waveband, reliable and efficient; 2/9, post free.—Shaw, 526, New Chester Rd., Rock Ferry, Cheshire. [9147]

SURPLUS for Disposal.—V. condensers: Two G.E.C. 0.0005, one 0.00025, one 0.00035 6/- each, one Ormond 0.00025, S.M. dial 6/-, one Cydon 0.0003 4/-; L.F. transformers: Ideal Junior 8/-, two Ideal 3 to 1, one 4 to 1 10/- each, one G.E.C. 6/-; one Polar H.F. coupler, 7/6; Lissen speaker unit, 4/-; Beco speaker, for portable, 5/-; two G.R. aerial coils, long and short waves, 5/-; pair two Dimec 1A, 3/- each, unused; valves: P.M.12 12/6, Mazda 240 10/-, P.M. 2D.X 8/-, P.M. 2-volt Pentode 15/-; P.M. 24A 17/6; S.G.215 12/6, all practically unused; three D.E.L.612 7/6 lot, three D.E.5 12/- lot, two D.E.5A 10/- lot, six D.E.H.612 3/4 each, three D.E.H.610 5/- each, all in good condition and guaranteed little use; one 8625 and holder, practically new, 12/6; one L.S.5, not used three hours, 12/6.—Box 5713, c/o The Wireless World. [9158]

The Brilliant "GRASSMANN" Moving Coil Loudspeaker



6 volt, 100 volt
D.C., 240 volt
D.C.

£4 - 17 - 6

240 volt A.C.
NO HUM model

£8 - 5 - 0

Demonstrated FREE IN YOUR OWN HOME!

Read Mr. J. H. Reyner's excellent article on the "Peter Grassmann" Moving Coil Speakers in the March issue of "The Wireless Magazine." You will then appreciate just why it is that they are so wonderfully popular.

The best dealers stock the Peter Grassmann, but should your dealer be out of stock he can readily obtain a model on approval from us.

"Peter Grassmann" Moving Coil Speakers, Inductive Dynamic Units and Chassis, also Electrical Pick-up complete with Tone Arm and Volume Control are obtainable from all good dealers.

ROTOR ELECTRIC Ltd.
2/3, Upper Rathbone Place, London, W.1.

For the Best in Radio

WILL-DAY Ltd.

(THE BEST IN THE WEST)

10 LISLE STREET, LEICESTER SQUARE, LONDON, W.C.2

Telephone: "Eleven Eight" (2000 and 2022) Telegrams: "Will Day" Ltd. Lond.

OPEN TILL 7 P.M.

WRITE FOR OUR CATALOGUE
POSTAGE 6d FREE TO CALLERS

ELEX

T.14 PLUGS & SOCKETS.

Standard Socket 1d. each. Plugs 8d. each.
6 colours. Name Plates, 40 kinds, 1d. each.
Write for list X99.

J. J. EASTICK & SONS, 118, Bunhill Row,
London, E.C.1.

Plug in parts.

LOW PRICES. BEST GOODS.

NEW FOREIGN LISTENER 4.

COMPLETE SETS OF PARTS FROM 210.

COILS 4, 30/-, BOXES 4, 18/-, TRANSFORMERS, 29/-.

KILO-MAG 4. RECORD III.

COILS, 33/-; ALL PARTS. COILS, 35/-.

1930 EVERYMAN 4. KIT. SET.

Trade supplied. METAL BOXES FROM 25/- Lists FREE.

A. T. STOTT, Telegraph Radio Wks., DUKE ST., ROCHDALE.

Components, Etc., for Sale.—Contd.

P.M.22, Osram Pentode, 17/6 each; D.E.5B, D.E.5, 6/- each; P.M.5A, 6/-, all only used few hours; Pye L.F. transformer, 10/-; B.T.H. 2-1 and 4-1, ditto, 10/-, as new; B.A.2 unit, 15/-; Brown unit, 20/-; ditto chassis, 10/-; Brown pick-up, 15/-, all hardly used; Reagentone, W.D.J., eliminator A.C., cost £4/19/6, used few hours, £3; 2 J.B. 0.0005 condensers, 10/- the 2.—Box 5669, c/o The Wireless World. [9140]

VALVES, 2v. Lissen Pentode, new, Cossor S.G., nearly new, 12/6 each; twin cone unit, new, 10/6; all post free.—E. "Southwood," Little Common Rd., Bexhill, Sussex. [9131]

RADIO HOUSE, HUDDERSFIELD, issues the Reliability Wireless Guide, which will be sent post free upon request by Messrs. J. H. Taylor and Co., 15, Macaulay St., Huddersfield. [7823]

PART Exchange.—See our advertisement under Receivers for Sale.—Scientific Development Co., 57, Guildhall St., Preston. [0028]

1929 Soiled Magnavox Mains Speaker, Mullard H.T. eliminator, both 200-210 mains, £5/15 and £2/15 respectively; Solodyne coils, long and short, screens and bases, 15/-.—141, Fitzalan St., Sheffield. [9135]

QUADRUPLE Gang Condenser, vernier control.—Write for particulars, Rose, York Av., Lincoln. [9159]

GENUINE Experimenters' Surplus—6-volt valves, 5/- each; 2 D.E.H., 2 D.E.L., 3 H.L., 1 D.E.F., 5/- each; 1 A.C.R., 10/-; 2 Ferranti A.F.3, 10/- each; Varley choke, 5/-; 24g. exam. wire, 2/6 lb.; Croise 400v. T.P.S.2, for 210 volt, 15/-; set 3 midjet Bakelite variable condensers dials, suitable for portable, 7/6 each.—150, Longmead Av., Bristol. [9163]

FERRANTI Portable Moving Coil Meter, ranges 15 milliamps, 7.5 volts, 150 volts, perfect order; £1/17/6, or offer.—Jeffcock, 21, Kensington Court, W.8. [9171]

MICRO Ammeter by Pye, type 7956; 35/-; guaranteed perfect.—Hobley, Drive, Wellingborough. [9167]

MISCELLANEOUS.

ALLEXANDER BLACK,
THE Original Wireless Doctor, will call (London and Home Counties) and cure your set.

CONSULTATIONS by Appointment Without Obligation, sets installed, maintained, and brought up to date, gramophone pick-ups, eliminators, and Webster moving coil speakers demonstrated; purity reproduction specialists.

55, Ebury St., Victoria, S.W.1. Sloane 1655. [0277]

CALIBRATE Your Set With the C.D.E.S. Calibration Chart; 8d., post free.—C.D.E.S., 98, Cherry Orchard Rd., Croydon. [8612]

SCOTT SESSIONS and Co., Great Britain's Radio doctors, officially approved as wireless repairers by Radio Society of Great Britain and Wireless League; old sets of every type repaired, rebuilt, modernised; send set for immediate quotation.

SCOTT SESSIONS and Co.—New sets constructed with your or our components, guaranteed finest workmanship; we specialise in "The Wireless World" circuits; remember, we have satisfied customers throughout the British Isles and in three Continents; if you so desire, we will design and construct high grade apparatus to suit your special circumstances for quality, range and selectivity.—Tel.: Tudor 5326. Muswell Hill, London, N.10. [0262]

PATENT AGENTS.

PATENTS and Trade Marks, British and foreign.—Gee and Co. (H. T. P. Gee, Member R.S.G.B. and A.M.I.H.E.), 51-52, Chancery Lane, London, W.C.2. 'Phone: Holborn 1525. [0001]

REPAIRS.

SCOTT SESSIONS and Co., Great Britain's radio doctors; read advertisement under Miscellaneous column. [0263]

REPAIRS Returned Post Free, and to ensure satisfaction send remittance after approval of same.—Leeds Wireless Repair Service.

LOUND-SPEAKERS, headphones, rewound to any resistance and remagnetised, 3/-; transformers rewound, 4/-; blue Spots, Triotrons and 4-gale units, 4/6; work guaranteed.—Leeds Wireless Repair Service, 5, Boston Place, Green Rd., Leeds. [8945]

GUARANTEED Repairs by Experts.—Loud-speakers, headphones, cone units, pick-ups, any type, rewound, remagnetised, and adjusted, post free 4/-; transformers from 4/-.—Howell, 91, Morley Hill, Enfield, Middlesex. [7882]

WANTED.

WANTED, all types of electrical and wireless apparatus; purchased for cash; large quantities only.—Tompkins, 1, South St., Greenwich, S.E.10. Tel.: 1259 Greenwich. [0331]

COILS and Other Parts for Short Wave Set.—Box 5670, c/o The Wireless World. [9141]

Mention of "The Wireless World" when writing to advertisers, will ensure prompt attention.



**"ECONO"
DOMESTIC & OFFICE
TELEPHONE**

Calling and Speaking both ways. The most reliable private Telephone known.

The New "ECONO" TELEPHONE eliminates the most unreliable part of all small telephones, i.e. the electric bell call. An entirely new call system is employed—discreet yet sufficiently loud to attract attention.

NO BREAKDOWNS owing to corroded electric bell or spring contacts are possible; such contacts are entirely avoided in the "ECONO" telephones. There are no delicate mechanical parts which are likely to get out of order. Each pair of Instruments is **GUARANTEED** for **2 YEARS.**

PRICE, including 50 yards connecting wire,
Per Pair **26/-**

Two suitable Dry Cells lasting 12 months.

3/-

CAN BE INSTALLED BY ANYONE IN LESS THAN 1 HOUR.



FREDK. ADOLPH, Actual Maker, Phone: 27, Fitzroy Street, London, W.1. Museum 8329.

**BROWNIE
SELECTIVITY
UNIT**

Mr. F. T. Collins, of East Barnet, writes: "Although I am within 6 miles of Brookmen's Park, I find the Brownie Selectivity Unit enables me to separate either wave length without the least difficulty. I feel that your Unit is the only relief for listeners in this area." Screen-Grid selectivity with any set—

that's what you get with the Brownie Selectivity Unit, at a cost of only 10/6! Your dealer will tell you all about it.

10/6

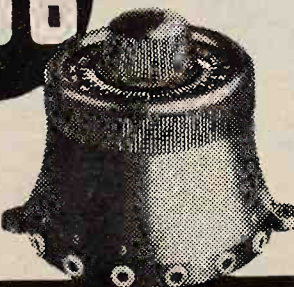

BROWNIE WIRELESS CO., (G.B.) LTD., Nelson St. Works, London, N.W.1.

Wanted.—Contd.

MOYING Coil Speaker, 200v., D.C., 0.1 amp, will exchange R.K. model, 230v. D.C., in excellent condition; required for poor East End parish hall.—Vicar, St. Judes, Vicarage, E.2. [9173]

EXCHANGE.

FERRANTI Meters, transformers, condensers, etc., for sale; wanted portable typewriter.—Wyer, High St., Hunstanton. [9133]

WE Will Accept Your Surplus Apparatus (making you a high allowance) in Part Payment for any new apparatus; your enquiry will be dealt with promptly.—Bostock and Stonnill, 1, Westbourne Terrace, S.E.23. [9164]

NOYOTONE, for electric gramophone motor, B.T.H. preferred, cash adjustment; or sell.—252, Berkhamsted Rd., Chesham. [9160]

SITUATIONS VACANT.

WIRELESS Operating Appointments Assured; short qualifying course, day, evening; fees payable after appointment for boarding students; Morse classes.—Manager, Wireless School, 21, Manor Gardens, London, N.7. Archway 3694. [8121]

WIRELESS Services.—The Premier Telegraph College in the British Isles (established 34 years) gives a sound training to all students, with assured positions on qualification. Fees are not disguised under expensive board-residence scheme. 44 students out of a total of 47 obtained qualifying wireless certificates at first attempt in the last seven Government examinations.—Apply for prospectus, Dep. W. The London Telegraph Training College, Ltd., Morse House, Earl's Court, S.W.5. [8943]

SITUATIONS WANTED.

YOUNG Man (20), seeks situation as packer, assistant storekeeper, etc., experienced, capable.—Stacy, Stratton House, Kildoran Rd., Brixton. [9102]

LOU D-SPEAKER and Pick-up Repairer, considerable experience on Blue Spot units, pick-ups, etc.; disengaged.—Box 5664, c/o The Wireless World. [9129]

BOOKS, INSTRUCTION, ETC.

"THE Wireless Manual" (new 1930 edition); by Captain Frost, is an ideal non-technical book full of up-to-date facts about wireless development, choice of set, how to use your own set, etc.; illustrated; 5/- (post 5/4), of a bookseller, or Pitman's, Parker St., Kingsway, W.C.2. [8178]

STEP by Step Wireless; a complete course of the theory of electricity in relation to the practical design of wireless apparatus, eliminators, circuits, etc., with extracts from a designer's notebook, giving up-to-date practical application.—Issued weekly, send 1/- p.o. for first 4 weeks.—Chifford Pressland, A.M.I.E.E.Eng., Dept. W.W., Hampton-on-Thames. [0195]

FREE: Inventor's Guide on Patents.—T. A. A., 253 (W), Gray's Inn Rd., London, W.C.1. [6373]

MAKE A GRAMOPHONE AT



a quartershop prices. Or buy Cabinets for Wireless. Order Set as shown: British spring motor, Velvet turntable, swan arm, metal soundbox, amplifier, needle cups, for £1 17 3 p.p., and build your own Cabinet. Portable Gramophones from 19/6, postage 1/6. Motors from 8/6. Lists free. 64-page Catalogue, Drawing and How to Make Gramophones, 3d.

REGENT FITTINGS CO. (W.O.), 120, Old Street, London, E.C.1.

BONA FIDE TRADERS' GUIDE.

Send for our comprehensive Illustrated List QUICK SERVICE. QUICK SERVICE.

THE QUALITY HOUSE.

PERSEUS MFG. CO., LTD. (Dept. W.W.), BRANSTONE RD., BURTON-ON-TRENT.

BOOKS on WIRELESS

Write for complete list to ILIFFE & SONS LTD., Dorset House, Tudor St., London, E.C.4.



J.B. JUNIOR LOG CONDENSER.

for Selectivity

Present-day requirements have been studied so closely by J.B. that in their wide range of Precision Condensers you will find just the model you need. Even though you may be within a mile or two of Brookmans Park—J.B. Precision Condensers will do more to separate difficult stations than any other Condenser on the market. Your circuit may be last year's design—J.B. Precision Condensers will bring it up to date. Make it a rule—J.B. for every set.

J.B. JUNIOR LOG CONDENSER.

0005	7/-	0003	6/9
00025	6/6	00015	6/6



PRECISION INSTRUMENTS

Advertisement of Jackson Bros., 72, St. Thomas' Street, London, S.E.1 Telephone: Hop 1837.

INDEX TO ADVERTISEMENTS.

	PAGE		PAGE		PAGE
Adolph, Fredk.	17	Holzman, L.	10	Regent Radio Supply Co.	11
Appleby, E. Hetherington	18	Hughes, F. A., & Co., Ltd.	2	Rigby & Woolfenden	14
B. & J. Wireless Co.	12	Jackson Bros.	17	Rothermel Corp., Ltd. (Electrad)	16
Baker's "Selhurst" Radio	15	Lectro Linx, Ltd.	14	Rotor Electric, Ltd.	16
Belling & Lee, Ltd.	9	Lever, Eric J. (Trix), Ltd.	4	Rowley Bros., Ltd.	3
Benjamin Electric, Ltd.	17	London Electric Wire Co. & Smiths, Ltd.	9	Scientific Supply Stores	16
British School of Engineering Tech.	Cover iii	Marconiphone Co., Ltd.	1	Standard Telephones & Cables, Ltd.	18
Brownie Wireless Co. (G.B.), Ltd.	17	McMichael, L., Ltd.	5	Stott, A. T.	13
Burne-Jones & Co., Ltd. (Magnum)	15	M-L Magneto Synd., Ltd.	13	Telegraph Condenser Co., Ltd.	Cover i. & 18
Carrington Manf. Co., Ltd.	16	Morogoro Trading Corporation, Ltd.	13	Thomas, Bertram	13
Celestion, Ltd.	Cover i.	Mullard Wireless Service Co., Ltd.	Cover i.	Transformer Repair Co.	12
Cole, E. K., Ltd.	15	Ormond Engineering Co., Ltd.	Cover iv.	Trellehorgs Ebonite Works	17
Concerton Radio & Electrical Co., Ltd.	16	Overseas Trading Co.	13	Turnock's Mouldings	11
Day, Will, Ltd.	16	Parker, W. H.	13	Varley (Oliver Pell Control, Ltd.)	17
Eastick, J. J. & Sons	15	Paroussi, E.	8	Vox-Veritas	Cover iii.
Edison Swan Electric Co., Ltd.	Cover ii. & 7	Persens Manf. Co.	17	Westinghouse Brake & Saxby Signal Co., Ltd.	Cover iii.
Electradix Radios	15	Pertrix, Ltd.	6	Wingrove & Rogers, Ltd.	12
Ever Ready Co. (G.B.), Ltd.	6	Phillips Lamps, Ltd.	18	Wilkins & Wright, Ltd.	Cover i.
Exact Manf. Co.	14	Player's	5	Wright & Weaire, Ltd.	Cover iii.
Gambrell Radio, Ltd.	4 & 14	Potter, H. B., & Co., Ltd.	10	Yates Sutton, Ltd.	13
Garnett, Whiteley & Co., Ltd.	14	Radiogramophone Development Co.	17		
Hayberd, F. C., & Co.		Regent Fittings Co.	17		

the service of the appleby

COUNTRY AND OVERSEAS ORDER SECTION

Devoted to the speedy supply of all the leading lines of radio equipment on the British Market, at Current List Prices, to customers in all parts of the World.

Complete Receivers, Speakers, Eliminators, Components and Kits of Parts ("The Wireless World" Designs especially catered for).

Customers not having deposit accounts should remit sufficient to cover the cost and carriage of material. Any difference will be adjusted upon despatch. Drafts should be made payable to E. HETHERINGTON APPLEBY, and crossed a/c Payee.

Deposit Order Accounts may be opened with sums of £2 upwards. To facilitate transactions, deposit order accounts are recommended.

appleby's

Where fashionable people buy fashionable things.
CHAPEL STREET, MARYLEBONE,
LONDON, N.W.1.

Bankers: Westminster Bank Limited.

Sections also for Radio Part Exchange and Radio Equipment and Receiver Hire.

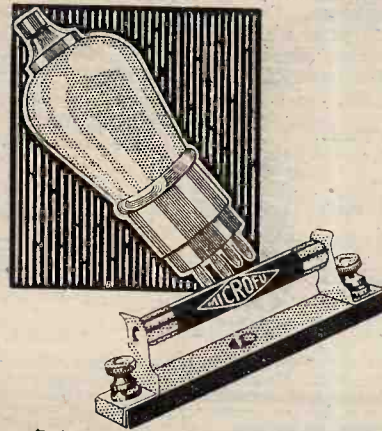

This valve could have been saved!

Just accidentally, the H.T. leads were fitted to the L.T. Terminals—a simple thing to do, but disastrous—it blew the valves! If a Microfu had been fitted it need never have happened, because a Microfu blows as soon as the current is excessive, it blows in 1/1000th part of a second. And remember, "Microfu," the Valve protector, is backed by T.C.C., the hall-mark of accuracy and reliability. Prices: Cartridge, from 2/-. With holder, from 2/9.



BACKED BY THE T.C.C.

Adel. Telegraph Condenser Co. Ltd., Wales Farm Rd., N. Acton, London, W.3

CA 4404

Sound in principle

SAYS THE

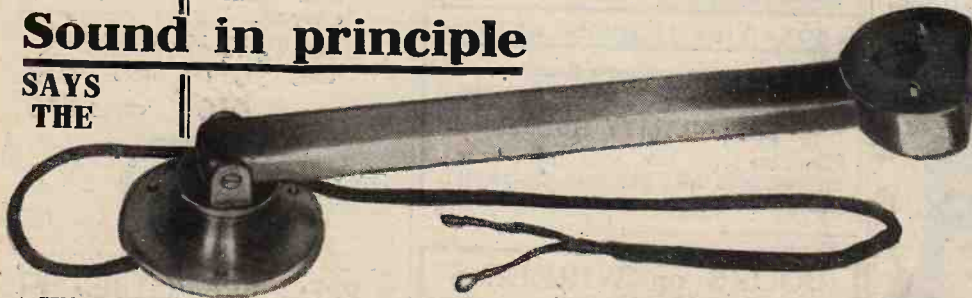

"Wireless World."

THE RADIOGRAMOPHONE DEVELOPMENT CO.,
ST. PETER'S PLACE, BROAD STREET, BIRMINGHAM.

THE R.G.D. PICK-UP

is free from resonance. No tracking wear. A highly finished Pick-up in Bronze, Oxidised Silver. Specially constructed for the Coil-driven Speaker.

Price
£2 : 10 : 0

Post free.

Mention of "The Wireless World," when writing to advertisers, will ensure prompt attention.

A SOUND MECHANICAL JOB



H.T.4
D.C. Output 150 v. 50 m.a.
37/6



A.3.
D.C. Output 9 volts 1 amp.
23/6

WESTINGHOUSE METAL RECTIFIERS

have no moving or fragile parts, and ARE UNAFFECTED BY SHOCK OR VIBRATION, otherwise they could not form part of the equipment of the Francis-Barnett Motor Cycle (shown below by courtesy of the Villiers Engineering Co., Ltd.). Their mechanical strength is one of the reasons for their widespread adoption for radio mains equipment.

There are rectifiers for all types of A.C. mains equipment. Those shown above are two of the popular units which are now very widely used.

Full details and circuits for all types are given in our 32-page book "The All-Metal Way, 1930." Every mains user should have one. Send 2d. stamp for a copy to:—

The WESTINGHOUSE BRAKE & SAXBY SIGNAL Co., Ltd.,
82, York Road, King's Cross, London, N.1.

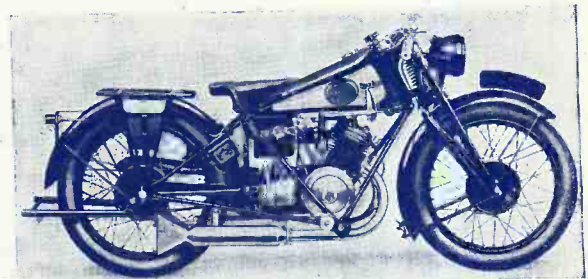

ENGINEERS!



Can't we get together?

All we ask is the chance to prove that you can earn £300, £400, £500 per year or more. Other men are doing it, and you can do the same

We have an unrivalled and world-wide organisation, waiting to help you whether you be novice or expert. If you wish for something more than a "bread and butter" job you owe it to yourself to investigate our Service.

Our handbook "Engineering Opportunities" has pointed the way to better things to over 20,000 of your fellows. It contains details of A.M.I.Mech.E., A.M.I.E.E., A.M.I.C.E., A.M.I.A.E., A.M.I.Struct.E. London Matric., C. & G., G.P.O., etc., Exams., outlines home study courses in all branches of Electrical, Mechanical, Motor and Wireless Engineering, and explains our unique guarantee of

Write for this Book today IT'S FREE!

NO PASS—NO FEE.

In a Brilliant Foreword Prof. A. M. Low shows clearly the chances you are missing. "Engineering Opportunities" and our advice are quite FREE. Don't neglect this offer—give vent to that "upward urge" and send a postcard NOW, stating Branch, Post or Exam. which interests you.

BRITISH INSTITUTE OF ENGINEERING TECHNOLOGY,
387, SHAKESPEARE HOUSE, 29-31, OXFORD STREET, W.1.

GUARANTEED

WEARITE

COMPONENTS

+YOUR TIME=BEST RESULTS—TROUBLE

MAINS TRANSFORMERS AND L.F. CHOKES

Type	Output.	Use.	Price.
T.2	4 v 5 a	For H.T. & L.T. For A.C. Valves Also U.5 Type Rectifier	37/6
	5.5 v 2 a		
	250 v 80 m/a		
T.3	135 v 50 m/a	For Westinghouse Rectifiers Styles H.T.3 & H.T.4	27/6
T.4	135 v 50 m/a	As T.3 with addition of windings for A.C. Valve Heater	32/6
	4 v 5 a		
T.5	230 v 50 m/a	For Westinghouse Rectifier Style H.T.1, also A.C. Valve Heater Winding	32/6
	4 v 5 a		

CONSTANT INDUCTANCE L.F. CHOKES.

	Inductance (Henries)	Resistance (Ohms)	Current-carrying capacity.	Price.
H.T.2	20	35	75 m/a	21/-
H.T.3	40	850	50 m/a	21/-

Potentiometers, 200, 300 or 400 ohms. **2/6**
Volume Controls, .25, .5, 1 or 2 megohms. **4/-**
To pass maximum 1 m/a.

Write for free illustrated lists:

WRIGHT & WEAIRE LTD.,

740, HIGH ROAD, LONDON, N.17. Phone: Tottenham 3847/8.

THE ANSWER TO THE INTERFERENCE PROBLEM!

A WAVE TRAP

THE ORMOND

A SELECTIVITY UNIT

SIMPLE TO FIX



SIMPLE TO USE

NO INTERFERENCE

DEAD SHARP TUNING

SELECTOR UNIT

Actual size

When a new problem arises in radio the wise always turn to the House of Ormond, where practised engineers are daily tackling technical problems. Hence this latest achievement—the Ormond Selector Unit, which is not only a selectivity unit, but in addition a Wavetrap, and gives the greatest selectivity to any set, eliminates unwanted stations, and solves the problem of ideal reception under the new B.B.C. Scheme of Wavelengths. This is your real answer to the "Interference Bogy." Easily fitted and neat in appearance, this unit is the best of its kind at an exceptionally low price. Supplied in attractive Brown Bakelite case. Cat. No. R/410.

PRICE

7'6

PRICE

7'6

THE
ORMOND ENGINEERING
CO., LTD.
Ormond House, Rosebery Ave.,
London, E.C.1.



Telephone :
Clerkenwell 5334-5-6 and 9344-5-6.

Telegrams :
"Ormondengi, Smith."

For Dependability & Reliability trust ORMOND

Printed for the Publishers, ILIFFE & SONS LTD., Dorset House, Tudor Street, London, E.C.4, by The Cornwall Press Ltd., Paris Garden, Stamford Street, London, S.E.1.

Colonial and Foreign Agents:
UNITED STATES—The International News Co., 131, Varick Street, New York. FRANCE—W. H. Smith & Son, 248, Rue Rivoli, Paris; Hachette et Cie, Rue Réaumur, Paris.
BELGIUM—W. H. Smith & Son, 78, Marche aux Herbes, Brussels. INDIA—A. H. Wheeler & Co., Bombay, Allahabad and Calcutta. SOUTH AFRICA—Central News Agency, Ltd.
AUSTRALIA—Gordon & Gotch, Ltd., Melbourne (Victoria), Sydney (N.S.W.), Brisbane (Queensland), Adelaide (S.A.), Perth (W.A.), and Launceston (Tasmania).
CANADA—The American News Co., Ltd., Toronto, Winnipeg, Vancouver, Montreal, Ottawa, St. John, Halifax, Hamilton; Gordon & Gotch, Ltd., Toronto; Imperial News Co., Toronto, Montreal, Winnipeg, Vancouver, Victoria. NEW ZEALAND—Gordon & Gotch, Ltd., Wellington, Auckland, Christchurch and Dunedin.

MAKING TRANSFORMERS FOR METAL RECTIFIERS

The Wireless World

4^D

AND RADIO REVIEW

The Paper for Every Wireless Amateur

Wednesday, April 30th, 1930.

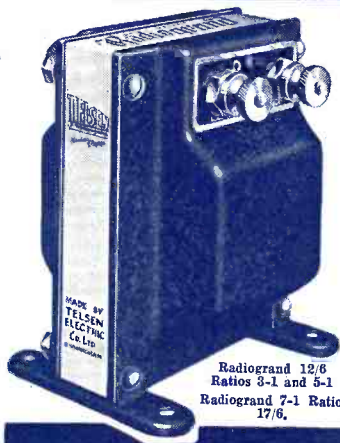

TELSEN

L.F. TRANSFORMERS

Radio's Choice

Have acquired a world-wide reputation for Quality and Value.

Built by Specialists in Transformer construction they have set a Quality of Performance above reproach. Your Set will work better with a Telsen Transformer - - - - Fit one now!

TELSEN ELECTRIC CO. LTD.
Miller Street,
Birmingham.

Radiogrand 12/6
Ratios 3-1 and 5-1
Radiogrand 7-1 Ratio
17/6.

CLAROSTAT

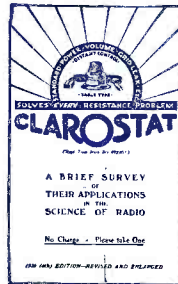

This authoritative 36-Page Book, compiled by Experts, with 47 Illustrations (27 circuits — 3 scale drawings), describes clearly and simply the home construction of all types of Eliminators, etc.

FREE AND POST FREE to "W. W." Readers on receipt of a postcard. The complete range of "ClarOstat" variable Resistances, and their uses, is also described.

CLAUDE LYONS Ltd.,
76, OLDHALL ST., LIVERPOOL.

A QUALITY VALVE AT A CHEAPER PRICE

TUNGSRAM

TUNGSRAM
ELECTRIC LAMP
WORKS (GREAT
BRITAIN) LTD.,
Radio Dept.,
72, Oxford Street,
London. W 1



BurTON

SELF-LOCATING VALVE HOLDER



1/- each

Pentode-Valve-Holders
1/6 each
Patent No. 316708

MANUFACTURED BY
C. F. & H. BurTon

PROGRESS WORKS
WALSALL, ENG.

PHILIPS BATTERY ELIMINATORS (H.T. UNITS)

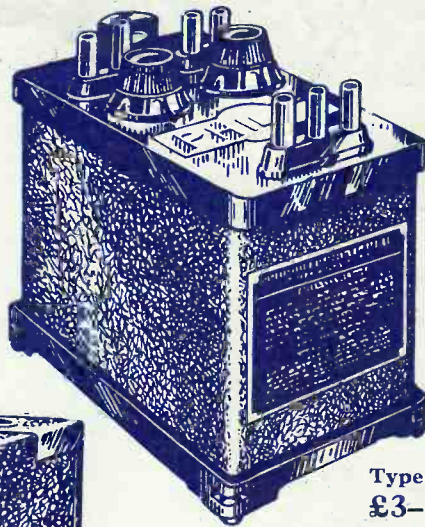

Type 3005
£3-17-6

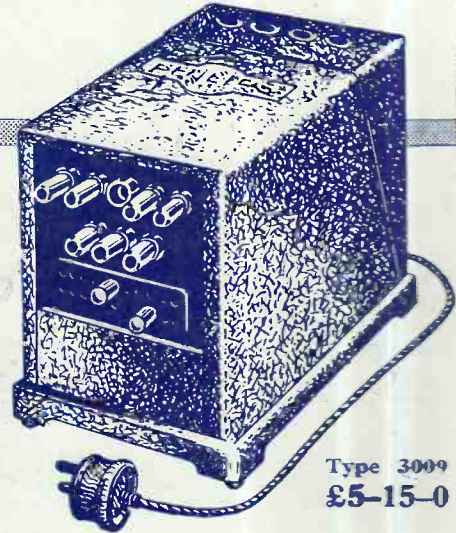

Type 3009
£5-15-0

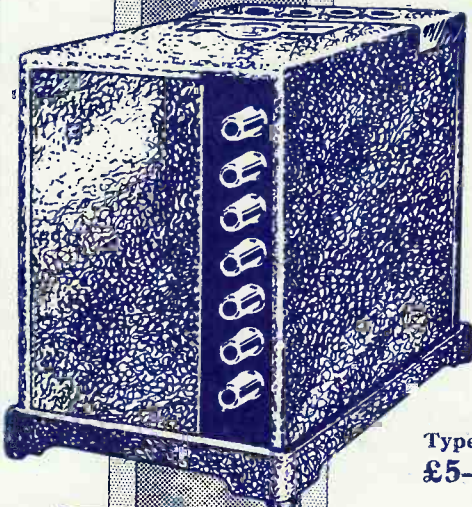

Type 3002
£5-10-0

Get the *best* out of your receiver—volume, tone quality, distance—by using a Philips Battery Eliminator and thus taking your H.T. current from the electric mains. Also it's *cheaper* than having to pay for new batteries every now and then. One of the three types of Philips Battery Eliminators meets your needs. Type 3009 and 3002 work off A.C. Mains—type 3009 giving grid bias as well as H.T. For D.C. Mains there is Type 3005.

For 10/- down you can have any of these on Philips' Easy Payment System.



PHILIPS

ALL-ELECTRIC RADIO

MADE BY THE MANUFACTURERS OF THE FAMOUS PHILIPS ALL-ELECTRIC RECEIVERS, ARGENTA ELECTRIC LAMPS AND NEON SIGNS.

PHILIPS LAMPS LTD., PHILIPS HOUSE, 145, CHARING CROSS ROAD, LONDON, W.C.2.

Mention of "The Wireless World," when writing to advertisers, will ensure prompt attention.

100% better

performance than

**any other screened
grid valve**



Constant research for over two years has made the Mazda A.C./S.G. Valve unequalled in performance by any other A.C./Screened Grid Valve, and it will give approximately twice the amplification of any other indirectly heated screened grid valve.

This remarkable performance is due to the Mazda equipotential cathode which gives a high mutual conductance, and the duplex screened grid which reduced the inter-electrode capacity to a negligible value. Both of these patented features are only available in Mazda Valves.

The Amazing

MAZDA
**ALL-MAINS
VALVES**

CHARACTERISTICS.

<i>Filament volts</i>	- - -	4.0
<i>Filament amps.</i>	- - -	1.0
<i>Amplification factor</i>	-	1,200
<i>Mutual conductance</i>	-	2.0*

*At Ea. 150; Es. 60; Eg. 0.

PRICE 25/-



THE EDISON SWAN ELECTRIC CO., LTD.,
Radio Division,
1a, Newnan Street, Oxford Street, W.1.
Branches in all the Principal Towns.

EDISWAN

V.35

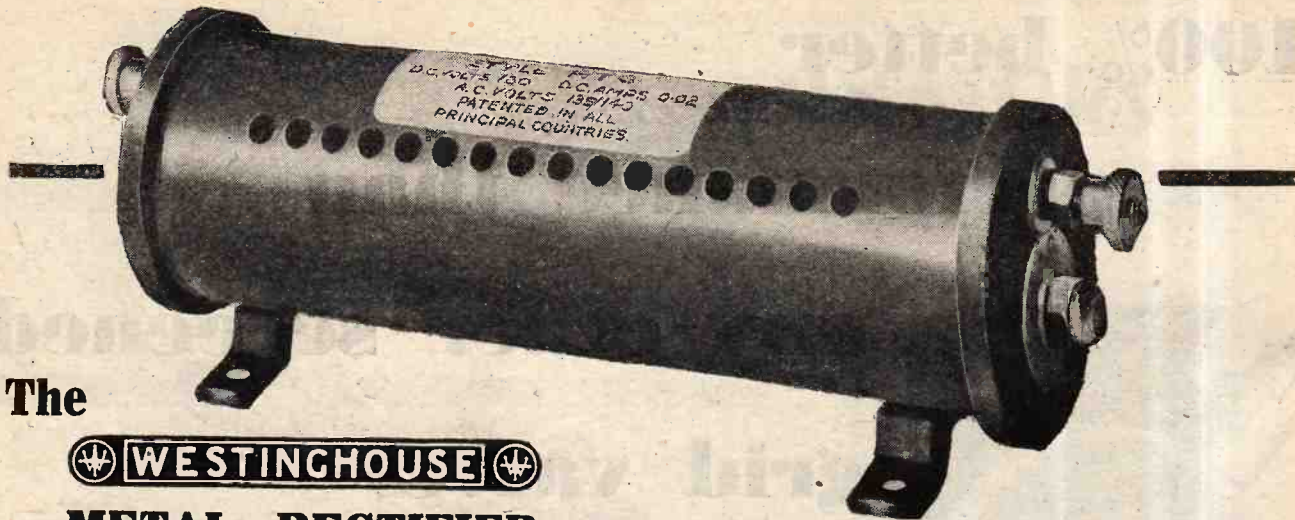

The

WESTINGHOUSE

METAL RECTIFIER

STYLE H.T. 3

FOR HIGH TENSION

D.C. OUTPUT 120 V., 20 M.A.

Price 21/-

MADE IN ENGLAND

SOME OF OUR OTHER TYPES:—

HIGH TENSION	Style H.T.4. 180 v., 30 m.a.	37/6
	Style H.T.1. 200 v., 100 m.a.	75/-
LOW TENSION	Style A3. 9 v., 1 amp.	23/6
	Style A4. 9 v., 2 amp.	39/6
GRID BIAS	Style G.B.1. 40 volts	17/6

All types are fully described, together with their suitable circuits, in our 32-page book "The All-Metal Way 1930"

Send a 2d. stamp for a copy to-day.

The WESTINGHOUSE BRAKE & SAXBY SIGNAL Co. Ltd.

82, York Road, King's Cross, London, N.1

Telephone: North 2415-6-7-8.

Weston sets the world's standard

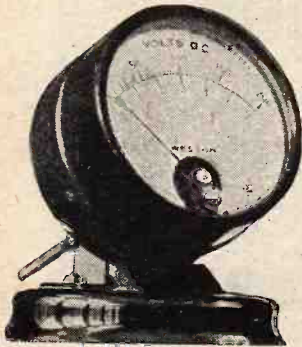

Model 506, Pin Jack Voltmeter complete with high range standard testing cables.

Price £2. 10. 0.

To obtain the very best results from your receiver, you must be quite sure that the High Tension, Low Tension and Grid Bias voltages are regulated correctly.

For exact measurements of these variable voltages be sure you use a Weston Pin Jack Voltmeter.

It is sold by all Radio Dealers as the finest instrument for accuracy and reliability.

WESTON

ELECTRICAL INSTRUMENT CO., LTD.,

15, Great Saffron Hill, London, E.C.1

A.2

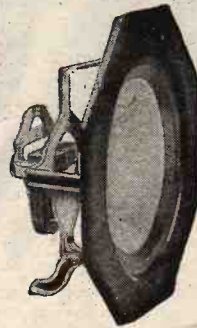

SQUIRE MODELS TO SUIT ALL TASTES

97B.—Single Cone type aluminium cradle. Fitted with 9 1/2" Vellume Cone and ebonised octagonal front. Will take all well-known types of drive unit. Price 15/-.

P77.—Single Cone type occupying very small space. Specially built for portable receivers. Price 18/6.

101.—Double Cone speaker cradle with both cones having floating suspension. Exceptionally fine tone. Price 39/-, plus royalty 3/-.

100.—New Double Cone speaker cradle with small free edge cone. All frequencies reproduced with amazing fullness of tone. Price 28/6.

Look for our "Sylphone" Moving Coil Speaker No. 21, which will shortly be placed on the market.

Write for fully descriptive leaflets, or ask your dealer to demonstrate whichever "Squire" model you prefer.

FREDERICK SQUIRE, LTD.,

KINGS WORKS, Leswin Place, STOKE NEWINGTON, LONDON. N.16. Telephone: Clissold 0334.

15/-
18/6
39/-
28/6

TESTS OF TIME



Built in
1843 ..

... by Mr. E. H. Bailey—Nelson's Column has stood the test of time for 87 years! The Telegraph Condenser Co. built the now famous "Condenser in the green case" over a quarter of a century ago. This famous condenser and Nelson's Column have one thing in common—they stand the test of time. Each T.C.C. condenser is individually tested before it leaves the factory. You can be sure—when you ask for a condenser of a certain capacity, if it's T.C.C. you get it!—they are accurate to a point almost of infallibility. Don't put up with inefficient condensers in your Set, there's no excuse now because the T.C.C. condenser costs no more. And remember, they are guaranteed.



The condenser illustrated is 800 volt D.C. test.
400 D.C. working 8/6

NELSON'S COLUMN

ADVERT. OF THE TELEGRAPH CONDENSER Co. Ltd. N. ACTON, W.3



RECTIFYING VALVES



For :

- Reliable H.T. Supply
- Dependability
- Long Life
- High Efficiency
- Output easily varied and smoothed

The rectifier that has stood the greatest of all tests—**TIME**

Made by the manufacturers of the famous Argenta Electric Lamps, Commercial and Industrial Fittings, All-Electric radio receivers, and Neon Signs.

PHILIPS RECTIFYING VALVES

PHILIPS LAMPS LTD., PHILIPS HOUSE, 145, CHARING CROSS ROAD, LONDON, W.C.2.

R.V.4

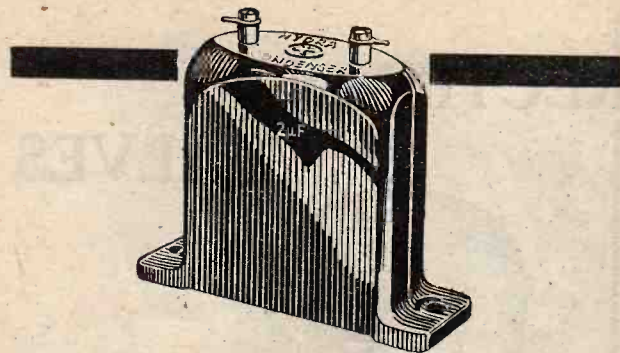

We do not attempt to satisfy you with a condenser until that condenser has satisfied us—under gruelling tests—that it will never fail you!

HYDRA

LOUIS HOLZMAN

37 NEWMAN STREET, LONDON, W.1.

Telephone: Museum 2647.

NO WAVE TRAPS

20 Stations in 5 minutes at Loud-speaker Strength

BY USING THE NEW PATENTED

Tapped Model D.A.T.3.

DUAL COIL



15/-

Tunes from 200-2,000 metres

Amplifies as a transformer, thus producing more volume. Simple Detector—L.F. Receivers can now compare with the latest Screened Grid Sets.

Bullphone Tapped Aperiodic Six-Pin SELECTIVE COILS

will also separate the National and Regional Stations.

Short Wave 4/6 Long Wave 5/6

Send for our Free Lists and Circuits—

BULLPHONE LTD. (Dept. W.W.)
38, HOLYWELL LANE, LONDON, E.C.2

ENGINEERS!

Can't we get together?



All we ask is the chance to prove that you can earn £300, £400, £500 per year or more. Other men are doing it, and you can do the same.

We have an unrivalled and world-wide organisation, waiting to help you whether you be novice or expert. If you wish for something more than a "bread and butter" job you owe it to yourself to investigate our Service.

Our handbook "Engineering Opportunities" has pointed the way to better things to over 20,000 of your fellows. It contains details of A.M.I.Mech.E., A.M.I.E.E., A.M.I.C.E., A.M.I.A.E., A.M.I.Struct.E., London Matric., C. & G., G.P.O., etc., Exams., outlines home study courses in all branches of Electrical, Mechanical, Motor and Wireless Engineering, and explains our unique guarantee of

Write for this Book today IT'S FREE!

NO PASS—NO FEE.

In a Brilliant Foreword Prof. A. M. Low shows clearly the chances you are missing.

"Engineering Opportunities" and our advice are quite FREE. Don't neglect this offer—give vent to that "upward urge" and send a postcard NOW, stating Branch, Post or Exam. which interests you.

BRITISH INSTITUTE OF ENGINEERING TECHNOLOGY,
387, SHAKESPEARE HOUSE, 29-31, OXFORD STREET, W.1.

**JUST
OUT**

A NEW "WIRELESS" BOOK
WRITTEN WITH THE FULL
AUTHORIZATION OF THE
INVENTOR.

TELEVISION

TO-DAY AND TO-MORROW

By Sydney A. Moseley & H. J. Barton Chapple, Wh. Sch. (B.Sc. Hons.), A.C.G.I., D.I.C., A.M.I.E.E., with Foreword by John L. Baird.

This remarkable book goes fully into the methods used for the wireless transmission of pictures. It describes the discovery of Television, the early efforts, and the technicalities of the actual methods of transmission and reception. It is written so that it is understandable by the technical and non-technical reader alike. As an intimate story of the "Baird" activities, and a detailed source of information on the subject, the book will be appreciated by all who are interested in Wireless.

Illustrated 7/6 net. 154 pp.

THE DAILY HERALD says: "An enthralling book."

THE DAILY NEWS says: "Many secrets of the apparatus are revealed in detail for the first time."

Of a Bookseller, or

SIR ISAAC PITMAN & SONS, LTD.,

Parker Street, Kingsway, London, W.C.2

Mention of "The Wireless World," when writing to advertisers, will ensure prompt attention.

D.C. to A.C.

If your supply mains are D.C. you can operate an A.C. All-Electric Receiver by using the



**D.C. to A.C.
ROTARY
TRANSFORMER**

Can be supplied to run from any voltage 12-250 V.D.C. 40 watt model £13; 85 watt model £19. Recommended and used by Philips Radio, Marconiphone, Burndept, Kolster-Brandes, M.P.A., Etc., Etc.

Write for Pamphlet 596/1 which gives full details.

THE M-L MAGNETO SYND. LTD.,
Radio Dept., COVENTRY.

Telephone : 5001.

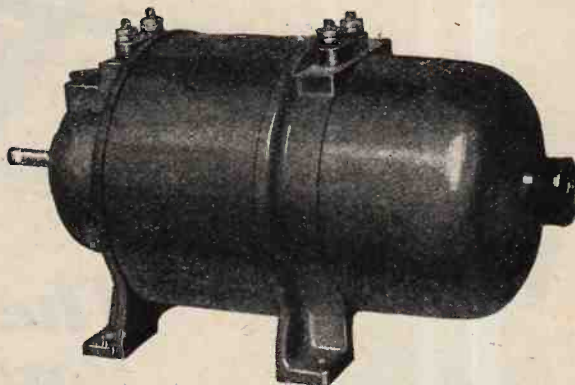

Godbolds

Guaranteed Transformers and Chokes

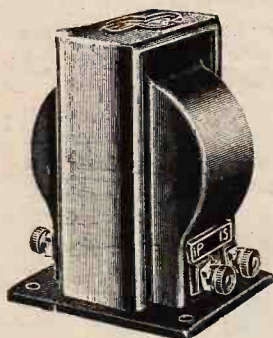

TRANSFORMERS

- "G" Type Price 30/-
- "J" Type Price 17/6
- "F" Type Price 14/-

THERE is an Igranic Transformer or Choke to meet every requirement. It does not matter whether you require a popular price or a De Luxe instrument. There is one in the Igranic range which is the best at its price. By buying Igranic Transformers and Chokes you know the component is backed by the Igranic guarantee.

Have you a copy of the Igranic Catalogue? If not, may we send you one? Write to Dept. U312.



CHOKES

- H.F. Price 5/-
- "G" Type, L.F. Price 27/-
- "F" Type, L.F. Price 15/-

147, QUEEN VICTORIA STREET, LONDON.

EVERYTHING

The
G. E. C.
 your guarantee

ELECTRICAL

The **NEW**

OSRAM P.X.4

Power-Valve

The Latest and Best Power Output Valve designed for A.C. Mains or Radio-Gramophones



PRICE 25/-

In 4-volt Battery Sets with H.T. eliminator, use OSRAM 410 valves with P.X.4. in last stage

In all A.C. Mains sets, use OSRAM M.4. valves with P.X.4. in last stage.

Primarily designed for the last stage of A.C. Mains operated sets, the filament current is sufficiently low (0.6 amp. approx.) to enable the valve to be used also in Battery Sets working from a 4-volt accumulator.

NOTE ALSO THESE POINTS:

1. Supplied with 200 volts H.T., the performance is comparable to that from an OSRAM L.S.5.A. at 400 volts.
2. Especially suitable for H.T. supply from D.C. Mains, 200—240 volt supply, the filament fed from a 4-volt accumulator.
3. This valve introduces absolutely no hum when used in the last stage of your mains set.
4. THE valve for moving coil loudspeakers and radio gramophones—the improvement in tone will astonish you.

Osram Valves

**MADE IN
 ENGLAND**

Sold by all Wireless Dealers

Advt. of The General Electric Co., Ltd., Magnet House, Kingsway, London, W.C.2.

Mention of "The Wireless World," when writing to advertisers, will ensure prompt attention.

The Wireless World

AND
RADIO REVIEW
(18th Year of Publication)

No. 557.

WEDNESDAY, APRIL 30TH, 1930.

VOL. XXVI. No. 18.

Editor : HUGH S. POCKOCK.
Assistant Editor : F. H. HAYNES.
Editorial Offices : 116-117, FLEET STREET, LONDON, E.C.4
Editorial Telephone : City 9472 (5 lines).
Advertising and Publishing Offices :
DORSET HOUSE, TUDOR STREET, LONDON, E.C.4.
Telephone : City 2847 (13 lines). Telegrams : "Ethaworld, Fleet, London."
COVENTRY : Hertford Street.
Telegrams : "Cyclist, Coventry." Telephone : 5210 Coventry.
BIRMINGHAM : Guildhall Buildings, Navigation Street.
Telegrams : "Autopress, Birmingham." Telephone : 2970 and 2971 Midland.
MANCHESTER : 260, Deansgate.
Telegrams : "Jiffie, Manchester." Telephone : 8970 City (4 lines).
GLASGOW : 101, St. Vincent Street, C.2.
Telegrams : "Jiffie, Glasgow." Telephone : Central 4867.
PUBLISHED WEEKLY.
Subscription Rates : Home, £1 1s. 8d. ; Canada, £1 1s. 8d. ;
other countries abroad, £1 3s. 10d. per annum.
Entered as Second Class Matter at New York, N.Y.
As many of the circuits and apparatus described in these pages are covered by patents, readers are advised, before making use of them, to satisfy themselves that they would not be infringing patents.

CONTENTS OF THIS ISSUE.

	PAGE
EDITORIAL VIEWS	447
MAINS TRANSFORMER CONSTRUCTION. DESIGN No. III.	448
EXPERIMENTAL PROOF OF THE EXISTENCE OF SIDEBANDS. BY F. M. COLEBROOK	451
PRACTICAL HINTS AND TIPS	454
BROADCAST RECEIVERS. PHILIPS PORTABLE	456
NEW APPARATUS REVIEWED	458
CURRENT TOPICS	460
WIRELESS THEORY SIMPLIFIED. PART XXVIII. BY S. O. PEARSON	462
BROADCAST BREVITIES	465
RADIO MEASURING INSTRUMENTS (CONCLUDED). BY E. H. W. BANNER	466
CORRESPONDENCE	469
READERS' PROBLEMS	471

CENTRALISING RADIO DEVELOPMENT.

A LITTLE over six years ago we first drew attention in these columns to the multiplicity of Government departments engaged in radio research and development and the apparent lack of systematic co-operation and centralisation of the work involved. Public money is expended in providing facilities and staff for radio research for the Post Office, the Army, the Navy, the Air Force, the Broadcasting Corporation, and other Government services, and it seems only right that the public should feel confident that the money so allocated is being put to the best use and that unreasonable overlapping and wastage does not occur.

We have always recognised that some of the problems of radio communication are peculiar to particular Government departments, but we believe that, with very few exceptions, these special problems only relate to practical design and detail, whereas all theoretical problems and the collation of general radio intelligence are common to all the services.

The Radio Research Board was originally set up with the idea of collating the results of research in various Government departments and carrying out special investigation work on their behalf. If it were possible to obtain the figures it would be extremely interesting to know what is the average annual expenditure on radio research and development work financed by the Government, and then see in what way this sum is allocated. We believe that such figures would show that the Radio Research Board, which is responsible for the expenditure on work carried out at the National Physical Laboratory, receives only a very small proportion of the total amount, and that the staff and facilities available to the Radio Research Board are ridiculously inadequate for the task which it was originally intended it should undertake.

We have previously advocated that at least the wireless research work of the Government should be centralised and that, as far as possible, this central wireless organisation should undertake research and design work for all Government departments; each department to be required to define their particular requirements, but leaving it to the central wireless department to prepare and submit designs to meet individual requirements. The central wireless department to be generously staffed with able technicians, whose business it would be to employ all the latest knowledge of the art in the designs which they prepared, and, in addition, to investigate any general research problems likely to be of benefit to the various services looking to them for expert advice.

Unfortunately, rivalry—we should, perhaps, not be exaggerating if we said jealousy—exists between the various Government departments, and not only are they unwilling to share the results of the investigations made by their technical staffs with other Government departments, but there is, we believe, sufficient evidence to show that co-operation with the Radio Research Board is but half-hearted, and there is an indication of disinclination to hand over any particular line of research to be investigated under the direction of the Radio Research Board.

At a time when we see other countries progressing more rapidly than our own in radio development we feel that there is an urgent need for the whole question of Government radio research to be investigated, with a view to centralising the work and the funds available, instead of having half a dozen or more departments each separately financed and sadly overlapping in the work which they are undertaking.

Mains TRANSFORMER CONSTRUCTION Design N^o III

A 50-cycle Transformer for Use with Westinghouse Metal Rectifiers.

THE two transformers recently described under this heading were intended for use with valve rectifiers, and this has given rise to some speculation with regard to the efficaciousness of alternative rectifying devices, since, so far, no mention has been made of them. A glance at the design of the transformers referred to will at once show that they are complementary, as both provide similar output voltages, the principal difference being that one is for a 50-cycle supply, whereas the other is for use on 25-cycle mains. The order in which the various designs are discussed is in no way indicative of the merits of the particular features exhibited by them, or that the arrangements with which they are associated show any marked superiority over those which it is hoped to describe later.

The transformer which forms the subject of the present article has been designed for use with the Westinghouse metal rectifiers, and is intended to be incorporated in an H.T. battery eliminator. In addition to the H.T. secondary winding, it has been thought advisable to include two others, since ample space is available, and the extra windings will materially widen the scope of the component. They add little to the cost and construction, so that their inclusion was thought well worth while.

One winding gives 45 volts, and is included to provide the grid bias by employing the Westinghouse G.B.1 rectifier unit. The other gives 4 volts, and the maximum current is 4 amps. This enables the indirectly heated type of valves to be employed, thereby dispensing entirely with batteries.

Although the immediate requirements of the constructor may not warrant these extra voltages, it would

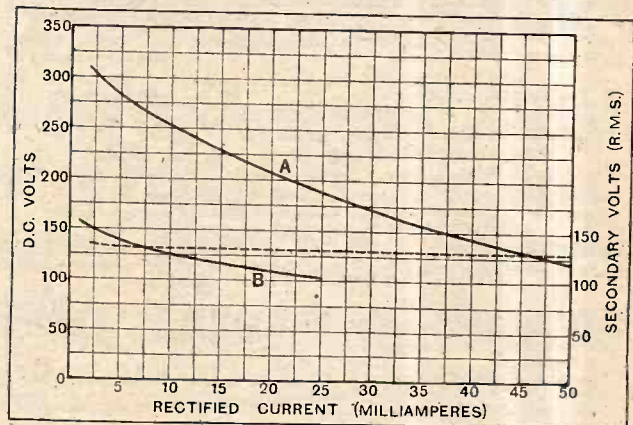

Rectified voltage regulation curves on load. Curve A refers to the Westinghouse rectifier H.T.4; B to the model H.T.3 using voltage-doubling circuit, and the broken line curve is the A.C. output from the 135-volt secondary.

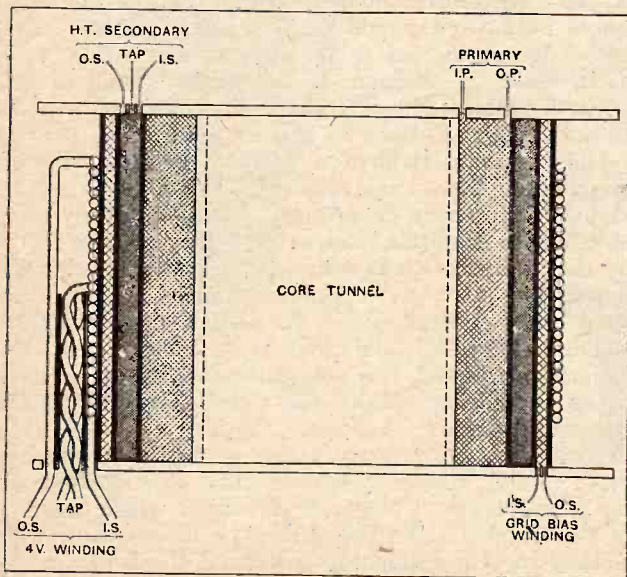

Sectional sketch of the bobbin showing the method of bringing out the ends of each coil.

be a wise plan to include them, since it is not always possible to anticipate future needs.

Data for all Supply Voltages.

The model illustrated has been wound to permit of the use of either the Westinghouse H.T.1 or the H.T.3 or the H.T.4 units. The first-mentioned requires 230 volts input, whereas the H.T.3 and H.T.4 operate on 135 to 140 volts. As this is the maximum potential they will stand, it was decided to tap the 230-volt secondary for the lower voltage, thus doing away with the necessity of two separate H.T. windings.

The material used is the same as that employed for the first model described. Either Sankey No. 4 size stamping or Savage "Electa" No. 4 can be utilised for the core, which is built up to a thickness of 1 1/2 in. Special bobbins to accommodate this amount of iron are available at a very reasonable cost. As we do not require all our coils to be centre-tapped, one large bobbin is used in place of the two smaller ones adopted

Mains Transformer Construction.—

for the first model. This single bobbin is listed as Type No. 4 F., and provides a winding space $2\frac{1}{4}$ in. long \times $\frac{3}{4}$ in. deep.

The primary winding, which is wound on first, must be chosen having regard to the voltage of the supply mains, and, since these vary from 100 volts to 250 volts, a table has been prepared from which the correct number of turns, and size of wire, can be seen at a glance for the majority of the supply voltages in use to-day. Should it be found that this does not cover all requirements, the number of turns can be calculated by multiplying the mains voltage by six and using the gauge of wire specified for the nearest voltage given in the table below.

Enamel-covered wire may be used in place of the alternative insulations specified without in any way affecting the performance of the transformer. It will occupy less space and work out a little cheaper. By adopting the coverings mentioned, the primary will build up approximately to the same volume in all cases. As a refinement, the primary can be tapped at suitable intervals, thereby enabling the transformer to be used on slightly different supply voltages. This course was adopted in the model illustrated. It was wound for a 240-volt supply with tapplings at the 1,320th and 1,380th turns to permit of use on 220- and 230-volt mains also.

TABLE OF PRIMARY WINDINGS.

Supply Voltage.	No. of Turns.	Wire Gauge.
100	600	24 D.C.C.
110	660	24 D.S.C.
120	720	24 Enamel
130	780	"
200	1,200	28 D.S.C.
210	1,260	"
220	1,320	28 Enamel
230	1,380	"
240	1,440	"
250	1,500	"

Three layers of "Empire" cloth should be wound over the primary as insulation, and then the H.T. secondary can be run on. This consists of 1,380 turns of No. 30 enamelled wire, with a tapping brought out at the 820th turn from the start. The full winding gives a nominal voltage of 230, and from the beginning to the tapping 135 volts. This is followed by three layers of insulating material, and then the 45-volt winding can be commenced. For this 270 turns of No. 36 enamel wire will be required. When completed, three layers

of insulation must be wound on as described above, and then the 26 turns of No. 18 D.C.C. wire for the 4-volt winding can be put on. This coil should have a tapping brought out at the 13th turn. The method of bringing out the beginnings and the ends of each coil is shown in the sectional sketch of the bobbin given herewith.

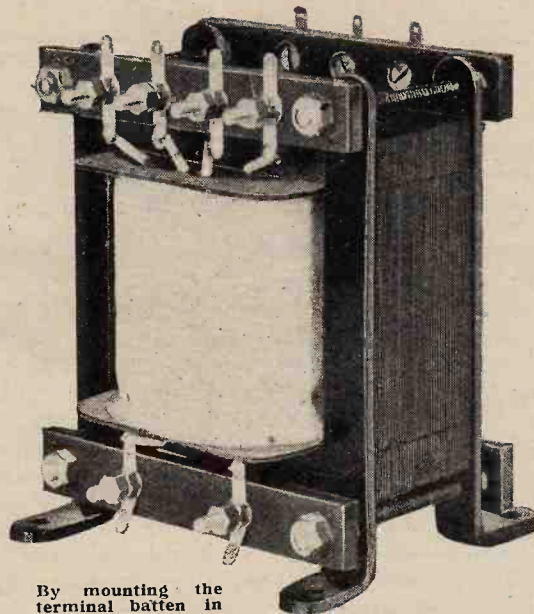

By mounting the terminal batten in the position shown, all connecting leads are kept as short as possible.

Preventing a Loose Core.

Certain points require watching during the process of winding, but, as this subject has been dealt with at length in the two previous articles¹ under this heading, they will not be repeated here. The reader is referred to these for a detailed description of the method recommended. These remarks apply, also, to the assembly of the core, which was described fully in the first article. For this transformer about 100 pairs of stampings will be required, and these should be packed as tight as possible in the core tunnel of the bobbin. Looseness in the core is likely to lead to an unpleasant

"buzzing" when the transformer is in use. Clamps for the core can be made from angle brass or strip iron, $\frac{1}{2}$ in. wide by $\frac{1}{8}$ in. thick. Those fitted in the present case were obtained correct to size; they cost 2s.

¹ The Wireless World, Jan. 22nd and Feb. 19th, 1930.

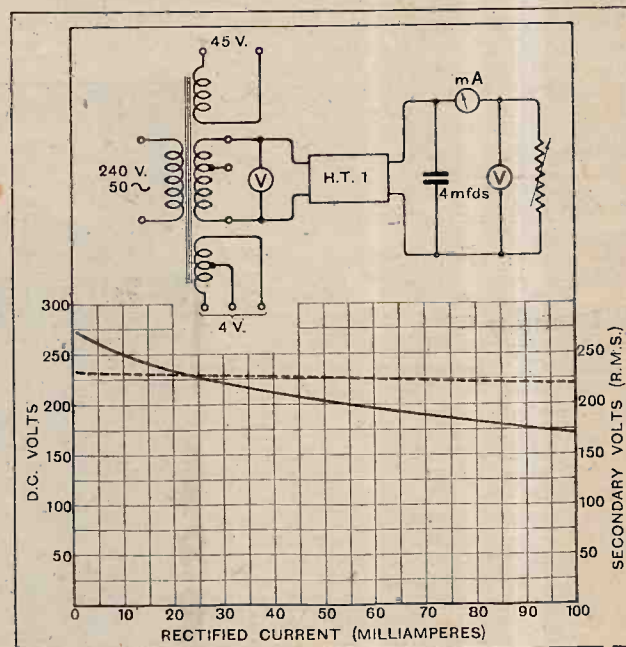

Voltage regulation curve using the Westinghouse rectifier H.T.1 with 230 volts input. The broken line curve is the A.C. voltage output from the secondary winding.

LIST OF PARTS.

100 pairs of No. 4 stampings.
1 bobbin, No. 4F (Savage).
1 set of clamps (Savage).
9 ozs. No. 28 enamel wire.
8 ozs. No. 30 enamel wire.
1 oz. No. 36 enamel wire.
4 ozs. No. 18 D.C.C.

1 foot 2 B.A. screwed rod.
16 2 B.A. nuts.
10 4 B.A. screws, $\frac{3}{4}$ in. csk.
20 4 B.A. nuts.
Small quantity paxolin strip, $\frac{3}{8}$ in. \times $\frac{1}{4}$ in., soldering tags and insulating cloth.

for a set of four, and are suitable for the No. 4 stampings. Terminal battens are made from $\frac{1}{4}$ in. paxolin strip, $3\frac{1}{2}$ in. long by $\frac{5}{8}$ in. wide, and each carries the appropriate number of 4 B.A. screws and nuts, with soldering tags. The primary and H.T. secondary leads come out through the top chucks of the bobbin, and the 45-volt winding and the 4-volt winding finish at the bottom set of terminals but on opposite sides of the core. The bolts supplied with the clamps were not long enough to accommodate also the four terminal strips, so 2 B.A. screwed brass rod was used as a substitute and was found to be entirely satisfactory. Four lengths, each 3 in. long, will be required, together with sixteen 2 B.A. nuts.

The transformer was connected to a 240-volt 50-cycle supply, and the output voltages measured on various loads, using the Westinghouse rectifiers mentioned in the earlier part of this article. These results are given

in graph form for the convenience of those constructors who are undecided as to which model will meet their particular requirements. The H.T.3. unit gives half-wave rectification only, but this is quite suitable for small sets where the total H.T. consumption does not exceed 20 mA. The H.T.4 model was employed in a voltage-doubling circuit using two 4-mfd. condensers as recommended by the makers. This gives full-wave rectification and will provide 150 volts, unsmoothed, at about 35 mA. For use with larger sets, and where the H.T. demands are of the order of 60 to 70 mA., the H.T.1 model is recommended. At 50 mA. a D.C. voltage of 200 is available, which, when smoothed, should provide about 180 volts for the valves. In all cases the full-line curves represent the D.C. output, while the broken-line curves show the A.C. volts—R.M.S. values—developed across the secondary winding.

H. B. D.

A Compact Station.

A neatly designed transmitting station in the West of England is shown in the accompanying illustration. It was built by Mr. H. W. Haydon at 158, Bristol Road, Gloucester, and has been in operation since February, 1925; the call-sign is G2ZL.

The apparatus is assembled in a special wooden frame, allowing accessibility to all parts, and the bottom shelf holds the screened-grid receiver. The transmitter employs four valves in parallel as oscillators, four in parallel as modulator and two for the two-stage amplifier, all being ordinary six-volt power valves. The input is derived from a 220 volt D.C. mains supply and the aerial current is approximately 0.7 amp.

The station usually operates on 170 metres.

o o o o

Good Wishes to G5NN.

On Saturday, April 12th, Mr. J. Ridley, Assistant Chief Engineer of the Research Department of Burndept Wireless, Ltd., was married at Walton-on-Thames to Miss D. E. Poupart, the daughter of Mr. J. Poupart, of Long Acre, Covent Garden, and Walton-on-Thames.

Mr. Ridley is well known as an amateur transmitter, and his station G5NN was the first to receive American broadcast in England. He also broadcast a running commentary, from a launch with a portable transmitter, of the memorable boat race some years ago when the Oxford crew sank.

We believe we voice the sentiments of all British transmitters in wishing Mr. and Mrs. Ridley the best of good fortune.

TRANSMITTERS' NOTES.

Returning from Iraq.

We hear that Mr. C. W. Leversedge and other operators of the well-known stations YI2CQ and YI6KR in Salaimania, are leaving for Mosul and will probably

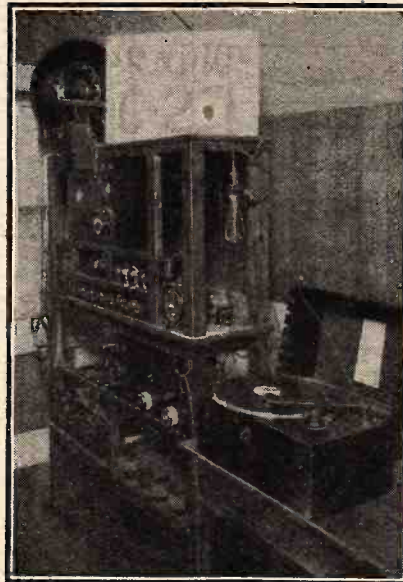

Mr. H. W. Haydon's Station G2ZL at Gloucester.

return to England at the end of the year. It is not yet certain whether their successors will carry on these stations under the same call-signs.

o o o o

New Call Signs and Stations Identified.

- G 210 J. Lees, 17, Trevose Gdns., Sherwood, Notts.
G5NN J. Ridley, Wayside Cottage, Orchard Ave., Shirley, Near Croydon. (Change of address.)
G 21P (Ex 2 AWV.) G. J. Reed, 184, Henleaze Rd., Bristol.
G 5SV M. F. Somerville, 185, Elm Park Mansions, Chelsea, S.W.3. (Change of address.)
G 6AP A. C. Porter, Southside, Stanhope Rd., Sidcup, Kent. (Change of address.)
G 6FO A. Forsyth, St. Aubyns, Gold Top, Newport, Mon. Transmits on 170 metres C.W. daily after 11.0 p.m. and on telephony every week-end during non-broadcasting hours.
G 6IZ E. G. Ingram, Tullos House, Nigg, by Aberdeen. (Change of address.) Transmits on 7,000 and 14,000 kc. wavebands.
G 6MB A. J. Buttress, 25, Staines Rd., Sunbury-on-Thames.
2 BSJ D. N. Biltcliffe, 41, Church St., Morley, Leeds. Experimenting on wavelengths below 10 metres and wishes to get into touch with others similarly engaged.

o o o o

BOOK RECEIVED.

Television, To-day and To-morrow.
By Sydney A. Moseley and H. J. Barton Chapple, with a foreword by J. L. Baird. An account of the history and development of the Baird system, with descriptions of the apparatus and chapters on Synchronism, Photo-electric Cells, Noctovision, Colour and Stereoscopic Television, Tele-Cinema and kindred subjects. Pp. 130+xxiii, with 38 diagrams and 48 half-tone plates. Published by Sir Isaac Pitman and Sons, Ltd., price 7s. 6d. net.

EXPERIMENTAL PROOF OF THE

EXISTENCE of SIDEBANDS

Some Sidelights on the Rectification of a Modulated Wave.

By F. M. COLEBROOK, B.Sc., D.I.C., A.C.G.I.

THE result of modulating a continuous-wave wireless transmission, that is, of varying its amplitude or intensity in a way that follows as closely as possible the displacement of the air particles in the sound waves produced by speech or music, is commonly represented as adding to the original unmodulated "carrier wave" frequency a number of additional radio-fre-

sidebands is no more than a convenient mathematical fiction.

Philosophically speaking, there is much to be said for the idea that sidebands are a convenient mathematical fiction, but as the same can be said of the whole body of mathematical physics, the criticism has no special cogency in this particular case. Fiction or not, there is no doubt about the convenience. The important point is whether a modulated continuous wave does in fact behave in every respect as if it consisted of a pure carrier frequency associated with sidebands. If it does, then the sidebands do exist physically in the only sense in which the word "exist" has any intelligible meaning.

In what follows I propose to describe some simple experiments which demonstrate the physical existence of the sidebands in the above sense. Incidentally, the experiments illustrate some facts about the rectification of a modulated continuous wave which will probably be new to most readers.

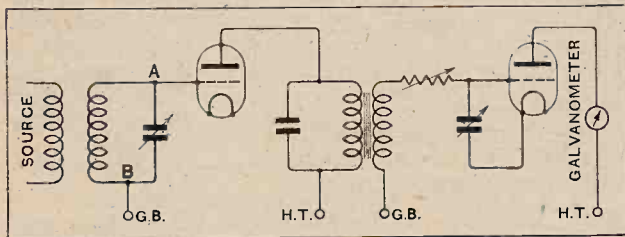

Fig. 1.—Essential details of the apparatus used for measurements. The last valve was used as a voltmeter.

quencies constituting what are known as the "sidebands." To take a simple case, the modulation of a carrier wave of, say, 300 metres (or one million cycles per second) with a single pure musical note having a frequency of one thousand cycles per second, is stated to result in the production of two additional radio-frequency wave-trains having frequencies of one million plus one thousand, and one million minus one thousand cycles per second respectively.

Neither the carrier nor the side-frequencies affect the senses directly. Further, it must be admitted that the actual mechanism of the modulation process is not such as to make the above interpretation of its results a simple and obvious physical conception. Finally, the fact that the whole process can be embodied in a well-known trigonometrical formula is probably, to non-mathematical persons, a suspicious rather than a convincing circumstance, and may even give rise to the idea that the existence of

The Resonance Curve of a Modulated Wave.

The apparatus used for the measurements is shown schematically in Fig. 1, which is self-explanatory. The last valve was used simply as a voltmeter. In the first measurements it was connected straight across the tuned receiving circuit, the first valve being disconnected.

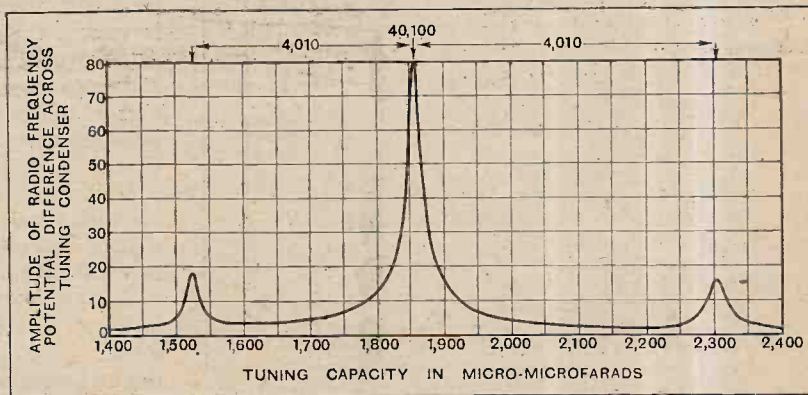

Fig. 2.—Resonance curves resulting from the modulation of a 40,100 cycle wave by a speech frequency of 4,010 cycles per second.

Experimental Proof of the Existence of Sidebands.—

With the audio-frequency oscillator switched off an ordinary resonance curve of the receiving circuit was taken at a frequency of 40,100 cycles per second by varying the tuning condenser, the voltage across the condenser being measured by the valve voltmeter. The transformer-coupled rectifying valve was disconnected during these measurements. The result was, of course, an ordinary resonance curve with a single peak. The audio-frequency oscillator (4,010 cycles per second) was then switched on and the resonance curve was taken again. The result is shown in Fig. 2. The side peaks correspond to radio-frequencies of $40,100 + 4,010$ and $40,100 - 4,010$ cycles per second respectively. These side-frequencies therefore exist in the sense that they produce resonance in a circuit tuned to them.

The rectification of a modulated continuous wave results, as is well known, in the production of an alternating current of modulation frequency. Assuming for the moment the physical existence of the side-frequency

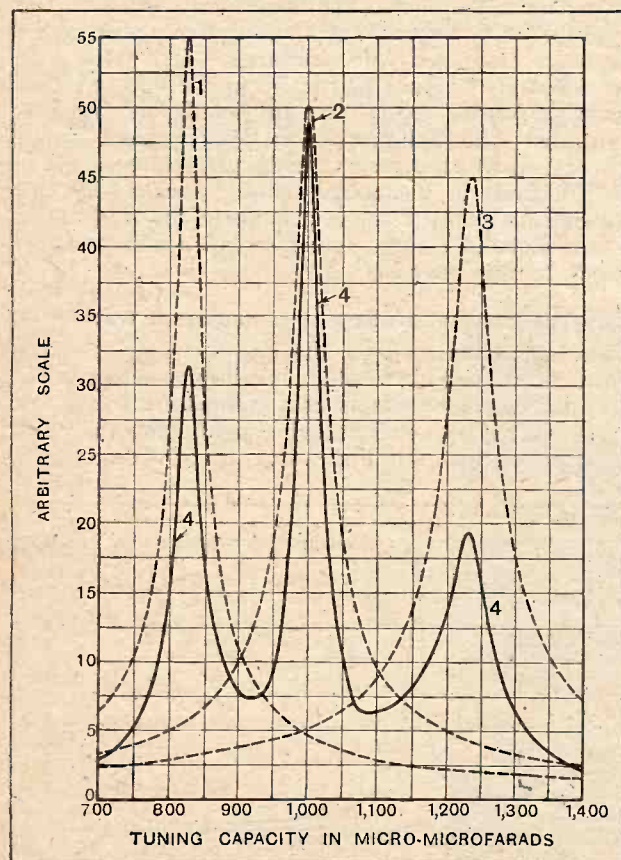

Fig. 3.—As the tuning capacity is varied, three peaks appear in the modulation frequency output. The peak of the higher side-frequency is a little taller and narrower than the other.

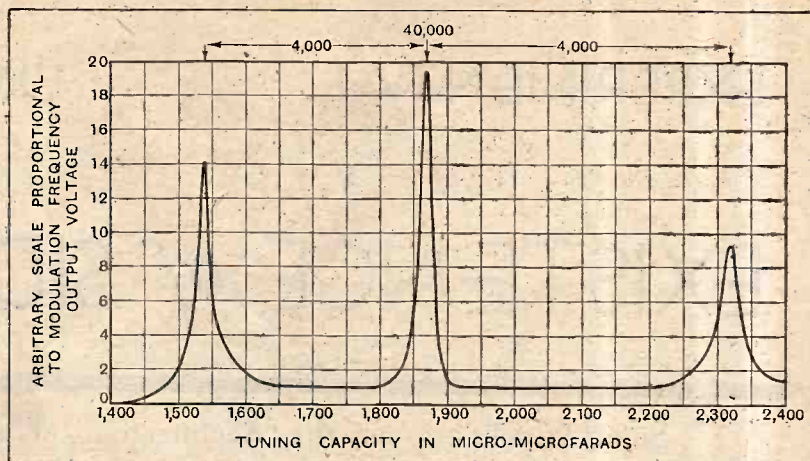

Fig. 4.—Experimental curves which check in essential respects the theoretical curves of Fig. 3.

components of the modulated continuous wave, it is easy to show, mathematically, that the production of this modulation frequency current involves the interaction of the carrier and side radio-frequency components in the process of rectification. Therefore any tuning condition which gives rise to a maximum intensity of any one of these three components will possibly—even probably—be associated with a maximum, or peak value, of the modulation frequency output current. A complete analytical investigation of this matter was made for the case of square-law rectification, assuming the following numerical values:

$$\omega = 5 \times 10^5, \text{ i.e. } \lambda = 3,768 \text{ metres}$$

$$\eta = 5 \times 10^4, \text{ i.e. modulation frequency} = 7,960$$

$$L = 4 \text{ millihenrys}$$

$$R = 40 \text{ ohms.}$$

The method of analysis was to represent the modulated continuous wave as the sum of carrier- and side-frequencies by means of the trigonometrical formula already referred to, calculate for each the potential difference it would produce for each assigned value of the tuning capacity, square the sum of these to represent the rectification process, and then isolate the modulation frequency component from the result. The result is shown in the full-line curve numbered 4 in Fig. 3. As already indicated, there are three peaks or maxima in the modulation frequency output as the tuning capacity is varied, these peaks corresponding to the carrier- and side-frequencies. It should be noted that the peak corresponding to the carrier-frequency is the highest, and of the side peaks that corresponding to the higher side-frequency is a little taller and narrower than the other.

It may be mentioned that the relative shape of the curve is entirely independent of the modulation percentage, but that its magnitude, i.e., the intensity of the output, is directly proportional to the modulation percentage.

This, however, is pure theory. The apparatus shown in Fig. 1 enabled the theory to be confirmed by experiment. The coupling between the receiving circuit and the oscillator was adjusted to a value which gave a sufficiently small e.m.f. for square-law rectification in the first valve, and a control experiment was made to ensure

Experimental Proof of the Existence of Sidebands.

that the audio-frequency transformer was effective as a filter, preventing radio-frequency voltages from reaching the measuring valve. (The latter was used in a sensitive condition with reflecting galvanometer, making it an R.M.S. instrument.) The variation of the modulation frequency output with the tuning capacity was then determined, and gave the result illustrated in Fig. 4. The curve differs somewhat in appearance from the theoretical curve of Fig. 3, but this is merely due to the different frequencies and circuit constants involved. The experimental curve checks the theoretical one in the essential respects already pointed out, namely, in respect of the three peaks and the relation between the peaks. A similar curve was recently demonstrated by Prof. Fortescue at a meeting of the Wireless Section of the Institution of Electrical Engineers.

Note that the centre peak is the only one for which the tuning capacity is independent of modulation frequency. Thus in the case of a complex modulation, such as speech, it is only the central tuning position which will give all the modulation frequencies in anything like their original proportion. This, incidentally, shows the undesirability of distuning as a means of volume control.

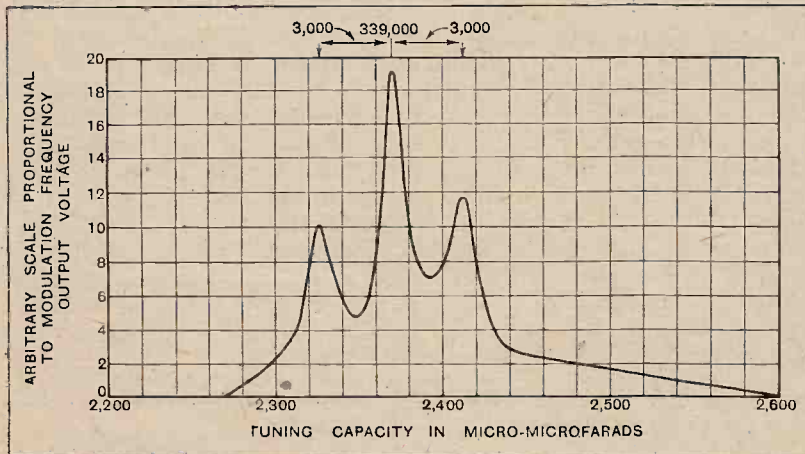

Fig. 5.—Curves corresponding to carrier and modulation frequencies of 339,000 and 3,000 cycles per second respectively. Resistance shunted across the tuned circuit may account for the left-hand peak being a little shorter than the right.

The actual distinctness and separation of the peaks will obviously depend on the ratio of the modulation to the carrier frequency, and on the sharpness of tuning of the receiving circuit. At short-wave broadcast frequencies there would not be nearly so distinct a separation of the peaks—probably there would be no more than a broadening of the tuning curve due to their coalescence. At medium-wave broadcasting frequencies, however, the peaks will probably still be distinct, at least for the higher modulation frequencies. This is

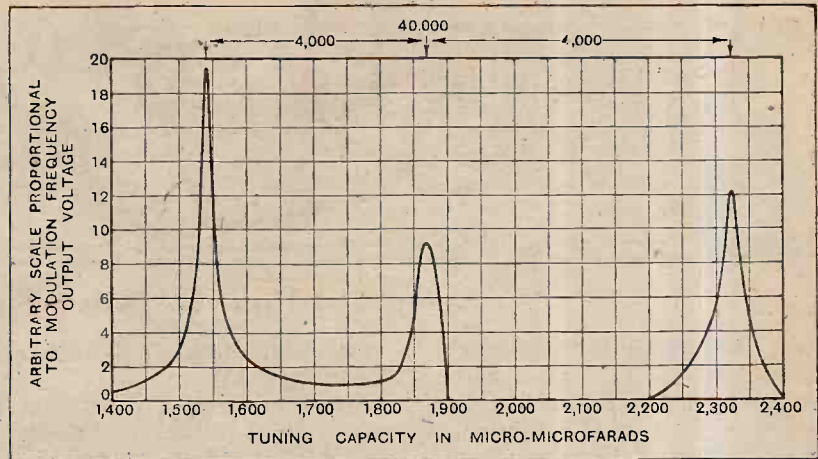

Fig. 6.—Tuning curve of the modulation frequency output for the same frequencies as shown in Fig. 4, but in this case the input was arranged to give "straight-line" rectification

confirmed by the curve of Fig. 5, which corresponds to carrier and modulation frequencies of 339,000 and 3,000 cycles per second respectively. It is noticeable that in this case the left-hand peak is actually a little shorter than the right-hand peak. The reason for this is not quite certain, but it can be stated that a shunt resistance connected across the tuned circuit would give this result, which may therefore be attributable to the input load of the rectifier valve. The above curve is consistent with a fact that readers may already have experienced—namely, that in calibrating a receiving circuit with a modulated oscillator wavemeter there may be three adjacent settings for any given radio-frequency. It is obviously the centre one which should be taken.

That, however, is incidental. The principal object of the above experiments is to demonstrate the physical existence of the sideband frequencies, and to show that theoretical deductions based on the assumption of their existence lead to conclusions which are confirmed in practice.

APPENDIX.

The "perfect" rectification of a modulated continuous wave.

For those whose main interest in the above experiments is in the light they throw on the process of the rectification of a modulated continuous wave the curve of Fig. 6 is included. This is the tuning curve of the modulation frequency output for the same radio and modulation frequencies as in Fig. 4, but in this case the amplitude of the input e.m.f. was such as to give an approximation to "perfect" or straight-line rectification. The striking feature is that the centre peak is now actually lower than those corresponding to the side frequencies. Unfortunately the case defies analysis and no theoretical explanation is as yet forthcoming. The result was repeated with a variety of experimental conditions which precluded the possibility of damping at the central resonance, or anode current limitation by saturation. The result must stand on its own merits as an experimental fact. It suggests that large amplitude rectification may be unfavourable in respect of interference from adjacent transmissions.

Practical Hints and Tips.—

using a larger reaction control condenser.

One of the most important advantages of a differential reaction condenser is that it automatically allows a fairly large capacity to be maintained between plate and filament. In consequence, it is safe to recommend the substitution of one of these components — generally with a capacity of from 0.0002 to 0.0003 mfd.—in cases where amateurs are dissatisfied with the performance of their detectors.

The necessary alterations are of the simplest kind, as indicated in Fig. 2(b). It is easiest to understand the operation of this type of condenser if we regard it as consisting of two separate units with insulated stators but with both rotors linked together electrically and mechanically. Drawn in the form of a circuit diagram, we get an arrangement like that of Fig. 2(a). Starting with condenser C, at its maximum setting and with C at minimum, reaction effects are as nearly at zero as residual capacity will allow. As the capacity of C is increased, regeneration comes into play, both by virtue of the fact that H.F. currents are now being passed through the reaction coil, and also because the by-pass capacity of C₁ is being reduced. It makes no difference to the functioning of the device that separate rotors are not actually used; indeed, to do so would be quite unnecessary.

One of the "buts" incidental to improved detection has already been mentioned; there remains the risk of impairing quality by adding to anode circuit capacity in a receiver where the various constants may have been carefully chosen from the "L.F." point of view. Actually, it is very seldom that any harm will be done by making a reasonable addition. If it happens that the detector is coupled to its succeeding L.F. amplifier through a resistance, the original frequency characteristics may be restored by using a somewhat lower value of anode resistance.

o o o o

AVOIDING A DOUBLE EARTH.

At a time when new regulations affecting the use of public electric mains in conjunction with wireless receivers are being framed, it is, per-

haps, inopportune to refer to the subject in these notes. But there is one point about which no ambiguity can exist: connection of a receiver to the supply should not introduce an extra metallic "earth" connection.

In the case of an A.C. system, the possibility of its doing so is avoided

condenser be inserted between the lead-in and the aerial terminal. This precaution should always be observed when the positive main is earthed.

There is a good deal of latitude in the capacities of these protective condensers; anything of from, say, 0.002 mfd. upwards will do well.

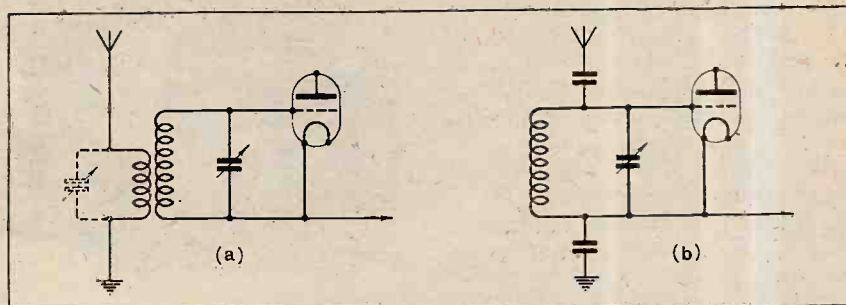

Fig. 3.—Isolating the aerial-earth system from the mains.

by the almost universal practice of using a double-wound transformer, which effectively insulates the supply from the "earth" to which the wireless receiver is connected.

Those who use D.C. are in a different position, and must take some precautions against either a direct short-circuit—which will be brought about if the positive main is earthed—or against the connections of the negative lead to earth at a point where some appreciable difference of potential may well exist.

Probably, the best plan is completely to isolate the set from the open aerial-earth system by using a double-wound coupling transformer, as indicated in Fig. 3(a). This plan is applicable if the aerial circuit is either tuned or "aperiodic": in either case, care must be taken to see that insulation between primary and secondary is good, and likely to remain so with changing settings of mutual coupling—if provision for varying the relative positions is made.

The more conventional method of providing isolation is that shown in Fig. 3(b). A fixed condenser is connected in the lead between receiver and earth in order to interrupt the continuity of the circuit. To guard against the possible ill-effects of a collapse of the aerial, it is also recommended that another

Their tested insulation resistance should be equal to at least twice the mains pressure.

o o o o

SIDEBANDS.

Although a receiver may be entirely beyond suspicion as far as its detector and L.F. amplifier are concerned, there remains in the mind of the earnest searcher after quality an uneasy feeling that the sidebands of modulation are possibly being lost in the tuned circuits.

It is not proposed to embark here upon a discussion as to the probable extent of loss existing in various receivers, but to point out that if all circuits are suitably detuned, there is not even the remotest possibility of distortion from this source. Consequently, those who live sufficiently near to a station to be able to work "off resonance" can rest assured that high-note loss is not taking place prior to the detector stage.

It should be emphasised that the circuits should be considerably detuned in order to bring about this state of affairs; very bad quality may result from a condenser setting slightly removed from the position giving loudest signals. As a rough-and-ready rule, it may be assumed that a dial reading differing by 5 per cent. or more from the true position of resonance is safe. Conventional circuit constants are assumed.

BROADCAST RECEIVERS

Solid Construction
and
High Grade Finish.

THE new Philips portable is a well-finished instrument of simple design and sturdy construction. The case is of solid walnut, highly polished, and is a beautiful example of the cabinet-maker's art. Unfortunately the quality of the cabinet work is reflected in the weight of the set as a whole, which is somewhat above the average. In this respect we would class the Philips set as somewhere between the "portable" and "transportable" categories. During transit the case is protected by a waterproof cover, which is lined with soft material to protect the polished surface and prevent damage by scratching.

A completely detachable front panel gives access to the batteries and valves, while a hinged flap protects the control panel. Both doors are provided with a lock and key.

The L.T. battery is an unspillable Exide of 48 ampere-hours capacity, and the H.T. a 108-volt, type No. 831, Siemens dry battery. The grid battery is a 15-volt Siemens unit. The batteries exactly fill the space provided, and no additional packing is necessary.

The receiver unit is enclosed in a metal screening chassis, and occupies a compartment over the batteries.

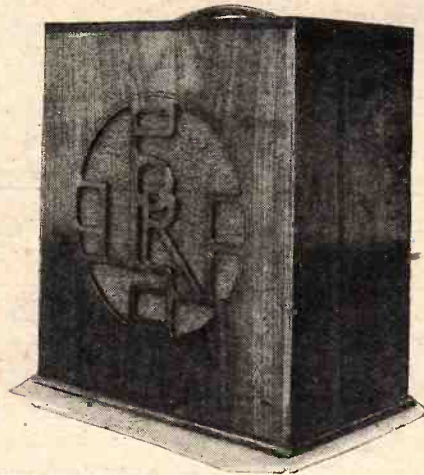

PHILIPS
Type 2522 PORTABLE

Performance Suited
to
Modern Conditions.

The valves are readily accessible, and the type of valve required for each position is marked by a metal tablet screwed to the partition immediately below each valve-holder. A sponge-rubber pad is fitted below the detector valve to assist in damping-out mechanical vibration and to take the extra weight of the valve, which is of a new type.

The circuit is simple and perfectly straightforward. There is a single stage of H.F. amplification employing a P.M.12 screen-grid valve, which is tuned-anode coupled to the detector. The condensers for the frame aerial and tuned

anode are ganged and controlled by a single knob and slow-motion drum dial. Trimming condensers are connected in parallel with each variable, but are not accessible and are correctly set before leaving the works. Provision is made for the attachment of an external aerial and earth, but the sensitivity of the set is such that it is unlikely that it will be found necessary to supplement the pick-up of the frame aerial.

Hooded Detector Valve.

A very small series condenser is inserted in the lead from the aerial socket, and this, in conjunction with the added H.F. resistance due to the external aerial, ensures that the ganging of the tuning condensers shall not be seriously disturbed.

The detector functions as a leaky-grid rectifier, the valve being a P.M.2D.T. This valve has similar characteristics to those of the P.M.2D.X., but is enclosed in a special double-glass bulb designed to prevent the transmission of mechanical vibration to the electrodes. Reaction is obtained by coupling the detector-anode circuit to the tuned-anode circuit of the screen-grid valve.

Following the detector is a two-stage L.F. amplifier with a P.M.2D.X. in the

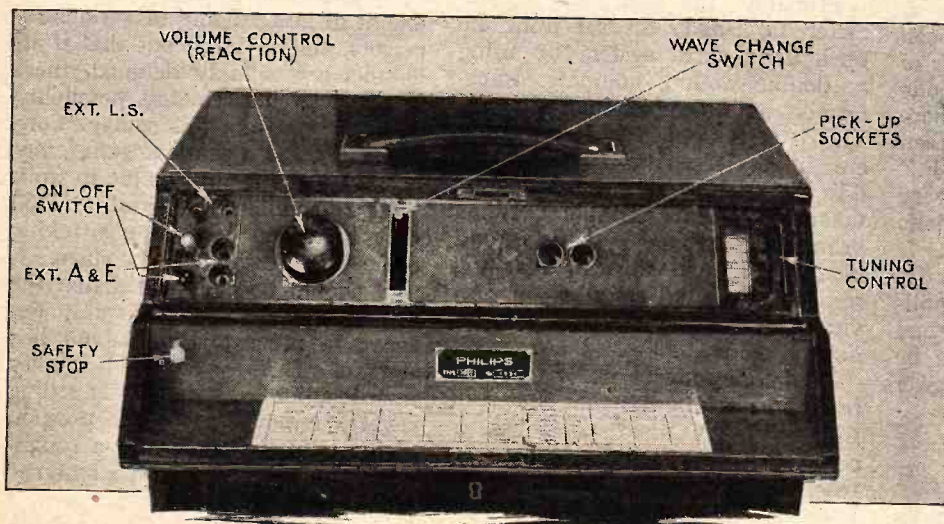

The controls of the Philips portable are localised in a narrow sloping panel running along the front edge of the cabinet. Note the stop on the hinged lid which automatically switches off the set when the lid is closed.

Broadcast Receivers—Philips Portable (Type 2522).— first stage and a P.M.22 pentode in the output stage. Both stages are coupled by transformers with high-permeability cores.

The controls are concentrated in a narrow panel running along the front top edge of the cabinet. On the extreme left is the on-off switch. This is of the twin press-button type, and a stud is arranged on the hinged lid in such a manner that the set is automatically switched off when the lid is closed. In addition to the aerial and earth connections already mentioned, sockets are provided for an additional external loud speaker and also for a gramophone pick-up. A lever switch effects the necessary inductance changes both in the frame aerial and tuned-anode circuits for reception either on the medium- or long-wave range. The main tuning control with its edgewise knurled operating knob and slow-motion dial are at the extreme right, while the reaction-condenser knob is between the wave-change switch and terminal panel on the left.

Reception Test.

The reaction control is free from back-lash, but in the particular receiver tested there was a certain amount of threshold howling both on the medium- and long-wave range. In all probability this was due to a faulty detector valve, as a certain amount of microphonic noise was also present in spite of the special design of the valve. This took the form of a faint but persistent ring, which was not sufficient to interfere with reasonably strong signals, but could be heard when the receiver was detuned.



Philips type P.M.2D.T. non-microphonic detector valve.

For the range and sensitivity of this receiver we have nothing but praise. In the space of little over an hour, after dark, twenty-five stations were logged on the medium-wave band and seven on long waves. Of these, sixteen on medium waves and five on long could be classed as reliable stations for the reception of programmes, while the remainder were sufficiently strong for identification.

The selectivity, too, is excellent. The Brookmans Park transmissions were easily separated with the reaction control set at minimum, while by using critical reaction the waveband occupied by London Regional (356 metres) extended only from 333 to 385 metres. In the case of the National (261 metres) the band occupied was from 245 to 284 metres. These figures, of course, apply only to Central London, where the test was made. On the long waves Königswusterhausen could be received clear of Radio Paris and Daventry 5XX by making use of critical reaction and the directional properties of the frame aerial. Incidentally, an efficient turntable is a standard item of the specification.

A Philips cone loud speaker is incorporated in the

set, and gives ample volume with quality of a very high standard for a portable set. The amplification preceding the pentode output valve is such that the latter can be easily overloaded, but the volume obtainable before distortion sets in is more than sufficient for normal use either in or out of doors.

The H.T. current consumption is rather high by comparison with other portables, the measured value for



General view of the Philips portable with front panel removed. The layout makes the best use of the space available and gives good accessibility to valves and batteries.

the set, tested with normal grid bias, being 14 milliamps. However, good volume and quality cannot be obtained without the expenditure of power in the output circuit, and in the Philips set the extra H.T. current is undoubtedly put to good use.

The price, complete with valves, batteries and waterproof cover, is £27 10s., and the makers are Philips Lamps, Ltd., 145, Charing Cross Road, London, W.C.2.

o o o o

BOOK REVIEW.

Report of the Radio Research Board for the Period Ended 31st March, 1929. Pp. iv+166. His Majesty's Stationery Office, Adastral House, Kingsway, London. 3s. 6d.

This is a general review of the work carried out under the auspices of the Board since its establishment in 1920. The extent of this work is indicated by the fact that the bibliography of papers published in connection therewith, which forms Appendix 1 of the Report, contains 105 items.

The first twenty pages give a general account of the establishment of the Board and the development of its activities. There follow detailed sections dealing with the Propagation of Waves, Directional Wireless, Atmospheric, Radio-frequency Standards and Precision Measurements, Antennae, Amplifiers, Interference, and Short Waves, and notes on Cathode Ray Oscillographs and High Vacuum Pumps. A perusal of the Report cannot but impress one with the large amount of useful work of a fundamental nature carried out. We welcome this well-arranged and very readable account of a number of long-sustained attacks on many interesting problems in radio.

G. W. O. H.

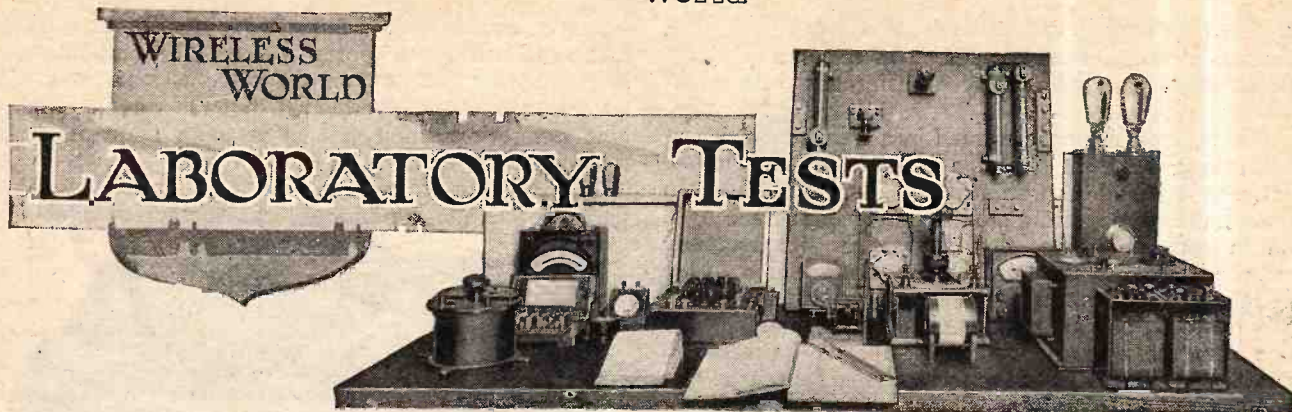

A Review of Manufacturers' Recent Products.

VARLEY HEAVY-DUTY L.F. TRANSFORMER.

In a receiver embodying a power amplifier it is sometimes necessary to employ a low impedance valve in the penultimate stage and follow this by transformer coupling to the output valve. A valve of this type passes a relatively heavy anode current—between 8 and 12 mA.—and few intervalve transformers will carry this current without leading to saturation of the core. The Varley heavy-duty intervalve transformer has been designed to meet these particular conditions, the

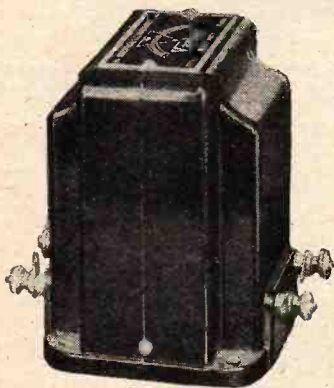

Varley heavy-duty L.F. transformer for use in power amplifiers.

maximum primary current that it will carry without saturation being of the order of 15 mA. The step-up ratio is 5:1.

Some practical tests were made using valves of various impedances to precede the transformer. The amplification, judged aurally, appeared to be fairly uniform over the whole of the audible scale, there being no noticeable resonance. Speech was clear and crisp, and orchestral music, reproduced on a moving-coil loud speaker, was correctly balanced throughout. Very good results were obtained when using a penultimate valve of 20,000 ohms A.C. resistance, the amplification being large and the quality of a high

order. It follows that the transformer may be used after a detector valve, preferably of the leaky-grid type, if desired when one L.F. stage only is employed.

The makers are Varley, Kingsway House, 103, Kingsway, London, W.C.2, and the price of this model has been fixed at 23s. 6d.

o o o o

"TANNOY" MAINS UNITS: Models 16C.H. and H.L.8.

The Tulsemere Manufacturing Co., 1-7, Dalton Street, West Norwood, London, S.E.27, has for long specialised in the production of mains units of all types in which the electrolytic type of rectifier is incorporated. To these has now been added a range of units fitted with the Westinghouse metal rectifiers, and two excellent examples of the new range are the models 16C.H. and H.L.8. The first-mentioned is a high-tension battery eliminator for A.C. mains, and suitable for operating 2-, 3- or 4-valve sets, provided the consumption does not exceed about 20 mA. With this value of current drawn from the unit, the terminal voltage was found to be 140. This dropped to 120 volts when the current was increased to 25 mA.

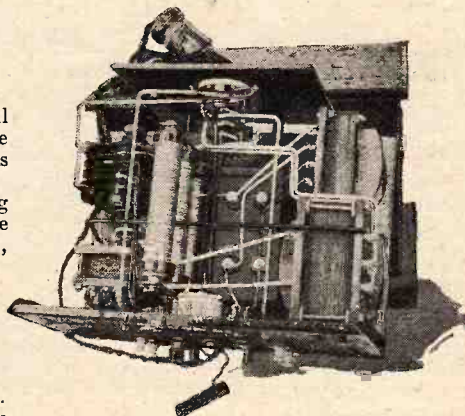

Plan view of the interior of the "Tannoy" combined H.T. eliminator and L.T. trickle charger; model H.L.8; note the neat layout of the components.

Full-wave rectification is provided, using the voltage doubling circuit. A single smoothing choke in the positive lead and generous-sized condensers suffice to remove practically all ripple from the D.C. output. A potential divider is connected across the output from the rectifier, and, being tapped at 10 points, gives the choice of several intermediate voltages. It is essential that a 2 or 4 mfd. condenser be included in the set between the H.T. terminals and the H.T. negative wherever lower potentials than the



"Tannoy" H.T. eliminator and trickle charger showing control panel and meter.

maximum are required, since there are no by-pass condensers between theappings on the potential divider and the negative of the D.C. supply. As a further precaution decoupling of these intermediate voltage points is recommended, as otherwise the common resistance may lead to L.F., and possibly H.F., instability. The mains transformer is tapped to suit supply voltages of 200/220 and 230/250 at 50 cycles. An external fuse is fitted in the shrouded wander plug, selecting the tapping required. The price of this model is £5 5s.

The model H.L.8 is more ambitious in its conception, and combines an H.T. eliminator with an L.T. trickle charger. In this unit bridge-connected Westing-

house metal rectifiers are used, which naturally provide a much larger output on the H.T. side than that of the model 16C.H. A load of 100 mA. is its safe maxi-



"Tannoy" H.T. battery eliminator, model 16C.H., incorporating Westinghouse metal rectifier.

mum, at which value the smoothed D.C. output was found to be 132 volts. The maximum terminal voltage at various current loads is given in the table below:—

Current in mA.	D.C. Volts.	Current in mA.	D.C. Volts.
10	210	60	162
20	200	70	155
30	190	80	147
40	178	90	140
50	172	100	132

In this model smoothing chokes are included in both positive and negative leads, and a potential divider is shunted across the output. Ten tappings are provided, but since blocking condensers for each have been omitted, these must be included in the set at all intermediate voltage points.

The L.T. accumulator should be connected to terminals provided on the unit, and the L.T. terminals on the set connected to two terminals on the unit marked "set L.T.+" and "set L.T.—". A three-position switch makes both H.T. and L.T. circuits when in the "set on" position, and when turned to "charge" trickle charges the accumulator. An "off" position is provided also. An ammeter is included with a centre zero reading 0.1 amp., either side. This indicates the rate of charge, also the L.T. current drawn from the cells when operating the receiver. An external fuse-cum-wander plug is included in the mains lead to the transformer. The price of the combined unit, with which 2-, 4-, or 6-volt accumulators can be used, is £10 12s., with Westinghouse metal rectifiers.

o o o o

GRIPPALL TUNING AND REJECTOR UNIT.

This device consists of an 8-ribbed ebonite former 2½ in. in diameter and 2½ in. long, on which is wound four separate coils, the sectional method of winding being adopted. An ebonite block 2½ in. square

is fixed to one end of the former, and in the centre of this is mounted the wave-change switch. The threaded bush of the switch serves also as a single-hole fixing device. Marked terminals are mounted on the rear end of the former, to which would be connected the aerial, earth, reaction feed and the grid of the valve. The ends of the rejector coil are brought out to two terminals mounted on the rear of the front ebonite block.

The long- and medium-wave coils are permanently connected in series, and the wave-change switch short-circuits the long-wave coil when pushed in. The insulated plunger of the switch actuates, also, a separate spring leaf, which changes over the aerial lead from a tapping on the medium-wave coil to the "earth" end of this coil for long-wave reception. By this means a tighter aerial coupling is achieved than would be available by leaving the aerial permanently connected to the tap on the medium-wave winding.

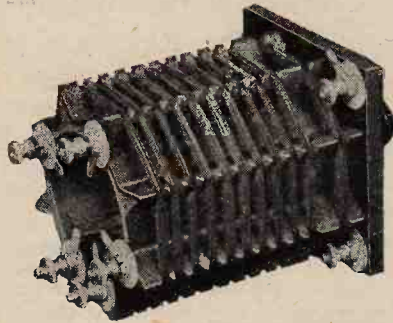

Grippall dual-wave coil incorporating a rejector winding and change-over switch.

The makers recommend using a 0.0003 mfd. condenser between the aerial and the aerial tapping, as this enhances the selectivity. We found on test, however, that a smaller value can be employed without materially reducing signal strength. The wave ranges covered, when connected to an average-sized aerial and with a 0.0002 mfd. in series, was found to be 231 metres to 570 metres and 950 metres to 2,050 metres respectively. Tuning on the lower part of the long-wave range was rather erratic between 950 and 1,080 metres, but beyond this it was quite normal. A tuning condenser of 0.0005 mfd. and a reaction condenser of 0.0002 mfd. were used throughout the tests.

The selectivity was found to be adequate to separate the twin Brookmans Park transmissions at about 10 miles, but at a lesser distance the rejector will, no doubt, be necessary. On test this was found to be decidedly effective. The makers are J. Rigant, 23, Eversholt Street, Mornington Crescent, London, N.W.1, and the price is 10s. 6d.

o o o o

BAWTREE BATTERY TESTER.

Reliable information as to the amount of charge in an accumulator can be ascertained by means of the "Singedrop" battery blotter recently introduced by Mr. A. E. Bawtree, 20, Manor Park Road, Sutton, Surrey. If a drop of the acid is

taken from each cell in turn, using a glass rod or a wooden stick, and allowed to fall on to the coloured surface of the blotter, a change in tint of the wetted spot will take place, from which the density of the electrolyte can be judged.

An orange colour indicates that the cell is fully charged, the specific gravity of the acid being 1250; a brown tint denotes half charge or acid S.G. 1200, and green that the acid is down to 1150. The cells would then be fully discharged. These blotters can be obtained at the price of 2d. each from the above address.

o o o o

"REGENTSTAT" POWER RESISTANCE.

This is a continuously variable resistance of the compression type, stated to range from 250 ohms to 4 megohms. The sample tested was found to have a minimum resistance of 50 ohms, and a maximum value of 2 megohms. Its maximum constant dissipation is given as 10 watts, but when handling this power the outer case becomes too hot to handle with comfort.

The resistance shows a tendency to change as the temperature rises, and as a consequence the final adjustments should always be left until the temperature has attained a steady value. When dissipating its maximum of 10 watts, the difference in resistance when hot and when cold is rather marked, but if the wattage dissipated is kept reasonably low the alteration in value need not cause any concern.

Our tests showed that the most satisfactory operating condition which gave a steady resistance value under load was when the power absorbed did not exceed 2.5 watts.



"Regentstat" variable power resistance.

The chief uses to which this device can be put are: voltage control in battery eliminators, anode feed and decoupling resistances, volume control across the primary of an L.F. transformer, to mention a few only. The makers are the Regent Radio Supply Co., 21, Bartlett's Buildings, Holborn, London, E.C.2, and the price is 7s. 9d.

o o o o

THE MELTROPE PICK-UP.

In connection with the description and characteristic curve of this pick-up which appeared in our issue dated April 2nd, we are informed by the makers, Amplifiers, Ltd., Billet Road, Walthamstow, London, E.17, that certain alterations will be made in the design before this component is finally put into production. We hope to publish a characteristic of the revised design in the Laboratory Tests section of this journal as soon as the new model is in production.

CURRENT

TOPICS

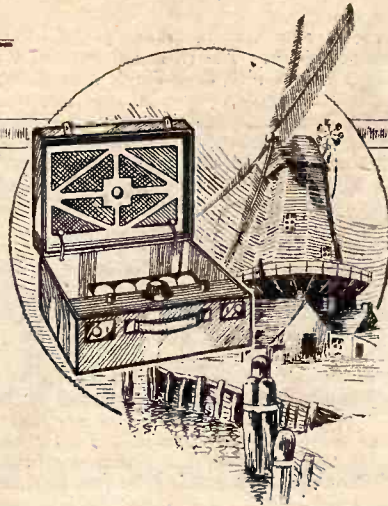
**THE PORTABLE PROWL.**

Post Office officials were scouring the highways and byways during the Easter holidays in search of owners of portable sets. Particulars of licences were taken and in cases where no licences were produced listeners had to furnish their name and address.

PORTABLES IN A MOTOR TRIAL.

Several portable wireless sets were observed in use during the London-Land's End motor trial at Easter. The reception of dance music during the evening journey helped to counteract the damping effect of the weather forecasts. Incidentally, it was found that a wireless set is easier to manage than a portable gramophone when travelling in a bumpy sidecar.

PARIS MAINS USERS IN TROUBLE.

Paris listeners who use battery eliminators are complaining at the action of one of the supply companies in cutting off the current on several occasions recently without giving due notice. The company replies that such stoppages are occasionally necessary for the purpose of repair work, and that listeners must regard these interruptions in their pleasure as "the ransom of progress."

ELECTRON THEORY OF METALS.

The Twenty-first Kelvin Lecture of the Institution of Electrical Engineers will be given at 6 p.m. on Thursday, May 1st, 1930, when Mr. R. H. Fowler, F.R.S., will deal with "Some Recent Advances in the Electron Theory of Metals." The meeting will be held at the Institution, Savoy Place, London, W.C.2.

Events of the Week
in Brief Review.**ANOTHER LICENCE INCREASE.**

The Postmaster-General has announced that the number of receiving licences in force on March 31st last was approximately 3,093,000. No statistics are available showing how many licensees use portable sets.

WIRELESS ON PLEASURE BOATS.

The L.M.S. passenger steamer "Duchess of Argyle" has been fitted with a complete wireless installation and is the first Clyde pleasure boat to carry such equipment.

RADIO BUREAU FOR FRENCH AIR SERVICE.

General Ferrié has been appointed president of a permanent commission instituted by the French Air Ministry to study and advise on all questions relating to the use of electro-magnetic waves.

"ARKAYO."

According to *The Wireless Age*, many Hollywood picture "stars" are petitioning American astronomers to name the newly discovered planet "Arkayo," to symbolise the age of high-class electrical entertainment. "Arkayo" suggests the initials "R.K.O.," which stand for the Radio-Keith Orpheum Circuit of talkie theatres!

TWIN TRANSMISSION EXPLAINED.

"A Wireless Broadcasting Transmitting Station for Dual Programme Service" is the title of a paper by Messrs. P. P. Eckersley and N. Ashbridge, B.Sc., to be read and discussed at a meeting of the Wireless Section of the Institution of Electrical Engineers at 6 p.m. on Wednesday next, May 7th.

WIRELESS-CONTROLLED AIRCRAFT.

A significant indication of the progress made in the wireless control of aircraft is afforded by the necessity for a new amendment to the Air Navigation Convention. The amendment provides that pilot-less aircraft shall not fly over countries other than their own.

RADIATION TESTS DURING TOTAL ECLIPSE.

The total eclipse of the sun on October 22 of this year will afford an opportunity for interesting radio transmission tests in the Pacific ocean. The line of totality passes through Suva (Fiji Islands) and Apia (Union Islands), both possessing wireless stations which will be used in the tests. The observations are to be carried out by the Astronomical Society of New Zealand.

PARISH PUMP CREATES STATIC.

Although the village of Aughnacloy, Tyrone, is far from the madding crowd, it is not far enough from the radio interference which is set up by the electric pump supplying water to the local reservoir. The twenty wireless licence holders of Aughnacloy have accordingly petitioned the authorities to stop the pump at six o'clock every evening, and we are glad to learn that the complaint is receiving sympathetic consideration.

FRANCE'S LARGEST RADIO SHOW.

A private company has been formed in Paris to erect the special buildings which will house the International Radio Exhibition in the autumn. This will probably be the largest radio show ever held in France, as it will unite the rival trade interests which have held separate exhibitions in past years. The site chosen for the "International Salon" is close to the Montparnasse railway station, in the Latin Quarter. The provisional dates for the Show are September 26th to October 9th.

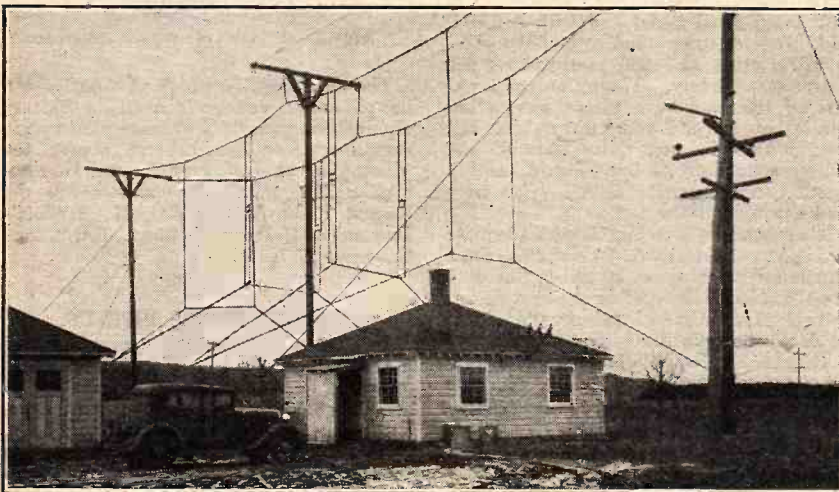

RADIO JUGGLERY IN AMERICA. Listeners to WGY, Schenectady, were recently entertained with a medley of transmissions from Sydney (Australia), Wellington (New Zealand), and Oakland (Cal.). The last mentioned is 3,000 miles distant but the signals covered 17,000 miles via Sidney, Schenectady.

CHATS WITH COCHIN CHINA.

A public radiotelephone service has been opened between France and Saigon (Cochin China), the fee being approximately £4 10s. for three minutes' conversation. The French transmitter and receiver are situated at Sainte Assise and Villecrenes respectively.

o o o o

PARIS RADIO GALA.

The amphitheatre of the Paris Sorbonne will be the scene of a brilliant wireless gala on the evening of June 5th, writes a correspondent. The organisers are the Federation of Paris Radio Associations, and the President on this occasion will be the Duc de Broglie, who is well known as an electrical research worker.

The chief item in the programme will be a statement by the Vice-president of the Wireless Traders' Association concerning efforts which are being made to suppress radio interference.

o o o o

NEW AMERICAN RADIO TRUST.

That the age of big wireless mergers has not yet passed was proved by the announcement on April 16th of the amalgamation of the General Electric Corporation and the Westinghouse Electric and Manufacturing Company with the Radio Corporation of America. In making the formal announcement, Mr. David Sarnoff, president of the R.C.A., said that the amalgamation would unify rights of manufacture and sale of wireless sets, thus reducing prices for sets and valves.

It is understood that the basis of the merger is the sale of some 500 million dollars' worth of R.C.A. stock in payment for the other companies' patents.

o o o o

A WIRELESS TEASER.

Without contemplating the inauguration of a regular Acrostics section we feel that readers may like to test their wits on the following specimen, forwarded by a reader in Devon. The solution will be given next week.

DOUBLE ACROSTIC.

1. For my initial—just initials, wrongly placed;
Those moving tones which ne'er good set displaced!
2. Opposition to a current is my clue;
To Reactance and Resistance this is due.
3. Remove my tail—two letters, think of bone,
Try Glazite, and you'll find a firm has grown.
4. A symbol scorned to-day by many a Fan
Who started life a humble One-valve man.
5. Some there are who feed their plates on "spec";
Correctly used this clue supplies a check.
6. Dot Dash in Morse you'll find supplies my start,
Dash Dot Dot completes my other part.
7. A circuit where, when current flows,
Distressing kicks the meter shows.
8. A picture here—or p'raps a graph is right—
You could get one from 5XX at night.

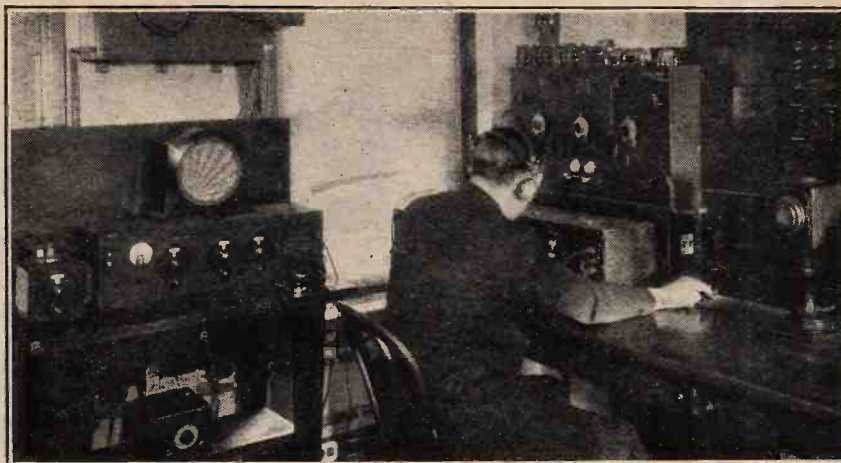

SCHENECTADY'S SHORT-WAVE STUNT. The control room at 2XAF, through which the transmissions from Australia, New Zealand and Oakland, California, were sent out to the WGY aerial in the form of a programme medley. The stations also conversed with each other.

9. Searching's his habit—reaction his pet,
I wish we could burn him along with his set!
 10. For filament saving an excellent ruse,
Cut off my head and you'll still find a use.
 11. Electrons find that I oppose their ways,
Yet with me volts and current are in phase.
- To prove my whole take three screen'd valves,
Plus two more for detection,
Add two L.F., divide in two,
Result—well, near perfection!

o o o o

CORRECTION.

We regret that a typographical error crept into the article on "Dielectric Properties of Insulators" in our last issue (April 23rd). In the last line of the article, on p. 444, "microfarads" should be read as "farads."

**REPORT OF THE
RADIO RESEARCH BOARD.**

THE report issued by the Radio Research Board of the Department of Scientific and Industrial Research covers the work accomplished since the establishment of the Board in 1920 up to March 31st, 1929, and demonstrates in a remarkable manner the progress of what may be termed the refinements of wireless during the past ten years.

It is interesting to note how often investigations which started on what appeared to be purely academical problems have led to results of great service in commercial and practical working. For example, experiments undertaken primarily to prove the existence of the Heaviside Layer and its nature have furnished invaluable data concerning the phenomena of fading and the choice of suitable wavelengths for different ranges. The study of the nature and origin of atmospherics involved the use of a special cathode ray

oscillograph, from which has been evolved a direct-reading visual direction-finder for ordinary wireless signals which is likely to prove a valuable aid to mariners.

The growing necessity for the accurate maintenance of frequencies has especially turned the attention of the Board towards the study of quartz resonators and oscillators, and to the construction of standard wavemeters.

The difficulties often experienced, especially in rough weather, in obtaining absolutely accurate bearings by means of direction-finding sets installed on board ships have led to the further development of the rotating Radio Beacon, which enables bearings to be obtained with an ordinary receiver and a stop-watch.

Among the miscellaneous researches undertaken by the Board may be noted the design of a high vacuum pump for use with large transmitting valves in which metal is used in place of glass for more readily dissipating heat. An appendix to the report gives a list of papers published up to March, 1929, describing some of the work carried out by members of the Board. Several of these papers have already appeared in the pages of *The Wireless World* or *Experimental Wireless*, and the names of the contributors are well known to our readers, and include Prof. E. V. Appleton, Dr. R. L. Smith-Rose, R. H. Barfield, D. W. Dye, R. M. Wilmotte, F. M. Colebrook, R. A. W. Witt, J. F. Herd, and others.

The report is published by H.M. Stationery Office at the very modest price of 3s. 6d. net.

TONE COMPENSATION.

"Realism from Records"—a brochure issued by Gambrell Radio, Ltd.—should appeal to all who are interested in electrical reproduction. In the space of 15 pages, full details are given of the "Novotone," its method of operation, and the results obtainable. Copies of the booklet can be obtained free of charge on application to Messrs. Gambrell Radio, Ltd., Buckingham House, Buckingham Street, Strand, W.C.2.

WIRELESS THEORY SIMPLIFIED

By S. O. PEARSON,
B.Sc., A.M.I.E.E.

Part XXVIII.—Outline of General Principles of Modulation.

(Continued from page 416 of previous issue.)

IN the transmission of radio telephony it is necessary, for the reasons already given, to employ a high- or radio-frequency to act as a "carrier" of the audio-frequency variations representing the sound waves. The normal practice is to cause the amplitude of the high-frequency oscillations in the transmitting aerial to vary from the normal or mean value in exact accordance with the audio-frequency variations to be transmitted. The high-frequency oscillations, when modified in this way, are said to be "modulated," and the low-frequency variation of amplitude is referred to as the "modulation frequency."

Let us suppose that a transmitting station is working

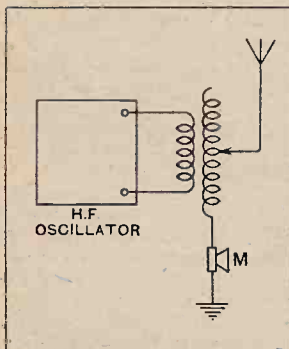

Fig. 1.—Simple arrangement for illustrating the principle of modulation of H.F. oscillations. The varying resistance of the microphone M causes corresponding variations in the amplitude of the H.F. oscillations in the aerial.

Now, suppose that it is required to employ the high-frequency ether waves passing between the transmitting station and the receiver as a means of carrying across an audio-frequency note of, say, 1,000 cycles per second; then, in the circuits of the transmitter the low-frequency variations of current corresponding to the note to be conveyed are arranged by suitable devices to vary the *amplitude* of the high-frequency oscillations in exact accordance with the wave-form representing the audible note.

A Simple Method of Effecting Modulation.

We are not concerned here with the elaborate methods employed for effecting modulation in a broadcasting transmitter, but rather with the nature and behaviour

of the modulated waves as they affect the receiver. Nevertheless, the nature of the waves is probably more easily understood when we have a knowledge of some simple means by which the high-frequency oscillations can be modulated, even though this means be not an efficient one. For instance, we can imagine an ordinary type of microphone with carbon granules to be connected in the aerial circuit of the transmitter in the manner shown by Fig. 1. When the microphone is spoken into, its resistance varies in accordance with the displacements of its diaphragm, which is itself actuated by the sound waves falling upon it.

Now, the amplitude of the high-frequency oscillations in the tuned aerial circuit is inversely proportional to the total resistance, and therefore the varying resistance of the microphone when being spoken into will cause corresponding variations in the amplitude of the high-frequency current. When the microphone is not being spoken into, or when no sound waves are reaching it, its resistance will be constant, and the high-frequency currents set up in the aerial circuit by the generating apparatus will have unvarying amplitude. The frequency of these unmodulated oscillations is referred to as the "carrier frequency," and the corresponding train of ether waves radiating from the aerial is called the "carrier wave."

In Fig. 2 the sine wave shown at (a) represents this unmodulated high-frequency oscillation in the aerial

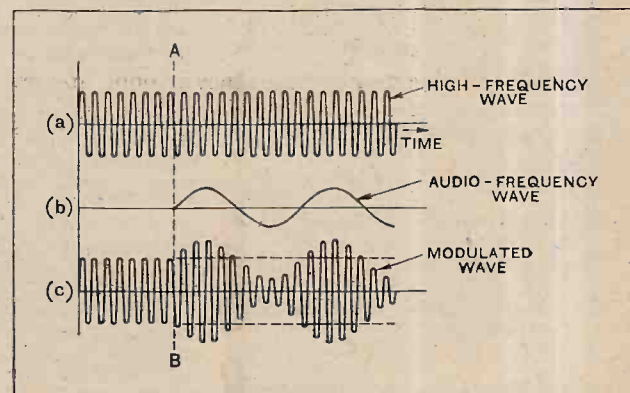

Fig. 2.—Diagram showing how in telephony transmission a high-frequency oscillation has its amplitude varied at an audible frequency.

Wireless Theory Simplified.—
circuit, assumed in this case to have a frequency of 1,000 kilocycles per second.

Single Note Modulation.

It will be simplest in the first place to consider the transmission of a pure tone, i.e., a simple note which can be represented by a pure sine wave without the presence of any harmonics. Therefore, let us suppose that, at an instant of time represented by the vertical line AB in Fig. 2, a note such as this, having a frequency of 1,000 cycles per second, suddenly reaches the microphone. This audio-frequency wave, shown at (b) in Fig. 2, has the immediate effect of causing the amplitude of the high-frequency oscillations to vary in sympathy in the manner illustrated at (c). In a case where the modulating system is perfect, the change in amplitude of the high-frequency wave from the normal or unmodulated value would be, at any instant considered, exactly proportional to the value of the low-frequency quantity at that instant. Thus the two contours of the positive and negative peak values respectively of the high-frequency oscillation will each have exactly the same shape or envelope as the low-frequency curve itself.

The same methods and reasoning can be applied to the general case where the low-frequency wave is one of irregular shape, and this will be considered in detail when we come to analyse a modulated wave.

Frequency of Modulated Wave.

It is important to note that the number of complete reversals per second of the high-frequency oscillations is exactly the same whether the amplitude is varying or not, and for this reason it is usually stated that a modulated high-frequency wave is one with constant frequency but whose amplitude is undergoing periodic variation. This statement, however, is not strictly correct, because the term "frequency" only applies in its true sense to a periodic wave or variation which repeats itself exactly cycle by cycle; and the same argument applies to the term "amplitude." So, when referring to a modulated wave, it will be understood that by "frequency" is meant the number of complete reversals per second, and that "amplitude" denotes the peak value of each half-wave.

The unmodulated carrier wave of Fig. 2 (a) is assumed to be a pure sine wave; but as soon as it is modulated the wave-shape of each half "cycle" of the high-frequency oscillation is no longer that of a sine wave—if it were, the "amplitude" would not be changing. Or, since the number of reversals per second is the same under both conditions, it is obvious that the change in peak value from cycle to cycle can only be

brought about by changing the *shape* of the high-frequency wave.

The extent to which a half-wave of the radio-frequency oscillation departs from the true sine shape depends upon the ratio of the maximum values of two successive positive half-waves, or, in other words, on the rate at which the "amplitude" is changing. This rate of change, in turn, depends on two factors: (a) the ratio of the modulation frequency to the carrier frequency, and (b) on the depth of modulation. By depth of modulation is meant the maximum amount by which the amplitude of the high-frequency oscillations is varied above or below the normal value, expressed as a ratio or a percentage of the normal amplitude when there is no modulation. Thus, when the modulation is 20 per cent., the amplitude of the high-frequency oscillation varies between limits 20 per cent. above and 20 per cent. below the normal value during one complete cycle of the modulation frequency.

In the case cited as an example, where the radio frequency is 1,000 kc. per second and the audio-frequency is 1,000 cycles per second, it is clear that during the time of one cycle of the low-frequency variation there will be 1,000 complete reversals of the high-frequency oscillation. In the diagrams of Fig. 2 only a few cycles of the high-frequency wave are represented as occurring during one cycle of the acoustic frequency—it would not be very practical to draw a sine curve with 1,000 waves within a space of an inch

or two. So the reader is left to imagine the conditions actually occurring, and it will be realised at once that when 1,000 oscillations occur during one cycle of the low-frequency wave, the difference in amplitude between any two successive positive half-waves will be extremely small indeed, and so there will be only a very slight deviation of the high-frequency oscillations from the true sine law. In transmitting this same 1,000-cycle note at a wavelength of 3,000 metres, in which case the carrier frequency is 100,000 cycles per second, there would be only 100 oscillations during each cycle of the low-frequency note. Therefore, at a time when the low-frequency wave is just about passing through its zero value, the difference in the amplitudes of two consecutive positive half-waves of the oscillation will be increased ten-fold in comparison with the 300-metre wave. In general, then, the difference of the relative amplitudes of consecutive half-waves of the H.F. oscillation will be greatest for high wavelengths and high-modulation frequency, and *vice versa*. However, it is not the actual difference of amplitudes which determines the behaviour of a modulated wave in a tuned circuit, but their ratio. For an unmodulated wave the ratio of consecutive amplitudes is unity at

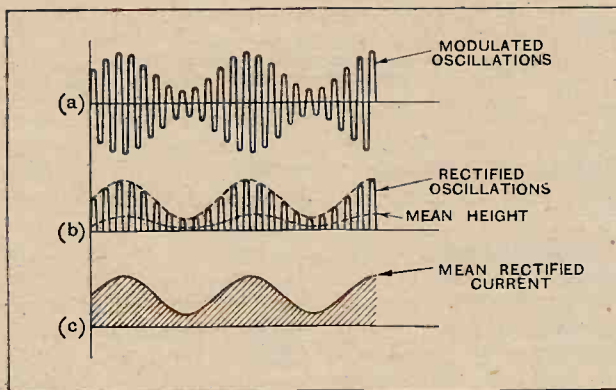

Fig. 3.—Curves showing how the low-frequency component is separated out from a high-frequency modulated oscillation. Curve (c) represents the rectified current (to a different scale) after the high-frequency pulsations have been smoothed out.

Wireless Theory Simplified.—

all times, but when the oscillations are modulated the ratio of the amplitude of each half-wave to that of the preceding one in the same direction varies above and below unity as time elapses. The effects of this amplitude variation in a tuned circuit are very important, and will be considered in detail at a later stage.

Oscillations in the Receiving Aerial.

The modulated ether waves emanating from the transmitting aerial and reaching a receiving aerial produce in the latter a high-frequency electromotive force exactly similar in form to the currents in the transmitting aerial. Now, if the receiving aerial behaved like a pure resistance, the current would be at every instant proportional to this voltage, and would, therefore, be an exact reproduction of the high-frequency currents in the transmitting aerial as regards variation, but, of course, on a much smaller scale. But the inductance and capacity required for tuning, unfortunately, have a modifying effect, in spite of the fact that their reactances cancel each other out at the resonant frequency; every change in amplitude of the high-frequency oscillation involves a change of stored energy in the tuned circuit, and the effect of this is partially to damp out or attenuate the modulation frequency or audio-frequency component, as will be explained subsequently.

For the present we shall assume that the current generated in the tuned aerial circuits of the receiver is an exact replica of that in the transmitting aerial. Suppose, then, that the upper curve (a) of Fig. 3 represents this current and that the resulting modulated high-frequency voltage built up across some part of the circuit is available for operating the receiver.

Separating the Note Frequency from the Carrier Wave.

The object in view is to obtain in the telephones or loud speaker a current whose wave-shape and frequency are the same as those in the microphone circuits at the transmitting end. From the upper curve of Fig. 3 it will be seen that, although the amplitude of the current is varying in accordance with the note frequency, the mean value is zero—there is as much of the curve above the zero-line as below it. Hence, if such a current were passed directly through the windings of a pair of telephones, there would be no acoustic-frequency variation in the pull upon the diaphragms, and no sound would be heard.

In order to operate the sound reproducer (telephones or loud speaker), it is necessary to pass through its winding a current; not proportional to the aerial current instant by instant, but proportional to the *amplitude* of the aerial current. This means that at the receiver the low-frequency component or modulation frequency must be separated from the carrier wave again, and this is the function of the *detector* in every receiving set.

Since the desired low-frequency current is to vary in accordance with the amplitude of the modulated wave,

the object will be attained if some means is provided for cutting off entirely all the negative half-waves of the modulated oscillation in the manner shown by curve (b) of Fig. 3. If this is done, the current passing to the telephones would consist of numerous pulses of current all flowing in the same direction, and the mean value, taken over an interval short compared with the time of one low-frequency cycle, but involving one or more complete pulses, would be proportional to the average amplitude during that time. Hence, the mean value of the current, as defined in this way, would vary in exact accordance with the amplitude of the high-frequency oscillations as shown at (c) in Fig. 3.

The Use of a Rectifier as Detector.

There are certain devices, such as a crystal, which allow current to pass much more freely in one direction than in the other. Such an arrangement is called a rectifier, and is said to possess unilateral conductivity to some extent. A perfect rectifier would be one which offered a constant resistance to current in one direction, but would allow no current whatever to flow the other way when the applied voltage is reversed. The characteristic curve of a perfect rectifier, showing the current passed for various values of applied voltage in each direction, would be similar to that shown in Fig. 4. The current would be exactly proportional to the positive values of applied voltage, but no current would flow with negative voltages. In practice no rectifier is perfect in every respect; some devices do act as perfect electrical non-return valves, allowing no reverse current to flow, but in the conducting direction the proportionality is not maintained as a general rule—that is to say, the rectifier does not obey a straight line law.

If a perfect rectifier were to be connected in series with a pair of telephones, and the combination then connected across some part of the tuned circuit in which there are modulated oscillations, unidirectional pulses of current would flow to the telephones, the low-frequency component of the oscillation thus being effectively separated out as explained above, and the corresponding note would be heard in the telephones.

(To be continued.)

o o o o

LECTURES ON THERMIONIC VALVES.

Beginning on Wednesday next, May 7th, a special course of six weekly lectures on "Thermionic Valves" is to be given at the Polytechnic, 307-311, Regent Street, London, W.1, by Mr. W. H. Date, B.Sc., A.M.I.E.E. The lectures, which will each begin at 6.30 p.m. and last two hours, will deal comprehensively with valve theory and will include demonstrations with measuring instruments, amplifiers, oscillators and public address equipment. It is felt that the lectures will appeal to all interested in wireless, radio-gramophone and talking-film work, who have attained a reasonable standard in electrotechnology. The course fee for London students is 7s. 6d., other rates being applicable to students residing at a distance.

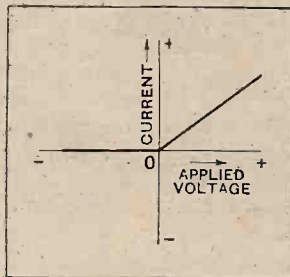

Fig. 4.—The voltage/current characteristic of an imaginary perfect rectifier.

Pirate War in the North.

The merry month of May holds black prospects for Newcastle, whither the G.P.O. detector van is now proceeding. The intention is to comb out the "pirates" throughout the Tyneside area, where the proportion of licensed listeners to the total population—the figure is 45 per thousand—has raised suspicions in official quarters.

o o o o

Honest Aberdeen.

This low figure is certainly rather significant in view of the fact that in Aberdeen 77 people in every thousand are paying for the privilege of listening. Newcastle seems thoroughly ashamed at this disclosure, and I understand that licence figures for the district are already mounting at an abnormal rate.

o o o o

A Month's Itinerary.

When the van has done its worst in Newcastle it will begin a reign of terror in Durham, and will subsequently pay similar compliments to Darlington, Stockton, and Middlesbrough.

The whole Tyneside tour is to last a month.

o o o o

Three Pirates a Day.

To keep their spirits up between campaigns the Post Office engineers have been recalling past triumphs. Going back as far as October, 1925, they have discovered that, since then, the number of successful prosecutions has averaged three on every week-day, the total being in the neighbourhood of 1,350.

o o o o

Was the Cow Libelled?

The B.B.C. engineers sent in this unemotional report a few days ago: "20.24-20.44, Midland Regional out of action; apparently caused by cow colliding with the feeder pole."

As an element of doubt persists it is still possible that the damage was done by Birmingham listeners enraged over the coming disbandment of their studio orchestra.

o o o o

The Blind Listener.

An official of the National Institute for the Blind tells me that the "Wireless for the Blind" Fund has now reached the figure of £15,000. While this represents a gratifying response to the appeal launched in December last, it is becoming more and more apparent that a far larger total is required if every sightless person in the country is to be supplied with a wireless set capable of bringing in the local programme.

Broadcast
Brevities

By Our Special Correspondent.

An Unforeseen Demand.

The Institute is now engaged on the colossal task of ascertaining the names and addresses of all eligible candidates in Great Britain and Ireland. Already the preliminary estimate of 15,000 persons has been passed, and further returns are coming in.

The aim of the Fund is to provide each blind person with a crystal set, except in places where a valve is absolutely necessary to ensure satisfactory reception. Tenders are now being invited from the leading manufacturers, whose estimates must be for the provision of receivers requiring a minimum of skill in their operation.

Why Crystal Sets?

Even a crystal set could bring untold joy to a blind listener, but it seems a pity that a valve set cannot be supplied in every case. No doubt the best argument in favour of the crystal is its simplicity, but I imagine that many blind persons are quite capable of battery management. Crystal sets are erratic in their behaviour, and the strain of listening to inadequate signals is very tiring.

o o o o

Valves for the Blind.

Listeners who would like every blind person to have a valve set can help to bring this about by forwarding subscriptions to the Rt. Hon. Reginald McKenna, Hon. Treasurer, British "Wireless for the Blind" Fund, 226, Great Portland Street, London, W.1.

o o o o

Pressmen at Dinner.

Why after-dinner speeches should have such a fascination for so many people is rather mystifying. There is no doubt, however, that "O.B.'s" from the dinner-tables of the mighty are listened to very keenly. One of the most promising events of this kind in the future should be the relay of the speeches from the Imperial Press Conference Dinner at the Guildhall on June 2nd, when several journalists of international repute will allow the microphone to report their after-dinner reflections.

o o o o

Another Relay from the River.

"The Pool of London at Night" will be one of the main items in the ninth programme of "Diversions," to be broadcast on May 9. It will consist of a description by Mr. J. C. Squire from a launch accompanying the river police of the nightly search of wharves and piers east of Wapping.

The launch will be fitted up with a microphone and short-wave transmitter. Mr. Squire was one of the Boat Race commentators.

o o o o

Staff Humour at Savoy Hill.

If the B.B.C. could put out regular programmes half as funny as the 48 pages of "Saveloy No. 2," the staff organ, we should laugh from Monday to Saturday and have difficulty in composing ourselves for the Sunday transmissions.

Listeners would relish the Running Commentary on the Departure of the Last Scotsman from Scotland, "by courtesy of an influential group of newspapers in Scotland—'The Dublin Mail,' 'The New York Record,' 'The London Letter' and 'The Yiddish Times.'"



THE SPONSORED PROGRAMME. The American Press holds strong opinions on the value of radio advertising, as is shown by this amusing cartoon in "The New York World."

RADIO MEASURING INSTRUMENTS

Meters for Use in High Frequency and Alternating Current Circuits.

By E. H. W. BANNER, M.Sc., A.M.I.E.E. (Instrument Department, Ferranti Ltd.).

(Concluded from page 436 of previous issue.)

DAMPING is usually pneumatic, and is rarely as good as is obtainable with moving-coil instruments using magnetic damping. The presence of a permanent magnet for damping in a moving-iron instrument is usually undesirable, as the alternating current tends to demagnetise the magnet and so renders the damping less effective; at the same time the magnet would almost certainly cause the reading with D.C. to vary with polarity, depending on whether the magnet assisted the winding or opposed it.

Another type previously unmentioned, but a form of moving-iron instrument, is the polarised-magnet type. Here the moving iron is actually of steel, and is constrained by a spring to take up its zero position in the field of a permanent magnet which "polarises" it. A fixed coil of wire carrying the current to be measured surrounds the moving system, and is disposed so that its field tends to rotate the moving system against the control of the polarising magnet and the spring. In some modifications no spring is used, the movement being magnetically constrained only. The polarising magnet, of course, makes this type dependent on polarity, so that only D.C. can be read. In the same way a centre zero is available as with a moving-coil instrument.

Numerous cheap instruments are of this type, although they are not widely used for wireless work, but they are extensively used for motor car lighting sets where the centre-zero feature is turned to account in providing for charge and discharge battery currents.

Among thermal instruments only those of the radiation or thermo-E.M.F. type will be dealt with, as they are superior to the expansion type and are now being manufactured in considerable quantities.

A heater wire, which may or may not be in an evacuated enclosure, warms a junction of dissimilar metals. The difference of temperature of this junction and the cold junction, which is the rest of the circuit, sets up an E.M.F. which is read by a millivoltmeter. There is nothing novel about the millivoltmeter except that it must be of a low range and low consumption, as the output from one or more thermo-couples on

heaters energised by only a fraction of an ampere is very small. A low-resistance movement is essential, and the millivolts available are only of the order of 20 or less (Fig. 6).

Insulation of the Heater.

The closer the junction to the heater the greater the developed E.M.F., but if it is actually in contact two troubles arise. For radio-frequencies stray capacitances are undesirable, and the capacitance of the instrument to earth may be appreciable if it is in direct contact with the heater. Secondly, unless the centre of the junction is exactly on the centre of the heater—a condition impossible of accurate attainment—there will be a reversal error on D.C., and as these instruments are for use on radio-frequencies it is much simpler to calibrate on D.C. If a reversal error is present it will necessitate all readings being taken twice, reversing the instrument polarity between each and taking a mean reading. The best practice, then, is to insulate the junction from the heater, but such insulation should not be a good thermal insulator or heat will not be rapidly conducted to the junction, leading to a sluggish-reading instrument.

Another advantage of the insulated junction is that any number of junctions may be connected in series and used on the one heater, thereby increasing the D.C. output obtainable from a heater wire run at a given temperature. Sensitivity is also increased when the junction and heater are run in *vacuo*, and this practice is common, but becomes troublesome in the larger sizes.

For true indication on the highest frequencies the inductance and capacitance of the instrument should be negligible. This needs a simple geometrical arrangement of the connections from one terminal through the heater to the other terminal, and all wires must be extremely short and not subject to sudden bends. Various ranges of milliammeters are obtained by choosing heater wires of suitable gauge, so that shunts are not necessary. Shunting for higher ranges is definitely bad practice, unless only low-frequencies are required to be measured, owing to the inductance of the shunt path.

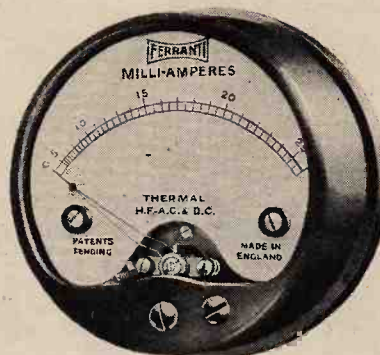

Fig. 6.—A thermofunction type instrument.

Radio Measuring Instruments.—

Apart from the limitation set by extremely high frequencies this type is extremely good for A.C. of any wave-form, as it measures the true r.m.s. value, and therefore is useful as a transfer instrument for D.C. calibration to check A.C. instruments or to make A.C. measurements.

The torque of an electrostatic voltmeter is proportional to the square of the voltage and to the rate of change of capacitance from zero to full-scale deflection, analogous to the case of the moving-iron instrument. Unlike this latter case, however, it is possible to get a high value for the rate of change of capacitance—80 per cent. or more—whereas the moving-iron instrument is usually only some 10 per cent., or less. Even with this high efficiency, however, the torque is low, and

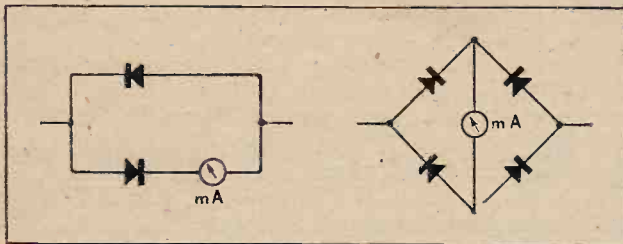

Fig. 7.—Alternative methods of connecting the rectifier type instrument.

for ranges of less than a few thousand volts is so low that a good movement of light weight is essential for a reliable instrument.

As no current flows there are no windings, and the resistance of the instrument becomes the insulation resistance; although at radio-frequencies the impedance is much less, due to the capacitance.

These instruments, like the thermal, are independent of wave-form, and can be calibrated on D.C. and used on A.C. Their use for radio purposes is definitely reviving, as there are instances in radio any current-operated instrument cannot be used; and some cases not necessarily for radio-frequency uses. Examples are—voltage on screen of screened-grid valves, grid voltage of large transmitting valves, etc.

In the early days of wireless, measurements were made by rectifying oscillating currents with a crystal and reading the direct current with an ordinary moving-coil galvanometer. These were mainly qualitative readings as it was difficult to calibrate such a set-up, and crystals were not usually constant in their rectifying properties to be of real use for quantitative work. The valve rectifier was brought into use soon after its inception as a detector in wireless work, and a previous paper by the present author dealt with a number of its uses.¹

These measurements were mainly for low-frequency use, although some of them could be used in radio

¹ "Measuring Small Alternating Currents." *Electrician*, 20th Aug., 1926, p. 202.

circuits provided that the measuring apparatus was inserted in the circuit at some point near earth potential and where its capacitance would not affect the radio-frequency circuit. The copper-oxide rectifier placed on the market by the Westinghouse Brake and Saxby Signal Co., Ltd., provides a small, compact and self-contained rectifier which can be used for measurements. A paper dealing with the theory of the action of the rectifier was published by Grondahl and Geiger.²

A later paper by the present author describes its application to measuring instruments.³

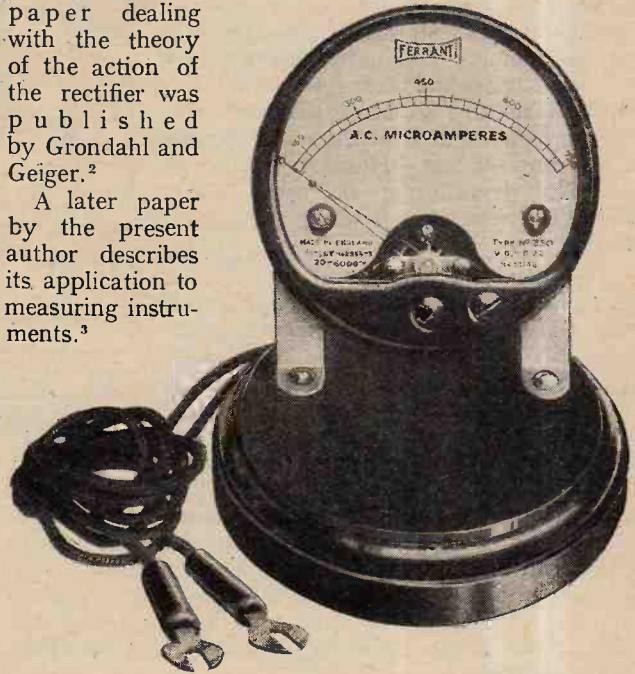

Fig. 8.—Rectifier type of instrument. It possesses ample torque and is adequately damped while having a scale as low as 750 microamperes.

The application of a rectifier of any type can be carried out in either of two ways. In one, two rectifier elements are used back-to-back, with the measuring instrument in series with one of them, and in the other four elements are used in a bridge connection (Fig. 7). The latter of these two methods is generally better, as with it full-wave rectification is carried out and the instrument carries the mean value of the current in the circuit. With two elements half-wave rectification results, and so only half the mean current is read. If the wave-form should not be symmetrical about the zero line, due to the presence of a D.C. component, then obviously half the mean value will depend on the polarity of the instrument, so that such readings are often of no use. In certain cases they are of real value; in order to find the asymmetry of a given wave-form, or to show any departure from a symmetrical wave, such a measuring circuit is of the greatest use. For general

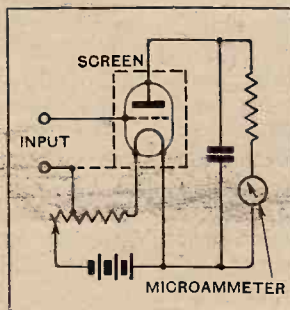

Fig. 9.—Circuit of thermionic voltmeter using anode rectification.

² "A New Electronic Rectifier." *Journal A.I.E.E.*, XLVI, No. 3, pp. 215-222.

³ "Rectifier Instruments for A.C." *Elec. Rev.*, 10th May, 1929, p. 823.

Radio Measuring Instruments.—

use, then, four rectifier elements are usual, and the mean value of the current is read. Such a value is usually not required, and so the r.m.s. calibration is more widely used. Actually mean current is still read, so that such a calibration assumes a sinusoidal wave-form, and the instrument, therefore, has a wave-form error.

The chief application of this instrument is to measurements of low volts and milliamperes in circuits connected to power mains where the departure of the wave-form from a sine wave is usually so small that the error on the instrument is of the order of only 1 per cent. or less. However, if a small saturated transformer or other wave-distortion apparatus is used, then such readings may be several per cent. in error.

The great advantage of the rectifier type of instrument over the moving-iron is the very much lower consumption, especially at low ranges. The lowest usual ranges of moving-iron instruments are of the order of 5-10 volts and 0.5-1 ampere. Rectifiers using moving-coil instruments find no difficulty in reading 1 volt and 1 milliampere for full scale, and these with the high torque and excellent damping common to moving-coil instruments. By using a galvanometer movement even lower ranges can be produced, the illustration in Fig. 8 showing a robust A.C. galvanometer reading to 750 microamperes. With more sensitive and delicate movements even smaller ranges could be produced, but would then lack robustness.

The rectifier instrument has a very wide range of frequency. For all supply frequencies there is no readable error, and at a frequency of 6,000 cycles the error is only about 2 per cent. Above this frequency the error increases slowly, but at high radio frequencies the error is so great that measurements are useless owing to the shunting capacitance of the rectifier bank which limits the useful range to the audio-frequency limits. A rectifier milliammeter of 1.5 milliamperes range is easily produced, and so any range of voltmeter from about 1 volt upwards can be made all with this very low consumption, whereas a moving-iron voltmeter of range 0-1 volt would consume an appreciable fraction of an ampere.

Due to the non-linear characteristic of the rectifier the scale is not uniform, there is some contraction near zero; but at high ranges this tends to be obscured and the scale more nearly approaches that of a moving-coil instrument.

Some few years ago the Moullin thermionic voltmeters were devised and at once became of great use for radio measurements.⁴ The designer first made two types, one employing grid rectification and the other anode rectification. At the present time there are five modifications, all intended to be of greatest use in particular circumstances. Briefly, the five patterns are:—

- A. Anode rectification, range 0.5-1.5 volts.
- B. Grid rectification, range 0.5-5 volts.
- C. Anode rectification, three ranges, 2, 12 and 120 volts, not for radio frequencies.
- D. Grid rectification, two ranges, 4 and 20 volts.
- E. Grid rectification, reads peak and mean volts, not for radio frequencies.

Type A is a voltmeter requiring a filament battery only, anode rectification being used, and the anode current corresponding to the applied voltage (which is applied to the grid) being read on an Unipivot microammeter.

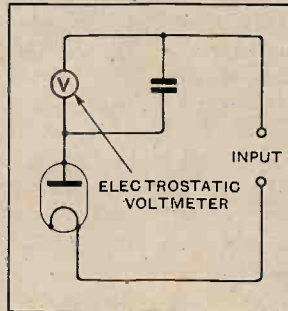

Fig. 10.—The peak voltmeter combining a diode rectifier and an electrostatic voltmeter.

This instrument is equally accurate on any supply, audio- or radio-frequencies, but there must be a conducting path between the terminals. It is thus useless for reading the voltage across one of two condensers in series. It is also incorrect if a steady potential is connected across the terminals. For either of these latter cases type B or D must be used. These use grid-current rectification, and are for use when there is no conducting external circuit across the terminals, or where a D.C. component exists. Type B

requires an anode battery of 50-70 volts, and its varying anode current is read on a double-pivoted milliammeter, whilst type D requires no anode battery and also uses an Unipivot instrument. Type C is more of a commercial instrument and will read on supply and low audio-frequencies only. It employs anode rectification, no anode battery being required. The standard model has three ranges, so that it becomes a very useful voltmeter for general laboratory work. Again an Unipivot galvanometer is employed. It is not independent of wave-form, but, being intended for supply mains, the error is generally negligible. Finally, type E⁵ gives readings both of peak and mean volts, so that on sinusoidal waves no movement of the pointer occurs on switching over from one measurement to the other, as the scales are arranged that for a sine wave the value on one scale corresponds to the reading on the other scale. It is intended for frequencies up to about 3,000 cycles, and on the "mean volts" scale D.C. potentials may be read.⁶

The valve, used as a diode, is adopted in conjunction with an electrostatic voltmeter to measure peak volts of an A.C. circuit, and in Fig. 10 will be seen the general connections in outline. The valve passes current in one direction, and so charges the condenser to the peak voltage of the circuit. An electrostatic voltmeter of appropriate range reads this potential. The capacitance of the condenser is not critical; it should be several times greater than the voltmeter capacitance at full scale, but not so great that it does not become fully charged for a long time. The valve must be able to withstand high voltages, so that above a hundred volts a transmitting valve is required.

⁵ "A Thermionic Voltmeter for Measuring Peak and Mean Voltages." Journal I.E.E. 66, p. 886.

⁶ The descriptions of the above thermionic voltmeters are given by permission of the Cambridge Instrument Co., London, the manufacturers.

⁴ "A Direct-reading Thermionic Voltmeter, and its Applications." Journal I.E.E. 61, 1923, p. 295.

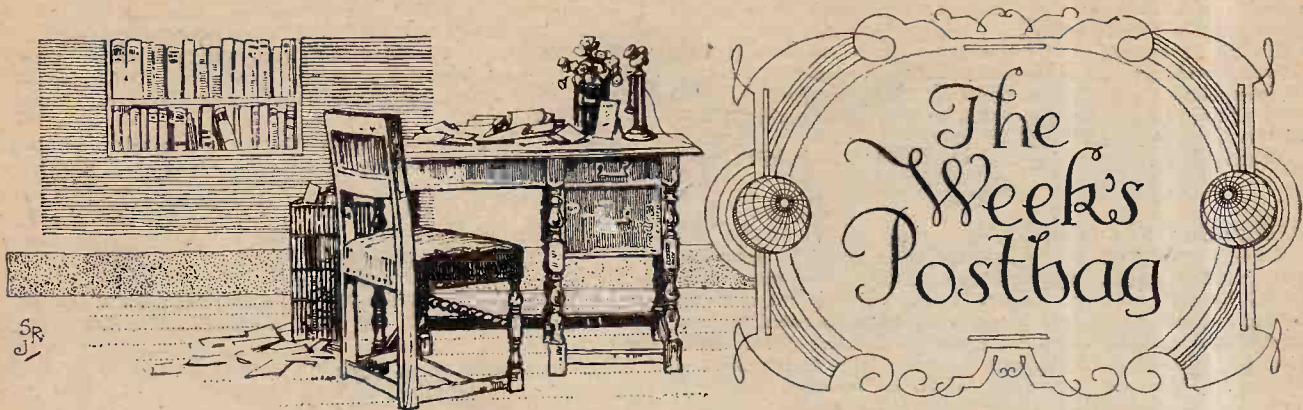

The Editor does not hold himself responsible for the opinions of his correspondents.

Correspondence should be addressed to the Editor, "The Wireless World," Dorset House, Tudor Street, E.C.4, and must be accompanied by the writer's name and address.

MIDLAND PROGRAMMES.

Sir,—I sincerely hope that Northern listeners did not act on Mr. Louis J. Wood's suggestion that they should ask the B.B.C. to relay the London or Midland Regional programmes through Manchester and Northern Regional stations.

Admittedly an alternative to the National Programme is required, but, surely, the obvious course is to demand that the Northern stations should relay Northern Regional programmes.

Why Lancashire and Yorkshire, with as many listeners as the whole of the London area, should be dependent on programmes from "outside" sources is incomprehensible and illustrates that attitude of mind, common among Southerners, which regards the North as a stage milder than Siberia. The title "Northern Region" perhaps encourages this view!

Please, Mr. Wood, lend your weight to a demand for Northern Regional programmes with the National through 5XX as the alternative. "NORTHERNER."

Liverpool.

cent. Any private trader carrying on his business on these lines would soon have his methods enquired into by the authorities, and the result would probably be very disastrous.

Could not some authority take up this matter officially with the Electricity Commissioners, or bring the matter up in Parliament, to save thousands of consumers from being deliberately exploited?

It should also be noted that it is not always possible to alter consumers' existing apparatus to suit the altered system of supply, but, if it can be economically altered, it is better for the makers of the apparatus to do it, and to get the guarantee.

Finally, the last sentence in "Ohm Sweet Ohm's" letter is one of the most sensible things I've seen in print for a long time, and I hope all readers of *The Wireless World* who are affected by such a change over will commit this sentence to memory.

Liverpool.

RESISTOR.

D.C. TO A.C.

Sir,—I have read with great interest the letters of "Enquirer" and "Ohm Sweet Ohm" on the subject of the change over from D.C. to A.C. in Edinburgh.

Many other towns are also adopting this attitude towards their consumers. I would also suggest to "Enquirer" that he reports his case to his local M.P., asking him to bring the matter up in the House. This would settle the question, and consumers would then know as much as the corporations on the subject.

With few exceptions, the various electric supply departments seem to be trying a huge game of bluff with consumers who charge their own accumulators at home, or who use battery eliminators.

The situation is, however, quite clear. The corporations are under a statutory obligation to replace all apparatus rendered useless by the change over, irrespective of whether the corporation have been advised that the apparatus is in use, or their permission has been obtained. The only exception is, where, after an individual notice has been served on the particular consumer in question, apparatus is then installed without the consent of the corporation. Some corporations, instead of replacing consumers' existing apparatus, supply additional apparatus to preserve the original source of supply.

This is done in churches, etc., and the usual method is for the corporation to install in a room near the organ a 2½kW. three-phase motor direct coupled to a direct-current generator, which in turn supplies direct current to the original D.C. motor driving the organ-blowing plant. Consumers should also observe that this additional plant is metered on the A.C. supply (not on the D.C. supply, as before), and in addition to this the consumer not only pays for the loss in the conversion of energy from A.C. to D.C., but is also saddled with the upkeep and depreciation of the additional plant as well.

The loss in conversion in the case mentioned is about 55 per

WAVEMETER SCALES.

Sir,—Respecting the article by Mr. W. H. F. Griffiths in your issue of April 9th, may I suggest a way out of the difficulty raised by him regarding the thickness of the lines on the graduated scale of a wavemeter?

My suggestion is that the scale should be graduated similarly to a surveyor's levelling staff: that is, comparatively thick lines are put on the scale, and the edge of the line is used. These staffs are graduated to one-hundredth of a foot, and they can be easily read with the naked eye at a distance of ten feet. With the telescope of a level they are used with great accuracy up to distances of 250-300 yards.

The scale is divided as shown in the sketch. The graduations being black on a white ground. It will be seen that the actual line for any reading has virtually no thickness, a white space being one-hundredth of a foot wide, and a black line a similar width.

I think that by adapting this to a circular scale, condenser readings to an accuracy of 0.5° could be obtained with moderate accuracy, and not, as shown in Figure 1 of Mr. Griffiths' article, by dividing 2° by the eye.

E. N. BROWNE.

Eccles, Lancs.

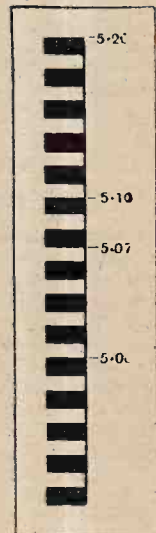

Sir,—The suggestion of Mr. E. N. Browne regarding the graduation of accurate condenser scales is, I think, quite good. Difficulty would, of course, be experienced in making the width of the line equal to that of the space in ordinary machine-engraved scales and also, perhaps, in those in which the gradua-

tion are moulded, but they could be reproduced by a photographic process quite easily.

The whole success of the scheme would depend largely, one feels, upon the fineness of the index line upon which the accuracy of interpolation between the limits of a line or space depends. Here again, perhaps, an edge would be more suitable than a line, however fine the latter could be made.

London, S.E.

W. H. F. GRIFFITHS.

TELEVISION SYNCHRONISER.

Sir,—Though I have not been able to trace the Inter-line synchronising device any further back than the period mentioned by your correspondent "Eureka," it may interest you to know that Mr. Geloso appears to have invented a very similar device, though he did not use the La Cour phonic drum principle with this. It appears to have been first published in *Radio News* for November, 1928, as under: "As this issue goes to press Mr. Geloso has not quite finished his automatic synchronising system. Briefly, his arrangement involves the transmission of a single strong impulse, at the end of each

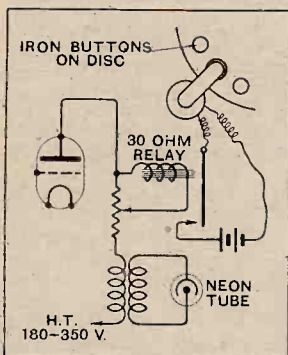

rotation of the transmitter's scanning disc. In the receiver this impulse will kick over a relay in the plate circuit of the last audio tube, and this relay, in turn, causes a magnetic device either to accelerate or retard the receiver's scanning disc. With one stabilising impulse every rotation, the disc will settle down to synchronism with the transmitting disc, etc." And again later in *Science and Invention* for December, 1928: "A more detailed view of the Geloso synchronising member is shown above (see diagram). When a synchronising impulse is transmitted once every revolution of the transmitter disc, it actuates the relay shown above, causing the magnet to attract the iron button fastened to the disc. One method of connecting the neon tube through a transformer is also shown above."

Could we not go a step further and combine the relay, controlled, say, by a control-grid glow tube, to the Baird toothed wheel synchroniser? I would welcome any comments on this.

Glasgow.

ARTHUR SUTHERLAND.

INTERFERENCE FROM LEIPZIG.

Sir,—I was very much interested to read the remarks of Mr. W. R. Craik in the issue of March 26th.

I have experienced the same trouble, only in my own case, in addition to a consistent background whenever Leipzig is working, I get periodic waves, as it were, of very bad distortion, B.P. on 261 metres being completely blotted out.

In addition, on occasions, bursts of practically pure music have come through, which rather indicated a swinging wave, this, of course, when B.P. was silent for a moment or so.

Other people in my neighbourhood have had similar trouble; a friend in Nottingham is getting the same thing.

In addition to Leipzig there is a station just below 261 metres which, in my opinion, contributes its quota of interference.

I get at times a certain amount of trouble on the other B.P. station, but not quite so bad as on the lower wavelength.

This is my first letter to you, and I should like to express my appreciation of your very excellent paper, and to wish you every success in the future.

Birmingham.

E. JOHN BIERMAN.

Sir,—I should like to endorse your correspondent, Mr. W. R. Craik's, experience with regard to serious interference with Brookmans Park on 261 metres. There is, after dark, nearly always a background of the foreign station here, with tuning as sharp as is consistent with good quality, and frequently sufficiently loud to quite spoil the National programme.

I informed the B.B.C. some time ago, and was advised to use 5XX, which I consider very unsatisfactory. Surely the premier Regional station should have arranged matters with regard to suitable wavelengths and power, to give a reliable service area embracing a greater distance than this (under 70 miles) from it.

Quality when free from interference is usually infinitely superior to 5XX, including, as the latter does, land line distortion.

Holland-on-Sea, Essex.

A. H. MAIDMENT.

A TELEVISION METHOD OF DETERMINING THE EQUIVALENT HEIGHT OF THE KENNELLY-HEAVISIDE LAYER.

Sir,—On reading through Mr. T. L. Eckersley's very interesting paper on the effects of wireless echoes in connection with the Marconi facsimile transmissions, it seemed to me that there ought to be multiple images due to echo signals in broadcast television and that it might be possible to measure the heights of the ionised layer by means of them. A simple calculation shows that the scheme is probably workable.

For broadcasting signals as used in the Baird transmissions at present, the time lag between the ground and atmospheric signals at a distance of 60 to 80 miles would be about 0.33 millisecond, and the question arises whether it would be possible to detect such a lag by the doubling of a television image. Let us suppose that a horizontal thin black line on a white ground is televised. The television "eye" travels from right to left and from bottom to top, making, I believe, 30 strip transits in, say, $\frac{1}{2}$ second. Thus, if the "echo" image were displaced, say, one-tenth of the total frame upwards, the lag would be about 0.23 millisecond.

For transmissions on shorter wavelengths and at shorter distances greater time delays would be expected. For example, at 30 miles from a 100-metre station I should expect a lag of as much as 1.5 milliseconds, which would show a much greater shift of the secondary image relative to the primary.

For long-distance reception the different images would be caused by the singly and multiply reflected signals from the ionised layer, but even in this case, knowing the lag, it is also possible to calculate the difference in path and, from that, the height of the layer by triangulation.

As some amateurs are, I understand, receiving the Baird transmissions at moderate distances, I should be grateful to hear from anyone who has observed such multiple image shifts and has noted the relation the shift bears to the size of the frame.

Wheatstone Laboratory,

(Prof.) E. V. APPLETON.

King's College.

DAVENTRY 5XX.

Sir,—Now that the great and all-important London has been soothed by the gift of Brookmans Park, perhaps the B.B.C. will pause in their mighty task of giving us programmes that for the most part fall upon cold filaments, and do something to improve the quality of transmissions from Daventry 5XX. There can, I think, be little doubt that this is the only worthwhile station for the majority of listeners in England, and there is therefore a considerable risk that that fact alone may prompt the B.B.C. to defer modernising 5XX for a painfully indefinite period.

I freely admit that the efforts of the programme department are rapidly reducing the necessity for having any transmitters at all, but while we 5XX listeners still have the habit of paying 10s. a year it seems a great pity that we cannot get even the odd fragments that appeal to us free from the distortion associated with the present land lines and equipment. The Regional scheme aims at providing two programmes for all listeners . . . a pleasant enough thought, but one that looks like taking years to put in practice, and before proceeding to give isolated areas their two programmes, surely it would be preferable to give everyone one programme of as high a standard of quality as is possible.

Is it possible that the neglect of 5XX is due to the fact that it is considered quite good enough for talks and that they are the only thing that really matters?

C. E. WOOD.

Parkstone, Dorset.



"The Wireless World" Supplies a Free Service of Technical Information.

The Service is subject to the rules of the Department, which are printed below; these must be strictly enforced in the interest of readers themselves. A selection of queries of general interest is dealt with below, in some cases at greater length than would be possible in a letter.

An Extra Winding Necessary.

Anode current for my receiver is supplied from A.C. mains through an eliminator, in which a 4-volt rectifying valve is used. The filaments of the set itself are fed from a 2-volt accumulator. Would it not be possible to fit a 4-volt super-power output valve, and to heat its filament directly from the low-voltage winding of the power transformer in the eliminator?
L. d'A. M.

This is quite impracticable. In an eliminator, the winding of the transformer which heats the filament of the rectifying valve is at high potential with respect to "earth," and consequently with respect to the filaments of the valves in the set. An attempt to do as you propose would introduce a short-circuit across the H.T. supply.

No Magnetic Coupling.

Referring to the throttle-controlled Hartley circuit discussed in "Hints and Tips" ("The Wireless World," April 2nd), will you please tell me if it is necessary that the long-wave loading coil L_1 should be in inductive relationship with the two halves of the medium-wave coil, $L(a)$ and $L(b)$?
T. G. D.

It is best to mount the long- and medium-wave coils at right angles to each other. Appreciable coupling between them is unnecessary or even undesirable.

An Impracticable Scheme.

I have successfully installed a "free" grid bias arrangement for the output valve of my "A.C. Three," and should now like to modify the detector grid circuit so that the bias battery may be entirely eliminated, except for a single cell for the H.F. valve.

Will you please examine my circuit diagram and say if the proposed connections are correct?
A. E. L.

Your diagram (reproduced in Fig. 1) shows that you propose to insert an 8,000 ohm resistance in the lead joining the detector cathode and the negative H.T. bus-bar. We fear that this plan is quite

impracticable, as you are depending for bias on a voltage drop across the resistance brought about by the anode current of the detector valve itself. As this anode current varies with signal input, it will be obvious that as it tends to rise through the application of signal voltages to the grid, it will be prevented from doing so by the fact that negative bias will also be

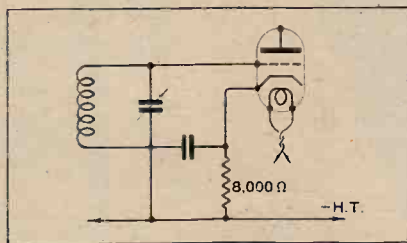

Fig. 1.—Circuit diagram submitted by "A. E. L."

tending to increase, and thus the requisite change in anode current cannot take place. You will find it necessary to take bias for the detector from a resistance that is connected in a circuit where the current flowing is high in value compared with that passing in the detector anode circuit.

RULES.

- (1.) A query must be accompanied by a COUPON removed from the advertisement pages of the CURRENT ISSUE.
- (2.) Only one question (which must deal with a single specific point) can be answered. Letters must be concisely worded and headed "Information Department."
- (3.) Queries must be written on one side of the paper and diagrams drawn on a separate sheet. A self-addressed stamped envelope must be enclosed for postal reply.
- (4.) Designs or circuit diagrams for complete receivers or eliminators cannot ordinarily be given; under present-day conditions justice cannot be done to questions of this kind in the course of a letter.
- (5.) Practical wiring plans cannot be supplied or considered.
- (6.) Designs for components such as L.F. chokes, power transformers, complex coil assemblies, etc., cannot be supplied.
- (7.) Queries arising from the construction or operation of receivers must be confined to constructional sets described in "The Wireless World"; to standard manufactured receivers; or to "K.U." sets that have been reviewed.

Negative Aerial Bias!

Will you please examine my circuit diagram and say whether the connections of the bias cell for the H.F. valve are correct? I have found it necessary to replace this cell several times, as it seems to become exhausted after a few days' use.

W. F. H.

Your diagram is correct enough, but as you are using an aperiodic auto-transformer input coil, the bias cell is, in effect, connected between aerial and earth. From the electrical point of view this does no harm, particularly as it is shunted by a by-pass condenser.

It occurs to us that there may be an intermittent contact between the aerial wire and earth, or more probably that you have a safety earthing switch which, when it is closed, will introduce a short-circuit across the cell. In either case, the trouble may be overcome by connecting a large condenser between the aerial lead-in wire (or the earthing switch if one is fitted) and the aerial terminal of the set.

Morse Practice.

I am trying to learn the Morse code, and have set up a practice buzzer and key. In order to imitate more closely the conditions of actual reception, an attempt has been made to connect the head telephones to the buzzer, but I find that by joining them across the contacts the signals heard are unbearably loud; the same applies when the phones are shunted across the windings. Can you suggest a simple way out of the difficulty?
H. L.

We think that your best plan is to join the phones in series with a variable condenser across the buzzer windings. By adjustment of the condenser it will be possible to regulate the intensity of sound.

If you have not got a spare condenser, a variable resistance would do as well.

Another way of getting signals of comfortable strength is to make a step-down transformer by winding a few turns of wire over one of the magnet bobbins, the phones being connected across this winding.

An Extra L.F. Stage.

Will you please show me how an intermediate resistance-coupled L.F. stage may be added to the "New Kilo-Mag Four" receiver?

I am not aiming at any very great increase in L.F. magnification, and should like to include an anode potentiometer for volume control, and a fixed potentiometer for controlling detector anode voltage.

The set is to be fed from an existing H.T. eliminator, which delivers nearly 200 volts at the estimated load imposed by the receiver.

Will you please suggest suitable values for the various resistances, etc., in the extra stage? P. D. W.

We suggest the arrangement shown in Fig. 2, in which suitable values are indicated. It would be permissible to use a lower value of H.F. stopping resistance in the grid circuit of the first L.F. valve if it is found possible to do so.

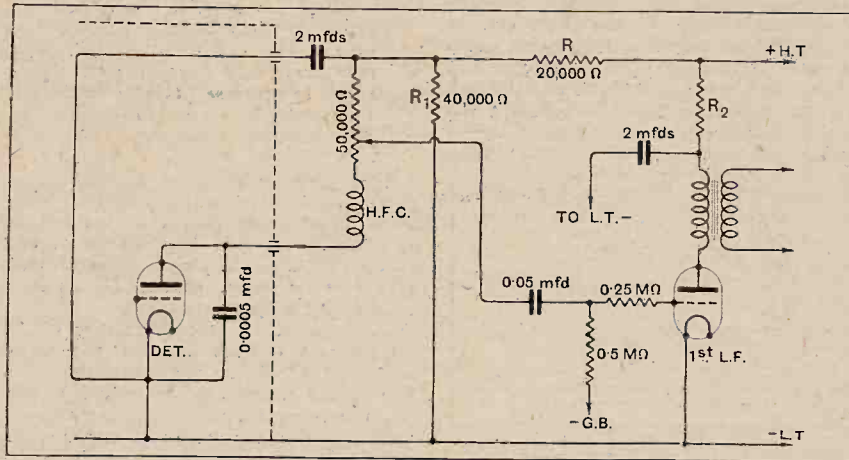

Fig. 2.—An extra L.F. stage for the "New Kilo-Mag Four," with anode potentiometer as volume control. Resistances R and R₁ are the elements of a fixed potentiometer for regulating detector anode voltage.

We have not assigned any value to R₂, which is the decoupling resistance for the first-stage L.F. valve; its value depends upon the characteristics of this valve. In all probability 20,000 ohms will be about right.

o o o o

Anode Current Consumption.

I am thinking of building the "New Kilo-Mag Four," but am rather afraid that its anode current consumption may be excessively high (I have to depend on dry batteries). Will you please give me an idea as to the probable load imposed upon them? C. T. E.

This depends largely on your requirements in the matter of volume, and consequently upon the type of output valve chosen. The two H.F. valves and detector will between them consume some 7 or 8 milliamps, and an economical type of power valve will take another 8 milliamps, making a total of 15 or 16 milliamps.

With a super-power valve in the output position, the total consumption will rise to about 20 milliamps.

The Effect of Back Pressure.

When charging my 150-volt H.T. accumulator battery from 220 volts D.C. mains I find that constant readjustment of the regulating rheostat is necessary in order to maintain the charging current at the rate fixed by the battery manufacturers. This is most inconvenient, and I am wondering whether there is any way of avoiding it. Does this need for control suggest that the battery is in poor condition? C. V. G.

We gather that you consider it essential that the charging rate laid down by the battery manufacturers should be rigidly adhered to. This is wrong: the point is that the rate should not be sensibly exceeded, but there is no harm done if the charging current falls to a lower value than the maximum rate recommended. In any case, it is quite normal that the charging current under fixed conditions as to supply voltage and regulating resist-

variable damping is being applied to the H.F. intervalve coupling. This, of course, is due to "reverse reaction" through the detector valve capacity.

We strongly advise you to attempt to improve stability by paying attention to screening and decoupling, and even, if necessary, by removing primary turns from the H.F. transformers. In any case, however, there should be no real difficulty in setting detector grid bias once and for all, even though the set may be normally on the verge of self-oscillation; all you have to do is temporarily to bring about conditions of complete stability by considerably detuning one of the H.F. valve circuits while listening to signals of sufficient strength. Under these conditions there should be no tendency whatsoever towards self-oscillation, and the detector grid bias adjustment should work "according to plan," the right setting being indicated, of course, by loudest signals.

o o o o

Pentodes in Parallel.

When connecting two pentode valves in parallel, is it necessary to provide separate decoupling resistances and by-pass condensers for each screening grid? M. L. N.

This complication is quite unnecessary; the two screening grid terminals may be connected together and fed through a common resistance, a single by-pass condenser being used.

FOREIGN BROADCAST GUIDE.**MILAN**

(Italy).

Geographical Position: 45° 27' N. 9° 11' E.

Approximate air line from London: 600 miles.

Wavelength: 501 m. Frequency: 599 kc. Power: 7 kW.

Time: * Central European (one hour in advance of G.M.T.).

* British Summer Time coincides with C.E.T.

Lady announcer. Call: EIAR (pronounced: Eh-ah) Radio Milano, or: Stazione Radiofonica di Milano.

Standard Daily Transmissions.

B.S.T. 08.15 news (Sun. 10.15); 10.45 concert (Sun.); 11.25 records (ex. Sun.); 12.30 concert, followed by news bulletins, talks, etc., until 20.30 when time signal is given and main evening programme; 21.15 news.

Programmes are frequently exchanged with Turin and the station usually closes down at 23.30—24.00 B.S.T.

Interval Signal: Morse letter T (-) at intervals of seven seconds.

Closes down with Italian National Anthem: *Marcia Reale* and Fascist Hymn; *Giovinanza* and words *Buona notte a tutti* (Goodnight, everybody).

ance should decrease progressively during the charge. This is due to the fact that the voltage of the battery, which rises on charge, is in opposition to that of the supply mains, and consequently the voltage available for driving current through the battery and series regulating resistance is progressively reduced.

o o o o

Incidental Control of Damping.

The detector-grid potentiometer of my "1930 Everyman Four" does not seem to work as it should; in fact, it operates in much the same way as reaction control; actual oscillation can be produced at the lower end of the tuning scale. You will realise that under these conditions it is an extremely difficult matter to find the right setting of detector bias. Will you please give me a few words of advice? S. B. G.

It seems fairly clear that your H.F. amplifier is far too near the point of self-oscillation, and that due to changes in detector valve impedance brought about by adjustments of the potentiometer,

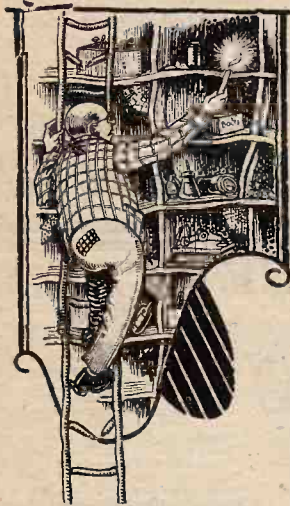

This sort of thing is out of date —

WHY NOT STORE YOUR GOODS WHERE THEY CAN BE FOUND?

Hunting in the dark in old-fashioned wooden shelves is quite unnecessary nowadays. Save Time, Temper, and be certain of finding what you are looking for by storing your goods in "TILTRACKS." There are many types—some for the Experimenter and some for the Manufacturer.

Write for Lists.

THE "BENCHRACK" (Tiltrack Principle)

A real help for storing small parts such as Terminals, Nuts, Washers, Insulators, etc. Made to stand on the work bench, it enables all small parts needed for the job in progress to be stored where they are immediately to hand. All the trays are tilted so that the parts stored can be seen at a glance, and the front faces of the trays are rounded so that the smallest parts can be swept up the slope with the fingers of one hand. Each tray is provided with patent hinging partitions which can be moved quickly to make larger or smaller compartments. Being so accessible these racks greatly facilitate stocktaking and being all steel there is no danger of fire. The Experimenter will do his jobs much quicker and with greater pleasure, and the Factory will save many pounds per year by installing this Benchrack.

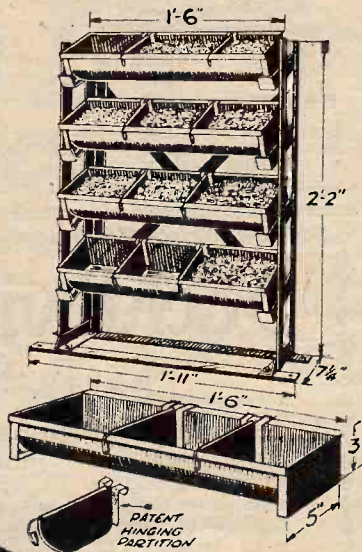

30' - F.O.R.

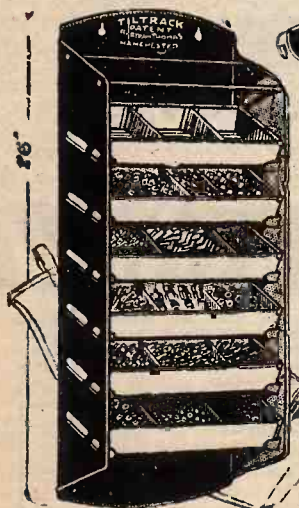

"TILTRACK JUNIOR"

This all-steel rack is designed to hang against a wall or other convenient position, and is a most excellent rack for storing small parts. It is supplied complete with white canvas protective cover to keep out the dust. All the trays are tilted and have movable partitions.

30' - POST FREE.

THERE ARE MANY MORE STYLES OF "TILTRACKS." PLEASE SEND FOR LISTS.

Particulars from Manufacturer & Patentee — **Worsley Street, Hulme, MANCHESTER.**
BERTRAM THOMAS,
 London Office & Showroom: — 28, Victoria Street, S.W.1.

Over 10,000 hours of Service



Dubilier Paper Condensers have been positively proved to give life-long, reliable service of the highest efficiency. Under a continuous test in our factory they have outlasted 10,000 hours. That is why Dubilier Condensers are used wherever efficiency over long periods must be maintained and a breakdown would be fatal.

Obtainable in a wide range of capacities and voltages; also in "blocks" for Battery Eliminator construction.

DUBILIER PAPER CONDENSER

Dubilier Condenser Co. (1925), Ltd., Ducon Wks., Victoria Road, N. Acton, London, W.3.

Free for the asking—"A Bit about a Battery." There's a copy for you at your dealers.

Cleaver B.C.297/P.

Sound in principle

SAYS THE

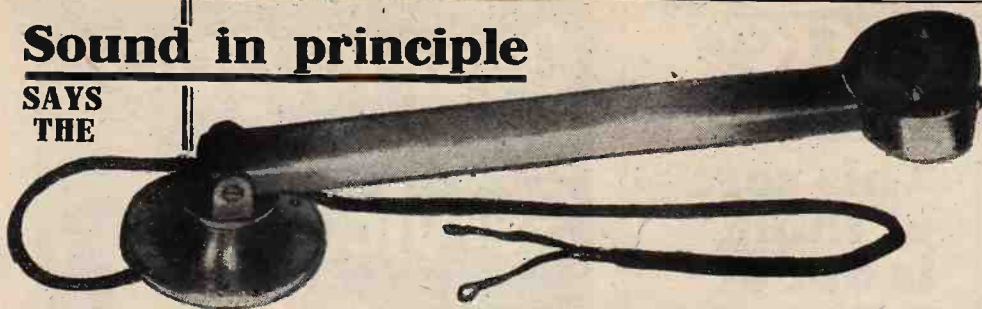

"Wireless World."

THE RADIOGRAMPHONE DEVELOPMENT CO.,
ST. PETER'S PLACE, BROAD STREET, BIRMINGHAM.

THE R.G.D. PICK-UP

is free from resonance. No tracking wear. A highly finished Pick-up in Bronze, Oxidised Silver. Specially constructed for the Coil-driven Speaker.

Price
£2:10:0

Post free.

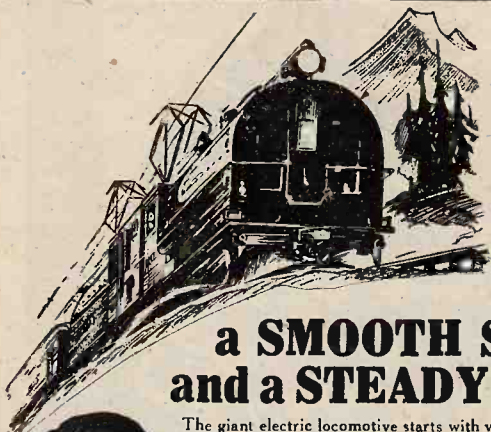

a SMOOTH Start and a STEADY Pull

The giant electric locomotive starts with velvet smoothness and pulls the heaviest loads with steady, unflinching power. It's all a matter of proper control. The increased sensitivity of your radio demands the S-m-o-o-t-h control that only Centralab can give. Noiseless, free of inherent sputtering—self-inflicted static. For smooth, quiet, velvety radio reception your radio must be CENTRALAB equipped.



Write for free booklet, "Volume Controls, Voltage Controls, their uses."

Centralab

THE ROTHERMEL CORPORATION LTD.,
24, Maddox Street, London, W.1.
Phone: MAYFAIR 0578/9.

EDDYSTONE SHORT WAVE APPARATUS

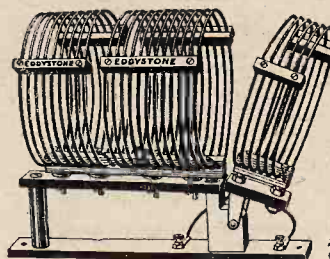

TYPE A.V. INDUCTANCE ASSEMBLY
This complete inductance unit for short wave reception consists of five interchangeable coils with mounting stand, the range from 18-90 metres being covered efficiently with a 00015 condenser. The arrangement makes use of serial, grid and reaction coils; the first named being variable to prevent blind tuning spots. Wound with well-spaced turns, entirely open core and low loss banana-type mounting pins, the short wave performance of the coils is unequalled. Full circuit details enclosed. Extra BBC coils can be supplied.

PRICE 20/- WITH STAND.
Send for complete list (W) of short wave apparatus.

Sole Manufacturers:
STRATTON & CO. LTD.,
BROMSGROVE STREET,
BIRMINGHAM.

London Service Depot:
WEBB'S RADIO ELECTRIC
STORES,
164, Charing Cross Road, W.C.2.



The Yachting World and Motor Boating Journal

The Leading British Yachting Journal

"THE YACHTING WORLD" deals with yachts and boats of all types and tonnages, whether on the sea or inland waters. Every aspect of yachting and motor boating is covered in an attractive and interesting manner.

Every Friday 6^D.

ILIFFE & SONS Ltd., Dorset House, Tudor St., London, E.C.4

REPAIRED VALVES—AS GOOD AS NEW

When Done By —

LUSTROLUX Ltd.

AND DON'T FORGET "LUSTROLUX" BRITISH-MADE NEW VALVES

The S.G.2. SCREENED GRID VALVE—2 volts only 15/-

"A" Type.

2, 4 & 6 volts H.F. L.F. R.C. POWER 5/- ea.

"Super" Type, Pipless.

2, 4 & 6 volts H.F. L.F. R.C. POWER 5/- ea. 7/- ea.

WHY WASTE MONEY ON NEW VALVES? If you have any damaged RING valves let us repair them. We guarantee that their original characteristics will be retained. They will be as good as new. Try us. You will save money.

ALL RING VALVES REPAIRED.

Price as follows:—

QUICK

L.F. H.F. R.C. - 5/3
Power Valve - - 6/3
Screened Grid - 11/3

ORIGINAL CHARACTERISTICS GUARANTEED

From your Dealer or Direct from—LUSTROLUX LTD.,
Lower House Mills, West Bollington, Nr. MACCLESFIELD.
Scottish Agent: Messrs. Bothwell Elec. Co., 54, Eglinton Street, Glasgow.

MISCELLANEOUS ADVERTISEMENTS.

NOTICES.

THE CHARGE FOR ADVERTISEMENTS in these columns is:

12 words or less, 2/- and 2d. for every additional word.

Each paragraph is charged separately and name and address must be counted.

SERIES DISCOUNTS are allowed to Trade Advertisers as follows on orders for consecutive insertions, provided a contract is placed in advance, and in the absence of fresh instructions the entire "copy" is repeated from the previous issue: 13 consecutive insertions 5%; 28 consecutive, 10%; 52 consecutive, 15%.

ADVERTISEMENTS for these columns are accepted up to **FIRST POST ON THURSDAY MORNING** (previous to date of issue) at the Head Offices of "The Wireless World," Dorset House, Tudor Street, London, E.C.4, or on **WEDNESDAY MORNING** at the Branch Offices, 19, Hertford Street, Coventry; Guildhall Buildings, Navigation Street, Birmingham; 280, Deansgate, Manchester; 101, St. Vincent Street, Glasgow, C.2.

Advertisements that arrive too late for a particular issue will automatically be inserted in the following issue unless accompanied by instructions to the contrary. All advertisements in this section must be strictly prepaid.

The proprietors retain the right to refuse or withdraw advertisements at their discretion.

Postal Orders and Cheques sent in payment for advertisements should be made payable to ILIFFE & SONS Ltd., and crossed & Co. Notes being untraceable if lost in transit should not be sent as remittances.

All letters relating to advertisements should quote the number which is printed at the end of each advertisement, and the date of the issue in which it appeared.

The proprietors are not responsible for clerical or printers' errors, although every care is taken to avoid mistakes.

NUMBERED ADDRESSES.

For the convenience of private advertisers, letters may be addressed to numbers at "The Wireless World" Office. When this is desired, the sum of 6d. to defray the cost of registration and to cover postage on replies must be added to the advertisement charge, which must include the words Box 000, c/o "The Wireless World." Only the number will appear in the advertisement. All replies should be addressed No. 000, c/o "The Wireless World," Dorset House, Tudor Street, London, E.C.4. Readers who reply to Box No. advertisements are warned against sending remittance through the post except in registered envelopes; in all such cases the use of the Deposit System is recommended, and the envelope should be clearly marked "Deposit Department."

DEPOSIT SYSTEM.

Readers who hesitate to send money to unknown persons may deal in perfect safety by availing themselves of our Deposit System. If the money be deposited with "The Wireless World," both parties are advised of its receipt.

The time allowed for decision is three days, counting from receipt of goods, after which period, if buyer decides not to retain goods, they must be returned to sender. If a sale is effected, buyer instructs us to remit amount to seller, but if not, seller instructs us to return amount to depositor. Carriage is paid by the buyer, but in the event of no sale, and subject to there being no different arrangement between buyer and seller, each pays carriage one way. The seller takes the risk of loss or damage in transit, for which we take no responsibility. For all transactions up to £10, a deposit fee of 1/- is charged; on transactions over £10 and under £50, the fee is 2/6; over £50, 5/-. All deposit matters are dealt with at Dorset House, Tudor Street, London, E.C.4, and cheques and money orders should be made payable to Iliffe & Sons Limited.

SPECIAL NOTE.—Readers who reply to advertisements and receive no answer to their enquiries are requested to regard the silence as an indication that the goods advertised have already been disposed of. Advertisers often receive so many enquiries that it is quite impossible to reply to each one by post.

"WIRELESS WORLD" INFORMATION COUPON

This Coupon must accompany any Question sent in before

MAY 7th, 1930

For Particulars of Free Service, see Rules on page 471.

B&J

ALL WIRELESS WORLD COILS, DIALS & CABINETS

Short Wave Coils, etc.

B&J. Wireless Co.

2, 3, & 4, Athelstane Mews, Stroud Green Rd., N.4.
Archway 1695.

the service of the appleby

RADIO Part Exchange—a description not being needed.

TRIPLE Instalment Purchase—a dignified method of instalment purchase without interest.

DEPOSIT Order Purchase—appreciated by those who travel or those who are overseas.

appleby's

CHAPEL STREET, MARYLEBONE, LONDON, N.W.1.

Bankers: Westminster Bank Ltd.

NOTICE

ALL lapsed part exchange credit notes will be honoured if presented for use before May 31st, 1930.

E. Hetherington Appleby, Merchant Craftsman.

BECAUSE

of their precision in design and construction, you secure with Polar a high degree of lasting service.

Write for Free Catalogue.

WINGROVE & ROGERS Ltd.
188-9, Strand, London, W.C.2.



POLAR



BELLING-LEE

THE WORLD'S GREATEST WANDER PLUG

NOW ONLY 3D

BELLING-LEE

FOR EVERY RADIO CONNECTION

Adv. of Belling & Lee, Ltd., Queensway Works, Ponders End, Middlesex.

RECEIVERS FOR SALE.

SCOTT SESSIONS and Co., Great Britain's Radio Doctors.—Read advertisement under Miscellaneous.

HIRE a McMichael Portable Set, by day or week, from Alexander Black, Wireless Doctor and Consultant, 55, Ebury St., S.W.1. Sloane 1655. [0328]

BURDETT 5-valve Ethogrand, with valves and coils, £7/10; Marconi V2, 30/-; ditto, with amplifier, 50/-; carriage extra.—James Scott and Co., Radio Engineers, Dunfermline. [0333]

5-VALVE 17-guinea Suitcase Portable, as new; £10.-6, Abbots Rd., King's Heath, Birmingham. [9195]

PHILIPS 2-valve A.C. 200 All Mains, £8; Celestion C12, mahogany, £3/10; little used, as new.—Phone, before 11 a.m., Abercorn 1566, or write 43, Southold Mansions, London, W.9, for appointment. [9207]

TONUPHONIC Portable 5-valve Set, £9; Sydney Two short-wave set, £6; or both sets £14.—Childs, 86, Leigham Court Rd., Streatham, S.W.16. [9204]

RADIO-GRAMOPHONE, mahogany cabinet; £25; would exchange for Austin Seven.—8, North Rd., S.W.19. [9181]

RECEIVERS, radio-grams, components, specialists in all "Wireless World" circuits and coils, all work under the supervision of a qualified ex-B.B.C. engineer; let us solve your difficulties free of charge.—Almayne Mfg. Co., Ltd., 17, Bartholomew Close, London, E.C. [9201]

BERLIF D.C.2 All Mains Receiver, 200 to 250 volts D.C.; price £14/10; with valves and royalties, suitable for M.C. speaker; particulars free; trade inquiries specially invited.—Simmonds Bros., Shireland Rd., Smethwick. [8734]

YOUR Old Receiver or Components Taken in Part Exchange for New; write to us before purchasing elsewhere, and obtain expert advice from wireless engineer of 25 years' professional wireless experience; send a list of components or the components themselves, and we will quote you by return post; thousands of satisfied clients.—Scientific Development Co., 57, Guildhall St., Preston. [0226]

MARCONIPHONE 5-valve Screen Grid, latest circuit, complete in cabinet, with valves and 6-volt L.T. battery; £9, or with Celestion C.12 speaker £12.—Todd, 83, Menes Rd., Wigan. [9251]

McMICHAEL Super Screened Four Portable; cost 35 guineas, price £18, as new.—Saul, 77, Headroomgate Rd., St. Ann's, Blackpool. [9252]

PHILIPS 2511 All Electric 4-valve Receiver, 240v.; cost £37/10, price £26; Philips 2013 moving coil loud speaker, cost 14 guineas, price £10; all as new.—Saul, 8, Ansell Rd., S. Ansell, Blackpool. [9253]

OSRAM Music Magnet, week old, used once, too powerful; £6/15.—Apply Langholm Garage, Calonne Rd., Parkside, Wimbledon. [9243]

PORTABLES, unique bargains, purchased surplus contract stock, well known manufacture, 1930 models; 5-valve cabinet type portable receivers, compact size, collapsible handle, Mullard or equivalent Ring valves, best British components, drum drive condenser, power H.T., charged unspillable accumulator, really exceptional performance and fully guaranteed; oak £8/7/6, walnut £8/12/6, complete; half usual price; crate, packing, and carriage 5/- extra; limited number available; remittance with order.—Powers and Son, Radio Department, 168, Aston Rd., Birmingham. [9257]

S.G. Four Set, good components, 150 volts Exide W.H., Epoch M.C. speaker; £15.—R. Cooper, 16, Cook St., Laisterdyke, Bradford. [9241]

IMPROVED Senior Model A.C. or D.C. Panatropé, complete with 2-valve radio and all components, generators, motor, etc., perfect condition; £80 or nearest offer.—Stockton, 173, Gainsborough Rd., Crews. [9235]

ORGOLA Senior 6-valve, Baker's moving coil loud speaker and mains drive, heavy output H.T. eliminator, L.T. battery and charger, wonderful reception, little used, heard evenings; best offer over £20.—Mack, 58, Thornton Avenue, Streatham Hill, London, S.W.2. Phone: Streatham 2454. [9232]

EMPIRE Five, complete with Lewcos coils, no cabinet; Elstree Six, complete, in mahogany cabinet, mains unit, 200 volts 50 ma., 3 taps, 2 variable; best offer secures any of above.—22, Park St., Shirley, Southampton. [9229]

A MATEUR Short Wave Set, detector and pentode, 8-60 metres, long wave stability, with valves, etc., ready to use; £5; view.—95, Springfield Park Rd., Chelmsford. [9228]

1930 Kolster Brandes 4-valve Portable; £14 or offer.—Box 5789, c/o The Wireless World. [9224]

SUPER 5-valve Portable by Bowyer-Lowe, oak case, with turntable, guaranteed absolutely new, will deliver for £11/15; cost 16 guineas.—Ford, Dentist, Kent House, Cranbrook. [8420]

ACCUMULATOR HIRE:

DON'T Buy Accumulators or Dry Batteries, join our C.A.V. low- and high-tension accumulator hire service, the largest and best in London; better and cheaper reception with no trouble; regular deliveries within 12 miles of Charing Cross; no deposit, payment on each delivery or by quarterly subscription; over 10,000 satisfied users; explanatory folder post free; phone or write to day.—Radio Service (London), Ltd., 105, Torrington Av., N.W.5. Phone: North 0623-4-5. [8751]

BATTERIES.

WET H.T. Replacements.—Sacs (capped or uncapped), highest grade, No. 1, 10d. per doz.; No. 2, 1/9 per doz.—See below.

ZINCS.—Best quality (wired), No. 1, 8d. per doz.; No. 2, 9d. per doz.; orders valued 5/- carriage paid, otherwise 6d. for postage.—British Battery Co., Clarendon Rd., Watford, Herts. [0253]

TEN 20v. H.T. Accumulator Units, practically new; £3 the lot (200v.), or 6/- unit.—Newman, 17, Fairville Av., Streatham. [9214]

CHARGERS AND ELIMINATORS.

CHEBROS.—Chebros for all types of transformers and chokes, high grade instruments at a very moderate price; enquiries invited.—Chester Bros., 244, Dalston Lane, London, E.8. [5290]

TANTALUM and Liumion for A.C. Rectifiers, for inexpensive chargers; blue prints for H.T. and L.T. 1/- each; Liumion electrodes, 2-3 and 5-8 amps.—Blackwell's Metallurgical Works, Ltd., Garston, Liverpool. [8298]

DYNIC A.C. H.T. Eliminator, £3; Regentone, £3; Philips L.T. charger, £2/10; Ferranti trickle chargers, £1/10; carriage extra.—James Scott and Co., Radio Engineers, Duntermine. [0335]

EDISWAN B.S. Eliminator (new) 100-volt A.C., suitable S.G.3 ordinary, also A.C. valves, cost £3, best offer; 2 new 100-volt A.C. Te-Ka-De trickle chargers, 2- or 4-volt accumulators, cost 29/6, best offer.—Box 5748, c/o *The Wireless World*. [9185]

EKCO 4-T-60 D.C. Eliminator, £2/15; also Garrard No. 12 motor, 15/-; both almost new.—Sinclair, 2, Moss Hall Crescent, Finchley, London. [9210]

PHILIPSON'S Safety High Tension Supply Units for A.C. and D.C. Mains, 200-250 volts 40-60 cycles, also 230 volts 25 cycles.

10/- Down and Small Monthly Payments Secures the Finest H.T. Supply Available.

PHILIPSON'S Safety H.T. Units are Guaranteed for 12 Months Against All Defects.

ALL Models Sold on 7 Days' Approval to Ensure Complete Satisfaction.

PHILIPSON'S Safety H.T. Units are the Cheapest to Install and the Cheapest to Run; £1/17/6 to £6.

WRITE for Our Booklet "Radio Power," which gives illustrations and full particulars.

PHILIPSON'S Safety Loud Speaker Output Filters for All Receivers, power valve, or Pentode; a remarkable output filter at a very low price; 16/6.

PHILIPSON and Co., Ltd., Radio Engineers, Astley Bridge, Bolton. Phone: 2038 Bolton. [0318]

SAVAGE'S Specialise in Wireless Power from the Mains, reliable apparatus at reasonable prices.

SAVAGE'S—Transformer laminations and Bakelite bobbins; intending home constructors should write for list.

SAVAGE'S—Reliable smoothing condensers, 1,500 volt D.C. test, 1 mid., 2/-; 2 mid., 3/-; 4 mid., 5/3; 500 volt D.C. test, 1 mid., 1/6; 2 mid., 2/3; 4 mid., 3/9.

SAVAGE'S—Super smoothing and output chokes, many types available; write for list.

SAVAGE'S—Mains transformer for Westinghouse H.T.4 unit, with additional winding, 4 volts centre tapped 23 amps, 25/-; transformers for other Westinghouse units available.

SAVAGE'S—Mains equipment for new Foreign Listeners Four, transformer N.F.L.4, 33/-; smoothing choke, C32G, 20/-; output choke C32O, 20/-.

SAVAGE'S—Mains transformer B.T.4, 500.0-500 volts, 120 m. amps., 7½ volts 3 amps., 6 volts 3 amps., 4 volts 2 amps., 4 volts 1 amp., 4 volts 1 amp., all central tapped, specially developed for automatic bias; 57/6.

SAVAGE'S—Mains transformers and power chokes are carefully and individually constructed from first class materials, with an exceptionally generous margin of safety.

SAVAGE'S, 146, Bishopsgate, London, E.C.2. Phone: Bishopsgate 6998. [9165]

AVOMETER, 1930 model, £6; Gilfay charger, 220v. D.C., 9v. 4a., as new, £2; 12in. desk fan, 230v. D.C., new, £1/15; ditto 230v., 50-cycle, £1/15; approval willingly.—Box 5793, c/o *The Wireless World*. [9221]

THE POLYTECHNIC,
309, REGENT STREET, W.1.
ELECTRICAL ENGINEERING DEPARTMENT
(Wireless and High Frequency Section).

A COURSE OF SIX LECTURES ON
THERMIONIC VALVES

by
W. H. DATE, B.Sc., A.M.I.E.E.,
on Wednesdays, commencing May 7th, 1930,
6.30—8.30 p.m.

The lectures will deal with the uses of thermionic valves in wireless, gramophone, public address and electrical work, and will be fully illustrated by demonstrations and lantern slides.

Fee for the Course, 7/6.
Particulars and syllabus from the Director of Education.

POWER CHOKES guaranteed
two months:

substantially built, for smoothing circuits in eliminators dealing with currents 100 to 300 milliamperes, inductance 30 henries, 8/6 post free.

8/6 REPAIRS

to any make of L.F. Transformer, Loudspeaker or Headphones. All repairs dispatched within 48 HOURS—TWO MONTHS' GUARANTEE with each repair. 4/- Post Free. *Terms to Trade*

TRANSFORMER REPAIR CO.

Dept. W.,
214, High Street, Colliers Wood, London, S.W.19.

THE NEW KILO-MAG 4

AFTER careful comparison with the leading 1929-30 receivers, we can state definitely that the New Kilo-Mag 4 is the outstanding set of the season.

In view of its remarkable performance we are specialising in this receiver and guarantee entire satisfaction.

Complete Receiver, wired and carefully tested, including Mullard or Marconi Valves,

£21.0.0

or Deposit of £1.16.9 and 11 payments of 36/9.

Complete Kit of Parts exactly to "Wireless World" specification, including Ritherton Steel Cabinet and Valves,

£17.10.0

or Deposit of £1.12.0 and 11 payments of 30/6.

The London Radio Supply Co.,
11 Oat Lane, Noble St., London, E.C.2.

Phone: National 1977.

BONA FIDE TRADERS' GUIDE.

Send for our comprehensive Illustrated List, QUICK SERVICE. QUICK SERVICE.

THE QUALITY HOUSE.

PERSEUS MFG. CO., LTD. (Dept. W.W.),
BRANSTONE RD., BURTON-ON-TRENT.

MOTOR CYCLE

The Motor Cyclist's Newspaper

EVERY THURSDAY — 3d.

Publishers: ILIFFE & SONS LTD., Dorset House, Tudor Street, London, E.C.4. W.W.14

Chargers and Eliminators.—Contd.

RADIELLE, model D.C.100 (200-250 D.C.), output 200-volt, 100 m.a., and 2 variable tappings; cost, £9/10, sell £3/5; brand new; sent c.o.d.—Priestley, 74, Aberdeen Rd., Highbury, London, N.5. [9254]

SURPLUS Bargains by Post.—Mains transformers, large, unused, inputs 200-250v., output 500v. 12/6; Hydra 1,000v. test fixed condensers, 2M.F., 2/6; 4M.F., large, 4/-; 5,000 ohm wirewound resistances, 1/-; all above post free on approval against cash.—Oliver, 325, Kennington Rd., London, S.E. [9236]

CABINETS.

ARTCRAFT Radio Cabinets are Britain's Best Value. [0313]

DIGBY'S Cabinets.—Table models in solid oak and mahogany; from 11/6 to 71/-.

DIGBY'S Cabinets, fitted with Radion or Resiston ebonite if required.

DIGBY'S Cabinets.—Pedestal model, with separate battery components; from 56/- to £12.

DIGBY'S Cabinets Made to Customers' Own Designs.

DIGBY'S Cabinets.—Write for new 16-page art catalogue.—F. Digby, 9, The Oval, Hackney Rd., E.2. Phone: Bishopsgate 6458. [0128]

ARTCRAFT Radio Cabinets are Britain's Best Value. [0311]

CABINETS for All Requirements.—F. W. Ramsey, 63, Shaftesbury St., London, N.1. Clerkenwell 7159. [8155]

ARTCRAFT Radio Cabinets are Britain's Best Value. [0309]

KAY'S Cabinets, the greatest range of pedestal cabinets in the kingdom; original creative designs at prices 50% lower than elsewhere; quotations for specials by return; delivery at short notice guaranteed.

RADIOGRAM Cabinets.—A variety of really practical and exclusive models from 60/-; illustrated lists free.

H. KAY, Wireless Cabinet Manufacturer, Mount Pleasant Rd., London, N.17. Phone: Walthamstow 1626. [8963]

ARTCRAFT Radio Cabinets are Britain's Best Value. [0310]

A LIMITED Number of Magnificent Radio-gramophone Cabinets, brand new, panel size 18in. x 7in., oak £6, mahogany £7; larger size, with double doors, panel 21in. x 8in., oak £11, mahogany £12/10; portable cabinets (suitcase type), 30/-; transportable (oak or mahogany), £2; cabinets with oval panel opening, suit 2- or 3-valve set, 17/6; carriage extra.—James Scott and Co., Radio Engineers, Duntermine. [0334]

ARTCRAFT Radio Cabinets: Britain's best value; lowest prices consistent with highest quality; illustrated list free from actual manufacturers.—Artcraft Co., 156, Cherry Orchard Rd., Croydon. Phone: Croydon 1981. [0040]

OLD Work Table, illustrated "The Wireless World," April 16th, suitable for housing electric gramophone; 30/-.—Alpha, 42, Olive Rd., Cricklewood. [9230]

COILS, TRANSFORMERS, ETC.

TRANSFORMERS and Chokes for Battery Eliminators.—Chester Bros., 244, Dalston Lane, London, E.8. [8652]

THREE 1930 Lewcos Dual Range Binocular Coils, 1 D.B.A. and 2 D.B.G. (for S.G. valves), with single control switching mechanism, guaranteed perfect condition; 35/-; deposit system.—Box 5775, c/o *The Wireless World*. [9219]

FERRANTI A.F.50, 18/-; A.F.6, 20/-; 1930 Binovacs coil B, 10/-; Ediswan 100 henry tapped choke, 10/-; mains transformer for H.T.4, 10/-.—27, Miles Hill Av., Leeds. [9217]

1930 Everyman Four Coils (Wearite), unused; cost 47/6, accept 30/-.—E. Jones, 34, Belle Vue, Shrewsbury. [9255]

POWER Transformer, input 240v., 50 cycles, output 400-400v., 130 m.a., etc.; 60/-; inquiries.—69, Derwent Rd., Palmers Green. Tel.: Palmers Green 3044. [9238]

IDEAL Home Receiver, slotted formers, 9/- set; 5½in. drum dials, with escutcheons, 5/6 each.—Groves Brothers, St. Mary's Place, Shrewsbury. [9226]

BERCLIF Coils, the standard of excellence for all "Wireless World" receivers; latest lists post free; trade supplied all quantities.—Simmonds Bros., Shireland Rd., Smethwick. [8735]

Mention of "The Wireless World," when writing to advertisers, will ensure prompt attention.

GRAMOPHONES, PICK-UPS, ETC.

B.T.H. Pick-up and Tone Arm, new last December, guaranteed perfect; 25/-—Box 5768, c/o *The Wireless World*. [9199]

B.T.H. Pick-up, latest type, 30/-; G.E.C. electric gramophone motor, complete, 70/-; perfect order.—Smith, 14, Gaspar Mews, Courtfield Gardens, S.W.5. [9194]

MARCONIPHONE Latest Type Pick-up and Arm; 40/-; guaranteed perfect.—P. Yeoman, 42, Price St., York. [9190]

GECOPHONE 2-valve Amplifier, ideal for pick-up or radio; £2/10.—Particulars, Angel, 28, Fossigate, York. [9189]

R.I. Varley Pick-up and Automatic Arm, both perfect; 35/-, or near offer.—Carter, 5, Wellesley Rd., Harrow. [9179]

GARRARD 10A Motor, perfect condition; 27/6.—Rider, London St., Chertsey. [9247]

PICTURE RECEIVER APPARATUS.

TELEVISION.—Scanning discs, Neon tubes, experimental models made.—John Salter, Member Television Society, Featherstone Buildings, Holborn, W.C. [9154]

TRANSMITTERS.

CHEBROS. Chebros. Chebros transformers and chokes of all descriptions, special transformers for transmitting and modulation; chokes a speciality; enquiries invited—Chester Bros., 244, Dalston Lane, London, E.8. [5240]

QUARTZ Lenses, 2/-; guaranteed oscillate without reaction.—Smith, Bryn Rodyn, Colwyn Bay. [9211]

LOUD-SPEAKERS.

BAKER'S SELHURST RADIO 36-page Booklet. "Sound Advice is Yours for the Asking"; write now for new edition; see displayed advertisement on page 14. [0231]

VIBRO-SKIN Special Leather for Fixing the Diaphragm of the Moving Coil Loud Speaker; price 2/- per piece 11in. square, 1/6 per piece 9in. square; post free; cash with order.—The Alder Leather Co., 3, Southwark St., S.E.1. Tel.: Hop 4448. [0330]

R.K. Moving Coil, £3; 2 old M.C. speakers, £1 each; new moving coil speakers, *220v. A.C., £3; carriage extra.—James Scott and Co., Radio Engineers, Dunfermline. [0336]

LINEX Speakers, fit the Perfecta chuck extension for 100% results; 1/3; post free.—Douglas Briggs, Radio Engineer, Newport, Mon. [9124]

WHITE Lambskin Leather, specially for diaphragms, 12in. square; 1/6. post free.—Harris, 89, London Rd., Kettering. [9148]

SILK Gauze, finest quality, gold finish; 1/3 sq. ft.—Douglas Briggs, Radio Engineer, Newport, Mon. [9123]

PERARDUA Moving Coil Reproducers.—These superlative instruments may be obtained for 15/- down, balance by 5 equal monthly payments; cash prices, 230-volt D.C., £3/3; 6-volt, £5.—R. Vevers, 4, York Rd., Maidenhead. [9169]

MARCONIPHONE 6v. Moving Coil Speaker, in mahogany cabinet; £5; both speaker and cabinet in perfect condition; deposit system.—Box 5774, c/o *The Wireless World*. [9218]

MOVING Coil Speaker, 6v., latest Epoch model 99, practically new; £3/12/6; approval.—Faulkner, 175, Station St., Burton-on-Trent. [9208]

WHAT Offers?—Nearly new Mullard model E, cost £3/5.—Bellamy, 9, Prince of Wales Terrace, W.8. [9206]

DON'T Buy a Moving Coil Speaker Until You Have Heard The Almayne, the finest speaker ever produced, can be driven by a straight two; £4/5; 7 days' approval against cash.—Almayne Mfg. Co., Ltd., 17, Bartholomew Close, London, E.C. [9200]

WESTERN ELECTRIC 6-guinea Speaker, unused; £2.—Head, Playden Cottage, Missenden, Bucks. [9174]

FINEST Suspension Leather, for fixing cones to moving coil or reed units, as supplied to principal makers; 2/- sq. ft., 1/6 10in. square; segments up to 12in. cone, 9d. for 4; all post free; cash with order.—Dilley, 8, Ashby Rd., Essex Rd., N.1. Chis-sold 0736. [9245]

HIGHLY Sensitive Permanent Magnet Moving Coil Speakers; no mains or batteries necessary; fitted with 35% cobalt steel magnets and high resistance moving coils; £3/10.—Duddles, 102, Cranford Lane, Heston, Middlesex. [9240]

PHILIP M.C. Speaker Unit, with transformer, as new. £5.—Murray, Ironmonger, Coldstream. [9177]

HIGHLY SENSITIVE SUPER-MICROPHONES



New, made on the latest principle, a vast improvement over all other types; will pick up whispered words from a distance of several yards, also strongly amplify and transmit speech and music over a distance through Loud-speaker or Headphones, splendid instruments for making Detectors, DEAF-AID, LOUD-SPEAKING TELEPHONE, Announcements through Loud-speaker, Amplifier for Crystal or Valve Sets, Electric Sound Detector, BABY ALARM or INVALID CALL etc. NO OTHER MICROPHONE OF EQUAL SENSITIVENESS KNOWN; each instrument finely black enamelled and fitted with a 3-ft. silk connecting cord. By return 8/6 of post

SPECIAL MICROPHONE TRANSFORMER for connecting Super-Microphone to Radio Headphones, Loud-speaker, Valve-set or Valve Amplifier 6/-

SMALL 10 OHMS EARPIECE for use with Super-Microphone as a HIGHLY EFFICIENT DEAF AID, or Detetaphone, etc.; thin 3-ft. silk connecting cord fitted. Earpieces Fine Black Enamelled 6/-

Mr. Middleburgh writes from HOVE, Sussex:

"I would like to tell you what a complete success the Super-Microphone and Transformer has proved.

"Baby's Nursery is on the fourth floor of the house, and our sitting room is on the first. I connected up with electric bell flex as you suggested, dropped the flex outside the house and led in below, both rooms fortunately being on the same side of the building. About 23 yards of flex was used for the connections, and we find that almost every sound in the Nursery is faithfully transmitted through the Loudspeaker.

"Your device should be more generally known, as it is an inestimable boon.

With best wishes,

Yours faithfully,

H. Middleburgh."

Full Directions for use of Super-Microphone for many purposes and Diagrams of connections free.

FREDK. ADOLPH, Actual Maker, Phone: 27, Fitzroy Street, London, W.1. Museum 8329.

Loud-Speakers.—Contd.

EPOCH Moving Coil Speakers are Masterpieces, designed and produced by master engineers.

EPOCH Moving Coil Speakers are the Standard by which other Speakers are Compared.

EPOCH Moving Coil Speakers are in Use in many Editorial Offices.

EPOCH Moving Coil Speakers are in Use in several Famous Laboratories.

EPOCH Moving Coil Speakers are in Use in many Broadcasting Stations.

EPOCH Moving Coil Speakers are in Use by most Prominent Musicians.

EPOCH Moving Coil Speakers Bring Unbounded Joy to Thousands upon Thousands of Homes.

EPOCH Moving Coil Speakers, the only Speakers that give clear, uncoloured reproduction.

EPOCH Moving Coil Speakers do Render Speech Perfectly and Music Correctly.

EPOCH Moving Coil Speakers Provide the Perfect Illusion of the Artist's Presence.

EPOCH Moving Coil Speakers Represent the Finest Intrinsic Value ever Offered.

EPOCH Moving Coil Speakers are Guaranteed for a year, but last for ever.

EPOCH Moving Coil Speaker bring the Grand Concert out of the most Modest Set.

EPOCH.—You can—hear a hundred Moving Coil Speakers, but Epoch is different.

EPOCH.—If you own the best set, only by Epoch can you confirm it.

EPOCH.—Away with the tin can and cracked banic reproduction, and install an Epoch.

EPOCH.—Away with the drumminess, droniness and huskiness of the average Moving Coil Speakers.

EPOCH.—The clearest, sharpest, cleanest reproduction—a marvel of accuracy and beauty.

EPOCH Moving Coil Speaker Models from £2/10 to £30.

EPOCH Moving Coil Speakers.—Models for every requirement and taste.

EPOCH Permanent Magnet Moving Coil Speakers.—Nine models from £3/15.

EPOCH Permanent Magnet Moving Coil Speakers Require no Mains or Batteries.

EPOCH Permanent Magnet Speakers are more Sensitive than most Energised Moving Coil Speakers.

EPOCH Energised Models are the Finest ever put on the market.

EPOCH Super Cinema Speaker has Created the Biggest sensation for many years.

EPOCH Super Cinema Model is many times as Sensitive as the so-called Supers.

EPOCH Super Cinema Speakers give Enormous Volume from a 1-watt Amplifier.

EPOCH Super Cinema Speakers are used on many 100-watt Amplifiers and never "rattle."

EPOCH Super Cinema Model is Standard on several Talkie Equipments.

EPOCH Super Cinema Model is already in use in over 200 Cinemas.

EPOCH Super Cinema are the only Moving Coil Speakers used in Large Theatres, unaided.

EPOCH Super Cinema Speakers provide alone the Upper as well as the Lower Register.

EPOCH.—Other Moving Coil Speakers require the help of exponential horns to provide depth.

EPOCH.—A list of many prominent cinemas using the Speakers supplied on request.

EPOCH Speakers are not Made of Tin or Aluminium Stampings, but are sound, solid, engineering jobs.

EPOCH Heartily Invite Comparison, on all counts, with any make, regardless of price or claims.

EPOCH.—Don't accept our quality claims without verification, but don't accept any other maker's either.

EPOCH.—Order one for 7 days approval, and test with a switch-over; the only real test.

EPOCH Moving Coil Speakers may be heard in our Demonstration Room Daily.

EPOCH.—Our demonstration room is in the heart of London.

EPOCH.—Its accessibility has been studied for the convenience of callers.

EPOCH.—If you cannot call, write for booklet W.S.3, and approval terms.

EPOCH RADIO MANUFACTURING Co., Ltd., Farringdon Av. (near Ludgate and Holborn Circuses), Phone: Central 1971. [8983]

2/6
THE DOMINION
VERNIER
DIAL

Only Brownie's huge production enables them to offer this really splendid dial for 2/6. The special non-backlash design makes hair-breadth tuning a matter of delightful ease, while its handsome appearance (black or beautifully grained mahogany bakelite) will add to the good looks of that new set you are building. BROWNIE WIRELESS COMPANY (G.B.) LIMITED, NELSON STREET WORKS, LONDON, N.W.1.

BROWNIE
WIRELESS

VALVES.

Amplifier Valve.—If you require power you cannot do better than one of these:—

Filament Volts 6. plate volts 400 (maximum), grid bias 84 volts (approx.), impedance 800 ohms, amplification factor 3.8, mutual conductance 4.35 m.a./volts; price £5/10; see article "The Wireless World," 24th July, 1929, then send to North London Valve Co., Ltd., 22½, Cazenove Rd., Stoke Newington, London, N.16. [9142]

Valves, P.M.24, 12/6; P.M.4D.X., 8/-; P.M.14, 8/-; Triotron X.D.4, 2/-.—27, Miles Hill Av., Leeds. [9216]

WIRE.

WIRE Up With Silver-plated Copper, the ideal conductor; per 20ft. 18 S.W.G., 1/3; 16 S.W.G., 1/9.—M. W. Pilpel, 54, Parley Av., London, N.W.2. [9192]

COMPONENTS, ETC., FOR SALE.

Belling-Lee Panel Fittings are designed to give an expert finish to any home-constructed set; catalogue post free.—Belling and Lee, Ltd., Queensway Works, Ponders End, Middlesex. [0018]

Weston Model 301, milliammeters, ammeters, and voltmeters, 21/- each; hot wire ammeters 0-1 amps., 4/-; 0-0.5 amp., 3/-; instrument repairs and alterations; send for list.—The Victoria Electrical Co., 47, High St., Battersea, S.W.11. Established 1910. [8626]

Components Lent on Hire.—Details from Alexander Black, Wireless Doctor, 55, Ebury St., S.W.1. Sloane 1655. [0329]

Ferranti Meter, 7.5-150 volts 30 milliamps, portable pattern, with switch, new last week, £2; "W. W." All-wave Three complete, accumulator, 22in. linen speaker, exchange for small bench treadle lathe (B.G.).—Southworth, Wham Lane, New Longton, Preston. [9213]

Two Pairs Matched P625s, pair L.S.6As, P.M.12, P.M.22, Garrard double spring motor, 6 mfd. 1,000v. condenser, numerous other components; offers.—Scott, 10, East Parade, Ilkley. [9178]

Permanent Magnet Moving Coil Speaker, with transformer, early B.T.H. model, 35/-; pair Colvern R2R coils, matched, 12/6, new; B.T.H. 2:1 transformer, 10/-; valves: S.G.207 12/6, P227 12/-, H.F.210 7/6, R.C.210 7/6; Lotus differential reaction (0.00013) condenser, 5/-, new; Ediswan crystal set, 5/-; Decca portable gramophone, 30/-, new; Tunewell 50 coil, 1/6; Ormond drum dial, 3/-; Burndept 3-pole 12-point switch 3/-; all above little used.—Dixon, 14, Colin Close, Hendon, N.W.9. [9188]

Five New W.Y. Units, 30/-; 2 new matched L.S.5A, 22/- the pair; table volume control, 9/-; Centralab 500,000 potentiometer, 7/-; new unused M.H.L.4, 10/-.—Temple, Knockdolian, Comrie. [9196]

Bankrupt Stock.—20 3-valve 2-stage push-pull amplifiers, containing 1 Ferranti A.F.3C transformer, ditto O.P.4C, 2 de-coupling resistances, Hydra 2 and 4 mfd. valve holders, terminals, etc., in box, 37/6, carriage paid; 5 B.T.H. Mackie rotary converters, input 6-12v., output 200v., 100 m.a., £2, carriage paid; large quantity of components at bargain prices to callers 5.30 to 7.30 evenings.—Franks, 42a, St. George's St., Cannon St. Rd., London, E.1. 'Phone: Royal 8546. [9205]

Ferranti Push-pull Transformer A.F.5C, 32/-; output 25-1, 14/-; milliammeter, 100 m.a., 20/-; 1 m.a., 25/-; voltmeters, 0-250 H.R., 30/-; 0-7, 20/-; G.E.C. Universal electric gramophone motor, £3/10.—Shelley, Meadowcroft, Trentham, Stoke-on-Trent. [9203]

Experimenter's Goods (75% new) at Quarter List Price, £14 worth of goods for £4, or exchange for Pathoscope films and accessories.—S. A. 2, Anlaby Rd., Teddington. [9215]

Mullard Eliminator, 110v., with valve, £3; set 6 Petto-Scott 6-pin split primary coils aerial and 2 H.F. trans., long and short wave, with bases and copper screens, £4.—Box 5769, c/o The Wireless World. [9198]

50 Henry Chokes, 300 m.a. D.C., Ironclad, insulated for 1,000 volts; £1 to clear, carriage extra.—Box 5770, c/o The Wireless World. [9197]

Brown Microphone Amplifier, 32/6. Wilson bar amplifier, 14/-; Amso triple gang condenser, 0.0005 each section, with individual adjustment, 22/6; 3 Lissen fieldless coils, medium wave, 7/6 each.—Box 5749, c/o The Wireless World. [9186]

Radio House, Huddersfield, issues the Reliability Wireless Guide, which will be sent post free upon request by Messrs. J. H. Taylor and Co., 15, Macaulay St., Huddersfield. [7823]

Part Exchange.—See our advertisement under Receivers for Sale.—Scientific Development Co., 57, Guildhall St., Preston. [0228]

Sensitive Microphone for Deaf Aids, detectaphones, public address work, and for the transmission of speech and music to any distance; all illustrated lists free.—Fredk. Adolph, Actual Maker, 27, Fitzroy St., London, W.1. [9239]

LET A
"SUPREMUS"
H.T. ELIMINATOR
DRIVE YOUR SET

B15 MODEL



PRICE 21/-

D.C. The B15 Model, giving 60 and 120 volts, 15 M/A. Price 21/-, as illustrated.

A.C. The Ero Model, giving 60 and 120 volts, 10 M/A. Price 65/-, complete with valve.

D.C. The C25 Model, with tapplings of 60, 120 and 150, 25 M/A. Price 32/6.

A.C. The E15, with tapplings of 60, S.G and 120, 15 M/A. Price 70/- complete

All models guaranteed 12 months. 24 models in stock.

Write for lists.

Valve or Westinghouse Rectification optional.

SUPREMUS SPECIALITIES LTD.,

118, HIGH STREET, ERDINGTON, B'HAM.

Northern Agents: THE CHORLTON METAL CO., 18, Amber Street, Manchester.
London Agent: P. H. SMEDLEY, 50, Richmond Road, Leytonstone, E.11.

How to sell a Portable!

For the sale or purchase of Portable or other Receivers use the Miscellaneous Columns of "The Wireless World." A recent advertiser writes as follows:

"I am very satisfied with the results obtained. The Portable set was sold the same day, and I had over twenty other replies, including prepaid Telegrams. I also had a large number of callers, and altogether am very pleased with the pulling powers of your valuable paper."

M. A. FROST,
54, Clerkenwell Road,
London, E.C.1.

W.W.55

Components, Etc., for Sale.—Contd.

B.T.H. Pick-up and Tone Arm, 30/-; 2 Marconi Ideal transformers, 2-1, 6-1 15/- each; Sifam milliammeter, 0-50 m.a., 15/-—59, Wellesley Rd., Chiswick, W.4. [9234]

Pentamu Output, 12/6; Lissen volume control potentiometer, 3/-; super power Pentode, P.T.625, 17/6; all as new.—Briggs, Carlton Rd., Shipley. [9231]

A.F.5C, O.P.M.1C, for sale; £2 pair, or exchange for A.P.5 and O.P.M.1 or O.P.I.—Roberts, 41, Otmore Rd., Kidderminster. [9227]

Ideal Transformer, 2.7-1, new, 10/6; Ampion BA2 cone unit, 15/-; large Hegra cone unit, 14/-; Kilo-Mag Four coils (new), 26/6.—E. Jones, 34, Belle Vue, Shrewsbury. [9256]

Western Electric Balanced Armature, Micarta diaphragm, moulded horn loud-speaker, with special output transformer, £2; Sterling tuned anode reaction units, L.W.-S.W., with panel fixture and diagram, 15/-; S625 and Colvern low loss holder, 12/6; P.M.5X, P.M.6, P.M.4D, 5/6 each; Siemens Crystacel 45 A.H.C., 7/6; all guaranteed.—Lawrie, 198, Boundedary Rd., Wood Green, N.22. [9250]

The Following Slightly Used Oddments at Clearance Prices, all guaranteed:—Loud-speakers: Marconiphone M.C. chassis for D.C. mains, 65/-; Ultra air chrome chassis, 30/-; Ampion Lion, 67/6; power model, £5; Brown disc, 50/-; vee unit and chassis, 27/6; Goodman's P.G.3 unit and chassis, 20/-; P.G.4 unit and senior chassis, 27/6.

R.C.C. Units.—R.I. Varley, 8/-; Mullard Orgola, 10/-; Dubilier, 4/6; Carborundum, 4/-; Marconiphone, 4/-.

Valves.—P.M.26, 12/-; P.M.5B, 5/-; D.E.H.610, 5/-; Mullard D.U.2 rectifying, 12/-; Philips 505 ditto, 9/-.

Coils.—Ferranti S.G. kit, 20/-; Lewcos B.A.C.5 4/-, B.A.C.20 4/-, B.A.R.20, 5/-; Dubilier Toroids, long, medium, 12/- pair; pair Lewcos Touchstone coils, 10/-; Q.S.P. coil 9/-, Q.A. ditto 7/-, Q.S.G. ditto 9/-; pair Colvern binocular S.P.H.F. transformers, 10/-; one set B.R.C. coils, aerial and 2 H.F., 40/-; set Aero short wave ditto, 20/-; Transformers: Pye pentode output, 10/-; Marconi universal output, 12/-; Ferranti A.F.5C and O.P.3C, 40/-; R.I. Pentamu, 12/- pair; R.I. Varley Bi-Duple heavy duty push-pull for Orgola senior, 30/-; Ferranti A.F.4, 10/-; R.I. Varley straight line, 12/-; Cossor, 12/-; Hypermu, 14/-; Lissen Super 13/-, 3/6 type 5/6; Ferranti E.M.I. mains transformer, 25/-; Metro-Vick H.T. L.T., 27/-, all 200-250-volt mains; Climax mains, 110-120-volt, 20/-; Eliminators: Mullard, 65/-; Metro-Vick 120v. 60 m.a. £5.

L.F. Chokes.—R.I. Varley, 20 henry, 10/-; Marconi 120 henry, 10/-; Heayberd 50 mhy. smoothing, 15/-; Igranic tapped output, 13/6; Lissen, 3/-.

Variable Condensers.—Brandes 0.0005, 8/-; Cylcon 0.0001 short wave 5/-, ditto 0.00025 6/-, ditto 0.0005 7/6, ditto dual 6/6; J.B. twin 39/6 type, 20/-; drum dial, 6/-; Igranic Lokvane 0.0005 6/-, 0.0003 5/-; also many sundries, neut. condensers, rheostats, etc., at two-fifths list prices; send requirements.—Scientific Development Co., 57, Guildhall St., Preston. [9249]

Wireless Transmitting Sets for Morse Telegraphy or Distant Control of Models, etc., lin. spark coil, condensers, spark gap, helix, etc., very compact, complete and ready to use, 12/6; high quality buzzer, good note, 3/6; heavy Morse tapping key with points, 3/6.—Below.

Electric Motors, 1/8 to 1/4 h.p., 110 and 220 volts D.C., silent running, carbon brushes, in perfect condition and working order, suitable for gramophones, television, or any small power uses, 10/-; a few with overheated windings, if rewound make good dynamos for H.T. accumulators, 6/-.—Below.

Complete Portable Telephones, magneto ringing, ready for use, 17/6; hand telephones, 4/6; 1,000 ohm H.F. chokes, 1/-; large earphones, 1/3; G.P.O. magnetic relays, high class instruments, 12/6; telegraphic relays, 6/6.—Below.

Highly Sensitive Button Microphones, mounted in case with two terminals, all new, 2/- watch type microphones, 2/6; breast plate microphones, with condenser and key switch, 7/6; microphone smoothing condensers, 6d.; microphone transformers, 2/6; lin. spark coils, fully complete, 6/-; Ford ignition coils, 3/4 in. spark, 4/-.—Below.

D.C. Electric Motors, all ball bearing and carbon brushes, 1/4 to 1/2 h.p., 110 volts, 30/-; ditto, 220 volts, 50/-; 6 and 12-volt car starter motors, 10/-; 1/4 h.p. Crompton motors, 220 volts, ring oil bearings, shunt wound, as new, 65/-; 110v. motor blower, 1/4 h.p. motor, 4in. outlets, 45/-; ditto, enclosed, 2in. outlet, 40/-.—Below.

Dynamos, shunt wound, for charging or lighting, 50 volts 4 amps., 35/-; 100v. 3a., 45/-; 110v. 3 amp. ball bearing, 55/-; 20v. 8 amp., ball bearing, 30/-.—Below.

Starters.—Please state requirements; starter regulators made good field rheostats for dynamos, to carry 2 amps., 7/6; to carry 5 amps., 10/-; to carry 8 amps., 12/6.—Below.

All above goods guaranteed; cash with order or c.o.d.: all goods 3 days' approval from date of delivery; all letters answered.—Galpin, Binfield Heath, near Henley-on-Thames. [9248]

Mention of "The Wireless World," when writing to advertisers, will ensure prompt attention.

Components, Etc., For Sale.—Contd.

FERRANTI A.F.4. 12/-; Mullard Permacore, 17/6; Pye 20 henry choke, 8/6; Mullard P.M.14, 8/-; Six-Sixty 4-volt Pentode, 15/-; Dubilier short wave choke, 2/6; Eddystone H.F. choke, 3/-; Lissen R.C. unit, 2/-; reaction condensers: Cydon 0.0002, 4/-; Keystone 0.0001, 3/-; Ormond 0.0001, 2/6; Ormond drum dials (2), 2/- each.—J. H. Ballen, 11, Hallelwell Rd., Edgbaston, Birmingham. [9246]

MISCELLANEOUS.

ALEXANDER BLACK,

THE Original Wireless Doctor, will call (London and Home Counties) and cure your set.

CONSULTATIONS by Appointment Without Obligation, sets installed, maintained, and brought up to date, gramophone pick-ups, eliminators, and Webson moving coil speakers demonstrated; purity reproduction specialists.

55, Ebury St., Victoria, S.W.1. Sloane 1655. [0277]

CALIBRATE Your Set With the C.D.E.S. Calibration Chart; 8d., post free.—C.D.E.S., 98, Cherry Orchard Rd., Croydon. [8612]

SCOTT SESSIONS and Co., Great Britain's Radio doctors, officially approved as wireless repairers by Radio Society of Great Britain and Wireless League; old sets of every type repaired, rebuilt, modernised; send set for immediate quotation.

SCOTT SESSIONS and Co.—New sets constructed with your or our components, guaranteed finest workmanship; we specialise in "The Wireless World" circuits; remember, we have satisfied customers throughout the British Isles and in three Continents; if you so desire, we will design and construct high grade apparatus to suit your special circumstances for quality, range and selectivity.—Tel.: Tudor 5326. Muswell Hill, London, N.10. [0262]

EASY Payments.—We supply, by easy payments, components, accessories, and sets, any make; 10% down, balance spread over 11 months.—Send list of requirements to London Radio Supply Co., 11, Oar Lane, London, E.C.2. [0337]

PATENT AGENTS.

PATENTS and Trade Marks, British and foreign.—Gee and Co. (H. T. P. Gee, Member R.S.G.B. and A.M.I.R.E.), 51-52, Chancery Lane, London, W.C.2. Phone: Holborn 1525. [0001]

KING'S PATENT AGENCY, Ltd., 146a, Queen Victoria St., E.C.4.—Free advice and handbook on patenting inventions and registering trade marks by registered agent with 43 years' experience. [0002]

REPAIRS.

SCOTT SESSIONS and Co., Great Britain's radio doctors; read advertisement under Miscellaneous column. [0263]

GUARANTEED Repairs by Experts.—Loud-speakers, headphones, cone units, pick-ups, any type, rewound, remagnetised, and adjusted, post free 4/-; transformers, from 4/-.—Howell, 91, Morley Hill, Enfield, Middlesex. [7882]

WANTED.

WANTED, all types of electrical and wireless apparatus; purchased for cash; large quantities only.—Tompkins, 1, South St., Greenwich, S.E.10. Tel.: 1259 Greenwich. [0331]

HYPERMU Transformer, Brown Vee unit.—Kilburn, 30, Newton St., Bensham, Gateshead. [9202]

TRANSFORMER, 220 input, about 350 output, also pick-up.—Spencer, Botolph's Corner, Sevenoaks. [9193]

ROTARY Converter, 240 volt D.C. to A.C.—46, St. Thomas St., Lymington. [9180]

PRISMATIC Compass Wanted, card must be oil immersed; quote.—Carlile, Wylam-on-Tyne. [9212]

WORK in connection with Design and Construction of Power amplifiers.—Box 5788, c/o The Wireless World. [9223]

BROWN or Similar 9-valve Amplifier, a number of Brown P.Q. or Power speakers; particulars and prices to Baker, 133, Trafalgar St., Gillingham, Kent. [9242]

EXCHANGE.

EXCHANGE.—We have at last perfected Radio Part Exchange; if you are wanting new goods write us before going elsewhere; state new requirements and what you have to offer; best offers only made.—The Northfield Radio Stores, The Leading Part Exchange Specialists, 157, Northfield Av., W.13. [9191]

WE Exchange Anything for Wireless Sets, gramophones, etc.; send for lists; exchanges.—George St. Chambers, Grimsby. [9233]

MAGNUM PICK-UP



"The Wireless World" (April 2nd) states:—"Taking the performance as a whole this Pick-up may be placed among the best half-dozen." Price 35/-

Comprehensive range of lists including "New Foreign Listener's Four," "Super Het S-W Adaptor," "Volume Controls and Dissolvers and How to Use Them" and list of leading short-wave stations. Free on request.

BURNE-JONES & Co., Ltd.,
"MAGNUM" HOUSE,
296, BOROUGH HIGH STREET, LONDON, S.E.1.
Telephone: Hop 6257 and 6258.

METAL Cabinets



Precisely to specification and sealed with Tubular Brass Gauze, for ALL "WIRELESS WORLD" SETS
Oak Base and Oak Finish 57/8 complete
Mahogany 63/-
Oak Base and Imitation Leather 63/-
Metal Container and Copper Screens, less woodwork 47 8
COILS, DRUM DIALS AND ESCUTCHEONS to "W.W." Specification.
1930 Everyman Four 47/8 per set
NEW Klomag IV 45/-
Record III 45/-
Wave Trap 10/3
5 1/2" Drum Dials with Escutcheons 5/6 each.
RIGBY & WOLFENDEN,
Sheet Metal Workers,
Milnrow Road, ROCHDALE. Phone 2013

The VOLUVERNIA
VOLUME CONTROL Resist. 0 to 1 meg. For Radio Receivers or Gramophone Amplifiers. Smooth and silent in operation. Can be used with metal panel if desired. 6/9

GAMBRELL RADIO LTD., 6, Buckingham St., Strand, London, W.C.2

Aluminium Cabinets and Screening Boxes.
All sizes to order.
Standard screening boxes 6" x 6" x 6" 5/- each, including baseboards.
YATES SUTTON LTD., Sheet Metal Workers, York Street, Leicester.

Exchange.—Contd.

EXCHANGE 1928 McEvoy Combination for mains radio-gramo or parts; cost £75.—97, Hanover St., Castleton, Rochdale. [9244]

WE will Accept Your Surplus Apparatus (making you a high allowance) in part payment for any new apparatus; your enquiry will be dealt with promptly.—Bostock and Stonnill, 1, Westbourne Terrace, S.E.23. [9237]

FINANCIAL PARTNERSHIPS.

FIRM of Radio Manufacturers Have Directorship Vacancy for Man with Business or Technical Experience; investment necessary, but ability of more importance; genuine opportunity for right type of individual.—Box 5740, c/o The Wireless World. [9175]

BUSINESSES & PROPERTY FOR SALE, TO BE LET, OR WANTED.

WEST LONDON, main road.—Wireless business, good charging connection; stock £150, 2 rectifiers, full fittings, lease at £80; price all at £500.—Write Box 5750, c/o The Wireless World. [9187]

SITUATIONS VACANT.

WIRELESS Operating Appointments Assured; short qualifying course, day, evening; fees payable after appointment for boarding students; Morse classes.—Manager, Wireless School, 21, Manor Gardens, London, N.7. Archway 3694. [9121]

MANAGER Wanted, to take charge of a suburban shop for wireless and electrical goods, knowledge of wireless absolutely essential.—Write full particulars and testimonials of character, to Box No. 15, National Publicity Co., Ltd., 43, Shoe Lane, E.C.4. [9183]

WANTED, man with thorough engineering knowledge of wireless, and capable of taking charge of 50 workers.—Write full particulars and testimonials in confidence, to Box No. 24, National Publicity Co., Ltd., 43, Shoe Lane, E.C.4. [9184]

WANTED, demonstrators for portable sets.—Box 5787, c/o The Wireless World. [9222]

SITUATIONS WANTED.

YOUNG Man Desires Progressive Appointment, sound theoretical, practical, knowledge electrical, modern radio technique, P.M.G. 1st, C.W. endorsed and study, 6 1/2 years' experience operating, servicing, keen.—Lidgate, 11, Vinage Grove, Wallasey, Cheshire. [9209]

WIRELESS Operator (Marine), new P.M.G. certificate, sound practical, theoretical knowledge electrical and radio engineering, set construction, 3 years' office experience, desires post in office, works, or shop.—Box 5790, c/o The Wireless World. [9225]

BOOKS, INSTRUCTION, ETC.

"THE Wireless Manual" (new 1930 edition), by Captain Frost, is an ideal non-technical book full of up-to-date facts about wireless development, choice of set, how to use your own set, etc.; illustrated; 5/- (post 5/4), of a bookseller, or Pitman's, Parker St., Kingsway, W.C.2. [8178]

STEP by Step Wireless; a complete course of the theory of electricity in relation to the practical design of wireless apparatus, eliminators, circuits, etc., with extracts from a designer's notebook, giving up-to-date practical application; issued weekly, send 1/- p.o. for first 4 weeks.—Clifford Pressland, A.M.I.E.E. Eng., Dept. W.W., Hampton-on-Thames. [0195]

FREE: Inventor's Guide on Patents.—T. A. A., 253 (W), Gray's Inn Rd., London, W.C.1. [6373]

BOOKS Sale.—Cyclopedia of applied electricity, Vols. 2 to 7, "Experimental Wireless," Vols. 1 and 2, "Wireless Worlds Weekly," 1922 to 1924, Keel's Direction Finding, and other electrical text books, Universal electric motor with table for gramophone; view appointment.—Bond, 11, Goldsmith Rd., Friern Barnet, N.11. [9182]

TUNING COILS
and METHODS of TUNING
By W. James. (1925)
Price 2/6 net. By post 2/10.
From ILIFFE & SONS LTD.,
Dorset House, Tudor Street, London, E.C.4,
and leading booksellers. w.w.32

INDEX TO ADVERTISEMENTS.

	PAGE		PAGE
Adolph, Fredk.	11	Gambrell Radio, Ltd.	13
Appleby, E. Hetherington	9	General Electric Co., Ltd.	6
B. & J. Wireless Co.	9	Heyberd, F. C., & Co.	4
Baird Television Development Co., Ltd.	14	Holzman, L.	4
Baker's "Selhurst" Radio	Cover iii.	Igranic Electric Co., Ltd.	5
Bayliss, William, Ltd.	9	Jackson Bros.	4
Belling & Lee, Ltd.	4	Lever, Eric J. (Trix), Ltd.	14
British Radio Manufacturing Co.	11	Lock, W. & T., Ltd.	10
British Institute of Engineering Tech.	4	London Radio Supply Co.	8
Brownie Wireless Co. (G.B.), Ltd.	11	Lustrolux, Ltd.	Cover i.
Bullphone, Ltd.	4	Lyons, Claude, Ltd.	Cover i.
Burne-Jones & Co., Ltd. (Magnum)	15	McMichael, L., Ltd.	5
Burton, C. F. & H.	Cover i.	M-L Magneto Synd., Ltd.	Cover iv.
Dubilier Condenser Co. (1925), Ltd.	7	Mullard Wireless Service Co., Ltd.	Cover iv.
Epoch Radio Mfg. Co., Ltd.	1	Perseus Manf. Co.	10
Exide	1	Philips Radio	Cover ii. & 3
Edison Swan Electric Co., Ltd.	14		
Electradix Radios	14		
Formo Co.	14		
		Pitman, Sir Isaac, & Sons, Ltd.	4
		Polytechnic, The	10
		Radiogramophone Development Co.	8
		Rigby & Woolfenden	13
		Rothermel Corporation Ltd. (Centralab)	8
		Squire, Fredk., Ltd.	2
		Stratton & Co., Ltd.	8
		Supremus Specialities, Ltd.	12
		Telegraph Condenser Co., Ltd.	3
		Telsen Electric Co., Ltd.	Cover i.
		Thomas, Bertram	7
		Transformer Repair Co.	10
		Tungram Electric Works	Cover i.
		Westinghouse Brake & Saxby Signal Co., Ltd.	2
		Weston Electrical Instrument Co., Ltd.	2
		Wingrove & Rogers, Ltd.	9
		Yates Sutton, Ltd.	13

SEND TO-DAY FOR OUR FREE 36-PAGE BOOKLET "SOUND ADVICE."



The Finest High-grade Speaker in the World

PERFECT RECEPTION FOR MUSIC LOVERS

BAKER'S 'selhurst' RADIO

Offices: 59, Selhurst Rd., 8, Norwood, S.E.25.
Works: 42, Cherry Orchard Rd., E. Croydon.

Super Power Moving Coil Speaker.



We have the Biggest Stock of Radio Apparatus, Laboratory Instruments, H.T. and L.T. Dynamos and Motors, Experimental and Laboratory Gear in this Country.

Immediate delivery from stock to any part of the World. Call and inspect or send addressed envelope for list. Tell us your wants and we will offer something suitable.

ELECTRADIX RADIOS,
218, Upper Thames Street, E.C.4.
City 0191. Electradix, Cent. London.

Put your trust and your set in **KABILOK** The Cabinet of Distinction.

Illustrated Catalogue Free on request.

W. & T. LOCK LTD.
ST. PETER'S WORKS BATH.
LONDON OFFICES: 11, Red Lion Square, W.C.1.

32% HIGHER!
A letter of interest to all advertisers!

Appleby's Radio Service Depot

THE CROFT, WILLESDEN, N.W.10.

April 14th, 1930.

"Though the facts revealed at a census taken early this year are more confirmatory than surprising, you will perhaps be interested to learn that as a result of advertising in various channels during the course of many years, given equal facilities, a response is attributable directly to advertisements appearing in 'The Wireless World,' showing a fluctuating response curve approximately **32% higher**, as an average, than that shown by other sources, deeming all sources to have been exploited suitable to their market.

Up to the moment of writing it has enabled contact to be established with a number approximately equal to half the average weekly circulation of the journal."

(Signed) E. H. J. C. HETHERINGTON APPLEBY.

Full particulars of advertising in "THE WIRELESS WORLD," together with Advertisement Tariff, will be sent on request to ILIFFE & SONS LTD., Dorset House, Tudor Street, London, E.C.4.

Mention of "The Wireless World," when writing to advertisers, will ensure prompt attention.

BAYLISS

Superior Quality Power Transformers
and Chokes for the Mains from 35/- each
—to Customers' Requirements.

BAYLISS ROTARY CONVERTER

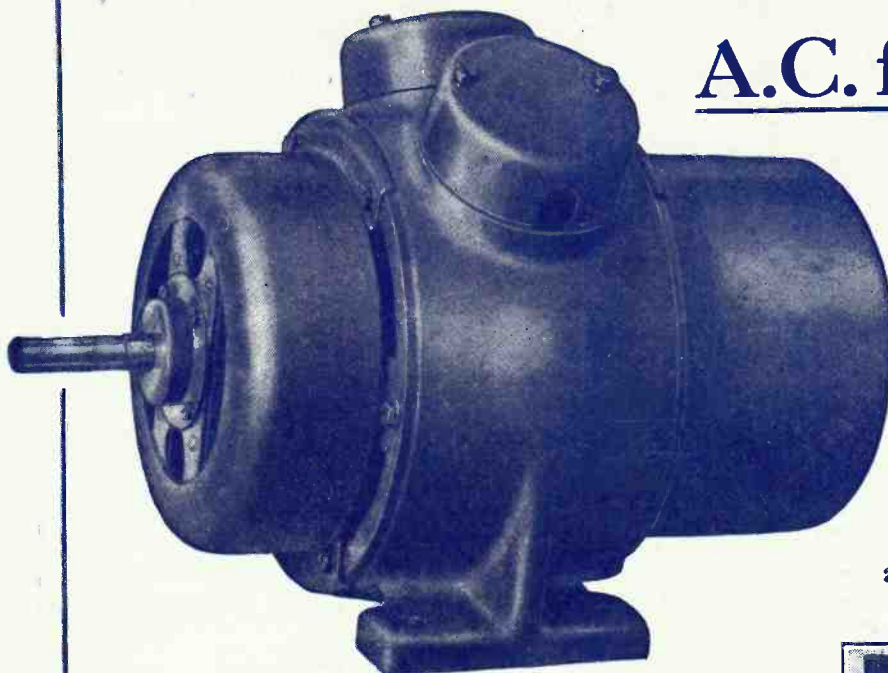

A.C. from D.C.

Load 400 Watts.

ANY Input.
ANY Output.

PRICE

£12 . 10 . 0

For Audio
Amplifiers
and General Purposes.

Also Dynamos,
Motor Generators, etc.
for all purposes.

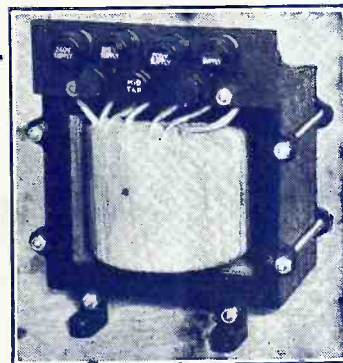

WILLIAM BAYLISS LTD.

Contractors to the Admiralty, War Office, Colonial Governments, etc.

Sheepcote Street

BIRMINGHAM

Telephone :
Mid. 1409.

Telegrams :
"Drawbench, B'ham."

PERFORMANCE PROVES THE P.M. FILAMENT.

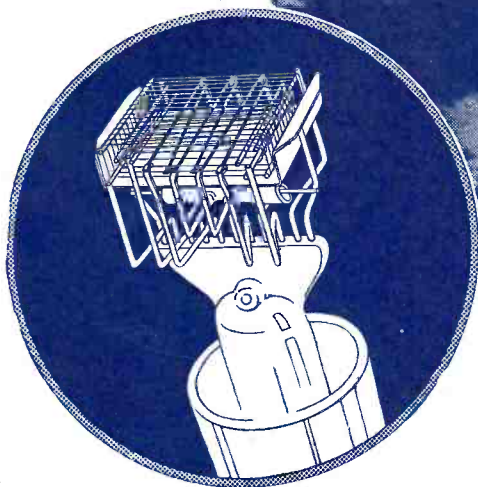

—that's how the enormous development and research on the P.M. principle can make itself known to you—through the results you obtain from your receiver with Mullard valves. Such technical improvements on the P.M. filament as

- ★ Increased Emission
- ★ Greater Efficiency
- ★ Improved Characteristics
- ★ Greater Mechanical Strength

mean incisive reception and vivid tonal purity. Act on this tangible evidence and plug a set of Mullard radio valves into your receiver to-day.

Mullard

THE · MASTER · VALVE

Advt. The Mullard Wireless Service Co., Ltd., Mullard House, Charing Cross Road, London, W.C.2.

Arts

Printed for the Publishers, ILIFFE & SONS LTD., Dorset House, Tudor Street, London, E.C.4, by The Cornwall Press Ltd., Paris Garden, Stamford Street, London, S.E.1.

Colonial and Foreign Agents:
 UNITED STATES—The International News Co., 131, Varick Street, New York. FRANCE—W. H. Smith & Son, 248, Rue Rivoli, Paris; Hachette et Cie, Rue Réaumur, Paris.
 BELGIUM—W. H. Smith & Son, 78, Marche aux Herbes, Brussels. INDIA—A. H. Wheeler & Co., Bombay, Allahabad and Calcutta. SOUTH AFRICA—Central News Agency, Ltd.
 AUSTRALIA—Gordon & Gotch, Ltd., Melbourne (Victoria), Sydney (N.S.W.), Brisbane (Queensland), Adelaide (S.A.), Perth (W.A.), and Launceston (Tasmania).
 CANADA—The American News Co., Ltd., Toronto, Winnipeg, Vancouver, Montreal, Ottawa, St. John, Halifax, Hamilton; Gordon & Gotch, Ltd., Toronto; Imperial News Co., Toronto, Montreal, Winnipeg, Vancouver, Victoria. NEW ZEALAND—Gordon & Gotch, Ltd., Wellington, Auckland, Christchurch and Dunedin.